

NOVEMBER 1953

RADIO — ELECTRONICS

LATEST IN TELEVISION • SERVICING • HIGH FIDELITY

HUGO GERNSBACK, Editor

In this issue:

How Color Television
Is Sent and Received

Field Strength Meter
for TV Installations

Bi-Phase Z-Axis Scope
Amplifier

R-C Circuit Problems

Junior Golden Ear
Amplifier

Build A Theremin



30¢

U. S. and
CANADA

Wiring Up a High-Quality Phonograph Kit

(See page 4)

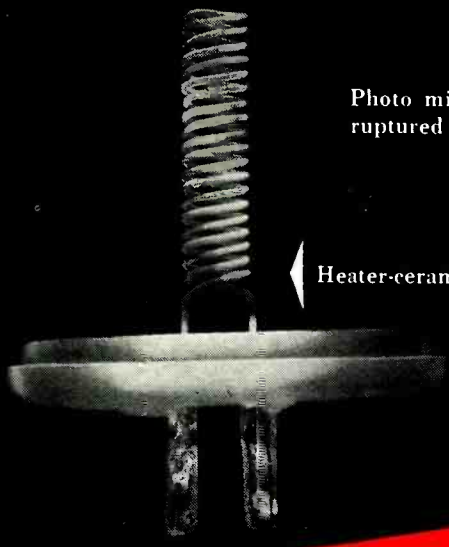
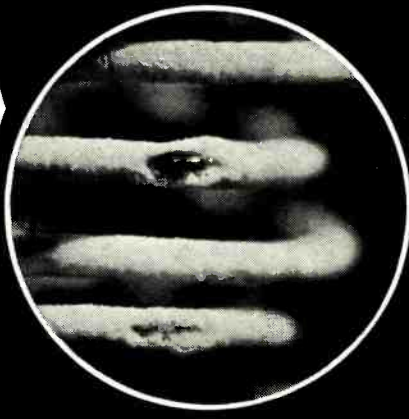

Photo micrograph of ruptured heater coating



Heater-ceramic assembly

DECIDE ON DU MONT

on the basis of...

*Product
Superiority*

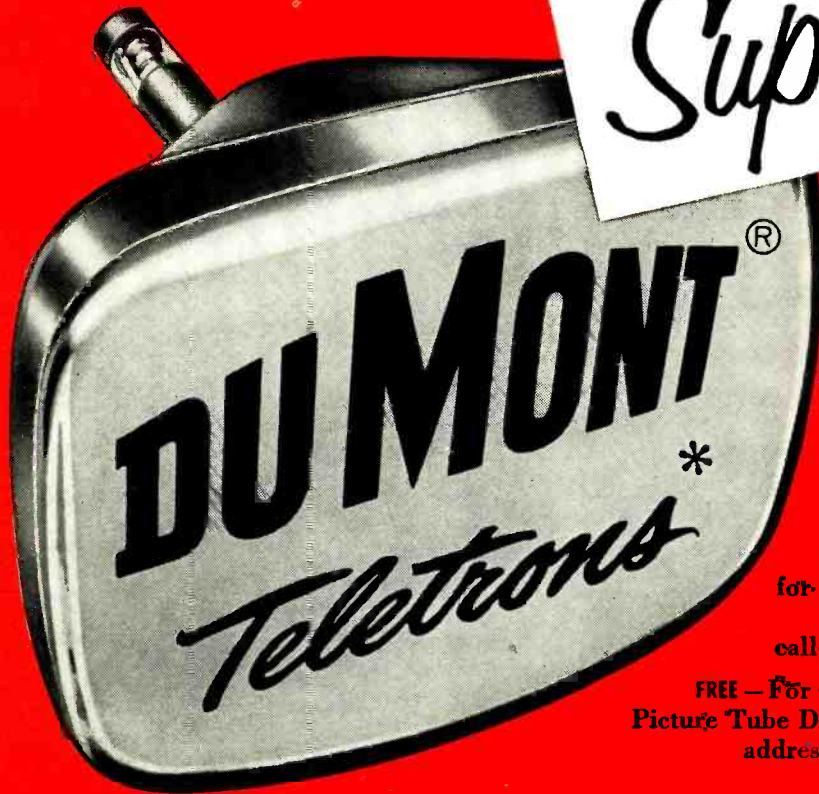

Exclusive construction of the Teletron Heater virtually eliminates heater-cathode shorts resulting from ruptured heater coating as shown above.

By accurately centering the heater helix within the cathode of the Bent-Gun, the Teletron heater-ceramic assembly avoids abrasion of the delicate heater coating against the cathode wall.

Only when you decide on Du Mont for your replacement needs, do you get this extra insurance against costly call-backs due to heater-cathode shorts.

FREE - For your copy of the 8th edition of the Picture Tube Data Chart send a postcard with your address and the name of this publication.

TRADE MARK

REPLACEMENT SALES, CATHODE-RAY TUBE DIVISION • ALLEN B. DUMONT LABORATORIES, INC., CLIFTON, N. J.

RADIO - ELECTRONICS

Formerly RADIO-CRAFT • Incorporating SHORT WAVE CRAFT • TELEVISION NEWS • RADIO & TELEVISION*

Hugo Gernsback
Editor and Publisher

M. Harvey Gernsback
Editorial Director

Fred Shunaman
Managing Editor

Robert F. Scott
W2PWG, Technical Editor

Jerome Kass
Associate Editor

I. Queen
Editorial Associate

Matthew Mandl
Television Consultant

Charles A. Phelps
Copy Editor

Angie Pascale
Production Manager

Wm. Lyon McLaughlin
Tech. Illustration Director

Sol Ehrlich
Art Director

Lee Robinson
General Manager

John J. Lamson
Sales Manager

G. Aliquo
Circulation Manager

Adom J. Smith
Director, Newsstand Sales

Robert Fallath
Promotion Manager



Member
Magazine Publishers
Association

ON THE COVER (Story on page 53)
Jerome Kass, Associate Editor of RADIO-ELECTRONICS, in an early stage of wiring up his Heathkit record player kit.
Color original by Avery Slack

CONTENTS

NOVEMBER, 1953

Editorial (Page 29)

Miniradiosby Hugo Gernsback 29

Television (Pages 30-43)

Color TV—The NTSC System.....by Marvin H. Kronenberg 30
 KCJB—TVby John W. Boler 33
 Tube Failures in TV Receiversby John B. Ledbetter 34
 Television—it's a Cinch (Seventh conversation, first half: Time Bases with High Vacuum Tubes)by E. Aisberg 36
 Measuring Field Strength for TV...by Engineering Staff, Scala Radio Co. 39
 TV Service Clinic.....Conducted by Matthew Mandl 42

Servicing—Test Instruments (Pages 44-52)

Z-Axis for your Scopeby Ronald L. Iyeg 44
 Analyzing the R-C Circuitby Cyrus Glickstein 47
 Radio Dial Mechanismby Herbert Michels 48
 Versatile Scope you can Buildby Lloyd B. Hust 49

Audio—High Fidelity (Pages 53-91)

High-Quality Record Player in Kit Form (Cover Feature) by Jerome Kass 53
 Junior Golden Ear Amplifierby Joseph Marshall 55
 High-Quality Audio (Part III, Loudspeaker Systems) ..by Richard H. Dorf 58
 British Audio Circuitsby Norman H. Crowhurst 74
 Velocity Microphoneby Gene Brizendine 78
 How to Build a Thereminby Charles L. Hansen 84
 Handy Remote Speaker from "Useless" Dynamic by H. J. M. Dunscombe 88

Broadcasting and Communications (Pages 94-102)

Simple Instrument Measures Frequency Deviation 94
 Best Wave for Urban Users.by I. Queen 98

New Design (Pages 105-108)

New Tubes (and Transistors) 105

Departments

The Radio Month	6	Technotes ...	125	People	144
Radio Business.	12	Miscellany	128	Communications	148
With the Technician ..	110	Try This One..	133	Electronic Literature ..	150
New Devices...	114	Radio-Electronic Circuits ...	136	Book Reviews..	152
New Patents...	118	Question Box..	139		



MEMBER Audit Bureau of Circulations

Vol. XXIV, No. 11

RADIO-ELECTRONICS, November 1953, Vol. XXIV, No. 11. Published monthly at Erie Ave., F to G Sts., Philadelphia 32, Pa., Gernsback Publications, Inc. Entered as Second Class matter September 27, 1948, at the Post Office at Philadelphia, Pa., under the Act of March 3, 1879.
 SUBSCRIPTION RATES: In U. S. and Canada, in U. S. possessions, Mexico, South and Central American countries, \$3.50 for one year; \$6.00 for two years; \$8.00 for three years; single copies 30¢. All other foreign countries \$4.50 a year, \$8.00 for two years; \$11.00 for three years.
 EXECUTIVE, EDITORIAL and ADVERTISING OFFICES: 25 West Broadway, New York 7, N. Y. Telephone REctor 2-8630. Gernsback Publications, Inc. Hugo Gernsback, President; M. Harvey Gernsback, Vice-President; G. Aliquo, Secretary.
 SUBSCRIPTIONS: Address correspondence to Radio-Electronics, Subscription Dept., Erie Avenue, F to G Sts., Philadelphia 32, Pa., or 25 West Broadway, New York 7, N. Y. When ordering a change please furnish an address stencil impression from a recent wrapper. Allow one month for change of address.
 BRANCH ADVERTISING OFFICES: Chicago: 7522 North Sheridan Road, Tel. Rogers Park 4-8000. Los Angeles: Ralph W. Harker and Associates, 1127 Wilshire Blvd., Tel. MADison 6-1271. San Francisco: Ralph W. Harker and Associates, 582 Market St., Tel. GARfield 1-2481. FOREIGN AGENTS: Great Britain: Atlas Publishing and Distributing Co., Ltd., London E.C.4. Australia: McGill's Agency, Melbourne. France: Brentano's, Paris 2e. Belgium: Agence et Messageries de la Presse, Brussels. Holland: Trillecton, Heemstede. Greece: International Book & News Agency, Athens. So. Africa: Central News Agency, Ltd., Johannesburg; Capetown, Durban, Natal. Universal Book Agency, Johannesburg. Middle East: Steimatzky Middle East Agency, Jerusalem. India: Broadway News Centre, Dadar, Bombay #14. Pakistan: Paradise Book Stall, Karachi 3. Copyright 1953 by Gernsback Publications, Inc. Text and illustrations must not be reproduced without permission of copyright owners. PDSTMASTER: If undeliverable send form 3578 to: RADIO-ELECTRONICS, 25 West Broadway, New York 7, N. Y. *Trademark-registered-U.S. Patent-Office.

NOW... get EVERYTHING YOU NEED
to prepare to earn REAL MONEY in

TELEVISION

...one of America's
BRIGHTEST
Opportunity Fields



Enjoy highly interesting work
... and a wonderfully promising future

America's great billion dollar Television field now offers you a chance of a lifetime to get started toward a good job or your own profitable business. With so many new TV stations coming on the air, Television is expected to grow as never before! Millions of TV sets must be produced, tested, installed and serviced. And Television is only *one branch* of this vast opportunity field of Electronics—for which D.T.I.'s amazingly effective training prepares you.

Right in your own home you may now get one of today's most interesting . . . PRACTICAL WAYS to prepare for your start in TELEVISION, including Radio and Electronics. No previous experience or advanced education are needed—because D.T.I. brings you a 3-WAY COMBINATION method that speeds your understanding and progress. You (1) Learn from well illustrated lessons, you (2) Learn by Seeing from D.T.I.'s wonderfully effective home movies and (3) you Learn by Doing from electronic parts that provide the practical experience you need.

You get and KEEP the same type of basic electronic equipment used in our modern Chicago Training Laboratory. You get home training that includes the knowledge and experience gained from training thousands of students first hand. In other words, you get LABORATORY TYPE TRAINING . . . RIGHT IN YOUR OWN HOME. But why not get the whole exciting story. Mail coupon today.

If preferred, you can get ALL of your training in D.T.I.'s CHICAGO LABORATORY . . . one of the nation's finest. Write for details.

EMPLOYMENT SERVICE

Get an honest-to-goodness EMPLOYMENT SERVICE to help you get a good job after graduating — or assistance in starting your OWN TV-RADIO SALES & SERVICE BUSINESS.

MILITARY SERVICE

If you're subject to military service, the information we have for you should prove very helpful. Mail coupon today.

EARN AS YOU LEARN

After you get part of D.T.I.'s training, with equipment at home, you may then, in your spare time, begin to earn real money servicing Radio and TV sets.

"One of America's Foremost
Television Training
Centers"

- Established 1931 -



DEFOREST'S TRAINING, INC.

AFFILIATED WITH

DEVRY Technical INSTITUTE

CHICAGO 14, ILLINOIS

300 EXPERIMENTS

Build over 300 fascinating experiments from 16 BIG SHIPMENTS of Electronic-Radio parts which you KEEP. You build and operate Television circuits, Radio receiving circuits, a wireless microphone and many other major projects—all designed to provide outstanding practical experience at home.

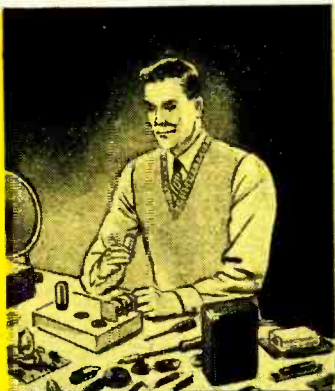

HOME MOVIES

Thanks to this exclusive D.T.I. home training aid, many important Television-Radio fundamentals quickly become "movie clear." Now you can actually see electrons on the march and other "hidden actions"—a wonderful advantage that's almost like having a teacher in your home.



BUILD YOUR OWN TEST EQUIPMENT

As part of your home laboratory project you build and keep a quality 5-INCH oscilloscope and a jewel-bearing Multimeter. You will find this equipment ideal for helping you earn in your spare time while a student—and later when working full time in the field.

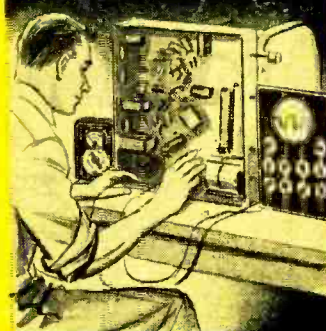

BUILD AND KEEP A BIG 21" TV SET

For added practical experience, you build and keep this top quality 21 INCH TV Set that provides TV reception at its finest (D.T.I. offers another home training but without the TV set.)



SEND FOR FACTS TODAY!

DeFOREST'S TRAINING, INC., RE-11-J
2533 N. ASHLAND AVENUE,
CHICAGO 14, ILLINOIS

I would like your Opportunity Bulletin showing "89 Ways To Earn Money In Television-Radio-Electronics"; also, complete facts about the training opportunities made possible by your organization.

Name _____ Age _____

Address _____ Apt. _____

City _____ Zone _____ State _____

TUNG-SOL TECHNICAL DATA BOOKS



T-58—Two volumes—nearly 700 pages of data on 600 types of tubes.



T-70 — More than 160 pages of data.

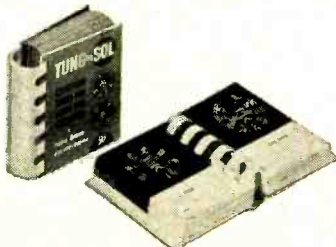

T-31—More than 300 blue-print-type base diagrams for more than 1100 tube types.

When opened, all books lie flat for easy reference.

These handy, easy-to-use books contain all the information that set designers, equipment designers and service dealers need for everyday use. They are the most practical tube reference books in the industry, with technical information and charts compiled for fast reading.

Take the trouble out of electron tube trouble-shooting. Get TUNG-SOL Electron Tube Technical Data Books. Ask your distributor's salesman, or write to Tung-Sol Electric Inc., Newark 4, N. J.

TUNG-SOL® ELECTRON TUBES

and all the technical help that goes with them.

EDWARD JULIAN NALLY, the first president of the Radio Corporation of America, passed away on September 22 at the age of 94.

Mr. Nally in association with the Marconi Wireless and Telegraph Co.



Edward Julian Nally

arranged the opening of the first trans-Atlantic wireless telegraph service and established the first commercial wireless circuit between the U.S. and Japan and between the U.S. and Great Britain.

Although he retired in 1925, Mr. Nally remained a director of RCA, RCA Communications, and the National Broadcasting Co. until 1950.

SATELLITE SYSTEMS have become a matter of Congressional Record. Representative Bush, Pennsylvania, urged establishment of unattended satellite TV stations in communities too small for regular TV broadcast stations. He stated that Sylvania Electric Products has developed such a system and will propose it for FCC approval soon.

For the past year, Sylvania has been searching for a satisfactory method of making TV available to small, isolated communities, particularly those in hilly or mountainous areas. The unattended satellite stations can be built for a cost of about \$15,000, and operated automatically with low power requirements and maintenance costs.

Satellite stations are better than booster stations, Rep. Bush stated, since they are not restricted to rebroadcasting the signals of a single mother station, and being locally controlled, are free to select programs of any station whose signal is available. The satellite stations would not create the interference booster stations cause.

Experimental satellite stations have been successfully operated in the high and low portions of the u.h.f. band—specifically on channels 22 and 82.

WOR-FM New York was surprised to learn that its quiz show, *Take a Number*, reportedly has been heard by a man in Antwerp, Belgium. The station noted that the Belgian listener even submitted a question to be used on the quiz show. He wrote that he would monitor his FM receiver every Friday night in the hope of hearing his question used.

COMPATIBLE COLOR television has made its debut on a country-wide basis. NBC has announced that the August 31 "Kukla, Fran, and Ollie" show was broadcast across the country in color and was received and seen in black and white on standard receivers.

Sylvester L. Weaver, vice-chairman of the NBC board, said the network has plans for regular commercial color telecasting to be started if the FCC approves. The color system was developed by RCA, of which NBC is a part. The RCA system is generally accepted as being synonymous with color standards filed with the FCC by the NTSC. (See Page 30).

Mr. Weaver emphasized that quantity production of color receivers cannot be achieved for many months after FCC approval. He estimated that color sets, with 14-inch picture screens, would cost between \$800 and \$1,000.

RADIO KITS constitute radio receiving sets within the meaning of the tax law, even though they are not assembled when sold. The Internal Revenue Service decision, in Revenue Ruling 167, was rendered in answer to a request as to whether the excise tax was applicable to the sale by a manufacturer of radio kits which contain all the necessary components for the assembly of a crystal radio receiving set, except antenna and ground wire, or for the assembly of a 1-tube radio receiver, except A and B batteries and antenna and ground wires.

IRS pointed out, however, that credit against tax due on the sale of such kits may be taken by the manufacturer of the kits for tax paid by the manufacturer of the tubes or other taxable components purchased and used in assembling the kits.

RADAR SPEED CHECK is proving effective. Sergeant William Hamil of the Rochester, N. Y. police said that motorists are using various odd devices, including tinfoil, steel marbles in their hub caps, and steel chains dragging behind their cars, in an effort to foul up the radar speed-clocking meters which in the last 14 months have obtained about 2,000 speeding convictions.

Sergeant Hamil said that Rochester motorists had not yet discovered anything to jam the device which registers almost instantaneously the speed of a car passing across its microwave beam and also makes a graph of the speed for permanent record.

A representative of the company manufacturing the radar speed timer said that the only way to jam the radar is to install in a car a transmitter using the same frequency (2,455 mc) as the radar apparatus, and then flip the sending switch as you pass the radar station.

Incidentally, the transmitter might cost about \$1,000 and would violate regulations of the FCC.



\$24⁹⁵
VALUE
 for only **\$5.00**
 and 30 Sylvania
 Premium Tokens . . .

You get both chest and parts tray

Between Aug. 1st and Nov. 15th

Servicemen! Here's Your Sylvania

T-N-T CHEST

(TUBE AND TOOL)

The Most Valuable Service Aid You've Ever Seen!

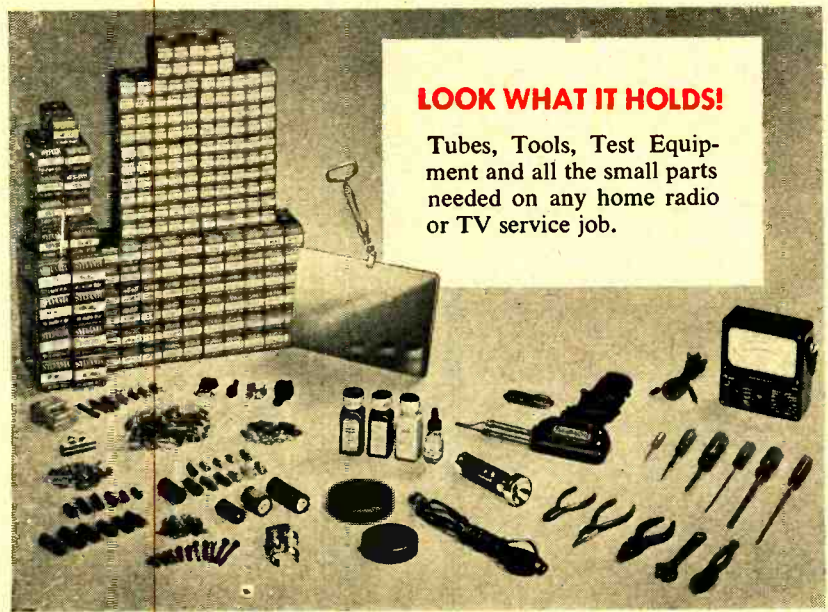

Talk about a useful servicing aid . . . this Sylvania T-N-T (Tube and Tool) Chest is really it! Carries more tubes, tools and parts than any chest on the market!

LOOK AT THESE FEATURES:

- Bass and fir plywood case
- Waterproof Du Pont Fabrikoid cover
- Holds 187 receiving tubes
- Lightweight folding aluminum tool and parts tray
- Unbreakable plastic handle
- Brass-plated hardware
- Room for mirror and ohmmeter
- It's a complete, portable service shop!

ACT NOW . . . Offer Limited!

This chest is now yours for only \$5.00 and 30 Sylvania Premium Tokens. Offer good only between August 1st and November 15th. See your Sylvania Distributor who has these kits now.

SYLVANIA

Sylvania Electric Products Inc., 1740 Broadway, New York 19, N. Y.

LIGHTING • RADIO • ELECTRONICS • TELEVISION

In Canada: Sylvania Electric (Canada) Ltd.
 University Tower Building, St. Catherine St., Montreal, P. Q.

Remember, you get 1 Sylvania Premium Token with every 25 receiving tubes or with every picture tube you buy.

FACTS YOU SHOULD KNOW ABOUT UHF CONVERTERS

Many converters on the market today are unsatisfactory in fringe and shadow areas where signal strength is low. Before you install a UHF converter in these areas you should know these facts:

- 1 Signal power loss in the preselector seriously affects picture quality. Most UHF converters use sliding-contact shorted line tuners in the preselector with a fixed power loss of 6 db. The Turner converter uses High Q coaxial cavity tuners with no sliding contacts. Signal power loss is cut to 3 db. The resulting low noise figure keeps picture quality high.
- 2 Oscillator radiation often causes disturbing interference with neighboring sets. In the Turner converter the oscillator tube socket and all associated circuits are inside the coaxial cavity, self-shielded. Removable covers provide a second shield against radiation.
- 3 High amplifier noise figure can further damage picture quality. The Turner converter uses a special broadband amplifier with Cascode circuit. It retains the preselector signal savings without appreciably increasing the noise figure. The Turner amplifier noise figure is only 4 db.

Whether you're selling converters for installations in shadow or fringe areas or putting one in your own home, remember . . . the Turner converter often means the difference between good reception and bad.

EXCLUSIVE TURNER FEATURES

- Higher sensitivity
- Extremely low noise figure
- Exceptional frequency stability
- Double shielding
- Hi-Q silver plated coaxial cavities
- No sliding contacts

OTHER MAJOR TURNER FEATURES

Continuous single-knob tuning. Illuminated slide-rule dial. Smaller size: 8"x6"x6". Use with UHF or combination antennas. Self powered, uses channels 5 or 6. Complete installation instructions for 110-120 volts 50-60 cycles AC. Schematic included.



List
price
\$49.50

In VHF fringe and shadow areas, the Turner Booster is a superior performer, too.

THE TURNER COMPANY

933 17th St., N.E., Cedar Rapids, Iowa
Export: Ad Auriema, Inc.,
89 Broad St., New York 4, N. Y.
Canada: Canadian Marconi Co.,
Toronto, Ont. & Branches

THE RADIO MONTH

JOHN JOSEPH O'NEILL, science editor of the *New York Herald Tribune*, died August 30, at the age of 64.

In 1937 he shared with four others the Pulitzer Prize in journalism for good reporting. An article written by O'Neill in 1940 was one of the first to inform the public of the successful release of atomic energy and its potentialities.

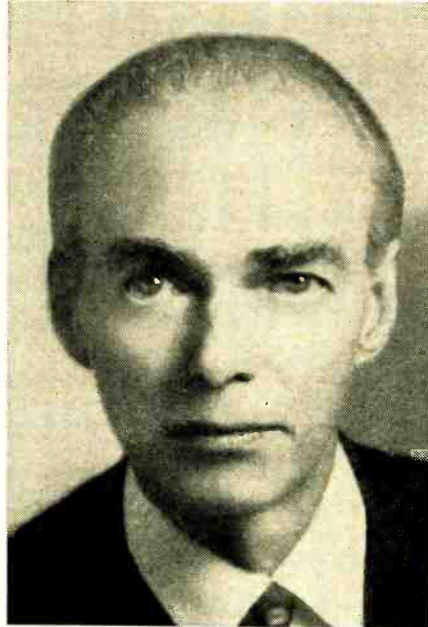

Among his books were: "Enter Atomic Energy," "Almighty Atom, The Real Story of Atomic Energy," "Prodigal Genius: The Life of Nicola Tesla," and "Engineering the New Age."

THE IRE MEDAL OF HONOR, highest technical award of the radio engineering profession, was bestowed upon Dr. William L. Everitt for the year 1954. Dr. Everitt, renowned radio authority and dean of the College of Engineering, University of Illinois, was given the award "for his distinguished career as author, educator, and scientist; for his contributions in establishing electronics and communications as a major branch of electrical engineering; for his unselfish service to his country; for his leadership in the affairs of the IRE."

In 1940, Dr. Everitt became a member of the Communications Section of the National Defense Research Committee and during World War II served as director of operational research in the Office of the Chief Signal Officer. In 1950 he served as a member of the Senate Advisory Committee on Color Television.

GERMAN TELEVISION is seriously considering a new approach to video, the aim of which is to have all the advantages of sponsored TV and none of the annoyances.

Under the German proposal, early each evening there would be thirty or sixty minutes devoted to nothing but advertisements. After all the commercials were out of the way, the evening's regular programs would continue without further interruptions until sign-off time.

Service Technicians!



NOW you can own
the invaluable
PHOTOFACT Library
this **EASY** way!

- ✓ Own the COMPLETE Library
- ✓ Fill in your present Library

Yes, now you can get through your PHOTOFACT Distributor, the complete PHOTOFACT Library (200 Sets of Folders) for only \$25.00 down and 18 full months to pay! Or you can fill in your present library and bring it up-to-date on the same amazing terms. Absolutely no interest and no carrying charge! You get immediate *prepaid* delivery of the world's finest service data. You *use it now!* It earns for you while it *pays for itself!* See your PHOTOFACT Distributor today!

Yes ONLY **\$25.00** DOWN!
UP TO 18 MONTHS TO PAY
No Interest • No Carrying Charge

PLUS the ultimate in
filing convenience. Your choice of:



BINDERS: Handsome, sturdy permanent binders that make up into handy volumes of 10 sets of Folders each. Order 20 for the 200 set Library or as many as you need to fill in. Shipped prepaid.



FILING CABINET: Sturdy 4-drawer file cabinet to hold your PHOTOFACT Library in ship-shape, easy-reference order. Shipped FOB factory.

Yes, you get either Binders or File Cabinet with your PHOTOFACT Library under the same Easy Terms — the entire deal for just \$25.00 down, up to 18 months to pay!

ORDER TODAY!

PAY AS YOU PROFIT with
The World's Finest Service Data

See your PHOTOFACT Distributor for full details. If you don't know his name, write us for it. Address: HOWARD W. SAMS & CO., INC., 2201 E. 46th St., Indianapolis 5, Ind.

END

CREI prepares you quickly for success in

The future is in your hands!

The signs are plain as to the future of the trained men in the electronics industry. It is a tremendous industry, and—at the *present time* there are more jobs than there are trained men to fill them. But—when there's a choice between a trained and untrained applicant, the trained man will get the job. Your biggest problem is to decide on—and begin the best possible training program.

**CREI Home Study . . .
The Quick Way to Get There.**



Since 1927, CREI has given thousands of ambitious young men the technical knowledge that leads to more money and security. The time-tested CREI procedure can help *you*, too—if you really want to be helped. CREI lessons are prepared by experts in easy-to-understand form. There is a course of instruction geared to the field in which you want to specialize. You study at *your* convenience, at *your* rate of speed. Your CREI instructors guide you carefully through the material, and grade your written work personally (not by machine).

Industry Recognizes CREI Training.

CREI courses are prepared, and taught with an eye to the needs and demands of industry, so your CREI diploma can open many doors for you. Countless CREI graduates now enjoy important,

good-paying positions with America's most important companies. Many famous organizations have arranged CREI group training for their radio-electronics-television personnel. To name a few: All America Cables and Radio, Inc.; Canadian Aviation Electronics, Ltd.; Canadian Broadcasting Corporation; Columbia Broadcasting System; Canadian Marconi Company; Hoffman Radio Corporation; Machlett Laboratories; Glenn L. Martin Company; Magnavox Company; Pan American Airways, Atlantic Division; Radio Corporation of America, RCA Victor Division; Technical Appliance Corporation; Trans-Canada Air Lines; United Air Lines. Their choice for training of their own personnel is a good cue for *your* choice of a school.



Almost immediately, you feel the benefits of CREI training. Your employer, when informed of your step toward advancement (only at your request), is certain to take new interest in you and in your future. What you learn in CREI Home Study can start helping you do a better job immediately.

- BROADCASTING
- TELEVISION
- MANUFACTURING
- COMMUNICATIONS
- SERVICING
- AERONAUTICAL ELECTRONICS



CREI also offers Resident Instruction

at the same high technical level—day or night, in Washington, D. C. New classes start once a month. If this instruction meets your requirements, check the coupon for Residence School catalog.

INFORMATION FOR VETERANS

If you were discharged after June 27, 1950—let the new G. I. Bill of Rights help you obtain resident instruction. Check the coupon for full information.

Get this fact-packed booklet today. It's free.

Called "Your Future in the New World of Electronics," this free illustrated booklet gives you the latest picture of the growth and future of the gigantic electronics world. It includes a complete outline of the courses CREI offers (except Television and FM Servicing) together with all the facts you need to judge and compare. Take 2 minutes to send for this booklet right now. We'll promptly send your copy. The rest—your future—is up to you.



CAPITOL RADIO ENGINEERING INSTITUTE

An Accredited Technical Institute • Founded in 1927

3224 16th Street, N.W.

Washington 10, D. C.

MAIL COUPON TODAY

CAPITOL RADIO ENGINEERING INSTITUTE
Dept. 1411, 3224 16th St., N.W., Washington 10, D.C.

Send booklet "Your Future in the New World of Electronics" and course outline.

CHECK FIELD OF GREATEST INTEREST

<input type="checkbox"/> TV, FM & Advanced AM Servicing	<input type="checkbox"/> Aeronautical Radio Engineering
<input type="checkbox"/> Practical Radio Engineering	<input type="checkbox"/> Broadcast Radio Engineering (AM, FM, TV)
<input type="checkbox"/> Practical Television Engineering	

Name.....

Street.....

City.....Zone.....State.....

Check— Residence School Veteran

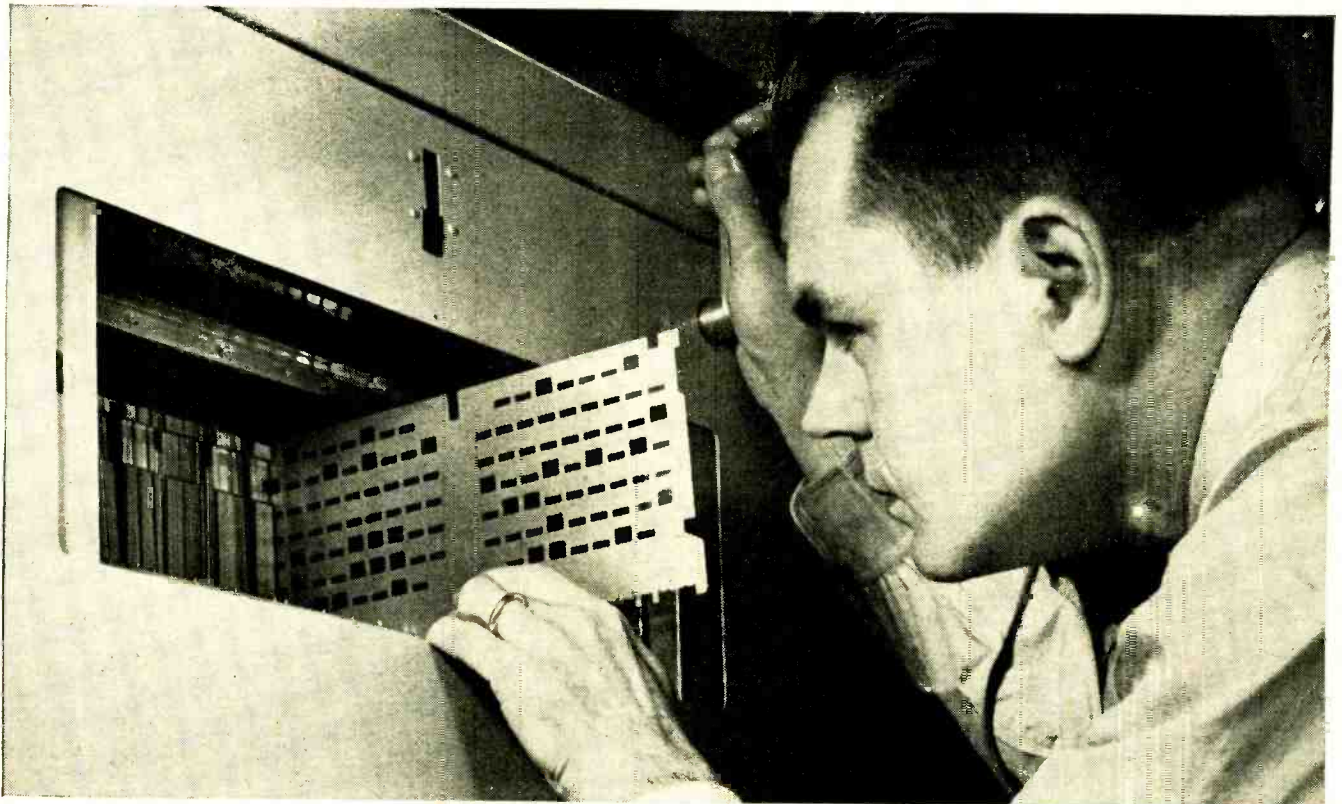

Checking perforated metal card in Bell's new "card file" which uses Phototransistors to help route Long Distance telephone calls along the best routes. If the first voice-way is in use, a "detour" is swiftly found. The equipment is known in telephony as a "card translator."

CARDS FOR CONVERSATION

To find out how to route Long Distance calls a dial system needs lots of information—fast. To provide it Bell Laboratories engineers developed a new kind of card file—one that dial systems can read.

Punched holes on metal cards tell how calls should be handled. When a call arrives the dial system "asks" the "card file" how to proceed to a particular area. Instantly the appropriate instruction card is displaced so that its pattern of holes is projected by light beams on a bank of Phototransistors. In a flash the Phototransistors signal switches to set up the best connection. Cards are quickly changed when new instructions are needed.

The "card file" will have its widest use in speeding Long Distance calls that are now dialed by a telephone operator and may one day be dialed by you personally. It is another example of how Bell Telephone Laboratories helps telephony to grow, as costs are kept down.

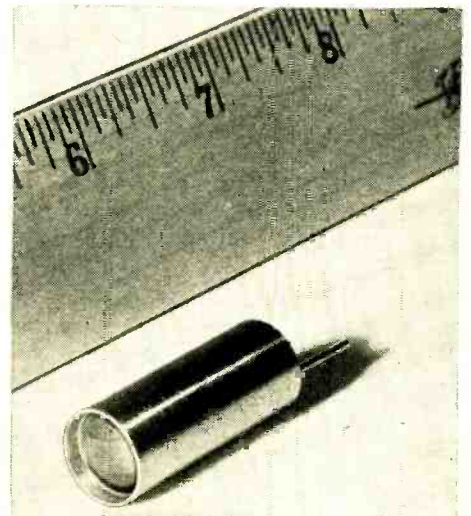

New Phototransistor unit. Light entering the cylinder is focused by the lens on a piece of germanium that responds by generating current. Like the Transistor, the Phototransistor was invented in Bell Telephone Laboratories.



BELL TELEPHONE LABORATORIES

IMPROVING TELEPHONE SERVICE FOR AMERICA PROVIDES CAREERS FOR CREATIVE MEN IN SCIENTIFIC AND TECHNICAL FIELDS

RADIO-ELECTRONICS

Six months from today Which Will You Hold?

this-

or this



Add Technical Training
To Your Practical Experience -
**GET YOUR FCC LICENSE
IN A HURRY!**

Then use our Amazingly Effective
JOB-FINDING SERVICE



TV ENGINEERING INCLUDED IN OUR TRAINING & COACHING

**Get This Valuable Booklet
FREE!**

● **TELLS HOW -**

Here Is Your GUARANTEE
If you fail to pass your Commercial License exam after completing our course, we guarantee to continue your training without additional cost and kind until you successfully obtain your Commercial license, provided you first sit for this examination within 96 days after completing your course.

We Guarantee TO TRAIN AND COACH YOU AT HOME IN SPARE TIME UNTIL YOU GET Your FCC License
If you have had any practical experience—Amateur, Army, Navy, radio repair, or experimenting.

● **TELLS HOW -**

Employers make JOB OFFERS Like These to Our Graduates Every Month

Letter from nationally-known Airlines, "We would also appreciate if you would place the following additional advertisement in your bulletin-Wanted-Superintendent of Communications . . . Salary \$666.66 per month."
Letter from nationally-known airplane manufacturer, "We need men with electronic training or experience in radar maintenance to perform operational check-out of radar and other electronics systems . . . starting salary . . . amounting to \$329.33 per month."
These are just a few samples of the job offers that come to our office periodically. Some licensed radioman filled each of these jobs . . . it might have been you!

HERE'S PROOF FCC LICENSES ARE OFTEN SECURED IN A FEW HOURS OF STUDY WITH OUR Coaching AT HOME in Spare Time.

Name and Address	License	Lessons
Lee Worthy 2210 1/2 Wilshire St., Bakersfield, California	2nd Phone	16
Clifford E. Vogt Box 1018, Dania, Florida	1st Phone	20
Francis X. Forch 38 Beucier Pl., Bergenfield, New Jersey	1st Phone	38
Sgt. Ben W. Davis 317 North Roosevelt, Lebanon, Illinois	1st Phone	38
Albert Schoell 110 West 11th St., Escondido, California	2nd Phone	23

Carl E. Smith, E.E., Consulting Engineer, President
CLEVELAND INSTITUTE OF RADIO ELECTRONICS
Desk RE-58, 4900 Euclid Bldg., Cleveland 3, Ohio

● **TELLS HOW -**

Our Amazingly Effective JOB-FINDING SERVICE Helps CIRE Students Get Better Jobs
Here are a few recent examples of Job-Finding results:

GETS CIVIL SERVICE JOB
"Thanks to your course I obtained my 2nd phone license, and am now employed by Civil Service at Great Lakes Naval Training Station as an Engineering Specialist."
Kenneth R. Lesser, Fair Oaks, Mt. Del., McHenry, Ill.

GETS STATE POLICE JOB
"I have obtained my 1st class ticket (thanks to your school) and since receiving same I have held good jobs at all times. I am now Chief Radio Operator with the Kentucky State Police."
Edwin P. Healy, 264 E. 3rd St., London, Ky.

GETS BROADCAST JOB
"I wish to thank your Job-Finding Service for the help in securing for me the position of transmitter operator here at WCAE, in Pittsburgh."
Walter Koschik, 1442 Ridge Ave., N. Braddock, Pa.

GETS AIRLINES JOB
"Due to your Job-Finding Service, I have been getting many offers from all over the country, and I have taken a job with Capital Airlines in Chicago, as a Radio Mechanic."
Harry Clare, 4537 S. Drexel Blvd., Chicago, Ill.

Your FCC Ticket is recognized in all radio fields as proof of your technical ability

OURS IS THE ONLY HOME STUDY COURSE WHICH SUPPLIES FCC-TYPE EXAMINATIONS WITH ALL LESSONS AND FINAL TESTS.



**Get All 3 Free
MAIL COUPON NOW**

CLEVELAND INSTITUTE OF RADIO ELECTRONICS
Desk RE-58—4900 Euclid Bldg., Cleveland 3, Ohio
(Address to Desk No. to avoid delay)

I want to know how I can get my FCC ticket in a minimum of time. Send me your FREE booklet, "How to Pass FCC License Examinations" (does not cover exams for Amateur License), as well as a sample FCC-type exam and the valuable booklet, "Money-Making FCC License Information." Be sure to tell me about your Television Engineering Course.

B

NAME

ADDRESS

CITY ZONE STATE

Paste on two-cent postcard or send airmail

WORLD'S LARGEST MANUFACTURER
OF CUSTOM BUILT TELEVISION

MATTISON

SILVER ROCKET 630 CHASSIS
• with TUNEABLE •

BUILT-IN BOOSTER
for Better DX Reception

Featuring NEW CASCODE TUNER
made for UHF interchangeable
tuning strips and COSINE YOKE

Tube
Complement:
28 tubes
3 rectifiers
1 CRT



32
All Channel Booster

- Broad band single knob control pre-amplifier built in to eliminate long leads which may cause regeneration and attenuation of signal.
- ONLY THE MATTISON 630 CHASSIS HAS AN ALL CHANNEL TUNEABLE BUILT-IN BOOSTER THAT INCREASES SIGNAL STRENGTH UP TO 10 TIMES. THE SILVER ROCKET WILL OUT-PERFORM ANY CHASSIS MADE AND IS PRICED RIGHT TO SELL FAST WITH AN EXTRAORDINARY MARGIN OF PROFIT FOR YOU. ALSO AVAILABLE WITHOUT BOOSTER.

Available for IMMEDIATE DELIVERY!
Silver Rocket for 27" Operation

ANNOUNCING
the New
AMBASSADOR
for 1954

The only open
face console
made in every
expensive
decorator
finish . . . on
guaranteed
genuine ma-
hogany, walnut,
oak and other
rare woods!



The AMBASSADOR 21" and 27"
Best Looking . . . Best Value, Too!
Full size console for eye level television. Available
in every expensive decorator finish. Featuring
removable safety glass. ALL CABINETS MADE
IN MATTISON'S OWN CABINET FACTORY.

DEALERS! SERVICE DEALERS! Here is your
opportunity to become the "important" TV
Dealer in your area for THE FINEST CUSTOM-
BUILT LINE OF TV RECEIVERS. FREE!!
Write for Mattison's merchandising portfolio
explaining the "UNASSEMBLED PLAN" and
"\$1,000,000 FLOOR PLAN."



When you buy from
Mattison you need
only one source of
supply! You can buy
a Mattison Chassis,
a Mattison Cabinet or
a complete Mattison
TV Set!

Manufactured with integrity
Mattison Television & Radio Corp.
10 West 181st St., Dept. RE, N.Y. 53, N.Y.



BAROMETER of the PARTS INDUSTRY

During September, 61 of the leading 400 manufacturers of Radio-Electronic-Television parts and equipment made changes in their lines. There was a decrease in "change activity" as compared to August.

In price revisions by the number of manufacturers and products affected, the following summary illustrates the comparative trend for the months of August and September.

	No. of Manufacturers			No. of Products	
	August	September		August	September
Increased prices	32	19	Increased prices	350	789
Decreased prices	16	9	Decreased prices	65	40

For a summary of the most active product categories, see the following tables:

Product Group	Increased Prices		Decreased Prices		New Products		Discontinued Products	
	No. of Mfrs.	No. of Products	No. of Mfrs.	No. of Products	No. of Mfrs.	No. of Products	No. of Mfrs.	No. of Products
Antennas & Access.	5	11**	2	6**	11	80**	4	19**
Capacitors	1	1*	0	0	1	2**	1	4*
Controls & Resistors	0	0**	0	0	1	21**	0	0**
Sound & Audio	7	70**	2	6**	16	50**	9	25**
Test Equipment	1	4**	0	0	5	44*	3	16*
Transformer	2	161*	0	0**	0	0**	1	8*
Tubes	5	542*	4	15*	7	147*	3	38**
Wire & Cable	0	0	1	13*	0	0**	1	1**

* Increase over August
** Decrease from August

Comment: For the first time in several months, a marked decrease in the number of manufacturers reporting changes in their line is noted. Activity among Sound & Audio manufacturers has declined since last month, while activity among Tube manufacturers has increased for the same period.

This data is prepared by the staff of United Catalog Publishers, Inc., 110 Lafayette Street, New York, publishers of RADIO'S MASTER, The Official Buying Guide of the Parts Industry.

Merchandising and Promotion

Alliance Manufacturing Co., Alliance, Ohio, is under way with what it calls the biggest fall advertising-merchandising program in the history of any television accessory. According to John Bentia, Alliance vice-president, the campaign features the introduction of two new Alliance Tenna-Rotors.

I.D.E.A., Inc., Indianapolis, designed a colorful counter display rack for use

Cannon Electric Co., Los Angeles, is featuring a new combination package display for its XL-type straight plug socket contacts.



by distributors of its Regency boosters. The brilliantly striped display asks the question, "How many Regency boosters do you need today?"

Westinghouse Electric Electronic Tube Division, Elmira, N. Y., launched a new sales promotion campaign designed to acquaint the public with the potential of u.h.f.

General Electric Tube Department is pushing a TV picture tube promotion package for service technicians, to tie in with G-E's national advertising for tubes. Window streamers, a display mirror, direct-mail pieces, and newspaper mats are being used.

Vaco Products Co., Chicago, is offering its personalized X-4 screwdriver set in an effective gift package. Manufacturers, distributors, or others may imprint their names on the handle of the screwdriver and on the plastic case and use the kit as a Christmas gift or premium.

Electronic Instrument Co., Inc., Brooklyn, N. Y., designed a new decal which radio and TV service technicians may attach to windows or vehicles.

Stromberg-Carlson, Rochester, N. Y., is running a series of institutional ads in leading business publications. Each ad will feature one product of the

Quick TV Success can be yours if you act now!

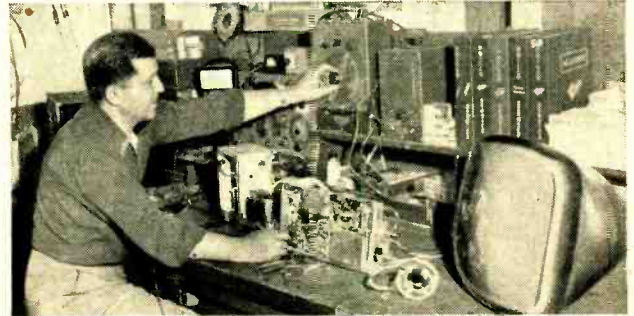
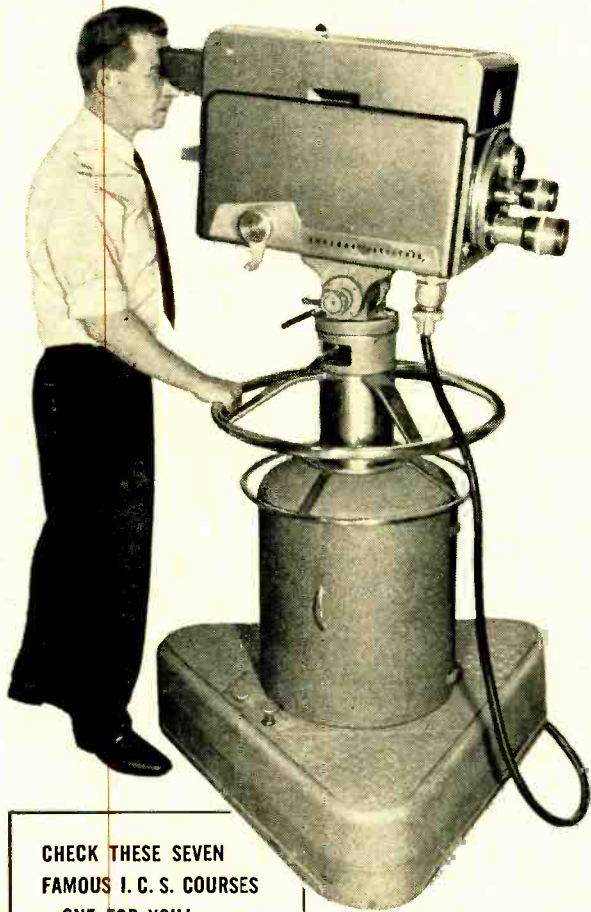

- Prepare now for the new Radio-TV-Electronics boom. Get in on VHF and UHF . . . aviation and mobile radio . . . color TV . . . binaural sound! The International Correspondence Schools can help you!

If you've ever thought about Radio or Television as a career . . . if you have the interest, but not the training . . . if you're waiting for a good time to start . . . NOW'S THE TIME!

No matter what your previous background, I.C.S. can help you. If Radio-TV servicing is your hobby, I.C.S. can make it your own profitable business. If you're interested in the new developments in Electronics, I.C.S. can give you the basic courses of training you need. If you have the job but want faster progress, I.C.S. can qualify you for promotions and pay raises.

I.C.S. training is *success-proved* training. Hundreds of I.C.S. graduates hold top jobs with top firms like R.C.A., G.E., DUMONT, I.T.&T. Hundreds of others have high ratings in military and civil service. Still others have successful businesses of their own.

With I.C.S., you get the rock-bottom basics and theory as well as the all-important bench practice and experimentation. You learn in your spare time—no interference with business or social life. You set your own pace—progress as rapidly as you wish.

Free career guidance: Send today for the two free success books, the 36-page "How to Succeed" and the informative catalog on the course you check below. No obligation. Just mark and mail the coupon. With so much at stake, you owe it to yourself to act—and act fast!

**CHECK THESE SEVEN
FAMOUS I. C. S. COURSES
—ONE FOR YOU!**

- PRACTICAL RADIO-TELEVISION ENGINEERING**—Foundation course for radio-television career. Basic principles plus advanced training. Radio. Sound. TV.
- TELEVISION TECHNICIAN**—To qualify you for high-level technical positions in television. Camera, studio, transmitter techniques. Manufacture, sale and installation of TV equipment.
- TELEVISION RECEIVER SERVICING**—Installation, servicing, conversion. Dealership. For the man who knows about radio and wants TV training.
- RADIO & TELEVISION SERVICING**—Designed to start you repairing, installing and servicing radio and television receivers soon after starting the course.
- RADIO & TELEVISION SERVICING WITH TRAINING EQUIPMENT**—Same as above but with addition of high-grade radio servicing equipment and tools.
- RADIO OPERATING COURSE**—Special course to help you pass the Government examination for operator's licenses. Code. TV. FM. Radio regulations.
- INDUSTRIAL ELECTRONICS**—Broad, solid background course devoted to the electron tube and to its many applications.

INTERNATIONAL CORRESPONDENCE SCHOOLS



BOX 2881-J, SCRANTON 9, PENNA.

Without cost or obligation, send me "HOW TO SUCCEED" and the booklet about the course BEFORE which I have marked X:

- | | | | | |
|---|---|---|--|---|
| <p>ART</p> <ul style="list-style-type: none"> <input type="checkbox"/> Commercial Art <input type="checkbox"/> Magazine and Book Illustrating <input type="checkbox"/> Cartooning <input type="checkbox"/> Show Card and Sign Lettering <input type="checkbox"/> Fashion Illustrating <input type="checkbox"/> AUTOMOTIVE <input type="checkbox"/> Automobile Mechanic <input type="checkbox"/> Auto-Elec. Technician <input type="checkbox"/> Auto Body Rebuilding and Refinishing <input type="checkbox"/> Diesel—Gas Engines <input type="checkbox"/> AVIATION <input type="checkbox"/> Aeronautical Engineering Jr. <input type="checkbox"/> Aircraft Engine Mechanic <input type="checkbox"/> Airplane Drafting <input type="checkbox"/> BUILDING <input type="checkbox"/> Architecture <input type="checkbox"/> Arch. Drafting <input type="checkbox"/> Building Contractor <input type="checkbox"/> Estimating <input type="checkbox"/> Carpenter and Mill Work <input type="checkbox"/> Carpenter Foreman <input type="checkbox"/> Reading Blueprints <input type="checkbox"/> House Planning <input type="checkbox"/> Plumbing | <p><input type="checkbox"/> Heating</p> <ul style="list-style-type: none"> <input type="checkbox"/> Steam Fitting <input type="checkbox"/> Air Conditioning <input type="checkbox"/> Electrician <input type="checkbox"/> BUSINESS <input type="checkbox"/> Business Administration <input type="checkbox"/> Certified Public Accountant <input type="checkbox"/> Accounting <input type="checkbox"/> Bookkeeping <input type="checkbox"/> Stenography and Typing <input type="checkbox"/> Secretarial <input type="checkbox"/> Federal Tax <input type="checkbox"/> Business Correspondence <input type="checkbox"/> Personnel and Labor Relations <input type="checkbox"/> Advertising <input type="checkbox"/> Retail Business Management <input type="checkbox"/> Managing Small Business <input type="checkbox"/> Sales Management <input type="checkbox"/> Salesmanship <input type="checkbox"/> Traffic Management <input type="checkbox"/> CHEMISTRY <input type="checkbox"/> Chemical Engineering <input type="checkbox"/> Chemistry <input type="checkbox"/> Analytical Chemistry <input type="checkbox"/> Petroleum—Nat'l Gas <input type="checkbox"/> Pulp and Paper Making <input type="checkbox"/> Plastics | <p><input type="checkbox"/> CIVIL, STRUCTURAL ENGINEERING</p> <ul style="list-style-type: none"> <input type="checkbox"/> Civil Engineering <input type="checkbox"/> Structural Engineering <input type="checkbox"/> Surveying and Mapping <input type="checkbox"/> Structural Drafting <input type="checkbox"/> Highway Engineering <input type="checkbox"/> Reading Blueprints <input type="checkbox"/> Concrete Construction <input type="checkbox"/> Sanitary Engineering <input type="checkbox"/> Foremanship <input type="checkbox"/> DRAFTING <input type="checkbox"/> Aircraft Drafting <input type="checkbox"/> Architectural Drafting <input type="checkbox"/> Electrical Drafting <input type="checkbox"/> Mechanical Drafting <input type="checkbox"/> Structural Drafting <input type="checkbox"/> Sheet Metal Drafting <input type="checkbox"/> Mine Surveying and Drafting <input type="checkbox"/> ELECTRICAL <input type="checkbox"/> Electrical Engineering <input type="checkbox"/> Electrician <input type="checkbox"/> Electrical Maintenance <input type="checkbox"/> Electrical Drafting <input type="checkbox"/> Electric Power and Light <input type="checkbox"/> Lineman <input type="checkbox"/> HIGH SCHOOL <input type="checkbox"/> High School Subjects | <p><input type="checkbox"/> College Preparatory</p> <ul style="list-style-type: none"> <input type="checkbox"/> Mathematics <input type="checkbox"/> Commercial <input type="checkbox"/> Good English <input type="checkbox"/> MECHANICAL AND SHOP <input type="checkbox"/> Mechanical Engineering <input type="checkbox"/> Industrial Engineering <input type="checkbox"/> Industrial Supervision <input type="checkbox"/> Foremanship <input type="checkbox"/> Mechanical Drafting <input type="checkbox"/> Machine Design-Drafting <input type="checkbox"/> Machine Shop Practice <input type="checkbox"/> Tool Design <input type="checkbox"/> Industrial Instrumentation <input type="checkbox"/> Machine Shop Inspection <input type="checkbox"/> Reading Blueprints <input type="checkbox"/> Toolmaking <input type="checkbox"/> Gas—Electric Welding <input type="checkbox"/> Heat Treatment—Metallurgy <input type="checkbox"/> Sheet Metal Work <input type="checkbox"/> Sheet Metal Pattern Drafting <input type="checkbox"/> Refrigration <input type="checkbox"/> POWER <input type="checkbox"/> Combustion Engineering <input type="checkbox"/> Diesel—Elect. <input type="checkbox"/> Electric Light and Power | <ul style="list-style-type: none"> <input type="checkbox"/> Stationary Steam Engineering <input type="checkbox"/> Stationary Fireman <input type="checkbox"/> RADIO, TELEVISION, COMMUNICATIONS <input type="checkbox"/> General Radio <input type="checkbox"/> Radio Operation <input type="checkbox"/> Radio Servicing—FM <input type="checkbox"/> Television <input type="checkbox"/> Electronics <input type="checkbox"/> Telephone Work <input type="checkbox"/> RAILROAD <input type="checkbox"/> Locomotive Engineer <input type="checkbox"/> Diesel Locomotive <input type="checkbox"/> Air Brakes <input type="checkbox"/> Car Inspector <input type="checkbox"/> TEXTILE <input type="checkbox"/> Textile Engineering <input type="checkbox"/> Cotton Manufacture <input type="checkbox"/> Rayon Manufacture <input type="checkbox"/> Woolen Manufacture <input type="checkbox"/> Loom Fixing <input type="checkbox"/> Finishing and Dyeing <input type="checkbox"/> Textile Designing |
|---|---|---|--|---|

Name _____ Age _____ Home Address _____
 City _____ Zone _____ State _____ Working Hours _____ A.M. to _____ P.M.
 Occupation _____

Special tuition rates to members of the U. S. Armed Forces. Canadian residents send coupon to International Correspondence Schools Canadian, Ltd., Montreal, Canada.

**YEAR OF THE SIX
MILLIONTH STUDENT**



SPEEDS SERVICE—MAKES MONEY—PLEASES CUSTOMERS

How'd you like to know what's wrong with a customer's TV receiver *before you make your service call*? You do with the new RAYTHEON TV SERVICE SAVER plan.

Here's how this wonderful new Raytheon servicing method works:

Both you and your customer have booklets in which are photographs showing 40 different picture conditions that may occur on the screen of a defective TV receiver. From 90 to 95% of all the troubles that may develop in a TV receiver are covered by these pictures. Illustrations are numbered and when a set falters, the

customer simply finds the picture in the booklet that matches the condition on the screen and then calls you and tells you what number it is, and which of 5 sound conditions exist.

Your booklet and a wall chart which you can place near your phone show the same set of numbered picture patterns, and in addition the booklet explains exactly what tubes, components or circuits may be causing the trouble and suggests what and where to test.

This pre-call knowledge of what ails a receiver helps you to greater profit in three ways: (1) You can go on a job with complete technical information about the required repair; (2) You can go on the job with all necessary parts and tubes; (3) You can clean up nuisance calls and avoid many needless call-backs by telephone. Then, too, it means satisfied customers — customers who see you go right to the root of the trouble and make repairs quickly and expertly.

Be sure to ask your Raytheon Tube Distributor how you can get in on this exclusive servicing asset — the RAYTHEON TV SERVICE SAVER plan. Act now, and be the first in your locality.



RAYTHEON MANUFACTURING COMPANY

Receiving Tube Division

Newton, Mass., Chicago, Ill., Atlanta, Ga., Los Angeles, Calif.

RAYTHEON MAKES ALL THESE:

RECEIVING AND PICTURE TUBES • RELIABLE SUBMINIATURE AND MINIATURE TUBES • GERMANIUM DIODES AND TRANSISTORS • NUCLEONIC TUBES • MICROWAVE TUBES



Excellence in Electronics

Pre-sold to Millions!



Custom Music Ensemble



G-E DUAL COAXIAL SPEAKER
Model A1-400

New approach to coaxial speaker design—high sensitivity at low cost. Exceptional balance between speakers with G-E Acoustic Balancer. Newly developed Pressure Equalizer... a wavefront shaping plug... provides smooth tweeter response.



G-E POWER AMPLIFIER
Model A1-300

A medium power, compact amplifier designed to provide needed speaker power. Essential element in the new General Electric "Custom Music" Ensemble. Delivers high-fidelity performance at very low cost.



G-E PREAMPLIFIER-CONTROL UNIT
Model A1-200

Combines functions of equalized pre-amplifier plus adjustable record compensation, program input selection, tone controls and volume control. Matching unit for the "Custom Music" amplifier. Self-powered for use with any installation.



G-E DELUXE TONE ARMS
A1-500 (12") A1-501 (16")

For home or broadcast station use. Compatible with the exceptional quality of G-E cartridges. Calibrated stylus pressure adjustment... 4 to 14 grams. They were developed to improve record reproduction in every installation.

G-E SPEAKER ENCLOSURE
Model A1-406 (6 cu. ft.)

Attractive corner or wall cabinet in hand-rubbed blond or mahogany veneers. "Distributed port" design provides full low frequency response. Tonal range with G-E Coaxial Speaker—40 to 15,000 cycles.



**FOR SUPERIOR PERFORMANCE...
LOW COST...MINIMUM SERVICE...
INSTALLATION ECONOMY!**

● Through the pages of nine top consumer magazines...in display rooms...on FM broadcasts...and at shows millions are discovering—indicating a preference for—the unique features of a G-E Custom Music Ensemble. Here is the single package of *matched high-fidelity equipment* you need to expand your audio business, assure satisfied customers. Get in tune today with the growing popularity of custom audio installations...add to your net profit...with complete General Electric equipment!

Individual components or the complete ensemble now available! Call a local G-E distributor or write for information.

SEND FOR COMPLETE INFORMATION

General Electric Company, Section 45113
Electronics Park, Syracuse, N. Y.

Please send me specifications and other data on the new G-E Custom Music Ensemble.

NAME.....

ADDRESS.....

CITY..... STATE.....

You can put your confidence in—

GENERAL  ELECTRIC

No dust-catchers



in Merit's line

but complete coverage
where it counts!

Keep inventory at a minimum, profits high with Merit's designed - for - action line. Among the new, quick-turnover items recently added: flybacks  for Motorola replacement, a new series of yokes and TV power transformers. Find Merit's complete line listed in John Rider's Tek-File and Howard Sam's Counter Facts and Photo Facts—Tape Marked* to help you.

And! Be sure to get Merit's new, *really* complete Replacement Guide.  Forty pages of replacement data and schematics, including IF-RF coils, an exclusive Merit feature.

*originated by Merit

M E R I T
Coil & Transformer Corp.
4425 North Clark Street,
Chicago 40, Illinois

company's several divisions, explaining how this product contributes to the advancement of communications.

Simpson Electric Co., Chicago, devised a new king-size "doodle pad." Printed in two colors, the pads measure



17 x 22 inches. They are being distributed to Simpson customers by the company's representatives.

Production and Sales

RETMA reported that 269,622,417 receiving tubes and 5,831,271 cathode-ray tubes were sold by manufacturers during the first seven months of 1953. The association also reported the manufacture of 4,150,525 TV sets and 7,941,001 radio sets for the same period. TV output for this period set a new record and radio production was nearly 2,000,000 above the first seven months of 1952.

Business Briefs

... The RCA Tube Department, Harrison, N. J., has made two components for use with 90-degree, 27-inch TV picture tubes available to TV service technicians for replacement purposes. They are a deflection yoke (219D1) and a horizontal output and high-voltage transformer 235T1.

... General Electric, Syracuse, N. Y., has begun production on new all-welded metal hermetically sealed junction transistors. The new transistors have essentially infinite life expectancy and power ratings up to three times those of any previously announced transistors. Pilot production is now under way at the General Electric plant at Electronics Park. Engineers there are also engaged in the development of a small transistorized portable radio.

... United Motors Service Division of General Motors, Detroit, is now marketing its u.h.f. and v.h.f. antennas through electronics parts distributors. The line consists of a dual-V antenna, bow tie, bow tie with reflector, conical, two-bay conical, four-bay conical, u.h.f. corner reflector, u.h.f. rhombic and indoor antenna.

... The Board of Directors of the Radio Parts & Electronic Equipment Shows, Inc., voted to allocate \$15,000 to match a similar amount already provided by NEDA to sponsor a comprehensive educational program for electronic parts distributors through a series of seminars in centrally located cities throughout the country.

... Raytheon Manufacturing Co., Waltham, Mass., won the 1953 engineering award of the Society of Hearing Aid Audiologists for its achievement in transistor design and production.

... Scott Radio Laboratories' president John S. Meck asked the Federal Trade Commission to provide a standard for high-fidelity performance and to take steps to protect the public from pseudo products. He urged that the term "high-fidelity" be used only for bona fide high-fidelity equipment.

... RETMA executive vice-president James D. Secrest, in a talk before the Radio and TV Service Clinic and Electronics Fair in Fort Worth, Texas, said that both TV sets and servicing were much better today than they were a few years ago.

... Pioneer Electronics Corp., Santa Monica, Calif., conducted a survey which indicated that the Western market would have upward of 4,000,000 TV sets and a picture-tube replacement business of about 1,000,000 annually within a few years. The company is preparing for production of 1,000 picture tubes per day.

... Ampex Corp. was selected as the new name of Ampex Electric Corp., Redwood City, Calif.

... Radio City Products, New York City, introduced a plan whereby its distributors would be able to finance carrying a sufficiently large stock of its test equipment.

... Sylvania Electric Products, announced the production of its 5,000,000th TV picture tube by its two tube plants in Seneca Falls, N. Y. and Ottawa, Ohio.

... Erie Resistor Corp., Erie, Pa., developed a new method for producing copper-foil printed circuits. It involves embossing copper foil in laminated bakelite sheets.

... Radio Apparatus Corp. states that its *Monitoradio* two-way communications equipment is being used in the 44-vehicle General Motors "Parade of Progress" caravan touring the nation.

... Transvision, Inc., New Rochelle, N. Y., is now building coin-operated TV sets for hotel use.

New Plants and Expansions

Audio-Master Corp. moved to larger quarters at 17 E. 45th St., New York City.

Berlant Associates, Los Angeles, Calif., manufacturer of tape recorders, completed an extensive expansion and renovation program which more than doubles existing floor space.

Bradford Components, Inc., a new electronic component manufacturing firm, was formed with headquarters in Bradford, Pa. The new company is headed by F. G. Schermerhorn, formerly with Aerovox and Speer Resistor Corp. The company will specialize in wire-wound resistors, precision coils, and subassemblies of all types.

General Electric expects to increase production of its aluminum TV tubes by 50% with a multi-million-dollar retooling project now under way at its Buffalo and Syracuse plants.

Simpson Electric Co., Chicago, has doubled its production facilities within the past year, following the expansion of its Lac du Flambeau, Wis., plant and the opening of a new plant adjacent to the Chicago plant. END



WANT MORE PAY? MORE SECURITY? A JOB WITH FUTURE UNLIMITED?

VETERANS! CIVILIANS! NO EXPERIENCE NECESSARY!

Go Into TELEVISION

I'll train you at home... in your spare time

for better-pay jobs in TV

L. C. Lane, B.S., M.A.
President: Radio-Television Training Association
Executive Director: Pierce School of Radio & Television

LEARN MORE

I give you ALL the practical training you need to qualify for the highest-paid technician jobs in TV.

RADIO-FM-TV TECHNICIAN TRAINING

No experience necessary! You learn by practicing with equipment I send you. It's easy! I give you the same successful guidance that has helped hundreds of men towards a TV career. Many started with only grammar school training.

FM-TV TECHNICIAN TRAINING

Saves you months if you have previous Armed Forces or civilian radio experience! Train at home. I give you kits, plus equipment to build BIG SCREEN TV RECEIVER, and FREE FCC COACHING COURSE! Everything AT NO EXTRA COST!

OPTIONAL: TWO WEEKS TRAINING IN NEW YORK CITY AT NO EXTRA COST!

You get two weeks, 50 hours, of intensive Laboratory work on modern electronic equipment at our associated school in New York City—Pierce School of Radio and Television. And I give you all this AT NO EXTRA COST whatsoever, after you finish your home study training in the Radio-FM-TV Technician course and FM-TV Technician Course.

FREE FCC COACHING COURSE!

Important for BETTER PAY JOBS requiring FCC License. You get this training AT HOME and AT NO EXTRA COST! Top TV jobs go to FCC licensed technicians.

NEW! PRACTICAL TV CAMERAMAN & STUDIO COURSE!

(For men with previous radio and TV training)

I train you at home for an exciting high pay job as the man behind the TV camera. Work with TV stars in TV studios or "on location" at remote pick-ups! A special one-week course of practical work on TV studio equipment at Pierce School of Radio & TV, our associate resident school in New York City, is offered upon your graduation.

VETERANS!

MY SCHOOLS FULLY APPROVED TO TRAIN VETERANS UNDER NEW G.I. BILL! If discharged after June 27, 1950—CHECK COUPON! Also approved for RESIDENT TRAINING in New York City at Pierce School of Radio and Television... qualifies you for full subsistence allowance up to \$160 per month. Write for details.

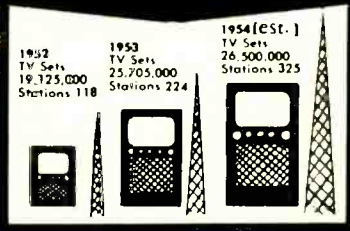

PROOF!

TV NEEDS THOUSANDS OF TECHNICIANS!

TV is coming into practically every community. More than 2,000 new TV stations authorized in this country alone! Thousands of new studios being planned and built. All kinds of new equipment coming on the market. Millions of new TV-set owners will need servicing. It's the rich field of the future with money-making opportunities NOW... if you get in on the ground floor. There just won't be enough TV Technicians to go around. It's your chance of a lifetime for GOOD EARNINGS in a TOP JOB or YOUR OWN BUSINESS!

Yours to build and keep!

GET MORE



Enough equipment to start your own home Laboratory! You learn by doing. I give you ALL the equipment. You build and keep a professional GIANT SCREEN TV RECEIVER complete with mammoth picture tube (takes any size up to 21 inch)...

...also a Super-Her Radio Receiver, RF Signal Generator, Combination Voltmeter-Ammeter-Ohmmeter, C-W Telephone Transmitter, Public Address System, AC-DC Power Supply, and more! 15 full Kits! All tubes supplied, too!



YOU GET ALL 4 FREE!

Just by mailing coupon. Try the Sample Lesson. Read how and where you can make big money in TV... easily!



MAIL THIS COUPON NOW! No Salesman Will Call!

Mr. Leonard C. Lane, President
RADIO-TELEVISION TRAINING ASSOCIATION
52 East 19th Street, New York 3, N. Y. Dept. R-11A

Dear Mr. Lane: Mail me your NEW FREE BOOK, FREE SAMPLE LESSON, and FREE aids that will show me how I can make BIG MONEY IN TELEVISION. I understand I am under no obligation and no salesman will call.

(PLEASE PRINT PLAINLY)

NAME _____ AGE _____
ADDRESS _____
CITY _____ ZONE _____ STATE _____

- I AM INTERESTED IN:
- Radio-FM-TV Technician Course
 - FM-TV Technician Course
 - TV Cameraman & Studio Course
- VETERANS!**
Check here for Training under NEW G.I. Bill

RADIO-TELEVISION TRAINING ASSOCIATION

52 EAST 19th STREET, NEW YORK 3, N. Y.

Licensed by the State of New York • Approved by the VA

2 NEW SERVICE AIDS . . .

**DESIGNED
BY AND FOR YOU!**

New CBS-HYTRON Tube-and-Tool Caddy ▶

Another Tube Caddy? Yes, but *you* service-dealers helped us design this one. Helped us throw out a dozen almost-right designs. Stayed with us until the CBS-Hytron Tube-and-Tool Caddy became *your* Caddy. Built the way *you* want it.

Your new Caddy has literally dozens of features . . . many unique. Here are only a few: *Roomy* . . . holds 218 tubes! Also all your necessary tools, small parts, volt-ohmmeter, flashlight, and reference data. *Compact* . . . functional design wastes not one inch of space. *Accessible* . . . everything in sight and reach. *Rugged* . . . strong, tip-proof — used safely as seat. *Test Mirror* . . . reversible for protection — mounted in cover supported by adjustable friction hinge.

Sorry, there's just not enough space to tell all. But *see* your new Caddy yourself at your CBS-Hytron distributor's. He has a red-hot deal for you. He'll show you how *amazingly easy* it is for you to own this unique CBS-Hytron Tube-and-Tool Caddy. See him today.

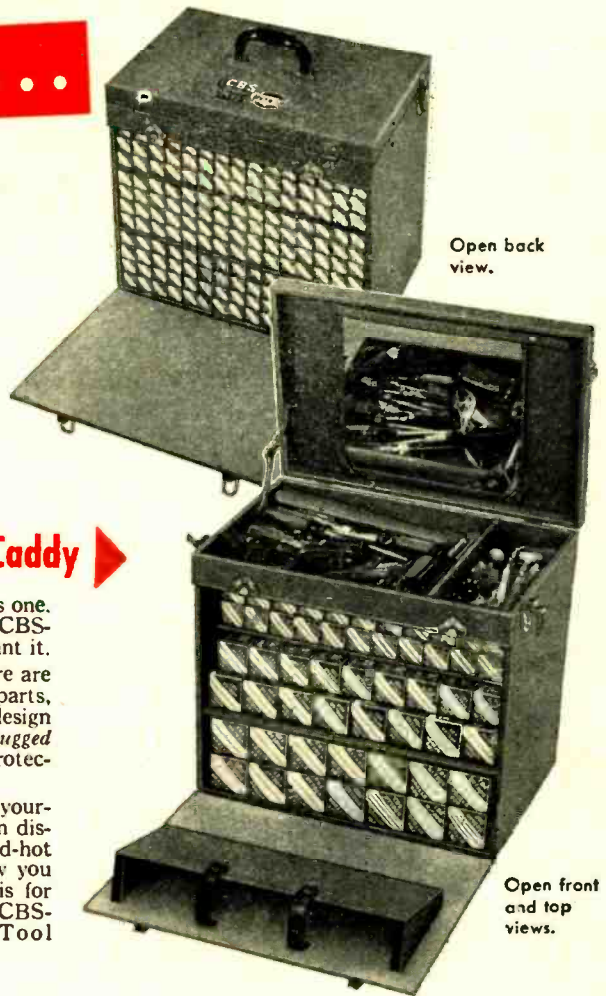

Open back view.

Open front and top views.



◀ New CBS-HYTRON Twin Pin Straightener

Ever wished you had a combination 7-Pin and 9-Pin Straightener? One that was handy, compact, light? But also a precision job, just like CBS-Hytron's original 7-Pin and 9-Pin Straighteners?

Here it is: The new CBS-Hytron Twin Pin Straightener, SH79. Same life-time, wear-and-corrosion-resistant steel dies. Same individually drilled, precision pin-circle holes. Same absence of guide-posts, permitting that final touch of sidewise straightening. The "Twin" is also roll-proof.

And the Twin is only 98¢ net. Get at least two . . . for pocket, tool kit, bench. Call your CBS-Hytron distributor today. Yes, he still has the famous individual CBS-Hytron 7-Pin and 9-Pin Straighteners at only 65¢ each net. Get them, too.



CUTTING YOUR CALL-BACKS WITH CBS-HYTRON CTS-RATED* 5AW4 and 6CU6?

They're the most-talked-about tubes in TV today. CBS-Hytron CTS-Rated 5AW4 and 6CU6 are both rated for dependable Continuous Television Service. Heavy-duty work horses, they replace the 5U4G and 6BQ6GT respectively.

Brand new designs, not just improved tubes, the 5AW4 and 6CU6 have big safety factors. Give you long . . . long trouble-free life. Loaf in those hard-working, heavily

loaded rectifier and horizontal amplifier sockets . . . even in 21-inch jobs.

Start slashing your call-backs with these tubes right now. 5AW4 and 6CU6 are available only from your CBS-Hytron distributor. See him today. Ask for complete 5AW4 and 6CU6 data. Or write direct. Above all, don't let another day slip by without trying these wonderful, new CBS-Hytron CTS-Rated tubes.

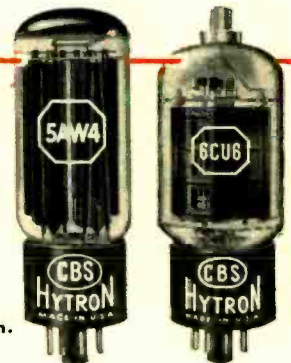

*Rated for Continuous Television Service



P.S. Yes, more CBS-Hytron CTS-Rated tubes are coming. Watch for them.

CBS-HYTRON Main Office: Danvers, Massachusetts

A Division of Columbia Broadcasting System, Inc.

A MEMBER OF THE CBS FAMILY: CBS Radio • CBS Television • Columbia Records, Inc. CBS Laboratories • CBS-Columbia, Inc. • and CBS-Hytron

**RECEIVING . . . TRANSMITTING . . . SPECIAL-PURPOSE AND TV PICTURE TUBES • GERMANIUM DIODES AND TRANSISTORS
RADIO-ELECTRONICS**



J. E. SMITH
President
National Radio
Institute
Washington, D. C.
40 years of success
training men at
home in spare time.

I Will Train You at Home For Good Pay Jobs, Success in RADIO-TELEVISION



Practice Broadcasting with Equipment I Send

As part of my Communications Course I send you kits of parts to build the low-power Broadcasting Transmitter shown at the left. You use it to get practical experience putting a station "on the air," performing procedures demanded of Broadcasting Station Operators. An FCC Commercial Operator's License can be your ticket to a better job and a bright future; my Communications Course gives you the training you need to get your license. Mail card below and see in my book other valuable equipment you build.

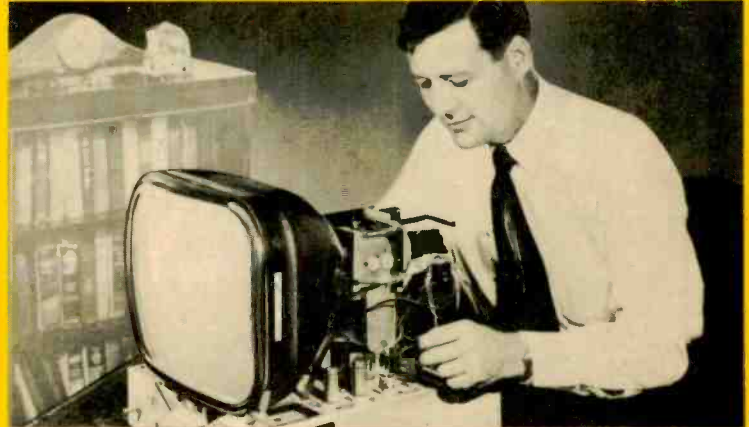

Practice Servicing with Equipment I Send

Nothing takes the place of PRACTICAL EXPERIENCE. That's why NRI training is based on LEARNING BY DOING. You use parts I furnish to build many circuits common to Radio and Television. With my Servicing Course you build a modern Radio (shown at right). You build a Multitester which you use to help fix sets while training. Many students make \$10, \$15 a week extra fixing sets in spare time starting a few months after enrolling. All equipment is yours to keep. Card below will bring book showing other equipment you build.

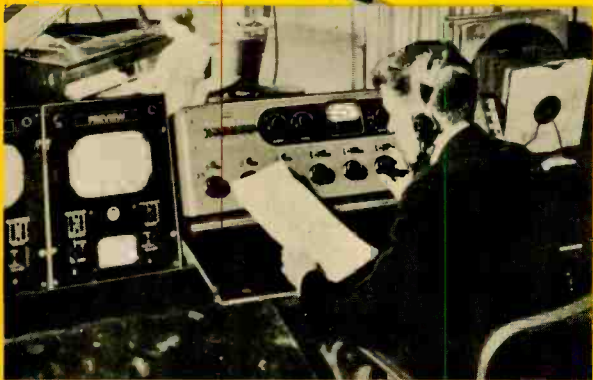
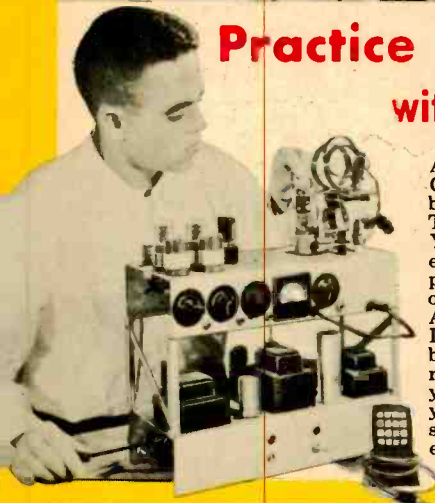

Television is Growing Fast Making New Jobs, Prosperity

More than 25 million homes now have Television sets and thousands more are being sold every week. Well trained men are needed to make, install, service TV sets. About 200 television stations on the air with hundreds more being built. Think of the good job opportunities here for qualified technicians, operators, etc. If you're looking for opportunity get started now learning Radio-Television at home in spare time. Cut out and mail postage free card. J. E. Smith, President, National Radio Institute, Washington, D. C. OUR 40TH YEAR.

AVAILABLE TO
VETERANS
UNDER G.I. BILL

Good Jobs, Good Pay, Success
in Radio-TV! SEE OTHER SIDE

CUT OUT AND MAIL THIS CARD NOW

Sample Lesson & 64-Page Book
Both FREE

This card entitles you to Actual Lesson on Servicing, shows how you learn Radio-Television at home. You'll also receive my 64-Page Book, "How to Be a Success in Radio-Television." Mail card now!

NO STAMP NEEDED! WE PAY POSTAGE

Mr. J. E. SMITH, President,
National Radio Institute, Washington 9, D. C.

Mail me Lesson and Book, "How to Be a Success in Radio-Television." (No Salesman will call. Please write plainly.)

NAME AGE.....

ADDRESS

CITY ZONE..... STATE.....

VETS write in date of discharge

B C D E F G

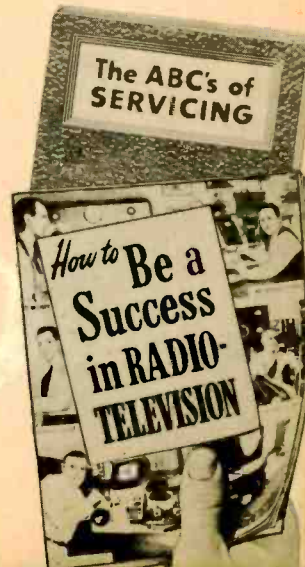

Train at Home to Jump Your Pay as a RADIO-TV Technician



**J. E. Smith, President
National Radio Institute**

The men whose messages are published below were not born successful. Not so long ago they were doing exactly as you are now... reading my ad! They decided they should KNOW MORE... so they could EARN MORE... so they acted! Mail card below now.

Get a Better Job—Be Ready for a Brighter Future in America's Fast Growing Industry

Training PLUS opportunity is the PERFECT COMBINATION for job security, good pay, advancement. When times are good, the trained man makes the BETTER PAY, GETS PROMOTED. When jobs are scarce, the trained man enjoys GREATER SECURITY. NRI training can help assure you and your family more of the better things of life.

Radio-Television is today's opportunity field. Even without Television, Radio is bigger than ever before. Over 3,000 Radio Broadcasting Stations on the air; more than 115 million home and Automobile Radios are in use. Then add Television. Television Broadcast Stations extend from coast to coast now with over 25 million Television sets already in use. There are channels for 1,800 more Television Stations. Use of

Aviation and Police Radio, Micro-Wave Relay, Two-way Radio communication for buses, taxis, trucks, etc. is expanding. New uses for Radio-Television principles coming in Industry, Government, Communications and Homes.

My Training is Up-to-Date You Learn by Practicing

Get the benefit of my 40 years experience training men. My well-illustrated lessons give you the basic principles you must have to assure continued success. Skillfully developed kits of parts I furnish "bring to life" the principles you learn from my lessons. Read more about equipment you get on other side of this page.

Naturally, my training includes Television. I have, over the years, added more and more Television information to my courses. The equipment I furnish students gives experience on circuits common to BOTH Radio and Television.

Find Out About the Tested Way to Better Pay

Read at the right how just a few of my students made out who acted to get the better things of life. Read how NRI students earn \$10, \$15 a week extra fixing Radios in spare time starting soon after enrolling. Read how my graduates start their own businesses. Then take the next step—mail card below.

You take absolutely no risk. I even pay postage. I want to put an Actual Lesson in your hands to prove NRI home training is practical, thorough. I want you to see my 64-page book, "How to Be a Success in Radio-Television" because it tells you about my 40 years of training men and important facts about present and future Radio-Television job opportunities. You can take NRI training for as little as \$5 a month. Many graduates make more than the total cost of my training in two weeks. Mailing postage free card can be an important step in making your future successful. J. E. Smith, President, National Radio Institute, Washington 9, D. C. OUR 40TH YEAR.

I TRAINED THESE MEN



Handicapped but Successful

"I am now Chief Engineer at WHAW. My left hand is off at the wrist. A man can do what he wants to." R. J. Bailey, Weston, W. Va.



\$10 a Week in Spare Time

"Before finishing, I earned as much as \$10 a week in Radio servicing in my spare time. I recommend NRI." S. J. Petruff, Miami, Fla.



Control Operator, Station WEAN

"I received my license and worked on ships. Now with WEAN as control operator, NRI course is complete." R. Arnold, Rumford, R. I.



Has Own Radio-Television Shop

"Doing Radio and Television servicing full time. Have my own shop. I owe my success to NRI." Curtis Stath, Fort Madison, Iowa.



Has Growing Business

"Am becoming expert Teletriple as well as Radiotriple. Without your course this would be impossible." P. Brogan, Louisville, Ky.



Got First Job Thru NRI

"My first job was with KDLR. Now Chief Eng. of Radio Equipment for Police and Fire Dept." T. Norton, Hamilton, Ohio.

NRI Training Leads to Jobs Like These

BROADCASTING
Chief Technician
Chief Operator
Power Monitor
Recording Operator
Remote Control Operator

GOVERNMENT RADIO
Operator in Army,
Navy, Marine Corps,
Coast Guard
Forestry Service
Dispatcher
Airways Radio Operator

SERVICING
Home and Auto Radios
P. A. Systems
Television Receivers
Electronic Controls
FM Radios

AVIATION RADIO
Plane Radio Operator
Transmitter Technician
Receiver Technician
Airport Transmitter Operator

IN RADIO PLANTS
Design Assistant
Transmitter Design Technician
Service Manager
Tester
Serviceman
Research Assistant

TELEVISION
Pick-up Operator
Voice Transmitter Operator
Television Technician
Remote Control Operator
Service and Maintenance Technician

SHIP AND HARBOR RADIO
Chief Operator
Assistant Operator
Radiotelephone Operator

POLICE RADIO
Transmitter Operator
Receiver Serviceman

FIRST CLASS
Permit No. 20-R
(Sec. 34.9, P.L. & R.)
Washington, D.C.

BUSINESS REPLY CARD

No Postage Stamp Necessary If Mailed In The United States

POSTAGE WILL BE PAID BY
NATIONAL RADIO INSTITUTE

16th and U Sts., N.W.

Washington 9, D. C.



Find Out What RADIO-TV Offers You



**SAMPLE LESSON
and 64-PAGE BOOK
Both FREE**

**Cut out and mail
postage-free card today!**

Start Soon to Make \$10, \$15 a Week Extra Fixing Sets

Keep your job while training. Many NRI students make \$10, \$15 and more a week extra fixing neighbors' Radios in spare time starting a few months after enrolling. I start sending you special booklets that show you how to fix sets the day you enroll. The multimeter you build with parts I furnish helps discover and correct troubles.



Do You Want Your Own Business?

Many NRI trained men start their own successful Radio-Television sales and service business with capital earned fixing Radios in spare time. My book tells how you can be your own boss. Joe Travers, a graduate of mine, in Asbury Park, N. J., writes: "I've come a long way in Radio and Television since graduating. Have my own business on Main Street."





J. E. SMITH
 President
 National Radio
 Institute
 Washington, D. C.
 40 years of success
 training men at
 home in spare time.

I Will Train You at Home

for Good Pay Jobs, Success in

RADIO-TELEVISION



Practice Broadcasting with Equipment I Send

As part of my Communications Course I send you kits of parts to build the low-power Broadcasting Transmitter shown at the left. You use it to get practical experience putting a station "on the air," performing procedures demanded of Broadcasting Station Operators. An FCC Commercial Operator's License can be your ticket to a better job and a bright future; my Communications Course gives you the training you need to get your license. Mail card below and see in my book other valuable equipment you build.

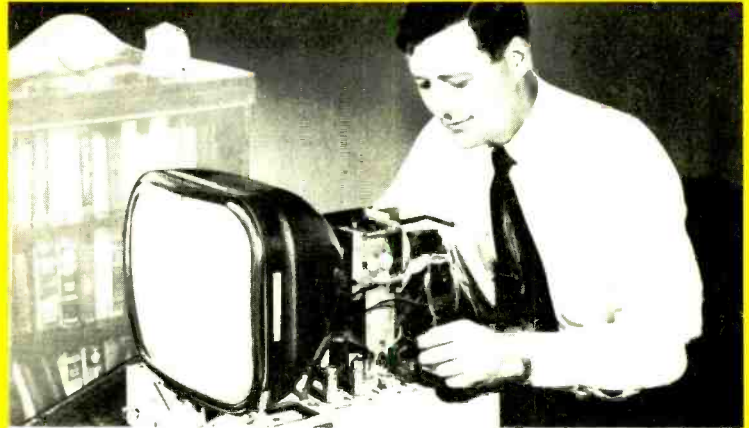

Practice Servicing with Equipment I Send

Nothing takes the place of PRACTICAL EXPERIENCE. That's why NRI training is based on LEARNING BY DOING. You use parts I furnish to build many circuits common to Radio and Television. With my Servicing Course you build a modern Radio (shown at right). You build a Multitester which you use to help fix sets while training. Many students make \$10, \$15 a week extra fixing sets in spare time starting a few months after enrolling. All equipment is yours to keep. Card below will bring book showing other equipment you build.



Television is Growing Fast Making New Jobs, Prosperity

More than 25 million homes now have Television sets and thousands more are being sold every week. Well trained men are needed to make, install, service TV sets. About 200 television stations on the air with hundreds more being built. Think of the good job opportunities here for qualified technicians, operators, etc. If you're looking for opportunity get started now learning Radio-Television at home in spare time. Cut out and mail postage free card. J. E. Smith, President, National Radio Institute, Washington, D. C. OUR 40TH YEAR.

AVAILABLE TO
VETERANS
 UNDER G.I. BILL

Good Jobs, Good Pay, Success
 in Radio-TV! SEE OTHER SIDE

CUT OUT AND MAIL THIS CARD NOW

Sample Lesson & 64-Page Book
Both FREE

This card entitles you to Actual Lesson on Servicing, shows how you learn Radio-Television at home. You'll also receive my 64-Page Book, "How to Be a Success in Radio-Television." Mail card now!

NO STAMP NEEDED! WE PAY POSTAGE

Mr. J. E. SMITH, President,
 National Radio Institute, Washington 9, D. C.

Mail me Lesson and Book, "How to Be a Success in Radio-Television." (No Salesman will call. Please write plainly.)

NAME AGE

ADDRESS

CITY ZONE STATE

VETS write in date of discharge
 B C D E F G

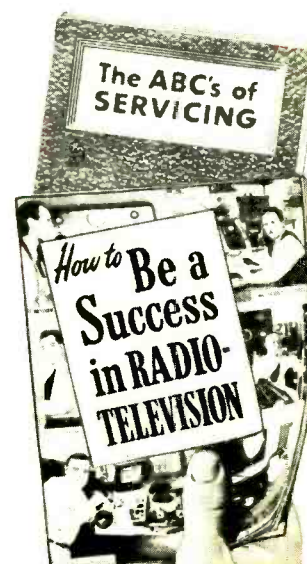

Train at Home to Jump Your Pay as a RADIO-TV Technician



**J. E. Smith, President
National Radio Institute**

The men whose messages are published below were not born successful. Not so long ago they were doing exactly as you are now . . . reading my ad! They decided they should KNOW MORE . . . so they could EARN MORE . . . so they acted! Mail card below now.

Get a Better Job—Be Ready for a Brighter Future in America's Fast Growing Industry

Training PLUS opportunity is the PERFECT COMBINATION for job security, good pay, advancement. When times are good, the trained man makes the BETTER PAY, GETS PROMOTED. When jobs are scarce, the trained man enjoys GREATER SECURITY. NRI training can help assure you and your family more of the better things of life.

Radio-Television is today's opportunity field. Even without Television, Radio is bigger than ever before. Over 3,000 Radio Broadcasting Stations on the air; more than 115 million home and Automobile Radios are in use. Then add Television. Television Broadcast Stations extend from coast to coast now with over 25 million Television sets already in use. There are channels for 1,800 more Television Stations. Use of

Aviation and Police Radio, Micro-Wave Relay, Two-way Radio communication for buses, taxis, trucks, etc. is expanding. New uses for Radio-Television principles coming in Industry, Government, Communications and Homes.

My Training is Up-to-Date You Learn by Practicing

Get the benefit of my 40 years experience training men. My well-illustrated lessons give you the basic principles you must have to assure continued success. Skillfully developed kits of parts I furnish "bring to life" the principles you learn from my lessons. Read more about equipment you get on other side of this page.

Naturally, my training includes Television. I have, over the years, added more and more Television information to my courses. The equipment I furnish students gives experience on circuits common to BOTH Radio and Television.

Find Out About the Tested Way to Better Pay

Read at the right how just a few of my students made out who acted to get the better things of life. Read how NRI students earn \$10, \$15 a week extra fixing Radios in spare time starting soon after enrolling. Read how my graduates start their own businesses. Then take the next step—mail card below.

You take absolutely no risk. I even pay postage. I want to put an Actual Lesson in your hands to prove NRI home training is practical, thorough. I want you to see my 64-page book, "How to Be a Success in Radio-Television" because it tells you about my 40 years of training men and important facts about present and future Radio-Television job opportunities. You can take NRI training for as little as \$5 a month. Many graduates make more than the total cost of my training in two weeks. Mailing postage free card can be an important step in making your future successful. J. E. Smith, President, National Radio Institute, Washington 9, D. C. OUR 40TH YEAR.

I TRAINED THESE MEN



Handicapped but Successful

"I am now Chief Engineer at WHAW. My left hand is off at the wrist. A man can do what he wants to." R. J. Bailey, Weston, W. Va.



\$10 a Week In Spare Time

"Before finishing, I earned as much as \$10 a week in Radio servicing, in my spare time. I recommend NRI." S. J. Petruff, Miami, Fla.



Control Operator, Station WEAN

"I received my license and worked on ships. Now with WEAN as control operator, NRI course is complete." R. Arnold, Rumford, R. I.



Has Own Radio-Television Shop

"Doing Radio and Television servicing full time. Have my own shop. I owe my success to NRI." Curtis Stath, Fort Madison, Iowa.



Has Growing Business

"Am becoming expert Teletician as well as Radiotician. Without your course this would be impossible." P. Brokan, Louisville, Ky.



Got First Job Thru NRI

"My first job was with KDLR. Now Chief Engr. of Radio Equipment for Police and Fire Dept." T. Norton, Hamilton, Ohio.

NRI Training Leads to Jobs Like These

- | | |
|--|---|
| BROADCASTING
Chief Technician
Chief Operator
Power Monitor
Recording Operator
Remote Control Operator | GOVERNMENT RADIO
Operator in Army, Navy, Marine Corps, Coast Guard
Forestry Service
Dispatcher
Airways Radio Operator |
| SERVICING
Home and Auto Radios
P. A. Systems
Television Receivers
Electronic Controls
FM Radios | AVIATION RADIO
Plane Radio Operator
Transmitter Technician
Receiver Technician
Airport Transmitter Operator |
| IN RADIO PLANTS
Design Assistant
Transmitter Design Technician
Service Manager
Tester
Serviceman
Research Assistant | TELEVISION
Pick-up Operator
Voice Transmitter Operator
Television Technician
Remote Control Operator
Service and Maintenance Technician |
| SHIP AND HARBOR RADIO
Chief Operator
Assistant Operator
Radiotelephone Operator | POLICE RADIO
Transmitter Operator
Receiver Serviceman |

Find Out What RADIO-TV Offers You

SAMPLE LESSON and 64-PAGE BOOK Both FREE

Cut out and mail postage-free card today!

Start Soon to Make \$10, \$15 a Week Extra Fixing Sets

Keep your job while training. Many NRI students make \$10, \$15 and more a week extra fixing neighbors' Radios in spare time starting a few months after enrolling. I start sending you special booklets that show you how to fix sets the day you enroll. The multitester you build with parts I furnish helps discover and correct troubles.



Do You Want Your Own Business?

Many NRI trained men start their own successful Radio-Television sales and service business with capital earned fixing Radios in spare time. My book tells how you can be your own boss. Joe Travers, a graduate of mine, in Asbury Park, N. J., writes: "I've come a long way in Radio and Television since graduating. Have my own business on Main Street."



FIRST CLASS
Permit No. 20-R
(Sec. 34.9, P.L. & R.)
Washington, D.C.

BUSINESS REPLY CARD

No Postage Stamp Necessary If Mailed In The United States

POSTAGE WILL BE PAID BY
NATIONAL RADIO INSTITUTE

16th and U Sts., N.W.

Washington 9, D. C.





J. E. SMITH
President
National Radio
Institute
Washington, D. C.
40 years of success
training men at
home in spare time.

I Will Train You at Home for Good Pay Jobs, Success in RADIO-TELEVISION



Practice Broadcasting with Equipment I Send

As part of my Communications Course I send you kits of parts to build the low-power Broadcasting Transmitter shown at the left. You use it to get practical experience putting a station "on the air," performing procedures demanded of Broadcasting Station Operators. An FCC Commercial Operator's License can be your ticket to a better job and a bright future; my Communications Course gives you the training you need to get your license. Mail card below and see in my book other valuable equipment you build.

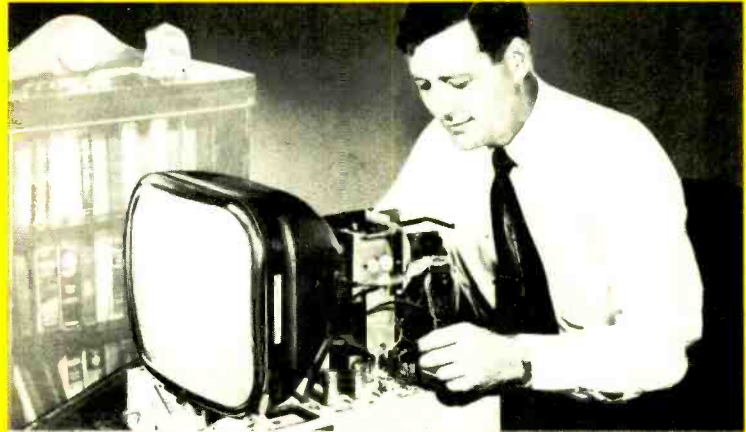

Practice Servicing with Equipment I Send

Nothing takes the place of PRACTICAL EXPERIENCE. That's why NRI training is based on LEARNING BY DOING. You use parts I furnish to build many circuits common to Radio and Television. With my Servicing Course you build a modern Radio (shown at right). You build a Multitester which you use to help fix sets while training. Many students make \$10, \$15 a week extra fixing sets in spare time starting a few months after enrolling. All equipment is yours to keep. Card below will bring book showing other equipment you build.

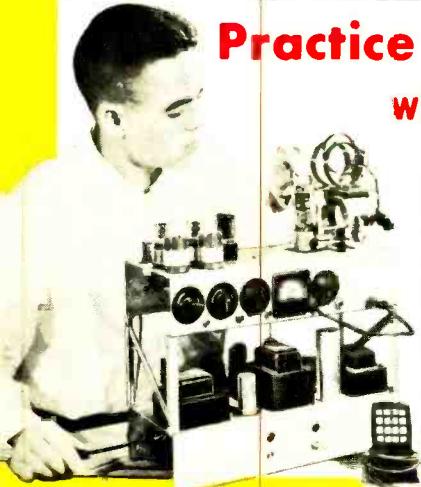

Television is Growing Fast Making New Jobs, Prosperity

More than 25 million homes now have Television sets and thousands more are being sold every week. Well trained men are needed to make, install, service TV sets. About 200 television stations on the air with hundreds more being built. Think of the good job opportunities here for qualified technicians, operators, etc. If you're looking for opportunity get started now learning Radio-Television at home in spare time. Cut out and mail postage free card. J. E. Smith, President, National Radio Institute, Washington, D. C. OUR 40TH YEAR.

AVAILABLE TO
VETERANS
UNDER G.I. BILL

Good Jobs, Good Pay, Success
in Radio-TV! SEE OTHER SIDE

CUT OUT AND MAIL THIS CARD NOW

Sample Lesson & 64-Page Book
Both FREE

This card entitles you to Actual Lesson on Servicing, shows how you learn Radio-Television at home. You'll also receive my 64-Page Book, "How to Be a Success in Radio-Television." Mail card now!

NO STAMP NEEDED! WE PAY POSTAGE

Mr. J. E. SMITH, President,
National Radio Institute, Washington 9, D. C.

Mail me Lesson and Book, "How to Be a Success in Radio-Television." (No Salesman will call. Please write plainly.)

NAME..... AGE.....

ADDRESS.....

CITY..... ZONE..... STATE.....

VETS write in date
of discharge.....
B C D E F G

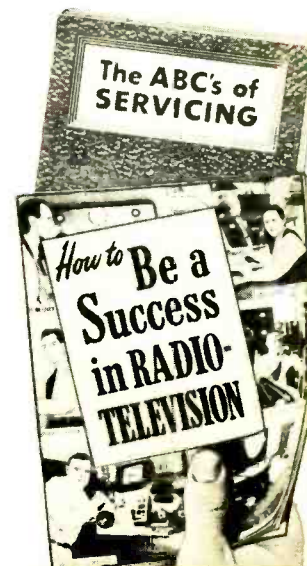

Train at Home to Jump Your Pay as a RADIO-TV Technician



J. E. Smith, President
National Radio Institute

The men whose messages are published below were not born successful. Not so long ago they were doing exactly as you are now... reading my ad! They decided they should KNOW MORE... so they could EARN MORE... so they acted! Mail card below now.

Get a Better Job—Be Ready for a Brighter Future in America's Fast Growing Industry

Training PLUS opportunity is the PERFECT COMBINATION for job security, good pay, advancement. When times are good, the trained man makes the BETTER PAY, GETS PROMOTED. When jobs are scarce, the trained man enjoys GREATER SECURITY. NRI training can help assure you and your family more of the better things of life.

Radio-Television is today's opportunity field. Even without Television, Radio is bigger than ever before. Over 3,000 Radio Broadcasting Stations on the air; more than 115 million home and Automobile Radios are in use. Then add Television. Television Broadcast Stations extend from coast to coast now with over 25 million Television sets already in use. There are channels for 1,800 more Television Stations. Use of

Aviation and Police Radio, Micro-Wave Relay, Two-way Radio communication for buses, taxis, trucks, etc. is expanding. New uses for Radio-Television principles coming in Industry, Government, Communications and Homes.

My Training is Up-to-Date You Learn by Practicing

Get the benefit of my 40 years experience training men. My well-illustrated lessons give you the basic principles you must have to assure continued success. Skillfully developed kits of parts I furnish "bring to life" the principles you learn from my lessons. Read more about equipment you get on other side of this page.

Naturally, my training includes Television. I have, over the years, added more and more Television information to my courses. The equipment I furnish students gives experience on circuits common to BOTH Radio and Television.

Find Out About the Tested Way to Better Pay

Read at the right how just a few of my students made out who acted to get the better things of life. Read how NRI students earn \$10, \$15 a week extra fixing Radios in spare time starting soon after enrolling. Read how my graduates start their own businesses. Then take the next step—mail card below.

You take absolutely no risk. I even pay postage. I want to put an Actual Lesson in your hands to prove NRI home training is practical, thorough. I want you to see my 64-page book, "How to Be a Success in Radio-Television" because it tells you about my 40 years of training men and important facts about present and future Radio-Television job opportunities. You can take NRI training for as little as \$5 a month. Many graduates make more than the total cost of my training in two weeks. Mailing postage free card can be an important step in making your future successful. J. E. Smith, President, National Radio Institute, Washington 9, D. C. OUR 40TH YEAR.

I TRAINED THESE MEN



Handicapped but Successful

"I am now Chief Engineer at WEAW. My left hand is off at the wrist. A man can do... if he wants to." R. J. Bailey, Weston, W. Va.



\$10 a Week in Spare Time

"Before finishing, I earned as much as \$10 a week in Radio servicing, in my spare time. I recommend NRI." S. J. Petruff, Miami, Fla.



Control Operator, Station WEAN

"I received my license and worked on ships. Now with WEAN as control operator, NRI course is complete." R. Arnold, Rumford, R. I.



Has Own Radio-Television Shop

"Doing Radio and Television servicing full time. Have my own shop. I owe my success to NRI." Curtis Stath, Fort Madison, Iowa.



Has Growing Business

"Am becoming expert Teletician as well as Radiotician. Without your course this would be impossible." P. Brogan, Louisville, Ky.



Got First Job Thru NRI

"My first job was with KDLR. Now Chief Engr. of Radio Equipment for Police and Fire Dept." T. Norton, Hamilton, Ohio.

NRI Training Leads to Jobs Like These

BROADCASTING
Chief Technician
Chief Operator
Power Monitor
Recording Operator
Remote Control Operator

GOVERNMENT RADIO
Operator in Army, Navy, Marine Corps, Coast Guard
Forestry Service
Dispatcher
Airways Radio Operator

SERVICING
Home and Auto Radios
P. A. Systems
Television Receivers
Electronic Controls
FM Radios

AVIATION RADIO
Plane Radio Operator
Transmitter Technician
Receiver Technician
Airport Transmitter Operator

IN RADIO PLANTS
Design Assistant
Transmitter Design Technician
Service Manager
Tester
Serviceman
Research Assistant

TELEVISION
Pick-up Operator
Voice Transmitter Operator
Television Technician
Remote Control Operator
Service and Maintenance Technician

SHIP AND HARBOR RADIO
Chief Operator
Assistant Operator
Radiotelephone Operator

POLICE RADIO
Transmitter Operator
Receiver Serviceman

FIRST CLASS
Permit No. 20-R
(Sec. 34.9, P.L. & R.)
Washington, D.C.

BUSINESS REPLY CARD

No Postage Stamp Necessary If Mailed In The United States

POSTAGE WILL BE PAID BY
NATIONAL RADIO INSTITUTE

16th and U Sts., N.W.

Washington 9, D. C.

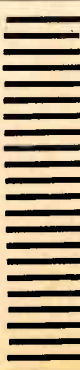

Find Out What RADIO-TV Offers You



SAMPLE LESSON and 64-PAGE BOOK Both FREE

Cut out and mail postage-free card today!

Start Soon to Make \$10, \$15 a Week Extra Fixing Sets

Keep your job while training. Many NRI students make \$10, \$15 and more a week extra fixing neighbors' Radios in spare time starting a few months after enrolling. I start sending you special booklets that show you how to fix sets the day you enroll. The multitester you build with parts I furnish helps discover and correct troubles.



Do You Want Your Own Business?

Many NRI trained men start their own successful Radio-Television sales and service business with capital earned fixing Radios in spare time. My book tells how you can be your own boss. Joe Travers, a graduate of mine, in Asbury Park, N. J., writes: "I've come a long way in Radio and Television since graduating. Have my own business on Main Street."



NEW HOME OF ALLIED RADIO

ultra-modern facilities TO SERVE YOU BEST



FREE!

get your value-packed

1954 ALLIED

268-PAGE CATALOG

The World's Largest Stocks

- TV and Radio Parts
- Test Instruments
- High-Fidelity Equipment
- Custom TV Chassis
- AM, FM Tuners and Radios
- Recorders and Supplies
- P. A. Systems, Accessories
- Amateur Station Gear
- Builders' Kits, Supplies
- Equipment for Industry

Fastest Service in Electronic Supply

the only **COMPLETE** catalog for everything in TV, Radio and Industrial Electronics

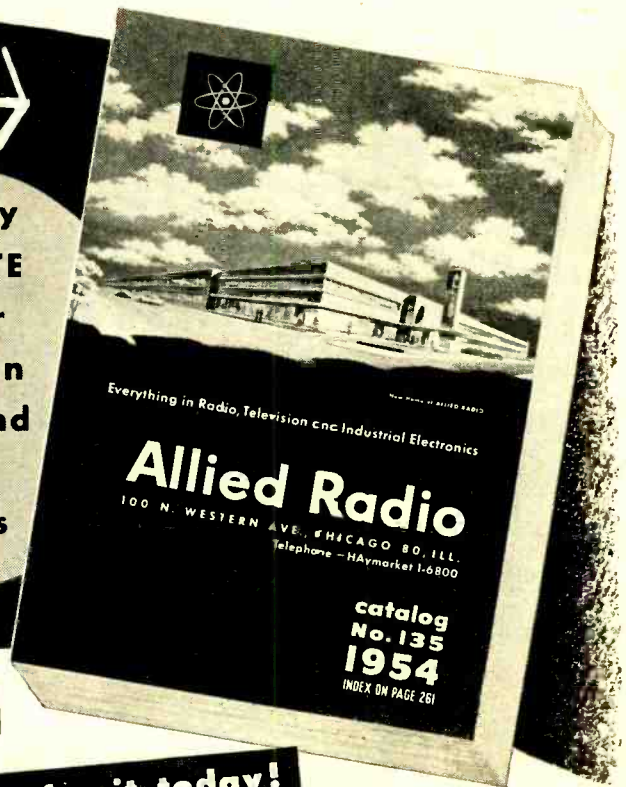

Send for it today!

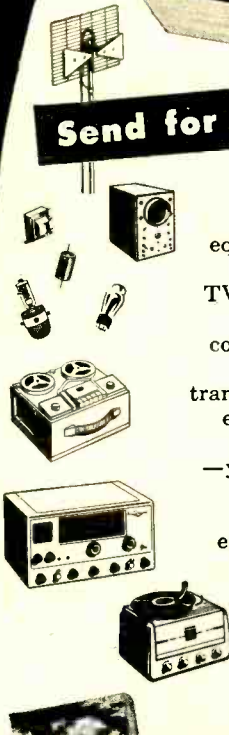

You'll want the *one* complete Buying Guide to *Everything in Electronics*—268 pages packed with the world's largest selection of quality equipment at lowest, money-saving prices. See all the latest releases in custom TV chassis, TV antennas and accessories; AM and FM tuners and radios; *everything* in High-Fidelity custom components; latest P.A. Systems and accessories; recorders and supplies; Amateur receivers, transmitters and station gear; specialized industrial electronic equipment; test instruments; builders' kits; huge listings of parts, tubes, tools, books —your choice of the world's *most complete stocks* of quality equipment. ALLIED gives you *every* buying advantage: speedy shipment, expert personal help, lowest prices, liberal terms, assured satisfaction. Get the 1954 ALLIED Catalog. Keep it handy—and save time and money. Send for your **FREE** copy today.

SAVE ON EVERYTHING IN ELECTRONICS

SEND FOR THE LEADING ELECTRONIC BUYING GUIDE

free

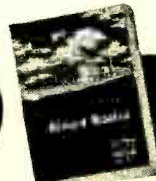

ALLIED RADIO

World's Largest Electronic Supply House

EASY-PAY TERMS

Use ALLIED'S liberal Easy Payment Plan—only 10% down, 12 months to pay—no carrying charge if you pay in 60 days. Available on Hi-Fi and P. A. units, recorders, TV chassis, test instruments, Amateur gear, etc.

TV and HI-FI SPECIALISTS

To keep up with developments in High-Fidelity and TV, look to ALLIED. Count on us for all the latest releases and largest stocks of equipment in these important fields. If it's anything in High-Fidelity or Television—we have it in stock!

ALLIED RADIO CORP., Dept. 2-L-3
100 N. Western Ave., Chicago 80, Illinois

Send FREE 268-Page 1954 ALLIED Catalog.

Name _____

Address _____

City _____ Zone _____ State _____



CHANNEL MASTER

introduces a

basically *new type*

of VHF antenna

CHAMPION*

the highest gain
all-channel VHF antenna
ever developed!

Featuring the unique new "Tri-Pole"

TRIPLE-POWERED DIPOLE

The "Tri-Pole" is a new antenna system in which the Low Band folded dipole also functions as three folded dipoles tied together in phase on the High Band. This is the heart of the Champion, the secret of its phenomenal performance on all 12 VHF channels.

the **CHAMPION** is the most sensitive all-channel VHF antenna ever designed!

Stacked **CHAMPION** provides:
11-13 D B High Band gain
6½-7½ D B Low Band gain

Here is a totally NEW kind of antenna, completely different — in principal and performance — from any VHF antenna you've ever seen! Since the lifting of the TV freeze means a gradual disappearance of the single-channel VHF area, the VHF antenna of the future will be a *multi-channel* antenna. Prepare now for outstanding reception on *all* VHF channels — present and future — with Channel Master's super-sensitive **CHAMPION**! Outperforms every all-channel VHF antenna made today — and many Yagis, too!

COMPARE these features with the antenna you are now using:

- Folded dipoles throughout — give close to 300 ohms impedance across the entire band.
- Screen-type reflector provides high uniform gain on every channel, 2 through 13. Not frequency sensitive — this reflector provides more than twice as much extra gain as straight bar reflectors.
- Phase-correcting harness is built-in and fully assembled; the only wiring you do is to attach the lead-in.
- All-aluminum construction . . . lightweight, durable, non-corrosive.

MARVEL OF PRE-ASSEMBLY

assembles faster than a
5-element yagi!

Collapsed "Pop-Up" screen opens instantly — no loose rods, elements or hardware. "Tri-Pole" assembly features automatic Spring Lock Action — all dipoles snap permanently into place without wing nuts or any other hardware.

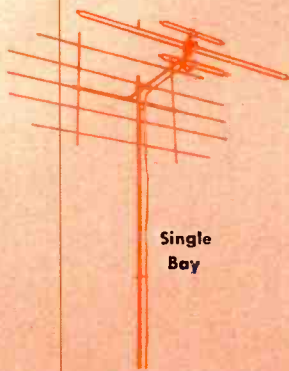

Single
Bay

It's a **CHAMPION** in any area!

- 1-bay—local areas
- 2-bay—secondary and fringe areas
- 4-bay—super-fringe areas

THIS ANTENNA...

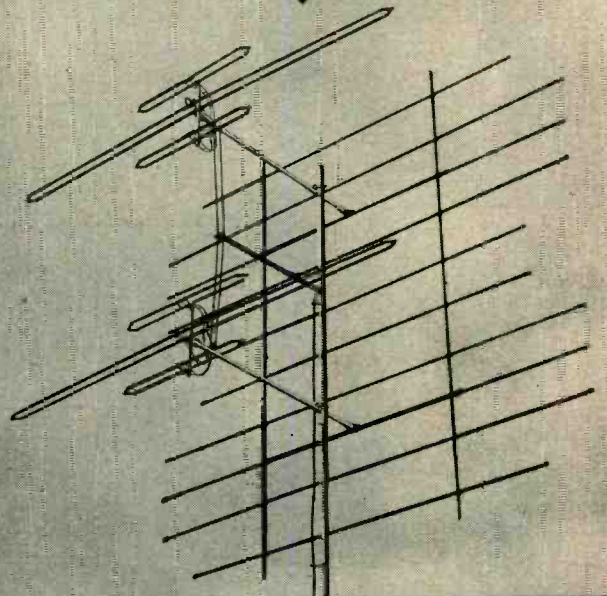

OUT-PERFORMS:

this ...

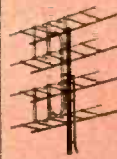

this ...

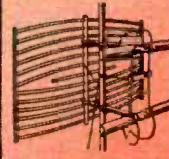

this ...



or this ...



The 2-Bay **CHAMPION** actually
gives you the performance of:

• Separate 5-element
Yagis for every Low
Band channel!

• Separate 10-element
Yagis for every High
Band channel!

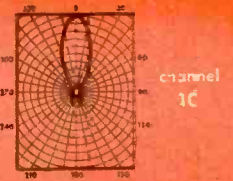
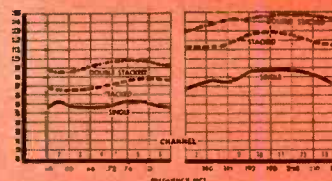

Model No.		List Price
325	Single Bay	\$20.83
325-2	2-Bay	\$42.34
325-4	4-Bay	\$88.89
Separate Stacking Harness		
325-3	2-Bay Harness	\$ 2.08
325-5	4-Bay Harness	\$ 4.15

Send for complete technical literature.

CHANNEL MASTER CORP.

GREENVILLE, N. Y.



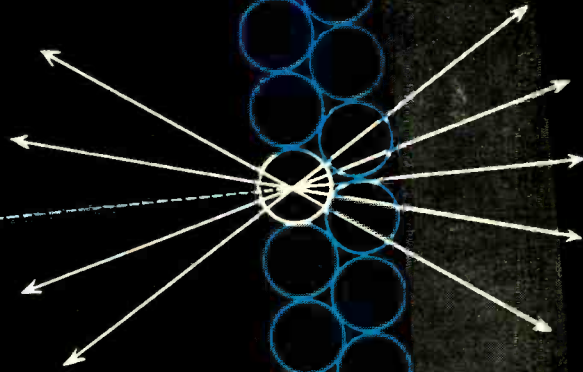

what Aluminizing means

Aluminizing means the efficient use of light—light is energy—energy is the pay-off.

Aluminizing means a brighter TV picture, greater contrast, lower beam current, smaller spot size, sharper focus, reduced screen scorch—all from the efficient use of light.

On the inside of any TV tube face is a coating of phosphor crystals—the picture screen. As the electron beam—tracing the picture—strikes these crystals, they glow, giving off light in all directions. And there's the problem! Half the light thus generated is *inside* the tube, either lost to usefulness or lighting areas that should be dark. Both brightness and contrast suffer.

But—put a mirror behind the phosphor and “wandering” light is reflected back through the tube face. *Aluminizing creates this desired mirror!*

To aluminize a picture tube, deposit a nitrocellulose film evenly over the phosphor. Over that, deposit a film of aluminum only millionths of an inch thick—just thick enough to reflect the light and just thin enough to let the electrons pass through. Under heat, evaporate the nitrocellulose film to leave a thin smooth coating of aluminum. Result—an efficient light reflecting mirror to specifications.

Simple as it sounds, Rauland research engineers worked for three years to solve the problem and were among the first to do so.

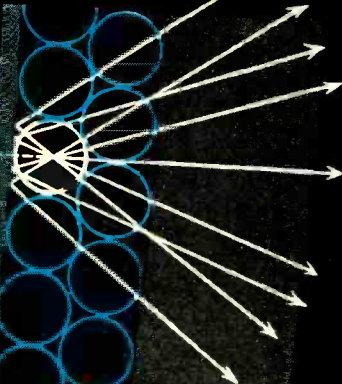

Rauland

Perfection through Research

ZENITH Subsidiary

For opportunities within your reach

See what the RCA TV Servicing Course offers you

Good-pay jobs. A business of your own.

OPPORTUNITIES FOR GOOD-PAY JOBS in Television are within your reach when you study TV Servicing by the RCA Institutes Home Study Method. Or perhaps you would like to start a TV Service business of your own.

If you are not satisfied with the way your future now stacks up, see how easily

you can change the course of your career. RCA Institutes Home Study Course in TV Servicing is helping thousands of other people to better jobs. It can help you. Right now thousands of opportunities are going begging. There is a critical shortage of trained TV servicemen. This is *your* big opportunity.

Easy-to-understand, illustrated lessons



The entire course is divided into ten units of several individual lessons. You study them at home in your spare time. Lesson-by-lesson you learn the theory and step-by-step procedures of installing TV antennas, of servicing and trouble-shooting TV receivers. Hundreds of pictures and diagrams help you understand the how-it-works information and the how-to-do-it techniques. You will be amazed how easily you absorb the knowledge of each lesson, how quickly you train yourself to become an experienced technician.

Experienced engineers and faculty prepared the course, grade your lessons



The RCA Institutes course was written and planned by instructors with years of specialized experience in training men by home-study and resident-school methods. The course embodies RCA's background of television experience plus knowledge gained in training several thousand technicians. A study of the course parallels an apprentice's training. Your lessons are carefully examined and accurately graded by friendly teachers who are interested in helping you to succeed.

One of the leading and oldest Radio-Television training schools



Founded in 1909, RCA Institutes, Inc. has been in continuous operation for the past 44 years. Its

wide experience and extensive educational facilities give students, just like you, unsurpassed technical training in the highly specialized field of radio-television-electronics.

RCA Institutes is licensed by the University of the State of New York . . . an affiliate member of the American Society for Engineering Education . . . approved by the Veterans Administration . . . approved by leading Radio-Television Service Organizations.

It costs so little to gain so much

RCA Institutes makes it easy for you to take advantage of the big opportunities in TV Servicing. The cost of the TV Servicing Home Study Course has been cut to a minimum. You pay for the course on a pay-as-you-learn unit lesson basis. No other home study course in TV Servicing offers so much for so little cost to you.

RCA Institutes conducts a resident school in New York City offering day and evening courses in Radio and TV Servicing, Radio Code and Radio Operating, Radio Broadcasting, Advanced Technology. Write for free catalog on resident courses.



RCA INSTITUTES, INC.

A SERVICE OF RADIO CORPORATION OF AMERICA
350 WEST FOURTH STREET, NEW YORK 14, N.Y.

SEND FOR FREE BOOKLET—Mail the coupon—today. Get complete information on the RCA INSTITUTES Home Study Course in Television Servicing. Booklet gives you a general outline of the course by units. See how this practical home study course trains you quickly, easily. Mail coupon in envelope or paste on postal card.



MAIL COUPON NOW!

RCA INSTITUTES, INC., Home Study Dept. RE 1153
350 West Fourth Street, New York 14, N.Y.

Without obligation on my part, please send me copy of booklet "RCA INSTITUTES Home Study Course in TELEVISION SERVICING." (No salesman will call.)

Name _____ (please print)

Address _____

City _____ Zone _____ State _____

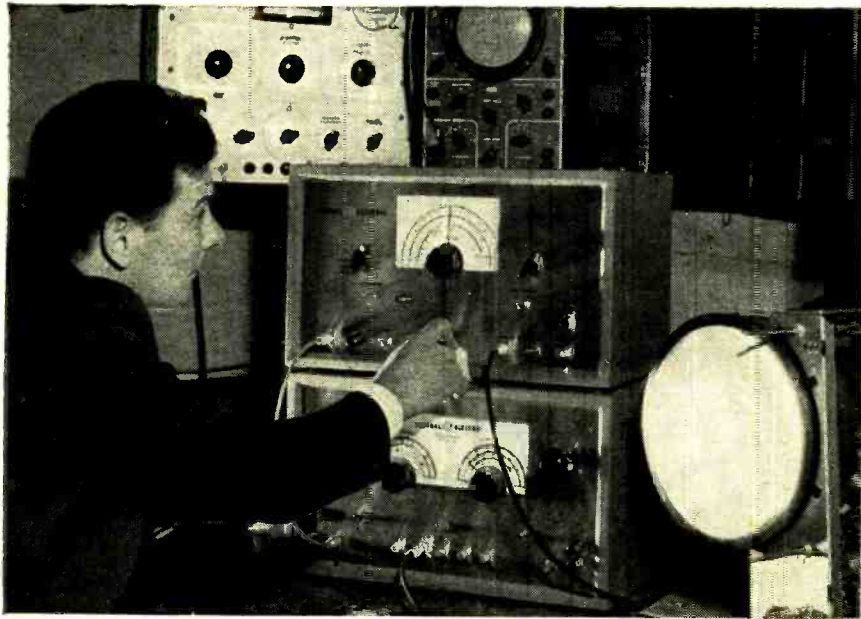

**"OUR CUSTOMERS TELL US
THAT THE PICTURES ARE
BETTER THAN WHEN THEIR
SETS WERE BRAND-NEW."**

*Says W. T. Gerlach
Roselle Radio and TV Service
1027 Chestnut St., Roselle, N. J.*

"Since the first TV sets were delivered in this area, we've installed almost every type and brand of picture tube, but we've yet to find any that gives a picture like the G-E Aluminized Tube.

"Our tube customers are not only satisfied—they are downright pleased! As a result, **more than two out of every three tubes we are installing are G-E Aluminized Picture Tubes.**"

"2 OUT OF EVERY 3 TUBES ARE G-E ALUMINIZED

Give your customers TV's finest picture—and make more money!

**"65% OF OUR PICTURE TUBES SOLD ARE G-E
ALUMINIZED. ONE OWNER TELLS ANOTHER."**

*Says Kenneth L. Middleton . . . HILLENS
740 N. Garey Ave., Pomona, Cal.*



**"GENERAL ELECTRIC ALUMINIZED PICTURE TUBES
ARE ONE OF MY REAL BIG MONEY-MAKERS!"**

*Says Norman Foster . . . Foster Television
2922 Milwaukee Ave., Chicago, Ill.*



**BRAND-NEW
MIRROR DISPLAY**

Eye-evidence why a G-E Aluminized Tube is up to 100% brighter. The mirror does it! . . . This 3-color display with polished, gleaming mirror sticks front or back to any flat surface—your store-window, door, or wall. A real attention-getter!

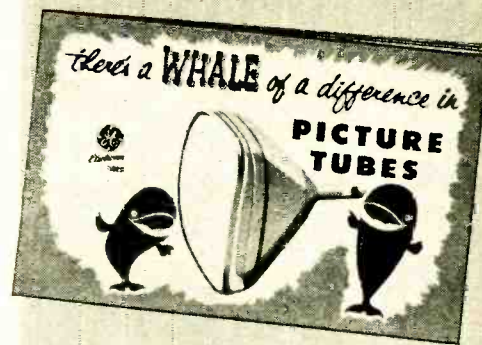
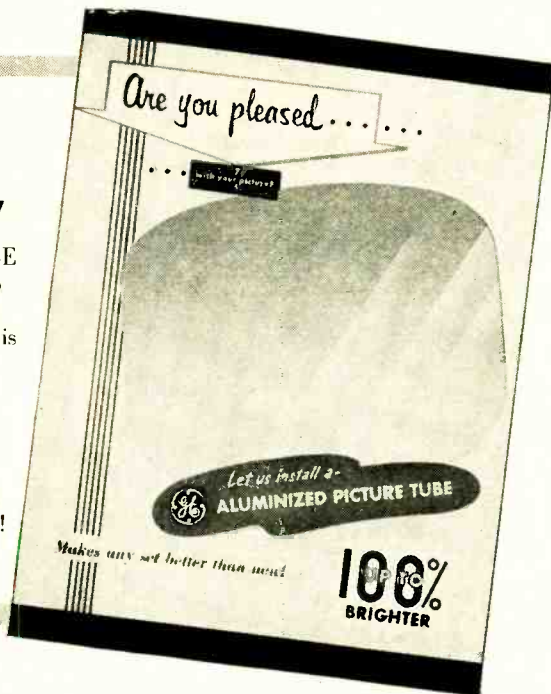

FACT-CRAMMED BOOKLET FOR TV OWNERS

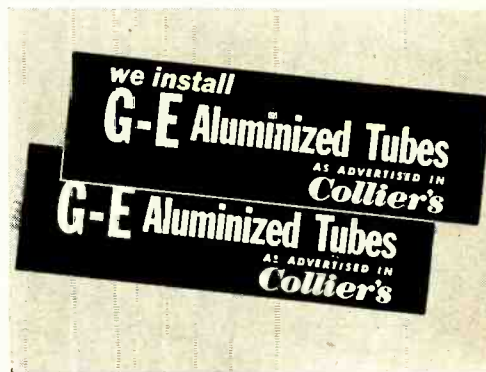

COLORFUL STREAMERS

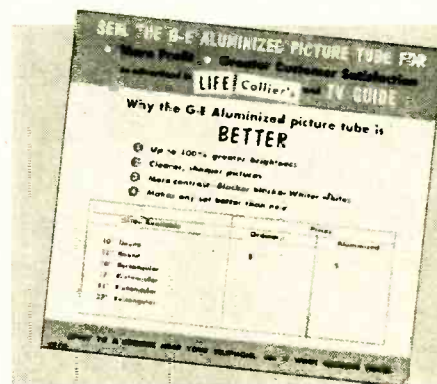

PHONE-SELLING PRICE GUIDE

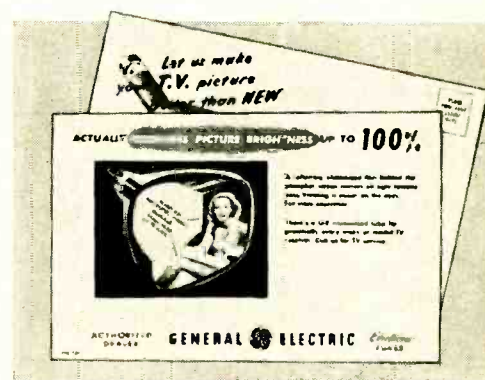

MAIL CARD THAT BUILDS INQUIRIES



NEWSPAPER
AD
MAT

WE INSTALL PICTURE TUBES!"

Ask for new 6-piece promotion kit!

All these helps are waiting for you at your G-E tube distributor!

GET the full kit of G-E Aluminized Tube sales aids! Use them to sell better-than-new TV! It's a sure-fire way to lick competition from inferior picture tubes offered to your customers.

This mirror, booklet, and other helps will work hard for you, developing profitable tube sales. General Electric further supports your efforts by a strong coast-to-coast advertising campaign to TV owners. Ads in LIFE, COLLIER'S, and TV GUIDE, reaching some 40,000,000 readers, tell why the G-E Aluminized Tube is brighter, better, the finest tube any set can have!

Today many leading TV builders are featuring new-model receivers with General Electric Aluminized Tubes. Demand for replacement tubes will skyrocket as the finer performance of the aluminized tube is made known by enthusiastic set owners.

Take a tip from successful service dealers everywhere! Sell TV's finest picture profitably! Tube Department, General Electric Co., Schenectady 5, New York.



GENERAL ELECTRIC

New! 7 INCH PUSH-PULL OSCILLOSCOPE

Only **EICO** Has All These Features:

- VERTICAL FREQ. RESPONSE: flat ± 2 db 10 cps - 1 mc
- VERTICAL SENS.: .01 volts rms/inch
- HOR. FREQ. RESP.: flat ± 0 db 10 cps - 200 kc, -4 db at 500 kc
- HOR. SENS.: .3 volts rms/inch
- SWEEP RANGE: 15 cps-100 kc
- 3-STEP FREQ.-COMPENSATED ATTENUATOR eliminates freq. distortion, overloading.
- CATHODE FOLLOWER inputs to both amplifiers
- PUSH-PULL outputs in both amplifiers
- RETURN TRACE BLANKING
- INT. VOLTAGE CALIBRATOR
- V & H TRACE EXPANSION & CENTERING: 1.5X full screen without distortion.
- DIRECT CONNECTION to vert. CRT plates. KIT \$79.95. WIRED \$129.50.
- PHASING CONTROL of internal 60 cps sine wave sweep.
- AT FRONT PANEL: intensity mod. input; 60 cps, sawtooth outputs.



MODEL 470K

KIT \$79.95. WIRED \$129.50.

FAMOUS EICO AMAZING FEATURE-PACKED ECONOMY-PRICED
425K PUSH-PULL SCOPE KIT \$44.95. WIRED \$79.95.

- AC & DC volts: 0-5, 10, 100, 500, 1000 V (30 KV with HVP-1 probe).
- 5 ohm ranges from .2 ohm to 1000 meg.
- DC Input Z 26 meg.
- 4 1/2" meter movement in can't-burn-out circuit.
- 1% mult. resistors.



221K VTVM KIT \$25.95. WIRED \$49.95.

- HIGH VOLTAGE PROBE \$6.95
- Extends range of VTVMs & voltmeters to 30 KV.

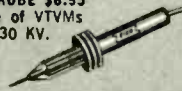

PIX TUBE ADAPTER for Tube Testers \$4.50. Checks TV picture tubes while in set.

- Illum. gear-driven "Speed Rollchart."
- New lever-action switches for individual testing of every element.
- Tests all conventional & TV tubes.



625K TUBE TESTER KIT \$34.95. WIRED \$49.95.

COUNTER CABINET for above: add \$10.00 to Kit or Wired Prices.

- Continuous coverage of all TV & FM freqs. from 500 kc to 228 mc.
- Sweep width variable 0-30 mc.
- Crystal marker oscillator, variable amplitude.



360K SWEEP GEN. KIT \$34.95. WIRED \$49.95.

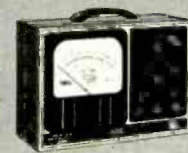

- Large 7 1/2" meter, can't-burn-out circuit.
- AC/DC volts: 0-5, 10, 100, 500, 1000 (30 KV with HV Probe).
- 5 ohm ranges from .2 ohm to 1000 meg.
- DC Input Z 26 meg.
- 1% mult. resistors.

214K VTVM KIT \$34.95. WIRED \$54.95.



- Measures & tests all resistors; .5 ohm to 500 megohms.
- Every type condenser, 10 mmf to 5000 mfd.
- 0-500 DC voltage source for capacitor leakage testing.

950A-K R-C BRIDGE & R-C-L COMP. KIT \$19.95. WIRED \$29.95.

NOW! ONLY EICO

the largest manufacturer of its kind in the world - gives you **LIFETIME SERVICE & CALIBRATION GUARANTEE***
...the Industry's greatest protection for your test equipment investment!

* at less than our cost of handling (see the EICO Guarantee Card enclosed with each Kit and Instrument).



NEW!
SCOPE VOLTAGE CALIBRATOR KIT 495K KIT \$12.95. WIRED \$17.95.

- Sq. wave output at power-line freq. with full-scale readings of .1, 1, 10 or 100 V. peak-to-peak.
- Accuracy $\pm 5\%$ of full-scale on each range.

NEW!
6V & 12V BATTERY ELIMINATOR KIT 1050K KIT \$29.95. WIRED \$38.95.

- DC output: 0-8 V or 0-16 V.
- Continuous current rating: 10 A at 6 V, 6 A at 12 V.
- Intermittent current rating: 20 A at 6 V, 12 A at 12 V.
- Separate Voltmeter & Ammeter.

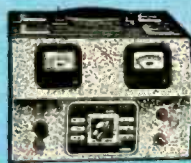

NEW!
DECADE CONDENSER BOX KIT 1180K KIT \$14.95. WIRED \$19.95.

- All capacitors precision silver mica, accuracy $\pm 1\%$.
- Range from 100 mmf - 0.1:1 mfd in steps of 100 mmf.
- Smooth-action positive detent ceramic switches.

Prices 5% higher on West Coast. Specifications and prices subject to change without notice.



- 1000 Ω/V ; 31 ranges
- DC/AC volts: Zero to 1, 5, 10, 50, 100, 500, 5000.
- DC/AC Current: 0-1, 10 ma; 0.1, 1 A.
- Ohms: 0-500, 100 K, 1 meg.

536K MULTIMETER KIT \$12.90. WIRED \$14.90.
526K MULTIMETER KIT \$13.90. WIRED \$16.90.



- Complete sine wave coverage, 20-200,000 cps in 4 direct-reading ranges.
- Complete square wave coverage, 60-50,000 cps.
- Cathode follower output circuit.

377K SINE & SQUARE WAVE AUDIO GEN. KIT \$31.95. WIRED \$49.95.



- 20,000 Ω/V ; 31 ranges.
- DC/AC/Output volts: 0-2.5, 10, 50, 250, 1000, 5000.
- DC Current: 0-100 ua; 10, 100, 500 ma; 10 A.
- Ohms: 0-2K, 200K, 20 meg.

565K MULTIMETER KIT \$24.95. WIRED \$29.95.
555K MULTIMETER KIT \$29.95. WIRED \$34.95. (1% precision resistors)



- Fundamentals 150 kc to 34 mc, harmonics to 102 mc.
- 5-step band switching.
- Colpitts audio oscillator generates 400 cps pure sine wave voltage.
- Permits pure RF, modulated RF, or pure AF.

320K SIG. GEN. KIT \$19.95. WIRED \$29.95.
322K SIG. GEN. KIT \$23.95. WIRED \$34.95.



- Resistance values from 0 to 99,999 ohms with 0.5% precision.
- All resistors have 0.5% accuracy.

1171K RES. DECADE BOX KIT \$19.95. WIRED \$24.95.



- Covers range of 75 kc to 150 mc.
- 7 calibrated scales: accuracy better than 1%.
- Bandsread vernier tuning.
- 4-step RF shielded output multiplier: constant output Z.

315K DELUXE SIG. GEN. KIT \$39.95. WIRED \$59.95.

Write NOW for FREE latest Catalog C-11

EICO

You build EICO Kits in one evening, but... they last a lifetime!
And you SAVE OVER 50%! See the famous EICO line TODAY, in stock at your local jobber.

ELECTRONIC INSTRUMENT CO., Inc., 84 Withers Street, Brooklyn 11, N. Y.

MINIRADIOS

Vast Expansion Due In Small Radio Receivers

By HUGO GERNSBACK

WHEN TELEVISION started its triumphant conquest, the prophets of doom foresaw a quick end for the radio receiver. We thought such reasoning was senseless and said so emphatically on this page at the time. ("Whither Radio?", June 1949 issue.)

In 1949 there were in use in the U.S. 81,000,000 receivers. Now there are over 120 million radios and the end is nowhere in sight. In the first seven months of 1953, we manufactured nearly *eight million* receivers, against nearly *eleven million* radios for the entire twelve months of 1952. We are certain to produce over *fourteen million* receivers during 1953.

Yet this figure is bound to look modest during the years to come. This reasoning is based upon the coming inevitable boom of the *Minireceiver*.

We were probably the first to publicize the idea of the *personalized* receiver in our September 1944 issue, in an editorial entitled "Miniature Receivers." Here are a few excerpts from that article:

... These new Pocket Radios will be much smaller than anything that has appeared on the market heretofore. Private constructors have built excellent pocket radios for a number of years—this magazine having described quite an array of them in its pages—but it is one thing for an individual to construct such a set, and quite a different problem to build it commercially by the million.

... The pocket and vest pocket type of radios, fill a real demand. Yes, even an acute demand. We predict that before long many millions will be built annually. An entirely new art will be reared upon them. They will be built mostly by female workers who are more nimble in assembling the exceedingly small parts than men. In a way it will bring clock or watchmaking procedure into radio set manufacturing practice.

... We will have thin types of radios for breast-pockets, thicker types for side pockets and extra small ones for vest pockets. The latter type—about the size of a cigarette pack—will probably be of the "strictly personal" variety.

What we said then holds true today, only more so, for the following obvious reasons. In 1944 we did not have the transistor, which will soon make the minireceiver not only a practical, but also an economic certainty. During the next few years, the cost of transistors is bound to go far below our present miniature tubes. With the battery drain at an astonishing low, minireceivers can be played daily for many hours, without the annoyance of constant battery replacements. Indeed it appears that the batteries will wear out *not because of current drain*, but by drying out, internal chemical activity, etc.

A number of radio set manufacturers are already deep in the projection stage of minireceivers. It now appears that several such pocket sets will make their appearance in 1954. Recently, the Radio Corporation of America gave several demonstrations of all-transistor miniature receivers with superheterodyne circuits. These extremely well performing sets were free of body capacitance, had internal antennas and played well inside a large steel-construction building. Rather large pocket size, they could have been made to fit into a vestpocket, were it not that the makers desired good quality sound reception. Hence a comparatively bulky loudspeaker was used.

As the art of minireceivers progresses, let no one presume that in the future good audio quality could not be achieved with a loudspeaker with a total diameter less than that of a 25¢ piece.

Once we mass-produce vestpocket minireceivers at a popular price, they will be used chiefly as personalized-portables. Or, to coin a more appropriate term: *Radiowear*. Instant weather reports, news, traffic-road bulletins, etc., are only a few of their uses.

But by far *the most important*—and vital—use will be during the next ten years, probably the most crucial period in our country's history.

The atomic peril has finally caught up with us and—while in our opinion neither the U.S. nor Russia will use atomic mass-destruction bombs—bombing of strategic targets with conventional bombs can no longer be called visionary. We already pointed this out in our March 1948 issue.

Recently our defense department began actual tests over the nation's radio stations with precisely this peril in mind.

Operation *Conelrad* (*Control of Electronic Radiation*) will make it impossible for enemy bombers to home on any of our radio broadcast transmitters. When the actual alert comes, all transmitters will operate intermittently—each a few seconds at a time on a nationwide plan. The stations will use only two frequencies: 640 or 1240 kc, to the exclusion of all others. As no station call letters are used, the enemy planes never know to which transmitters they are listening. (RADIO-ELECTRONICS, July 1953, p. 66)

How important personalized receivers will become when the bombs start falling was foreshadowed in our September 1950 issue, under the title of "Emergency Receivers." Here are a few excerpts which we feel are apropos during the present state of a high-tension and jittery world:

... In our personal opinion—as stated on this page in our March, 1948, issue—no atom bombs are likely to be used by us or by Russia. Yet we may feel fairly certain that many of our large cities will be bombed by regulation bombs during the next war, if and when it comes. Every military man seems to feel certain that such wholesale bombing will be devastating—certainly much worse than it was in England and Germany during World War II.

It does not take an expert to foresee that, when our metropolises are being bombed, communication is vital. Many radio stations will remain intact and will be able to operate despite all bombings. This was wartime experience in England and Germany. During alert periods and after bombing, radio's importance to morale is incalculable. One thing that a nervous and jittery population demands during such an emergency is quick information. In England and Germany electric lines and electric power plants suffered considerably from heavy raids. Line-operated radio receivers in the affected districts were put out of commission—often for days. Unless the people had battery sets—which in Europe are far more prevalent than in the United States—no radio information could be received.

... What is needed even more is an honest-to-goodness pocket-size radio receiver that can be used, not only during emergencies, but in normal times. *In our opinion, any receiver that weighs more than one pound is not a personalized portable.*

In England and Germany there were literally millions of bombed out persons who, unless they found immediate shelter with other families were completely bereft of radio information.

It is important that radio set manufacturers bestir themselves vigorously to perfect a low-priced, battery-powered pocket receiver, that will not bulk too much in a man's pocket and which will also fit into a woman's handbag.

Make no mistake—the miniradio will be the next great developmental phase of radio communications. The world is ready and waiting for *instant*, personalized radio intelligence, wherever humans may find themselves.

COLOR TV—THE NTSC SYSTEM

By MARVIN H. KRONENBERG

DURING the past few years a number of methods of TV color transmission and reception have been developed. One of these, the field-sequential method promoted by the Columbia Broadcasting System, was sufficiently good to win FCC approval. But electronic engineers felt that the final solution to many color TV problems had not been discovered and a group of TV manufacturers formed the *National Television Standards Committee* to pool their ideas and work toward a more advanced system of color TV.

The NTSC system now has the backing of all or probably all the industry and is favorably considered by the FCC. Many of the details of this system are somewhat complicated, but the basic concepts are easy to understand. The NTSC color system is very similar to the "dot-sequential" method developed by RCA some years ago. It is a compatible system (that is, it uses black-and-white scanning standards) and a simultaneous system (as opposed to the obsolete field-sequential system).

To transmit TV in black-and-white the transmitter must be able to send electrical information which is related only to the brightness and detail of the televised scene. The color transmitter must also describe the color components of the picture. To do this within the existing 6-mc channels allocated for TV broadcasting, and without materially degrading the pictures, it is necessary to use either a sequential-type system or a simultaneous system in which a *subcarrier* is used to convey the color information. This latter technique forms the basis of the current NTSC system.

Before discussing the color TV transmitter, let us consider certain fundamentals about color. Three things determine what our eye perceives when it sees a color. They are *hue*, *brightness*, and *saturation*. Hue is the shade by which we identify the color; brightness is the intensity; and saturation is the dilution of the color with white. A pastel or washed-out color is said to be desaturated, and conversely a rich tone is saturated. Another important concept is that what we see as white is really a mixture of colors in just the proper proportions. In order to make white, three primary colors are necessary. Although many combinations of hues may be mixed to make white, it is standard practice in color TV to use red, green, and blue.

The problem of transmitting a color picture is similar to black-and-white

TV, except that a "third dimension" must also be included to carry the information which relates only to the color of the object. In the NTSC system, the transmitter sends out the same video signal as in black-and-white TV, plus the color subcarrier. This carrier is located approximately 3.58 mc higher in frequency than the picture carrier, and, unlike the sound carrier (4.5 mc), does not result from a separate transmission but is manufactured in the transmitter video system. This color subcarrier conveys the color information of the televised scene. The color information appears on the color carrier in the form of phase (hue) and amplitude (saturation) modulation. Thus, during color transmission, the video contains in addition to the regular black-and-white signal, a color carrier which is rapidly varying in both phase and amplitude as the various picture elements are scanned by the camera.

To illustrate the way a simultaneous color-video signal is made, a simplified color transmitter is shown in Fig. 1. The color-TV transmitter starts with three cameras instead of the one used in black-and-white TV. Each camera is conventional except for the red, green and blue filters placed in front of the lenses. Due to these filters, the video output of each camera will be a function only of that color component in the scene which can pass through the color filter. The red camera sees only the red parts of the scene, and so on for the green and the blue cameras.

The outputs of the cameras are fed to adder 1 which combines their outputs and supplies the resultant electrical equivalent of white (brightness and fine detail of the scene) to adder 2. The outputs of the cameras are also connected to the transmitter samplers, and at this point the color information is translated onto the color carrier.

The adder which is commonly used in TV transmitter and receiver circuitry does exactly what its name implies. In its simplest form an adder may consist of a dual triode with its plates tied together, and the information to be added is fed separately to each grid.

The color carrier is manufactured in the transmitter sampler. The term *sampler*, as applied to this part of the circuit was undoubtedly coined years ago when the color information was actually selected by an electronic means which was the equivalent of a switch. The commutator of the switch rotated

rapidly at a rate which was equal to the color subcarrier frequency and selected or sampled the color information at the output of the color cameras. The NTSC transmitter sampler is somewhat analogous to this basic sampler. However, the action of NTSC sampler on all three color channels is simultaneous rather than sequential.

The transmitter sampler shown in Fig. 2 consists essentially of a local oscillator supplying the color carrier (approximately 3.58 mc), a delay line, and three color modulators which in effect operate as gates for the subcarrier oscillator. The gate is actuated by the video signal. For example, if a pulse of red video, corresponding to a red sector in the televised scene, is applied to the red sampler, a pulse of 3.58 mc will appear in the output of the sampler. The phase of the sampler output will be determined by the delay line which affects the phase of the 3.58 mc input to the sampler.

The output of the transmitter sampler, consists of the color subcarrier modulated both in phase and amplitude. The phase of the color subcarrier is a function of the hue of the scene, and its amplitude (in relation to the white video amplitude) is determined by the degree of color saturation.

The outputs of the transmitter samplers which identify hue and saturation are then connected to adder 2, as is the white video, and are combined to form a simultaneous color TV signal at the output of adder 2.

To visualize the content of the transmitter output, the video-frequency spectrum of such a transmission is shown in Fig. 3. From it we can see that the simultaneous color transmission consists of two basic components in monochrome and color. The monochrome video is equivalent to that in present-day black-and-white broadcasts and results from scanning, brightness, and picture detail information modulated upon the video carrier. The color component consists of a color carrier (approximately 3.58 mc) and sidebands as shown in Fig. 3. These result from phase (hue) and amplitude (saturation) modulation on the color carrier which is determined by the color content of the televised scene.

Over a part of the spectrum, the white video and the color video components appear to interfere. In early systems of this type they actually did interfere, with resultant degrading effects in the received picture. By choosing the color subcarrier frequency in correct relation to the horizontal

scanning frequency—approximately 15,750 cycles—it is possible to cause the color and white sidebands to be interleaved, resulting in a minimum amount of interference. This is known as dot-interlace.

An important feature of the NTSC color system is known as constant-luminance sampling, which results in reduction of the effects of interference to the color subcarrier. This and other features of the system are extremely important in the reception of satisfactory color pictures. However, we are treating only the basic ideas of the system, and a detailed discussion of constant luminance will be left to future articles.

The NTSC color receiver

Up to the point of the video detector, the circuit of the color receiver is very much the same as the present-day black-and-white TV set. Scanning frequencies are approximately 30 frames per second and 525 lines per frame as in existing black-and-white standards.

The signal at the output of the video detector contains the frequency components shown in Fig. 3, that is, the video black-and-white information 0-4 mc and the modulated color subcarrier (3.58 mc and sidebands). The process of using this information to make a color picture which is an accurate reproduction of the televised scene is substantially the inverse of what is done at the transmitter. In a typical NTSC system color receiver (shown in block diagram form in Fig. 4) the second detector video signal is amplified and fed to the kinescope as in the present day black-and-white receiver. This is known as the brightness channel. This portion of the signal contains all the electrical information necessary to describe the brightness or black-and-white components of the picture, including the fine picture detail. In order to extract the color information that is contained in the composite video signal at the video detector, the detector output is also fed through a 2-4 mc band-pass filter to the receiver sampler. At the input of the receiver sampler are frequency components associated with the color subcarrier. Since the phase of the color carrier is determined by the hue of the televised picture, in converting these phase changes back to useful video information the receiver sampler is actually a phase detector. A local oscillator in the receiver which is synchronized to the transmitter is used in conjunction with the receiver sampler to supply the comparison signal for the phase detectors. The delay line shown in Fig. 4 provides phase shifts for the color subcarrier frequency which corresponds to the delay line in the transmitter.

So that the receiver sampler may interpret the phase of the color subcarrier correctly it is necessary that the color subcarrier oscillator in the receiver be precisely in phase with the transmitter. This is done by transmitting a burst at the start of each line-

NOVEMBER, 1953

To learn about television the hard, but least expensive way, we established a closed-circuit TV system in the city of Minot, North Dakota, on July 26, 1952. To the best of our knowledge, the system was original and the first to be established in the United States. The operation differed from the conventional community antenna system in that all programs were originated locally. We are 510 miles from the closest TV stations (Minneapolis-St. Paul).

An average of nine hours per day of program service was offered to subscribers daily except Sunday. It was originally established to supply receiving sets located in stores throughout the business district. Later the system was expanded to the residential area. The area served was limited to the route of the cable extending to the baseball park, college football field, and school and college basketball gymnasiums.

We originally established the closed-circuit system to give our staff experience in local program production. Our staff of engineers and program personnel were totally inexperienced in television, and everyone had to learn from scratch. John Martin, prominent New York TV director-producer was hired, and the first five weeks of operation was under his supervision.

The \$12,000 we invested in our closed-circuit operation already has paid dividends. When we went on the air with KCJB-TV April 4, a great number of people told us that our production was excellent. Our technical and program staff operated like veterans. Our transmitter has not been off the air for more than 60 seconds since our initial telecasts. We are doing an unusual amount of local programming for a new station. We are operating 7 1/4 hours daily, from 3:45 pm until 11:00 pm seven days weekly, and approximately half of this

•President, North Dakota Broadcasting Co., Minot, N. D.

NOVEMBER, 1953

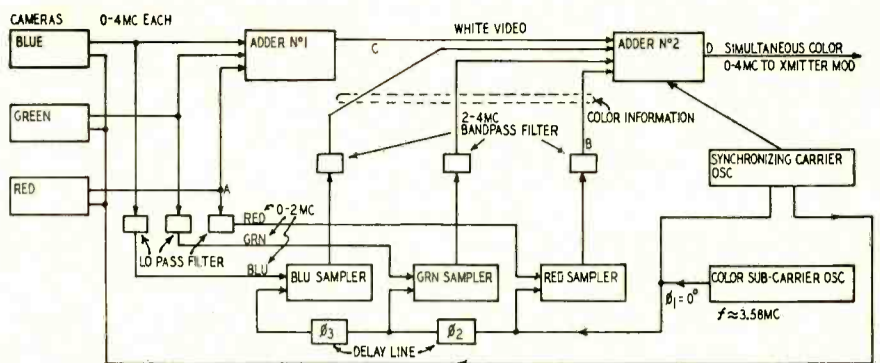

Fig. 1—Basic simultaneous color television transmitter uses three cameras.

scanning interval. This consists of a sample 3.58-mc color subcarrier generated in the transmitter. A comparison of the standard black-and-white video signal with the NTSC color signal viewed on an oscilloscope at a line-frequency sweep rate is shown in Fig. 5 to illustrate the nature of these color-synchronizing bursts. This burst is in phase (0°) with the transmitter subcarrier oscillator (approximately 3.58 mc), and is separated from the composite video signal in the receiver. The burst, separated from the composite video signal, is used in establishing two continuous wave signals of color subcarrier frequency, having a 90° phase displacement from each other. These two signals are generated by a quartz crystal oscillator whose exact frequency is controlled by a reactance tube. The reactance tube derives its control information from an error signal proportional to the difference in phase between the transmitted burst and the local crystal oscillator output. This latter circuit is a conventional a.f.c. system.

The outputs of the receiver samplers consist of video information which is a function only of the hue and saturation of the televised image. These signals are applied to the tricolor kinescope as shown (Fig. 4), and combined with the black-and-white information to produce a color picture which theoretically contains substantially the quality of detail and tonal gradation of black-and-white TV pictures received on present home receivers, but with the additional color information.

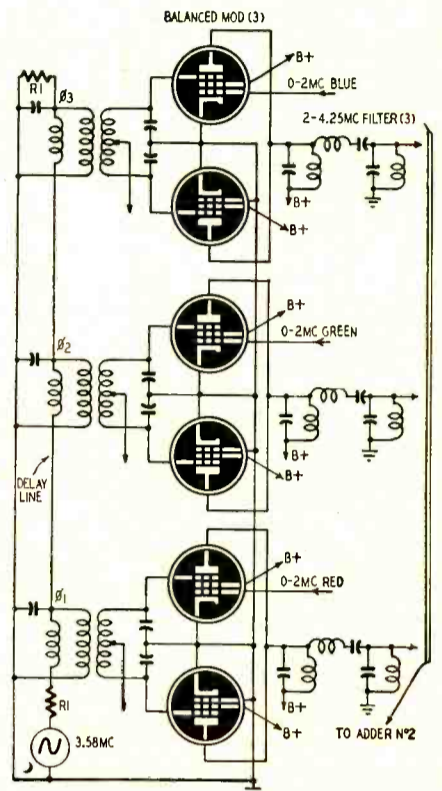

Fig. 2—Sampler contains oscillator, delay line, and 3 color modulators.

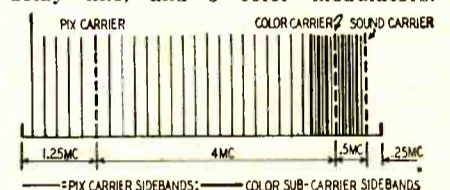

Fig. 3—Color video frequency spectrum.

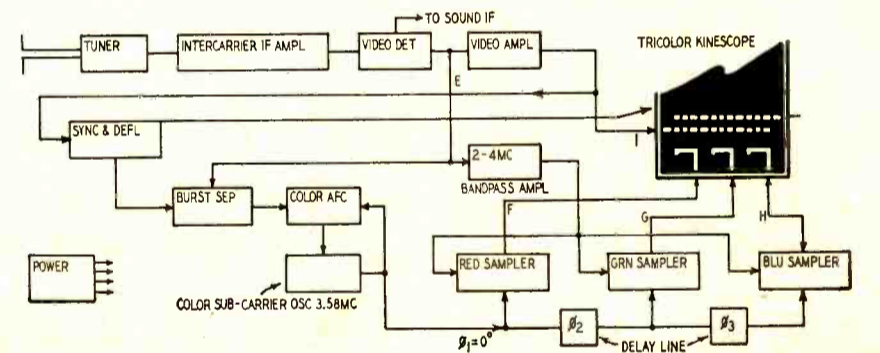

Fig. 4—Block diagram of a typical NTSC system basic color television receiver.

time is filled with local programming and live talent.

We are now using our RG-11/U coaxial cable, from our old community antenna system, in certain areas as a remote broadcast loop. For example, we are televising the local baseball games. Instead of following the usual procedure of microwave operation we hook our camera chain on the end of this line and get excellent quality to the transmitter. We use one camera to cover the baseball games and are doing it successfully. All games are sponsored at double the price of our AM games and the sponsors are very happy.

The only portion of our community antenna system which continues in operation is the portion of the cable used for remote pickups. We no longer charge the original subscribers for the service, since they can get the same broadcasts on the air.

We feel that we will have recovered our entire investment in the closed circuit just from our sports events this year. If we had not had the experience and the facilities installed, we would not have been able to televise the baseball games or basketball games this past spring and summer.

There were numerous program ideas which after having been tested on closed circuit were abandoned because they proved to be impractical either from a standpoint of production cost or lack of interest by advertisers.

We were able to use our closed circuit to interest civic officials and college and high school administrators. As a result, the schools now use five half-hours each week on KCJB-TV and are doing an excellent job of producing programs for themselves.

We are giving consideration to establishing community antenna systems in one or two cities in our fringe area at some later date. Now that we know what and what not to do, we believe that, through the use of closed circuits, we can increase our circulation—which

is badly needed in this area due to the sparse population. We are also considering a plan whereby sports events, after this season, may be confined to paying customers on a closed-circuit system. The determining factor will be the attendance figures at baseball games this past summer and basketball games this fall. Schools would be paid on a royalty basis, based on the number of television receivers connected to the system.

Prior to opening KCJB-TV, we had a total staff of nineteen persons operating KCJB Radio. The staff has been increased to the extent of only four persons—three of the four are technicians. A staff of three covers the sports events: one engineer, one cameraman, and one announcer. These games are simulcasts on radio and TV. Commercials are inserted at the studio, using a second camera chain.

We believe that this market will support one television station, but we do not see how a market much smaller than Minot, North Dakota, could support a television station. Minot has two radio stations operating on regional channels and one excellent daily newspaper with a circulation of 24,000, plus a weekly newspaper.

Our TV operating cost will average approximately \$10,000 per month. Our total installation costs will be a little less than \$200,000. We have erected a 600-foot tower on Signal Hill, approximately 15 miles south of Minot. The point of radiation is approximately 900 feet above average terrain. We have a 5-kw transmitter on channel 13 with an effective radiated power of approximately 28.9 kw. We estimate that there are approximately 15,000 television sets in use at this date. We believe our market potential will be 40,000 sets and this is expected to be accomplished within two years. We have great expectations for our station. Our experience with closed-circuit TV paid dividends.

END

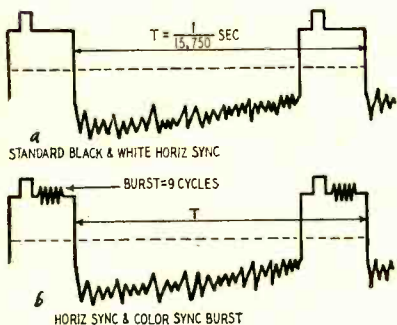

Fig. 5—Comparison of the standard video signal with the NTSC color signal.

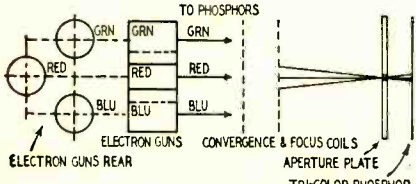

Fig. 6—Tricolor kinescope for NTSC color receivers has three electron guns.

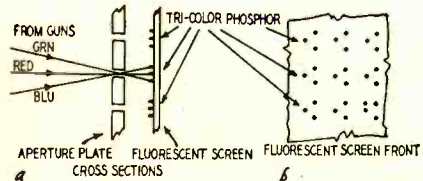
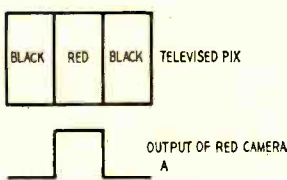

Fig. 7—View of phosphor deposits on fluorescent screen and aperture plate.



One type of the RCA tricolor kinescope, used in conjunction with the development of NTSC type color receivers, contains three separate electron guns (Fig. 6). The individual structure of these electron guns is similar to that in the conventional black-and-white kinescope. The electron beam formed by each gun is focused and caused to converge so that the three beams pass through holes in an aperture plate placed in front of the specially deposited fluorescent screen. Three primary color phosphors are deposited on the screen in the manner shown in Fig. 7. The converging electron beams pass through a hole in the aperture plate and each beam strikes and lights up only one phosphor dot. The holes in the aperture plate correspond to picture elements, and each group of three phosphor dots is arranged so that it is directly in front of a hole in the aperture plate. Thus the three converging electron beams will light up their correct phosphor at any point on the screen. Tricolor tubes currently use aperture plates with approximately 600,000 holes. These microscopic holes are made by a photographic etching process.

The convergent electron beams are deflected in much the same manner as the single beams of a conventional kinescope. Special techniques are required to maintain accurate convergence of the three electron beams (red, green, and blue) at every point on the raster so that the red gun will always light only red phosphor, the green gun the green phosphor, and the blue gun blue. The video signals are applied to the tricolor kinescope in the receiver of Fig. 4, by paralleling the control grids and applying the black-

transmission over the air.

In the receiver the second detector signal is similar to the adder 2 output in the transmitter. The brightness and hue information are then separated. The color carrier is fed to the receiver samplers, and the red sampler of the receiver in this case will supply maximum output during the red color interval since its phase is 0° . The blue and green samplers give negative outputs during this interval, and thereby cancel the brightness signal at the blue and green grids so that only signals on the red gun grid and cathode add to produce a red bar on the screen. The action of the system for the other primary colors, green and blue, is the same. When a secondary color such as yellow is to be televised then both the red and the green cameras and subsequently the red and the green guns of the tricolor kinescope operate simultaneously. The red and the green phosphors therefore light simultaneously and the eye interprets the color correctly as yellow. When the picture element to be televised is white, the three cameras are picking up the red, the green, and the blue components and the transmitter samplers act to cancel each other out so that only information is left in the brightness channel. In other words, when white is televised the color sub-carrier becomes zero. The white video is transmitted to the receiver, and since there is no color signal in the video detector output only the brightness channel of the receiver is active and each gun is lit with equal signals appearing at the control grids. The three phosphors light simultaneously, producing what the eye interprets as a white picture on the screen.

TUBE FAILURES in TV RECEIVERS

JOHN B. LEDBETTER*

A LIST of expected tube failures can save time in servicing and reduce inventory requirements. Whether you are an old-timer in television receiver servicing or have just entered the field, you have noticed the tendency of certain types of tubes to become weak or burn out more rapidly than others. Other types may become gassy, leaky, microphonic or intermittently shorted, but seldom burn out. Have you ever thought of the time which could be saved if each tube type could be "catalogued" with its most likely or expected tube failures? If such traits can be considered as average or typical, such a list not only would save servicing time but would be a valuable aid in rearranging or modernizing your tube stock.

The following list of tube failures has been compiled with this thought in mind.

1. Tubes most likely to burn out: The low-voltage rectifiers (5AX4-GT, 5U4-G, 5Y3-GT, 5Z4, and similar types). These tubes supply high current and run very hot. They also may weaken fast, especially when the load current approaches the rectifier's maximum rating. Check for a weak low-voltage rectifier as well as a weak r.f. oscillator if the latter becomes sluggish or drops out of oscillation on the higher channels.

The horizontal damping tube (5V4-G, 6AS7, 6BY5-G, 6W4-GT, etc.) also is high on the list. In series-filament receivers, tubes like the 25L6-GT, 35L6-GT, 25Z6-GT, 50B5, and 50L6-GT have a tendency to burn out before other types.

2. Tubes most likely to become weak: Tubes in the sweep circuits (horizontal oscillator, horizontal output, vertical oscillator, and vertical output; types 6SN7-GT, 12SN7-GT, 6K6-GT, 6J5, 6BG6-G, 6CD6-G, 6BQ6-GT, etc.). Next in line are the high-voltage rectifiers like the 1B3-GT, 1X2-A, and 2X2-A.

3. The most critical tubes: The r.f. oscillator. Tubes like the 6J6, 6F8, and 7F8 are notorious for going bad or becoming unstable on the higher channels. Other types to watch are the 6AB4, 6X8, 12AT7, and 12AV7. (The usual result is drifting, or mushy sound, or complete loss of sound on one or more high-frequency channels. The picture may or may not be affected). Oscillator control or automatic-frequency control tubes (6AL5, 6AC7, 6SH7, etc.) can be very critical (especially

the 6AL5). These tubes may check good but still fail to function in the receiver.

4. Tubes most likely to become gassy: The horizontal output (6BG6-G, 6CD6, 6BQ6-GT, etc.); the a.g.c. amplifier (6AL5, 6AH6, 6AT6); and the sound discriminator (6AL5). Replace these for a check even though they test good.

5. Tubes which often short or become leaky: The video i.f. amplifiers (6AC7, 6AG5, 6AU6, 6BC5, 6CB6); the video amplifiers (6AG7, 6AU6, 6CL6, 6K6-GT, 7C5, 12AU7, 25L6-GT); the r.f. amplifier (6AU6, 6AG5, 6AK5, 6AB4, 6BC5, 6BK7, 6BQ7, 6BZ7, 6J6). Test on a good mutual-conductance tester while tapping gently with a pencil eraser or the fingers.

6. Tubes most likely to become microphonic: The r.f. oscillator or video i.f. amplifiers. The 6J6 is especially critical in this respect. Noise and vibration usually develops an internal mechanical oscillation which results in a high-pitched squeal or sustained howl. The 12AT7 is next in line, with the 6AC7 a close second. (A lead weight on the tube will provide mechanical damping in all but the most serious cases). Occasionally, a microphonic 6AU6, 6AG5, or similar type will show up in the video i.f., sound i.f., or audio section.

Other tube failure causes

1. Ceramic capacitors. When a TV set is less than a year old, many of its tube failures can be traced to a defective ceramic-type capacitor. A weak, gassy tube or a burned-out resistor often is the result of a temporary breakdown in one of these capacitors. In many sets, they will become leaky or break down only when the set is on. When it is off, they may pass all tests. A faulty capacitor also may cause intermittent operation of picture or sound, or both.

Suggestions: One method of locating a defective capacitor is to apply heat (i.e., with a floodlamp, sunlamp, etc.) to the suspected unit. Use extreme care

and definitely do not use this method if any of the leads near the capacitor are made of plastic. Heat will melt or break down the insulation and cause more troubles. Replacing the suspected capacitor is the most logical and time-saving method.

2. Insulation breakdown. Many of the later-model sets use plastic insulation on transformers, wiring, terminal connections, and other parts. Under certain conditions, breakdown or arcing will occur.

3. Terminals. Poorly soldered or badly spaced terminal lugs sometimes short to ground and burn out a resistor, peaking coil, or other component, or weaken it so that later circuit defects will cause a complete breakdown. More often than not, such a condition, even temporary, will cause permanent damage to a tube.

4. Tube sockets. Arcing from tube socket pins to ground (or from pin to pin) is more likely to occur in the sweep or high-voltage circuits. Replacement with high-quality, low-loss sockets and high-voltage terminal boards will correct this trouble. In every case where arcing or breakdown has occurred in the plate circuit (especially in the sweep tubes), replace the plate-dropping resistor and give the tube a thorough test for intermittent or direct shorts before operating the receiver. An intermittent tube could cause the original trouble to recur.

While the above list represents the most common tube weaknesses, it is only a basic presentation. You can keep it up-to-date by including newer tubes as they appear. (Generally tubes which perform the same circuit functions will be subject to similar weaknesses). As your experience with special circuits widens, you can expand the list to include practically every tube in current use. This list will prove to be a valuable tool. END

Figures 2, 3, and 6 appear through the courtesy of RCA. Figures 1, 4, 5, 7, 8, 9, and 10 first were published in G-E's service publication "Techni-Talk." They appear by courtesy of G-E.

TV TROUBLES CAUSED BY DEFECTIVE TUBES.

Fig. 1—Burned out or shorted video i.f.

Fig. 2—Poor interlace; defective sync-amplifier or vertical oscillator tube.

Fig. 3—Burned out or shorted r.f. amplifier.

Fig. 4—Cathode-heater short in video i.f., video detector, or video amplifier tube.

Fig. 5—Defective cathode ray tube.

Fig. 6—Gassy or short circuited horizontal automatic frequency control tube.

Fig. 7—Shorted horizontal AFC tube.

Fig. 8—Defective horizontal AFC tube, or horizontal discriminator transformer.

Fig. 9—Barkhausen oscillation, caused by defective horizontal output tube.

Fig. 10—Short circuit in picture tube.

*Engineering Writer, Convair. Material in this article abstracted from the author's book, *TV and You*.

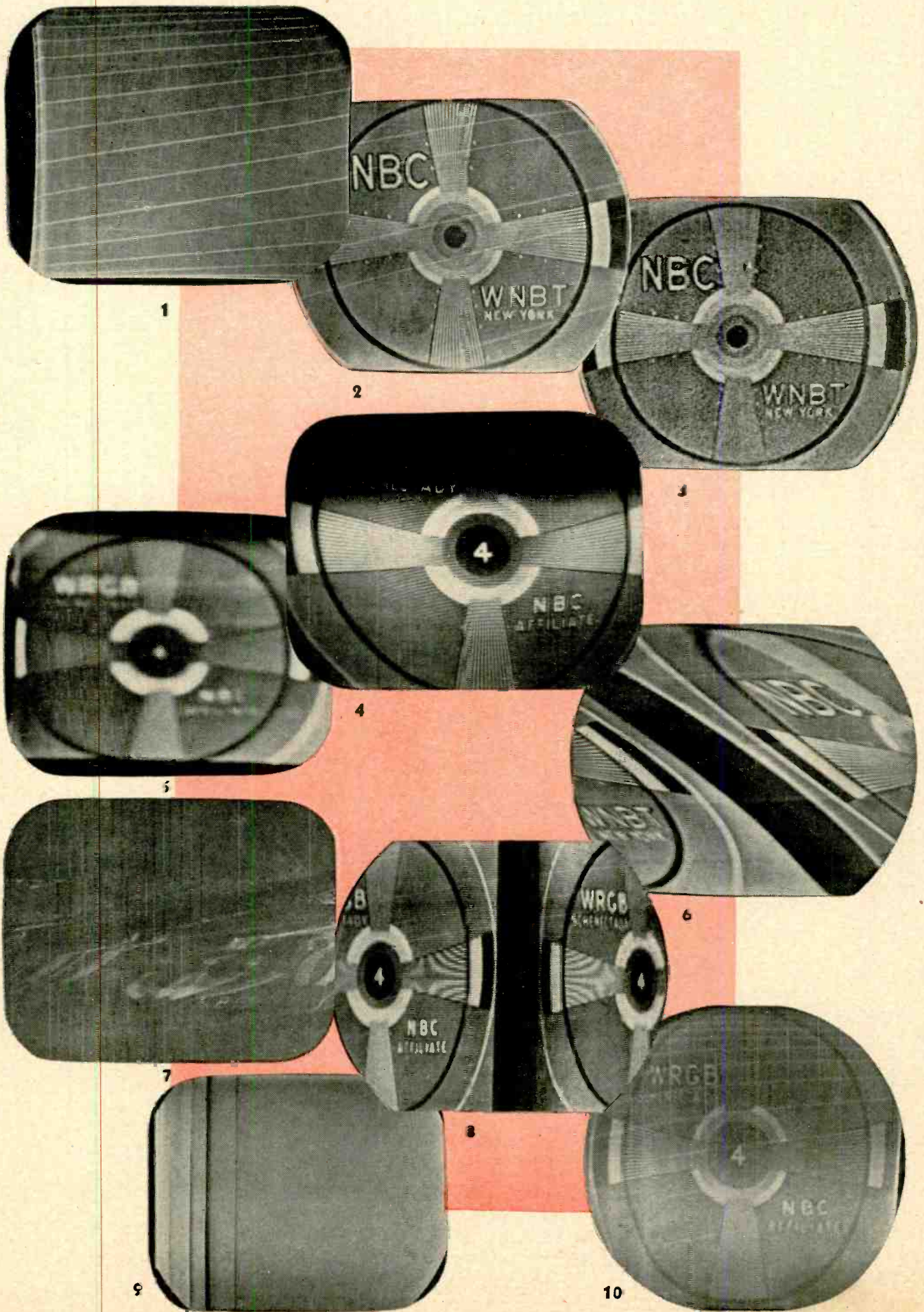

From the original "La Télévision? . . . Mais c'est très simple!" Translated from the French by Fred Shunaman. All North American rights reserved. No extract may be printed without the permission of RADIO-ELECTRONICS and the author.

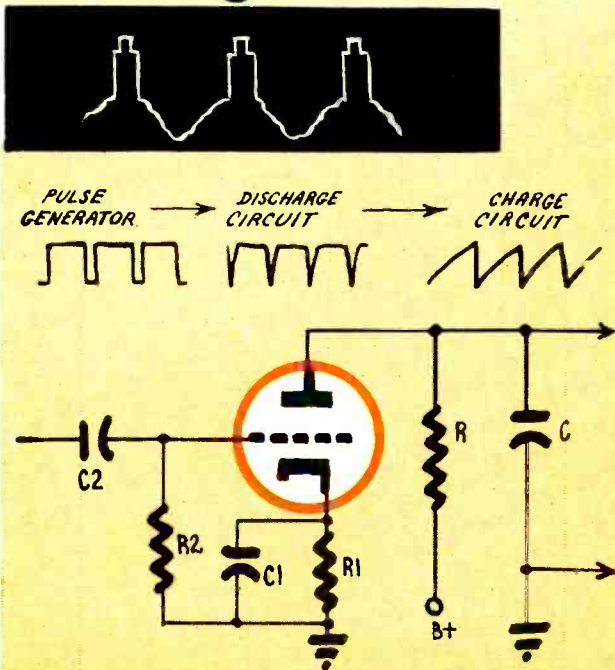
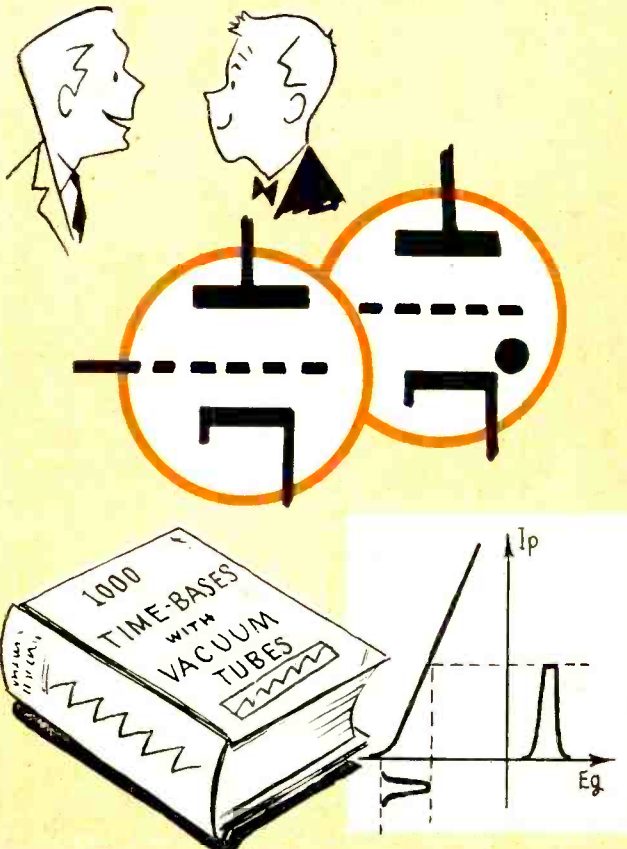

TELEVISION... It's a cinch

By E. AISBERG

Seventh conversation, first half: Time bases with high vacuum tubes.

The "Will" time-base

WILL—You sort of broke a bad habit when you said at the end of our last conversation that thyratron time-bases are really used by modern TV receivers . . .

KEN—Well-l, I may have stretched things a little. They *are* currently used in European television receivers. And they have been used here. But I can't think of a manufacturer using them now. After all, gas tubes have a rather short life . . .

WILL—That's right! I can't see that using thyratrons is a good idea, anyway! Ordinary vacuum tubes would do the job just as well. I've worked out a very simple scheme that will make thyratron time-bases look silly!

KEN—Well, let's hear about it! But I warn you in advance that plenty of inventors have designed time-bases with high-vacuum tubes, long before you!

WILL—As usual! There's never anything left for me to invent. Why wasn't I born 50 years ago? But take a look at this time-base diagram. This is just the "Will" circuit—not the Williamson. It uses one vacuum tube—in this case a triode. It must be one with high mutual conductance and a sharp cutoff. Then we bias it to the point where the current is just cut off, so that a positive voltage pulse on the grid will produce a rather large plate current.

KEN—I can see what you are trying to do.

WILL—It ain't hard. I have a charging circuit made up of resistor R and capacitor C , same as in the thyratron circuit. The cathode-anode space of the tube is the discharge circuit. Normally the cathode resistor R_1 (decoupled by C_1) biases the tube just about to cutoff. During cutoff time capacitor C becomes charged, at a rate set by resistor R and capacitor C . Then I apply positive synchronizing pulses to the control grid through capacitor C_2 . As each pulse arrives, plate current is established, permitting capacitor C to discharge itself rapidly through the tube. What do you think of the idea. I'll be surprised if you haven't got at least a few objections!

KEN—No, Will, your lineup will work O.K., *if* the sync pulses arrive at the receiver with roughly constant amplitude. It would work fine with a receiver near a transmitting station. But in a fringe area, the synchronizing signals don't all arrive with the same strength and the discharges would be produced at a variable frequency, which would deform the pictures. Another thing—when your station isn't transmitting, you get no sweep. Then the spot stays in the same place on the screen and destroys the phosphor there.

WILL—If I get you, my idea isn't worth too much?

KEN—No, I think your hookup is good. Only, instead of producing the discharges by applying the pulses direct to the grid, it's better to use locally generated pulses, with their frequency and amplitude both carefully regulated. Then you can control them with the sync pulses, and trigger your discharge tube reliably.

Old idea in a new role

WILL—In other words, you want to introduce scientific organization by separating the functions. The resistance-capacitance charge circuit does its part of the work. The tube acts as the discharge circuit. Some mysterious device puts voltages on the grid to trigger the pulses. And finally, the sync pulses from the transmitter regulate the frequency of the pulses produced by the mysterious device?

KEN—Everything really is just about the way you put it.

MEASURING FIELD-STRENGTH FOR TV

Antenna installation is simplified with TV meter.

By Engineering Staff, Scala Radio Co. **Fig. 1—Complete field-strength meter.**

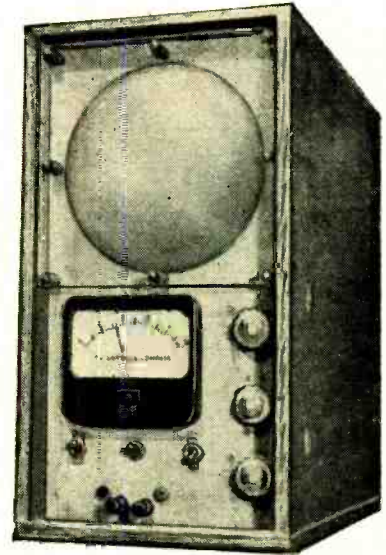

TO get the complete information on field strength needed for fringe-area and master-antenna installations, you need an instrument that displays picture quality and indicates field strength in microvolts. This is because there may be ghosts which can be eliminated by using the right kind of antenna. If the field-strength meter does not show picture quality, two strong ghosts may add in phase or out of phase, causing the field-strength indication to be entirely misleading. With the picture visible, the operator sees what he is measuring, and is not easily misled.

Noise (snow) can also lead to incorrect conclusions, unless the picture quality is determined at the time of the field-strength measurement. Although some noise information can be obtained from headphones energized from a narrow-band circuit, satisfactory data can be obtained only by quantitative measurements in wide-band circuits tuned to the desired channel. The reason for this limitation is that noise is not always uniformly distributed with respect to frequency. In many cases noise which interferes with television reception is resonant at a certain frequency, or over a limited band of frequencies.

An instrument designed to present the required information and to provide operating features for convenient application and accurate indication is illustrated in Fig. 1. Technical details which might be overlooked by the beginner, but which are required to obtain complete information, are developed later in this article.

The field-strength meter is constructed from a small TV chassis and a conventional field-strength meter providing relative field-strength readings. A Simpson TV antenna compass was used in this case. The TV receiver chassis is removed from its cabinet and

mounted in a carrying case with a recessed panel, which protects the controls from damage under practical field conditions. For purposes of toughness and utility the carrying case is constructed of plywood.

Quarter-inch transparent plastic sheet is mounted over the face of the 7-inch picture tube, as seen in Fig. 1. This transparent protective sheet is superior to glass for knock-about use in the field. The speaker is mounted on the side of the carrying case and holes are drilled in the side of the case to provide egress for sound, as shown in Fig. 2. The constructor will find it necessary to mount the speaker at a reasonable distance from the picture tube to avoid raster distortion due to the speaker field. It may be necessary to put a ferrous shield over the neck and flare of the tube, as seen in Fig. 3. This shield must be grounded to the chassis, to avoid shock.

Circuit considerations

The front-panel facilities seen in Fig. 1 provide for viewing the quality of the picture, measuring the relative field strength of the video signal, indirect measuring of the absolute field strength, monitoring the audio signal, viewing the waveshape of the video signal with an auxiliary oscilloscope, and for measuring the a.g.c. voltage with an auxiliary v.t.v.m.

The circuit diagram shown in Fig. 4 provides for both 75-ohm unbalanced and 300-ohm balanced input. This feature is very desirable for absolute measurement of field strength, since standard signal generators with calibrated attenuators and an output meter work into 75-ohm unbalanced loads. Although the technician can use a balun between the output of the signal generator and the antenna input terminals of the field-strength meter, it is difficult

in practical work to avoid appreciable standing waves in the conversion arrangement. This leads to inaccuracy in the microvolt measurement. When field-strength measurements are read on the meter from a 300-ohm balanced antenna system, and this relative field strength is measured by applying a signal from a standard signal generator, a correction factor must be applied to the calibrated attenuator indication of the generator because of the differing impedances. This correction factor is easily derived, as explained later.

The audio signal must be monitored at the time of the relative field-strength measurement, because—due to changes in propagation, or defects in the distribution system—the video voltage may be much larger than the audio voltage, or vice versa. When such situations are encountered, the technician must take steps to correct the defect, either by relocating the antenna, or by using a more suitable type of antenna (such as one with a narrower lobe), or by correct alignment of tuned circuits which may be discriminating against the sound or picture signal.

It is desirable to be able to view the composite video signal on an auxiliary oscilloscope, because the amplifiers used in distribution systems may be improperly adjusted, with the result that the sync tips are limited or the camera signal is limited, or both. In such case, the technician knows the cause of the trouble and does not waste time looking for trouble in the wrong places. The experienced technician can view the composite video signal on a d.c. scope and tell immediately whether the system amplifiers are performing correctly or not. A pair of binding posts are provided at the bottom of the panel for connection of the oscilloscope.

The technique of checking the video signal for compression or clipping, which leads to sync buzz in the sound,

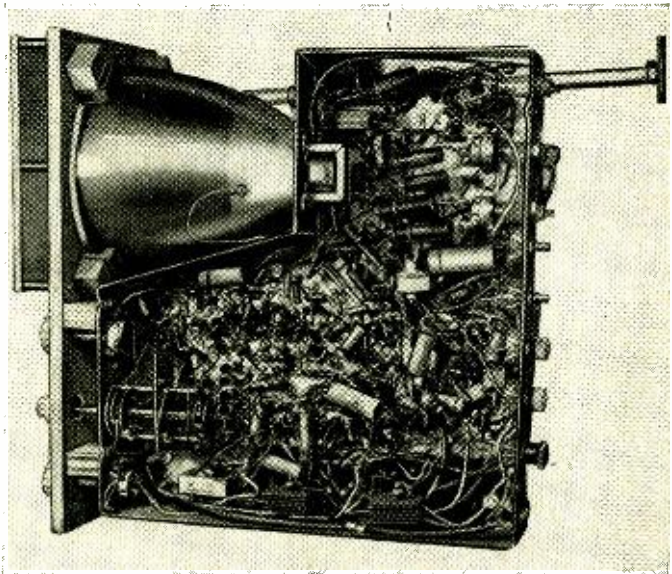
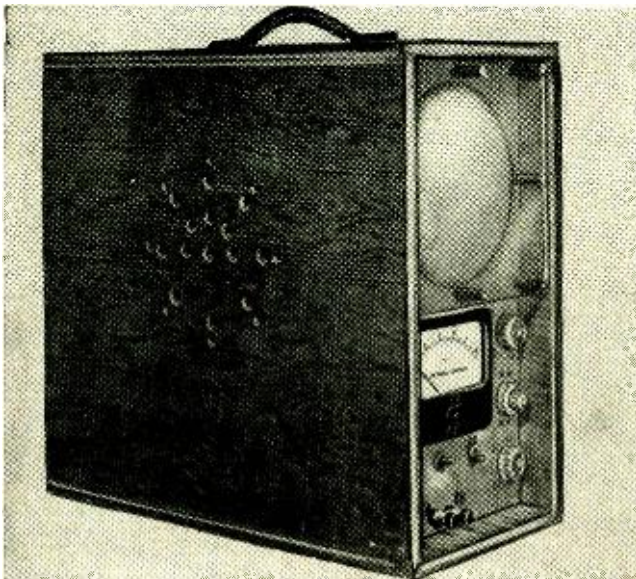

Fig. 2 (Above)—Side view of carrying case. Fig. 3 (Right) Underside view. Shield over neck of C-R tube prevents distortion.

black or white saturation of the picture, and unstable sync action, is illustrated in Fig. 5. As transmitted from the TV station, the picture signal has a maximum modulation of 85%, which leaves 15% of unmodulated carrier at all times for intercarrier heterodyning of the sound signal. If this margin of carrier is reduced by compression of the signal, or if from the same cause the sync tips are limited, cross-modulation of sound and picture occurs in the signal circuits of the receiver. This intensifies the sync-buzz component in the sound signal beyond the ability of the ratio detector to separate the AM disturbance from the FM sound component.

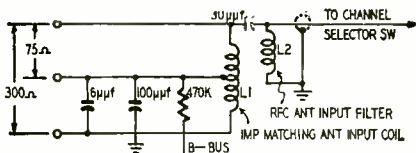

Fig. 4—Antenna input has provision for proper match to 75-ohm unbalanced and 300-ohm balanced line and antenna.

A d.c. scope is required to make a complete check of the signal, because the 15% margin of picture carrier cannot be observed on an a.c. scope, as illustrated in Fig. 5. Although a v.t.v.m. can be used in combination with an a.c. scope to check the percentage of modulation of the signal from the distribution amplifier, the determination can be made more directly and ac-

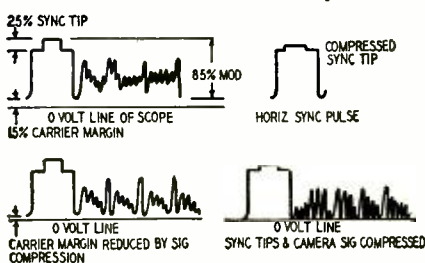

Fig. 5—Characteristics of a video signal, which can be checked with a scope.

curately with a d.c. scope which indicates the a.c. and d.c. components of the signal simultaneously.

As seen from the circuit diagram (Fig. 6), the relative field strength meter is energized from the output of the video amplifier. This field-strength indication will rise or fall somewhat in accordance with line-voltage variations—hence the need for measuring the line-voltage value at the time of the field-strength measurement.

The switches provide front-panel control for disabling the a.g.c. circuit of the receiver, for switching in a meter multiplier to extend the range of the relative field-strength readings, and for removing the meter completely from the video circuit when oscilloscope tests are desired.

The a.g.c. system of the instrument must be disabled during the measurement of field strength, since the meter is energized from the video amplifier, and the normal a.g.c. action of the receiver largely swamps out the meter indication. Accordingly, the switch is thrown to A.G.C. OFF for relative field-strength readings. A meter multiplier (present in the original meter assembly) is used to accommodate wide ranges of field-strength variation. Since the meter loads the video circuit somewhat, it is desirable to be able to switch the meter out of the circuit for inspecting the video-signal waveform with an auxiliary oscilloscope. It is useful to be able to measure the value of the a.g.c. voltage in the receiver with a v.t.v.m., because this reading can be compared with the value developed when the receiver is energized from the distribution system; abnormal operation is sometimes encountered due to the inability of the receiver a.g.c. circuits to accommodate the high signal level from the distribution amplifiers. Receiver readjustment is facilitated by measurement of both video voltage and a.g.c. voltage. Relative field-strength readings can be obtained from the a.g.c. voltage indication.

Signal-to-noise ratio

By detuning the field-strength meter to one side of the picture, the relative field strength of the noise can be measured. With the picture tuned in, the relative field strength of noise plus video signal can be measured. From these two measurements, the signal-to-noise ratio is easily determined. However, the operator must be careful to not be misled by resonant noise. Resonant noise can be detected in most

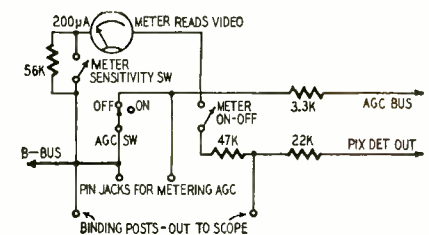

Fig. 6—Diagram of field-strength meter.

cases by watching the screen of the picture tube and listening to the sound as the tuning adjustments are made. A comparative check for resonant noise can also be obtained by making an independent measurement on another channel which develops approximately the same relative field strength of video plus noise voltage. If the technician finds that he is concerned with resonant noise, the determination of signal-to-noise ratio cannot be carried out as described above; instead, a qualitative judgment must be made by merely viewing the picture and listening to the sound.

The operator will often find that maximum signal strength does not always correspond to the best picture, because two in-phase ghosts will develop an abnormally large but unusable video signal. In the same manner, standing waves on the antenna input signal can develop abnormally large video voltages having poor quality. When installing an antenna under dif-

ficult conditions of reception, it is good practice to first try the best possible antenna; then, if the picture quality and field strength are entirely satisfactory, a less expensive and elaborate one can be tried. This procedure is preferred to starting with a poor antenna and working up, as it usually saves time.

The operator should also measure the field strength and view the picture obtained from the lead-in system alone, with the antenna completely disconnected, since line pickup can cause leading ghosts and poor picture quality which may, in error, be blamed upon other parts of the system. By keeping such landmarks clearly in mind, much lost time can be avoided.

Having determined that the lead-in system is operating satisfactorily, the relative field-strength readings of signal and noise combined with observation of picture and sound quality will usually indicate to the experienced technician the approximate type of antenna which will be required for satisfactory reception. Such knowledge is gained from experience, and avoids the necessity for methodically trying out a series of antennas.

Absolute field strength

Measurement of the field strength in microvolts is accomplished (when considered desirable) by energizing the field-strength meter from a standard signal generator having an output meter and a calibrated attenuator. Having made the substitution, the tech-

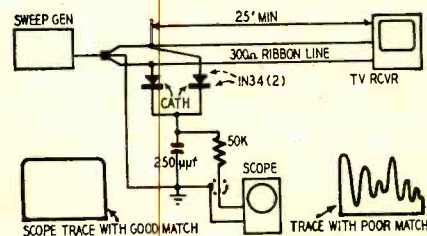

Fig. 7—Determining impedance match of twin lead to receiver with balanced crystal probe, scope, and generator.

nician adjusts the calibrated output generator until he gets the same peak-to-peak reading at the video detector that he got with the TV transmitter signal. Since the meter provided with the instrument indicates r.m.s., it cannot be used for this purpose. Although the two signals would have the same peak-to-peak value, they would not have the same r.m.s. value. This peak-to-peak voltage can be compared by simply measuring the energy at the terminals provided in the front panel with an oscilloscope or peak-to-peak v.t.v.m.

The question is frequently asked why this measurement is not made directly on the instrument. The answer is that line-voltage variations in the field will cause inaccuracy in measurement. Furthermore, it is found that because of tube aging in the instrument, a calibration in microvolts is not permanent. For this reason, it is preferred to conduct field tests in terms of relative field strength, and to occasionally convert

the relative reading into an absolute measurement in microvolts, if required.

If a receiver having both 75-ohm and 300-ohm input terminals is used in the field-strength meter, the measurement of field strength in microvolts is facilitated, since an impedance-matching device is not required between the output of the signal generator and the input of the field-strength meter. However, there are several pitfalls which may lie in wait for the unwary. For example, it must be remembered that the receiver circuits are voltage-operated, and if the coupling circuits used in the input system of the receiver cause a different voltage to be applied to the grid of the r.f. amplifier tube when the 75-ohm input terminals are used, a suitable correction factor must be applied. For practical work, the service man should accept the advice of the receiver manufacturer in this regard.

The percentage modulation of the signal and recognition of the difference between r.m.s. and peak-to-peak voltages must not be overlooked. The video signal voltage indication on the field-strength meter is necessarily based on the peak-to-peak voltage of the video signal. The output from a standard signal generator, on the other hand, is conventionally rated in r.m.s. voltage. Hence, the r.m.s. voltage output from the generator must be multiplied by 2.83 for proper comparison with the TV signal voltage. The output from the standard signal generator is usually modulated 30%, and it is this modulated component which is measured on the field-strength meter. Since the TV signal is customarily modulated 85% (as on a test-pattern transmission), the differences between these modulation percentages must be taken into account.

The correction factor for 30% modulation is practically unity; that is, the output voltage from the signal generator must be divided 85/30 to correct for the different percentage of modulation, but the output voltage from the signal generator must also be multiplied by 2.83 to correct for r.m.s. vs. peak-to-peak voltages. For other percentages of modulation the correction factor will be some figure other than 1.

Impedance matching

Impedance mismatches are a source of difficulty in several ways. First, the rated input impedance of a receiver is subject to manufacturing tolerances and to disturbance during service procedures. In a long line used in a master distribution system, poor matches lead to poor picture quality because of the time-lag and multiple reflections which may occur. When plugging a line into a receiver for tests, the operator should use 300-ohm jacks rather than switches which disturb the line impedance. The jack should be mounted as close to the front end of the receiver as practical, to avoid unequal lengths of line in the tests. These are typical refinements in technique, some of which are more important than others, but all of which will be taken into account by the professional service tech-

nician. Of the various mismatch considerations, line mismatch in the master distribution system is usually most serious.

Impedance checking is a complete subject in itself, and cannot be covered in this article. However, the reader may be interested in referring to Fig. 7, which shows how a sweep-frequency generator can be used with a scope and balanced crystal probe to check for an impedance match of a line to a load, such as a length of twin lead connected to the front end of a TV receiver. The chief consideration is for the service technician to recognize the basic factors which are at work. He can then devise his own testing procedures to meet the requirements of individual jobs.

Some sweep generators provide a zero-volt reference-line function, as indicated in the sketches of traces shown in Fig. 6. The zero-volt reference-line function is quite useful in checking impedance matches, because this zero-volt line makes it possible to determine the ratio of maximum to minimum; otherwise, the technician may be in considerable doubt concerning whether the mismatch is large or small.

The reader should carefully note that a generator without a zero-volt reference-line function can be used as well, provided an extra test is made. This test consists of shorting the load end of the line which causes an extreme standing-wave pattern. The peaks and valleys of this extreme pattern exhibit the worst possible situation of mismatch; the technician can draw a pair of horizontal lines on the scope screen with a grease pencil to indicate the maximum pattern excursion for com-

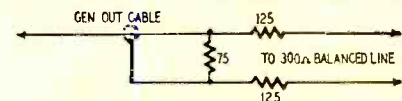

Fig. 8—Balun for impedance matching.

plete mismatch, which automatically locates the zero-volt reference line. Lesser degrees of mismatch are then easily sized up by the operator.

To acquaint himself with the various degrees of mismatch and the patterns which correspond to them, the technician will find it very instructive to terminate the line with various values of resistors, such as 10, 100, 300, 500, and 1,000 ohms. By noting the various scope patterns which result from the use of these load values, the technician will get the feel of the job, and will be able to conduct the tests with confidence.

Some sweep generators have a 300-ohm balanced output, while others have a 75-ohm unbalanced output. Since conventional twin lead has a 300-ohm balanced impedance, the operator must use a balun to drive a twin lead from a 75-ohm unbalanced generator. A suitable balun for this purpose is shown in Fig. 8. The principle of the balun is to provide a resistive pad which has approximately 75 ohms impedance looking into the pad from the generator end, and approximately 300 ohms impedance looking into the pad from the line end.

END



Fig. 1—Antenna is misoriented by 90°.

A NUMBER of localities are serviced by only one or two v.h.f. stations. In fringe areas, narrow-band Yagi antennas are often used. During the current reallocation plan of FCC, many such stations are assigned new channels. When the station frequency is changed, the narrow-band Yagi antennas give inferior results and often produce a blurred picture. Several readers have complained of reception which resembles ghosts, and have asked for dimensions so that they can modify the Yagi antennas to restore good reception. Other readers have asked for data on designing Yagis for fringe-area installation, or to replace other types of antennas.

The spacing between the elements is not as critical as the element lengths in Yagi antennas. Thus, complete redesign is not necessary when the new frequency is only one or two channels removed from the old. A change of element lengths will usually restore the antenna to receive clear pictures with almost the same gain as before. Table I gives the lengths of the antenna, reflector, and director for the v.h.f. spectrum. A table covering the u.h.f. band may be published in a later issue. Where a station has been changed to a higher channel it simply means cutting the antenna elements down to the dimensions given in table I. If the allocation has been to a lower channel, new rods will have to be installed.

*Author: Mandl's Television Servicing

Channel Number	Over-all antenna length (in inches) (Corrected for end effect)	Reflector (inches)	Director (inches)
2	97.2	102	93.3
3	88	92.3	84.4
4	80	84.3	77
5	70	73.6	67.3
6	65.2	68.2	62.5
7	3.2	32.8	30
8	30.2	31.8	29.0
9	29.2	30.8	28.1
10	28.4	29.8	27.2
11	27.6	29	26.4
12	26.8	28.2	25.7
13	26	27.3	24.9

Table I—Antenna, reflector, and director lengths for channels 2 to 13.

Often the antenna and reflector elements can be used for the directors, thus reducing the number of new rods which must be purchased. For the busy technician, the quickest solution is the installation of a new antenna for the reallocated station.

Another factor which can affect picture quality is orientation. When Yagi antennas are used for either v.h.f. or u.h.f., the antenna should be oriented carefully for maximum signal strength. Not only will picture quality be impaired when the antenna is not oriented correctly, but also sync stability may be affected. In some instances the effect on sync may be noticeable before picture quality suffers greatly. Fig. 1 shows reception of a strong signal with the antenna misoriented by approximately 90°. Note the beginning of picture pull as evidenced by the bending of the vertical wedges. This is the forerunner of severe horizontal instability and vertical roll.

Even with the broad-pattern characteristics of the biconicals, misorientation is a frequent cause of poor picture quality and poor synchronization. This is usually the case when the antenna is to receive three stations from one general direction. When the signals arrive over an angle of approximately 60° to 90° the antenna will be misoriented for one and perhaps two stations, with resulting pulling, weaving, and poor picture quality. A good clue is sync instability or the tendency toward pulling and weaving by one of several stations which can be received. Orienting the antenna to favor the weaker station usually solves the problem. If the trouble is present for all stations, the receiver itself will have to be checked.

Vertical linearity

In an Admiral 20T1 receiver there is very poor vertical linearity. I have tried adjustments with the controls and also replaced the vertical output tube but this did not help. Brilliance is adequate and horizontal width is all right. I checked all the parts associated with the vertical linearity control but nothing seemed wrong. I used my scope on the grid of the 6S4 tube and the waveshape seemed good. I tried the scope

across the vertical deflection coils but got a waveshape which looked like the letter S in reverse. Some vertical ringing seems to indicate that the resistors across the deflection coils are missing. Is my diagnosis correct, or what is the trouble? V. Z., Haddon Heights, N. J.

You mentioned trying a new vertical output tube, but often this trouble can be caused by the vertical oscillator tube, so you should try this tube also before making other checks. If the damping resistors across the vertical coils are open or are missing, they should be installed as shown in Fig. 2.

For proper observation of the waveshape in the vertical deflection coils, a 10-ohm resistor should be placed in series with the coils and a scope reading taken across it. Magnetic deflection is created by a linear current rise, and to produce this, a modified sawtooth voltage is used. The current flow through the 10-ohm resistor will establish the proper waveshape for viewing purposes.

Power line arcing

In our locality, channels 2, 4, and 5 are persistently interfered with by what I suspect is a corona discharge from a main power transmission line. This runs cross-country, north and south, and is located about two miles west of the receiver. From the size of the insulators, the transmission voltage is certainly in excess of 100 kilovolts. The interference is similar to auto-ignition interference but is grouped into two well-defined bands, separated by approximately one-half the picture height. These bands drift slowly up or down, and, since the stations are all in Los Angeles, it indicates that the interference is related to the local power system which is not interconnected with the Los Angeles system. I surmise that corona discharge takes place on the positive and negative swings of the 60-cycle power frequency, or 120 times a second, resulting in two bands on the raster.

If my diagnosis is correct, I would appreciate your comments regarding what can be done about the interference. There is the possibility that the antenna is coupled to the source of interference by the secondary power distribution

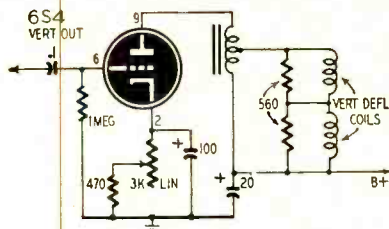
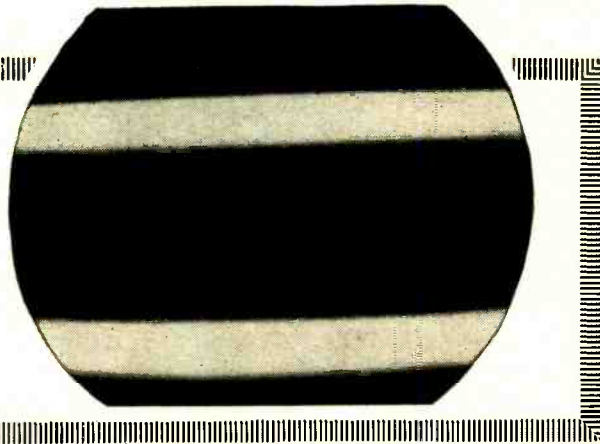

Fig. 2 (above)—Location of damping resistors across vertical deflection coils.
Fig. 3 (right)—120 cycle modulation.



line which is seldom more than 100 or 200 feet away from the antennas in this area. J. M., San Diego, Calif.

Your diagnosis of the source of interference is correct, for corona discharge at both peaks of an a.c. wave will introduce the two-bar impulse type of noise on the screen. In some investigations into double-bar interference in television receivers I ran across a complaint where two black bars appeared on the screen (Fig. 3). This was later traced to an amateur station where the filter capacitors of a full-wave supply had opened, causing heavy 120-cycle modulation of the carrier (and harmonics). Another instance was a double-bar pattern with ignition type of streaks, similar to what you described. This was traced to a local home where an ultraviolet-ray machine was in use periodically for therapeutic purposes. In one locality (embracing several blocks) the double-bar interference was present most of the time, again of the ignition type. The condition was worse during rain, which led us to suspect corona and arcing in a distribution line carrying several kilovolts. A portable battery-type radio finally seemed to indicate a transformer, because the noise became a roar in the radio near the pole on which the transformer was mounted. The matter was reported to the power company and the condition was corrected by them.

There is little you can do except report the matter to the power company. Line filters may help a little, as would a higher and more powerful antenna. The latter would increase the signal-to-noise ratio for the lower channels—where most impulse-type noise becomes noticeable in TV.

U.h.f. bowtie

Please advise me regarding dimensions of a bowtie u.h.f. antenna suitable to receive channels 51 to 67. What are the stacking dimensions for a pair of these? R. W., Easton, Pa.

The bowtie antenna is a broad-band type and if designed for the lowest channel to be received, will work for the higher channels. (This is not the case with narrow-band Yagi antennas.)

You could make the length of the bowtie 12 inches, which would cover channels 14 to 83. If you want it designed for channels 51 to 82, an 8-inch

over-all length would be suitable.

The bowtie has low gain as compared with the Yagi types. A screen reflector placed about 6 inches behind the bowtie would increase gain and improve the front-to-back ratio.

For stacking, use the same distances mentioned above for the antenna lengths. Thus, a 12-inch spacing will be approximately one-half wavelength for channel 14 and will favor the lower channels. To favor higher channels, space the stacked antennas one-quarter wavelength (one-half the dimensions given for the over-all antenna length).

Transient trap

In an Admiral 221K46 receiver I am getting vertical white bar interference. I have replaced the horizontal output tube, the damper, and also the high-voltage rectifier. I have checked the capacitors in the damper circuit with no results. I have also replaced leaky capacitors in the horizontal output circuit and still get the vertical bar interference. What could cause this? W. H., Dayton, Ohio

First, adjust the drive control below the point where left-hand stretch or center compression occurs. If the white lines still remain, obtain the following parts:

Width coil, part No. 94A4.

Capacitor, .01- μ f, 600 volts.

Resistor, 470 ohms, 1 watt.

Connect these units in parallel and insert this filter in series with the lead from terminal 4 of the horizontal output transformer to the plate of the damper-tube, pin 5, 6W4-GT. Adjust the slug of the coil until the vertical bar interference is reduced to a minimum. In some instances an omission of the 470-ohm resistor may help reduce the bar interference.

Hv arcing

Recently I cleaned the high-voltage compartment of an RCA 9PC41 projection receiver using air pressure. Since then a crackling sound comes from the high-voltage unit for about two minutes after the receiver is turned on. After warmup, an intermittent loud crack occurs, putting a flash across the screen. What is the best method for eliminating this arcing? J. O., Newark, N. J.

The fact that the crackling sound

stops after the set warms up indicates that during load the peak voltages have decreased to where no arcing or corona occurs. Evidently when you cleaned the unit under air pressure some of the wiring may have been disturbed. You should check the unit by watching the high-voltage compartment in a darkened room to see where the arcing occurs. Space the wires apart from each other and from the chassis, and avoid sharp bends. You also could use a plastic spray or anticorona dope to insulate the sections where arcing occurs.

Poor signal

I have installed a rotator on the antenna for a Philco model 90 receiver. I also had to splice a 5-foot section of twin-lead to the original lead-in. Since then reception has been poor and the picture contains considerable snow. What is the likely cause? J. O., Portland, Ore.

An open circuit probably exists in the newly installed system. It is also possible that the 5-foot section which was added to the existing lead-in may not be making a good connection. A soldered joint should be made where the two wires connect, to insure good contact.

Also make sure the antenna lead-in is not taped to the mast. Standoff insulators should be used and the lead-in spaced off from tin roofs, rain gutters, and other metal objects.

17BP4 to 17HP4

A Mattison Silver Rocket model 630-6AB receiver uses a 17BP4A tube. I would like to use a 17HP4 electrostatic focus. What changes are necessary? B. S., Ontario, Canada

If the 17BP4A is to be replaced with a 17HP4, the focus unit must be removed from the neck of the tube and a variable resistor installed in the low-voltage power supply which will permit a voltage change from about minus 50 to plus 270 volts. This becomes the focus control.

A much better plan is to use a self-focus tube such as the 17KP4 or the 17SP4. These do not need a variable-focus potentiometer. The focus unit is removed from the neck of the tube, and when the ion trap is adjusted for maximum brilliancy, the focus will be properly set.

END



-AXIS for your SCOPE

Put your oscilloscope to work. Z-axis amplifier gives it new life and versatility.

By RONALD L. IVES



Front-view photo of the Z-axis amplifier.

WHENEVER serious experimental work is undertaken, the need for one or more additional amplifiers becomes apparent. This need becomes particularly acute if the oscilloscope is not equipped with a Z-axis amplifier, and a timing circuit is desired. The amplifier to be described is designed to insert timing "pips" or "breaks", via the Z-axis, into an oscilloscope display.

Fundamental requirements

For most types of experimental work, a Z-axis amplifier needs a voltage gain of little more than 1,000; an output power of more than 100 milliwatts; a very low hum level; and great electrical stability. For convenience, it should be self-contained and compact. To keep first cost and maintenance at a minimum, components should be standard wherever possible. Some means of reversing the phase of the output is highly desirable; and all exposed components should be "dead" with respect to power supply voltages (both a.c. and d.c.).

The circuit

After considerable experimenting with several types of amplifiers, the circuit in the schematic was arrived at as being the best compromise between technical perfection and operating convenience. It consists of a pentode first stage with high impedance input, a triode phase inverter (phase inversion optional); and a pentode power output. (All operated from a power supply with adequate filtering.)

The input stage is conventional, and uses a 6J7 because of the ease of circuit isolation. This stage has a theoretical voltage gain of almost 200—and an attainable voltage gain of about 150—from 25 cycles to 50,000 cycles. Gain falls off rapidly from 50,000 to 100,000 cycles and becomes erratic at higher frequencies, though some amplification is still noticeable at 1 mc.

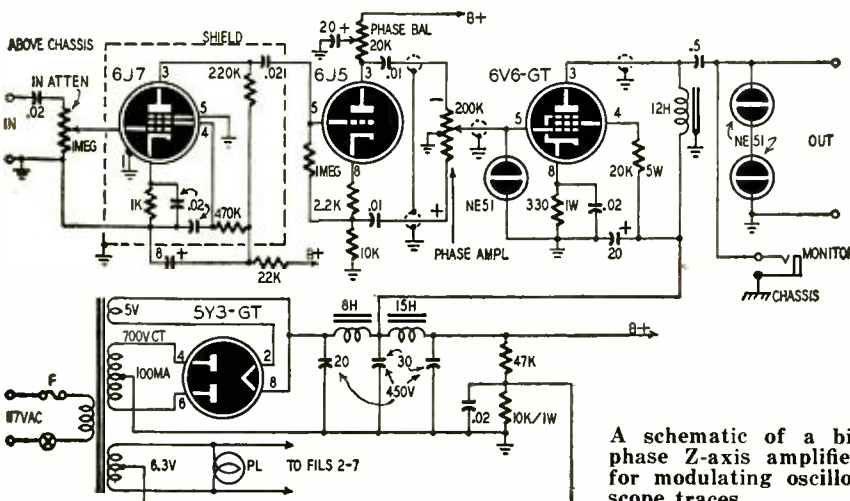

A schematic of a bi-phase Z-axis amplifier for modulating oscilloscope traces.

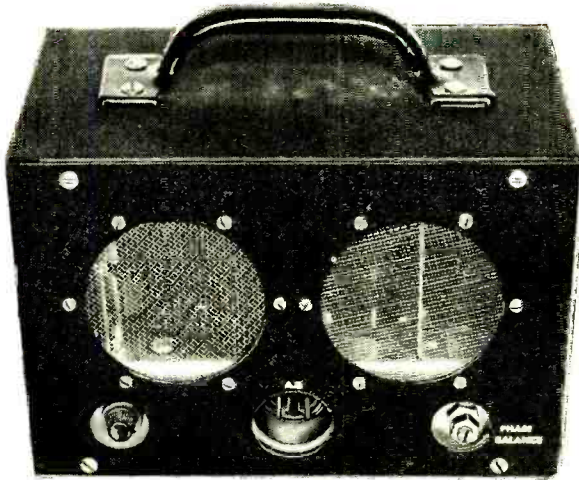

Rear-view photo of the amplifier showing ventilating grilles and phase balance.

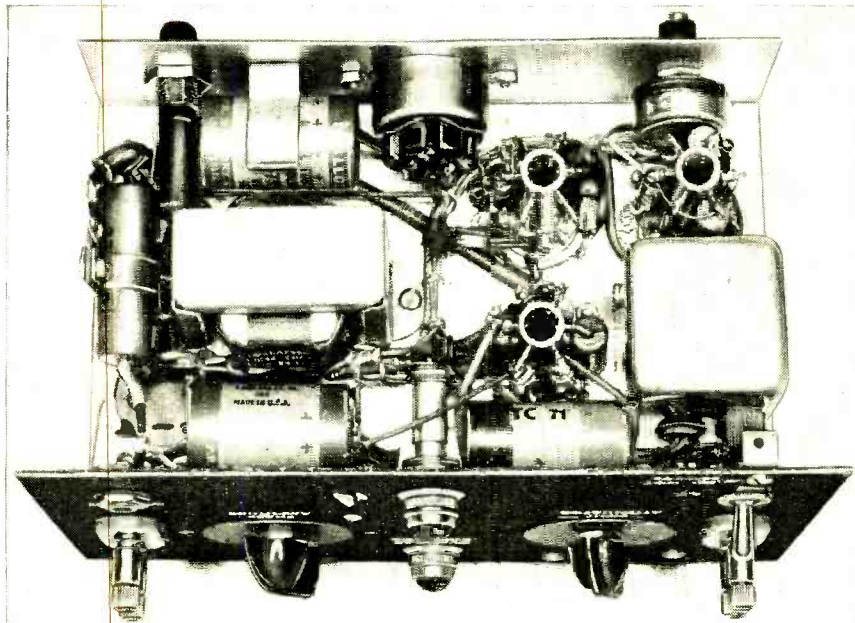

Bottom-view photo of Z-axis amplifier showing turret sockets and shielding.

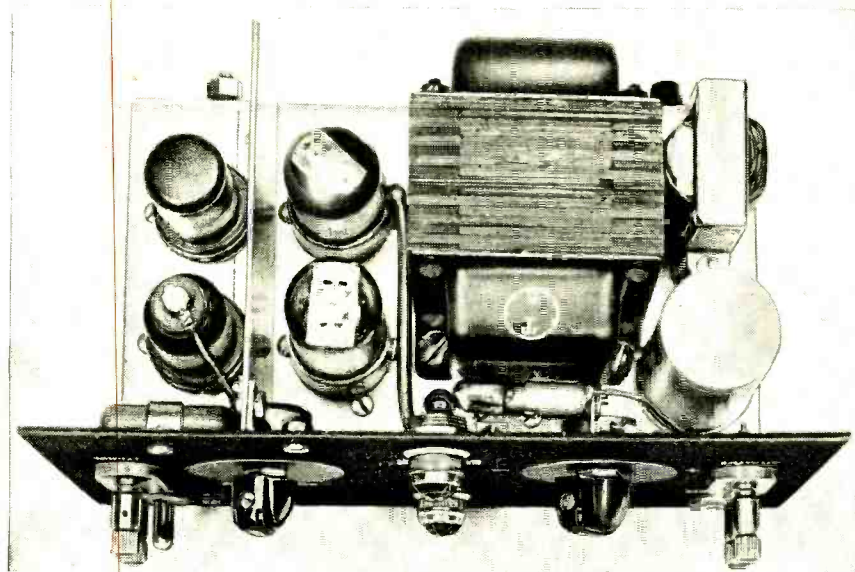

Top view of the amplifier. The dark line to left of power transformer is copper tube shielding the 6V6 grid input lead.

The triode phase inverter, a 6J5, is connected in a somewhat modified "hot cathode" circuit, with "bootstrap" bias. The output capacitors, instead of being connected to the grids of a pair of push-pull output tubes, are connected to a center-tapped potentiometer, permitting the choice of either phase in any desired amplitude. The arm of this phase amplitude control is connected to the final tube input.

The output tube is a 6V6-GT, pentode-connected, with a choke output. The NE-51's in the grid and plate circuits of this tube are used as "de-peakers," and are highly desirable to prevent spark-overs when the input amplitude is too high. Because this amplifier is designed to handle pulses as well as sine waves, some sort of spark-over protection is essential.

The power supply is a fairly conventional full-wave arrangement, with a two-section L-C π -type filter. Filter capacitors are considerably larger than optimum, to compensate for gradual loss of capacitance with age. To reduce hum, particularly that due to diode action from cathode to filament of the tubes, the filament center-tap is biased about 45 volts positive with respect to ground.

Construction

As originally breadboarded, and minus the circuit-isolating resistors and capacitors, this amplifier, loosely arranged on an 11 x 17 x 3-inch chassis, performed beautifully, and was very stable. Because bench space is somewhat limited, and all instruments used in a given test should be within reach from one position, some reduction in size was found desirable.

The component parts totaled slightly more than 140 cubic inches. Making due allowance for shape factors, cooling space, and necessary supports, it appeared that this amplifier, with its power supply, could be built in a standard 5 x 6 x 9-inch utility box, using standard parts throughout.

This concentration of parts proved highly unstable on the first attempt. The amplifier functioned as a very powerful a.f. oscillator. After considerable experimenting, during which the shielding and circuit isolations necessary for stable operation were determined, the final model shown in the photographs was designed and constructed. Internal arrangements of components and shields required some careful planning to avoid packing-factor troubles. Use of a mild-steel chassis (not aluminum) was found essential, and the above-chassis shield partition also was made of mild steel, cadmium plated to prevent rusting. The placement of parts is shown in the interior above-chassis view of the amplifier. The filter capacitor, a triple unit (Mallory FP 396), is mounted to the right of the power transformer to isolate it from tube heat. Directly behind it, the second filter choke and the output choke are mounted "piggy-back," to conserve space.

To provide convenient mountings for the smaller components, Vector turret sockets were used throughout, as is apparent in the under-chassis view. Extensive shielding of signal leads was found essential; and the entire first stage subchassis assembly was shielded with an aluminum can. Braided tinned copper shielded tubing was adequate for the low-power leads, but short sections of spring curtain rod (iron) were found better for higher-power leads. To prevent damage from vibration, all capacitors are mounted either on turrets, on brackets, or on clips, and all supply leads are cabled. The ends of the lacing cord are made safe with cellulose cement (red nail polish works well).

Wiring is fairly straightforward, and only two sets of connections need polarization. The phase attenuator should be so connected that the input and output signals are in phase when the knob is turned to + position (extreme clockwise rotation of the control marked PHASE AMPLITUDE in the photo); and the output choke should be polarized for minimum hum.

Panel terminals (National R-39) were chosen for compatibility with terminals and connectors already in use on other equipment. To eliminate recurrent difficulties with dangling cords, which usually get stepped on at inopportune moments, a male a.c. connector, in a sunk mount (Amphenol 61-M10), was installed at center rear of chassis. A standard fuse mount was included in the supply circuit.

All front panel controls, terminals, and indicators are labeled with commercial decals (Tekni-cals), as are rear connector and control (see photographs). Strong rubber feet are bolted to the bottom of the case, to eliminate scuffing and skidding; and a strong handle (Stanley No. 3 door pull) was bolted to the top of the case. As the amplifier weighs 13 pounds 2 ounces, it could cause considerable damage if dropped cornerwise onto someone's foot!

Ventilation was provided through two-inch holes in the back of the case. These were covered with wire screen grilles. The grilles consist of rings of soft iron, 3/4-inch o.d. and 3-inch i.d., to which the wire screen is soldered, and are held in place by six 6-32 machine screws spaced 60°. For ease of servicing, the front lip of the case was cut away at the lower left, to clear the first stage shield can, and the screw normally in that position was replaced by an angle-bracket, so that the holding screw goes through the bottom of the case (DO NOT REMOVE in the photograph). All sheet-metal screws, supplied with the case, were replaced with 6-32 binding-head screws, tapped into the case, to eliminate future stripping trouble.

Adjustment

After assembly is completed, and the amplifier has been checked for operation, the two phases should be adjusted for balance. This is done quite simply. Connect a signal generator across the

input of the amplifier, setting the frequency at about 400 cycles per second. Connect a vacuum-tube voltmeter across the output terminals, and load the output with a shunt resistor of about 10,000 ohms. Neither the input frequency nor the output load are at all critical.

Adjust the input attenuator to any convenient setting below the overload point (overload indicator not flashing). Set the PHASE AMPLITUDE control at the extreme clockwise position (+), and record the voltage indicated by the v.t.v.m. Set the phase attenuator at extreme counterclockwise position (-), and adjust the PHASE BALANCE potentiometer (on rear of chassis) until output is the same at maximum positive and maximum negative settings of the phase attenuator. After careful checking, tighten the shaft lock of the balancing potentiometer. Ordinarily, it will need no further adjustment until the 6J5 needs replacing.

Since many oscilloscopes do not provide a Z-axis input, it may be necessary to construct one. The most direct method is to feed the output of the Z-axis amplifier to the control grid of the oscilloscope through a .05- μ f capacitor, with a 1-megohm resistor from the hot input terminal to scope ground. The capacitor should have at least a 2.2 kv rating.

Performance

Rather careful checking of the performance of this amplifier indicates that it is somewhat better than is needed for a Z-axis input amplifier.

With a 0.1-volt (r.m.s.) input, available output exceeds 150 volts from 45 cycles to slightly over 15,000 cycles. From 15,000 cycles to about 60,000 cycles, the available output falls off rather uniformly, reaching 35 volts at about 60 kc. From this point up, amplification is somewhat erratic, and waveforms are visibly distorted, although a signal of sorts is put out at all frequencies up to about 1.2 mc. These tests were made with a sinusoidal input and a 10,000-ohm output load.

Tests with pulse input show that clean pulse output is obtained with pulses up to 3.5 microseconds long, at repetition frequencies up to 100,000 cycles per second. With longer pulses,

a damper diode is needed across the output to eliminate flybacks; and with higher repetition frequencies, pulse stretching causes pileups.

Power output is approximately 2.25 watts without visible distortion, at frequencies from 45 to 15,000 cycles. If the neon overload lamp is removed, an output (badly distorted) of up to 6.5 watts is obtainable at voice frequencies.

Materials for Z-axis amplifier

Resistors: 1—1,000, 1—2,200, 1—10,000, 1—22,000, 1—220,000, 1—470,000 ohms, 1—1 megohm, 1/2 watt; 1—30, 1—10,000, 1—47,000 ohms, 1 watt; 1—20,000 ohms, 5 watts. 1—20,000-ohm, 1—200,000-ohm, 1—1-megohm potentiometer.

Capacitors: (Paper) 2—.01, 6—.02, 1—.05 μ f, 600 volts. (Electrolytic) 1—8, 2—20, 1—20-30-30 μ f 450 volts.

Chokes and transformers: 1—8-henry, 80 ma; 1—12-henry, 80 ma; 1—15-henry, 60 ma; 1—power transformer, 700 volts c.t., 100 ma; 5 volts, 2 amp; 6.3 volts, 3 amp.

Tubes: 1—6J7, 1—6J5, 1—6V6-GT, 1-5Y3-GT; 3—NE-51 neon tubes.

Miscellaneous: Pilot light and socket, 2-amp fuse and holder, sockets, chassis, shield partition, off-on switch, hardware, wiring, etc.

Conclusion

After approximately six months use in varied experimental and test work, it appears that this amplifier not only meets the need for which it was originally designed—Z-axis input—but is also a very satisfactory general-purpose test amplifier. In addition to its primary function, this amplifier has performed well as a speech amplifier, as a trigger amplifier in stroboscopic work, and as a component in an electrical stethoscope.

Total cost of this amplifier, at 1952 net prices, was just under \$30, with top-quality parts used throughout, and ample margins of safety being allowed. Costs might be approximately halved by use of off-brand and surplus parts, although such might reduce the dependability of the instrument.

Construction time of this model was about 20 hours, and down-time for repairs, during six months, was zero. As nearly as can be determined from experience with this amplifier, and with similarly constructed equipment, the only maintenance work likely is replacement of the pilot lamp after 750 hours, replacement of tubes after 2,500 hours, and replacement of electrolytic capacitors after two years (whether the equipment is used or not). END

UNUSUAL INTERMITTENT PICTURE

The "intermittent" in this instance was in a G-E model 830 and the symptoms were baffling. Customer complaint was that the picture would suddenly grow dim and sometimes disappear completely. The sound was unaffected. When I switched the set on I found the picture brilliantly clear. This happened several times, and once, just as I was leaving the shop to have another look at it, I received a cancellation. The lady said the picture had returned all by itself when she left the set on for a while.

By this time it became evident that a poor connection, a cold-soldered or

corroded joint, or an intermittent component was responsible, but there were hundreds of spots where the trouble might lie. Luckily, I remembered that somewhere, sometime, I had found a loose wire in a tube-base pin which had caused plenty of trouble although the spot of solder at the end of the pin made detection difficult. The wire from one of the tube-filament leads was just resting against the spot of solder at the end of the hollow base pin.

Well, a hot iron and a bit of rosin-core solder was the answer here, too. Believe me, I never saw this trick in any TV handbook. —Albert White

Analyzing the R-C CIRCUIT

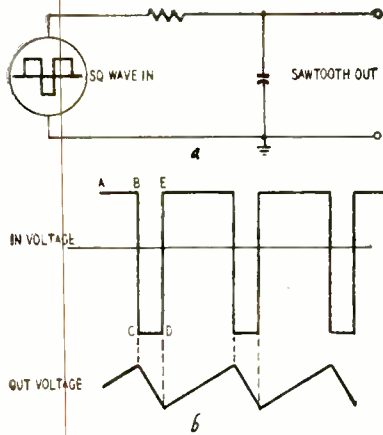

Fig. 1—Generation of a sawtooth wave.

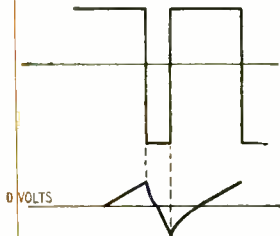

Fig. 2—This kind of thing doesn't happen!

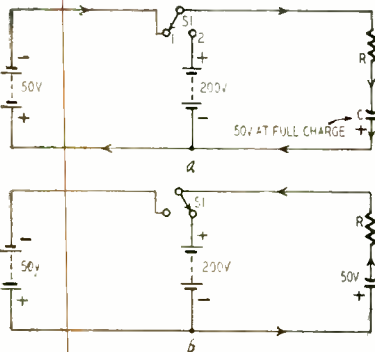

Fig. 3—The capacitor is first charged to 50 volts, then is discharged in series with a 200-volt battery, as shown.



Fig. 4—Simple R-C discharge circuit.

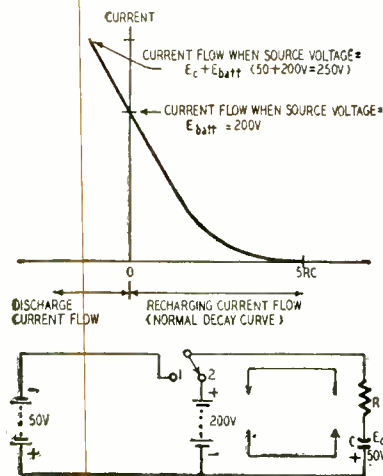

Fig. 5—Current flow as capacitor discharges to 0, then recharges to 200 volts.

R-C theory frequently reveals the basic characteristics of a circuit's operation, greatly facilitating its design and repair

By **CYRUS GLICKSTEIN**

THE key to a circuit problem is often tied to one small point that just doesn't fit into place. After the "minor" point is broken down, there is a completely new picture of circuit operation. A simple illustration of this situation is shown in the circuit of Fig. 1, where a sawtooth wave is projected from a square wave.

TV technicians are familiar with the fact that a square wave applied across an R-C circuit as in Fig. 1-a, produces a sawtooth wave (Fig. 1-b) provided the R-C circuit has a long time-constant and the output is taken off the capacitor (integrated).

It seems reasonable that the capacitor charges linearly when the square wave is first applied, giving a rising sawtooth voltage in the first quarter-cycle. But in the next quarter-cycle, when the square wave voltage reverses, why doesn't the capacitor voltage discharge exponentially to zero (as shown in Fig. 2) before the capacitor charges up in the reverse direction? From ordinary R-C circuit theory it seems a capacitor should do just that. Yet from experience (oscilloscope examination, etc.) we know that a linear sawtooth is obtained.

This action is based on an interesting point about capacitor action not found in most reference texts. The basic action can be illustrated in the circuit shown in Fig. 3. The capacitor C has been charged to 50 volts when the switch is placed in the No. 1 position of the switch, Fig. 3-a. When the switch is placed in the No. 2 position (Fig. 3-b), there is a 200-volt battery in series with the charged capacitor. In this switch position, the capacitor first discharges to zero and then recharges in the opposite direction

to 200 volts. Current in the circuit then stops. How long does it take the capacitor to discharge down to zero, before it starts charging in the reverse direction? In a simple discharge circuit, Fig. 4, it takes a charged capacitor 5RC to discharge to (approximately) zero. But the answer is definitely not 5RC in the circuit of Fig. 3-b because this is not a simple discharge circuit. It is a modified discharge circuit until the capacitor discharges to 0 volts. Then, the circuit acts exactly like any normal charge circuit while the capacitor recharges in the opposite direction to the battery voltage of 200.

To explain the discharge action, it must be remembered that in any R-C circuit, whether charge or discharge, the current at the instant the switch is closed is determined by the potentials in the circuit. These voltages may be in the battery or across the charged capacitor or both, if the capacitor already has a charge across it. In this case, at the instant the switch is thrown to the No. 2 position, the initial current depends on both the battery voltage (200) and the voltage across the capacitor (50). The two voltages are in series and can be considered one voltage in analyzing the action. An initial current flows which is based on the sum of the two voltages. The discharge circuit therefore acts exactly the same as if the capacitor were charged up to 250 volts, with no battery in the circuit. Current keeps decreasing as the capacitor discharges to zero. At the instant the capacitor voltage is zero, only the battery voltage of 200 is in circuit. The capacitor then charges in the reverse direction. Current continues in the same direction and continues

to decrease, in typical charge circuit action. When the capacitor is fully charged to the battery voltage, no current flows.

It does not take long for the capacitor to discharge to zero, compared to the time needed for recharging. At the instant the switch is thrown to position 2, the current is maximum. There is a voltage drop of 250 across R. When the capacitor voltage is zero, there is a voltage of 200 (battery voltage) across R. Current therefore must drop 20% or $\frac{1}{5}$ to cause the voltage across R to go from 250 to 200 volts. According to R-C series circuit theory, a 20% drop in current (or in voltage across R or C) takes place in a time of 0.2 RC. More important, the first 20% of charge or discharge in an R-C circuit is *linear*. To state this fact somewhat differently: as long as the capacitor voltage is small ($\frac{1}{5}$ or less compared to the battery voltage) when the switch is thrown to position 2, the discharge of the capacitor will be linear. After the discharge to zero, the recharge in the opposite direction will also be linear, provided the capacitor is not allowed to charge up to more than 20% of the source voltage.

Actually the initial discharge in such circuits can be considered a linear extension of the standard charge curve for current (Fig. 5).

This principle explains the production of a sawtooth voltage across a capacitor when a square wave is applied to an R-C circuit as shown in Fig. 1-a. Assume the square wave (Fig. 1-b) is positive at A, when the switch is turned on. The capacitor starts to charge. When the square wave goes sharply negative (B-C) there is no exponential decay of voltage to zero before the capacitor recharges. Instead, the negative source (square wave) voltage is in series with the voltage in the capacitor. It discharges *linearly* to zero on the basis of the total voltage in the circuit. At the instant the capacitor voltage reaches zero, it then starts to recharge in the opposite direction, based only on the source voltage. The recharge is linear also, when the capacitor does not have time enough to charge up to a substantial percentage of the applied voltage. When the source voltage reverses polarity again, the capacitor voltage again is in series with the applied voltage, and the discharge current is based on the combined voltages. There is a linear discharge until the capacitor voltage reaches zero, then it recharges, and so on.

A linear sawtooth is produced when the time-constant of the charging circuit is large compared to the time of the applied voltage. The capacitor then charges to only a small part of the applied voltage. This means it charges only on the initial portion of the charging curve where the voltage rise is linear.

The principles of capacitor action discussed in this article can be applied to clarify the operation, design, and repair of many different kinds of circuits.

END

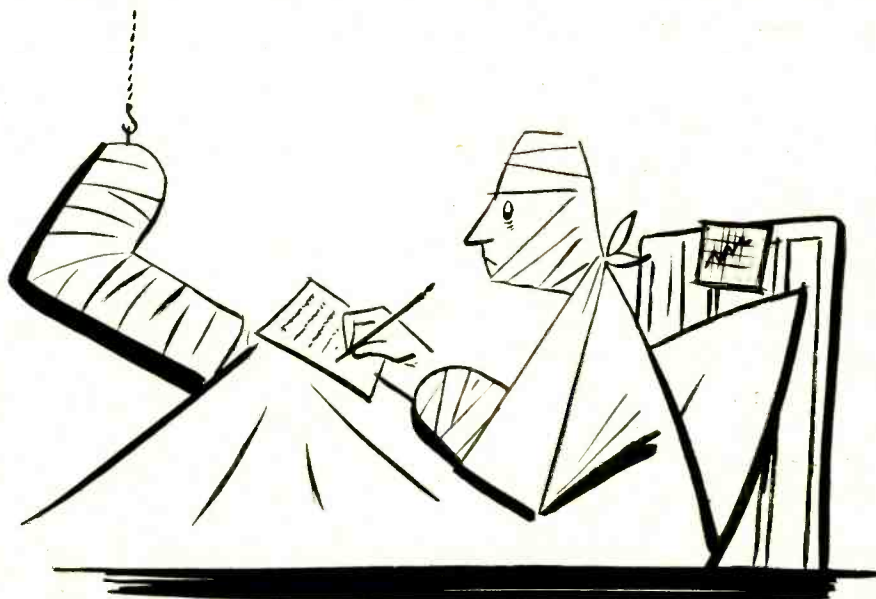

RADIO DIAL MECHANISM

National Service Manager
Superoptic Radio and TV Corp.
Ninety Six, S. C.

Dear Sirs:

Thank you very kindly for the instruction sheet which you enclosed with the new dial cord and pointer kit for replacement in your model T-175. There is some question, however, as to the completeness of the installation procedure as outlined on the sheet. The following are a few points that might be added:

First, as the cord is grasped firmly in the left hand and the dial spring is held in the right hand (as shown in the instructions), I found no trouble in threading the cord around drum A, through eyelet 3A and under slider X. However, I think it should be noted that in order to cut the cord at W while spring R-1 is stretched to 1.1 inches and the dial pointer is located at 720, it is necessary to transfer the cord (W-1) so that it is held between the teeth, so the left hand is free to cut the cord at H.

Also, since the dial drum tends to move while stretching spring R-1, it is necessary to remove one shoe (preferably the right) and place the big toe through cutout S-1, under plate 7 of variable capacitor C17A, being careful not to bend the plates with the toenail. A note of caution is also necessary in the instructions for stretching tension spring B-7 to point A; since in case the spring is pulled beyond point A, serious injury may result to the right elbow (required to hold drum C from falling off shaft T while set-screw S-19 is loose). In addition it should be advised that a first-aid kit be kept handy while looping cord 2 through hole F and around drum G. It seems that this procedure often causes heavy pressure on springs L-1 through L-7, resulting in their flying in all directions around the room.

My second suggestion is to provide a procedure for setting the dial pointer P1 to indicate 720 on the dial. Since it is required to set the pointer before cutting the dial cord, and since the cord cannot be cut until spring R-1 is stretched to exactly 1.1 inches, some difficulty may be encountered. Remember that the left hand is holding cutting pliers; the right hand is stretching spring R-1; the teeth are holding cord Y; the left knee is preventing the chassis from falling off the table; the right elbow is holding drum C on shaft T; and the right toe is inserted in cutout S-1 under plate 7 of variable capacitor C17A. It is therefore necessary that a board (not supplied with kit) be propped up behind the dial plate between J and D to apply pressure to the slider at Z. This will hold the dial pointer exactly at 720. Extreme care must be taken in placing the board on the slider since the board will tear the speaker cone completely off the speaker frame if it slips.

After cutting the dial cord (at point W as shown on the instructions) it was found that a note of final warning should be included on the instruction sheet. The heavy tension caused by spring R-1, when stretched to 1.1 inches, results in the sudden revolving of dial drum C (despite the pressure of the elbow against it). Dial drum C will then spin off of shaft T and spin across the front of the chassis, breaking tubes V1, V2, and V3, unless these have been removed.

Also, please note my order for another installation kit of the same type—the original was ruined when the cutter slipped. Please send the kit as soon as possible, since my physician advises me that I will be on my feet again in a few weeks.

Very truly yours,
Herbert Michels

Versatile Scope you can build

Vertical and horizontal sweep circuits make it useful for television work.

By LLOYD B. HUST

THE oscilloscope is a versatile instrument. It is useful in measuring voltages, indicating phase differences, indicating modulation percentages, etc. When sweep circuits and amplifiers are added to it, its versatility is increased many times. Its voltage range can be extended, and it becomes very useful for indicating frequency and waveform.

The oscilloscope described here is more versatile than most models now on the market. Its horizontal sweep frequency extends to 100 kc, which is double or triple that of most oscilloscopes. Its sensitivity is better than that of many others, and it incorporates a vertical sweep circuit, which increases its usefulness in television work. Sixty-cycle a.c. can be switched into either the horizontal or the vertical inputs, and provision has been made to have the 60-cycle input to the horizontal circuit 180° out of phase with that supplied to the vertical, which makes for interesting phase comparisons.

The frequency response of the instrument is relatively flat to 2 mc, somewhat lower than the video amplifier of a good television set, but adequate for most oscilloscope purposes, including television servicing. This response could be made to approach that of a good TV set if video peaking coils were used in the plate circuits of the amplifier stages. Such extended response is seldom necessary in any case. The frequency response permits viewing a fair

television picture on the cathode-ray tube of the oscilloscope.

The circuit (Fig. 1) consists of amplifiers for both vertical and horizontal circuits, sweep oscillators for both circuits, internal or external synchronization for the horizontal sweep circuit, and external synchronization for the vertical sweep circuit.

The vertical amplifier consists of a 6J5 cathode follower which feeds a 12AT7. Both sections are connected in cascade. The 12AT7 feeds a 6C4 which is used as a phase inverter to supply the signal to the vertical output tube, a 12AT7. This push-pull output tube feeds the vertical plates of the cathode-ray tube, which can be a 5BP1 or 5BP4. The input of the first stage contains a step-attenuating circuit controlled by S3, which allows signals of either high or low intensity to be fed into the vertical amplifier. The switch S1 switches the input of the first stage to the output of the vertical sweep oscillator, or directly to the oscilloscope input terminal, or to a 60-cycle test voltage. S2 (ganged to S1) removes the plate voltage to the vertical oscillator for all positions of S1 except position 1. Thus, the oscillator is disabled when not switched to the input of the amplifier.

The cathode follower input stage allows good high-frequency response because the necessity of the volume control being in the grid circuit of this tube is eliminated, thereby eliminating high-frequency attenuation caused by grid

resistance variation. This type of input stage makes it possible to mount the first tube near the front panel, and the following tubes near the base of the C-R tube, the long leads introducing little loss as they would in other types of circuits. Large capacitors and direct coupling from the 12AT7 to the 6C4 insure good low-frequency response.

The horizontal amplifier consists of a 6J5 which acts as a phase inverter feeding a 12AT7 which supplies the signal to the horizontal plates of the C-R tube. The spot is positioned by the potentiometers across the plate load resistors of the output stages. The horizontal amplifier is connected to either the output of the horizontal sawtooth oscillator, the horizontal input binding post, or a 60-cycle test voltage by switch S5. S6 cuts off the plate voltage to the oscillator when S5 is in positions 2 or 3, but connects it when S5 is in position 1, the position in which the output of the sweep oscillator is fed to the input of the amplifier. The 60-cycle test voltages supplied to the vertical and horizontal amplifiers are 180° out of phase as each is taken from an opposite side of the filament supply, the center of which is grounded. Although this gives only 3.15 volts for the a.c. test, it is adequate to give a trace close to 2 inches long on the C-R tube.

Low values of plate resistance are used in both amplifiers, and all cathodes are unbypassed. These two factors limit the gain of the amplifiers, but this

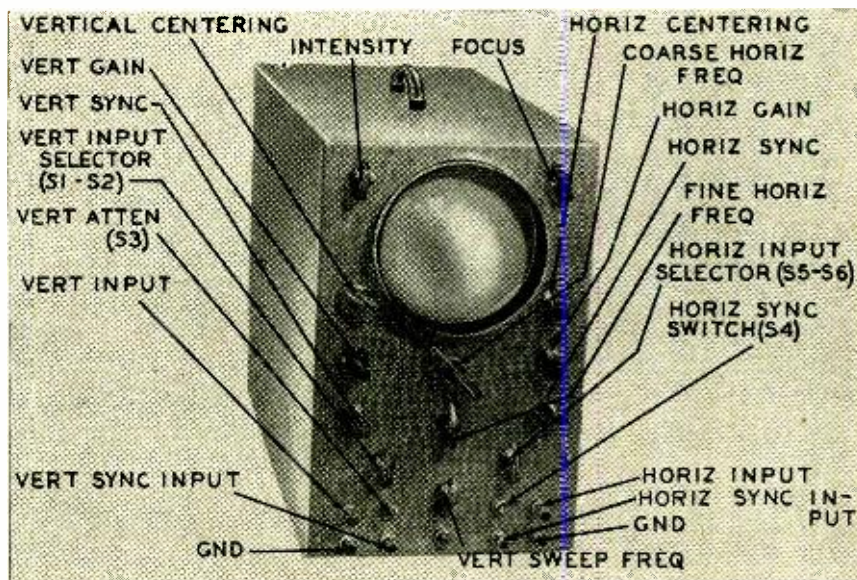

Front view of oscilloscope. Controls are neatly arranged.

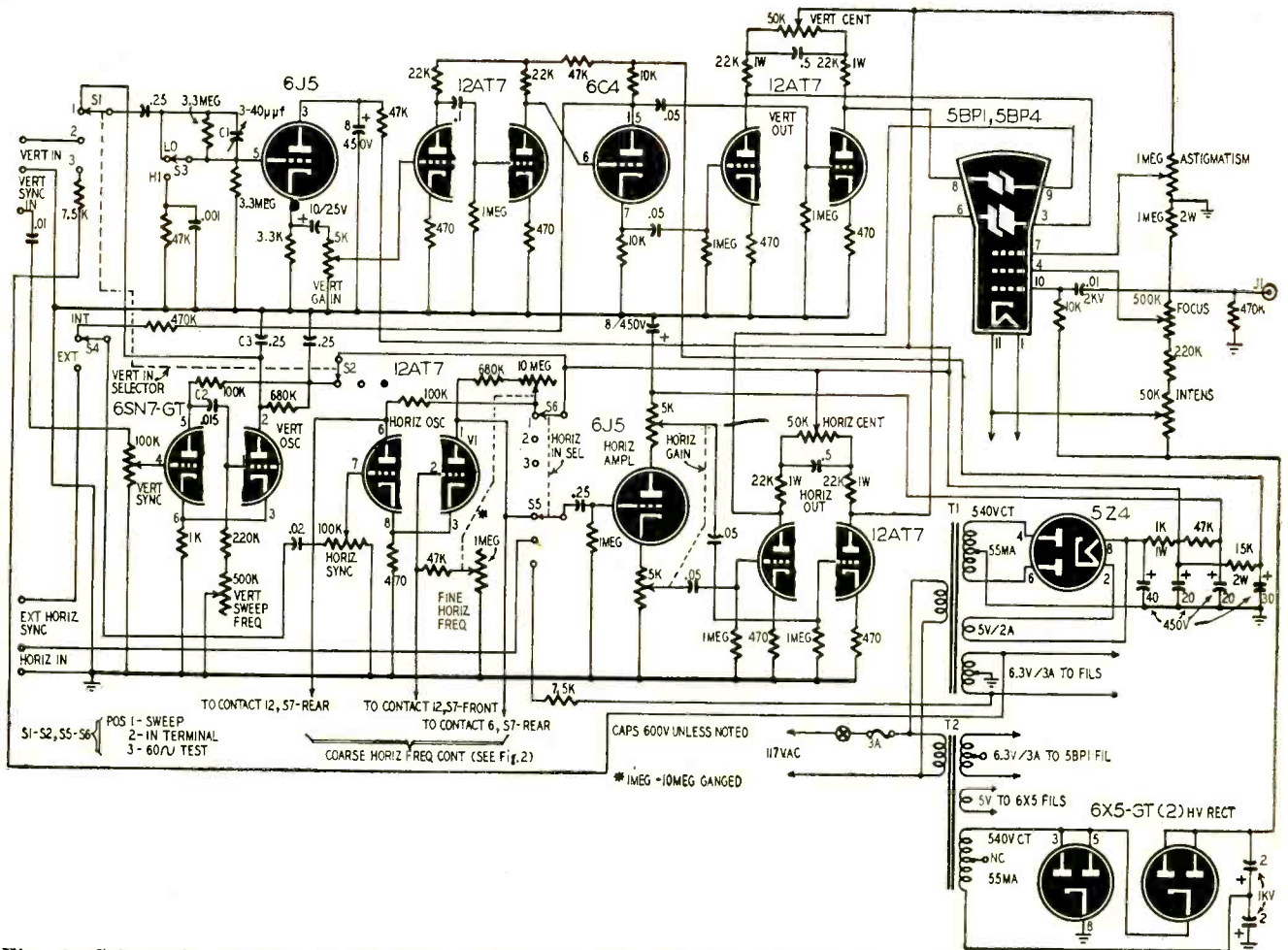
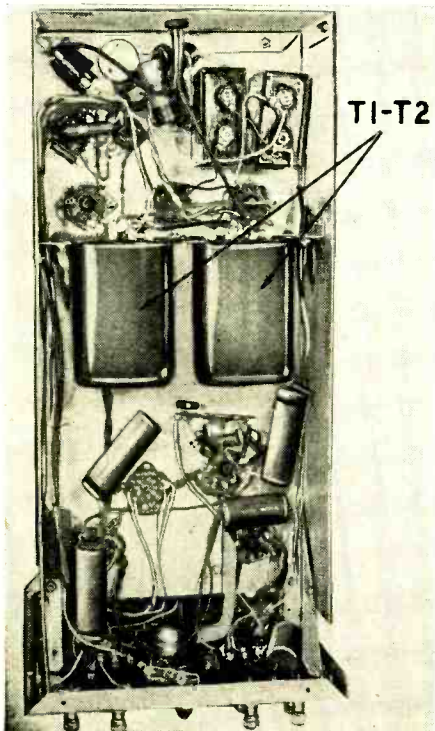
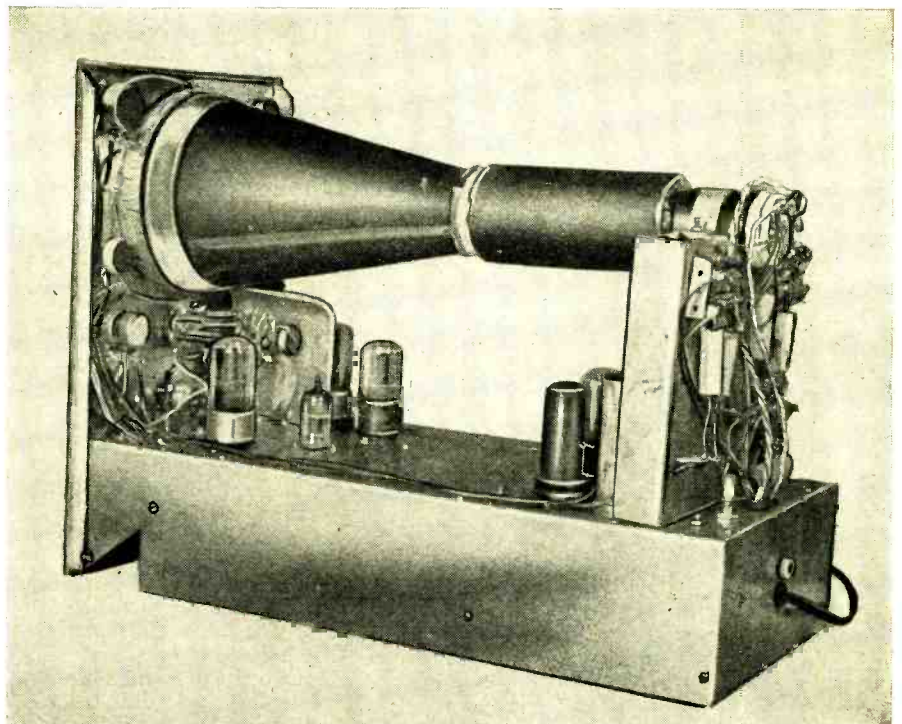

Fig. 1—Schematic diagram of versatile oscilloscope. All cathode resistors are un-bypassed to reduce distortion.



Underchassis view of oscilloscope. Angle brackets are mounted on the corner of each transformer, and to the side of the chassis. Primary terminals are up.



Side view. To eliminate stray fields, length of iron pipe is placed over neck of tube. Vertical chassis with components mounted is seen at right.

disadvantage is offset by the higher quality of the amplified signal. The reason for this is that the degeneration introduced in each stage by the lack of bypassing reduces distortion, and the low-value plate load resistors aid in maintaining good high-frequency response. The amplifiers have enough gain for the purposes of the instrument.

The horizontal sweep circuit is composed of a multivibrator built around a 12AT7 tube. This tube produces a sawtooth voltage. Its frequency depends upon the values of the capacitors switched into the circuit by S7 (Fig. 2), and by the values of resistance introduced into the circuit by the sections of the FINE HORIZ. FREQ. control. Output of the sweep generator varies from a minimum of about 12 cycles per second to slightly over 100 kc, giving a very useful range. The frequencies of this circuit for the different positions of the COARSE HORIZ. FREQ. control are as follows: position 1, 12 to 120 cycles; position 2, 120 to 1,200; position 3, 1,200 to 12,000; and position 4, 12,000 to over 100,000. The setting of the horizontal sync control will vary these values somewhat.

The switch S7 which is used as the coarse frequency control, is listed in the parts list as Mallory 1325-L. This is a 2-gang, 2-circuit-per gang, 5-position switch. It has an adjustable stop which should be set so that only the first four positions are used. The switch should be wired as shown in (Fig. 2). Capacitors C4, C5, C6, C7 and C8 should be mounted between the terminals of the front and rear sections of the switch. This facilitates mounting and makes it possible to isolate these circuits from others by shielding.

The vertical sweep circuit is somewhat similar to the horizontal, except that it uses a 6SN7-GT tube and covers a frequency of about 15 to 90 cycles. It was incorporated into the instrument to make it possible to view a television picture directly on the oscilloscope. This circuit is very similar to the vertical sweep circuits used in electrostatic deflection TV sets. Since commercial tolerances on resistors—and particularly on capacitors—vary, it may be necessary to experiment with the value of C3. Check this capacitor if the vertical sweep fails to supply a 60-cycle sawtooth wave at about the mid-setting of the vertical sweep control, which corresponds to the vertical hold control on a TV set.

The power supply is somewhat different from that of most other oscilloscopes. I wanted to use good-quality shielded transformers, but did not want to have to purchase specially designed units. The Chicago PSC-55 power transformers were found to be ideally suited for this application. One of these is used in a conventional full-wave power supply, with a 5Z4 tube as rectifier. This supply furnishes the voltages to the various amplifier and oscillator tubes. The other transformer is used in a voltage-doubling circuit with two 6X5 tubes to supply the high voltage

to the C-R tube. Filament power for the 6X5's and for the C-R tube is furnished by this transformer. The 5-volt filament winding is connected to the 6X5's, and although the ratings of these tubes indicate 6.3 volts for filaments, the 5 volts supplied by this transformer does the job in fine style. The center-tap of the high-voltage winding is left floating and the entire high-voltage winding supplies the voltage to the doubler circuit. This type of high-voltage supply has several advantages; a standard radio power transformer can be used; the voltage rating of the h.v. capacitors can be just half that required by conventional half-wave power supplies; and special high-voltage rectifier tubes are not necessary.

The voltage delivered by this doubler circuit is practically double that of the peak rating of the high-voltage winding of the power transformer. Measurement with a v.t.v.m. showed the voltage across each of the voltage-doubling capacitors to be from 850 to 900, giving a total of 1,700 to 1,800 volts for use by the C-R tube. Since the current drain is small, there is practically no voltage drop, and this voltage gives excellent brilliance on the cathode-ray tube, even when its face is covered with a television raster.

It is very important that shielded transformers be used for both power supplies, as the strong magnetic field which surrounds unshielded transformers will deflect the electron beam in the cathode-ray tube. It is also important that the power transformers be mounted *underneath* the chassis and well toward the rear. The photograph of the under side of the chassis will serve as a guide in the mounting of these units.

Construction

Although exact chassis layout can vary, the photographs show the general construction and can serve as a guide to the builder. I followed the practice of some commercial oscilloscope builders in mounting the input tubes and power supply on the main chassis, and the other tubes on a small vertical chassis at the back. The small vertical chassis also holds the cathode-ray tube. The builder can depart from this layout, but he should keep in mind that the input and oscillator tubes should be mounted near the front panel. The horizontal oscillator tube and associated components should be separated by a shield from the other tubes and components. The power supply should be on the main chassis, and the power transformers underneath the chassis and toward the rear of the unit.

The tubes feeding the cathode-ray tube should be mounted near its base. The cathode-ray tube mounting should clamp the metal part of the tube base solidly, but should not put any strain on the neck of the tube. If the front of the tube is mounted as shown in the photos, with a felt lining protecting it, and the base is clamped firmly, no additional support will be needed.

The panel is drilled for the various controls and switches, etc., as shown in the front-view photo. The opening for the C-R tube is 5½ inches in diameter and can be cut with a circle cutter in a drill press. A slow speed is necessary for cutting a hole of this size. A strip of sheet metal about 2 inches wide is bent into a circle and is inserted in this hole as shown in the photographs. It is soldered to the back of the panel, and it should project about an inch to the front and rear of the panel. It is lined with a piece of soft felt or velvet of such thickness that the end of the C-R tube will make a snug fit. Panel and chassis sizes can vary to suit builder.

A few precautions should be taken. First, because many of the leads carry high voltage, the hookup wire should be well insulated. See that no high-voltage terminals are bent close to the chassis, or that other bare wires run near them. A few terminal strips conveniently placed will facilitate wiring. Since the vertical amplifier is essentially a high-gain unit, take great care to prevent hum. All ground connections should be made carefully. Although it is not necessary to have a ground bus, it is wise to make the grounds in connection with each tube at the same place. Most sockets are provided with grounding lugs for this purpose.

The power transformers are mounted on an angle-iron bolted underneath the chassis. In addition, a small angle bracket is fastened to a mounting hole on the corner of each transformer and to the side of the chassis as seen in the photograph. The transformers were mounted with the primary terminals up (when the chassis is upside down for wiring). The power supply should be wired first, and the voltages should then be tested. It will be noted that the *positive* side of the C-R tube high-voltage supply is grounded, while the *negative* side of the amplifier plate supply is grounded in the conventional manner.

The builder must realize that the chassis is "hot" with respect to the negative side of the C-R tube supply as well as to the positive side of the amplifier supply.

Testing

When the power supplies have been wired and tested, the C-R tube and its controls—intensity, focus, centering, etc.—can be wired in, and proper operation of that circuit can be tested by seeing if a spot will appear and can be centered on the screen of the tube. Make this test as soon as possible so that any "bugs" can be removed before continuing with the wiring of the amplifiers and oscillators. A small round spot which can be focused and moved from side to side and up or down, insures that the C-R circuit is correct.

If it is impossible to secure a small round spot after adjusting the INTENSITY and FOCUS controls as well as the ASTIGMATISM control, which has some effect on the shape of the spot, make any changes necessary to achieve this

end. The usual reason for producing an elongated spot, or in some cases a small round circle, is electromagnetic interference. This is usually caused by the magnetic fields surrounding the power transformers. Even shielded units will have some magnetic field about them.

In my first attempt, the spot was elongated, and I found that by changing one of the primary leads on the power transformers, the two transformers worked in a hum-bucking arrangement, and the trouble was eliminated. The connections to the primaries of the transformers were made in this way: One power line lead went to pin 1 on T1, the other power line lead going to pin 2. Then pin 1 on T1 was connected to pin 2 on T2, and pin 2 on T1 was connected to pin 1 on T2. This may not work in every case, but in this instance it cleared up the trouble.

Shielding the C-R tube will also help, and although a good spot was obtained on the model shown without shielding, I decided to do this shielding for good measure. A piece of 2-inch iron pipe was cut the length of the narrow neck of the C-R tube, and the neck of the tube was wrapped with sponge rubber held in place by Scotch tape. The iron pipe was then slipped in place. If these measures do not eliminate all trouble from stray fields, the transformers may have to be rotated slightly to remove or cancel out their fields.

As soon as a small round spot can be obtained on the scope, the other parts may be wired. The C-R tube should be removed while this is being done. When wiring is completed, the final tests can be made. Remember that a bright stationary spot can burn the fluorescent material on the face of the tube, so keep the spot as faint as possible or keep it moving.

If all wiring is correct, the following results should be obtained: With S3 in low position (high input signal needed), and S1 and S5 in position 2, with all gain controls off, a stationary spot should appear on the screen. This spot should be capable of being centered by the two centering controls. Then with S2 in position 3, and the vertical gain control turned up, the spot should become a vertical line. With S1 back in position 2, and S5 in position 3, a similar line in a horizontal direction should result as the horizontal gain control is advanced. With S1 and S5 in position 3, a diagonal line should result if both horizontal and vertical gain controls are advanced. If these results are obtained, the action of the sweep generators can be tested.

S1 should be in position 3, and S5 should be in position 1. This will place a 60-cycle test voltage in the vertical circuit and a sawtooth sweep voltage in the horizontal circuit. The coarse horizontal sweep control should be in position 1, that is, in the counterclockwise position, and the sweep vernier control can be adjusted from minimum to maximum position. The minimum position would show about 5 cycles of sine waveform as the vertical gain control is advanced. Increasing the rota-

tion of the sweep vernier should make it possible to get 4, then 3, then 2, and then 1 cycle on the screen. Advancing this control still further should produce a half cycle, which will be represented by something like the letter "X." These traces can be made to stand still by rotating the horizontal sync control if the sync switch is in the internal position. Only as much sync as is necessary to make the trace stand still should be used, otherwise the wave may be distorted.

The vertical sweep circuit can now be tested. S1 is set to position 1, and S5 is set to position 3. This will place a 60-cycle voltage in the horizontal circuit and vertical sawtooth voltage in the vertical circuit. With these settings, and with both horizontal and vertical

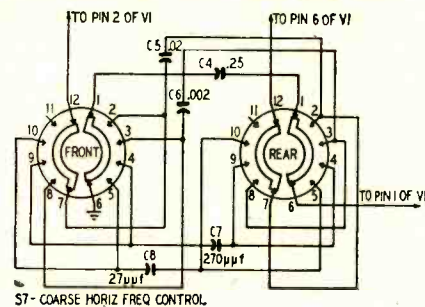

Fig. 2—Switch shown in position 1, looking from the front or knob end, in extreme counterclockwise position.

gain controls advanced, it should be possible to get one cycle to appear on the screen. This will occur in a vertical position and will look something like the letter "S." If this occurs with the vertical frequency control at or near mid-position, all is well with the vertical sweep circuit. If it is impossible to get one cycle in this position, it may be necessary to change the value of C2. This can range from about .01 to .02µf. On the scope shown here, the value of .015µf worked out just right. If one cycle can be obtained by this method, then it is suggested that both S1 and S5 be turned to position 1, and a sawtooth voltage will be observed. Then by rotating the horizontal frequency control switch to the fourth position, and advancing the fine frequency control slightly, a raster similar to that on a television screen will appear. It will be necessary to increase the intensity control and to readjust the focus control to obtain sufficient brilliance, since this raster will form a rectangle filling the screen of the C-R tube.

When these tests have all been made, the instrument is ready for final adjustment. This consists of adjusting the trimmer C1. A square-wave generator is necessary for this. A square wave of about 10 kc is connected to the vertical input binding posts. The attenuator switch S3 should be set to low position, that is, the position in which the gain of the amplifier is lowest. C1 should then be adjusted for the flattest top of the square wave. The frequency of the generator can now be set at 1,000 cycles and the trimmer readjusted for a flat-topped wave. This makes the fre-

quency response of the amplifier in the low position the same as in the high one. If a square-wave generator is not available, this adjustment can be postponed until one can be borrowed, as the oscilloscope will give good results even without this adjustment being made.

This instrument has one use not commonly found in oscilloscopes: you can observe a television signal with it. To observe such a signal, the grid of the TV picture tube is connected by a short length of wire to the jack J1, which is known as the intensity modulation jack, and is located at the back of the scope. The horizontal sync pulse is applied at the horizontal sync binding post, the sync selector switch being set for external sync. The vertical sync pulse is taken from the TV set after it has passed through the integrating circuit in the TV set. This pulse is applied to the vertical sync binding post. The vertical sync control is advanced, and the vertical frequency control is adjusted for a frequency slightly less than 60 cycles. The horizontal frequency control switch is placed in position 4 and the fine frequency control is rotated slowly, along with the sync control, until the picture locks into place. To lock the signal in, it is necessary that the sync pulses have negative polarity. No attempt has been made to supply d.c. reinsertion to the scope C-R tube grid, so the TV signal background lighting may not be accurate. In spite of this, all the normal contrasts of the TV picture will be present.

Oscilloscope parts list.

Resistors: 7—470, 1—1,000, 1—3,300, 2—8,200, 3—10,000, 2—22,000, 5—47,000, 2—100,000, 2—220,000, 2—470,000, 2—680,000 ohms, 6—1 megohm, 1—3.3 megohms, 1/2 watt; 1—1,000, 4—22,000 ohms, 1 watt; 1—15,000 ohms 1—1 megohm, 2 watts.

Potentiometers: 1—5,000, 3—50,000 (linear), 2—100,000, 2—500,000 ohms, 1—1 megohm; 1—1 megohm —10 megohms, ganged; 1—5,000—5,000 ohms, ganged.

Capacitors: (Paper) 1—.01 µf, 1—.015 µf, 2—.02 µf, 4—.05 µf, 1—.01 µf, 5—.025 µf, 2—.05 µf, 600 volts; 2—2 µf, 1,000 volts; 1—.01 µf, 2,000 volts. (Ceramic) 1—3.40 µf, trimmer; 1—27 µf; 1—270 µf; 1—1,000 µf; 1—2,000 µf. (Electrolytic) 2—8 µf, 1—30 µf, 1—20—20—40 µf, 450 volts; 1—10 µf, 25 volts.

Tubes: 2—6J5; 4—12AT7; 1—6C4; 1—6SN7; 1—5Z4; 2—6X5; 1—5BP1 or 5BP4 C-R tube.

Miscellaneous: 2—power transformers, 540 volts, c.t., at 55 ma, 6.3 volt at 3 amp., 5 volt at 2 amp. (Chicago PSC 55); 2—2-pole 3-position switch, (Mallory 322-3J); 2—s.p.d.t. toggle switch; 1—2-gang, 2 circuits per gang, 5-position switch (Mallory 1325 L); 1—s.p.s.t. switch; 1—6.3-volt pilot light; 1—insulated phone tip jack; 1—3-amp fuse.

It was not intended that this scope be used as a TV slave unit, but a sufficiently accurate picture can be obtained to aid in the servicing of a TV set, particularly when there is some question as to the condition of the TV picture tube.

The case for the instrument was made from 24-gauge galvanized sheet steel. The local tinner was co-operative in allowing his equipment to be used for the building of both case and chassis. If the builder does not have the tools for building such a case, he can have it built at almost any tin shop. The case measures 8½ x 17¼ x 13 inches. It has a 2-inch hole in the rear to accommodate the power cord and the intensity modulation jack. END

HIGH-QUALITY RECORD PLAYER IN KIT FORM

By JEROME KASS

ASSOCIATE EDITOR

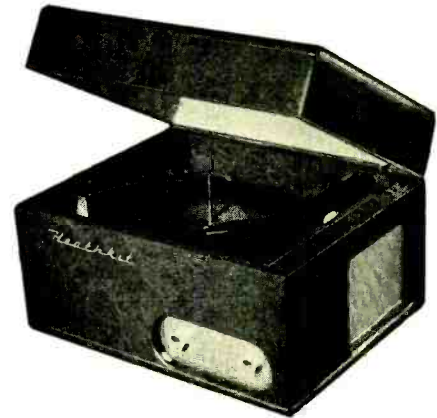

AFTER MANY YEARS in the complex field of electronics, I have become very suspicious of any attempts to oversimplify, whether in equipment or literature. Experience has shown that the fabulous one-tube this or that, usually falls far short of expectations, and the handy-dandy fix-it-yourself booklet has left many a TV owner bloody and bowed.

I have watched the growth of the various kit companies with a wary eye. From the very simplest devices, kit

manufacturers have expanded their lines to include equipment to outfit the home, workshop, and laboratory. I have seen many assembled kits in action, in homes and in factories, and have been impressed with their performance. However, I took exception to the manufacturers' claims of the ease with which they can be assembled. I could understand a skilled technician undertaking the task, but when the manufacturer claimed that a complete novice could do an artistic job, I had my doubts. As

the years went by, and the kit manufacturers expanded and diversified their lines, my curiosity became overwhelming; I had to see for myself. Having a pretty complete line of test instruments, I decided upon the Heathkit record player. It would satisfy my curiosity and at the same time possibly provide entertainment for all the family.

The package arrived. With tongue slightly in cheek, I examined the contents. There was a 3-speed record changer, two 6-inch speakers, a cabinet, and several bags filled with parts for the assembling of the amplifier. This can be done by a novice? Ridiculous!

I noticed some papers in the box, and I assumed them to be the schematic and parts list. To my amazement, they turned out to be 22 pages of instructions and 4 huge pictorial diagrams. This seemed unbelievable. I've seen broadcast transmitters assembled on less instructions. Well, I thought, I'll have none of it. I spread out the various parts, took the chassis in hand, studied the schematic briefly, and began to mount tube sockets. Since each socket has two positions, 180° displaced, I studied the pin connections to find the most convenient position. After a few minutes of study, I decided, well, it wouldn't hurt to take a little peek at the pictorial layout. After taking a peek, then followed by a long perusal, a thought began to dawn upon me.

Perhaps there was rhyme and reason to these papers. Perhaps they could be the result of careful and scientific research in the layout of this record player. And perhaps what I was starting out to do had been done many times by the manufacturer and these papers might represent the most efficient and simplest method of assembly. But why so many pages for a record player? I turned to the first page and read.

The schematic diagram was drawn in conventional style. It showed the cartridge working into a high-impedance input. The volume control fed a 12AX7 voltage amplifier-phase inverter, which in turn drove 2-35C5's in push-pull. B plus was supplied by a 35W4 half-wave rectifier working with a double-pi R-C filter. The speakers were in parallel, and

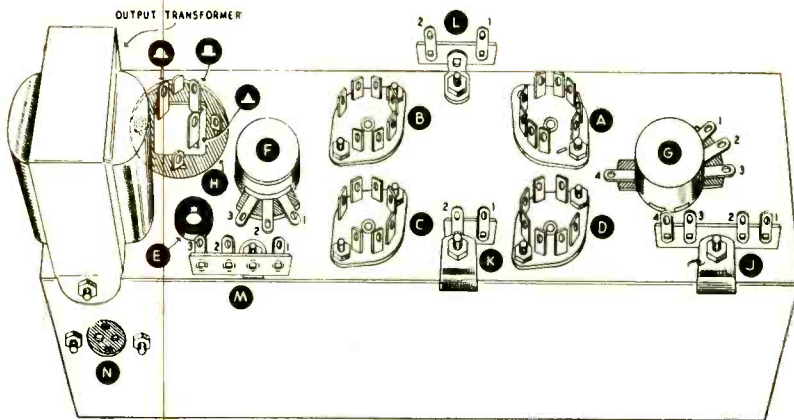

Chassis before wiring. Letters and numbers minimize possibility of errors.

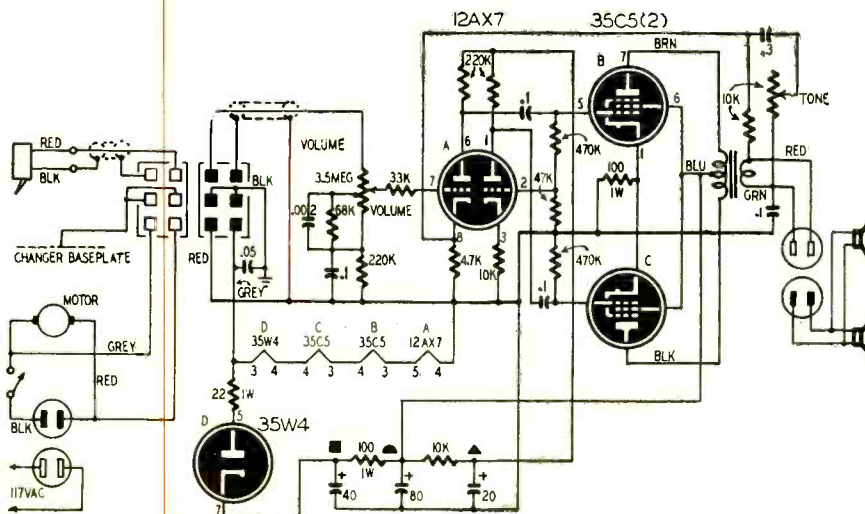

Schematic diagram of the Heathkit record player. Letters indicate code to text.

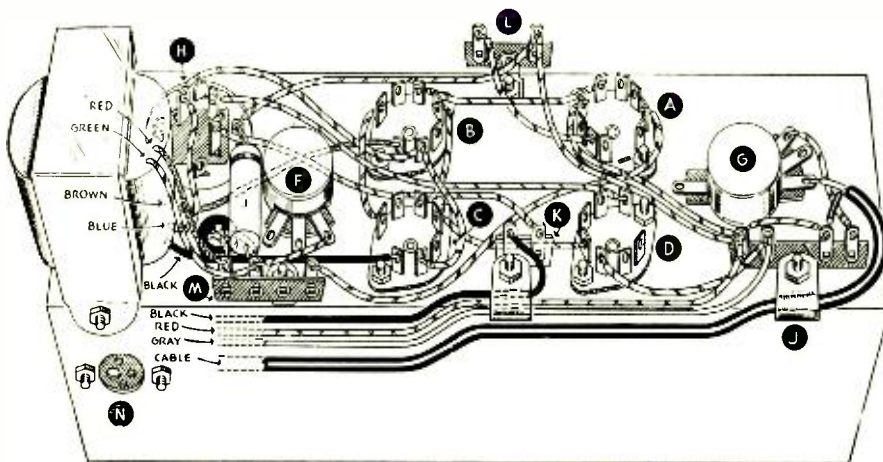

Pictorial shows amplifier wiring. Cable and transformer are color coded.

the tone control was part of a feedback network from the output transformer secondary to the cathode of the input triode. The sequence of filament wiring with respect to ground also was shown. All this would be quite clear to a technician, but probably hopelessly complicated for a beginner. I scanned the next page on soldering and wiring. Pretty good, I thought. This would be clear even to my wife.

I was now up to the mechanical assembly. A glance at the pictorial layout on this page instantly revealed the method to all this madness. The entire layout of parts was resolved into an elementary system of letters and numbers. The four tube sockets would hereafter be known as A, B, C, and D. Every part was identified by a letter, and if that part had more than one possible connection, such as in tube sockets and terminal strips, each connection was numbered. Here indeed was the master plan. Any child who could read and had some manual dexterity could assemble this amplifier.

The next few pages contained deliberate step-by-step instructions for mounting. I followed along, checking off each step, in the space provided, as I went. I saw that by this checking, and watching the pictorial diagram, a mistake was virtually impossible. I ran into a minor difficulty when my capacitor-mounting wafer did not fit the prepared position. With a small reamer and rat-tail file this obstacle was overcome.

With everything mounted, I was now up to page 7, the start of amplifier wiring. Here again, I was immediately confronted with a pictorial diagram showing the exact positioning of every wire in the amplifier. Since the only hookup wire supplied was black, I reached into my private stock and allowed myself the luxury of various colored wire to color-code the amplifier circuits. The wiring ran smoothly with one serious exception. The output transformer was color-coded differently from the instruction sheet. If I had connected color for color, the loudspeakers might have been ruined. This was the only occurrence where complete ignorance of electronics might have resulted in damage to the record player. I paused

at this point to consider the human equation. Here was a tragedy of oversimplification. A slight error by the manufacturer could cost the uninformed builder time and expense. (I wrote to the manufacturer, and was informed that this situation has since been corrected.)

The wiring followed a very logical pattern. Out of curiosity, I followed the step-by-step instructions on the diagram. First the filaments were wired, then the power supply, and so on. The wiring on the pictorial was so clearly illustrated that the exact placement and even the curvature of wiring could be easily duplicated. On page 10 a special cable was assembled. Whenever detailed work of this sort appeared it was accompanied by copious illustrations. Page 12 completed the amplifier assembly with the mounting of the capacitors and resistors. Once again a pictorial diagram facilitated the assembly. A few of the pictorials were actually larger than lifesize.

With the completion of the amplifier, the final assembly began. The two speakers and the amplifier were mounted in the cabinet. This required some fine carpentry. The instructions were clear, but the fittings were close. Breaking through the proxylin covering of the cabinet required utmost care. Finally, after a mild application of blood, sweat, and tears, everything was properly mounted. In the course of final assembly, I ran out of some hardware, and had an excess of others. This I suppose is inevitable. The hardware, being standard (6/32-screws), was easily located. Wiring of the speaker plug required some patience. As many radio technicians have learned, soldering phone tips can be tedious.

The preliminary testing began on page 16. The instructing sheet called for a visual inspection followed by a test run. At this point I became unnerved. I had learned from many sad experiences the danger of plugging in an electronic device without any preliminary resistance measurements. Yet, I had followed instructions to the letter up to now; I had been impressed with them, and I resolved to continue to the bitter end. With a stiff upper lip, eyes

closed, and fingers crossed, I plugged in the record player. Displaying incredible nerve, I placed one of my wife's favorite records on the changer.

When the tone arm made contact with the record, the room was filled with the most beautiful music this side of Benton Harbor. I used a symphonic recording to obtain bass of reasonable duration. I then reversed the speaker leads several times while listening carefully to the music. I retained the position which gave me the more predominant bass response. The tone arm required no adjustment, as the sapphire stylus made a perfect one-point landing. The tone and volume control seemed to have effective range, and with these controls turned up and no signal input, only a slight low-pitched hum was audible.

Flushed with success, I decided to measure the playback response of the amplifier. I had listened to several recordings with such pleasure that I was anxious to know just what the frequency capabilities of this amplifier were. Fortunately, I was able to avail myself of a test record specifically designed for this purpose. I used a v.t.v.m. to avoid any loading effect on the amplifier, connecting it across the secondary of the output transformer. Making allowance for the test record's (a Cook 10LP) response curve, I measured the output from 30 to 20,000 cycles.

From approximately 100 to 20,000 cycles, the output remained within 1 db of the AES playback curve. Below 100 cycles I had a bass boost of a few db. Since I had the volume turned down low, this boost was probably due to the volume control which is compensated for the Fletcher-Munson effect at low levels. This response confirmed my initial opinion: in its price range this was an excellent player.

What intrigued me most was that this was all done without any necessity for the schematic. Anyone who could read and handle a soldering iron could have built this record player. Looking back, the step-by-step organization was something to truly marvel at. As far as my particular record player was concerned, it was completed. It wasn't unique in design, being similar to the Columbia 360 and possibly others, but it was a kit and I had assembled it.

What if something had gone wrong? What if I had obtained smoke instead of music? I read on. In the center of page 18 was a paragraph headed, "In case of difficulty." Here in very calm, cool, and collected language was troubleshooting procedure. Hints on checking wiring, a voltage chart listing the potential on every pin of every socket, and control settings for obtaining various effects were clearly listed. The troubleshooting section ends with a brief discussion on common errors and circuit checking.

And so, 6 hours after I began, the 22 pages came to an end. Only then was I able to fully appreciate what had been accomplished. My cynicism toward the kit manufacturer has been replaced with a healthy respect. END

JUNIOR GOLDEN EAR AMPLIFIER

By JOSEPH MARSHALL

Here is what we've all been waiting for. A truly inexpensive high-fidelity amplifier. The frequency range is stretched, while the dollar is squeezed. Circuit is not critical.

HIGH fidelity today is expensive. Good commercial amplifiers start at around \$100 and run to \$300. Even the cheapest Williamson kit leaves no change out of a \$50 bill, which is still likely to strain the average music lover's pocket book and family relationships. In short, what this country needs is a good \$25 high-quality amplifier.

In my last article "Extending Amplifier Bandwidth" (in the September, 1953, issue) I indicated that it is possible to design an inexpensive amplifier with whose performance only the most critical "golden ear" could quibble. This article presents the Junior Golden Ear amplifier which can be reproduced at a total parts cost of around \$25, and yet will take very little if any backtalk from \$100 amplifiers. The circuit is not critical and is easily constructed by anybody with any construction experience.

The circuit

Those who have read the article mentioned above will recognize the circuit as that of a direct-coupled inverter and voltage driver, capacitance-coupled to a pair of self-bias output tubes, with two feedback loops. The first 12AU7 and the 12AX7 comprise a cross-coupled phase inverter which is direct-coupled to a neutralized 12AU7 driver stage. Presuming that the output capacitor on the tuner or preamp is .05- μ f or larger, response of the inverter and driver, without feedback, will be approximately 2 to approximately 50,000 cycles. The input tube is a cathode follower and its input resistance is therefore several times the value of the grid resistor. So, any capacitor of .05- μ f or larger will have a time-constant long enough to pass signals below 10 cycles. Since the 12AX7 is driven by the very low impedance of the cathode follower it is

not affected by the Miller effect below 100 kc. The neutralization of the 12AU7 driver minimizes the operation of the Miller effect in that stage, and the direct coupling produces no phase shift at any frequency below 50 kc.

The 0.5- μ f capacitors which couple this section to the output tubes are the only source of internal phase shift in the amplifier, but much if not all of this phase shift is neutralized by the inner feedback loop from the plates of the output tubes to the cathodes of the driver stage. The 6V6 output tubes are operated in a modified form of the Ultra-Linear circuit by connecting the screens to the 4,000-ohm taps of the UTC S-15 output transformer. This method of operation is intermediate between triode and tetrode and has several virtues. First, it improves the high-frequency response because this connection in effect neutralizes the plate-grid capacitance of the output tubes,

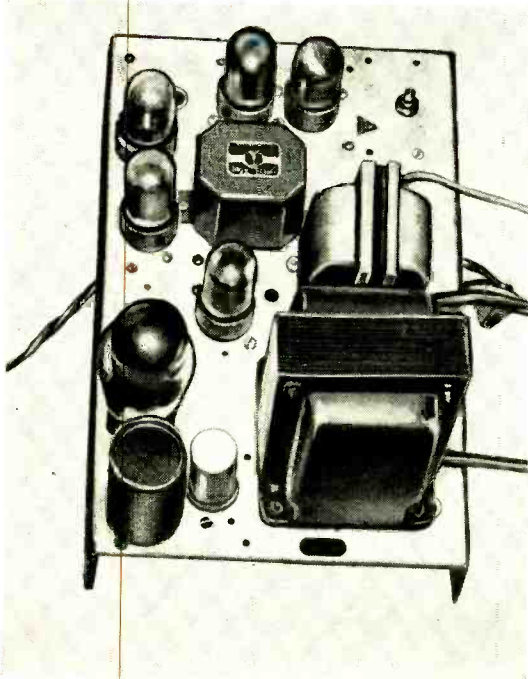

Left—Top view of Junior Golden Ear Amplifier. Note position of transformers. They are placed at right angles to prevent undesirable coupling.

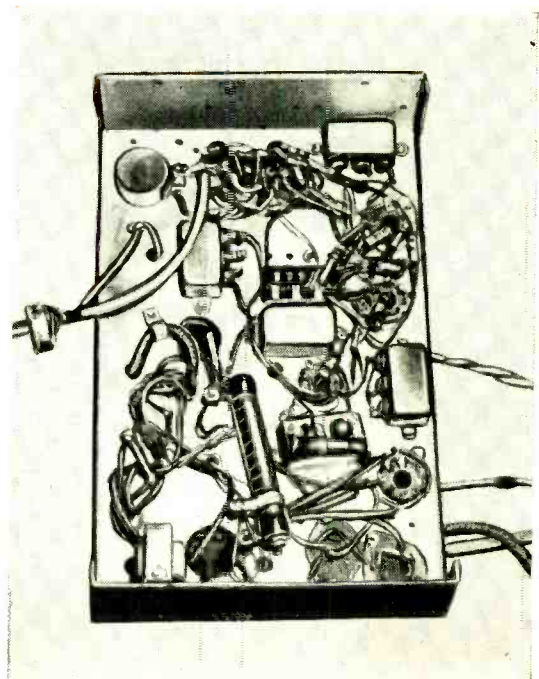

Right—Underchassis view of amplifier. Note the use of bathtub capacitors. These high-quality capacitors assure excellent low-frequency response.

which in triode operation would result in very serious attenuation above 10,000 cycles. Second, it more than doubles the 4 watts output which 6V6's deliver as triodes. The optimum screen load for true Ultra-Linear operation is 18.5% of the plate load. Special (and expensive) transformers are manufactured for this style of operation. However, a ratio of 40%, as in this case, results in excellent performance and permits a standard medium quality output transformer to be used. The maximum output of the amplifier is more than 8 watts.

Two feedback loops are employed. The inner loop, from plates of 6V6's to cathodes of the drivers, provides a feedback factor of 14 db. The time-constant of the feedback network is the same as the time-constant of the coupling network from drivers to output tubes, but the phase shift in the feedback loop is exactly opposite to that in the coupling. So this feedback loop in effect neutralizes the low-frequency phase shift of the capacitor coupling, and the amplifier—though not entirely direct-coupled—is, for audio purposes, just about as responsive at low frequencies as a direct-coupled amplifier. The inner feedback loop, being balanced, also helps maintain the excellent static balance of the amplifier over the full dynamic range. Since it also includes the two stages responsible for most of the distortion, the output tubes and drivers, it produces about a 5-1 reduction in distortion. The over-all feedback loop runs from the output transformer secondary to the cathode of one of the input tubes. The feedback factor in this loop is more than 20 db. This not only further reduces the distortion but it is enough to flatten the response of the output transformer to a level acceptable for high fidelity.

The response of the amplifier from input to output transformer is virtually flat from 2 or 3 to over 100,000 cycles. The response of the output transformer is flat only from 50 to 10,000 cycles. However, the extreme bandwidth of the amplifier itself, plus the more than 20 db of over-all feedback, extend the response on both sides of the slopes of the output transformer, producing an output curve which is essentially flat at levels of 2 watts or less, from 10 to some 60,000 to 70,000 cycles. This is as good or better than that of most Williamson-type amplifiers using much better output transformers, but possessing a very much narrower internal bandwidth because of Miller effect and uncorrected low-frequency phase shift.

Because the distortion-producing stages are subjected to a feedback factor of 30 or more, the output distortion is extremely low. At levels below 2 watts, which represent the average power peak in home listening, the distortion is measurable only on laboratory equipment. At maximum output the harmonic distortion is under 1% while the intermodulation is about 1%. This is so slight as to be of no practical consequence, since an output level of

2 watts, given a reasonably efficient speaker system, will not often be exceeded in small home or apartment listening.

Although the photographs of the experimental model show bantam-type tubes, it is better to use the miniature tubes specified in the wiring diagram. If you already have two 6SN7-GT's and a 6SL7-GT and want to use them, there will be only a slight difference in high-frequency response, and that will probably be noticeable only by measurement and not by ear.

The amplifier is push-pull from beginning to end and can be balanced both statically and dynamically. Thus maximum use is made of the distortion-canceling properties of push-pull amplifiers. The series resistors, common to both sides of the plate loads of the voltage-amplifier section, are balancing resistors and should not be left out. The 2,000-ohm balancing control in the cathode circuit of the input stage and the single-pole, double-throw switch provide a means for over-all dynamic balancing. They should preferably be mounted on the rear or top of the chassis where they will not be disturbed accidentally.

There is nothing at all critical about the layout, and no special wiring measures have to be taken. If your chassis is already punched, arrange the tubes as conveniently as possible. Vector turret sockets could be used if the most compact amplifier is desired. A common ground wire should be run from the ground point of the input jack around the chassis and all ground leads should be soldered to it. The filament wires should be twisted together and the two sides of the filament loop kept about the same length. The center-tap of the filament transformer is returned to the voltage divider at a point between 40 and 50 volts positive. By this means,

as well as the two feedback loops, the hum level is kept extremely low. In fact, it should be completely inaudible, with your ear at the speaker, unless a Klipsch-type horn is used, in which case you may be able to hear some hum with your ear right at the output of the horn.

The neutralizing capacitors in the 12AU7 driver are 1.5- μ f molded gimmicks of the type used for oscillator injection in superheterodynes. They are available from most parts distributors. The NPO series of ceramic capacitors can also be used. In an emergency the capacitors can be improvised by twisting together two 2-inch lengths of hook-up wire. Be sure to connect the end of one wire to the plate and the end of the other wire to the grid. The two open ends should be lightly taped to prevent any possible accidental shorts to chassis.

The 0.5- μ f coupling capacitors to the 6V6 grids must be of good quality with low leakage. Bathtub types are recommended. Do not substitute lower values or the low frequency response will suffer. The 0.25- μ f capacitors in the feedback loop should also be of equally good quality.

The plate, grid and cathode resistors in the opposite sides of the push-pull stages should be matched. This can be done effectively enough on an ohmmeter. Ordinary carbon resistors will do. Of any five of a given value, two can usually be found which match to 1 or 2%. The exact value is not important, as long as they match. Thus the 220,000-ohm plate loads can be 200,000 or 240,000 ohms, so long as both are as nearly identical as possible. Be careful not to overheat the resistors when soldering them in place, for it might change their value. If you hold the wire leads in a pair of large pliers between the soldering point and the body of the resistor,

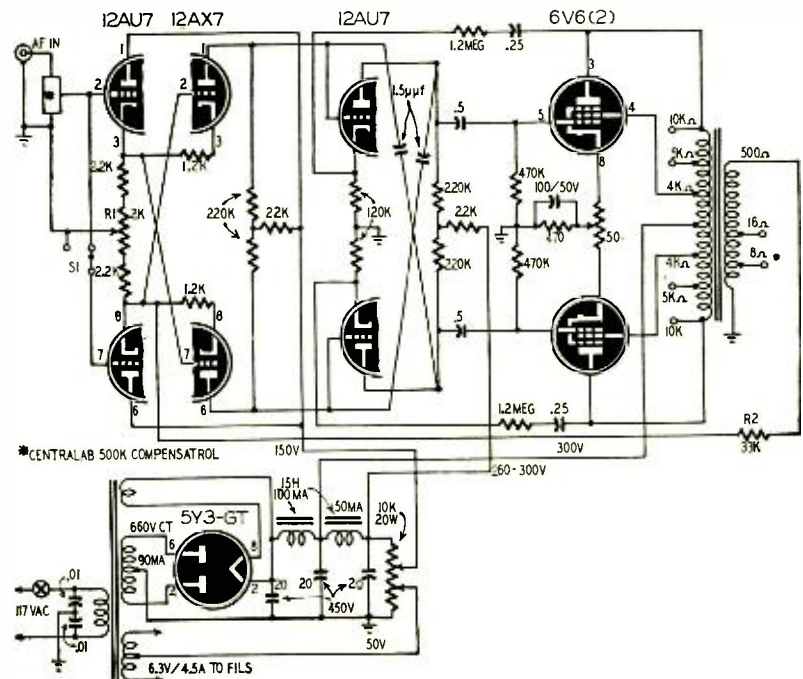

Schematic diagram of amplifier S1 enables overall dynamic balancing. RADIO-ELECTRONICS

most of the heat will be dissipated in the pliers before reaching the resistor. If you have a Wheatstone bridge, it would be an excellent idea also to match the coupling and feedback capacitors, to preserve the best possible frequency balance.

The output tubes are balanced through the 50-ohm potentiometer which is adjusted for equal plate currents, or for zero voltage difference as indicated on a high-resistance voltmeter connected from plate to plate. The bias voltage should be about 20 with a plate voltage of around 300.

The cathodes of the 12AU7 driver should be about 10 volts more positive than the grids. This will be achieved with approximately a 2-1 ratio of plate load to cathode resistance. The direct-coupled front section is balanced, as indicated later, at d.c. by the balancing potentiometer in the input tube circuit. The switch is a great convenience in obtaining over-all balance, permitting easy rebalancing from time to time to compensate for tube aging or when changing tubes. It is not essential to the operation of the amplifier.

When connecting the inner feedback loop, be sure that you do not cross it by connecting it to the opposite side instead of the same side. Proper connection is evidenced by reduced output. The diagram shows the over-all feedback loop going to the lower side of the amplifier, but it should be applied to whichever side produces negative instead of positive feedback. Touching the end of the loop to each of both grids, in turn, of the 12AX7 will determine the proper one. With the transformer specified, the feedback loop should result in stable operation. If another transformer is substituted, or if feedback results in oscillation, the feedback resistor R2 should be increased in value until oscillation cannot be sustained.

The power supply is conventional except for the connection of the filament center-tap to a positive point on the voltage divider. If your power transformer does not provide a center-tapped filament winding, insert a potentiometer of 50 to 100 ohms across the winding, connect the slider to the positive voltage point, and adjust the potentiometer for minimum hum. A 90-ma power transformer will more than suffice. Ultra-Linear operation does not produce as great current swings as does triode operation. The plate current remains quite constant over almost the total dynamic range. The low current requirement of this amplifier makes practical the use of a larger transformer to supply both the amplifier and associated tuner.

I believe that in the large majority of cases tone-control circuits are neither necessary nor desirable. Therefore, a Centralab Compentrol in the amplifier input is specified. This gives boosts at both low and high frequencies at low volume levels and is very satisfying, except perhaps in rooms whose acoustics at low frequencies produce too boomy a sound. The amplifier does not include

a phono preamp. Any of the standard circuits can be added, or a G-E preamp can be mounted on the chassis and connected to the same power supply. In that case, it would be well to add another switch at the input to permit switching in the different input sources—FM tuner, AM tuner, phono, etc.

This amplifier apparently can be built without regard to wire lengths, parts layout, and so forth. Several versions of the amplifier have been put together quickly on breadboards, old chassis, etc., with no resulting trouble. If you are relatively new at constructing amplifiers, keep this in mind: Double-check each connection before you make it, and several times after it is made, to see that it is correct. Before inserting tubes and turning on power, make resistance measurements at the socket terminals with an ohmmeter to be sure that you have no shorts or opens. Make the connections firm, and solder carefully so that you do not have noise-producing joints. When you are sure the hookup is correct, make the following adjustments, in the order given:

1. Insert the output tubes and adjust the cathode control so both tubes draw equal current, or so a high-resistance voltmeter connected from plate to plate indicates zero voltage.

2. Insert the other tubes. Connect the voltmeter from plate to plate of the 12AU7 driver stage, and adjust R1 for zero voltage.

3. Turn switch S1 so that the two grids of the first 12AU7 are tied together; feed any signal into the input and now adjust R1 again for a null in the output from the amplifier. Because of feed-through via the over-all feedback loop, a true null may not be obtainable; in that case, adjust the minimum output, using an a.c. meter if possible.

This procedure will balance the entire amplifier from beginning to end. Periodically, the balance can be checked and retrimmed as in step 3. It should also be done any time one or more of the tubes are changed.

The Junior Golden Ear amplifier is capable of very high quality reproduction, and merits the use of the best speaker you can afford. Fortunately, several good combinations of speaker and baffle are today available from \$30 to \$50. One of these amplifiers and the Baruch-Lang speaker system provides a very compact portable system with astonishing reproduction. With good speakers, tuners and magnetic phono-graph pick-ups, the Junior Golden Ear will yield results which belie the low cost, and are very likely to shock owners of Williamson and commercial amplifiers costing many times more. Do not let the small output transformer mislead you. After all it is not the transformer curve which counts, but the overall response curve.

While the output transformer in the Junior Golden Ear is much poorer than that of Williamson amplifiers, the rest of the amplifier is excellent in flatness

of bandwidth and freedom from phase shift, with the result that the over-all performance is just about as good.

Modifications

The only thing which stands between the Junior Golden Ear and a place in the ranks of the really great audio amplifiers is the output transformer. If you have an additional \$15 to spare, you can remove this imperfection by adding an Acro-Sound T-310 output transformer. This will give you true Ultra-Linear performance with an output in excess of 10 watts and an over-all bandwidth of 2 or 3 to nearly 200,000 cycles. The distortion characteristics should be superior to those of any other amplifier in its class. For a still more de luxe model, with higher output and, I believe, the finest performance the art permits, you are referred to the New Golden Ear amplifier, senior version, as described in my articles in recent issues of *Audio Engineering*. The senior version uses the same input section but fixed bias output tubes with higher power output and still wider bandwidth and lower distortion.

It may be that you have an amplifier with a fairly good—or even extra good—output transformer, and would like to improve it. The addition of the direct-coupled front section and the inner feedback loop will improve any amplifier, including higher priced commercial ones. If your present output transformer does not provide intermediate primary taps, you can use tetrodes as triodes, but adding neutralization to eliminate the Miller effect. The simplest way to achieve neutralization is to add a pair of 4-30- μ f ceramic trimmers in the standard cross-neutralizing style. Before connecting the feedback loops, remove the filament voltage from the output tubes, feed a signal into the amplifier, and adjust the trimmers for a null in the output.

Materials for Golden Ear Amplifier

Resistors: 1—470, 2—1,200, 2—2,200, 2—22,000, 1—33,000, 2—120,000, 4—220,000, 2—470,000, 2—1.2 megohms, 1/2 watt; 1—10,000 ohms, 20 watts, 2 adjustable taps; 1—50 ohms, 1—2,000 ohms, potentiometers; 1—Centralab Compentrol.

Capacitors: (Ceramic) 2—1.5 μ f. (Paper or bath-tub) 2—.01, 2—.25, 2—5 μ f, 600 volts. (Electrolytic) 1—20-20-20 μ f, 450 volts.

Tubes: 2-12AU7, 1-12AX7, 2-6V6, 1-5Y3-GT.

Miscellaneous: 1—Output transformer, type UTC-S-15; 1—Power transformer, 660 volts c.t. at 90 ma., 6.3 volt at 4.5 amp.; 1—Filter choke, 15 h at 50 ma.; 1—filter choke, 15 h at 100 ma.; 1-s.p.d.t. switch; wire, tube sockets, chassis, and hardware.

The modification will extend the bandwidth of any amplifier, no matter how good or expensive it is, and because the two loops provide more feedback, will also reduce distortion. Finally, because of the wide bandwidth, the low phase shift, and the neutralization of positive feedback loops due to grid-plate capacitance, the circuit will also improve the transient response, despite the added feedback. I have found this circuit highly suitable for 6L6's, 1614's, 5881's, KT66's, 807's, etc. The operating voltages would have to be adjusted to conform with the tubes operating conditions. END

The solution is to separate the back and the front of the cone so that the air movements they create can no longer reach the air together and cancel. One way to do this is to mount the speaker in a hole in a large, flat board, so placed that the front of the board faces the listener. Now before reaching the ear the air movements from the back of the cone must take time to go around the edges of the board, while those from the cone front reach the ear directly. The board is known as a *baffle*. If the baffle is large enough, it will permit excellent bass response.

The baffle is not the perfect answer, though it is often used in installations where intelligibility counts more than high sound quality—as in paging and in some public address systems. The sound from the rear still can reach the listener's ear, even though it may not come soon enough to exactly cancel that from the front. At certain frequencies a rarefaction from the rear may reach the ear together with a compression from the front. Even though they may be several cycles apart, they tend to cancel and at that frequency there will be a definite dip or valley in the response curve. At other frequencies, rarefactions from the front may be concurrent with rarefactions from the rear, and at those frequencies there will be definite peaks. These effects depend on the distance between the speaker location and the edges of the baffle in terms of wavelengths of sound in air. Since the number of wavelengths at any such particular distance depends on the frequency, it is impossible to find any combination of dimensions which will make the distance equal to exactly the right number of half-wavelengths to prevent these bad effects at some frequencies. Of course, if the baffle is very large indeed—20 to 30 feet in each dimension—the sound from the back may be sufficiently attenuated by the time it reaches the front to interfere less seriously.

The reader should note that the usual commercial radio-phono combination cabinet acts as a baffle—not as an enclosure for the speaker—since the back is usually open. Its only effect toward good bass is to provide some delay before the sound from the back of the speaker cone reaches the front, and not much delay at that. This is the reason why, despite the occasional use of comparatively large speakers—12-inch sometimes—bass is rarely satisfactory on a combination. Some models have labyrinths or other acoustical provisions, and they perform better. But at best the speaker cannot perform at its highest efficiency in the same cabinet with the rest of the components.

The "infinite" baffle

After the simple baffle, the next step in improving bass is merely an extension of the baffle toward infinite dimensions. That is, theoretically the board would be of infinite size and the time required for the rear sound to reach the front, infinitely long. This

would give optimum sound, but unfortunately infinity cannot be reached. Therefore we stay on the level of practicality and build a box.

The box can be a very simple one of any shape, such as a rectangle or triangle. It should have only one opening for each speaker, a round hole against which the speaker is mounted (inside the box). If the box material is very solid and if there are no stray openings of appreciable size, the rarefactions and compressions of air caused by the back of the speaker cone cannot reach the outside air at all, and we have, in effect, an infinite baffle.

Such a speaker enclosure is a very good one and is often used in the best-sounding systems. It is the best type for constructors to build because it is not critical as to design and is easily made. Only the front of the speaker cone can affect air that reaches the listener's ear, and the speakers will reproduce the lowest tones of which it is mechanically and electrically capable.

A few musts have to be observed. The wood must be very solid so that it does not vibrate appreciably. Nothing lighter than $\frac{3}{4}$ -inch plywood should be used, and even that should be braced internally. The inside volume of the box must be large enough so that when the speaker cone moves inward it does not compress very much of the air in the box and encounter more resistance than it does from the outer air in moving outward. This calls for a volume of at least 8 cubic feet, and 10 is a more comfortable margin. At least one of every two parallel walls within the box must be covered with very soft material such as thick cotton batting or Ozite, the material that goes under rugs. This prevents sound from bouncing from wall to wall and creating interfering modes that reflect back to the speaker cone. The front can be covered with loose-woven speaker cloth. Fig. 8 shows a Cabinet enclosure of this type with 8 cubic feet content.

Bass-reflex

The bass-reflex enclosure is a variation of the infinite baffle. It, too, is a box, but it contains a rectangular slot cut in the front wall below the speaker opening. The function of the slot is to deliberately allow certain of the back-waves to come through to the front. Its size and that of the box proper is so designed that the back-wave coming through the slot is in phase with the front-wave and reinforces it at a frequency slightly below the mechanical resonance frequency of the speaker.

The bass-reflex enclosure is an attempt to extend the bass range of a speaker without making the enclosure as large as infinite baffling would require. For best effect it is designed for a particular speaker, and even then it is doubtful that really high-quality results are possible, for there are interfering effects at other frequencies. If space for the enclosure is limited, bass-reflex may be beneficial. An article on page 84 of the March, 1949, issue of RADIO-ELECTRONICS gives dimensions

for enclosures of various sizes. The right-hand cabinet in Fig. 9 is a typical bass-reflex unit.

The horn

Once we have managed to separate the front and back waves so that the speaker pushes some air at all its operating frequencies, we have another problem. While a good speaker in an infinite baffle has excellent frequency response, it lacks real efficiency at the lowest frequencies because its cone area is limited and it cannot push *enough* air when it is moving slowly. The reason is that there is poor mechanical coupling between the small speaker cone and the large volume of air in the room.

The solution to this problem, which is actually an acoustic impedance mismatch, is to make the transition between the speaker cone area and the air with an exponential horn—one whose diameter increases as the exponent of the increase in distance from the small end. (If the exponent is 2, for example, the diameter increases in proportion to the square of the distance; if it is 3, the increase is proportional to the cube.)

Fig. 10 shows a roughly exponential horn used for public-address work. Note that the sides of the horn curve into a flare, rather than being straight as in a megaphone, showing that it is more exponential than linear. This kind of horn is the ideal projector of all frequencies down to a limit set by the diameter of the mouth (large end) in relation to the cutoff frequency. The horn of Fig. 10 is not useful below about 200 cycles.

To reach the low frequencies required for high-quality audio, the horn would have to be so gigantic that no normal house could hold it. Indeed, there are one or two examples of enthusiasts who have built houses around horns, with part of the horn housed in a separate building. The modern home solution is a folded horn, a passageway for the sound which starts with the small cross-sectional area of the speaker and takes the sound through a gradually increasing-area path to the outer air; the passageway is not straightforward but is folded within an enclosure of practical size.

One of the earliest and still finest enclosures of the folded-horn type was designed by Paul W. Klipsch. It and similar types are sold today by the designer and other firms. The Klipsch enclosure, pictured in Fig. 11, is placed in a corner of the room and uses the walls, floor, and ceiling as the walls of the final section of the folded horn. Sound emerges through the sides of the enclosure rather than the front, which is solid, after passing through passageways built into the inside. The corner location benefits the treble frequencies which tend to be confined to a limited angle around the speaker axis.

The choice of a speaker system is difficult for the average music enthusiast to make. In the final analysis, the only way to make a really intelligent choice is to listen. (TO BE CONTINUED)



**TRAIN FASTER—TRAIN BETTER—TRAIN EASIER
IN 10 MONTHS—OR LESS—FOR
RADIO-TELEVISION**

Our 21st Year Training Men for Greater Incomes and Security in Radio-Television

**I SEND YOU
18 BIG KITS**

of Radio-Television parts and equipment. Much of your training will be actual construction and experimentation... the kind of truly PRACTICAL instruction that prepares you for your Radio-Television career.



Frank L. Sprayberry
President
Sprayberry Academy
of Radio

NEW! NO OBLIGATION PLAN

**You Have No Monthly Payment Contract to Sign
Pay For Your Training as You Earn and Learn**

You can get into Radio-Television, today's fastest growing big money opportunity field, in *months* instead of *years*. My completely new "package unit" training plan prepares you in as little as 10 months or even less! *No monthly payment contract to sign—thus NO RISK to you!* This is America's finest, most complete, practical training—gets you ready to handle any practical job in the booming Radio-Television industry. Start your own profitable Radio-Television shop... or accept a good paying job. I have trained hundreds of successful Radio-Television technicians during the past 21 years—and stand ready to train you, even if you have no previous experience! Mail coupon and get all the facts—FREE!

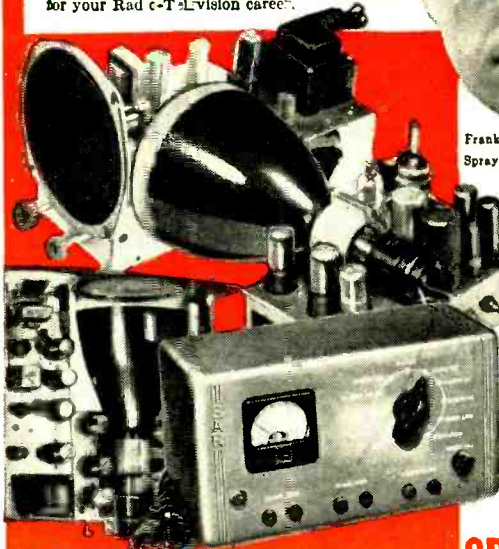

**Valuable Equipment Included
With Training**

The new Sprayberry "package" plan includes many big kits of genuine, professional Radio-Television equipment. You perform over 300 demonstrations, experiments and construction projects. You build a powerful 6-tube 2-band radio set, multi-range test meter, signal generator, signal tracer, many other projects. All equipment and lessons are *yours to keep*... you have practically everything you need to set up your own profitable Radio-Television service shop.

Earn Extra Money While You Learn!

All your 10 months of training is IN YOUR HOME in spare hours. Keep on with your present job and income while learning. With each training "package" unit, you receive extra plans and "Business Builder" ideas for spare time Radio-Television jobs. New television stations everywhere, open vast new opportunities for trained Radio-Television Technicians—and those in training. If you expect to be in the armed forces later, there is no better preparation than practical Sprayberry Radio-Television training.

YOU BUILD the Television set and the powerful superhet radio receiver shown above. IN ADDITION to the other test units shown here (many are not shown because of lack of space) all equipment I send you is **YOURS TO KEEP.**

Approved for Veterans under the G. I. Bill

**MAIL COUPON
TODAY!
NO OBLIGATION**

**SPRAYBERRY ACADEMY OF RADIO 111 NORTH CANAL ST.
Dept. 20-C, Chicago 6, Ill.**

**SPRAYBERRY ACADEMY OF RADIO, Dept. 20-C
111 North Canal St., Chicago 6, Ill.**

Please rush to me all information on your 10-MONTH Radio-Television Training Plan. I understand this does not obligate me and that no salesman will call upon me. Be sure to include 3 books FREE.

Name..... Age.....

Address.....

City..... Zone..... State.....

**I invite you to get all the facts—
FREE TO YOU 3 BIG
RADIO-TELEVISION BOOKS**

I want you to have ALL the facts about my new 10-MONTH Radio-Television Training—without cost! Rush coupon for my three big Radio-Television books: "How to Make Money in Radio-Television," PLUS my new illustrated Television Bulletin PLUS an actual sample Sprayberry Lesson—ALL FREE. No obligation and no salesman will call. Mail coupon NOW!





Heathkit VACUUM TUBE VOLTMETER KIT

MODEL V-6

\$24.50

SHIPPING WT. 6 LBS.

The beautiful Heathkit Model V-6 VTVM, the world's largest selling kit instrument, now offers many outstanding new features in addition to retaining all of the refinements developed and proven in the production of over 100,000 VTVM's. This is the basic measuring instrument for every branch of electronics. Easily meets all requirements for accuracy, stability, sensitivity, convenience of ranges, meter readability, and modern styling. It will accurately measure DC voltages, AC voltages, offers tremendous ohmmeter range coverage, and a complete db scale for a total of 35 meter ranges.

New 1½ volt full scale low range provides well over 2¼" of scale length per volt. Upper DC scale limit 1,500 volts. DC ranges 0-1.5, 5, 15, 50, 150, 500, 1,500 volts full scale. AC ranges 0-1.5, 5, 15, 50, 150, 500, 1,500 (1,000 volts maximum). Seven ohm-

meter ranges from .1 ohm to 1,000 megohms. For added convenience a DC polarity reversing switch and a center scale zero adjustment for FM alignment.

The smartly styled, compact, sturdy, formed aluminum cabinet is finished in an attractive gray crackle exterior. The beautiful two-color, durable, infra-red, baked enamel panel further adds to the over-all professional appearance.

Top quality components used throughout. 1% precision resistors — silver contact range and selector switches — selenium rectifier — transformer operated power supply. Individual calibration on both AC and DC for maximum accuracy. DB scale printed in red for easy identification, all other scales a sharp, crisp black for easy reading. A variety of accessory probes shown on this page still add further to over-all instrument usefulness.

Features

- ✓ New 1½ volt full scale low range
- ✓ 1,500 volt upper limit DC range
- ✓ Increased accuracy through 50% greater scale coverage
- ✓ High impedance 71 megohm input
- ✓ Center scale zero adjust
- ✓ Polarity reversal switch
- ✓ 1% precision resistors
- ✓ Clearly marked db scales

Heathkit 30,000 VOLT DC PROBE KIT

For TV service work or any similar application where the measurement of high DC voltage is required, the Heathkit Model 336 High Voltage Probe Kit will prove invaluable. A precision multiplier resistor mounted inside the two-color, sleek, plastic probe body provides a multiplication factor of 100 on the DC ranges of the Heathkit 11 megohm VTVM. The entire kit includes precision resistor, two-color plastic probe, tip connector spring, test lead, phone plug panel connector, and complete assembly instructions.



No. 336

\$4.50SHIP. WT.
2 LBS.

No. 338-B

Heathkit PEAK-TO-PEAK PROBE KIT

**\$5.50**

SHIP. WT. 2 LBS.

Now read peak-to-peak voltages on the DC scales of the Heathkit 11 megohm VTVM. Readings can be directly made from the VTVM scale without involved calculations. Measurements over the frequency range of 5 kc to 5 mc. Use this probe to extend the usefulness of your VTVM in radio and TV service work. The Peak-to-Peak Probe Kit features the new polished aluminum housing with two-color polystyrene probe ends. Detailed assembly sheet including instructions for probe operation.

Heathkit RF PROBE KIT

The Heathkit RF Probe used in conjunction with any 11 megohm VTVM will permit RF measurements up to 250 mc, ± 10%. A useful, convenient accessory for those occasions when RF measurements are desired. The RF probe body is housed in the new, smartly-styled polished aluminum probe body featuring two-color polystyrene probe ends and a low capacity flexible shielded test lead. The kit is complete with all necessary material and a detailed assembly sheet as well as instructions for probe operation.



No. 309-B

\$3.50

SHIP. WT. 2 LBS.

Heathkit AC VACUUM TUBE VOLTMETER KIT

MODEL AV-2

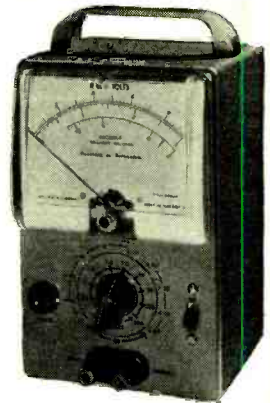
\$29.50SHIPPING WT.
5 LBS.

The new Heathkit AC VTVM that makes possible those sensitive AC measurements required by laboratories, audio enthusiasts, and experimenters. Especially useful for hum investigation, sensitive null detection, phono pick-up output measure-

ments, making frequency response runs, gain measurements, ripple voltage checks, etc. Low level measurements are easy to make because of the complete voltage coverage of the instrument and the one knob operation.

The large 200 microampere Simpson meter has clearly marked and easy to read meter scales. Ten voltage ranges covering from .01 rms full scale to 300 volts rms full scale, with frequency response ± 1 db from 20 cycles to 50,000 cycles. Instrument input impedance 1 megohm, ten db ranges from -52 db to +52 db. For stability and good linearity characteristics the meter bridge circuit features 4 germanium diodes. Attractive instrument styling, a companion piece for the popular Heathkit VTVM and the new AW-1 Audio Wattmeter.

HEATH COMPANY • Benton Harbor 20, Mich.

CHECK THESE *Features*

- ✓ 20,000 ohms per volt DC sensitivity, 5,000 ohms per volt on AC
- ✓ Polarity reversal switch
- ✓ 1% precision multiplier resistors
- ✓ 50 microampere $4\frac{1}{2}$ " Simpson meter
- ✓ Meter ranges for service convenience
- ✓ New resistor ring-switch assembly
- ✓ Total of 35 meter ranges
- ✓ New Modern cabinet styling

NEW *Heathkit* MULTIMETER KIT

MODEL MM-1

\$26⁵⁰

SHIPPING WT. 6 LBS.



The most important Heathkit announcement of the year, the new 20,000 ohms per volt Heathkit Multimeter, Model MM-1. The universal service measuring instrument, accurate, sensitive, portable, and completely independent of AC line supply. Particularly designed for service use incorporating many desirable features for the convenience of the service man. Full 20,000 ohms per volt sensitivity on DC ranges — 5,000 ohms per volt sensitivity on AC—polarity reversal switch, no bothersome transferring of test leads—1% precision multiplier resistors—large $4\frac{1}{2}$ " recessed non-glare 50 microampere Simpson meter—conveniently slanted control panel—recessed safety type banana jacks—standard universally available batteries—rugged practical sized cabinet with plastic carrying handle, and a total of 35 calibrated meter ranges.

RANGES

Voltage ranges selected entirely for service convenience. For example $1\frac{1}{2}$ volt full scale low range for measuring portable radio filament voltages, bias voltages, etc., 150 volt full scale range for AC-DC service work, 500 volt full scale range for conventional transformer operated power supply systems. Complete voltage ranges AC and DC, 0-1.5—5—50—150—500—1,500—5,000 volts. DC current ranges, 0-150 microamperes—15 milliamperes—150 milliamperes—500 milliamperes—15 amperes. Resistance measurements from .2 ohms to 20 meg-

ohms x 1 x 1,000 x 10,000.
DB coverage from -10 db
to +65 db.

CONSTRUCTION

Entirely new design permits assembly, mounting and wiring of precision resistors on a ring-switch assembly unit. The major portion of instrument wiring is completed before mounting the ring-switch assembly to the panel. No calibration procedure is required, all precision resistors readily accessible in event of replacement.

CABINET

Strikingly modern cabinet styling featuring two piece construction, durable black Bakelite cabinet, with easy to read panel designations. Cabinet size $5\frac{1}{2}$ " wide x 4" deep x $7\frac{1}{2}$ " high. Good cabinet physical stability when operated in vertical position.

The Heathkit MM-1 represents a terrific instrument value for a high quality 20,000 ohms per volt unit using all 1% deposited carbon type precision resistors. Here is quality, performance, functional design, and attractive appearance, all combined in one low priced package.

Heathkit BATTERY TESTER KIT



MODEL BT-1
\$8⁵⁰
SHIP. WT.
2 LBS.

The Heathkit Battery Tester measures all types of dry batteries between $1\frac{1}{2}$ volts and 150 volts under actual load conditions. Readings are made directly on a three color Good-Weak-Replace scale. Operation is extremely simple and merely requires that the test leads be connected to the battery under test. Only one control to adjust in addition to a panel switch for "A" or "B" battery types. The Heathkit Battery Tester features compact assembly, accurate meter movement, and a three deck wire-wound control, all mounted in a portable rugged plastic cabinet. Checks portable radio batteries, hearing aid batteries, lantern batteries, etc.

Heathkit HANDITESTER KIT



MODEL M-1
\$14⁵⁰
SHIPPING WT.
3 LBS.

The Heathkit Model M-1 Handitester readily fulfills major requirements for a compact, portable volt ohm milliammeter. Despite its compact size, the Handitester is packed with every desirable feature required in an instrument of this type. AC or DC voltage ranges full scale, 0-10—30—300—1,000—5,000 volts. Two ohmmeter ranges, 0-3,000 and 0-300,000. Two DC current measurement ranges, 0-10 milliamperes and 0-100 milliamperes. The instrument uses a Simpson 400 microampere meter movement, which is shunted with resistors to provide a uniform 1 milliampere load on both AC and DC ranges. Special type, easily accessible, battery mounting bracket—1% deposited carbon type precision resistors—hearing aid type ohms adjust control. The Handitester is easily assembled from complete instructions and pictorial diagrams. Necessary test leads are included in the price of this popular kit.

HEATH COMPANY • Benton Harbor 20, Mich.



New *Heathkit* 12 Volt BATTERY ELIMINATOR KIT

MODEL BE-4

\$31⁵⁰SHIPPING WT.
18 LBS.

CHECK THESE *Features*

- ✓ Either 6 or 12 volt operation
- ✓ Continuously variable voltage output
- ✓ Constant ammeter and voltmeter monitoring
- ✓ Automatic overload relay — self-resetting
- ✓ Two 10,000 mf condensers
- ✓ New 18 disc split type heavy duty rectifier unit
- ✓ Fuse protection

Here is the new Heathkit Battery Eliminator necessary for modern, up-to-date operation of your service shop. The Heathkit Model BE-4 furnishes either 6 volts or 12 volts output which can be selected at the flick of a panel switch. Use the BE-4 to service the new 12 volt car radios in addition to the conventional 6 volt radios.

This new Battery Eliminator provides two continuously variable output ranges, 0-8 volts DC at 10 amperes continuously, or 15 amperes maximum intermittent; 0-16 volts DC at 5 amperes continuously or 7.5 amperes maximum intermittent. The output voltage is clean and well filtered as the circuit uses two 10,000 mf condensers. The continuously variable voltage output feature is a definite aid in determining the starting point of vibrators, the voltage operating range of oscillator circuits, etc. Panel mounted meters constantly monitor voltage and cur-

rent output and will quickly indicate the presence of a major circuit fault in the equipment under test. The power transformer primary winding is fuse protected and for additional safety an automatic relay of the self-resetting type is incorporated in the DC output circuit. The heavy duty rectifier is a split type 18 plate magnesium copper sulfide unit used either as a full wave rectifier or voltage doubler according to the position of the panel range switch.

Here is the ideal battery eliminator for all of your service problems and as an additional feature, it can also be used as a battery charger. Another new application for the Heathkit Battery Eliminator is a variable source of DC filament supply in audio development and research. More than adequate variable voltage and current range for normal applications.

Heathkit VIBRATOR TESTER KIT

Your repair time is valuable, and service use of the Heathkit Vibrator Tester will save you many hours of work. This tester will instantly tell you the condition of the vibrator being checked. Checks vibrators for proper starting and the easy to read meter indicates quality of output on a large Bad?-Good scale. The Heathkit VT-1 checks both interrupter and self rectifier types of vibrators. Five different sockets for checking hundreds of vibrator types.

The Heathkit Vibrator Tester operates from any battery eliminator capable of delivering continuously variable voltage from 4 to 6 volts DC at 4 amperes. The new Heathkit Model BE-4 Battery Eliminator would be an ideal source of supply.

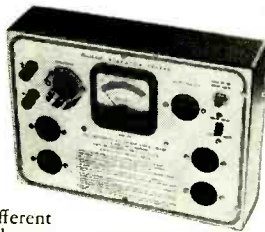

MODEL VT-1

\$14⁵⁰SHIPPING WT.
6 LBS.

NEW *Heathkit* VARIABLE VOLTAGE ISOLATION TRANSFORMER KIT

The new Heathkit Isolation Transformer Kit provides line isolation for AC-DC radios (not an auto transformer), thereby eliminating shock hazard, hum problems, alignment difficulties, etc. The output voltage is variable from 90 to 130 volts AC and is constantly monitored by a panel mounted AC volt meter. Use it to increase AC supply voltage in order to induce breakdown of faulty components in circuits thereby saving service time. Use it also to simulate varying line voltage conditions and to determine the line voltage level at which oscillator circuits cease functioning, particularly in three-way portable radios. Rated at 100 watts continuous operation and up to 200 watts maximum intermittent operation. A useful radio and TV service tool.



MODEL IT-1

\$16⁵⁰

SHIP. WT. 9 LBS.

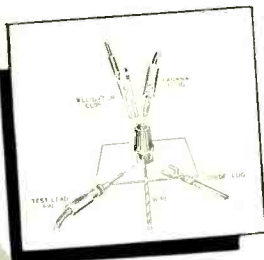

Heathkit BINDING POST

Binding post kit now available so that standardization of all instrument connectors is possible. This new, five-way binding post will accommodate an alligator clip, banana plug, test lead pin, spade lug, or hook-up wire. Sold in units of 20 binding post assemblies. Each assembly includes binding post, flat and shoulder fiber washers, solder lug, and nut. 120 pieces in all. Kit 362, \$4.00.

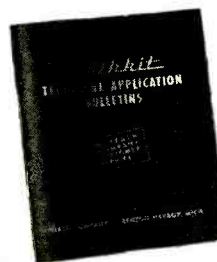

Heathkit TECHNICAL APPLICATION BULLETINS

An exclusive Heathkit service. Technical application bulletins prepared by recognized instrument authorities outlining various combinations of instrument applications. Available now with 40 four-page illustrated bulletins and an attractive flexible loose-leaf binder. Only \$2.00. (No c.o.d. on this item, please.)

HEATH COMPANY • Benton Harbor 20, Mich.

CHECK THESE *Features*

- ✓ INCREDUCTOR controllable inductor sweep
- ✓ TV and IF sweep deviation 12-30 mc
- ✓ 4 mc- 220 mc continuous frequency coverage
- ✓ Oscillator operation entirely on fundamentals
- ✓ Output in excess of 100,000 microvolts
- ✓ Automatic amplitude circuit
- ✓ Voltage regulation
- ✓ Simplified operation

NEW *Heathkit*
**TV ALIGNMENT
 GENERATOR
 KIT**

MODEL TS-3

\$44.50SHIPPING WEIGHT
18 POUNDS

Proudly announcing an entirely new, advanced model TV and FM Sweep Generator, the Heathkit Model TS-3. This new design provides features and combinations of functions not found in any other service type instrument. Every design consideration has been given to the requirements of the TV service man to provide a flexible, variable sweep source with more than adequate RF output and complete frequency coverage throughout the TV and FM spectrum.

The frequency range of the TS-3 is from 4 mc to 220 mc in four switch selected ranges. All frequency ranges are overlapping for complete coverage. A particularly important feature of the instrument is that the oscillator operates entirely on fundamentals, thereby providing complete freedom from spurious oscillation and parasitics normally encountered in beat frequency type oscillators. This circuitry assures a much higher total RF output level and simplifies attenuation problems.

The new TS-3 features an entirely new principle of sweep operation. Sweep action is entirely electronic with no moving parts or electro-mechanical devices so commonly used. The heart of the sweep system is a newly-developed INCREDUCTOR controllable inductor. With this system, the value of inductance of each oscil-

lator coil is electrically varied with an AC control current, and the inductance variation is achieved by a change in the magnetic state of the core on which the oscillator coils are wound. This system provides a sweep deviation of not less than 12 mc on all TV frequencies, and up to a maximum of 30 mc on TV IF frequencies. The high RF output level throughout the instrument frequency range overcomes the most common complaint of the older type sweep generators. A new, automatic amplitude control circuit maintains the output level flat to ± 2 db throughout the instrument range. For convenience of operation a low impedance 50 ohm output is used.

Operation of the instrument has been simplified through the reduction of panel controls and separate panel terminals provide for external synchronization if desired. The circuit uses a voltage regulator tube to maintain stable instrument operation. A built-in variable oscillator marker further adds to flexibility of instrument operation. Provisions are also made for the use of an external marker, such as your service type signal generator, if desired. Use the Heathkit TS-3 for rapid, accurate TV alignment work, and let it help you solve those time consuming, irksome problems so frequently encountered.

NEW *Heathkit*
SIGNAL GENERATOR KIT

MODEL SG-8

\$19.50SHIPPING WEIGHT
8 POUNDS

Announcing the new Heathkit Model SG-8 service type Signal Generator, incorporating many design features not usually found in an instrument in this price range. The RF output is from 160 kc to 100 mc in five ranges, all on fundamentals, with useful harmonics up to 200 mc. The RF output level is in excess of 100,000 microvolts throughout the frequency range.

The oscillator circuit consists of a 12AT7 twin triode tube. One half is used as a Colpitts oscillator, and the other half as a cathode follower output which acts as a buffer between the oscillator and external load. This circuitry eliminates oscillator frequency shift usually caused by external circuit loading.

All coils are factory wound and adjusted, thereby completely eliminating the need for calibration and the use of additional calibrating equipment. The stable low impedance output features a step and variable attenuator for complete control of RF level. A 6C4 triode acts as a 400 cycle sine wave oscillator and a panel switching system permits a choice of either external or internal modulation.

The transformer operated circuit is easy to assemble, requires no calibration, and meets every service requirement for an adjustable level variable frequency signal source, either modulated or un-modulated.

NEW *Heathkit*
BAR GENERATOR KIT

MODEL BG-1

\$14.50SHIPPING WEIGHT
6 POUNDS

The Heathkit BG-1 Bar Generator represents another welcome addition to the fast growing line of popular Heathkits. The station transmitted test pattern is rapidly disappearing, and the bar generator is the logical answer to the TV service man's problem in obtaining quick, accurate adjustment information without waiting for test patterns.

The Heathkit BG-1 produces a series of horizontal or vertical bars on a TV screen. Since these bars are equally spaced, they will quickly indicate picture linearity of the receiver under test. Panel switch provides "stand-by position" — "horizontal position" — "vertical position." The oscillator unit utilizes a 12AT7 twin triode for the RF oscillator and video carrier frequencies. A neon relaxation oscillator provides low frequency for vertical linearity tests. The instrument will not only produce bar patterns but will also provide an indication of horizontal and vertical sync circuit stability, as well as overall picture size.

Instrument operation is extremely simple, and merely requires connection to the TV receiver antenna terminal. The unit is transformer operated for safety when used in conjunction with universal or transformerless type TV circuits.

HEATH COMPANY • Benton Harbor 20, Mich.

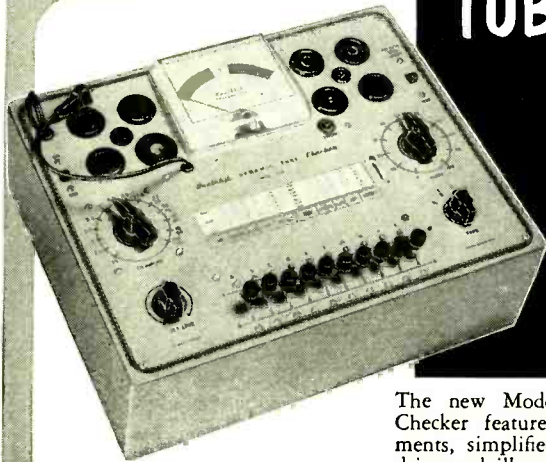

NEW *Heathkit* TUBE CHECKER KIT

MODEL TC-2

\$29.50

SHIP. WT. 12 LBS.

The new Model TC-2 Heathkit Tube Checker features many circuit improvements, simplified wiring, new roll chart drive and illumination of roll chart. The instrument is primarily designed for the convenience of the radio and TV service man and will check the operating quality of tubes commonly encountered in this type of work. Test set-up procedure is simplified, rapid, and flexible. Panel sockets accommodate 4, 5, 6, and 7 pin tubes, octal and loctal, 7 and 9 pin miniatures, 5 pin Hytron and a blank socket for new tubes. Built-in neon short indicator, individual three-position lever switch for each tube element, spring return test switch, 14 filament voltage ranges, and line set control to compensate for supply voltage variations, all represent important design features of the TC-2. Results of tube tests are read directly from a large 4½" Simpson three-color meter, calibrated in terms of Bad-?-Good. Information that your customer can readily understand. Checks emission, shorted elements, open elements, and continuity.

The use of closer tolerance resistors in critical circuits assures correct test information and eliminates the possibility of inaccurate test interpretation. Improvement has been made in the mechanical roll chart drive system, completely eliminating diagonal running, erratic operation, and backlash. The thumb wheel gear driven action is smooth, positive, and free running. As an additional feature, the roll chart is illuminated for easier reading, particularly when the tube checker is used on radio or TV home service calls.

Wiring procedure has been simplified through the extended use of multi-cable, color coded wires, providing a harness type installation between tube sockets and lever switches. This procedure insures standard assembly and imparts that "factory built" appearance to instrument construction. Completely detailed information is furnished in the new step-by-step construction manual, regarding the set-up procedure for testing of new or unlisted tube types. No delay necessary for release of factory data.

The new Heathkit Tube Checker will prove its value in building service prestige through usefulness—simplified operation—attractive professional appearance. Don't overlook the fact that the kit price represents a savings of \$40.00 to \$50.00 over the price of a comparable commercially built instrument. At this low price, no service man need be without the advantages offered by the Heathkit Tube Checker.

CHECK THESE NEW *Features*

- ✓ Simplified harness wiring
- ✓ Improved, smooth, anti-backlash roll chart action
- ✓ Optional roll chart illumination
- ✓ Individual element switches
- ✓ Portable or counter style cabinet
- ✓ Spare blank socket
- ✓ Contact type pilot light test socket
- ✓ Simplified test set-up procedure
- ✓ Line adjust control
- ✓ 4½" three-color meter

New HEATHKIT PORTABLE TUBE CHECKER KIT

MODEL TC-2P

\$34.50

SHIP. WT. 14 LBS.



The portable model is supplied with a strikingly attractive two-tone cabinet finished in rich maroon, proxylin impregnated, fabric covering with a contrasting gray on the inside cover. Detachable cover, brass-plated hardware, sturdy plastic handle help to impart a truly professional appearance to the instrument.

PORTABLE TUBE CHECKER CABINET as described above will fit all earlier Heathkit TC-1 Tube Checkers. Shipping weight 7 lbs. Cabinet only, 91-8, \$7.50.



Heathkit TV PICTURE TUBE TEST ADAPTER

No. 355
Ship. Wt. **\$4.50**
1 lb.

The Heathkit TV Picture Tube Test Adapter used with the Heathkit Tube Checker will quickly check for emission, shorts, etc., and determine picture tube quality. Consists of standard 12 pin TV tube socket, four feet of cable, octal socket connector, and data sheet.

Heathkit POWER SUPPLY KIT



MODEL PS-2

\$33.50SHIPPING WT.
17 LBS.

The Heathkit Laboratory Power Supply features continuously variable, regulated voltage output with good stability under wide load variations. A 4½" Simpson plastic enclosed panel mounted meter provides accurate meter output information of voltage or current. All panel terminals completely isolated from the cabinet. Separate 6.3 volt AC supply at 4 amperes for filament requirements. Ripple component exceptionally low, stand-by switch provided to eliminate warm-up time of the five tube circuit.



LABORATORY AND SERVICE SHOP BOOKLETS

"Planning Your Service Business" by John T. Frye, and "Establishing the Industrial Electronics Laboratory" by Louis B. Garner, Jr., are booklets available to Heathkit customers at no charge. These booklets, written by nationally recognized authorities, outline the various requirements and considerations for establishing your own service business or for setting up an industrial electronics laboratory. Full attention is given to various details that are frequently overlooked when projects of this nature are undertaken. Just write in to the Heath Company requesting your free copy, or attach a memo to your next order.

HEATH COMPANY • Benton Harbor 20, Mich.

CHECK THESE *Features*

- ✓ Visual and aural signal tracing
- ✓ Two channel input
- ✓ High RF sensitivity
- ✓ Unique noise locator circuit
- ✓ Calibrated wattmeter
- ✓ Substitution test speaker
- ✓ Utility amplifier
- ✓ RF, audio probes and test leads included

Heathkit VISUAL-AURAL SIGNAL TRACER

KIT

MODEL T-3

\$23⁵⁰

SHIPPING WEIGHT
10 POUNDS

An entirely new type of signal tracer incorporating a combination of features not found in any other instrument. Designed expressly for the radio and TV service man, particularly for the servicing of AM, FM, and TV circuits. Here in a five tube, transformer operated instrument are all of the useful functions so necessary for speedy, accurate isolation of service difficulty.

This new signal tracer features a special high gain RF input channel, used in conjunction with a newly-designed wide frequency range demodulator probe. High RF sensitivity permits signal tracing at the receiver antenna input. A separate low gain channel and probe available for audio circuit exploration. Both input channels are constantly monitored by an electron ray beam indicator, so that visual as well as aural signal indications may be observed. The instrument can also be used for comparative estimation of gain per stage.

A decidedly unusual feature is a noise localizer circuit in conjunction with the audio probe. With this system, a DC potential is applied to a suspected circuit component and the action of the

voltage in the component can be seen as well as heard. Invaluable for ferreting out noisy or intermittent condensers, noisy resistors, controls, coils, IF and power transformers, etc. A built-in calibrated wattmeter circuit is very useful for a quick preliminary check of the total wattage consumption of the equipment under test. Separate panel terminals provide external use of the speaker or output transformer for substitution purposes. Saves valuable service time by eliminating the necessity for speaker removal on every service job. The terminals also permit the utilization of other shop equipment, such as your oscilloscope or VTVM. The T-3 Signal Tracer can be used as a high gain amplifier for checking tuners, record changers, microphones, phono crystals, etc.

Don't overlook the interesting service possibilities provided through the use of this new instrument and let it work for you by saving time and money. The kit is supplied complete with all tubes, circuit components, demodulator probe, audio probe, and additional test leads.

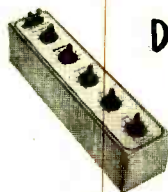

Heathkit DECADE RESISTANCE KIT

MODEL DR-1 The Decade Resistance Kit provides individual switch selection of resistance values using twenty 1% resistors providing a choice of 1 to 99,999 ohms in 1 ohm steps. Ceramic wafer switches, silver-plated contacts, smooth, positive detent action, baked enamel panel, and handsome, polished birch cabinet.

\$19⁵⁰

SHIP. WT.
4 LBS.

Heathkit DECADE CONDENSER KIT

The Heathkit Decade Condenser Kit features silver mica, precision condensers with a rated accuracy of $\pm 1\%$. Capacity values are arranged in three decades from 100 mmf to .111 mf in steps of 100 mmf. Ceramic wafer switches with silver-plated contacts and smooth detent action. Useful in laboratory work, for circuit development.

MODEL DC-1

\$16⁵⁰

SHIP WT.
4 LBS.



Heathkit RESISTANCE SUBSTITUTION BOX KIT

MODEL RS-1

\$5⁵⁰

SHIP. WT.
2 LBS.



The Heathkit Resistance Substitution Box provides individual switch selection of any one of 36 RTMA 1 watt 10% standard value resistors, ranging from 15 ohms to 10 megohms. Many applications in circuit development work, and also in radio and TV service work. Ideal for experimentally determining resistance values and for quickly altering circuit operating characteristics. Entire unit housed in attractive Bakelite cabinet, featuring the new universal type Heathkit binding posts to simplify circuit connections.

Heathkit CONDENSER CHECKER KIT

MODEL C-3

\$19⁵⁰

SHIPPING WT.
8 POUNDS



Use the Heathkit C-3 Condenser Checker to quickly and accurately measure those unknown condenser

and resistor values. All readings are taken directly from the calibrated panel scales without requiring any involved calculation. Capacity measurements in four ranges from .00001 mf to 1,000 mf. Checks paper, mica, ceramic, and electrolytic condensers. A power factor control is available for accurate indication of electrolytic condenser measurements. A leakage test switch with switch selection of five polarizing voltages, 25 volts to 450 volts DC, will indicate condenser operating quality under actual load condition. The spring return leakage test switch automatically discharges the condenser under test and eliminates shock hazard to the operator.

Resistance measurements can be made in the range from 100 ohms to 5 megohms. Here again all values are read directly on the calibrated scale. Increased circuit sensitivity coupled with an electron beam null indicator increases overall instrument usefulness.

For safety of operation the circuit is entirely transformer operated and the instrument is housed in the attractive, newly-styled Heathkit cabinet, featuring rounded corners, and drawn aluminum panel. The outstanding low kit price for this surprisingly accurate instrument includes necessary test leads. Good service shop operation requires the use of this specialized instrument, designed for the express purpose of determining unknown condenser values and operating characteristics.

HEATH COMPANY • Benton Harbor 20, Mich.



Heathkit **AMATEUR
TRANSMITTER
KIT**

MODEL AT-1
\$29.50
SHIPPING WEIGHT
16 POUNDS

- CHECK THESE
NEW Features**
- ✓ Single knob band switching
 - ✓ Pre-wound coils
 - ✓ Metered operation
 - ✓ 52 ohm coaxial output
 - ✓ Crystal or VFO excitation
 - ✓ Built-in power supply
 - ✓ Rugged, clean construction

Here is the latest Heathkit addition to the ham radio field, the AT-1 Transmitter Kit, incorporating many desirable design features at the lowest possible dollar-per-watts price. Panel mounted crystal socket, stand-by switch, key click filter, AC line filtering, good shielding, etc. VFO or crystal excitation — up to 35 watts input. Built-in power supply provides 425 volts at 100 ma.

This kit features pre-wound coils, single knob band switching, 52 ohm coaxial output, plug in chassis provisions for VFO or modulator and rugged clean construction. Frequency range 80, 40, 20,

15, 11, and 10 meters. Tube line-up 6AG7 oscillator-multiplier, 6L6 amplifier-doubler, 5U4G rectifier. Physical dimensions 8 1/8" high x 13 1/8" wide x 7" deep.

This amazingly low kit price includes all circuit components, tubes, cabinet, punched chassis, and detailed construction manual. The ideal kit for the novice just breaking into ham radio. It can be used later on as a stand-by rig or an all band exciter for higher powered transmitter.

NEW *Heathkit*
ANTENNA COUPLER KIT

New Heathkit Antenna Coupler, specially designed for the Heathkit AT-1 Transmitter. The Antenna Coupler can be used with any 52 ohm coaxial input — up to 75 watts power. Low pass filter with cut-off frequency of approximately 36 mc — L section tuning network — neon tuning indicator — rugged, compact construction — transmitter type variable condenser, and high Q coil are all outstanding features. The AC-1 has both inductance and capacity tuning for maximum operating versatility. Dimensions 8 1/8" wide x 4 3/8" high x 4 7/8" deep.

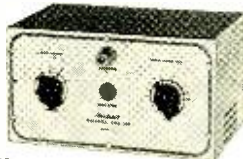

MODEL AC-1
\$14.50 SHIP. WT.
3 LBS.

Heathkit
ANTENNA IMPEDANCE METER

Use the Heathkit Antenna Impedance Meter for measuring antenna impedance for line matching purposes — adjustment of beam antennas — phone monitor, etc. It will determine antenna resistance at resonance, match transmission line for minimum SWR, determine receiver input impedance, and provide a rough indication of SWR. Precision resistors, germanium diode, 100 micro-ampere Simpson meter. Dial calibrated from 0-500 ohms. Shielded aluminum cabinet. 7" long x 2 1/2" wide x 3 1/4" deep.

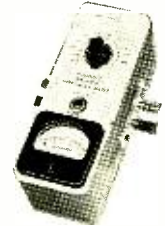

\$14.50
MODEL AM-1
SHIP. WT. 3 LBS.

Heathkit
COMMUNICATIONS RECEIVER KIT



MODEL AR-2
\$25.50 SHIP. WT.
12 LBS.

Here is the new receiver kit you have repeatedly asked for, the Heathkit Communications Receiver. The perfect companion piece for the AT-1 Transmitter kit. Many outstandingly desirable features have been incorporated in the design of the AR-2; such as, electrical bandspread for logging and tuning convenience — high gain miniature tubes — IF transformers for high sensitivity and good signal to noise ratio — separate RF gain control with optional automatic volume control or manual volume control, in addition to the conventional audio gain control. Noise limiter — stand-by switch — stable BFO oscillator circuit — headphone jack — transformer operation, etc., all contribute to a high performance standard.

Frequency coverage is continuous from 535 kc to 35 mc in four ranges. For added convenience, various ham bands have been separately identified in respect to their relative placement on the slide rule tuning scale. A chassis mounted, 5 1/2" PM speaker is included with this kit. Tube line up 12BE6 mixer oscillator, 12BA6 IF amplifier, 12AV6 detector AVC audio, 12BA6 BFO oscillator, 12A6 beam power output, 5Y3GT rectifier.

RECEIVER CABINET

Proxylin impregnated, fabric covered, plywood cabinet with aluminum panel designed expressly for the AR-2 Receiver. Part 91-10, shipping weight 5 lbs., \$4.50.



IMPROVED *Heathkit*
**GRID DIP
METER KIT**

\$19.50 SHIP. WT.
4 LBS.

MODEL GD-1B
The invaluable instrument for service men, hams, and experimenters. Useful in TV service work for alignment of traps, filters, IF stages, peaking compensation networks, etc. Locates spurious oscillation, provides a relative indication of power in transmitter stages, use it for neutralization, locating parasitics, correcting TVI, measuring C, L, and Q of components, and determining RF circuit resonant frequencies. With oscillator energized, useful for finding resonant frequency of tuned circuits. With the oscillator not energized, the instrument acts as an absorption wave meter. Variable meter sensitivity control, head phone jack, 500 microampere Simpson meter. Continuous frequency coverage from 2 mc. to 250 mc. Pre-wound coil kit and rack, new three prong coil mounting, 6AF4 high frequency triode.

Two additional plug-in coils are available and provide continuous extension of low frequency coverage down to 355 kc. Dial correlation curves included. Shipping weight 1 lb., kit 3-41, \$3.00.

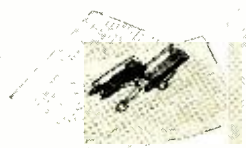

CHECK THESE *Features*

- ✓ First popular priced Q Meter
- ✓ Reads Q directly on calibrated scale
- ✓ Oscillator supplies RF frequencies of 150 kc to 18 mc
- ✓ Calibrate capacitor with range of 40 mmf to 450 mmf with vernier of ± 3 mmf
- ✓ Measures Q of condensers, RF resistance, and distributed capacity of coils
- ✓ Many applications in design and development work
- ✓ Useful in TV service work for checking deflection yokes, coils, chokes, etc.

Another outstanding example of successful Heathkit engineering effort in producing a Q Meter Kit within the price range of TV service men, schools, laboratories, and experimenters. This Q Meter meets RF design requirements for rapid, accurate measurement of capacity, inductance, and Q at the operating frequency and all indications of value can be read directly on the meter calibrated scales. Oscillator section supplies RF fre-

Heathkit "Q" METER KIT

MODEL QM-1
\$44.50

SHIPPING WT. 14 POUNDS

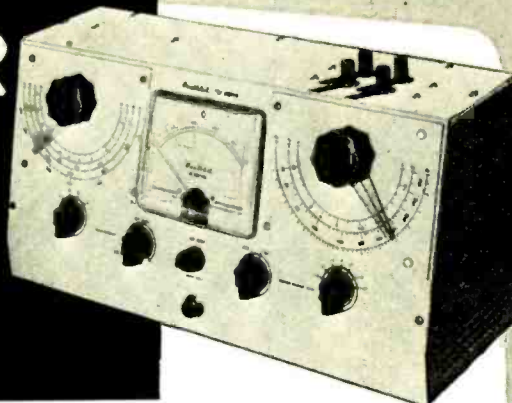

quencies of 150 kc to 18 mc. Calibrate capacitor with range of 40 mmf to 450 mmf, with vernier of ± 3 mmf.

Particularly useful in TV service work for checking peaking coils, wave traps, chokes, deflection coils, width and linearity coils, etc. At this low kit price research laboratory facilities are within the range of service shops, schools, and experimenters.

Heathkit INTERMODULATION ANALYZER KIT



MODEL IM-1
\$39.50

SHIPPING WT.
17 POUNDS

The Heathkit IM-1 is an extremely versatile instrument specifically designed for measuring the degree of inter-action between two signals in any portion of an audio chain. It is primarily intended for making tests of audio amplifiers, but may be used in other applications, such as checking microphones, records, recording equipment, phonograph pick-ups, and loud-speakers. High and low test frequency source, intermodulation unit, power supply, and AC vacuum tube volt meter all in one complete instrument. Per cent intermodulation is directly read on the calibrated scales, 30%, 10%, and 3% full scale. Both 4:1 and 1:1 ratios of low to high frequency easily set up. With this instrument the performance level of present equipment, or newly developed equipment can be easily and accurately checked. At this low price, you can now enjoy the benefits of intermodulation analysis for accurate audio interpretation.

Heathkit AUDIO GENERATOR KIT

A Heathkit Audio Generator with frequency coverage from 20 cycles to 1 mc. Response flat ± 1 db from 20 cycles to 400 kc, down 3 db at 600 kc, and down only 8 db at 1 mc. Calibrated, continuously variable, and step attenuator output controls provide convenient reference output level. Distortion is less than .4% from 100 cps through the audible range. The ideal controllable extended frequency sine wave source for audio circuit investigation and development.



MODEL AG-8
\$29.50
SHIP. WT. 11 LBS.

Heathkit AUDIO OSCILLATOR KIT

Sine or square wave coverage from 20 to 20,000 cycles in three ranges at a controllable output level up to 10 volts. Low distortion, 1% precision resistors in multiplier circuits, high level output across entire frequency range, etc., readily qualify this instrument for audio experimentation and development work. Special circuit design consideration features thermistor operation for good control of linearity.



MODEL AO-1
\$24.50
SHIP. WT. 11 LBS.

Heathkit AUDIO FREQUENCY METER KIT



MODEL AF-1
\$34.50
SHIP. WT. 12 LBS.

The Heathkit Audio Frequency Meter provides a simple and convenient means of checking unknown audio frequencies from 10 cycles to 100 kc at any voltage level between 3 and 300 volts rms with any non-critical wave shape.

Instrument operation is entirely electronic. Just set the range switch, feed an unknown frequency into the instrument, and read the frequency directly on the calibrated scale of the Simpson $4\frac{1}{2}$ " meter.

Heathkit SQUARE WAVE GENERATOR KIT



MODEL SQ-1
\$29.50
SHIP. WT. 12 LBS.

The Heathkit Square Wave Generator provides an excellent square wave frequency source with completely variable coverage from 10 cycles to 100 kc. This generator features low output impedance of 600 ohms and the output voltage is continuously variable between 0 and 20 volts, thereby providing the necessary degree of operating flexibility. An invaluable instrument for those specialized circuit investigations requiring a good, stable, variable square wave source.

HEATH COMPANY • Benton Harbor 20, Mich.

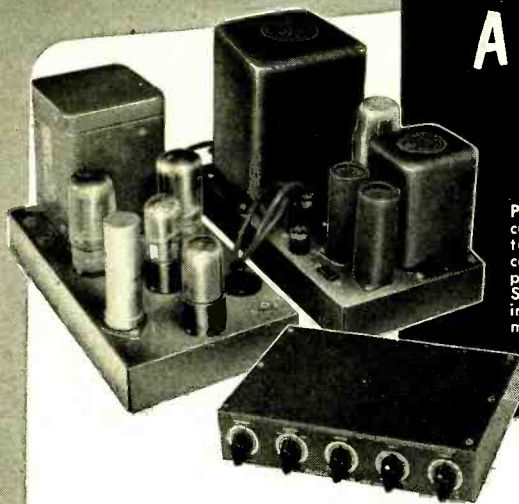

Heathkit WILLIAMSON TYPE AMPLIFIER KIT

MODEL W-2

Particularly designed for custom installations, featuring separate cable connected units for simplicity of installation. Sheet metal work finished in attractive gray hamertone for smart appearance. All control shafts of the adjustable length break-off type.

\$69.50

PRICES OF COMBINATIONS

W-2 Amplifier Kit including main amplifier, power supply, and WA-P1 Preamp Kit. Shipping Weight 37 lbs. Shipped Express only. **\$69.50**

W-2M Amplifier Kit includes main amplifier and power supply. Shipping Weight 29 lbs. Shipped Express only. **\$49.75**

WA-P1 Preamp Kit only. Shipping Weight 6 lbs. Shipped Express or Parcel Post. **\$19.75**

When selecting an amplifier for the heart of your high fidelity audio system, investigate the outstanding advantages offered by the Heathkit Williamson Type Amplifier. Meets every high fidelity audio requirement and makes listening to recorded music a thrilling new experience.

This outstanding amplifier is offered with optional output transformer

operation, providing either the conventional triode output circuit or the new extended power circuitry in which the screen supply voltage is obtained from separate transformer primary taps. Frequency response within ± 1 db from 10 cycles to 100 kc. Tube complement—6SN7 cascade amplifier and phase splitter, 6SN7 push pull driver, two 5881 push pull power amplifiers, one 5V4G cathode type rectifier.

Matching preamplifier available providing three switch selected inputs, correct compensation, and individual bass and treble tone controls. Uses 12AX7 (or 12AX7) preamplifier—12AU7 tone control amplifier.

Particularly designed for the novice kit builder and requires no specialized knowledge or equipment for successful assembly and operation.

NEW Heathkit 20 WATT High Fidelity AMPLIFIER KIT

MODEL A-9A

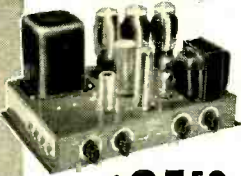

\$35.50

SHIP. WT. 18 LBS.

A new 20 watt high fidelity amplifier, designed especially for custom audio installations demanding clean reproduction, adequate power, and flexibility to meet individual requirements. Separate treble and bass tone controls provide up to 15 db boost or cut. Four switch selected inputs, each with the necessary compensation for the service desired. Output transformer impedances of 4, 8, and 16 ohms.

Preamplifier, tone control, and phase splitter circuits utilize 9 pin twin triode miniature tubes for low hum and noise level. Two 6L6 push pull power output tubes provide full 20 watts power. Frequency response ± 1 db, 20-20,000 cycles. Total harmonic distortion 1% (at 3 db below rated output). Tube line-up: 12AX7 preamplifier, 12AU7 voltage amplifier and tone control, 12AU7 voltage amplifier and phase splitter, two 6L6 push pull pentode power output, 5U4G rectifier. Truly outstanding amplifier performance coupled with low cost.



MODEL A-7B

\$15.50

SHIP. WT. 10 LBS.

Heathkit ECONOMY 6 WATT AMPLIFIER KIT

The new Heathkit Model A-7B Amplifier offers many unusually fine features not normally expected in this low price range. Either of the two input circuits may be individually switch selected for phono or tuner operation. Separate bass and treble tone controls. Output impedances of 4, 8, and 15 ohms. Push pull beam power output stage for balanced reproduction. Excellent voltage gain characteristics, good frequency response, and full 6 watts power output. 12J5 amplifier, 12SL6 second amplifier and phase splitter, two 12A6 beam power output, one 5Y5 GT rectifier.

A-7C incorporates preamplifier stage with special compensated network to provide necessary gain for operation with variable reluctance or low output level phono cartridge. Circuit is properly compensated for microphone operation. \$17.50.

NEW Heathkit BROADCAST BAND RECEIVER KIT

Another new Heathkit for the student, beginner, or hobbyist. If you have ever had the urge to build your own radio receiver, this kit warrants your attention.

New high gain miniature tubes and IF transformers provide excellent sensitivity and good signal to noise ratio. A built-in ferrite core rod type antenna has been provided. A chassis mounted $5\frac{1}{2}$ " PM speaker provides excellent tone and volume. Convenient phono input. Can be operated either as a receiver or tuner. Simplified construction manual outlines circuit theory. Ideal for students. Tube line-up: 12BE6 mixer oscillator, 12BA6 IF amplifier, 12AV6 detector-AVC-first audio, 12A6 beam power output, 5Y3GT rectifier.

CABINET—Proxylin impregnated fabric covered plywood cabinet. Shipping weight 5 lbs. Part number 91-9, \$4.50.



MODEL BR-2

\$17.50 SHIP. WT. 11 LBS.

Heathkit FM TUNER KIT

The Heathkit FM-2 Tuner was specifically designed for simplified kit construction. Can be operated through the "phono" portion of your radio or with a separate amplifier. The kit features a pre-assembled and adjusted tuning unit, three double tuned IF transformers, and a discriminator transformer in an 8 tube AC operated circuit. Frequency coverage 88 to 108 mc. Experience the thrill of building your own FM tuner and at the same time enjoy all of the advantages of true FM reception.

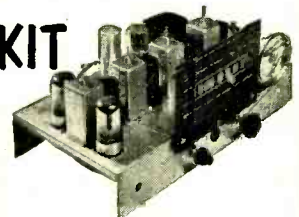

MODEL FM-2

\$22.50

SHIP. WT. 9 LBS.

Free CATALOG

Write for free catalog containing latest price information, schematics, specifications, and descriptions of all Heathkits.

HEATH COMPANY • Benton Harbor 20, Mich.

BRITISH AUDIO CIRCUITS

High-quality circuits result primarily from the application of time and effort to improve conventional circuits, obtaining optimum circuit values.

By NORMAN H. CROWHURST

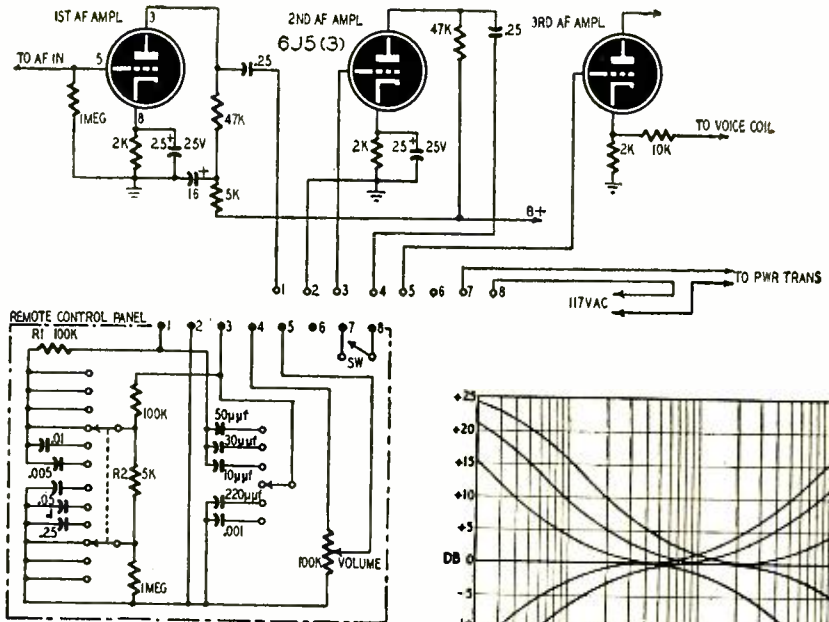

Fig. 1—Telrad remote-control circuit.

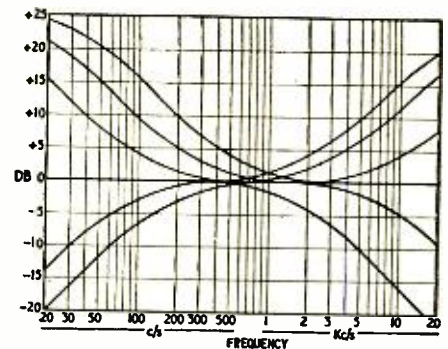

Fig. 2—Curves for six control positions.

It has been said, on both sides of the Atlantic, that the British appear to lead the audio field. When asked to gather material on British audio circuit features, I naturally asked myself the questions: *Why* do the British lead in this field? In what does this leadership consist? Is it more advanced know-how, or is it just doing an ordinary job a little better?

The consensus is that there is nothing particularly clever about our circuitry in most instances. Rather, it is that more time and effort is put into getting the best out of well-tried circuits or their variations. Until recently, there was very little interest in audio. American production-minded concerns did not find it attractively profitable to invest in research for such small volume. However, some British outfits, working on a smaller scale, found the outlay worth while.

The market is growing with the widening interest, and it may be that the concerns who manufacture in large quantities will soon take the lead from our small-timers. But it is probable that we shall hold our own, for, even with the market bigger, it will remain essentially an individualist one. Audio enthusiasts are connoisseurs, and ears,

like palates, vary. So there should continue to be room for everybody who is prepared to do a really good job.

Probably the connoisseur aspect of the audio fan (or should it be audiophile?) is best evidenced in the variety of circuits for quality control, tone compensation, or whatever name you like to give it. The author recently questioned a statement to the effect that bass boost and treble cut have the same effect, and vice versa. He was immediately shown higher authority for this opinion. The truth would appear to be that the difference is indistinguishable to some, while to the more discriminating ear the finer details of frequency response require some control to obtain a satisfying effect.

Most modern audio equipment incorporate the control features in a preamplifier remote from the main amplifier. An exception to this is an equipment made by Telrad Electronics, where to produce many of the advantages of more expensive contemporaries the whole amplifier is carried on one chassis. The controls are remote and are connected to the main chassis by a relatively short length of multi-conductor cable, terminated in an octal plug. Fig. 1 shows the remote panel

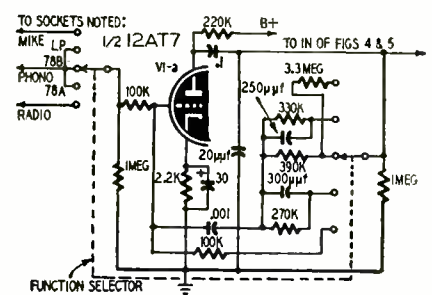

Fig. 3—Leak input compensation.

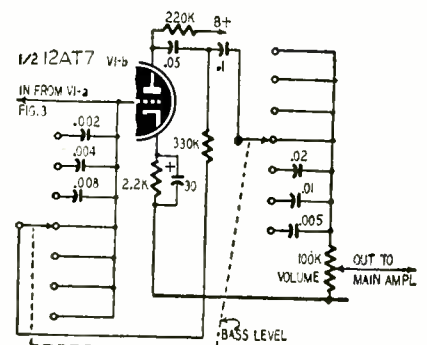
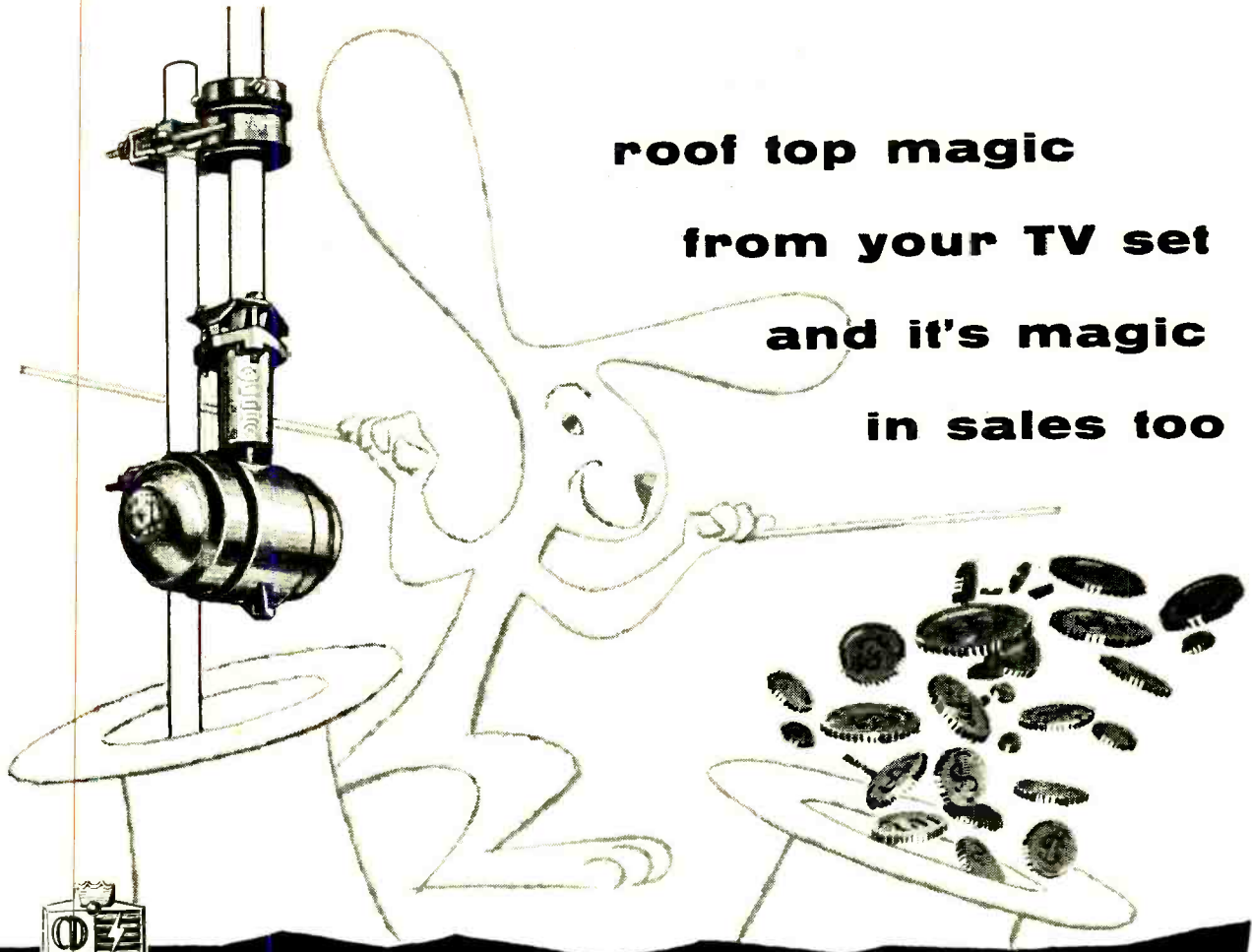

Fig. 4—Leak bass control circuit.



roof top magic

from your TV set

and it's magic

in sales too



the C·D·R Rotors

NATIONALLY PROMOTED IN TELEVISION

★ There's real MAGIC to the CDR ROTOR!
The way it IMPROVES any TV picture is magic
... the way it sells... is magic! BUT... the real
answer is quality manufacture of a proven design!

That adds up to continued dependable
performance... CDR ROTORS ARE BUILT TO
LAST... built to perform under any conditions!

NOW... MORE IN DEMAND THAN EVER
BEFORE with the BIG consumer advertising
campaign in full swing... if you don't
have your BIG CDR PROMOTION KIT with
selling and advertising aids... write us
for your kit... to help you sell EVEN MORE!

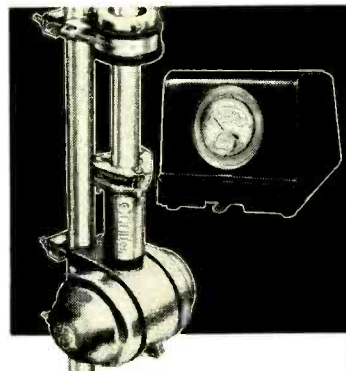

TR-12... a special combination value consisting of complete rotor including thrust bearing... handsome modern design cabinet with meter control dial... **\$47.95**

TR-11... same as TR-12 without thrust bearing **\$44.95**

TR-2... the HEAVY DUTY rotor especially suited for special TV antenna installations. Complete rotor with "Compass Control" cabinet having illuminated "perfect pattern" dial. **\$49.95**

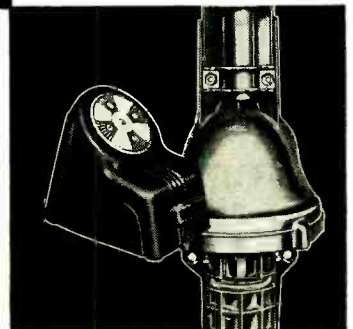

THE RADIART CORPORATION
CLEVELAND 13, OHIO



THE CORNELL-DUBILIER ELECTRIC CORP.
SOUTH PLAINFIELD, N.J.

NO OTHER UHF ANTENNA COMBINES ALL

- 1** Extra high gain
- 2** All channel reception
- 3** Sharp vertical and horizontal directivity

3



Model 4150

List \$14.50

WALSCO

CORNER REFLECTOR

Not **1**... Not **2**... but all **3** combined for amazing picture clarity

NOTHING... *absolutely nothing* compares with Walsco's Corner Reflector. It's the only UHF antenna that offers a 3-way *combination* that produces sharper, clearer TV pictures. Truly a masterpiece in precision electronic engineering.

WALSCO *A Model to Fit Every Installation*

Walter L. Schott Co.
3225 Exposition Place
Los Angeles 18, California

COMPARISON CHART

	High Gain	All channel Performance	Sharp Directivity
WALSCO CORNER REFLECTOR	YES	YES	YES
ANTENNA B	NO	YES	NO
ANTENNA C	NO	YES	NO
ANTENNA D	YES	NO	YES

Overseas Representative: Ad Auriema, Inc., 89 Broad St., New York 4, New York

Latest Books for TV "KNOW-HOW"!

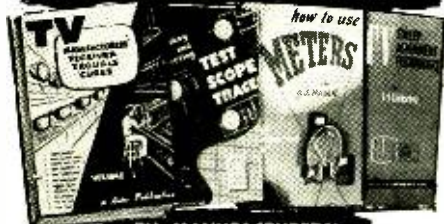

TV MANUFACTURERS' RECEIVER TROUBLE CURES VOL. 1, VOL. 2, VOL. 3 and VOL. 4

Positive cures for TV troubles! Gives you exact directions for correcting TV receiver performance "bugs". Each cure is official, factory-authorized, direct from the receiver's manufacturer. Listings by manufacturer and model or chassis number. Helps correct the most difficult faults—picture jitter, hum, instability, buzz, tearing, etc.

Vol. 1, 115 pages (5¼ x 8¼")..... **\$1.80**

Covers 12 brands, Admiral through Dumont

Vol. 2, 117 pages (5¼ x 8¼")..... **\$1.80**

Covers 11 brands, Emerson through Jackson

Vol. 3, 119 pages (5¼ x 8¼")..... **\$1.80**

Covers 16 brands, Kaye-Halbert through Philco

Vol. 4, over 115 pages (5¼ x 8¼")..... **\$1.80**

Covers 10 brands, Philharmonic through Shaw TV

VOLUME 5 COMING SOON!

Prominent manufacturers not in first 4 volumes

ONE SERVICE JOB WILL MORE THAN PAY

THE COST OF THIS SERIES OF BOOKS!

OBTAINING AND INTERPRETING TEST SCOPE TRACES

by J. F. Rider

Over 500 actual photographs of test scope traces. Shows how to use scopes and what traces mean. Valuable for servicing TV receivers, FM and AM radio receivers, audio systems and test equipment. Specific test equipment set-ups shown with each application. No other book like it! Over 140 pages... **Only \$2.40**

HOW TO USE METERS

by J. F. Rider

Panel type, volt-ohm-milliammeters, vacuum tube voltmeters for servicing radio and TV receivers, audio amplifiers, power supplies; for use and repair of ham transmitters. Written for the service technician, the TV and Radio student and hams.

Over 140 pages..... **Only \$2.40**

TV SWEEP ALIGNMENT TECHNIQUES

by Art Liebscher, *Test Equipment Specialist*

Never before has there been a book such as this on TV sweep alignment! An expert gives you accurate time-saving methods—and tells you how they work. Introduces the new Supermark method. Chock-full of sweep curve pictures. Valuable for servicing in UHF signal areas. 123 (5½ x 8½") pp., illus..... **\$2.10**

HOW TO USE SIGNAL AND SWEEP GENERATORS

By J. R. Johnson

First book on all types of signal and sweep generators. Gives test uses and discusses problems and their solutions in using this equipment. Applications of all signal and sweep generators in AM, FM radio and TV servicing.

Over 120 (5½ x 8½") pages..... **\$2.10**

GUIDE TO AUDIO REPRODUCTION

By David Fidelman

A to Z explanation of the reproduction of sound. Design, construction, assembly and testing of sound systems and their components. Valuable for service technicians, engineers, amateurs.

Over 250 (5½ x 8½") pp., illus..... **\$2.10**

RADIO TROUBLESHOOTING GUIDEBOOK

By J. F. Rider and J. R. Johnson

Here is a troubleshooting guidebook that covers the more than 100 million radio receivers now in use! Explicit information about troubles and possible causes. Completely practical for the radio service technician and student. Over 140 (5½ x 8½") pages.

Write for information on all RIDER books.

Buy these books now from your jobber... bookstore... If not available from these sources, write to:

JOHN F. RIDER Publisher, Inc.

Dept. RE 11, 480 Canal Street, New York 13, N. Y.

Velocity Microphone

*This little job
will sound good
if well made*

By **GENE BRIZENDINE***

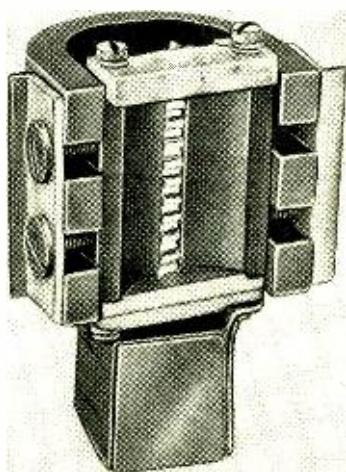

Fig. 1—The home-made velocity microphone. Magnets were taken from a war-surplus field telephone; the ribbon was cut from an aluminum-foil chocolate-bar wrapper. The matching transformer is in the black box at the bottom.

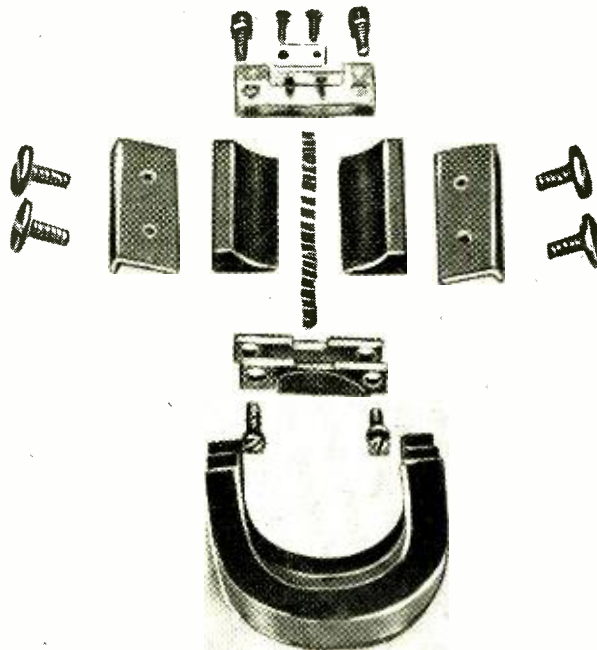

Fig. 2—All the parts of the velocity microphone before final assembly. See text for instructions in cutting pole pieces, side clamps, and end brackets.

ALTHOUGH the velocity microphone was developed quite a number of years ago, it is still used more than any other type for high-quality sound pickup in broadcasting and recording. The velocity unit built by the writer provides faithful reproduction and high output, and may be duplicated by anyone with only simple hand tools. Actually, the unit shown in Fig. 1 may be assembled by drilling only four holes!

Basically, the velocity or ribbon microphone is simply a thin strip of metal suspended in a strong magnetic

field. Any motion of the ribbon at right angles to the lines of force induces a voltage across the ends of the ribbon, which is an electrical reproduction of the original sound. The ribbon is corrugated and hangs rather loosely, so that its mechanical resonant frequency is below audibility. This arrangement prevents peaks from appearing in the usable audio spectrum. The corrugations also increase the output, since they cut more magnetic lines of force than would be the case with a flat, shorter ribbon.

The microphone shown in Fig. 1 was

*c/o CAA, Berry Field, Nashville, Tenn.

1 CONTROLS



Model B16 Radiohm®
Miniature



Twin and dual concentric Radiohms



Model B Blue Shaft Radiohms



Type AB Adashaft® Radiohms

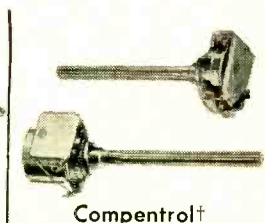

Compentrol†
Infinitely variable loudness control

2 SWITCHES

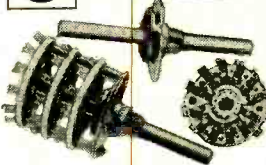

PA-2000 Miniature Rotary, Steatite Insulation

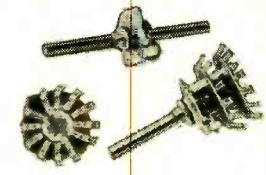

2500 Series Standard Rotary, Steatite Insulation



Ham Type

FOR SALE!

These and 100,001 other Centralab quality electronic components

HERE'S a perfect check list to determine your electronic needs. And there are hundreds of variations available to you. Whether you need a few items or dozens — no other single manufacturer can offer you such a wide choice of standard fastest-for-servicing parts. That's why Centralab is the industry's No. 1 electronic component source . . . and keeps your distributor supplied with the latest developments in the fast-changing electronics field.

You know CRL parts are your best value because each is backed by a written guarantee. That means they're safest for servicing. And you'll agree that's mighty important for building consistent customer satisfaction.

So when you need parts, look for the familiar blue and white Centralab package — the product inside is the result of more than 30 years of electronic experience. This experience has pioneered many profit-building "firsts" for you! For complete performance data and engineering specifications mail coupon.

† Trademark
P.E.C.—Printed Electronic Circuits

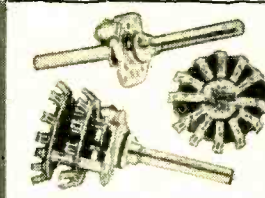

1400 Series, Standard Rotary, Phenolic Insulation



Small General Purpose and tone

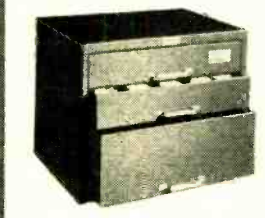

Complete Switch Kits

3 CAPACITORS

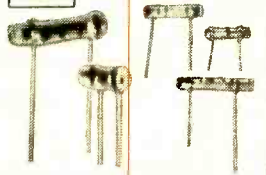

BC Tubular TC Tubular

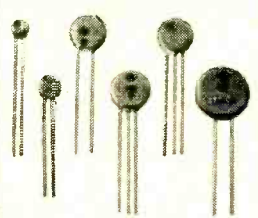

BC Discs

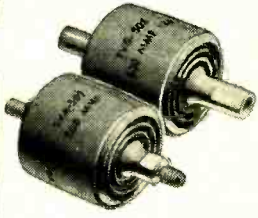

TV HI-VO-KAPS®

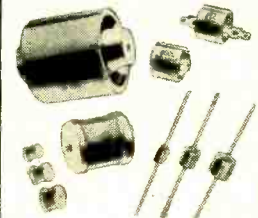

Transmitting Capacitors

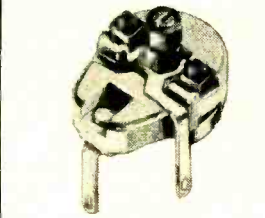

Ceramic Trimmers

4 P.E.C.

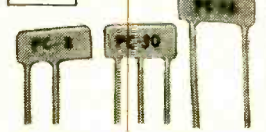

Miniature Resistor and Resistor-Capacitor Units

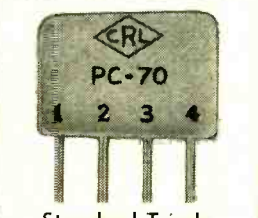

Standard Triode Couplate®

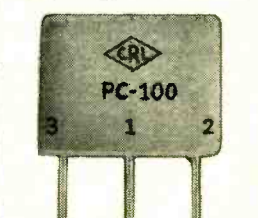

Vertical Integrator

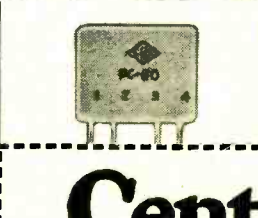

PC-70



PC-90

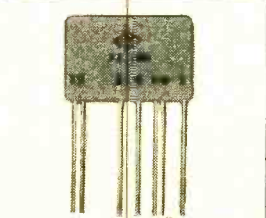

Audet®
Audio-detector plate

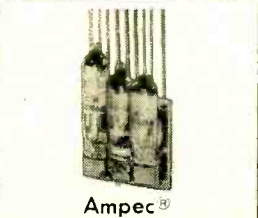

Ampec®
standard and miniature 3-stage amplifiers



P. E. C. Kits

Centralab

A Division of Globe-Union Inc.
922K E. Keefe Ave., Milwaukee 1, Wis.
804 Mt. Pleasant Road, Toronto 12, Ontario

Please send me Catalog 28 with information on Centralab products.

Name.....
Title.....
Company.....
Address.....
City..... Zone..... State.....

A set is no better than
its Tuning Mechanism!
...and, there's
no better tuner than the
TARZIAN TUNER

It's no happen-so that so many of the nation's leading set manufacturers—the makers of the best-known receivers—use the **TARZIAN TUNER** in their products.

No other commercial unit possesses so many desirable features found in the **TARZIAN TUNER**. It's a small, precision-built instrument, expertly designed to provide unsurpassed selectivity and improved reception in ALL areas.

And, the practical, full band—all-channel approach to UHF (another first for Tarzian)—is making the **TARZIAN TUNER** more popular than ever. It's popular with the manufacturer as well as the ultimate consumer who wants "everything" on the television set he buys.

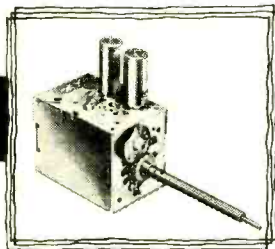

**SARKES
TARZIAN, Inc.**

**Tuner Division
Bloomington, Indiana**

PHOTOGRAPHS

RADIO-ELECTRONICS can use good photographs of service benches, service shops, high-fidelity audio layouts, and any other interesting and original radio-electronic devices.

We will pay \$6.00 each for good professional photos or equivalent, suitable for reproduction.

Full information on subject photographed will increase their acceptability.

**The Editor, RADIO-ELECTRONICS
25 West Broadway, New York 7, N. Y.**



Fig. 3—The finished microphone housed in an air-freshener can. All-around perforations are essential to allow free passage of air through the microphone.

built with magnets from a war-surplus type EE-8-A field telephone. Magnets from small gasoline engines or other telephone ringers would contain magnets equally suitable. Before dismantling the original magnet assembly, mark the poles so that like poles may be placed adjacent in the microphone.

The concave pole pieces are soft iron and should be handled with care. The magnets, one pole piece, and the end plates are the only items needed from the surplus unit.

After the parts are separated, saw *one pole piece lengthwise*, through its thinnest section. The two parts thus obtained will eventually form the microphone pole pieces. These can be seen on either side of the ribbon in Fig. 2, with their concave faces forward.

The two flat magnet clamps next to the pole pieces may be made from brass, aluminum, or any *nonmagnetic* metal. These should be at least $\frac{1}{16}$ -inch thick. The holes are spaced to match the tapped holes already in the sides of the pole pieces. The four large-headed screws are used to clamp the magnets to the pole pieces, and are the type used to hold panels to standard equipment racks.

Immediately below the pole pieces, one ribbon clamp is seen. This is made by simply sawing two strips from the original magneto end plates, or from *nonmagnetic* metals, so that the holes accept screws which thread into the pole-piece ends. The same screws also clamp one end of the ribbon. This end of the ribbon is thus grounded. At the top end of the pole pieces in Fig. 2, is an insulating ribbon clamp. This is a simple assembly, and may be made from bakelite, polystyrene, or any other suitable insulating material.

AUDIO—HIGH FIDELITY

The small brass clamping strip immediately above forms the other ribbon terminal. It is necessary only that the ribbon clamps hold the ribbon between and parallel with the pole pieces. Actual mounting of the ribbon should be the last step of assembly.

Assemble the pole pieces first by running screws through the end plates into the tapped pole-piece ends, leaving the screws rather loose. Next, align the magnet and pole pieces, and clamp the assembly into final position with the large-headed screws, so that the inner faces of each magnet are pressed flat against the pole pieces. Interchanging magnets may be necessary to obtain best alignment.

With the unit thus assembled, dress the sawed edges of the pole pieces, filing lengthwise and keeping the filed faces as nearly parallel as possible. The tang of the file may be used to gauge the width of the gap during this process. The final width of the gap will of course depend upon the width of ribbon used. These dimensions do not appear too critical, and a spacing of about $\frac{1}{32}$ inch on each side of the ribbon proved satisfactory in this unit.

A replacement-type ribbon may be purchased reasonably, or you can make your own easily from aluminum foil. The ribbon used in this model was made by cutting a foil strip about $\frac{3}{32}$ " inch wide from a Nestle's chocolate-bar wrapper, using a straightedge and razor blade. The corrugations were formed by rolling the strip between two small gears held in the hands. Tooth spacing was about $\frac{1}{8}$ inch. This dimension is not critical either, but the foil should be at least as thin as that mentioned above.

The matching transformer may be any ribbon-to-line or ribbon-to-grid type and should be mounted near the ribbon terminals. Be sure the transformer core is not positioned so that it forms a magnetic path across the magnet poles. This would bypass a large part of the flux around the ribbon gap. Ground one secondary terminal of the transformer to the magnet assembly, using a lug under any convenient screw.

At this point the ribbon may be mounted, and stretched just enough to prevent it from rubbing against the pole pieces when the unit is in its normal upright position.

The outside case may be of any material, the major requirement being that it permits free passage of sound past the ribbon. The writer's microphone is mounted in a salvaged air-freshener container which was given a coat of brown wrinkle varnish. See Fig. 3.

The magnet-ribbon assembly is simply "floated" inside the case on strips of sponge rubber, preventing disturbances to the case or stand from reaching the ribbon.

If hum pickup is encountered, it may be minimized by orienting the microphone while watching the volume-level indicator, or listening to the hum level in the output. For most natural reproduction, the source of sound should be at least 12 to 18 inches from the ribbon. **END**

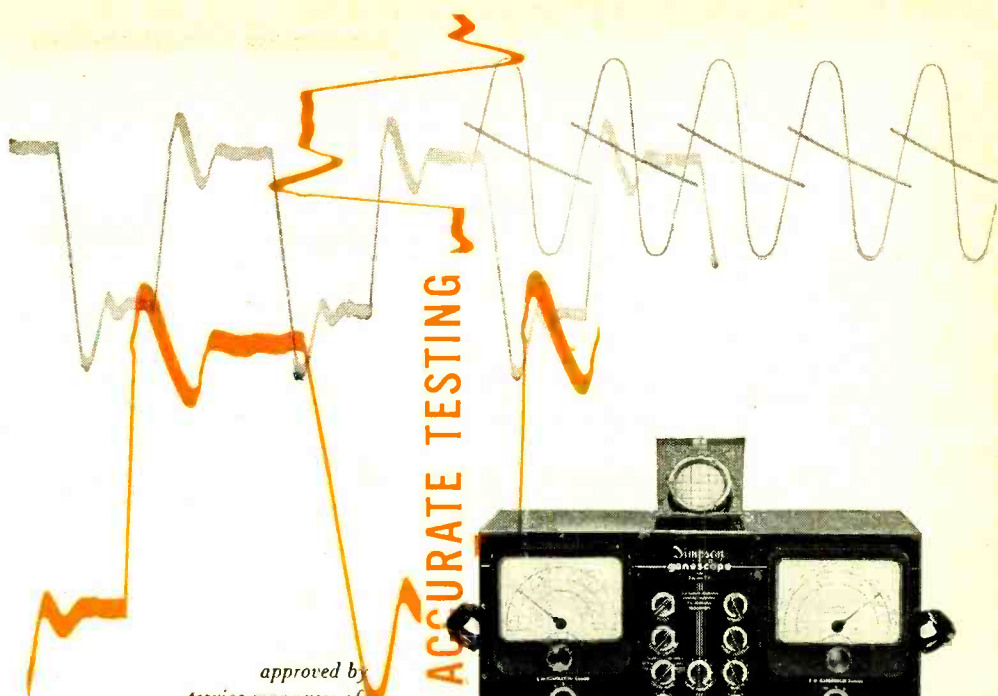

approved by
service managers of:

admiral
zenith
motorola
emerson
hoffman
hallicrafters

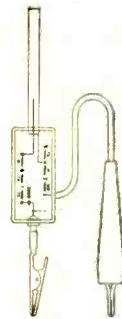

SIMPSON MODEL 480 GENESCOPE FOR ACCURATE TESTING

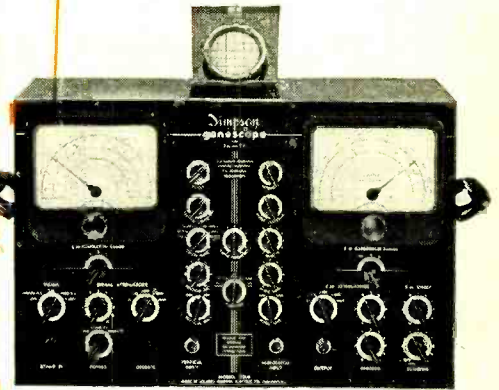

All the necessary signal sources for alignment of FM and TV receivers • Includes the Simpson High Sensitivity Oscilloscope and high frequency crystal probe for signal tracing • Independent, continuously variable attenuators and step attenuators for both AM and FM units offer complete control of output at all times • 0-15 megacycle sweep is provided by a noiseless specially designed sweep motor based on D'Arsonval meter movement principles • The exclusive Simpson output cable (illustrated) includes a variable termination network, quickly adapted to provide open, 75 or 300 ohm terminations — the addition of a pad provides attenuation and isolation. Use of appropriate resistors across certain terminals will provide any other termination required. A .002 MFD blocking condenser can be added on any termination for use on circuits containing a DC component • The FM generator output voltage is constant within .2 DB per MC of sweep.

dealer's net \$475.00

SIMPSON ELECTRIC COMPANY

5200 W. Kinzie St., Chicago 44, Illinois • Phone: ESTbrook 9-1121 • In Canada: Bach-Simpson, Ltd., London, Ont.

25-5229

TRAIN AT HOME FOR UHF-TV AND

**TELEVISION
SERVICING**

Learn practical, professional type TV Servicing without leaving your present job. Included are money-making extras such as set conversion, master antenna installation, UHF-TV, field servicing short cuts. You can start earning Television money after first few lessons. You learn to test, trouble shoot and repair all types of TV sets.

HERE'S HOW YOU GET EXPERIENCE!

You train on a large screen, modern TV receiver, furnished with the course and yours to keep! As an optional feature you can get two weeks actual experience with Chicago's largest independent servicing organization. You learn by doing! Age is no barrier. Many students are over 40! ACT NOW! Send for FREE Catalog and SAMPLE LESSON today!

TV COMMUNICATIONS INST.
205 W. Wacker Dr., Dept. RE-23
Chicago 6, Ill.

VETERANS!
T.C.I. is approved for G.I.
training. Under Public
Law 550. Check coupon.



MAIL NOW FOR FREE BOOKLET

MILTON S. KIVER, President
TELEVISION COMMUNICATIONS INST.
205 W. Wacker Dr., Dept. RE-23, Chicago 6, Ill.
Rush FREE Catalog and Sample Lesson. I
am not obligated. Salesman will not call.

Name..... Veterans:
Check here
Address.....
City..... Zone..... State.....
 BEGINNERS check here for Basic TV Course.

FALCON Introduces -

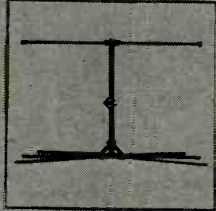

Channels 2-13, peaked for low channels (2 thru 6)

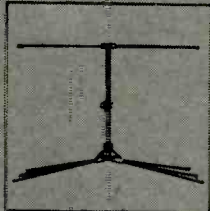

Channels 2-13, normal position, peaked for all VHF channels (2 thru 13)

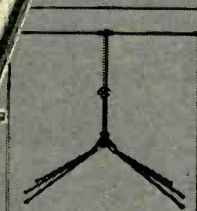

Channels 2-13, peaked for high channels (7 thru 13)

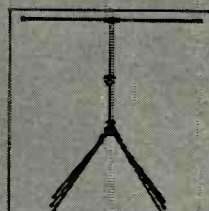

Channels 2-83, peaked for UHF channels

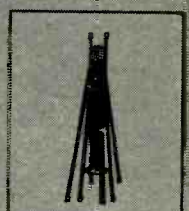

Falcon "VARI-CON" folded for packing

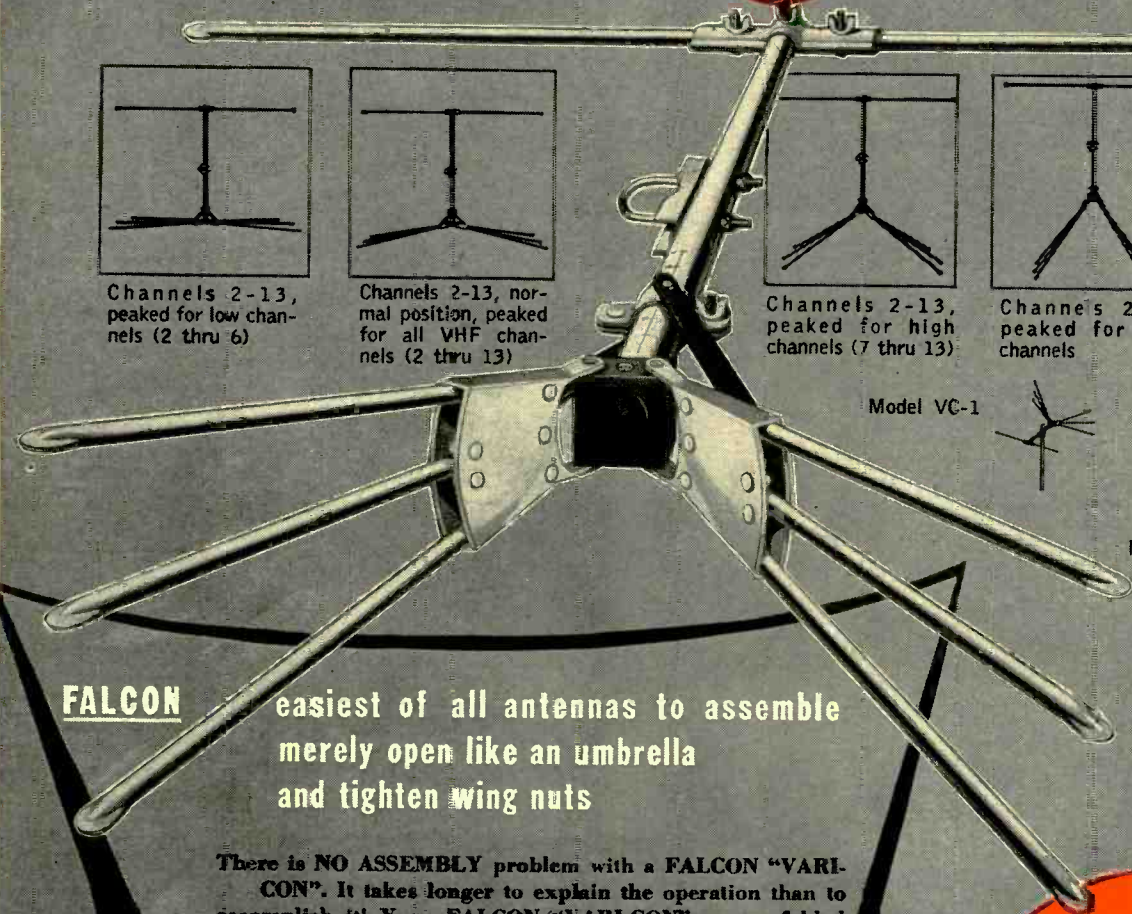

Model VC-1



Model VC-2



Model VC-4

Stack them for added gain.

FALCON easiest of all antennas to assemble merely open like an umbrella and tighten wing nuts

There is NO ASSEMBLY problem with a FALCON "VARI-CON". It takes longer to explain the operation than to accomplish it! Your FALCON "VARI-CON" comes folded into one compact unit. You need only swing the reflector into position and tighten the wing nuts. Move the sliding sleeve to the calibrated channel setting you desire and tighten. The butterfly springs snap the elements into position and lock them securely. The FALCON "VARI-CON" is ready to install, ready to provide peak performance. Changing the channel peaking of the "VARI-CON" is just as simple and easy as making the original setting. No tools are needed for either operation.



Calibrated sleeve for quick peaking of antenna.

THE HEART OF THE "VARI-CON"

Above is a view of the new mechanism which enables anyone to adjust the peaking of the FALCON "VARI-CON" to any range of channels desired. The sliding sleeve, on the calibrated boom, automatically fans out the elements to their correct position.

A simple, trouble-proof, snap-action spring in the

butterfly keeps the elements solidly in place. The insulated hinge assembly is extremely strong, durable and weather-resistant and has an extra long leakage path. Weight has been kept to a minimum, strength at a maximum in order to assure long life and freedom from wind and weather damage. A heavily plated mast clamp is supplied.

the "VARI-CON"

(The conical that's variable)

Provides all Channel Performance...

Yet can be Peaked for Increased Gain on any Channel Range

The FALCON "VARI-CON" was designed for today, tomorrow and years to come. Its unusual construction permits setting the "VARI-CON" for all-channel performance peaked to provide the additional gain needed on special channels. In addition, the variable patterns obtainable are of great value in ghost elimination.

There is no guess work; no tedious assembly; no field strength equipment needed to peak the "VARI-CON" for high-gain, sharp pattern performance in your area. It's as simple and easy as opening an umbrella. Here's all you do: Unpack the "VARI-CON"—Slide the adjusting sleeve to the calibrated marking on the boom for the best reception of channels in your area — Fan out the reflector elements — Tighten the locking wing nuts. The "VARI-CON" is

automatically peaked WHERE YOU WANT IT and ready to install. It is the only conical that enables you to provide a custom-made installation resulting in higher gain and increased customer satisfaction.

The NEW FALCON "VARI-CON" is ruggedly constructed. Heavy-duty heads will not crack or break. The steel spring snap-action butterfly assemblies are unbreakable. Full length, 48 inch, elements are used. One of the most capable engineering staffs in the industry has worked out every last detail of this truly remarkable TV antenna. To the high gain all-channel performance and excellent line match of the conical, FALCON engineers have added the "plus" feature — adjustable, calibrated channel range peaking!

FALCON

The new "VARI-CON" is one of the most significant additions to antenna design. Watch for the other new FALCON antennas which will be announced in the near future! Each will represent the most advanced, most efficient antenna design of its type.

WRITE FOR ILLUSTRATED FOLDER AND PRICES

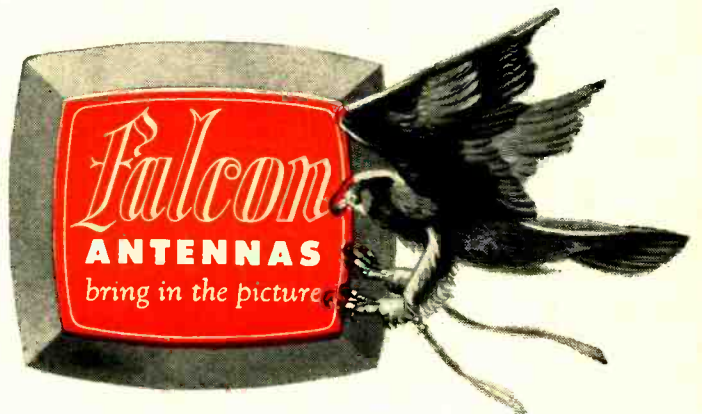

FALCON ELECTRONICS COMPANY • 2003 CEDAR ST. • QUINCY, ILLINOIS

NATIONAL ADVERTISING TO BACK NEW FALCON "VARI-CON"

To stimulate sales on all levels, FALCON is conducting one of the most aggressive advertising campaigns in the industry. Full two-page color spreads are appearing regularly in many of the nation's top trade and consumer publications.

NOVEMBER, 1953

NOVEMBER, 1953

Complete Professional Service Training



at only a small fraction of the price you might expect to pay!

The NEW Ghirardi SERVICE LIBRARY



FOR BETTER JOBS • BIGGER PAY IN TELEVISION • RADIO • ELECTRONICS

When you buy Ghirardi training books you **KNOW** you're getting the best—at lowest possible cost!

For over 20 years, Ghirardi books have been more widely used in schools, for military training and home study than any others of their kind.

Let these two up-to-the-minute Ghirardi training books teach you to handle ALL types of AM, FM and Television service jobs by approved professional methods—and watch your efficiency and earnings soar!
If broken into lesson form and sent to you as a "course," you'd regard this training as a bargain at \$100 or more. Instead you buy both big books complete for only \$12—and save \$1.25 in the bargain!
Written so you can easily understand every word, these books train you for fast, accurate service on any type of home radio-TV-electronic equipment ever made. Each book is completely modern, profusely illustrated. Each contains the latest data on the latest methods and equipment. Together they form a completely modern service library to help you work faster and lots more profitably. Almost 1500 pages and over 800 clear illustrations show how to locate troubles faster, how to repair them better.
Everything is completely indexed. You can use the books to solve puzzling service problems in a jiffy.

Radio & Television Receiver TROUBLESHOOTING & REPAIR

This big book is a how-to-do-it guide to professional service methods—the kind that help you get better jobs, bigger pay. For beginners, it is a complete, easily understood training course. For experienced servicemen it is a quick way to "brush up" on specific jobs; to develop improved troubleshooting techniques; or to find fast answers to puzzling service problems on specific types of equipment or components.

Modern test methods of all types are clearly described and their advantages shown. Special problems in hard-to-fix sets are explained. Step by step charts demonstrate professional procedures almost at a glance. The television section includes everything from general troubleshooting and pattern analysis to what to do about fading and propagation troubles; handling intermittents and dozens of other subjects—everything the modern serviceman needs to know. Contains 820 pages and 417 clear illustrations. Price \$6.75 separately.

Radio & Television Receiver CIRCUITRY & OPERATION

It's lots easier to repair ANY radio or television set when you know all about its circuits and just why and how each one works. You locate troubles faster and with less testing. You repair them more efficiently!

This big book gives a complete understanding of modern circuits; teaches you to recognize them quickly; and shows how to eliminate useless testing and guesswork in making repairs. Covers all basic circuits used in modern television and radio receivers as well as phono pick-ups and record players. Contains 669 pages and 417 helpful illustrations. Price separately \$6.50.

10 DAY FREE EXAMINATION

Dept. RE-113, Rinehart Books, Inc., Technical Division, 232 Madison Ave., New York 16, N. Y.

Send books checked below for 10-day FREE EXAMINATION. In 10 days, I will either remit price as indicated or return books postpaid and owe you nothing.

Check here to order books singly:

- Radio & TV Receiver CIRCUITRY & OPERATION (Price \$6.50 separately)
- Radio & TV Receiver TROUBLESHOOTING & REPAIR (Price \$6.75 separately)

Check here for MONEY SAVING COMBINATION—Save \$1.25!

Both of the above big books at the special price of only \$12.00 for the two. (Regular price \$12.75—you save \$1.25.) Payable at the rate of \$3 after 10 days if you decide to keep books and \$3 a month thereafter until the total of \$12 has been paid.

Name _____
Address _____
City, Zone, State _____

OUTSIDE U.S.A.—\$7.25 for TROUBLESHOOTING & REPAIR book; \$7.00 for CIRCUITRY & OPERATION; \$13.00 for both books. Cash with order only. Money refunded if you return books in 10 days.

Only \$12 for the complete training!
See SPECIAL COMBINATION offer in coupon

3 Months to Pay

where the tone stops coming through. The volume circuit is now oscillating strongly and its rectified d.c. output voltage is sufficient to cut off the variable-gain tube. Move the hand near the volume antenna and notice that the closer the hand the louder the tone. Several adjustments of this capacitor are necessary to get smooth operation. If too much voltage is developed by the oscillator and rectifier, the volume of the tone will be greatly reduced. This can be corrected by increasing the size of the dropping resistor R1.

The operation of the Theremin's oscillators will cause no more interference with nearby radio sets than a wireless phonograph oscillator. Choking and bypassing the a.c. input to the power supply will prevent r.f. from passing into the a.c. line to a radio set. Voltage can be reduced on the oscillator tubes. Actually, it is recommended; it reduces the required warm up time and makes for more stable operation while playing. With these precautions, there should be no interference problems.

A ten minute warmup period is required each time the Theremin is used. This allows the oscillator circuits to stabilize. The useful frequency range of the instrument is 150-4,000 cycles. To strike the best balance in hand travel, the tuning capacitor should be adjusted for the lowest desired note while holding the hand about one foot from the sound antenna. Large capacitance changes are possible by forming the fingers of the hand in the position of holding a pencil.

Now, the fun is just beginning. After an hour or so of getting acquainted with the Theremin I guarantee that anyone with an ear for music will at least be able to play "Home Sweet Home." Most record shops have a number of recordings that feature the Theremin. Playing along with the record is probably the best method of learning. I suggest that in the learning process, ear-phones be used lest drastic action either from the family or neighbors be taken against the user. **END**



"Now we can reach out much farther with our tom-toms."

Accurate CAPACITANCE METER

Combined With a True VTVM

Measures Capacitance directly on a large 9 inch meter...
As low as 0.5 mmf... As high as 1000 mf... In 7 ranges...

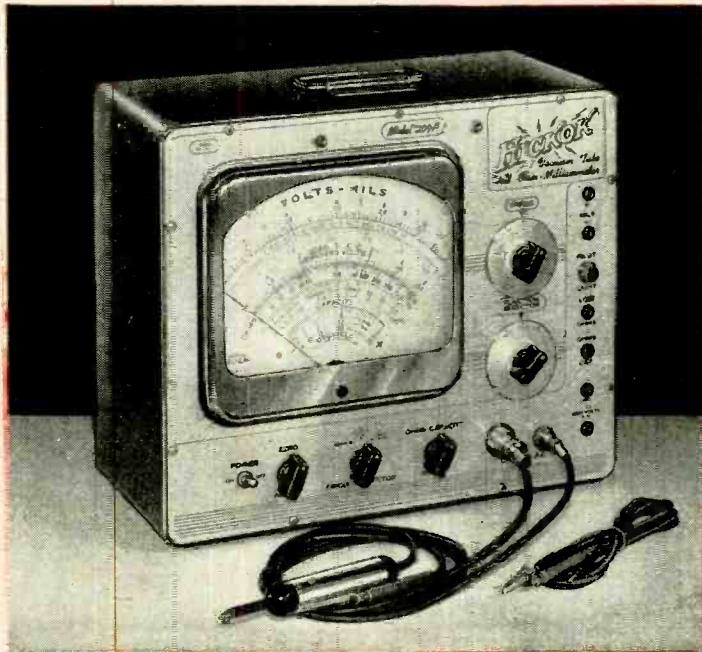

Model 209 A

In addition to being an accurate capacitance meter, the 209A furnishes the following readings on a large, 9-inch colored scale:

- DC Volts, 0-1200 in 6 ranges
- AC, RMS Volts, 0-1200 in 6 ranges.
- AC, Peak to Peak Volts, 0-1200 in 6 ranges.
- AF, IF and RF voltages from 10 cycles to 300 megacycles.
- 0.1 ohm to 10,000 megohms in 7 ranges.
- 50 mh to 100 henries.
- DC Mils, 0-1200 in 6 ranges.
- DC Zero-center scales, 0 to ± 1200 volts.
- Decibels -20 to +25 in 3 ranges.
- AC input impedance: 8 mmf, shunted by 12 megohms.
- DC input impedance: Approximately 12 megohms.
- Built-in power supply permits high accuracy even with wide line-voltage fluctuation.

This HICKOK Model 209A is years-proven in the most demanding field and laboratory use. It is, without a doubt, the most dependable and accurate instrument of its kind. These 209A's seem never to fail in service, cause trouble, or wear out... And don't forget, the high frequency probe and leads are included. Also a high voltage probe is available to extend DC range to 30,000 volts.

ACTUAL
SIZE

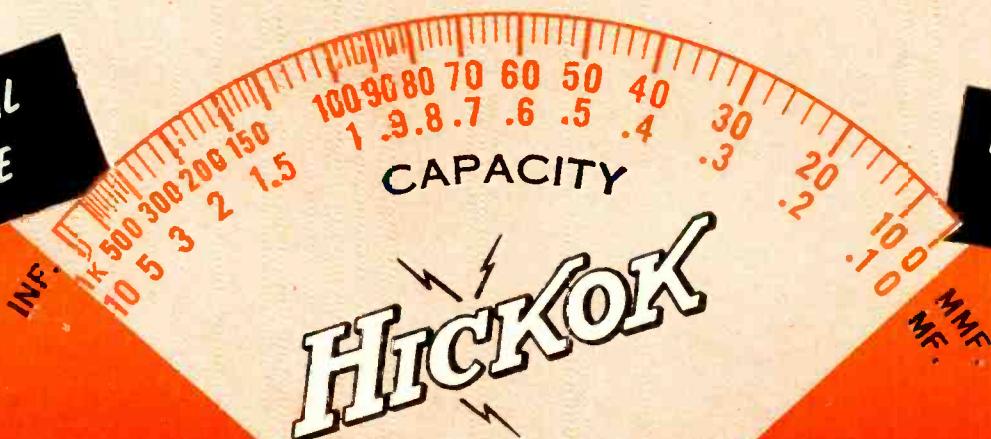

EASY TO
READ

THE HICKOK ELECTRICAL INSTRUMENT COMPANY

10531 Dupont Avenue

Cleveland 8, Ohio

THERE ARE

QUAM[®] *Adjust-a-Cone* SPEAKERS

FOR ALL* YOUR
REPLACEMENT NEEDS



Manufacturers of

High Fidelity
Speakers

Outdoor Theatre
Speakers

Quam Focalizer
Units

Tru-Match Output
Transformers

Quam Ion Traps

Be sure to get the latest Quam catalog, listing 94 replacement speakers—at the best distributors in every city—or write us for your FREE copy.

Quam replacement speakers are listed in Photofact Folders and in Counterfacts.

QUAM-NICHOLS CO.
236 East Marquette Road
Chicago 37, Illinois

*Quam cataloged speakers are available in any voice coil impedance and field resistance.



The author's remote-speaker assembly. The sloping-front wood baffle can stand by itself or hang on a wall. Mounting the speaker off-center helps to flatten out the frequency response.

Handy remote speaker from "useless" dynamic

By H. J. M. DUNSCOMBE

HERE'S a use for that perfectly good field-coil dynamic speaker that's lying in the junk box. All you need to turn it into a handy remote speaker is the simple a.c.-d.c. field supply shown in the diagram, and a pair of terminals connected to the voice-coil leads on your radio.

If the resistance of the field coil is 2,500 ohms or more, simply connect a selenium or copper-oxide rectifier that will handle 50 to 70 ma in series between the power line and the field. Then connect a 150-volt electrolytic capacitor

GYRO SPECIALS

- SENSITIVE RELAYS—SIGMA 4F—1 Ma.\$4.50
- KURMAN BK-35—1/2 Ma.—11k ohms\$4.25
- METAL CABINET—13 1/2x9 3/4x6; beautiful finish—louvers; less front panel\$7.75
- METERS—2 Inch—0.1 Ma. \$3.75; 0-1/2 Ma. \$5.85.
- RADIO CONTROL RECEIVER KIT—All parts including Tube and Sigma 4F Relay\$10.15
- License—FREE RADIO CONTROL TRANSMITTER, complete with 27.255 Mc. Xtal & Tubes \$16.50
- CODE-PRACTICE OSCILLATOR & BLINKER KIT, compl. with btry less fones.\$1.95
- MULTIMETER KIT—all parts incl. meter to make 0-3 Ma.; 0-6; 60; 600 Volts & Continuity\$3.15
- SUBMINIATURE Hearing-Aid TRANSFORMERS & CHOKES—several types\$1.25
- HAYDON SYNCHRONOUS MOTOR—60 Cycles, 24 Volts—Operates 110 AC Line with series condenser. High torque geared shaft—5 RPH\$1.25
- "OSF" Type QUENCH COIL—\$1.65; CRYSTAL 27.255 Mc.—Peterson ZDA\$4.75
- 6 Volt DYNAMOTOR—180 Volts @ 100 Ma. \$7.95
- MINI 6 Volt Storage BATTERY—2 1/2x1 3/4x3 1/2 \$2.95
- WHIP ANTENNAS—for 10, 20, 40, 80 Meters—16 ft.—\$2.45; 24 ft.—\$3.95; 32 ft.—\$5.25.
- MINI 6 Volt VIBRATOR POWER SUPPLY—2 1/4" Dx 3 1/4" —Output 100 V. @ 15 Ma. type—\$2.95
- SELENIUM RECTIFIER—Small Bridge type—115 Volts AC—15 Ma.\$1.25
- Phono AMPLIFIER KIT—3 Tube, all parts less tubes—\$2.25
- WIRELESS PHONO OSCILLATOR KIT—all parts less tubes\$2.25
- GENERATOR: 12-24 V. @ 15 Amps\$2.25
- SELENIUM RECTIFIERS & TRANSFORMERS at lowest Prices!

Supply Limited—Order Today—Free Catalog

GYRO ELECTRONICS COMPANY Dept. E, 325 Canal St. New York 13, N. Y. Worth 6-1290

SUBSCRIBERS

If you're moving, please don't forget to send us your address as it appears on the copy of the magazine, including the numbers shown beside your name, as well as your new address.

If we receive this information before the 20th of the month, you will continue getting the magazine without interruption.

Your cooperation will be most helpful and greatly appreciated.

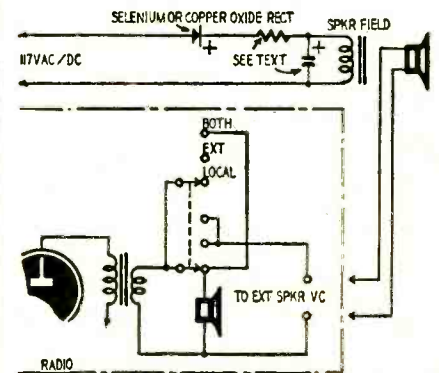

Circuit diagram of the power supply for the field-coil speaker, and one method of switching speakers at the receiver. The series resistor may be needed with low-resistance field coils to limit the current to a safe value.

THE BEST SET IS ONLY AS GOOD AS ITS ANTENNA!

The **KAY-TOWNES**
"BIG JACK"
 IS *not* A NEW ANTENNA

The "BIG JACK", recognized even by competitive manufacturers as the best performing VHF antenna design ever developed HAS BEEN ON THE MARKET FOR MORE THAN 1½ YEARS!

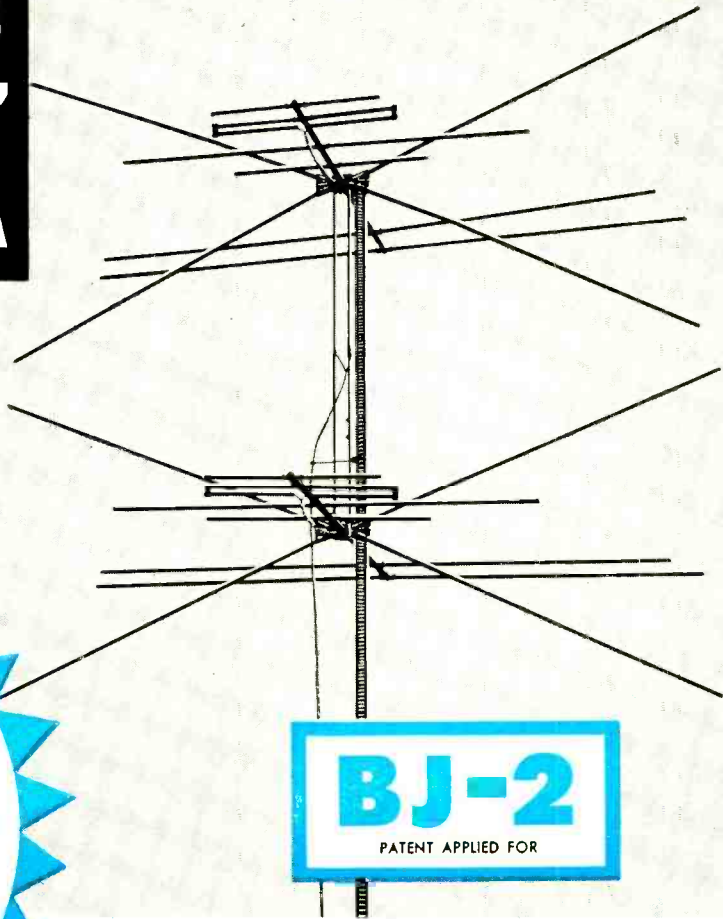

WE
CHALLENGE
 any other manufacturer
 who claims this design
 as his original
 idea!

Model	Type	List Price
BJ-1	single bay	\$16.78
BJ-2	2-bay	\$35.05

- ★ HIGH GAIN ON ALL VHF CHANNELS
- ★ PREASSEMBLED
- ★ 1" HEAVY ALUMINUM BOOM
- ★ CRIMPED & DOWEL REINFORCED HEAVY (7/16" O.D.) ALUMINUM TUBING
- ★ "SURE-GRIP" CAST ALUMINUM MAST CLAMP WILL NOT SPREAD, BEND OR COLLAPSE.

THIS GAIN CHART *Proves* THE SUPERIORITY OF THE K-T "BIG JACK" VHF ANTENNA

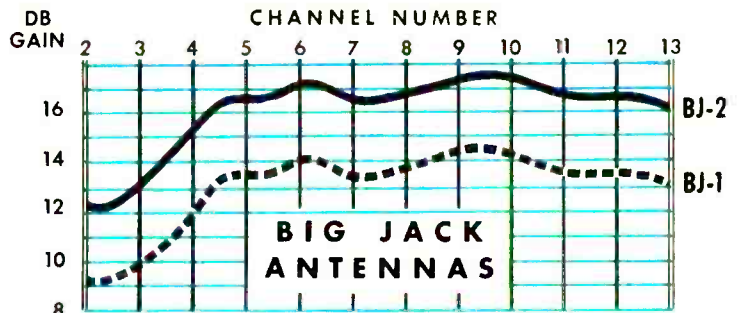

NO OTHER VHF ANTENNA CAN HONESTLY CLAIM THESE "BIG JACK" RATINGS AS A RESULT OF THEIR OWN ORIGINAL ENGINEERING AND DEVELOPMENT

KAY-TOWNES ANTENNA CO. ROME, GEORGIA
Recognized leaders in the field of fringe area antenna design

AMPHENOL

BO-TY

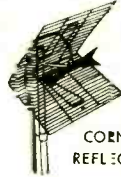

CORNER REFLECTOR

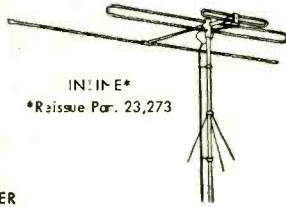

IN-LINE*
*Reissue Pat. 23,273

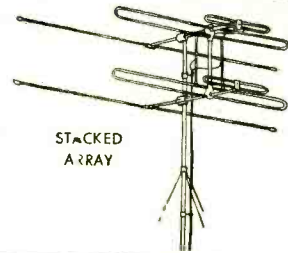

STACKED ARRAY

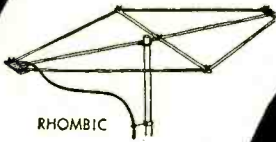

RHOMBIC

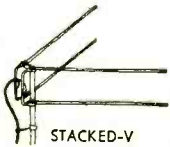

STACKED-V



YAGI

a sure prescription for

Better TV Picture Quality

AMPHENOL UHF/VHF ANTENNAS

The finest picture a set is capable of delivering—this is the advantage that AMPHENOL UHF and VHF antennas give every discriminating TV set owner. And this extra dividend in better TV picture quality is unique with AMPHENOL—the result of AMPHENOL engineering and craftsmanship construction.

Because of AMPHENOL engineering, each antenna is characterized by superb electrical performance—backed up by published gain charts and radiation patterns made in accordance with proposed RETMA standards and, therefore, a reliable index to antenna performance.

Because of AMPHENOL construction, fine materials assembled into rugged examples of craftsmanship and quality checked throughout every phase of manufacture, each antenna will give long years of trouble-free service.

For every installation, new or replacement, the surest prescription for better TV picture quality is the specification of an AMPHENOL quality antenna.

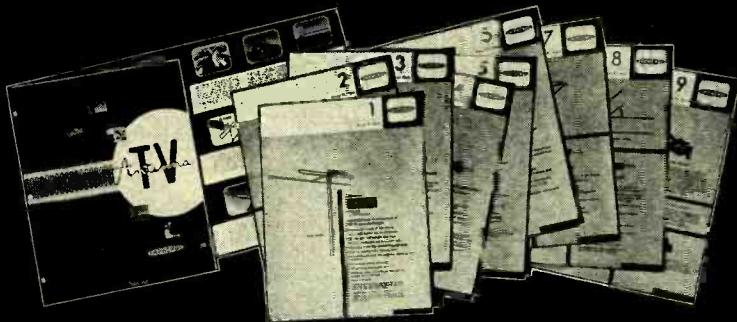

read the story
of television

the "TV Antenna Folio"

A new and instructive AMPHENOL guide to the problems of television is the "TV Antenna Folio." Filled in full color with Kodachrome illustrations from the AMPHENOL film "The UHF-VHF Television Antenna Story," it stories and compares UHF and VHF television waves from the transmitting antenna to the antenna on the rooftop. Write today for your free copy.

AMERICAN PHENOLIC CORPORATION
1830 South 54th Ave., Chicago 50, Illinois

Please send me the "TV Antenna Folio."

Name _____

Company _____

Street _____

City _____

Zone _____ State _____

mail coupon now



(16 µf or larger) across the field coil to filter out the hum. An ordinary line-cord lead to the voice coil of the rehabilitated speaker completes the job.

You may want to cut out the local speaker on your radio when the remote speaker is in use. In that case a two-pole, three-position switch wired as shown will allow you to select either speaker, or both if you wish.

Field-coil dynamics with lower field resistances can be used in the same way, provided you insert enough series resistance between the rectifier and the filter capacitor to limit the current to a safe value. A good general rule is that the d.c. input to the field coil should be at least equal to the audio power fed to the voice coil, but there's no need to overexcite the field, especially where the speaker is merely an extension on the average home radio.

To find the proper d.c. voltage for the field use the following formula:

$$E = \sqrt{WR}$$

Where W is the maximum audio power in watts, and R is the field-coil resistance. Then adjust the series resistance to keep the d.c. voltage as far under this value as possible without affecting the sound quality.

If the resistance of the field coil is extremely low (say 10 ohms or less) the speaker was probably part of an auto radio originally, and you will have to excite it with a 6-volt storage battery or an equivalent eliminator. This would hardly be practical for home use, but it might make a fine rear-seat speaker for a car. (Some television speakers have field-coil resistances of around 60 to 75 ohms. These require about 200 ma at about 12 to 15 volts for full excitation. Unless you have the parts lying around, a power supply for this type would probably cost more than a new PM speaker.)

Don't worry too much about a possible impedance mismatch between the voice coil of the extra speaker and the output transformer in your radio or amplifier. In most cases—especially with the average small radio—even a three-to-one mismatch won't make much difference in the sound quality. But if you want to know the nominal impedance of the voice coil, there's an old rule-of-thumb that works out pretty well: Multiply the *voice-coil resistance* by 1.25.

The rectifier-filter assembly for this speaker was mounted on an aluminum bracket bent to fit over the magnet yoke, as shown in the photograph. The extension speaker was then installed in a simple sloping-front wooden baffle fitted with a small plate at the top for hanging on the wall. Note that the speaker is mounted off-center vertically and horizontally. This helps smooth out the frequency response.

The uses for a remote speaker are too numerous to mention. There is usually a need for it anywhere from basement to attic. Most of the field-energized speakers that can be found lying around are of good quality, and will provide many hours of "found" entertainment. END

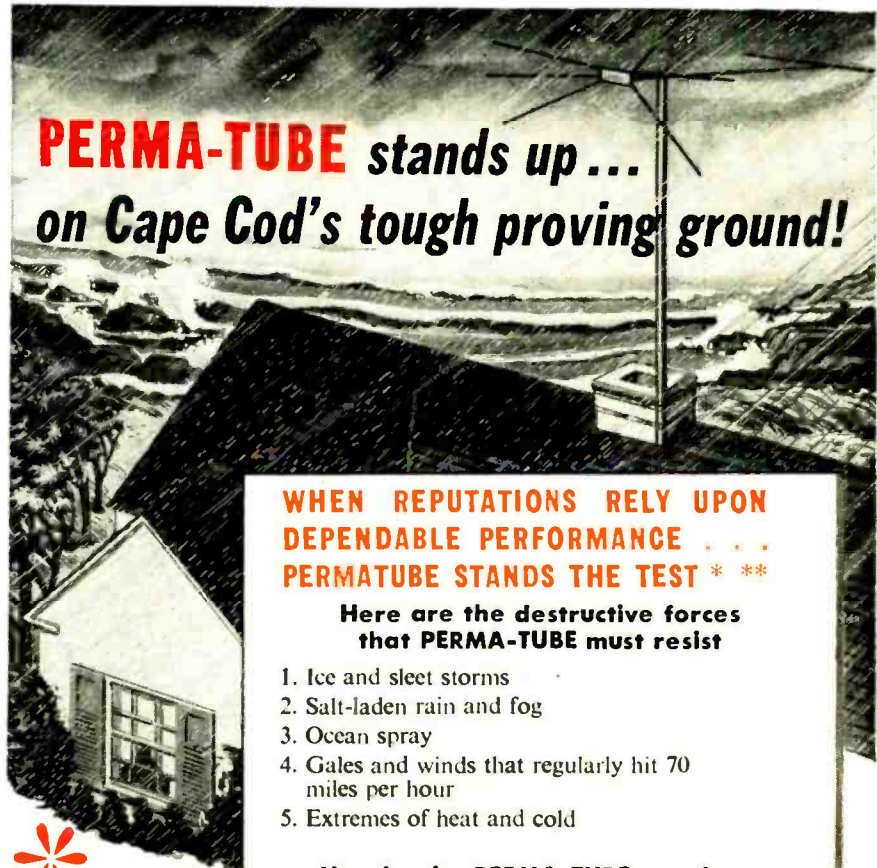

PERMA-TUBE stands up ... on Cape Cod's tough proving ground!

**WHEN REPUTATIONS RELY UPON
DEPENDABLE PERFORMANCE . . .
PERMATUBE STANDS THE TEST * ****

**Here are the destructive forces
that PERMA-TUBE must resist**

1. Ice and sleet storms
2. Salt-laden rain and fog
3. Ocean spray
4. Gales and winds that regularly hit 70 miles per hour
5. Extremes of heat and cold

**Here's why PERMA-TUBE stands up
under the most severe conditions**

1. PERMA-TUBE is **STURDY** . . . it's made of special, high-strength, J&L steel.
2. PERMA-TUBE IS **CORROSION-PROOF** . . . it's treated with vinsynite—then coated inside and outside with a metallic vinyl resin base.
3. PERMA-TUBE IS **MECHANICALLY SOUND** . . . it's the only mast with both ends of the joint machine fitted.



*From the records of Ware Radio Supply Company of Brockton, Massachusetts over 500,000 feet of PERMA-TUBE used on Cape Cod installations—and not a single complaint.

**From the records of Bill Perry—Cape Cod radio and television sales and service expert . . . over 1000 installations of PERMA-TUBE in three years—and not one single mast failure.

Here's proof of how Perma-Tube resists corrosion

Section of ordinary conduit tubing used for TV masts after 96 hours in a salt spray test (A.S.T.M. Designation B-117-49T) to accelerate corrosion. Extensive rust inside the mast has reduced strength—caused rusty water to drain onto the owner's home.



Section of PERMA-TUBE after 500 hours salt spray test shows no evidence of corrosion. Strength has been retained and the chance of rust streaks on owner's home is eliminated. Note sturdier wall thickness of PERMA-TUBE sample.

**PERMA-TUBE IS AVAILABLE IN STANDARD LENGTHS . . . DIAMETERS . . .
WALL THICKNESSES. FOR COMPLETE INFORMATION MAIL THIS COUPON.**



Jones & Laughlin Steel Corporation
496 Gafeway Center, Pittsburgh 30, Pa.

Without charge Name of nearest distributor
please send me Complete information on PERMA-TUBE

Name: _____
Company: _____
Address: _____

Presenting . . . at most moderate cost . . .

ESPEY

25th Anniversary "Trophy" Models

AM-FM CHASSIS • TUNERS • AMPLIFIERS



In commemoration of twenty-five years' experience in the manufacture and development of high-fidelity audio equipment, Espey is proud to present its distinguished "Trophy" models. Renowned for beauty of styling and excellence of performance, the new Espey models are so reasonably priced that for the first time magnificent listening pleasure is within the means of all lovers of fine audio reproduction.

Descriptive literature on the new Espey AM-FM chassis, tuners and amplifiers is now available . . . your inquiry is invited.

SYLVAN A. WOLIN & ASSOCIATES SALES CORP., 409 GRAND AVENUE, ENGLEWOOD, N. J.



"See, I told you a
JENSEN NEEDLE
would guarantee results."

National Electronics GREATEST Special Purchase BARGAIN
Tremendous Savings While They Last

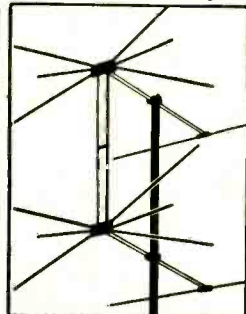

**2 BAY
16 ELEMENT
CONICAL
ARRAY**
INCLUDING
HIGH BAND
ADAPTERS
\$4.65
Each

IN LOTS OF THREE
Single Lots \$4.95

Never before has National Electronics had a BARGAIN like this. We made a special purchase in order to get these sensational prices. And this array has everything. This conical 2-bay 16-element array provides ultra-fine fringe reception. Includes sixteen 3/4 inch airplane type aluminum elements, including hi-hand adapters for greater gain on the high channels and is complete with one pair of stacking bars to each array. These are packed in cartons of three 16-element arrays per carton, with tie rods, at \$13.95 per carton.

When purchased in single 16-element arrays, separately boxed—your cost is . . . \$ 4.95 each
3 Two-Bay Arrays per carton without Tie Rods 12.50 carton
4 Bay Ultra-Fringe Stacking Assembly for Above—Model 4B \$1.95 set

FAMOUS ROCKET ZOOM-UP TOWERS

• Sturdy • Reliable • Easiest Installation
Economize with Rocket Zoom-up Towers. Offers quickest, easiest way to make an installation up to 50'. Each section telescopes inside the other—to erect, simply slide out each section in its turn—insert bolt thru section below—tighten to keep mast from turning. Each tower complete with guy rings, bolts, and mounting base suitable for peak or flat roof. Handsome and sturdy, Rocket Zoom-ups offer you economy and long life. Order by size.

20' \$ 9.95 30' \$16.95
40' 21.95 50' 32.95
(Deduct 10% discount in lots of 3)

Sensational Low Prices on UHF Accessories
M-5-C 5' steel mast extender (crimped to mate with 1 1/4" steel mast) \$1.05
UHF low-loss tubular twin-lead—100' coil 4.95
7 1/2" UHF mast stand-off13
7 1/2" UHF screw stand-off06
UHF-VHF antenna coupler—low-loss 2.75 ea.

SUPER SENSATIONAL!

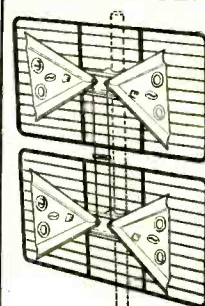

BOW TIE UHF REFLECTOR
Ultra High Gain
Bargain Priced
at
\$1.95
ONLY

For Single Array
ONLY \$4.45 For
Two-Bay Array

We are offering the BIGGEST UHF TV Antenna Bargain ever offered. The single array is designed for metropolitan areas—the two-bay array where greater gain is required—and the 4-bay array for fringe. At this sensational low price this antenna is the BEST BUY on the market. Get your needs filled while they last!

In lots of 6, individually carton-d \$10.95 for 6
4-bay arrays, with tie rods 8.75 ea.
Matching tie rods—per pair50 pr.

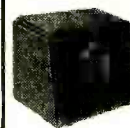

Sutco "Metropolitan" UHF CONVERTER

Sutco's new Metropolitan area UHF converter offers the least expensive means of securing UHF reception with your VHF set in metropolitan areas. Easily installed. Attractive bakelite cabinet.
Model 37A \$22.00 net

SUTCO CONVERTER BOOSTER

Sutco's fringe-type Converter-Booster provides top-notch UHF conversion. PLUS VHF booster for improving fringe reception. \$34.95 dealer net for Model 21A.

ALL PRICES F.O.B. CLEVELAND, OHIO
Do not remit more than complete purchase price. Pay shipping charges on receipt of goods. 25% deposit on all C.O.D. orders, please. Money-back guarantee.
Prices Subject to Change Without Notice

National Electronics OF CLEVELAND
THE HOUSE OF TV VALUES
211 Delco Building Cleveland 3, Ohio

Send for Your
FREE
Copy of the NEW 1954
MIDWEST
TELEVISION and
RADIO Catalog

MIDWEST *Presents*

For 1954 a Completely NEW LINE of
21" and 27" TELEVISION

CONSOLES
TABLE MODELS

and
COMPLETE
CHASSIS

at
LOW FACTORY
PRICES



YOUR CHOICE OF EITHER 12 CHANNEL
VHF or All-Channel VHF-U-F Models

Buy your Television or Radio Direct from the Midwest Factory . . . on
30 DAYS TRIAL . . . Easy Terms . . . and at LOW FACTORY PRICES.
For 34 years Midwest, the world's largest and oldest exclusive Factory-
To-You radio and television manufacturer, has served hundreds of thou-
sands of satisfied customers all over the world.



EASY TERMS
— . —
30 DAYS
TRIAL



FACTORY-TO-YOU

Also—Powerful New 1954 World-Ranging
MIDWEST Series 16 RADIOS
In Beautiful Consoles and Complete Chassis

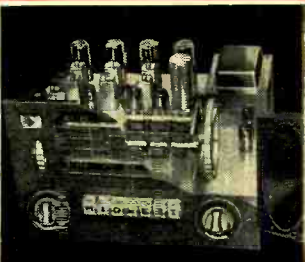

Once again Midwest offers its famous series 16 five band AM-FM radio chassis and the magnificent new Symphony Grand Radio-Phonograph with 3-Speed Automatic Inter-mix Record Player. Also, a complete line of clock radios, table radios, and portables.

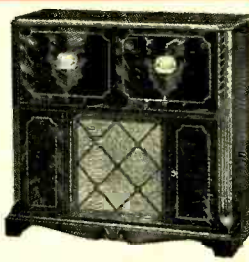

All models available in your choice of mahogany, walnut finish or blond lined oak.

● **WRITE IN NAME AND ADDRESS (PLEASE PRINT) ON COUPON OR 2c POSTCARD** ●

MIDWEST RADIO & TELEVISION CORP.
Dept. C-38 909 BROADWAY • CINCINNATI 2, OHIO
Please send me your new FREE 1954 Catalog.

NAME _____
ADDRESS _____
CITY _____ ZONE _____ STATE _____

MIDWEST RADIO & TELEVISION CORP.
DEPT. C-38 909 BROADWAY, CINCINNATI 2, OHIO

SELLING OUT!

\$100,000. STOCK

of Nationally Advertised Radio & Television Testing Equipment,
Parts, and Electrical Appliances.

Complete Stock of Radio and Television Testing Instruments and
Parts to be sold regardless of cost.

This is the opportunity of a lifetime!
PRICES REDUCED UP TO 80%

Below mentioned units are not kits, but all factory wired and brand
new. **Some models have been discontinued by the manufacturer,**
but every one is factory sealed and carries a one year, factory
guarantee.

			Dealers Net Price	Our Selling-Out Price
SUPERIOR	Model 1553	Multitester	29.25	14.50
"	"	PB-100 Multitester	28.40	15.00
"	"	680—5000 Ohms per volt Multitester	27.65	14.50
"	"	670 Supermeter	28.40	22.75
"	"	TV-10 Tube Tester	47.50	37.95
"	"	660 Signal Generator	42.95	34.50
"	"	TV-20, 20,000 ohms per volt Multimeter	49.95	34.50
TEST RITE	"	B-45, A.M., F.M. and Television Signal Generator, battery operated	27.75	14.50
METROPOLITAN	"	111, A.C.-D.C. Multitester	21.50	11.50
"	"	999, A.M.-F.M. & Television Signal Generator and Signal Tracer, battery operated	39.50	19.50
TEST CRAFT	"	TC-10, A.C.-D.C. Multitester	14.85	9.85
"	"	TC-50, Combin. Tube and Set Tester	49.50	29.50
"	"	TC-75, Combin. Test Speaker and Signal Tracer	39.50	24.50
SUPREME	"	543-S, Multitester	24.50	14.50
RADIO CITY PRODUCTS	"	322, Tube Tester	41.50	29.50
"	"	668, Electronic Multitester	74.50	39.50
"	"	665, A.C.-D.C. V.T. Volt-Ohm Capacity	95.40	59.50
MONITOR	"	200, Crystal operated Signal Generator	59.50	29.50
WESTON	"	689-IF, Multitester, incl. case	31.50	19.85
SHALLCROSS	"	630, Wheatstone Resistance Bridge	145.00	75.00
"	"	637, Kelvine Wheatstone Res. Bridge	185.00	100.00
REINER ELECTRONICS	"	333, D.C. Volt-Ohm Milliammeter	26.95	14.50
ELECTRONIC MEASURE- MENTS CORP.	"	102, Volometer	14.90	11.90
"	"	205, Tube Tester	47.50	37.50
"	"	206, Mutual Conductance Tube Tester	83.50	67.50
"	"	600, Oscilloscope	99.50	79.50
GRUEN	"	2 1/2" D.C., D'Arsonval Type, 1 Milliammeter, Meter	9.95	2.95
WESTON	"	Model 606, 1 Milliam. Meter	12.95	3.95
SIMPSON	"	2 1/2" square, 5 Milliam. Meter	7.95	1.95
WESTON	"	Model 507, F.S.-1.2 Milliam. Meter	12.95	3.95
TRIPLETT	"	Model 331-JP 30 Amperes, Meter	12.95	4.95
MARION	"	3" D'Arsonval Type, 1 Milliam. with calibrated Volt-Ohm Current Scale, Meter	12.95	4.95
ACRO	"	Radio & Phonograph Chassis Cradles	6.95	2.95
PHILCO	"	6 1/2" Paper Recording Discs, sold only in cartons of 100	.15 each	.03
DUOTONE	"	8" Glass Recording Discs, sold only in cartons of 24	.75 each	.15
"	"	10" Glass Recording Discs, sold only in cartons of 24	1.00 each	.20
DUOTONE	"	6 1/2" Metal Recording Discs, sold only in cartons of 100	.60 each	.10
"	"	12" Metal Recording Discs, sold only in cartons of 50	1.50 each	.30
HOLYOKE	"	180 ohm resistance line cords, 6 feet with plug	1.25 each	.35
"	"	No. 22, stranded, tinned, copper push-back wire on 500" spools	5.00 each spool	2.50
DUOSONIC	"	3 speed recordplayers, with life-time needle, portable case, speaker & amplifier	39.50 each	14.95
MAGUIRE	"	Recordchanger	37.50 each	9.95
V-M	"	Model 950, 3 speed Recordchanger, Tri-O-Matic, intermixed	46.50 each	24.50
V-M	"	3 speed Recordchanger, automatic, with life-time needle, portable case, speaker and amplifier	79.50 each	39.50
CAPITOL	"	Automatic Pop Up Toaster, fully guaranteed	19.95 each	9.95
NELSON	"	Model 441, double, twin-sized electric Waffle Maker	14.95 each	7.95
CUCKOO CLOCK	"	Genuine, imported Black Forest, hand-carved, cuckoos every 15 minutes	19.95 each	7.95
GLO	"	Electronic, oscillating massager with infra-red heat combined	8.95 each	3.95
ROTO-BROIL 400 MODEL "RIVIERA"	"	Fully Automatic Rotisserie and Broiler Combination, 7 way, with time clock, 3 heat element, double powered	69.50	37.95

All prices are f.o.b. New York, 20% deposit with order, balance C.O.D., or full remittance with order

WRITE, PHONE OR WIRE YOUR ORDER FOR IMMEDIATE DELIVERY, QUANTITIES ARE LIMITED.

METROPOLITAN ELECTRONICS & INSTRUMENT CO.
106 Fifth Ave., New York 11, N.Y.

Telephone: OREGON 5-1707
Cable Address: METRONICS

craftsmen national advertising is Taylor made to bring you new high fidelity customers!

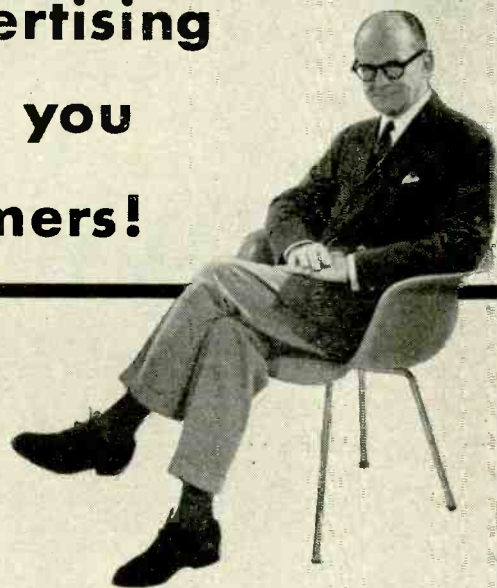

Deems Taylor . . . known to millions of Americans as the world's greatest authority on music . . . once again spearheads Radio Craftsmen national advertising with the High Fidelity Story. Through Craftsmen full page advertisements in scores of the nation's leading magazines Mr. Taylor, in interesting and informative columns, will be telling more than 2,500,000 readers—key prospects for you—the distinct advantages of unit High Fidelity Plan now to squeeze every ounce of value out of this great promotion by featuring the complete Craftsmen line. Write today for details.



high fidelity units by craftsmen can give you one of these distinctive home music installations

Deems Taylor says— "better listening can be better looking, too!"

Whether or not you are a serious student of music, your home should be equipped for the most enjoyable listening experience. The new High Fidelity Plan now offers you a complete line of high fidelity units, including the complete Craftsmen line. This is the first time in the history of the radio industry that a complete line of high fidelity units has been offered to the general public. The new High Fidelity Plan now offers you a complete line of high fidelity units, including the complete Craftsmen line. This is the first time in the history of the radio industry that a complete line of high fidelity units has been offered to the general public.

Send for this "HOW TO DO IT" booklet by Deems Taylor.

high fidelity by craftsmen means distinctly better listening

Month After Month in popular magazines, carefully selected to reach your customers and prospects, smashing full page advertisements like these will be pounding home the Taylor story . . . the High Fidelity Story . . . the Craftsmen Story!

Cash in on craftsmen advertising— order these sales helps today!



Deems Taylor Booklet

Revised edition including new installation photos and complete Craftsmen line. Lithographed in color, 24 pages of information on High Fidelity so basic, so clear you'll want to use it as a selling tool!

Color Displays

Outstanding new window and counter display materials for the complete Craftsmen "Assembly," individual units, Deems Taylor booklet. Die-cut, attention getting cards that stop them in their tracks—and sell!

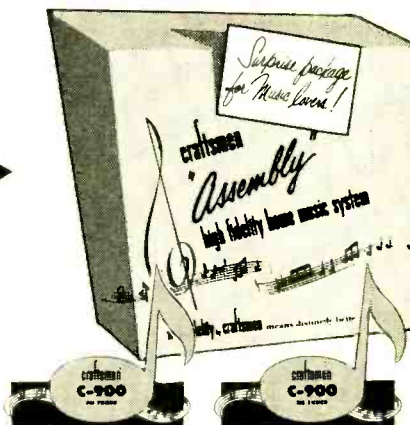

Consumer Literature

Attractive, hard-selling folders promoting the Craftsmen "Assembly" and the complete Craftsmen line. Useable as envelope stuffers, imprint space provided. Complete technical literature available in quantity.

the  craftsmen line  is the
shortest distance  between sales 

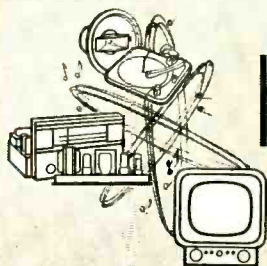

high fidelity by craftsmen®

means distinctly better listening

the radio CRAFTSMEN, inc., Dept. L-10, 4401 N. Ravenswood Ave., Chicago 40, Ill.

There's **REAL** Money in
TV Signal Distribution

with the

Add-A-Unit

**MASTER TV SYSTEM
for UHF and VHF**



The B-T Add-A-Unit System is a new tool. It is your 'open sesame' to the biggest boom that has ever hit the TV servicing industry.

Hotels, motels, schools, apartment houses, community developments, hospitals, and hundreds of others with multi-receiver problems are clamoring for low cost, easy-maintenance, efficient TV distribution systems.

This is YOUR BIG MARKET... your real money market

The B-T Add-A-Unit System offers you these advantages:

1. It is the lowest cost amplified distribution system ever designed.
2. It is the easiest system to install under all conditions... requires no special tools and no outside engineering assistance.
3. Its flexibility is practically unlimited and it can serve 2000 TV receivers as effectively as it can serve 2.
4. It has no 'bugs' and requires little or no maintenance.
5. It permits complete control of signal strength: amplification or attenuation, as may be required, assuring high quality reception at all TV outlets from all available channels.
6. Every B-T Master System installed by you is a sure fire 'clinch' for additional business.

Let the B-T System
Work for You.

The B-T Add-A-Unit Master TV System consists of the following B-T units:

- MIXER AMPLIFIER
- DISTRIBUTION AMPLIFIERS
- COMMERCIAL ANTENSIIFIER
- RESISTOR OUTLET BOX
- TV SYSTEM ACCESSORIES

- Attenuator
- Matching Transformer
- Remote Control
- Line Splitters
- Line Loss Equalizer
- Weather-Proof Housing

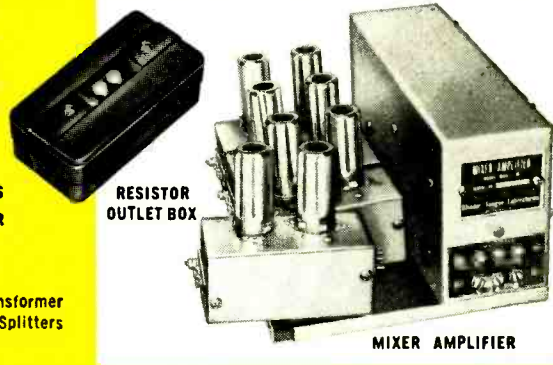

Write to Dept. NL-3 for Free Installation Manual and Complete Specification Data.
BLONDER-TONGUE LABORATORIES, INC.
Westfield, New Jersey

BEST WAVE FOR URBAN USE

What is the best frequency for communication in urban areas? This important question is of interest to radiotelephone, TV, ham, and other services often concentrated in and around cities. The Bell Telephone System has the answer, at least for mobile radiotelephone using FM. After extensive tests and comparisons over a frequency range from 150 to 3,700 mc, Bell scientists conclude that 500 mc is optimum. Furthermore, they find that 900 mc is better than 150 mc. These and other facts are presented in the Bell System Technical Journal for November, 1952.

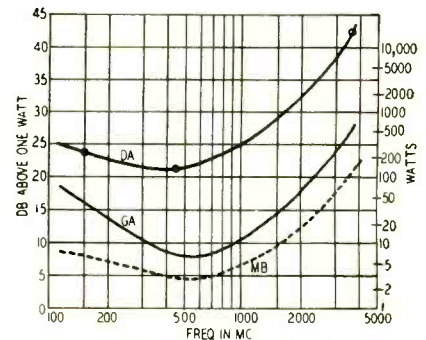

Fig. 1
DA-DIPOLE ANT LAND XMITTERS
GA-GAIN ANT LAND XMITTERS
MB-MOBILE XMITTER (ASSUMING 6 LAND RCVRs WITH DIPOLE ANTS)

It is a basic truth that transmission efficiency drops as frequency rises. For example, 450 mc is less effective than 150 mc by 7 db. At 900 mc, reception would be off by 11 db, and at 3,700 mc the loss is 31 db. There are other factors, however. At higher frequencies there is less noise. In this respect, 900 mc is better than 150 mc by 13 db. Also, directional antennas benefit the upper bands. The higher the frequency, the more practical it is to build directional radiators.

Fig. 1 shows power required for reliable communication in urban and suburban districts. A quarter-wave whip antenna is used at the receiver. The upper curve is for a dipole radiator. It shows that 150 watts at 450 mc is equivalent to 250 watts at 150 mc and to 270 watts at 900 mc. The frequency difference is more marked when a "gain" antenna is used. This concentrates power in the horizontal plane. Note the optimum near 500 mc.

An important factor in evaluating mobile radio transmission is the strength of the r.f. path. The mobile units of a mobile system are either moving around or, if stationary, are located at random. Since the effects of the many geographical features, buildings, and the like, which influence propagation can combine differently for different locations of a car, even where the locations are only a fraction of a wavelength apart, the only meaningful measure of signal strength is a statistical one.

The Bell experiments were carried on in New York City. The radiator was 450 feet high, atop the Long Lines Building in Manhattan. A station wagon carried the receiving and measuring equipment.—I. Queen

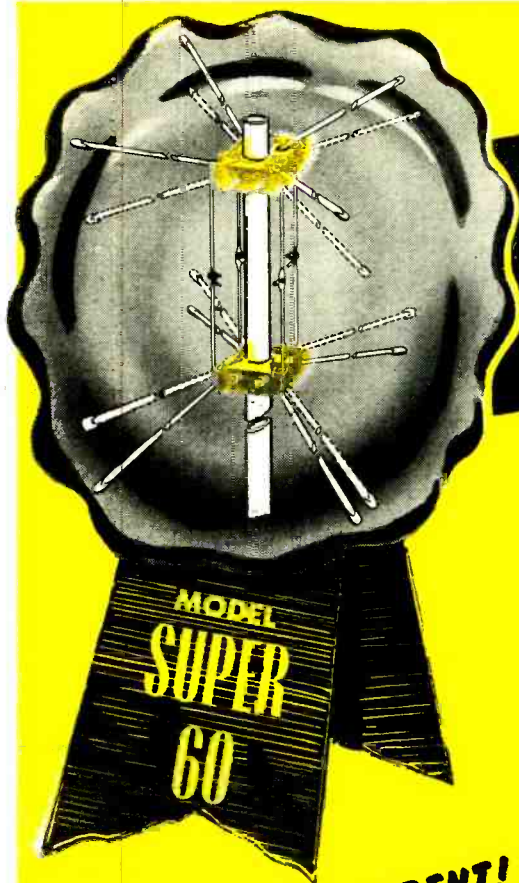

GUARANTEED PERFORMANCE

MONEY BACK GUARANTEED TO RECEIVE *All* UHF and *All* VHF STATIONS IN *All* DIRECTIONS FOR 60 MILES WITHOUT A ROTORMOTOR OF ANY KIND!!

**SO NEW! SO DIFFERENT!
IT'S PATENTED!**

- #2,585,670
- #2,609,503
- #2,625,655
- #2,644,091

OTHERS PENDING

WORLD'S MOST POWERFUL UHF - VHF TELEVISION ANTENNA

While antenna reception is guaranteed for 60 miles, perfect pictures have been consistently received as far as 160 miles from stations.

NEW POLYMICALENE 4 CONDUCTOR TRANSMISSION LINE

- Low Loss External - Air Dielectric
- Matched Impedance
- Eliminates End Sealing
- Eliminates Condensation
- Up to 50% Less Loss Than Tubular When Wet
- Easily Spiraled
- No Breaking or Shorting
- Patents Pending - T. M. Reg.



All NEW DESIGN FOR '54

- LOW-LOSS SWITCH
- LOW-LOSS PHENOLIC INSULATORS
- USES NEW 4-CONDUCTOR MATCHED IMPEDANCE LINE
- ONLY 10 INCH SPACING BETWEEN ANTENNA BAYS



The 9 position selector switch electronically rotates the antenna in a stationary position.

LIST PRICE

\$36.75

SEE YOUR LOCAL JOBBER

PRICE INCLUDES

- Complete stacked array • 4 stacking bars • 9 position switch • Switch-to-set coupler • 2 - 7 1/2" stand offs • Individually boxed in mailable carton

Money Back Guarantee IN EVERY AREA IN ALL LOCATIONS WITH STATIONS IN ALL DIRECTIONS

The new All Channel Model Super 60 is guaranteed to bring in, immediately on installation, every UHF and every VHF station within 60 miles in any direction, giving clearer and sharper pictures than any antenna or combination of antennas with or without rotor motors.

If, immediately on installation, it fails to do this, we agree to refund to the jobber to whom we sold and shipped it his full purchase price.

ALL CHANNEL ANTENNA CORP.

70-07 Queens Blvd., Woodside 77, N. Y.

Hickory 6-2304

TRIO

AMERICA'S MOST DEPENDABLE TV ROTATOR



TRIO Manufacturing Co.

GRIGGSVILLE, ILLINOIS

FACTORY TESTED to equivalent of three months normal use before shipment.

TEMPERATURE PROOF. Operates perfectly at -50° , even under heavy icing conditions.

FOOLPROOF. Stops itself at ends of rotation. NO burned out motors: NO broken feedlines.

IMPROVED BRAKE. NO coasting; NO drifting.

TWO MOTORS. Separate motor for each direction of rotation.

SMART—EASY TO USE Control unit. Indicates direction without turning rotator.

TWO YEAR GUARANTEE instead of the usual one.

**Write for literature.*

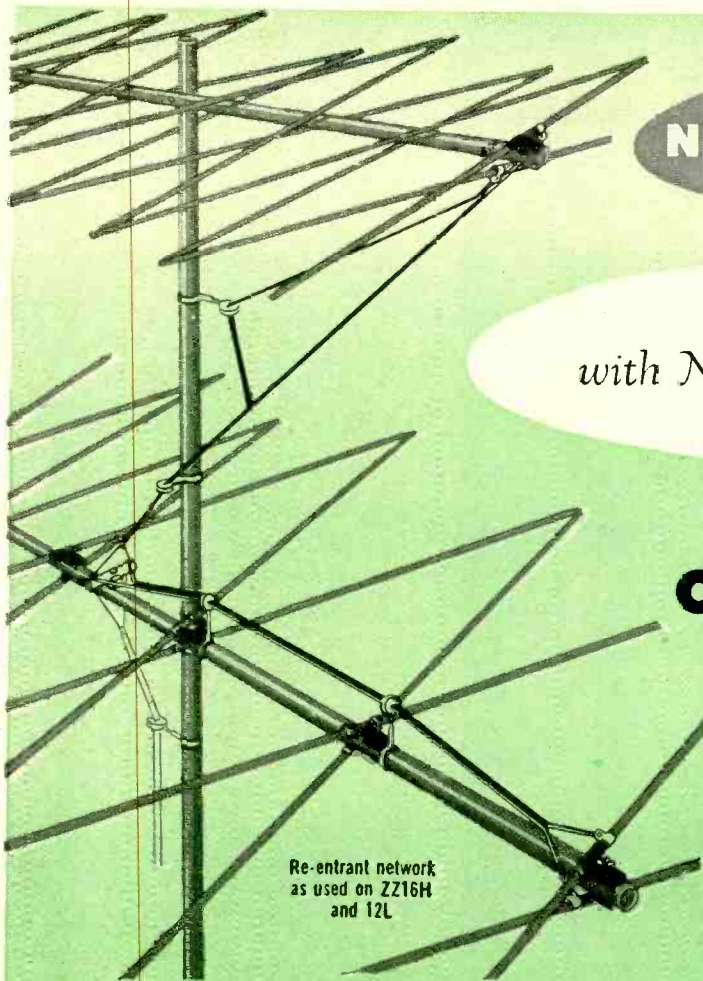

Re-entrant network
as used on ZZ16H
and 12L

NEW IMPROVED ZIG-ZAG

with New Re-entrant Network

OUTPERFORMS ON ALL CHANNELS

(Using Single Lead-in)

The sensational, radically new TRIO ZIG-ZAG antenna, introduced less than a year ago, has enjoyed the greatest acceptance of any TV antenna ever made!

NOW — TRIO introduces a radically new improvement that makes this great antenna even greater than before! It consists of a new re-entrant type impedance matching network for ZIG-ZAG antennas which now provides an almost perfect impedance match to the feedline on EVERY channel!

UNIFORMLY HIGH GAIN

There is no measurable difference in gain on ANY channel whether operating stacked high-band and low-band ZIG-ZAG antennas from a single feed-line or using them separately. There is no insertion loss such as found in isolation networks. For example, the ZZ12L and ZZ16H now provide 3 to 6 DB. more gain than elaborate, stacked cut-to-channel arrays. This additional gain is often the difference between a good picture and a poor one.

Elaborate tests conducted all over the country under every conceivable type of terrain and in locations where ten out of the thirteen VHF channels were available, proved conclusively that TRIO ZIG-ZAG ANTENNAS OUTPERFORM ANY and EVERY colinear, conical, or broadband multi-element Yagi on the market today — AND ZIG-ZAG

does it on ALL VHF channels. Whether its a new installation or a replacement, INSIST ON TRIO ZIG-ZAG TV ANTENNAS, with their EXTREMELY HIGH GAIN, SHARP DIRECTIVITY, SUPERIOR LINE MATCH, MULTI-CHANNEL COVERAGE and RUGGED-LONG LIFE CONSTRUCTION.

Illustrated above is the NEW re-entrant network developed by TRIO engineers for the model ZZ12L and ZZ16H combination. Current shipments will include the complete network. There is nothing else needed for single feed-line operation!

Used stacked — or separately — TRIO ZIG-ZAG antennas are the hottest ever designed!

New descriptive literature available direct or from your supplier.

New network supplied with all high-gain Zig-Zag models

ANOTHER NEW TRIO PLANT TO SERVE YOU!

This modern, new addition to TRIO's present facilities adds 24,000 sq. ft. of manufacturing space. A new laboratory, not illustrated, has also been added.

Although TRIO has definite commitments for 60 cars of aluminum to meet increased demands, we are not sure we will be able to fill all orders. We suggest you order now!

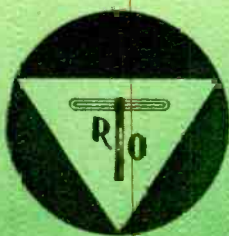

TRIO
Manufacturing Co.

GRIGGSVILLE, ILLINOIS

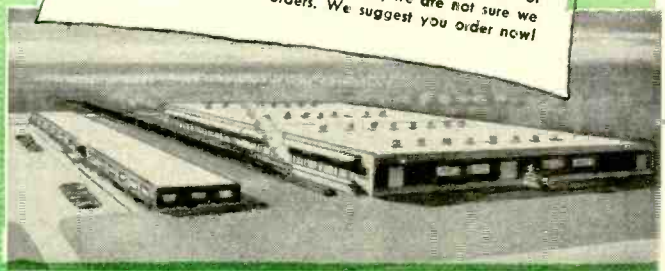

**BETTER PICTURES... BETTER SOUND
PEAK PERFORMANCE ALL AROUND!**

the **NEW**
SKYLINE UHF-VHF

- ▶ ONE LEAD-IN
- ▶ ALL CHANNELS
- ▶ ALL FREQUENCIES

▶ PARTS AND PERFORMANCE
WARRANTY!

▶ PRE-ASSEMBLED

▶ QUICK RIG

▶ NOW 32 ELEMENTS

▶ SEPARATE UHF-VHF
CIRCUITS

▶ AMAZING RECEPTION TO
150 MILES AND MORE!

IT'S TOMORROW'S ANTENNA **TODAY!**

SKYLINE MFG. CO., 1458 E. 17th Street, Cleveland 14, Ohio

to the

**E. E. or
PHYSICS GRADUATE**

*with an interest
or experience in*

**RADAR or
ELECTRONICS**

*Hughes Research and
Development Laboratories, one
of the nation's large electronic
organizations, are now creating a
number of new openings in an
important phase of operations.*

*Here is
what one of
these
positions offers
you*

OUR COMPANY

located in Southern California, is presently engaged in the development of advanced radar devices, electronic computers and guided missiles.

THESE NEW POSITIONS

are for men who will serve as technical advisors to the companies and government agencies purchasing Hughes equipment.

YOU WILL BE TRAINED

(at full pay) in our Laboratories for several months until you are thoroughly familiar with the equipment that you will later help the Services to understand and properly employ.

AFTER TRAINING

you may (1) remain with the Laboratories in Southern California in an instruction or administrative capacity, (2) become the Hughes representative at a company where our equipment is being installed, or (3) be the Hughes representative at a military base in this country—or overseas (single men only). Adequate traveling allowances are given, and married men keep their families with them at all times.

YOUR FUTURE

in the expanding electronics field will be enhanced by the all-around experience gained. As the employment of commercial electronic systems increases, you will find this training in the most advanced techniques extremely valuable.

How

to

apply

*If you are under 35 years of age
and have an E.E. or Physics
degree and an interest or
experience in radar or electronics,*

write

to **HUGHES**

**RESEARCH AND DEVELOPMENT
LABORATORIES**

Scientific and Engineering Staff

Culver City,

Los Angeles County, California

Assurance is required that the relocation of the applicant will not cause the disruption of an urgent military project.

FINAL
EDITIONTest Equipment  Good NewsFINAL
EDITION

PHILCO TEST EQUIPMENT SPECIFICALLY DESIGNED FOR THE SERVICEMAN

AGAIN PHILCO LEADS THE INDUSTRY

Serviceman's needs seen as Philco's Engineering Goal

This new Philco VHF to UHF adapter pioneers a whole new approach to service problems and at the same time is the most economical and practical unit ever offered. Servicemen are taking full advantage of the introductory demonstrations of this amazing piece of equipment now offered by Philco distributors coast to coast.

The First and Only VHF to UHF Signal Generator Adapter

Continuing its engineering program designed to provide the serviceman with the best possible test equipment Philco Corporation now offers at a fraction of the usual cost an exclusive highly specialized adapter unit for converting the output of VHF TV servicing test equipment to UHF.

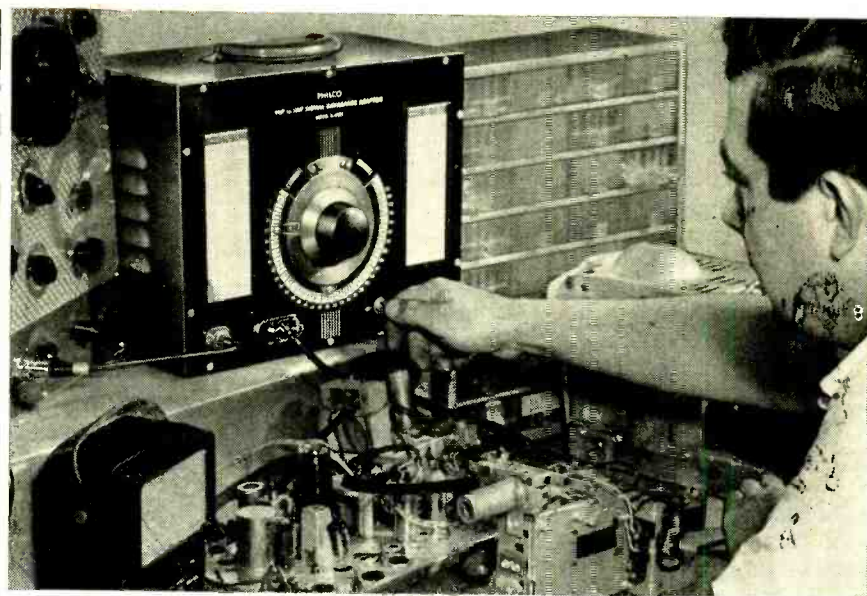

Under the trained eye of a Philco Serviceman the amazing model G-8000 VHF to UHF signal generator adapter is shown in action.



One of the Finest Vacuum Tube Voltmeters ever Designed

Facing up to the task of measuring high impedance circuits where loading effect must be kept to a minimum Philco has again designed a unit which meets the most rigid engineering specifications. All reports indicate this unit is unexcelled for complete and accurate measurements.

Practical Portable 3-inch Television Oscilloscope

The tremendous growth of television requires the most practical and versatile types of equipment to answer service needs. Philco has such equipment, particularly in its 3" scope which is 2½ times smaller than other 3" units, making it adaptable to either bench use or field servicing. High sensitivity and wide response make it ideal for TV work.



"Philco Test Equipment Specifically designed for the serviceman!" That's the theme of Philco's engineering program. A program which you, the serviceman, can depend upon to supply the very finest in service test equipment. Discover how easy it is to own a complete Philco Test Equipment Laboratory. Your Philco Distributor is eager to serve you by offering his new special payment plan to best accommodate your needs. Fill out the attached coupon as shown and mail to Philco Accessory Div.

PHILCO CORPORATION

Accessory Division

Allegheny Ave. & "A" St., Phila. 34, Pa.

I am interested in the Philco Test Equipment shown here. Please send me details of your SPECIAL PURCHASE PLAN for obtaining these units.

Please send FREE copy of your new booklet on Philco Test Equipment.

NAME

ADDRESS

CITY STATE

over **99%***
hit the bull's-eye
for quality!

that's why we call

Federal
PICTURE TUBES

"BEST-IN-SIGHT"

Thousands of famous-name picture tubes were quality-tested by a famous-name TV set manufacturer.* When the scoring was over, Federal led all the brands tested . . . with an "OK" on over 99% of its tubes!

Here's proof, Mr. Serviceman, that it pays to replace with *Federal* . . . here's assurance of top performance . . . of less time wasted on call-backs . . . of more profit per tube replaced!

Federal quality brings to servicemen a tremendous opportunity to create customer-goodwill . . . to build steady replacement business.

Federal quality *stands by* servicemen, because it *stands up* in service . . . backs up their years of experience and know-how . . . their *trained* judgment. That's one of many big reasons why more and more servicemen are specifying Federal "Best-in-Sight" picture tubes.

Join the trend today . . . ask your Federal Distributor about the popular-size line that takes care of over 90% of all TV replacements . . . ! For information, write to Dept. N-363.

"Federal always has made better tubes"

Federal
Telephone and Radio Company



100 KINGSLAND ROAD, CLIFTON, N. J.

In Canada: Federal Electric Manufacturing Company, Ltd., Montreal, P. Q.
Export Distributors: International Standard Electric Corp., 67 Broad St., N. Y.



**Get Your Copy of
Federal's
TV Picture Tube
DATA BOOK**

12-page booklet with information on interchangeability, basing diagrams, bulb outlines, dimensions, characteristics. Address your inquiry to Dept. listed above.



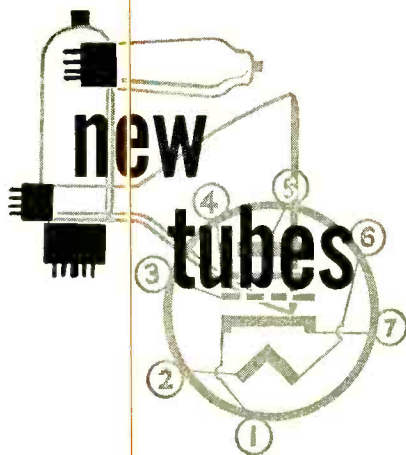

(and Transistors)

As might be expected of a relatively new product, transistors continue to undergo rapid and basic development.

General Electric has announced new all-welded junction transistors with essentially infinite life expectancies. The new units, type 2N43 for high-gain, 2N44 for intermediate-gain, and 2N45

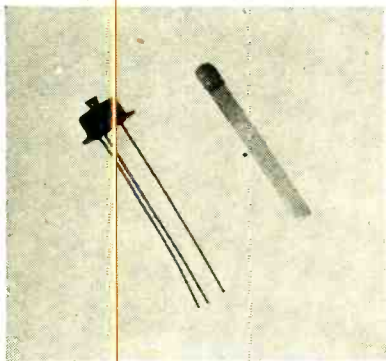

GE hermetically sealed all welded junction transistor, now in production. for medium-gain, are evacuated, hermetically sealed, and of all-welded metal construction. This eliminates the aging effects of moisture and trapped solder-flux fumes. The new construction also allows power ratings up to three times those of any previously announced transistors (almost 1 watt, with two units in a class-B push-pull circuit).

In a novel exhibit at the West Coast Electronics Show in San Francisco, the transistor was operated as the heart of a miniature radio transmitter while frozen in a cake of ice which was then melted and turned into boiling water. This demonstrated the transistor's ability to perform efficiently under extreme variations in temperature and humidity.

The germanium fused junction transistors are triode P-N-P units. The absolute maximum ratings are: collector voltage (referred to base)—45; collector current—10 ma; emitter current 10 ma.

Transistor Products, Inc., has announced the development of a type X-25 germanium N-P-N junction photo transistor said to be the first commercially available amplifying photo transistor

YOU'VE HEARD ABOUT THE

Telechief®

It's HERE—Sangamo's new premium molded paper tubular capacitor that will outlast and outperform any other tubular . . . built for better TV performance.



NOW

see your jobber for this

SPECIAL INTRODUCTORY OFFER!

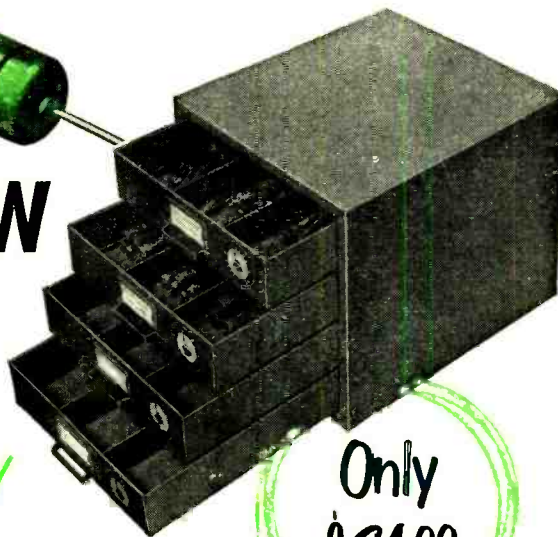

Only \$24.00

Slightly higher in Canada

Here's a deal you can't afford to miss. You get a basic balanced inventory of fast-moving "Telechiefs"—assortment based on national popularity—PLUS a heavy gauge steel chest with two extra drawers for small parts—PLUS your choice of 100 attractive folders to promote your business. You get all this for only \$24.00—the dealer net price of the capacitors alone. (They list at \$40.00.)

Get acquainted with the Telechief today—your Jobber has these kits in stock.



You can have 100 of any of these business-building folders without extra cost—a sample of each is enclosed in the kit.

Those who know... choose Sangamo



SANGAMO ELECTRIC CO. MARION ILLINOIS

OVER 50,000 TECHNICIANS HAVE LEARNED



'SERVICING BY SIGNAL SUBSTITUTION' A BEST SELLER FOR OVER 12 YEARS! (NEW, UP-TO-DATE, 12TH EDITION)

HOW TO GET THE MOST OUT OF BASIC TEST EQUIPMENT

ONLY 40¢ 103 pages. Invaluable information that will help you re-double the value of your basic test equipment.

The Modern, Simplified, Dynamic Approach to Receiver Adjustment & Alignment Problems.

- ★ Nothing complicated to learn
- ★ No extra equipment to purchase
- ★ Universal... non-obsolete
- ★ Employs only Basic Test Instruments

Ask for "S.S.S." at your local Radio Parts Jobber or remit 40¢ in small stamps or coin directly to factory.

for A.M. - F.M. - TV

PRECISION APPARATUS COMPANY, INC. 92-27 HORACE HARDING BLVD., ELMHURST 4, N. Y.

The master

of television signal generators

- more sweep
- greater RF output
- better stability
- increased accuracy
- unlimited flexibility
- lower cost

model TVG-2

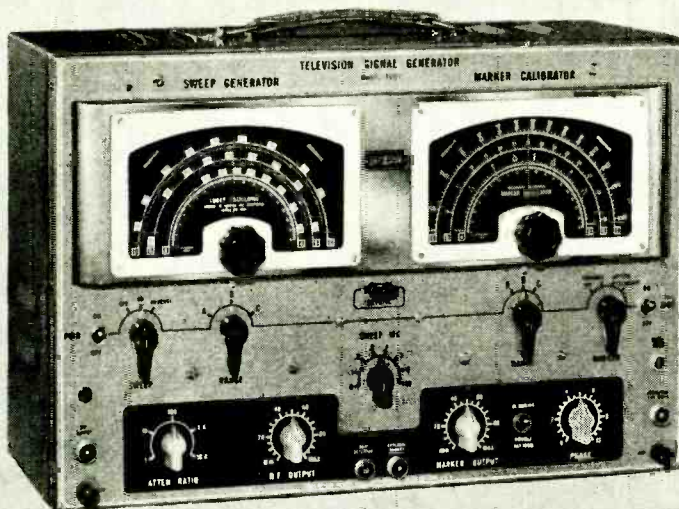

See your electronics distributor or write.

JACKSON

"service engineered" test equipment

JACKSON ELECTRICAL INSTRUMENT CO.
DAYTON 2, OHIO

IN CANADA:
THE CANADIAN MARCONI CO.

NEW DESIGN

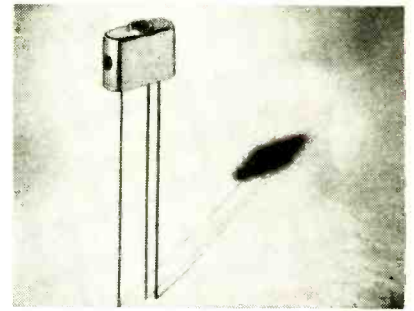

X-25 amplifying photo transistor.

ever made. Its immediate applications will include use in automatic equipment such as punch-card accounting machines, dimmers for automobiles, and brilliance controls on television receivers.

The X-25 photosensitive transistor has sufficient power output to operate a relay. Maximum operating power is 60 mw and maximum nondestructive power is 400 mw. The X-25 may be considered as a light-sensitive device with an incorporated amplifier.

RCA has announced production of three premium-type tubes. The 5719 is a high-mu triode of the subminiature type for use primarily as an audio amplifier in mobile and aircraft receivers where dependable performance under shock and vibration is a prime consideration. In audio use as a resistance-coupled amplifier, the 5719 is capable of providing high voltage gain. A pure tungsten heater is used to give long life under conditions of frequent on-off switching.

The 5814 is a medium-mu twin triode of the 9-pin miniature type for use in many diversified applications including mixers, oscillators, multivibrators, synchronizing amplifiers, and industrial control devices where performance under shock is important. The 5814 has electrical characteristics similar to those of the 12AU7, but differs in that it has higher heater current and a lower heater-cathode voltage rating. The 5814 also has a pure tungsten heater for frequent on-off switching, a mid-tapped heater to permit operation from either a 6.3-volt or a 12.6-volt supply, and separate terminals for each cathode for flexible circuit arrangement.

The 5840 is a sharp-cutoff pentode of the subminiature type for use as a broad-band r.f. or i.f. amplifier in mobile and aircraft receivers. Like the 5719 and the 5814, the 5840 has a pure tungsten heater. The 5840 has three leads to the cathode to permit isolation of the input and output circuit returns and to reduce the cathode lead inductance.

Another RCA release is the 12AQ5, a beam power amplifier of the 7-pin miniature type intended primarily for use in the output amplifier of automobile radio receivers operating from a 12-volt storage battery. The 12AQ5 is identical in characteristics with the 6AQ5 with the exception of its filament voltage of 12.6, and filament current of .225 amperes.

Five new tubes have been added to

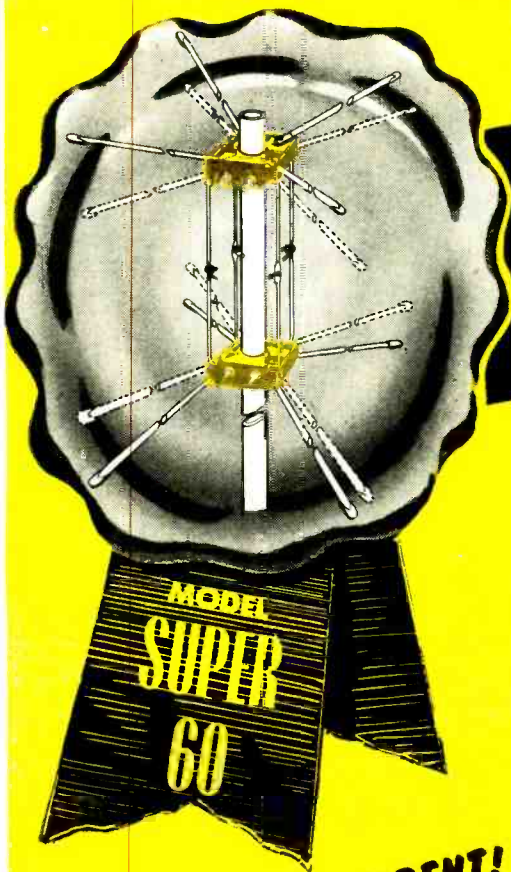

GUARANTEED PERFORMANCE

MONEY BACK GUARANTEED TO RECEIVE *All* UHF and *All* VHF STATIONS IN *All* DIRECTIONS FOR 60 MILES WITHOUT A ROTORMOTOR OF ANY KIND!!

**SO NEW! SO DIFFERENT!
IT'S PATENTED!**

- # 2,585,670
- # 2,609,503
- # 2,625,655
- # 2,644,091

OTHERS PENDING

WORLD'S MOST POWERFUL UHF—VHF TELEVISION ANTENNA

While antenna reception is guaranteed for 60 miles, perfect pictures have been consistently received as far as 160 miles from stations.

NEW POLYMICALENE 4 CONDUCTOR TRANSMISSION LINE

- Low Loss External - Air Dielectric
- Matched Impedance
- Eliminates End Sealing
- Eliminates Condensation
- Up to 50% Less Loss Than Tubular When Wet
- Easily Spiraled
- No Breaking or Shorting
- Patents Pending - T. M. Reg.



100 Ft.\$8.90 Minimum quantity

Mfg. solely by

ALL CHANNEL ANTENNA CORP.
Woodside 77, N. Y.

All NEW DESIGN FOR '54

- LOW-LOSS SWITCH
- LOW-LOSS PHENOLIC INSULATORS
- USES NEW 4-CONDUCTOR MATCHED IMPEDANCE LINE
- ONLY 10 INCH SPACING BETWEEN ANTENNA BAYS

The 9 position selector switch electronically rotates the antenna in a stationary position.

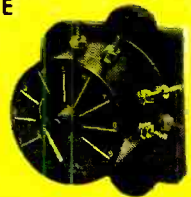

PRICE INCLUDES

- Complete stacked array • 4 stacking bars • 9 position switch • Switch-to-set coupler • 2 - 7 1/2" stand offs • Individually boxed in mailable carton

Dealer Price
\$22.05
LIST PRICE
\$36.75

GREYLOCK ELECTRONIC SUPPLY CO., Inc.
115 Liberty Street, N.Y.C. 6, N.Y.

Please send me.....amount at \$36.75 list price.
Please send me.....amount at \$22.05 dealer net.
Dealers order on letterhead.

Please send me feet of Polymicalene 4 Conductor.

Name _____
Address _____
City _____ State _____

Check Enclosed Money Order Enclosed
 C.O.D. enclosed please find 25% of total purchase price . . .
check . . . Money Order. Please send new 8 page cat.
supplement
 Please put my name on your mailing list.
() Enclosed find \$..... in full. Send prepaid.

GREYLOCK ELECTRONICS SUPPLY COMPANY

• NEW YORK 6, N. Y. • BEckman 3-0224

NOW-GREAT TWO PRECISE OSCILLOSCOPES

(IN KIT OR WIRED FORM)

THE NEWEST, THE ONLY ONE OF ITS KIND!

8½" OSCILLOSCOPE: PRECISE MODEL #308

Now another great Precise Oscilloscope! The only 8½" Oscilloscope on the Commercial Market... in Kit or Wired Form... at an unbelievably low price. Designed to bring you true TV picture clarity and laboratory tested accuracy.

ALL THE OUTSTANDING FEATURES OF THE MODEL 300 as shown below, PLUS:

- ★ INTENSIFIER ANODE
- ★ HI-LOW-NORMAL SYNCH. (A Precise First)
- ★ 8½ INCH TUBE (A Precise First)
- ★ VOLTAGE REGULATION (A Precise First)

"Seeing is Believing"—Go and See! your nearest jobber

308K—kit form..... **\$129.50**

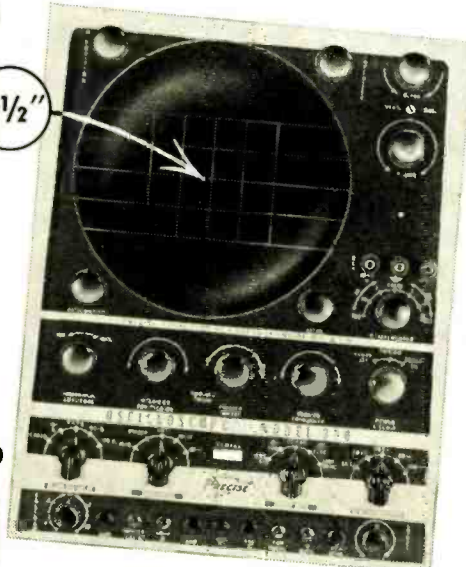

SPECIFICATIONS: PRECISE MODEL 300 OSCILLOSCOPE

VERTICAL — Vertical-Rat (3db) DC through 5 megacycles with sensitivity of greater than 10 millivolts push-pull (3.94 Millivolts/cm); Constant Resistance. Push-pull input immediately converted to single-ended normal or reverse phase by shorting bar at inputs 1 and 2. Frequency compensated vertical stepping attenuator selects AC or DC inputs. Push-pull DC amplifiers from input through output; internal electronic mixing through inputs 1 and 2; five-way binding posts.

POSITIONING — Bridge type positioning on vertical and horizontal does not vary tube characteristics.

HORIZONTAL — Frequency compensated stepping attenuator in horizontal amplifier; Push-pull horizontal out.

BLANKING — Internal (return trace blanked), external (return trace not blanked), 60 cycle or 120 cycle Blanking through Blanking amplifier circuit.

SYNCHRONIZATION — External, Internal Positive, Internal Negative, Internal 60 cycle or Internal 120 cycle synchronization.

SWEEP RATE — Driven or non-driven linear sweeps from 1 cycle to 80K in five ranges (1-10 cycles uses external C circuit); trigger potentiometer.

MAGNIFIER — Electronic magnifier and magnifier positioner allows any part of a signal to be magnified up to ten times (equivalent to 70 inches of horizontal deflection).

CALIBRATION — Internal square wave calibrator and potentiometer for using oscilloscope at a VTVM or peak to peak measurements.

CALIBRATION SCREEN — Edge-illuminated scale and graticule may be turned on or off; filtered screen.

OUTPUTS ON FRONT PANEL — Plus Gate output; Sawtooth output; 60 cycle phasing output; 60 cycle unphased output; Calibration output.

FOCUSING — Astigmatism, focus and intensity control.

CRT — NEW 7" Tube, normally supplied is medium persistency type 71P1 (oscilloscope green trace) — high persistency types available at additional cost.

DIRECT — Deflection Plates available from rear of cabinet.

INTENSITY MODULATION — Z modulation through modulation amplifier.

GENERAL — Low loss components; Over-designed fused power supply for additional circuits; Die-cast aluminum Panel; New parts from original manufacturers — (NO SURPLUS); Steel cabinet; 11" x 14" x 17" complete with instruction book and all components; Accessories: Model 912(MM) Demodulator Probe and Model 950 Capacity Attenuator Probe available at extra cost — please see specifications on following pages.

There are many additional features and circuits in kit form, which may be added to the Model 300. Please write us for descriptive literature.

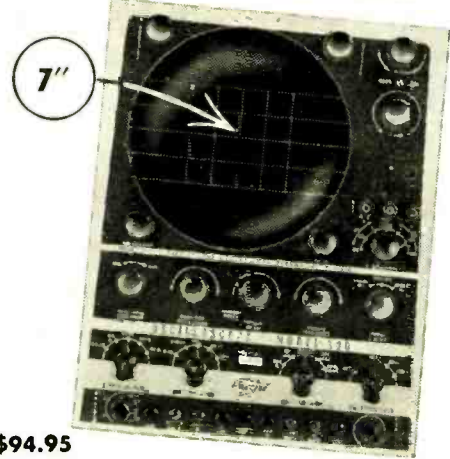

300K—kit form **\$94.95**
300W—factory wired **\$199.50**



Prices slightly higher in the West. Prices and specifications subject to change without notice.

PRECISE DEVELOPMENT CORP. Dept. RE 23
999 LONG BEACH ROAD - OCEANSIDE, L. I., NEW YORK

GENTLEMEN: Without any obligation on my part, kindly send me the following:

PRECISE CATALOG
 NAME OF DISTRIBUTOR NEAREST ME

NAME _____
ADDRESS _____
CITY _____ ZONE _____ STATE _____

precise DEVELOPMENT CORP.
OCEANSIDE, NEW YORK

General Electric's "Five-Star" line to bring the total of available types to 31, capable of performing all typical electronic functions in receiving-tube applications. Specifically designed for

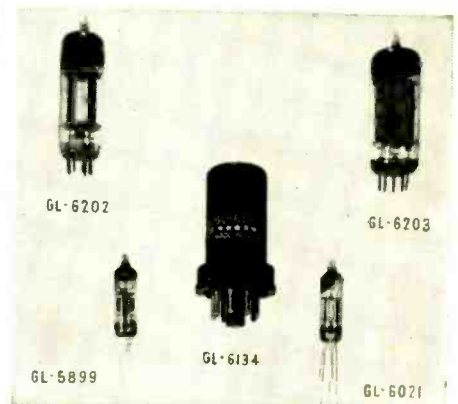

Additions to GE "Five-Star" line.

use in equipment in which extreme electrical and physical dependability is essential, the newest group of "Five-Star" tubes includes a twin diode, two twin triodes, and two pentodes.

The GL-5899 is a subminiature, semi-remote-cutoff pentode for use as a wide-band, high-frequency amplifier. Its semi-remote-cutoff characteristic makes it suitable for use in automatic-gain-control circuits. The tube is especially suited for compact military applications because of its dependable performance, stable operating characteristics, and small size.

The GL-6021 is a subminiature medium-mu twin triode suitable for use in general-purpose amplifier applications. Each section has an individual cathode and is electrically independent. The tube is designed for service under severe conditions of mechanical shock and vibration, high ambient temperatures, and is especially suited for compact military applications.

The GL-6134 is a sharp-cutoff pentode intended for service as a wide-band radio-frequency or intermediate-frequency amplifier, or as a video amplifier. Features include a high degree of mechanical strength and a heater-cathode construction designed to withstand many thousand cycles of intermittent operation. Electrically and physically, the GL-6134 is a replacement for the 6AC7.

The GL-6202 is a miniature full-wave high-vacuum rectifier for use in power supplies in which the d.c. current requirements do not exceed 50 milliamperes. Within the limits of its maximum ratings, it is a replacement for the 6X4. The GL-6202 may be used at altitudes as high as 60,000 feet, and will withstand a peak impact acceleration of 700 g.

The GL-6203 is a miniature full-wave high-vacuum rectifier intended for use in power supplies of a.c. and storage battery operated equipment. Like the GL-6202, the tube may be used in applications which are subject to altitudes as high as 60,000 feet, and will withstand a peak impact acceleration of 700 g. **END**



Why didn't someone do this before?



Only Superotor®

has the Quick Detachable Drive Unit

A **Leader** FIRST!



“TERRIFIC!” say TV servicemen — and you’ll echo their words when you see the amazing new Superotor. Imagine — a drive unit as easy to replace as a light bulb! Strictly a one-man job! No fussin’, no cussin’, — no need to dismount the antenna — no need to interrupt TV viewing while the drive unit is being serviced. Great? Yes! — and this is just one of FIVE major advances that put Superotor years ahead of anything on the market. No wonder the big switch is to Superotor!

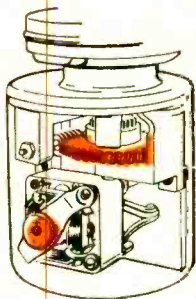

● Double Lock Stop Prevents Drift & Coast

A **Leader** FIRST!

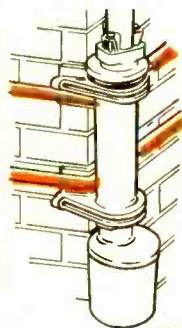

● Built-in Chimney Mount Design

A **Leader** FIRST!



● Steel Reinforced Construction

A **Leader** FIRST!

VP* Tuning

*Varnier Precision

A **Leader** FIRST!

Patent Applied for Copyright



2925 EAST 55th ST., CLEVELAND 27, OHIO

... LEADING THE WAY TO BETTER PRODUCTS

These outstanding

SHURE

PICKUP CARTRIDGES

provide maximum fidelity of RCA 45 r.p.m. records

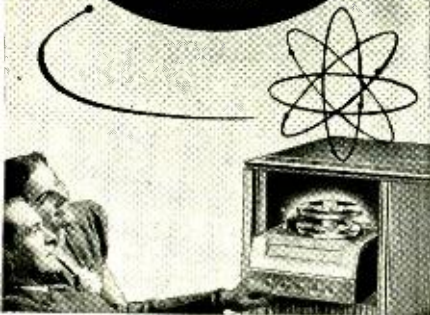

"DIRECT DRIVE" CRYSTAL (W31AR)
 High output (2.1 volts!) "Direct Drive" cartridge specifically designed for use with all fine-groove records. Universal mounting bracket provides quick, easy installation in RCA-type 45 r.p.m. changers. (Fits 1/2" and 5/8" mounting centers.) Has easy-to-replace needle. For maximum quality, highest output, and low cost, specify Model W31AR at the low list price of only \$6.50.



"DIRECT DRIVE" CERAMIC (WC31AR)
 Same as Model W31AR, except for ceramic element and .65 volts output. Highly recommended in areas where heat and humidity make use of conventional crystal cartridges impractical. List price.....\$6.50



"VERTICAL DRIVE" (W21F)* High-fidelity cartridge. Provides superlative reproduction for 33 1/3 and 45 r.p.m. records. Extended frequency response (50 to 10,000 c.p.s.). Low tracking pressure (only 6 grams) and high needle compliance guarantee faithful tracking and longer record life. Uses quiet tracking Shure "Muted Stylus" needle, scientifically designed for maximum performance and long life. List price.....\$7.75

*Cartridge with .453 Mount for Oak Changer

SHURE

SHURE BROTHERS, Inc.

Microphones and Acoustic Devices
 325 W. HURON ST. • CHICAGO 10, ILLINOIS
 Cable Address: SHUREMICRO

CREDIT FOR REPAIRS

A plan for providing credit for radio and TV repairs as well as purchases has been worked out by the Radio-Television Association of Kalamazoo, Michigan, in co-operation with a local finance company. Under the plan, approved customers will receive loans to pay their repair bills. Service organizations will receive cash, thus saving the expense of mailing statements, keeping charge accounts on their books, and making collections.

The Kalamazoo RTA has just finished a newspaper advertising campaign which explained to the TV-owning public the many problems facing the TV repairman, the service performed by ethical service firms, and the reasons why TV repairs sometimes can be expensive.

SELF-SERVICE TV

A Brooklyn components store is catering to the trade created by the "fix-it-yourself" propaganda widely distributed by publishers of so-called "TV guidebooks." Calling itself Self-Service TV, the firm has distributed leaflets like the one illustrated, urging TV owners to bring their troubles to the store. The customer, according to Charles Schlosser one of the proprietors, describes his symptoms, and in cases where tubes appear to be at fault, is given tubes covering the suspected portion of the receiver. Nine times out of ten, says Schlosser, the trouble is cured. Customers can also make a few other minor repairs, he says, but where major service work is required, they are referred to service shops in their neighborhoods. Self-Service does no repair work on its own.

SELF SERVICE TV

2300 86th Street Esplanade 2-9539

"Fix It Yourself"

— It's Easy —

Radio and Television Parts
At WHOLESALE Prices!

Antennas !
Brackets
Radios, Phonos

Masts !
Antenna Lines !
Needles !

Tubes 40% off
Batteries 20% off

TUBES TESTED FREE!

Complete Line of Antenna Equipment

RADIOS

PORTABLES

PHONOS

}

At Large Discounts!

Visit our Gift Dept. — All Gifts 25% off

Music Boxes — Musical Lighter — Imported Clocks

SELF SERVICE TV 2300 86th St.

Souvenirs to All!

OPPOSE ANTENNA LAWS

Proposed regulations governing installation of TV antennas are opposed by technicians of Kansas City, Mo. The Television and Radio Technicians section of the Electric Association of Kansas City pointed out several reasons

GO TESCO!

for **UHF**



For greater gain in UHF

ULTRA BOW-TENNA

Model 704

Stronger reception Ruggedly built

ULTRA V-TENNA

Model 703

Covers Channels 2 thru 83

VHF-UHF ULTRA-ROCKETENNA

PRL-742

Tesco engineers developed the ULTRA-TENNA series for VHF-UHF, or UHF alone, to solve all antenna problems. Write now for complete information, it's the cats whiskers... and just as sensitive!

TESCO

TV PRODUCTS CO. SPRINGFIELD GARDENS
 NEW YORK, 13, N. Y.
 NEW YORK TO 'FRISCO, ... IT'S TESCO

RADIO-ELECTRONICS

easy...split second installation!

TELCO

corner reflector
Golden Grid
uhf antenna

Identified by its golden screen

FACTORY-ASSEMBLED

- vibration-proof
- ready to install
- reduces installation cost
 - sturdily constructed
- only 1 mast bracket to attach
- anti-corrosion plating meets government specifications

Exclusive

UHF "WISHBONE" INSULATOR

Only Telco gives you this remarkable "plus" feature

1-2-3 Ready To Go!

- 1 OPEN CARTON . . . REMOVE FACTORY-ASSEMBLED UNIT
- 2 OPEN LIKE A BOOK . . . FASTEN STRUT WIRES
- 3 MOUNT ON MAST . . . JOB COMPLETE

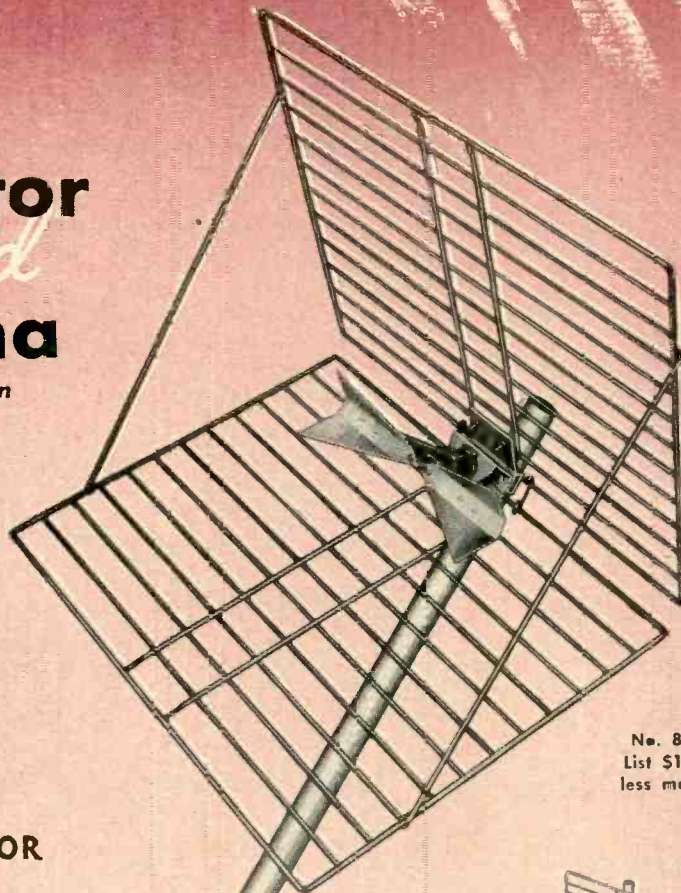

No. 8984
List \$11.75
less mast

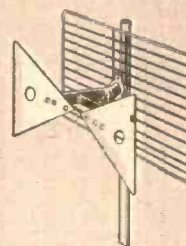

No. 8965 Butterfly
Wishbone Antenna
List \$5.50
With Stacking Bar

No. 9000 "Golden Halo"
Indoor UHF Antenna
Pure Gold Plated
List \$4.95



No. 8642 Universal
Lightning Arrester
U. L. Approved
List \$1.25



WRITE FOR FREE TELCO CATALOG

TELCO



television hardware mfg. co.

DIVISION OF GENERAL CEMENT MFG. CO.
910 TAYLOR STREET, ROCKFORD, ILL.

Installing Speakers?

INSIST ON *Utah*

Your one complete

SPEAKER SOURCE

Whether you are making a sound installation in a church, school, tavern, factory or office—or a replacement in an automobile, radio or television set—insist on the tops in the speaker field—insist on Utah Pre-tested speakers.

A Utah speaker is as close to you as your telephone—all leading jobbers handle Utah—because Utah has the widest line of speakers available to the trade—is your one complete speaker source.

The name Utah on a speaker signifies the finest quality in design, engineering, production and performance.

Repeat sales—customer satisfaction—is assured when you insist on and install a Utah Pre-tested speaker.

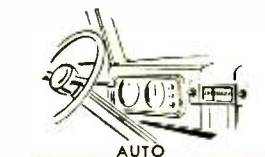

AUTO



SOUND INSTALLATIONS

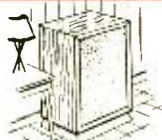

HIGH FIDELITY



TELEVISION

Utah

Radio Products Co., Inc.

Export Dept. Rocke International Corporation—N.Y.C.

A WHOLLY OWNED SUBSIDIARY OF NEWPORT STEEL CORPORATION

EASY TO LEARN CODE

It is easy to learn or increase speed with an Instructograph Code Teacher. Affords the quickest and most practical method yet developed. For beginners or advanced students. Available tapes for beginner's alphabet to typical messages on all subjects. Speed ranges 5 to 40 WPM. Always ready—no QRM.

ENDORSED BY THOUSANDS!

The Instructograph Code Teacher literally takes the place of an operator-instructor and enables anyone to learn and master code without further assistance. Thousands of successful operators have "acquired the code" with the Instructograph System. Write today for convenient rental and purchase plans.



INSTRUCTOGRAPH COMPANY

4701 Sheridan Rd., Dept. RC, Chicago 40, Ill.

RADIO-ELECTRONICS is paying good rates on acceptance for original and unusual articles on audio, television, FM and AM servicing, as well as articles on industrial electronic equipment and applications. Send for a copy of our Authors' Guide. Address:

THE EDITOR, RADIO-ELECTRONICS
25 West Broadway, New York 7, N. Y.

for their stand to the City Plan Commission:

Kansas City has had less TV service trouble than any city of similar size in the country, according to the technicians—and qualified technicians in the city are vitally interested in safety. As proof, they cite the convincing argument that no complaints, damage suits, or reports of injuries related to TV antennas have been registered in Kansas City.

As minor arguments, the technicians point out that with power increases for transmitters coming in the near future, the problem of the large outside antenna will become less and less important. Improvement in television receivers and tuners—especially u.h.f. receivers and tuners—will still further decrease the need for outdoor antennas.

BUFFALO ACTIVE

The Radio Television Service Association of Buffalo, N. Y., is meeting regularly every month at the Hotel Lafayette, according to a communication recently received from that organization. The present officers are: Ferdinand J. Lynn, president; Clarence Thielke, vice-president; John G. Wick, secretary; William Harrington, treasurer; William Wagner, sergeant-at-arms.

TWO NEW CODES

Two codes of ethics, one used by the Radio-Television Service Association of western New York, the other by the Albany, N. Y., Television Service Association, have been published recently. The western New York group (centering on Buffalo) are pledged to perform as follows:

1. Guarantee radio and television repair work for 90 days and replacement parts for 90 days.
2. Use only parts of recognized quality in repair work.
3. Charge no more than list price for parts installed.
4. Test customers' tubes as accurately and reliably as possible.
5. Keep charges for labor in such repair work at a fair and reasonable level.
6. Perform only such repair work as is necessary or authorized.
7. Maintain and use service equipment essential to good repair work and reliable tube testing.
8. Subscribe to the principles of the Buffalo Better Business Bureau in the public interest.

The Albany group, made up of 11 retailers and service agencies, adopted a code which differs in some respects:

1. We will maintain proper test equipment and service information libraries to keep abreast of the rapid electronic advances.
2. We will not advertise or offer service or sell materials that are questionable or unfair to customers or ourselves.
3. Protect our customers and ourselves with insurance coverage on property, personal liability and service contracts.
4. We will give estimates before shop repairs, return defective parts along with an itemized bill and standard guarantee.
5. Render prompt service (in the home when possible) using standard brand parts and replacing only necessary parts.
6. We will charge fair prices for our service and will answer to our association regarding any complaints brought to its attention.
7. We will employ qualified personnel and be responsible for proper training in service methods, courtesy and honesty.

The group has set up a schedule service prices and formed a complete committee to work with the Albany Chamber of Commerce on customer service complaints.

RADIO-ELECTRON

SERVICEMAN'S DIARY...as told to Ben Grim, **SPRAGUE PRODUCTS COMPANY**

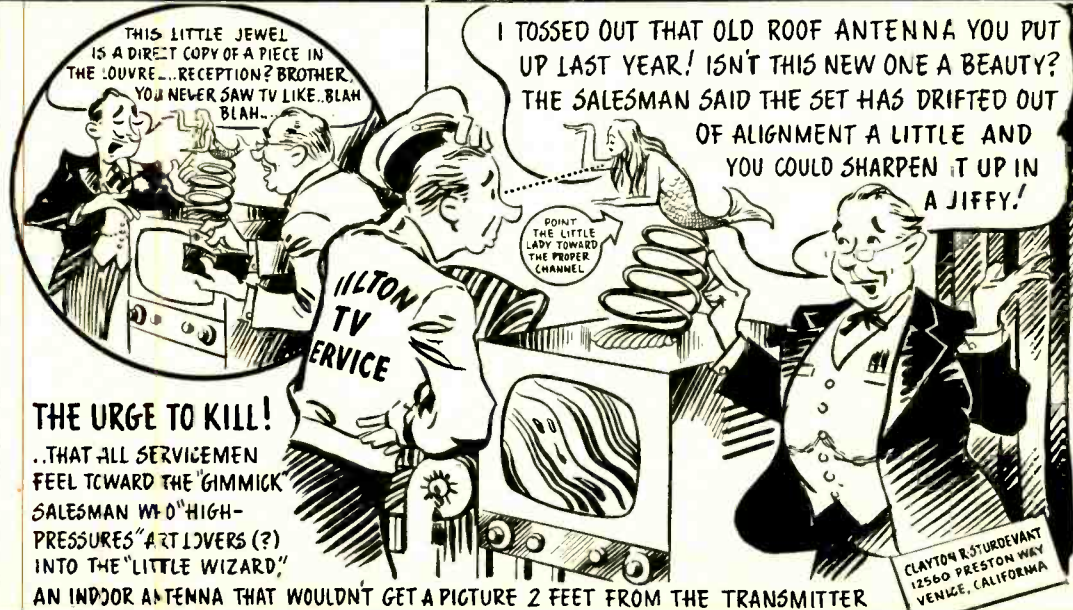

THE URGE TO KILL!

..THAT ALL SERVICEMEN FEEL TOWARD THE "GIMMICK SALESMAN WHO "HIGH-PRESSURES" ART LOVERS (?) INTO THE "LITTLE WIZARD," AN INDOOR ANTENNA THAT WOULDN'T GET A PICTURE 2 FEET FROM THE TRANSMITTER

CLAYTON RSTURDEVART
12560 PRESTON WAY
VENICE, CALIFORNIA

NEW DRESS for an OLD FAVORITE!



Cera-Mite Capacitors are now packaged in the clear, molded Plasti-Pak* for your greater convenience*

NOW the complete Sprague ceramic line for virtually every replacement need comes to you in the crystal-clear molded Plasti-Pak* box. This rigid, reusable container lets you see contents and capacitor ratings at a glance. There's a positive snap lock on this slim new space-saving polished styrene package with the hinged lid to eliminate spilling.

The Plasti-Pak is another of the service tested, forward-looking features for which you can depend on Sprague.

Remember, there's a Sprague ceramic capacitor or printed circuit for every replacement requirement.

And there are Sprague distributors in every major trading area. For the name and address of your nearest genuine Sprague parts depot, write to Sprague Products Company, 81 Marshall Street, North Adams, Mass.

*Trademark

Look To SPRAGUE For LEADERSHIP IN EVERY Type of CAPACITOR!

Do you have the complete Sprague Catalog C-609?

SPRAGUE  **WORLD'S LARGEST CAPACITOR MANUFACTURER**

SPRAGUE PRODUCTS CO IS THE DISTRIBUTORS' DIVISION OF THE SPRAGUE ELECTRIC COMPANY

NEW ANTENNAS

LaPointe Electronics, Inc., Rockville, Conn., has added new items to its Vee-D-X line. Among these are the *Special*, an all-channel Yagi antenna with five elements for high-channel reception and four elements for low; broad-band Yagi's in 10- and 5-element models; isolation filters; and a lightning arrester.

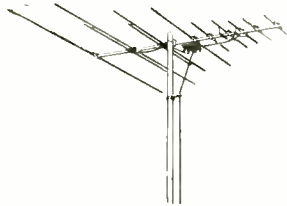

ANTENNA ROTOR

Jeb Sales Corp., 41 Wycoff Ave., New York 37, N. Y., has introduced a new antenna rotor. The unit develops 40 foot-pounds torque at the antenna mast. The model's electrical braking system results in instant stopping of the rotor, without drift.

The rotor makes 1 r.p.m. through an arc of 365° and is stopped at the end of travel by electrically actuated switches.

REMOTE CONTROL

Gonset Co., 801 S. Main St., Burbank, Calif., is producing a universal TV remote-control unit which may be attached to any conventional TV receiver.

Featuring a Standard Coil cascade tuner ahead of a booster amplifier, the unit not only permits channel selection from the viewing position (including volume, contrast, and fine-tuning adjustments), but also provides improved reception in weak-signal areas, particularly on older sets. The unit thus takes the place of both a booster and a u.h.f. converter, as the turret



tuner has provision for snap-in coil strips.

A sound-output connection is provided for headphones, for silent-set viewing in hospitals, apartments, or wherever else desired. The unit is available in a choice of cabinets for either 21 or 40 mc. i.f. amplifier.

ANTENNA MAST

Channel Master Corp., Ellenville, N. Y., is producing an antenna mast, the *Strato-Matic*, featuring a safety device called the "Third Hand," which permits one-hand extension.



An automatic, removable locking device holds mast sections up when you let go. Both hands can be removed from the mast at any time during elevation and sections cannot slide down.

UHF-VHF ANTENNA

Neal Electronic Co., P.O. Box 376, Huntsville, Ala., has announced the *Paraborar*, for channels 2-83. The an-

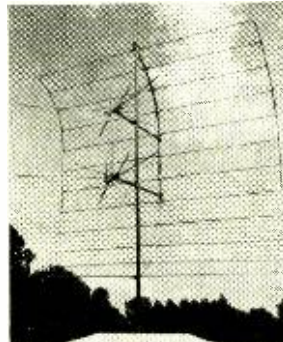

tenna is based on the radar parabolic type, and is designed for high average gain, with only one transmission line for both v.h.f. and u.h.f.

TUBE TESTER

Triplet Electrical Instrument Co., Bluffton, Ohio, has released a proportional mutual-conductance tube tester, model 3423. Tubes are tested by applying a high-frequency signal to the grid and measuring the signal component in the output by a special instrument circuit.

In the plate circuit a high-Q tuned circuit which responds only to 4 kc is used to extract the amplified signal. Tubes with widely varying characteristics can be checked without overloading or other damage to the tube because of a wide selection of tube

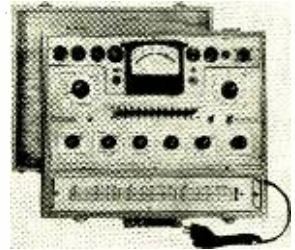

parameters. The case is wood, gray leatherette covered, and measures 1 3/4 x 1 3/4 x 8 1/2 inches.

VOLTAGE BOOSTER

Service Instruments Co., 422 So. Dearborn St., Chicago, Ill., has announced the *Up-Ten* voltage booster, which is designed to add 10 volts to the existing line voltage when used with any television set or electrical appliance, up to 300 watts.





Build your own

#630

Super Deluxe TV CHASSIS

with . . . U.H.F.

With a #630 SUPER DELUXE 31-TUBE TV KIT including your favorite U.H.F. Station • OPERATES 16" TO 24" PICTURE TUBES • Engineered in strict adherence to the genuine RCA #630 plus added features • FULL 4MC BANDWIDTH • CASCODE TUNER • COSINE DEFLECTION YOKE • LARGER POWER TRANSFORMER • KEYED AGC • 12" SPEAKER • UNIVERSAL MOUNTING BRACKETS • CONDENSERS and RESISTORS at rated capacities and tolerances. You receive a COMPLETE SET OF PARTS and TUBES, everything needed is included (less wire & solder). All I.F. Coils and Transformers are factory pre-aligned and tuned. You will enjoy building it with "LIFE-SIZE easy to follow step-by-step ASSEMBLING INSTRUCTIONS" included with each KIT. **NOTHING BETTER AT ANY PRICE!**

only . . . \$119.44

#630 SUPER DELUXE TV CHASSIS

with U.H.F.—Licensed under RCA patents

COMPLETE READY TO PLUG IN AND PLAY—Similar in characteristics and features to the TV KIT to left • Manufactured especially for us by Regal Electronics Corporation • No efforts or expense have been spared in workmanship or materials, to make this #630 SUPER DELUXE TV CHASSIS the Best obtainable for fringe areas, clarity and all-around-performance, regardless of price. Customers report reception better than 200 miles • Each Set is factory aligned and air-tested • All parts carry the RMA three month guarantee • Our mass volume of business on this CHASSIS (numbering thousands of pleased customers) now makes it possible for us to reduce the price to . . . only **\$157.97** (less CRT)

2-#630 TV SPECIALS BY TECH-MASTER

both with U.H.F.

TECH-MASTER Model C-30 TV CHASSIS, Complete Ready to Plug in and Play—The Model C-30 has retained the outstanding characteristics of the RCA-630 circuitry, namely the four-stage, full bandwidth picture IF strip and the three-stage FM sound section • In addition, the latest innovations in synchronization and sweep circuits have been incorporated to produce a custom-quality receiver assuring outstanding performance • 30 tubes, 12" speaker.

Special at **\$149.50** (less CRT)

TECH-MASTER Gold Medal Series Model 2430-9 TV CHASSIS, 90° deflection, operates all 24" or 27" rectangular and 30" round picture tubes Complete Ready to Plug in and Play—The last word in TV achievement • Ideal for wall or custom-cabinet mounting • Detailed technical data mailed on request, however with the knowledge that this CHASSIS is a 30-tube #630 with both TECH-MASTER'S and OUR guarantee, you need not hesitate sending your order in now.

Special at **\$262.50** (less CRT)

FINEST STANDARD GUARANTEED PICTURE TUBES

MOST desirable 5 sizes — ALL RECTANGULAR • • • BRAND NEW in Factory Sealed Cartons — With a Full Year Guarantee

17" #17BP4A	\$29.63	20" #20CP4A	\$39.74	21" #21EP4A	\$44.68	24" 90° #24CP4A	\$58.26	27" 90° #27NP4A	\$82.57
-------------	---------	-------------	---------	-------------	---------	-----------------	---------	-----------------	---------

HI-FI COMPONENTS

Espey Manufacturing Co., Inc., 528 E. 72 St., New York 21, N. Y., is producing a new line of AM-FM high-fidelity components. The units, known as the Trophy models, consist of model 100 AM-FM

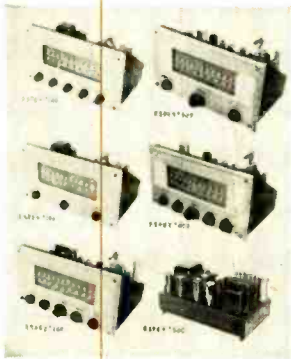

radio chassis; model 101 AM-FM tuner; model 200 AM-FM radio chassis; model 300 AM-FM tuner; model 400 AM-FM de luxe tuner; and model 500 de luxe amplifier.

ANTENNA ROTATORS

Alliance Manufacturing Co., Alliance, Ohio, has added two new Tenna-Rotators to its present line. The U-83 is fully

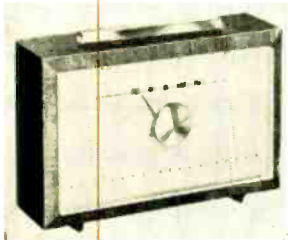

automatic, and supplies rotation to any preselected stop position. Model T-10 (control unit shown) is manually operated.

INDOOR BOWTIE

Radio Merchandise Sales, Inc., 2016 Braxdale Ave., New York 62, N. Y., has developed an indoor bowtie, model 1BT-500. The *NevoTip* is designed for u.h.f. and stands about 8 1/2 inches high in a heavy metal base.

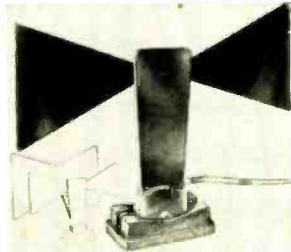

Gain is doubled by the addition of a reflector, model R-500, which plugs into the fitting at the back of the antenna.

POWER AMPLIFIER

Shields Laboratories, Inc., 315 Shields Bldg., 810 N. Lincoln Ave., Pittsburgh 12, Pa., has introduced a power amplifier, the SPA-25.

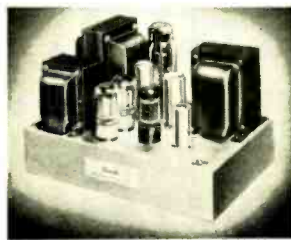

This 25-watt audio power amplifier has a frequency response of ± 1 db from 7 cycles to 100 kc. Power response is ± 1 db from 18 cycles to 40 kc. Intermodulation distortion is 0.7% at the rated output and 0.09% at the 1-watt level.

The model SPA-25 amplifier has an internal impedance of less than 1 ohm.

PEAK-TO-PEAK VTVM

Radio City Products Co., Inc., 152 W. 25th St., New York 1, N. Y., has announced a peak-to-peak v.t.v.m., model 655. This meter features peak-to-peak a.c. measurements of 0.2-4,200 volts; a.c. r.m.s. measurements of 1-1,500 volts; d.c. measurements of .02-1,500 volts; and resistance measurements of 0.2 ohm to 1,000 megohms, all on 7 ranges.



TWO AMPLIFIERS

Newcomb Audio Products Co., 6824 Lexington Ave., Hollywood 38, Calif., has two new amplifiers. The E-245 has a cellulose acetate insulated output transformer for maximum protection

against the effects of humidity. This 25-watt amplifier has a 4-channel mixer with 3 microphone inputs and a phono input. It delivers 30 watts maximum at less than 5% distortion. Frequency response is ± 2 db 40-15,000 cycles.

Model E-504 is similar, but provides 50 watts of power.

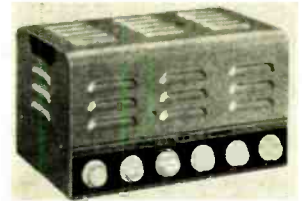

VOLTAGE CALIBRATOR

Electronic Instrument Co., Inc., 84 Withers St., Brooklyn 11, N. Y., has announced the model 495 oscilloscope voltage calibrator. The unit provides accurate peak-to-peak voltage measurement of complex waveforms required to test and align TV receivers according to manufacturer's specifications.

The calibrator has a square-wave output at power-line frequency with full-scale readings of 0.1, 1, 10, or 100 volts peak-to-peak. Amplitude is variable from zero on each range. Input is 105-125 volts a.c., 50-60 cys. Over-all dimensions are 7 7/8 x 5 x 4 1/2 inches. The 495 weighs four pounds.



CUSTOM-BUILT CABINETS FOR #630 AND ALL OTHER TV SETS — FROM FACTORY TO YOU

5 LEADING STYLES in genuine mahogany or walnut (blond 10% extra). • • • Ready drilled for any #630 TV chassis and cutout for any 14", 16", 17", 19", 20" or 21" picture tube at no extras in price. • • • Also supplied with undrilled knob panel for any other TV set. • • • EVERYTHING NECESSARY for an easy perfect assembly is included. Each cabinet is delivered complete as pictured with mask, safety glass, mounting brackets, backboard, backcup, hardware and assembling instructions. • • • Each cabinet is shipped in an air cushioned carton from FACTORY to YOU.

THE VOGUE
Most Popular
Table Model

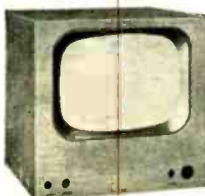

H-25", W-26", D-22"

\$39.89

The MANHATTAN
Style, Quality, Price

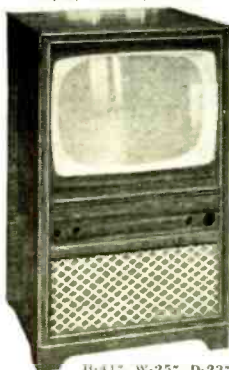

H-31", W-25", D-23"

\$59.37
MANHATTAN for 24" or 27" CRT
H-46 1/2", W-27 3/4", D-24" \$86.22

The MAYFAIR

Exquisitely modern, with an elegance of simplicity in styling.



H-40", W-26", D-25"

\$98.56

The PLYMOUTH

Choice of interior Decorators, truly superb in every detail.

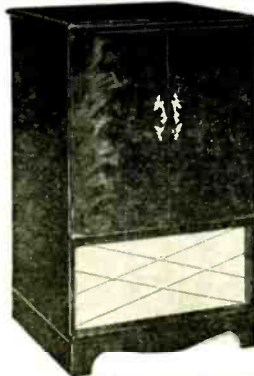

H-40", W-27", D-23"

\$105.48

The TOWN & COUNTRY

Patterned after the popular credenza. Available for all size picture tubes 14" to 27"

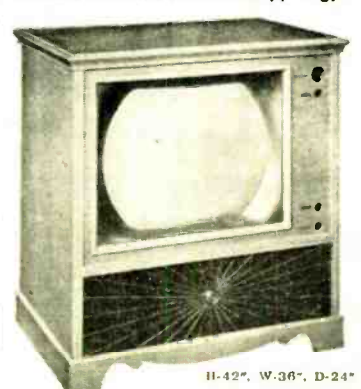

H-42", W-36", D-24"

For 14", 16", 17", 19", 20", 21", 24" or 27" C.R.T.'s **\$109.62**

#630 PARTS & COMPLETE SETS

- TV WIRE & SOLDER KIT, for any Set... \$1.49
- 630-KIT, screws, nuts, rivets, washers, etc. 1.69
- VIDEO AND I.F. KIT, 19 items 7.84
- UNIVERSAL CRT MOUNTING BRACKETS 6.97
- VARIABLE CONTROL KIT, 9 controls 5.83
- CARBON RESISTOR KIT, 107 resistors... 6.98
- WIREWOUND RESISTOR KIT, 4 resistors... 2.31
- BRACKET AND SHIELD KIT, 18 items... 8.63
- ELECTROLYTIC CONDENSER KIT, 6 cond 7.37
- TUBULAR CONDENSER KIT, 38 condensers 4.28
- CERAMIC CONDENSER KIT, 28 condensers 3.37
- MICA CONDENSER KIT, 11 condensers... 1.38

Modernize a #630 or any TV Set with a **STANDARD CASCODE TUNER** For better all around performance **\$22.49**

Complete with tubes, and Brooks CAS-CODE MANUAL with step-by-step instructions and all extra parts needed.

Brooks CASCODE MANUAL, how to install Cascode Tuner in any make TV Set. Postpaid **50¢**

PULSE KEYED AGC KIT
Finest, most accurate and the easiest Kit to install in a #630 or in any other make TV receiver. Improves performance, and insures a steady picture on all channels. **COMPLETE SET OF PARTS \$4.59**
Including 6AU6 tube & instructions

Brooks LIFE-SIZE TV Instructions, for building any #630 TV Receiver. Postpaid **\$2.49**

HINTS FOR BETTER PERFORMANCE, on your #630 TV receiver. Postpaid **\$1.00**

84 VESEY ST., Dept. A, NEW YORK 7, N. Y.

arkay

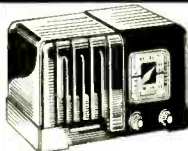

RADIO KIT

Model S-5E

5-Tube superhet designed for radio students, includes new 3d dimension instruction book in color. Covers the broadcast Band. Tubes: 12SA7, 12SK7, 12SQ7, 50L6 and 35Z5. Complete with glistening walnut bakelite cabinet.

\$14.95

3 BAND AC/DC RADIO KIT

Model P

5-Tube radio with 6" Alnico V dynamic speaker. Highly sensitive receiver including short wave bands. Frequencies: 550-1600KC, 2.3-7MC, 7MC-18. Only finest components used with specially designed tone control circuits. Tubes: 12SA7, 12SK7, 12SQ7, 50L6 and 35Z5. Handsome mottle brown bakelite plastic cabinet.

\$25.75

2-BAND, AC/DC RADIO KIT

Model T-5X

5-Tube superhet circuit that includes all advanced designs. A.V.C. extra high gain coils, 5" (12 cm) Alnico V dynamic speaker with only quality components. Easily assembled, AC/DC. Frequency range: 550-1700 kc (550-175 meters); 6-18 mc (16.6-50 meters).

\$19.95

2 SPEAKER HI-FI AUTOMATIC RECORD PLAYER KIT

Model RC3

Quality 3 speed (VM) record changer with new flipover crystal cartridge, quality dual speakers in an acoustically perfected cabinet covered in beautifully designed simulated leather; 4-tube amplifier assures realistic tone. Changer shuts off automatically after last record.

\$59.00

VACUUM TUBE VOLTMETER KIT

Model VTVM-012

Ideal kit for signal tracing, dynamic testing, where a high impedance voltmeter is required and for high resistance circuits as in TV & FM. 1% precision resistors throughout. Improved dial scale makes readings easier and more accurate. Pictorial and schematic diagrams with step-by-step instructions supplied. Finished in gray wrinkle.
Ranges: AC/DC—V, 0.3, 30, 100, 300, 1000
DC input resistance: 11 megohms
AC input impedance: 6.5 megohms
Ohmmeter: 0-1000, 100,000, 1 meg, 10 megs, 100 megs

\$23.95

Write for new catalog of the complete ARKAY line of radio, TV, phonograph and test equipment kits.

world's finest radio kits

arkay
RADIO KITS, INC.

120 Cedar St.,
New York 6,
N.Y.



PORTABLE RADIO KIT AC/DC BATTERIES

Model 2X3W4

3-Way portable for simple construction; including 4" Alnico V permanent speaker, built-in loop antenna, hi-gain coils throughout. Unusual, attractive leatherette cabinet with a semi-airplane dial covering half the cabinet.

\$19.95 Net

Same as above in 2 bands



5-TUBE AC/DC RADIO KIT

Model Q5

5-Tube radio with 5" Alnico V speaker, precision engineered. 550 kc to 1700 kc. Smart, conservative cabinet design in glistening mottle brown bakelite. Features new, magic-glow lucite dial with hidden pilot light that makes dial glow when set is turned on.

\$16.95



3-SPEED RECORD PLAYER KIT

Model RP-2
Phonograph that plays 33 $\frac{1}{3}$, 45 & 78 RPM records of all sizes. Includes self-contained amplifier and powerful speaker; housed in smart luggage-type simulated leatherette case. AC.

\$18.95



HI-FI AUDIO AMPLIFIER KIT

Model A10

10 Watt high-fidelity amplifier. Separate tone controls for bass and treble through inverse feedback circuit; 10 watt output or 32 db. less than 3% distortion; frequency response: \pm 1 db from 20 to 20,000 cps. Tone controls produce max. bass boost \pm 8 db @ 100 cps. Treble controls produce max. treble boost \pm 10 db @ 10,000 cps. Hum: 70 db below rated output.

\$21.95

kits

NEW DEVICES

VOLTAGE ADJUSTER

P. R. Mallory & Co., Inc., 3029 E. Washington St., Indianapolis 6, Ind., has announced a line-voltage adjuster and isolation transformer, type LVA2. Completely enclosed in an enameled metal case, the LVA2 provides infinitely variable a.c.-line adjustment from 90 to 130 volts at 1200 watts; infinitely variable low voltage from 0 to 40



volts a.c. at 4 amp in the isolation position, or 0 to 40 volts a.c. at 8 amp in the common line position; and an isolated, infinitely variable 90- to 130-volt a.c. output at 350 watts. The LVA2 case dimensions are 7 $\frac{1}{8}$ -inches high x 5 $\frac{3}{4}$ -inches deep x 6 $\frac{1}{2}$ -inches wide. It is supplied complete with a 6-foot, rubber-covered line cord, and has been designed to operate from a line voltage of 115 volts \pm 10 volts, 60 cycles, single phase.

UHF-VHF ANTENNA

Falcon Electronics Co., 2003 Cedar St., Quincy, Ill., has announced the Vari-Con, an all-channel antenna peaked for top performance on any channel range. Element heads are coupled to a

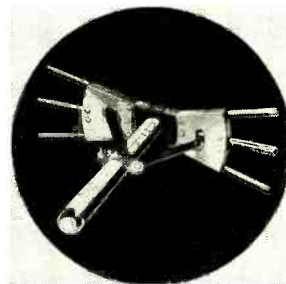

sliding sleeve on the boom, and the sleeve is moved to the calibration mark corresponding to the channel peaking desired.

TAPE RECORDER

TapeMaster, Inc., 13 W. Hubbard St., Chicago 10, Ill., has developed a professional tape recorder obtainable at moderate cost. The model HF-500 has an internal amplifier and 6-inch extended range speaker, but can be switched to external amplifier and speaker.

The unit is single-speed (7.5 i.p.s.). There are inputs for microphone and radio-phonograph. Brush professional

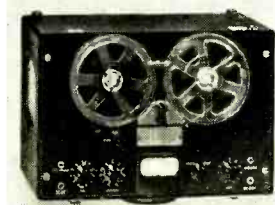

head is used. Power output is 2 watts. The recorder operates on 105-125 volts, 60 cycles a.c. It comes in a leatherette carrying case, and measures 19 $\frac{3}{4}$ x 8 $\frac{3}{4}$ x 13 inches.

All specifications given on these pages are from manufacturers' data.

For the very best yet in



- science fiction stories
- articles
- features
- illustrations

READ SCIENCE-FICTION PLUS

December issue Now on sale!

Read the exciting and stimulating stories of science-fiction masters like Harry Bates, Murray Leinster, Eric Frank Russell and many, many others. Ponder over the challenging article "Extra-Terrestrial Communication" by Leslie R. Shepherd. See the finest science illustrations published anywhere, by such top flight artists as Frank R. Paul, Virgil Finlay and Lawrence.

On sale at all better newsstands, 35¢.

Now...another **PR**

JAN TYPE

1N34A

GERMANIUM
DIODE FOR
MILITARY USE

with the PLUS factor of
polarity at a glance or touch

To the list of Radio Receptor diodes that can be designated JAN type comes another important model—1N34A. Built to the high standards of this designation, 1N34A as well as all Radio Receptor diodes gives you simplified polarity identification. The tapered case speeds up assembly, reduces possibility of error in connecting the diodes into the circuit, which all adds up to lowered production costs.

These JAN type diodes | 1N69 1N70 1N81
now available for | and now 1N34A
prompt delivery

Many other types of diodes are available too, including a range of computer diodes made to meet special requirements. Radio Receptor also makes Germanium Transistors and SELETRON Selenium Rectifiers. Our engineers will gladly study your problems without obligation and submit their recommendations.



Seleton and Germanium Division
RADIO RECEPTOR COMPANY, INC.

Since 1922 in Radio and Electronics
SALES DEPT.: 251 West 19th Street, New York 11, N. Y.
FACTORIES IN BROOKLYN, N. Y.

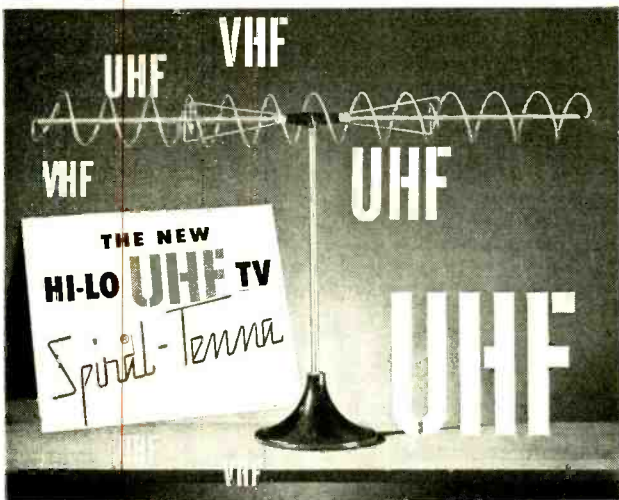

Peak Performance for Indoor UHF and VHF Television Reception

Now—the nationally advertised, consumer accepted HI-LO TV Indoor Spiral-Tenna is applicable for both VHF and UHF with our exclusive UHF antenna adapter from channels 2-83. But, you still get the volume by selling at the same low, low price.

The Hi-Lo UHF antenna adapter is available separately for all previous HI-LO antennas. List Price \$2.00.

at the same low list price!

U. S. Patent No. 2,495,579 Canadian patents 1951 — other patents pending

ORDER HI-LO UHF-VHF TV Spiral-Tenna TODAY!

Hi-Lo TV ANTENNA CORP.
1540 N. Ravenswood • Chicago 13, Illinois

\$9.95
LIST PRICE

BUILD 15 RADIOS ONLY AT HOME \$19.95
With the New Improved 1954

Progressive Radio "EDU-KIT"

NOW INCLUDES
SIGNAL TRACER and CODE OSCILLATOR



- FREE TOOLS WITH KIT
- ABSOLUTELY NO KNOWLEDGE OF RADIO NECESSARY
- NO ADDITIONAL PARTS NEEDED
- EXCELLENT BACKGROUND FOR TV
- 10 DAY MONEY-BACK GUARANTEE

WHAT THE PROGRESSIVE RADIO "EDU-KIT" OFFERS YOU

The Progressive Radio "Edu-Kit" offers you a home study course at a rock bottom price. Our Kit is designed to train Radio Technicians, with the basic facts of Radio Theory and Construction Practice expressed simply and clearly. You will gain a knowledge of basic Radio Principles involved in Radio Reception, Radio Transmission and Audio Amplification. You will learn how to identify Radio Symbols and Diagrams; how to build radios, using regular radio circuit schematics; how to mount various radio parts; how to wire and solder in a professional manner. You will learn how to operate Receivers, Transmitters, and Audio Amplifiers. You will learn how to service and trouble-shoot radios. You will learn code. You will receive training for F.C.C. license. In brief, you will receive a basic education in Radio exactly like the kind you would expect to receive in a Radio Course costing several hundreds of dollars.

THE KIT FOR EVERYONE

The Progressive Radio "Edu-Kit" was specifically prepared for any person who has a desire to learn Radio. The Kit has been used successfully by young and old in all parts of the world. It is not necessary that you have even the slightest background in science or radio. The Progressive Radio "Edu-Kit" is used by many Radio Schools and Clubs in this country and abroad. It is used by the Veterans Administration for Vocational Guidance and Training. The Progressive Radio "Edu-Kit" requires no instructor. All instructions are included. All parts are individually boxed, and identified by name, photograph and diagram. Every step involved in building these sets is carefully explained. You cannot make a mistake.

PROGRESSIVE TEACHING METHOD

The Progressive Radio "Edu-Kit" comes complete with instructions. These instructions are arranged in a clear, simple and progressive manner. The theory of Radio Transmission, Radio Reception, Audio Amplification and servicing by Signal Tracing is clearly explained. Every part is identified by photograph and diagram. You will learn the function and theory of every part used. Therefore you will build radios to illustrate the principles which you learn. These radios are designed in a modern manner, according to the best principles of present-day educational practice. You begin by building a simple radio. The next set that you build is slightly more advanced. Gradually, in a progressive manner, you will find yourself constructing still more advanced radio sets, and doing work like a professional Radio Technician. Altogether you will build fifteen radios, including Receivers, Transmitters, Amplifiers, Code Oscillator and Signal Tracer. These sets operate on 105-125 V. AC/DC.

THE PROGRESSIVE RADIO "EDU-KIT" IS COMPLETE

You will receive every part necessary to build 15 different radio sets. Our kits contain tubes, tube sockets, chassis, variable condensers, electrolytic condensers, mica condensers, paper condensers, resistors, line cords, selenium rectifiers, tie strips, coils, hardware, tubing, hook-up wire, solder, etc. Every part that you need is included. These parts are individually packaged, so that you can easily identify every item. Tools are included, as well as an Electrical and Radio Tester. Complete, easy-to-follow instructions are provided. In addition, the "Edu-Kit" now contains lessons for servicing with the Progressive Signal Tracer, F.C.C. instructions, quizzes. The "Edu-Kit" is a complete radio course, down to the smallest detail.

TROUBLE-SHOOTING LESSONS

Trouble-shooting and servicing are included. You will be taught to recognize and repair trouble. You will build and learn to operate professional Signal Tracer. You receive an Electrical and Radio Tester, and learn to use it for radio repairs. While you are learning in this practical way, you will be able to do many a repair job for your neighbors and friends, and charge fees which will far exceed the cost of the "Edu-Kit". Here is your opportunity to learn radio quickly and easily, and have others pay for it. Our Consultation Service will help you with any technical problems which you may have.

FREE EXTRAS

- ELECTRICAL AND RADIO TESTER • ELECTRIC SOLDERING IRON • BOOK ON TELEVISION • RADIO TROUBLE-SHOOTING GUIDE • MEMBERSHIP IN RADIO-TELEVISION CLUB • CONSULTATION SERVICE • QUIZZES • TRAINING FOR F.C.C. LICENSE

Send me the "Edu-Kit" with 10 Day Money-Back Guarantee—include All FREE extras. Send further information.

Check or M.O. enclosed—postage prepaid C.O.D. (U. S. Only)—I will pay postage

NAME _____

ADDRESS _____

Outside U.S.A.—no C.O.D.'s; send check on U.S. bank or international M.O. for \$19.95. Postage prepaid. "Edu-Kit" for 210-250 V. AC/DC \$22.45.

PROGRESSIVE ELECTRONICS CO.

497 UNION AVE., Dept. RE-77, Brooklyn 11, N. Y.



70% to 90% off list! TOP TUBE BUYS

All Tubes Individually Boxed! Same Day Service!
Check this list for Fully 1-Year Guaranteed Tubes.

Type	Price	Type	Price	Type	Price	Type	Price	Type	Price
1A5GT	.30	6A4F	.90	6H6GT	.41	7X7	.70	25AV5	.83
1A7GT	.47	6AG5	.48	6J5GT	.37	12A8	.61	280Q6GT	.62
1AX2	.68	6AM4	.57	6J6	.52	12A15	.37	26L6GT	.39
1B3	.65	6AJ5	.65	6J7G	.43	12AT6	.37	26	.45
1B7GT	.30	6AK5	.55	6K5	.47	12AT7	.56	27	.39
1C5GT	.43	6AL5	.38	6K6GT	.37	12AU6	.38	32L7	.89
1E7	.29	6A05	.39	6K7	.44	12AU7	.43	35	.58
1G4GT	.24	6A06	.37	6L6	.64	12AV6	.39	35B5	.40
1G6	.30	6AR5	.37	6Q7	.45	12AV7	.59	35C5	.39
1H4G	.30	6A55	.50	6S4	.38	12AX4	.48	35L6GT	.41
1HSGT	.40	6AT6	.37	6S8	.53	12AX7	.48	35W4	.37
1J6	.24	6AU4	.68	6SA7GT	.43	12AV7	.95	35Z4	.39
1L4	.46	6AUG	.38	6SD7GT	.41	12BA6	.38	35Z5GT	.39
1N5	.46	6AV5	.83	6SF5GT	.46	12BA7	.60	36	.60
1P5	.57	6AV6	.37	6SG7GT	.41	12BD6	.45	41	.42
1Q5	.58	6AX4	.53	6SH7	.73	12BE6	.39	42	.42
1R5	.45	6AX6G	.24	6SJ7GT	.41	12BF6	.39	43	.55
1S5	.41	6B4G	.45	6SK7GT	.41	12BH7	.63	45	.55
1T4	.45	6BA6	.39	6SL7GT	.48	12BY7	.65	45Z3	.44
1T5	.53	6BA7	.57	6SN7GT	.52	12BZ7	.65	45Z5	.49
1U4	.45	6BC5	.49	6SQ7GT	.37	12C8	.34	50B5	.39
1U5	.60	6BD5GT	.59	6SR7GT	.45	12J5GT	.42	50C5	.39
1V	.39	6BD6	.45	6S57	.42	12J7GT	.34	50L6GT	.51
1X2A	.63	6BE6	.39	6T4	1.05	12SB	.70	50Y7	.50
2A3	.30	6BF5	.41	6T8	.56	12SA7GT	.55	53	.24
2A4G	.24	6BF6	.37	6U4	.60	12SF5	.50	56	.24
2W3	.38	6BG6G	1.25	6U5	.44	12SG7GT	.52	57	.58
2X2	.59	6BH6	.46	6U6	.63	12SK7GT	.53	58	.60
3A4	.45	6B16	.39	6U8	.61	12SL7GT	.47	70L7GT	1.09
3E5	.46	6B06GT	.69	6V6GT	.39	12SN7GT	.52	71A	.60
3Q4	.48	6BQ7A	.95	6W4GT	.44	12SQ7	.46	76	.44
3Q5GT	.49	6BZ7	.95	6W6GT	.44	12SR7	.49	77	.57
3S4	.46	6C4	.37	6X4	.37	12V6GT	.46	78	.47
3V4	.47	6C5GT	.39	6X5GT	.37	14J7	.30	80	.35
5U4G	.50	6C6	.58	6X8	.75	14A7	.44	83V	.68
5W4	.50	6C86	.44	6Y6G	.48	14W7	.30	85	.59
5Y3G	.32	6CD6G	1.11	7A4	.47	14H7	.44	117L7	.99
5Y3GT	.32	6D6	.45	7AF7	.53	198GGG	.95	117Z3	.37
5Z3	.46	6E5	.48	7B4	.44	19C8	.70	807	1.19
6A7	.59	6FSGT	.39	7C6	.40	19T8	.79	1274	.30
6A8	.62	6F6	.37	7E6	.30	19B8	.89	2050	.89
6AB4	.44	6G6G	.52	7N7	.46	24A	.63		

NOW! RAD-TEL PARTS AT BIG SAVINGS!

Here's your big opportunity to save as never before on parts you need now. Look at the savings.



NATIONAL TURRET TV BOOSTER
Brand New Factory Boxed
Model TVB-20
\$995

ARMY-NAVY HEADSETS
Individually Boxed Very sensitive Meets both Army and Navy specifications
List \$16.00
\$2.95 each per set



12" Magnavox P.M. SPEAKER
Heavy Magnet
List \$11.50
\$595

5" UTAH AUTO SPEAKER
3-4 Ohm V.C. - 4 Ohm Field
List \$5.05
79c

4 X 6 INCH WELL-KNOWN P.M. SPEAKER
Lowest Price Oval Speaker
Alnico 5 Field
List Price \$4.75
\$195

RAD-TEL SUPER BUY! RESISTORS
200 TO PKG.

Standard RIMA Coded or Value Printed, Uninsulated, 1/2 Watt, 1 Watt, 2 Watt and some 10 Watt

ASSORTMENT OF 200 for \$139



70° YOKE (Mfg. by Todd)
List \$7.50 **\$195**



RCA TYPE FLYBACK TRANSFORMER
Type 215T1 **95c**



FILTER CONDENSERS KITS* 150 V
*(10 to a pkg., minimum)
20-20 **\$2.95**
40-40 **\$3.25**
50-30 **\$3.25**

DRY ELECTROLYTIC CAPACITOR
10 MFD 50J WV 600 Peak
Box of ten (10) **\$2.95**

HI-VOLTAGE CERAMIC CONDENSERS
500 mmlid 10 KV **39c ea.**
500 mmlid 15 KV **49c ea.**
500 mmlid 20 KV **49c ea.**

VERTICAL OUTPUT TRANSFORMER
10-1 Ratio RCA Type
List \$4.50 **95c**

100 INSULATED RESISTORS Box of 100
50 1/2 & 1/2 Watt, 25 1 Watt, 25 2 Watt **\$265**

50 ASSORTED MICAS Box of 50
Regular & Silver Type **\$195**

ANODE CAP List \$.75 **19c each**

TERMS A 25% deposit must accompany all orders—balance C.O.D. All shipments F.O.B. Irvington warehouse. Orders under \$10—\$1.00 Handling Charge. Subject to prior sale.

RAD-TEL TUBE CO.

"Integrity is Our Chief Asset"
Phone: Essex 5-2947 115 Coit Street
Dept. RE-11 Irvington 11, N.J.

NEW PATENTS

PHOTOTRANSISTOR CONTROL UNIT

Patent No. 2,641,712

Reymond J. Kircher, Summit, N. J.

(Assigned to Bell Telephone Laboratories, Inc.)

When light falls on a junction-type germanium transistor, a voltage is generated between the ends of that crystal. Current will flow through a load without the need of a power supply. Output varies with the intensity of the light. It also depends upon the spot on which the light falls. Output is maximum if light is focused on the junction between N-type and P-type germanium. Fig. 1 shows how output varies with distance from a junction.

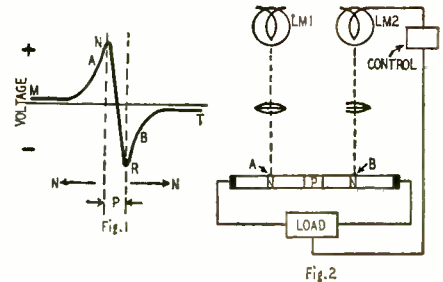

Fig. 2 shows one application of this invention. Beams from lamps LM1, LM2 are focused on the crystal. LM1 may be a standard lamp with fixed intensity; the intensity of LM2 is variable. The lamps illuminate points A and B, which are equidistant from the junctions. When the lamps are equally brilliant, they generate equal and opposite voltages (see Fig. 2). No current flows through the load. If LM2 grows dimmer, the net output from the crystal will be positive; more light from LM2 will cause a net voltage that is negative.

Part of the output voltage is fed to a control unit. This increases the illumination from LM2 when the load voltage is positive. When the output is negative, LM2 is decreased. Thus the circuit tends to maintain the lamps equally brilliant.

The combination used in Fig. 2 may be used in photographic exposure control processes, in stage light intensity control systems and in infra-red baking processes. It may be used also in translating or transcribing systems for coding, decoding, and information blending systems.

One general object of this invention is to improve the performance characteristics of semiconductor photosensitive devices, and to expedite the realization of relatively large responses from photosensitive semi-conductor devices.

TRANSISTOR MODULATOR

Patent No. 2,644,925

Leslie L. Koros, Camden, N. J.

(Assigned to Radio Corp. of America)

Transistors can replace vacuum tubes in many types of circuits. Generally, the circuit needs some sort of modification because transistors need different supply voltages, impedance matching, and circuitry. This modulator uses a transistor instead of a tube, but must be redesigned to take into account leakage from emitter to collector. There is no corresponding leakage between elements of a tube.

The modulator is shown in the figure. A high-frequency carrier is impressed between emitter and ground. Rectified current through this circuit flows through R to generate bias for the emitter. An a.f. signal feeds the collector and modulates the carrier.

Ohmic leakage causes a carrier component to

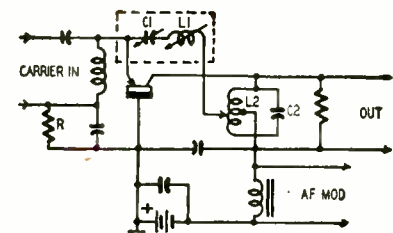

Buy on our radically new

NO INTEREST!! **Time Payment Plan** **NO CARRYING CHARGES!!**



Measures 6 1/4" x 9 1/2" x 4 1/2"

Superior's new
Model 670-A **SUPER METER**

A COMBINATION VOLT-OHM MILLIAMMETER PLUS
CAPACITY REACTANCE INDUCTANCE AND DECIBEL MEASUREMENTS

SPECIFICATIONS:

- D.C. VOLTS: 0 to 7.5/15/75/150/750/1,500/7,500 Volts
- A.C. VOLTS: 0 to 15/30/150/300/1,500/3,000 Volts
- OUTPUT VOLTS: 0 to 15/30/150/300/1,500/3,000 Volts
- D.C. CURRENT: 0 to 1.5/15/150 Ma. 0 to 1.5/15 Amperes
- RESISTANCE: 0 to 1,000/100,000 Ohms 0 to 10 Megohms
- CAPACITY: .001 to 1 Mfd. 1 to 50 Mfd. (Quality test for electrolytics)
- REACTANCE: 50 to 2,500 Ohms 2,500 Ohms to 2.5 Megohms
- INDUCTANCE: .15 to 7 Henries 7 to 7,000 Henries
- DECIBELS: -6 to +18 +14 to +38 +34 to +58

ADDED FEATURE:

The Model 670-A includes a special **GOOD-BAD** scale for checking the quality of electrolytic condensers at a test potential of 150 Volts.

The Model 670-A comes housed in a rugged, crackle-finished steel cabinet complete with test leads and operating instructions.

\$28⁴⁰
NET



Superior's new
Model TV-11 **TUBE TESTER**

SPECIFICATIONS:

- ★ Tests all tubes including 4, 5, 6, 7, Octal, Lock-in, Peanut, Bantam, Hearing Aid, Thyatron, Miniatures, Sub-miniatures, Novals, Sub-minars, Proximity fuse types, etc.
- ★ Uses the new self-cleaning Lever Action Switches for individual element testing. Because all elements are numbered according to pin-number in the RMA base numbering system, the user can instantly identify which element is under test. Tubes having tapped filaments and tubes with filaments terminating in more than one pin are truly tested with the Model TV-11 as any of the pins may be placed in the neutral position when necessary.
- ★ The Model TV-11 does not use any combination type sockets. Instead individual sockets are used for each type of tube. Thus it is impossible

- to damage a tube by inserting it in the wrong socket.
- ★ Free-moving built-in roll chart provides complete data for all tubes.
- ★ Newly designed Line Voltage Control compensates for variation of any Line Voltage between 105 Volts and 130 Volts.
- ★ **NOISE TEST:** Phono-jack on front panel for plugging in either phones or external amplifier will detect microphonic tubes or noise due to faulty elements and loose internal connections.

The model TV-11 operates on 105-130 Volt 60 Cycles A.C. Comes housed in a beautiful hand-rubbed oak cabinet complete with portable cover

\$47⁵⁰
NET

EXTRA SERVICE — The Model TV-11 may be used as an extremely sensitive Condenser Leakage Checker. A relaxation type oscillator incorporated in this model will detect leakages even when the frequency is one per minute.

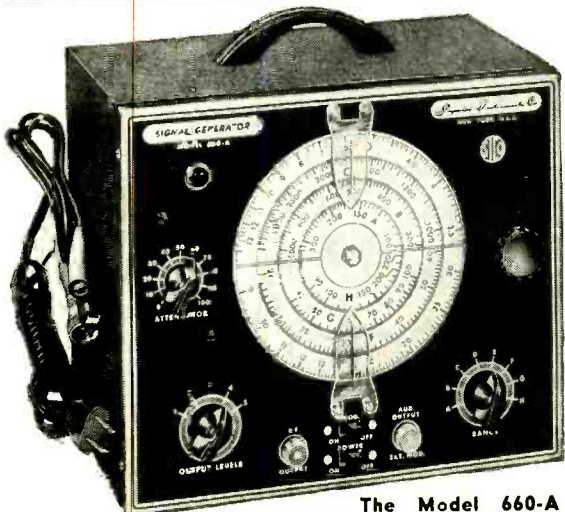

Superior's New Model 660-A AN AC OPERATED
SIGNAL GENERATOR

PROVIDES COMPLETE COVERAGE for AM-FM & TV Alignment

SPECIFICATIONS:

- Generates Radio Frequencies from 100 Kilocycles to 60 Megacycles on fundamentals and from 60 Megacycles to 220 Megacycles on powerful harmonics.
- Accuracy and Stability are assured by the use of permeability trimmed Hi-Q coils.
- R.F. available separately or modulated by the internal audio oscillator.
- Built in 400 cycle sine wave audio oscillator used to modulate the R.F. signal also available separately for audio testing of receivers, amplifiers, hard of hearing aids, etc.
- R.F. Oscillator Circuit: A high transconductance hep-

toide is used as an R.F. oscillator, mixer and amplifier. Modulation is effected by electron coupling in the mixer section thus isolating the oscillator from load changes and affording high stability.

- A.F. Oscillator Circuit: A high transconductance heptode connected as a high-mu triode is used as an audio oscillator in a High-C Colpitts Circuit. The output (over 1 Volt) is nearly pure sine wave.
- Attenuator: A 5 step ladder type of attenuator is used.

Tubes used: 1—6BE6 as R.F. Oscillator, mixer and amplifier. 1—6BE6 as Audio Oscillator. 1—6H6 as Power Rectifier.

\$42⁹⁵
NET

The Model 660-A comes complete with coaxial cable test lead and instructions.

MOSS ELECTRONIC DISTRIBUTING CO., INC.
Dept. B-83, 38 Murray Street, New York 7, N. Y.

Please send me the units checked. I am enclosing the down payment with order and agree to pay the monthly balance as shown. It is understood there will be no carrying, interest or any other charges, provided I send my monthly payments when due. It is further understood that should I fail to make payment when due, the full unpaid balance shall become immediately due and payable.

Name.....
Address.....
City..... Zone..... State.....

- MODEL 670-A** Total Price \$28.40
\$7.40 down payment. Balance \$3.50
monthly for 6 months.
- MODEL TV-11** Total Price \$47.50
\$11.50 down payment. Balance \$6.00
monthly for 6 months.
- MODEL 660-A** Total Price \$42.95
\$12.95 down payment. Balance \$5.00
monthly for 6 months.
- I enclose \$..... as down payment.
- Ship C.O.D. for the down payment.

Eliminate major mechanical changes



with TRIAD TRANSFORMERS

Triad doesn't expect a serviceman to reconstruct or re-engineer a television chassis to accommodate a replacement part.

For that reason every Triad television component is circuit tested.

As an example,

Triad's R-BS Series Power Transformers,

listed below, are tube socket types for use where rectifier tube is mounted directly on the transformer.

They are made for under-chassis or top-chassis mounting and are exact replacements for many popular chassis.

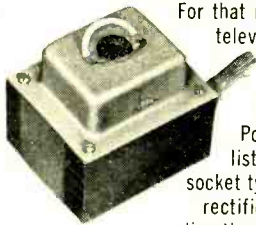

Type No.	Plate Supply		Filaments—Volts and Amperes	
	AC Volts	DC Ma		
R-47BS*	725 V C.T.	225	5V—3A	6.3V—10A, 6.3V—2.7A
Tube socket type: wired for 5U4G and designed to deliver 360 V into 80 m f d condenser; low capacity damper tube winding.				
R-48BS*	750 V C.T.	180	5V—3A	6.3V—9A, 6.3V—2.7A
Tube socket type: wired for 5U4G and designed to deliver 375 V into 80 m f d condenser; low capacity damper tube winding.				
R-49BS*	650 V C.T.	240	5V—3A	6.3V—8A, 6.3V—9A, 6.3V—1.2A
Tube socket type: wired for 5U4G and designed to deliver 325 V into 80 m f d condenser; low capacity damper tube winding.				

*B means Horizontal Mount; S, Socket Type

Triad Television Components will simplify and speed your service work. See your jobber for Triad Television Components, catalogs and replacements guides, or

Write for Catalogs TR-53B and TV-53B



arrive at the collector out of phase with the desired amplified signal. To cancel this phase distortion, part of the carrier input is fed directly through network L1-C1 to the L-C tank L2-C2. Complete cancellation is effected by tuning L1-C1 and choosing the correct tap-point on L2.

SEMICONDUCTOR PHOTOCCELL

Patent No. 2,641,713

John N. Shive, Plainfield, N. J.
(Assigned to Bell Telephone Labs., Inc.)

When light strikes germanium, charges are liberated within the crystal. Normally a single electron and one positive charge are released for each photon absorbed. Due to current multiplication, a transistor greatly increases this effect. This invention discloses methods of obtaining maximum efficiency from a phototransistor. A junction-type crystal of this type can release as many as 100 electrons for each photon absorbed.

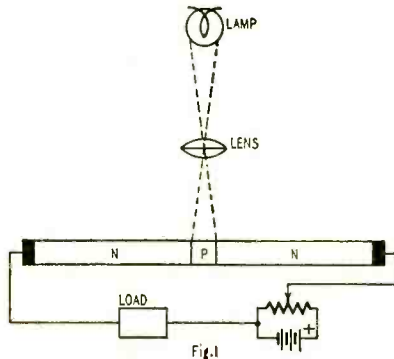
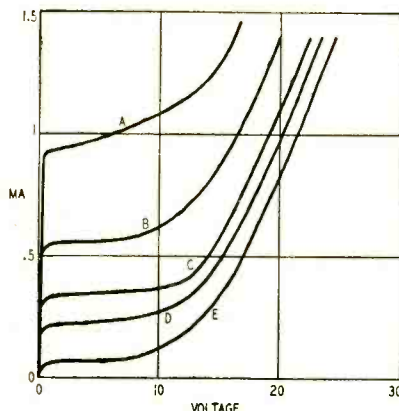

Fig. 1—Bias is in series with load.

Fig. 1 shows an NPN-type crystal with a bias supply in series with a load. Light is focused on or near its P region. This decreases the impedance of the crystal and permits more current to flow through the load.



A=180FC; B=98FC; C=45FC; D=ROOM LIGHT; E=DARK

Fig. 2—Output is in foot-candles.

For maximum efficiency, the germanium must be specially treated to reduce the rate at which charges recombine with it. The P zone must be very thin (a few tenths of a millimeter). The N zones, particularly the emitter, must have low resistivity.

Fig. 2 shows various outputs for different light intensities in foot-candles. The light source is a tungsten lamp. The load is 4,000 ohms.

PULSE MODULATOR SWITCH

Patent No. 2,633,528

Leroy S. Hutson, Bronx, N. Y.
(Assigned to United States of America as represented by the Secretary of the Army)

This invention uses tubes in a modulating switch circuit. It can turn a high-power transmitter on and off at a rapid rate. Such a switch is needed to generate radar pulses, for example.

Negative pulses are fed to an inverter which excites the triode grids in opposite phase. At the instant shown, V1 receives a positive pulse, V2 a

NEW FEATURES MAKE PHOTOFACT more useful than ever for faster, more profitable servicing

Alignment Frequencies
right on photos adjacent to adjustment number—to speed up adjustment.

Voltages on Schematics
to help speed voltage analysis for quick location of trouble.

Waveforms on Schematics
reproduced right on the diagram at vital points for rapid analysis by 'scope.

Series Filament Schematic
for quick reference when receiver employs series or series-parallel combination filament string.

Blank Pin or Locating Key
shown on each tube in placement chart (top view) to aid in substituting and replacing tubes without chassis removal.

NEW "EXTRAS"

- Tube types on chassis top photo views
- Tube failure check chart in TV Folders
- Fuse location on tube placement chart
- TV Trouble-Shooting Aids Chart
- Tips on TV servicing in the field
- Color code on transformer lead

NOW! GET THE PROOF FOR YOURSELF!

FREE We'll send you a Free Photofact Folder on any receiver covered in Sets No. 101 and following

Learn for yourself—at our expense—how PHOTOFACT pays for itself by earning bigger profits for you! Select any Folder appearing in PHOTOFACT Sets Nos. 101 and following, from the PF Index. (If you haven't a copy, see your distributor.) When you write for your Free Folder, be sure to state Photofact Set and Folder Number as shown in the Index (offer limited to Folders in sets subsequent to No. 101). Get your Free Folder now. Examine, use, compare—see why PHOTOFACT belongs in your shop!

HOWARD W. SAMS & CO., INC.
2205 E. 46th St., Indianapolis 5, Ind.

HOWARD W. SAMS & CO., INC.

FREE! A FAMOUS CBS-HYTRON Soldering Aid to every contestant in this, your **CBS-HYTRON SOLDERING AID** BIG *Certified* QUALITY SERVICE CONTEST!



FIRST PRIZE
... FORD
PANEL TRUCK
(painted with your name and address and delivered to your door)

9 Other BIG Prizes!

- Second Prize: \$1000 in Savings Bonds
- Third prize: 600 in Savings Bonds
- Fourth prize: 500 in Savings Bonds
- Fifth prize: 400 in Savings Bonds
- Sixth prize: 300 in Savings Bonds
- Seventh prize: 200 in Savings Bonds
- Eighth prize: 100 in Savings Bonds
- Ninth prize: 50 in Savings Bonds
- Tenth prize: 25 in Savings Bonds

Get an ENTRY BLANK with the EASY CONTEST RULES from your CBS-HYTRON DISTRIBUTOR

On this entry blank, complete in 25 additional words or less: "I like the CBS-Hytron *Certified* Quality Service plan because . . ." Sign your name, then *print* your name and address below your signature. Ask your Distributor's Salesman or Counterman to help you. *Be sure to print his name and company on line indicated.* (If you win, he wins.) Mail to CBS-Hytron, Dept. (A), A Division of Columbia Broadcasting System, Inc., Danvers, Massachusetts.

FACTS ABOUT YOUR *Certified* QUALITY SERVICE Plan

If you could advertise nationally, chances are you'd do just what CBS-Hytron is doing for you. You'd tell the world in LIFE and the POST that you promise quality TV and Radio service, parts, and tubes . . . and at fair charges. And that's just what CBS-Hytron is doing for you with advertisements that sell you as a *Certified* Quality Service dealer . . . a dealer in whom the public can have confidence.

You'd identify your service repair shop as the one people are reading about in the magazines.

You'd use a *Certified* Quality Service decalcomania on your door. You'd use a *Certified* Quality Service window streamer and the big LIFE and POST easel display blow-up. Above all you'd use *Certified* Quality Service tags that tell your customer he is getting more for his money when he

calls your service repair shop . . . because you *Certify* the quality of service, parts, and tubes . . . and at fair charges.

Yes, by using all this material, and more to come, you cash in on your big *Certified* Quality Service advertising campaign. Get your kit. It contains all the material you need to identify you as a *Certified* Quality Service dealer. Ask your CBS-Hytron distributor for special deal.

To be eligible for Contest prizes, you must be actively participating as a *Certified* Quality Service dealer by using the CBS-Hytron *Certified* Quality Service Promotion Kit; including tags, decalcomania, window streamer, and easel display blow-up. Awards will not be made to any dealer or serviceman not participating by December 15, 1953.

GET YOUR KIT AND CONTEST ENTRY BLANK TODAY! ASK YOUR DISTRIBUTOR . . . OR MAIL COUPON,

BUT DO IT NOW!

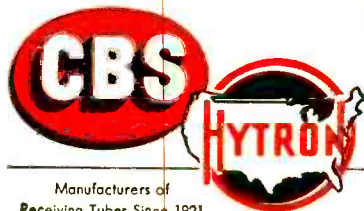

Manufacturers of Receiving Tubes Since 1921



CBS-HYTRON, Danvers, Massachusetts
A Division of Columbia Broadcasting System, Inc.

A member of the CBS family . . . CBS Radio • CBS Television • Columbia Records, Inc. CBS Laboratories • CBS-Columbia, Inc. • and CBS-Hytron

CBS-HYTRON, Danvers, Mass.

Please rush me the *Certified* Quality Service promotion kit, containing:

1. 18- by 28-inch LIFE and POST easel display . . .
2. New *Certified* Quality Service decal . . .
3. 8- by 23-inch window streamer . . .
4. AND 250 *Certified* Quality Service tags imprinted with MY name and address.

HERE IS MY 3-LINE IMPRINT:

Name _____ (please print)

Street _____

City _____ State _____

I enclose \$2.00 to cover the cost of imprinting.

Signed: _____

P.S. Please send me also entry blank with easy Contest rules.



LOOK at these LOW PRICES

THEN COMPARE
WITH ANY AERIALS
... ANYWHERE!

RADELCO BAR-X DIPOLE

with the exclusive
HIGH CHANNEL
DIRECTOR BAR

Definitely improves performance on high channels. Heavy duty construction thru-out. All boom fittings are pre-assembled.

SINGLE STACK
Model RS-751
List Price \$7.45

DOUBLE STACK
Model RS-752
List Price \$15.75

QUAD STACK
Model RS-754
List Price \$35.00

\$745
LIST PRICE
Model RS-751
Single Stack

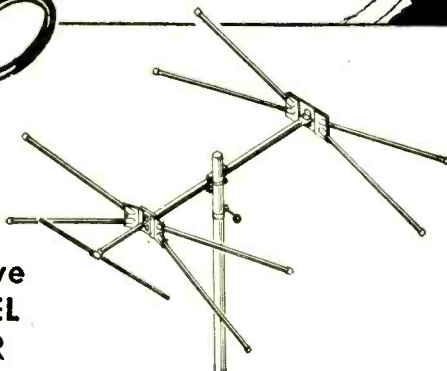

RADELCO 5 ELEMENT YAGI

Ideal for Extreme Fringe Areas

• Aluminum elements pre-assembled on a 1" steel boom. U-bolt mounting assembly accommodates up to 1 1/2" mast. Exact 300-ohm impedance. Fittings and brackets of heavy gauge steel with thick zinc plating.

Model	Chan.	List	Model	Chan.	List
YS-502	2	\$12.00	YS-506	6	\$9.25
YS-503	3	11.35	YS-507		7.00
YS-504	4	10.65	thru		
YS-505	5	10.00	YS-513		7.00

AS LOW AS
\$700
LIST PRICE
Models YS-507
thru YS-513

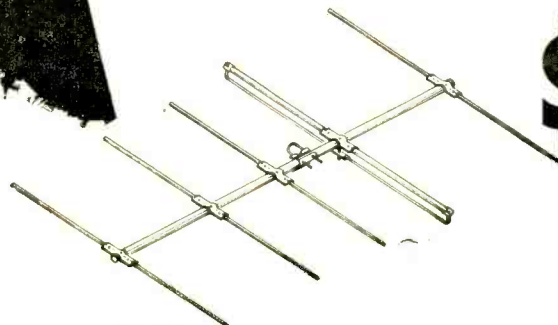

7580 GARFIELD BLVD.
CLEVELAND 25, OHIO

negative pulse. Under these conditions V1 has low plate resistance and the resistance of V2 becomes very high, practically isolating the lead L from B minus. Therefore L transmits a large positive pulse to a transmitter T.

When the signal pulse goes off, V2 passes considerable current since it is unbiased. The large

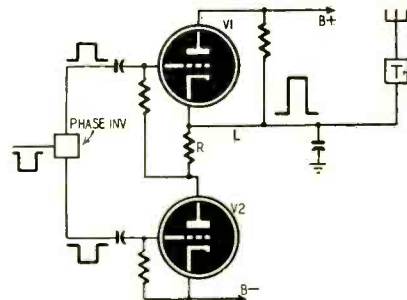

current through R biases V1 at or near cutoff. L is nearly isolated from the B plus terminal, while its resistance to B minus is low. Thus a large negative pulse feeds T to block the transmitter.

The output lead L may be connected to the transmitter screen grids. When it is positive, full power is radiated from T. When L goes sufficiently negative, it blocks the transmitter.

POCKET RADIATION METER

Patent No. 2,634,374

Francis R. Shonka, Riverside, Ill.

(Assigned to United States of America as represented by the U.S. Atomic Energy Commission)

Handling and working near radioactive material can be very dangerous. The radiation passes through the human body, destroying living tissue in its path. Ill effects may not be noticed until long after the damage is done. Therefore radiation must be measured at frequent intervals to determine whether an individual is in danger. For protection, the technician may carry a dosimeter to indicate total exposure during a given period. This patent discloses a dosimeter that is convenient to carry, easy to calibrate, and inexpensive to make.

Fig. 1-a shows the instrument, which is a combined microscope and electrometer. It is housed within a metal cylinder with a removable cap at the bottom. An optical system with four lenses is focused on E, a quartz fiber. The position of E is observed on a calibrated scale through the lenses.

The quartz fiber and metal housing constitute an electrometer for measuring electric charge. The fiber, insulated within an ionization chamber, terminates in a contact. Below it is a second contact, normally in the position shown. The lower

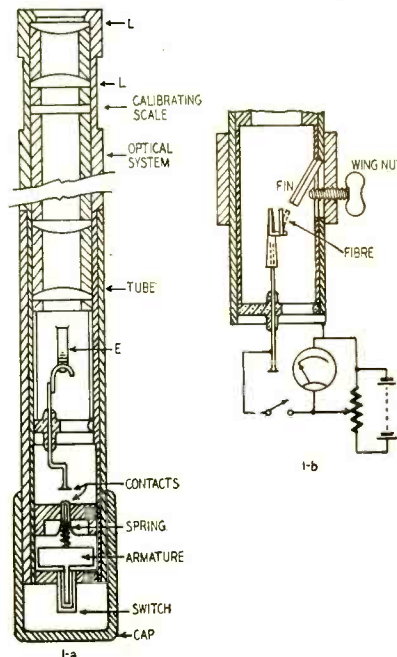

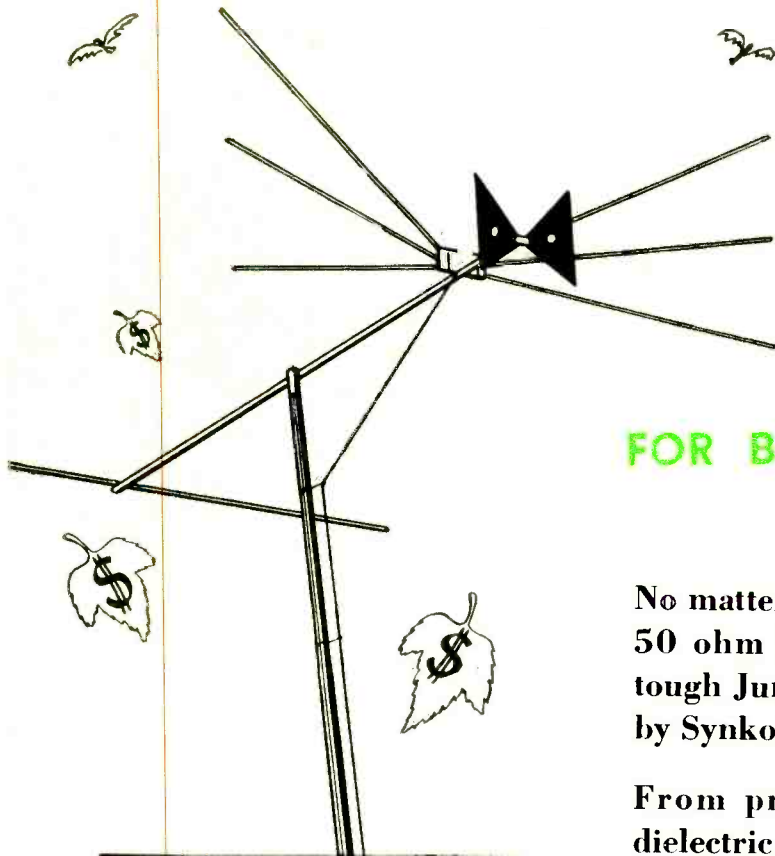

**FOR BETTER WIRE—
SPECIFY SYNKOTE**

No matter what your needs . . . from 50 ohm Flatline to heavy, rough-tough Jumbo Ovaltube . . . it's made by Synkote . . . and it's made better!

From precisely constructed air-dielectric TV wires . . . from the inside to the outside . . . physically or electrically—Synkote wire is superior. Get the best—at no added cost.

Discover how you can benefit by giving and getting better service . . . make more profits . . . if you use Synkote TV wires. Call your Plastoid representative or write us—Now!

SYNKOTE DEPENDABLE TV WIRE
for every purpose . . . for every purpose

	
SYNKOTE FLATLINE (nom. 50 — 100 mil web)	SYNKOTE PERFORATED (60 mil web)
	
SYNKOTE ULTRATUBE	SYNKOTE OVALTUBE
	
SYNKOTE JUMBO (185 mil web)	SYNKOTE SHIELDED (300 OHM)
	
SYNKOTE ROTOR CABLE (flat; 3, 4, 5 conductor)	SYNKOTE ROTOR CABLE (round; 4, 5, 8 conductor)
	
SYNKOTE COAXIAL (72 ohm Jr. Coax)	SYNKOTE COAXIAL (RG 11/U and 59/U)



"Manufactured by the mile . . . tested by the inch"

PLASTOID
Corporation

42-61 24th St., Long Island City, N.Y.

GUARANTEED!
to outperform all others

LONG RANGE
Broad Band

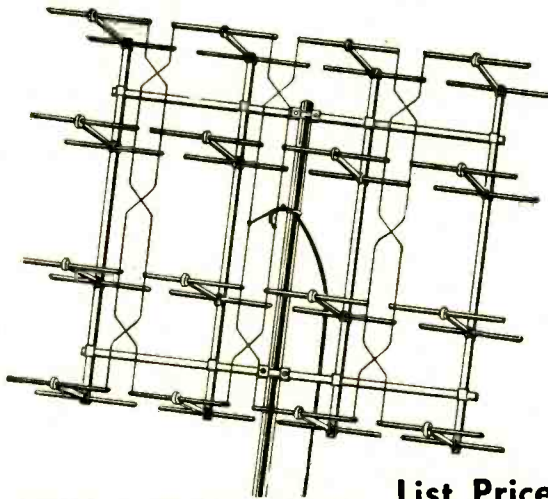

Tel-a-Ray

800 D-A

UHF

List Price
\$ 31.90

Super
Fringe Master
ANTENNA

A Broad Band cut to channel, Colinear Antenna—covers 10 and more channels on each side of cut channel

Testimonials have been received to verify perfect reception up to 60 miles and more from station.

PROVEN UNSURPASSED . . . in Little Rock, Ft. Smith, West Palm Beach, Muncie, Dayton, Henderson, Handford, Cal. and all other new UHF areas.

ELIMINATES . . . the most difficult fringe problems — brings in PERFECT reception where picture is snowy with other antennas . . . eliminates ghosts . . . has high front to back ratio, very sharp directivity and very low noise level.

COMPLETELY ASSEMBLED . . . READY TO MOUNT ON MAST.

Take this coupon to your Tel-A-Ray Distributor and get your Sample Super Fringe Master on this money back guarantee today!
If you do not have a Tel-A-Ray Distributor in your area, mail the coupon direct to Tel-A-Ray Enterprises, Box 332, Henderson, Ky.

Please rush me one (1) Stacked Array UHF Super Fringe Master cut to channel Via Railway Express Prepaid today. I understand that if this antenna does not out perform all other UHF antennas I may return it within 15 days Freight Collect and my money will be refunded or bill cancelled.

Name..... Firm.....
Street Address.....City..... State.....
I am a.....Distributor.....Dealer.....Consumer
 Bill me Ship C. O. D. I am enclosing check

contact may be pushed upward (against the force of a spring) by a switch. Since the switch is enclosed in an airtight chamber, it is closed by an external magnet. This is done by removing the cap, placing the dosimeter between the poles of an electromagnet (not shown), and energizing the latter to attract the armature.

Fig. 1-b shows a more detailed section of the instrument. The electrometer is charged from a d.c. source of predetermined voltage. The charge between the fiber and the outer cylinder deflects the fiber as shown by the dotted lines.

Radiation through the ionization chamber causes a loss of charge. With continued exposure, the fiber gradually returns to its normal position. The position of the fiber may be observed at any time through the optical system, so that the technician may continue to work as long as his dosimeter does not show excessive exposure to radiation.

KINE CONTROL FOR COLOR TV

Patent No. 2,633,547
Harold B. Law, Princeton, N. J.
(Assigned to Radio Corp. of America)

Multicolor kinescopes have individual phosphor lines or dots which must be excited at precisely the correct instants. For example, the green phosphor must be excited only when the signal representing green is present. The same is true for the red and the blue.

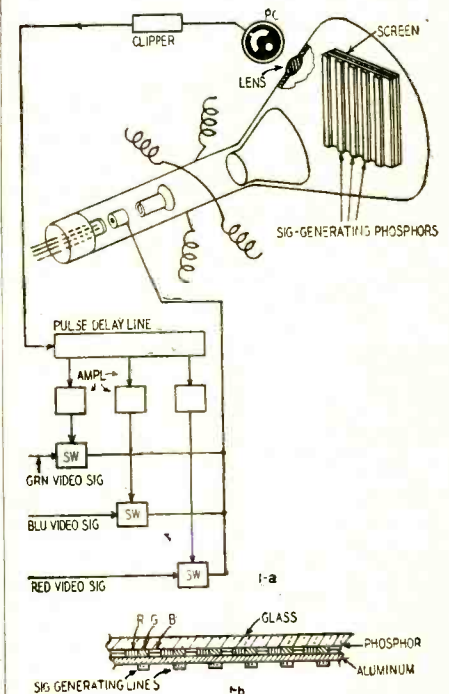

The two-sided screen is shown in Fig. 1-a. The front surface is glass. Behind it are phosphor layers in groups of three. Each group contains a vertical line of phosphor for red (R), one for green (G), and one for blue (B). The lines extend from top to bottom of the screen. Behind the phosphors is an aluminum layer for reflecting light. Finally, signal-generating phosphor lines are placed behind each green phosphor, as shown.

Fig. 1-b shows a multicolor kinescope with the special two-sided screen. As the beam is deflected horizontally it cuts across the signal-generating phosphor lines, and the impact results in light emission. The aluminum backing prevents the light from reaching the face of the tube, but reflects a large portion of it through a lens to a photocell PC. The signal is clipped and fed to a delay line. Separate amplifiers energize switches which pass the video signals.

As the electron beam strikes any signal-generating phosphor, a signal arrives at the relay line and immediately operates the first switch. This switch transmits the video signal representing green. Thus correct timing is maintained since only the green video signal should excite a green phosphor. An instant later, the delay line will feed a signal to the second switch which passes the blue signal. This delay is equal to the time required for the beam to move from the green phosphor to the blue. **END**

PHILCO 48-1270 RADIO

A few of these sets have been brought in with complaints that the power switch doesn't work, thus making it impossible to turn the set on or off. In most cases, this trouble is caused by an error in assembling the push-button assembly and not by a defective switch as might be suspected.

Two rivets were supposed to be used to fasten the trigger to the push-button arm, but in some receivers only one was used. When the second rivet is left out, the trigger eventually loosens up so it will not operate the switch. One way to correct the trouble is to remove the entire push-button assembly and install a second rivet. This is a difficult, time-consuming job.

It is much easier to make the repair by soldering the trigger to the arm. Insert a piece of wire of the correct size into the holes provided for the second rivet and then solder the trigger to the arm. You must use a small soldering iron for the job because working space is limited. Do a good soldering job and the switch will work perfectly.

If you should find it necessary to remove the push-button assembly, realign the set when the assembly is reinstalled. Realignment is not required if the repair is made by soldering the arm to the trigger.—*Ross Harris*

INTERMITTENT HUM

Recently, I came across a regulated power supply that had a bad case of intermittent 60-cycle hum. Checking the tubes showed the 5V4-G rectifier to have intermittent emission from one plate. A further check showed that one section of the heater was intermittent. The trouble was eliminated by replacing the tube.—*Charles Erwin Cohn*

G-E 16C113

The symptoms were unstable vertical sync, horizontal pulling, and failure of the contrast control to operate properly.

The trouble, which may also occur in G-E models 16T3, 16T4, and 16C116, was traced to a high-resistance short

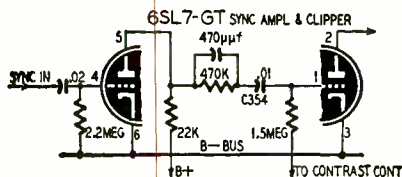

in the .01-µf coupling capacitor between the sync amplifier and clipper sections of the 6SL7-GT. This capacitor is shown as C354 in the manufacturer's diagram. Replace the defective component with a 600-volt molded capacitor.—*Edgar B. Kastelberg*

CAPEHART 320, 322 & 324

In some areas, the vertical hold adjustment is critical. To improve vertical stability, try replacing the 6CB6 first sync amplifier with a 6AU6. After inserting the 6AU6, note the broadening of the vertical lock-in range by slowly rocking the vertical hold control.—*Donald A. Weiler*



"Boy... Have I Got the Lines!"

You, too, can have the lines—that meet your exact leadline conditions — whether you are a TV Set Dealer or Service Organization making the finest television reception installations, or a TV fan that demands sharp, "SNOW-FREE" pictures.

We specialize in the manufacture of television transmission lines — built with only one idea in mind: "THE FINEST TELEVISION RECEPTION"

For UHF and VHF

"SHEATH-LEED" — the all-weather leadline for the toughest conditions: Salt spray in coastal areas; hot, humid weather, or for frosty, icy, wintry wind-whipping conditions which impose a severe tax... Pure Polyethylene Tubing encasing Standard GOODLINE AIRLEAD.



"GOODLINE" AIRLEAD—standard of leadline excellence —with 80% of the loss producing web removed. Correct impedance for sharp, "snow-free" pictures. Of pure polyethylene with flexible stranded copper-clad conductors. MANY IMPORTANT FEATURES.

NEW FULL-WEB "SHEATH-LEED" — the pure polyethylene of "SHEATH-LEED" and full characteristics of GOODLINE AIRLEAD — but NO PERFORATED WEB. No 20 (7 strand 28) character wire in pure electronic golden clear polyethylene — with a pure silver-gray polyethylene sheath overall — for Maximum Weather Protection.

Don Good, INC.

SOLD BY LEADING JOBBERS & DEALERS

Send coupon NOW!
Get samples "in your hands"
—you'll realize why
Don Good Products make
the finest television
reception possible.

DON GOOD, INC. 1-10
1014 Fair Oaks Ave., So. Pasadena, Calif.
Please rush Samples and Complete Information covering Don Good Products.

Name _____
Street _____
City _____ State _____

WANTED

WE NEED YOUR SURPLUS ELECTRONIC EQUIPMENT

WE PAY TOP \$\$\$ FOR:

- ★ RADIO RECEIVERS
- ★ TRANSMITTERS
- ★ ARC-1
- ★ ARC-3
- ★ ART-13
- ★ CONTROL BOXES
- ★ INDICATORS
- ★ CLAMPS
- ★ PLUGS
- ★ CORDS
- ★ RELAYS
- ★ TELEPHONE MATERIALS
- ★ AN CONNECTORS
- ★ WE BUY ANYTHING!

Write, Wire today! Tell us what you have.
TALLEN CO., Inc., Dept. RE
159 Carlton Ave., Brooklyn 5, N. Y.

WE ARE QUICK & CASH BUYERS

We're looking for surplus inventories of all types of electronic parts—receiving, transmitting and special-purpose Tubes. Anything in the Radio-TV and electronic field.

SMALL or LARGE QUANTITIES— SEND US YOUR LIST
Submit samples where possible, amount of each item and prices.
NAT ADELMAN
168 Washington St., New York 6, N. Y.

OSCIL-O-PEN

Extremely convenient test oscillator for all radio servicing; alignment • Small as a pen • Self powered • Range from 700 cycles audio to over 800 megacycles u.h.f. • Output from zero to 125 v. • Low in cost • Used by Signal Corps
• Write for information.

GENERAL TEST EQUIPMENT
38 Argyle Ave. Buffalo 9, N. Y.

*Train IN
Great COYNE shops
for big pay jobs*

**IN Television
-Radio**

**OR
Electricity
-ELECTRONICS**

**Learn on REAL EQUIPMENT!
in Best Equipped School of its
kind in U. S.**

Prepare for your future NOW! Come to the Great Shops of Coyne. Get practical training in opportunity fields—TELEVISION-RADIO—ELECTRICITY—ELECTRONICS. Prepare for a better job in industry or better service rating if drafted.

WE TRAIN YOU IN CHICAGO

At Coyne you learn on real, full-size equipment. Trained instructors show you how, then you do shop jobs yourself. No previous experience or advanced education needed.

Approved for Veterans

Finance Plan—Enroll now, pay most of tuition later. If you need part-time work to help out with living expenses while at Coyne, we'll help you get it. *Special tuition plan for men of draft age.*

FREE BOOK Clip coupon for Big Free Illustrated Book. No salesman will call. Act NOW.

COYNE SCHOOL

510 S. Paulina St., Dept. 83-81H
Established 1899
APPROVED for VETERANS

E. W. COOKE, Pres.
COYNE School
510 S. Paulina St., Chicago 12, Ill., Dept. 83-81H
Send FREE BOOK and full details on:
 TELEVISION-RADIO ELECTRICITY

NAME

ADDRESS

CITY.....STATE.....



TRUETONE A.C.-D.C. SETS

Unusually short tube life in some Truetone a.c.-d.c. sets using a 35W4 or 35Z5-GT rectifier may be caused by an error in wiring the rectifier heater circuit. I've found several cases where the hot side of the line connects to the pilot lamp tap instead of to one side of the filament. This applies excessive voltage to the heater string and shortens tube life.

This condition can be cleared up by changing the line cord connection from the pilot lamp tap to the high side of the rectifier filament—usually pin 2 on the 35Z5-GT and pin 4 on the 35W4.—*J. E. Ryan*

MORE WIDTH FOR GE801

You can increase the width of the picture about 1 inch by replacing the 5Y3-GT rectifier with a 5V4-GT and connecting a 30- μ f electrolytic capacitor in parallel with the 30- μ f input filter capacitor C63. (Better install a 20-ohm, 2-watt resistor in series with each plate lead to bring the plate-supply impedance up to the minimum value specified for the 5V4-GT.—*Editor*)—*Lyle Briggs*

ZENITH H401 PORTABLE

The complaint was hum with slight distortion all over the band when the set was plugged into a 117-volt a.c. outlet.

After the usual tests and substitutions failed to clear up the trouble, I tried shielding the 1S5 detector. This didn't help, so I rewired the socket and substituted a 1U5 in place of the 1S5. This eliminated the hum and distortion. The 1U5 is an improved electrical equivalent of the 1S5. The new internal structure and pin connections reduces any tendency toward microphonics and hum and minimizes play-through from the diode detector to the control grid.—*Albert L. Sohl*

HUM IN MOTOROLA 52R

Modulation hum when a station is tuned in may be caused by insufficient bypassing action of the .047- μ f capacitor between the 35W4 plate and the B minus bus. It can be eliminated by removing the capacitor from the plate and connecting it to pin 6 on the 35W4. This circuit change was made in the HS-289 plated chassis using the same circuit. (See "Plated Chassis" in the December, 1952, issue.)

The complaint can be cleared up, without removing the chassis from the cabinet, by simply connecting a .05- μ f, 400-volt molded-paper capacitor across the male part of the line interlock connector.—*G. P. Oberto*

WHINE IN AUTO RADIOS

A high-pitched whine heard over an auto radio is not always an indication that the auto's generator or noise-filter capacitors are at fault. This has also been traced to a leaky oscillator-mixer or i.f. amplifier tube in the receiver. Replacement of the leaky tube will eliminate the trouble. Also check the r.f. amplifier.

—*John A. Comstock. END*

**FIX 3 OUT OF 4
Television and
Radio Receivers**

**Just by
reading
this one
book!**

Just Out

Here's the practical television and radio repair book for you—easy, plain, and simple, and written for the man with no technical training.

Just think—without math or heavy circuit theory, you can start doing actual repair work *even before you finish the book!* No trick methods—only the sound, correct, safe way to do things. Read it and—so quickly it will surprise you—you can fix your own and friends' sets... get a service shop job... even start your own money-making business. Here's the reason you'll learn so quickly: You deal only with the things that go wrong in sets—the parts—instead of spending long weeks studying circuits and doing lab work.

**TELEVISION AND
RADIO REPAIRING**

Gives all these helps:

How to run your own business
How to test and replace tubes
How to test tubes without equipment
How to eliminate receiver noises
How to improve dim TV pictures
How to solder
How to repair, replace and adjust:
—Power supplies
—carbon and wire-wound resistors
—controls and switches
—condensers, coils, and transformers
—tuning devices
How to fix phono pickups
How to repair wood and plastic cabinets
How to install, adjust, and repair different types of antennas
and many others

by John Markus
Assoc. Editor, *Electronics*
556 pp., 225 illus. \$7.95

Simple! Easy-to-read!

For every television and radio part, no matter what make the set is, Markus shows you how to recognize symptoms of trouble... how to test to make sure... how to order the new part... and how to install it. He explains everything in plain language and uses pictures throughout so you actually see what he's talking about.

Be a well-paid repairman—Even start your own business

Here's your chance to share the big money going to servicemen today—without investing a good deal of cash—and by starting right in your own home or working for a service outfit. The book tells you what few tools to buy, how to make a service call, how to collect the bills. It shows you how to test television and radio parts with a multi-meter.

Just one repair job pays for the book!

10 DAYS' FREE EXAMINATION

McGraw-Hill Book Co., Dept. RE-11,
330 W. 42nd St., New York City 36

Send me John Markus' TELEVISION AND RADIO REPAIRING for 10 days' examination on approval. In 10 days I will remit \$7.95, plus few cents for delivery, or return book postpaid. (We pay for delivery if you remit with this coupon; same return privilege.)

(Print)
Name

Address

City..... Zone.... State.....

Company

Position

RE-11
(This offer applies in U.S. only)

TRIPPLET 630 Volt-Ohm-Mil-Ammeter

"speaks" for itself in any company



ing to desired circuit thru a single $2\frac{1}{2}$ " knob flush with the face panel. The molded switch itself embodies the most advanced engineering practices. Fully enclosed, the silvered contacts are kept permanently clean. Its rugged construction means stronger performance and longer life.

These two factors are but samples of the many ways in which on-the-job needs have been anticipated and provided for in a beautiful streamlined tester. It provides A.C.-D.C. Volts, D.C. Micro-amperes, Milli-amperes, Amperes, Ohms, Megohms, Decibel and Out Put readings in a no-short design embodying interior construction with all direct connections; no harness cabling. Its fool-proof unit switch construction houses precision resistors in insulated recesses in direct connection with switch contacts.

Study the following Ranges and descriptions and compare them point by point with any similar instrument for conclusive proof that Triplet 630 "speaks" for itself in any company.

Ranges

D.C. Volts: 0-3-12-60-300-1200—at 20,000 Ohms/Volt (For Greater Accuracy on TV and other High Resistance Circuits.)

A.C. Volts: 0-3-12-60-300-1200-6000—at 5,000 Ohms/Volt (For Greater Accuracy in Audio and other High Impedance A.C. Circuits.)

Decibels: -30, +4, +16, +30, +44, +56, +70. (For Direct Reading of Output Levels.)

D.C. Microamperes: 0-60—at 250 Millivolts.

D.C. Milliamperes: 0-1-2-12-120—at 250 Millivolts.

D.C. Amperes: 0-12—at 250 Millivolts.

***Ohms:** 0-1,000-10,000—(4.4-44 at center scale).

***Megohms:** 0-1-100—(4,400-440,000 center scale).

Output: Condenser in series with A.C. Volt ranges.

**Resistance ranges are compensated for greatest accuracy over wide battery voltage variations. Series Ohmmeter circuits for all ranges to eliminate possibility of battery drain when leaving switch in Ohms position.*

TRIPPLET 630 Volt - Ohm - Mil - Ammeter has many significant advantages and features that make it stand distinctly apart from similar instruments in its price class. Actually in components, in engineering, in minutely accurate performance, Triplet 630 closely approaches laboratory standards.

Since the scales of any VOM comprise the means by which it makes its multiple services most valuable, the legibility and easy-read-ability are of prime importance. Triplet engineers have created in Triplet 630 the longest scales available in this size tester. (The upper arc by actual measurement is four and three-eighths inches.)

This long-scale factor accounts for the ease with which precise readings are easily made. Further legibility is gained by use of black and red scale markings. D.C. and D.B. are black and white. A.C. and Ohm markings are red on white. Ohms from one hundred million to one-tenth ohm mark the range of this amazing scale. On low ohms, center scale reading is 4.5 ohms.

The Single Switch

Further indication of the practical skill and engineering "know-how" behind Triplet 630 is the Single Switch. Its simplicity of operation assures no burn-outs thru momentary memory lapses. There is instant switch-

Get a Triplet 630 into your own hands at your distributor.
U. S. A. Dealer Net \$3950

TRIPPLET ELECTRICAL INSTRUMENT COMPANY
BLUFFTON, OHIO

TRIPPLET

Check! these NJRT TUBE prices 70% to 90% off list . . .

Type	Price	Type	Price	Type	Price	Type	Price
1A7GT	.45	6A6	.49	6BQ6GT	.57	6X4	.35
1B3GT	.47	6AB4	.42	6BQ7	.80	6X5GT	.35
1H5GT	.38	6AF4	1.06	6BZ7	.89	7F8	.63
1L4	.44	6AF6	.75	6C4	.39	12AL5	.40
1L6	.41	6AG5	.41	6CB6	.42	12AT5	.35
1LC5	.49	6AJ5	.88	6CD6G	1.09	12AT7	.54
1LN5	.49	6AK5	.73	6F6G	.37	12AU6	.38
1NSGT	.44	6AL5	.36	6F6GT	.35	12AU7	.38
1R5	.43	6AQ5	.37	6J5GT	.40	12AV6	.80
1S5	.37	6AQ6	.35	6J6	.50	12AV7	.87
1T4	.43	6AT6	.35	6K6GT	.35	12AX4GT	.46
1U4	.43	6AU4GT	.69	6L6	.62	12AX7	.49
1U5	.37	6AU6	.36	6S4	.37	12BA6	.36
1X2	.52	6AV6	.35	6S8GT	.51	12BA7	.44
3A4	.43	6AX4GT	.57	6SA7GT	.41	12BE6	.37
3Q5GT	.46	6BA6	.41	6SD7GT	.39	12BH7	.65
3S4	.44	6BA7	.57	6SK7GT	.39	12SA7GT	.42
3V4	.44	6BC5	.42	6SL7GT	.46	12SK7GT	.46
5A24	.50	6BD6	.45	6SN7GT	.50	12SN7GT	.50
5U4G	.45	6BE6	.37	6SQ7GT	.35	12SQ7GT	.42
5Y3GT	.33	6BG6	.92	6T8	.54	12SR7MET	.47
5Y4G	.30	6BH6	.44	6U8	.59	12V6GT	.60
5Z3	.37	6BK7	.65	6V6GT	.37	19BG6G	.96
6A3	.57	6BL7GT	.60	6W4GT	.42	19T8	.77
				6W6GT	.45	25BQ6GT	.60
						35Z5GT	.35
						807	.97

Guarantee

ALL NJRT TUBES ARE BRAND NEW AND FULLY GUARANTEED FOR 1 YEAR.

Type	Price	Type	Price
25L6GT	.37	42	.40
25W4GT	.45	43	.53
25Z6GT	.35	45	.53
35A5	.50	50B5	.37
35B5	.38	50C5	.37
35C5	.37	50L6GT	.39
35L6GT	.40	70L7GT	1.07
35W4	.35	76	.42
35Z3	.43	117Z3	.35
35Z5GT	.35	807	.97

T.V. PIX TUBE BRIGHTENER \$1.59
LOTS OF 10\$1.49

Free 50

Assorted Condensers with each \$25.00 tube order.

For T.V. sets where voltage supply is low AC LINE BOOSTER with safety fuse and switch\$5.95

Many 7 volt types not listed. All tubes individually boxed. Minimum order \$10.00. Tubes offered subject to prior sale. Prices subject to change. Orders shipped prepaid if check is enclosed. 25% deposit required on c.o.d. shipments.

SEND FOR FREE TUBE LISTING.



NEW JERSEY TELEVISION SUPPLY CO.

906A WESTFIELD AVE., ELIZABETH, N. J. EL 3-6166

CONVERT TO UHF

New UHF station in your area here's all you need to get it on your set.

1. UHF Bow-tie Ant. famous make 3.24
2. UHF-VHF Coupler 2.65
3. UHF-VHF Electro-Voice converter 29.63

PURE POLYETHYLENE WIRE

55 MIL—22 GA wire	1000 ft	\$12.00
100 MIL—20 GA wire	1000 ft	\$18.00
Tubular Twin Lead	1000 ft	\$29.65

FAMOUS MAKE SELENIUM RECT.

Individually boxed

Current	each	6 lot ea.	KIT 100 asstd resist.	1.85 ea.
200 ma	1.25	...	KIT 100 molded tub cond.	1.85 ea.
250 ma	1.45	...	KIT 100 knob springs in plastic box	1.75 ea.
300 ma	1.60	1.45	7"x3 1/2"x1 1/8"	1.75 ea.
350 ma	1.75	1.58		
450 ma	2.05	1.85		

LINE FILTERS for small appliances, sparking switch, small motors, fluorescent lights. .42 ea.

COMPLETE STOCKS OF:

A.T.R.	IRC	FOTOFACTS
CINAUDI-	JENSON	SPRAGUE
GRAPH	NEEDLES	STANCOR
DUMONT	JFD	STANWYCK
EICO	LITTLEFUSE	SYLVANIA
ELECTRO-	PENTRON	WEBSTER
VOICE	RAM	ELECTRIC
GENERAL	JOHN F. RIDER	WELLER
CEMENT	REEVES	XECELITE
	SAMS	SARKES-TARZAIN

SPECIALS

FAMOUS MAKE ANTENNAS

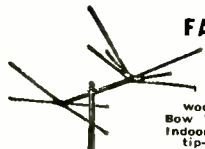

- 10 element conical, 3/8" alum. tub'g, wood dowl'g \$2.70 ea.
- Window conicals \$3.75 ea.
- "V" beam, 3/8" alum. tub'g wood dowl'g \$3.00 ea.
- Bow Tie, UHF \$3.24 ea.
- Indoor antenna, metal base, tip-proof \$1.15 ea.
- Corner Reflector—UHF—Quick Rig. \$10.05 ea. 12 lot \$8.38 ea.

FAMOUS MAKE COMPONENTS

- 5" PM Speaker, Alnico #5 .68 oz. \$ 1.25 ea.
- 500 mmfd—20 KV Aerovox HI-Q Cond. .59 ea.
- Lighting Arrestors54 ea.
- 6x9" PM Speaker 18.80 ea.
- Cascode Tuner49 ea.
- 50/30 150 V Cond. 6 for \$2.4052 ea.
- 6V6 audio Output xfmr20 ea.
- Anode caps—6 for .90 1.50 ea.
- Two set coupler, Printed Cir. UHF-VHF Coupler—one leaddown Hermetically sealed 2.65 ea.
- Ion traps—single—6 for \$1.8035 ea.
- Ion traps—double—6 for \$3.0055 ea.
- 4 prong universal Vibrator 6/1.25 ea. 1.49 ea.

WRITE FOR BI-WEEKLY TUBE BULLETIN RE-11

MANNFRED Electronics Corporation

21-26 36th Ave. L. I. C. 6, N. Y. Telephone Exeter 2-6000

Minimum Order \$5.00—All Merchandise Fully Guar. anteed. 25% Deposit with Order. Bal. COD, FOB, NY



IN NOVEMBER

NOVEMBER will be a generally quiet month for the TV dx enthusiast. There will be slightly more sporadic-E dx than in the past two months, but, in nearly every instance, the periods of dx reception will be shorter and the reception inferior to the summer season.

Receiving conditions will be tapering off toward the winter minimum, and fringe-area reception can be expected to deteriorate in average quality as the colder weather approaches. The more northerly parts of the country will be feeling this more than in the South, where tropospheric reception can be expected to hold up well for at least another month.

The newcomer to TV dx may get the idea that only the summer months provide anything of interest. Nothing could be farther from the truth. TV dx can occur at any time or season; it just shows up less often in the next few months. Tropospheric propagation can be very good in November, too, though there may be only one or two periods in the month when the weatherman will be working for us. Watch for the mild, calm, "Indian summer" days, with high barometer and a gradually thickening haze in an otherwise clear sky. The evening and early-morning hours are almost certain to provide above-average signals over distances up to about 300 miles during such typical fall weather.

High-band propagation will fall off considerably with the coming of cold weather, and it is likely that u.h.f. reception will not be as good as during the summer. However, our experience to date with u.h.f. has been so limited, that we don't really know much of what to expect from winter weather. Observations on the comparison between low-band, high-band, and u.h.f. reception at various distances are welcomed. With the opening of so many new u.h.f. stations, large viewing audiences will be developed. This will probably lead to a great deal of information on TV dx in the u.h.f. band. We'll pass it on as we get it. It should prove very interesting.

November should see some aurora borealis displays. Here is another opportunity for the dx observer. We need more detailed reports on any unusual reception experienced while aurora lights the northern skies. Turn those arrays toward the flickering lights, and try all the v.h.f. channels. What you pick up may be hard to identify, because of the diffused nature of the auroral reflection, but don't let that keep you from trying!

END

The RADIO-ELECTRONICS ANNUAL INDEX Will Appear in our DECEMBER ISSUE. WATCH FOR IT!

11 CPS to 30 Mc

... covered by two new RCA Companion Signal Generators for testing and trouble-shooting audio, AM, FM and TV equipment

RCA WA-44A
Audio Signal Generator
 Continuous sine-wave coverage from
 11 cps to 100 kc
ONLY \$8750 Suggested
 User Price

Features new RCA-type oscillator having wide frequency range, and frequency stability of $\pm 3\%$ or better. Regulated power supply. Amplified agc circuit insures an output uniform within ± 1 db over entire frequency range. Total harmonic distortion, 2% or less. Has direct-reading scales. Can be used with high- or low- impedance circuits. Useful for all response measurements. Has separate line-frequency output for inter-modulation distortion measurements. Compact, weighs only 10 lbs. Ac-operated.

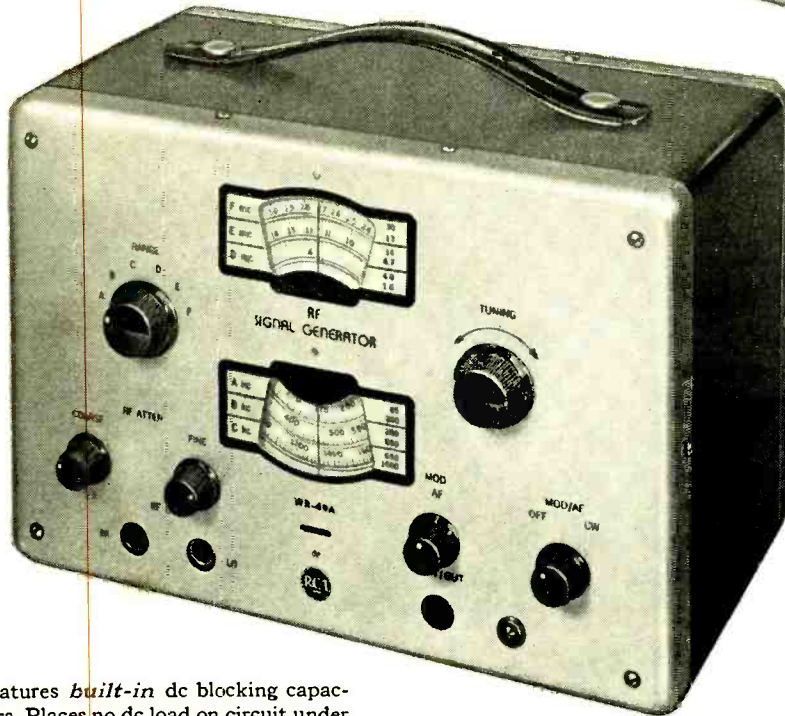
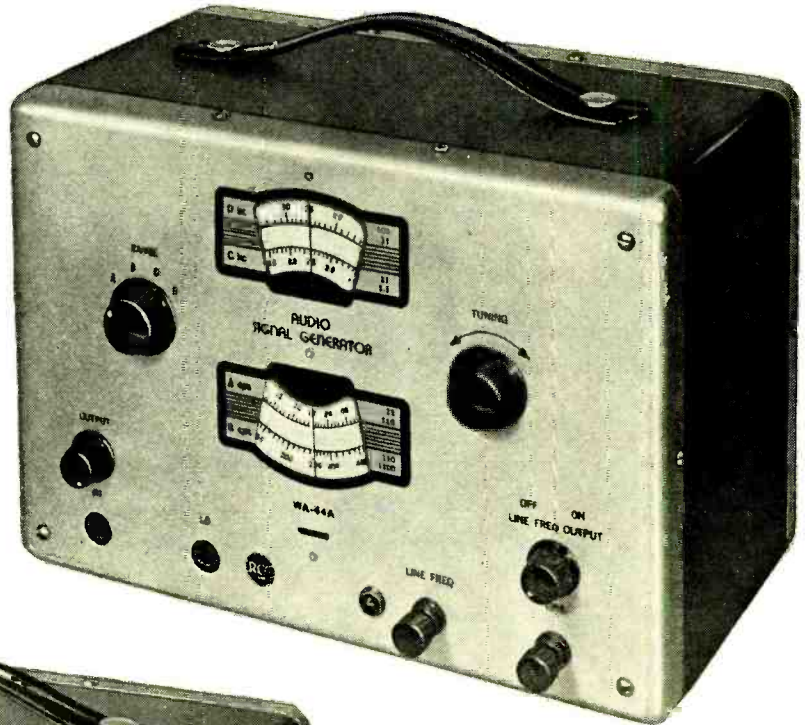

RCA WR-49A
RF Signal Generator
 Continuous coverage on fundamentals
 from 85 Kc to 30 Mc
ONLY \$5950 Suggested
 User Price

Features *built-in* dc blocking capacitors. Places no dc load on circuit under test... protects instruments when connected to B-plus circuits. Cathode-follower output stage isolates oscillator from effects of load reactance and resistance, thereby maintaining good output waveform, voltage regulation, and frequency stability of the oscillator.

Built-in 400-cycle oscillator for internal modulation. Modulation percentage continuously variable. Dial calibrations accurate to $\pm 1\%$ on all six bands. Complete shielding of copper-plated cabinet and of cables for minimum leakage. Compact, weighs only 8 lbs. Ac-operated.

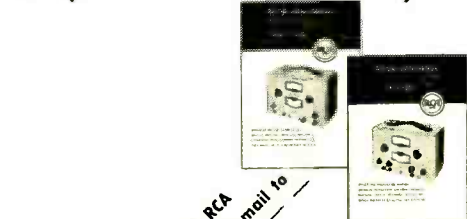

RADIO CORPORATION of AMERICA
 TEST EQUIPMENT
 HARRISON, N. J.

Get full details today from your RCA
 Distributor or clip the coupon and mail to
 RCA Commercial Engineering
 Section 49KX
 Harrison, N. J.
 Please send me complete information on (check)
 RCA WA-44A Audio Signal Generator
 RCA WR-49A RF Signal Generator
 Name _____
 Address _____
 City _____ State _____ Zone _____

BARGAINS · BARGAINS · BARGAINS

BARGAINS · BARGAINS · BARGAINS

Standard Brands

TUBES

All Brand New Individually Boxed Far Below Wholesale Cost

0Z466	6AC71.29	6BG61.99	6SL796	12AV71.14	35Z553
1A787	6AG589	6BM689	6SN786	12AX71.06	50B584
1B399	6AG71.24	6BK71.26	6SQ763	12AZ71.59	50C584
1H573	6AH61.39	6BL71.14	6T81.09	12BA672	50L671
1N582	6AK51.44	6BQ61.35	6U81.14	12BE678	50Y679
1R579	6AK61.49	6BQ71.49	6V6GT71	12BH783	6X41.59
1S579	6AL571	6BN61.14	6W473	12SA783	4059
1T479	6AQ579	6BZ71.59	6W691	12SK779	117N71.59
1U578	6A0589	6C466	6X462	12SL791	117P71.59
1V579	6AR573	6CB687	6X563	12SN791	117Z364
1V2A1.02	6AS583	6CDB62.59	6X81.09	12SQ766	6696
3Q489	6AT672	6H671	7C571	12S0766	117Z664
3Q589	6AU51.04	6J563	7F789	25B061.41	
3S479	6AV671	6J669	7N787	25L673	
3V482	6AV571	6L6A1.39	7Y469	25W473	
5U485	6BA663	6SA773	12AH71.18	25Z667	
5V499	6BA799	6SC784	12AL571	35B579	
5Y349	6BC586	6SH786	12AT662	35C577	
6AB479	6BC71.04	6SJ766	12AT71.07	35L653	
6AB799	6BE674	6SK772	12AU677	35W477	
			12AU794	35Y474	

Wen SANDER-POLISHER



Here is the unit you have been waiting for. Does everything from sanding your car to polishing your shoes. Large sanding area a full 13 3/4" sq. Lightweight, easy to use. Complete with on-off switch, 6 sheets of sand paper and polishing cloth. Powerful high speed motor. Choice of 3 colors: Black, Fire-Engine Red, and Marbled Green. 110-120 volts 60 cycles. AC only.

polishing cloth. Powerful high speed motor. Choice of 3 colors: Black, Fire-Engine Red, and Marbled Green. 110-120 volts 60 cycles. AC only.

List Price \$13.95 Net Price **10.46**

Minimum Order \$5.00

R.M.S. TELEVISION BOOSTERS

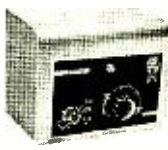

BOOSTERS

Models SP-6, SP-5, SP-6J
STEVE-EL brings you the booster buy of the year. We bring you these boosters at a price less than manufacturer's cost. These boosters are brand new factory aligned in sealed cartons. Complete with circuit diagram and operating instructions. Fully guaranteed. All TTL approved. 110-120 Volt. AC only. Model SP-5 Pentode Type for extreme fringe \$8.50 Model SP-6 Pentode Type for extreme fringe 7.95 Model SP-6J Triode Type for semi-fringe. 8.95

STEVE-EL now carries full line of Eico, E.M.C., Pilot, Tech-Master, Pentron, Wen Products, Burgess, Shure, etc. Write for free catalog.

STEVE-EL ELECTRONICS CORP.

Dept. RE-11 61 Reade St., New York 7, N. Y. COrtland 7-0086

Why Count Profits in Small Change? WHEN YOU CAN STACK IT IN \$\$\$

Dealers and TV Service Organizations selling DAVIS SUPER-VISION ALL-CHANNEL TELEVISION ANTENNAS do count their PROFITS IN DOLLARS



SOLD TO YOU WITH A MONEY-BACK GUARANTEE

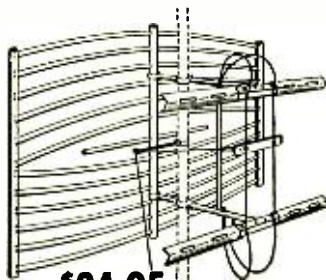

\$34.95

BUILT BY AMERICA'S FASTEST GROWING ANTENNA MANUFACTURER

Copyright 1953



DON'T WAIT! . . . Get the "BIG DOLLAR PROFIT FACTS" from our Jobber's Salesman in your area. We will get him in touch with you. USE COUPON.

DAVIS ELECTRONICS BOX 1247, Burbank, California 2-44

SIRS: RUSH INFORMATION TO ME AS CHECKED:

- Send Complete Information and Technical Data on New SUPER-VISION ANTENNA.
- Send Name and Address of NEAREST JOBBER.

Name _____
Street _____
City _____ State _____

MISCELLANY

THE FUND REACHES \$10,823.59



HELP-FREDDIE-WALK FUND

As most of our readers know, Freddie Thomason, the five-year-old son of Herschel Thomason, radio technician of Magnolia, Arkansas, was born without arms and legs. Through the generosity of many hundreds of wonderful people, the Help-Freddie-Walk Fund has been able to send over \$18,000 to Freddie and his parents during the past three years.

However, we have been dismayed to note that during the past several months the number of donations received has constantly dwindled, until now what was once a flood has become merely a trickle.

We are well aware of the fact that money today is "tight," and that each of us has something of a struggle to make ends meet, but we would like to impress on you all the fact that rehabilitation of Freddie is a longtime project. Throughout his life, he will be dependent upon mechanical appliances in order to perform simple acts, like walking and eating, that we all take for granted. During the years of his growth, these appliances must be changed regularly to keep up with him. All of this costs money—thousands and thousands of dollars.

May we ask each and every one of our readers to make a special effort to send in a contribution this month, and to send them in as regularly as possible thereafter. No amount is too small to warrant our sincere thanks and appreciation, as well as the thanks and appreciation of the Thomasons, and receipt of every contribution is acknowledged by us. Make all money orders, checks, etc., payable to Herschel Thomason. Address all contributions to

Help-Freddie-Walk Fund
RADIO-ELECTRONICS MAGAZINE
25 West Broadway
New York 7, New York

FAMILY CIRCLE CONTRIBUTIONS

Balance as of August 18, 1953 \$ 602.50
FAMILY CIRCLE Contributions as of September 18, 1953 602.50

RADIO-ELECTRONICS CONTRIBUTIONS

Balance as of August 18, 1953 . . . \$10,205.09
Anonymous, Folly Beach, S.C. 1.00
B & S Radio & Television, Inc., Springfield, Ohio 5.00
Cpl. R. Bacon, Phoenixville, Pa. 2.00
Joseph P. Cavedine, Solvay, N. Y. 5.00
Merle Haase, Ashby, Minnesota 2.00
Lauraville Radio Service, Baltimore, Md. 1.00

RADIO-ELECTRONICS Contributions as of September 18, 1953 . . \$10,221.09
FAMILY CIRCLE Contributions as of September 18, 1953 602.50

TOTAL Contributions as of September 18, 1953 \$10,823.59

RADIO-ELECTRONICS

A Full Size
LIGHTNING ARRESTER
at the Price of a Midget



LIGHTNING ARRESTER

MODEL TA5 Real protection against lightning and static charges — the RADIART Lightning Arrester has all the features! Fits anywhere... inside or out... handles standard or jumbo leads... no wire stripping necessary... does not unbalance the line... low internal capacity... no loss of signal... internal resistance "leaks off" static discharges! UNDERWRITERS LABORATORIES APPROVED.

THE **RADIART** CORPORATION
CLEVELAND 13, OHIO

TECH-MASTER *High Fidelity*
Amplifier and
Preamplifier
KITS

- Tech Master audio amplifier kits are made with the same "custom-quality" attention that has made Tech-
- Master the first name in TV chassis. They are built to a standard, not to the price. There have been no compromises... every component is the finest obtainable
- ...workmanship is meticulous.

UL* WILLIAMSON TYPE AMPLIFIER KIT:

(with power supply.) Famous Williamson circuit with modifications for increased, undistorted power output. Uses specially wound quality output transformer.
Model TM-15A, Kit of Parts..... Net Price . . . \$49.95

Model TMD-15A, DELUXE KIT: Factory assembled, all major components mounted, ready to wire. Net Price . . . \$59.95

*Ultra linear operation through use of screen-tapped primary output transformer

4 CHANNEL PREAMPLIFIER-EQUALIZER KIT:

Provides complete equalization for virtually all recording characteristics now employed. Extra flexibility provided by independent bass and treble boost and attenuation controls.
Model TM-15P, Kit of Parts..... Net Price . . . \$19.95

Model TMD-15P, DELUXE KIT: Factory assembled, all major components mounted, ready to wire. Net Price . . . \$29.65

AT ALL LEADING RADIO PARTS DISTRIBUTORS



TECH-MASTER PRODUCTS CO.
443-445 BROADWAY, NEW YORK 13, N. Y.

TECH-MASTER, MAKERS OF CUSTOM-BUILT TV CHASSIS, QUALITY TV KITS & HIGH FIDELITY AUDIO EQUIPMENT.

Literature
Upon Request

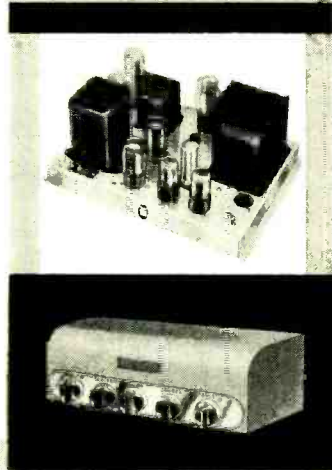

Get This Valuable Book

Just for Examining COYNE'S New 6-Volume Set

FREE



"Applied Practical Radio-Television"

ON 7 DAY
FREE TRIAL!

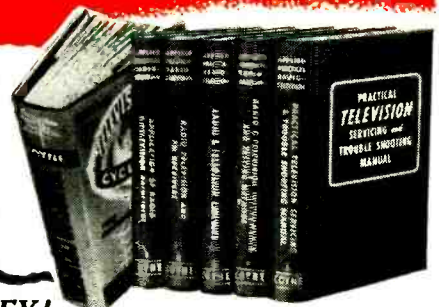

Yes, you get this big, brand new book, "150 Radio-Television Picture Patterns and Diagrams Explained", absolutely FREE! Just off the press! Gives complete wiring circuits and diagrams on the latest Radio and Television Sets. Easy-to-read, large 8½ x 11" pages, with full instructions on how to read and use the diagrams. A "must" in every Radio and Television service-man's repair kit. You get this valuable book as a FREE Gift for asking to see Coyne's great new 6-book set, "Applied Practical Radio-Television"!

Here's "Know-How" That Makes You Worth More!

Coyne's great new 6-volume set gives you all the answers to servicing problems—quickly! For basic "know-how" that is easy to understand, you'll find everything you want in volumes 1 to 5 which contain over 5000 practical facts and data. They cover every step from principles to installing, servicing, trouble-shooting and aligning all types of radio and TV sets. So up-to-date it includes COLOR TV and UHF, adaptors and converters. Also covers very latest information on TRANSISTORS.

882-Page Television Cyclopeda Included

And then, for speedy on-the-job use, you get volume 6—the famous COYNE TELEVISION CYCLOPEDIA. It answers today's television problems on servicing, alignment, installation and others. In easy-to-find ABC order, cross indexed. Use this 6 volume TV-RADIO LIBRARY free for 7 days; get the valuable Servicing Book ABSOLUTELY FREE!

SEND NO MONEY! Just mail coupon for 6-volume set on 7 days free trial. We'll include book of 150 TV-Radio Patterns & Diagrams. If you keep the set, pay \$2 in 7 days and \$2 per month until \$22.50 plus postage is paid. (Cash price \$20.95). Or you can return the library at our expense in 7 days and owe nothing. **YOU BE THE JUDGE.** Either way, the book of TV-Radio Patterns is yours FREE to keep! Offer is limited. Act NOW!

FREE BOOK — FREE TRIAL COUPON!

COYNE ELECTRICAL & TELEVISION-RADIO SCHOOL, Dept. B3-T1
500 S. Paulina St., Chicago 12, Ill.
YES! Send 6-volume "Applied Practical Radio-Television" for 7 days FREE TRIAL per your offer. Include TV-Radio Patterns & Diagram Book FREE.

Name..... Age.....
Address.....
City..... Zone..... State.....
Where Employed.....
() Check here if you want library sent COD. You pay postman \$20.95 plus COD postage on delivery. 7-day money-back guarantee.

COYNE ELECTRICAL & TELEVISION-RADIO SCHOOL
500 S. Paulina St., Dept. B3-T1 Chicago 12, Ill.

A New Champion!

tops in the field of molded tubular capacitors



C-D's Cub



- * Outperforms all other molded tubulars in humidity tests!
- * Stands up under temperatures up to 100°C.
- * You get more for your dollar with this premium tubular designed and built especially for replacement needs, with "better-than-the-original" performance!

* Ask your C-D jobber about the special "Cub-Kit"!

* * * *

For the name of your C-D distributor, see the yellow pages of your classified phone book. Write for Catalog to: Dept. RC-113, Cornell-Dubilier Electric Corp., South Plainfield, N. J.

CONSISTENTLY DEPENDABLE
CORNELL-DUBILIER

There are more C-D capacitors in use today than any other make.

PLANTS IN SOUTH PLAINFIELD, NEW JERSEY; NEW BEDFORD, WORCESTER AND CAMBRIDGE, MASSACHUSETTS; PROVIDENCE AND HOPE VALLEY, RHODE ISLAND; INDIANAPOLIS, INDIANA; SANFORD AND FUGUAY SPRINGS, NORTH CAROLINA. SUBSIDIARY RADIART CORPORATION, CLEVELAND, OHIO



"HIGH-FIDELITY"?

The radio-phonograph industry was cautioned "to use the phrase 'high-fidelity' with discretion, or risk a loss of public confidence at a time when the entire nation is becoming high-fidelity conscious."

The warning came from Frank Freimann, president of the Magnavox Company, at the annual Trade Show of the National Association of Music Merchants. He declared that "growing public interest in the faithful reproduction of sound in phonograph, television, and radio sets must not be nipped in the bud by the careless use of the term 'high-fidelity.'"

Leonard Carduner, president of British Industries Corp., referring to the Trade Show stated: "There I saw and heard a large number of new 'high-fidelity' radio phonograph combinations, many of which will be the subject of extensive advertising and promotion this fall. Most of these are an improvement over previous sets. It is with concern and apprehension that I found that many of these units are *not* really high-fidelity; not at all capable of reproducing sound with the lifelike qualities which genuine high-fidelity imparts."

CORRECTION NOTICE

We have been informed by Amperex Electronic Corp. that the 1N tube recommended for the simple Geiger counter described on page 119 of our October issue is no longer obtainable. A tube with closely parallel characteristics is the 75N. It is slightly larger than the 1N, and is rated at 700 volts instead of the 1N's 600.

The 75NB3 is electrically identical with the 75N, but uses a pee-wee 3-pin base. If construction details are slightly modified, this might be a more convenient tube.

Radio Thirty-Five Years Ago
In Gernsback Publications

HUGO GERNSBACK Founder	
Modern Electrical	1908
Wireless Association of America	1908
Electrical Experimenter	1913
Radio News	1919
Science & Invention	1920
Television	1927
Radio-Craft	1929
Short-Wave Craft	1930
Television News	1931

Some of the larger libraries still have copies of ELECTRICAL EXPERIMENTER on file for interested readers.

**November 1919
ELECTRICAL EXPERIMENTER**

- Interplanetary Communication, by Dr. C. S. Brainin, Ph.D., of the Columbia University Observatory
- Submarine's Under-Water Radio
- Nauen Radio Opened Again
- New Kolster Decremeter and Wave Meter
- Improving the Amateur Receiving Set, by Edward T. Jones
- High Tension Condenser Switch
- Code Teacher Made of Knotted String, by Alton D. Spencer

RADIO-ELECTRONICS

BEST

VHF and UHF

Broadband Television Antennas

- Proved Best in Gain — Clear Pictures up to 150 miles from Stations!
- Top Performance in Any Weather — No Insulators to Collect Moisture or Dust.
- Rugged Construction—Minimum Wind Resistance—No Joints to Corrode.
- Sold Coast to Coast with a Money-Back Guarantee through Leading Distributors.

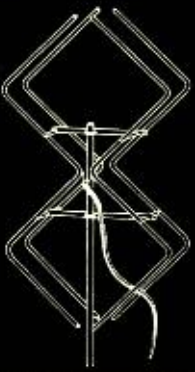

DISTRIBUTORS—
Write or wire now to:

BEST ELECTRONICS CORPORATION
2254 Colby Ave., Los Angeles 64, Calif.

TV SERVICE MIRROR

On most TV service calls, it is customary to touch-up the rear-panel controls to assure that the set is working at its best. Since these adjustments must be made while watching the screen, it is important to have a suitable mirror.

It is inconvenient to carry a large mirror on every service call. Too, the mirror is always subject to breakage. It is sometimes embarrassing to ask the set owner for a mirror as he may not have one or the one he has is so small that it is practically useless for the purpose. Also, it is important to maintain a professional appearance. A service technician doesn't add to his prestige by coming improperly equipped.

I always carry a 10 x 14-inch photofinisher's ferrotype plate in my tube kit. These highly polished plates make good mirrors and do not break. You can purchase ferrotype plates from a photographic supply store. They come in various sizes which will fit conveniently into almost any TV tube and service kit.—*Orville Hellman*

CLAPBOARD DIALS

Experimenters who need a good flat white material for dials, meter scales, and small panels which require accurate marking will find the popular white aluminum siding an ideal material. The metal is light, thin, and stiff, and works well. Its flat enamel coating takes both pencil and India ink readily, and is washable for correction and reuse. A scale made of this material is far superior in appearance to the usual paper or cardboard makeshifts.

Having such a good material handy encourages construction of many small units with other inexpensive materials and components. For example, with a small piece of siding, the 50-to-1 ratio vernier dial used on BC-375 tuning units can be converted into an excellent dial for a v.f.o., mobile converter, signal generator, or communications receiver. A round, rotating dial can be fastened directly to the hub of the drive mechanism, replacing the small scale originally provided, or a fixed scale may be fastened to the panel by the same screws that attach the drive unit, and a sweeping pointer of transparent plastic attached to the hub. On one receiver we built, we extended the horizontal drive shaft to permit use of a 6-inch rotary dial scale with excellent results.—*Wm. Bruce Cameron, W8IVJ*

WEAK U.H.F. TV SIGNALS

Recently a new u.h.f. TV station began operating in our area. Signal strength was generally satisfactory, but in my location, it was too weak and the pictures were snowy with little or no contrast. I installed an all-channel v.h.f. booster in the transmission line between the u.h.f. converter output and the antenna terminals of the set. Now the picture is remarkably clear when the booster is tuned to the converter i.f.—*Max P. Vineski*

SPACE RESERVED!

for RCP Model 808A "Do-All" Tube and Set Tester

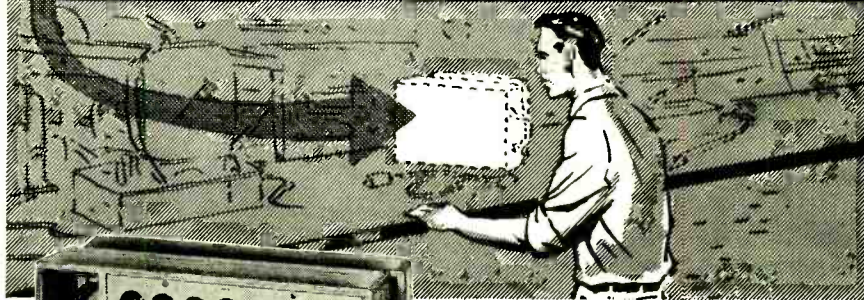

Because the Radio City Products Model 808A gives you more than just the facilities of a Tube Tester. It fills the need for a TV-Radio-CR Tube Tester and VTVM—with all this extra value designed into one unit.

Five Times Better Because It Is Five Instruments In One!

A TUBE TESTER—All the features of the famous 323 Dynoptimum free point tube tester—protected against obsolescence—tests all modern standard, miniature, naval base and subminiature tubes. Easily read on 4 1/2" meter.

A CATHODE RAY TUBE TESTER—Will check all magnetic deflection type Television Picture tubes. Locates and isolates all shorts or leaks.

A REACTIVATOR—Revises and Reactivates many otherwise Dim or Bad Television Picture tubes. Can also be used on other tubes.

A VT VOLT METER (A.C.-D.C.)—This really outstanding 17 Range instrument is a VT Voltmeter for AC as well as DC. Balanced bridge type push-pull circuit. Draws negligible current due to high Impedance

of 25 megohms. Accuracy $\pm 3\%$ DC, $\pm 5\%$ AC. Discriminator alignment scale with zero center. AC & DC volts 0 to 5-25-100-250-1000-db — 20 to 16, —6 to 30, 6 to 42, 14 to 50, 26 to 62.

AN OHMMETER—Reads all Resistances 0.2 ohms to 1000 megohms on 5 ranges. Use this instrument also to check condensers for leakage and shorts.

Equipped with a double rollindex and enlarged, easy to read letters and numbers, the new RCP 808A is so designed as to simplify each operation. Truly a professional instrument for the professional technician.

The RCP 808A is housed in a handsome hand-rubbed oak carrying case and features an attractive, highly visual panel. Compartment available to hold test leads, isolation probe, batteries, etc. Size 12 1/2" x 12 3/4" x 4 3/4". Weight 12 lbs. Complete, ready to operate at. **\$99.95**

Understand why so many servicemen agree that RCP is The Best For Test. Ask your local distributor for a copy of the latest Radio City Products Catalogue or write to us, in care of Dept. RE11

RADIO CITY PRODUCTS CO., INC.

152 WEST 25th STREET • NEW YORK 1, N. Y.



PRES-PROBE CONDENSER TESTER

Finds Intermittent Condensers Instantly



Pres-probe's sliding tip with variable resistance prevents condenser heating. Tests with power on. Requires no adjustment. Stops guesswork. Saves time. Convenient probe size (7/16" long). Satisfaction guaranteed.



See Your Dist. or Order Direct

PRES-PROBE CO.
4034 N. Sixth St., Milwaukee 12, Wisc.

ENJOY 3 COLOR TELEVISION FILTER SCREEN NOW

Changes dull eye-straining black and white pictures into beautiful color tones. Seconds to attach. No tools used. Helps eliminate glare and snow in fringe areas. Order direct. Send \$1 for screen size up to 16". \$1.25 size 17". \$1.50 size 20". \$1.95 size 24". We pay postage except on C.O.D. orders. Satisfaction guaranteed. Dealers in TV areas needed.

Zingo Products, Johnstown 13, New York

\$3.00 FOR CARTOON IDEAS

RADIO-ELECTRONICS prints several radio cartoons every month. Readers are invited to contribute humorous radio ideas which can be used in cartoon form. It is not necessary that you draw a sketch, unless you wish.

Address
RADIO-CARTOONS, RADIO-ELECTRONICS
25 West Broadway, New York 7, N. Y.

... to servicemen
who really want to
learn to use the
OSCILLOSCOPE
fully and accurately!

A complete
guide to using
the handiest
service instru-
ment of all...
... On all kinds
of jobs!...
Written so you
can really
understand it

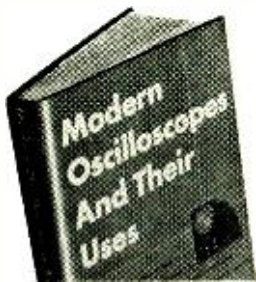

**MODERN OSCILLOSCOPES
AND THEIR USES**

By JACOB H. RUITER, Jr.
of Allen B. DuMont Laboratories, Inc.
326 pages, 370 illustrations, \$6.00



Like most servicemen, you've probably read a lot about oscilloscopes—but still don't know how to use them as well as you'd like to.

If so, here's the book you've been looking for. In MODERN OSCILLOSCOPES AND THEIR USES, Mr. Ruitter starts right at the beginning. He shows how oscilloscopes are designed and how they work. Then he explains exactly how, why and where to use them. No involved mathematics. No puzzling theoretical discussions. Instead, this world famous authority gets right down to earth in answering the questions that have probably kept you from taking full advantage of the money-making service possibilities in oscilloscopes.

**HOW TO HANDLE TOUGH JOBS
EASIER AND FASTER**



From routine troubleshooting to handling the toughest re-aligning and adjusting jobs, each operation is carefully explained. These include determining where and how to use the oscilloscope; how to make connections; how to adjust circuit components; how to set the controls—AND, ABOVE ALL, HOW TO ANALYZE PATTERNS. From dozens of pattern photos you see and learn to recognize patterns that are wrong, nearly right and exactly right!

**SAVE HUNDREDS OF DOLLARS
IN AM-FM-TV SERVICE TIME!**



Busy servicemen have told us that the television service section of MODERN OSCILLOSCOPES alone is worth the entire price of the book. Here you get exact procedures for aligning the I-F stages; aligning V-F tuned circuits in the mixer stage; troubleshooting the gain of the picture I-F stage by stage; troubleshooting the sweep circuits . . . and dozens of other jobs. Similar big sections cover use of the oscilloscope in AM and FM radio servicing and other electronic uses.

No other type of specific service training can mean so much to you in terms of increasing your efficiency and earning power. Use coupon today!

READ IT 10 DAYS at our risk!

Dept. RE-113, RINEHART BOOKS, Inc.
Technical Division
232 Madison Avenue, New York 16, New York

Send MODERN OSCILLOSCOPES AND THEIR USES for 10-DAY FREE EXAMINATION. If book is satisfactory, I will then send you \$6.00 promptly in full payment. If not, I will return book postpaid in good condition and owe you nothing.

Name.....
Address.....
City, Zone, State.....
Employers' Name and Address.....
Price outside U.S.A. \$6.50, cash only. Money back if you return book within 10 days.

TRY THIS ONE

PICTURE-TUBE CHECKERS

I use two simple adapters to make preliminary checks on brightness and contrast controls and to check for video signal and grid-2 voltage at the base of the picture tube. If the circuits check O.K., then the fault is very likely to be in the picture tube.

The adapters consist of electron-ray indicator tubes which plug into the picture-tube socket and indicate circuit performance by changes in shadow area and brightness of the fluorescent glow.

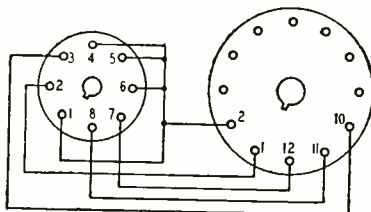

Fig. 1

Fig. 1—Adapter using 6AL7 indicator.

The circuit in Fig. 1 uses a 6AL7 and Fig. 2 uses a 6E5. The tubes plug into Eby sockets mounted in bases removed from old picture tubes. The socket fits loosely in the tube base, so four segments were cut from the base of an old 5U4-G and placed around the inside wall of the picture-tube base to make a snug fit for it. The sockets can also be mounted on long extension cables for use on test benches.

When the set is turned on and the tester is plugged into the picture-tube socket a bright glow indicates B plus voltage on grid (pin 10). The intensity

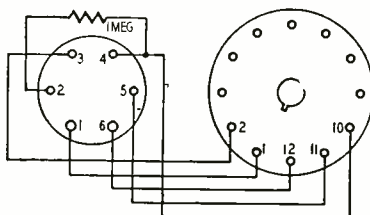

Fig. 2

Fig. 2—Adapter using 6E5 indicator.

of the glow and the shadow area should change with the settings of the contrast and brightness controls. The edges of the shadow area will appear blurred if video signal reaches the picture-tube socket. This will change with the setting of the fine-tuning control when the set is tuned to a telecasting channel.

—Hyman Herman

(All modern TV picture tubes use 6.3-volt, 600-ma heaters, so it is advisable to connect a 20-ohm, 5-watt resistor across the heater pins inside the adapter. This protects the indicator tube when the adapter is plugged into a set using a series heater string.)

—Editor

AMPLIFIERS FOR TV SETS

Quality-conscious music fans often feed the audio output of their TV sets into wide-range amplifiers and speaker systems. Before undertaking a job of this type, check the TV set carefully for the slightest trace of intercarrier buzz, because the increased bass response will greatly accentuate it. Since it is prac-

FREE!
THE HOTTEST VALUE-
PACKED BULLETIN
IN THE MAILS!

Over 153,000 subscribers
buy and save through
**WHOLESALE RADIO'S
F.Y.I.
BULLETIN
EVERYTHING
IN RADIO • TV
HI-FI SOUND**

Write for
New FYI
#203
Just Off
The Press

**WHOLESALE
RADIO PARTS
COMPANY, Inc.**
311 W. Baltimore St.
Baltimore-T, Md.

Nationally
Famous
T.V. SETS

17" Table \$122.68 Pl. \$12.27 Fed. Excise Tax	Check these luxury features: Ultra sensitivity, dynamic range control, UHF adaptability, Duo power supply, Acousticlear Sound System . . . All in a beautiful Mahog- any Finish Cabinet.	21" Console \$164.95 Pl. \$16.50 Fed. Excise Tax
20" Table \$134.50 Pl. \$13.45 Fed. Excise Tax		20" Console \$149.95 Pl. \$15.00 Fed. Excise Tax

ALSO AVAILABLE T.V. CHASSIS

All sets have full 1 yr. factory picture tube warranty, and standard 90 day RTMA parts warranty.
MAIL and Phone orders filled, \$25 deposit, Balance C.O.D.. Shipping Charges Add'l.

STEPHEN SALES CORP.
45 Crosby St., N. Y. 12. Phone WO 4-8233

Dealer Inquiries Invited

Please mention
RADIO-ELECTRONICS
when answering
advertisements

tically impossible to eliminate residual traces of buzz from intercarrier sets, it is wise to restrict your conversion jobs to split-sound sets or intercarrier sets which do not have a perceptible trace of buzz. The only other alternative, is to use an amplifier with a bass response attenuator. —Charles Erwin Cohn

HOOKLESS ALLIGATOR CLIPS

Test leads, cables, antenna lead-ins, and test instrument wires equipped with insulated alligator clips often become an entangled mess on the bench because the built-in "hook" on the backside of the alligator clip snags the other wires on the bench. It is aggravating to attempt to unsnarl a mass of leads by pulling, twisting, and looping the various leads in and out and through one another.

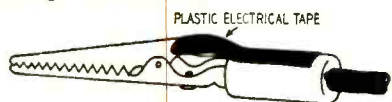

The drawing shows how a small piece of Scotch electrical tape may be placed across the open hook portion of the clip to keep this from happening. When cleanup time comes, the various leads and test wires untangle with ease. —Geo. D. Philpott

MIKE ADAPTER FOR PHOTOLAMP STAND

The simple adapter shown in the photo will permit almost any photolamp or music stand to be used as a stand for your microphone. The stand, need not be altered and the adapter allows it to be used interchangeably for a photolamp or a microphone.

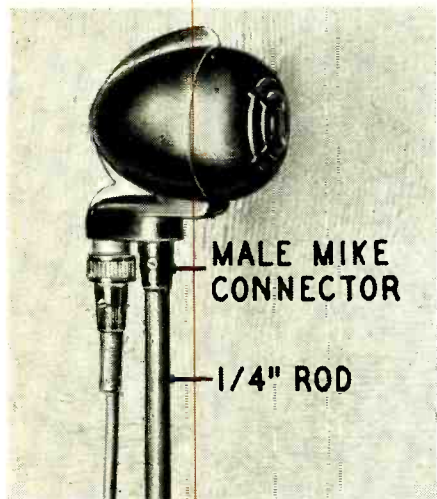

MALE MIKE CONNECTOR

1/4" ROD

Remove the cable-protecting spring from an Amphenol type 75-MC1M male microphone cable connector, insert a 3-inch length of 1/4-inch diameter brass rod, and tighten the set-screw. Screw the cable connector into the socket of the mike and insert the rod into the top draw-tube of the stand. In some cases it may be necessary to reduce the diameter of the rod slightly with a file, so that the rod will slip into the draw-tube easily but snugly. —Arthur Trauffer

END

WHY PAY MORE?

Custom Built

TV CABINETS

Don't be misled! Other cabinets may look the same, but they are NOT similar in QUALITY. Our cabinets are massively constructed, fully reinforced, smartly styled in the modern manner, and offered to you at today's LOWEST PRICES. Buy with confidence. All cabinets illustrated available in Mahogany. Add 10% for Blonde Korina and Lined Oak. Complete catalog on request.



Model 1200
H 35" W 40"
D 23"
\$130.00

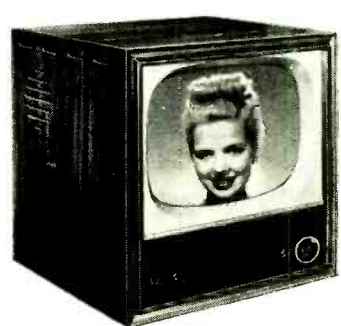

Model 500
H 25" W 25" D 21 1/2"
17" to 21" \$42.00
24" & 27" 59.50

TV CHASSIS SPECIAL VALUES

all less picture tube

VIDEO 530 DX Chassis	\$139.50	TECHMASTER C-30-TV Chassis	\$149.50
VIDEO 630 Super-Deluxe	149.50	TECHMASTER 1930 TV Chassis	179.50
VIDEO 630-DX Chassis	159.50	TECHMASTER 2431-P TV Chassis	199.50

Please include 25% deposit with orders, balance C.O.D. All shipments P.O.R., NYC. Prices subject to change without notice.

Save Money with TELE SOUND "Package Deals"!

Order the Tele Sound Cabinet you want combined with Vide 530 DX Chassis, 12" speaker and picture tube, at these terrific low prices:

CABINET STYLE	17" CRT	20" CRT	21" CRT	24" CRT	27" CRT
250	\$218.81	227.73	229.87
500	204.09	213.01	215.15	266.63	329.03*
1200	287.69	296.61	298.75	333.61	396.01*

* For other TV chassis add: Video 630, \$5; Video 630-DX, \$10; Techmaster C-30, \$5; 1930, \$30; 2431-P, \$50. These models equipped with Video 530-DX-C-27 chassis.

Model 250
H 40 1/2" W 25"
D 22"
\$57.50

Standard Brand
PIX TUBES—1 YR. GUARANTEE

17" 17BP4A	\$28.90
30" 20CP4A	38.05
21" 21EP4A	40.25
34" 24PB4	75.00
27" 27GP4 (electro-magnetic)	90.00

Tele Sound

CORPORATION

"Designers and Manufacturers of Custom TV and Radio Furniture."

431 West 28th Street
New York 1, N. Y.
Phone: WI 7-0719

TELEVISION

Big demand for graduates

B.S. DEGREE IN 27 MONTHS in radio including TV engineering—VHF, UHF, AM and FM. Students use over \$100,000 worth of equipment including 2 large commercial type transmitters in new TV lab. Intense specialized course includes strong basis in mathematics, science and advanced design in radio and TV.

Hundreds of young men each year are earning engineering degrees in this recognized institution. Start any quarter. Many earn a major part of expense in this industrial center. Low tuition. Competent instruction. Thorough, intense, practical program.

Also **B.S. DEGREE IN 27 MO.** in Aeronautical, Chemical, Civil, Electrical and Mechanical Engineering. G.I. Gov't approved. Enter Dec., March, June, Sept. Free catalog. **ENROLL NOW.**

INDIANA TECHNICAL COLLEGE
17113 E. Washington Blvd., Fort Wayne 2, Indiana

ANOTHER OUTSTANDING JOBBER

NIDISCO

713 Newark Ave.
Jersey City, N. J.

55 State St.
Hackensack, N. J.
294 Passaic St.
Passaic, N. J.

658 Anderson Ave.
Cliffside, N. J.
126 So. Warren St.
Trenton, N. J.

HAS THE SENSATIONAL NEW

EICO

1180-K DECADE CONDENSER BOX KIT IN STOCK!



\$14.95

Fringe Beam

Presents the sensational NEW

VHF-UHF

PARABORAY

- High average gain across entire TV spectrum.
- Based on the radar parabolic-type antenna.
- Dipole of entirely new design produces sharp pattern.



Model FB-P283 List \$39.50

CHECK THESE OUTSTANDING SELLING FEATURES

1. No other antenna is necessary with the Paraboray; and only one transmission line is needed for VHF and UHF.
2. Lightweight, but ruggedly constructed to withstand the most adverse weather conditions.
3. Will give more performance per dollar than any other antenna on the market.
4. Clear picture in the 100—200 mile range.

An outstanding line for outstanding representatives. Some territories still open. Write today!

NEAL ELECTRONIC CO.

P. O. Box 376

Huntsville, Ala.

RAM COMPLETES THE SWEEP
NEW VERTICAL COMPONENTS

Now the most complete Sweep Replacement Line.

Simplify your replacement problems with the RAM combination of vertical components, horizontal output transformers, deflection yokes, width and linearity coils. RAM, as original manufacturers, assures you the highest quality and performance standards.

RAM

For complete specs and local jobbers name, write Dept. RE-11

ELECTRONICS SALES CO., IRVINGTON, N. Y.



RADIO-ELECTRONIC CIRCUITS

REVISED HIGH-VOLTAGE SUPPLY

I constructed the high-voltage generator described on page 62 of the December, 1951, issue and found it necessary to add additional capacitors between terminal 4 of the transformer and the plate circuit to make it operate. The capacitance value was critical and it

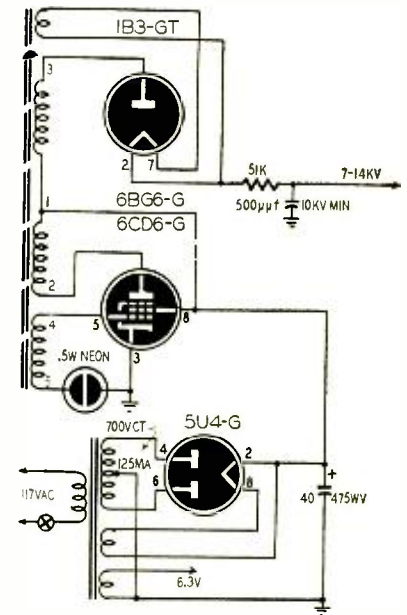

took quite a bit of experimenting to get it to work properly. I made a number of experimental changes in the circuit and finally developed a circuit which uses fewer components than the original and works every time. I have used it with several flyback transformers with good results. The modified circuit is shown in the diagram.—F. D. Whitten

ANTENNA FOR U.H.F. TV

In many u.h.f. TV installations, a high-gain antenna must be used to compensate for losses in the transmission line and to assure an adequate signal at the receiver in fringe areas. Since a full wavelength in the u.h.f. TV band varies from about 25 inches on channel 14 to about 13 inches on channel 83, a high-gain array for u.h.f. TV is inexpensive and is not cumbersome to construct. The 4-bay array shown in the diagram was described in *Sylvania News*. It has a forward gain of nearly 12 db over a single folded dipole cut for the same frequency. Response is broad enough to cover several channels on each side of the center frequency.

The antenna is designed to feed a 450-ohm transmission line. If the receiver or converter has a 300-ohm input, use a 368-ohm quarter-wavelength matching stub between the lead-in and the receiver or use a tapered matching section. The latter consists of a section of transmission line which is spaced to have a characteristic impedance of 450 ohms at one end and 300 ohms at the other. This section should be at least two wavelengths long.

The antenna may be made from aluminum, brass, or copper tubing or

rod. No. 8 aluminum wire (clothes line) will probably work nicely. The phasing lines between the dipoles should have an impedance of 280 ohms. Lengths of 300-ohm ribbon line will be close enough

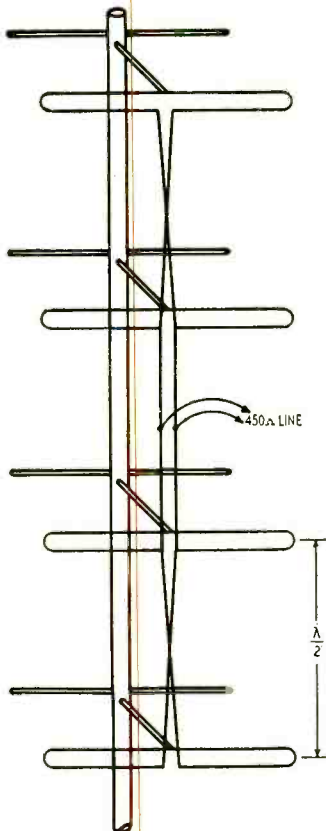
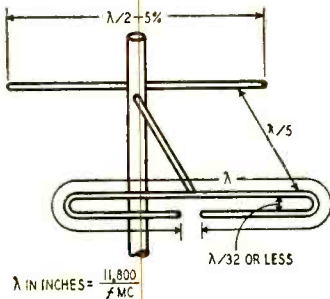

to the required impedance, but you can use any size wire as long as the ratio of wire diameter to center-to-center spacing is held at about 5.3. No. 8 aluminum wire spaced 0.65 inch may be used.

On u.h.f. TV channels, one wavelength (in inches) at the center of the channel can be derived from the formula:

$$\lambda \text{ (inches)} = \frac{(6 \times \text{u.h.f. channel No.}) + 389}{11,800}$$

CONSTANT-OUTPUT OSCILLATOR

The output level of variable-frequency oscillators in transmitter exciters, signal generators, and high-quality communications receivers should be stabilized against changes caused by variations in operating voltages and circuit constants. Various types of automatic voltage control have proved unsatisfactory for class-C oscillators because of their self-biasing feature. Clippers can be used to limit the amplitude but

The Latest and Best in TV ANTENNAS AND ACCESSORIES

from Admiral

World's Largest Television Manufacturer

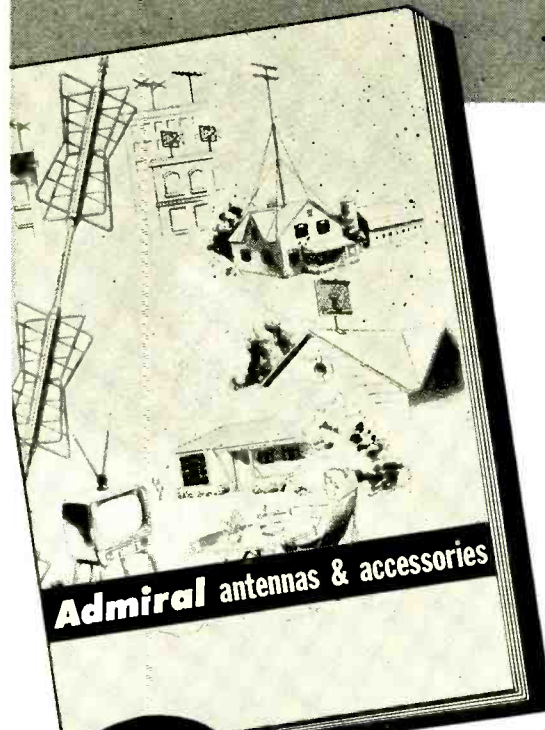

Admiral is first with the best and the mostest. Your Admiral distributor now carries the most complete and up-to-the-minute line of TV antennas and accessories. See the Admiral Catalog for high-gain UHF antennas of the most advanced design . . . rotators . . . all-weather transmission line . . . mast and tower equipment for every type of installation.

Now you can get everything needed from one source, at one time . . . no need to waste time shopping around. Quick, close-to-home service. Admiral prices are lowest. And every item conforms to Admiral's high quality standards. Send for your catalog today!

FREE
Mail coupon for
Admiral
CATALOG

Admiral Corporation, Accessories Division
3800 Cortland St., Chicago 47, Illinois
Please send free catalog.

Name _____
Address _____
City _____ State _____

RE-11

TV GLO-TEST
The answer to the T.V. serviceman's prayer.

An extremely compact all purpose T.V. tester, that almost talks. TV GLO-TEST was designed by T.V. instructors; men who know what is needed for fast and accurate servicing. In actual servicing tests it was proven that TV GLO-TEST can find trouble much easier and faster than many other common methods. By the liberal use of miniature components TV GLO-TEST is kept small in size with no loss in overall efficiency or accuracy. The price has been kept so low that all T.V. servicemen can afford TV GLO-TEST. Its cost is much lower than almost any one of the many instruments it replaces. One or two service jobs can pay for TV GLO-TEST. The instrument is more rugged than an ordinary VTVM. TV GLO-TEST comes complete with instruction book, explaining 50 USES of the instrument plus a trouble shooting guide. A few of the 50 USES are: Pixtube tester, low and high range voltmeter up to 50kv, with accuracy comparable to VTVM, Condenser tester, Signal tracer, Signal generator, tests all circuits and components. See your distributor, or order direct. New low price \$12.50.

VIDEO SPECIALTIES INC.
4508 Firestone Blvd. South Gate, Calif.

CORONA RADIO KITS

• Easy Assembly • Excellent Reception

SINGLE BAND SUPER
Rocket 115K—Latest superhet circuit for ultimate in sensitive reception and tonal quality. Kit includes all necessary parts, punched chassis, attractive bakelite mahogany cabinet, built-in loop antenna, iron core IFs, big 5" Alnico V speaker, tubes 12SK7, 12SA7, 12SQ7, 50L6. \$14.75

33Z5. Automatic vol. control, beam power tube. Tunes 340 to 1700 Kc. Simple step-by-step instructions included.

2 BAND AC-DC SUPER
Piazza 812K—Excellent sensitivity. Tunes standard Broadcast 535 to 1800 Kc, foreign shortwave 6 to 18 Mc (11.6 to 50 meters). Features iron core IFs, bass-treble tone control, 5" Alnico PM Spkr., phono jack. Handsome bakelite mahogany cabinet. 11 1/2" x 8 1/2" x 3 1/2". Tubes: 12SK7, 12SA7, 12SQ7, 50L6, 36Z5. All parts, punched chassis, easy step-by-step instructions included. \$20.75

3-BAND SUPER Globemaster 814K Complete Kit. Net \$24.75
All kits supplied loss wire and solder. Please include 25% deposit with C.O.D. Orders. Dept. E-11

CORONA RADIO & TV CO.
136 LIBERTY ST., NEW YORK 6, N. Y.

there's always something **new** being developed by *Perma-Power*

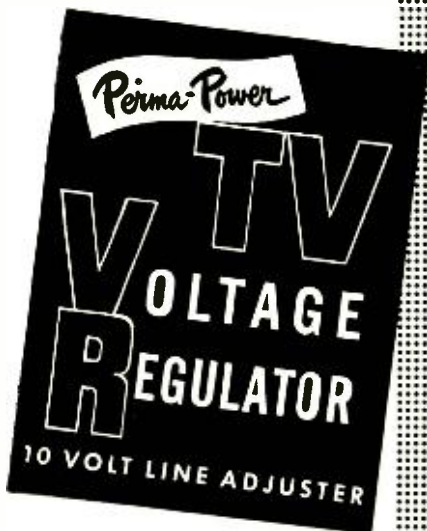

- NORMAL LINE VOLTS
 - 10 VOLTS INCREASE
 - 10 VOLTS DECREASE
- 300 WATTS**

List Price
\$6⁷⁵

Sold Through
Better Jobbers

manufactured by
Perma-Power COMPANY
Chicago 25, Ill.
Manufacturers of Electronic Equipment Since 1928

this distorts the waveform and produces undesirable harmonics.

A constant-amplitude oscillator, developed by N. C. Hekimian of the National Bureau of Standards, and described in *Summary Technical Report 1710*, provides an r.f. voltage that remains reasonably stable regardless of changes in tube parameters, operating voltages, or load impedance. The device shown in the diagram consists of a conventional oscillator with a diode connected across its output ter-

minals. Output stability is provided by a biased clamper tube sharing the same plate-dropping resistor (R1) with the oscillator.

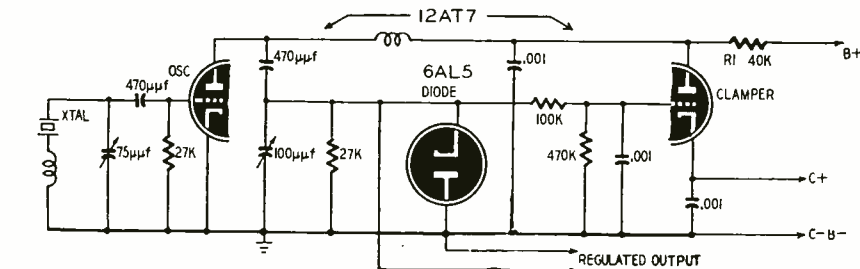

minating resistor R1, its plate voltage drops too. Thus, as the oscillator output voltage increases, the clamper tends to maintain the final output voltage at a relatively fixed level. An experimental investigation of the effect of different values of R1 on the oscillator output voltage shows that a resistance of 10,000 ohms permits a 12-volt variation for a change in plate supply from 200 to 350 volts. A plate-load resistance of 40,000 ohms, however, restricts the output variation to

1.5 volts with the same change in plate supply. In both of these instances the bias supply voltage was held at 18 volts.

The bias for the clamper tube is usually obtained from a low-impedance constant-voltage source. In the test model the bias voltage was obtained from batteries with internal resistances of about 5 ohms. A bias of 25 volts permits the output to vary between 12 and 17 volts for a change in supply from 200 to 350 volts; whereas a bias voltage of 18 volts results in a change of only 1 volt in the output for the same change in supply.

Improved clamping may be obtained by employing a voltage-multiplier type of rectifier to drive the clamper tube. Thus a greater ratio of d.c. control bias to r.f. output is obtained and results in better regulation. Also, if a power amplifier replaced the clamper portion of the 12AT7, its greater plate-current capabilities would result in more positive control action. **END**



"You don't have to fix that. I never watch it."

Suggested by Jeanne De Good, Kansas City

TUNING INDICATOR CIRCUIT

? I would like to add a tuning indicator to my AM-FM tuner. The AM circuit is conventional; the FM circuit uses a ratio detector.—M. G. S., Vicksburg, Miss.

A. The diagram shows how a 6U5 or similar tuning indicator tube can be added to the circuit of a typical AM-FM tuner or receiver which uses a ratio detector. A suitable control voltage for the indicator can usually be

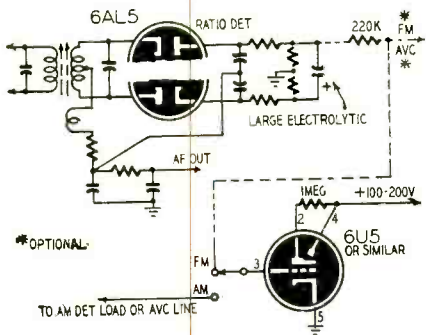

tapped off to the negative terminal of the electrolytic capacitor which is a part of the ratio detector circuit. The 220,000-ohm resistor may be added to improve the performance of the circuit.

For AM tuning, the grid of the tuning indicator can be connected directly to the a.v.c. line or it may be connected to a point on the detector load resistor. The switch may be separate or it may be added as a part of the AM-FM switch.

POWER SUPPLY

? How do I go about designing a power supply delivering 150 volts regulated B plus, 20 volts bias for grids, and 2 volts d.c. at 1 ampere for the filaments of the English battery set which I am converting.—I. I., Montreal, Canada

A. The first step in designing any power supply is to set down the voltage and current requirements of each circuit to be supplied. You did not specify the current drain on the 150-volt line.

The basic diagram of a simple power supply of the type that you want is shown in the diagram. The values of

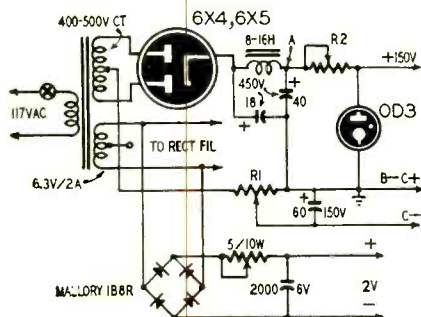

R1 and R2 are not given because these depend on the current through the 150-volt circuit. A single 0D3 can be used to stabilize the voltage at 150 if the current does not exceed 40 ma. If the total drain on the regulated source exceeds 40 ma, you may be able to split the load into several branches which



Standardize on

WEBSTER ELECTRIC
Featheride
REPLACEMENT CARTRIDGES

When you stock these five models of Featheride Replacement Cartridges, you can handle virtually all replacement needs—regardless of make of record player or changer—quickly, easily, profitably, and with a minimum inventory investment.

Mail the coupon for free copy of our handy new Replacement Chart YF-2, showing how you can most profitably fill your replacement needs.

these 5 models are all you need!

Model WS • A versatile unit capable of replacing the majority of 78 RPM Cartridges in the field.

Model AX • A complete unit for three-speed application, furnished with a removable twist mechanism.

Model BX • Designed primarily for RCA Automatic record changers and Columbia players. Unusually high fidelity.

Model CX • May be used with a three-mil needle for 78 RPM or two-mil needle for three-speed application.

Model FX • A two-needle twist cartridge, delivering high or low output.

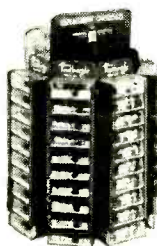

THIS NEW DISPENSER WILL INCREASE YOUR SALES

• This attractive Featheride Replacement Cartridge Dispenser on your counter or wall will boost your sales and profits. It comes with a basic stock of 10 each of the 5 models shown above—each cartridge packaged with all needed fittings, instructions and data, all in individual transparent plastic box. Replacement chart included in back of dispenser.

Send coupon for details of our Special Dispenser Offer, whereby you save \$10 if you order promptly.

WEBSTER ELECTRIC
RACINE WISCONSIN

"Where Quality is a Responsibility and Fair Dealing an Obligation"
WEBSTER ELECTRIC COMPANY, RACINE, WISCONSIN • EST. 1909

Webster Electric Co., Dept. RE-11, Racine, Wisconsin
Send me, without obligation, the items checked below:
 Free Featheride Replacement Chart YF-2
 Details of Special Dispenser Offer, whereby we can save \$10.00

Ordered by _____
Company _____
Address _____
City _____ Zone _____ State _____

SAVE ON INSTRUMENTS!

- do better testing with fewer instruments
- avoid buying costly equipment you don't really need
- discover new uses for old instruments
- learn all about ALL instrument types; how to use them more efficiently; how to interpret their readings



Get the real "low-down" on

Current and voltage meters
TV pattern generators
Grid-dip oscillators
Oscilloscopes
Ohmmeters
Volt—Ohm—Milliammeters
V-T voltmeters
Power meters
Capacitor checkers
Impedance meters
Special-purpose bridges
Tube testers
TV sweep and marker generators
Distortion meters
TV linearity pattern generators
Square-wave generators
R-F signal tracers
Signal generators
R-F test oscillators
Inductance checkers
R-F and A-F measuring devices
... and over 30 other standard instrument types!

This book can save you hundreds of dollars by avoiding unnecessary instrument purchases. And it can help you handle all kinds of testing faster and more accurately in the bargain by putting your present instruments to better use!

Actually, BASIC ELECTRONIC TEST INSTRUMENTS is a complete training course covering over 60 instrument types for TV and radio service, ham and experimental use. The author's whole object is to help you do better work; choose instruments intelligently and use them fully. Dozens of work-saving short-cuts are outlined. New uses for old instruments are clearly explained.

Practically all present day instruments—including the latest television types—are impartially discussed. You learn exactly how to use each type and to know exactly what it can and cannot do.

MONEY-SAVING "TRICKS"

You discover new uses for VOM's, oscilloscopes, signal generators, etc. You see how to extend the range of many old instruments; how to use power drain measurements for fast TV trouble-shooting; how a bridge can be built from old instruments; how to measure r-f impedance the easy way; how to measure inductance and capacitance with a grid-dip oscillator and dozens of other money-saving "tricks".

Use coupon now for 10-day FREE trial.

10-DAY FREE TRIAL

Dept. RE-113, Rinehart Books, Inc., Technical Div., 232 Madison Ave., New York 16, N. Y.

Send Turner's BASIC ELECTRONIC TEST INSTRUMENTS for 10-day FREE examination. If I decide to keep book, I will then remit \$4.00 plus postage. Otherwise I will return book post-paid promptly and owe you nothing.

Name.....

Address.....

City, Zone, State.....

OUTSIDE U. S. A.—Price \$4.50 cash only. Money back if book is returned in 10-days.

QUESTION BOX

do not exceed 40 ma. Each branch can then be regulated by a separate OD3 and series-dropping resistor. Vacuum-tube voltage-regulator circuits should be used if the load exceeds 40 ma and cannot be split into two or more branch circuits carrying not more than 40 ma each. See "Voltage Regulation" in the August, 1952, issue.

The value of R2 can be found from the formula

$$R = \frac{E_s - 150}{40}$$

where E_s is the supply voltage as measured at point A and 40 (ma) is the maximum operating current of the OD3.

The value of R1 is found by dividing the required bias voltage (20) by the total current drawn from the 150-volt line.

Filament voltage is obtained by rectifying the voltage across a 6.3-volt filament winding on the transformer. The simple filter circuit shown will work for some sets. In others, it may be necessary to add a low-inductance, 1-amp filter choke and an additional 2,000- μ f filter capacitor to reduce hum caused by ripple on the filament line.

High-voltage loss

? In a Fada receiver having an RCA 630-type chassis, I have intermittent loss of high voltage. Replacement of the 1B3-GT and 6BG6-G cured the trouble for about two months but it has developed again. During the absence of the high-voltage I measured the plate voltage at the 6BG6-G and the 1B3-GT and have obtained two different readings. At one time the voltage measured 100 volts negative and at another time, 220 volts positive. The flyback transformer has been checked for continuity and the resistance conforms to that in the schematic. Capacitors C188 and C186 have been checked and found normal. E. F. A., Santa Ana, Calif.

A. The fact that you get a variation in readings at the plate of the 6BG6-G indicates that an intermittent condition in this circuit is causing your trouble. The reading of minus 100 volts at one time, and the high positive voltage at another would give intermittent high voltage because loss of B-plus on the 6BG6-G would also remove the flyback pulse.

Your trouble might be in the damper circuit, which generates the voltage boost for the 6BG6-G. Try a new damper tube and also check all parts in that circuit. You should secure a steady 430 volts at C188 feeding the bottom of the horizontal output transformer.

Using a v.t.v.m. at the plate of the 6BG6-G is dangerous, for the v.t.v.m. can be damaged. When high voltage is present pulses in excess of 6,000 volts are present here besides the regular low-voltage B-plus. Better confine your voltage checks to the voltage boost system, screen of 6BG6-G, etc., and use continuity checks (with receiver off) for the coil sections.

Stereophonic field recordings can now be made with ease and assured professional results using a choice of three models operating at tape speeds of 15, 7½ and 3¼ ips. to provide frequency responses up to 15,000, 7,500, and 5,000 cycles respectively. 15 and 7½ ips. models meet primary and secondary NARTB standards for flutter, frequency response and dynamic range.

Enables stereo-enthusiasts, sound engineers, researchers, broadcasters and motion-picture producers to economically experiment and efficiently produce ideal recordings with optimum stereophonic effect.

All models measure 8½ x 11 x 10 in. and weigh 17 lbs. Employ two completely isolated channels for recording and playback. Utilize 60 kc ultrasonic bias oscillator. Provide 50 hours of operation from one economical set of standard dry cell batteries.

Incorporates governor-controlled constant speed spring-motor. Stereo-headphone monitoring while recording and playback. Overall dynamic range 50 db. Flutter less than $\pm 0.1\%$.

Stereo-cephaloid crystal or dynamic microphone available to produce diffraction and acoustic pickup pattern simulating human stereophonic hearing.

Completely battery-operated stereophonic recording-playback system easily carried and operated anywhere. Uses standard ¼ in. tape on 5 in. reels.

Write for complete technical literature and direct factory prices to Dept. RE

AMPLIFIER CORP.
of AMERICA

398 Broadway, N. Y. 13, N. Y.

*T.M. Reg. U.S. Pat. Off.

S-38-C NOISE LIMITER

? An early version of the S-38 receiver included an automatic noise limiter. My S-38-C does not have this feature. How can I add one to my set?—*J. O., Olive View, Calif.*

A. A set such as this may not have enough gain for proper operation of an automatic noise limiter but we are showing two circuits you can try. Fig.

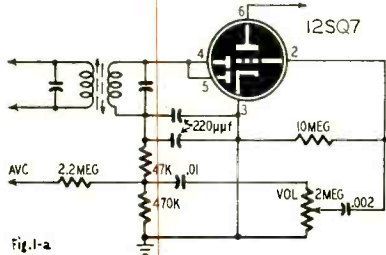

Fig. 1-a

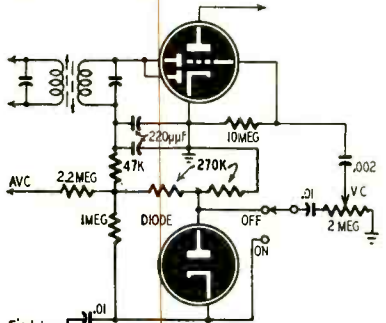

Fig. 1-b

1-a is the original circuit of the detector and first a.f. amplifier. Fig. 1-b shows how a diode noise limiter may be added to the circuit. You can substitute a 12S8-GT triple-diode-triode for the 12SQ7 or you can try a germanium diode. The diode noise limiter circuit is extremely sensitive, and great care should be exercised in the mounting of the switch. Because it readily picks up hum and introduces feedback, it should be mounted close to the tube.

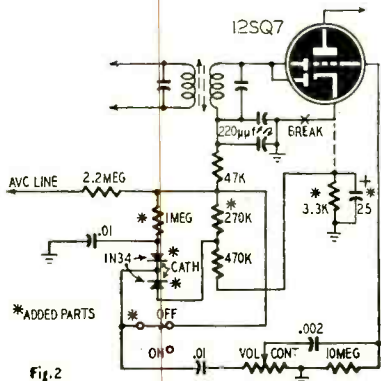

Fig. 2

Fig. 2 is a modification for using a pair of 1N34 diodes in a series-shunt noise limiter circuit. Components marked with an asterisk are added to the original circuit. Compare Fig. 2 with Fig. 1-a.

TRANSMITTER CONVERSION

? I am planning to build the low-power transmitter described in the December, 1952, issue. However, I am a novice and cannot use a v.f.o., so I will need details on adding crystal

GONSET'S NEW DE LUXE TV Remote Control

FOR USE WITH ANY TELEVISION RECEIVER



Now . . . you can sit back and relax in that comfortable chair and really enjoy your TV viewing. There will be no need to jump up to change to another program . . . or to make adjustments in contrast . . . or in audio volume level. Now . . . all this can be done right from where you sit with the new Gonset De Luxe Remote Control!

This compact unit, housed in a smartly styled Blonde or Mahogany cabinet sits on a small end table or on the floor beside your chair . . . takes over all TV panel controls . . . places them directly at your fingertips. An unobtrusive cable, colored to blend into the background of walls or carpeting, makes complete connections to your TV set. Here is a really simple, troublefree arrangement that may be used with any make or model TV set, old or new.

There's no loss of picture or sound quality . . . can actually effect a decided improvement in many older model sets. No danger of obsolescence either . . . your Gonset unit can be shifted to any new set you may subsequently purchase.

There's also provision for earphones. Now . . . personalized TV listening and viewing at any hour without objection by family or neighbors.

The Gonset De Luxe Remote is a complete TV front-end: Cascade RF, Mixer-oscillator, (Standard Coil Tuner), I.F. booster stage and integral power supply.

No loss in picture quality or brightness. Actually improves many of the older sets.

May also be used as UHF converter as turret tuner has provision for snap-in coil strips.

Has earphone provisions! Ideal for sick-rooms, hospitals, "Night owl" listening

Connects to I.F. of existing receiver. Two models cover standard TV I.F., frequencies. Doesn't require major set alterations.

SERVICE DEALERS

You'll want full technical and dealer price information on this highly popular item. Write today. (Business letterhead, please.)

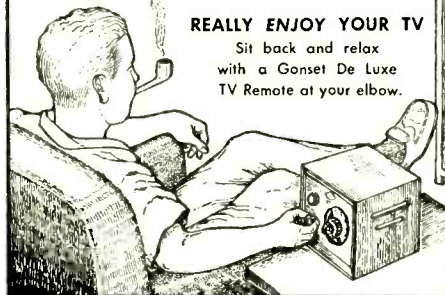

REALLY ENJOY YOUR TV
Sit back and relax with a Gonset De Luxe TV Remote at your elbow.

Write today!



801 South Main St., Burbank, Calif.

GONSET CO. DEPT. RE-1

801 South Main St., Burbank, Calif.

Please send further details and price information on your new De Luxe TV Remote Control Unit.

NAME _____

ADDRESS _____

DEALER _____

SERVICE TECHNICIANS

What was your most unusual service case? Not necessarily the most difficult one, but the one you will remember longest, either because of the problem itself or because of other conditions surrounding the job. If the experience was interesting to you, it probably will be to other readers of RADIO-ELECTRONICS. We will pay \$10 for each "My Most Unusual Service Job" item we consider outstanding enough to publish in this magazine. If the item is striking enough or carries sufficient technical information to be worth more than \$10 in our opinion, it will be paid for at our regular space rates. Address your stories to

Unusual Service Job

RADIO-ELECTRONICS

25 WEST BROADWAY

NEW YORK 7, N. Y.

Attention!! • EXECUTIVES • SALEMEN • PUBLIC OFFICIALS
• POLICEMEN • FIREMEN • OUTDOOR MEN
REPORTERS • FIELD INSPECTORS • DOCTORS • LAWYERS, ETC.

DICTATE IN YOUR CAR

with **ATR** INVERTERS

for changing your battery current to
A.C. Household CURRENT
Anywhere . . .
in your own car!!



\$25.55
AND UP

EASY TO INSTALL
EASY TO OPERATE

A VALUABLE TIME SAVER FOR:

- **TRAVELLING SALESMEN**—Dictate reports in your own car. Send your dictated reports in daily to your home office or sales manager.
- **FIELD INSPECTORS & INVESTIGATORS**—Dictate your field inspection reports in the field—on the spot. Give the complete story factually and completely. Include your clients recordings also.
- **DOCTORS**—Dictate and record your house calls on the completion of your call while everything is fresh in your mind. Have these records for transcription by your office girl.
- **LAWYERS**—Record evidence in the field of your client's premises. Obtain factual and complete witness reports, etc.
- **EXECUTIVES**—Dictate in your car all business matters while on trips for pleasure or business.
- **PUBLIC OFFICIALS**—Dictate complete field reports in your car. Obtain recorded opinions and expressions of Mr. Public in the field. Dictate your business reports while traveling.
- **POLICE SQUAD CARS**—Dictate accident reports right on the scene complete and factual. Include witness recordings at the same time. Have the complete story available by dictation.
- **FIRE TRUCKS**—Dictate your fire reports, factually and complete on the scene and include witness reports. Have the complete story.
- **AMBULANCES**—Dictate complete reports of your ambulance run. Include witness recordings, etc.
- **ADVERTISING AGENCIES**—Use AC operated animated or illuminated displays in or on the car.
- **FISHERMEN & HUNTERS**—Use your electric radio on camping trips, operating in your car. Also small home radios and other electrical or electronic items.
- **CAMPERS**—Make your camping and outing trips more exciting using mix-masters, tape recorders, or wire recorders operating from your car battery.
- **WAREHOUSE & MATERIAL HANDLERS**—Dictate your inventory and material handling reports on the scene, in the warehouse yard, or wherever you may be.

There is an ATR INVERTER for most applications for converting D.C. Voltages (ranging from 6 volts D.C. to 220 volts D.C.) to 110 volts A.C. . . . Specially Designed for operating A.C. Radios, Tape Recorders, Wire Recorders, Dictating Machines, Electric Razors, Record Changers, Television Sets, Amplifiers, Address Systems, Radio Test Equipment and most small electrical and electronic devices FROM D.C. VOLTAGES IN AUTOMOBILES, BUSES, TRUCKS, SHIPS, TRAINS, PLANES AND IN D.C. DISTRICTS.

Additional information available upon request.

FREE!! ATR INVERTER!
Given away every 30 days to lucky registrant of preceding month. Mail a postcard as your registration request today!

TYPE	Input DC Volts	AC Output 60 Cycles	Output Wattage Inter. Contin. uous	Wattage Inter. Contin. uous	List Price	RECOMMENDED APPLICATIONS
6-LIF 12-LIF	6 12	110 volts 110 volts	40 50	35 35	\$25.55 25.55	For operating small flea-power AC motors, electric razors, small radios and small portable dictating machines having wattage consumption less than 35 watts.
6-RSD 12-RSD	6 12	110 volts 110 volts	85 125	75 100	39.25 39.25	Recommended for operating small AC motors, Radio Sets, PA Systems, Amplifiers, and Radio Test Equipment having input wattage consumption within continuous output wattage ratings indicated.
6-ISQ-F 12-ISQ-F	6 12	110 volts 110 volts	85 125	75 100	49.95 49.95	Especially recommended for operating dictating machines, wire recorders, tape recorders, and small AC motors and electronic or electrical apparatus having input wattage consumption within continuous output wattage ratings indicated.
6T-HSG 12T-HSG	6 12	110 volts 110 volts	175 250	150 200	96.45 96.45	For operating large tape recorders, wire recorders, PA Systems, amplifiers, and small TV sets having input wattage consumption within the continuous output wattage ratings indicated.

See your jobber or write factory ✓ NEW MODELS ✓ NEW DESIGNS ✓ NEW LITERATURE

"A" Battery Eliminators, DC-AC Inverters, Auto Radio Vibrators

ATR AMERICAN TELEVISION & RADIO CO.

Quality Products Since 1931
SAINT PAUL 1, MINNESOTA—U. S. A.

BLAK-RAY SELF-FILTERING ULTRA-VIOLET LAMP



BLAK-RAY 4-watt lamp, model X-4, complete with U-V tube. This lamp gives long-wave ultra-violet radiation having a wave-length of 3654 to 4000 angstrom units. Some of the substances made to fluoresce visibly when illuminated by U-V light are certain woods, oils, minerals, milkstone, cloth, paints, plastics, yarn, drugs, crayons, etc. This lamp is self-filtering and the invisible U-V rays are harmless to the eyes and skin. Equipped with spectral-finish aluminum reflector. Consumes only 4 watts and can be plugged into any 110 volt 50-60 cycle A.C. outlet. Will give 2000 to 3000 hours of service. It weighs but 1 3/4 lbs. Approved by the Underwriters Laboratories and has a built-in transformer so that it may be safely used for long periods when necessary. Extra U-V tubes are available.
Ship wt. 4 lbs.
ITEM NO. 125
UNUSUAL BUY **\$14.75**

POWERFUL ALL PURPOSE MOTOR



Sturdy shaded pole A.C. induction motor. 15 watts, 3000 rpm. 3"x2"x1 3/4"; 4 mounting studs; 7/8" shaft, 3/16" diameter; 110-120 volts, 50-60 cycles. A.C. only. When geared down, this unit can operate on an 18" turntable with a 200 lb. dead weight. Use it for fans, displays, timers and other purposes. Ship wt. 2 lbs.
ITEM NO. 147
UNUSUAL BUY **\$2.45**

WATT HOUR METER



Leading makes—reconditioned. Ideal for trailer parks. 100-110 volts, 60 cycles, 2-wire A.C. 5 amp. Heavy metal case 8 1/2" x 6 1/4" x 5". Easy to install. Ship. wt. 14 lbs.
ITEM NO. 33
NOW ONLY **\$4.50**

WESTERN ELECTRIC BREAST MIKE



Lightweight 1 lb. carbon microphone. Aircraft type. Breastplate mounting, adjustable 2-way swivel. Easily fastened straps. For home broadcasts, communications etc. Complete with 6 foot cord, hard rubber plug. Sheradized plate, non-rusting finish. Ship. wt. 2 lbs.
ITEM NO. 152
NEW LOW PRICE **\$2.25**

AMAZING BLACK LIGHT



250-watt ultra-violet light source. Makes fluorescent articles glow in the dark. Fits any lamp socket. For experimenting, entertaining unusual lighting effects. Ship. wt. 1 lb.
ITEM NO. 87
A SAVING AT **\$2.45**

250 POWER TELESCOPE LENS KIT



Make your own high powered 6 ft. telescope! Kit contains 2" diam., .75" focal length, ground and polished objective lens and necessary eye pieces. Magnifies 50x to 250x. Full instructions. Ship. wt. 1 lb.
ITEM NO. 123
YOU SAVE AT **\$2.95**

HUDSON SPECIALTIES CO.
25 West Broadway, Dept. RE-11-53
New York 7, N. Y.

I am enclosing full remittance for items circled below. (Be sure to include shipping charges.)

OR, my deposit of \$..... SHIP balance C.O.D.
MINIMUM C.O.D. ORDER \$5.00.
C.O.D. ORDERS ACCEPTED ONLY WITH 20% DEPOSIT
INCLUDE SHIPPING CHARGES.

Circle Items Wanted
87 147 33 152 125 123

Name Please Print Clearly
Address
City Zone State

RADIO-ELECTRONICS

STAN-BURN ELECTRONICS

★ CATHODE RAY TUBE SPECIALS ★ ONE YEAR GUARANTEE

G.E.		STAN-BURN	
★ 5TP4	\$44.95	★ 10BP4	\$11.00
★ 7BP4	17.10	★ 12LP4	11.25
★ 10BP4A	19.25	★ 14CP4	17.00
★ 10FP4A	24.00	★ 15DP4	19.50
★ 12KP4A	27.10	★ 16AP4	21.60
★ 12LP4A	21.70	★ 16FP4	19.60
★ 12UP4B	28.25	★ 16GP4	21.60
★ 14CP4	24.50	★ 16P4A	22.60
★ 16AP4A	30.95	★ 16DP/HP4	19.60
★ 16DP4A (N.U.)	28.20	★ 16DP/HP4A	20.60
★ 16GP4	31.25	★ 16KP4	18.50
★ 16KP4/16RP4	28.20	★ 16LP4	20.60
★ 17BP4A	23.90	★ 16LP4A	21.60
★ 17CP4	23.90	★ 17BP4	18.50
★ 19AP4A	39.45	★ 17CP4	21.60
★ 20CP4	32.50	★ 19AP4	23.90
★ 20LP4	37.50	★ 19AP4A	25.90
★ 21EP4A	37.30	★ 20CP4	29.50
★ 21EP4 A	78.50	★ 21EP4	37.50

★ ANTENNA SPECIALS ★

★ RED DOUBLE "V" Antenna	1-5	★ 6 or more
★ 10 ELEMENT CONICAL	2.19	★ 1.98
★ Dowled Inset	2.98	★ 2.79
★ Forced H. Straight Low Quick Rig		
★ 1/2" elements	4.25	★ 3.25
★ WINDOW CONICALS	4.95	★ 3.75
★ MASTS		
★ 5 FOOT SWAGED	1.79	★ .69
★ 10 FOOT PLAIN	1.29	★ 1.29
★ NEPCO MASTS	1.69	★ 1.49

★ TV WIRE ★

★ 42 Mil. 300 OHM	\$9.95 M. Ft.
★ 55 Mil. 300 OHM	\$11.95 M. Ft.
★ 72 OHM COAXIAL	\$35.00 M. Ft.
★ 12" Heavy Slug Speaker	Special \$3.98

★ CHASSIS 630 REBAL with Cascade Tuner. \$14.00

★ OPEN FACE CABINET 42.00

★ WIRE RECORDERS IN STOCK ★

★ PENTRON—Model 9T3C—2-speed Tape Recorder Write for Price.

★ RADIO CRAFTSMAN ★

★ Model C400—Hi Fi Amplifier	Net \$42.90
★ Model C10—AM-FM Tuner	Net 131.50
★ Model C500—Williamson Amplifier	Net 99.50

★ We also carry MASCO—BOGEN—PILOT, etc. Amplifiers—Pre-Amps, FM Tuners and WEBSTER Tape Recorders.

★ 6"X9" PM SPEAKER \$3.98

★ 7" PM SPEAKER 3.98

★ 771 G.E. Flyback 1.98

★ 70" Yoke 1.98

★ 630 Vert. Output Upright 1.98

★ 630 Vert. Output Potted 1.29

★ 630 Vert. Blocking Osc. Xform.89

★ CASCADE TUNERS 19.95

★ STANDARD TUNERS 17.95

★ DUMONT 21.25mc 14.95

★ AUTHORIZED DISTRIBUTORS for: General Electric, Kenrad, Tung-Sol, National Union, De Wald, Regal, Automatic and General Motors. ★

★ AUTOMATIC CUSTOM-BUILT RADIOS for Plymouth, Ford, Chevrolet and many other always in stock. We carry a complete stock of HI-FIDELITY and SOUND EQUIPMENT. Send us your requests. We also carry a complete line of popular makes of Radio tubes at 50/10% discount. Also many other special purpose and transmitting types, and all electronic parts and equipment at lowest prices. Send us a list of your requirements for prompt quotations.

★ Terms: 20% with order. Balance COD. All prices FOB. NEW YORK Warehouse. Minimum order \$5.00.

★ Write for our latest price list and Hi-Fi Catalog to Dept. RE-11.

STAN-BURN RADIO and ELECTRONICS CO.
(C.B.S. THEATRE BLDG.)
1697 BROADWAY • NEW YORK 19, N.Y.

OUTSTANDING TRANSFORMER VALUE

325-0-325 at 225 ma. 6.3 at 5A, 5V at 3A. Pri. 115V. 60 cy. AC. Size: 1 3/4" x 1 3/4" x 3 7/16".	Only	\$6.95 ea.
350-0-350 at 300 ma. 6.3 at 1A, 6.3 at 8A, 5V at 3A. Pri. 115V. 60 cy. AC. Only		\$7.95 ea.
350-0-350 at 350 ma. 6.3 at 10A, 5V at 6A. Pri. 115V. 60 cy. AC. Only		\$8.95 ea.
450-0-450 at 200 ma. 5V at 3A, 6.3 at 5A. Pri. 115V. 60 cy. AC. In shielded case. Only		\$8.90 ea.
920-0-920 or 710-0-710 AC at 200 ma. Pri. 115V. 60 cy. AC. Upright shielded case. Excellent for 807's.	Only	\$10.80 ea.
Isolation transformer. Useful for AC-DC supplies, etc. Pri. 117V. Sec. 150V AC at 25 ma. Also, 6.3V at 1/2 amp. Only		\$1.98 ea.
Isolation transformer. Pri. 115V. Sec. 117V at 50 ma. Also, 6.3V at 2 amps. Only		\$2.98 ea.
2.5V at 10A AC. 10,000V insulation. Pri. 115V. 60 cy. AC. Only		\$3.39 ea.
Modulation transformer. 15 watt. Both pri. and sec. adjustable for 2000 to 20,000 ohms. Pri. 50 ma per side. max. Sec. 50 or 100 ma depending upon connections used. Only		\$6.45 ea.
Modulation transformer. 60 watt. Also adjustable with pri. and sec. adjustable for 2000 to 20,000 ohms. Pri. 150 ma per side. Sec. 150 or 300 ma depending upon connections used. Only		\$9.60 ea.

OFFENBACH-REIMUS

1564 Market Street, San Francisco, Calif.

control. Will this rig work on 11 and 15 meters with crystal control? Please show me how to add crystal control to this rig.—H. M., Lake Worth, Fla.

A. The diagram shows how the 6V6 doubler can be converted to a crystal oscillator for use on the novice bands. A 2.5-mh r.f. choke, a 100- μ f capacitor, and a key jack are added to the 6V6 cathode circuit and a crystal socket across the grid leak as shown. You can construct the rig as a 3-tube crystal-controlled circuit or you can add the buffer and v.f.o. as described in the original article and use a switch in the 6V6 grid circuit to change over from crystal to v.f.o. control.

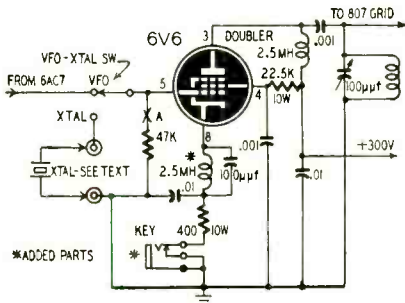

The 6V6 can be operated as a fundamental oscillator or as a frequency multiplier. The 807 can be used straight-through or as a doubler. You can operate on 15 meters by tripling in the oscillator from a 7-mc crystal or by using a 10.5-mc crystal and doubling in the oscillator or final. To reach 11 meters, you can use a 6.75-mc crystal and quadruple in the oscillator, or double in the oscillator and in the final, or you can use a suitable 14-mc crystal and double in the oscillator or in the final.

Try to avoid using harmonic and overtone type crystals because these often require special oscillator circuits for best performance. If the keying is sluggish, try connecting a 2.5-mh r.f. choke in series with the oscillator grid leak at point A.

You can use commercial plug-in coils in the oscillator and 807 plate circuits or you can wind your own from data which you will find in the various amateur radio handbooks. If care is taken, there is little to choose between commercial and home made coils.

HEATHKIT PREAMP MODIFICATION

? I plan to use a G-E record compensator ahead of the Heathkit WA-P1 preamplifier so I would like to modify the latter to provide flat response. How can I do this?—E. E. S., Bronx, N. Y.

A. According to information supplied by the Heath Company, all you have to do is to remove the turnover switch, the 100,000-ohm resistor, and the two .022- μ f capacitors in the feedback network between the triode halves of the 12AY7 or 12AX7. Leave the 2,200-ohm cathode resistor intact. The response of the preamplifier-equalizer will now be flat when the tone controls are in the nine o'clock position. END

YOUR HIGH-PAYING
interesting career in
TELEVISION
starts here!

Complete, Easy-to-Learn
HOME STUDY COURSE
with one of America's
LARGEST schools

There's a place for YOU in the tremendous, billion-dollar Television, Radio & Electronics industry! It's so easy to get started with the

famous CRESCENT SCHOOL course. Learn at home, in your spare time. Illustrated, simplified lessons and kits to practice on. No previous training needed. Send for FREE sample lesson... make this day the day you started on your way to a brilliant profitable career!

APPROVED FOR KOREAN VETS
Also Day & Eve. Classes
Trained at Our School

CRESCENT SCHOOL
"One of the Largest of its kind"

SEND COUPON TODAY!
CRESCENT SCHOOL Dept. E-11
500 Pacific Street, Bklyn. 17, N.Y.
Sirs: Rush your FREE sample lesson and full details about the CRESCENT SCHOOL Course—at no obligation to me!
 Home Study Course Residential Course
NAME _____
ADDRESS _____
CITY _____ ZONE _____ STATE _____

ELECTRONIC TUBES
URGENTLY NEEDED
CASH PAID FOR:
Radio, TV, Special Purpose, all types, small and large quantities. State types, quantities, prices.
WRITE NOW to BOX R-11-53

Watch for the
DECEMBER ISSUE
of Radio-Electronics
on the newsstands
NOVEMBER 25, 1953

**INTERNATIONAL
RECTIFIER
CORPORATION**

EL SEGUNDO
CALIFORNIA

DIRECT
REPLACEMENT

**RADIO Selenium TV
Rectifiers**

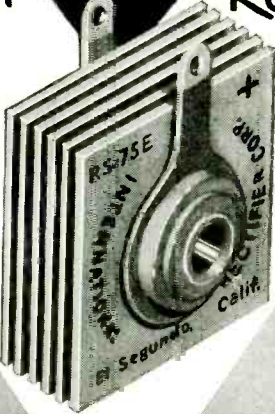

**UNIVERSAL
MOUNTING**

**WIDER
RANGE**

*Write for
Bulletin JRP-1*

**INTERNATIONAL RECTIFIER
CORPORATION**

1521 E. Grand Ave., El Segundo, Calif • Phone: ORegon 8-6281
 CHICAGO: 205 W. Wacker Drive • Phone: Franklin 2-3889
 NEW YORK: 501 Madison Avenue • Phone: Plaza 5-8665

PEOPLE

Jack Hughes, former vice-president in charge of sales for Littelfuse, Inc., Des Plaines, Ill., was named vice-president and operations general manager of the



J. Hughes

company. In his new position, Mr. Hughes will continue to handle sales, with additional responsibilities in purchasing, production, production control, and time control.

Harry H. Kline was named to the newly created position of general sales and merchandise manager of Ward Products, Division of Gabriel Co., Cleveland. He had been sales engineer, and more recently supervisor of inventory control for Ward.



H. H. Kline

W. Ward Willett joined LaPointe Electronics, Rockville, Conn., as advertising manager. He was formerly with the Plax Corporation. Lincoln N. Kinnicutt,



W. W. Willett

who was the former director of advertising and public relations of LaPointe Electronics, has now been promoted to assistant to Webster E. Barth, the general sales manager of the company.

A. L. Champigny was promoted to advertising and sales promotion manager for the General Electric Tube Department, Schenectady, N. Y. He was previously manager of replacement sales promotion for the Tube Department. In his new position, he succeeds G. A. Bradford who was recently appointed manager of advertising and sales promotion for the General Electric Radio and Television Department in Syracuse, N. Y.



A. L. Champigny



G. M. Ehlers

G. Milton Ehlers has recently joined Aerovox Corp., New Bedford, Massachusetts, as chief research engineer. He was formerly president of the Herlec Corp., a subsidiary of Sprague Electric.

Paul G. Mathes joined the staff of Trio Manufacturing Co., Griggsville, Ill., as advertising manager. He was formerly with International Harvester.

Obituary

Julius G. Aceves, a pioneer inventor in the field of radio, died in New York City at the age of 65. He was a partner



10" TV REMOTE AUXILIARY (SLAVE) SET—BUY OF A LIFETIME FOR THAT EXTRA SET IN THE HOME, BAR or OFFICE!! Operates with any standard TV receiver.

FEATURES:

- 19 TUBES incl. 10B14
- ALL 90 DAY GAR'TD.
- H.V. OSC. POWER SUPPLY — detachable unit.
- 4" PM Hvy. Duty Speaker.
- MAJOR STANDARD Vert. Outputs, Two 100 ohm Chokes, 150 ma Sel Rect., Electrolytics, Controls, etc.
- HANDSOME WALNUT VENEER & LEATHERETTE CABINET
- COMPLETE SCHEMATIC & HOOK-UP DATA SUPPLIED. Operates on 110V. DC: AC conversion data supplied.

PARTS ALONE WORTH SEVERAL TIMES THE PRICE!
(Overall: 20 1/2" x 17 1/4" x 14 1/2". Shhd. wt. 18 lbs. Perfect Condition—Used)

\$23.95

8 POS. PUSH-BUTTON ASSEMBLY. DPST. transfer . . . 98
Set of 8 knobs . . . 49

COPPER OXIDE RECTIFIER E. W. bridge
24V. In. 300V. 12"x3/4" (0.1) . . . ea. 98c 6/5.50

1/4" GLOSSY BLACK BAKELITE 6"x12"—69c
6"x10"—59c; 4"x8"—49c

POLYSTYRENE—12" lgths; longer lgths. avail.
ROD: 1/2"—9c; 3/4"—20c; 1"—39c; 3/8"—55c;
3/4"—75c; 1"—1.49

TUBING (O.D.): 1/2"—7c; 3/8"—12c; 1/4"—17c
3/4"—21c; 1"—35c; 1 1/2"—\$1.10

T-30 THROAT MIKES w/ P1291. Less neckhand . . . 69
5 RPM AC MOTOR—115V. 60 cy. 2 watt.
Bristol #2004. O.D. 2"x1 1/4" . . . 2.95

"ALNICO MAGNET SPECIALS"—Pol. BAR.
9/16"x7/32"x3/4" (1.9) . . . 12/1.00 100/7.50
U Type—3"x3/4"x1/2" . . . ea. 49c

"HEELING" MAGNETS—Set of 2 round 5/8"
O.D. bars. 41/2" lg. 1/2" dia. Wood cased. Set \$1.98

ALNICO MAGNET KIT—Powerful Bar. Block.
ROD, etc. Kit of 10 asstd. . . 1.98
(WRITE FOR LATEST "ALNICO" SUPPLEMENT)

!! IT'S TERRIFIC . . . OVER 5000 SOLD !!

Now even BIGGER & BETTER THAN EVER!
Leotone's "JUMBO RADIO-ELECTRONICS PARTS KIT"—Here's just Plain Fun!
get: ASSTD. RESISTORS, CONDENSERS, PHOTOFACTS & TV DIAGS., CONTROLS, SWITCHES, WIRES, ETC.
ETC. Shpg. wt. 20 lbs.

\$3.95

CABINET DRAW SLIDES—silent ball-bearing
13" (9" ext)—\$2.10 pr.; 15" (11" ext)—\$2.25 pr.
16 1/2" (12 1/2" ext)—\$2.39 pr.; Hvy. duty all-steel
16 1/2"—\$3.25

TUBE CARTONS—plain white. Prices per 100:
Min (1"x2 1/2")—\$1.20; GT (1 1/4"x3 3/4")—\$1.45;
Med. (1 1/2"x4")—\$1.65; Large (2"x4")—\$1.88

"DIRECT FACTORY SPEAKER REPAIRS SINCE 1927"

Min. Order \$3.00. 20% deposit req. on all C.O.D.'s.
Please add sufficient postage—excess refunded

LEOTONE RAD' O. CORP.

67 Dey Street
New York 7, N. Y.

Editors and Engineers PUBLICATIONS

IT'S NEW!

WORLD'S EQUIVALENT TUBES (BRANS' NEW 10TH EDITION). (Equivalents Vade Mecum)

A simple index makes it easy to find completely equivalent or tubes having a few differences in the latter case, what these differences are

Book No. E&E-VM10 . . . \$5.00*

A COMPANION VOLUME

WORLD'S RADIO TUBES (BRANS' VADE MECUM). NEW 9TH EDITION. Lists over 15,000 tubes from every tube making country. Printed in 16 languages. Book No. E&E-VM9 . . . \$5.00*

RADIO HANDBOOK. GIANT 13TH EDITION. A one-volume library of radio information with extensive, simplified theory. Detailed how-to-build-it data on dozens of items of practical radio equipment. Book No. E&E-RH13 . . . \$6.00*

BETTER TV RECEPTION (in fringe and low signal areas). NEW SECOND EDITION. The standard guide for installation technicians. A popular text for TV enthusiasts. Book No. E&E-TR2 . . . \$2.50*

RADIOTELEPHONE LICENSE MANUAL. Typical study questions with concise answers for any commercial U.S.A. radiotelephone operators license. Book No. E&E-RL1 . . . \$3.75*

ANTENNA MANUAL. A practical, comprehensive book on antennas, for everyone interested in transmission and reception. Over 300 pages. Book No. E&E-AM1 . . . \$3.50*

SURPLUS RADIO CONVERSION MANUAL. VOL. 1. Practical conversions. Write for list of contents. Book No. E&E-SM1 . . . \$2.50*

SURPLUS RADIO CONVERSION MANUAL. VOL. 2. Companion to Volume 1. Book No. E&E-SM2 . . . \$2.50*

*Plus any tax.

BUY FROM YOUR DISTRIBUTOR

ADD 10% ON DIRECT MAIL ORDERS TO EDITORS AND ENGINEERS, Ltd., BOX 6898, SANTA BARBARA, CALIF. Bookstore editor: Tom BAKER & TAYLOR, Holmdel, N. J.

in the electronics engineering firm of Amy, Aceves, and King, Inc.

Personnel Notes

. . . Dr. Ivan Getting, vice-president and director of engineering of Raytheon Manufacturing Co., Newton, Mass.; Harold Bugbee, president of Walter B. Snow, Boston advertising agency; and Dr. Jerome B. Wiesner, director of research of electronics at Massachusetts Institute of Technology, were chosen as judges for the \$10,000 Transistor Contest sponsored by the Raytheon Receiving Tube Division.

. . . Alfred E. Bourassa joined CBS-Hytron, Danvers, Mass., as assistant to the advertising manager. He was formerly with Carter's Ink Co.

. . . Harold Blumenthal was named sales manager of Manufacturers Division of Shure Brothers, Chicago. He was formerly a sales engineer with the company.

. . . Sheldon Rutter, one of the country's top designers, was retained by Channel Master Corp., Ellenville, N. Y., to do all product design and to be packaging and art consultant.

. . . Stanley Niciejewski, former distributor sales manager of Sarks Tarzian Rectifier Division, Bloomington, Ind., was promoted to sales manager, according to an announcement by George Eannarino, director of the Rectifier Division. Alfred D'Urso, former sales engineer, was promoted to assistant sales manager on distributor sales, and Fred Lucas, previously with Federal Telephone and Radio, joined the Sarks Tarzian Rectifier Division as assistant sales manager of industrial sales.

. . . Robert C. Sprague, Chairman of the Board of Sprague Electric Co., North Adams, Mass., was selected as a member of the Business and Industry Advisory Committee of the New England Colleges Fund.

. . . Donald S. Burge joined Jensen Manufacturing Co., Chicago, to handle production control. He was formerly with Milled Screw Products.

. . . Dr. William L. Everitt, radio authority and dean of the College of Engineering of the University of Illinois, will receive the IRE Medal of Honor for 1954. The award will be made during the association's annual banquet in New York next March.

. . . Clarence Rohwedder joined Littelfuse, Inc., Des Plaines, Ill., as a process engineer. He held a similar position with A. O. Smith Corp. prior to his appointment. David H. Shean joined Littelfuse as purchasing agent. He was formerly with Redmond Co.

. . . Clarence M. Clark, former manager of Accounting at the Westinghouse Electronic Tube Division plant at Elmira, N. Y., was appointed manager of

LEARN MORE! EARN MORE!

WITH H. G. CISIN'S



NEW! 1954 TV Consultant TV Serviceman's Silent Partner



New, easy-to-use way to solve toughest TV troubles. UHF sect. includes conversions, installations and servicing. Modern alignment methods shown by pictures, diagrams and simple directions. Tell exactly what to do and how to do it. Practical pointers on use of all TV Test Instruments. Over 300 pix, raster and sound symptoms. Detailed directions tell where and how to find faulty parts. Over 135 RAPID CHECKS, many using pix tube as trouble locator. 125 illustr. of scope wave forms, diagrams, station patterns show various defects—take mystery out of TV servicing. NO THEORY—NO MATH—NO FORMULAS—just practical service info. covering all types of TV sets.

Only \$2

NEW! Trouble Shooting PIX GUIDE inc. TV TERMS Explained

Sec. 1 is a fully illustrated GUIDE to oft-recurring pix faults. Causes and cures explained. Copyrighted Trouble Indicating Illustrated chart tells where troubles start in typical TV set—illustrations show resulting faulty TV pictures. Sec. 2 explains hundreds of TV terms in non-technical language. SPEEDS UP TV SERVICING—HELPS YOU DO A BETTER JOB FASTER!

Only \$1



NEW! TV Tube Locator



Money-Making Time Saver tells which tubes to replace to cure every type of tube trouble. Over 135 such TV troubles listed with clear charts for quickly locating the faulty tubes. Copyrighted TROUBLE INDICATING TUBE LOCATION GUIDES for over 3100 most popular models from Admiral to Zenith, 1947 to 1953 models. A storehouse of valuable TV servicing info. priced very low for large volume sales.

Only \$1

NEW! TV Trouble Tracer

70 Common TV troubles traced to source and cured. Copyrighted trouble indicating tube location guides covering over 300 most popular TV models. Many models different from those shown in TV TUBE LOCATOR. Contains over 70 illustrations and tube location guides. Forty most common picture troubles illustrated, with symptoms described, causes given and remedies prescribed.

Only \$0c



H. G. CISIN, PUBLISHER

Order from your Jobber today, or if not stocked, write to
Harry G. Cisin, Dept. E-23
Amagansett, New York

Enclosed find \$ Send

TV Consultant TV Locator

TV Pix Guide TV Tracer

Name

Address

City Zone State



Send for Cannon Bulletin RJC-6
... a special condensed catalog

Covers the Radio, Sound and Miniature Connectors that are available to you through Franchised Distributors, Electrical Wholesalers and Radio Parts Distributors.



FITTINGS: For audio, instrument and related uses. 3 contacts, 15a max., 14 basic shapes. Latchlock coupling. Available at your Radio Parts Distributor.



FITTINGS: For audio, TV and instrument uses. 2 to 8 contacts, 30a max., 16 basic shapes. Universally used in sound and allied applications.



FITTINGS: 3-contact oval-shaped plugs and receptacles, equipped with latchlock device. For microphones and related uses. 6 basic shapes. 30a max.



FITTINGS: Designed in cooperation with RMA Committee, combining all features of P, O and XL Series. Gold plated contacts. Rubber relief collar and bushings.



TEST POINT JACKS: High quality phone tip jacks to accommodate ATMA phone tip for laboratory uses. Rugged construction, nylon insulation precision-made for long life.

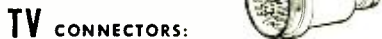

Specialized "LK" and "LKT" plugs used on television cameras and related equipment.



SUB-MINIATURE SERIES: Hermetic sealed, vitreous insulated receptacles and Silcan insulated plugs for instruments, relays, transformers and other sealed components.



SUB-MINIATURE SERIES: Gold plated contacts. Rack-and-panel or cord mounted disconnect for portable radio and related equipment. Hermetic sealed if desired.

Additional related audio and power Cannon connectors include Types X, XK, M1, GB and BP, all available through selected Cannon Franchised Distributors. See your classified telephone directory.

CANNON ELECTRIC

Since 1915



CANNON ELECTRIC CO., LOS ANGELES 31, CALIF. Factories in Los Angeles, Toronto, New Haven. Representatives in principal cities. Address inquiries to Cannon Electric Company, Department K-144, Los Angeles 31, California.

the company's Tube plant in Bath, N. Y.

... Christian J. Reimuller joined Javex, Redlands, Calif., as head of the newly created Publicity and Public Relations Department. He previously was co-owner of a hydraulic machine-tool manufacturing concern.

... Harry A. Ehle, International Resistance Co., was elected president of the Radio Parts and Electronic Equipment Shows, Inc., sponsors of the Electronic Parts Show. Others elected were: H. M. Carpenter, Thurow Distributors, vice-president; Francis F. Florsheim, Columbia Wire & Supply, secretary; Bernard L. Cahn, Insuline Corp. of America, treasurer.

... W. O. Spink was appointed assistant equipment sales manager of the Sylvania Electronics Product Sales Department, with headquarters in New York City. He has been a member of the Sylvania sales staff since 1947.

... J. C. Van Arsdell, former manager of Sales Engineering for the Electronics Division of Erie Resistor Corp., Erie, Pa., was promoted to assistant general manager of the division. William Klevans, former field sales engineer, was advanced to Van Arsdell's previous position.

... Joseph H. Morin joined Howard W. Sams & Co., Indianapolis, as sales promotion manager. He had been distributor sales manager of Shure Brothers.

... Martin W. Krenske was named assistant sales manager of Edwin I. Guthman Co., Chicago. He was previously with Standard Transformer Corp.

... Dr. W. R. G. Baker, General Electric, was reappointed chairman of the RETMA Television Committee. Max F. Balcom, Sylvania, was reappointed chairman of the Educational Television Committee, and Glenn McDaniel, general counsel of the RETMA, was reappointed chairman of the Legal Committee. Paul V. Galvin, Motorola, and H. A. Pope, National Union, were reappointed chairmen of the Committee to Survey Subscription Television and of the Credit Committee, respectively. William L. Dunn, Raytheon, was appointed chairman of the Sales Managers Committee of the Set Division of RETMA.

... Bruce R. Carlson, an investment analyst, joined Sprague Electric, North Adams, Mass., as statistical assistant to the president.

... Joseph F. Whitaker, formerly with International Resistance Co., joined Weller Electric Corp., Easton, Pa., as sales manager.

... Nat Welch joined Orradio, Opelika, Ala., as sales manager. He was formerly a manufacturers' representative in the electrical industry.

COMPARISON PROVES EICO OFFERS GREATEST V-O-M values!



World-renowned EICO VOLT-OHM-MILLIAMMETERS

536 KIT \$12.90. Wired \$14.90
526 KIT (with 1% multipliers) only \$13.90. Wired \$16.90

COMPARE EICO Multi-meters with any others and you'll agree... only EICO gives you ALL the features you want—PLUS 9 new exclusive EXTRAS—at the LOWEST COST in the industry!

COMPARE the PLUS versatility and performance of ALL THESE 9 EXTRA features: • full-scale ranges of 0-1 volt up to 0-5000 volts on both AC and DC • grand total of 31 full-scale ranges • Current ranges on both AC and DC • large 3" meter • 400 ua sensitivity • 1000 ohms/volt on both AC and DC • minimum battery-drain ohm ranges • dual rectifier with separate low and high voltage calibration on AC ranges • available in both KIT and WIRED form. Just think of the amazing value and versatility of these 31 different ranges! DC/AC Volts: Zero to 1, 5, 10, 50, 100, 500, and 5000! DC/AC Current: 0-1 ma, 10 ma, 0.1 Amp, 1 Amp. Ohms: 0-500, 100 K, 1 meg. 6 DB ranges:—20 to 69.

Yes, Comparison proves it... you get the MOST VERSATILITY—and you really SAVE—only with EICO! See the famous complete EICO line of V-O-Ms, Scopes, VTVMs, generators, tube testers, battery eliminators, bridges, decade boxes, etc. at your jobber today. Write NOW for FREE Catalog MC-11 and name of local jobber. Prices 5% higher on West Coast.

ELECTRONIC INSTRUMENT CO., Inc.
84 WITHERS STREET, BROOKLYN 11, N. Y.

Let me show you how EASY it is to LEARN TV the practical way--



Pay as You Wire \$39 Down Payment

I WILL HELP YOU to start learning TV the practical way — by assembling a TRANSVISION TV KIT in EASY STAGES. For only \$39 you get PACKAGE #1 (standard first pkg. for all of our kits). This package gives you the BASIC CHASSIS and over 450 TV COMPONENTS with complete Instructions, Drawings, Photos, Service Booklet, and a year's subscription to my "TV and Electronics Notes". When ready, you order the next stage (pkg. #2), etc. Low prices make your complete kit a terrific buy!

FREE CATALOG Shows 6 Great TV Kits: EXCLUSIVE: Only Transvision TV Kits are adaptable to UHF. Ideal for FRINGE AREAS. No Previous Technical Knowledge required. Write now! TRANSVISION, INC., Dept. RE11 NEW ROCHELLE, N. Y.

Mr. D. Gnessin, Educational Director
TRANSVISION, INC., NEW ROCHELLE, N. Y. Dept. RE11

I'm enclosing \$ _____ deposit. Send standard kit PACKAGE #1, with all Instruction Material. Balance C.O.D.

Send FREE copy of your new TV Kit Catalog.

Name _____
Address _____
City _____ State _____

END

OSCILLOSCOPE TIME MARKER

Obtain laboratory quality from kit type oscilloscope with this time base marker. Easily enstalled in 15 minutes. Provides 10 micro second markers on any oscilloscope.

Complete with tube
\$6.95 P.P.

ROBERT H. ARNOLD
6 S. ANNISTON
SYLACAUGA, ALA.

ELECTRONIC HOBBYISTS

Build and play my latest polyphonic organ without a knowledge of music. Or get blueprints for a miniature electronic brain, and other projects. Send 3¢ stamp for air mail reply.

JIM KIRK, W6JKX
1552 Church St., San Francisco 14, Calif.

AUDELS TV-RADIO SERVICE LIBRARY

HERE IS LATE INFORMATION IN A HANDY FORM FOR RADIO & TELEVISION REPAIRMEN, SERVICEMEN & STUDENTS

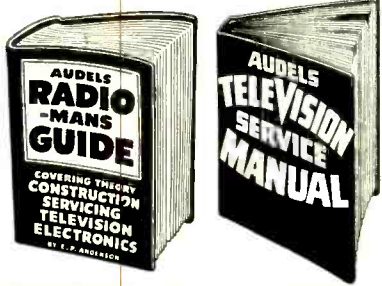

2 VOLS. \$6 COMPLETE \$14
PAY ONLY 1 MO.
IT PAYS TO KNOW!

AUDELS T.V.-RADIO SERVICE LIBRARY presents the important subjects of Modern Radio, Television, Industrial Electronics, F.M. Public Address Systems, Auto, Marine & Aircraft Radio, Phonograph Pick-Ups, etc. Covers Basic Principles—Construction—Installation—Operation—Repairs—Trouble Shooting. Shows How to get Sharp, Clear T.V. Pictures. Install Aerials—How to Test. Explains Color Systems & Methods of Conversion. 1001 Facts—Over 1260 Pages—625 Illustrations—Parts & Diagrams—Valuable for Quick Ready Reference & Home Study. Tells How to Solve T.V. & Radio Troubles—Answers T.V. & Radio Questions.

Get this information for Yourself.
7 DAY TEST—ASK TO SEE IT!

MAIL ORDER

AUDELS Publishers, 49 W. 23 St., N. Y. 10
Mail AUDELS T.V. RADIO SERVICE LIBRARY 2 Vols. \$6 on 7 days free trial. If O. K. I will remit \$1 in 7 days and \$1 monthly until \$6 is paid. Otherwise I will return them.

Name _____
Address _____
Occupation _____
Employed by _____ RE

NOVEMBER, 1953

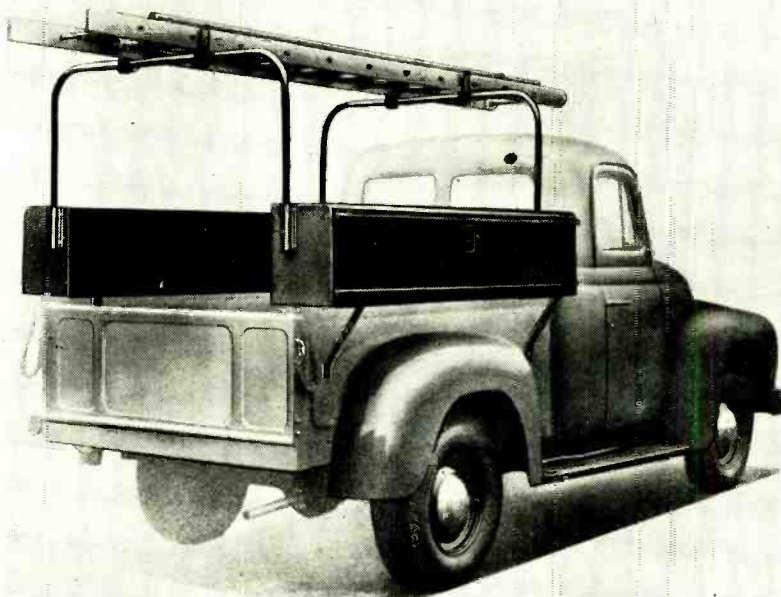

CONVERT YOUR PICK-UP TO A MODERN SERVICE TRUCK!

It's easy; it's quick. Low Cost Craftsman Side Boxes mount on any pick-up truck, have recessed locking door handles, keyed alike. Here is safe, dry, convenient storage for tools, parts and equipment. Write today for prices and full information.



IT'S READY NOW!

SEND FOR YOUR GIANT NEW Concord Catalog

1954 EDITION

FAMOUS BRAND!
Model 360

SWEEP GENERATOR



Normally \$49.95
OUR PRICE
ONLY \$29.50
Completely Wired, Less Cabinet and Crystal

Here's your chance to get a top-quality sweep generator at a saving of almost 50%! This famous-make laboratory precision instrument fills every alignment need in TV-FM servicing.

- 500 KC Thru 228 Mc continuous sweep
- RF Shielded continuous type attenuator
- Vernier dial calibrated in TV channel numbers
- Crystal marker oscillator with variable amplitude control.
- Latest HF tubes: 6X5GT, 12AU7, 2-6C4.
- 110-120 V AC 60 cy. Wt. 10 lbs.

IT'S GOT EVERYTHING!

- Standard Lines
- Special Buys

IT'S FREE!

CONCORD RADIO, 55 Vesey St., New York 7, N. Y. Dept. C-11
Send Giant New FREE Concord Catalog at once to:

Name _____
Address _____
City _____ Zone _____ State _____

Concord Radio
55 Vesey Street, New York 7, N. Y.
Phone DLgby 9-1132

EDLIE
says

"Save with confidence"

The Lowest Priced Kits on the Market



Completely Wired

LOWEST PRICED SIGNAL GENERATOR, BROADCAST BAND

New simplified circuit provides the following switch tuned, tone modulated frequencies:

1. 455 K.C.—Intermediate I.F. frequency
 2. 1500 K.C.—High frequency of Broadcast Band
 3. 600 K.C.—Low frequency of Broadcast Band
 4. Audio tone—for audio amplifier trouble shooting
 5. An attenuator control is included for adjustment of the output signal strength
- Housed in small black bakelite cabinet size 6"x6"x3 1/2". Can be useful for alignment of all Broadcast Band radio receivers. Completely Wired.

\$7.95

INTRODUCTORY OFFER

Deduct \$1.00 if ordered with Kit #1 or #2

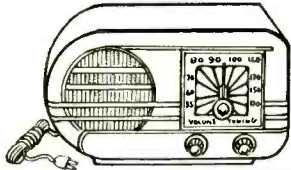

5 TUBE AC-DC SUPERHET KIT

Kit #1—Five Tube superheterodyne kit, A.C.-D.C. contains all components required to construct this latest design, highly sensitive superheterodyne broadcast receiver, complete with black bakelite cabinet (excludes wire and solder) ... Only

\$7.95

Kit of 5 tubes (12AT6, 12BA6, 12BE6, 35W4, 50C5). Only \$3.25.

D 1273

INSULATED RESISTOR KIT

Contains 100 resistors 1/2, 1/2, 1 & 2 watts from 5% to 20% tolerance. Housed in a transparent plastic box. Price complete

\$1.65

D 1278 PAPER TUBULAR BY-PASS CONDENSER KIT

Contains 50 by-pass condensers ranging in capacity from .005 mfd. to .5 mfd. and at voltages from 200 to 1600, housed in a plastic transparent cabinet, size 7" x 3 1/2" x 1 1/8". Price \$2.95 per kit.

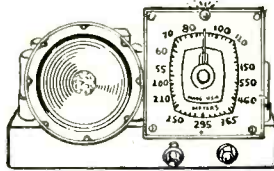

6-TUBE RADIO KIT

Kit #2—A low-priced 6 TUBE KIT designed for high sensitivity, excellent selectivity and good tone quality. Uses 25L6, 25Z6, 6SQ7, 6SA7, 6SK7, 6SK7 in an easily constructed circuit. The 6 Tube Kit is shipped with all parts, including punched chassis, resistors, condensers, coils, sockets, PM Speaker, hardware, etc.

And at a closeout price of only (less tubes and cabinet) **\$6.95**

Matched set of six tubes **\$3.25**

for kit

PHONO OSCILLATOR

Not a Kit!

Wireless phono oscillator transmits recording for crystal pickups or voice from carbon mike through radio without wires. Can also be used as an intercomm by using P.M. speaker as mike. Price (excluding tubes) **\$2.95**

With Complete Set of Tubes... **\$3.95**

3-TUBE PHONO AMPLIFIER

Not a Kit!

An assembled unit ready for installation using tone and volume control and six feet of rubber cord (Not including Tubes) **\$2.95**

With Complete Set of Tubes... **\$3.95**

D 1274

PRECISION RESISTOR KIT

This kit consists of 50 1% Wilkor carbon film resistors of 50 different ohmages, housed in a transparent plastic box. These can be combined in series or parallel to produce almost any desired ohmage. Each resistor retails at about .85. Price for kit **\$2.45**

D 1279

DISC CONDENSER KIT

Contains an assortment of 50 Erie type disc ceramicons, includes the following capacities 001, 2 x .001, .0015, 2 x .0015, 2 x .004, .0047, .005, 2 x .005, .01, 2 x .01 and 10 assorted printed circuited capacitors, housed in a transparent plastic box. Price **\$2.95** per kit.

Electronic Code Practice Oscillator & Blinker Kit

AC/DC or Battery Operated!

Kit #3—One of the most practical Code Practice Oscillators ever designed, yet one of the simplest to build and operate. Can be used with any number of headphones. Adjustable Pitch Control—Any type of headphone can be used.

No warmup time—ready to operate instantly.

Simple and safe to operate.

Operates anywhere—with AC or DC power, or from a 90 volt Miniature Battery.

Learn Blinker Code with flashing light.

Blinker can be used as signaling device. International Morse Code included.

Kit **\$1.95** Ac—**\$2.95** with 1-1/2" Btd

D 1910 Supersensitive Two Station Intercommunication system.

This unit is suitable for use in home, office, factory, nursery or sick room. So sensitive it will pick up a baby's cry at a reasonable distance. Operates from 115 volts AC/DC. Both stations housed in compact plastic cabinets (6"x6"x3 1/2"), and requires only 2 wires to connect. Furnished with about 40 ft. of twin conductor. Price **\$16.95**

D 1275 Ceramic Condenser Kit

Contains 50 assorted ceramics ranging from 0.5 mmfd to 2000 mmfd, housed in a transparent plastic box. Price **\$1.95** per kit.

Terms: All merchandise shipped F.O.B. New York City. Prices are subject to change without notice. Include 20% deposit for C.O.D.'s.

WRITE FOR NEW CATALOG—Free!

EDLIE Electronics

154 Greenwich St.
DI 9-3143
New York 6, N. Y.

OPPORTUNITY ADLETS

Rates—45¢ per word (including name, address and initials). Minimum ad 10 words. Cash must accompany all ads except those placed by accredited agencies. Discount, 10% for 12 issues. Misleading or objectionable ads not accepted. Copy for January issue must reach us before November 21, 1953.

Radio-Electronics, 25 W. Broadway, New York 7, N. Y.

SPEAKERS REPAIRED at wholesale prices. Guaranteed workmanship. Fast service. Amprite Speakers Service, 70 Vesey St., New York 7, N. Y.

SUTCO UHF CONVERTER-VHF BOOSTER MODEL 21A, \$31.95. Free Lists. Ben's Radio, N. Tonawanda 2, N. Y.

THREE TUBE PHONO AMPLIFIERS, WITH TUBES, \$3.95; intercoms with remote station, 25" wire, \$17.50. Chemel, 4701 Woods, Rt. 2, Kansas City, Missouri.

TEST EQUIPMENT REPAIRED AND CALIBRATED by factory staff. All makes. Solar, Simpson, Triplett, Heath, etc. Immediate service. Douglas Instrument Laboratory, 176a Norfolk Avenue, Boston 19, Mass.

TUBES—FREE LISTING, 70% TO 90% OFF LIST PRICE. Send post card to Geneva Electronics of New York, Dept. RE11, 9306 Corona Ave., Elmhurst 73, N. Y.

TUBES, TV, RADIO, TRANSMITTING, AND SPECIAL PURPOSE TYPES BOUGHT, SOLD, AND EXCHANGED. Send details to B. N. Gensler W2LN1, 136 Liberty, N. Y. 6, N. Y.

ALL MAKES OF ELECTRICAL INSTRUMENTS AND TESTING equipment repaired. Write for free catalogue on new and used instruments at a savings. Hazelton Instrument Co., 128 Liberty Street, New York, N. Y.

"RADIOBUILDER" MAGAZINE FOR EXPERIMENTERS, beginners, 12 issues \$1.50; Copy 15¢. Unusual catalog free. Laboratories, 328-B Fuller, Redwood City, California.

WANTED: AN/APR-4, other "APR-", "TS-", "IE-", ARC-1, ARC-3, ART-13, BC-348, etc. Microwave Equipment, everything Surplus. Special tubes. Tec Manuals. Lab Quality Equipment. Meters. Fast Action. Fair Treatment. Top Dollar! Littell, Fairhills Box 26, Dayton 9, Ohio.

BUY WHOLESALE—25,000 ITEMS—CATALOG 25¢. Matthews, 112-P2 Broadway, N. Y. C. 36.

ALUMINUM TUBING ANGLE AND CHANNEL Plain and perforated sheet. Willard Radcliff, Fostoria, Ohio.

USED TELEVISION \$30 UP. W4API, 1420 South Randolph, Arlington, Virginia.

TV FM ANTENNAS. ALL TYPES INCLUDING UHF Mounts, accessories. Lowest prices. Wholesale Supply Co., Lunenburg 2, Mass.

LOUDNESS CONTROLS

Dear Editor:

The article entitled "Loudness Controls" by M. G. O'Leary, published in the August, 1953, issue of RADIO-ELECTRONICS seemed to me a well thought out analysis of the subject. However, O'Leary posed the question, "If the loudness control compensates properly for the loud passages, does it also compensate properly for the softer ones?" Also, the closing paragraph of the article said, "Perhaps some genius will design a dynamic loudness control which will automatically vary the loudness compensation according to the type of musical passage being played." The answer to the question quoted above appears to be yes. Therefore a special dynamic loudness control is not needed.

The basic premise in Fletcher-Munson compensation is that the relative loudness of a group of tones shall remain the same regardless of the playback level. Thus, a 100-cycle bass tone of 80 db loudness and a 1,000-cycle middle tone also of 80 db loudness heard at the orchestra conductor's ear must both sound like 50 db when either is reproduced at only a 50 db loudness level. Similarly, if the 100-cycle bass tone is later played by the orchestra at 60 db but the 1,000-cycle tone remains at 80 db, then when the 1,000-cycle tone is reproduced at a 50-db level the 100-cycle tone must be reproduced at a 30-db level. These two instances are the conditions of O'Leary's question. If it can be demonstrated that the compensation is substantially the same for the 100-cycle tone in each instance, then the yes answer is proved. Calculation of the compensation is outlined below:

Original 100 cps tone	
Sensation level	Acoustic level
80 db	83 db
60 db	72 db

Reproduced 100 cps tone			
Acoustic level without comp.	Desired sensation level	Corres. acoustic level	Comp. required
53 db	50 db	67 db	14 db
42 db	30 db	57 db	15 db

If the bass tone had been 50 cycles but all other conditions remained the same, the compensations work out to 19 and 20 db.

JOHN R. SCHJELDERUP

Washington, D. C.

COMMUNITY ANTENNA SYSTEMS

Dear Editor:

In answer to the points raised in Mr. Shapp's letter (RADIO-ELECTRONICS, October, 1953), I believe that the fundamental consideration is simple. Where a community TV system is designed for distribution of not more than three channels, there are probably some advantages as to cost in the use of strip-type amplifiers, which

HI-FI?

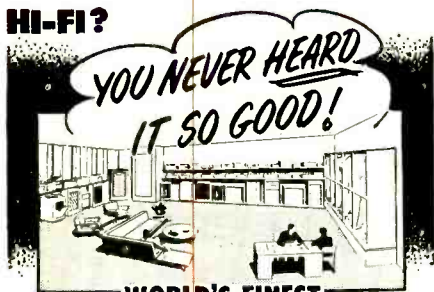

WORLD'S FINEST

AUDIO COMPARISON STUDIOS

Music Lovers and Hi-Fi Enthusiasts... Make it a MUST to visit the Hudson Sound Comparison Studio nearest you! See, Hear, and instantly Compare the World's Finest Hi-Fi Components, with our ingenious Remote Controlled Push-Button Mechanism... Hear the amazing new Electronic Radio, Phono and Recording Equipment that brings Concert Hall "Presence" into your own home at Low Cost!

AND NOW IN NEWARK, N. J...

New Hudson Salesrooms... Complete Stocks, Same Superlative Service as our two N.Y.C. Stores... AND, "Studio 35," Newark's Newest, Finest, and Most Completely Equipped Sound Studio. Lowest Published Prices!

FREE Hudson 1954 HI-FI CATALOG

Finest Manual of Its Kind... Contains Everything in High Fidelity... Components, Recording Equipment, Replacement Parts and Tubes, TV Chassis and Cabinets for All Types of Installations. Send for your FREE Copy TODAY!

Dept. R-11



3 GREAT SALESROOMS to Serve You!

Adjoining Radio City 48 West 48 St. New York 36 Circle 6-4060
 Downtown New York 212 Fulton St. New York 7 Circle 6-4060
 Newark, N. J. 35 William St. Newark, N. J. Market 4-5151

Now! HANDLE UP TO 90% OF TV TROUBLES

by the easy PICTURE ANALYSIS METHOD!

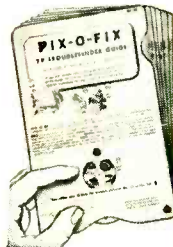

PIX-O-FIX TV TROUBLE FINDER GUIDE

By Chirard, & Middleton

Only \$1.

Covers 24 common troubles identified by actual screen photos

- • • 190 possible causes of these troubles localized to receiver stage or section where they are most likely to occur.
- • • 253 step-by-step remedies.
- • • 4,500 words in CAUSE AND REMEDY section to show just what to do.

Out hours of tedious TV trouble-shooting to minutes! Make repairs (once as fast! Operation of Chirard's new PIX-O-FIX TV TROUBLE FINDER GUIDE is simplicity itself. Covers all TV receivers. Just turn dial until actual TV screen photo appearing in PIX-O-FIX "window" matches distorted picture on set being repaired. PIX-O-FIX then gives you all possible causes for this trouble and just where they're likely to be found.

WHAT TO DO—HOW TO DO IT

Step-by-step repair instructions follow. Components likely to be faulty are specified. Quick tests are outlined. PIX-O-FIX guides you every step of the way! Remember! PIX-O-FIX is NOT a "fix-it-yourself" gadget for consumers. It is a truly professional device for servicemen, apprentices and students—prepared by two of the nation's foremost service instructors—A. A. Chirard and R. G. Middleton.

MONEY BACK IF YOU'RE NOT SATISFIED!

Simply pin a \$1 bill to this ad. Mail with your name and address to the publisher. If not satisfactory, return PIX-O-FIX in 10 days and your \$1 will be refunded promptly. (Price outside U.S.A. \$1.25, same money-back guarantee).

Dept. RE-113, RINEHART BOOKS, Inc. Technical Div., 232 Madison Ave., N. Y. 16, N. Y.

NOVEMBER, 1953

NOVEMBER, 1953

amplify each channel individually. Where more than three channels are to be distributed, now or in the future, I feel there are definite advantages in both cost and flexibility in specifying broadband amplifiers.

All the more recent community TV installations with which I am familiar are using strip-type amplifiers or pre-amplifiers with associated a.g.c. at the antenna site, and then broadband amplifiers for most of the remaining system. This has been done either because the operators are now distributing four or more channels, or because they plan ultimately to distribute several channels to their subscribers as new TV stations go on the air. Many are considering the addition of a channel for subscription TV, in addition to programs taken off the air; and in at least one case, it is planned to distribute FM radio programs as well as several TV channels.

The use of strip-type amplifiers at the headend or antenna site and broadband amplifiers in the remainder of the system is now in operation with equipment manufactured by Jerrold as well as that by Entron, SKL, and Telemeter.

Manufacturers of broad-band amplifiers have definitely considered the problem of matching amplifier gain to cable attenuation characteristics. Both SKL and Telemeter do this successfully, with equalizers designed to compensate for variations in cable attenuation with frequency. Entron accomplishes the same thing by "tilting" its broad-band amplifiers—that is, providing less gain at channel 2 than at channel 6 to match the cable attenuation curve.

Since manufacturers of broad-band amplifiers are making available designs with a gain of about 40 db, as well as models with lower gain for shorter cable runs, it is possible to use approximately the same number of broad-band amplifiers in a typical community installation as would be required if strip-type amplifiers were specified. This is particularly true because none of the strip-type amplifiers can be operated to full rated output if more than one channel is to be distributed, because of troublesome cross-modulation. If four or more channels are to be distributed, it is less expensive to use broad-band amplifiers.

In regard to maintenance, the failure of a tube in a chain-type amplifier reduces gain about 1.5 db and does not result in snow or cross-modulation. The difference with one tube out can't be detected by looking at the picture. Contrary to Mr. Shapp's belief, less than 1% of amplifier tube failures have been interelement shorts, according to the records of broad-band amplifier manufacturers and the operators of community TV systems. Where the number of channels exceeds three, more tubes are required in a strip-amplifier system than in a broad-band system, hence it is likely that maintenance costs would be higher in the former.

—E. D. LUCAS, JR.

Los Angeles, Calif.

from **TELEMATIC INDUSTRIES INCORPORATED**

TOP VALUE
in Antenna Switches at
L-O-W
L-O-W
Price

\$2.00
 List

Model AS-46
 Matched two-position (300 ohm) Switch
 Tops in performance

It's TELEMATIC for the Most Complete Line in Antenna Switches

Model AS-18
 Three-Position (300 ohm) Impedance matched. Low-Loss Antenna Switch

Model AS-49
 Four-Position (300 ohm) Impedance matched. Rotary Antenna Switch

Model AS-47
 Three-Position (72 ohm) Antenna, Phono, Audio and Microphone Switch

Model AS-48
 Two-Position Co-Ax Switch for Antenna, Phono, or Microphone, etc.

Prices slightly higher west of the Rockies

TELEMATIC INDUSTRIES INCORPORATED

Write for catalog.

9 Joralemon St., Brooklyn 1, N. Y.

REAL SALE TUBE WHOLESALE PRICES!

Tube Orders Over \$15.00, with full remittance, Prepaid to you in USA.

Stock up now on these amazing tube values! All tubes are of popular brands and fully guaranteed.

Table with columns: Type, Net, Yr, No, Type, Net, Yr, No. Lists various vacuum tube types and prices.

Above is a partial listing of our large stock. You may order types not listed at approx. the same savings. Many new special-purpose types in stock.

- ODDS & ENDS! ERCO MARINE TRANSMITTER-RCVR 4 channels, 12 V.D.C. operation. FCC approved. New, complete (less xtls) \$179.50. BRAND NEW VIBRAPACKS 12 V.D.C. input 300 V.D.C. @ 125 ma. output. Complete with vibrator \$12.95. TRIMM FEATHERWEIGHT HEADSET 1000 ohm impedance. New, orig. boxes. \$3.75. 1/4" W.E. STEEL RACK PANELS 10 3/4" x 10" notched for mounting. Commercial grey. Brand new. Wgt. 10 lbs. Regularly \$1.92. SPECIAL \$1.00. FILAMENT TRANSFORMER 2 1/2 V.C.T. @ 3 1/2 A. output 110 V. 60 cy. input. Strap mounted—2 3/8" hole centers. Thornderson type T50P61. Regularly \$1.85. SPECIAL \$1.59. JONES TYPE CABLE SOCKET Similar to S 306 PHT, 300 series. 6 contacts. flared hole in side of cap. New. Bulk packed. Regularly \$ 31. SPECIAL ea. \$ 19. 100 lots. ea. \$ 15. CARBON RESISTOR BARGAINS! Get luck assortment of 1/4-1 1/2 watt, 5% and 10% . All in sealed spare parts bags. 1 to 12 in a bag. All brand new and guaranteed perfect. 25 mixed bag asstnt. (approx. 125 res.) \$ 2.25. 50 mixed bag asstnt. (approx. 250 res.) \$ 2.25. 100 mixed bag asstnt. (approx. 500 res.) \$ 2.25.

BARRY ELECTRONICS CORP. 136B Liberty Street, N. Y. 6, N. Y. Rector 2-2562. Terms: 2 1/2% with order, balance C.O.D. All merchandise guaranteed, F.O.B. N.Y.C.

ADVERTISING INDEX

Table listing various companies and their page numbers in the directory.

RADIO SCHOOL DIRECTORY (Page 155)

Table listing radio schools, training centers, and their contact information.

THE NEW TV DYNATRACER TRACES TV SIGNALS AND VOLTAGES. LOCATES DEFECTIVE COMPONENTS INSTANTLY. REQUIRES NO ADDITIONAL EQUIPMENT. \$4.95. Ideal for trouble-shooting television in the field or on the bench. Used under actual operating conditions, will out-perform more expensive testers. A MUST FOR EVERY ALERT TV TECHNICIAN! SPECIFICATIONS: The "DYNATRACER" is a self-powered quality instrument designed to trace TV signals through any Video, Sound, Sync. AFC or Vertical and Horizontal Sweep Circuit—will isolate trouble to a stage or component. ADDED FEATURE: The "DYNATRACER" will also trace voltages and instantly locate open, shorted or intermittent condensers, resistors, coils, speakers, transformers, etc. COMPLETE INSTRUCTION BOOK ENCLOSED 10-DAY MONEY BACK GUARANTEE. Clip Adv. Write Name and Address in Margin. Attach \$5.00 Bill, Check or M.O. and Mail to Century ELECTRONICS CO. 8509-21st Ave., Dept. 107, Brooklyn 14, N. Y.

RECORDING TAPE (plastic base) 40% off WASHINGTON, D. C.: WHERE ELSE WOULD THERE BE MORE REEL A TAPE? Magnetic. • 1200 ft. plastic tape with plastic reel included. • Each reel individually boxed. • Choice of nationally famous top quality brands such as: • Weaber (290B) 3.20; Reeves (SPN-12) 3.20; Audio (1251) 3.20; Scotch (111-A) 3.20; Panasonic (711-A) 3.25; Irish, Professional grade (211-IR) 3.50. • Recording studios, schools, radio stations and other large quantity users—write for bulk price. ***** USED RECORDING TAPE (PLASTIC BASE) 1.99 for 7"—1200 foot .99 for 5"—600 foot .59 for 4"—300 foot .29 for 3"—150 foot Plastic reels included with all above sizes. New empty plastic reels in boxes for easy labeling, 3" 10c; 4" 22c; 5" 24c; 7" 30c; 7" Professional reel (2 3/8" hub) 75c ea. EMPTY BOXES: 3" 3c; 4" 5c; 5" 5c; 7" 10c ea. We carry now recorders, recording blanks, tape recorders, etc., at large savings. PLEASE INCLUDE SUFFICIENT POSTAGE. COMMISSIONED ELECTRONICS CO. 2503 Champlain St. N.W., Washington 9, D. C.

UHF and THE KLIPZON CRYSTAL PROBE. SELF HOLDING POINTS. solves your UHF ... VHF ANTENNA PLACEMENT and ORIENTATION problems. No more roof-top shouting—No phones—No expensive field strength measuring equipment! Use a KLIPZON Type C PROBE We show you how. Maximum picture guaranteed in a jiffy! SAVE TIME AND MONEY Many other uses described in FREE 4-page illustrated bulletin. Ask for KLIPZON Type C at your local distributor; if not stocked, send \$6.95 check or M. O. direct to: UNITED TECHNICAL LABORATORIES BOX 425 F • MORRISTOWN, N. J. RADIO-ELECTRONICS

RADIO SCHOOL DIRECTORY

GET INTO ELECTRONICS

You can enter this uncrowded, interesting field. Defense expansion, new developments demand trained specialists. Study all phases radio & electronics theory and practice: TV; FM; broadcasting; servicing; aviation, marine, police radio. 18-month course. Graduates in demand by major companies. H.S. or equivalent required. Begin Jan., March, June, Sept. Campus life. Write for catalog.

VALPARAISO TECHNICAL INSTITUTE
Dept. C Valparaiso, Ind.



TV REPAIRMEN MAKE TOP MONEY!

In just 39 weeks, you can get complete TV service training! Streamlined course gives you all essentials for a good job as service technician. Graduates in great demand; jobs are plentiful in this growing field. Other courses in electronics, radio operation and maintenance. Day or evening classes; modern equipment. Opportunity for employment in local industry.

Write for Catalog 111 Today

INDIANAPOLIS ELECTRONIC SCHOOL
312 E. Washington, Indianapolis 4, Ind.



RCA INSTITUTES, INC.

A service of Radio Corporation of America
350 West 4th St., New York 14, N. Y.

OFFERS COURSES IN ALL TECHNICAL PHASES OF RADIO, TELEVISION, ELECTRONICS

Approved for Veterans
Write Dept. RC-53 for Catalog

MAKE \$600 EXTRA EACH MONTH!

F.C.C. LICENSE REQUIRED

Service 2-way mobile radio systems. Our free booklet tells of opportunities, explains the different types and classes of F.C.C. licenses required, and tells how you can get your license QUICKLY. 2nd class in 5 weeks. 1st class in 3 additional weeks. Both correspondence and residence training available. Write today for free booklet.

GRANTHAM SCHOOL OF ELECTRONICS, DEPT. 101
6064 Hollywood Blvd., Hollywood 28, Calif.

SENDING SPEED

CODE RECEIVING

Be a "key" man. Learn how to send and receive messages in code by telegraph and radio. Commerce needs thousands of men for jobs. Good pay, adventure, interesting work. Learn at home quickly through famous Candler System. Quality for Amateur or Commercial License. Write for FREE BOOK.

CANDLER SYSTEM CO.
Dept. 3-M, Box 928, Denver 1, Colo., U.S.A.

CORRECTION

The 500-ma meter in the diagram of the "Tube-Filament Checker" which appeared in the July, 1953 issue is correct, rather than the 5-ma meter as specified in the text. The article appeared on page 91.

Unlimited Opportunities in RADIO ENGINEERING

DEGREE IN 27 MONTHS

Complete Radio Engineering course including telev. U. H. F. and F. M. Bachelor of Science Degree also in Mech., Civil, Elect., Chem., and Aero. Eng.; Bus Adm., Acct. Extensive campus, modern buildings, well equipped labs. Low cost. Prep courses. Personalized, practical instruction. Founded 1884. Placement service. Growing shortage of engineers. Prepare now. Approved for Korean vets. Enter January, March, June, September. Write for catalog.



TRI-STATE COLLEGE

24113 College Ave. ANGOLA, IND.

RADIO ENGINEERING 27 MONTHS DEGREE

Intensive, specialized course including strong basis in mathematics and electrical engineering, advanced radio theory and design, television. Modern lab. Low tuition. Self-help opportunities. Also B.S. degree in 27 months in Aeronautical, Chemical, Civil, Electrical and Mechanical Engineering. G.I. Gov't approved. Enter December, March, June, September. Catalog.

INDIANA TECHNICAL COLLEGE

1511 E. Washington Blvd., Fort Wayne 2, Indiana

EARN MORE MONEY— BE A PROFESSIONAL TELEVISION SERVICE TECHNICIAN

STEP INTO THE TOP PAY \$5,000—\$10,000 A YEAR CLASS. 7 MONTHS' SHOP TRAINING QUALIFIES YOU.

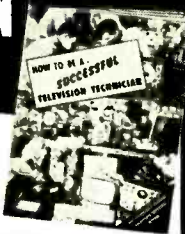

If you want to reach your goal as a Successful Service Technician you will need plenty of "KNOW HOW" to qualify for the better servicing jobs or profitable shop ownership.

SEND FOR FREE BOOK TODAY!

WESTERN TV offers real experience on live equipment in our **BIG SHOPS AND LABORATORIES** in the shortest practical time under expert instructors. Graduates are in big demand because they have the "field experience" necessary for immediate "bench" or supervisory positions. You learn every phase of Radio and TV servicing (AM, FM, VHF, UHF). WT men win fast promotion... can demand better pay... develop highly profitable businesses of their own with the latest and most **PRACTICAL PERSONALIZED TRAINING BEHIND THEM**. You concentrate all your time on being a **PROFESSIONAL TV SERVICE TECHNICIAN**—non-essential math and engineering theory omitted. **YOU CAN EARN WHILE YOU LEARN**. Special Finance Plan. **APPROVED FOR VETERANS**. Find out how you can get into the **TOP PAY GROUP**—Send for this fact-packed book NOW!

WESTERN TELEVISION INSTITUTE

America's Leading Television Servicing School

Western Television Institute Dept. E-113
341 W. 18th St., Los Angeles 15, Calif.
Without obligation, please send FREE fully illustrated booklet. (No salesman will call.)

NAME _____ AGE _____
ADDRESS _____
CITY _____ ZONE _____ STATE _____

BECOME AN ELECTRICAL ENGINEER

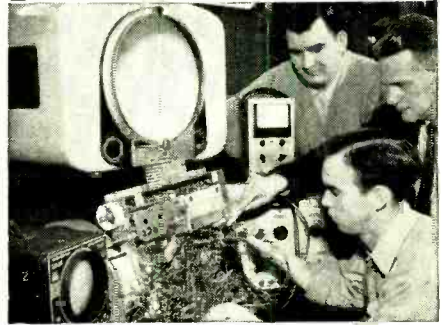

Bachelor of Science Degree in 36 months.

Major in Electronics or Power. Now, prepare for a career in these rapidly expanding fields.

This school will prepare you to become an engineer, technician or service man. Previous military, academic or practical training may be evaluated for advanced credit.

Enter Both Radio and Television

In 12 months you can attain the **Radio-Technician's** certificate. An added 6 months course qualifies you for the **Radio-TV Technician's** certificate and the Degree of "Associate in Applied Science." The Technician's course is the first third of the program leading to a Bachelor of Science Degree in Electrical Engineering with a major in Electronics.

Also offered: 12-month Radio-TV service course; 12-month Electronics or Electro Technician Courses; 6-month Electrical Service Course and 3-month refresher and general preparatory classes.

Terms Open January, March, June, October
Famous for its Concentric Curriculum. Faculty of specialists. 50,000 former students. Annual enrolment from 48 states and 23 overseas countries. Non-profit. 50th year. Courses approved for Veterans. Residence courses only.

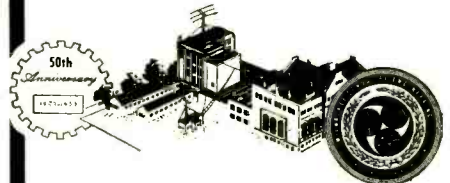

MILWAUKEE SCHOOL OF ENGINEERING

MILWAUKEE SCHOOL OF ENGINEERING
Dept. RE-1153, 1025 N. Milwaukee
Milwaukee 1, Wisconsin

Send: Free 45-page "Your Career" booklet describing Electrical Engineering Courses; Booklet on Careers in Radio-TV.

I am interested in _____ name of course _____
Name _____ Age _____
Address _____
City _____ Zone _____ State _____
If veteran, indicate date of discharge _____

"TABS" NEW TRANSFORMER STOCK
2.5VCT/10A 12.5KVINS Kenyon \$6.98
75VCT/200MA 5V/3A 6.3VCT/5V \$3.98
150VCT/300MA 5V/3A 6.3VCT/5V \$3.98

FILAMENT TRANS.
2.5V/2A @ 79¢; 2 for \$1.49; 10 for \$6.49
6.3V/2AMP @ \$1.08; 2 for \$1.98
2.5VCT/10A 12.5KVINS Kenyon \$6.98

TRANSFORMERS
All 115 V 60 Cycle Input TV & CR
PWR Xmfr up to 20" Tubes. HI
VOLTS to 20 KV (w/quadriplier)

POWERSTAT SPECIALS
Type 20-0-135V/3 5 10.00
Type 116-0-135V/7.5 16.98
Type 116 as above 20.49

FILTER CHOKES
12Hy/30ma/H'Sid/3KvINS 2.25
10Hy/125ma/1TC/Csd/4 1.49
10Hy/125ma/1TC/Csd/4 1.49

TUBES
*From This Special List We Ship \$10.00 and
Up Tube Orders At Our Expense (Post-
paid) Within Continental Limits of U.S.A.

TAB'S THAT'S A BUY

RHEOSTAT SALE
2 ohm 50W Model J .225; 5 for 10.00
6 ohm 25W Model LH .149; 2 for 2.49

POWERSTAT SPECIALS
Type 20-0-135V/3 5 10.00
Type 116-0-135V/7.5 16.98

SPEEDWAY ELEC. DRILLS
115VAC JACOBS CHUCK, III-
Torque Unit Appvd.
200 1/4" RPM 1500 & 9

OIL CONDENSERS WAREHOUSE CLEARANCE SALE
RECTANGULAR CASE
15MFD 1500VDC 2 for \$1.50

BATHROOM SIDE TERMINALS
1MF 600VDC 1 for 1.00
4MF 50VDC 5 for 2.00

DC POWER SUPPLY
0 to 12 VDC/2 Amp. Variable DC supply, un-
dressed and completely
usable - Inpt. 115V/60 cy

FEDERAL "ITT" SELENIUM BATTERY CHARGER RECTIFIER
10-0-10V (CT) 100 Amp., fan cooled. Re-
place your old inefficient sulfide rectifier

SELENIUM RECTIFIERS
CURRENT LIST WAVE FOR RADIO & TV
65MA @ 130V \$1.50 \$0.59 \$6.48

RECTIFIER XFMRs
Primary 115V 60 Cyc
Secondary 0-9-12-18-24-36V
4 Amp \$ 8.75

SELENIUM RECTIFIERS
We specialize in Rectifiers, Power supplies
& accessories. Immediate delivery

TELEVISION ANTENNA
VEE CONICAL Broad re-
sponse, all channel, power-
ful for fringe areas. \$8.95

TV & COAX CABLE
300 Ohm Twine, Heavy duty 65
mil all copper TV lead in.

CRYSTAL DIODES
IN238 Sylvania \$1.89
Smaller Quantity, Unit Price \$2.25

"LAST MINUTE SPECIALS"
HELIPOT 50K OHM 10 Turn 0.5% \$ 8.95
DUAL ATTENUATOR 7470 & 1003

TUBE SPECIALS
YOU PICK THEM 39¢
Cracked base or broken key
electrically

RELAY SALE
SPST mini size 115VAC 3A
1/2" 36V Batteries w/acid. \$2.75

STORAGE BATTERIES
36 volt WILLARD Mmm-BRAND NEW: 5 oz
14 Regulated Portable Equip Models. 98¢; 4 for \$5.35

AUDIO AMPLIFIERS
READY TO GO
Model 305MP 5 Watt
Ampl. as Pictured above

AUDIO COMPONENTS
GE RPX041 Photo Cart. \$4.49
GE RPX050 Triple Play Cart. 6.98

TAB "SUN-FLASH" LAMPS
No. 1 Replaces Max. Each
U5W SPRG/FA104 150 \$5.00

100 WATT SEC PHOTOFLASH KIT
Includes DX Flash Lamp Rated
100 W/1/4" Dia. Wash Lamp

METER SPECIALS
0-30 VDC "AN" 1.98; 2 for 3.25
0-100 VDC "AN" 1.98; 2 for 3.49

MONEY BACK GUARANTEE (Cost of
Mds. Only) \$5 Min. Order F.O.B.
N.Y.C. Add Shpg. Charges or 2.5%

Continuation of TUBES list with various tube types and prices.

Continuation of TUBES list with various tube types and prices.

CONDENSER SPECIAL
2 MFD 1000 VDC 25¢
330 VAC "CD" MFR Lots of 10

YOU PICK THEM 59¢ WHILE THEY LAST
LOTS OF 10
Your selection of 10 at 59¢ each or
smaller quantity at indicated prices.

ELECTROLYTIC CONDENSERS
2X 20MFD/450VDC 3 for \$1.95
3X 15MFD/450VDC 3 for 2.50

ELECTROLYTIC CONDENSER KIT
POPULAR VALUES 25¢ ea.
lots of 15
Here is a handy assortment of 15 condens-
ers for the serviceman. Only \$3.75

TACHOMETER GENERATOR
MARK V STUD MTG
GENERAL ELECTRIC Part 22CM5AK-20 \$4.98 ea.
Write for quantity price

OIL CONDENSER SPECIAL
10 MFD \$1.75 ea
600 VDC lots of 3
Case dimensions, not including
insulators 4 1/2" x 3 1/2" x 1 1/2"

HI-FI POWER SUPPLY
SOLA constant voltage power
transformer, mounted on
chassis with 23 ocdl rectifier
sockets.

INFRARED SNOOPERSCOPE
SEE-IN-DARK TUBE
Image-Converter Tube. Sensitivity sim-
plified design 2" dia. Willemite screen-
data & tube, ea. \$4.98; 2 for \$9.49

866A KIT and XFORMER
2 Tubes, Sekts. xmfr.
15Vdc 1/2 Inpt. outpt.
2.5Vct/10A/4

CIRCULAR SLIDE RULE
Equi to 12" Only 2 1/4" Radius, LAMI-
NATED-Print Stays On Mill, Div. Sls.
Cubes & Roots, Log, Decimal Equiv. 98¢

ONE YEAR GTD PICTURE TUBES
74P4 \$17.95
12" Glass 16.95

THAT'S A BUY TAB'S THAT'S A BUY
Dept. 10RE 111 LIBERTY STREET, NEW YORK 6, N. Y., U.S.A.

YOU PICK THEM \$1.00 WHILE THEY LAST
LOTS OF 5
KITS AND COMPONENTS
Oil Condensers Asst. 5 for \$1.25

SELSYNS
AY1 & AY5 28V/400 Cy \$3.49
or 22V/60 Cy, Each

SOCKET ASSEMBLIES
1 1/2" JEWEL SOCKET 29¢ ea
Ordered in smaller quantity, Ea. 59¢
1 1/2" JEWEL Candelabra (screw) base 55¢

PALMER CLAW HAMMERS 85¢
REGULAR \$2.95
STD 16 OZ BRAND NEW
SMALLER QUANTITIES, EACH 98¢

THAT'S A BUY TAB'S THAT'S A BUY
Dept. 10RE 111 LIBERTY STREET, NEW YORK 6, N. Y., U.S.A.

YOU PICK THEM \$1.00 WHILE THEY LAST
LOTS OF 5
KITS AND COMPONENTS
Oil Condensers Asst. 5 for \$1.25

SELSYNS
AY1 & AY5 28V/400 Cy \$3.49
or 22V/60 Cy, Each

SOCKET ASSEMBLIES
1 1/2" JEWEL SOCKET 29¢ ea
Ordered in smaller quantity, Ea. 59¢

PALMER CLAW HAMMERS 85¢
REGULAR \$2.95
STD 16 OZ BRAND NEW

THAT'S A BUY TAB'S THAT'S A BUY
Dept. 10RE 111 LIBERTY STREET, NEW YORK 6, N. Y., U.S.A.

Depend on Mallory
for
Approved Precision Quality

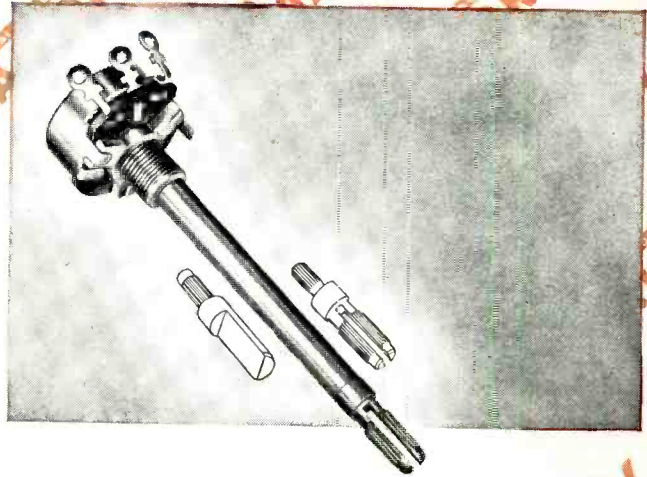

"WE'LL HAVE IT

BACK TOMORROW"



Mallory Dual Control Kits

Three kits of controls and switches, selected to meet varying requirements in different parts of the country, will serve 50 different models of radio and television sets. You pay only for the controls and switches; attractive 3-drawer metal cabinet is free of extra cost. Get details from your Mallory Distributor.

Fast turnover . . . more jobs done per day . . . that's the answer to greater profits for any service shop. Every minute saved is time available for turning out more work.

That's why Mallory Midgetrols® were designed for fast, easy installation in any set . . . TV or radio.

Round tubular shafts can be cut accurately and quickly . . . fit split-knurl or flatted-type knobs.

AC switches can be attached instantly without disassembling the control.

Unique design simplifies inventory problems . . . makes them quickly available from your distributor.

Midgetrols are engineered to match the electrical characteristics of the original equipment of any TV or radio set. They will give equal, and often better, performance and life than the original control.

For all your service work, use Mallory Midgetrols. They are the answer to fast installation . . . precision quality on every job.

This will save you time, too. Ask your Mallory Distributor for a copy of the Mallory Control Guide. It is a complete cross reference between set manufacturers' part numbers and the equivalent Mallory control.

P. R. MALLORY & CO. Inc.
MALLORY

CAPACITORS • CONTROLS • VIBRATORS • SWITCHES • RESISTORS
RECTIFIERS • POWER SUPPLIES • FILTERS • MERCURY BATTERIES

APPROVED PRECISION PRODUCTS

P. R. MALLORY & CO., Inc., INDIANAPOLIS 6, INDIANA

A serviceman's *"best friend"* is an RCA Tube

An RCA Tube starts working for you from the instant the customer first sees the familiar red, black, and white carton. You have her confidence from the start, because she knows and respects the RCA trademark.

But the big payoff to you begins when the tube goes to work. For, experience has proven that the superior quality of RCA Receiving Tubes and Kinescopes is your best measure of protection against premature tube failures. With RCA Tubes, you can be sure the job is well done.

Helping you to safeguard your reputation is a vital, everyday service of RCA Tubes. And that protection is yours at no extra cost.



**UNLOCK
 THE DOOR TO
 BIGGER
 PROFITS**

Here's *your* key to better business... RCA's dynamic Dealer Identification Program. Ask your **RCA Tube Distributor** for your copy of the colorful, 16-page booklet "A Magic Pass-Key to Customer Confidence." It tells you how you can become a Registered Dealer... and get *extra* sales benefits.



RADIO CORPORATION of AMERICA
 ELECTRON TUBES
 HARRISON, N. J.