

By the Publishers of *Radio-Electronics*

Special Projects

The magazine for people who build electronic projects

Photog's Printmeter

Get the most from your enlarged prints!

See page 77

#9

WINTER 1984

\$2.25 U.S./\$2.75 CANADA

48784



Build

Digi-Slot—armless bandit for home play

Desktop Antennas for Shortwave Listeners

Digital Capacitance Meter—from 1 pF to 9999 μ F



Expanded Bargraph Display

See page 55

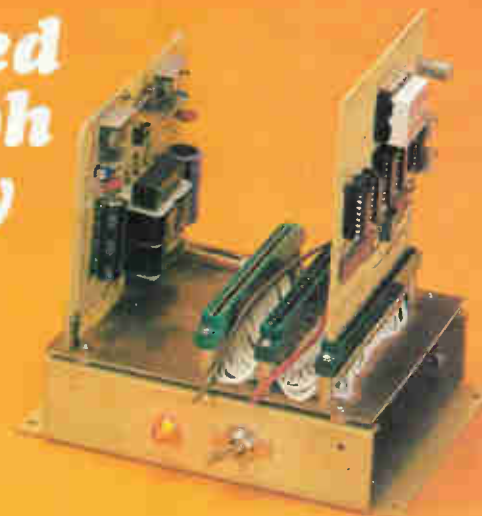

Dot-Bar Generator

See page 72

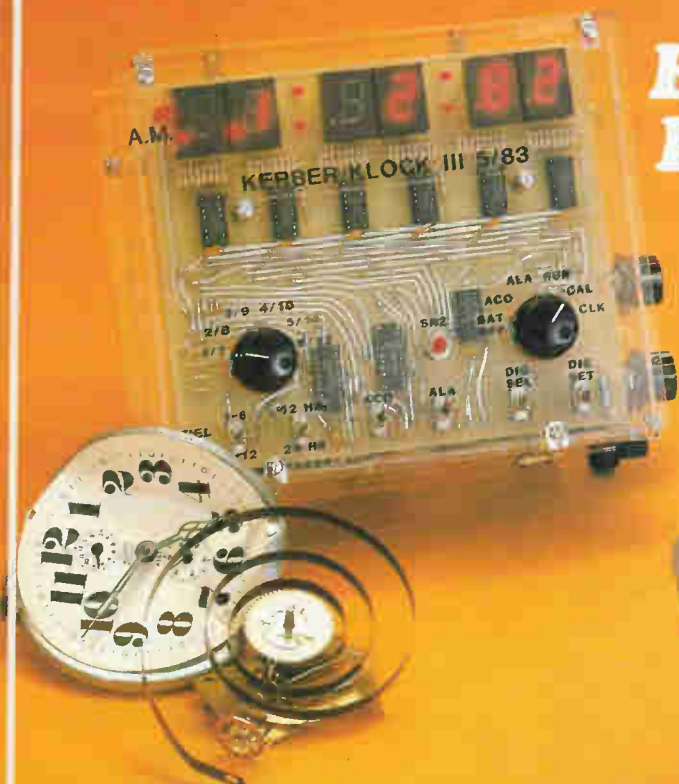

KERBER KLOCK

See page 21



A GERNSBACK PUBLICATION

Plus—New Departments on DX'ing and Computers

WHAT IF

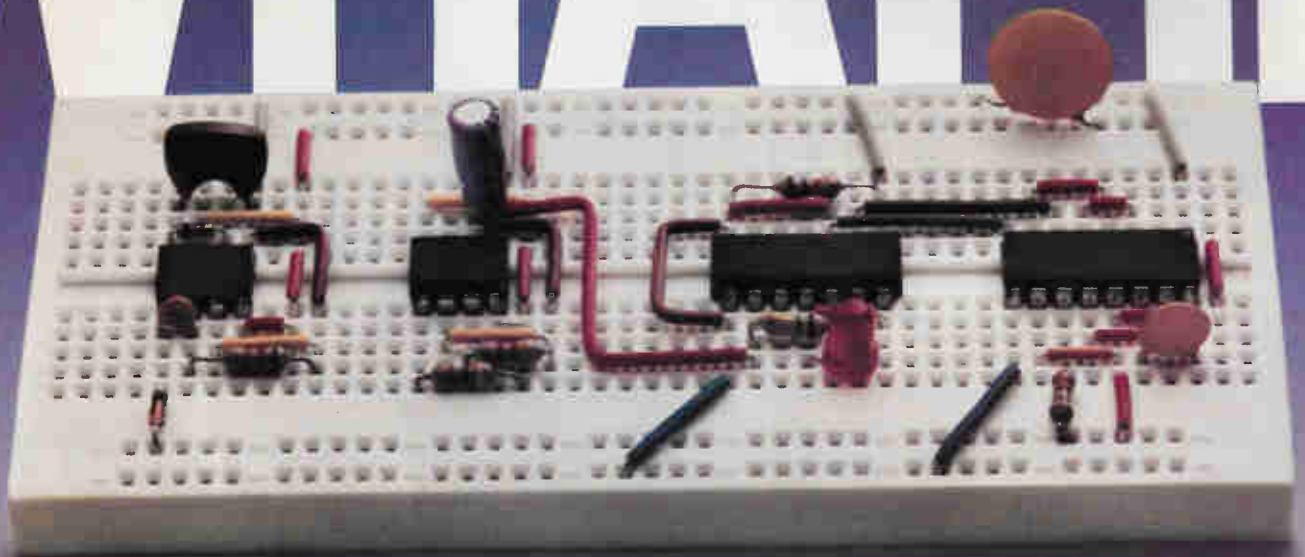

What if there were a faster way to build and test circuits?

There is. Circuit-Strip from AP PRODUCTS makes circuit building a snap, giving you more time to experiment, to create. With a Circuit-Strip solderless breadboard, all you have to do is plug in components and interconnect them with ordinary #22 AWG solid hook-up wire. If you want to make a circuit change, just unplug the components involved and start over. It's just that easy. Circuit-Strips feature 610 plug-in tie-points and have a capacity of up to 6 14-pin DIPs. Four separate distribution buses of 35 tie-points each give you access for power, ground or signal.

What if it were easier to identify tie-point locations in a circuit?

It is. Circuit-Strip has a molded-in alpha-numeric grid for instant identification of every tie-point. Schematics can be labeled with each tie-point location to make circuit building faster and troubleshooting easier. Circuit-Strip is ideal for electronic training programs as well as laboratory use.

What if Circuit-Strip had a new low price?

It does. Circuit-Strip now carries a suggested resale price of only \$12. That means that the best tool for the job now has the best price ever.

What if you need more information?

That's easy, too. Just call toll free 800-321-9668 for the name of the distributor near you. (In Ohio, call collect (216) 354-2101.)

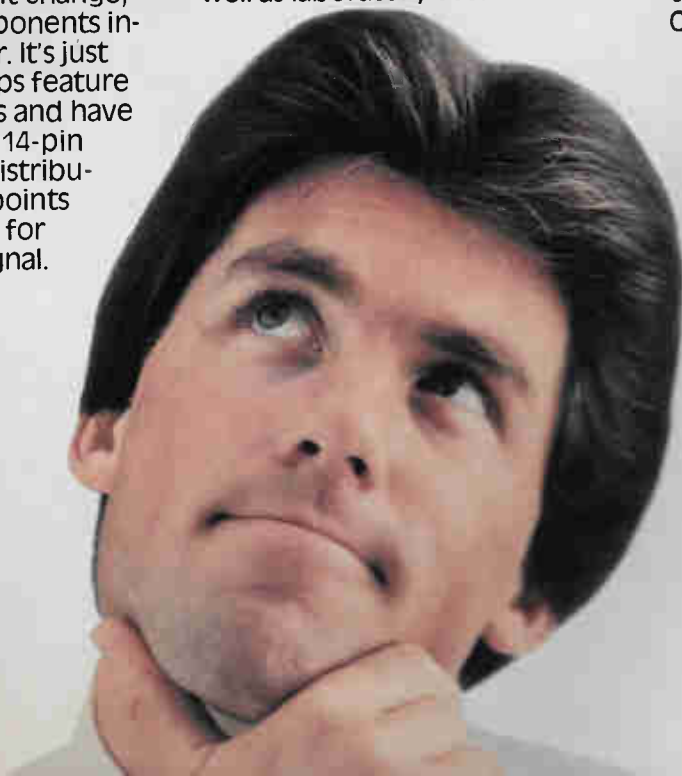

AP PRODUCTS INCORPORATED
8450 Pineneedle Dr. • Box 540
Mentor, Ohio 44061-0540
(216) 354-2101
TWX: 810-425-2250

In Europe, contact A P PRODUCTS
GmbH Baumlesweg 21
D-7031 Weil 1 • West Germany
Phone: [07157] 62424
TLX: 841 07 23384

CIRCLE 401 ON FREE INFORMATION CARD

What time is it?

How many times have you asked that question, or had it asked of you? All too often you look at your wristwatch to discover its still too early to leave work, look away, and promptly forget the time. Time is an essential part of our daily lives, yet we are ignorant of it most the time, or unduly stress the need for knowing the time on other occasions when it's really unimportant. The closest commodity to time to which we concern ourselves with equal vigor is the weather. As you can guess by now, I'm about to tell you of our melody/alarm digital clock we call Kerber Klock III.

For a period that lasted a few weeks, my office became a popular place to hang out during the time Kerber Klock III sat on my desk quietly telling the exact time of day except on the quarter hours when melodies stirred the air creating a "come hither, let's chat" atmosphere. For, on each quarter hour, Kerber Klock III would call out one of twelve melodies selected to be played that day. The time was always exact, and the clock was a conversation piece considering that the digital readout and electronics was housed in a clear plastic case. You'll enjoy owning this digital clock, but you'll have to build your own should you want one—it's not for sale in the marketplace. Turn to page 21 for the complete plans author Kerber (who else) has prepared for you.

And, keep those subscriptions to **Special Projects** coming. Frankly, I had no idea there would be so many project builders interested in a magazine edited solely for them. And, thanks for writing, because your suggestions are being considered, and affecting the format of this magazine. For example, your letters indicated that you want information on computers for beginners. Also, many of you want information related to your softwave listening hobby. Well, this issue of **Special Projects** contains two brand new columns on both subjects. I suggest you read them. Both columnists are professionals in their respective hobby fields. We have a few other goodies coming up in following issues. So stay tuned to your newsstand or mailman—however you may obtain **Special Projects**!

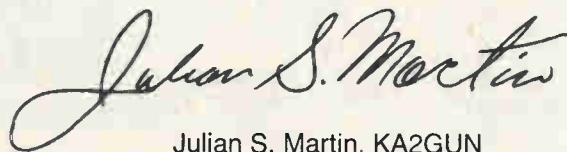

Julian S. Martin, KA2GUN
Editor

Special Projects, (ISSN 0033-7862) published quarterly by Gernsback Publications, Inc., 200 Park Avenue South, New York, NY 10003. Phone 212-777-6400. Four-issue subscription rate is \$9.00—U.S. funds only. Canada and Mexico subscribers add \$3.00 for postage. All others add \$7.00. Mail all subscription orders, address changes, correspondence and Postmaster Notices of undelivered copies (Form 3579) to **Special Projects** Subscription Service, Suite 1101, 200 Park Avenue South, New York, NY 10003. Single-copy price \$2.25. © 1983 by Gernsback Publications, Inc. All rights reserved. Printed in U.S.A.

A stamped self-addressed envelope must accompany all submitted manuscripts and/or artwork or photographs if their return is desired should they be rejected. We disclaim any responsibility for the loss or damage of manuscripts and/or artwork or photographs while in our possession or otherwise.

As a service to readers, **Special Projects** publishes available plans or information relating to newsworthy products, techniques and scientific and technological developments. Because of possible variances in the quality and condition of materials and workmanship used by readers, **Special Projects** disclaims any responsibility for the safe and proper functioning of reader-built projects based upon or from plans or information published in this magazine.

Hugo Gernsback (1884-1967) founder
M. Harvey Gernsback, editor-in-chief
Larry Steckler, CET, publisher
Art Kleiman, editorial director
Julian S. Martin, KA2GUN
editor
Carl Laron, associate editor
Brian C. Fenton, assistant editor
Ruby Yee,
production manager
Robert A. W. Lowndes, production
associate
Joan Roman, circulation director
Arline R. Fishman,
advertising coordinator

Cover photo by Robert Lewis
Composition and interior design by
Mates Graphics

BUSINESS AND EDITORIAL OFFICES

Gernsback Publications, Inc.
200 Park Ave. S., New York, NY 10003
President: M. Harvey Gernsback
Vice President; Larry Steckler

NATIONAL ADVERTISING SALES

Joe Shere
1507 Bonnie Doone Terrace
Corona Del Mar, CA 92625
714/760-8697

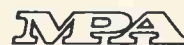

FEATURES

- 21 **Kerber Klock III**—a modern day grandfather's clock that's digital and melodic—but you've got to see it to believe it.
- 38 **Burn Baby, Burn**—There's gold in those surplus circuit boards only if you know how to pull out IC's without damaging them.
- 41 **Desktop Software Antenna**—pull in 3—30 megaHertz on a short length of wire
- 45 **Printer Power**—a mini-project that permits the use of a modern printer with a Radio Shack Model 1 computer
- 50 **Digi-Slot**—A no-arm bandit that gives you the thrills of Vegas at home
- 55 **Expanded Bargraph Display**—surprisingly easy to read, it has an accuracy of 1-2% and reads from 0 to 109
- 60 **LED Head Lightchaser**—weird or gimmicky? Either way it's an outrageous project designed for fun
- 63 **Digital Capacitance Meter**—if its unmarked, or in a strange color code, don't fret—you can measure it now
- 70 **Vacuum-Operated Contact-Printer**—squeeze the film to the copper-clad board and eliminate the fuzzies
- 72 **Dot-Bar Generator**—now you can make dynamic and static adjustments on that color picture tube with a little help from our friend
- 77 **Printmeter**—take the guess work out of the darkroom, and produce enlarged prints like the pros do
- 80 **Digital AC Line Monitor**—monitor the AC line's voltage at a glance
- 83 **New Life for an Old Monitor**—we're talking about a retrofit cost of a few dollars
- 87 **Battery Saver for Personal Portables**—you'll wonder why you didn't build it a long time ago
- 90 **Room Temperature Stabilizer**—pump heat from where it is to where it isn't and save heat bucks at home

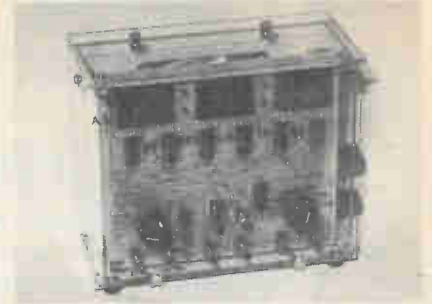

Kerber Klock III—page 21



Digital Capacitance Meter—page 63

DEPARTMENTS

- 1 **Editorial**—What time is it?
- 4 **New Products** (with more on pages 8 and 16)
- 5 **Letters**—with answers
- 9 **Friedman on Computers**—Why your new printer won't do what it's supposed to do
- 12 **Jensen on DX'ing**—getting started on the shortwave bands

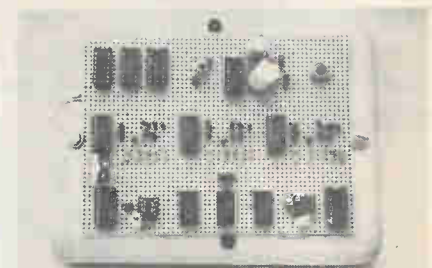

Digi-Slot—page 50



Printmeter—page 77

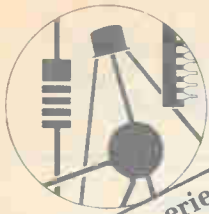

The ELECTRONICS BOOK CLUB

The latest *computer*
and *electronics* titles for
hobbyists and professionals!

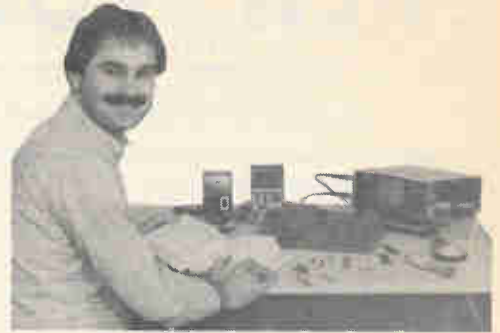

18 years experience

State of the art technology . . . projects . . .
troubleshooting and repair . . . even
how to build your own microcomputer!

Select 6 Books for \$2⁹⁵
Save up to \$118⁷⁵



1449
List \$19.95



1108
List \$15.95



1431
List \$17.95



1409
List \$15.95



1616
List \$19.95



1487
List \$15.95



1277
List \$19.95



1486
List \$17.95



1503
List \$21.95



1306
List \$19.95



1128
List \$12.95



1321
List \$12.95



1296
List \$18.95



1199
List \$18.95



1332
List \$16.95



1466
List \$17.95



1498
List \$18.95



1195
List \$13.95



1473
List \$19.95



1383
List \$13.95 (paper)



1497
List \$15.95



1532
List \$17.95



1451
List \$18.95



1536
List \$14.95

7 very good reasons to try Electronics Book Club Blue Ridge Summit, PA 17214

- **Exceptional Quality.** All books are first-rate publisher's editions, filled with useful, up-to-the-minute information
- **Reduced Member Prices.** Save 20% to 75% on books sure to increase your know-how
- **Satisfaction Guaranteed.** All books returnable within 10 days without obligation
- **Club News Bulletins.** All about current selections—mains, alternates, extras—plus bonus offers. Comes 13 times a year with dozens of up-to-the-minute titles you can pick from
- **"Automatic Order."** Do nothing, and the Main selection will be shipped automatically! But . . . if you want an Alternate selection—or no books at all—we'll follow the instructions you give on the reply form provided with every News Bulletin
- **Continuing Benefits.** Get a Dividend Certificate with every book purchased after fulfilling membership obligation, and qualify for discounts on many other volumes
- **Bonus Specials.** Take advantage of sales, special events, and added-value promotions



ELECTRONICS BOOK CLUB Blue Ridge Summit, PA 17214

Please accept my membership in Electronics Book Club and send the 6 volumes circled below, billing me \$2.95 plus shipping and handling charges. If not satisfied, I may return the books within ten days without obligation and have my membership cancelled. I agree to purchase 4 or more books at reduced Club prices (plus shipping/handling) during the next 12 months, and may resign any time thereafter.

1108 1128 1195 1199 1277 1296 1306 1321
1332 1383 1409 1431 1449 1451 1466 1473
1486 1487 1497 1498 1503 1532 1536 1616

Name _____ Phone _____

Address _____

City _____

State _____ Zip _____

Valid for new members only. (Orders outside U.S. or Canada must be prepaid in International Money Orders in U.S. dollars. Canada must remit in U.S. dollars.) This order subject to acceptance by Electronics Book Club. RESP-1183

NEW PRODUCTS SHOWCASE

For more details use the free information card inside the back cover

Radio Shack Programmable Pocket Computer

The TRS-80 Pocket Computer model *PC-3* is a computer small enough to fit into a shirt pocket, and weighs only 4 ounces. Ideal for students, business people and engineers, the *PC-3* can be programmed to solve problems in easy-to-learn BASIC language. The *PC-3* provides 16 arithmetic and 8 string functions and features a 24-character liquid crystal display, along with an accuracy up to 10 digits and 1.4K memory. Other features include 2-digit exponents, multiple statements, and arrays. The *PC-3* can also be used as a direct key-entry calculator.

The automatic statement compaction of the *PC-3* uses every ounce of memory space efficiently, while the automatic power-off feature saves battery life. Programs on the *PC-3* can accept strings of up to seven characters. The *PC-3* is compatible with Radio Shack's existing library of software for the pocket computer model *PC-3*, including nineteen ready-to-



CIRCLE 430 ON FREE INFORMATION CARD

run programs on such topics as engineering math, statistics, aviation, personal and business finance, real estate and games. All that's needed is the optional *PC-3* interface and recorder.

The *PC-3* (Catalog no. 26-3590) is available for \$99.95 at Radio Shack computer centers and participating Radio Shack stores and dealers, and comes complete with batteries and manual. The

matching *PC-3* Printer/Cassette Interface (Catalog no. 26-3591), is available for \$119.95. It allows use of a cassette recorder to load and store programs and data on cassette tape. A thermal dot-matrix printer produces 24-characters per line, one-line per second. The *PC-3* Printer/Cassette Interface includes rechargeable batteries, a cassette adapter/charger, paper, cable and manual.

BK-Precision Oscilloscope

A new 60-MHz triple-trace, dual-time base, delayed-sweep oscilloscope featuring 5mV/div vertical sensitivity to 60 MHz selectable to 1 mV/div sensitivity to 20 MHz and built-in signal-delay line to permit clear viewing of the leading edge of high frequency waveform has been introduced by BK-Precision. Designated model 1560, the unit includes a 5-in. rectangular CRT with internal graticule, scale illumination and 16-kV accelerating voltage; and five trigger sources: Ch 1, CH 2, CH 3/Eternal, Line and V Mode for displaying three signals unrelated in frequency.

The user can select from 22 calibrated sweep time ranges on the A Time Base (0.5 s/div to 0.05 us/div) and 19 calibrated ranges on the B Time Base (5B ms/div to 0.05 us/div). A X10 sweep magnification feature extends the maximum sweep rate to 5 ns/div and allows closer examination of waveforms. The variable trigger hold-off feature permits observation of complex pulse trains.

Other features include front-panel X-Y operation. Channel 1 output on rear panel, sum and difference capability, gate and sweep output, auto focus and single-sweep operation for viewing and pho-

tographing one-time events. The model 1560 is sold exclusively through electronics distributors. The \$1150.00 price includes two 10:1/direct probes, spare fuses, instruction manual, schematic dia-

gram and parts list. For further information contact: BK-Precision/Dynascan Corporation, 6460 West Cortland Street, Chicago, IL 60635. Telephone: 312/889-9087.

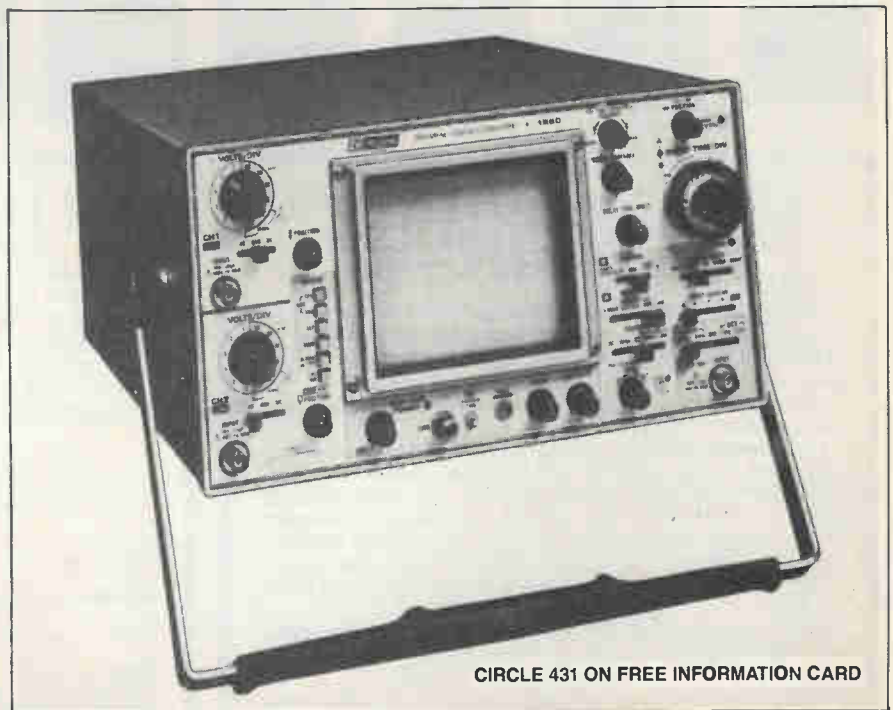

CIRCLE 431 ON FREE INFORMATION CARD

LETTERS

....and answers!

WHY SPEND MORE?

I see it in every issue of Special Projects—some authors solder the IC chip directly to the board of a project; whereas others have DIP sockets in place, and the chips plugged in. I prefer to use sockets so that I can reuse the chip should I have need of that chip at a later date. What's your opinion?

Dave L.
Saskatoon, Sask.

It's up to you! If the circuit is to be a permanent project—one that will be used for some time—I would solder the IC chip(s) in place. If one of those chips is very expensive, I'd use a socket and eliminate the possibility of accidental destruction due to overheating while soldering. Some experimenters like to use sockets because they offer a neater appearance, but in particular instances, as in high-speed computer circuits, it is best to avoid sockets. Actually, we could discuss this subject for hours (in magazine talk I should say, "pages") and not come to an agreement. So, do your thing as you see it, but build, build, build! That's the beauty of our magnificent hobby.

HOT TOPIC

I know that tips don't belong in your letter column but I just had to write this letter. I detest the smell of fuel oil in my hamburgers so I dumped all the petroleum charcoal flame starters I owned and purchased an electric charcoal starter. It worked great, and so did its successor, but both units burned out in one summer. I know it is impossible to get quality products of that type for my barbecue burner; however, I think that your readers would like to find out how I licked the problem.

What I did was purchase a third unit and used a bit of common sense. What I do now to start the charcoals glowing is this: I place the starter on the lower grille of the burner, place a two-pound coffee can on top of it (the grounds were previously consumed and the can has both the top and bottom lids removed) and fill the can with charcoal nuggets. Now, when the starter is plugged into an AC outlet, the bottom coals will begin to ignite sending the combined heat of the starter and glowing coals up the coffee-can chimney, which heats the coals above the kindling temperature. As soon as the bottom coals are glowing, I unplug the starter, slide it out of the coals, and allow the starter to cool slowly. The bottom glowing coals soon generate enough heat to ignite the entire chimney of coals to a bright red glow. Then, with pliers, I lift the coffee can straight up and

the coals fall into place on the grille. That may sound complicated, but give it a try. You'll get the fastest, hot-coal fire you ever had, without the stench of petroleum products. As for my third electric charcoal starter—it has gone two summers and still looks like new.

Marv B.
Shiller Park, IL

Thanks for tip and making possible several hundred first-class burgers barbecued this past season. The reason the starters were burning out was that they

were heated excessively by the hot coals and then cooled too quickly thereafter. One thing that I've noticed in the letters received—our readers combine their electronics hobby with the real world, on the job and in the home, and with other sciences. Hamburger barbecuing is a science to those who delight in producing superb culinary delights in the outdoors over hot coals.

TIMES UP

My old digital clock starts blinking four
continued on page 100

Electronics Paperback Books NEW Paperbacks You'll Want To Read CHECK OFF THE ONES YOU WANT

An Introduction to Video

20 Programs for the ZX Spectrum & 16K ZX81

20 PROGRAMS FOR THE ZX SPECTRUM & 16K ZX81.....\$5.00. Included with each program is a detailed flow chart for both games and practical applications in filing, statistics, and engineering.

30 Solderless Breadboard Projects - Book 2

30 SOLDERLESS BREADBOARD PROJECTS—Book 2.....\$5.75. 30 more new projects based on CMOS ICs that you can try in minutes on an electronic breadboard.

How to Get Your Electronic Projects Working

HOW TO GET YOUR ELECTRONIC PROJECTS WORKING.....\$5.00. When you can't get that home-built experiment to work, this book may have the answers you need.

Electronic Science Projects

ELECTRONIC SCIENCE PROJECTS.....\$5.75. Fascinating projects for any science fair. Includes unique blocks, earthquake detectors and more.

How to Design and Make Your Own PCBs

DESIGN & MAKE YOUR OWN PRINTED-CIRCUIT BOARDS.....\$5.75. Everything you ever needed to know about how to make printed circuit boards at home.

The Art of Programming the ZX Spectrum

ART OF PROGRAMMING THE 16K ZX81.....\$8.25. What happens when you add the pens when you add the RAM pack, Scrolling, PEEK POKE, Page graphics and more.

Multi-circuit Board Projects

MULTI-CIRCUIT BOARD PROJECTS.....\$5.00. 21 simple projects that can all be built on one circuit board. Use the same components in several projects.

International Transistor Equivalents Guide

INTERNATIONAL TRANSISTOR EQUIVALENTS GUIDE.....\$7.50. Lists possible substitutes for a popular user-oriented set of transistors. The products of more than 100 manufacturers are included.

International Transistor Equivalents Guide

INTERNATIONAL TRANSISTOR EQUIVALENTS GUIDE.....\$7.50. Lists possible substitutes for a popular user-oriented set of transistors. The products of more than 100 manufacturers are included.

Easy Add-on Projects for Spectrum, ZX81

EASY ADD-ON PROJECTS FOR SPECTRUM, ZX81.....\$7.00. Pulse detector, picture digiter, 5-key pad, model controller, light pen and more.

Practical Electronic Building Blocks, Book 1

PRACTICAL ELECTRONIC BUILDING BLOCKS, Book 1.....\$5.75. Electronic circuits are all made up of individual building blocks. Make the blocks, then combine them to build the circuits you need.

Practical Electronic Building Blocks, Book 2

PRACTICAL ELECTRONIC BUILDING BLOCKS, Book 2.....\$5.75. Follow up to Volume 1 presents more building blocks for the experimenter.

The Pre-computer Book

THE PRE-COMPUTER BOOK.....\$5.00. Armed at the beginner with no knowledge of computing. An entirely non-technical discussion.

Basic Pascal in Parallel

BASIC PASCAL IN PARALLEL.....\$3.75. Develops programs in both languages simultaneously. Sample programs illustrate structure.

An Introduction to Programming the ORIC-1

AN INTRODUCTION TO PROGRAMMING THE ORIC-1.....\$5.00. A new authoritative manual for owners of this new personal computer.

International Transistor Equivalents Guide

INTERNATIONAL TRANSISTOR EQUIVALENTS GUIDE.....\$7.50. Lists possible substitutes for a popular user-oriented set of transistors. The products of more than 100 manufacturers are included.

Electronics Simplified—Crystal Set Construction

ELECTRONICS SIMPLIFIED—CRYSTAL SET CONSTRUCTION.....\$4.50. All of these receivers are designed around modern inexpensive components and hand-wound coils.

PRICES GOOD UNTIL MARCH 31, 1984

ELECTRONIC TECHNOLOGY TODAY INC. SP9A
P.O. Box 240, Massapequa Park, NY 11762

Number of books ordered

Total Price of Books _____

Sales Tax (NY State Residents only) _____

Shipping and Handling (75¢ 1 or 2 books 30¢ each add. book) _____

TOTAL ENCLOSED _____

Name _____

Address _____

City _____ State _____ Zip _____

Diskette Users...

When you've heard from all the animals in the diskette zoo, but you need fast delivery and high quality diskettes...

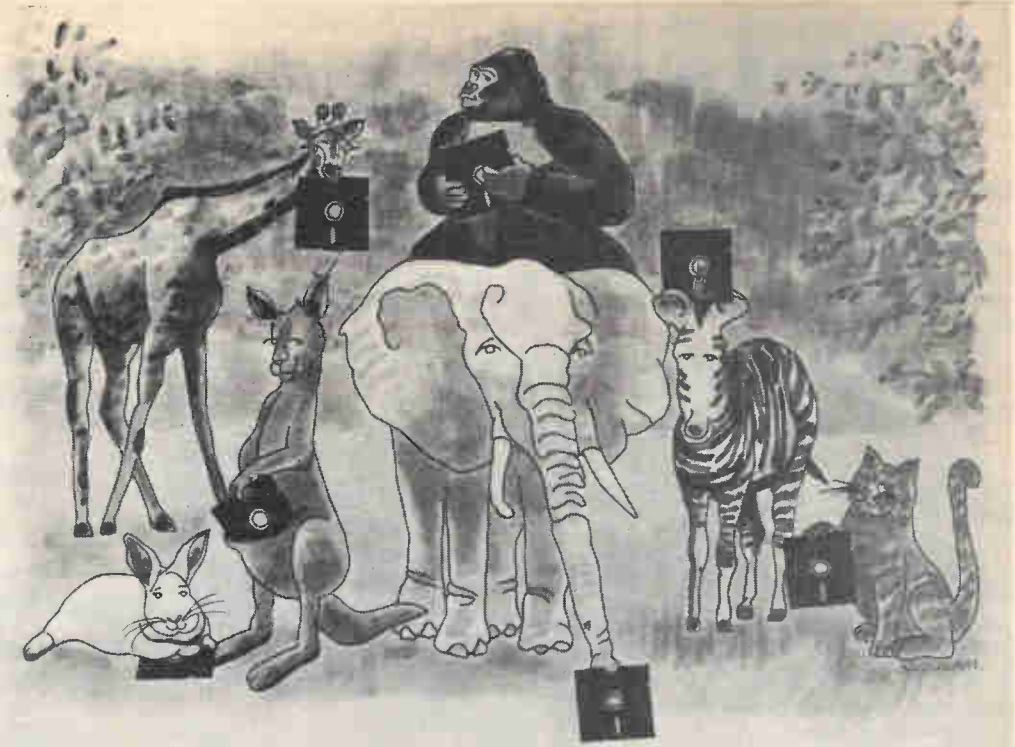

Call Communications Electronics

Diskette order desk
800-521-4414
 In Canada 800-265-4828

Choose your brand
Choose your price



Wabash diskettes for as low as
\$1.29 each

Ultra diskettes for as low as
\$1.39 each

Product Description	Wabash Part #	CE quant. 100 price per disk (\$)	Ultra Part #	CE quant. 100 price per disk (\$)
8" SSSD IBM Compatible 128B/S, 26 Sector	F111	1.89	81726	1.99
8" SSSD Shugart Compatible, 32 Hard Sector	F31A	1.89		
8" SSDD IBM Compatible (128 B/S, 26 Sectors)	F131	2.39	81701	2.49
8" DSDD Soft Sector (Unformatted)	F14A	2.99	82701	3.19
8" DSDD Soft Sector (256 B/S, 26 Sectors)	F144	2.99		
8" DSDD Soft Sector (512 B/S, 15 Sectors)	F145	2.99		
8" DSDD Soft Sector (1024 B/S, 8 Sectors)	F147	2.99	82708	3.19
5 1/4" SSSD Soft Sector w/Hub Ring	M11A	1.49	50001	1.79
5 1/4" SSSD Same as above but bulk product	M11AB	1.29	00153	1.39
5 1/4" SSSD 10 Hard Sector w/Hub Ring	M41A	1.49	50010	1.79
5 1/4" SSSD 16 Hard Sector w/Hub Ring	M51A	1.49	50016	1.79
5 1/4" SSDD Soft Sector w/Hub Ring	M13A	1.79	51401	1.89
5 1/4" SSDD Same as above, but bulk product	M13AB	1.59	00096	1.59
5 1/4" SSDD Soft Sector Flippy (use both sides)	M18A	2.69		
5 1/4" SSDD 10 Hard Sector w/Hub Ring	M43A	1.79	51410	1.89
5 1/4" SSDD 16 Hard Sector w/Hub Ring	M53A	1.79	51416	1.89
5 1/4" DSDD Soft Sector w/Hub Ring	M14A	2.69	52401	2.79
5 1/4" DSDD Same as above, but bulk product	M14AB	2.49	00140	2.49
5 1/4" DSDD 10 Hard Sector w/Hub Ring	M44A	2.69	52410	2.79
5 1/4" DSDD 16 Hard Sector w/Hub Ring	M54A	2.69	52416	2.79
5 1/4" SSDD Soft Sector w/Hub Ring (96 TPI)	M15A	2.59	51801	2.59
5 1/4" DSDD Soft Sector w/Hub Ring (96 TPI)	M16A	3.69	52801	3.69
5 1/4" Fileware Diskette for Apple® Lisa Computer				

For more information about this brand call:

6 year warranty
 For more info on Wabash call
800-323-9868
 In Illinois 312-593-8363

Lifetime warranty except bulk
 For more info on Ultra call
408-728-7777
 Monday-Friday 9 am-4 pm PT

CE...your best source for diskettes

For you the diskette buyer, it's a jungle out there. There are so many different brands to choose from, you need to go on a safari to find a good brand at a reasonable cost. Fortunately, CE has already hunted for the best diskettes and offers you an excellent choice at a CE price. To save you even more, CE also offers bulk product where 100 diskettes are packed in the same box without envelopes or labels. Since we save packaging costs, these savings are passed on to you. Diskette envelopes are also available from CE.

Other Useful Computer Accessories

When the read/write heads on your computer are dirty, that can cause you a lot of grief. Now...with **CE Head Cleaning Diskettes**, you can clean the read/write heads on the diskette drives yourself in just 30 seconds. Each kit contains two head cleaning diskettes, and enough solution for 30 cleanings. Order # 5-CLE for 5 1/4" drives and order # 8-CLE is for 8" drives. Only \$25.00 each. Also available from CE are **3M data cartridges**. The DC100A data cartridge is a small version of the DC300A data cartridge. The DC100A contains 140 feet of 0.150" tape in a package measuring 2.4 x 3.2 x 0.5 inches. Cost is \$14.00 each. The DC300A is a pre-loaded tape cartridge containing 300 feet of one mill thick by 1/4" computer tape. The DC300A costs \$18.00 each. The DC300XL is an extra length data cartridge with 450 feet of tape. It is the same size and interchangeable with the DC300A. The DC300XL provides a total storage capacity of 34.5 million bits at 1600 BPI. The cost of the DC300XL is \$22.00 each. If you need **extra mini-diskette envelopes**, CE sells super strong and tear resistant Tyvek® envelopes for \$12.00 per 100 pack. Use order # TE-5 for a 100 pack of 5 1/4" diskette envelopes. **Smith-Corona TP-1 letter quality printers** are available in serial or parallel versions for only \$529.00 each.

Quantity Discounts Available

Our diskettes are packed 10 disks to a carton and 5 or 10 cartons to a case. The economy bulk pack is packaged 100 disks to a case without envelopes or labels. Please order only in increments of 100 units for quantity 100 pricing. With the exception of bulk pack, we are also willing to accommodate your smaller orders. Quantities less than 100 units are available in increments of 10 units at a 20% surcharge above our 100 unit price. **Quantity discounts** are also available. Order 300 or more disks at the same time and deduct 1%; 500 or more saves you 2%; 1,000 or more saves 3%; 2,000 or more saves 4%; 5,000 or more saves 5%; 10,000 or more saves 6%; 50,000 or more saves 7%; 100,000 or more saves 8%; 500,000 or more saves 9% and 1,000,000 or more disks earns you a 10% discount off our super low quantity 100 price. Almost all our diskettes are immediately available from CE. Our efficient warehouse facilities are equipped to help us get you the quality product you need, when you need it. If you need further assistance to find the flexible diskette that's right for you, call the appropriate manufacturers compatibility hotline telephone number listed at the bottom of this ad. **Dealer inquiries invited.**

Buy your diskettes from CE with confidence

To get the fastest delivery from CE of your computer products, we recommend you phone your order directly to our Computer Products Division and charge it to your credit card. Be sure to calculate your price using the CE prices in this ad. Written purchase orders are accepted from approved government agencies and most well rated firms at a 30% surcharge for net 30 billing. For maximum savings, your order should be prepaid. All sales are subject to availability, acceptance and verification. All sales are final. All prices are in U.S. dollars. Prices, terms and specifications are subject to change without notice. Out of stock items will be placed on backorder automatically unless CE is instructed differently. Minimum *prepaid* order is \$50.00. Minimum *purchase order* \$200.00. All shipments are F.O.B. CE warehouse. No COD's. Non-certified and foreign checks require bank clearance.

For **shipping charges** add \$8.00 per 100 diskettes and/or any fraction of 100 8-inch diskettes, or \$6.00 per 100 diskettes and/or any fraction of 100 5 1/4-inch mini-diskettes. For cleaning kits, add \$3.00 per kit. For tape data cartridges, add \$1.00 per cartridge. For envelopes, add \$3.00 per pack of 100 envelopes. For printers add \$20.00 each for U.P.S. ground shipping and handling in the continental U.S. For Canada, Puerto Rico, Hawaii, Alaska, or APO/FPO delivery, shipping charges are *three times* continental U.S. rates.

Mail orders to: Communications Electronics, Box 1002, Ann Arbor, Michigan 48106 U.S.A. If you have a Visa or Master Card, you may call and place a credit card order. Order toll-free in the U.S. Dial 800-521-4414. In Canada, order toll-free by calling 800-265-4828. If you are outside the U.S. or in Michigan dial 313-973-8888. Telex anytime 810-223-2422. Order today. Copyright © 1983 Communications Electronics™ Ad #102783

COMMUNICATIONS ELECTRONICS™

Computer Products Division

818 Phoenix □ Box 1002 □ Ann Arbor, Michigan 48106 U.S.A.
Call TOLL-FREE 800-521-4414 or outside U.S.A. 313-973-8888

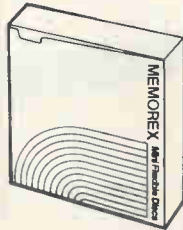

3M diskettes for as low as
\$1.94 each

3M Part #	CE quant. 100 price per disk (\$)
8SSSD	1.94
8SSSD-32	1.94
8SSDD	2.49
8DSDD	3.14
8DSDD-1024	3.14
5SSDD-RH	1.94
5SSDD-10RH	1.94
5SSDD-16RH	1.94
5DSDD-RH	2.69
5DSDD-10RH	2.69
5DSDD-16RH	2.69
5SSDD-96RH	2.79
5DSDD-96RH	3.74
5APPLE-FW	4.34

Memorex diskettes for as low as
\$1.94 each

Memorex Part #	CE quant. 100 price per disk (\$)
3062	1.94
3015	1.94
3090	2.49
3102	3.14
3104	3.14
3481	1.94
3491	2.69
3501	3.74

Burroughs diskettes for as low as
\$2.09 each

Burroughs Part #	CE quant. 100 price per disk (\$)
FD-101	2.09
FD-105	2.09
FD-108	2.64
FD-109	3.29
FD-110	3.29
FD-111	3.29
FD-112	3.29
MFD-11	2.09
MFD-12	2.09
MFD-13	2.09
MFD-14	2.84
MFD-15	2.84
MFD-16	2.84
MFD-20	2.94
MFD-23	3.89

Dyan diskettes for as low as
\$2.99 each

Dyan Part #	CE quant. 100 price per disk (\$)
800501	2.99
800618	2.99
800605	3.89
800803	4.59
800839	4.59
801184	2.99
801186	2.99
801185	2.99
801187	3.19
801014	3.19
801188	3.19
802060	3.89
802062	3.89
802061	3.89
800439	3.89
802067	4.49

Lifetime warranty

For more info on 3M call

800-328-9438
In Minnesota 612-736-9524

5 year warranty

For more info on Memorex call

800-538-8080
In California 800-672-3525

1 year warranty

For more info on Burroughs call

800-448-1422
Monday-Friday 9am-4pm ET

1 year warranty

For more info on Dyan call

800-552-2211
In California 408-970-6096

NEW PRODUCTS SHOWCASE

For more details use the free information card inside the back cover

TEN-TEC/Bassett HF/VHF Antenna Line

TEN-TEC, Inc., the amateur/commercial radio transceiver manufacturer, acquired the Bassett antenna line. The new TEN-TEC/Bassett line includes both multiband fixed station and single band mobile antennas.

The fixed-station, trapped dipole antennas are offered in 13 models of two-, three-, four- and five-band systems covering 10 through 75 meters. All models use helium-filled traps and baluns, stainless steel hardware and "Copperweld" wire. Each model operates as a fundamental broadside dipole, band change is automatic, and no tuner is required to achieve VSWR of 1:5/1 or less. Power ratings are 2 kilowatts PEP.

The single-band mobile whip antennas feature helical inductors sealed in helium-filled lower sections with stainless-steel top whips. Models are available for all bands from 2 through 75 meters. Average weight is just 6 oz., yet they remain vertical and resonant at all highway speeds and are impervious to weather. Power ratings are 750 watts PEP.

Accessories include a single-hole, 5/8-

CIRCLE 442 ON
FREE INFORMATION CARD

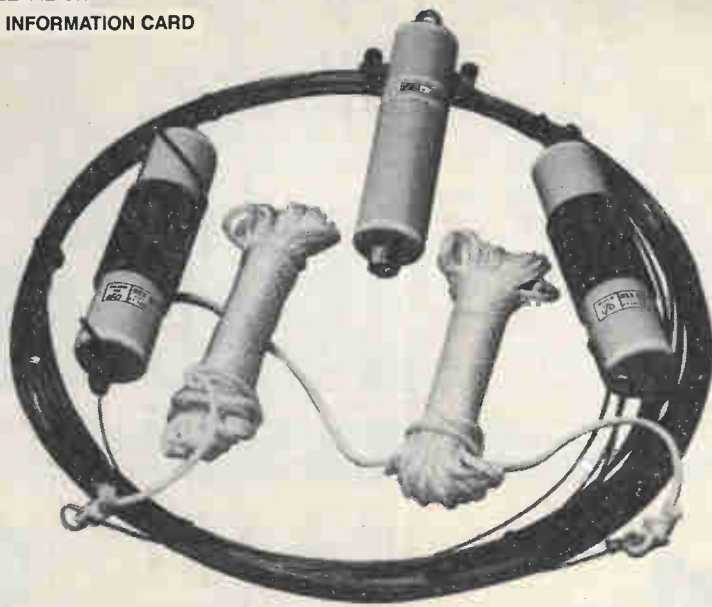

in.-fiberglass, mobile deck mount and a non-inductive 5-band switchable mobile matcher to match 3-30 MHz mobile antennas to 50-ohm coaxial cable. The balun which features a helium-filled, high-

efficiency air core rated to 5 kilowatts PEP is also available separately as are the helium traps for 30 meters. For complete information, write TEN-TEC, Inc., Sevierville, TN 37862.

LEADER 1 GHz Frequency Counter

Leader Instruments has added the LDC-825 to its line of frequency/period counters. The LDC-825 is an 8-digit counter with a bandwidth of 10 Hz to 1 GHz (gigaHertz). The resolution ranges from 0.1 Hz at 10 Hz to 100 Hz at 1 GHz with a time base accuracy of 0.03 ppm. The LDC-825 has two-selectable frequency ranges, two sensitivity ranges and four-gate times to allow the user to precisely match the instrument to his measurement needs. A large fluorescent display makes the LDC-825 well suited to production test and other applications where a bright readout is essential.

The LDC-825 also has period measurement capability. This function is particularly useful for high resolution measurements of low-frequency signals when long-gate times are otherwise required in the frequency mode. In addition, because the counter is reading the time duration of one period of the signal, frequency fluctuations are more apparent when in the period mode. The LDC-825 sells for \$1,295.00. For more information

on Leader's LDC-825 and other instruments, contact Leader Instruments Corporation, 380 Oser Avenue, Hauppauge,

NY 11788; or telephone 516/231-6900 or 800/645-5104—toll free. Say you saw it in **Special Projects**.



CIRCLE 443 ON FREE INFORMATION CARD

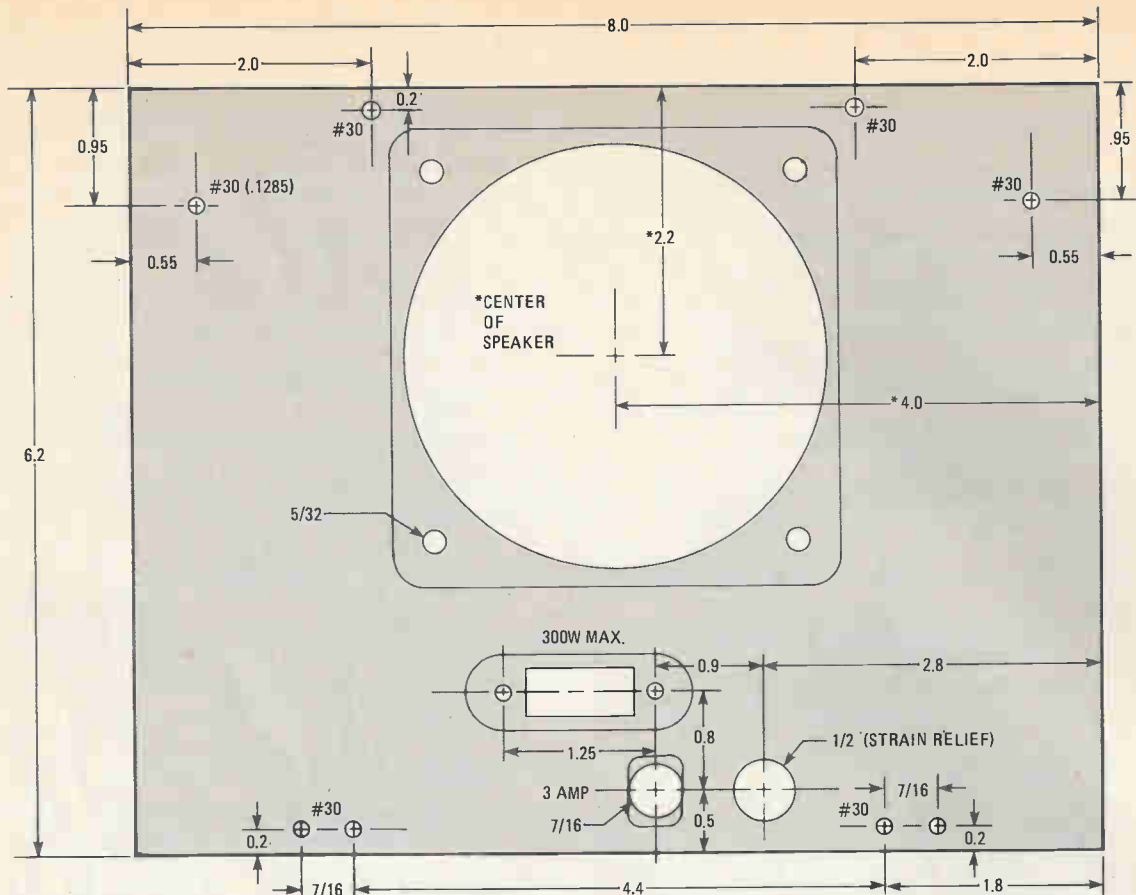

FIG. 16—BACK PANEL detailed diagram showing location of parts mounted on the panel. Drill holes to match speaker selected for project. All dimensions are in inches and drill size.

The alarm is a true 24-hour alarm. When the clock time is coincident with the present alarm time the ALA switch is up, the alarm will sound. The alarm is terminated by putting the ALA switch down. By pushing the SNZ switch, the alarm output will be disabled for a period of 8 minutes. The SNZ switch may be pushed as many times as desired until alarm is disabled by the ALA switch. The ALARM volume can be set by pushing the SNZ button with ALA switch in the up position.

The AC outlet (ACO) on the back of the case is an accessories outlet which can control appliances rated up to up to 300 watts. It can be used to turn off a radio and/or light automatically after you go to sleep and turn them on in the morning when the alarm comes on. There is a 9-hour and 59-minute counter which can be set in 1-minute increments. The ACO will stay on for the preset time period and also come on at the alarm time if ACO switch is up. The CALA button will not turn off the ACO.

The melodies are selected by combining the lefthand rotary switch (Sc) with MEL SEL toggle switch. With MEL SEL in the up position (1-6), melodies one through six are selected by Sc. With MEL SEL in the down position (7-12), melodies seven through twelve are selected by Sc. Any melody can be played on demand by pushing the SNZ button and ALA switch down. Your Kerber Klock III has been programmed to play the following melodies:

1. Westminster Chimes
2. London Bridge
3. Somewhere My Love
4. The Way We Were
5. Love Me Tender
6. Ronald McDonald Theme
7. More

8. The High and the Mighty
9. Misty
10. Jingle Bells
11. Oh! Susanna
12. Everybody Loves Somebody

Optional Battery Back-up

Battery back-up is optional but is highly recommended. A momentary AC power failure may cause the Kerber Klock III microprocessor to reset or go off-into-the-woods. During an AC power failure, six AA, rechargeable, Ni-Cd batteries provide power to the internal reference oscillator and other timekeeping circuitry. When AC power is restored, the correct time will be displayed.

Here are the steps you must take to initially set the clock to the correct time and pre-set the alarm. You may omit those steps related to the battery insertion should you elect not to use them.

Unplug line cord from AC outlet.

Take the top panel off by removing four screws: Two at the top front and two at the back top. Then, remove two screws at the top of either side panel and move the back panel back by its hinges. Last, remove two screws from the bottom front panel.

Set the righthand rotary switch to BAT OFF position and unplug the front panel and circuit board assembly.

Install six AA Ni-Cd batteries. Make sure they are installed correctly as shown on the battery holder. Make sure the rotary switch is in the BAT OFF position. Plug the front panel and circuit board assembly into the edge card connector. Connect 9-volt battery snap to battery holder. Now, reverse those steps to close the Plexiglas cabinet.

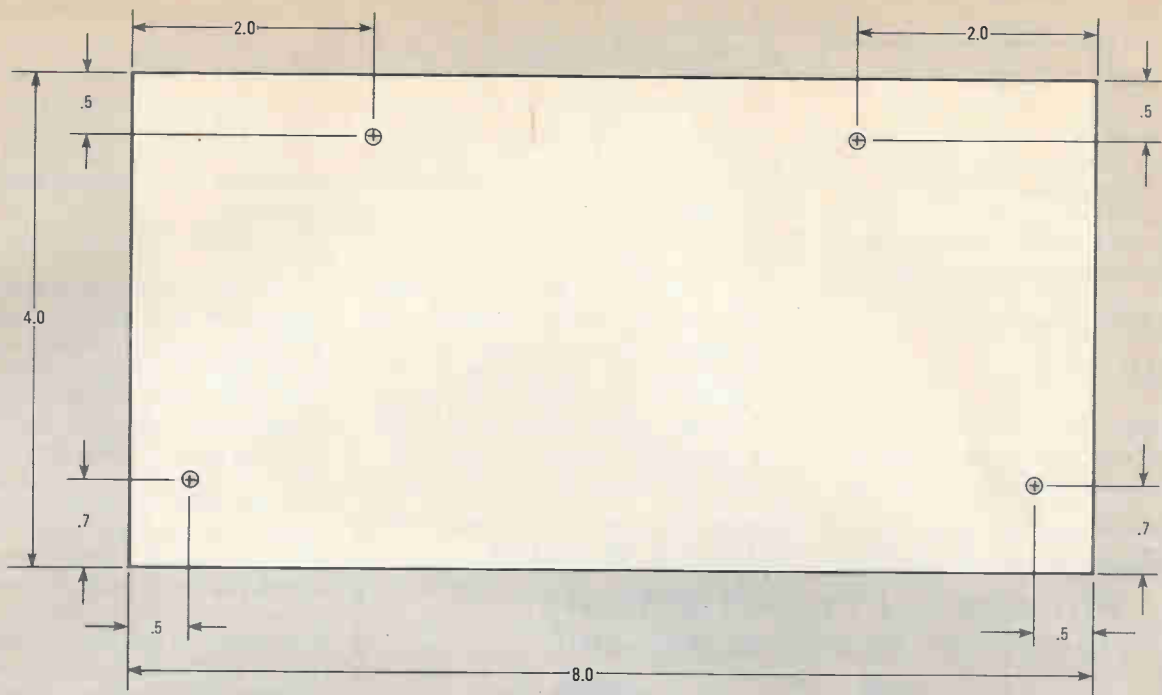

FIG. 17—TOP PANEL detailed diagram is the copper on the unique Kerber Klock III. Dimensions in inches. Use #30 drill to make holes.

Plug the line cord into a standard 120 VAC 60 Hz outlet. The display will come on with all zeros (24 hour mode) or 12:00:00 with AM LED on. At one second past the hour, a melody will start to play depending upon the position of the lefthand rotary switch. Adjust the MEL VOL as desired. To play the melody again, simply push the SNZ button with the ALA switch down. To sound the alarm push the SNZ button with the ALA switch up. Adjust the ALA VOL control as desired.

Setting the Time (CLK)

Rotate righthand rotary switch (Sa) to CLK position. That will freeze the clock time on the display (HH:MM:SS).

Put DIG SEL (Digit Select) toggle switch in up position. A lit decimal point means that digit is ready to be changed.

Put DIG SET (Digit Set) toggle switch in up position. The digit which has a decimal point lit will start to increment at a $\frac{1}{2}$ of a second rate. Seconds will reset to 00.

Put DIG SETX in down position when desired digit is displayed.

Put DIG SEL in down position and then back to up position. The lit decimal point will move to the next digit. Set the time for that digit. Do it for all the digits except for the seconds digits.

To avoid repeating the above steps, preset the time a minute or two later than actual time. Set DIG SEL in the down position. Then, wait for a time signal to rotate the righthand switch to the RUN setting. Seconds cannot be set. That is why you must wait for a time signal that's on the minute.

Setting the Calendar (CAL)

Rotate rotary switch Sa to CAL position. That will freeze the date on the display (MM:DD:YY). Put DIG SEL in up position. A lit decimal point means that digit is ready to be changed.

Put DIG SET in up position. The digit which has its decimal point lit will start to increment at a $\frac{2}{3}$ second rate. Put DIG SET

in down position when desired digit is displayed. If desired digit is already displayed correctly, skip this step and proceed.

Put DIG SEL in down position then back to up position. The lit decimal point will move to the next digit (left to right). Return DEG SEL to the down position and rotate Sa to RUN position. Note that the time of day was not affected while setting the date.

Setting the Alarm (ALA)

Rotate Sa to ALA position. The procedure for setting the alarm time is the same as setting the time of day. Rotate Sa to RUN position after the alarm time is set correctly. Be sure the AM LED is on for AM alarm settings.

Put ALA switch in up position. The decimal point of the second digit from the left will light.

Set the ALA VOL as desired by pushing the SNZ button. When the time of day is coincident with the alarm setting, the alarm tone will sound. There are two ways to turn the alarm off:

1. Put ALA switch down.
2. Push the SNZ button. After 8 minutes, the alarm will sound again. That procedure will continue until the ALA switch is down.

Setting the AC Outlet (ACO)

Rotate Sa to ACO position. The procedure for setting the counter is the same as setting the time of day. Putting ACO switch up will turn on a relay which puts 117 VAC to the AC outlet on the back of the Kerber Klock III. The ACO switch up also starts the counter counting downward. When the ACO counter reaches 0:00:00, the AC outlet will turn off. Switch Sa can be left in the ACO position to watch the counter count down or it can be put back to the RUN position. The lefthand digit decimal point will light if the ACO switch is up.

OK, now our time is your time--enjoy your Kerber Klock III.

Letters

continued from page 5

"eights" every time the power fails in the neighborhood. Four eights are OK in my book when you're playing five-card draw poker, but not for getting up in the morning. The trouble is that the power usually cuts out for a few seconds then comes back. I don't mind losing a few seconds, but my boss resents my showing up at work three hours late. What can I do to my clock to hold the time?

Jeff N.
Woburn, MA

You could float a Ni-Cd in the circuit that would retain the circuit's memory—the last established time. However, you

would have no idea how much time was lost. Was it a few seconds or three hours? Next, you could add a back-up 60-Hertz generator (actually a couple-megaHertz oscillator stepped down) that would provide reasonably accurate time pulses during the AC line shutdown period. What you now will have is the kind of clock you need with enough guts hanging out of it to fill your junkbox. So, I suggest that you take a look at the Kerber Klock III (that's the spelling) in this issue of **Special Projects**. We've had it about the office for several weeks while working on the manuscript and have grown to like it considerably. Its selection of melodies (a different one was selected each day) and quarter-hour melody segments brighten the passing of time. Turn to this article in this issue—

you'll want to assemble Kerber Klock III.

LED BAR-GRAPH DISPLAYS

I wonder how I should go about to enact a law that will eliminate all LED bar-graph displays from consumer products. Each one I have seen to date is as valuable to the operation of the consumer product as the chrome-fluted knobs. Fred F.
Chattanooga, TN

I'll admit that bar-graph indicators are installed in many consumer-electronics products to dazzle the buyer into paying a few bucks more than need be paid. Their effect is very much like the chaser lights on a theater's marquee. But the LED bar-graph display does have many useful purposes, and economically it is cheaper than the analog meter it replaces. For example, when used as a modulation-level indicator, the LED bar-graph display is vastly superior to the analog meter. The automotive industry has picked up variations of the LED bar-graph display producing jazzier speedometers, tachometers, and various automotive gauge indicators that are eye-catching and vastly superior to the devices they replace. In this issue of **Special Projects** an LED bar-graph display uses two ten-unit sections for indications that can be read in units from zero to one hundred, and more. That's equivalent to a 0-100-volt meter or Celsius thermometer with 1-percent accuracy.

NO TREES

I just don't have any trees on my property, and I like to put some kind of an antenna that will boost my SWL receptions. Got any ideas?
Jack K.
Wright, KS

Have we got a winner for you! Ed Noll, one of our top authors, contributed a story for next issue that'll get SWL's stringing antenna farms across the country—well, not exactly antenna farms. Ed designed a simple shortwave antenna using common PVC piping as antenna masts. SP

Electronics Paperback Books Projects For Project Builders CHECK OFF THE BOOKS YOU WANT

Hi-Fi Book of Hi-Fi Loudspeaker Enclosures
Build your own speaker enclosures—corner reflex, bass reflex, louvered horn, labyrinth and more.

28 Tested Transistor Projects

28 TESTED TRANSISTOR PROJECTS...\$4.25. A variety of projects for beginner and pro alike. Try this one. You'll like it.

How To Build Your Own Metal & Treasure Locators

52 PROJECTS USING THE 741...\$4.00. If you have some 741s on hand, this book will show you what you can do with them.

50 SIMPLE LED CIRCUITS...\$4.25. Interesting and useful applications for LEDs. An important book for any project builder.

How to Make Wafer-cables

HOW TO MAKE WALKIE TALKIES...\$5.00. Everything from licensing to frequency bands to practical circuits to antennas.

SOLID-STATE SHORT-WAVE RECEIVERS FOR BEGINNERS...\$4.50. Several receiver designs that use only relatively low and inexpensive components.

50 PROJECTS USING THE CA3130...\$4.50. How to use this op-amp to make audio, rf, test equipment and household oriented projects.

50 PROJECTS USING GERMANIUM, SILICON & ZENER DI....\$3.75. On the wonderful world of diodes. Lots of applications for inexpensive devices.

IC 555 PROJECTS...\$5.00. Basic & general circuits, motor car model railroad circuit alarms, noisemakers, plus a section on the 555, 558, 558.

Projects in Opto Electronics

PROJECTS IN OPTOELECTRONICS...\$5.00. Infra-red transmitters detectors, modulated-light transmission, photographic projects are just some examples.

50 CMOS IC PROJECTS

50 CMOS IC PROJECTS...\$4.50. Build multivibrators, amplifiers, oscillators, trigger devices and special devices.

Radio Circuits Using IC's

RADIO CIRCUITS USING IC'S...\$4.50. Integrated circuits and how they can be used in circuit for AM, FM and stereo decoder receivers.

50 (FET) Field Effect Transistor Projects

50 PROJECTS USING RELAYS, SCR'S & TRIACS...\$5.00. Motor control, dimming and heating control, light and heating control, light and heating control, light and heating control, light and heating control.

50 (FET) FIELD-EFFECT TRANSISTOR PROJECTS...\$4.50. Fit amplifiers, rf converters, test equipment, aids, tuners, receivers, mixers, etc.

ELECTRONIC PROJECTS FOR BEGINNERS...\$5.00. A variety of projects, many with component and wiring layouts. Some that require no soldering.

Beginners Guide to Building Electronic Projects

BEGINNERS GUIDE TO BUILDING ELECTRONIC PROJECTS...\$5.00. Component identification, soldering, loops, soldering, construction techniques.

PRICES GOOD UNTIL MARCH 31, 1984

ELECTRONIC TECHNOLOGY TODAY INC. SP9A
P.O. Box 240, Massapequa Park, NY 11762

Number of books ordered

Total Price of Books _____

Sales Tax (NY State Residents only) _____

Shipping and Handling _____

(75¢ 1 or 2 books 30¢ each addl. book)

TOTAL ENCLOSED _____

Name _____

Address _____

City _____ State _____ Zip _____

ADVERTISING INDEX

SPECIAL PROJECTS magazine does not assume any responsibility for errors that may appear in the index below.

Free Information No.	Page
401	A P Products Cover 2
402	Calvert Instruments, Inc. Cover 4
---	Cleveland Institute of Electronics, CIE 37
403	Communications Electronics 6.7
---	Electronic Technology Today 5, 100
---	NRI Schools 19
---	Reprint Bookstore 94
---	Software Store 20
404	TAB Books 3
---	Windjammer Cover 3

FOR FREE INFORMATION USE THESE POST-PAID CARDS

1

Print your name, address and Zip Code on one of the attached post-age-paid cards.

2

Circle the number (or numbers) on the card that corresponds to the number at the bottom of each advertisement or editorial item that you want information on. Advertisers' free-information numbers also appear in the ad index at the left on the facing page.

3

Mail the card. It's Postage-Paid.

NOTE:

Use the postcard address for Free Product Information only. Address all editorial inquiries to Editor, RADIO-ELECTRONICS, 200 Park Avenue South, New York, N.Y. 10003.

POSTAGE-PAID FREE INFORMATION CARD

SP983

401	411	421	431	441	451	461	471	481	491
402	412	422	432	442	452	462	472	482	492
403	413	423	433	443	453	463	473	483	493
404	414	424	434	444	454	464	474	484	494
405	415	425	435	445	455	465	475	485	495
406	416	426	436	446	456	466	476	486	496
407	417	427	437	447	457	467	477	487	497
408	418	428	438	448	458	468	478	488	498
409	419	429	439	449	459	469	479	489	499
410	420	430	440	450	460	470	480	490	500

700 Please send me 12 issues of RADIO-ELECTRONICS for \$11.97 and bill me. (Canada \$14.97 U.S. FUNDS)

Please print

Only one card per person

NAME _____

COMPANY NAME (If applicable) _____

ADDRESS _____

CITY _____ STATE _____ ZIP _____

Void after May 31, 1984

Allow 6-8 weeks for delivery of first issue
OFFER VALID U.S. AND CANADA ONLY.

POSTAGE-PAID FREE INFORMATION CARD

SP983

401	411	421	431	441	451	461	471	481	491
402	412	422	432	442	452	462	472	482	492
403	413	423	433	443	453	463	473	483	493
404	414	424	434	444	454	464	474	484	494
405	415	425	435	445	455	465	475	485	495
406	416	426	436	446	456	466	476	486	496
407	417	427	437	447	457	467	477	487	497
408	418	428	438	448	458	468	478	488	498
409	419	429	439	449	459	469	479	489	499
410	420	430	440	450	460	470	480	490	500

700 Please send me 12 issues of RADIO-ELECTRONICS for \$11.97 and bill me. (Canada \$14.97 U.S. FUNDS)

Please print

Only one card per person

NAME _____

COMPANY NAME (If applicable) _____

ADDRESS _____

CITY _____ STATE _____ ZIP _____

Void after May 31, 1984

Allow 6-8 weeks for delivery of first issue
OFFER VALID U.S. AND CANADA ONLY.



NO POSTAGE
NECESSARY
IF MAILED
IN THE
UNITED STATES

BUSINESS REPLY CARD
FIRST CLASS PERMIT NO. 597 BOULDER, COLORADO

POSTAGE WILL BE PAID BY ADDRESSEE

Radio-Electronics®
SUBSCRIPTION SERVICE
P.O. Box 2520
BOULDER, COLORADO 80321



wind
ands
call for
and
ul.
eat,
body
ach-
Carib-
ird
great
tart
of the
it"

"eights" neighbor book wh poker, bu ing. The cuts out back. I d but my t work thre my clock Jeff N. Woburn,

You ca that wou the last e

BUSINESS REPLY CARD

FIRST CLASS PERMIT NO 27346 PHILADELPHIA, PA

POSTAGE WILL BE PAID BY ADDRESSEE



FREE PRODUCT INFORMATION
P.O. BOX 13775
PHILADELPHIA, PA. 19101

NO POSTAGE
 NECESSARY
 IF MAILED
 IN THE
 UNITED STATES

BUSINESS REPLY CARD

FIRST CLASS PERMIT NO 27346 PHILADELPHIA, PA

POSTAGE WILL BE PAID BY ADDRESSEE



FREE PRODUCT INFORMATION
P.O. BOX 13775
PHILADELPHIA, PA. 19101

NO POSTAGE
 NECESSARY
 IF MAILED
 IN THE
 UNITED STATES

Radio-Electronics.

SIGN ME UP for a no risk subscription to RADIO-ELECTRONICS

Send me the first issue for my review. If I like it, bill me for the remaining 11 issues of a 12-month subscription for only \$11.97, a savings of \$6.03 over the newsstand price of \$18.00. If I'm unhappy I can keep the first issue free, cancel and owe nothing. (CANADA \$14.97 - U.S. FUNDS ONLY)

Same deal, except I'll try - at no risk - 24 issues at \$21.97, a savings of \$14.03 over the newsstand price of \$36.00. (CANADA \$27.97 - U.S. FUNDS ONLY)

FOR NEW SUBSCRIBERS ONLY

Please print

Name _____

Company Name (if applicable) _____

Address _____

City _____ State _____ Zip _____

Important

Allow 6-8 weeks for delivery of first issue.
 OFFER VALID U.S. & CANADA ONLY

4PC99

For new ideas in electronics read Radio-Electronics

During the next 12 months

- Radio-Electronics will carry up-to-the-minute articles on:
- hobby computers
 - solid-state technology
 - TV games • Video
 - color TV • stereo
 - test equipment
 - radio
 - radar detectors
 - industrial electronics
 - servicing
 - TV-radio-stereo
 - experimenter circuits
 - exceptional construction projects

Don't take a chance on missing even one issue. Subscribe now and save!



NEW IDEAS AND INNOVATIONS IN ELECTRONICS

The newest ideas and innovations in electronics appear in Radio-Electronics, Keep up-to-date!

Subscribe Today!



PRICES GOOD

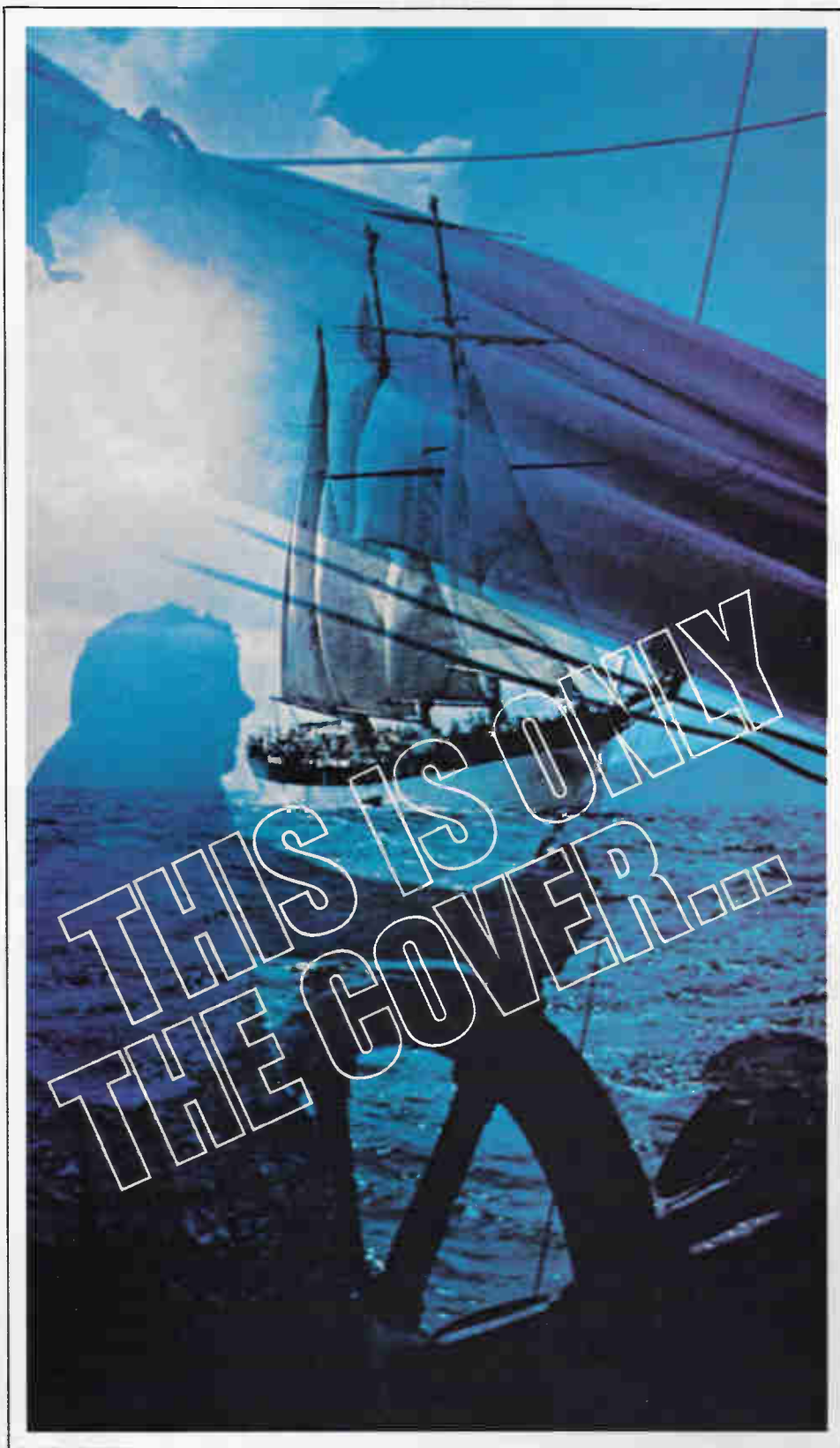

**...you
should
see the
rest!**

It's full of fun, sun,
barefeet & bikinis.

It's runnin' with the wind
to small, tropical islands
and unique ports o' call for
those with itchy feet and
adventure in their soul.

We're not the Love Boat,
but we'll take on anybody
when it comes to beach-
combing, sailing &
exploring the exotic Carib-
bean. It's our backyard
and we know all the great
places in paradise.

And, 6-day cruises start
from \$425.

So send for the rest of the
booklet. It's free!

Look us over & "sea it"
our way!



**Windjammer
Barefoot Cruises, LTD.**

Box 120, Dept. 1642, Miami Beach, FL 33119-0120

or call TOLL FREE and tell us you need the rest of the booklet: 800-327-2600 in FL: 800-432-3364

Amazing new solid-state oscilloscope... fits in the palm of your hand

CRT oscilloscopes just became obsolete! The revolutionary new solid-state digital LED Pocket-O-Scope does it all, in a 4-ounce package you can put in your pocket.

Easy to use. Ideal for the hobbyist or the technician. The Pocket-O-Scope is 100% solid-state, focus and brightness on the 210 point, high-intensity illuminated screen are *electronically* self-controlled. The trace is *always* in sharp focus. Zero and sweep positions are maintained automatically. Zero-reference, or cross-over line is always centered for full trace minimum on the screen. Automatic internal circuitry always assures a properly positioned wave form. **4 solid-state controls do it all.** The only knobs on the Pocket-O-Scope are for positive and negative sensitivity and for coarse and fine synchronization of the frequency of the incoming signal. The easiest to use, full capability scope available!

Years in development. The Pocket-O-Scope is the culmination of years of development in high technology, micro-electronic components and digital design.

Features: All solid-state, digital design • Hand-held or bench operation • High resolution 210 point, 1.5" square display • Battery or A/C operation with adapter • Factory calibrated – *never requires recalibration* • Full function, single trace capability plus 1/2 channel dual trace and signal inverter • Full overload protection to prevent damage to scope



Patent Pending

• Automatic zero voltage centering • Automatic free run or locked image • Automatic full horizontal sweep circuit • External input/output for add-on capability

- Full overload protection to prevent damage to scope
 - Automatic zero voltage centering •
 - Automatic free run or locked image •
 - Automatic full horizontal sweep circuit •
 - External input/output for add-on capability
- Specifications:**
- 5 Megahertz bandwidth •
 - Sensitivity – vertical, 10MV •
 - Accuracy ± 3% on

wave forms – sweep linearity ± 5% • Time base – .1 microseconds to .5 seconds

- Vertical gain – 0 to 120 volts •
 - Continuous free run to locked image response •
 - Power supply 9VDC – dual polarity
- Controls:** Single or dual trace • On-off, battery-A/C • Sensitivity; separate pos. & neg. controls • Sync C & Sync F controls

Limited, 90-day warranty

No risk introductory offer. The revolutionary Pocket-O-Scope is a development of Calvert Instruments, Inc., for 25 years a manufacturer of electrical equipment. As an introductory offer for a limited time only, you can buy the Pocket-O-Scope including a carrying case, A/C adapter, 3 standard "grabber" probes and 2 high voltage probes for only \$249.95, a \$321 value. If you act now, you will also receive FREE Calvert's 200-page Comprehensive Oscilloscope Training Manual, a \$15.95 value!

Put your Pocket-O-Scope to the test for two weeks. And if you decide, for *any* reason, that the Pocket-O-Scope is not for you, return it within the 14-day trial period for a prompt refund. The training manual will still be yours to keep.



Mail this coupon today, or call toll-free* while the introductory offer is still in effect.

Calvert Instruments, Inc.

19851 Ingersoll Dr., Cleveland OH 44116 • 216-356-2155

Please send me:

_____ Pocket-O-Scope(s), including carrying case, A/C adapter, standard and high voltage probes, and FREE training manual. (Batteries not included) all for \$249.95 plus \$5 for postage and insurance. Ohio residents add 6.5% sales tax.

_____ Pocket-O-Scope only with standard probes: \$179.95 plus \$5 postage. Ohio Residents add 6.5% sales tax.

My check is enclosed.

Please charge the credit card account checked below. (Fill in all account number digits of the one credit card you wish to use.)

MasterCard Visa REP 1283

Expiration Date _____ Interbank No. _____ (MasterCard only)

Full signature _____

Name _____ (please print)

Address _____ Apt. _____

City _____

State _____ Zip _____

*CALL TOLL-FREE 800-835-2246 EXT. 118 to order by phone, request further information or to inquire about becoming a distributor. In Kansas, call 800-362-2421 Ext. 118. Allow 6-8 weeks for delivery.

CIRCLE 402 ON FREE INFORMATION CARD



Friedman on COMPUTERS

Why your new printer won't do what it's supposed to do!

□PRINTERS PROBABLY CAUSE MORE unhappiness than any other item of personal-computer hardware. If all your hardware and software comes from the same manufacturer, such as Radio Shack, IBM, or Kaypro, you probably have no idea what I'm talking about because everything was made to go with everything else, and it's all working together—software and hardware—without any hassles! At least that's the way it's supposed to be.

But if you're the typical electronic hobbyist, with a Brand A computer, Brand B disc drivers, and Brand C printer, you know exactly what I mean because you probably haven't had a real moment's peace since you've hooked up the printer.

The reason why printers give sleepless nights is because there's no such thing as a "standard" printer—virtually none have the same features, and if they have the same features, they are accessed differently. Then again, you might assume—quite logically—that every printer must have certain features, and then you discover that the printer you purchased simply hasn't got those features, or your software won't support the printer.

A few concrete examples of some of the major printer problems will give you an idea what to look for, or not to look for, when you start shopping for a printer.

The Auto Linfeed

The earliest printers were mechanical, usually teleprinters (the printer section of a teletypewriter). They required a carriage return followed by a linefeed, or vice versa. When Radio Shack came out with the legendary model 1 computer they naturally wanted to chain the user to Radio Shack products, so their printers produced an automatic line feed after a carriage return, and the computer software did not send a linefeed to the printer. If you attempted to use a non-Radio Shack printer (which required a linefeed) with a Model 1 computer, the printer simply overprinted on the same line. On the

other hand, if you attempted to use a Radio Shack printer with a different computer you might get double instead of single line spacing because of automatic linefeed that followed the carriage return.

The Smith Corona *TP-1*, the most outstanding value in Daisy Wheel printers, attempted to be universal by providing an automatic linefeed and then canceling the first-received linefeed. If you figure it out you will see that the *TP-1* will space once whether it receives a carriage return or a carriage return and a linefeed. That works out reasonably well for many different brands of computers, but some third-party word-processing software for Radio Shack computers space the paper with a line feed instead of a carriage return. Double-spacing should be a carriage return plus another carriage return. Instead, the software produces a carriage return plus a linefeed; since the printer cancels the first linefeed, it spaces only once.

There are ways to get around the problem, but some of them throw off the automatic page formatting.

However, it can be done—because this column was prepared with a Radio Shack computer, Tipit software, and a *TP-1*; but when your printer spaces once instead of twice, or twice instead of once, don't look for defective equipment, it's usually just a problem of matching unrelated hardware and software.

Speaking of the *TP-1* printer, it's a good value for word processing (it takes Mylar film ribbon) but think twice if you need a printer mostly for listing BASIC programs. The *TP-1* printwheel does not have the less than (<) and greater than (>) symbols. The printer produces only a space in which the user may pencil in the symbol by hand; a somewhat difficult job if many entries are required.

No Backspace

Think you'll do better with a more expensive printer? Then consider the Brother *HR-15*, a simply magnificent piece of machinery. Unfortunately, the engineers never had to backspace, so they gave it no thought and did not include backspace—which meant the

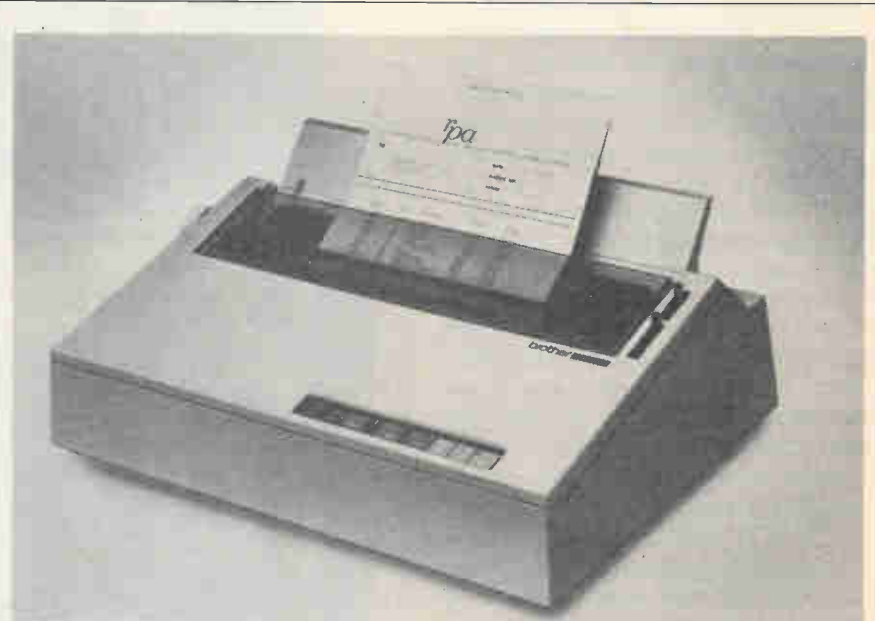

A compact, neat-package appearance is seen in the Brother HR-15 daisy-wheel printer. Latest versions can handle the underscore from word processors.

CIRCLE 440 ON FREE INFORMATION CARD

Friedman on COMPUTERS

user could not underscore, produce slashed zeros, or overstrike. Maybe you don't need slashed zeroes and overstrikes, but underscore is the standard symbol for italics in the publishing trade; if you write for a living, you *must* have underscore. Later versions of the *HR-15* can underscore. If you have an early model, it can be retrofitted with a PROM (Programmable-Read-Only-Memory) that provides the backspace, subscript, and superscript.

Lack of backspace is not restricted to specialty—meaning Daisy—printers. For example, the early Epson printers also lacked a backspace. You can upgrade your old Epson with the Grafrax retrofit ROM's (available from most mail-order equipment dealers).

Seven Isn't Eight

Are you into graphics but can't seem to get it quite right, even though your printer has dot-addressable capability? What computer are you using, or plan to use? Bit-image graphics require 8 data bits from the computer, but an Apple II produces only 7 data; maybe that's your problem. Or maybe you're trying to get graphics from a Radio Shack Color Computer (CoCo) but all your printer does is feed paper. The CoCo works just great with Radio Shack's own printers (even the really cheap models), but the computer sends a control-code character that another printer sees as a form feed, so what you get is paper flowing out of the printer instead of your "art-work."

What's a control code? OK, we'll end this month's column on control codes. All modern printers have an on-board computer (a microprocessor) that converts the incoming data stream from the computer into a alphanumeric characters and printer functions and possibly graphic characters. The alphanumeric characters and functions are produced by data from the computer that corresponds to 128 numeric codes numbered from 0 to 127 in decimal (00 to 7F in hexadecimal, or HEX) called the "ASCII CODE," which is given in Table 1. Any received code from number 33 to 126 will cause the printer to print a character. A 32 produces a space. A 127, which normally was a rub out of the preceding character, is often interpreted by the printer as a special

function, while the codes from 0 to 31 are control codes. (That means that they do not print, but rather affect some special computer or printer function.) If a control code affects the printer, it is being used as a printer control code. For example, decimal 13 (ODH) is universally the carriage return. Other "universal" functions are shown in Table 1, such as Bell, Form Feed, Tab, and Escape. The remaining codes from 0 to 31 have no standard meaning; each printer manufacturer selects his own function for ASCII control codes if he so desires.

For example, decimal code 25 starts a complete underscore sequence on a *TP-1* printer (a tremendous convenience). No other printer, to my knowledge, does that on receiving code 25. On the other hand, Radio Shack's new low-cost *DWP-210* Daisy printer (which is really a *Diablo*) goes into automatic underscore with a decimal 15. Other printers use the available 0 through 31 to automatically set left and right margins, set horizontal and/or vertical tabs, or the size and spacing of the characters.

Any ASCII code that causes the printer to take an action other than print a character is called a printer-control

code. Since there is a finite limit to the number of printer functions that can be controlled with the 0 through 31 ASCII codes, most printers also use "ESCAPE sequences."

An ESCAPE sequence works this way: Table 1 shows that ESCAPE is decimal 27 (1B HEX). The printer's microprocessor is generally programmed so that on receipt of an ESCAPE character it is to accept the next character as a printer-control code and not print it, or provide the function usually associated with the ASCII code. For example, on receiving an ASCII ESCAPE 4 (1B 34 in HEX) an Epson *MX-80* printer with Grafrax will switch to the italics character set; it will not print the character "4". Similarly, an ESCAPE E (1B 45 in HEX) will turn on the emphasized printing mode, while an ESCAPE F (1B 46 in HEX) will turn off the emphasized printing.

As soon as the printer processes the code following the ESCAPE it returns to the printing mode and will print the characters. Let's use the same Epson printer for illustration. If it receives this HEX data stream from the computer: 48 45 4C 4F 1B 34 54 48 45 52 45,

Concluded on page 93

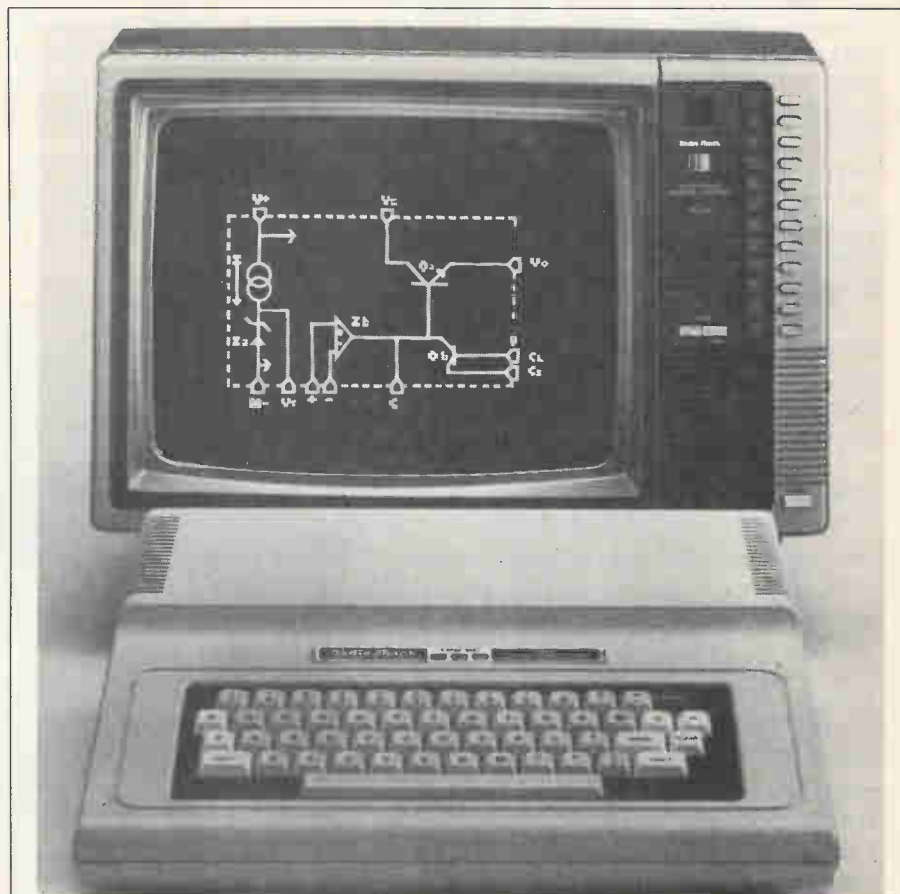

For under \$400.00 you can work with color graphics using the Radio Shack 64K Extended BASIC Color Computer (CoCo). Monitor screen is a color TV receiver.

CIRCLE 441 ON FREE INFORMATION CARD

Special Projects

Photog's Printmeter

Get the most from your enlarged prints!

Digi-Slot—armless bandit for home play
Desktop Antennas for Shortwave Listeners
Digital Capacitance Meter—from 1 pF to 9999 μ F



Plus—New Departments on DX'ing and Computers

INTRODUCING OUR NEW SUBSCRIPTION OFFER!

Become a Charter Member Subscriber!

Get every issue!

SUBSCRIBE TODAY!

Use the order form below.

Subscribe Today!

■ IF YOU'RE THE KIND OF READER that doesn't want to wait, you can order your next copy of **Special Projects** now. **Special Projects** is crammed full of electronic projects that you won't be able to wait to build for yourself. You can expect top-notch digital projects, fun-to-play electronic games, valuable add-on computer projects, BCB and shortwave receivers, photographic/darkroom gadgets, devices to improve your car's performance, test equipment ideas, and more in every jam-packed issue of **Special Projects**.

■ TO HELP YOU TO BE SURE that you don't miss any future issues of **Special Projects**—SUBSCRIPTIONS ARE NOW AVAILABLE!

■ YOU CAN HAVE THE NEXT FOUR ISSUES of **Special Projects** delivered directly to your home for only \$9.00. We pay the postage. If you want the next eight issues, you can even save a dollar off the newsstand price. Get eight issues for \$17.00.

■ EVERY ISSUE OF SPECIAL PROJECTS will continue to contain a variety of construction articles to suit every taste. In addition, feature articles on electronics fundamentals, test equipment and tools will round out each issue. Of course, we will continue to provide new product and literature listings to keep you up to date on the latest developments in electronic technology.

■ GET IN ON THE ACTION! Order your next issue of **Special Projects** today. Use the convenient order coupon below.

Special Projects SUBSCRIPTION

Detach and mail today to:
SPECIAL PROJECTS
SUBSCRIPTION DEPT.
200 PARK AVE. SOUTH
NEW YORK, N.Y. 10003

CASH WITH ORDER ONLY SP-9
Allow 6-8 weeks for the first issue to arrive.

I want to be sure I don't miss any issues. Send me the next four issues of **Special Projects** for \$9.00: starting with #10 Postage is free in U.S. For Canada add \$3.00. Foreign add \$7.00.

I want to be sure I don't miss any issues and want to save \$1.00 too. Send me the next eight issues of **Special Projects** for \$17.00: Starting with #10 Postage is free in U.S. For Canada add \$6.00. Foreign add \$14.00.

Send me _____ copies of **Special Projects** #10 at \$2.25 plus \$1.00 postage and handling for US, Canada and Mexico. U.S. funds only. All other countries add \$2.00.

Please print

(Name) _____

(Street Address) _____

(City) _____

(State) _____

(Zip) _____

DSP



Jensen on DX'ing

Getting started on the shortwave bands!

□IT BEGAN WAY BACK WHEN RADIO BEGAN, more than 60 years ago. But it is just as fascinating a pastime now as it was for Granddad back in the 1920's.

DX, in radio jargon, means distant, as in far-off stations. DX'ing is the hobby of listening to them, just for fun. Those who do it as a hobby are called DX'ers.

What you can hear, and how you can tune in the world on shortwave is what this regular column is all about.

DX'ing—maybe you prefer SWL'ing, for shortwave listening—tends to be a one-person, one-radio thing. It's hard to know just how many SWL/DX'ers there are out there. Marketing studies by receiver manufacturers and broadcasters suggest we number in the millions. Could be that your neighbor or the kid down the block is a closet shortwave listener, and you never knew it.

If you're a beginner at all of this, or you'd like to be, let's have a bit of backgrounding before we go much further. If you're not, skip over the next few paragraphs and wait for us to catch up to you. We'll be along shortly.

Now, First Things First

Shortwave frequencies? Those are the so-called frequencies between 3,000 and 30,000 kiloHertz (kHz). Where do they fit into the radio-frequency spectrum? Your standard AM radio covers frequencies from 540 to 1,600 kHz. Shortwaves are above that range, but way below the FM radio band, 88,000 to 108,000 MHz. (Divide kHz by 1,000 to get megaHertz, or MHz—the unit of measurement usually used in the VHF and UHF ranges.)

Don't hold me precisely to the 3,000-30,000 kHz limits, though. Occasionally we'll wander a bit outside that parameter for some particularly interesting DX.

Generally, three broad categories of stations inhabit the shortwave frequencies, mostly grouped in various bands.

There are the hams, or Amateur Radio operators, together with CB'ers.

Other magazines specialize in coverage of those interests. And for good reason: Those operators talk and listen—DX'ers only listen.

There are the shortwave broadcasters, the stations which air regular programming. Since, experience has shown, most DX'ers are most interested in those stations, most of this column will offer reports in this area.

The remaining category, which DX'ers call the "utilities," is, simply, everything else. That includes two-way communications by countless commercial, governmental, and military transmitters, international aeronautical and maritime communications, standard time and frequency stations and, well, much more. From time to time we'll

cover some of those operations.

The shortwave broadcast stations (SWBC) can be high-powered international broadcasters, or low-powered domestic stations in remote corners of the world. The former, the *Voice of America*, *Radio Moscow*, *BBC*, and others, seek overseas audiences and speak in many languages. They are normally easy to hear.

In many parts of the Third World, shortwave is used for reaching home audiences, just as we use the AM radio band. Those stations don't need powerful transmitters. Usually their programs are not in English. They are, naturally, harder for U.S. and Canadian shortwave listeners to hear.

Concluded on page 14



RADIOVATICANA QSL shows the view the Popes have of the Vatican and Rome. The microphone was used in the first broadcast on February 12, 1931.

It's like no other magazine in the world!

Between the covers of this special annual publication are carefully selected articles on scientific developments, recent technical advances, consumer products trends, development of services, exotic communications advances, design information, hobbying tips, and "what's new" material compiled for your reading pleasure and information. Each article was specifically chosen and prepared for publication by the editorial staff of *Radio-Electronics* magazine, updated to the moment it went on press and printed. Here's what you will read about in the 1984 edition:

VIDEO ENTERTAINMENT—It couldn't be said all in one article so we compiled a 16-page special section covering the changing and growing field of entertainment in the home: new video components with screens from the gigantic to the tiny postage-stamp size, accessories that didn't exist last year, and tips on getting the most from what you own or plan to buy.

SATELLITE TV—The countryside is strewn with parabolic tracking dishes installed by home owners to pull-in the countless television channels transmitted back to earth by satellites poised in space in geosynchronous orbits. You, too, can enjoy the programming selection—and much of it is commercial-free, too!

MOBILE TELEPHONES—What was once a status symbol for the idle rich is quickly becoming a working

tool for the common man. Cellular technology promises more channels with a little help from applied computer technology.

DIGITAL AUDIO DISCS—Laser rays are bringing new noise-free, pulse-encoded audio programming to your stereo system embedded in a plastic disc immune to strawberry jam, sandpaper, and desert heat.

MAIL ORDER BUYING—You've heard the bad points, including the myths. Now, here are the facts and economics of buying mail order that will be an asset to your business or hobby.

PLUS—There's so much more, we have space only to mention an electronic guitar tuning project, theory on digital filters, how to make inexpensive computer cables, build a programmable home thermostat, tips on buying pocket-size shortwave receivers, stereo audio for TV, all about VLF active antennas, news on pagers, how to restore antique radios, and...



Radio-Electronics ANNUAL 1984

How to Order—

We can't drop your copy of **Radio-Electronics Annual 1984** into the mail sack until we receive an order from you! So, do it today! Fill out the coupon below, giving us all the information requested, write a check or money order (no stamps) for the correct amount, and mail at once to:

RADIO-ELECTRONICS ANNUAL
Circulation Department
200 Park Avenue South
New York, NY 10003.

Okay, drop my copy of **Radio-Electronics Annual 1984** into the mail bag. I am enclosing \$2.50 for the issue plus \$1.00 for postage and handling for US, Canada and Mexico. All other countries add \$2.00. US funds only.

I can use _____ copies of **Radio-Electronics Annual 1984**. I am enclosing \$2.50 for each copy plus \$1.00 for postage and handling for US, Canada, and Mexico. All other countries add \$2.00. US funds only.

SEND CHECKS OR MONEY ORDERS ONLY
Allow 6-8 weeks for delivery.

SP-9

I know you have a limited supply of the 1983 Edition of the **Radio-Electronics Annual**. Please send me _____ copies. I am enclosing \$2.50 for each copy plus \$1.00 for postage and handling for US, Canada, and Mexico. All other countries add \$2.00. US funds only.

Please Print

Name _____

Street Address _____

City _____

State _____

ZIP _____

Jensen on DX'ing

Continued from page 12

Introducing Bands

SWBC stations, for the most part, are found in 12 broadcasting bands: 11-meter band (25,600-26,100 kHz); 13-meter band (21,450-21,750 kHz); 16-meter band (17,700-17,900 kHz); 19-meter band (15,100-15,450 kHz); 25-meter band (11,700-11,975 kHz); 31-meter band (5,950-6,200 kHz); 60-meter band (4,750-5,060 kHz); 75-meter band (3,800-4,000 kHz); 90-meter band (3,200-2,400 kHz); and technically outside our lower frequency limit, 120-meter band (2,300-2,495 kHz).

Natural phenomena, which make long-distance shortwave reception possible, affect different frequencies in different ways. Broadly speaking, tune the higher frequencies (11 through 19-meter bands) during your daylight hours; the lower frequencies (49 through 120-meter bands) during darkness. You have more leeway in tuning the middling ranges.

On shortwave you can hear programs from literally scores of different countries without too much difficulty...music, news, commentary (or propaganda, depending on one's outlook). Many SWL's enjoy the world's music or hearing global events reported from where they happen. You can learn about another nation's culture and language, or travel vicariously without leaving home.

For starters, your receiving equipment need not be elaborate or terribly expensive.

Questions? You'll probably have dozens. But that's no reason not to get started now. Explore the shortwave bands. Discover what you can hear. Your questions—just send them to me—will be answered in future columns.

So what are you waiting for? Discover the fun of DX'ing.

Battle of Words

One of the real attractions of listening to shortwave is the sense of immediacy you feel. You are, by radio, right there when the news is happening.

Whenever in the world there is conflict and bloodshed, there is usually a parallel battle of words via radio. That

surely is the case in Central America today, and, in particular, in Nicaragua.

The leftist government in Managua operates a shortwave station, the *Voice of Nicaragua*, with hour-long programs in English at 0100 and 0400 hours, Greenwich Mean Time/Universal Coordinated Time (GMT/UTC).

Signals have been good on 5,950 kHz, but you might also check two additional frequencies in the 25-meter band, 11,715 and 11,840 kHz.

There are two revolutionary groups seeking to topple the Managua regime. Each has at least one clandestine broadcaster on shortwave. Very likely they are located outside Nicaragua proper, although the stations claim otherwise.

Their programs are mostly in Spanish, and they can be heard without too much difficulty at various times during the evening hours.

Listen on 6,220 kHz for *La Voz de Sandino*, and on 6,900 kHz for *Radio 15 de Septiembre*.

Bandsweep

Let's take a look at some of the shortwave broadcasters you can hear. Some of those outlets will be easy catches, widely noted daily in North America. A few will be tougher catches, in languages other than English, and with weaker signals. It may take some luck, sharp tuning and more than a few tries to log them. The times are in GMT/UTC, equivalent to EST + 5, CST + 6, MST + 7 or PST + 8 hours. Thus, if the GMT/UTC is 1700 hours (5 PM London time) and you live on the west coast, the Pacific Standard Time (PST) would be 0900 hours (9 AM).

4,875 kHz...One of those more difficult loggings I mentioned is the *Radio Republik Indonesia* station at Sorong. Sorong is an oil port in the Indonesian part of the island of New Guinea called West Irian or Irian Jaya. Programming is in the Indonesian language, since it is aimed at a domestic audience, but the music—when they stay away from rock, country, and western—can be lovely. Pulling in that station is easier west of the Mississippi than in the East; try about your local dawn.

6,015 kHz...The voice of Roman Catholicism to the world is *Vatican Radio*. It has a rather limited English-language service, but is easily heard in North America at 0050 hours GMT/UTC (midnight EST) on that frequency. Like many of the shortwave broadcasters, *Vatican Radio* will reply to listeners who write reporting their reception, in-

cluding frequency tuned, details of programs heard and quality of reception. Those replies often take the form of attractive postcards known to DX'ers as QSL's. The illustration shows a recent *Vatican Radio* QSL, depicting a Vatican view, with a 1931 model microphone used by Pope Pius XI to inaugurate the station over a half century ago.

7,065 kHz...Most strident of the voices from eastern Europe is that of Albania's *Radio Tirana*. Listening to the heavily propagandized broadcasts is almost like being transported back in time to the chilliest days of the Cold War. Most listeners will find that station not difficult to tune at 0000 GMT/UTC (6 PM CST), in English.

9,745 kHz...Shortwave radio is considered an effective way to spread the Gospel by many missionary organizations around the globe. Some buy program time on commercial shortwave outlets; others actually operate their own stations. HCJB, the *Voice of the Andes* in Quito, Ecuador, has had its own station since the 1930's. It is clearly one of the most popular and easily heard stations in North America today. Listen most anytime during the North American evening hours.

11,700 kHz...Within the past year, Chicagoan Jeff White has managed to get his own shortwave program on the air. White, himself a Dx'er, is one of the hosts of *Radio Earth*. That program is produced and recorded on Curacao in the Netherlands Antilles, but is transmitted by a station in the Dominican Republic, *Radio Clarin*. As of this writing, *Radio Earth* can be heard from 0330 GMT/UTC (8:30 PM MST—the day before), but it may be going to an earlier time.

17,705 kHz...*Radio New Zealand* is an interesting station to hear. It's not the most powerful station in the world by far, but signals can be reasonably good, programs are in English and low keyed, not particularly aimed at overseas listeners. Give that one a try around 0300 to 0400 GMT/UTC or so.

There's a nice handful of stations to try for. Before we get together again next time, I hope to hear from you. What are you Hertzing? What do you want to hear? What do you want to know about this hobby called DX'ing? And, while you're at it, send along your photo, preferably with your SWL'ing setup and receiver. I'll run them in this column as space permits.

Good listening! —Don Jensen

This will be coming to you when you subscribe to **Radio-Electronics:**

- **HELPFUL CONSTRUCTION ARTICLES . . .**
 - Test Equipment
 - Hi-Fi Accessories
 - Telephone Accessories
 - Music Synthesizers
 - Computer Equipment
 - Automotive Equipment
 - Intruder Alarms
 - Home & Car
 - Video Accessories

- **NEWS ON NEW TECHNOLOGY . . .**
 - Computers
 - Microprocessors
 - Satellite TV
 - Teletext
 - Automotive Electronics
 - Speech Synthesizers
 - IC Applications

- **FASCINATING "HOW TO DO IT" ARTICLES . . .**
 - Build Your Own Projects
 - Make Your Own PC Boards
 - Wiring Techniques
 - Soldering and Desoldering
 - Design and Prototyping

Radio-Electronics

HOW TO REJUVENATE ANTIQUE RADIOS

\$1.50 MAR. 1983
U.K. £50

COMPUTERS - VIDEO - STEREO - TECHNOLOGY - SERVICE

Portable **SHORTWAVE RECEIVER**
Buyers guide

Inside the new **767 COCKPIT**

Build an **ACTIVE ANTENNA**
for your VLF receiver

Back-to-school series
POWER AMPLIFIERS

Inexpensive and versatile
2 DVM CIRCUITS
you can build

PLUS:

- ★ Videogames ★ Hobby Corner
- ★ Computer Corner ★ Drawing Board
- ★ State-Of-Solid-State ★ Equipment Reports



Radio-Electronics covers all aspects of the fast moving electronics field . . . featuring **COMPUTERS • VIDEO • STEREO TECHNOLOGY • SERVICE COMMUNICATIONS • PROJECTS**

Get it all!

- **HOW YOU AND THE COMPUTER CAN BE FRIENDS . . .**
 - Getting Started
 - Programs, Circuit Design, Games
 - A/D-D/A Interfacing
 - Peripheral Equipment

- **NEW AUDIO DIMENSIONS FOR YOUR PLEASURE . . .**
 - Noise-Reduction Devices
 - How to Connect that Extra Add-On
 - Hi-Fi Accessories
 - New Technology

- **TV WONDERS FOR YOUR FUTURE . . .**
 - Latest Receivers and Circuits
 - The Home Entertainment Center
 - Projection TV Today
 - Satellite TV Receivers
 - Jack Darr's Monthly Service Clinic
 - Service Problems and Solutions

- **AND you also get these regular MONTHLY FEATURES:**

- **LOOKING AHEAD** by Dave Lachenbruch
- **HOBBY CORNER** by "Doc" Savage
- **STATE-OF-SOLID-STATE** by Bob Scott
- **WHAT'S NEWS**, new products, stereo news
- **VIDEOGAMES**, new products, game reviews
- and **NEW IDEAS, STEREO PRODUCTS, NEW COMPUTER PRODUCTS FOR HOME/JOB and MUCH MORE!**

Subscribe today to **Radio-Electronics**. Don't miss a single issue and . . . you save as much as \$7.03 off the newsstand price.

When you select one of the subscription offers listed on the handy coupon—you'll be assured of having your copy reserved, even if it sells out on the newsstand. Make sure you get all the excitement in every issue of **Radio-Electronics**, every month, by filling in and mailing the coupon, today.

Mail to: **Radio-Electronics**
P.O. Box 2520, Boulder, CO 80322

Every Month!
Get the Best—Mail Today!

7S92

- 1 year—**12 issues only \$14.97** (You save \$3.03 off newsstand price.)
- 2 years—**(Save More)—24 issues—\$28.97** (Save \$7.03 off the newsstand price.)

- Payment Enclosed
- Bill Me

Name _____ (please print)

Address _____

City _____ State _____ Zip Code _____

Offer Valid In U.S. Funds Only.
Allow 6-8 weeks for delivery of first issue

Canada—Add \$3.00 per year
All other countries—Add \$7.50 per year

NEW PRODUCTS SHOWCASE

For more details use the free information card inside the back cover

Discwasher Enhanced Joystick

As videogames become more sophisticated, video-gamers are demanding equally sophisticated accessories. Discwasher, designer of the revolutionary PointMaster Competition Joystick, has responded to the demand with a second-generation joystick and a joystick add-on accessory designed for the video-gamer looking to get the most out of his game system.

The Discwasher Pointmaster PRO Tournament Joystick is an upgraded version of the Pointmaster Competition Joystick. The Pointmaster Pro incorporates Discwasher's unique "constant fire" circuit which allows the user to fire constantly by simply holding down the fire button. (The constant fire circuit is able to fire as quickly as is allowed by the individual game software.) The unit also features suction feet, allowing the player to place the joystick on any flat surface and simulate arcade play by only requiring one hand to control the joystick and five button functions. The Pointmaster Pro is compatible with the Atari VCS, 400/800 computers, Vic-20 and Sears Tele-Game systems and has a suggested retail of \$27.95—available at local game stores.

For those who want to add the constant firing function to the joysticks they already own, including the original Discwasher PointMaster (compatible with Atari VCS, 400/800 computer, Vic-20 and Sears Tele-Game), Discwasher is offering the Pointmaster Fire Control Constant Fire Adaptor. About the size of a disposable lighter the PointMaster Fire



CIRCLE 444 ON FREE INFORMATION CARD

Control connects between the joystick and the game mainframe to allow for constant firing while simply holding down the joystick fire button. The device has a suggested retail of around \$10 at your local game store.

For those who want the constant firing function to the joysticks they already own, including the original Discwasher Point-

Master (compatible with Atari VCS, 400/800 computers, Vic-20 and Sears Tele-Game), Discwasher is offering the PointMaster Fire Control connects between the joystick and the game mainframe to allow for constant firing while simply holding down the joystick fire button. The device has a suggested retail of around \$10 at your local game store.

VIZ Digital Wattmeter

VIZ model WD-766 Digital Wattmeter will measure AC volts, AC amps, and AC watts directly from the 120-volts AC power line. The digital display is a three-digit, high efficiency, .56-in.-high, red, seven-segment display. Measurement selection is accomplished by three pushbutton switches. Maximum power that can be measured is 999 watts which makes this instrument ideal for repair, production testing, education or design applications. Suggested user price is \$179. Distributed by VIZ Manufacturing Co., 335 E. Price St., Philadelphia, PA 19144. Telephone: 275/844-2526.



CIRCLE 445 ON FREE INFORMATION CARD

COMPUTERS ARE CREATING JOBS FOR NRI-TRAINED PEOPLE.

IF YOU'RE SERIOUS ABOUT MAKING MONEY IN MICROCOMPUTERS, NRI IS SERIOUS ABOUT SHOWING YOU HOW.

The U.S. Department of Labor projects job openings for qualified computer technicians will soon double. International Resource Development, Inc., estimates a 600% increase in these jobs in a decade. And most of these will be new jobs, created by the expanding role of computers.

NEVER HAS THERE BEEN A FASTER-GROWING FIELD OF TECHNOLOGY.

Many people are afraid of losing their jobs to computers, but thousands of jobs will be created for those who are prepared to meet the challenge.

With NRI training, you'll be prepared. You can have a profitable, exciting

who can handle the operational, programming and technical aspects of all kinds of microcomputers and microprocessors.

LEARN IN YOUR SPARE TIME

NRI trains you in your home. at

With NRI training you'll explore your computer's registers, memory and input-output ports. You'll even write programs to control the circuits you've designed and built. You'll perform hundreds of challenging experiments, always backed by a full-time faculty ready to help you personally.

When your NRI training is complete, you'll be a computer technician, ready for your first job — servicing, testing or programming all types of microcomputers — in a rewarding and challenging new career.

THE CATALOG IS FREE, THE TRAINING IS PRICELESS.

Send the postpaid card today for your FREE 104-page catalog.



RUSH THIS POSTAGE-PAID CARD FOR YOUR FREE CATALOG
The catalog is free.
The training is priceless.
NEW!

- Computer electronics with your choice of TRS-80 Model 4 or Color Computer
- TV/Audio/Video servicing with choice of computerized Heath/Zenith color TV and videocassette recorder, or audio system
- Industrial Electronics and Robotics with TRS-80 Color Computer for hands-on training
- Electronic Design Technology with design lab program for creative circuit and equipment design



CHECK ONE:

- Microcomputers and Microprocessors
- Color TV, Audio, and Video System Servicing
- Digital Electronics
- Electronics Design Technology
- Industrial Electronics
- Communications Electronics • FCC Licenses • Mobile • Aircraft • Marine
- Basic Electronics
- Small Engine Servicing
- Appliance Servicing
- Automotive Servicing
- Air Conditioning, Heating, Refrigeration, & Solar Technology
- Building Construction and Remodeling

All career courses approved under GI Bill. Check for facts.

Name _____ (Please Print) Age _____
 Street _____ State _____ Zip _____
 City _____

Accredited by the Accrediting Commission of the National Home Study Council

TRS-80 is a trademark of the Radio Shack division of Tandy Corp.



We'll give you tomorrow.

Electronics
 Continuing
 Education Center
 3939 Wisconsin Avenue
 Washington, D.C. 20016

NEW PRODUCTS SHOWCASE

For more details use the free information card inside the back cover

Discwasher Enhanced Joystick

As videogames become more sophisticated, video-gamers are demanding equally sophisticated accessories. Discwasher, designer of the revolutionary PointMaster Competition Joystick, has responded to the demand with a second-generation joystick and a joystick add-on accessory designed for the video-gamer looking to get the most out of his game system.

The Discwasher Pointmaster PRO Tournament Joystick is an upgraded version of the Pointmaster Competition Joystick. The Pointmaster Pro incorporates Discwasher's unique "constant fire" circuit which allows the user to fire constantly by simply holding down the fire button. (The constant fire circuit is able to fire as quickly as is allowed by the individual game software.) The unit also features suction feet, allowing the player to place the joystick on any flat surface and simulate arcade play by only requiring one hand to control the joystick and five button functions. The Pointmaster is compatible with the Atari VCS computers, Vic-20 and Sears Tele-Game systems and has a suggested retail price of \$27.95—available at local game stores.

For those who want to add a constant firing function to the joystick they already own, including the Discwasher PointMaster (compatible with Atari VCS, 400/800 computers and Sears Tele-Game), Discwasher offers the Pointmaster Fire Constant Fire Adaptor. About the size of a disposable lighter the



CIRCLE 444 ON FREE INFORMATION CARD

Compatible with Atari VCS, Vic-20 and Sears Tele-Game systems.

BUSINESS REPLY CARD
FIRST CLASS PERMIT NO. 10008 WASHINGTON, D.C.

POSTAGE WILL BE PAID BY ADDRESSEE
NRI Schools
McGraw Hill Continuing
Education Center
3939 Wisconsin Avenue
Washington, D.C. 20016

NO POSTAGE
NECESSARY
IF MAILED
IN THE
UNITED STATES

VIZ Digital Wattmeter

VIZ model WD-76 will measure AC volt watts directly from power line. The digital, high efficiency seven-segment display deflection is accomplished with touch switches. Maximum current measured is 999.99. Instrument ideal for testing, education. Suggested user price is \$19.95. Manufactured by VIZ Manufacturing Co., 355 E. 12th St., Philadelphia, PA 19144. Telephone: 275/844-2526.

CIRCLE 445 ON FREE INFORMATION CARD

COMPUTERS ARE CREATING JOBS FOR NRI-TRAINED PEOPLE.

IF YOU'RE SERIOUS ABOUT MAKING MONEY IN MICROCOMPUTERS, NRI IS SERIOUS ABOUT SHOWING YOU HOW.

The U.S. Department of Labor projects job openings for qualified computer technicians will soon double. International Resource Development, Inc., estimates a 600% increase in these jobs in a decade. And most of these will be new jobs, created by the expanding role of computers.

NEVER HAS THERE BEEN A FASTER-GROWING FIELD OF TECHNOLOGY.

Many people are afraid of losing their jobs to computers, but thousands of jobs will be created for those who are prepared to meet the challenge.

With NRI training, you'll be prepared. You can have a profitable, exciting future as an expert



Your NRI course will include the new TRS-80 Color Model 4 with Disk Drive or the TRS-80 Color Computer with NRI Computer Access Card...plus a professional LCD multimeter, NRI Discovery Lab and hundreds of demonstrations and experiments. It's all yours to keep.



who can handle the operational, programming and technical aspects of all kinds of microcomputers and microprocessors.

LEARN IN YOUR SPARE TIME.

NRI trains you in your own home, at your convenience...no classroom schedules to meet, no need to quit your job. As a class of one with complete course materials and the backing of a staff of professional electronics instructors, you'll get extraordinary hands-on training on the latest, most popular microcomputer: the new TRS-80™ Model 4 with Disk Drive. Designed to perform diverse personal and business functions and accept more software, the TRS-80 is yours to keep.

LEARN HOW TO USE, PROGRAM AND SERVICE STATE-OF-THE-ART MICROCOMPUTERS.

Through your carefully designed NRI course, you'll get a wealth of practical experience. You'll build circuits...from the simplest to the most advanced...with your NRI Discovery Lab.® You'll use a professional 4-function LCD digital multimeter for analysis and troubleshooting.

With NRI training you'll explore your computer's registers, memory and input-output ports. You'll even write programs to control the circuits you've designed and built. You'll perform hundreds of challenging experiments, always backed by a full-time faculty ready to help you personally.

When your NRI training is complete, you'll be a computer technician, ready for your first job — servicing, testing or programming all types of microcomputers — in a rewarding and challenging new career.

THE CATALOG IS FREE, THE TRAINING IS PRICELESS.

Send the postpaid card today for your FREE 104-page catalog.



For greater computer memory capacity, a double density disk drive is included.

It's a valuable guide to opportunities and training in the high-tech revolution. You'll see how easily you become part of the growing high-tech world of microcomputers.

If the card has been removed, please write to us today.



NRI School of Electronics
McGraw-Hill Continuing
Education Center
3939 Wisconsin Avenue
Washington, D.C. 20016

We'll give you tomorrow.

Radio-Electronics Software Store

New for our readers....A mailorder source of software for Atari 400, Atari 800, IBM P C, Commodore VIC-20, Apple II, and other personal computer systems.

IBM PC



FLIGHT SIMULATOR by Microsoft ... List \$49.95. Our price ... \$43.00. Highly accurate simulation of flight in a single-engine aircraft. Working instruments. Out the window graphics. Real-time flight conditions. (IBM P C, 64k, color graphics, disc)

EASYWRITER II by Information Unlimited ... List \$350.00. Our price ... \$300.00. Turns your computer into a word processor. You see everything on the screen. There are no imbedded commands. (IBM P C, disc)

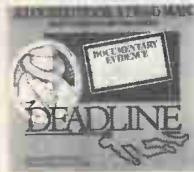

DEADLINE by Infocom ... List \$49.95. Our price ... \$43.00. A locked door. A dead man. You have 12 hours to solve the mystery. One false move, and the killer strikes again. (IBM P C, 48k, disc)

ALGEBRA, Vol. 1 by Eduware ... List \$39.95. Our price ... \$34.00. A first year algebra tutorial covering definitions, number line operations, sets, etc. (IBM P C, 48k, color graphics, disc)



MICRO/TERMINAL by Microcom ... List \$94.95. Our price ... \$83.00. Allows access to remote mainframes and minis, information data banks, and other personal computers. (IBM P C, disc)

PC TUTOR by Comprehensive Software ... List \$79.95. Our price ... \$69.00. Interactive program teaches you how to use your IBM Personal Computer, including hardware and software. (IBM P C, 64k, disc)



APPLE



PRISONER2 by Interactive Fantasies ... List \$32.95. Our price ... \$28.00. Escape is hardly possible. The island keeps you under surveillance. Just try and get out! (Apple II, 48k, disc)

PRISONER2 by Interactive Fantasies ... List \$39.95. Our price ... \$34.00. (Atari disc)

THE MASK OF THE SUN by Ultrasoft Inc ... List \$39.95. Our price ... \$34.00. An animated adventure through a series of hi-res screens. An ultimate adventure challenge. (Apple II, 48k, disc)

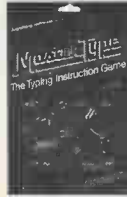

MASTERTYPE by Lighting Software ... List \$39.95. Our price ... \$34.00. A typing instruction system in an exciting hi-res game format. Learn to type while battling waves of attacking enemy words. (Apple II, 48k/64k, disc)

THE GRAPHICS MAGICIAN by Penguin Software ... List \$59.95. Our price ... \$53.00. Make your own animated graphics. Handles up to 32 independent objects. Stores hundreds of color pictures. (Apple II, 48k, disc)



RENDEZVOUS by Eduware ... List \$39.95. Our price ... \$34.00. In four phases, simulates an actual space-shuttle flight from Earth Liftoff through Orbital Rendezvous and Approach to Alignment Docking with a space station. Hi-res graphics (Apple II, disc)

SAT WORD ATTACK SKILLS by Eduware ... List \$49.00. Our price ... \$43.00. A tutorial for mastering vocabulary, deciphering new or unfamiliar words, and taking tests. (Apple II, disc)



COMMODORE VIC-20



PIPES by Creative Software ... List \$39.95. Our price ... \$34.00. Connect a pipeline from the water supply tank to every house. Watch out for leaks. Use as little pipe as possible. 5 skill levels. (Commodore VIC-20 cartridge)

SHAMUS by Human Engineered Software ... List \$39.94. Our price ... \$34.00. Only you can stop the Shad-ow's mad reign of terror. Two levels with 20 rooms each. A joystick challenge. (Commodore VIC-20 cartridge)



HOUSEHOLD FINANCE by Creative Software ... List \$17.95. Our price ... \$15.00. Home utility program records and analyzes your monthly income, expenses and budget in 16 categories. (Commodore VIC-20 tape cassette)

HOME OFFICE by Creative Software ... List \$29.95. Our price ... \$25.00. Combines VICPRO, a flexible and efficient word processor with VICDATA a powerful and sophisticated information storage and retrieval system. (Commodore VIC-20, cassette tape, 8k additional memory required)



ATARI



SUBMARINE COMMANDER by Thorn EMI ... List \$49.95. Our price ... \$43.00. A submarine patrol simulator to hunt and destroy enemy ships. 9 skill levels. Plug-in cartridge. (Atari Cartridge 400/800)

APPLE

MINER 2049 by MicroLab ... List \$39.95. Our price ... \$34.00. Chase into a Uranium mine thru 10 levels of traps and capture Yukon Yohan. Scale ladders, jump from moving platforms, and win—if you can. (Apple II, 48k, disc)



Radio-Electronics Software Store

200 Park Avenue South
New York, NY 10003

SP-9

Number of items ordered

Total Price of Software \$

Sales Tax (NY State Residents Must Include)

Shipping (\$2.00 per item)

TOTAL ENCLOSED (Sorry, No COD's) \$

Name

Address

City State ZIP

SORRY - NO CREDIT CARD OR COD ORDERS

KERBER KLOCK III

A modern day grandfather's clock that you can see through and select one of 12 melodies played on the quarter hour!

R. J. "BOB" KERBER

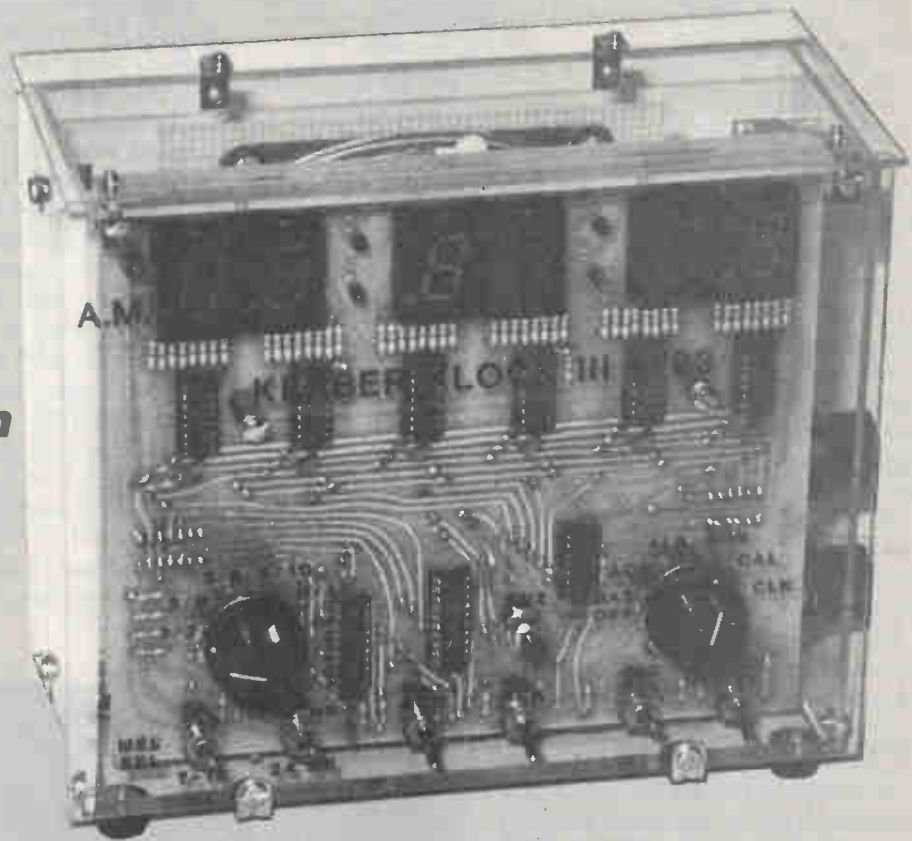

☐ SUNDIALS WERE THE FIRST ATTEMPT TO INDICATE THE time of day. It was noticed that a stick in the ground cast a shadow in a different direction at different times during the day. That primitive arrangement has been continually improved upon throughout the centuries. Today, mechanical timepieces have been all but replaced by solid-state electronic devices. One can find electronic digital clocks placed in anything from necklaces, to cars, to the end of a ballpoint pen.

Musical grandfather clocks are still very popular in many households. This article describes the electronics application for building a microprocessor-based, solid-state digital clock with 12 different melodies which are selected by the user. We call it the Kerber Klock III.

The construction of the enclosure can be at the discretion of the user. For those interested in woodworking projects, the electronics could be housed in a mantle clock or carriage clock made out of solid walnut, cherry, whatever. Other materials could be metal, plywood, paneling, or anything else that comes to mind. This article describes the author's

enclosure, which uses clear plastic. A clear enclosure is not only an interesting conversation piece but is a unique method of displaying one's handiwork.

Kerber Klock III is a digital clock which not only displays the time and date but also plays a melody on the quarter hour similar to a grandfather clock. There are 12 preprogrammed melodies, which are user selected by a rotary switch on the front plate. At fifteen minutes past the hour, a quarter of the melody will play. At half-past the hour, half the melody will play. At forty-five minutes past the hour, three quarters of the melody will play. On the hour, the whole melody will play and the hour will be counted. Almost any melody can be preprogrammed into the clock at the request of the user.

There are no moving parts in the Kerber Klock III to wear out because it is built with the latest state-of-the-art electronics. The circuit incorporates a 6802 microprocessor, a 4K EPROM, and CMOS and TTL devices that provide a completely solid-state instrument.

As with any other precision instrument, the Kerber Klock III must be handled with reasonable care. It should not be

dropped or exposed to adverse weather conditions. It should not be placed in direct sunlight, because excessive heat may build up in the cabinet.

For the more adventurous hobbyist, the schematic diagrams (Figs. 1 through 4) and EPROM program listing is all that is required. Perfboard with wire-wrap sockets will do the job. Many of the parts used in this project are readily available in your electronics-parts drawer. In any case, all the parts are available from one or more of the suppliers in the Vendors List at the end of the Parts List.

Circuit Description

Refer to schematic diagrams (Figs. 1 through 4) for the following circuit description, which will cover each component and its particular function in the circuit. Microprocessor theory will not be discussed; that will be left to the interested reader.

The Motorola 6802 microprocessor is the same as the 6800—with some important improvements. The 6802 (Fig. 1) has its own internal clock and driver requiring only an external crystal. It also has 128 bytes of on-chip RAM, therefore, it does not require external RAM with addition circuitry for address decoding.

A 100,000-ohm resistor and 4.7- μ F capacitor (Fig. 1) provide a RESET pulse to the 74LS14 Schmitt trigger inverters. That signal to pin 40 of the 6802 microprocessor causes it to begin its restart sequence on initial start-up.

A 3.58-MHz color TV crystal oscillator (Fig. 1) is used in conjunction with a 17-stage programmable oscillator/divider 5369 to provide an external clock to run the processor and provide a 60-Hz frequency for timing upon power failure. Two 1,200-ohm resistors and two 1N914 diodes provide wave shaping of the 60 Hz line frequency for normal timing when there is power. A 1,200-ohm resistor monitors the secondary 5 volts (V_S) for a power failure. If V_S goes LO, the 60-Hz frequency from 5369 is gated through to the IRQ (pin 4) of the processor; otherwise, the 60 Hz line frequency is gated through.

The Interrupt Request (IRQ) is used for timing the digital clock and the length of the tones in the melodies.

EPROM Control

An EPROM 2532 or 2732 stores the machine language program that tells the processor what to do. If a 2532 is used

(Fig. 1), a jumper wire is required from E1 to E2 and from E3 to E4. If a 2732 is used, a jumper wire is required from E2 to E3 and from E4 to E5. That is due to different manufacturers of those devices using different pins for certain signals.

Address decoding starts with 74LS138-1 (Fig. 2). Valid Memory Address (VMA) and the E clock are ANDed through 4011 at pin 3 (Fig. 1) to provide a LO true signal $VMA \cdot E$. Address line A15 and $VMA \cdot E$ enables 74LS138-1 to recognize A14, A13, and A12 which causes the appropriate output to go LO when true. When signals A15, A14, A13, and A12 are all HI (high), pin 7 (F000) goes LO enabling the EPROM.

Address E000 from the 74LS138, pin 9 (Fig. 2) is decoded only for use in the author's troubleshooting and test fixture. Address D000 (pin 10) and C000 (pin 11) are not used. (N.C. in the diagrams indicates no connection.)

Address B000 from the 74LS138 (Fig 2) is used to control the AM LED (Light Emitting Diode) and ACO (Accessory Output) relay. Address A000 is used to direct either the melodies or the alarm out to the speaker. Address 9000 is used to select one of the 96 different musical notes. Those three addresses are discussed later.

Address 8000 is used to control the 7-segment LED displays (Fig. 2). Each of the six displays are driven by an 8-bit addressable latch chip (74LS259). Address lines A2, A1, and A0 select the appropriate display segment at the same that address lines A6, A5, and A4 select the appropriate 7-segment display. A hex buffer chip (4050-3) is used to provide more drive capability for address lines A2, A1, and A0 and for data lines D4 and D0.

In other words, each segment of each digit has a specific address. For example, the top segment (segment a) of the far left digit (Tens-of-Hours) has an address of 8056. To get a further understanding, one needs to know how address lines are converted to hex-a-decimal numbers. The 6802 microprocessor has 16 address lines, labeled A15 through A0. Those address lines can be broken up into four 4-bit hexadecimal numbers:

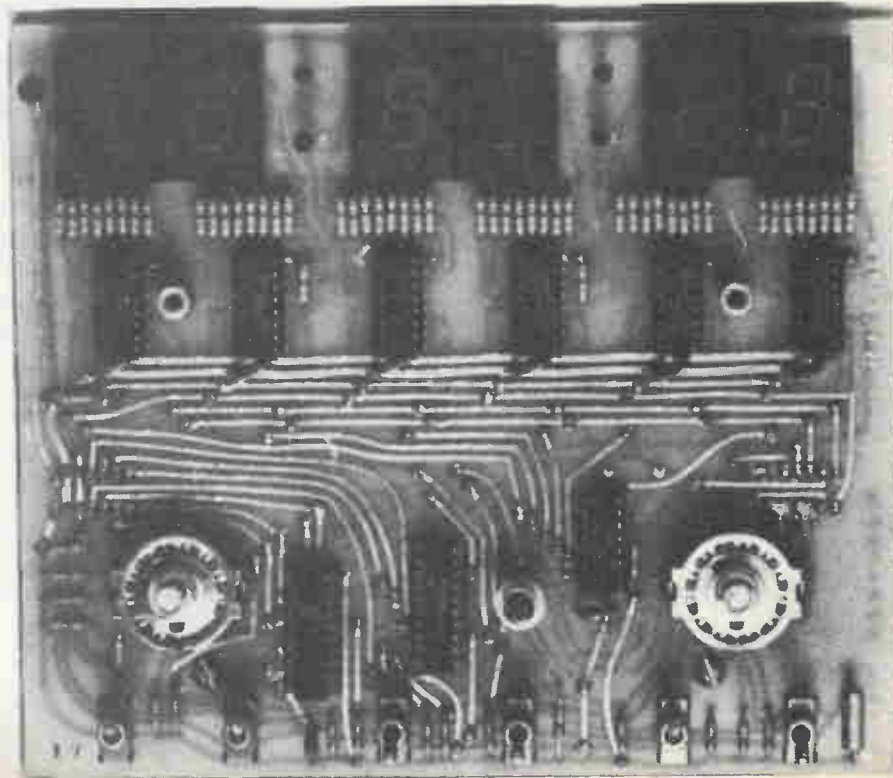

THIS VIEW of the Kerber Klock shows the display and control board (also see Figs. 6 and 8) with the display LED's facing forward. The controls are mounted on the printed-circuit board, however, their shafts should line up with the front panel (see Fig. 5).

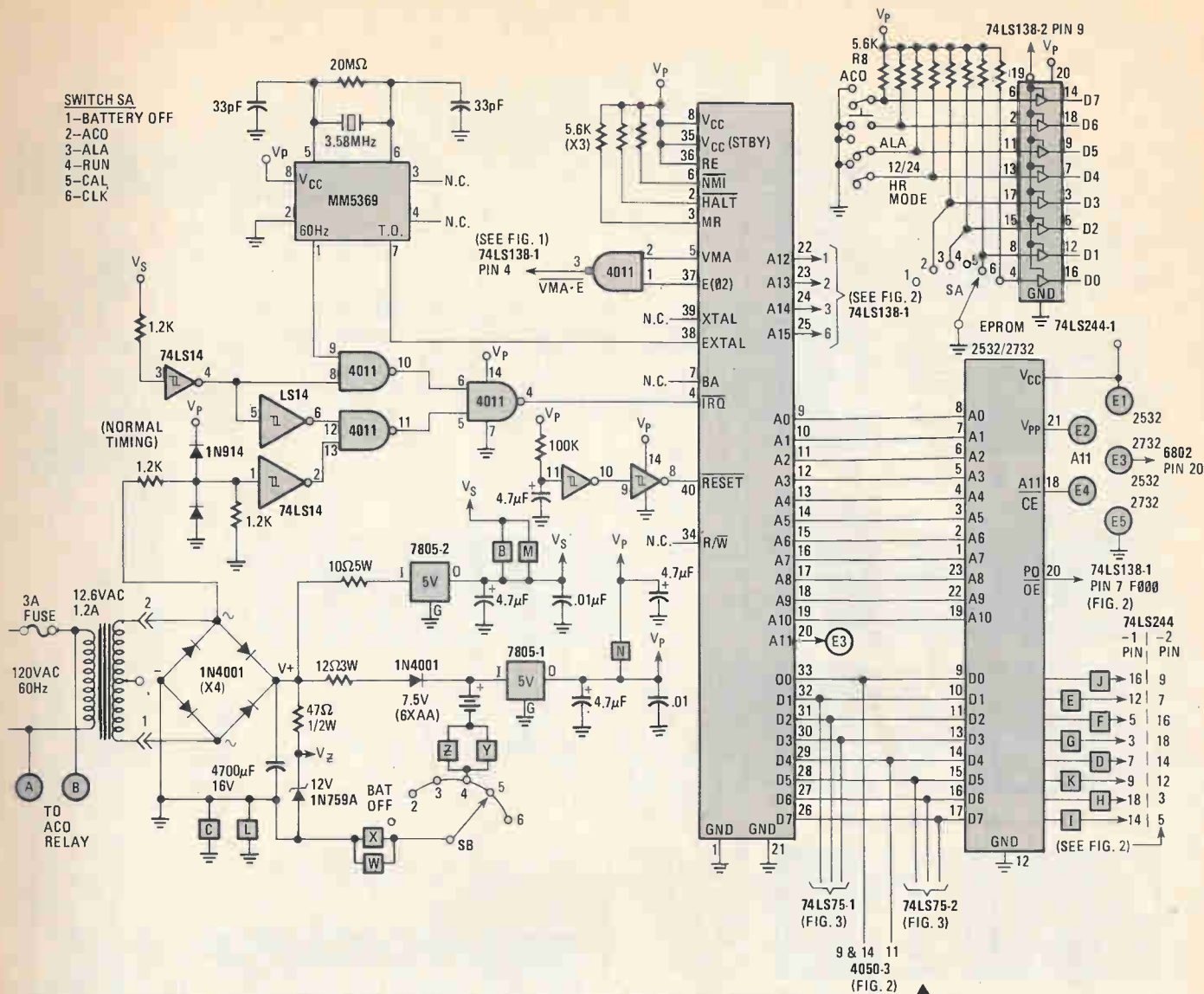
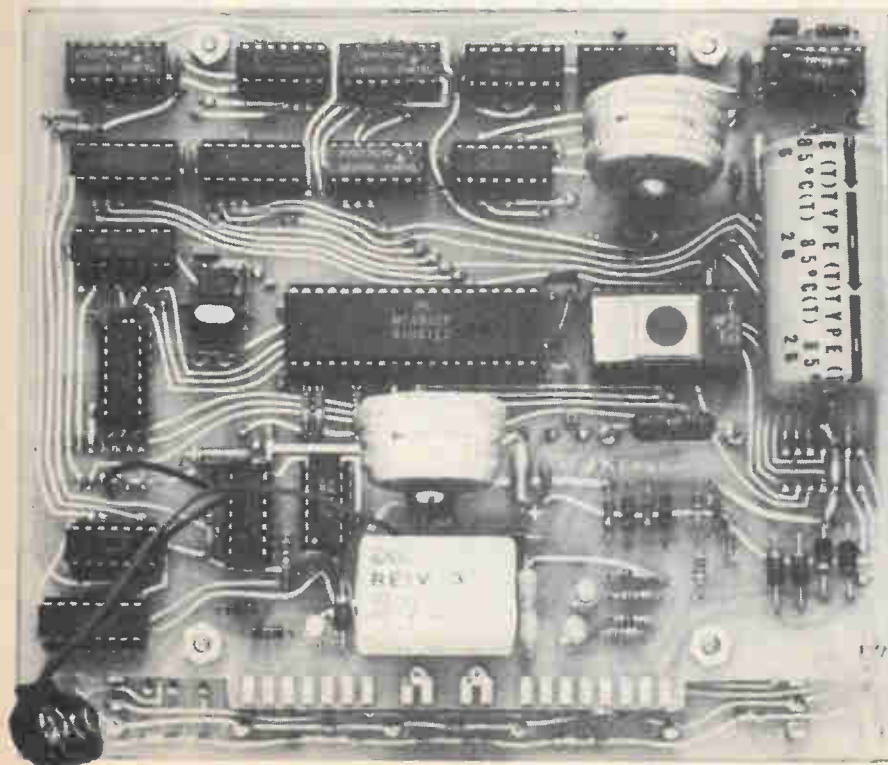
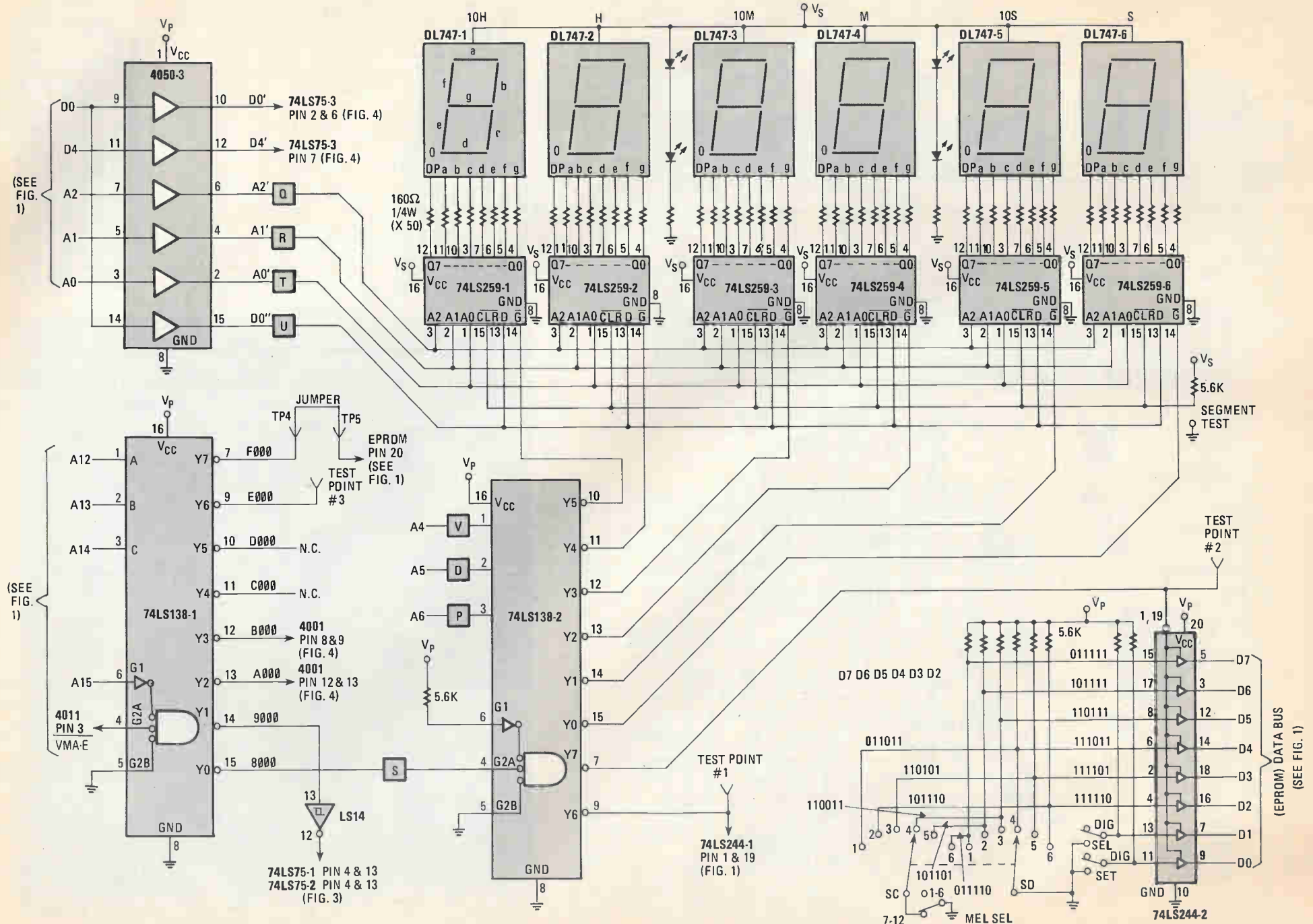

FIG. 1—IT'S IMPOSSIBLE to draw the entire schematic diagram of Kerber Klock III on one page of this magazine. Instead the diagram was divided into four drawings (Figs. 1 to 4). We suggest that you scan all four drawings and get a feel for the circuit before you become involved with the circuit details.



REAR VIEW of the two circuit boards, the display and control board and the microprocessor board, assembled. This assembly is installed by plugging it into the card-edge connector installed in the base of the clock. The transistor battery connector in the lower left of the photo connects to the battery holder.



A15	A14	A13	A12	A11	A10	A9	A8	A7	A6	A5	A4	A3	A2	A1	A0
1	0	0	0	0	0	0	0	0	1	0	1	0	1	1	0
H8				H0				H5				H6			
DECODER				NOT DECODED				DECODER				DECODER			
74LS138-1								74LS138-2				74LS259-1			

Address 8000 is also used to interrogate the switches. Specifically, 8060 interrogates switches inputting to 74LS244-1 (Fig. 1). Switch interrogation occurs 60 times a second (16.67 millisecond). The 5,600-ohm resistors pull the inputs to 74LS244-1 and -2 (Figs. 1 and 2) HI unless a particular switch setting pulls that input LO. When the processor addresses a switch decoder, it takes the information present on the data lines (D7 through D0) at that instant in time and takes appropriate action on that data. For example, if Sa were in CAL position (as shown in Fig. 1), data line D1 would instruct the processor to display the date and prepare to make a change.

The Music Starts Here

A MOS top-octave frequency generator 50240 (Fig. 3) provides a full octave of 12 musical notes on the equal tempered scale. Clocking of the 50240 is by a 4049 hex-inverter oscillating at a 2.38 MHz frequency. The outputs of 50240 are switching from +12 volts to ground. Two hex buffers, 4050-1 and -2, are used as logic level converters to change the MOS +12 volt levels to TTL (+5 volt) logic levels. Instead of 4050 hex buffers, 4049 hex inverter buffers can be used interchangeably as logic level converters.

Address 9000 loads information on data lines D7 through D0 into latches 74LS75-1 and -2 (Fig. 3). Data selectors 74LS251-1 and -2 transfer whichever frequency is selected to the Y1 or Y2 output. One of the twelve possible frequencies is selected by data lines D3, D2, D1 and D0.

The 74LS393 is a binary counter (Fig. 3) which divides the frequency at the 1A input by 2, 4, 8, 16, etc. The eight outputs are exactly one octave apart. One of eight possible octaves is selected by data lines D6, D5, and D4. Data line D7 strobes the selected musical note to the outputs Y3 and W3. Twelve (12) possible frequencies multiplied by eight (8) possible octaves result in ninety-six (96) possible musical notes.

Address A000 selects either the melody or the alarm depending upon whether data line D0 is HI or LO. Refer to Fig. 4. If D0 is LO, 74LS75-3 will latch a zero at the IQ output to enable 4001 pin 3 to gate the melody at W3 through to the 10,000-ohm MEL VOL control. If D0 is HI, 74LS75-3

FIG. 2—ADDRESS DECODING begins in this portion of the schematic diagram for Kerbor Klock III. The circuit interrogates the switches discovering where they are set and initiates the correct clock action.

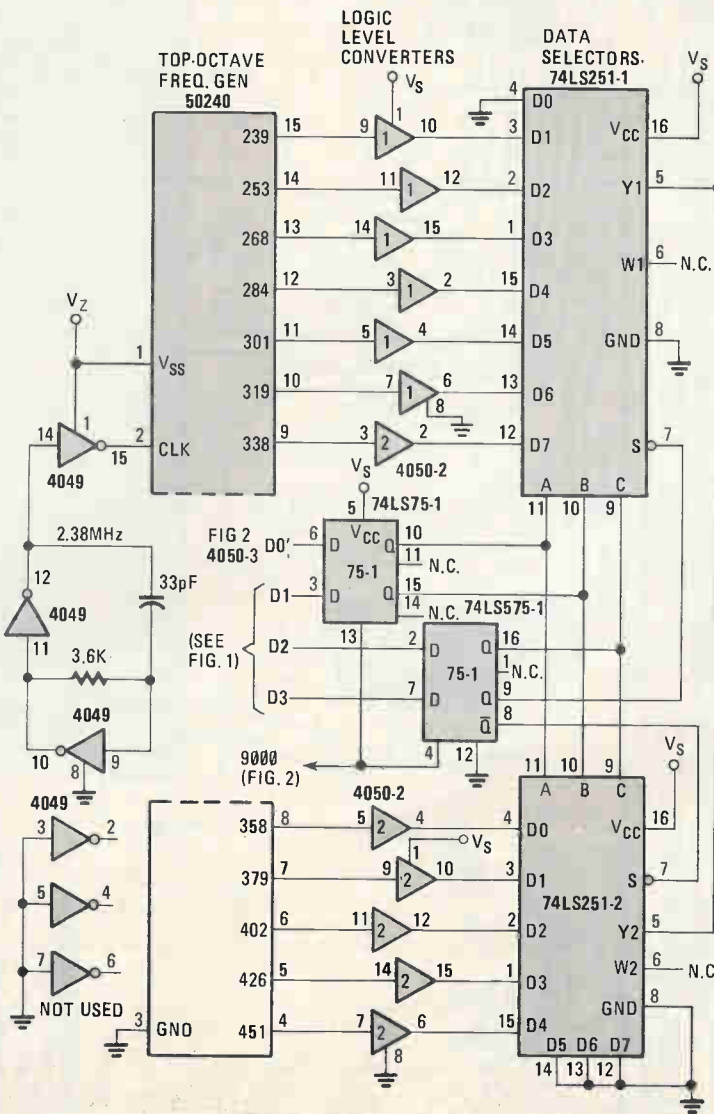
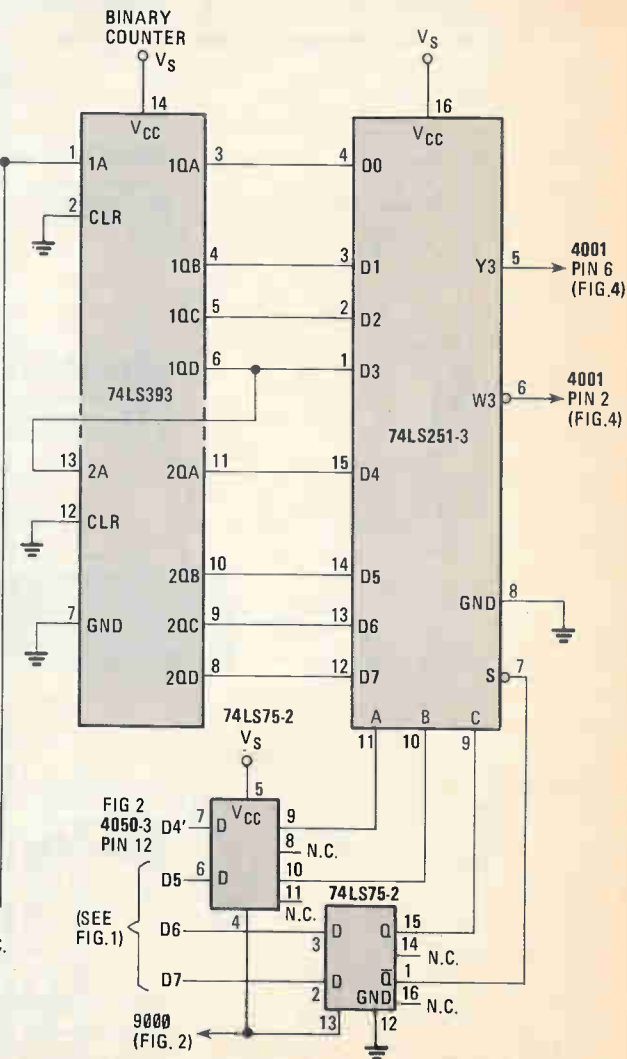

FIG. 3—SHOULD THIS PART of Kerbor Klock III circuit go bad, you can expect the melodies that can be played to go flat, if heard at all. The 50240 chip provides the 12 musical notes at the high octave to be divided down.



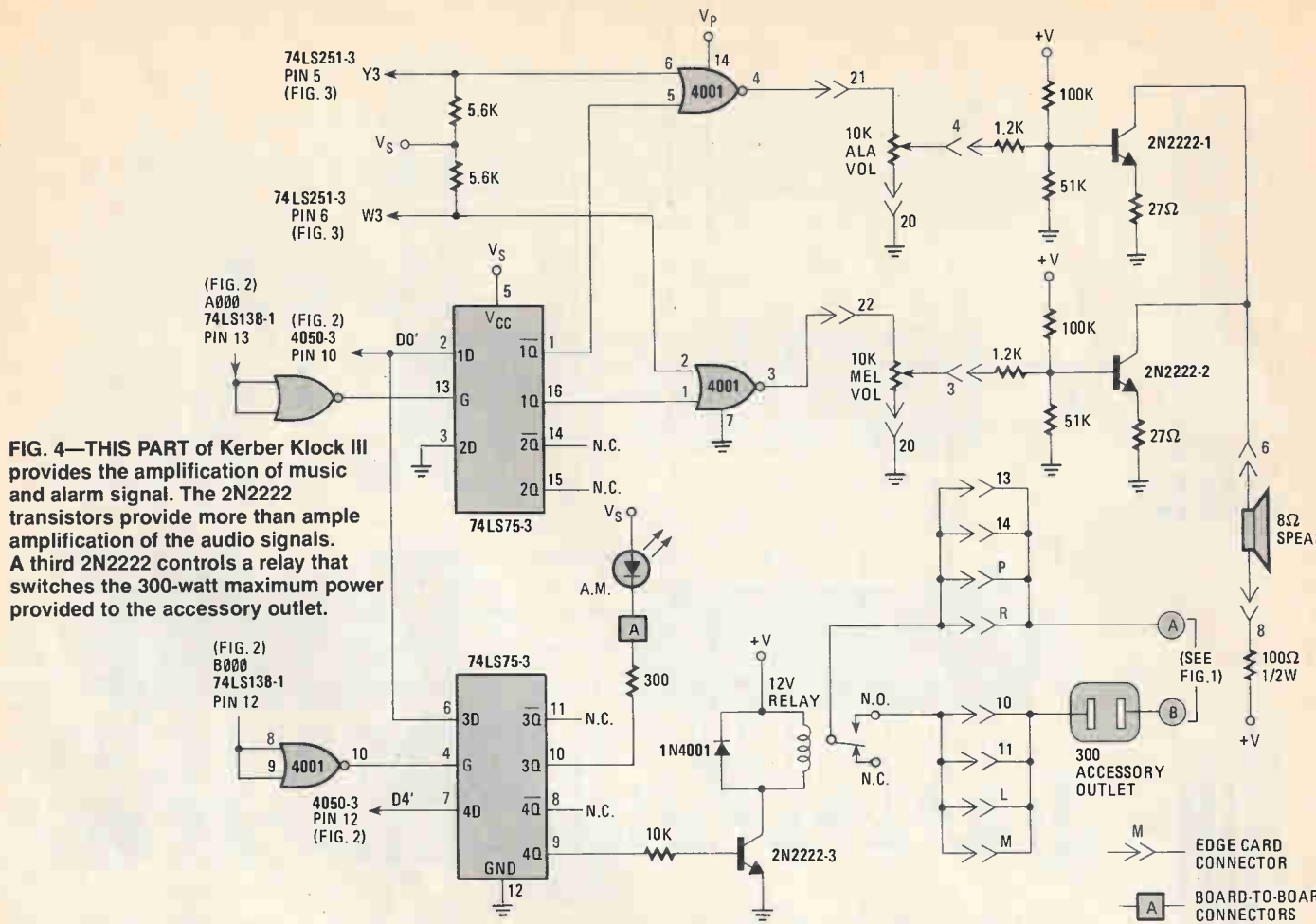
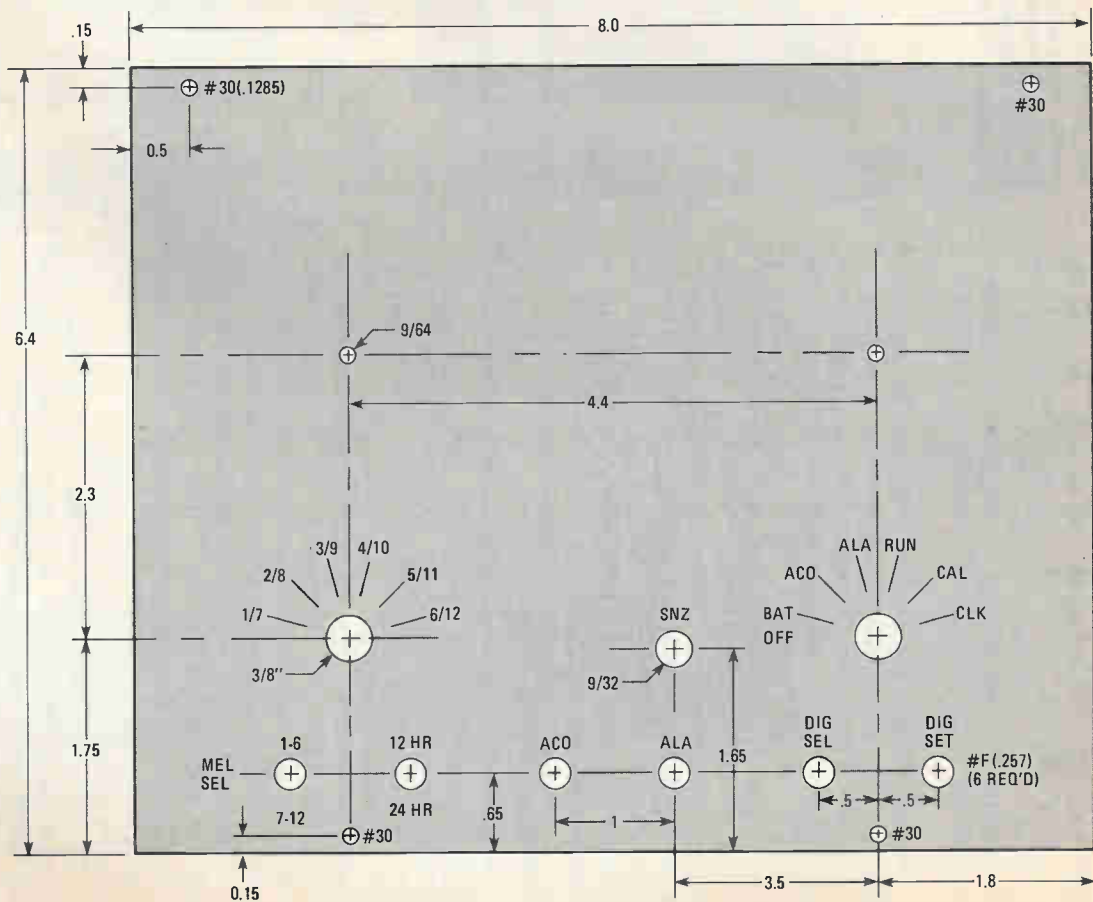

FIG. 4—THIS PART of Kerber Klock III provides the amplification of music and alarm signal. The 2N2222 transistors provide more than ample amplification of the audio signals. A third 2N2222 controls a relay that switches the 300-watt maximum power provided to the accessory outlet.

FIG. 5—FRONT PANEL details provided here are critical since they must align with the foil layout of the display and control printed-circuit board shown in Fig. 6. You may use clear or smoked plastics to make the cabinet. Switch positions are marked in this diagram for you to copy. All dimensions are in inches or drill size.



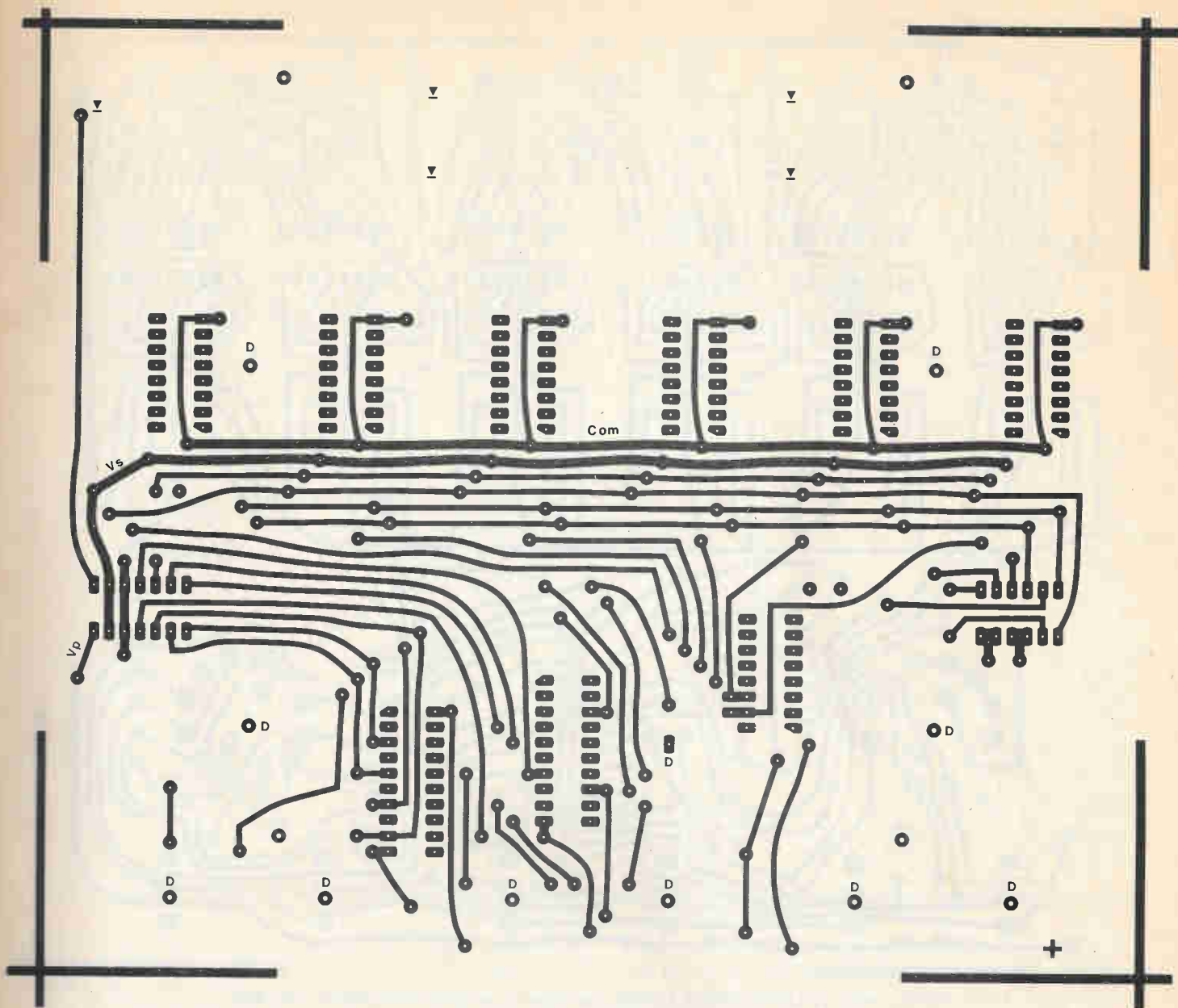

FIG. 6—DISPLAY AND CONTROL printed-circuit board front foil pattern shown same size ready for photo-copying.

will latch a zero at the 1Q-bar output to enable 4001, pin 4, to gate the alarm at Y3 through to the 100,000-ohm ALA VOL control. Simple 2N2222-1 and -2 transistor amplifiers drive the speaker. Separate volume controls are provided because it is very likely that the user will want a different volume setting for the alarm than for the melodies.

The Power Supply

The rectifier circuit is a full-wave bridge type (Fig. 1) using four 1N4001 diodes to rectify the 12.6 VAC secondary winding of the step-down transformer. A 4700- μ F capacitor filters the rectified voltage $V\phi$ output of the bridge circuit. $V+$ is about 14 volts. Zener diode 1N759A provides 12-volt reference (V_z) through a 47-ohm $\frac{1}{2}$ -watt dropping resistor. Twelve volts is required for the top octave generator 50240 and oscillator 4049-1 (Fig. 3).

The two 5-volt 3-terminal regulators 7805-1 and -2, provide a V_p (primary) and V_s (secondary) voltage (Fig. 1). The V_p voltage is backed up by Ni-Cd batteries. The V_s voltage is not required upon the loss of AC power. The 12-ohm, 3-watt resistor is a voltage-dropping resistor to take

some of the heat away from the 7805-1 3-terminal regulator and provide current limiting to trickle charge the Ni-Cd batteries. Diode 1N4001 prevents battery current from flowing through the 12-ohm and 10-ohm resistor to V_s . The 10-ohm, 5-watt resistor dissipates power otherwise dissipated in the V_s regulator, thus allowing the 7805-2 to run cooler.

Display and Control Board Assembly

Read these instructions through at least once before starting the actual construction, in order to get the general idea of what is to be done.

NOTE: It is important that all dual-in-line integrated circuits (IC's) and the six 7-segment displays be mounted in sockets!!

The display and control board (DCB) is used as a template for accurately locating two mounting holes, two rotary switches, one pushbutton switch, and six toggle switches through the front plate. Position the DCB, component side up, on the front plate (Fig. 5) to drill holes as shown in Fig. 6. Figure 7 illustrates the flip, or circuit, side of the DCB. The material to use for the front plate and other details will be

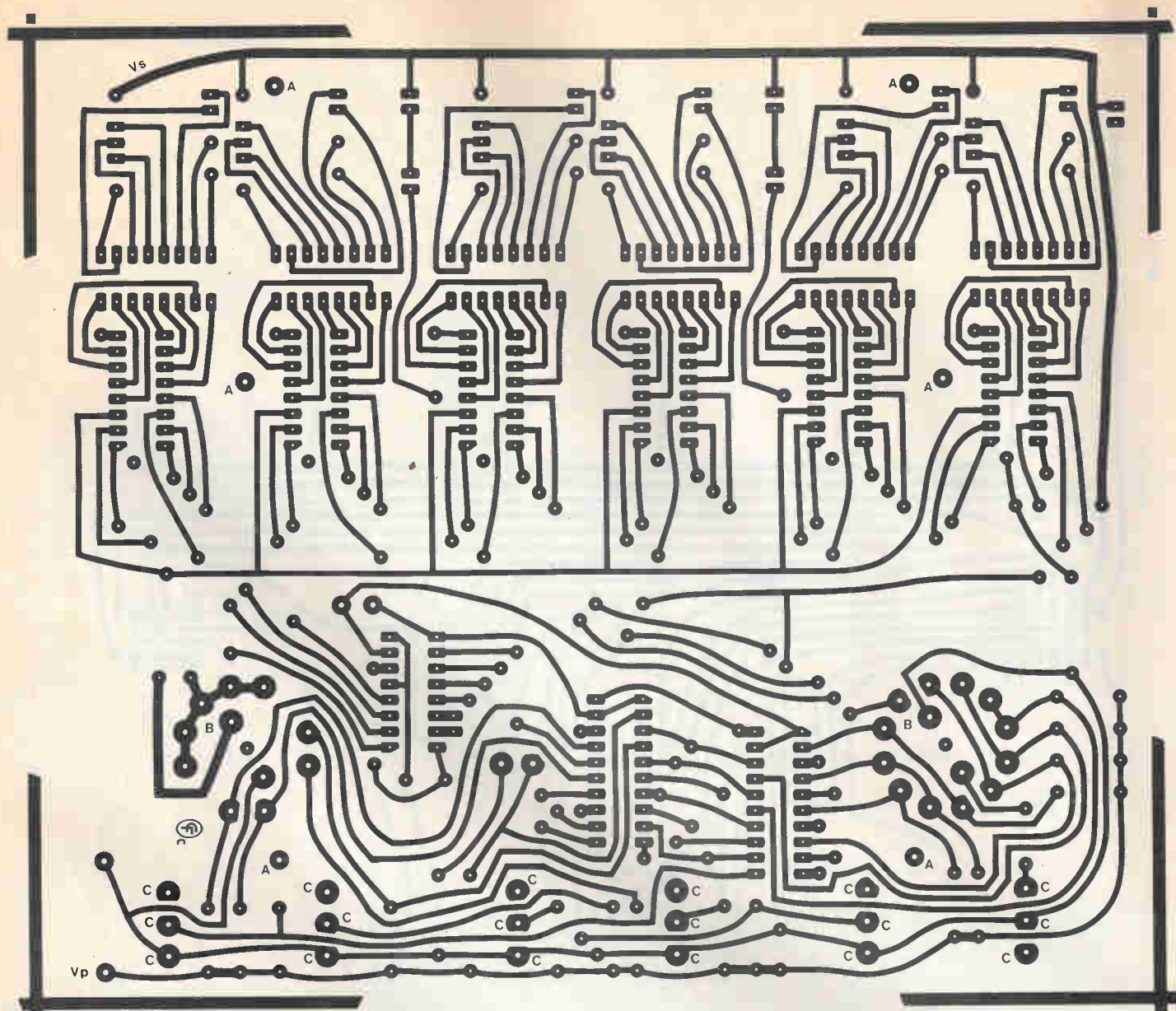

FIG. 7—DISPLAY AND CONTROL printed-circuit board rear foil pattern shown same size.

given soon and this paragraph will be referenced. Drill a $\frac{1}{16}$ -in. diameter hole in the center of each of the eleven D pads through the circuit board and front plate. Set the front plate aside for now.

With the DCB circuit side up, drill a $\frac{1}{32}$ -in. diameter hole in the center of each pad regardless of the letter next to the pad. Refer to Figs. 6 and 7. The final hole size will be drilled later. With the component side up, drill a $\frac{1}{32}$ -in. diameter hole in the center of the remaining pads. There is one group of 14 holes on the left and another group of 12 holes on the right. With the circuit side up, drill the final hole size as instructed below:

Display and Control Board

Hole	Size (in.)	Qty
Unmarked	$\frac{1}{32}$	All
A	$\frac{9}{64}$	6
B	$\frac{5}{64}$	25
C	$\frac{1}{16}$	8
D	$\frac{1}{16}$	11

Using the DCB component location drawing (Fig. 8), insert a $.025 \times .025$ -in. wire-wrap post in each of the holes marked by a circle with a cross centered on it. Solder the post

to each side of the board and cut the pin off close to the board. Install a post at SEGMENT TEST pad, but leave the pin $\frac{1}{8}$ -in. long on the component side. Do not install anything at TP1 and TP2.

Those posts serve as plated-through holes (PTH's) which provide an electrical connection from one side of the board to the other. Some component leads are also used as PTH's. For example, when a resistor lead goes through a hole with a pad around it on the component side, the lead must be soldered to the pad. That is true for any component lead which goes through a hole on the component side with a pad around it. Those pads are identified as black, or solid, circles with a white dot in the center as shown on PCB component drawing (Fig. 8).

Refer to DCB component location diagram (Fig. 8) when installing all parts in the following paragraphs.

Install all resistors as indicated.

Install and solder a 4.7- μ F capacitor in the lower-right corner with positive end down as shown. Install and solder eight disc capacitors as shown by the rectangular symbol with a letter C inside.

Six 24-pin low-profile open-frame sockets are used for the

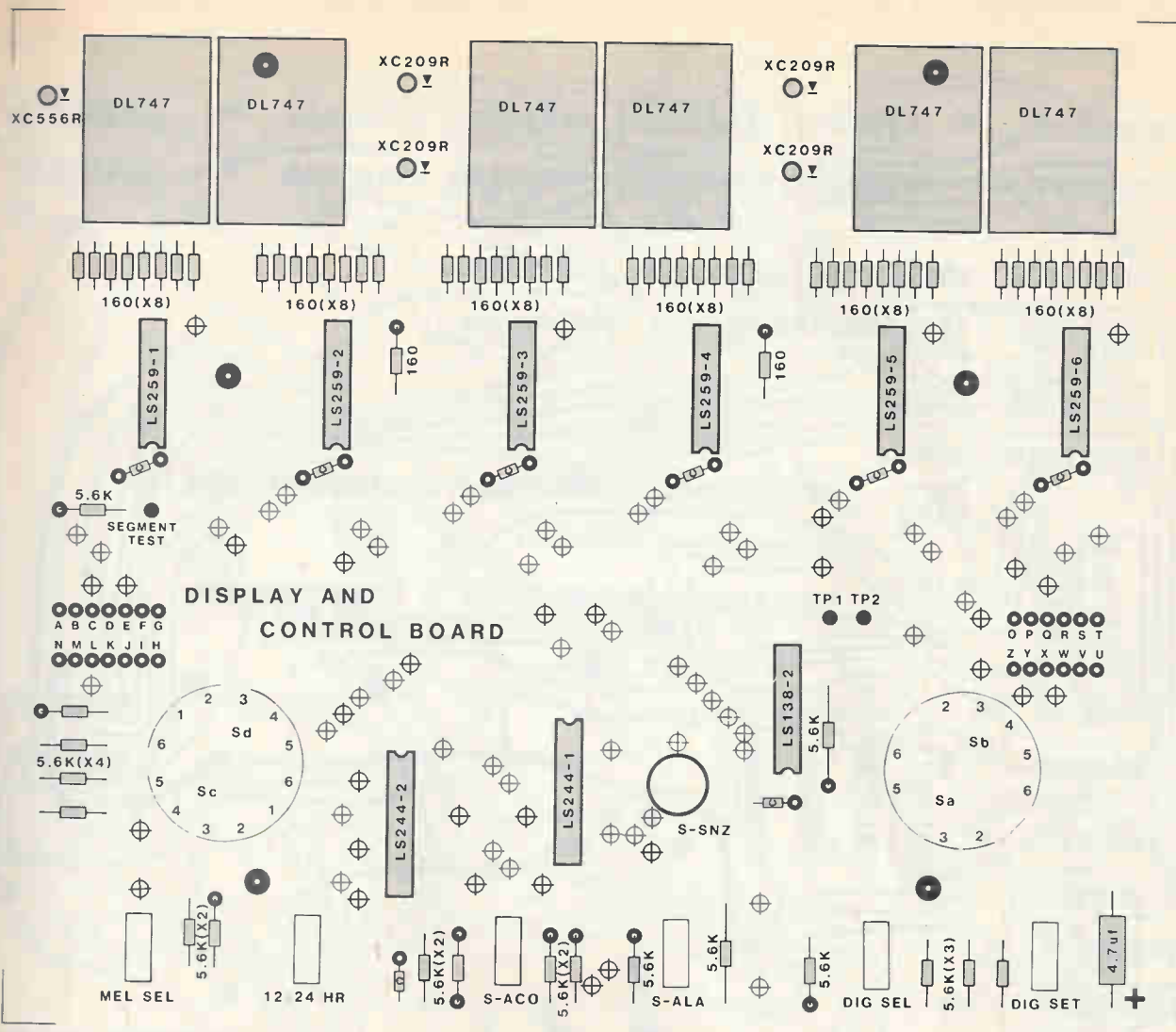

FIG. 8—DISPLAY AND CONTROL printed circuit-board component location diagram—may be silk-screened on surface shown in Fig. 6.

displays. The open-frame sockets provides clearance for two mounting screws behind the second and fifth display for bolting the two circuit boards together. Remove pins 1, 2, 5, 7, 9 through 15, 17, 21, 23, and 24. Install and solder the display sockets with pin 1 toward the top of the board. Install and solder the remaining IC sockets. Be sure that sockets are oriented as shown.

Install and solder five light emitting diodes (LED's). Do not mount the LED down on the board. The top of the LED should be at the same height as the seven segment displays. Polarity is critical. Each LED will have a slightly flat surface by either lead. That is the cathode lead and must be down toward the bottom edge of the board. The cathode lead of the AM LED must be soldered on the component side.

Insert nine IC's as shown. Pin 1 must be located at the end with the notch.

Since the front plate is used as a fixture for holding the switches for soldering, the switches will be mounted later. Set the display and control board aside for now.

Assembling the MicroPB

Throughout the construction, 6-32 pan-head screws of different lengths will be used. Those screws will be referred to simply by size: for example, 1/2-in. screw. Of course, associated washers, lockwashers, and nuts should be of the same size for proper fit and threading.

The microprocessor board (MicroPB) is drilled entirely from the circuit side. Refer to Figs. 9 and 10 to identify the MicroPB sides. With the circuit side up, drill a 1/2-in. diameter hole in the center of each pad regardless of the letter next to the pad. With the circuit side still up, drill the final hole size as detailed below:

Hole	MicroPB Size (in.)	Qty
Unmarked	1/32	All
A	9/64	4
B	3/64	28
C	1/16	5

Using the MicroPB component location drawing (Fig. 11), insert a .025 × .025-in. wire wrap post in each hole marked as an open circle which a cross centered on it. Solder the post to each side of the board and cut the post off close to the board.

Refer to Fig. 11 when installing components. Remember that all component leads that go through a hole on the component side with a pad around it must have its lead soldered to the pad.

Install and solder all resistors, except the 10-ohm 5-watt and 12-ohm 3-watt resistors as indicated.

Install and solder all diodes as indicated. Polarity is crit-

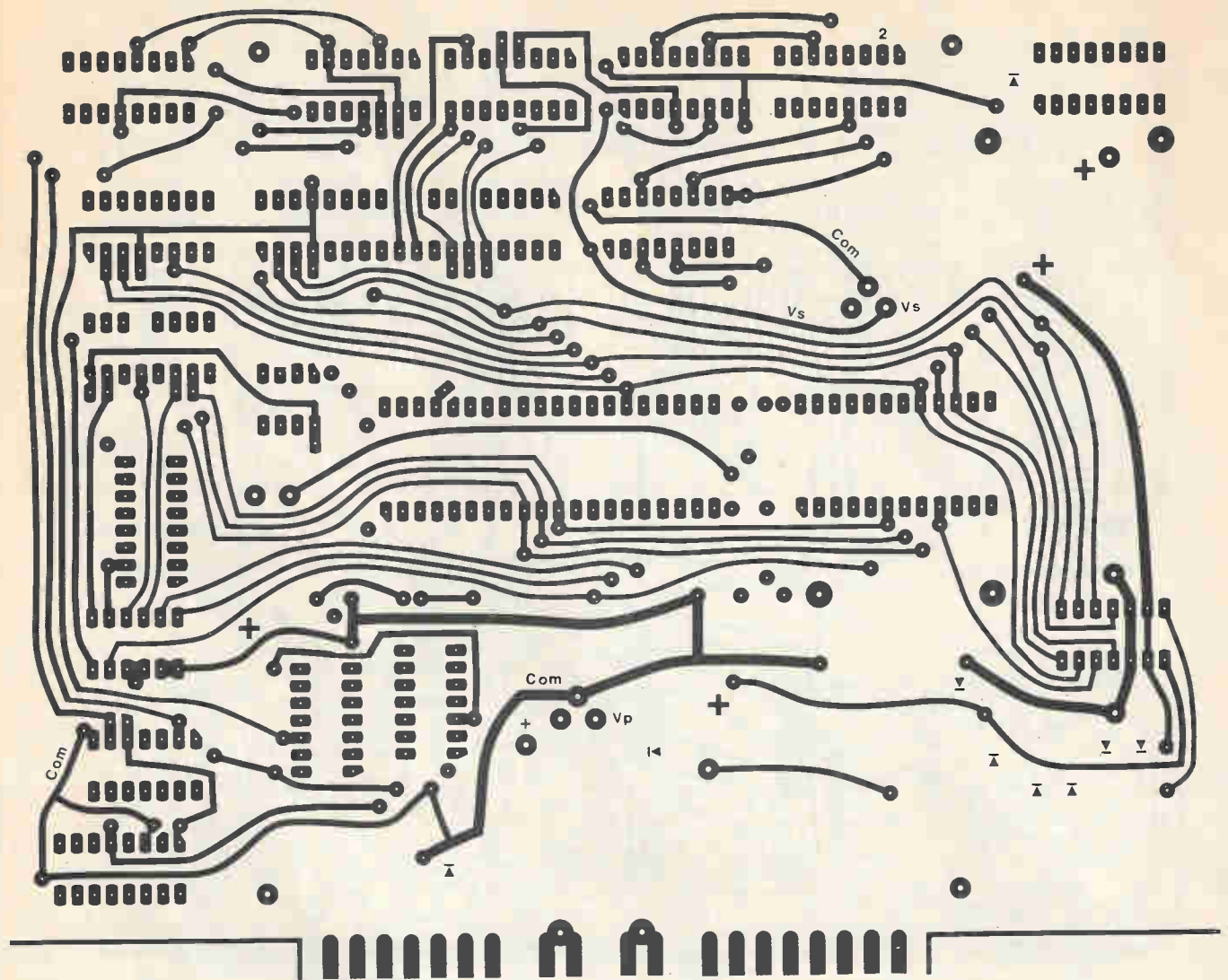

FIG. 9—MICROPROCESSOR printed-circuit board front foil pattern shown same size.

ical. Install with banded and (cathode) toward the bar end of the symbol.

Install and solder four 14-pin sockets. Mount with pin 1 of the socket toward the notch as shown.

Install and solder seven jumper wires on the circuit side of the board. Use #22 AWG or #24 AWG solid insulated wire. Strip the insulation so the ends can be soldered on both sides of the board. On the component side, add a jumper wire from TP4 to TP5. Do not install anything at TP3. If a 2532 EPROM is used, put a jumper from E1 to E2 and from E3 to E4. If a 2732 EPROM is used, put a jumper from E2 to E3 and from E4 to E5. Mount all jumper wires $\frac{1}{16}$ -in. off the board.

Install and solder eleven disc capacitors, as shown by the symbol of a rectangle with a letter C inside. Install and solder three 4.7- μ F capacitors, making sure the positive end is mounted toward the plus sign as shown. If the 4.7- μ F capacitors are not insulated, they should be mounted $\frac{1}{16}$ in. off the board. Install and solder three 33-pF capacitors as shown.

Install and solder twelve 16-pin sockets as shown. Remove pin 13 from the 4050-3 socket and pin 6 from the 74LS251-1 socket. Install and solder one 40-pin, one 24-pin and one 8-pin socket. Mount with pin 1 toward the notch.

Use two 14-pin sockets for the board-to-board connection. Mount a 14-pin socket from the circuit side, and solder all pins to the component side of the board. Remove the end two pins (pin 7 and 8) of the other socket. Mount it from the circuit side and solder all pins to the component side of the board. The orientation of pin 1 for either socket is not important.

Install and solder three 2N2222A transistors as shown. The bottom of the transistor case should be mounted $\frac{3}{16}$ in. off the board.

Install and solder the red lead of the 9-V battery clip at BAT (+) and the black lead at BAT (-).

Install and solder the 10-ohm, 5-watt and 12-ohm, 3-watt power resistors. Those resistors should be mounted off the board with $\frac{3}{4}$ -in. space between the board and body of the resistor.

The 3-terminal 5-volt regulators require a heat sink. An aluminum cap from a quart beverage bottle is used. Remove the plastic seal inside two bottle caps and drill a $\frac{9}{64}$ -in. diameter hole in the center of the top. Using a $\frac{1}{4}$ -in. screw, star lockwasher and nut, bolt the bottle cap to the 5-volt regulator. The lockwasher and nut should be inside the cap. Bend the center pin of the regulator toward the top of the

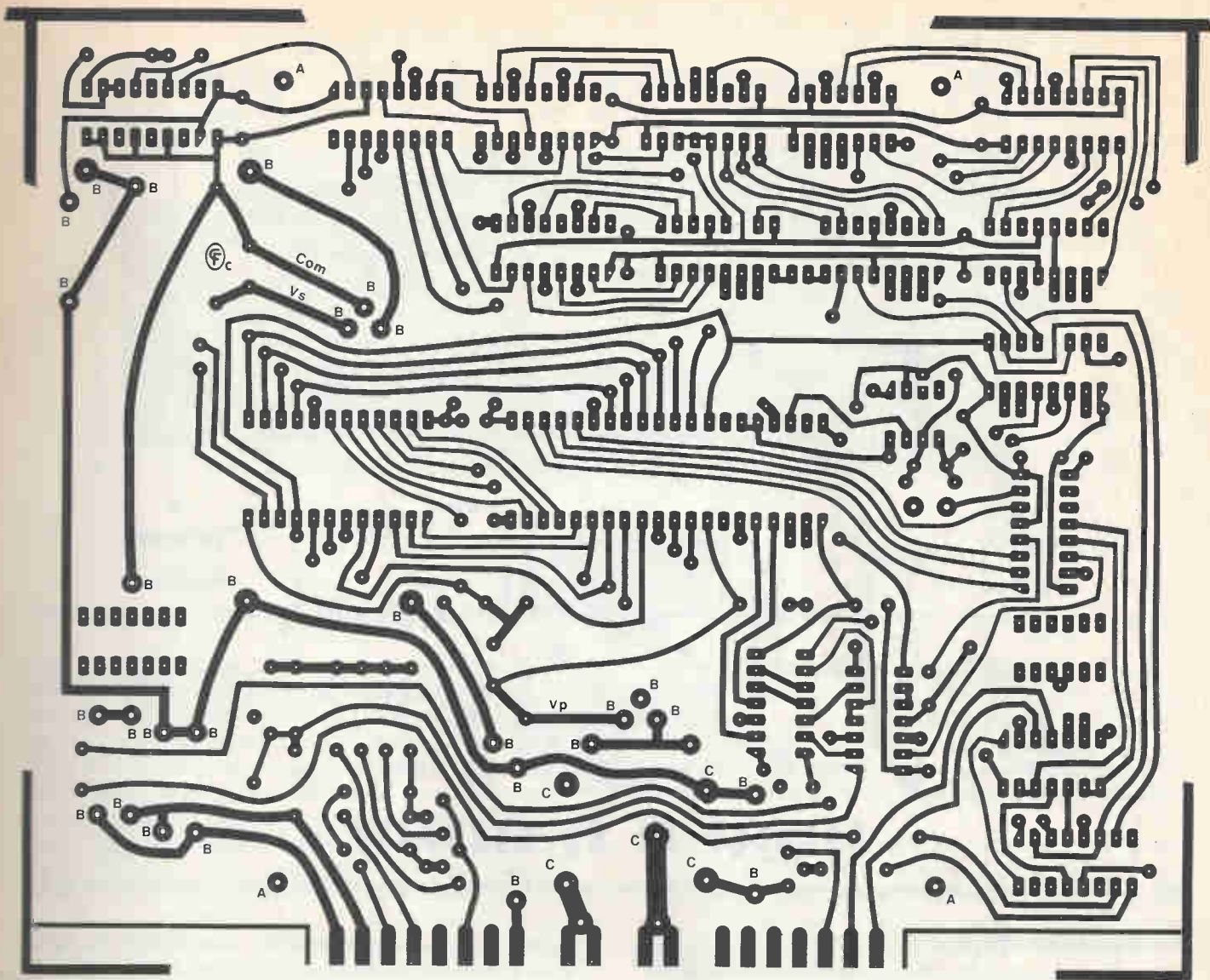

FIG. 10—MICROPROCESSOR printed-circuit board rear foil pattern shown same size.

circuit board slightly to fit the hole pattern. Mount the regulators as high as possible off the board and still make a good solder connection on the circuit side. Solder the pins to the component side also.

Install and solder the 4700- μ F capacitor with the positive end toward the top of the board.

Install and solder the relay.

Insert all the 74LSXXX IC's. Pin 1 must be located toward the notch as shown on the MicroPB component location drawing shown in Fig. 11.

Caution: CMOS (Complementary Metal Oxide Semiconductor) devices are susceptible to damage by static electricity due to their high input impedance. Handling of those devices should be kept to a minimum. DO NOT remove those devices from their conductive container until ready to install.

Insert the 4001 and 4011 first. Insert the 4050's, the 5369, the 4049 and 50240. Insert the EPROM and 6802 last.

Set the MicroPB aside for now.

MOUNTED ON THE MICROPROCESSOR BOARD are two +5-volt regulator chips that throw off heat. To prevent a dangerous heat buildup, a cap from a soda or beer bottle is bolted to the regulator chip and used to radiate heat into space.

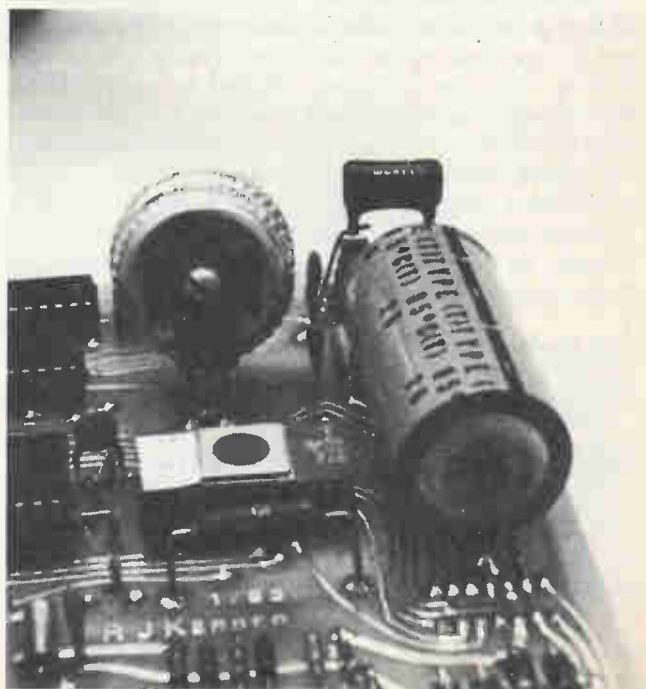

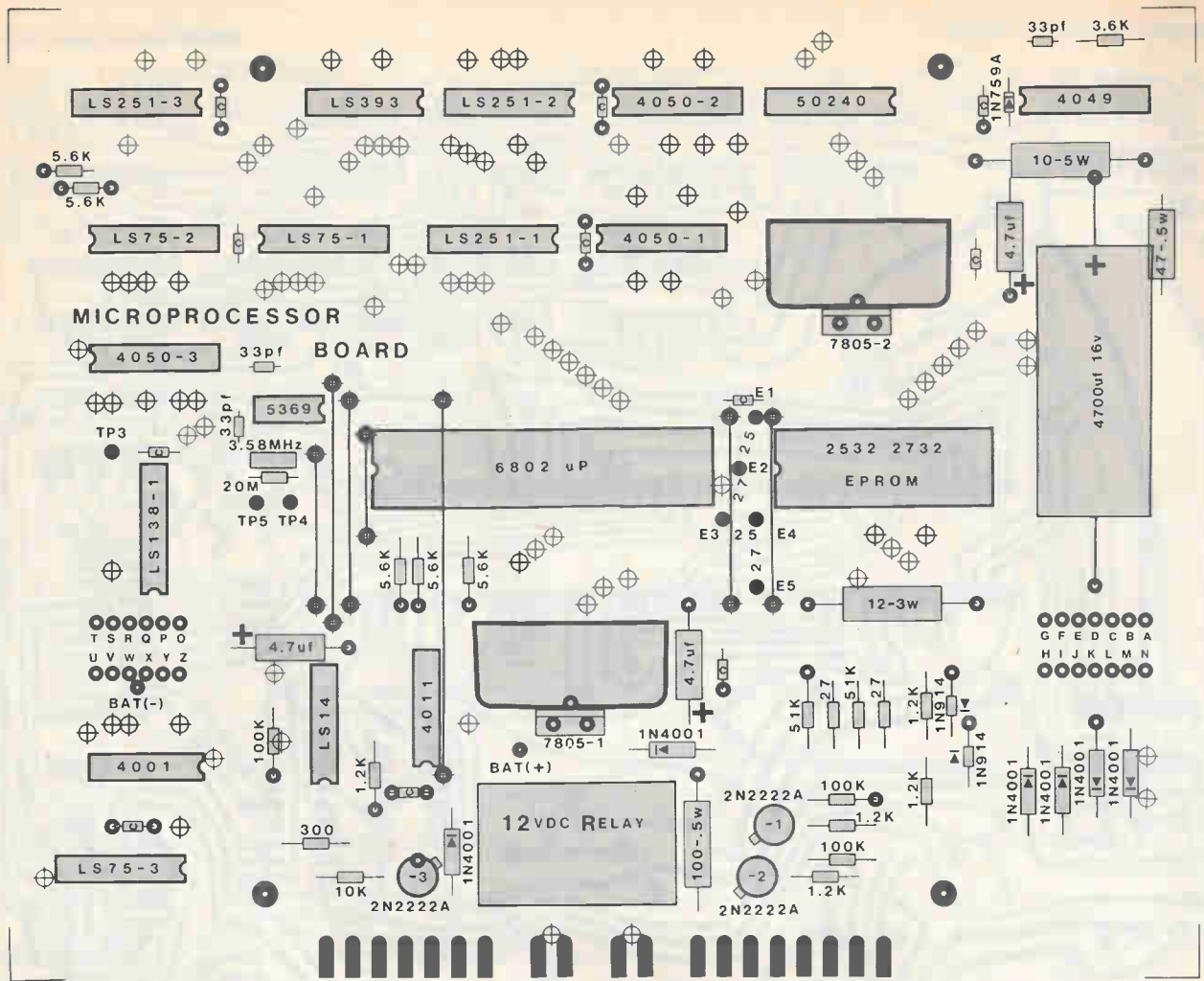

FIG. 11—MICROPROCESSOR printed-circuit board component location diagram. This illustration may be silk-screened on the surface of Fig. 9.

Enclosure Construction

Plexiglas has many of the same properties as wood. It can be drilled, can be cut on a table saw or jigsaw, and its edges can be sanded smooth. Its one drawback is that it can easily be scratched. Always leave the protective paper or other covering, on its surface until all holes are drilled and the edges are smoothed. Edges can be smoothed by using a fine metal file, then fine sandpaper, followed by emery cloth. Polish the edges by rubbing with a smooth piece of rubber, leather, or chammy. When protective covering is removed, wash in clear, cold water to remove plastic dust.

Important: If another bracket is used other than the one shown in Angle Bracket Drawing, the hole locations on the enclosure will need to be relocated accordingly.

Front Plate

The front plate uses 3/32-in. or 0.1-in. thick Plexiglas. Cut to size as shown on front plate drawing in Fig. 5. Earlier, it was mentioned how the DCP could be used for locating switch holes. Locate and drill a 1/16-in. pilot hole at the top two and bottom two #30 diameter holes. Drill the #30 (.1285-in. diameter) holes and include the 1/16-in. diameter holes predrilled by using the DCP as a drilling template. Drill all holes to their final size per front plate drawing.

On the component side of the DCB, mount four 5/8-in. threaded spacers: two at the middle A holes and two at the lower A holes, using a 1/4-in. screws.

The snooze pushbutton terminals need to be folded back upon themselves and a bare wire (a cut-off resistor lead will do) soldered to them. Mount the pushbutton to the front panel using the nut provided. Do not use the lockwasher.

The righthand rotary switch needs three terminals cut off. Position the switch over the hole pattern and cut off the appropriate pins. Cut the shaft off both rotary switches to 3/8-in. Install the two rotary switches and six toggle switches, but do not solder. The toggle switch terminals may have to be bent slightly to fit the hole pattern. Mount the front plate over the switches with the pushbutton wires going through the holes in the PC board. Adjust the height of the rotary switches so that the front plate sets evenly down on the 5/8-in. spacers. Secure the front plate to the top two spacers using a 1/4 screws. Secure the rotary switches to the front plate using one flat washer and nut. Make sure that the front plate sets down flush on the bottom spacers.

Solder the rotary switches to the circuit side. Solder the wires from the SNZ (snooze) button. Solder the six toggle switches, making sure that their height off the board is uniform. Remove the front plate from the DCB and remove the bottom two 5/8-in. spacers.

Label the switches as shown on the front plate drawing in Fig. 5. Press-type or Dymo labels work well. Set the front plate aside.

Base Plate

The base plate uses 3/16-in. thick Plexiglas. If different parts

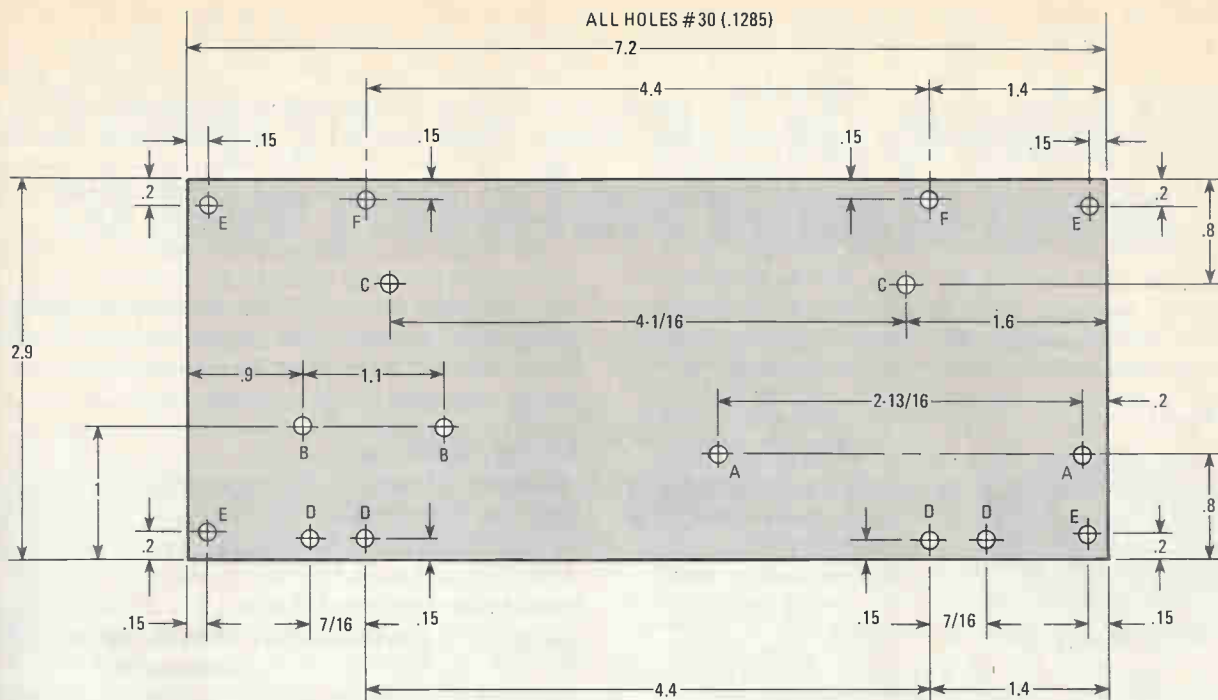

FIG. 12—BASE PLATE detailed diagram used to mount the outside surfaces and some parts of Kerber Klock III. Dimensions are in inches.

than specified in Parts List are used, the appropriate holes will have to be moved accordingly. Locate and drill all holes as shown on base drawing in Fig. 12. It is recommended that a $\frac{1}{16}$ -in. diameter drill be used first to make a pilot hole. Smooth the edges as described earlier, remove the protective covering, and wash. Mount four feet and four angle brackets from the bottom at E holes using a $\frac{5}{16}$ -in. screws. The long end of the angle bracket is between the rubber foot and the base, and extends out the sides to pick up the side panels. A #30 (.1285-in. diameter) drilled hole serves as a tap drill hole for a 6-32 screw; therefore, a nut and lockwasher are not necessary. Mount two angle brackets from bottom at F holes using two $\frac{1}{4}$ -in. screws. The long end of the angle bracket is mounted to the base and extends out the front to pick up the front panel.

Wire the edge-card connector—wiring diagram is given in Fig. 13. Split the strands of the #18 AWG wire so that half are soldered to pins 14 and R and the other half soldered to pins 13 and P. Do the same at pins 11 and M, and at pins 10 and L. The #22 AWG wires should be different colors. Mount the edge card connector, as shown, to the base using two $\frac{3}{4}$ -in. screws. Support the connector off the base using two $\frac{1}{4}$ -in. diameter \times $\frac{1}{4}$ -in. spacers.

Use the base and connector as a holding fixture while fastening the two circuit boards together. Insert the MicroPB into the edge card connector with the component side toward the back. Remove the second and fifth displays to allow access to two mounting holes. Using four $\frac{1}{2}$ screws, four nuts and four $\frac{1}{4}$ -in. \times $\frac{1}{4}$ -in. diameter spacers, secure the DCB to the MicroPB. The screws are inserted from the DCB side. The spacers are between the boards and the nuts are on the MicroPB side. Do not tighten until the board-to-board wires have been installed.

A $\frac{1}{4}$ -watt resistor lead is inserted through the DCB into the IC sockets on the circuit side of the MicroPB. Insert 14 wires on the left and 12 wires on the right. Make sure that the wires are inserted all the way into the sockets. Tighten the four screws. Solder the board-to-board wires on DCB component side and cut off excess wire. Unplug the two board assembly and set aside for now.

Mount two hinges from the bottom at D holes using a $\frac{3}{16}$ -in. screws. Mount with the hinge pin up. Mount the transformer on the top at A holes using $\frac{1}{4}$ -in. screws. The 120-VAC, 60-Hz primary winding is toward the hinges. The battery holder needs two $\frac{5}{32}$ -in. diameter holes drilled in its bottom to mount at B holes. Drill the holes on 1.1-in. centers as shown on enclosure wiring diagram in Fig. 14. Fit two $\frac{1}{4}$ -in. screws inside the coil springs and secure to base. Battery back-up is optional but is highly recommended. Install six AA Ni-Cd batteries making sure that they are mounted in the

REAR VIEW of Kerber Klock III prior to installing the printed-circuit assembly in its socket and assembly of the rear plate to the clock. Be careful when soldering. A dropped glob of solder will mar the plastic surface.



correct direction, as shown on the battery holder. Set the base aside for now.

Side Panels

The side panels use $\frac{3}{32}$ -in. or 0.1-in. thick Plexiglas. Locate and drill all holes as shown on side panel drawing in Fig. 15. A $\frac{1}{16}$ -in. diameter drill should be used first to make a pilot hole. Drill the #30 holes next and include the two volume-control holes. That will provide a pilot hole for the $\frac{3}{8}$ -in. diameter drill. Smooth the edges, remove the protective covering, and wash. Label the volume controls. Mount the volume control potentiometers from the back with the terminals positioned down. Set the side panels aside.

Back Panel

The back panel uses $\frac{3}{32}$ -in. or 0.1-in. thick Plexiglas. Location of mounting holes for the speaker will depend upon the speaker being used. An 8-ohm speaker with mounting ears is required. Its size should not exceed $3\frac{1}{2} \times 5$ in. or $3\frac{1}{2}$ in. square. Its depth should not exceed $1\frac{5}{8}$ in. and the center of the speaker must be located as shown to avoid interference with components mounted on the MicroPB.

Locate the speaker mounting holes on the back panel (Fig. 16) and drill four $\frac{3}{32}$ -in. diameter holes to agree with the mounting holes on the speaker. Standard perfboard is used as a speaker grill. Cut the perfboard $\frac{1}{8}$ -in. larger than speaker and drill a $\frac{3}{32}$ -in. diameter hole to agree with mounting holes on the speaker. It is recommended that rubber grommets be inserted in the speaker mounting holes. That will float the speaker, giving a more pleasant sound. The grommets should have an ID for a 6-32 screw. The mounting holes for the speaker may need to be enlarged for the grommets.

Cut a hole in the back panel to agree with the size of the speaker cone. Locate and drill two mounting holes and cut a

hole for the AC outlet. Locate and drill a $\frac{7}{16}$ -in. diameter hole for the panel-mounted fuse holder. The top and bottom of the hole must be filed; use a round file until the fuse holder fits. Locate and drill a $\frac{3}{16}$ -in. diameter hole for line cord strain relief. Locate and drill a #30 (.1285-in. diameter) hole at the remaining eight locations. Smooth the edges, remove the protective covering and wash. Label the AC outlet and fuse as shown in Fig. 16.

Mount the fuse holder with the side terminal UP. Install the line cord and strain relief. There should be at least 2 in. of line cord inside the case. Secure the back panel to the base using four $\frac{3}{16}$ -in. screws. The hinge should be inside the case. Mount the AC outlet from the outside, using two $\frac{1}{4}$ -in. screws. The speaker will be mounted later.

Enclosure Wiring

Refer to enclosure wiring diagram (Fig. 14). Connect and solder one lead of the AC line cord to the center terminal of the fuse. Connect, but do not solder, the other lead to the AC outlet. Connect and solder the remainder of the circuit illustrated in Fig. 14 using #18 wire.

Mount the speaker and perfboard to the back panel as shown in Fig. 16 using four $\frac{1}{2}$ screws and nuts. Connect and solder two #22 AWG wires from the connector to the speaker terminals. Route the remaining wires from the connector as shown and solder them to the volume controls. That completes the enclosure wiring.

Mount the right side to the base, using two $\frac{3}{16}$ -in. screws. Mount the left side to the base in the same manner. Mount two angle brackets from the inside at top two holes in the back panel. The long end of the brackets are secured with two $\frac{3}{16}$ -in. screws and extend outward to pick up the side panels. Before closing up the back panel, plug in the circuit boards and front plate assembly. Do not connect the 9-volt battery at this time.

The top panel uses $\frac{3}{32}$ -in. or 0.1-in. thick Plexiglas. Locate and drill all holes on top panel (Fig. 17). Smooth the edges, remove the protective covering and wash. Mount two angle
continued on page 96

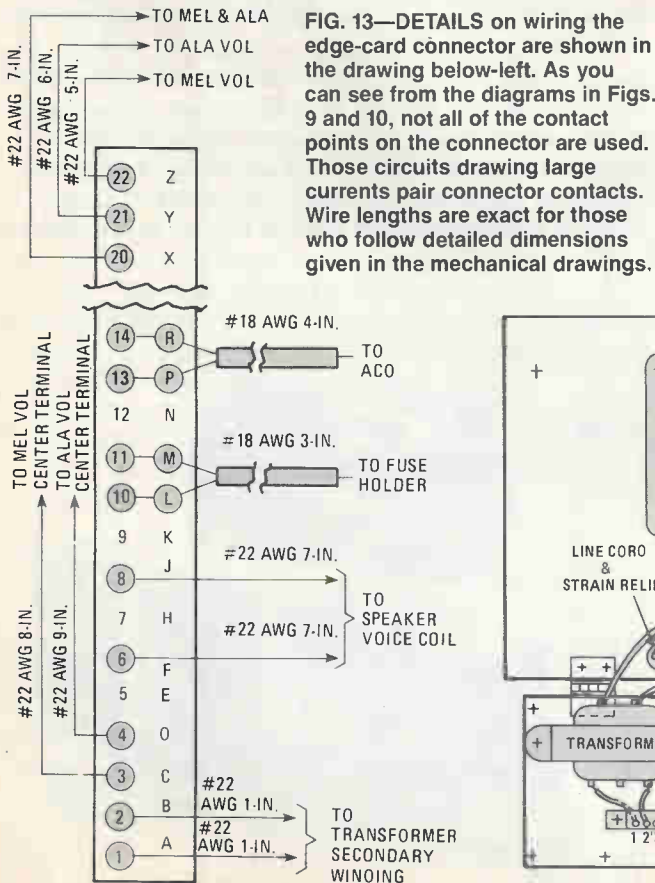
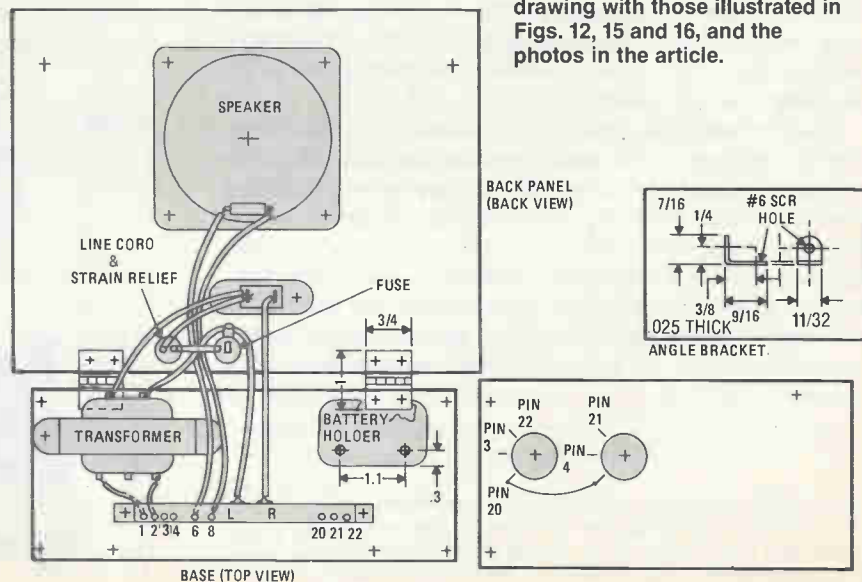

FIG. 13—DETAILS on wiring the edge-card connector are shown in the drawing below-left. As you can see from the diagrams in Figs. 9 and 10, not all of the contact points on the connector are used. Those circuits drawing large currents pair connector contacts. Wire lengths are exact for those who follow detailed dimensions given in the mechanical drawings.

FIG. 14—BACK PANEL connections to the base plate are detailed in the drawing below. Also, hookup of potentiometers on the right side is identified. Small inset drawing at the right provides dimensional information on the angle bracket used to assemble the clock.



Is a career in electronics right for you? To help you decide, CIE would like to give you a few simple facts.

FACT Electronics offers more career opportunities than almost any other field today.

Just look around you and you'll see that the new technology is the backbone of almost everything man does or will do. Industry, aerospace, business, medicine, science, government, communications - you name it. And the backbone of the new technology is electronics. Quite simply, few other fields, if any, offer more career opportunities, more job security, more room for advancement.

FACT CIE is the largest independent home study school specializing exclusively in electronics.

We're specialists in training electronics specialists, with a record that speaks for itself. According to a recent survey, 92% of CIE graduates are employed in electronics or a closely related field. And because our success record is our greatest strength, we'll do everything we can to help you succeed, too.

FACT We've been refining our teaching methods for 50 years.

We believe in independent study because it puts you in a classroom of one. So you can study where and when you want to. At your pace, not somebody else's. And over the years we've developed the proven approaches that give you the support such study demands. For example, our

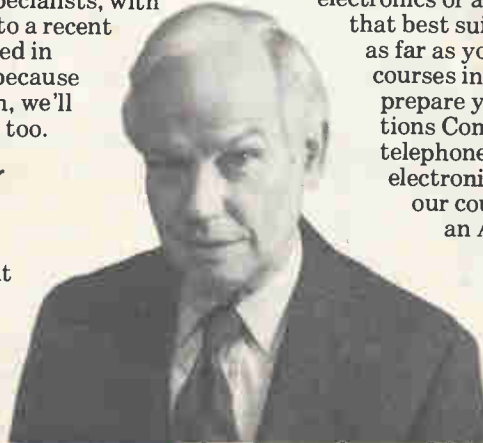

the theories of basic circuitry into practice. Other courses include equipment like a 5MHz triggered sweep, solid state oscilloscope and our Micro-processor Training Laboratory, with 512 bytes of random access memory, to let the advanced student apply digital technology in many of the same ways electronics professionals do.

FACT You can chart your own course.

CIE's broad range of entry, intermediate, and advanced level courses in a variety of career areas gives you many options, whether you know a little about electronics or a lot. You start with the Career Course that best suits your talents and interests and go as far as you want. More than half of CIE's courses include a series of optional lessons to prepare you to pass the Federal Communications Commission exam for an FCC Radio-telephone License - a requirement for some electronics jobs, a credential for all. And all of our courses can also advance you towards an Associate in Applied Science Degree in Electronics Engineering Technology from CIE.

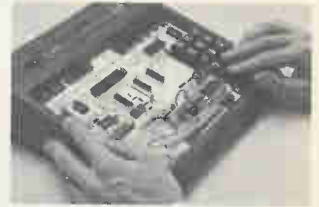

Get the facts for yourself.

If you're willing to work, we can help you towards a career in electronics as we have helped before you. But for yourself and t we offer against . Send today for ol catalog and kage of career in- ie information is d it will help you to start and how to go. Also, for nce, we'll try to representative o review the vari- al programs and se selection. Just age-paid card or ning the name and agazine. But please, **FREE** catalog nt to help you get rat's a fact!

Mail this postage-paid card today for

FREE SCHOOL CATALOG

Yes, please send me CIE's FREE school catalog, which will give me complete details on independent study with CIE.

Print Name _____

Address _____ Apt. _____

City _____ State _____ Zip _____

Age _____ Phone (area code) _____ / _____

Check box for G. I. Bill information Veteran Active Duty RE Special Projects RP-18

CIE Cleveland Institute of Electronics, Inc.
1776 East 17th Street, Cleveland, Ohio 44114

DETACH AND MAIL TODAY!

correct direction, as shown on the battery holder. Set the base aside for now.

Side Panels

The side panels use $\frac{3}{32}$ -in. or 0.1-in. thick Plexiglas. Locate and drill all holes as shown on side panel drawing in Fig. 15. A $\frac{1}{16}$ -in. diameter drill should be used first to make a pilot hole. Drill the #30 holes next and include the two volume-control holes. That will provide a pilot hole for the $\frac{3}{8}$ -in. diameter drill. Smooth the edges, remove the protective covering, and wash. Label the volume controls. Mount the volume control potentiometers from the back with the terminals positioned down. Set the side panels aside.

Back Panel

The back panel uses $\frac{3}{32}$ -in. or 0.1-in. thick Plexiglas. Location of mounting holes for the speaker will depend upon the speaker being used. An 8-ohm speaker with mounting ears is required. Its size should not exceed $3\frac{1}{2} \times 5$ in. or $3\frac{1}{2}$ in. square. Its depth should not exceed $1\frac{1}{8}$ in. and the center of the speaker must be located as shown to avoid interference with components mounted on the MicroPB.

Locate the speaker mounting holes on the back panel (Fig. 16) and drill four $\frac{5}{32}$ -in. diameter holes to agree with the mounting holes on the speaker. Standard perfboard is used as a speaker grill. Cut the perfboard $\frac{1}{8}$ -in. larger than speaker and drill a $\frac{5}{32}$ -in. diameter hole to agree with mounting holes on the speaker. It is recommended that rubber grommets be inserted in the speaker mounting holes. That will float the speaker, giving a more pleasant sound. The grommets should have an ID for a 6-32 screw. The mounting holes for the speaker may need to be enlarged for the grommets.

Cut a hole in the back panel to agree with the size of the speaker cone. Locate and drill two mounting holes and cut a

hole for the AC outlet. Locate and drill a $\frac{1}{16}$ -in. diameter hole for the panel-mounted fuse holder. The top and bottom of the hole must be filed; use a round file until the fuse holder fits. Locate and drill a $\frac{3}{16}$ -in. diameter hole for line cord strain relief. Locate and drill a #30 (.1285-in. diameter) hole at the remaining eight locations. Smooth the edges, remove the protective covering and wash. Label the AC outlet and fuse as shown in Fig. 16.

Mount the fuse holder with the side terminal UP. Install the line cord and strain relief. There should be at least 2 in. of line cord inside the case. Secure the back panel to the base using four $\frac{3}{16}$ -in. screws. The hinge should be inside the case. Mount the AC outlet from the outside, using two $\frac{1}{4}$ -in. screws. The speaker will be mounted later.

Enclosure Wiring

Refer to enclosure wiring diagram (Fig. 14). Connect and solder one lead of the AC line cord to the center terminal of the fuse. Connect, but do not solder, the other lead to the AC outlet. Connect and solder the remainder of the circuit illustrated in Fig. 14 using #18 wire.

Mount the speaker and perfboard to the back panel as shown in Fig. 16 using four $\frac{1}{2}$ screws and nuts. Connect and solder two #22 AWG wires from the connector to the speaker terminals. Route the remaining wires from the connector as shown and solder them to the volume controls. That completes the enclosure wiring.

Mount the right side to the base, using two $\frac{3}{16}$ -in. screws. Mount the left side to the base in the same manner. Mount two angle brackets from the inside at top two holes in the back panel. The long end of the brackets are secured with two $\frac{3}{16}$ -in. screws and extend outward to pick up the side panels. Before closing up the back panel, plug in the circuit boards and front plate assembly. Do not connect the 9-volt battery at this time.

The top panel uses $\frac{3}{32}$ -in. or 0.1-in. thick Plexiglas. Locate and drill all holes on top panel (Fig. 17). Smooth the edges, remove the protective covering and wash. Mount two angle
continued on page 96

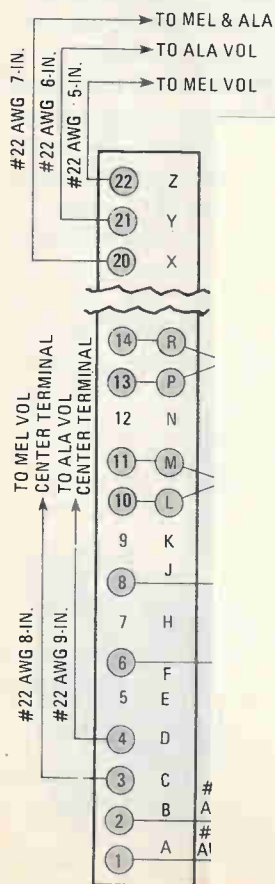

FIG. 13—DETAILS on wiring the edge-card connector are shown in the drawing below-left. As you can see from the diagrams in Figs.



NO POSTAGE
NECESSARY
IF MAILED
IN THE
UNITED STATES

BUSINESS REPLY CARD

FIRST CLASS PERMIT NO. 8685 CLEVELAND, OHIO

POSTAGE WILL BE PAID BY ADDRESSEE

CIE

Cleveland Institute of Electronics, Inc.

1776 East 17th Street
Cleveland, Ohio 44114



Is a career in electronics right for you? To help you decide, CIE would like to give you a few simple facts.

FACT Electronics offers more career opportunities than almost any other field today.

Just look around you and you'll see that the new technology is the backbone of almost everything man does or will do. Industry, aerospace, business, medicine, science, government, communications - you name it. And the backbone of the new technology is electronics. Quite simply, few other fields, if any, offer more career opportunities, more job security, more room for advancement.

FACT CIE is the largest independent home study school specializing exclusively in electronics.

We're specialists in training electronics specialists, with a record that speaks for itself. According to a recent survey, 92% of CIE graduates are employed in electronics or a closely related field. And because our success record is our greatest strength, we'll do everything we can to help you succeed, too.

FACT We've been refining our teaching methods for 50 years.

We believe in independent study because it puts you in a classroom of one. So you can study where and when you want to. At your pace, not somebody else's. And over the years we've developed the proven approaches that give you the support such study demands. For example, our Auto-Programmed® lessons are carefully designed by specialists to present topics in a clear, logical, step-by-step sequence. Your lessons are graded and mailed back promptly with appropriate instructional help for instant learning reinforcement. And our experts are always ready to respond in writing whenever you have a question or problem.

FACT We teach you theory backed with practical hands-on training.

To bring textbook theory alive, many of our courses let you work with the actual tools of the trade. CIE's Personal Training Laboratory, part of several career courses, helps you put

the theories of basic circuitry into practice. Other courses include equipment like a 5MHz triggered sweep, solid state oscilloscope and our Micro-processor Training Laboratory, with 512 bytes of random access memory, to let the advanced student apply digital technology in many of the same ways electronics professionals do.

FACT You can chart your own course.

CIE's broad range of entry, intermediate, and advanced level courses in a variety of career areas

gives you many options, whether you know a little about electronics or a lot. You start with the Career Course that best suits your talents and interests and go as far as you want. More than half of CIE's courses include a series of optional lessons to prepare you to pass the Federal Communications Commission exam for an FCC Radio-telephone License - a requirement for some electronics jobs, a credential for all. And all of our courses can also advance you towards an Associate in Applied Science Degree in Electronics Engineering Technology from CIE.

Get the facts for yourself.

If you're willing to work, we can help you towards a career in electronics as we have helped many others before you. But get the facts for yourself and compare what we offer against other schools. Send today for our CIE school catalog and complete package of career information. The information is all **FREE**, and it will help you decide where to start and how far you want to go. Also, for your convenience, we'll try to have a school representative contact you to review the various educational programs and assist in course selection. Just mail the postage-paid card or write, mentioning the name and date of this magazine. But please, send for your **FREE** catalog today. We want to help you get ahead. And that's a fact!

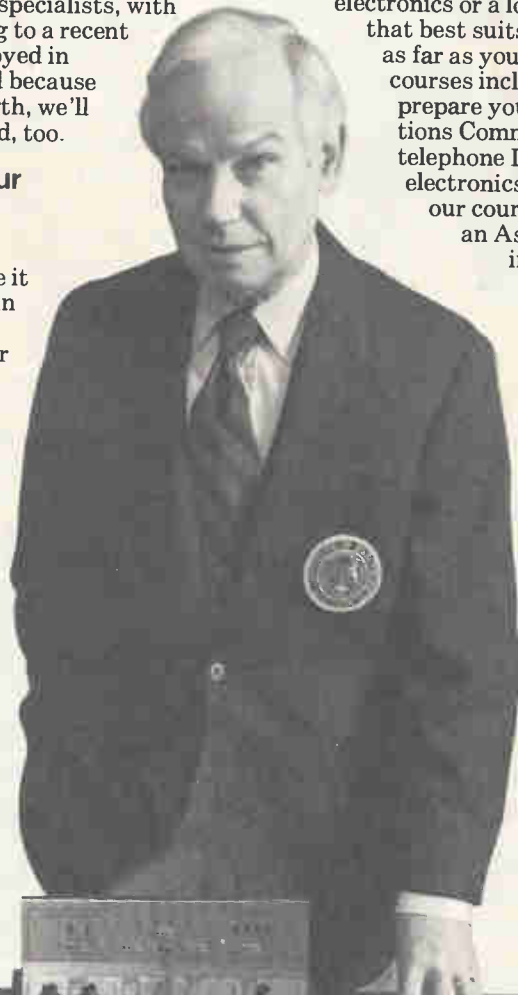

RP-17

CIE Cleveland Institute of Electronics, Inc.
1776 East 17th Street, Cleveland, Ohio 44114
Accredited School National Home Study Council

BURN, BABY,

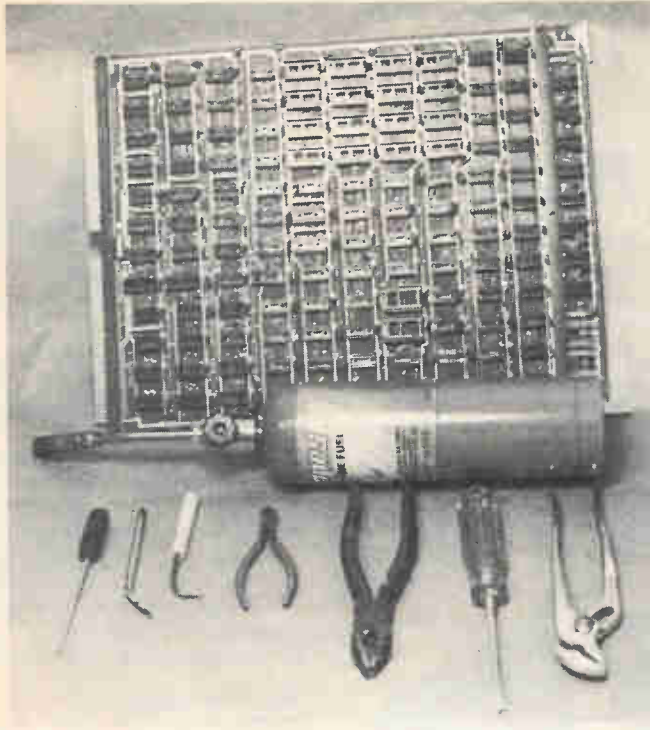

There's gold in those surplus circuit boards! All you have to do is find a practical way to pan for those IC's.

D. E. PATRICK

□ IF YOU'RE AN ELECTRONICS EXPERIMENTER OR TECHNICIAN working on a limited budget, then this article's for you. Using an ordinary propane torch, you can remove IC's from cheap surplus circuit-boards and reuse them for as little as 1 to 2 cents per chip. That's a lot better than paying around 20 cents to several dollars for TTL, LSTTL, and CMOS, and you can really make out stripping microprocessor and memory surplus boards.

Further, considering the high cost of other components such as tantalum caps, transistors, precision resistors, potentiometers, and other parts, you can see that selective

shopping and burning is one way to really cut costs. Also, obtaining components from circuit boards by burning them out offers other advantages.

Many manufacturers run pre-tests on integrated-circuit chips and other components before using them, especially on MILSPEC parts, dumping the fallouts and installing the goodies. Then, there are a myriad of quality assurance tests, not to mention the fact that the circuit boards are usually pulled out of good working equipment and discarded with all the parts in 100 percent working order.

Going further

Now, when you're after components, desoldering individual leads or using a fancy multi-pin desoldering attachment on your soldering iron is the wrong way to go! Here are some good reasons!

First, where your main interest is getting cheap components, not repairing or salvaging a board, you're not interested in what happens to the board and more interested in a speedy way of going about removing the components without damaging them.

Second, although it might not look like it, you actually stand a better chance of overheating an IC with a soldering iron applied to individual leads than going after it with a torch, especially in multi-layered boards. You can see this more clearly by reviewing how boards are put together:

(1) The components are placed on the board. (2) The pin side is floated over a hot liquid flux. (3) The board is floated over solder so the bottom side just touches or solder is *slapped* at the board using a slap-solder machine. (4) The board is generally liquid cooled, albeit air cooling can also be used. (5) The board is cleaned by Freon or some type of fluorinated or chlorinated hydrocarbon.

So we can see that using a torch on IC's and other components for a few seconds is actually the reverse of the way the board was put together in the first place. If done correctly the process will actually expose a multi-pin component like an IC to less heat over time than going at individual pins, waiting for the solder to melt at each pin and using a solder sucker or braided wick.

The Methods of Burning

There are two basic ways to burn a circuit board, the *Burn & Slap Method* and the *Burn & Jimmy Method*. Each has its own advantages and disadvantages.

The *Burn & Slap Method* is the easiest, fastest, and sloppiest. It can be used where components are just placed on the board as opposed to having one or more bent pins to hold IC's, sockets, etc. on the board. Also, this method allows the use of the widest torch flame, where almost any standard propane torch will do.

BURN!

Using the burn & slap method, you simply heat up sections of the board, starting at the bottom farthest from your hand. (That makes sense!) Then sweeping the flame back and forth about the width of 3 to 6 IC's, slap an unheated portion of the board against a tabletop. Doing approximately half the board from farthest edge in and working from bottom to top preheats the components mounted above. Thus, things get easier as you move along. When finished one half the board, you can let it air cool and move on to the next board, stick it in a tub of water, or if you've got gloves, simply turn it around and finish it off.

When the board is slammed on the edge of a table, an elastic collision takes place. It hits the table and rebounds backwards, then back into the table, something like plucking a violin string or tuning fork which is highly damped. But the components which have been loosened by the torch are not restrained by the table and the momentum created by slamming the board into the table causes them to literally fly off. Twenty-five large boards and 50 small boards per hour can be done in this manner once you've got the hang of it.

However, there are some drawbacks. When IC's, sockets, etc. let fly, the liquified solder from the board, especially on double sided boards, also goes along for the ride. So wear some old protective clothing, goggles, and work in an area that won't get messed up. Don't try this method on the kitchen table or over a good rug. Further, the IC's and sockets may need to be cleaned up and pins straightened once they're removed. For the clean-up use a little wire brush and your soldering iron. The pins may be straightened, although this is seldom necessary, with a pair of long-nose pliers and/or pin straightener.

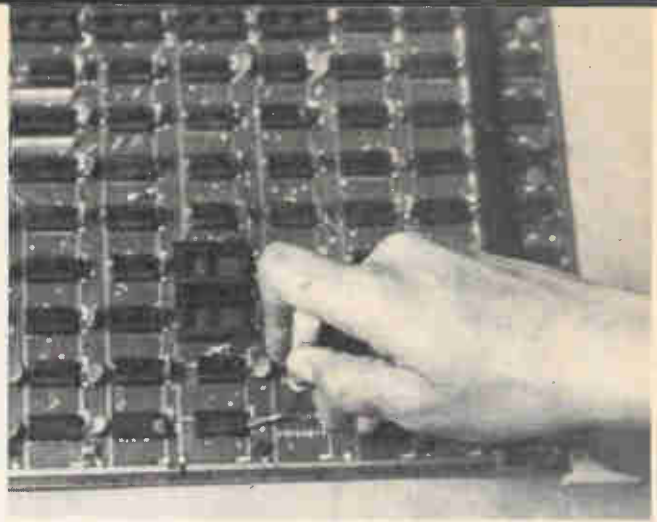

HERE'S THE HARD WAY of removing an integrated-circuit chip from a PC board. As one hand pries the IC from the board, a second hand (not seen) holds a soldering iron that applies heat to the pins. This chip doesn't stand a ghost of a chance to survive the scorching ordeal!

Burn & Jimmy

The *Burn & Jimmy Method* takes a little more work and is slower, but cleaner. It can be used where components are just placed on the board or where pins are bent over. Instead of heating large sections of a circuit board, specific components or groups of components are heated. Therefore, a smaller flame displacement is required.

The circuit board is fixed in place by a vice instead of being whacked into a table. And generally a pair of pliers, channel locks, or vice grips are used to pull the IC's or components off the board. But solder will still fly because when the IC or component frees itself, the board will rebound backwards, usually throwing out some molten solder in the process. However, this is still a cleaner way to go.

In the case of some parts, especially large IC's and sockets, the use of a small awl and/or screwdriver to pry them off

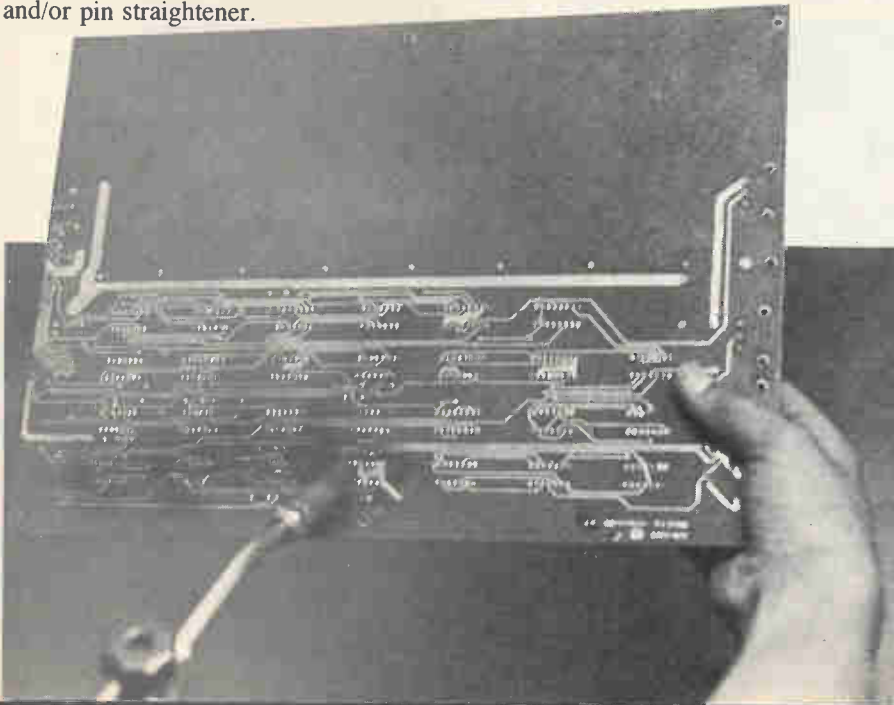

THE BURN & SLAP METHOD produces the most chips for your effort-time! After slapping out your second batch of chips from your first board, you are certified as an expert. Remember, just use a minimum amount of heat from the torch to soften the solder—then "wham!" The slap motion is all in the wrist. Do not slap one batch of IC's over the previous released batch because the flying solder will only foul the pins of the freed chips.

THESE are the kind of tools you should not carry with you at night lest the local law enforcer mistake your occupation. Except for the torch, almost everyone who assembles projects has those tools. The torch is a good investment and an excellent tool to have around the house.



will work better. Where numerous pins are bent over, a rarity these days, it may be necessary to straighten the pins with you soldering iron to avoid breakage. Avoid these boards by selection where possible. Also, if you have a problem with large arrays, IC's or sockets, you should go at one side at a time with an awl or small screwdriver. In any case, start at the bottom of the board and work up as outlined in the Burn & Slap Method.

The Do's and Don'ts of Burning

Having discussed the whys and methods of burning, let's take a look at the do's and don'ts.

DO use a propane torch with a moderate-size flame for the *Burn & Slap Method* and a fine flame for the *Burn & Jimmy Method*. If necessary change the orifice to suit your needs in an existing torch.

DON'T use non-oxygenated acetylene which gives a dirty burn, or oxygenated propane or acetylene which is just too hot.

DO wear goggles and old protective clothing to guard against solder splatter.

Do work in an area where solder splashes won't do any damage.

DO work in a well ventilated area. When a PC board is exposed to high temperatures, it will release some pretty mean gases, so make sure the area is well ventilated, such as outside and downwind from smoke and emitted gases.

Final Caution

Some boards and the plastics on them will give off hydrogen chloride which ends up as hydrochloric acid when mixed with the moisture in your lungs. Further, it is possible to get hydrogen cyanide gas and hydrogen sulfide gas, all of which will make the cause of death hard to fix for the coroner when inhaled in sufficient quantities. Do the coroner a favor and don't kill yourself. Burn your boards downwind and outside for the safest way to go. Indoors, always use a vent fan where you can feel the hairs on your arms moving in the breeze.

Also, when you work with fire, keep a fire extinguisher nearby, or a bucket of water. When the job is finished, clean up carefully, removing all the loose solder which can scratch your skin.

SP

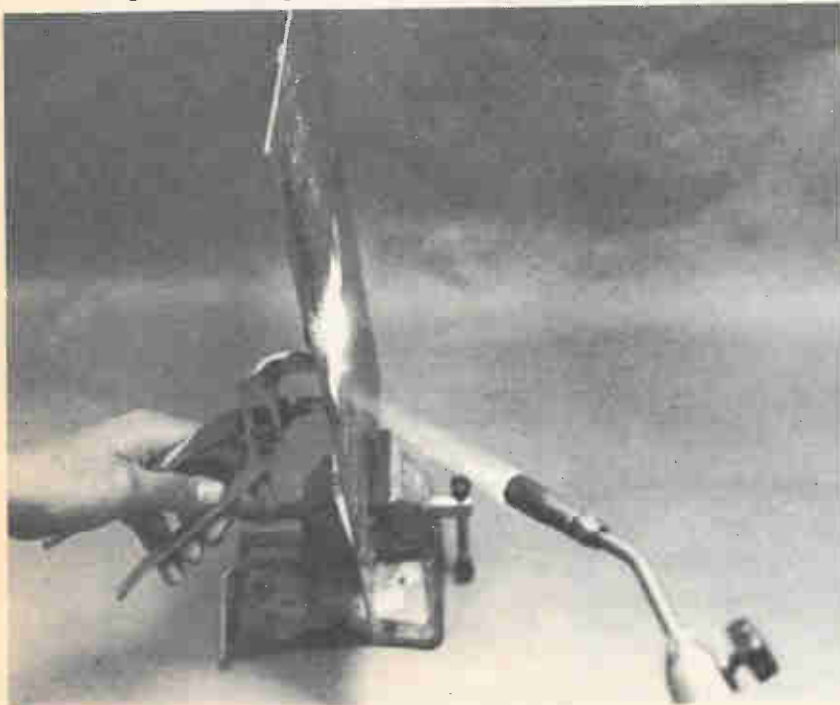

THE BURN & JIMMY METHOD has its limitations but can be used when necessary. In the photo, a selected integrated-circuit chip is being removed from the board. Bent pins on a valuable chip have eliminated the use of the Burn & Slap technique. Should you have a chip-grabbing tool especially designed for the task, use it in place of the Channel-Lock pliers. Try to pinpoint the flame to those pins that will be removed. Try not to heat up pins from adjacent chips and other expensive circuit parts.

DESKTOP SHORTWAVE ANTENNA



With a short length of wire, this broadband preamplifier pulls in 3-30 MHz

STAN GIBILISCO

FOR VARIOUS REASONS, THE SHORTWAVE LISTENER SOMETIMES cannot put up a large outdoor antenna. There are many possible reasons why it may not be feasible to install a long-wire antenna. (For example, the landlord may forbid it, and others in the household may frown on the idea of hanging unsightly wires across the living room.) Not everybody shares the interest an SWL'er has in listening to the wide, wide world of shortwave communications. Also, it is not always practical to climb a tree or send up a captive balloon with a few hundred feet of wire! Here's a simple, practical alternative to stringing a long-wire antenna.

The Desktop Shortwave Antenna is a broadband, radio-frequency peamplifier that allows a short length of wire, or a small whip antenna, to perform as a shortwave antenna in the high-frequency range 3 to 30 MHz. The Desktop Shortwave Antenna uses a single dual-gate MOSFET (Metal-Oxide Semiconductor Field-Effect Transistor) as an RF amplifier stage in a broadband configuration, and a bipolar emitter-follower for matching the high-output impedance of the MOSFET to the 50-ohm unbalanced input of most shortwave radio receivers. The circuit is shown schematically in Fig. 1. The circuit is straightforward without any tricky applications. A high-pass filter consisting of L1 and C1, which has a theoretical cutoff frequency at about 5 MHz, provides attenuation on signals from the standard broadcast band (which can cause overloading), while not greatly degrading the gain between 3 and 5 MHz. If the broadcast band were not dropped out, its strong local signals would swamp out all others by overloading the circuit.

All of the components, with the possible exception of the dual-gate MOSFET Q1, may be obtained from local parts distributors. The Desktop Shortwave Antenna is housed in a

plastic enclosure using an aluminum cover measuring $4\frac{7}{16} \times 2\frac{7}{16} \times 1\frac{1}{16}$ -in. The Desktop Shortwave Antenna requires one 9-volt transistor-type battery for power. A section of single-

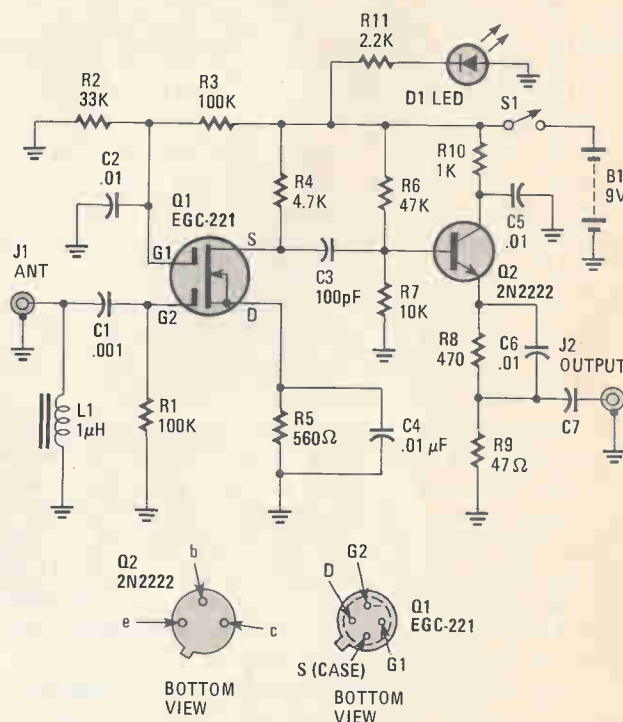

FIG. 1—SCHEMATIC DIAGRAM of the dual-gate MOSFET preamplifier we call the Desktop Shortwave Antenna. The bipolar transistor provides matching for 50-ohm antenna circuits.

sided experimenter PC board, available at Radio Shack (see Parts List), is used to mount parts and provide the foil surfaces to make circuit connections.

Initial Construction

The first step in building the Desktop Shortwave Antenna involves drilling the holes in the plastic case and cutting the circuit board to fit inside the case. Fig. 2 shows cabinet-hole locations and sizes for the front and back panels. The PC board has drilled holes located by a crosshatch identification system labeled A through T and 1 through 20. Refer to Fig. 3. Cut the board right along the 13th row of holes, either using a hacksaw and vise, or by first nicking the board on both sides with a sharp knife and then carefully breaking it. File the edge with an emery board or fine sandpaper. For easy reference in locating component mounting positions, you may want to attach a piece of paper to the non-foil side of the board, punch through all the holes with a sharp instrument, and label them A through T and 14 through 20 as shown in the component-layout diagram (Fig. 3).

Before mounting the components on the PC board, be certain that the board will fit into the larger (rear) part of the plastic cabinet, with enough clearance on the lower side for the 9-volt battery to lie flat against the cabinet floor in its holder.

Component mounting

The first items to be soldered on the experimenter board are power switch S1, light-emitting diode power indicator LED1, RF coil L1, resistor R2, and capacitor C2. Those components should go on the foil side of the board; all other items are mounted on the non-foil side.

Solder the switch S1 to the board by cutting the lugs off to about 1/10th-in., tinning them and the PC-board foil heavily with solder, and then heating the connections with a small-tip soldering iron as you hold the switch against the board. That assures a mechanically as well as electrically strong bond. Solder R2 and C2 so they are as close to the board as possible without the leads shorting against the foil. Cut the leads of the LED to 1/2 inch and push the leads through the circuit-board holes so that the ends are just flush with the non-foil side of the board; pay attention to the polarity of LED1—then solder.

Inductor L1 is a 10- μ H RF choke (Radio Shack part 273-101) that must be modified. Cut the enameled wire carefully away from one of the leads, and unwind the coil until one-third of the turns are left. Move the remaining turns so that they are more or less equally spaced along the ferrite material. Then cut and scrape the wire and solder it back to the axial lead. That reduces the coil inductance to about 1 μ H. Solder the coil to the foil side of the PC board as shown in Fig. 3. Keep it as close to the board as possible without causing short circuits with R2 and C2.

The remainder of the components should be mounted on the non-foil side of the board. Mount all resistors first, in vertical fashion, and keep their extension above the board to an absolute minimum by bending the top leads around tightly and pushing the resistors down as far as they will go to the board's surface. Mount the capacitors next, and finally the transistors, keeping them, too, down close to the PC board. Jumper wires, of course, present no problem in that respect; just put them flat against the board.

A note of caution about MOSFET Q1: Those devices are highly susceptible to damage by static electricity. If you live in a cold climate, and it's January, and you have shag carpeting and hard-soled shoes, you'd better take precautions to minimize the possibility of static discharge when handling

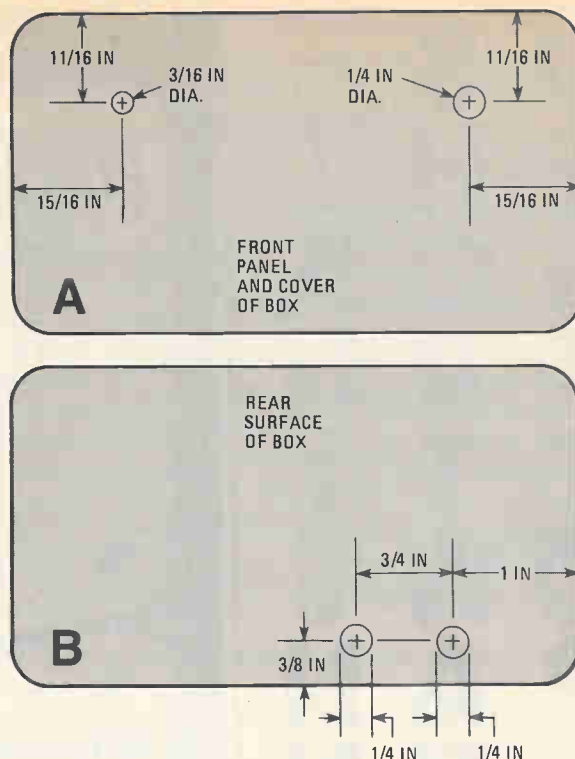

FIG. 2—HOLE-DRILLING LAYOUT for plastic cabinet specified in text. At A, the front panel; at B, the rear panel. The cabinet is Radio Shack part 270-221.

PART LIST FOR DESKTOP SHORTWAVE ANTENNA

SEMICONDUCTORS

- LED1—Jumbo light-emitting diode, red (Radio Shack 270-221, or equivalent)
- Q1—Dual-gate MOSFET, GE FET-4, Sylvania ECG-221, Japanese 3SK63GR, or equivalent
- Q2—2N2222 NPN bioplar transistor, or equivalent

RESISTORS

- (All resistors are fixed, 1/4-watt, 5% or 10%)
- R1, R3—100,000-ohm
- R2—33,000-ohm
- R4—4,700-ohm
- R5—560-ohm
- R6—47,000-ohm
- R7—10,000-ohm
- R8—470-ohm
- R9—47-ohm
- R10—1,000-ohm
- R11—2,200-ohm

CAPACITORS

- (All capacitors disk ceramic type)
- C1—.001- μ F
- C2, C4-C7—.01- μ F
- C3—100-pF

ADDITIONAL PARTS AND MATERIALS

- B1—9-volt transistor-radio battery
- J1, J2—RCA phono jacks
- L1—1- μ H, RF coil (Radio Shack 273-101, or equivalent)
- S1—SPST toggle switch
- Battery holder (9V transistor), battery-clip connector, cabinet (Radio Shack part 270-221), circuit board (Radio Shack part 276-160, or equivalent), phono cord, hardware, wire, solder, etc.

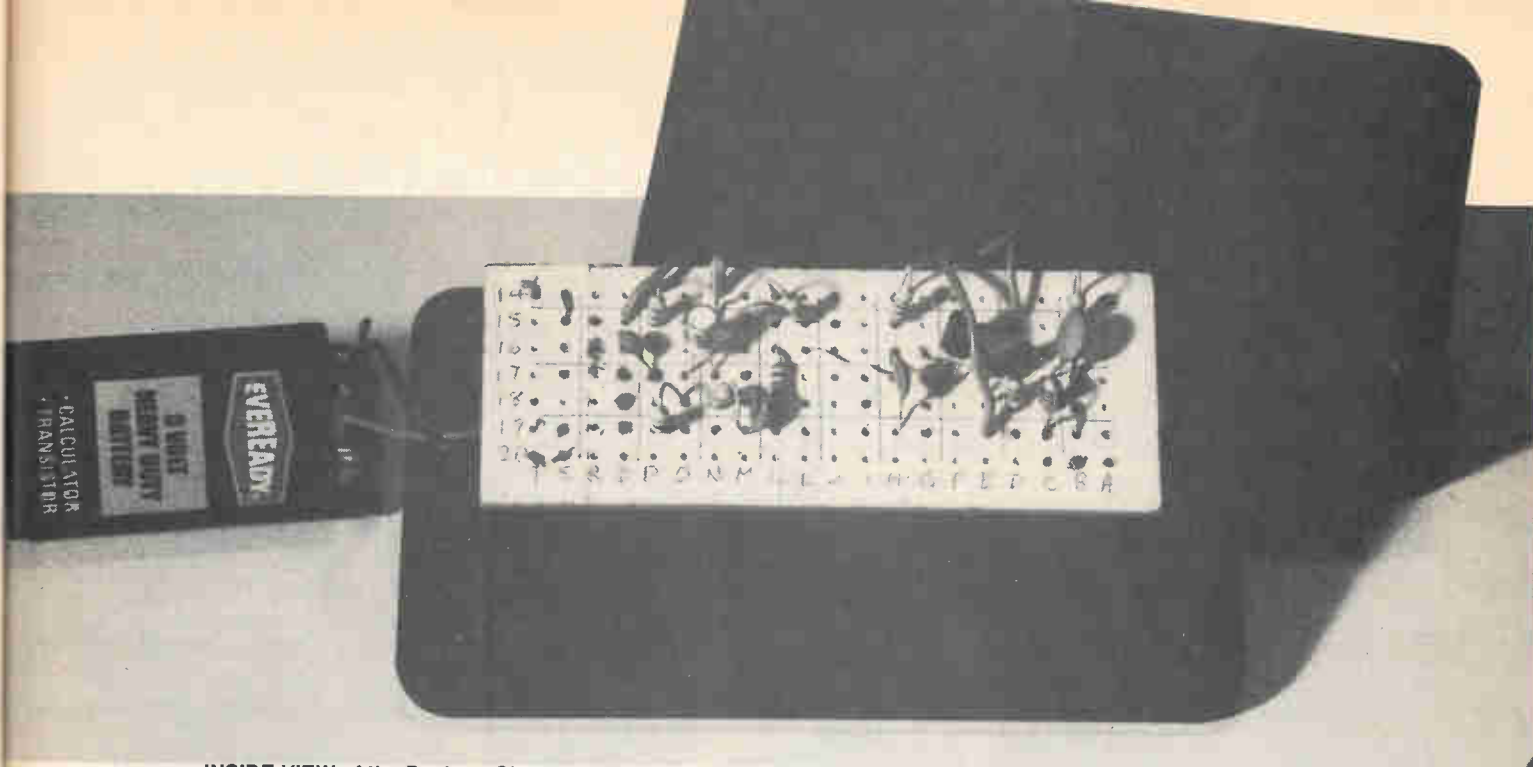

INSIDE VIEW of the Desktop Shortwave Antenna showing the PC board and components. White paper may be glued to the board (non-foil side) for marking of hole rows and columns for rapid identification of the hole positions.

the circuit. The above example is not as extreme as it may sound! Actually, you should *always* take preventive measures when handling circuits with MOSFET devices.

Final Assembly

The lead wires for the antenna and receiver phono pin jacks (J1 and J2) should be mounted last. Cut them to about 2 inches. Use stranded, insulated #22 or #24 wire. Mount the 9-volt battery holder at this time as well. A common ground lead is used for both the antenna (input) and receiver (output) terminals; it may be soldered to either phono pin jack ground lug, and the two ground lugs turned toward each other and joined with a short bit of wire and solder.

Place the front panel over switch S1 and LED1, after first removing all the nuts and washers from the switch shaft. The foil side of the circuit board will then face the front panel, and the component side will face away. Screw down the switch; you may also secure LED1 to the front panel with a little glue—but wait until you've tested the circuit! Looking at the module from the front, the antenna and receiver jacks should be at the lower left of the rear cabinet. Connect the 9-volt battery; if should be placed flat (broadside) against the bottom of the cabinet at lower right, its terminals facing toward the right.

If the front panel won't go all the way down into the rear cabinet, it might be because some components are sticking up too far from the non-foil side of the PC board. Or perhaps the holes in the front panel aren't exactly positioned right. The first problem is corrected simply by finding the guilty components and mounting them more tightly. The latter hang-up may be alleviated by carefully clipping off about 1/20 inch of PC board on the three edges corresponding to row 20 and columns A and T. Use a diagonal cutter.

After you are sure that the unit fits nicely together, screw down the front panel. Be sure that there are no internal short circuits. The 9-volt battery case and the two RCA phono jacks, J1 and J2, are the most likely culprits in that case. Do not force the case together if it is difficult to close. Be sure that all the screws (the switch and jacks) are tight. Now you're ready to test the circuit.

Operation Check

Solder a 24-inch length of wire to a male RCA phono plug and attach it to the antenna input jack J1 of the Desktop Antenna. With a shielded cable, connect the output of the preamplifier to the 50-ohm input terminals of your shortwave receiver. (If your receiver input impedance is not 50 ohms, don't despair; a minor circuit change will provide the right

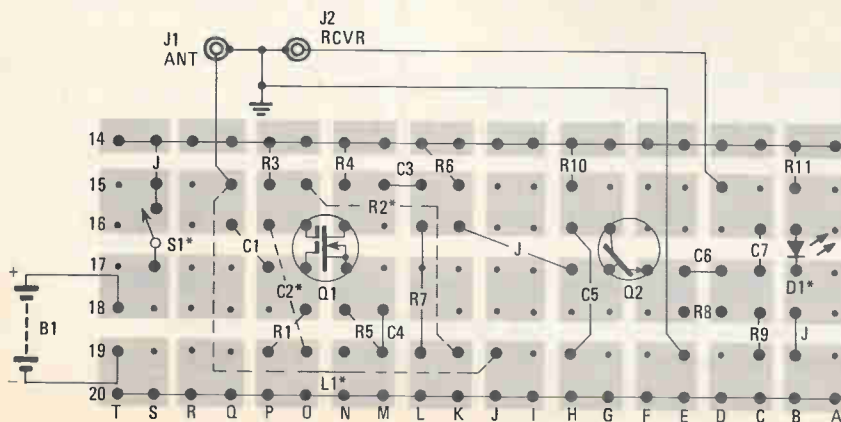

FIG. 3—COMPONENT LAYOUT on experimenter PC board. An asterisk indicates that the component is to be mounted on the foil side of the board. All others mount on the non-foil side. This view is from the non-foil side with the foil shown as an X-ray view. If you cannot obtain this particular board, use any perfboard with an .1-inch hole array and hard solder leads.

matching. We'll discuss that soon.)

Switch on the amplifier and tune the receiver to about 10 MHz. You should receive signals at that wavelength whether it is day or night. If you hear no signals, try tuning up a few MHz if it's daytime, or down a few MHz if it's nighttime.

If you still hear no signals, connect a length of wire about 16 feet long to the receiver antenna terminals directly. That should tell you whether your receiver is at fault, or if it's the preamplifier. (It might be a solar flare causing total deterioration of shortwave propagation, but that is rare.)

If the preamplifier doesn't work, you will have to troubleshoot it. Check the battery first! Then check for wiring errors and omissions, solder bridges, internal short circuits, and open connections. You may have a defective component, too (were you careful with the MOSFET?) and to find it, you have to replace them individually unless you happen to have access to a full laboratory of test equipment. But the circuit is quite simple, and the problem shouldn't be hard to locate.

With the preamplifier working, you then check to be sure that there are no birdies caused by overloading from an unusually strong local signal. A nearby AM broadcast station might cause that to occur. The emitter follower stage, in the presence of an extremely strong signal, becomes nonlinear and produces all kinds of intermodulation garbage. The high-pass filter (L1-C1) at the input of the MOSFET stage should eliminate powerful AM broadcast energy in all but the worst situations.

Tune above 20 MHz at night, especially in the ham bands at 21.000 to 21.450 MHz and 28.000 to 29.700 MHz. If you hear numerous signals that sound like AM broadcast, you probably are in the near field of a standard broadcast station. In the rare event that you have that problem, additional filtering will be needed at the antenna input of the preamplifier. Listen to the station and determine its call letters; they are broadcast on the hour, and some stations fall in love with their call signs announcing them every five minutes or less. Knowing the station's frequency, a trap circuit may be built using a 10- μ H inductor and a capacitor connected as shown in Fig. 4. For 10 μ H of inductance, the required capacitance in pF is given by

$$C = 2550/f^2,$$

where f is the frequency of the offending station in MHz.

You may position the short, wire antenna just about anywhere, as long as it is not next to anything metallic. It may be left to hang down behind the table, or it can be tacked onto the rear edge of a wooden desktop. While that antenna should

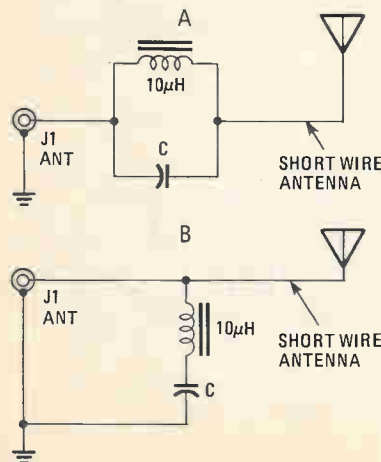

FIG. 4—HERE ARE two antenna trap circuits for eliminating interference from strong local signals. At A, parallel tuned; at B, series tuned.

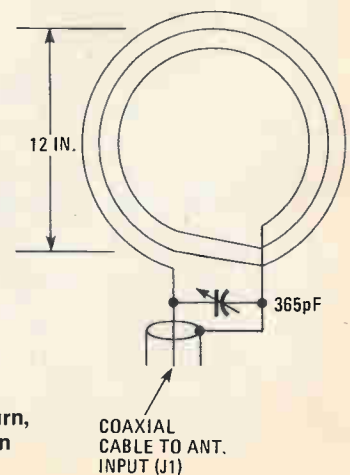

FIG. 5—A FOUR-TURN TUNED-LOOP ANTENNA is shown for use between about 3 and 15 MHz. A one-turn, tuned-loop antenna of the same diameter will function equally as well at about 10 to 30 MHz.

provide good shortwave reception between 3 and 30 MHz, it is important to realize that a tiny piece of wire, while surprisingly effective with a sensitive preamplifier, can't be expected to perform as well as an outdoor longwire antenna. It's a compromise.

Variations

Some shortwave receivers have antenna inputs different from 50 ohms impedance. This preamplifier circuit is designed to work best with a 50-ohm unbalanced load. It is not difficult, however, to change that value to some extent.

By increasing the resistance of R9, the output impedance can be increased. Some receivers have antenna impedance requirements in the neighborhood of 300 ohms. Small portable shortwave receivers, if they have a jack for an external antenna, should accept 50 ohms; but if there is no such jack and you must use the external whip antenna for coupling, you can get a reasonable impedance match by increasing R9 to 470 ohms. In general, the output impedance of the Desktop Antenna will be equal to the value of R9 up to about 500 ohms. To be certain of the antenna impedance requirements of your receiver, consult the instruction manual or specification sheet.

The antenna you use with this preamplifier circuit need not be the short, single wire we have described. A small loop antenna, with or without a variable capacitor for resonating, will provide good results. If no capacitor is used, a single turn of wire about 1 foot in diameter may outperform the short wire. A tuned loop, such as the one in Fig. 5, is even better.

For the range approximately 3 to 15 MHz, use a four-turn loop having a diameter of 1 foot and a 365-pF, receiving-type, variable capacitor. For the range 10 to 30 MHz, use a one-turn loop of the same diameter. Disconnect inductor L1 if you use a tuned loop antenna.

The main advantage of the tuned loop over a simple short wire or non-resonant loop is the front-end selectivity that is offered. That reduces the chance of intermodulation distortion (IMD) from a strong source of RF energy nearby. Extra front-end selectivity is also an advantage with the less sophisticated shortwave radios, which often lack that characteristic. The variable capacitor should be adjusted for maximum signal, and reset when the frequency is changed by more than about 0.5 MHz.

Whether your receiver is a small multiband portable or a sophisticated PLL-tuned digital unit, the desktop shortwave antenna is convenient to use when a full-size longwire is not practical. The device can be built easily in one evening, and the cost is minimal—only about fifteen dollars. **SP**

PRINTER POWER

HERB FRIEDMAN

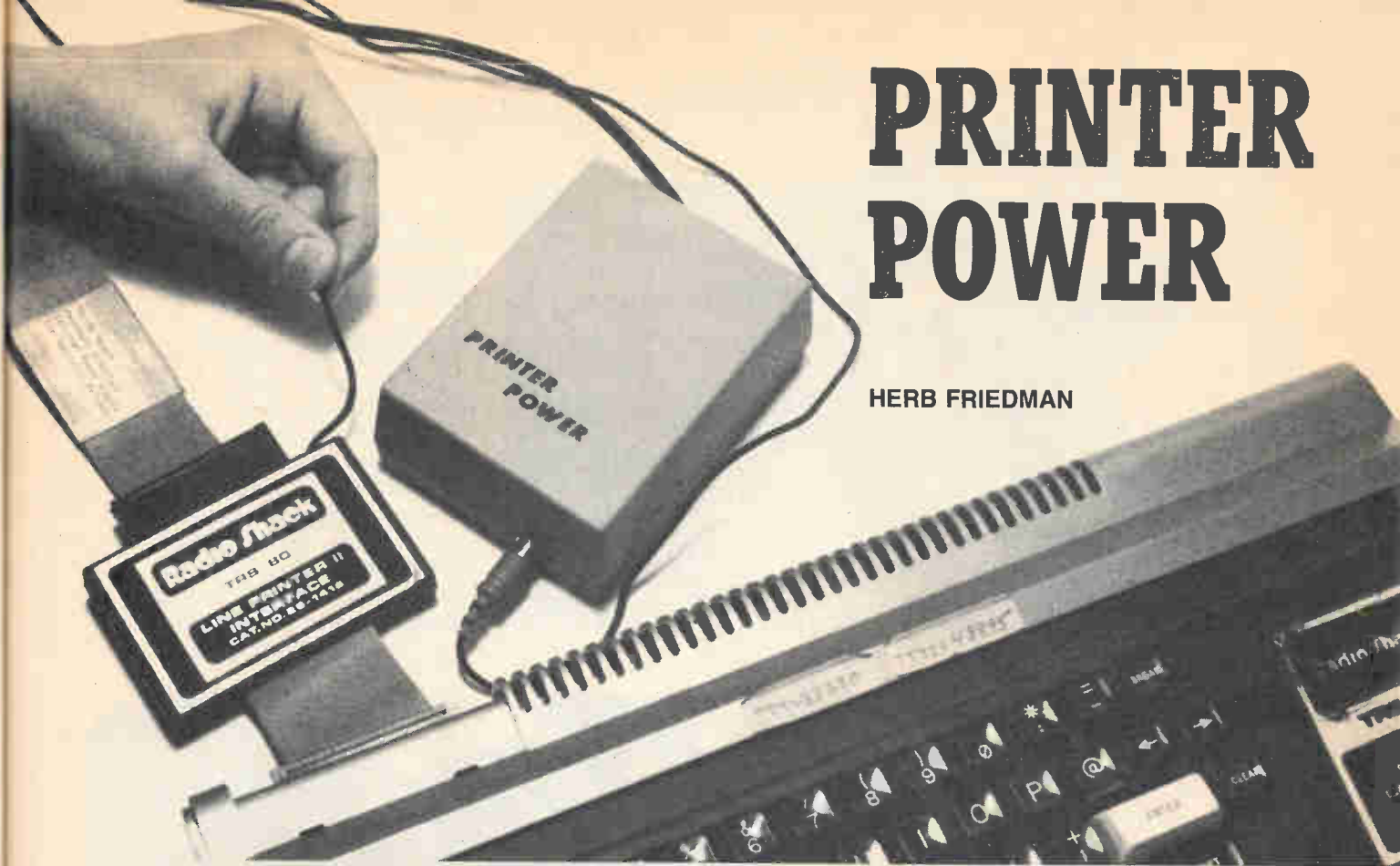

ONE OF THE GREATEST VALUES IN PERSONAL COMPUTERS was the original Radio Shack model *I*. For only \$599 the user got a combination keyboard/computer, a video monitor, and a cassette recorder for program and data storage. The sales exceeded anything anyone dreamed. Informed estimates are that almost a half-million model *I* computers were sold before it was discontinued. To make the model *I* as attractive as possible, Radio Shack made available a low-cost, line-printer interface that permitted the keyboard's data bus connector to drive a printer. For several years the combination was, and remains, an unbeatable value.

But like everyone else, Radio Shack builds "hooks" into their equipment that create problems if you want to use someone else's hardware. That is particularly true of the line-printer interface. Try to use one of the modern matrix or specialty printers with your model *I* keyboard and unless it's a Radio Shack printer it probably won't work. Radio Shack's old matrix printer will work just fine, but one of the new low-cost,

daisy-wheel printers won't put a single mark on the paper; even the famed Epson printer won't budge, nor will some of Radio Shack's newest printers.

The *honeymoon* is over. If you want to use a modern printer, Radio Shack wants you to purchase their new model *III* computer, or you purchase a used, expensive interface from someone. But as we'll show, it's easy to modify the line-printer interface so you can use a modern printer without blowing \$150 (used) on the expansion interface.

The problem of modern printer incompatibility with the model *I*'s data-bus output connector comes about through Radio Shack's use of the so-called "Centronics-compatible" parallel-printer interface connections. It is implied that there is such a thing as a Centronics standard and that Radio Shack uses the standard. Well, in some places they do, in some place they don't. (Originally, Radio Shack's printers were made by Centronics, but Radio Shack didn't use the Centronics connector. The RS connector was nowhere near the quality of the connector

on the Centronics' versions of the same printer—which were lower priced than the Radio Shack models.)

But a more important problem was Radio Shack's use of terminal #35 on the printer itself and the line-printer interface that RS used for the model *I* keyboard. On most printers that is either N.C. (no connection), or it is pulled up to 5 volts; meaning, 5-volts DC is available at extremely low current. What Radio Shack did in their early printer was to put the 5-volts DC from the printer's power supply on terminal #35, and run it back through the connecting cable to the line-printer interface. It is this 5-volt DC that powers the accessory interface, not the computer's internal 5-volt supply.

If you choose to use a modern printer, say a low-cost Bytewriter or Smith Corona daisywheel, or an Epson, or even Radio Shack's Line Printer VII, nothing happens when you try to feed the printer—because the printers don't provide the 5-volt power source on terminal #35. Everything else remains normal: the computer works, it will

A thin umbilical power cord from a slightly modified printer interface and a small power supply is all that's needed to use a modern printer with a Radio Shack model *I* computer. You don't need a \$300 expansion interface or a new computer if you want to use an up-to-date printer.



1 THIS IS HOW THE INTERFACE appears before you make any modifications. Note the slot in the printed-circuit connector on the right side. It's the locating notch for the matching plug.

2 THIS IS HOW THE PRINTED-CIRCUIT BOARD appears when removed from its case and the three right-hand printed-circuit terminals have been cut away. Note there is no longer a locating notch for the matching plug.

3 PENCIL POINTS TO THE NOTCH that results when the right three terminals are cut away. Make certain that the board is cut back a sufficient depth so that there is no way that terminal #35 can come in contact with the terminal on the matching plug. Check mechanical fit!

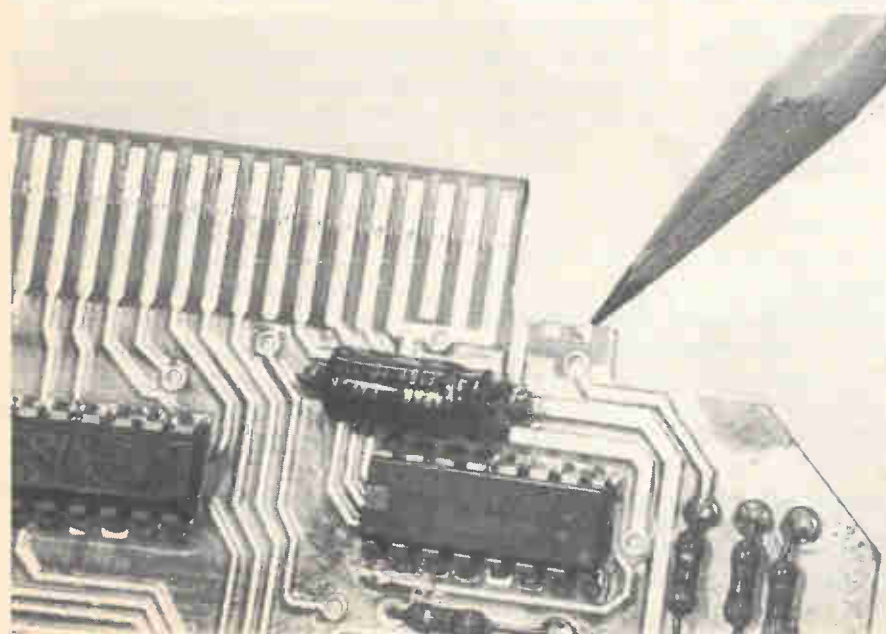
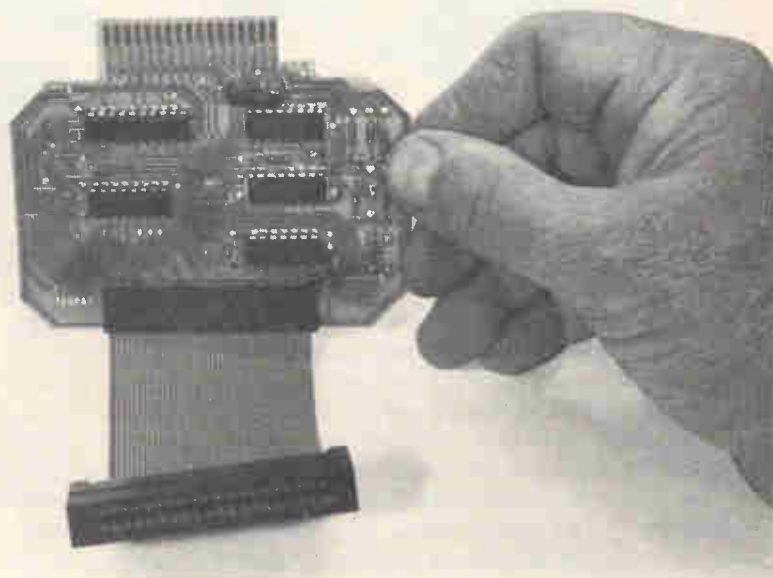

SAVE and LOAD to tape, but it won't LPRINT.

But getting 5-volts DC to the interface is not more than, at most, an evening's work: about 30 minutes for a goof-proof modification to the interface and the rest of the evening to assemble a rugged and reliable 5-volts DC/100-mA power supply.

The interface modification

It makes no difference whether you have the 26-1416 or 26-1411 printer interface. The modification is the same for both because it's the same interface; only the catalog number is different.

Photo 1 shows the unmodified interface. Note that the edge connector along the top has a slot on the right side. The slot is used to prevent inadvertent reversal of the connecting plug, which

has a plastic strip inside the plug that slips into the matching slot.

The connector terminal to the immediate left of the slot is #35. The pin on the extreme left of the connector is #1; it is so labeled on the PC board, and will be seen when you remove the cover(s).

When counting connector terminals, keep in mind that those on one side are all odd, all even on the other side. When counting terminals count 1,3,5...33,35, etc. Do not count 1,2,3,4...etc. Radio Shack used consecutive numbering (1,2,3,4,5) on some early computer equipment, which led to the early demise of the computer when a user tried his own connecting cables. It was one of the "hooks" quickly discarded when more computers were blown out under warranty than after.

4 PENCIL POINTS TO THE POSITIVE END of the 5-volt, power-rail filter capacitor. Your power cable is tack-soldered here. The power cable's shield gets tack-soldered to the opposite (negative) end of the capacitor.

Disassemble the case! The interface's case is held together by internal plastic pins at each corner. Slip a small knife or screwdriver between the halves of the case and pry gently. If the corner doesn't snap free, cut through the pin with a very sharp knife. The case will be reassembled with four drops of glue if you have to cut through the pins.

When the cover separates, the PC board will be retained in the bottom half of the cover. It is held in place by five foam pads. Gently pry the PC board free, or reach under with a screwdriver and push through the pads. Either way, the pads will probably split in half. Again, you can re-cement them later.

Remove the PC board from the case (see photo 2) and using a coping saw, jeweler's saw, model-maker's saw, or small bandsaw, cut off the right three terminals, Nos. 35, 37, and 39. (37 and 39, and the even numbered terminals on the flip side aren't used at all, neither is the flip terminal under #35). See photo 3. Cutting from the edge to the notch will remove Nos. 37 and 39. Terminal #35 will require a cut parallel to the terminal and then one across from the notch. Be careful not to cut into #33. If you tend to get sloppy, cut extremely close to #35 and then get rid of the remainder with a small file.

If you're afraid to cut the PC board near terminal #35, and you have one of those small hobby-type hand grinders available, use a small fluted cutter or coarse grinder to strip the #35 PC foil off the board.

Cut the terminals back far enough so that there is no possibility that #35 can come in contact with the terminals on the associated cable plug. Photo 3 shows a close-up of the cut, indicated by the pencil.

The power source will connect across the capacitor that's located almost directly below the cut. The pencil in Photo 4 points to the positive end of the capacitor which is rated at 10- μ F

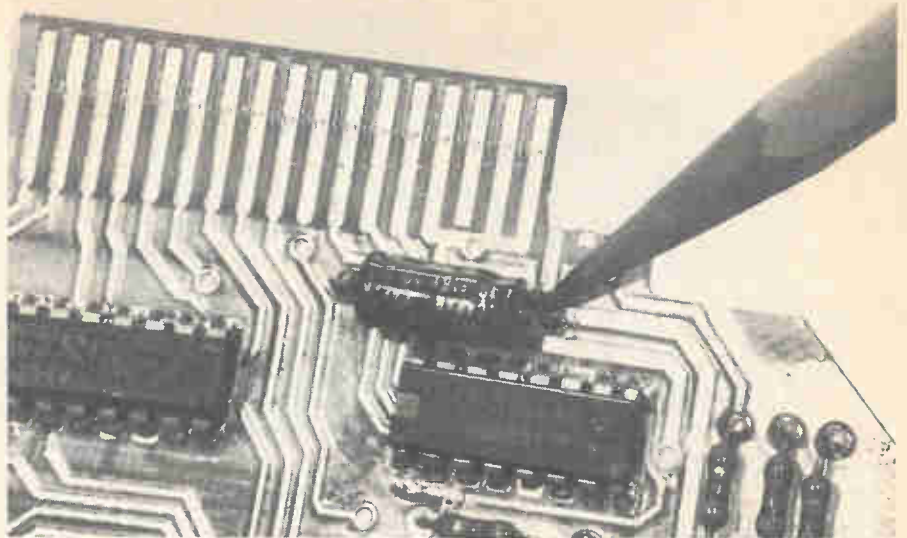

at 16-WVDC. Use a thin audio-patch cord—about $\frac{1}{16}$ -in. diameter—with phono-type plugs for the power cord. Don't use a big, thick patch cord thinking it's better—it won't fit conveniently in the cabinet. Cut the phono plug off one end of the cord and strip the shield back about $1\frac{1}{4}$ -in.

A cable with a phono jack is preferred because the phono-type connection is a lot more reliable than the itty-bitty 3.5 or 2.5 miniature plug and jacks used on some audio-patch cords. Often, an intermittent powerline interruption caused by the jack and plug can cause some scrambling of the data in memory. A phono connector is the best low-cost insurance against this kind of problem.

Tack-solder the shield right up

against the capacitor's negative terminal. If there is any possibility that any part of the shield can possibly short to an adjacent printed-circuit foil—even if it's a single strand, slip a small strip of tape between the wire and the printed-circuit foil(s). In a similar manner, tack-solder the cable's center conductor to the capacitor's positive terminal.

File a small notch in the top-half of the cover about $\frac{1}{2}$ -inches from the side so that the wire can be passed out of the interface. Route the wire parallel to the capacitor, across the pins of the adjacent IC, and out where the notch will be. Place a drop of airplane cement on each torn foam pad, and at each corner of the cabinet. Position everything where it belongs and use a few turns of

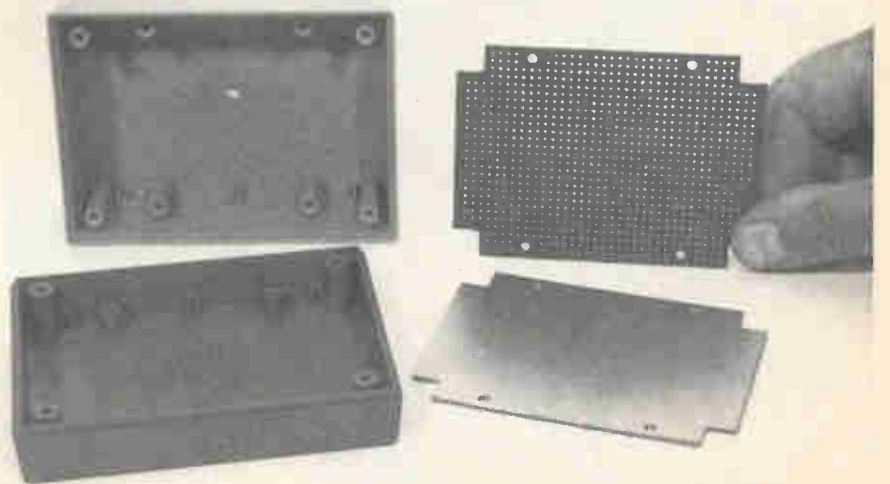

5 THESE ARE THE MAJOR PARTS of the UNIBOX packaging system. The cabinet sections have extrusions for mounting printed-circuit and grid boards either horizontally or vertically. Too bad we can't show color—the system looks "all pro!"

tape to hold it all together until the adhesive dries.

The power supply

Nothing is unusual about the power supply other than it is regulated, very conservative in design within the limitations of readily available components, and reliable. Essentially, the object is not to have glitches in the power supply cause memory problems. A daisy-wheel printer pulling enough power on the strike to flicker the video display won't budge this supply—it chugs along with nary a *glitch*.

Since I wanted the supply to look as good as the rest of my computer installation I used a commercial-quality, though hobbyist-priced enclosure system called UNIBOX, for which the printed-circuit template is specifically intended. If you use a different cabinet, simply change the printed-circuit layout accordingly.

The UNIBOX cabinet hardware is from AMEREX. You can write to them for a catalog at P.O. Box 2815, Riverside, CA 92516. A typical UNIBOX system is shown in Photo 5. The two halves of the cabinet have internal ex-

trusions to hold matching printed-circuit or gridboard flat across either side, or smaller module boards can be positioned vertically. (Yes, the necessary mounting screws are provided with each assembly.) A pre-cut gridboard assembly predrilled for mounting screws is shown held in the hand. Below it is the matching pre-cut and drilled printed-circuit board. The cabinet used for this project was a type 144, which measures approximately $4 \times 5\frac{1}{4} \times 2$ -in.

A note about the printed-circuit board. It is on a heavy, non-warping plastic base, and the copper is much heavier than the stuff usually found on hobby-grade printed-circuit board. It takes about three times as long to etch away the unwanted copper even if you're using an air-burst etching bath.

Photo 6 shows the finished power supply ready for installation in the cabinet. Most of the parts come from mail-order advertisers; you don't have to pay an arm and a leg for "industrial grade" components. A notch filed in the edge of the cabinet's bottom section provides clearance for power switch S1. The power indicator is a miniature

LED from a 20-for-\$1 assortment. It is positioned on the printed-circuit board with extra-long leads folded under, so it's somewhat flexible. The LED just overhangs the printed-circuit board. If a matching, slightly larger hole is drilled in the base of the enclosure, the LED will slide into the hole when the printed-circuit board is installed. Any small printed-circuit type 12-volt power transformer with at least a 100-mA (0.1-ampere) rating can be used. The small Radio Shack 12V/600-mA transformer more or less fits the printed-circuit template—but it is relatively expensive. Whatever transformer you decide to use, make certain that it is small enough to allow the enclosure to be assembled.

The specified 5-volt DC voltage regulator, IC1, does not require a heat sink. If you make any substitutions, check on whether a sink will be required. Capacitor C1 is simply too large to fit inside the cabinet if it has printed-circuit leads (both located on one end). Capacitor C4 can be the printed-circuit type, and is the most commonly found type in surplus. Do not eliminate the 0.1- μ F capacitors, and keep them with-

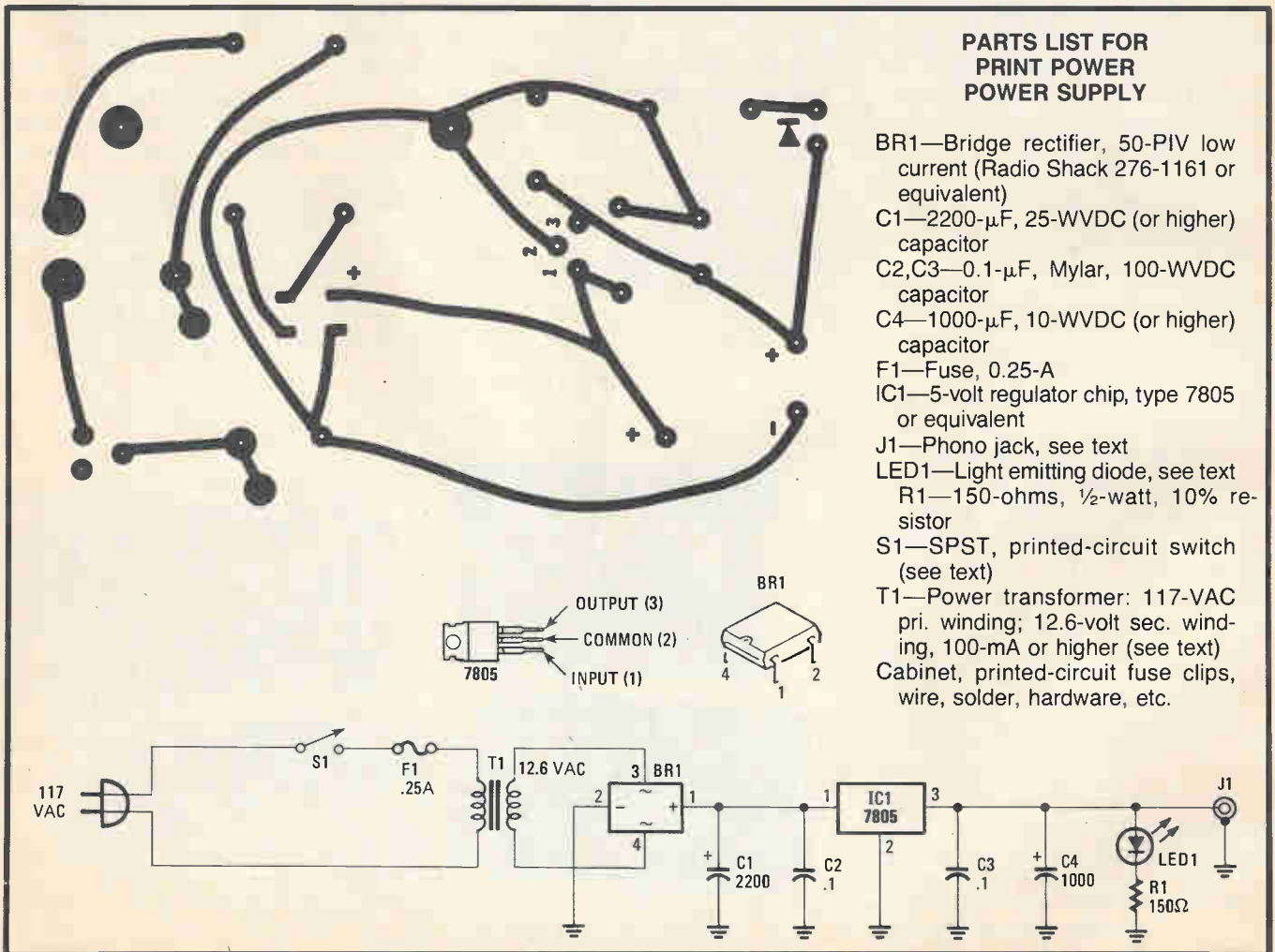

in 1/2-inch of IC1's leads if you change the printed-circuit template. The fuse is optional.

The project doesn't produce much heat, but it can get warm after several hours. Provide a few small air vents in the top cover along the bottom of the sides and the top of the back of the cover.

Do not connect the power supply to the interface until you have checked it out and are absolutely certain the voltage at output jack J1 is +5 volts DC, give or take a *tenth* of a volt.

When the supply checks out shut down all power to the computer, plug the printer interface into the keyboard's data buss connector, plug the printer into the interface, and plug the power cord from the interface into the power supply. There is no longer a locating notch on the interface for the printer

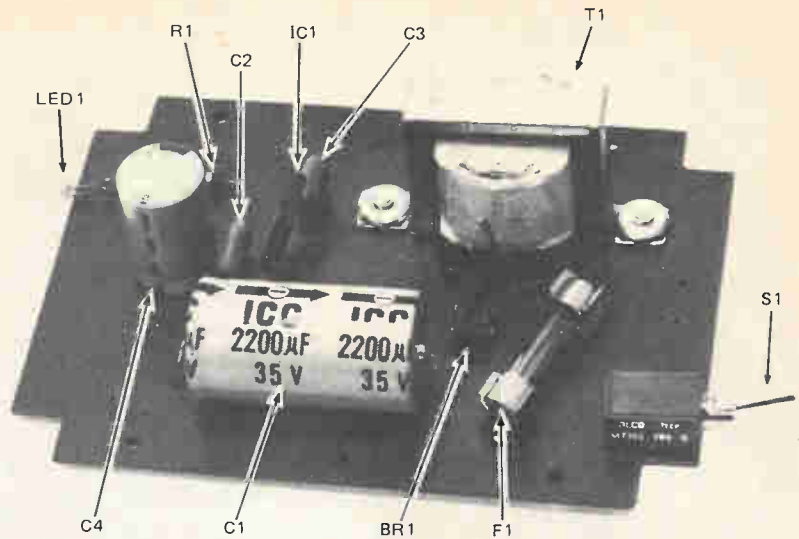

▲ **6 THE FINISHED PRINTED-CIRCUIT ASSEMBLY** read for installation in the cabinet. Note the use of the flat-mounting ALCO power switch (relatively inexpensive from surplus dealers), and the LED1 power indicator sticking out over the left edge of the printed-circuit board. J1, the output jack, is mounted on the cabinet.

◀ **7 THE COMPLETED POWER SUPPLY** with the plastic cover removed. The circuit board is secured to the cabinet base with screws supplied with the board.

▼ **8 READY TO PRINT.** The interface connects to the keyboard's data bus connector and the printed cable connects to the interface. The only difference from the usual arrangement is that now there is a thin power cable that connects the interface to the power supply.

connector, so take care that the left side of the connector—the end with the number 1 terminal—is flat up against the left edge of the interface's printed-circuit strip. Then turn on the printer and the interface power supply, and finally the computer.

If you have the original printer interface, but have also added the expansion interface—say because you wanted disk drives—you can power one printer off the expansion interface and one off the converted keyboard printer interface. In fact, that's exactly the arrangement I use. I drive an Epson MX-80 off the expansion interface and an IBM Selectric off the converted keyboard printer interface. It saves moving connectors—which always leads to damage—and it saves the expense of a \$125 parallel-printer switchbox. **SP**

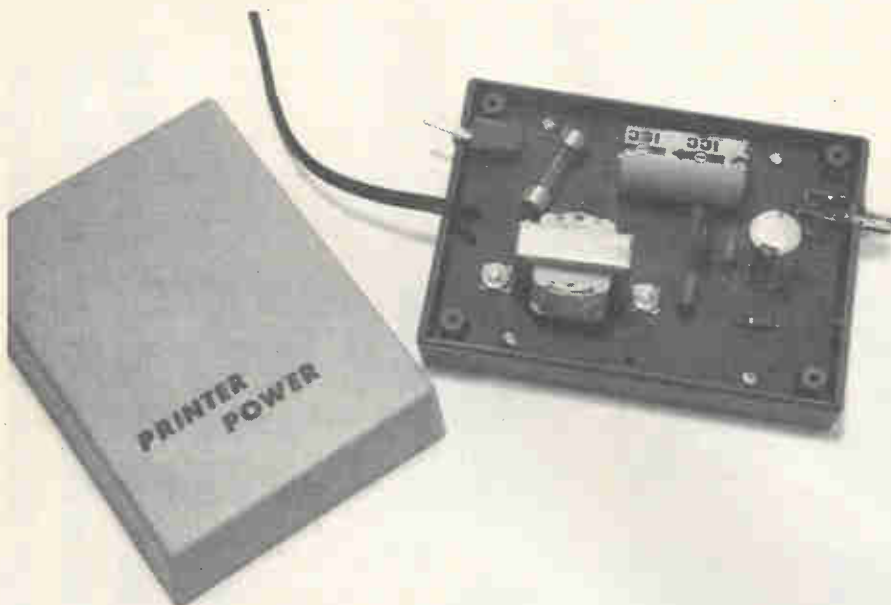

Digi-Slot

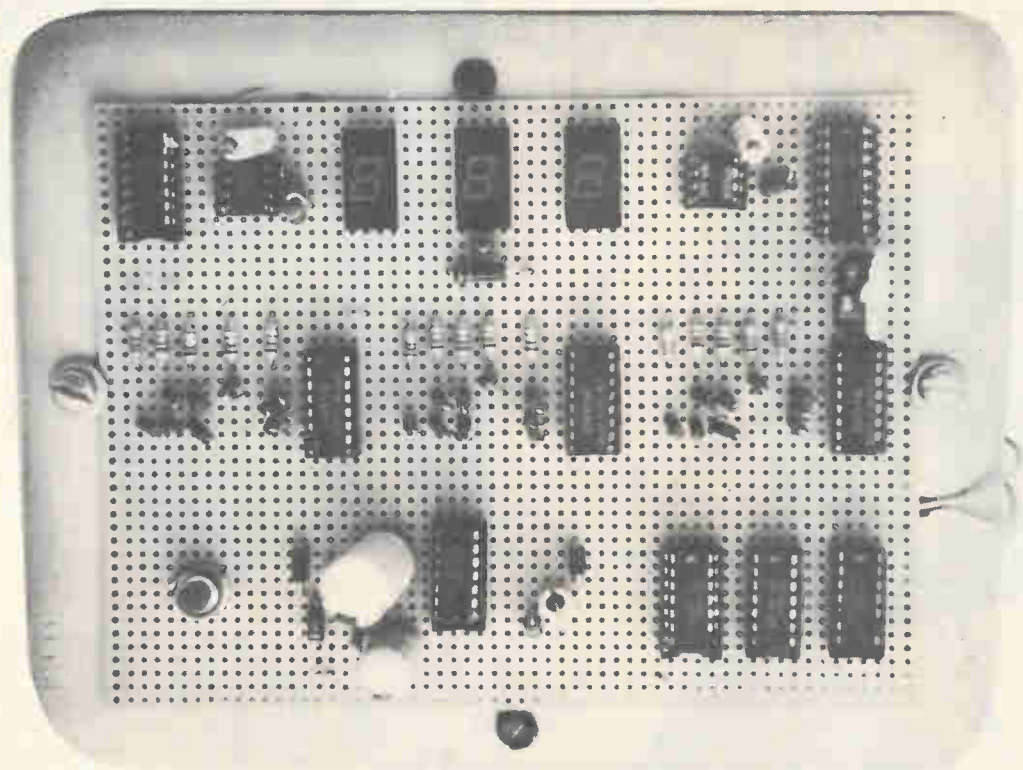

BOB MASTAFAPOUR

This no-arm bandit can teach you the fine art of losing your money at home where it won't hurt the pocket. It'll enrich your theory knowledge

AS DIGITAL IMITATIONS OF GAMBLING GAMES BECAME more and more popular, better ways were found to do the same function. The Digi-Slot described here is not a new idea, but it uses an important concept, often overlooked by electronics hobbyists. This Digi-Slot uses the diode-matrix circuit concept which both reduces the total parts count, and also provides the option of a user-selectable output.

Almost everyone is familiar with a slot machine. Simply, it is a gaming device with three spinners that roll and stop sequentially. If the items displayed are all the same, the player wins in that game. Sorry, no provision was made for one or two cherries. The Digi-Slot does the same thing. A button is pressed and released. The display "rolls" quickly (the speed can be varied) and, one by one, the displays stop from right to left, and reveal a random selection.

If all the items displayed on the Digi-Slot are the same, a light-emitting diode will flash, indicating a winning combination. The LED can be replaced (option of the circuit builder) with another kind of win indication, such as a beeper or any triggerable noise and or flashing-light circuit. The parts count could also be reduced by three integrated-circuit chips if no verify circuit is wanted—again the builder's option.

The Digi-Slot circuit is split up into three circuits to make

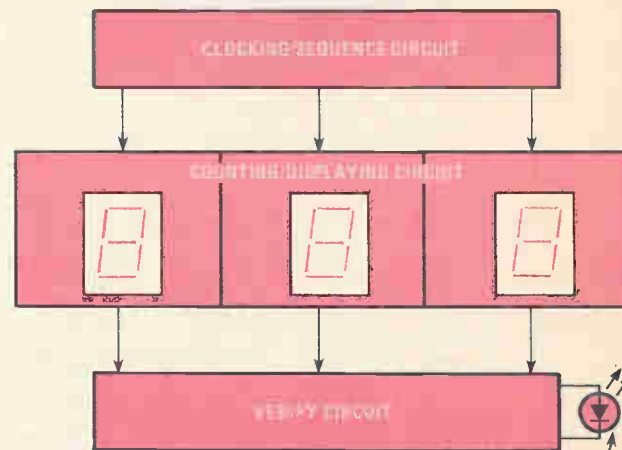

FIG. 1—THE DIGI-SLOT functional block diagram shows that the project's circuit can be divided into three sections. This simple slot machine displays only one of four fruits in the LED display—A-apple, C-cherry, L-lemon and O-orange.

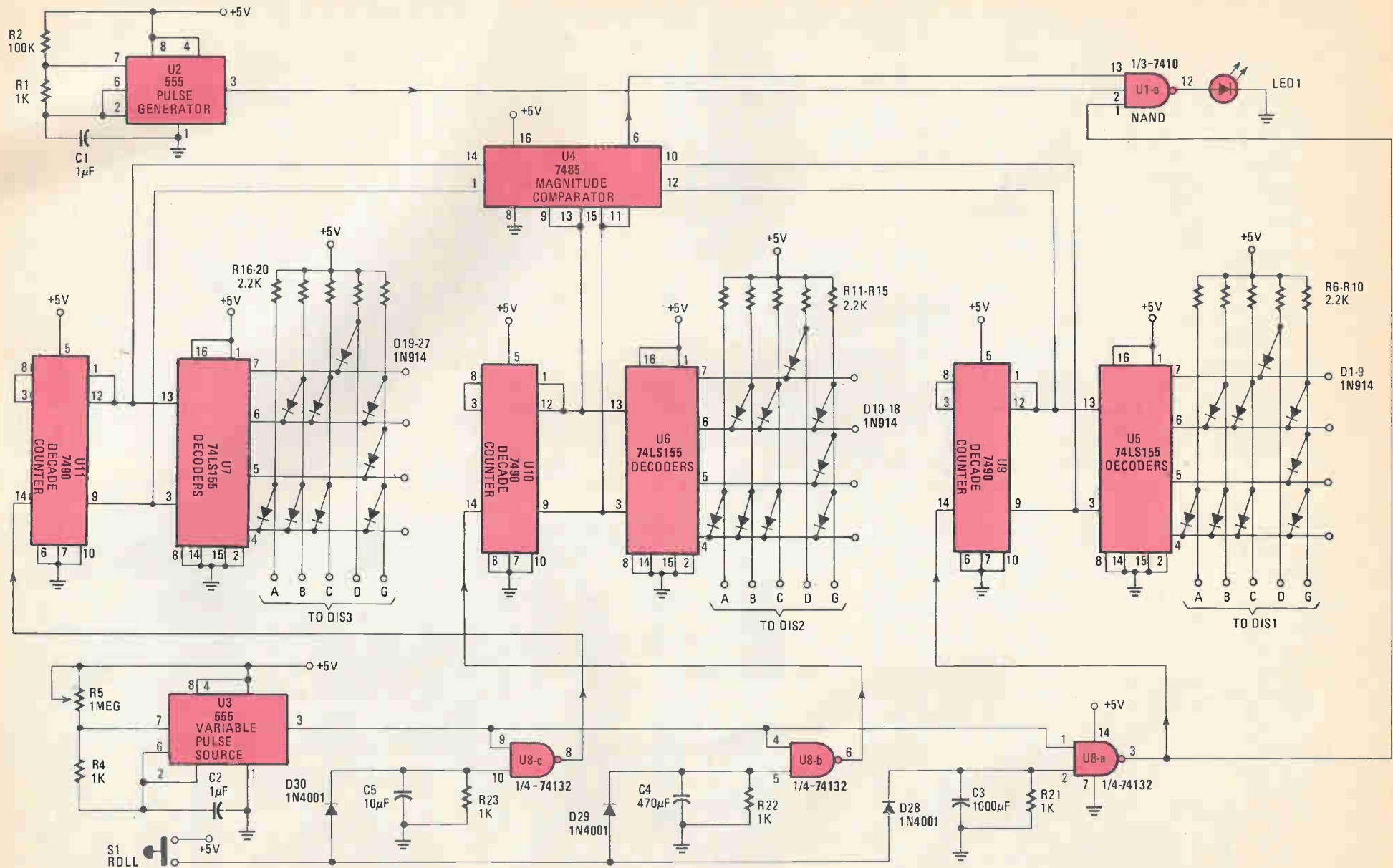

FIG. 2—COMPLETE SCHEMATIC DIAGRAM for the Digi-Slot project is shown on this page. The advanced experimenter can assemble his project from this diagram. Neophytes should follow author's layout. If you wish, replace the winning signal LED1 with a light-emitting diode opto-isolator to actuate a bell or siren when a winning combination is revealed.

construction, troubleshooting, and comprehension easier. The first circuit is the clocking section. It is a relatively easy to construct. The next portion is the counting/displaying section. It is the most difficult and largest section. The last circuit portion is the optional verify section. The block diagram of the three sections are shown in Fig. 1.

Circuit Operation

Throughout that discussion, different options will be described. You can choose a number of options to build your own unique Digi-Slot. Feel free to make your own modifications and circuit additions, but remember that the schematic diagram shown in Fig. 2 is the basic unit.

Clocking/Sequencing

The clocking/sequencing circuit involves U3, a 555 timer integrated-circuit chip, and U8, a 74132 quad NAND Schmitt trigger integrated-circuit chip. U3 is operating as a variable-pulse source with potentiometer R5 varying its pulse rate. U3 feeds three NAND Schmitt triggers (U8-a,b,c). Each NAND Schmitt trigger in U8 acts the same way a normal NAND gate would, except that the inputs are more immune to the effects of noisy signals. The Schmitt trigger tends to smooth out noise generated by such things as switching devices—like those in that circuit.

ROLL pushbutton switch S1 is a single-pole, single-throw, normally-open, momentary switch. One side is connected to

+5-volts DC and the other is connected via three independent diodes (D28-D30) to the second input of the Schmitt triggers. Each Schmitt trigger has a timing capacitor and bleeder resistor connected (C3-C5 and R21-R23, respectively). Each capacitor has a different value—1000- μ F, 470- μ F and 10- μ F. When S1 is pressed, capacitors C3-C5 all charge allowing the gates to pass pulses from U3 to their respective outputs.

When S1 is released, each capacitor (C3-C5) starts discharging. Diodes D28-D30 isolate each capacitor and prevent them from interfering with each other's discharging rate. The 10- μ F capacitor, C5, will almost immediately discharge—shutting off the pulse flow from its Schmitt trigger of U8-c. The 470- μ F capacitor, C4, will discharge a few moments later, thus cutting off its Schmitt trigger's (U8-b) pulse flow. The same process occurs moments later with the 1000- μ F capacitor, C3, and the cutting off of U3-a. Those selected time-delays provide the sequential stopping of the rolling displays.

Counting/Displaying

The counting/displaying circuit consists of three 74155 (U5-U7) two-to-four-line decoder/demultiplexers (we'll call them "decoder" for short), associated 1N914 diodes (D1-D27) and display (Fig. 3), and three 7490 decade counters (U9-U11). A glance at Fig. 2 will tell you that the three indicator sections are identical. The counting/displaying circuit's function is to sequence all four symbols on the LED displays (A—apple, C—cherry, L—lemon, O—orange). Several methods are used to make those outputs available easier than using pure logic-gate circuitry.

The circuit action begins by accepting pulses from the Schmitt trigger when the capacitor is charged. (Only one of the units will be discussed since they are all identical.) The 7490 (U9) accepts pulses from Schmitt trigger U8-a and starts counting. U5 is wired to count from 0-4 and recycle (the 74155 has only four outputs for its two inputs). U9 then sequentially makes low each of its four normally high outputs which control the diode matrix (D1-D9).

The diode matrix used eliminates a lot of gates that would have produced the same output. Each diode line is connected to +5-volt DC via a current limiting resistor (R6-R10). Those display lines (to the 7-segment displays A,B,C,D,G inputs of DIS1) are normally high when there is no diode pulling it low (see Fig. 3). Each diode is designated to turn off a segment of the display when the line from the 74155 (U5) goes low. If the 74155 were taken out of its socket and the circuit were powered up, all the display segments would be lit, because they are connected directly to +5-volt DC via the 2200-ohm resistors (R6-R10). When U5 is functioning and producing an output low, the diodes on that line pull the corresponding display line low, shutting off the designated segment of the LED 7-segment display, DIS1. Segments E and F of display DIS1-DIS3 are always on because they are connected directly to +5-volts DC as shown in Fig. 4.

The diode-matrix method opens up an endless combination of outputs because you can pick exactly what characters are to be sequenced. The schematic diagram shows the matrices used to produce the original O, L, A, and C output. Rearranging the diodes in the manner wanted can produce different characters on the displays.

Verification

The verification circuit involves verifying all three displays to see if they are the same (indicating a winner). The circuit

PARTS LIST FOR DIGI-SLOT

SEMICONDUCTORS

- D1-D27—1N914 diode, or equivalent
- D28-D30—1N4001 rectifier diode
- DIS1-DIS3—7-segmented, common-cathode LED 7M display
- LED1—Light-emitting diode, jumbo type
- U1—7410 triple 3-input NAND gate integrated-circuit chip
- U2, U3—555 timer/pulse-generator integrated-circuit chip
- U4—7485 4-bit magnitude comparator integrated-circuit chip
- U5-U7—74LS155 dual 1-of-4 data distributor integrated-circuit chip
- U8—74132 quad Schmitt-trigger inverter integrated-circuit chip
- U9-U11—7490 decade counter integrated-circuit chip

RESISTORS

- (Note: All resistors are 1/4-watt units unless otherwise noted.)
- R1, R4, R21-R23—1000-ohm
 - R2—100,000-ohm
 - R3—330-ohm, 1/2-watt
 - R5—1-Megohm, PC-mount potentiometer
 - R6-R20—2,200-ohm

CAPACITORS

- (Note: All capacitors are 16-WVDC electrolytic units.)
- C1-C2—1- μ F
 - C3—1000- μ F
 - C4—470- μ F
 - C5—10- μ F

ADDITIONAL PARTS AND MATERIALS

- S1—SPST, normally-open, pushbutton switch
- Perfboard, flea-clips, sockets, styrofoam, solder, wire, hardware, etc.

uses a 7485 4-bit magnitude comparator (U4), a 555 pulse generator (U2) and a 7410 3-input NAND gate (U1-a). Refer to Fig. 2. U4 compares two 4-bit binary numbers. It indicates if one is greater than, less than or equal to the other. The circuit is only interested in equal to comparisons, because it indicates a winning combination. The 7485's two 4-bit inputs are split up to verify three 2-bit numbers. The output from U4 joins the pulses from U2 at the input NAND gates of U1-a. That NAND gate decides when to let LED1 blink to indicate a winner. The LED is normally on to indicate power. Without the use of the NAND gate, the 7485 would constantly verify

the displays as they are rolling, thus blinking LED1 annoyingly.

Construction

Using a standard 6 x 4½-inch piece of perforated board, insert the components as shown in Fig. 5. Using sockets for the integrated-circuit chips, wire the power connections first. Check to see that all critical pins are getting the correct level of voltage by briefly connecting the power. Later, it could be a big headache to locate a simple thing such as an open power bus, or short circuit with all the interconnecting wire forming a "rat's nest."

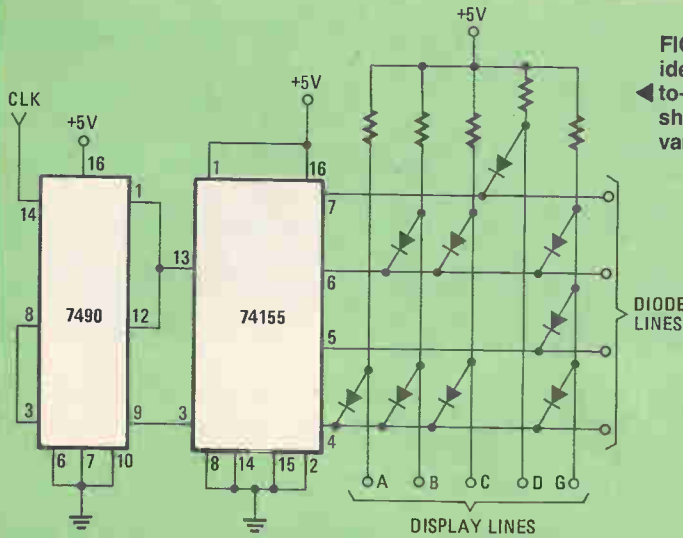

FIG. 3—THE COUNTING/DISPLAY CIRCUIT consists of three identical sections as diagrammed at left. The 74155 is a two-to-four-line decoder multiplexer which we call "decoder" for short. Only five segments of the 7-segment LED display are varied during the game, because two others are always lit.

FIG. 4—THE a, b, c, d, and g segments of the three LED displays are switched on by the decoder. Segments e and f are always on. Can you figure out why?

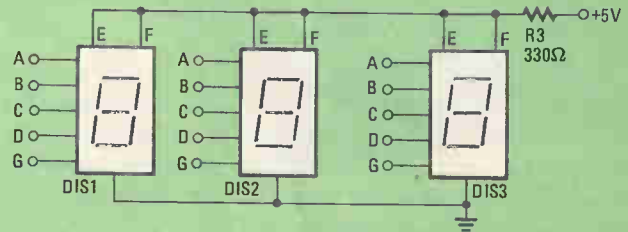

FIG. 5—THE PHOTOGRAPH locates the position of the major components in the Digi-Slot project assembled by the author.

It's a bare-bones project which can be dressed up to Vegas standards with a little bit of work and showmanship.

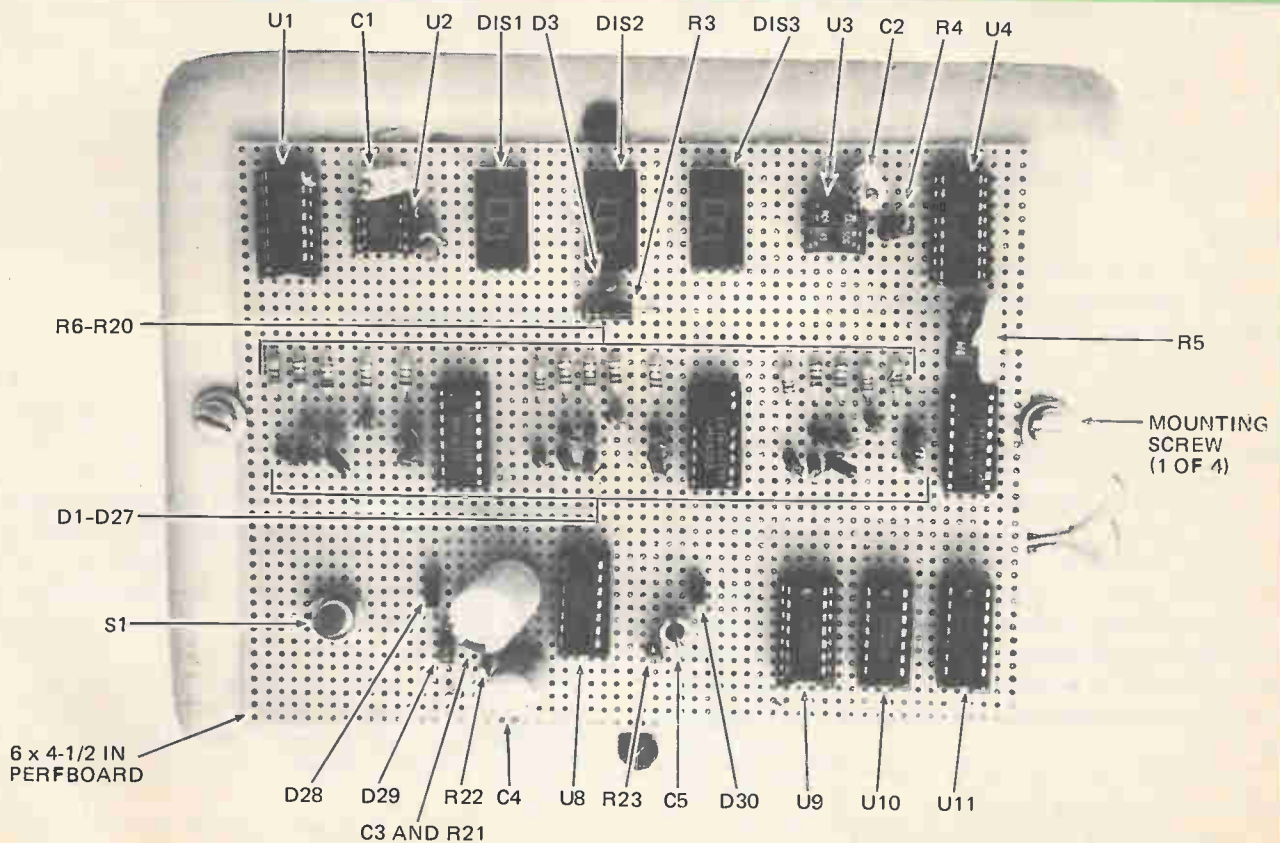

FIG. 6—IF YOU WANT more than four symbols to show up on the LED's, resort to a 74154 decoder which offers up to 16 characters.

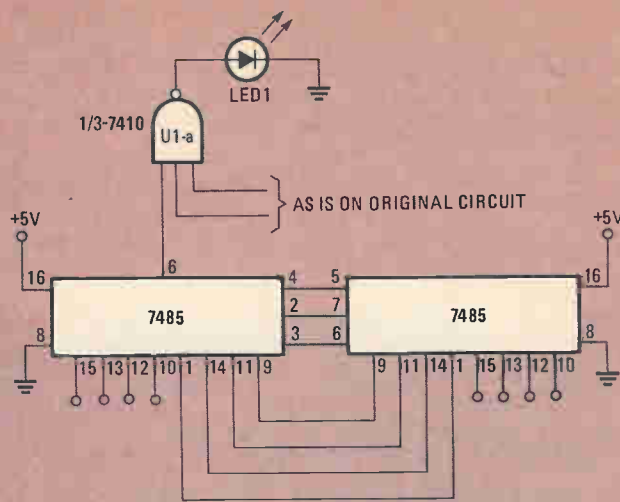
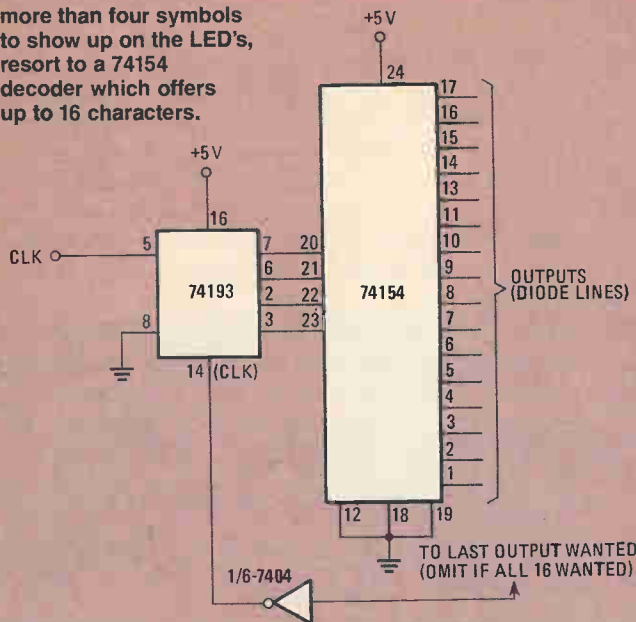

FIG. 7—VERIFICATION of the expanded circuit shown in Fig. 6 requires the installation of an additional 7485 chip.

Now, wire the diode matrices. Be careful not to short adjacent diodes. Finish up the rest of the counting/displaying circuit, making sure that the correct LED display receives the proper outputs from the 74155 chips. Remember that each one is a unit grouped by the proper display, 74155 and 7490. Refer to the schematic diagram, Fig. 2.

Now, complete the wiring of the clocking/sequence circuit by hooking-up the 74132 and its associated capacitors, bleeder resistors and diodes. Connect the ROLL switch, S1. Wire the 555 timer associated with the circuit (U3). Double check the polarity of the diodes and the electrolytic capacitors.

The verify circuit is the last connected. First, wire in the 7485 (U4). Next, connect the 7410 (U1) and the 555 pulse generator associated with the verify section (U2). The assembly of the circuit is now done.

Testing

Since the circuit is broken up into sections, construction should be straight forward and without hitches. If a problem occurs, follow that guide:

Power up the circuit with a 5-volt DC regulated supply. The prototype drew 198-milliamperes when all the displays were on. Check the current drawn by your unit. If it is excessively high, or some of the chips get hot, turn off power immediately. Check the power connections to all chips (especially those getting hot). When turned on, the displays should not be rolling and show a random display. The power LED should be glowing. Press ROLL button, S1. The displays should roll and stop sequentially from left to right when the button is released. If nothing happens, adjust potentiometer R5 to vary the rolling speed. If nothing still happens, check the connections around U3. If the displays roll, but some segments on the displays are wrong, check the polarity of the diodes in the matrix.

If the verify portion seems to be malfunctioning, get all the displays to one letter by manually advancing the 7490's. That can be done by touching pin 14 to ground while the ROLL button is not pressed. Touch it as many times as necessary to advance all 7490's to one letter. If the power/winner LED is

not blinking, check the logic level at pin 6 of the 7485. If it is high, check U2 for pulses and U1 for proper connections. If it is low, check the 7485 for a wrong connection.

Enclosure

A piece of high-strength styrofoam was used as an enclosure—more accurately, as a breadboard. Scoop out a space so that the leads under the perfboard will fit. Sand and finish the styrofoam. It handles like wood. Paint it with a latex water-base paint. A petroleum base paint (such as most spray paints) will eat through styrofoam. A couple of securing screws lipping over the perfboard edge ensure a snug fit.

Operation and Maintenance

Operating the Digi-Slot is as easy to operate as any other slot machine device—except that no coins are needed. As long as the unit does not receive more than 5-volts DC, it is fine. As an added insurance measure, a 7805 5-volt regulator chip can be connected permanently to the circuit to insure no over-voltage destroys the circuit.

Advanced Version

The Digi-Slot can be expanded so that it isn't confined to just four characters on the output display. The 74155's can be replaced by their big brothers the 74154's. The 74154's are four-to-sixteen line decoders/demultiplexers. They have sixteen outputs which can generate up to sixteen characters. Fig. 6 shows the hookup of a 74154. The 7490 must be replaced by a 74193 4-bit binary counter as shown. The inverter's input is connected to the last output wanted. Suppose you wanted a sequence of ten characters; connect the input of the inverter to the tenth 74154 output. The output of the inverter clears the 74193's count and makes it start all over (recycle). A real elaborate design would be to utilize all the 74154's outputs and connect the inverter's input to a several position switch. The switch positions can then be hooked up to different 74154 outputs to achieve a spectrum of chance levels (the hardest being the last output).

Verification for the expanded model would not be difficult. Another 7485 would be needed. The hook-up is shown in Fig. 7.

EXPANDED BARGRAPH DISPLAY

Here's an eye-catching bargraph display that is surprisingly easy to read, offers 1 to 2% accuracy, and reads 0-to-109!

MARK C. WORLEY

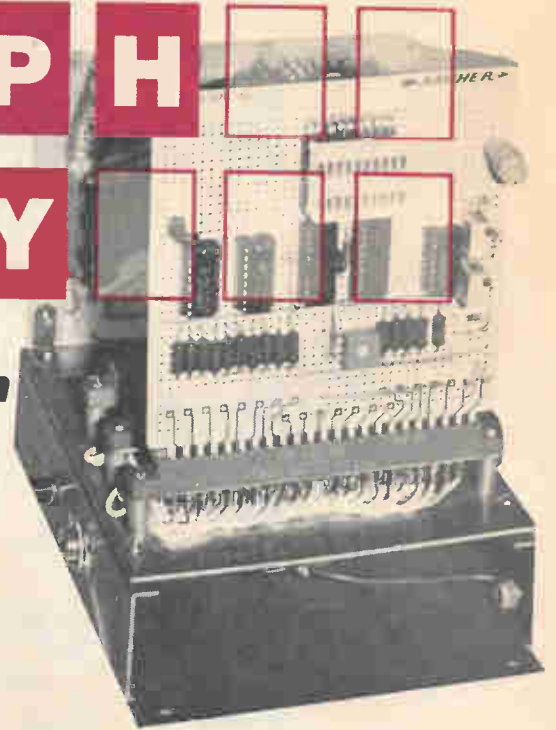

WITH 19 LIGHT-EMITTING DIODES, 2 LM3914 BARGRAPH driver chips, and a handful of additional parts, you can build an Expanded Bargraph Display having a resolution equal to 109 light-emitting diodes! (Normally, you would need 11 LM3914 chips, 109 light-emitting diodes, and an awful lot of power supply current to make such a display.) The Expanded Bargraph Display, which you will learn about soon, is also easier to read, and it doesn't cost nearly as much, either.

Two 10-LED bargraphs are used to display tens and units, much like a 2-digit digital display. The prototype assembled by the author has the two bargraphs mounted one above the other with the tens above the units display. As the input signal

increases, more tens-LED's turn on while the units-LED's seem to race back and forth across the face of their display. That is definitely an eye-catching display, and one that is surprisingly easy to read even without displayed numerals.

Due to its smaller display size, the Expanded Bargraph Display can be used to replace a digital panel meter with novel effect, or use it as an expanded linear audio-power meter, or even as a high-resolution tachometer for your car. The device isn't intended to replace a digital voltmeter where high accuracy is needed, but where an exciting visual display of a varying signal is desired, the 1 to 2% accuracy of this display should be perfect.

Theory of Operation

Refer to the block diagram shown in Fig. 1. The Expanded Bargraph Display's circuit consists of an input amplifier, 2 bargraph drivers and their displays, a 5-volt reference, a digital-to-analog (D/A) converter, and two reference-offset amplifiers.

The heart of the circuit is a pair of LM3914 bargraph drivers (U1 and U2) and a special offset circuit (U3-c and U3-d). For ease of description, assume that the input signal varies over a range of 0 to 1 volt, so that with each 0.1 volt change in the input signal, DIS1 display (tens) will change by one lighted LED. Both U1 and U2's signal inputs (pin 5) are tied together, so normally DIS1 and DIS2 would have identical displays. However the reference offset amplifiers, U3-c and U3-d, along with the D/A converter (U3-b, U4 and U5) reference U2 to a voltage that step-changes with each change in DIS1's display.

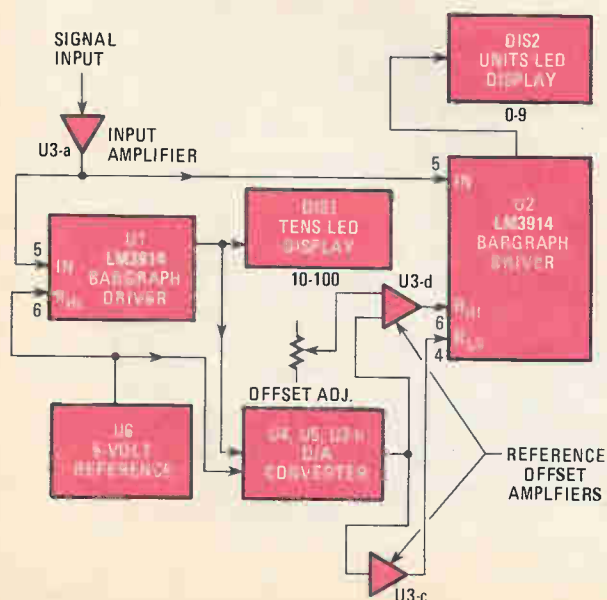

FIG. 1—FUNCTIONAL BLOCK DIAGRAM of the Expanded Bargraph Display indicates how two bargraph LED displays can be ganged to indicate units and tens of units.

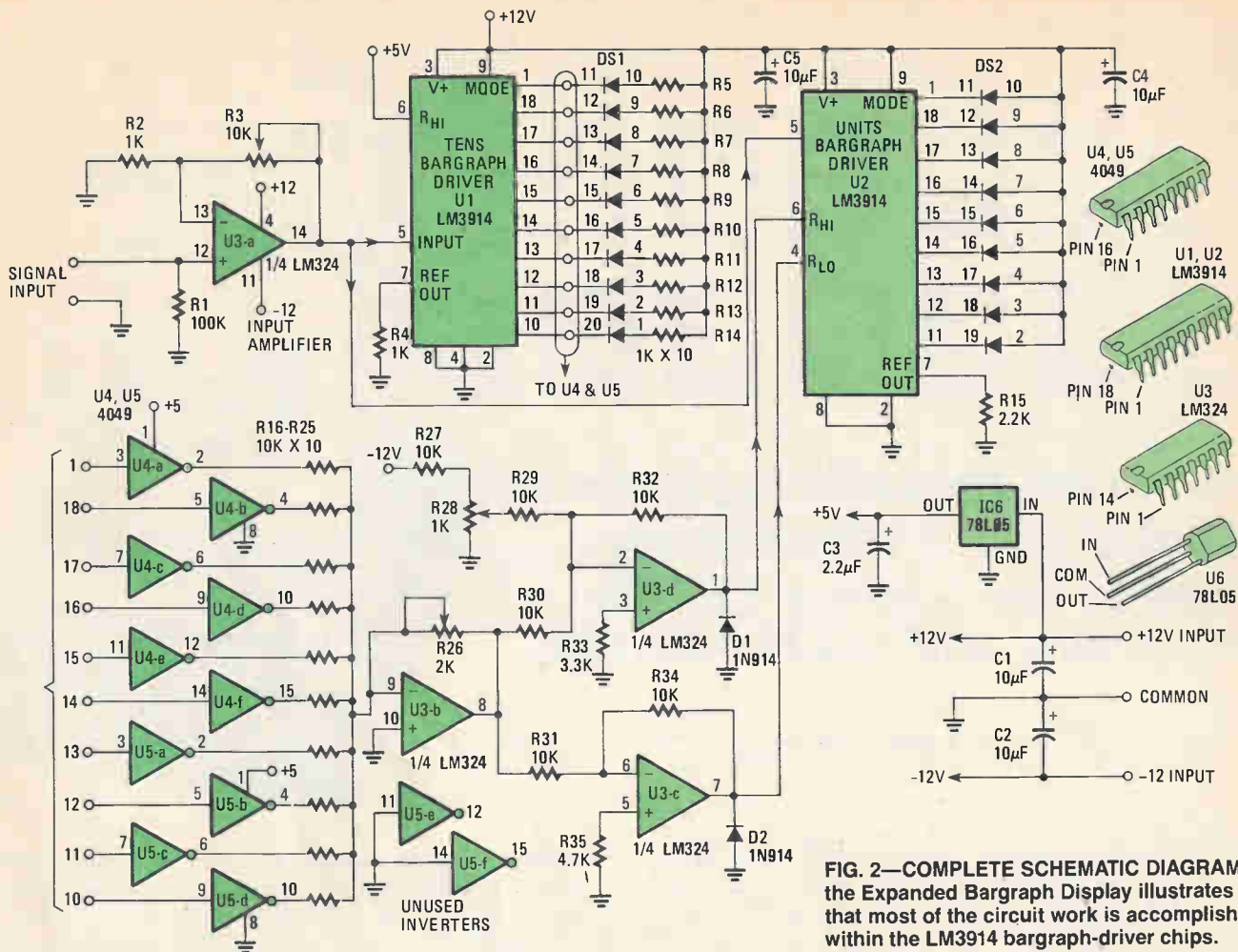

FIG. 2—COMPLETE SCHEMATIC DIAGRAM of the Expanded Bargraph Display illustrates that most of the circuit work is accomplished within the LM3914 bargraph-driver chips.

The stepped offset voltage (delivered to Pins 4 and 6 of U2) is the key to that novel circuit application.

For those not familiar with the LM3914, it's an integrated-circuit that senses an analog input signal and drives ten LED's that provide a linear display of that signal. It has a series of ten comparator/LED drivers connected to both an internal 10-step voltage divider and the input signal. A comparison between the individual voltage-divider points and the input signal determines how many LED's will be turned on. The LM3914 operates in either a dot or bar mode, although in the present application only the bargraph mode will be used. For a more detailed description of the LM3914, refer to National Semiconductor's data book or data sheets.

As an alternative, the LM3915 is a logarithmic 3-dB/step version of the LM3914 that you might want to try using for audio applications. Its pinout connections are the same as the LM3914; only the internal voltage divider is changed.

Getting a Bit more Detailed

The D/A converter (see Fig. 1) generates a DC voltage that is proportional to the number of LED's lit in the bar display of DIS1, and is used to bias U2's internal referenced-divider circuit via pins 4 and 6.

Resistors R5-R14 (see Fig. 2), in series with the LED's in DIS1, are used to create proper logic levels for the ten inverters. Normally the anodes of the LED's would be connected directly to the supply voltage, as are DIS2's LED's. With the LED's on or off, the cathode voltage would measure the same, about 10.5 volts; one LED voltage-drop below the 12-

volt supply voltage. With the series resistors in place, the LM3914 LED drivers saturate and turn on fully, reducing the LED cathode voltage to less than 1 volt, while the excess voltage is dropped across the series resistors. That way the voltage on the LED cathodes is made to vary from 10.5 volts when off, to less than a volt when on, which provides the proper logic levels for the inverters.

As each LED in DIS1 turns on, an inverter housed in either U4 or U5 switches state (input-low, output-high), forcing current through one of the ten precision resistors, R16-R25, into U3-b's inverting input. Refer to Fig. 2 Since the resistors have a 1-percent tolerance, each inverter that turns on or off will step-change the current into U3-b by an equal-amount. If all of DIS1's LED's are off, then all the inverter outputs are low, and no current is forced into U3-b. If one LED in DIS1 turns on, that inverter's output will go high to about 5 volts and force 0.5-mA of current into U3-b. So, if three LED's were on, 1.5-mA would flow into U3-b. That current generates a negative voltage at pin 8 of U3-b that is proportional to the number of LED's in DIS1 that are lit. Potentiometer R26 is then adjusted so that the output at pin 8 is equal to exactly -0.5-volt per LED.

Although the schematic diagram (Fig. 2) lists specific pins for the hex inverters U4 and U5 to connect with U1, it is important which inverter in either chip connects to which output pin on U1. Just as long as one inverter in either U4 or U5 is connected to each of U1's output pins (1,10-18), everything will be OK, because all the inverter outputs feed into U3-b's input. Since only ten of the twelve inverters are used,

PARTS LIST FOR EXPANDED BARGRAPH DISPLAY

CAPACITORS

C1, C2, C4-C5—10- μ F, 16-WVDC, electrolytic
C3—2.2- μ F, 16-WVDC, electrolytic or tantalum

SEMICONDUCTORS

D1, D2—1N914, 1N4148 diode or equivalent
DS1, DS2—Bargraph display, RBG1000, MV57164,
Radio Shack 275-081A, or equivalent
U1, U2—LM3914 dot/bar display driver integrated
circuit
U3—LM324, or LF347 quad op amp integrated
circuit
U4, U5—4049 CMOS hex inverter/buffer integrated
circuit
U6—78L05 5-volt positive regulator integrated
circuit

RESISTORS

(NOTE: All resistors 1/4-watt, 5% unless
otherwise noted)

R1—100,000-ohm
R2, R4-R14—1000-ohm
R3—10,000-ohm, PC-mount potentiometer
R15—2200-ohm
R16-R25, R29-R32, R34—10,000-ohm, 1% or better
R26—2000-ohm, PC-mount potentiometer
R27—10,000-ohm
R28—1000-ohm, PC-mount potentiometer
R33—3300-ohm
R35—4700-ohm

ground the inputs to the two unused inverters and leave their outputs unconnected.

The inverters in U4 and U5 aren't intended to be used as current sources, so the output voltages aren't guaranteed to be matched under load. However, in the present circuit application with low output current drain, they work quite well. The 4049 inverters have the unique ability to accept input levels up to +15 volts without damage while operating from a 5-volt supply. That allows them to take the 10-volt logic levels from the LED's and transform them into 5-volt outputs. Because of that ability and their high output current capacity (for CMOS), the 4049 hex inverter/buffer is often used to interface between CMOS and TTL chips.

The reference-offset amplifiers circuit (U3-c and U3-d) takes the output of the D/A converter (U3-b), inverts it to a positive voltage, adds an offset voltage, and applies it to the R-high and R-low end of U2's internal reference divider, pins 6 and 4. See Fig. 2.

Since U3-c is a unity-gain, inverting amplifier, its output is equal, but of opposite polarity, to the output of U3-b. U3-d is also a unity-gain, inverting amplifier, but with an added offset-adjust potentiometer, R28. Its output is equal to the output of U3-c plus 0.5 volts. If, for example, five of U1's LED's were lit, U3-b's output voltage would be -2.5 volts; the output of U3-c would be +2.5 volts, and the output of U3-d would be +3.0 volts. The outputs of U3-c and U3-d always change in 0.5-volt steps, and U3-d is always 0.5 volts higher than U3-c because of the voltage offset from R28. That is what keeps a 0.5-volt difference across U2's internal resistor divider reference, and which is equal to one-tenth the full-scale input to U1.

National Semiconductor's published specifications require a minimum reference of 200-millivolt across the LM3914's (U1 and U2) internal resistor divider in the bargraph mode. Since the voltage across U2's divider will be one-tenth of U1's reference voltage, that would require at least a 2.0-volt reference for U1. In the present case, because U1's nominal reference is 5 volts provided by U6, I set U2's voltage divider to 0.5 volts, which is one-tenth of U1's.

The voltage reference, U6, is a 100-mA, 5-volt regulator that provides a reference voltage for U1. It also powers U4 and U5 so that their outputs are 5 volts.

The Rest of the Circuit

Resistor R15 and U2 sets the brightness of the 9 LED's in DIS2 (see Fig. 2). With the 2200-ohm value, a fairly good match is made between the two sets of LED's. Reducing the

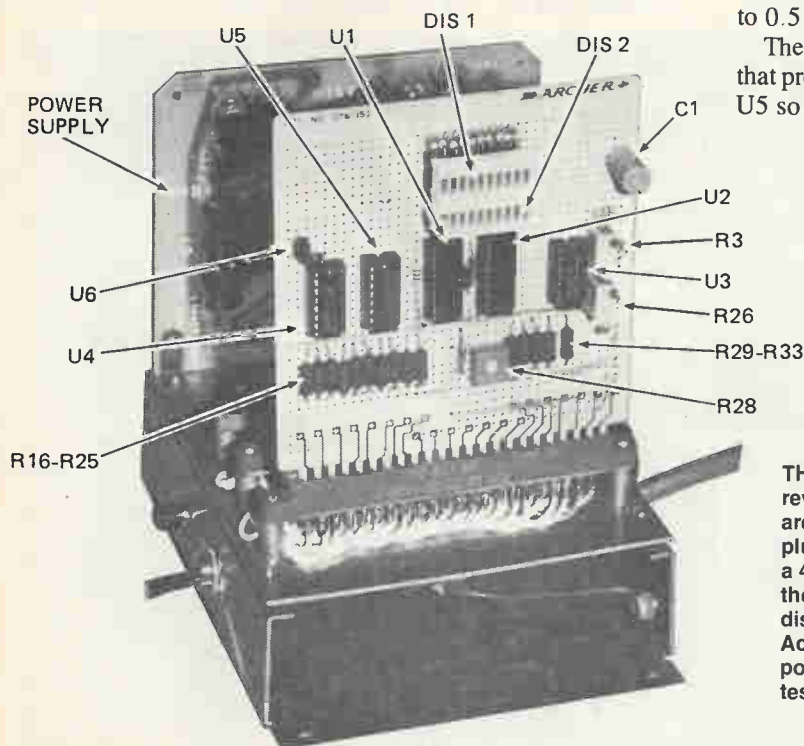

THIS VIEW OF THE Expanded Bargraph Display reveals that the circuit elements shown in Fig. 2 are assembled on an Archer (Radio Shack) multi-purpose, plug-in board #276-152 and plugged into a 44-pin card-edge socket. The socket connects the circuit to the voltage to be measured and displayed, and to the power sources required. Actually, the chassis with three connectors and power-supply card in the rear is a power-supply test stand used by the author for his many projects.

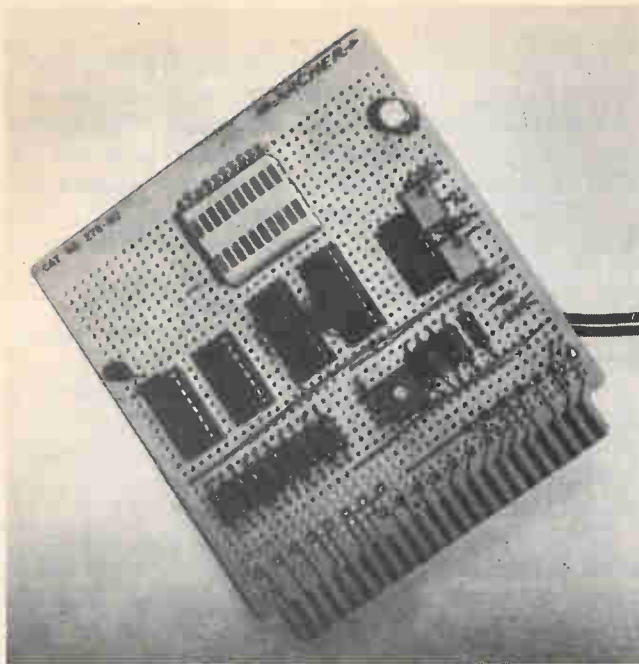

value of R15 will increase their brilliance, but be careful not to exceed the chip's power-dissipation limits. The 1000-ohm resistors (R5 to R15) in series with U1's LED's limit the LED currents to about 10 mA.

When building the circuit, adjust potentiometer R3 in the U3-b-c-d circuit so that the maximum full-scale input to pin 6 of U2 will be amplified to 5 volts; or more exactly, the actual value of the voltage measured on pin 6 of U1.

Diodes D1 and D2 on the outputs of U3-c and U3-d limit the negative output voltage of those two amplifiers to about -0.6 volts. That protects U2 (pins 4 and 6) from negative transients, which can occur when turning the circuit's power on and off. The signal input to pins 5 of U1 and U2 are internally protected against voltages as great as ± 35 volts, so

THE WIRED Expanded Bargraph Display illustrates how the author took advantage of the foil pattern of an existing plug-in, printed-circuit card to assemble his project.

U3-a doesn't need a protection diode on its output.

While DIS1 has a standard set of ten LED's, DIS2 only has nine LED's because it displays the units values and only needs to count from 0 to 9 before the next tens-LED turns on. A display of 39 would have 3 tens on and 9 units on. When the display changes to 40, all the unit LED's turn off, and 4 tens-LED's turn on. Only nine LED's are actually needed to indicate units.

Ideally, all ten LED's on U2 could be connected so that with an input signal equal to a displayed value of 110, all 20 LED's would be lit. However, due to tolerance errors in the 1% resistors and the reference dividers in the LM3914's, plus offset errors in the op amps, the tenth LED in the units column tends occasionally to come on when it's not supposed to. Closer tolerance resistors and null potentiometers on each op amp could allow the last LED to be used but at considerable added expense for just one more LED.

Building the Circuit

No special precautions are needed to assemble the circuit as long as a few simple rules are followed. The prototype on a Radio Shack #276-152 plug-in board was handwired. The board was convenient to use because of the etched copper pattern, which includes power and ground buses; however, a piece of perfboard would do as well. Extra buses for +12 volts and ground were added across the middle of the board to reduce voltage drop and noise problems, which could cause erratic bar displays.

A printed-circuit board could be designed for the circuit; however the numerous connections between U1, and the ten LED's of DS1, the ten inverters, and resistors R5-R14 would make it difficult to design a single-sided board for the experimenter at home.

On both LM3914 chips, be sure to connect pin 9, the mode

PARTS LIST FOR POWER SUPPLY

- B1—SPST toggle or slide switch, SPST
- BR1—VM08 bridge-rectifier module (or Radio Shack 276-1161 or equivalent)
- C1—470- μ F, 25-WVDC, electrolytic capacitor
- C2—100- μ F, 25-WVDC, electrolytic capacitor
- C3,C4,C6,C8—10- μ F, 16-WVDC, electrolytic capacitor
- C5—.0-1 μ F, ceramic, disc or mylar capacitor
- C7—50- μ F, 16-WVDC electrolytic capacitor
- D1,D2—1N914, 1N4148, or 1N4000 series diode rectifier
- F1—1-ampere fuse
- R1—1000-ohm, 1/4-watt, 5% resistor
- R2—10,000 ohms, 1/4-watt, 5% resistor
- T1—Power transformer: 117-volts AC; 25.5-volts at 200 mA, or better
- U1—7812 12-volt positive regulator integrated circuit
- U2—7912 12-volt negative regulator integrated circuit
- U3—555 oscillator/timer integrated circuit
- U4—79L05 5-volt negative regulator integrated circuit

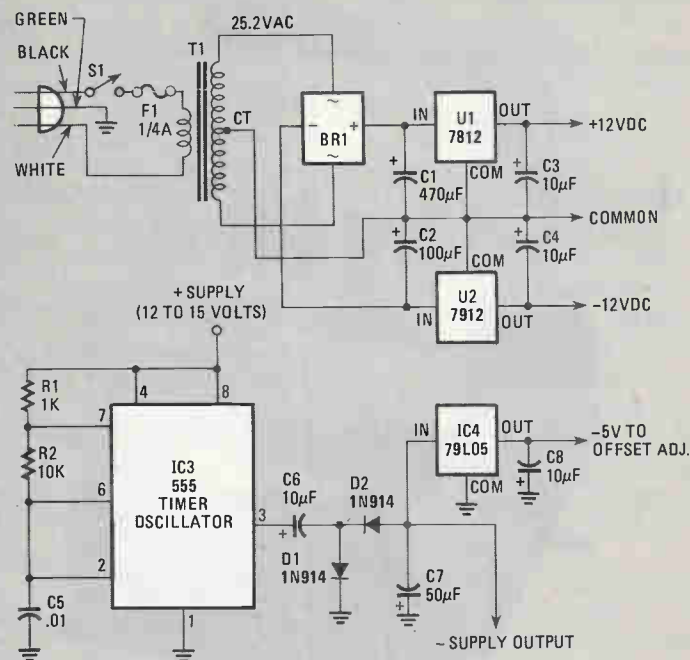

pin, directly to pin 3 so that they both see the same voltage. Don't assume that pins 3 and 9 will be at the same potential just because they're connected to a common power bus; National Semiconductor stresses that point in their data book. Also, extra filter capacitors scattered around the board—particularly between ground and the supply pin of each chip—will help to reduce potential feedback and instability problems. 2.2- μ F tantalum capacitors were used because they are small and usually available; however 10- μ F electrolytic capacitors as shown in the schematic diagram (see Fig. 2) are also suitable, plus they're usually cheaper.

It's a good idea to use sockets for the integrated-circuit chips, especially for the LM3914's, since they cost about four dollars each, and so do the bargraph LED displays. You could use individual LED's for a less expensive and more customized display if you prefer.

Be careful when wiring U4 and U5; pin 1, not pin 16, is the power connection to the chip. Pin 13 and 16 have no internal connections.

Carefully wire the board, then make continuity checks without the integrated-circuit chips, or LED's, installed to see if any supply lines are shorted to ground, or if those lines are not going where they're supposed to go. Still, without the integrated-circuit chips and LED's installed, apply power and make some voltage checks to assure yourself that all is well.

After all the checks have been made, and any problems corrected, install the integrated-circuit chips, apply power and a DC input signal. You should be able to get some of DIS1's LED elements to light, and maybe some of DIS2's, also.

Now apply the full-scale input signal to U3-a and adjust the gain potentiometer, R3, for an output voltage equal to the reference voltage on pin 6 of U1. All of DIS1's LED elements should now be lit. Reduce the input voltage to half, so that only five of DIS1's LED elements are lit. Assuming that you're using a 5-volt reference on U1, monitor the output of U3-b and adjust its gain potentiometer, R26, so that the output is -2.5 volts. The output of U3-c should now be

+2.5 volts if everything is operating properly. Then, while monitoring U3-d's output, adjust the offset potentiometer, R28, for 3.0 volts—that's a .5-volt increase. The circuit should now be fully operational so that as you vary the input signal, the 19 LED's will give a proper graphic display. You may need to tweak the various potentiometers slightly to get the display to more closely agree with the input-signal voltage.

If the quad op amp, U3, gets hot, turn off the power. U3 should have no perceptible warmth. Check your wiring again and look for shorts on the op amp outputs to either of the supply voltages or to ground. Also check for proper ground on pins 2 and 8 of U2, otherwise chips U1 and U2 will run too warm.

This Expanded Bargraph Display was primarily assembled for demonstration purposes; therefore, it's not ideally suited for practical applications, due to the board size and mounting of the bargraph displays. The one you build can be more compact and built with the displays mounted more appropriately. It wouldn't be difficult to install the displays and resistors R5-R14 on a small board for remote mounting and run a 20-wire cable back to the main board for the nineteen LED's and power. Since the LED's are not multiplexed, there shouldn't be any noise problems even if you use several feet of wire. The current drain per LED is low, so the small, added resistance of the wire won't cause any dimming of the displays.

Power for the Circuit

The power supply wasn't built onto this Expanded Bargraph Display circuit board, although with a larger circuit board it could have been. The 78L05 voltage regulator, U6, used both as the 5-volt reference for U1 and power for U4 and U5, is mounted on the board. A circuit diagram for a typical power supply that is adequate for this project is included in Fig. 3. Be sure to heatsink the +12-volt regulator since it's the one doing most of the work to power the circuit and will supply over 100 mA when all 19 LED's are lit.

Also, shown in the power supply schematic diagram (Fig. 3) is a DC-to-DC converter using a 555 timer/oscillator. It can be used to generate a negative voltage for the circuit when used in an automobile or other battery-powered applications. The 555 astable oscillator operates with a 50-50 duty cycle at about 7 kHz with the non-critical parts values shown. Since the negative current drain for the bargraph circuit is about 8 milliamperes maximum, the 1N914 diodes act as excellent, inexpensive rectifiers, although 1N4000 series rectifiers can be used instead. Watch the polarities of C6-C8 when building the converter!

A regulated negative supply is unnecessary to operate the integrated-circuit chips although a 79L05 regulator (see U4 in Fig. 3) should be used for the offset bias circuit to keep it stable. The values of R27 and R28 (Fig. 2) should be cut about in half if you use the negative 5-volt reference instead of -12 volts. With a +12-volt supply to the 555, the unregulated output will be around -9 volts, which is sufficient voltage for the op amps and the 79L05. **SP**

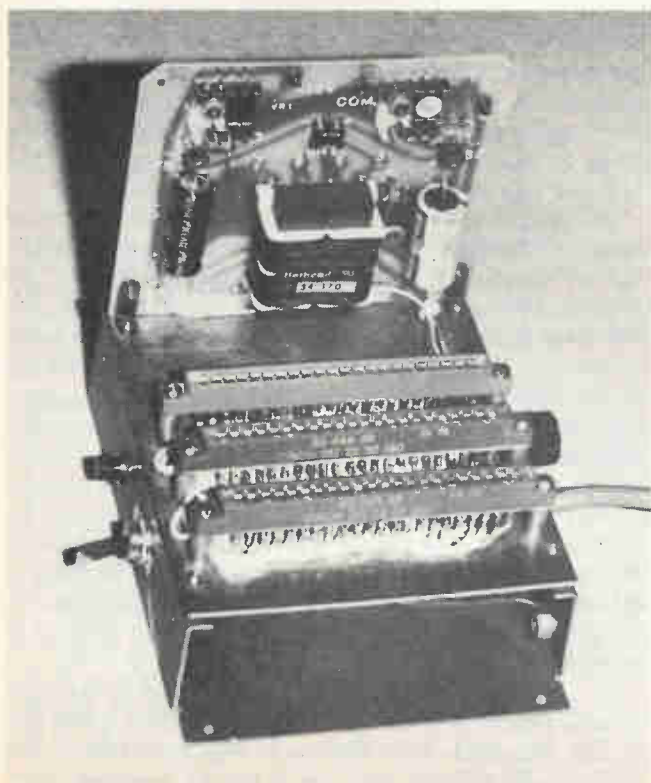

JUST IN CASE you'd like to build a power supply like that made by the author, here's what it looks like without any project boards plugged into the three 44-pin card-edge connectors. See schematic diagram and Parts List at left.



LED HEAD Lightchaser

Electronic gimmickry at its best—an outrageous project designed for fun!

COLIN DAWSON

□ LED CHASERS HAVE BEEN USED IN SOME WEIRD AND WONDERFUL devices over the years but few have been as outrageous as this project. In our uncompromising quest for state-of-the-art electronic gimmickry we have designed an electronic headband using the LED chaser. The circuit is quite compact and simple; it could just as easily be used to adorn a sun visor of a car, a blackboard pointer, retail showcase eyecatcher, or any other likely item or application.

We are assuming, however, that most project builders will opt for the LED chaser headband*, and in honor of those innovators, we have christened the project "LED Head". Why LED Head? Well, there aren't many names suitable for a project that sets light-emitting diodes chasing around a person's pre-frontal lobe, and, it seemed like a bright idea!

The LED Head should prove very simple to construct, and in most cases will be one of the cheapest projects you can build. The actual light chaser circuit, including a box, should

not cost much over \$10. The only additional expenses are for a battery and suitable headband.

The LED Head does not incapacitate the wearer while it is being demonstrated. You can go about your business as normal if wearing LED Head is normal for you. For that reason we anticipate that the LED Head may be used for rather long continuous periods. Of course, that makes a fairly heavy demand on the power supply, which may not be met by the ordinary transistor-radio battery commonly used in portable projects. That 9-volt battery will give a useful life of about one hour of continuous use, and is the only battery which will fit in the small plastic utility box. If its capacity is inadequate, the solution is to use an external battery pack. An alternative would be to use a bench power supply but that might present a problem if you wish to do some serious disco-ing.

Giving the impression of movement to a string of lights, light chasers produce an appealing effect. Besides the well-known commercial applications, they are almost mandatory on the control panel of science fiction spaceships. To the technically uninitiated, such displays are synonymous with computers, death rays, and other devices of unfathomable complexity. In fact, that circuit is quite simple, but only **Special Projects** readers need know it.

It is possible to give the impression of movement to any number of lamps in a "string" by wiring them in groups of four. It is then only necessary to use a sequential four pole switch (or its electronic equivalent) to switch the lamps in sequence. At the first switch position, only the first lamp from each group is on; at the second position, only the second lamp should be on, and so on. By placing several groups of lamps end to end, movement appears continuous from one end of the array to the other.

The circuit used in the LED Head fits neatly in a small plastic utility box mounted on a printed-circuit board. That part of the circuit can be considered as three parts: an oscillator (U1); a divider (U2); and a buffer/driver section (the four transistors, Q1-Q4). Refer to Fig. 1.

Integrated-circuit chip U1 is a 4011 CMOS quad two-input NAND gate. That may sound rather daunting, but it simply means that the chip has four NAND (NOT AND) gates, each gate having two inputs. In the circuit, only three of the gates are used with the inputs to the fourth gate tied permanently low. By tying the inputs of a NAND gate together, the gate can be made to operate as an inverter, that is, its input is in the opposite state to its output.

Referring to the circuit diagram in Fig. 1, it can be seen that three such inverters, U1-a, b, and c, are connected in series. A 1- μ F capacitor, C1, and a 27,000-ohm resistor, R2, are connected between the outputs of U1-b (pin 4) and U1-c (pin 10). Since those two outputs will always have opposite polarity (because U1-c is an inverter) the capacitor will be charged in one direction, or the other. The 27,000-ohm resistor provides a time of about 60 milliseconds for the charging. After that time has elapsed, the input of U1-a (pins 1 and 2) will be taken low (or high) and the gate output will change.

That will cause the other gates to change states and the 1- μ F capacitor (C1) now begins to charge in the opposite direction, again with the same charging time. The result of the continuing sequence is a squarewave output at pin 10, which then provides clock pulses at a frequency of about 17 Hertz for the counter, U2.

To give the desired sequential switching of the LED groups, a 4017 CMOS decade counter is used for U2 (see Fig. 1). That integrated-circuit chip has 10 outputs, numbered 0-9, and normally each one goes high in turn for one clock cycle.

*Original project appeared in *Electronics Australia*, January, 1983 Edition, and reappears here by permission.

Because we only require four different outputs, the fifth output is connected to the reset and the effective count is four.

The 17-Hertz output of U1-c at pin 10 is connected to the clock input (pin 14) of U2, the 4017 decade counter. On each positive transition of the squarewave, the 4017 advances one count. The decoded "4" output (pin 5) is connected to the reset (pin 15). As soon as pin 5 goes high, the counter is reset with the decoded "0" (pin 3) going high. That last operation is independent of the clock input and, so far as the circuit is concerned, is instantaneous. Hence the 4017 (U2) is operating as a one-of-four counter.

Four NPN transistors, Q1-Q4, are used to buffer the outputs of the 4017 counter, U2. Four 10,000-ohm resistors (R3-R6) connect each output of U2 to the base of its respective transistor.

LED Combinations

Assuming that there are to be 12 LED's in the array (see Fig. 1), the LED's driven by the decoded zero (pin 3) will be 1, 5 and 9. Similarly, the decoded 1 (pin 2) will drive LED's 2, 6 and 10; decoded 2 (pin 4) LED's 3, 7 and 11; and decoded 3 (pin 7) LED's 4, 8 and 12. If an additional 12 LED's are included, they must be wired in the same manner as the first 12. The two displays are then mounted end to end (in the mechanical sense).

As we have presented it, the display has 12 LED's arranged in four groups of three. One group is on at any given time, meaning that three LED's at a time must be driven. In fact, the three LED's are driven in series to minimize the current drain from the 216-type battery. The printed circuit board allows the option of adding another four groups of LED's, the second group being driven in parallel with the first. Consequently, the current drain of the circuit is doubled. That virtually eliminates the 216 battery as a practical power source with a pack of four 1.5V "AA" cells becoming the smallest practical power supply.

A separate current limiting resistor is used for each group

of LED's so that the value of the resistor can be tailored to suit the LED's used. Different value resistors are required to compensate for the differing operating characteristics of various LED types. For example, red-colored LED's will exhibit a forward voltage drop of typically 2-volts, whereas green LED's will be nearer to 2.6 volts. Assuming that the chaser has homogeneous LED groups, the red LED's will require a higher-value limiting resistor than the green. In fact, the values suggested are 220 ohms and 68 ohms for red and green LED's, respectively. Our prototype used red LED's only, for minimum current drain.

Actually, the values of 220 ohms and 68 ohms do not precisely equalize the operating currents. The green LED's are purposely operated at a slightly higher current than the red to compensate for their lower efficiency. Amber and yellow LED's are also available and their operating characteristics can generally be expected to fall between red and green LED's.

PARTS LIST FOR LED HEAD LIGHTCHASER

- B1—9-volt transistor battery or six type-A batteries or better (See text)
 - C1—1- μ F non-polarized electrolytic capacitor
 - C2—100- μ F, 16-WVDC electrolytic capacitor
 - LED1-LED2—Red light-emitting diode
 - Q1-Q4—MPS2222A NPN transistors
 - R1—1-Megohm, 1/4-watt resistor
 - R2—27,000-ohm, 1/4-watt resistor
 - R3-R6—10,000-ohm, 1/4-watt resistor
 - R7-R10—220-ohm, 1/4-watt resistor
 - S1-SPST momentary pushbutton switch
 - U1—4011 CMOS quad 2-input NAND gate integrated-circuit chip
 - U2—4017 CMOS decade counter integrated circuit chip
- Printed-circuit board material, rainbow cable, headband, plastic utility box, battery snap-connector, solder, wire, hardware, etc.

FIG. 1—THE LED HEAD LIGHTCHASER consists of an oscillator (U1), counter circuit (U2), and LED driving transistors (Q1-Q4) that can be compacted into a small package, including the battery. The low voltage makes this circuit much safer than the neon type it replaces.

FIG. 2—SAME-SIZE printed-circuit board gives you an idea of exactly how small the final project will be. Just photocopy the foil pattern, or trace it, to make your project's board.

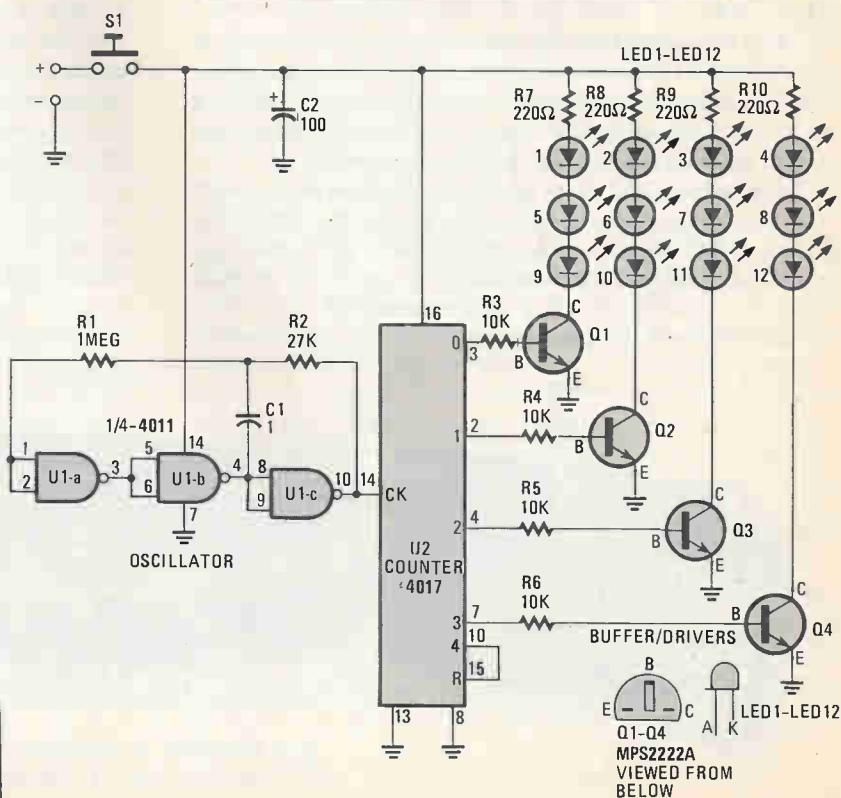
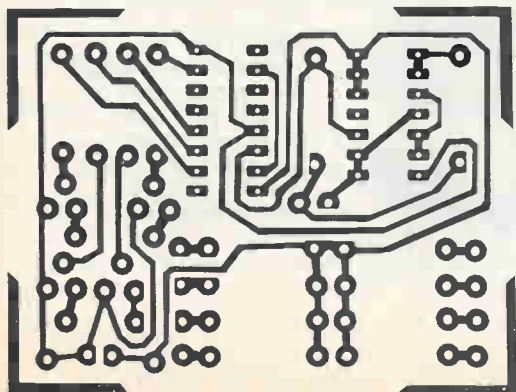

THE ENTIRE CIRCUIT except for the LED's are mounted on the printed-circuit board. If you choose to eliminate switch S1 (Fig. 1), the battery clip can be used to disconnect the battery from the circuit. The clip's leads connect to the unused holes either side of C2—connect positive lead to + side.

Irrespective of the current limiting resistor used, the battery can be expected to have a shorter useful life if green LED's are used. With three LED's in series, the total forward voltage drop is 3×2.6 -volts or 7.8-volts. Once the battery voltage falls below that level, the LED's will not illuminate at all. Hence the useful life of the battery is the time it takes to discharge from a nominal 9-volts to 7.8-volts, which, for a transistor-radio battery, will be somewhat less than one hour. By comparison, the circuit will continue to function down to about 6 volts with red LED's.

Construction

If you are housing the electronics for the project in a plastic box, make sure that the printed-circuit board fits into the box. The printed-circuit board (see Fig. 2) has nominal dimensions of 1.8-in. wide by 2.4-in. long. Once that has been taken care of you can begin assembly of the printed-circuit board components. Mount the integrated-circuit chips U1 and U2 last and connect the barrel of the soldering iron to a good ground when doing so. Solder the ground pins (7 for U1 and 8 for U2) first, followed by the positive supply pin (14 and 16). That protects the chips from static damage. Refer to Fig. 3 for parts location on the printed circuit board. You don't have to use a printed-circuit board; a perfboard will do just as well. In fact, should you plan to conceal the circuit board on your person, you may want to use some stiff, but flexible, insulation material like a vinyl plastic—and forgo the use of a plastic box.

The box needs to have two holes drilled in it. One of those is for switch S1 and the other is for the wires connecting to the LED's. For a momentary contact pushbutton switch, a hole of $\frac{1}{4}$ in. diameter is needed. Make sure that you mount the switch high enough to clear the printed-circuit board.

To prepare the LED's for mounting, bend the leads so that they are perpendicular to the encapsulation. That allows the LED's to face forward (rather than upward) after mounting. Make sure that you bend the leads the same way on each LED; for example, the anode always to the left.

Assembly will be simplified if the cloth is of the looped

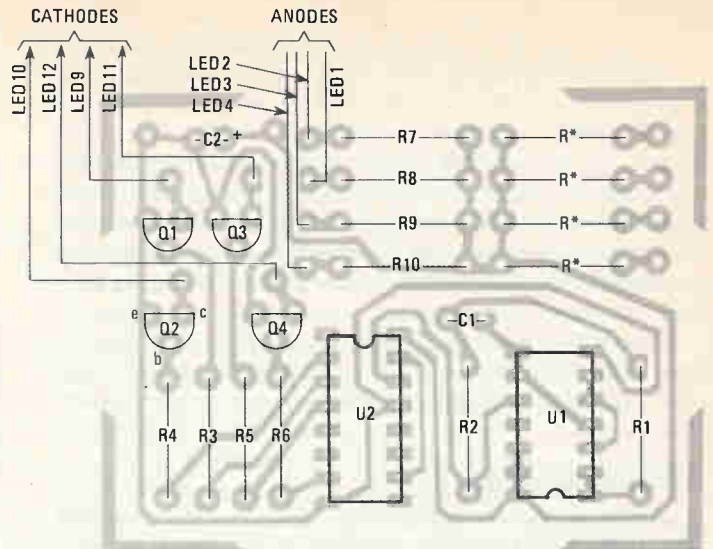

Terry-towelling type. You may want to use the pro-type sweatbands used by joggers. The leads of the LED's are pushed through the loops on the outside of the headband. If the leads are spaced by about $\frac{1}{4}$ inch, the LED's will be less prone to movement after assembly. Once the wiring was completed, we found that no other means of securing the LED's was necessary with the qualification that a periodic re-alignment may be needed.

The method of connecting the series strings are as follows: LED 1 to LED 5 to LED 9; 2 to 6 to 10; 3 to 7 to 11; 4 to 8 to 12. Connect the LED's anode to cathode using links of hook-up wire that are long enough to accommodate the full stretch of the headband. The anodes of the first four LED's are connected to the current limiting resistors and the cathodes of the last four LED's are connected to the driving transistors. The cathode connections will have to be in the correct sequence, or the light-chasing effect will be lost.

The wiring is the major part of the construction for this project so it is well worthwhile re-checking it before switch on. The LED's may be damaged by having a reverse bias applied to them and that would undoubtedly be cause for disappointment amongst potential LED Headers. If the circuit is operating correctly, you will be greeted with a chain of LED's which appear to chase rapidly around the head. The speed at which they chase can easily be altered by changing the value of the 27,000-ohm resistor, R2. Now you are ready to wear the LED Head. Do so at your own risk as to what your friends and family will say and think about you. Please do not mention **Special Projects** until the comments from your friends are favorable. **SP**

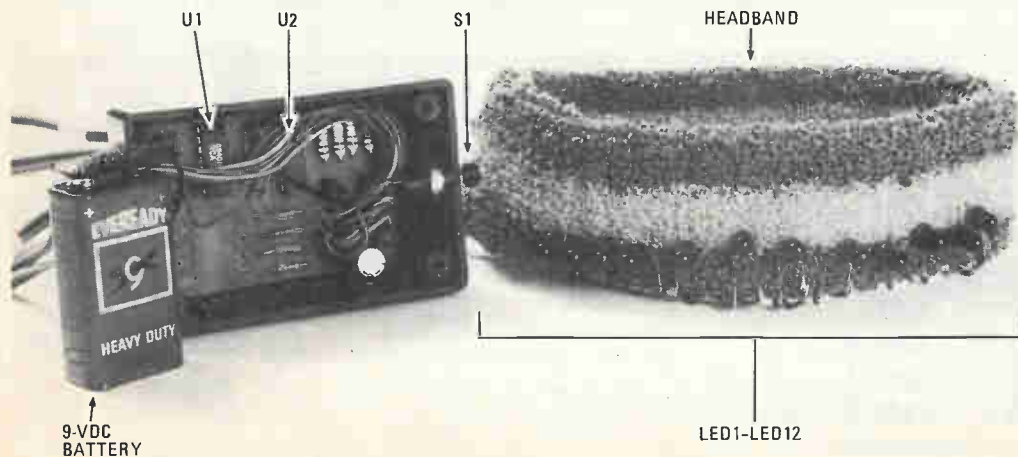

HERE IT IS—all assembled and ready for the next party! Should you install S1 in your project, connect it in series with the positive lead of the battery.

Don't fret about unusual color codes or no markings at all—just use our...



Digital Capacitance Meter

□ HAVE YOU EVER WANTED TO CHECK A SUSPECT CAPACITOR when troubleshooting? Have you ever been totally confused by capacitor markings? If you're like me, then you probably have a junkbox full of old capacitors—unknown and unusable. You know the kind I'm talking about; those with the good old value markings, or no markings at all! If that sounds familiar, then the Digital Capacitance Meter is just what you need! The design for the device uses easy-to-obtain and inexpensive components, which will allow you to build it in just a few hours at about half the cost of comparable meters. Due to its CMOS design, the meter will operate from a battery or wall-adaptor power source, and is relatively immune to external noise.

The total range of measurement for the Digital Capacitance Meter is from 1 picofarad (pf or $\mu\mu\text{F}$) to 9999 microfarads (μF). The meter is capable of accuracy in excess of 5% at full scale, and resolution on any range is plus or minus 1 unit. Options allow you your choice of LED display color, and a nanofarad or low microfarad range indication.

Theory of Operation

By allowing the capacitor under test to control the period of a one-shot timing circuit, the output pulse is variable to the extent that its duration is a direct function of the test capacitor. (Part of quad timer 558, U1, in Fig. 1.) Now, if we allow that pulse to control the number of clock pulses which are to

be fed into a counter circuit, then we can decode and display a count which will be equal to the value of the test capacitor. We may accomplish such a design with a 555 timer circuit, and a NAND gate. One of three calibrated resistances, (one for each range), and the test capacitor are the timing elements used by the one-shot timing circuit. Its output variable pulse is fed to one input of a NAND gate. The other input to the gate are the clock pulses, which we want to control. Clock pulses will only be present at the output of the gate during the period of the variable gate or pulse.

Three different clock frequencies are used in the Digital Capacitance Meter. A separate clock frequency is used for each range, so that the values of the range-trimmer resistors (TR1-TR3 in Fig. 1) will provide reasonable results for the desired total range of the instrument. A 1-MHz crystal oscillator (U2-b) supplies the clock frequency for the picofarad (PFD) range. That frequency is divided by sections of a dual BCD counter (U3) which provides 100-kHz and 10-kHz clocks. Those clock frequencies are used on the nanofarad (LO) and microfarad (MFD LO) ranges, respectively. The desired clock frequency is set to the input line of the NAND gate via bilateral switch sections of quad-switch U3. The RANGE switch, S1, setting determines which bilateral switch section in U4 is enabled, and thus which clock frequency is to be applied to the NAND gate of U2-a.

Residual input capacitance will cause the meter to indicate

**SAMUEL T. ELKINS and
JIMMIE L. BRECKENRIDGE**

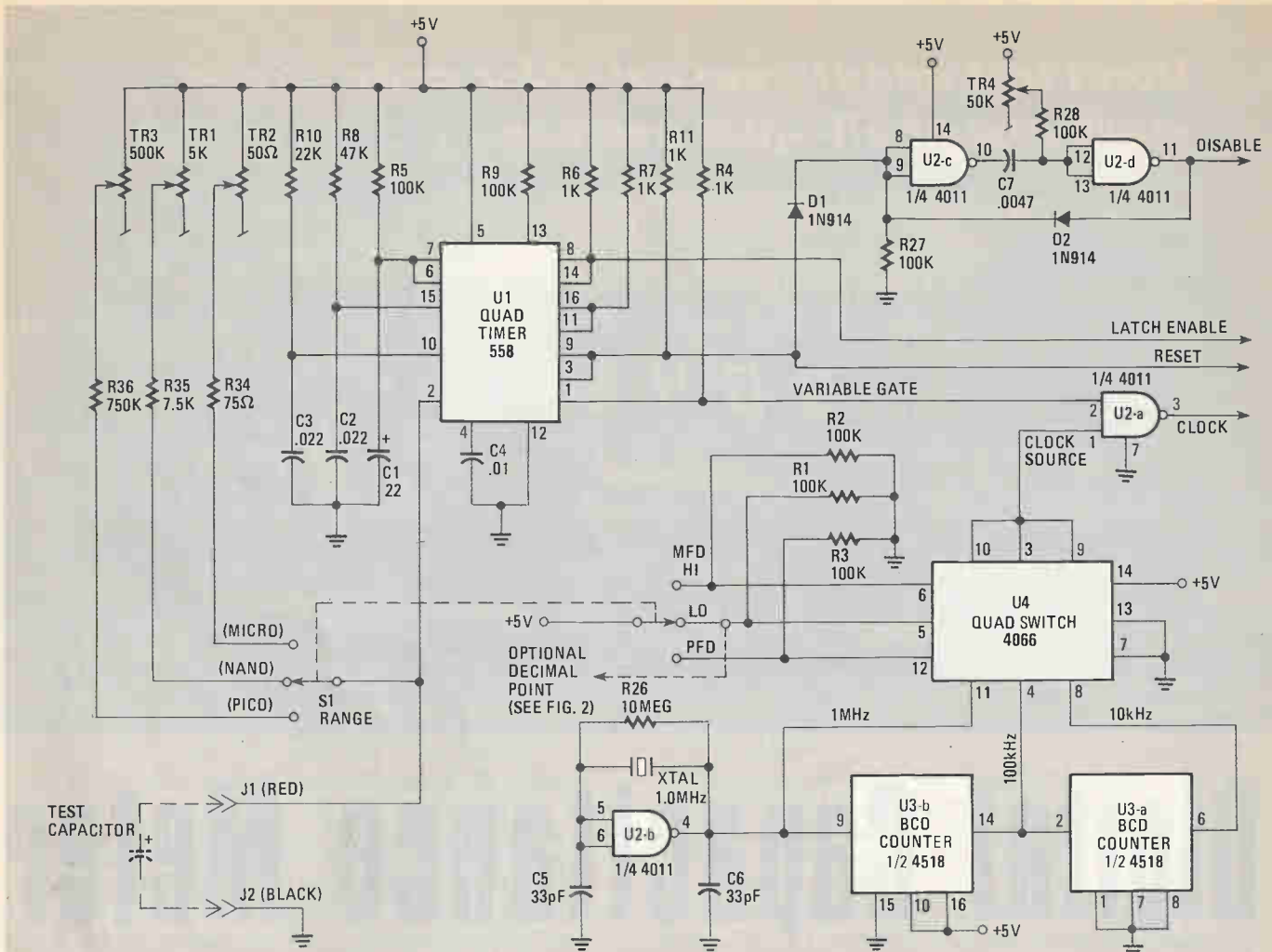
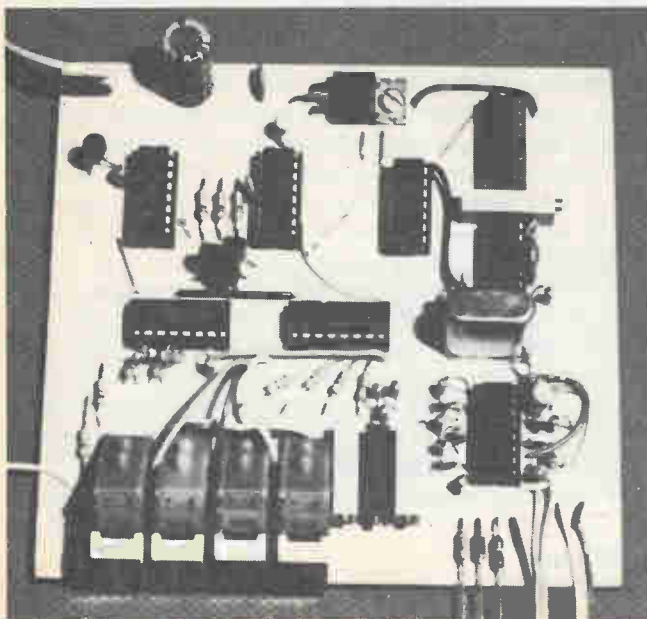

FIG. 1—THE SCHEMATIC DIAGRAM for the Digital Capacitance Meter is broken into two parts. In this illustration the diagram shows the basic timing circuits and clock generator.

an error at the low end of the picofarad range. To eliminate that problem, a masking pulse is generated during the first few microseconds of each test cycle. That pulse is used to inhibit the count of the clock pulses momentarily. The residual capacitance is still there; however, it will not be count-

ed. Only the additional capacitance due to the test capacitor in the input jacks will be counted and displayed. The masking pulse is generated by two NAND gates (U2-c and U2-d in Fig. 1), and a few discrete components, which are configured as a one-shot circuit. Its output pulse is fed to the disable input of the first counter stage (refer to Figs. 1 and 2).

The design of the Digital Capacitance Meter uses a 558 (quad 555-type timers), IC. That IC is the heart of the meter, because it provides all of the timing and control as well as the test circuit for the capacitor to be measured. One stage is configured as an oscillator, to provide a 1.1-second test interval, while the remaining three stages are used as one-shots. One of those is used for our test circuit; the other two are used to control the counter section. The counter section consists of two 4553 counters (U5 and U6 in Fig. 2), and two 4511 decoder/drivers (U7 and U8). The BCD count is multiplexed into the display LED's (DIS1-DIS4). The displayed count represents data from the previous test cycle, which has been latched into the counters' output latches. Update of the display (DIS1-DIS4) is accomplished at the end of each test cycle, when the 558 IC's 1.1-second oscillator pulses the counters' latch enable input. Following display update, the



THE BULK OF THE CIRCUIT COMPONENTS are located on an easy-to-assemble printed-circuit board shown at left with the external wiring ready for hookup within the chassis.

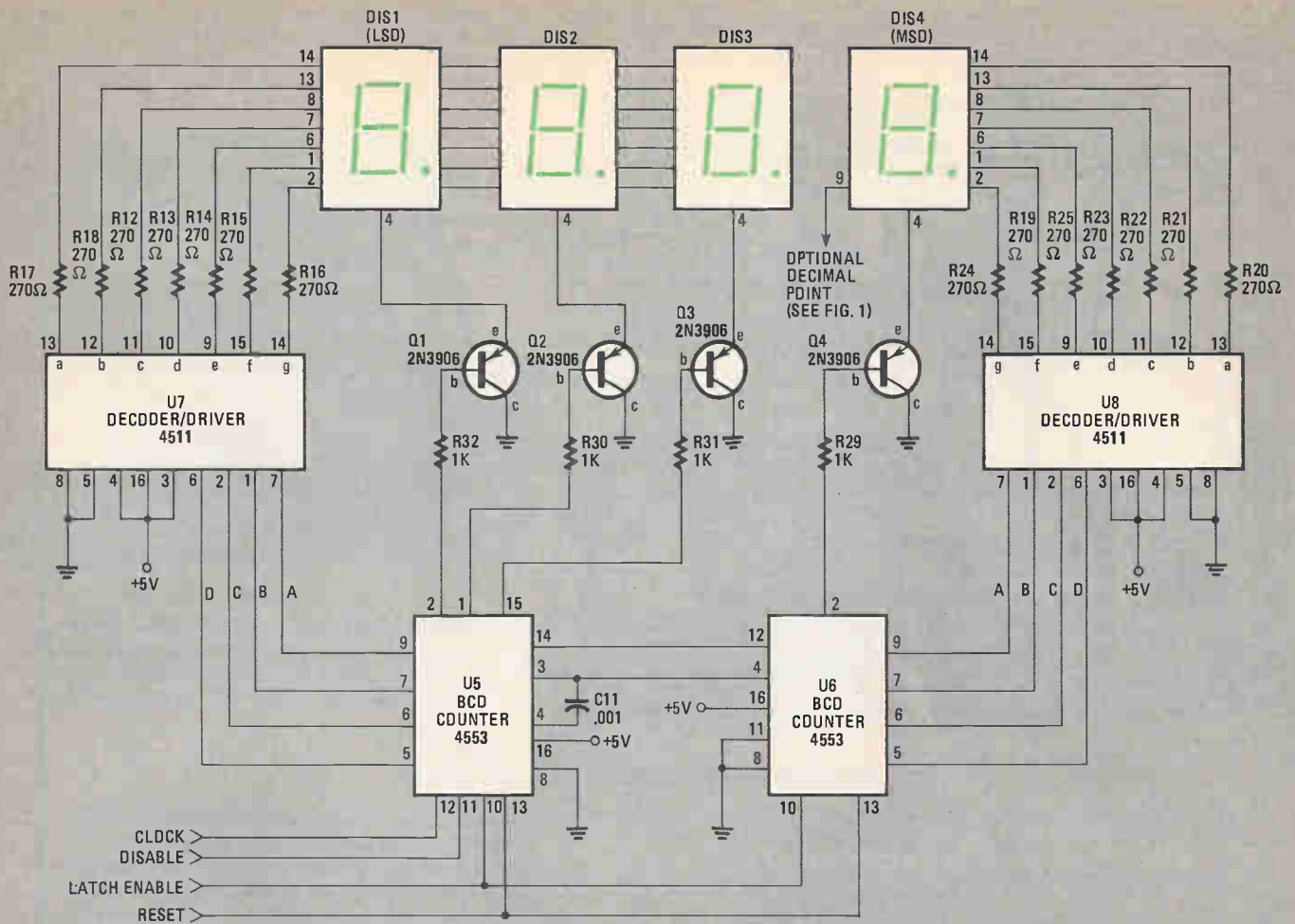

FIG. 2—THE DISPLAY SECTION of the Digital Capacitance Meter is almost standard for four-digit indicators of this type. The optional decimal indication is not necessary unless you loan out your test gear.

558 IC'S master reset circuit resets the counters, and triggers the start of the next test interval.

An optional decimal point can be added to the LO (nanofarad) display by connecting the two dashed leads in Figs. 1 and 2. It is suggested that you review the theory of operation of the Digital Capacitance Meter and refer to the waveform diagrams in Fig. 3. Then, you will get a better understanding of the time relationships of the events happening in the circuit in conjunction with the mechanics of the circuit operation.

Assembly

A pre-etched, printed-circuit board is recommended for this project. The artwork to produce one at home is shown actual size in Fig. 4; however, a complete assembly manual and PC board are available (see Parts List). Use the parts-placement diagram (Fig. 5) to position the components on the printed-circuit board. Note that the diagram shows the components' locations as viewed from the bottom, (foil side), of the PC board. That is so that you might find it easier to locate the components using the circuit traces as a reference. However, should you prefer a top of the board guide, a

photograph is supplied so that you can compare it to your wired unit.

We suggest the use of 5-minute epoxy to adhere the LED display sockets to the board prior to soldering. That will allow for precise alignment of the sockets, and will increase the structural integrity of the display. The use of sockets for all DIP IC's is highly recommended.

The physical size of certain components, as well as their tolerance, is critical — so don't deviate from the parts specified in the parts list.

Keep all jumpers neat and as short as possible. Route the

THE COMPLETE Digital Capacitance Meter, wired and with batteries in place, just before the unit is buttoned up for the final test. Battery cable connector may be omitted.

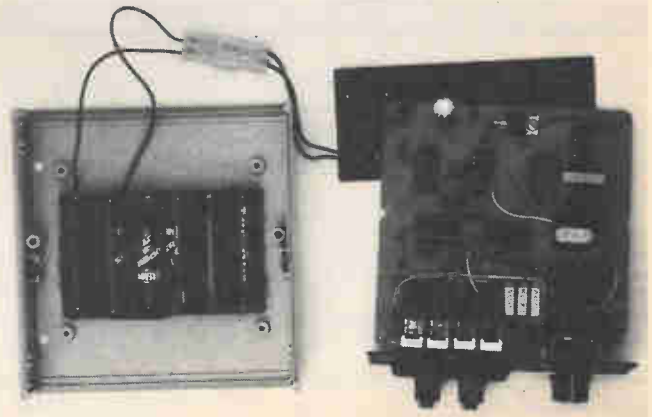

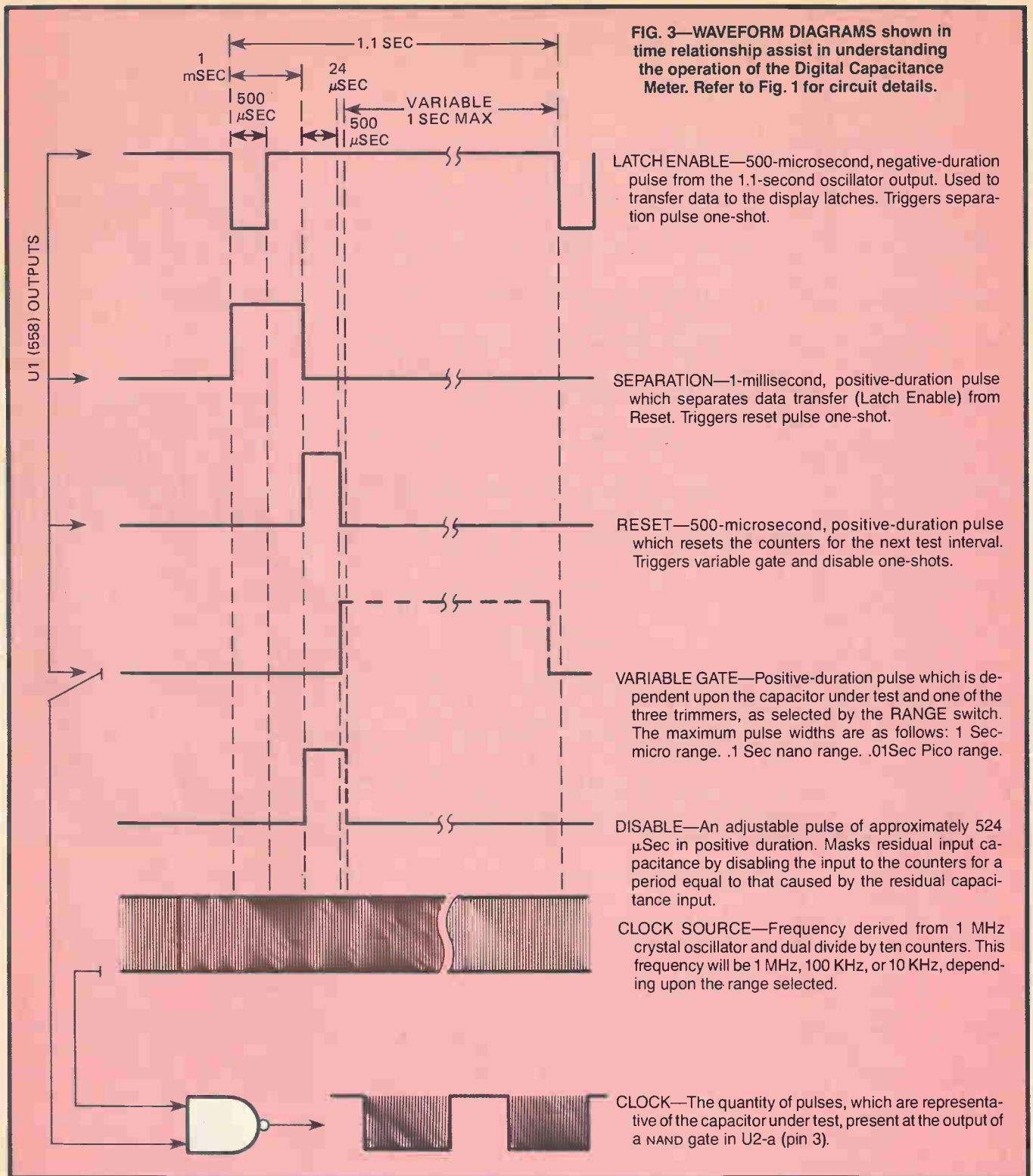

jumpers around, not over, components where necessary.

A non-corrosive flux paste may be applied to all solder-pad areas before soldering with a low-wattage soldering iron, (15-watts or less). The flux residue may be removed, following assembly, with a flux stripper (Radio Shack 64-2324).

Connect the RANGE switch, S1, to the printed-circuit board as shown in Fig. 6. The RANGE switch may be epoxied to the board as in our prototype. That will make a neat integrated assembly, which can then be easily mounted in a small plastic case (Radio Shack 270-218). A battery holder may be epoxied inside the case, and a jack may be mounted at the rear of the case for DC wall adapter operation. Pushbutton terminals

(Radio Shack 274-621) were used on the prototype. Those are well-suited to that application, because they provide a quick, yet positive, connection to the capacitor under test. Test leads, which will clip into the pushbutton terminals, may be fabricated. Terminate those leads with test clips to allow easy connection to large capacitors, or those junkbox specials with short leads!

Since not all of the component parts are shown in Fig. 5, the external wiring and its associated wiring is shown in Fig. 6. Resistors R34-R36 each have one radial lead soldered to the board and the other end connected to a terminal on S1. As mentioned earlier, on the LO range (nanofarads) you can have

FIG. 4—PRINTED-CIRCUIT BOARD for the Digital Capacitance Meter is a one-sided job that distributes the parts location so that the board is not crowded when assembled. It is shown here foil-side up.

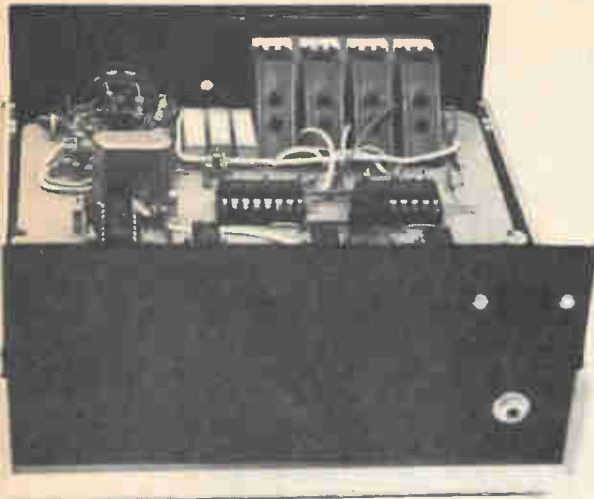

PEEKING OVER THE REAR CHASSIS APRON, the LED displays are seen positioned in front of the hole cut for them. Take care and do a neat job here so that the meter looks good.

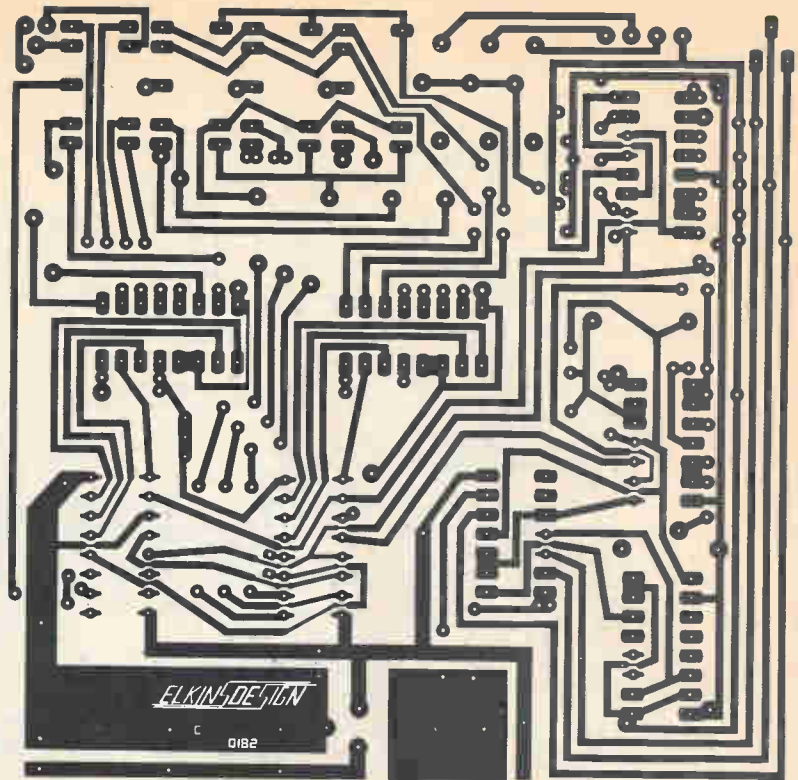

PARTS LIST FOR DIGITAL CAPACITANCE METER

SEMICONDUCTORS

- D1, D2—1N914 general purpose diode
- DIS1-DIS4—MAN-84A 7-segment LED display
- Q1-Q4—2N3906 PNP silicon switching/amplifier transistor
- U1—LM558 CMOS quad timer integrated circuit
- U2—4011 CMOS quad NAND integrated circuit
- U3—4518 CMOS dual BCD counter integrated circuit
- U4—4066 CMOS quad bilateral switch integrated circuit
- U5-U6—4553 CMOS 3-digit BCD counter integrated circuit
- U7-U8—4511 CMOS BCD to 7-segment decoder/driver integrated circuit
- U9—7805 +5-volt regulator integrated circuit

RESISTORS

- (All values are 5%, 1/4-watt units)
- R1-R3, R5, R9, R27-R28—100,000-ohm
- R4, R6-R7, R11, R29-R32—1000-ohm
- R12-R25, R33—270-ohm
- R8—47,000-ohm
- R10—22,000-ohm
- R26—10-Megohm
- R34—75-ohm
- R35—7500-ohm
- R36—750,000-ohm

TRIMMER POTENTIOMETERS

- (Use Beckman Model 43P, 15-turn linear taper, or equivalent)
- TR1—5000-ohm
- TR2—50-ohm
- TR3—500,000-ohm
- TR4—50,000-ohm

CAPACITORS

- C1—22- μ F tantalum
- C2—.022- μ F monolithic ceramic
- C3—.022- μ F film (5% or better)
- C4—.01- μ F monolithic ceramic

- C5, C6—33- or 47-pF ceramic (both same value)
- C7—.0047- μ F film (5% or better)
- (C8-C10 used in on-board 5-volt regulator circuit)
- C8—1- μ F tantalum
- C9—.01- μ F ceramic
- C10—220- μ F, 16-WVDC, radial-lead electrolytic (100- μ F lowest permissible value. Regulator chip U9 will work harder when on wall adaptor)
- C11—.001- μ F monolithic ceramic

ADDITIONAL PARTS AND MATERIALS

- J1-J2—Dual test jacks, red and black (Radio Shack 274-621)
- S1—2-pole, 3-position rotary, non-shorting switch (Radio Shack 275-1386 2-pole, 6-position type may be substituted)
- S2—Spst, slide switch
- XTAL—1.0-MHz crystal
- Plastic case (Radio Shack 270-218, battery holder, wall adapter with matching female jack, TO-220 mounting hardware for IC regulator, 4 ARIES 14-810-90R 14-pin, vertical (right angled) sockets, or equivalent, epoxy, knob, hardware, decals, DIP IC sockets, hardware, solder, wire, etc.

SOME SOURCES FOR PARTS ARE:

- Digi-Key Corporation, Highway 32 South, PO Box 677, Thief River Falls, MN 56701, 1-800-346-5144.
- Jameco Electronics, 1355 Shoreway Road, Belmont, CA 94002, 415-592-8097
- SINTEC Co., Drawer Q, Milford, NJ 08848-9990, 1-800-526-5960 (right angled display sockets, IC sockets, etc.)

The following items are available from Elkins Design Inc., PO Box 1231, Homestead, FL 33030:

Kit of parts with manual, less case and switches, etc.—\$55.00.

Etched, drilled, and plated PC board with assembly manual—\$15.00.

Florida residents add 5% sales tax.

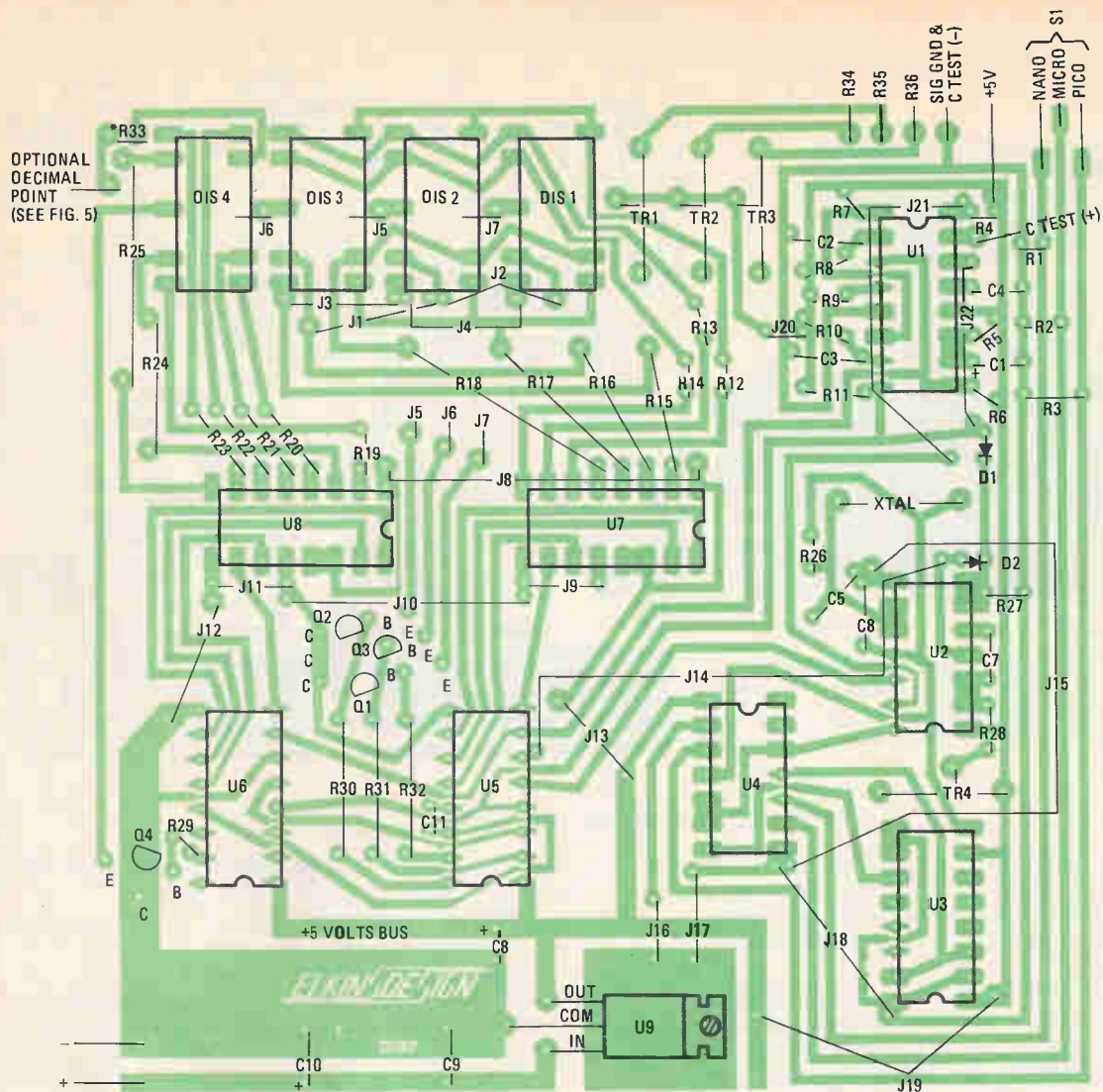

FIG. 5—PARTS LOCATION DIAGRAM is illustrated here from the foil side up to assist readers should they wish to trace the circuit when troubleshooting. A photo is provided showing the parts location from the top side of the board. Do not install wires that leave the board until after switch S1 is installed and electrical connection to the rear and front panels are to be made.

a decimal point added to your unit's display by the addition of one wire shown in Fig. 6.

Power supply

Power for the Digital Capacitance Meter may be obtained from four, or more, series-AA cells. However, you may want to use a surplus wall-adaptor DC power module, filtered or unfiltered, to power the unit. Any 6- to 9-volt unit will do the

job. Integrated circuit U9 is a standard +5-volt DC regulator chip known to all experimenters, and coupled with capacitors C8 through C10 comprise the entire voltage regulator circuit. See Fig. 7. Should you prefer to use batteries only, eliminate those parts and save the cash. Should you prefer both power sources, then wire up the printed-circuit board completely and use a jack that will break the battery circuit when the

THE FRONT PANEL of the Digital Capacitance Meter contains just the capacitor hookup terminals (red for positive when needed), a window to view the LED display, and the range switch that permits LED indications from 1 pica—farads up to 9,999 microfarads in an eye's blink.



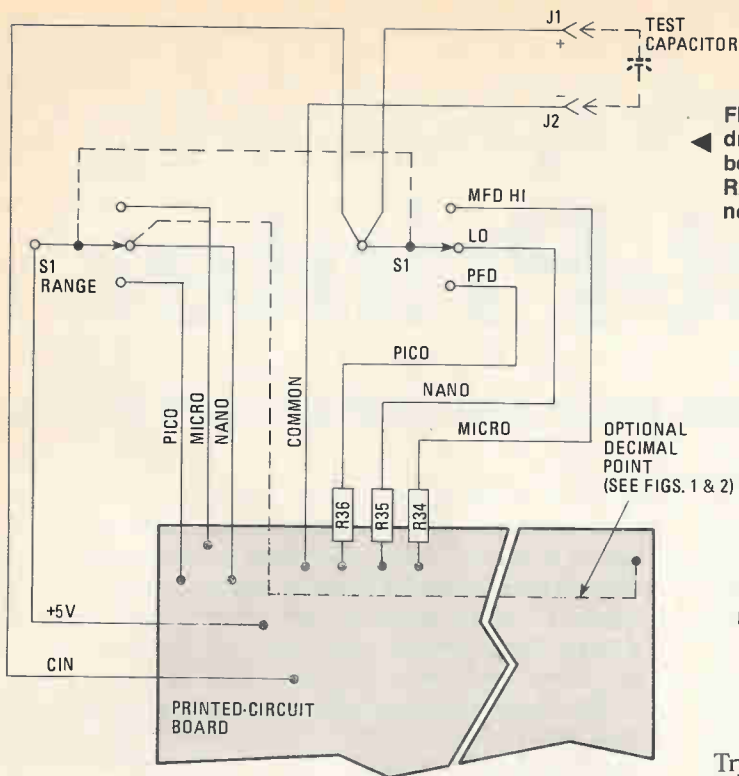
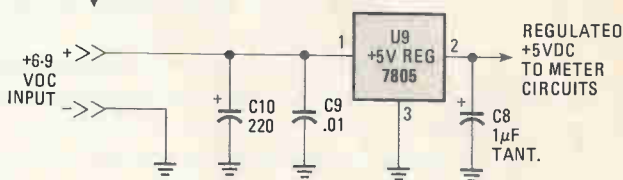

FIG. 6—OFF-BOARD WIRING DETAILS are detailed in this drawing. Resistors R34-R36 are mounted on the printed-circuit board vertically with the free lead connected to a terminal on RANGE switch S1. Optional decimal point connection is made now should the builder require it.

FIG. 7—THE +5-VOLT POWER SUPPLY can be added to the printed-circuit board at locations provided in the original design. If you wish, it can be omitted, and the unit remain a battery-operated meter only. The value for C10 can be reduced to 100-microfarads. Other capacitor values are not critical and can vary +100%/ - 50%. A heat sink is not required for U9.



wall-adaptor DC power-pack module is plugged into the meter.

Checkout and Calibration

With U1 removed from its socket, connect an ohmmeter between the 5-volt supply and the switch side of the fixed range resistors (R34-R36). Adjust the trimmer potentiometers as indicated:

- R34 (75 ohms): Adjust TR2 for a reading of 90.9 ohms
- R35 (7500 ohms): Adjust TR1 for a reading of 9090 ohms
- R36 (750,000 ohms): Adjust TR3 for a reading of 909,000 ohms

Apply 6-9 VDC power to the board—check polarity before switching power on. The LED display should illuminate, and may indicate some value; however, it will zero on the next test cycle. Select the picofarad (PFD) range and note the display. Adjust TR4 clockwise until the displayed value is at maximum. That value represents the residual input capacitance of the meter, and it is probably about 14 pF. Adjust TR4 counterclockwise, slowly, until the display just indicates zero. An occasional 1 indication is good. Insert a low pF value capacitor, (a 40-40 pF trimmer cap is ideal), into the test jacks, and check for a stable reading. The display may change by a pF or so at regular intervals as the 1.1-second test interval repeats.

JUST IN CASE you resort to a hard-wired project, refer to the positioning of parts in this photo and Fig. 5 so that you can eliminate the high degree of "rat's nest" wires on the underside of the board. The printed-circuit board is the best way to go in the construction of the meter.

Try measuring the values of other capacitors on the other ranges.

Congratulations! You are now the proud owner of a new Digital Capacitance Meter, which you built yourself for less than half of what a comparable unit would have cost! The calibration of the meter should be within 5% at full scale, which is more than sufficient to specify the value of most capacitors. If you desire greater accuracy, then you will need standard capacitors to which to adjust the meter. You may use several groups of 5% or better capacitors of the same value per group to check the high and low ends of each range. Adjust the range trimmers so that the displayed value is the average of the differences noted.

SP

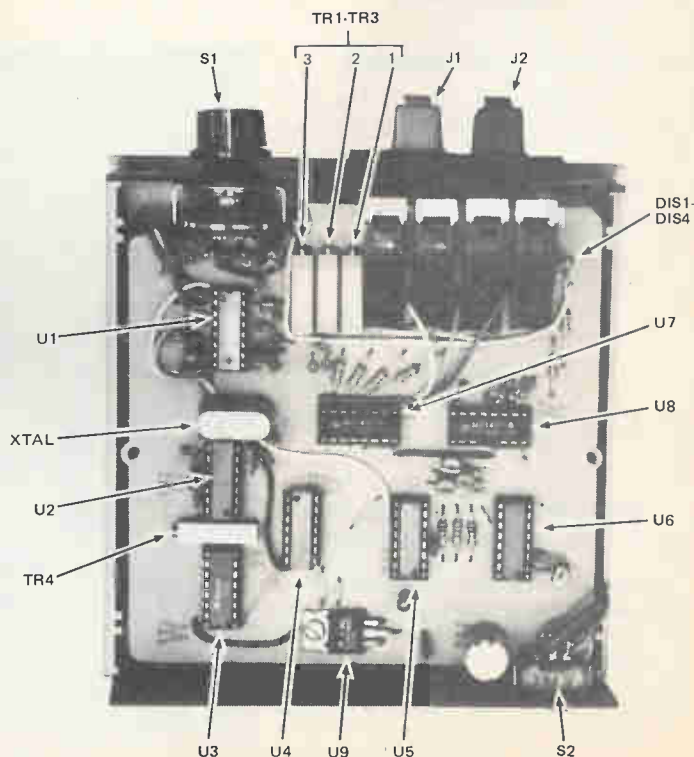

Vacuum-Operated Contact-Printer

Phase out the fuzzies from your printed-circuit boards

D.E. PATRICK

□IF YOU WANT TO ELIMINATE THE FUZZIES WHEN ETCHING photo-sensitive, printed-circuit boards, front panels, contact prints, and plates; then you need a good vacuum-operated, contact-printer like that used by the pros; but those beasts can be quite expensive.

However, the junkbox version shown in Fig. 1 can be slapped together for next to nothing, built in any convenient size, and can be both portable and lightweight. The most expensive component is the vacuum pump. The small vacuum pump used in this project was purchased from a surplus electronics store, Gateway Electronics, for around \$40. You'll have to do some looking to find a small, good unit at a low price.

The window frame, glass, etc., were pulled out of trash heaps, albeit they may also be purchased for under \$30 if you're not a connoisseur of trash-can explorations like me.

If you are a headhunting cannibal like the author, then you'll find that most glass and plastics supply houses throw out tons of the stuff, including aluminum window and screen frames. So, if you don't mind getting your hands dirty—glass, plastic, and frame materials will cost you nothing. And the whole vacuum-operated, contact-printer unit is just pop riveted and/or glued together.

Construction and Operation

In a "brute-force" or "force-fit" contact-printer, negative or positive art or film is placed on top of a photo-sensitive plate, PC board, etc., usually sitting on top of a piece of black foam.

THE CONTACT-PRINTER assembled and ready for use on the author's next printed-circuit project. Lift up the glass-frame lid, place a photosensitive copper-clad board face up in the center of the inside surface, place the film art over the board, close the glass lid, and turn on the vacuum pump. The film will be pressed tight against the board ready for exposure, with the final product void of the fuzzies.

Next, a hinged glass or plastic plate is pulled down and locked in place, holding everything secure, pushing them into the foam. Then, the fixture is exposed to a suitable light source for some period of time. Finally, the plate, film, contact paper, printed-circuit board, or whatever you are using is removed, developed, and processed.

The "brute force" method applies edge pressure on the glass and depends on the resiliency of the foam to force negative, or positive, art or film into contact with the photo sensitive plate, printed-circuit board, etc. This is not always the case as some of your previous tries may attest. Thus, you can end up with "fuzzy" results, especially using cheap contact-printers, or in those instances where the foam ages and loses some of its resiliency. Further, the larger the printer, the greater the chance for problems, where edge pressure alone just won't get it.

On the other hand, vacuum contact-printers are operated and constructed in a similar manner, with one important exception. Instead of just relying on edge pressure and foam, a vacuum pump is used to suck the hinged glass down. This assures the closest possible contact, which after all is what a contact-printer is supposed to be about.

In a vacuum-operated contact-printer the hinged glass or

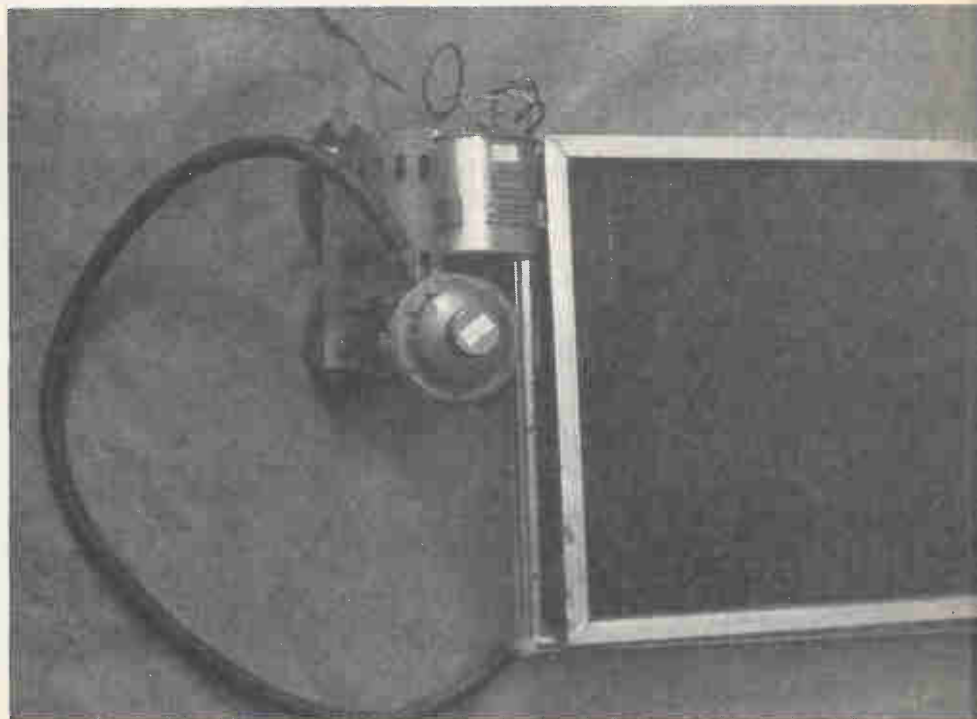

plastic lid has an airtight gasket. Once locked into position and the pump turned on, it is pulled into a piece of black foam by a vacuum created by the pump. The black foam is supported by an aluminum or plastic mesh plate allowing air to be pulled through, or evacuated, once the pump is turned on. The hinged glass cover acts as the top of a box, the bottom of the box is an airtight base plate, and the mesh plate is placed in between. Air is pulled out the bottom of the box, which sucks down the glass top into the foam. Thus, instead of just applying edge pressure, an even pressure is applied over the surface of the glass, increasing with the amount of applied vacuum. Therefore, since there is no way for light to run under and between artwork and what you're printing, the fuzzies are eliminated.

Going Further

Using an ordinary aluminum window frame, the kind with a framed glass or plastic window and screen that slide up and down, construction is a snap with a pop rivet gun and some silicon rubber. Here's the step-by-step procedure as I did it:

The glass and screen are removed from the aluminum frame.

The extruded aluminum frame is cut and pop-riveted into a box frame. See details in A of Fig. 1. The length and width is determined by the size on the material you plan to place in the contact-printer.

The glass frame (B of Fig. 1) is hinged (C) to the top of the box frame (A) and pop-riveted in place. You can use most any available hinge(s), or you may want to pick up a piano-type hinge cut to the length of the glass frame at a lumber-supply outlet.

An intermediate screen plate (D) of aluminum or wire mesh is cut and slid in place in the box frame between extruded aluminum sides and pop-riveted in place.

Rubber seals (E and F) are placed around the top of the box

frame (A) and glass frame (B) with some silicon rubber cement.

Some 1/2-inch black foam (G) is cemented to the screen plate (D) with silicon rubber cement. If you can get your hands on 1/4-inch black foam, it is a suitable substitute.

A hole is drilled in box (A) and an outlet pipe (H) for the vacuum pump is fitted in place and sealed with silicon rubber.

A bottom plate (I) is cut from a piece of sheet metal and pop-riveted to box frame (A) and sealed with some silicon rubber cement.

Box (A) and glass frame (B) are fitted with a latch to provide a snug closing. A simple furniture brass hook latch will do the job. You can pick one up at the same time you purchase the piano hinge.

Finally, the vacuum pump (K) is attached with a slip-on rubber or clear-plastic tubing commonly used in chemistry labs, or sold by fish-tank suppliers. This completes the construction of the vacuum-operated, contact-printer.

Comments

You may ask why dimensions for the vacuum-operated, contact-printer are not given? The answer is simple—how big a contact surface do you need? How big a glass are you starting with? In fact, what are your needs? You decide! Remember, more than 14 pounds-per-square-inch of atmospheric pressure are pushing down on the glass plate. And, this pressure remains constant over every square inch of surface no matter how big the surface be. For larger surfaces, the vacuum pump will work a bit longer to evacuate all the air, but the job will be done. Also, the larger the unit's dimensions, the probability of air leaks increases, so that you may have to go for a larger pump if you cannot detect and eliminate all the air leaks. In a small unit put together by the author, the leaks were nil (if they existed at all) and the vacuum pump was large enough to keep the vacuum. **SP**

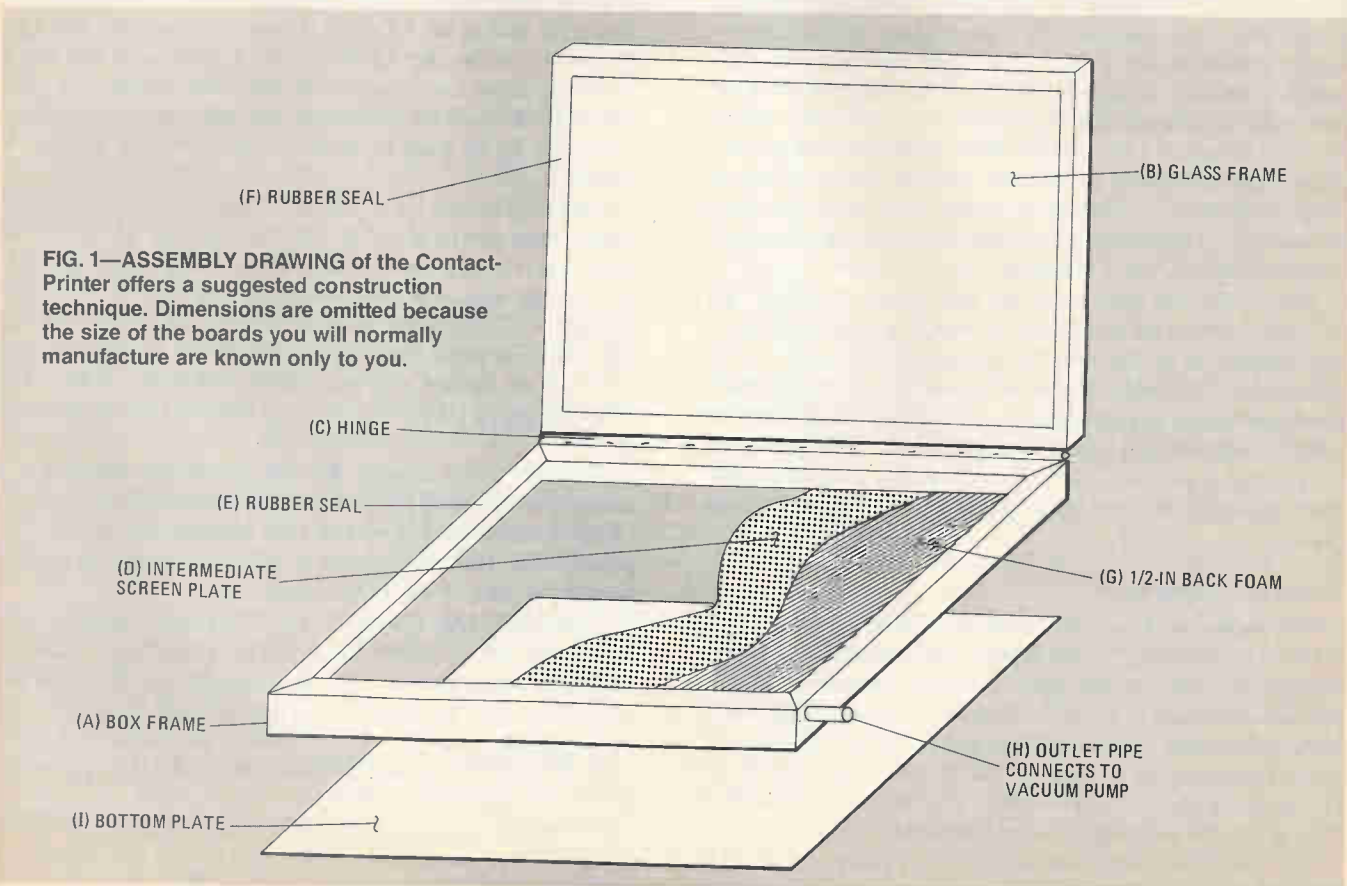

FIG. 1—ASSEMBLY DRAWING of the Contact-Printer offers a suggested construction technique. Dimensions are omitted because the size of the boards you will normally manufacture are known only to you.

LUTHER M. STROUD, C.E.T.

DOT-BAR GENERATOR



The perfect instrument for the part-time service technician who cannot afford a professional device

□THE POCKET DOT-BAR GENERATOR IS DESIGNED TO BE A small, low cost, reliable TV convergence instrument—a handy substitute for a high-cost, high-battery-drain, full-featured, factory-made test instrument. The unit provides the two most-often-used basic patterns used for color-picture tube convergence adjustments, the cross-hatch and dot displays. The dot display is normally used for center-dot static magnet adjustments. The crosshatch display is normally used for dynamic adjustments away from the center of the screen near the edges of the TV picture.

The in-between position of the pattern-select switch cuts off video drive to the modulator to provide a grey-field-raster-only display on picture tube for purity and color temperature adjustments. An extra feature of this device is an automatic power-off circuit to extend battery life. When you're finished with Pocket Dot-Bar Generator, just toss it into your cadycase and it will turn itself off without any help from you. Since it is quite thin and light, you could stick it in your shirt pocket

Theory of Operation

The master clock frequency of 2.012 MHz is generated by U1-a (1/4 of CD4001), Y1, R1 and C1. Refer to Fig. 1. Resistor R1 provides bias to the gate for linear operation and C1 provides feedback to sustain oscillation. The resulting 2.012 MHz squarewave clocks the U4 (CD4024) which divides the clock frequency by a total of 128 to yield a frequency of 15,720 Hz at pin 3, the Q7 output. The clock is also divided by 8 at the U4 output pin 9, the Q3 output.

IC U5-b (1/2-CD4082) combines the Q7 pulse and the Q4, Q5, Q6 pulses to form a positive pulse approximately 4

microseconds (usec) wide with rate of 63.5 usec at pin 13. The other half of the CD4082 (U5-a) combines the Q3, Q2, Q1 pulses of the the CD4024 and a sample of the clock frequency to form positive pulses one clock-period wide. The pulses are 16 times the horizontal sync rate and one-eighth the clock rate to be used to form the vertical lines in the TV picture.

Integrated circuit U6 (CD4040) counts the horizontal sync pulses from pin 13 of U5-b. Q1, Q2, and Q8 of U6 are all logic one (HI) at a count of 262. Refer to Fig. 1. Diodes D3, D4, D5 and resistor R3 form a 3-input AND gate to clock one-half of U7 (CD4013) and reset U6 at the count of 262. Pin 3 of U6 outputs a pulse every 32 counts of the horizontal sync pulses to be formed into horizontal lines in the video. The other portion of U7 divides the reset pulse to U6 by two at pin 13.

Trimmer potentiometer R6 and coupling capacitor C4 narrows the pulse at pin 3 of U6 and delivers it to U3-b (1/3-CD4073) so that it begins and ends between horizontal sync pulses. The buffered output of U3-b is at pin 6 are the horizontal lines in the video signal.

Diodes D1, D2, D8 and U3-a (1/3-CD4073) form a five-input AND gate to shape the positive vertical sync pulse of about 180 milliseconds width at a frequency of 60 Hz at pin 10. The actual frequency for purists is 60.02 Hz.

Integrated circuit U1-d (1/4-CD4001) combines horizontal sync from U5-b and the vertical sync from U3-a into composite negative sync at pin 10.

Horizontal line video from U3-b and vertical line video from U5-a are combined and inverted by the two remaining sections of the CD4001 (U1-b and U1-c). The output at pin 3 is

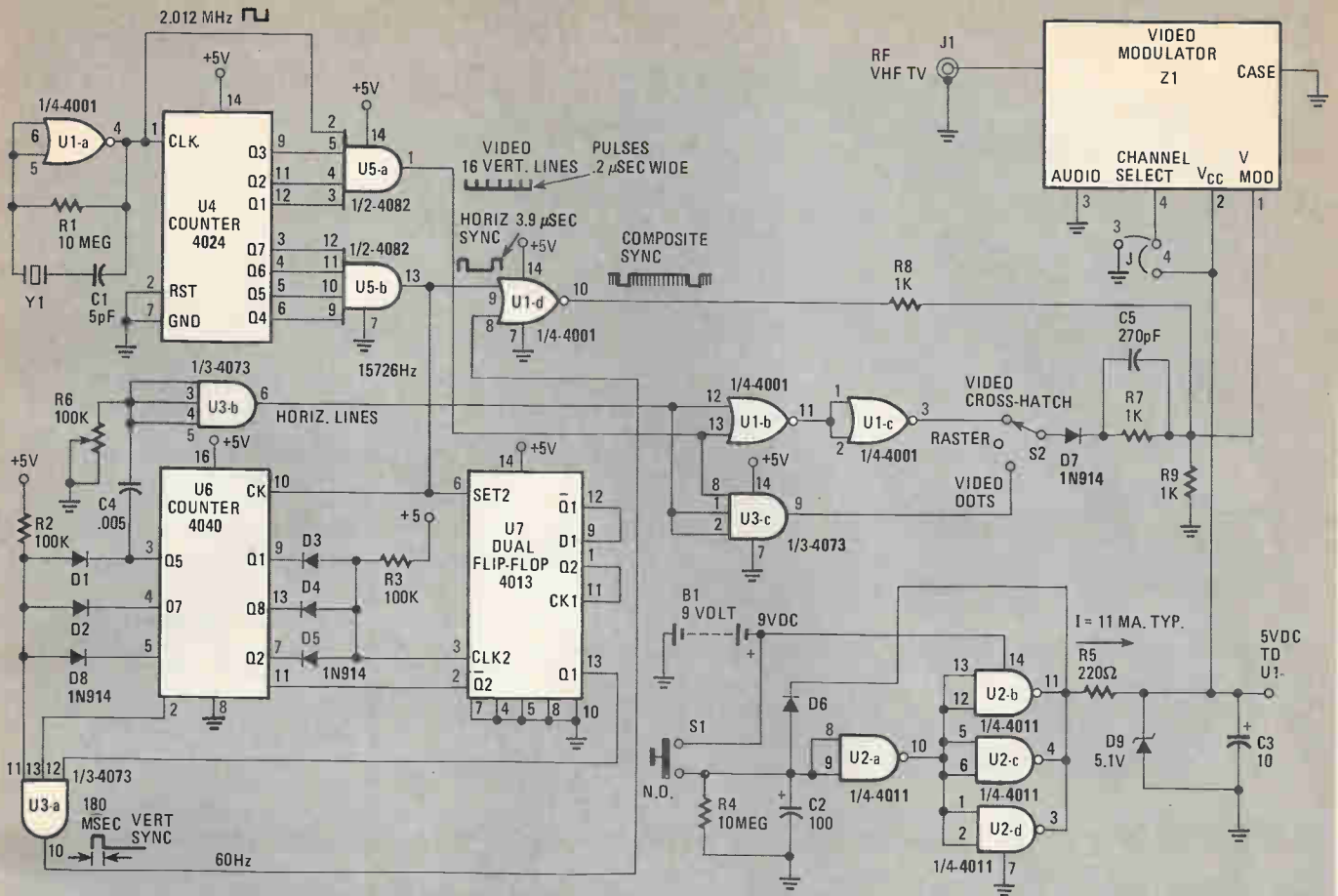

FIG. 1—SCHEMATIC DIAGRAM for the Dot-Bar Generator is actually a miniature television station for the UHF band. The unique power-supply timing circuit automatically turns off the power 10 minutes after power switch S1 is depressed.

the video cross-hatch display.

Horizontal and vertical line video are combined by the remaining section of the CD4073 (U3-c) which is wired as a two-input AND gate. The output at pin 9 is the video dot display. The pattern generated is an 7×11 crosshatch or dot array.

Adding the RF

Composite sync from U5-a and the selected video display at the pole of S2 are combined at proper DC levels by R7, R8, R9, and D7 for drive to pin 1 input (Vmod) of the video modulator, Z1. Capacitor C5 provides high frequency peaking for sharpness in video display on the TV. It can be omitted, or value changed for optimum results after the Pocket DCt-Bar Generator is operational. The modulator audio input is not used and is grounded to the case. The case is grounded to the negative power supply. Pin 2 is connected to the five-VDC supply. For VHF TV channel 3 operation ground pin 4. Otherwise, connect pin 4 to five-volt supply for VHF TV channel 4 operation. Select the channel that is unused in your area.

Power When You Need It

The battery-saver circuit consists of a quad CD4011 AND gates (U2) wired as two cascaded inverters. When S1 is momentarily closed, C2 charges to nine volts. The combined output at pins 11, 4 and 3 also go to nine volts. That output forms the power supply for the remaining circuitry. Notice the

nine-volt battery applies power to U2 at all times. When Pocket Dot-Bar Generator is at rest, it draws very little current and the battery will last its shelf life. When powered on, U2 can easily deliver the 10 to 12 milliamperes required by Pocket Dot-Bar Generator's circuitry. The unit will perform well until the battery voltage drops below 4.7 volts. You can expect about 100 hours of service from one fresh transistor battery.

Momentarily closing S1 charges C2 to nine volts. R4 slowly discharges C2 back to ground. The values are selected for on time of about ten minutes. Diode D6 discharges C2 completely at end of timing cycle. Component parts R5, D9 and C3 form a regulated and filtered five-volt supply for the unit.

Design Notes

Not all CD4001 integrated circuits will work at 2.012 MHz, but most will. Some 4001's will not oscillate properly, and some will not start-up reliably. Vertical lines in the crosshatch display might appear washed out. Select a usable 4001 chip by trial and error that provides crisp, sharp vertical lines with good contrast at low TV brightness level settings. The reader may have to select a few 4001 chips to obtain one for proper operation.

Resistor R9 may be increased to 1500-ohms for more contrast in the video display. That is optional with each user. Also, C5 may be varied from 0 to 320 pF depending on the degree of high-frequency compensation required—if any.

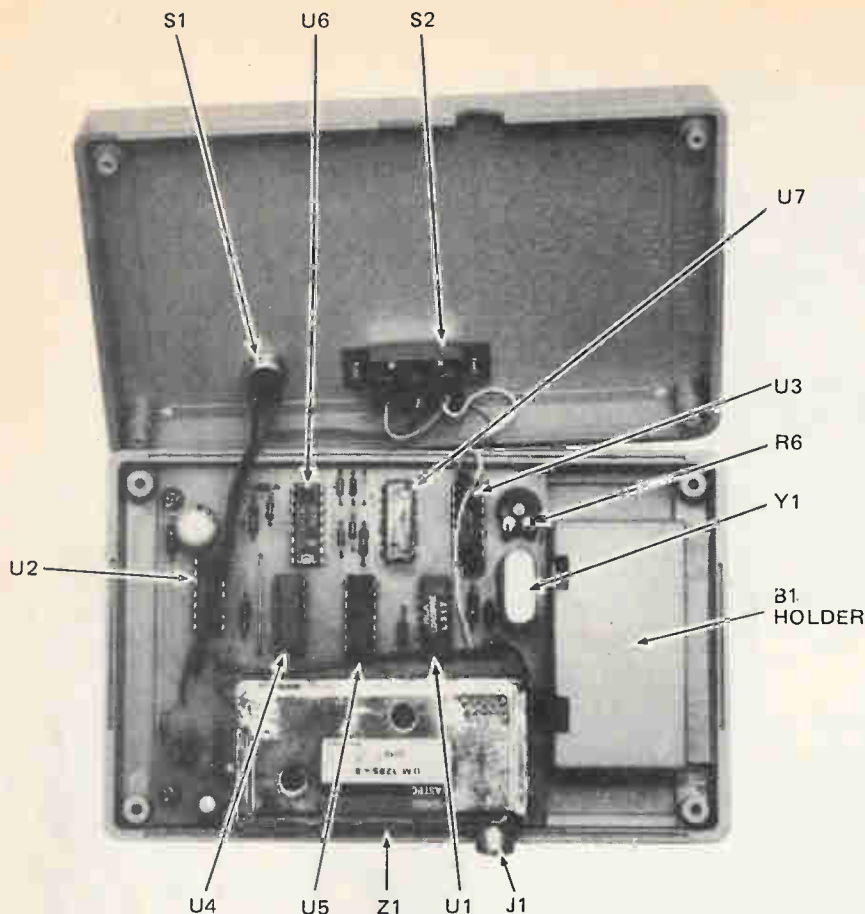

THE DOT-BAR GENERATOR fits snugly into a plastic case—no shielding is required here. The TV modulator unit, Z1, mounts directly onto the printed-circuit board. Two switches, the power-on pushbutton switch, S1, and selector switch, S2, mount on the front panel, and the battery, B1, slides into its own compartment. Once the case is closed, there should be no reason to open it. The battery can be replaced by opening a slide door located on the rear surface. Do not over tighten the four self-tapping screws because the plastic material will scoop out and the hole for the screw will become too large to catch.

About 270 pF is a typical value.

The value of R4 in the battery-saver circuit is specified at 10 Megohms, which, in combination with the 100- μ F of C2 produces about 8 to 10 minutes of power on. Alter the value of R4 for longer or shorter power-on periods.

Operational instructions for the Pocket Dot-Bar Generator

can be read directly from the front panel illustration (Fig. 4) in the article. Remember, be sure to disconnect the antenna system to avoid accidental transmission of the Pocket Dot-Bar Generator's VHF signal to nearby television receivers. Although the unit should be designed for an unused channel, hash may exceed the channel's band limits causing inter-

FIG. 2—HERE IS THE FOIL PATTERN used to make the printed-circuit board exactly like that made by the author. In fact, it is commercially available (see Parts List). The mounting holes in the board for the video modulator, Z1, are positioned for the Radio Shack unit (277-221) or ASTEC unit (UM1285-8). Should you use a different unit, check the mounting tabs on the modulator before you make your printed-circuit board. The design pattern in the lower two-thirds portion of the diagram can be salvaged as it stands should the modulator not fit in the mounting holes provided.

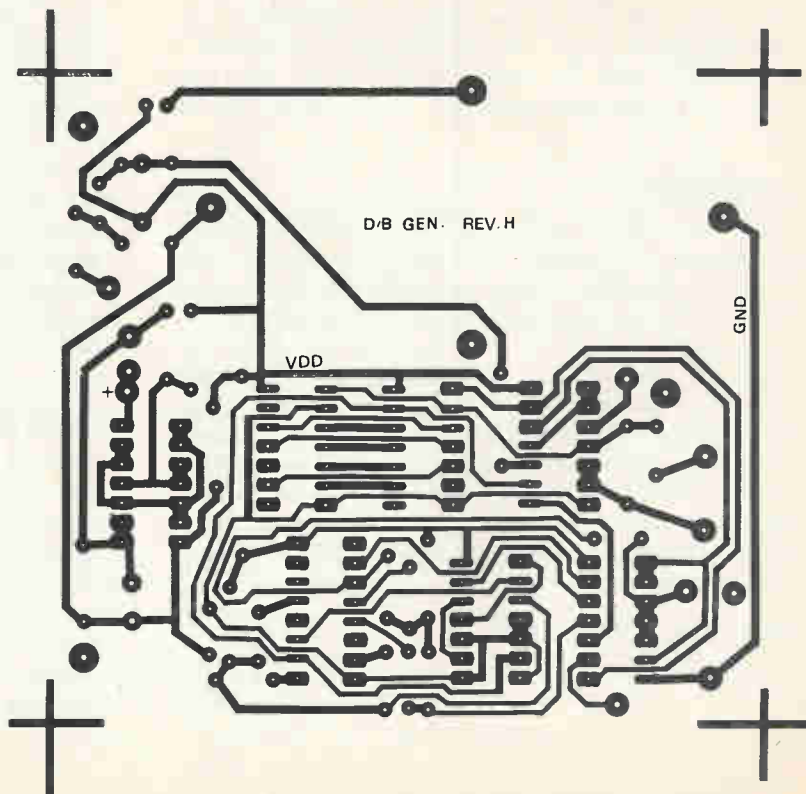

PARTS LIST FOR POCKET DOT-BAR GENERATOR

SEMICONDUCTORS

- D1-D8—1N914 signal silicon diode
- D9—5.1-V, 400-mW Zener diode
- U1—CD4001B CMOS quad 2-input NOR gate integrated circuit
- U2—CD4011B CMOS quad 2-input NAND gate integrated circuit
- U3—CD4073 CMOS triple 3-input AND gate integrated circuit
- U4—CD4024 CMOS 7-stage binary ripple counter integrated circuit
- U5—CD4082 CMOS dual 4-input AND gate integrated circuit
- U6—CD4040 CMOS 12-stage binary counter integrated circuit
- U7—CD4013 CMOS dual D flip-flop integrated circuit

RESISTORS

(All fixed-value resistors are 1/4-watt units)

- R1, R4—10-Megohm
- R2, R3—100,000-ohm
- R5—220-ohm
- R6—100,000-ohm, PC-mount potentiometer
- R7-R9—1000-ohm

CAPACITORS

- C1—5-pF, 50-WVDC disc
- C2—100- μ F, 16-WVDC electrolytic
- C3—10- μ F, 16-WVDC electrolytic
- C4—.005- μ F (or .0047- μ F polyester-film)
- C5—270-pF, 50-WVDC disc

ADDITIONAL PARTS AND MATERIALS

- B1—9-V transistor-radio battery
 - J1—RCA phono jack (part of video modulator Z1)
 - S1—SPST, normally-open, pushbutton switch
 - S2—DPST-center-off slide switch
 - Y1—2.012-MHz, series-mode HC33/U microprocessor crystal
 - Z1—Video modulator (Radio Shack 277-221, ASTEC UM1285-8)
- Printed-circuit material, plastic portable case MPAC-TEC HP-K 9VB, listed in Active Electronics catalog) 9-volt transistor battery clip, audio cable, alligator clips, hardware, solder, wire, etc.

Note: The following parts are available from the listed vendors:

2.012 crystal (Y1) available from:
Pershing Technical Services, P.O. Box 1951, Fort Worth, TX 76101

JAN Crystals, 2400 Crystal Drive, P.O. Box 06017, Fort Myers, FL 33906-6017. Telephone: 813/936-2397

Available from Pershing Technical, Box 1951, Fort Worth, TX 76101

Kit of parts and PC board less hardware, switches, and video modulator—\$21.00
Crystal—\$4.50 Etched and drilled PC board—\$12.00

Add \$1.00 for postage and handling, and Texas residents add 5% sales tax

ference to other viewers.

Should you have trouble finding a single-pole, double-throw slide switch with a center-off position, you could resort to a standard SPDT slide switch and carefully position the slide control at its center position to obtain the off position. That technique works on most slide switches.

Construction

Etch and drill the printed-circuit board from art work provided in Fig. 2. If you wish, the printed-circuit board may be ordered from a vendor referenced in the Parts List. Referring to parts location guide provided in Fig. 3, install resistors and capacitors at locations shown. Note the polarity of electrolytic capacitors. Install signal diodes D1-D8 and Zener diode D9 at locations shown. Note polarity of banded end. Install VHF modulator Z1 by first cutting off small horizontal tabs on mounting terminals. Position the video modulator, Z1, as shown in Fig. 3 and the photo. Four tabs fit into plated holes in the printed-circuit board and are soldered in place, thus providing the ground connection for Z1. Connect pin 4 (terminal closest to bottom of video modulator Z1 in Fig. 3.) to select VHF TV channel 3 or 4, the unused channel in your area. With pin 4 connected to Z1's case (ground), you select channel 3. With pin 4 connected to +5-volts DC, you select

THE AUTHOR's Dot-Bar Generator is shown here about same size. The slide switch selects either DOTS or CROSSHATCH at its extreme positions. Positioning the slide switch dead center will give neither, producing a RF gray-field raster useful for purity adjustments.

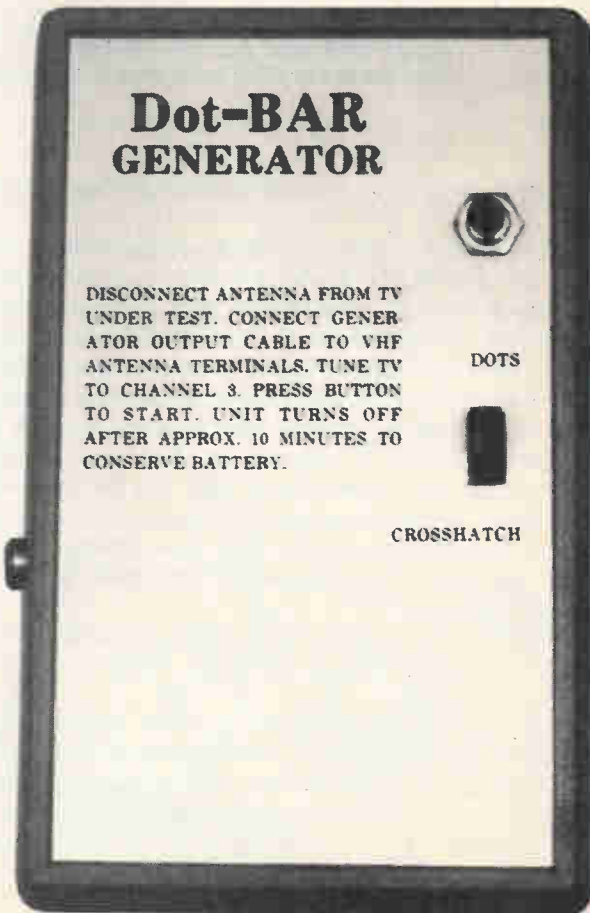

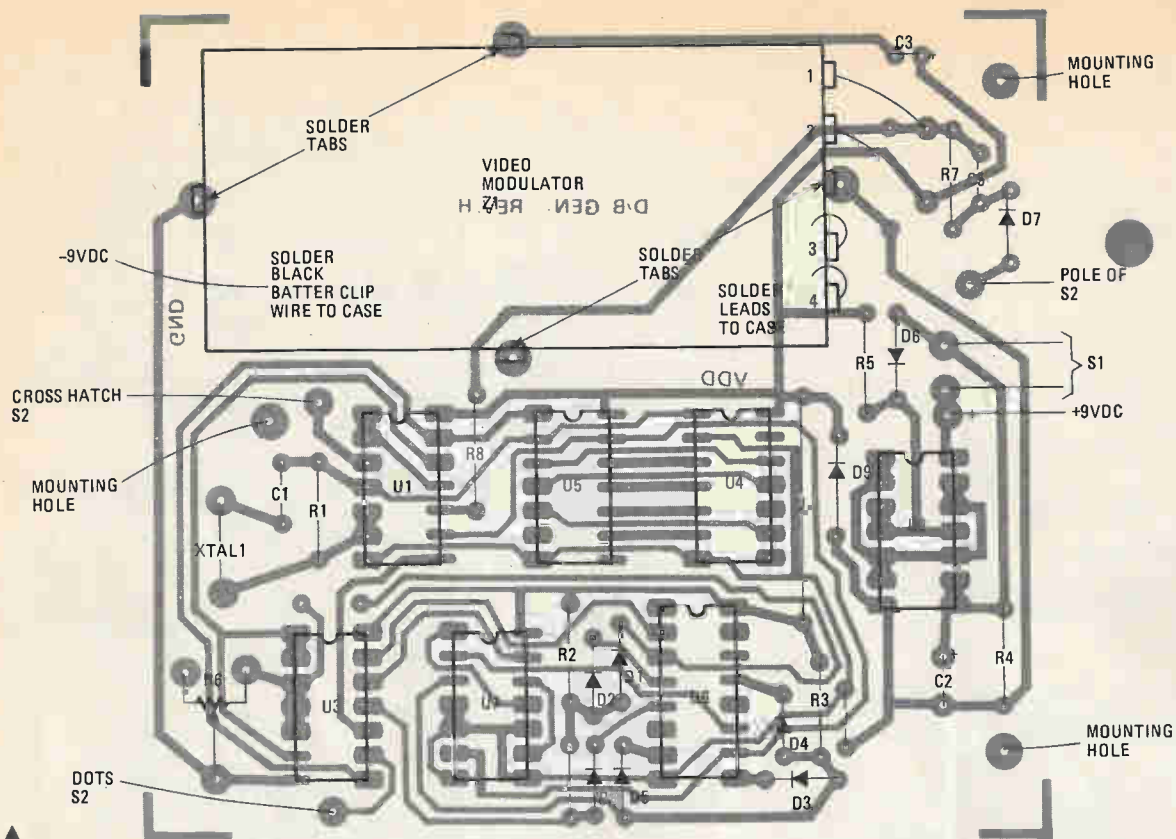

FIG. 3—PARTS LOCATION DIAGRAM shows the X-ray view of the printed-circuit board (the flop of Fig. 2) in gray with the circuit components in place. Wire jumpers may be without insulation. Note the six leads leaving the circuit board for the switches and battery.

XEROX this drawing and use it as a face plate for your Dot-Bar Generator. Just follow the instruction on the front panel and you'll experience no problems at all.

channel 4. Ground pin 3 (audio input of Z1) since it is not needed.

Solder 3 wire jumpers into printed-circuit board at locations shown in Fig. 3. Solder insulated, stranded wires for connection to switches into board. Pass wires from battery clip through cabinet battery compartment before soldering to board. The clip's negative lead is soldered to the modulator case. CMOS IC's are installed last to limit possible damage to them by static charge. Note IC notch locations in Fig. 3, and use same alignment in your project. Avoid solder bridges where copper foils run between IC pins. The Pocket Dot-Bar Generator is installed in a portable plastic case with built-in battery compartment available from parts jobbers and mail order companies. Dress wires away from crystal XTAL1 on final assembly.

Prepare a shielded audio cable with a phono plug on one end and alligator clips on the other. Make it twelve- to eighteen-in. long.

The only adjustment required to make Pocket Dot-Bar Generator operational is in potentiometer R6 which determines the single horizontal line scan for the proper video display. Adjust potentiometer R6 until one horizontal line just fills the TV picture from the left to right sides of a TV receiver functioning normally. Now that you have it, use the Pocket Dot-Bar Generator to align that set.

SP

Dot-BAR GENERATOR

DISCONNECT ANTENNA FROM TV UNDER TEST. CONNECT GENERATOR OUTPUT CABLE TO VHF ANTENNA TERMINALS. TUNE TV TO CHANNEL 3. PRESS BUTTON TO START. UNIT TURNS OFF AFTER APPROX. 10 MINUTES TO CONSERVE BATTERY.

DOTS

CROSSHATCH



Just one spot of jet black on your B&W prints, and everyone will be talking about your darkroom skills when you use our...

LARRY MANN

PRINTMETER

□GOOD PICTURES DON'T COME CHEAP! IN FACT, GOOD PICTURES often don't come at all. Between the automated developing machines and underpaid help who couldn't care less whether the chemicals are fresh or exhausted, color prints come out too brown, too blue, too dark, too light... anything, but good. And as for black and white, commercial finishers seem to have forgotten there is something called gray scale. because their black-and-white prints usually have but two tones: black and white.

For real quality work you've got to make the prints yourself. Unfortunately, more time is often spent getting the enlarger's exposure correct than taking care of artistic details. But for less than \$20—less than \$10 if you have some routine junkbox parts lying round—you can literally throw together a PRINTmeter that will almost guarantee a good-to-perfect exposure every time. Well, maybe not every single time, but often enough to put the fun back into making your own printers.

While the PRINTmeter shown in the photographs was specifically designed for black-and-white printing, we'll show later how it can also be used to establish the proper exposure for color prints.

Look for the Black

The basic premise behind a black-and-white printmeter of any kind is that the average black-and-white print will appear pleasing to the eye if there is some spot—no matter how small—that is jet black—called print 'd-max' for maximum

density. For the average "family" photograph the proper exposure is the one that produces at least a spot of jet black. (The enlarger light that produces d-max in a print comes through the least dense—almost clear—part of the negative.) The exception to the d-max rule is artistic prints, such as portraits which might have no black at all, but even then the PRINTmeter will simplify the job by making the exposure for what you select as "skin tone."

The PRINTmeter is used that way. First, you make a "perfect" print using your standard or preferred exposure time. Let's assume it's 20 seconds. Do not disturb the enlarger's adjustment. Place the PRINTmeter on the easel so that the small opening for the LDR1 (Light-Dependent Resistor) is under the brightest light—the light that will produce d-max (jet black) in the print. Set sensitivity switch S1 to "L" (open) and turn the meter on by pressing down on push-switch PB1. Refer to photo and Fig. 1. One or both LED's will turn on.

THIS BATTERY-POWERED PRINTmeter can be built from mostly junkbox parts. It permits you instantly to set the enlarger light intensity for a predetermined exposure time.



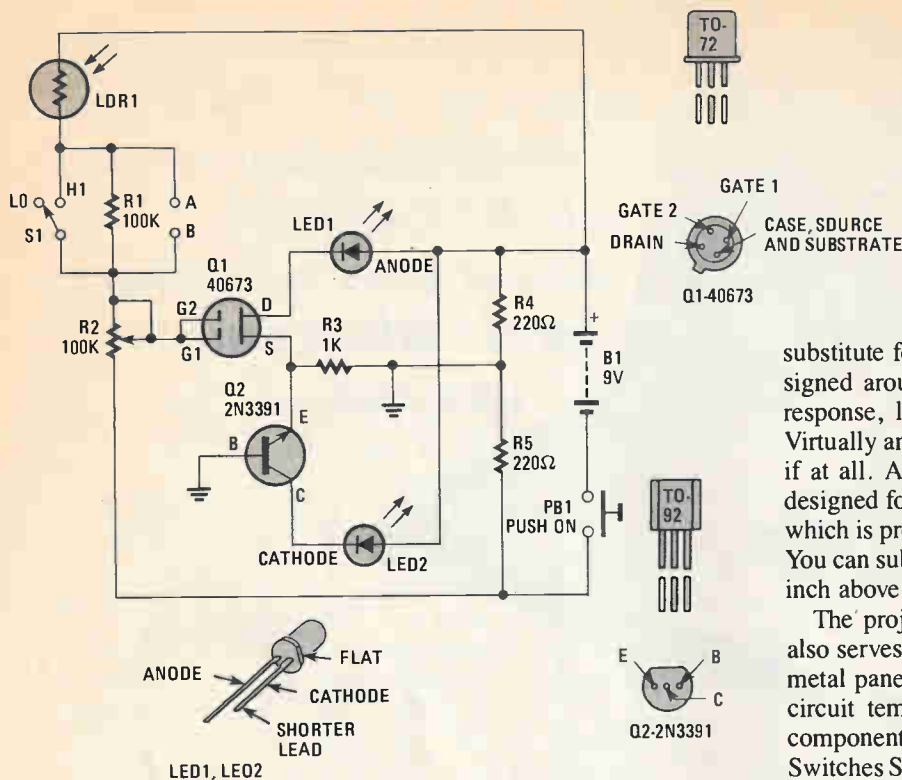

FIG. 1—SCHEMATIC DIAGRAM for Printmeter illustrates how simple the circuit is and how cheaply it can be assembled from a few inexpensive parts.

substitute for the specified LDR1 because the project is designed around its specific resistance, relatively high-speed response, low “memory”, and particular color sensitivity. Virtually any other LDR1 is guaranteed not to work properly, if at all. As for the cabinet, the PRINTmeter is specifically designed for an operating height above the easel of 1½-inch, which is provided by a Radio Shack 270-233 plastic cabinet. You can substitute any other enclosure that places LDR1 1½-inch above the easel.

The project is assembled on a printed-circuit board that also serves as the cover (panel) for the cabinet. (Discard the metal panel supplied with the cabinet.) A full-size printed-circuit template is provided in Fig. 2. The board’s small component holes are made with a #55 or #56 drill bit. Switches S1 and PB1 will probably fit a ¼-inch hole if you use miniature switches, while R2 requires a ⅜-inch hole. The LDR1 “window” is ⅜-inch and it must be precisely ⅜-inch; smaller or larger will produce inaccurate meter readings.

Except for LDR1, the components with underside connections—S1, PB1, and R2—are handled that way. Refer to Fig. 3 and photos. First, pass a solid bare wire through a component terminal and the matching hole in the printed-circuit board. Solder the component connection and clip the wire flush with the top of the board. Next, using long-nose pliers, ease the wire just enough so that the cut end drops below the top of the board; then solder the wire to its fail pad. In that way you will have no sharp wire tips protruding through the board.

Adjust calibration potentiometer R2 until both lights are equal in brilliance, thereby calibrating the PRINTmeter to your particular negative(s), paper, chemicals and print quality. (The LED’s have virtually no “facing range”, they almost snap on and off when R2 is adjusted.)

To make other prints, simply focus the negative, set the meter under the light that will produce d-max in the print, adjust the enlarging lens’ diaphragm until both LED’s are equal in brilliance, and then use your standard exposure of 20 seconds. Most times, the new print will be good to great; at worst, a slight modification of the exposure will make it “perfect;” on the second try. (You save a lot of printing paper by using a PRINTmeter.)

If the negative is so dense that control R2 is almost at the extreme end of the adjustment, increase the sensitivity by setting S1 to “H” (closed).

But what if your photos have no black? What if you’re into something artistic such as portraiture? Simple! Make your good reference print and then take the exposure reading off a standard “skin tone” such as the forehead. You decide what facial tone will be your particular reference standard and take the readings accordingly.

What About Color?

The PRINTmeter can serve as an exposure guide for color prints! Make a good color print that has your preferred saturation. Note the exposure time. Place a diffuser (light integrator) under the lens, position the PRINTmeter’s LDR1 directly under the lens, and adjust R2 for balanced LED’s. For the next print from a different negative, focus, put the diffuser under the lens, place the PRINTmeter under the lens and adjust the lens’ diaphragm for balanced LED’s. Use the “standard” exposure time for your color prints. (Make certain that you compensate the exposure time if you change the filter pack.)

Construction

Except for LDR1 and the cabinet, nothing else is critical. Use whatever you can salvage from the junkbox, but do not

PARTS LIST FOR printmeter

SEMICONDUCTORS

Q1—N-channel FET, 2N311 or 40673 (See text)

Q2—2N3391 transistor

LED1, LED2—Light-emitting diode, diffused type

RESISTORS

(Resistors are ¼-watt 10% unless otherwise specified.)

R1—100,000-ohm (See text)

R2—100,000-ohm linear potentiometer

R3—1000-ohm

R4, R5—220-ohm

LDR1—Light-dependent resistor (LDR), National 4941 (don’t substitute)

ADDITIONAL PARTS AND MATERIALS

—9-volt transistor radio battery, type 2U6 or equivalent.

PB1—N.O. pushbutton switch

S1—SPST miniature toggle switch

Battery snaps, plastic cabinet (see text), printed-circuit materials, knob, solder, wire, hardware, press-on type, etc.

The National 4941 light-dependant resistor is available for \$5 each plus \$2 postage and handling charge per total order from Specialty Parts, Box 22, West Hempstead, NY 11552. New York state residents must add local sales tax. Canada and foreign readers must add an additional \$1. US funds only.

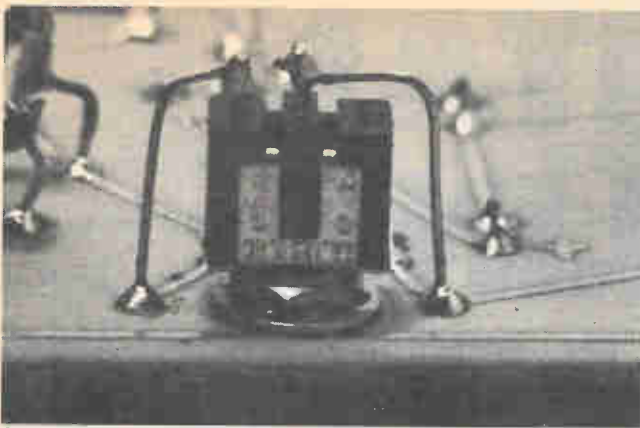

STANDARD SOLDER-LUG COMPONENTS are used even though the project is assembled on a printed-circuit board. The leads from S1 actually extend only partly into the board so that they don't protrude on the top surface. The wide bends allow the wires to be eased flush before soldering.

LDR1 requires a careful positioning so that it is connected to oversized solder pads. Cut LDR1's leads to 1/4-inch. Grip each lead with long-nose pliers directly at the LDR1 base and bend the wire over the pliers so that a strain-relief loop is formed (as shown in the photograph). Then bend the tips of the wires so that the cell can sit flat on the printed-circuit board. Position the cell directly between the pads, in line with the center of the pads, and tack solder one LDR1 lead to a pad. Ease LDR1 into its correct location and solder the remaining lead to its pad. Check LDR1's position by looking in through the window hole in the printed-circuit board. You should see what appears to be etched lines running across the

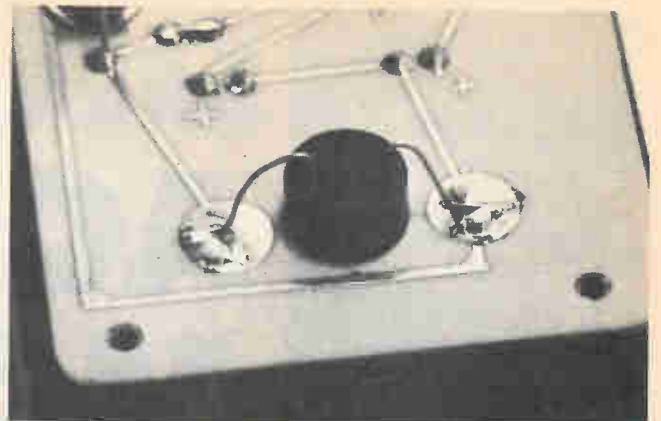

LDR1 IS SOLDERED directly to oversized foil pads; the leads don't pass into the board. That permits freedom of movement when positioning LDR1, which is important because it must be centered over the opening in the board.

window. If you see the edges at the right or left, simply give the cell a push to center the active section under the window. Finally, make certain that the cell is flat to the printed-circuit board; it should not be below the board. To make viewing easier when working in the dark, punch a 1/4-inch hole in a piece of white adhesive label (cut to your desired size) and apply it to the top of the printed-circuit board, with the hole positioned over LDR1's window.

The LED's can be anything you have around, though the diffused kind are the easiest to work with in the dark. Potentiometer R2 should be a linear taper; a log or audio taper will

Continued on page 93

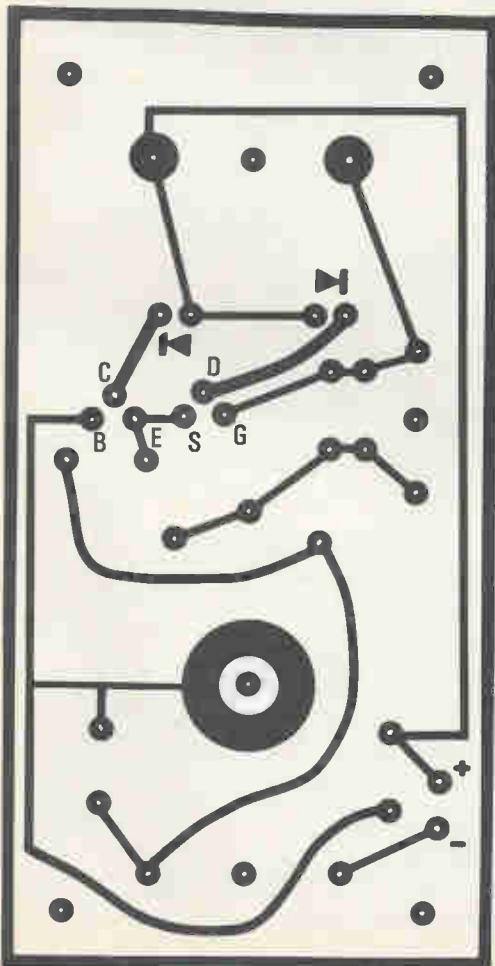
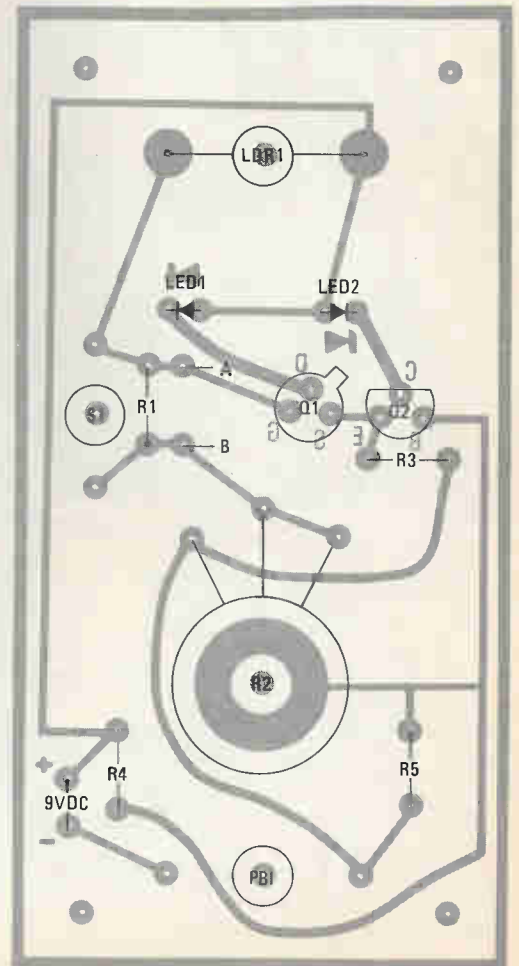
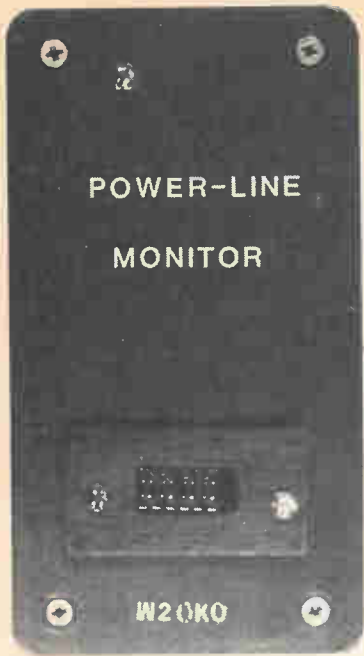

FIG. 2—FOIL PATTERN for the printed-circuit board used to mount the parts in Printmeter. The board serves as the cover on the unit's box.

FIG. 3—PARTS LOCATION diagram reveals the low density of parts to the unit area on the board's surface. Switch S1, potentiometer R2, and light-dependent resistor LDR1 mount on the PC board's foil side.





DIGITAL AC LINE MONITOR

*Now you can pinpoint problems
caused by variations in the AC line*

R.M. MENDELSON

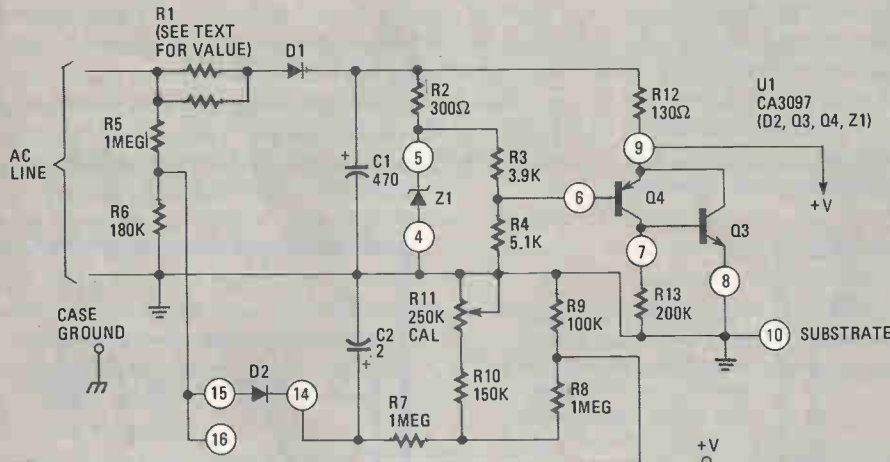
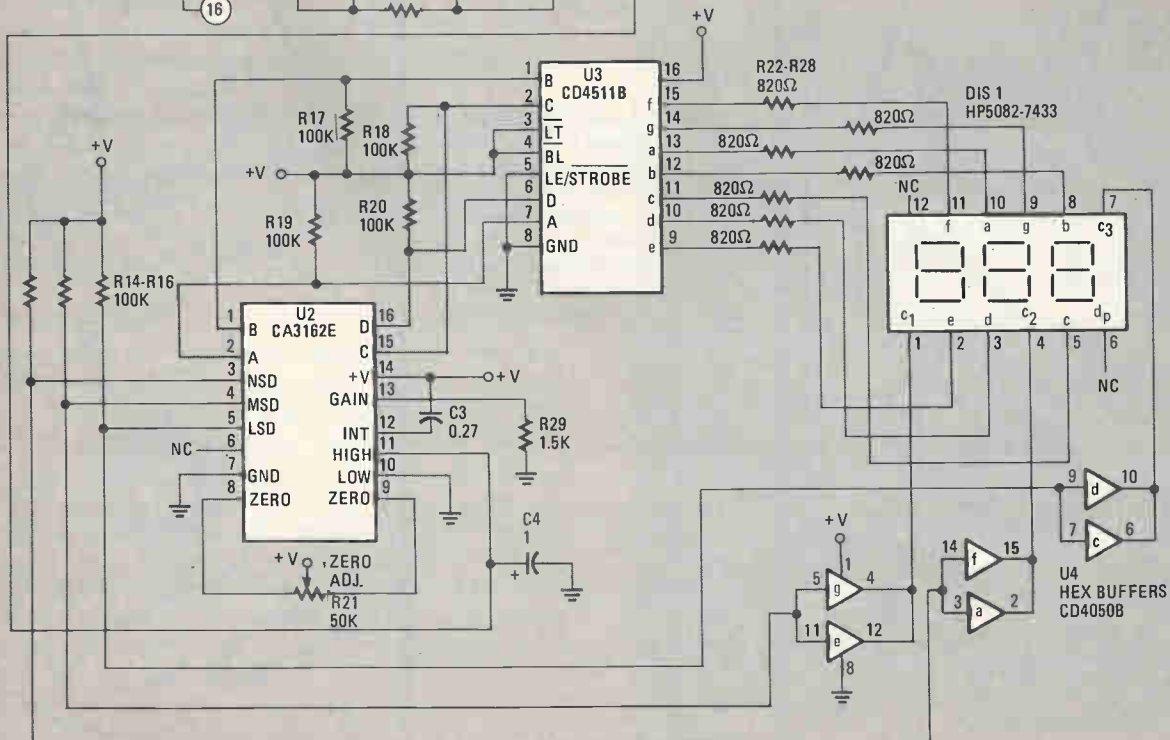

FIG. 1—THE DIAGRAM may look a bit complex; however, the use of four IC chips and a packaged, miniature, LED display simplifies the construction. A novel feature in the circuit is the use of a multi-component chip, U1, to supply required discrete components.



□ THE DIGITAL AC LINE MONITOR WILL TRACK THE LINE'S voltage range from 90 to 130 volts, or 200 to 240 volts, with an accuracy of ± 1 volt. The monitor consumes less than 2 watts of power and may be connected into a circuit permanently. The monitor requires no isolation or step-down transformer.

Inside the Circuit

The simplicity of circuit design (Fig. 1 shows the schematic diagram) results from the use of the RCA CA3097 thyristor/transistor array integrated circuit, which provides all but one of the solid-state devices needed for an *rms*-to-DC converter as well as the regulated 5-volt supply required to power the digital-readout circuits. The CA3097 consists of five independent active components on one chip: An NPN transistor (used to form a diode, D2, in this circuit); a PNP/NPN transistor pair; a Zener diode; a PUT (programmable unijunction transistor); and an SCR (silicon controlled rectifier). Neither the PUT device nor the SCR are used in the monitor. The only active device needed external to the CA3097 is the line-voltage rectifier, diode D1. Additional IC's include a CA3162E A/D converter, a CD4511B BCD-to-7-segment

latch-decoder, and the CD4050B buffers used to drive a miniature common-cathode 3-digit LED display. (The reader may want to refer to *RCA Linear Integrated Circuits Databook*, RCA Solid State Division Publication No. SSD-240A, page 261.)

Figure 1 shows an AC line with one side grounded. Care should be taken in construction to protect the user should the monitor be inserted in the circuit with the ground tied to the "hot" AC line. The meter will function properly with either side of the line grounded.

Circuit Operation

The line voltage is reduced by a power-dropping resistor, R1, and rectified by D1 to develop 10 volts across capacitor C1. The value of R1 is chosen as a function of the line voltage: for the voltage range of 90 to 130 volts, R1 is rated at 1500-ohms, 2 watts, and for the 200 to 240-volt range; 3000-ohms, 5 watts. The DC voltage developed by D1 is applied through R2 to the 8-volt Zener diode, Z1. That voltage provides a reference for the PNP/NPN pair, Q3, Q4, which is used as a shunt regulator to produce the +5-volt supply for the digital readout circuits. The base current for the transistor pair (at

PARTS LIST FOR DIGITAL AC LINE MONITOR

SEMICONDUCTORS

- D1—1N4001 diode rectifier
- D2—Diode—part of U1
- DIS1—Miniature 3-digit, 7-segment, common-cathode LED display (HP5082-7433 or equivalent)
- Q3, Q4—PNP/NPN transistors—part of U1
- U1—CA3097 thyristor/transistor array including D2, Q3, Q4 and Z1
- U2—CA3162E full-function stereo preamplifier integrated circuit
- U3—CD4511B CMOS BCD-to-7-segment latch decoder driver integrated circuit
- U4—CD4050B hex noninverting buffer and TTL driver
- Z1—Diode—part of U1

RESISTORS

- (All fixed resistors are $\pm 5\%$, $\frac{1}{4}$ -watt)
- R1—3000-ohm, 5-watt for 200-240 VAC, or 1500-ohm, 2-watt for 90-130 VAC (See text)
 - R2—300-ohm
 - R3—3900-ohm
 - R4—5100-ohm

- R5—1-Megohm
- R6—180,000-ohm
- R7, R8—1-Megohm
- R9, R14-R20—100,000-ohm
- R10—150,000-ohm
- R11—250,000-ohm CAL, PC-mount potentiometer
- R12—130-ohm
- R13—200,000-ohm
- R21—50,000-ohm ZERO ADJ, PC-mount potentiometer
- R22-R28—820-ohm
- R29—1500-ohm

CAPACITORS

- C1—470- μ F, 16-WVDC electrolytic
- C2—2- or 2.2- μ F, 25-WVDC, axial leads electrolytic
- C3—.27- μ F tubular
- C4—1- μ F, 16-WVDC, PC-mount, electrolytic

ADDITIONAL PARTS AND MATERIALS

Printed-circuit materials or perfboard, line cord with 2- or 3-prong molded plug, IC sockets (optional), plastic case with cover, wire, hardware, solder, etc.

FIG. 2—SAME-SIZE FOIL PATTERN permits the reader to either trace or photocopy author's design when manufacturing circuit board at home.

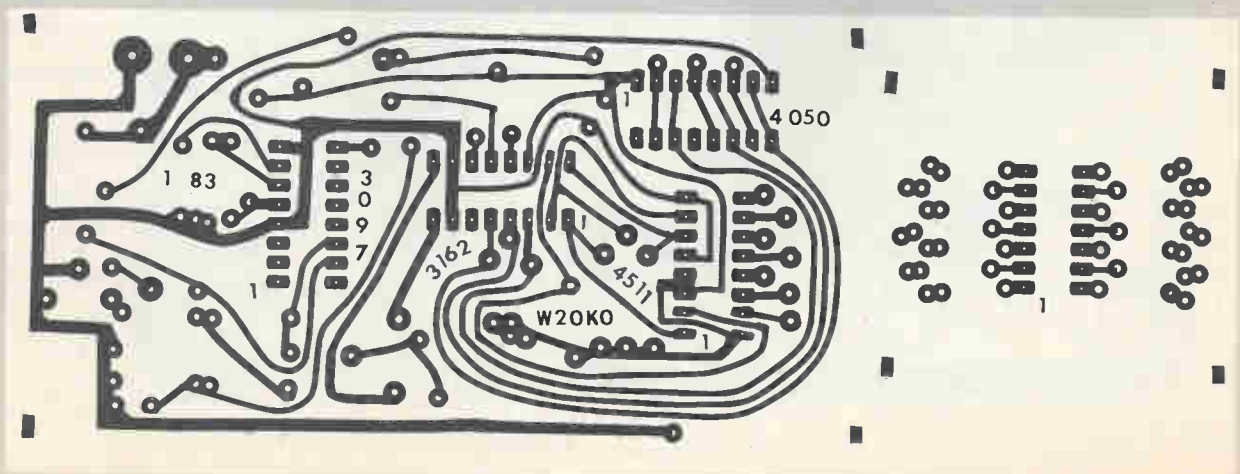
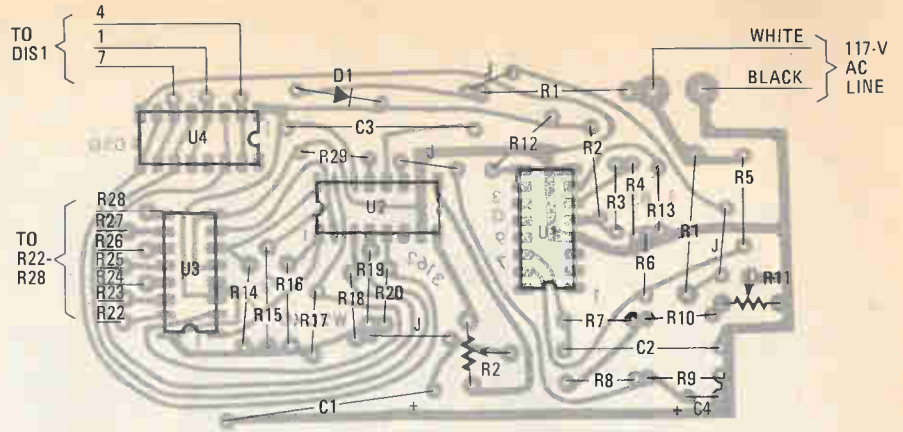
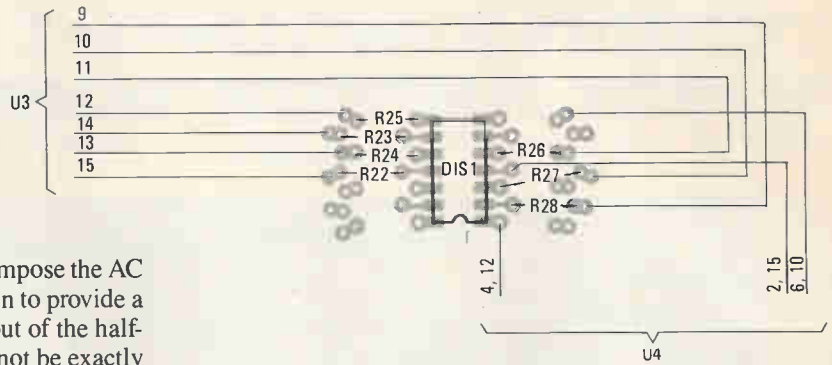

FIG. 3—THE FOIL PATTERN looks a bit different in this figure than in Fig. 2 because the board was cut apart. The foil pattern in the lower portion of this drawing was separated from the main board to reduce the overall size of the project and permit locating LED display DIS1 on the box's surface. Should the monitor be wired into a project or appliance, this design permits the LED display to be mounted on the front panel, whereas the main circuit may be located anywhere in the unit.



terminal 6 of U1) is supplied from the regulated 8-volt bus by means of the voltage-divider network, R3, R4, and terminal 9 is set to 5 volts. The value of $V+$ will not vary by more than 0.2 volts over the normal AC line voltage range of 105 to 125 volts. The variation is within the operating voltage specification of the digital readout circuit components.

The values of R5 and R6, the resistors that compose the AC voltage divider across the line, have been chosen to provide a sample of approximately 10 volts AC to the input of the half-wave rectifier diode, D2. The resistor ratio cannot be exactly 10:1 because of loading by the circuit following the diode. As mentioned above, diode D2 is really the collector-base junction of the NPN transistor in the CA3097 (U1). The DC potential (approximately 10 volts) developed at terminal 14 of the CA3097 (U1) is divided by voltage divider network R7, R8, R9, R10, and R11, to provide the DC potential needed to drive the digital-readout circuits through terminal 11 of the



CA3162 (U1), the input terminal for those circuits. Because the decimal point is not shown, a 0.2-volt DC signal at terminal 11 provides a digital readout of 200; a 0.12-volt signal yields a readout of 120.

Other digital-readout circuits may be used in the monitor circuit, provided that the load on the regulated 5-volt $V+$

THIS IS WHAT the monitor looks like just before buttoning up the unit after all the wiring is completed. Note that parts density is not severe.

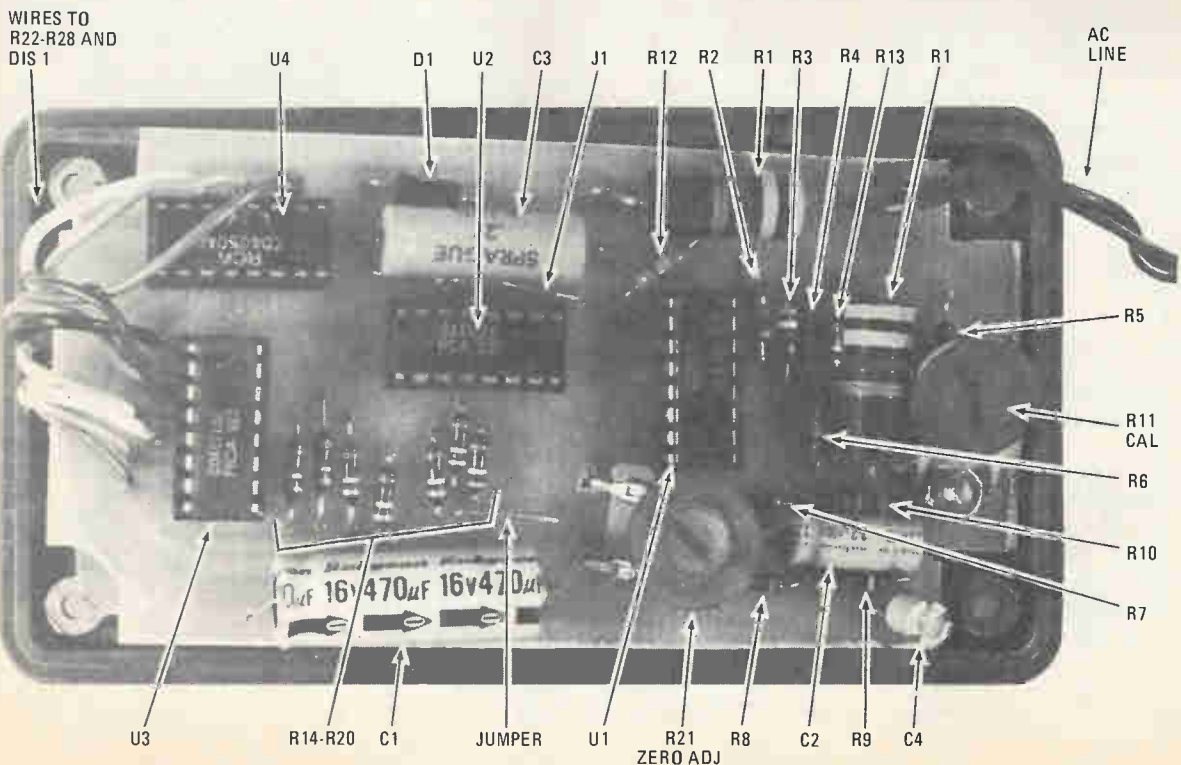



New Life for an Old Monitor

HERB FRIEDMAN

Retrofit your old Model 1 Monitor for use with Timex, Vic-20, Apple, or other personal computers.

□ MANY EARLY PERSONAL-COMPUTER HOBBYISTS STARTED out with the Radio Shack model *I* home computer, a budget machine that deserved a lot more credit than it ever received. Over the years, many have crashed, or have been replaced with more modern microcomputers such as the Radio Shack model *III*, the model *4*, an IBM, or whatever. Regardless whether the computer simply died, or was replaced, many of the old model *I* video monitors can be found at computer flea markets, surplus equipment dealers, and in the used-computer section of local penny-saver newspapers.

Those monitors are generally still serviceable, and with an evening's time and effort they can be retrofitted for use as a low-cost remote monitor, a spare monitor, or even as the main monitor for any computer with a composite video output, such as a Commodore *VIC-20*, a modified *Timex*, or even an *Apple*.

The Reasoning

Why retrofit what appears to be working equipment? Because, an unmodified Radio Shack model *I* video monitor will work only with a Radio Shack model *I* computer. It won't work with any other computer without some minor modifications. If you don't make the necessary modifications, the monitor screen will light up, the monitor will appear to be working, but nothing will be seen on the screen.

The reason for the lack of screen display is the monitor's AC/DC chassis ground. To keep the selling price low, Radio Shack designed the model *I* computer system to use part of a standard 13-in. TV receiver for the video monitor. The company that supplied the monitor simply stripped out the tuner assemblies, the IF strip, and the sound circuitry, and left only

the horizontal and vertical circuits, and the video amplifier. Unfortunately, the chassis ground was hot—it was an AC/DC chassis ground—and the last thing Radio Shack wanted was a hot ground running back to their computer.

They resolved the problem of the hot ground by using an opto-isolator to isolate the computer and monitor grounds. Figure 1 (on the next page) shows how it's done. An opto-isolator is an encapsulated device consisting of an LED and an optical sensor, which can be a photoresistor, photodiode, or phototransistor. As shown in Fig. 1, in the case of the Radio Shack video monitor, it's a photodiode. The input digital signal from the computer is fed to the LED inside the opto-isolator package, which blinks on and off in step with the binary 0's and 1's from the computer. The photodiode senses the light pulses from the LED and feeds corresponding 0 and 1 current pulses to the base of the following transistor, which is the input to the TV's video amplifier section. Note, in particular, that the ground of the LED circuit is isolated from the ground of the photodiode/video-amplifier: the LED ground is from the computer, the video amplifier's ground is from the monitor.

The actual circuit used in the Radio Shack monitor is somewhat more complex than the simplified circuit in Fig. 1—there are additional transistors driving the LED—but the application theory is the same.

Solving the Problems

Because the opto-isolator circuit requires its own ground system, its power source must also be independent of the monitor. Radio Shack did that by bringing out from the computer both the composite video and +5-volt DC needed

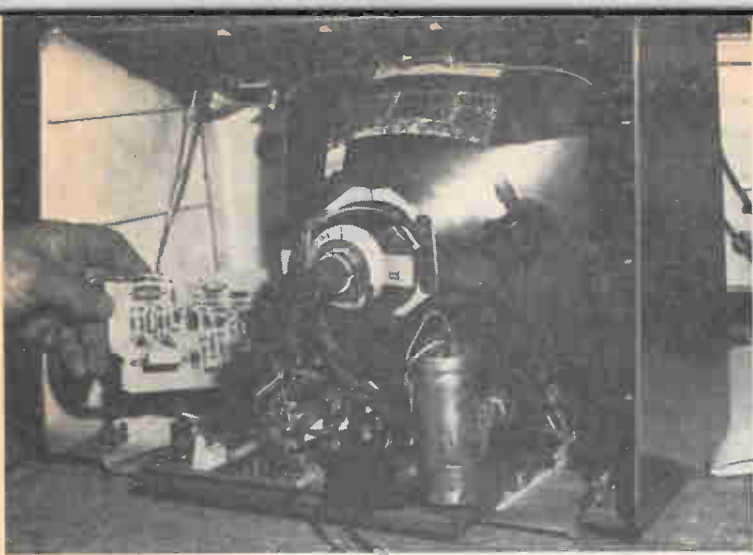

THE OPTO-ISOLATOR is on a plug-in board. Remove it as a unit to keep it out of harm's way until the job is done.

for the opto-isolator. That is why simply connecting composite video to the monitor doesn't produce a display—there must also be +5-volt DC to power the opto-isolator and its associated input circuit.

To convert the monitor for general use, it's only necessary to provide isolated-ground power for the opto-isolator and the composite video. Essentially, that comes down to a small isolated power supply installed within the monitor. As shown in the photographs, there's plenty of room inside the monitor's cabinet because it's really a stripped-down TV. The space formally used for the VHF and UHF tuners—which is on the left when looking into the back of the cabinet—is an ideal location, because the mounting studs for #8 self-threading screws are molded into the cabinet. The printed-circuit foil template we provide for the power supply and video loop-through exactly fits location.

The Muscle Work

The power supply is a conventional 3-terminal regulator 5-volt circuit. See Fig. 2. Because the opto-isolator isn't fussy about the applied voltage, and requires relatively low current (less than 30 mA), power transformer T1 can be either 6 or 12 volts. Use whatever you have around or can purchase inexpensively. The printed-circuit foil layout (Fig. 3) is specifically for the Radio Shack transformers with printed-circuit terminals; if you substitute for the specified transformer, modify the printed circuit's foil layout accordingly.

The video input to the opto-isolator loops through the

FIG. 1—SIMPLIFIED opto-isolator circuit used to transmit computer data to a monitor without any interconnecting wires.

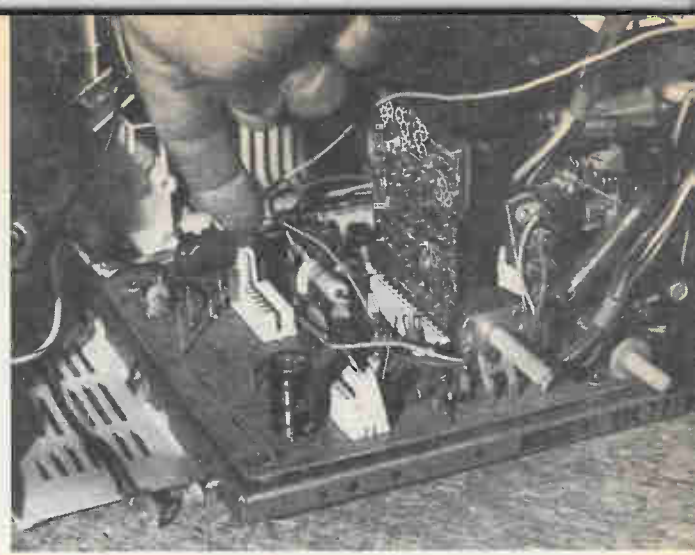
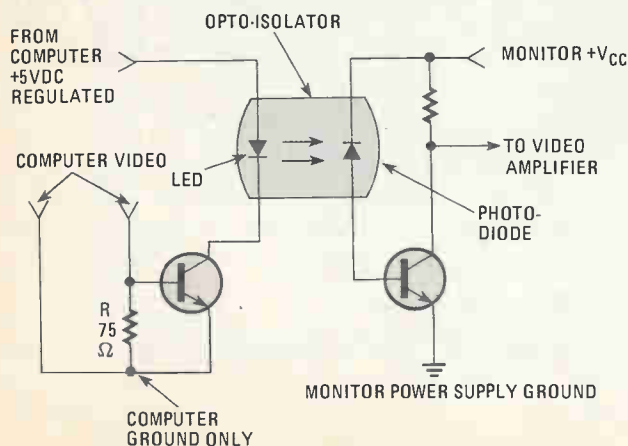

FINGER points to the clips used to secure the opto-isolator board. Be sure to release this clip before removing board.

power-supply board (see Fig. 2) to keep the wiring in its original 3-wire configuration—that way you can easily restore the monitor to its original wiring if necessary.

Nothing is unusual about the power-supply assembly as long as you take care that there is no way that the ground system for the power supply and video input can contact or connect to the TV's chassis ground—or any other part of the TV circuitry. The printed-circuit board is quite large; to remove the possibility of strain (caused by its mounting) from cracking the board when the cabinet heats up, elongate three of the mounting holes, as shown in the photos. When you install the board in the monitor, place the first mounting screw in the round hole, then the others. Don't force a screw; if it's tight, make the hole in the printed-circuit board a little larger.

The connections to the foils of the printed-circuit board are from the top of the board through terminal pins, which are actually wire-wrap pins passed through the board, folded on the underside, and soldered to the foils. If you don't have (or can't get) a few pins, substitute ordinary Vector push-in terminals.

Reaching Inside the Monitor

The opto-isolator's printed-circuit board is the one connected to the cable that passes out the front of the cabinet—there's a DIN plug connected to the end of the cable. Free the wire from the clamp(s) and then remove the opto-isolator printed-circuit board. Don't try to work on the opto-isolator assembly while it's still in the TV, because it's dangerously close to the CRT—if a tool slips, the CRT has had it. Instead, remove the opto-isolator board. It's an original retrofit for the TV set, and not really part of the TV, so it's easily removed. If you look at the bottom of the board, you'll see that it's installed in a socket. A small metal clip at the back of the board secures the board in the socket. Push the clip out of the way with your finger and gently rock the board loose. Estimate how much cable you'll need to reach the power-supply terminals and cut the existing cable. Remove the board and then strip and prepare the free end of the wires.

Install the power-supply board in the cabinet with #8 self-tapping screws. Then connect the supply's 120-VAC terminals to the monitor's switched power source; in that way the opto-coupler's power supply will be controlled by the monitor's power switch, which is located at the upper left of the front panel (when looking in from the back of the set).

Locate the terminal strip to which the monitor's power cord is connected. One terminal, the largest, is the common line

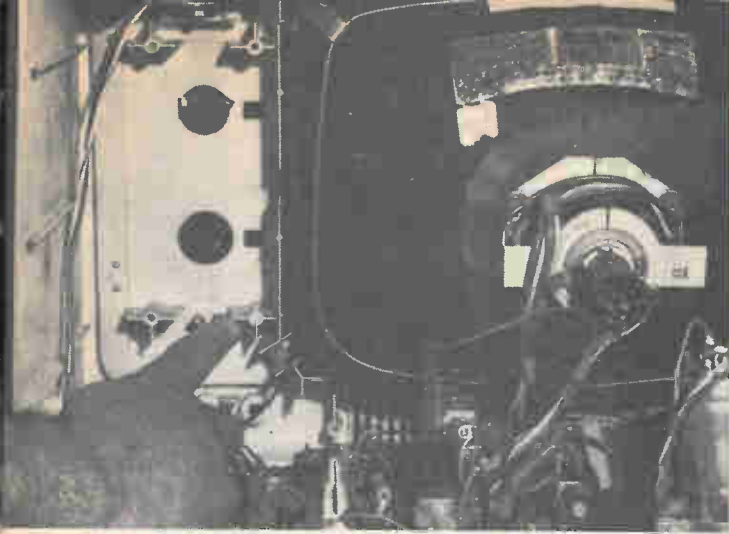

THE HAND points to an open panel area where a TV tuner would normally be installed—put the power supply here.

connection and is used for one connection to the power supply. The other line connection passes through a fuse, then on to the on-off switch. Trace the switch's return wire back to the terminal strip; that is the other line connection for the power supply. Route the wires from the terminal strip to the power supply through the same cable clamps and guides used for the monitor's factory-installed wires.

Start Checking It Out

At this point, fire up the monitor and check the output of the power supply with a DC voltmeter connected between the power-supply pins labeled C and 5. If you get a meter reading of 5 volts, give or take a tenth or two, all is ok, and you can go on to final assembly. If you read more than 5.1-volts DC (allowing for meter tolerance), check your power supply

FIG. 2—HERE'S THE POWER SUPPLY and the interconnections required to modify your Model 1 monitor for universal use.

HERE'S HOW the back of the monitor looks (see lower right) after the power-supply board is installed in the monitor.

CONNECTIONS are made to the power supply via wire-wrap terminals that are soldered to the underside of the board.

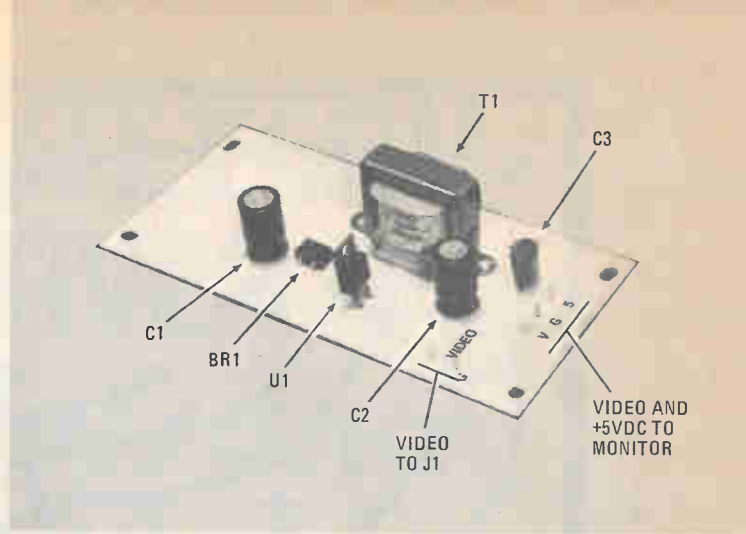

PARTS LOCATION on the printed-circuit board (see Fig. 3) indicates that there's plenty of room on the circuit board.

construction for an error or a defective component.

When you are certain that the power supply is working properly, install a phono jack, J1, on the lower right of the right side of the cabinet. Since you'll be making frequent connections to that jack, use a decent quality jack. I specifically recommend a Switchcraft phono jack, the type that mounts in a 3/8-in. hole with a volume-control-size nut. If you can't get one of those, use the type that mounts in a 1/4-in. hole and put a lockwasher under the mounting nut.

Connect jack J1 to the VIDEO terminals on the power-supply board, using any kind of shielded cable—coax, audio, whatever you have. The cable's shield connects to the

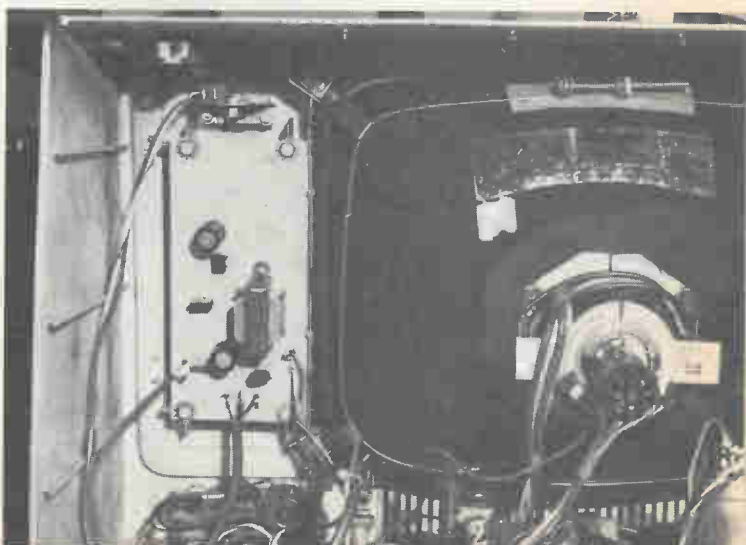
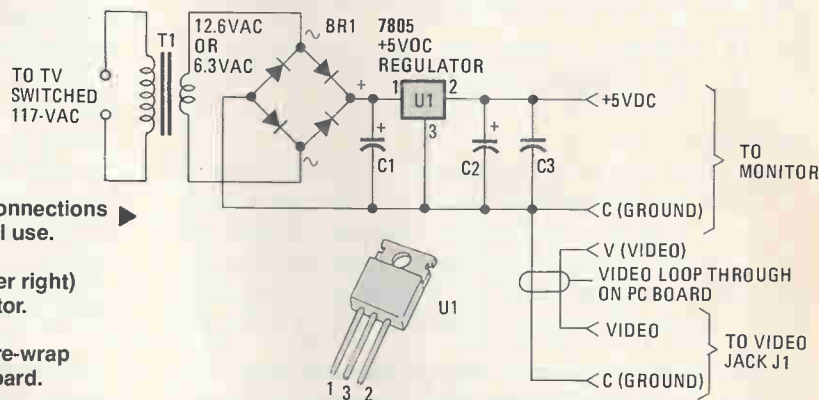

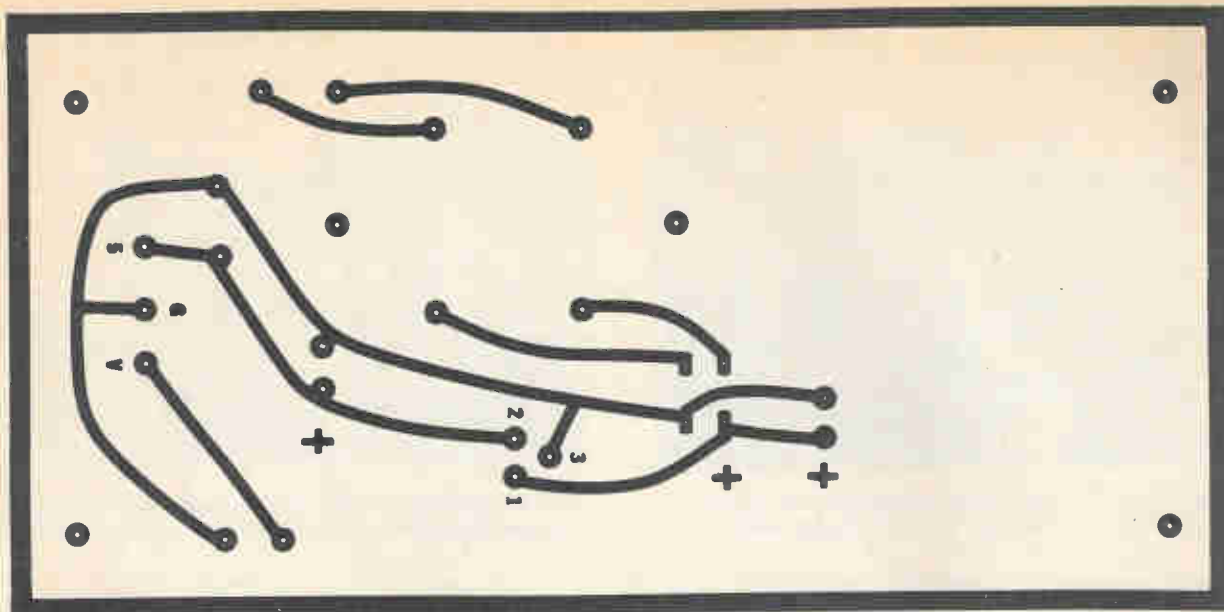

FIG. 3—SAME-SIZE foil pattern used by the author to make his printed-circuit board.

jack's frame and the VIDEO C terminal on the power supply. The cable's center conductor connects to the jack's hot (center) terminal and the VIDEO terminal.

Finally, install the opto-isolator board in its socket, make certain the spring clip locks into the notch in the board, and connect the three wires in the cable to the V, G, and 5 terminals on the power supply board. The black wire connects to the G (ground) terminal; the red wire connects to the 5-volt terminal, and green wire, which is video, connects to the V terminal.

Put the back cover on the monitor and it's ready for use; there are no adjustments to be made.

Power Up

To use the monitor, simply plug it in to your computer as you would with any other composite monitor. Don't worry about loading the computer's output, because a 75-ohm load was incorporated in the original opto-isolator board and it's still there. If you plan to use the monitor with a modified Timex computer the display will be somewhat light, because

AUTHOR POINTS OUT terminal strip that connects to the monitor's AC line cord. Wide lug is the common connection.

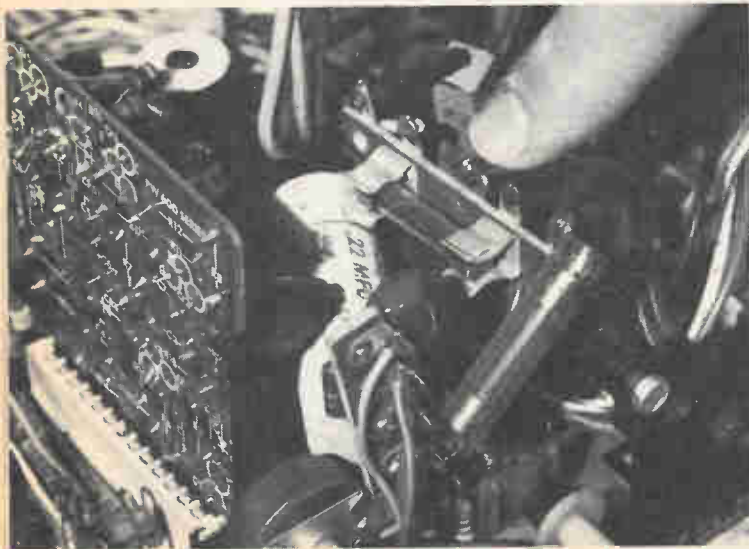

PARTS LIST FOR MONITOR RETROFIT

- BR1—Bridge rectifier module, rated at 50-PIV (Radio Shack 276-1161)
 - C1, C2—100- μ F, 25-WVDC, electrolytic capacitor
 - C3—.1- μ F, Mylar capacitor
 - J1—RCA phono jack, quality type (See text)
 - T1—Filament transformer: 117-volt AC primary winding; 12.6 or 6.3-volt AC at 300 mA secondary winding (Radio Shack 273-1385 or 273-1384, or equivalent)
 - U1—7805 +5-volt regulator integrated circuit, or equivalent
- Printed-circuit materials, wire-warp or push-in terminals, coaxial or shielded cable, wire, solder, hardware, etc.

the Timex's video output is about half the standard value. In that case, pull the opto-isolator board, locate the 75 ohm resistor, and remove it. The Timex display will now appear with standard density.

The monitor conversion seems to be a lot more difficult as you read than it really is to perform. Just follow the steps in the photos and you should be able to do the job in less than an evening. **SP**

THE FINAL TOUCH—an input jack is located to the side of the monitor's cabinet. Avoid touching chassis ground.



BATTERY SAVER For Personal Portables

Why buy expensive batteries when an outlet can do the work?

JOHN CLARKE



□ WHILE TYPICAL AC PLUGPACK ADAPTERS CAN SUBSTITUTE for batteries in calculators, their use with portable audio equipment is often unsatisfactory, due to high hum levels. The Plugpack Regulator* solves that problem and saves on the cost of batteries without giving you hum between the ears.

Although battery-operated equipment has the advantage of being operable anywhere, its greatest disadvantage is the need to replace the batteries periodically, whether the item is used or not. In many cases, battery-operated equipment is used close to all AC power outlet and so battery costs can be saved by powering from the AC line.

Nickel-cadmium rechargeable batteries can be used, and charged periodically or continuously trickle-charged, and those constitute a long-term cost improvement over primary batteries which cannot be recharged. On the other hand, rechargeable batteries can only be justified if their portability is used. If the equipment is used mostly in the house, then operation from a power supply is more economical.

The power-supply plugpack has rescued many battery-operated devices from the scrapheap by providing a cheap source of power, while the costs of dry batteries escalate. But most people who have tried a DC plugpack to power portable radios and cassette recorders have been very disappointed by the excessive hum level they produce. That hum is due to the 120-Hz ripple superimposed on the plugpack's supply output and is a common failing in most simple inexpensive DC plugpacks.

The most effective solution is to build a power supply fitted with a voltage regulator. The regulator, by the very fact that it regulates the voltage, acts as a very effective filter; so effective that its performance could only be matched by using very large and expensive electrolytic capacitors. Over and above that, the regulator takes care of line-voltage variations, and potential-voltage variations, due to changes in load or output current.

Our Plugpack Regulator is housed in a small plastic utility box, glued onto the rear of an AC plugpack. The leads from the plugpack enter the regulator box and emerge fully regulated and without the ripple that causes hum. The voltage from the regulator is necessarily several volts less than the voltage available from the plugpack and so a 12-volt DC plugpack is a suitable choice.

Voltages available from the regulator can be selected from between 1.5- and 9-volts. That range is sufficient for virtually any piece of portable radio or audio equipment. At 9-volts the maximum current available before the regulation ceases is 350 mA; at 6-volts, 430 mA; and at 3-volts, 66 mA. The Plugpack Regulator can be adjusted to any voltage required, by turning a small trimpot; or fixed resistors can be installed to provide a single preset voltage.

The Plugpack Regulator circuit is relatively simple and comprises an adjustable three-terminal regulator, five diodes, and associated resistors and capacitors. A full-wave bridge rectifier converts the AC voltage from the plugpack to pulsating DC and that is filtered to moderately smooth DC with the 470- μ F capacitor across the supply. For transient suppression, the 0.1- μ F capacitor is also included across the supply.

The remainder, and vital, part of the filtering is performed by the LM317T three-terminal regulator IC which, as already hinted, also pegs the output voltage within very close limits over a wide range of input (line) voltage variations and output load (current) variations.

How it Works

To provide a better understanding of how the regulator circuit works in the Plugpack Regulator, we have prepared a much simplified diagram of it (Fig. 1). As we show it, the LM317T consists of a power transistor in an emitter-follower configuration, with the base being fed from the output of an operational amplifier. The input to the operational amplifier is taken from the output of the emitter follower—thus making it a feedback system—but, more specifically, it is the voltage developed across R2. The op amp monitors the voltage across R2 and adjusts the drive to the power transistor, to keep the output voltage within tight limits.

*Original project appeared in *Electronics Australia*, January, 1983 Edition, and reappears here by permission.

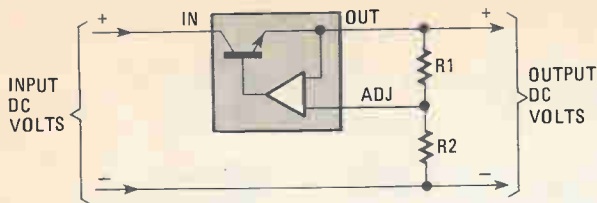

FIG. 1—SIMPLIFIED SCHEMATIC DIAGRAM of the Plugpack Regulator offers designer's-eye view of how the circuit functions. The voltage output of the circuit is determined by the equation: $V_{out} = 1.25(1 + R2/R1)$.

The whole system is so adjusted that it strives to maintain a constant value of about 1.25-volts across R2 which means that, in turn, it also maintains a constant current through R2 and thus, the same constant current through R1. By selecting the value of R1 we can regulate the voltage that will appear between the OUT terminal and the negative bus, which will be 1.25-volts higher than the voltage across R1.

Let us now consider what happens if the output voltage (between OUT and negative bus in Fig. 1) tends to vary, due either to variations in the input voltage or variations in the load current across the output terminals. Let's say that the input DC voltage tends to rise. That would have the effect of trying to force more current through the R2/R1 network and increasing the voltage across R2. But the feedback network will have none of that; it will immediately pull down the forward bias on the transistor, thus lowering the output voltage until the requisite 1.25-volts is restored across R2.

Similarly, if the voltage should tend to fall, the reverse corrective action would occur. That is a greatly simplified explanation of both the regulator circuitry and the manner in which it functions in the circuit; but it should give the reader at least a basic grasp of what is involved. It also explains how the LM317T can control the voltage between its output and ADJ terminal precisely, while negligible current actually flows into or out of the ADJ connection.

In Greater Detail

In practical terms, and reverting to our main circuit for the Plugpack Regulator shown in Fig. 2, R2 should be 744 ohms for a 9-VDC output; 456 ohms, for 6-VDC; and 168 ohms, for 3-VDC. The table on the circuit diagram (Fig. 2) shows the parallel combination of standard 10% resistor values to obtain those specific resistances. Alternatively, a single

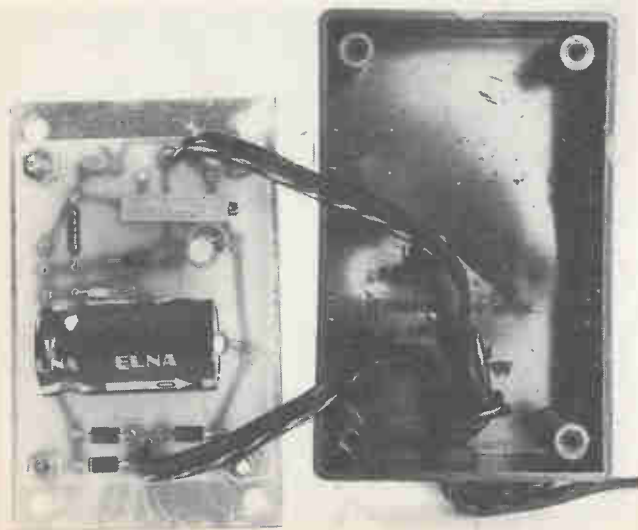

PARTS LIST FOR BATTERY SAVER

SEMICONDUCTORS

D1-D5—1N4002 1-ampere, silicon diode
U1—LM317T, 3-terminal, adjustable regulator integrated circuit

RESISTORS

R1—120-ohm, 1/4-watt, 5%
R2—See text and Table in Fig. 2

CAPACITORS

C1—470- μ F, 25-WVDC, axial-leads, electrolytic
C2—.1- μ F, ceramic
C3—10- μ F, 16-WVDC, tantalum, electrolytic
C4—22- μ F, 16-WVDC, PC-mount, electrolytic

ADDITIONAL PARTS AND MATERIALS

1—Plugpack power supply, AC type rated at 12-VAC at 500 mA (See text for additional details and substitution)
1—Set of matching DC plug and socket (See text)
Plastic utility box with aluminum cover, printed-circuit materials, 4 1/4-in. spacers, insulating mica washer kit for TO220 case (U1), grommet, wire, hardware, solder, etc.

multi-turn 1000-ohm trimpot can be used and adjusted for the correct voltage.

The values of R2 have been calculated on the basis of the quoted center voltage of 1.25 for the LM317T. The actual spread is from 1.2- to 1.3-volts; and that, together with normal resistor tolerances, could produce slightly higher or lower voltages. However, even under worst-case conditions—assuming 5%-tolerance resistors—the highest voltage would be about 13% high. (Most appliances could cope with that without trouble but, in any case, typical variations would be much less than that.)

The 10 μ F tantalum capacitor, C3 (Fig. 2), bypasses the voltage at the adjust terminal of U1 to ensure a stable output of the LM317 regulator without transients. Similarly, the 22 μ F capacitor, C4, at the output of U1 provides decoupling and transient suppression.

An RF bypass capacitor in parallel with the 22 μ F capacitor may be desirable in some cases, but the need for it is unlikely. If you wish, connect a .05- to .2 μ F disc capacitor across C4 during the construction of the project. Most circuits designed for battery operation would already have such a capacitor across the supply-input terminals, to cope with aging batteries.

Diode D5 (Fig. 2), is used to protect the regulator against supply voltage's entering the output of the regulator. In normal circumstances, that diode is unused because it is reverse biased. If a voltage higher than the regulator voltage is applied to the output—when, say, a charged capacitor is connected, the diode conducts and shunts the current from the regulator.

Not to forget the bridge rectifier, we caution experimenters to observe diode polarities of D1-D4. An error here will destroy regulator U1 at first power-up.

That more or less completes the circuit description. There

BELLY-UP VIEW of the plastic case with the aluminum cover removed. Note the four mounting screws and nuts that hold the printed-circuit board to the lid. Regulator U1 cannot be seen. It is mounted on the foil side of the board.

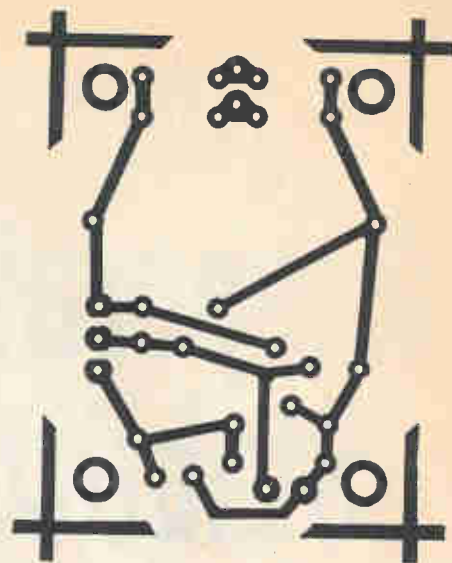
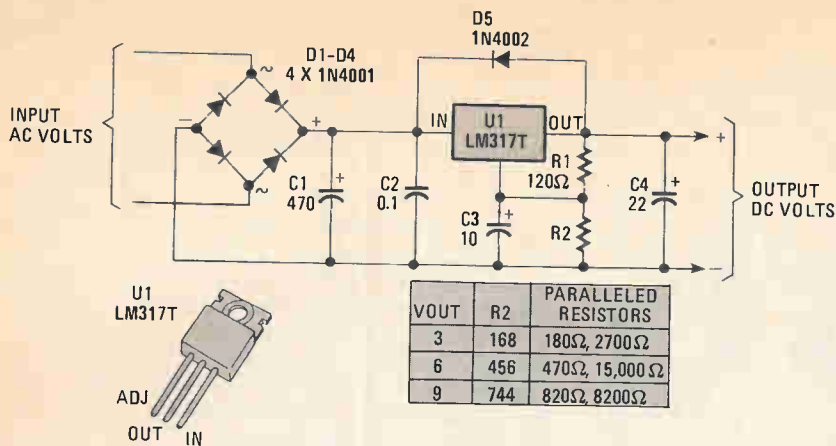

FIG. 2—DETAILED SCHEMATIC DIAGRAM of the Plugpack Regulator provides the information necessary to build the unit. Resistor R2 is a selected value of 5% or 10% tolerance resistors paralleled together, forming the suitable combined resistance for the desired voltage output.

is not much to it, but it offers high-regulation performance. The circuit is completely safe, because the plugpack AC power supply is double-insulated and does not require grounding.

Construction

Construction is on a printed-circuit board, as shown in Fig. 3. The board is mounted in a plastic utility box measuring 1½ × 2½ × 3¼-inches. That box is glued to the rear of the plugpack to make a small, neat unit.

Start construction by making sure that the printed-circuit board you fabricate will fit within the utility box. If it doesn't, file the edges of the board until it has sufficient clearance. Remember, the edges of the printed-circuit board are determined by the inside dimensions of the case you purchase. Now mark the mounting holes on the lid of the box so that, when the board is mounted on the lid, the whole assembly will fit inside the box. At that stage, mark the mounting position for the regulator, which is fitted on the copper side of the printed-circuit board, but is mounted on the lid. The leads of the regulator will need to be bent through 90 degrees, and Figs. 4 and 5 show the mounting details and connections.

Drill holes for those mounting positions, and also a hole,

FIG. 3—FOIL PATTERN used to make the printed-circuit board for the Plugpack Regulator. Small size is important, considering mounting technique used. Should you desire to include the Plugpack Regulator as part of a project, size and positioning of parts can be changed because their location is not critical to circuit operation.

suitable for a small grommet, at the end of the plastic box. Deburr all the holes, particularly around the regulator-mounting hole. That is to prevent swarf (metallic burrs caused by the drilling operation) from punching through the mica insulating washer.

Insert and solder all the components into the printed-circuit board, making sure that they are oriented correctly. (See Fig. 4.) Solder the regulator chip U1 to the underside of the board and bend the leads so that it can be secured to the case lid. Place a smear of heatsink compound on both sides of the mica washer and then bolt the regulator to the case lid, as shown in Fig. 5.

While most AC plugpacks are fitted with an output lead and connector, some are fitted with screw terminals. If your plugpack has a fitted lead, that should be cut short and wired to the AC input of printed-circuit board. The remaining lead and connector can then serve as the output lead for the regulator circuit. If your plugpack has no fitted lead, it will be necessary to provide a suitable length of twin lead, preferably with a color streak to indicate polarity.

Plugpack Options

Although we have recommended a 12-volt AC plugpack, that is by no means the only power source that can be used. If only voltages below 6-

Continued on page 95

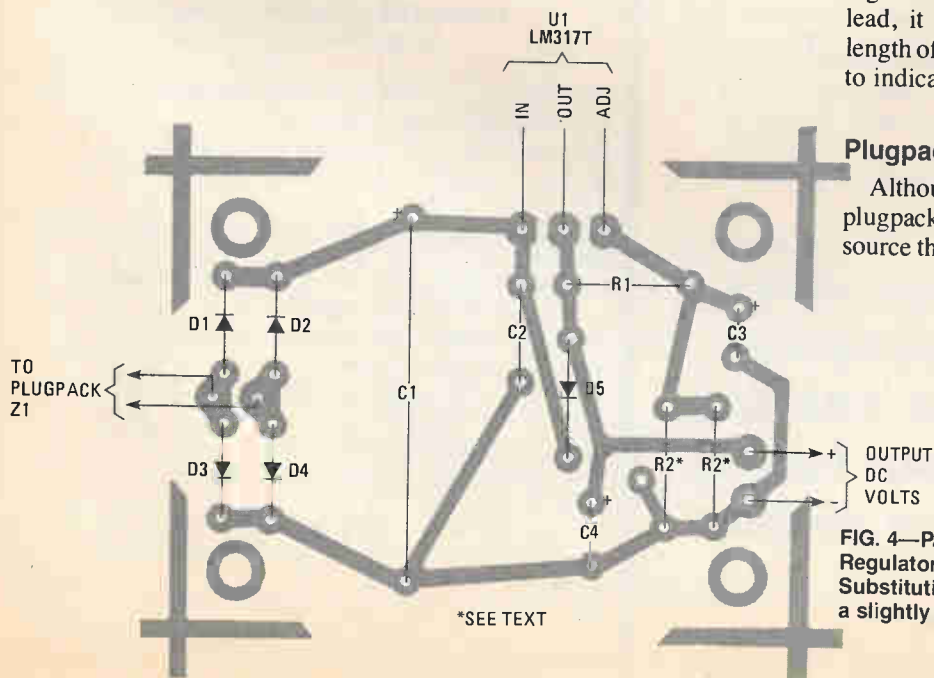

FIG. 4—PARTS LOCATION on the Plugpack Regulator circuit board is detailed here. Substitution of parts from the junkbox may call for a slightly different parts-layout.

Room Temperature Stabilizer

□ THE ROOM TEMPERATURE STABILIZER IS A SIMPLE BUT effective device that offers a means of control for moving warm or cool air from one localized area in a room throughout the room. Also, the stabilizer balances the temperature in a room in a house or apartment which runs too hot or too cold, summer or winter, when ordinary means such as adjusting vents, radiators, etc., fail. The stabilizer is nothing more than a means to control a fan to pump warm air to a cooler location, or cool air to a warmer location. In some buildings the heat available at a radiator may not efficiently exchange heat into the room thereby requiring a heat-exchange pump (a simple fan) to extract as much heat as possible from the radiator when the heat is available.

The basic design of the Room Temperature Stabilizer consists of a temperature controller such as an LM3911, which turns on a TRIAC, solid-state AC relay, or coil-type relay. Sensing ambient temperature, the temperature controller turns on a fan pumping warm air into a room you want heated or cold air into a room you want cooled. Since the average small electric fan is very inexpensive to operate, the design provides a simple inexpensive solution to many people's problems, especially apartment dwellers with fixed heat or cooling sources that they have little or no control over, such as old radiators.

Using a Temperature Controller Chip

The LM3911, and similar temperature-controller integrated circuits, usually have a temperature sensor, stable voltage reference, and op amp all fabricated on a single monolithic chip, while other PTAT temperature sensors such as the LM334 and AD590 do not. (See **Special Projects #5**,

***Here are 3 design ideas
you can use to program
improved uniform heating
and cooling in your home,
and save valuable dollars***

D.E. PATRICK

PARTS LIST FOR ROOM TEMPERATURE STABILIZER ILLUSTRATED IN FIG. 1

C1—1- μ F, 200-WVDC capacitor
C2—500- μ F, 25-WVDC, electrolytic capacitor
D1—1N4002 silicon diode
Q1—2N2905 PNP switch/amplifier transistor
Q2—40529 (or SK3506) Radio Shack 276-1001
R1—330-ohm, 2-watt resistor
R2—5800-ohm, 1/2-watt resistor
R3—50,000- to 100,000-ohm potentiometer
R4—150,000-ohm, 1/2-watt resistor
R5—2200-ohm, 1/2-watt resistor
R6—1500-ohm, 1/2-watt resistor
U1—LM3911 temperature sensor control IC

Spring 1983 "Build A 2% Temperature Sensor Probe" for a discussion of PTAT temperature sensors.) The beauty of the Former is that for simple control applications, such as turning on a solid-state relay, the parts count is minimal. Additionally, to drive a TRIAC or relay, we only need add a simple transistor driver.

The LM3911 can be used over a -25 -degree C (-77 -degree F) to $+85$ -degree C (185 -degree F) range. Its output voltage is proportional to temperature in degrees Kelvin at 10 mV/K (that's 10 millivolts per degree Kelvin), but its internal op amp can be used to provide conversion to degrees Celsius, Fahrenheit, and Rankine. (Again, see **Special Projects #5** for more on Kelvin-absolute temperature, Celsius, Fahrenheit, and Rankine conversion.

But in any case, the op amp can also be used as a comparator; that is how we'll apply it here, where its output will be made to switch at an adjustable set point.

This Room Temperature Stabilizer can be operated off any DC power source greater than 6.8 volts with suitable external resistors, because of its 6.8-volts nominal shunt regulator. Further, the output collector of the op amp can be returned to a supply voltage up to 35 volts providing an output sink

PARTS LIST FOR ROOM TEMPERATURE STABILIZER ILLUSTRATED IN FIG. 2

C1—100- μ F, 100-WVDC electrolytic capacitor
C2—1- μ F, 25-WVDC capacitor
C3—5- μ F, 16-WVDC electrolytic capacitor
D1-D6—1N4002 silicon diodes
D7—1N457 diode
K1—DPST or DPDT relay, coil rated at 24-V at 50-mA, contacts in excess of fan start-up current
Q1, Q2—2N2222 NPN silicon transistor (or replace with one D40C4 Darlington)
(All fixed resistors are 1/2-watt)
R1—27,000-ohm resistor
R2—5000-ohm potentiometer
R3—33,000-ohm resistor
R4—100,000-ohm resistor
R5—10-Megohm resistor
R6—12,000-ohm resistor
R7—18,000-ohm resistor
T1—Power transformer: 117-VAC pri. winding; 24-VAC at .5 A sec. winding
U1—LM3911 temperature sensor control IC

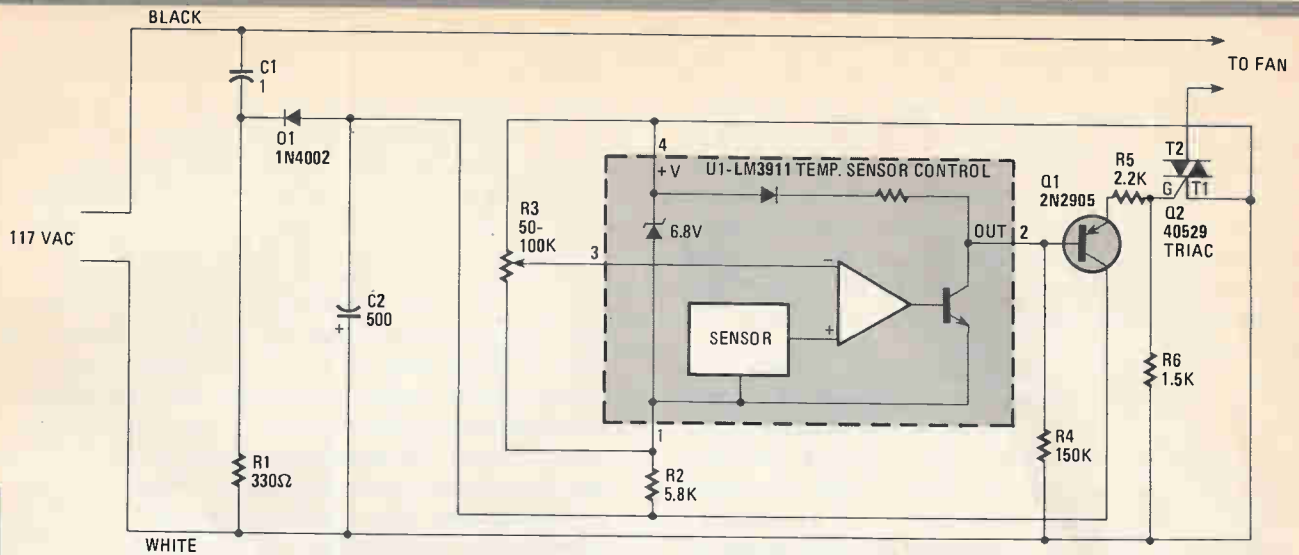
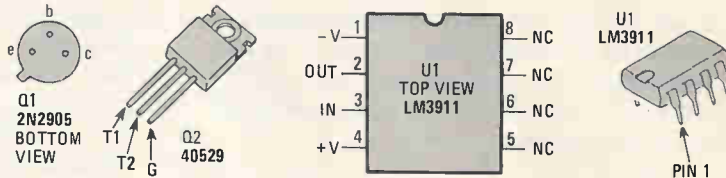

FIG. 1—OUR SIMPLE-AS-POSSIBLE (SAP) design should be assembled in a plastic chassis box with plastic cover. This circuit isn't AC-line isolated.



current of 2 mA minimum, which can be built out with a single transistor, SCR, etc.

How the Stabilizer Works

In Fig. 1 we have a simple-as-possible (SAP) configuration where C1, R1, D1, and C2 supply DC to U1 via limiting resistor R2. Potentiometer R3 adjusts the temperature set point such that when temperature rises above that level set by R3, the op amp internal to U1, used as a comparator, turns on a TRIAC, Q2, a 40529 which operates the fan.

In Fig. 2, step-down power transformer T1 supplies 24 volts to a diode bridge circuit (D1-D4) which is decoupled by D5 and filtered by C1 for U1. In that configuration unfiltered

DC is used on Relay 1. Resistor R6 limits current through the shunt regulator in the LM3911 to about 3 mA. However, the set-point resistor R3 in Fig. 1 has been broken down into three resistors R1, R2, and R3 in Fig. 2, limiting temperature range adjustment from approximately 20-degree C (68-degree F) to 60 degree C (140 degree F). Capacitor C2 has been added to eliminate noise pickup in the divider, R4, R5, and D7 provide a $\pm 10\text{mV}/^\circ\text{C}$ hysteresis to insure a solid on or off switched state. Transistors Q1 and Q2 may be replaced by a single Darlington transistor D40C4.

In Fig. 3 we have the same basic configuration as in Fig. 2. However Q1, Q2, K1, and associated circuitry have been replaced by solid-state relay K1.

FIG. 2—CONSIDERING THE SAFETY DESIRES of our readers, AC line isolation was added to this design along with relay control of the external AC fan motor.

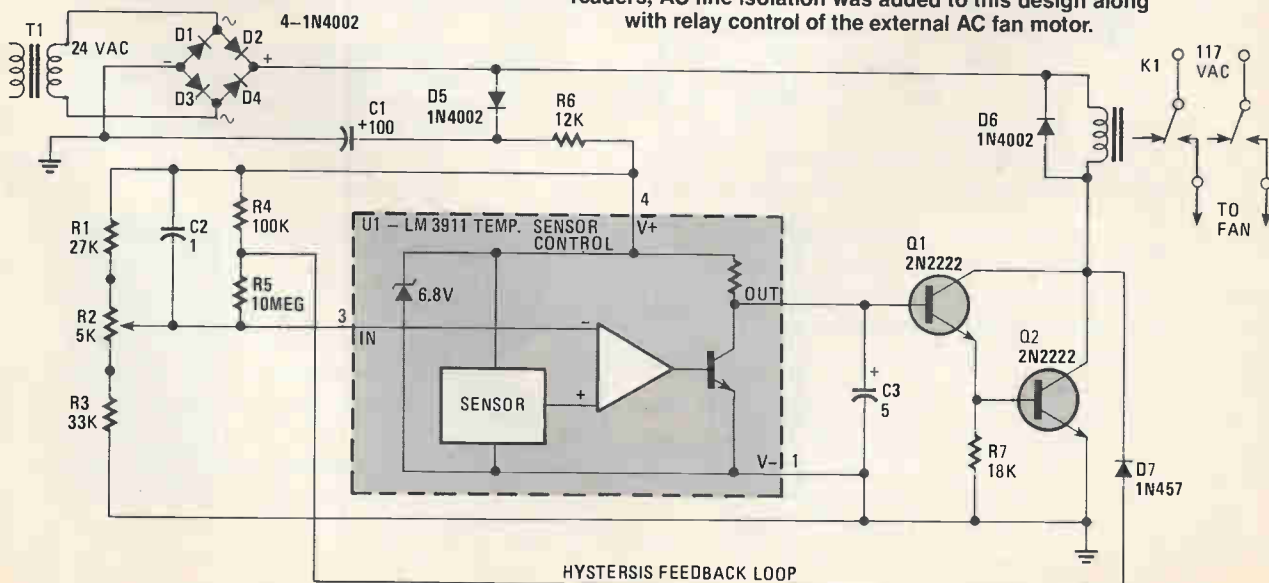

Construction Hints

There's nothing critical about construction. The circuits can easily be breadboarded. However, where TRIACs are used, depending on the load you want to pull, they may require heatsinking. Generally, for small loads, using #14, or better, copper wire to install the TRIAC will provide heat-sinking enough. Another alternative is to sink the TRIAC by using an aluminum enclosure, or heatsink, and mounting the TRIAC to it. But don't mount the TRIAC or relay used where it can heat the LM3911. And be sure that your construction design eliminates the possibility of accidental contact with the AC line, or other high voltages.

Also, it was empirically determined that the LM3911 reacts much more quickly to changes in room temperature caused by drafts, etc. when mounted on the outside of an enclosure, or when unused pins are soldered to a metal enclosure. With the unit mounted inside an enclosure it responds more to average room temperature.

Parts Lists for the three diagrams are supplied. Within the boxed area of each diagram are complete details so that you can acquire the parts and assemble that version of the Stabilizer you wish to build. Of course, you may want to modify the circuits to one that will better suit your home's needs and what's available in your junkbox.

Using the Stabilizer

The Room Temperature Stabilizer design came about when it was noted that in a large L-shaped room, the radiator bank from an old steam-heat system radiated more than enough heat at the foot of the "L" to heat the entire room, but natural drafts were induced by the shape of the room itself and the furniture it contained. A floor fan was installed and it distributed the heat when it was available. However, the fan ran continuously, causing chilling drafts when the heating system was shut down, and the fan increased the ambient noise level unnecessarily when it provided no useful func-

tion. Also, the fan does consume electrical energy. Now, with the Room Temperature Stabilizer in control of the fan, heat is distributed throughout the room whenever heat from the radiator is available. In no way is the radiator-heat availability in time with the firing of the oil furnace in the basement because of the long, and unpredictable, thermal-time lag. In fact, steam is generated by the latent heat of the fire bricks even after the furnace shuts down.

In a later installation, two old floor vents were re-opened between the first floor and the basement. A fan was installed in one of them and made to turn on whenever the heat in the basement exceed 80-degrees F. That heat buildup occurred after an outside fresh-air venting modification was provided for the furnace, leaving the basement relatively airtight. The other floor vent, in the cooler part of the first level, provided return air feed. The concept works well, provided that someone doesn't close doors that block the free flow of air.

Next summer, some experimentation will be done using a similar Room Temperature Stabilizer to actuate a Casablanca-type ceiling fan to distribute the cooling air effectively from three window air conditioners located on the first level. Take a look around your home, and you'll find ways to make it a bit more comfortable in terms of temperature distribution. And it's a sure bet that when you do, you will be finding more efficient ways to distribute heating and cooling energy that will end up as dollars saved. **SP**

PARTS LIST FOR ROOM TEMPERATURE STABILIZER ILLUSTRATED IN FIG. 3

- C1—100- μ F, 100-WVDC electrolytic capacitor
- C2—1- μ F, 25-WVDC capacitor
- D1-D4—1N4002 silicon diodes
- K1—Solid-state relay
- (All fixed resistors are 1/2-watt)
- R1—27,000-ohm resistor
- R2—5000-ohm potentiometer
- R3—33,000-ohm resistor
- R4—12,000-ohm
- T1—Power transformer: 117-VAC pri. winding; 24-VAC at .5 A sec. winding
- U1—LM3911 temperature sensor control IC

FIG. 3—REDUCING THE TOTAL number of parts to a handful, this circuit offers the beginner the greatest chance of construction success with the most advanced circuit design.

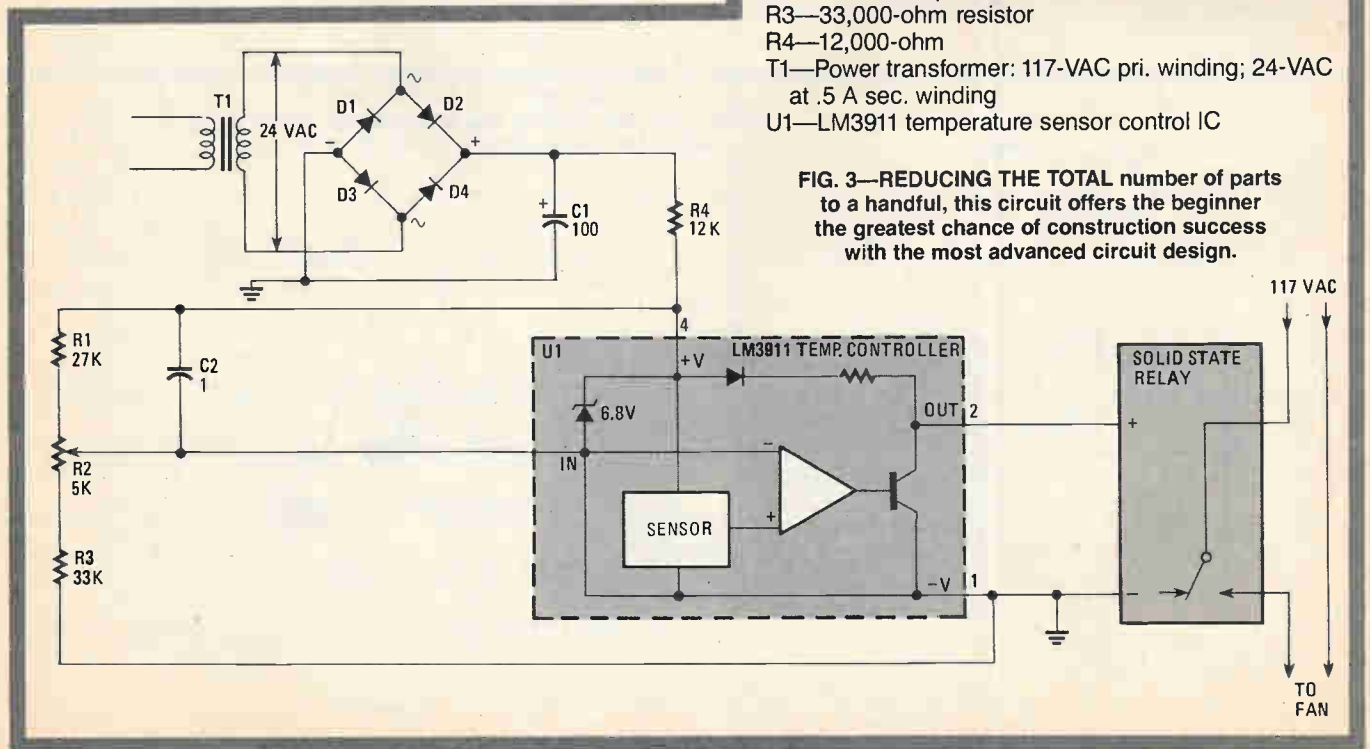

FRIEDMAN ON COMPUTERS

Continued from page 10

printer will print HELLO THERE. If you work out the HEX representation using Table 1, you'll see that the 1B 45 did not print. Being a printer-control code, 1B 45 instructed the printer to shift into the italics mode. Control codes can be sent from the computer in ASCII or HEX as required by the printer or the associated software.

A major difficulty with printer-control codes is that much software makes no provision for sending more than a handful; usually the ones you don't need. Often, you can send a set up printer-control code—such as for expanded type—through a BASIC print statement such as LPRINT CHR(27); "S", meaning "ESCAPE S". [Note: Convention puts punctuation within quotation marks; however, in order not to confuse computer and programming commands, it will be my policy to place

punctuation outside of quotation marks which would be required within a program. For example, CHR(27); "S", will run, CHR(27); "S," will not run. It will be interesting to see how school textbooks resolve the problem of punctuation within program quotation marks.

That's it for this issue. Please write and let me know what you would like us to cover, but keep it to personal computing—no mainframes or minicomputers.
—Herb Friedman

TABLE 1—ASCII CODE CHART

This is a standard ASCII code in both decimal and HEX. The codes from decimal 00 to 31 (00 to 1F HEX) were originally intended for teletypewriters. For clarity, only the decimal 00 to 31

codes commonly used for standard printer-control codes are shown—the remainder are usually specifically assigned by a printer manufacturer and might or might not correspond to codes

and functions of other printers. The Standard ASCII character set does not define characters with a value higher than 127. Some terminal's display such characters as special graphic characters, but no standard set of graphic characters has yet been defined.

(^ indicates a control-character; for example, "^ A" is "CONTROL-A")

HEX	Dec.	ASCII										
00	00	^(null)	20	32	space	40	64	@	60	96	.	
01	01	^A	21	33	1	41	65	A	61	97	a	
02	02	^B	22	34	"	42	66	B	62	98	b	
03	03	^C	23	35	#	43	67	C	63	99	c	
04	04	^D	24	36	\$	44	68	D	64	100	d	
05	05	^E	25	37	%	45	69	E	65	101	e	
06	06	^F	26	38	8c	46	70	F	66	102	f	
07	07	^G(bell)	27	39	'	47	71	G	67	103	g	
08	08	^H(backspace)	28	40	(48	72	H	68	104	h	
09	09	^I(tab)	29	41)	49	73	I	69	105	i	
0A	10	^J(line feed)	2A	42	*	4A	74	J	6A	106	j	
0B	11	^K	2B	43	+	4B	75	K	6B	107	k	
0C	12	^L(form feed)	2C	44	,	4C	76	L	6C	108	l	
0D	13	^MCR	2D	45	-	4D	77	M	6D	109	m	
0E	14	^N	2E	46	.	4E	78	N	6E	110	n	
0F	15	^O	2F	47	/	4F	79	O	6F	111	o	
10	16	^P	30	48	0	50	80	P	70	112	p	
11	17	^Q	31	49	1	51	81	Q	71	113	q	
12	18	^R	32	50	2	52	82	R	72	114	r	
13	19	^S	33	51	3	53	83	S	73	115	s	
14	20	^T	34	52	4	54	84	T	74	116	t	
15	21	^U	35	53	5	55	85	U	75	117	u	
16	22	^V	36	54	6	56	86	V	76	118	v	
17	23	^W	37	55	7	57	87	W	77	119	w	
18	24	^X	38	56	8	58	88	X	78	120	x	
19	25	^Y	39	57	9	59	89	Y	79	121	y	
1A	26	^Z	3A	58	:	5A	90	Z	7A	122	z	
1B	27	^(escape)	3B	59	;	5B	91	[7B	123	(
1C	28	^_	3C	60	<	5C	92	/	7C	124	(
1D	29	^)	3D	61	=	5D	93]	7D	125)	
1E	30	^^	3E	62	>	5E	94	^	7E	126	-	
1F	31	^`	3F	63	?	5F	95	-	7F	127	delete/rub-out	

PRINTMETER

Continued from page 79

jam the adjustment near the ends of rotation and be extremely difficult to set.

Transistor Q2 is a 2N3391, or any substitute transistor with a beta of at least 250. Q1 can be one of several different N-channel field-effect transistors (FET's), and the printed-circuit foil layout has been made to accommodate a range of types so you can possibly use something you have around—try what you have before you buy. If you don't have an FET,

use a 3N211 or 40673. The printed-circuit board's identification has been converted to ECB to make life a little easier for you, because some FETs are sold with connections shown as ECB. E (for emitter) is an FET's source. C (for collector) is an FET's drain. B (for base) is everything else, even if you must twist leads together. For example, the 3N211 and 40673 has two gates (the base connection). Simply twist the two gate leads together so that they both fit the "B" hole.

There is an entire set of holes near S1—labeled A and B in the schematic diagram (Fig. 1)—which is used for a trimming resistor if needed. If your negatives are such that R2's adjustment is at one extreme, and then the other when R1 is

switched in, connect a 100,000-ohm resistor across holes A and B.

The battery can be secured to the bottom of the cabinet with double-sided tape.

Checkout

Under normal room lights, depress (PB1). At least one of the two LED's should light. If not, make sure that you have not reversed the polarity of the LED's (a common problem). Next, set S1 to "L" and cover LDR1 with your finger while holding down PB1. Rotate R2. At some point the second LED should turn on. If you continue rotating R2, the first LED will turn off. If both lights seem to lock up, the room light is probably too high.

Next, set up your enlarger, eyeball the light on the easel to something you consider normal, and try using the meter. If you cannot get the LED's to alternately turn on and off as you rotate R2, the FET you used for Q2 is simply wrong for the project. Try getting the 3N211 or 40673.

The battery is dead when the LED's are either too dim to see, or no longer turn on. **SP**

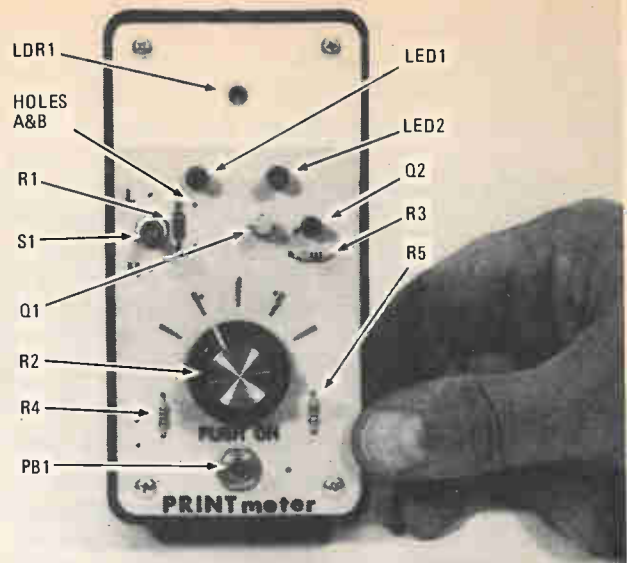

COMPLETELY ASSEMBLED, the Printmeter has some of its parts located on the cover. There's no danger of shock.

Digital AC Line Monitor

Continued from page 82

supply is maintained at less than 15 milliamperes. If higher currents are required, appropriate values of R5 and R6 must be substituted. The miniature LED display was chosen be-

cause with it little current is required beyond that drawn by the display itself. An LCD readout can also be used, although additional logic chips are then needed.

Calibration

The Digital AC Line Monitor is calibrated by matching its reading to a laboratory instrument through adjustment of the potentiometer, R11.

Construction

Duplicate the printed-circuit board foil diagram shown in Fig. 2 and the project is more than half finished. Cut the board apart at the dashed lines because the foil pattern at the extreme right is used to mount the miniature LED display. The display need not be on the same board as the remainder of the circuit, and, in fact, can be located elsewhere when interconnected by a cable. Refer to Fig. 3 for parts location on the printed-circuit board.

The author assembled the monitor in a plastic case with the LED display on the front panel. That is a valid construction procedure should you want a portable unit. A line cord with AC plug can be added for use just about anywhere.

Two positions are available on the printed-circuit board for mounting resistor(s) R1. These positions are connected in parallel. Thus, if you wish to use two 3000-ohm, 1-watt resistors in parallel to obtain 1500-ohms at 2-watts, there is space on the board to do so.

You may want to mount the monitor's circuit board within the cabinet of existing electronic equipment, or add it to a planned project of the future. All the options are open to you. **SP**

Radio-Electronics REPRINT BOOKSTORE

- | | |
|--|---|
| <input type="checkbox"/> Build Your Own Satellite TV Receiver \$7.00 | <input type="checkbox"/> Special Projects (Spring 1981) \$4.50 |
| <input type="checkbox"/> 8-Ball Satellite TV Antenna \$5.00 | <input type="checkbox"/> Special Projects #4 (Summer 1982) \$4.50 |
| <input type="checkbox"/> Build Your Own Robot \$12.00 | <input type="checkbox"/> Special Projects #5 (Winter 1983) \$4.00 |
| <input type="checkbox"/> TV Descrambler (January, February 1981) \$3.00 | <input type="checkbox"/> Special Projects #6 (Spring 1983) \$3.50 |
| <input type="checkbox"/> Radio-Electronics back issues (1983) \$3.00 | <input type="checkbox"/> Special Projects #7 (Summer 83) NOT AVAILABLE |
| (January, February 1983 not available) | <input type="checkbox"/> Special Projects #8 (Winter 83) \$3.00 |
| Write in issues desired | <input type="checkbox"/> Radio-Electronics Annual 1983 \$3.50 |
| <input type="checkbox"/> Radio-Electronics back issues (1982) \$3.50 | <input type="checkbox"/> Radio-Electronics Annual 1984 \$2.50 |
| (January 1982 not available) | <input type="checkbox"/> Radio-Electronics Annual \$2.50 |
| Write in issues desired | <input type="checkbox"/> How to Make PC Boards \$2.00 |
| <input type="checkbox"/> Radio-Electronics back issues (1981) \$4.00 | <input type="checkbox"/> All About Kits \$2.00 |
| (February, March, December 1981 not available) | <input type="checkbox"/> Modern Electronics (Vol. 1. #1 \$2.25 |
| Write in issues desired | April 1908) |
| <input type="checkbox"/> Etch your own PC boards \$3.00 | <input type="checkbox"/> Electro Importing Co. Catalog \$4.95 |
| | (1918) (176 pp) |

To order any of the items indicated above, check off the ones you want. Complete the order form below, include your payment, check or money order (DO NOT SEND CASH), and mail to Radio-Electronics, Reprint Department, 200 Park Ave. South, New York, NY 10003. Please allow 4-6 weeks for delivery.

If you need a copy of an article that is in an issue we indicate is unavailable you can order it directly from us. We charge 50¢ per page. Indicate the issue (month & year), pages and article desired. Include payment in full, plus shipping and handling charge.

ARTICLE _____

MONTH _____ YEAR _____

PAGES _____

TOTAL PAGES _____ @ 50¢ each TOTAL PRICE _____

MAIL TO: **Radio-Electronics** SP9
 Reprint Department, 200 Park Ave. South, New York, NY 10003 All payments must be in U.S. funds

Total price of order \$ _____

Sales Tax (New York State Residents only) \$ _____

Shipping & Handling (U.S. & Canada only) (Includes FIRST CLASS POSTAGE) \$1.00 per item \$ _____

All other countries (\$2.00 per item, sea mail) \$ _____

(\$4.00 per item, air mail) \$ _____

Total Enclosed \$ _____

Name _____

Address _____

City _____ State _____ Zip _____

Battery Saver for Personal Portables

Continued from page 89

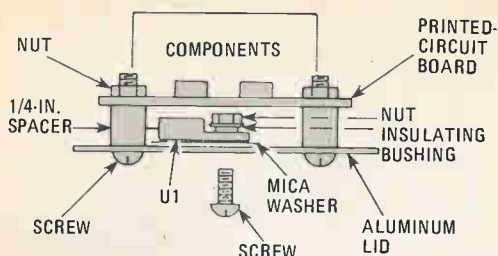

FIG. 5—ASSEMBLY of the printed-circuit board to the aluminum cover of the plastic case. Use care not to short regulator U1 to underside of printed-circuit board or aluminum cover.

volts DC are required then a 9-volt, 200-mA DC plugpack can be used, and that constitutes a considerable saving over the 12-volt AC plugpack. Alternatively, the plugpack regulator can be used in cars by tapping the 12-volt DC battery line via the cigar-lighter socket. In either case, the rectifier diodes are unnecessary and the voltage is applied to each side of the 470 μ F capacitor, C1.

Should you have a surplus DC plugpack in the junkbox, you have another option. Open it up and eliminate all the electronics except the step-down transformer. Check its voltage. If it was originally designed to deliver 9-volts DC, or better, then the output from the transformer is suitable for the design purposes of the Plugpack Regulator. After circuit modification of the DC plugpack, restore the case to its original state with a bit of epoxy glue, if necessary. The DC rectifying section of the plugpack usually is not suitable for use with the Plugpack Regulator's because there may be a current-limiting resistor; and the rectifying section may be of half-wave construction.

Buttoning Up

Before mounting the printed-circuit board on the stand-offs, check to make sure that the regulator is electrically isolated from the lid—you do that by measuring with a multimeter, switched to the "ohms" range. Now the lid can be secured onto the plastic-box base and the regulator is ready for testing. If a trimpot is used for resistor R2, a hole in the side of the plastic box directly opposite the screw of the trimpot will facilitate adjustment without removing the lid.

We used plastic cement to glue the back of the plugpack to the base of the box. Before gluing, roughen the mating surfaces with a file so that the glue will have sufficient "key" to the plastic. While the glue is curing, clamp the two pieces together.

Connect a multimeter on the DC-volts range, plug the plugpack into an outlet, and switch on. The voltage should be as set by R2. If a trimpot is used, adjust it for the required

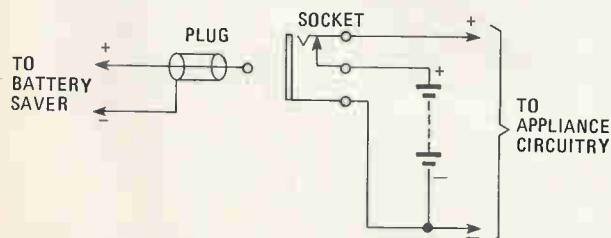

FIG. 6—OPTIONAL CIRCUIT addition that can be added to the battery-powered appliance for connection to the Plugpack Regulator. Not all battery-powered devices have jacks that outboard to external battery or AC power supplies.

voltage. Now the Plugpack Regulator is ready to be put into service.

The low-voltage plug to be used at the end of the regulator lead will depend on the matching socket already fitted to the appliance to be powered. If one is not fitted on the appliance, the type that is most easily fitted should be used. There are four popular types. There is the audio-jack type normally used for earphone connections; it comes in two sizes: 2.5-mm and 3.5-mm. If one of those is contemplated, make sure that it cannot be confused with any existing socket on the appliance.

The other connector type is a power plug with a hole down the center; it mates with a pin electrode on the socket. Those come in two sizes also; 2.1-mm and 2.5-mm. Both types of socket have the facility to break one connection when the plug is inserted. That is commonly used to isolate the battery when the external power supply is plugged in.

Some appliances have an external power-inlet socket built into the unit so that a suitable plug with the correct voltage and polarity can be inserted into the socket. To make sure that the correct polarity is applied, consult the manual or open up

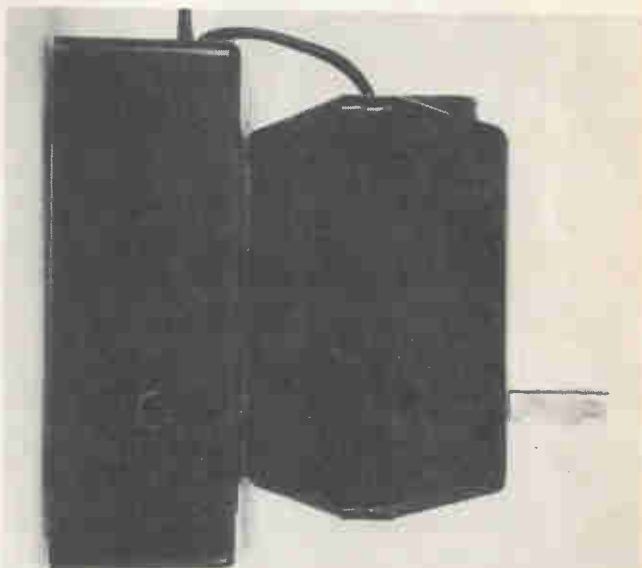

HERE'S WHAT your Plugpack Regulator will look like when completed. The plug pack is glued to the plastic case. Note the cable coming from the powerpack delivering low-voltage, line-isolated AC to the regulator circuit.

the case and check polarity by following the wires to the battery terminals. Generally, the red wire is positive and the black negative—that is not necessarily the case all the time.

Neither type of socket, as fitted to various appliances, is necessarily always wired in the same way. In the cases of the power plug and socket, for example, the outer conductor is frequently positive; but some manufacturers adopt the opposite convention.

For those appliances without an external power socket, one will have to be installed. Open the case and find a suitable free area where a socket can be fitted without fouling when the lid is replaced. Drill a hole for the socket, and mounting holes if needed, and mount the socket. Use the circuit diagram (Fig. 6) to help you in wiring the socket from the battery connections. When complete, the lid can be replaced and the plug connected to the Plugpack Regulator leads.

Over all, the circuit has proved to be both reliable and effective, with no audible hum from the audio equipment. In fact a similar unit has been powering a portable radio on the editor's desk for several months.

SP

Kerber Klock III

continued from page 34

FIG. 15—LEFT AND RIGHT SIDE PANELS detailed diagram shows outside surfaces face up.

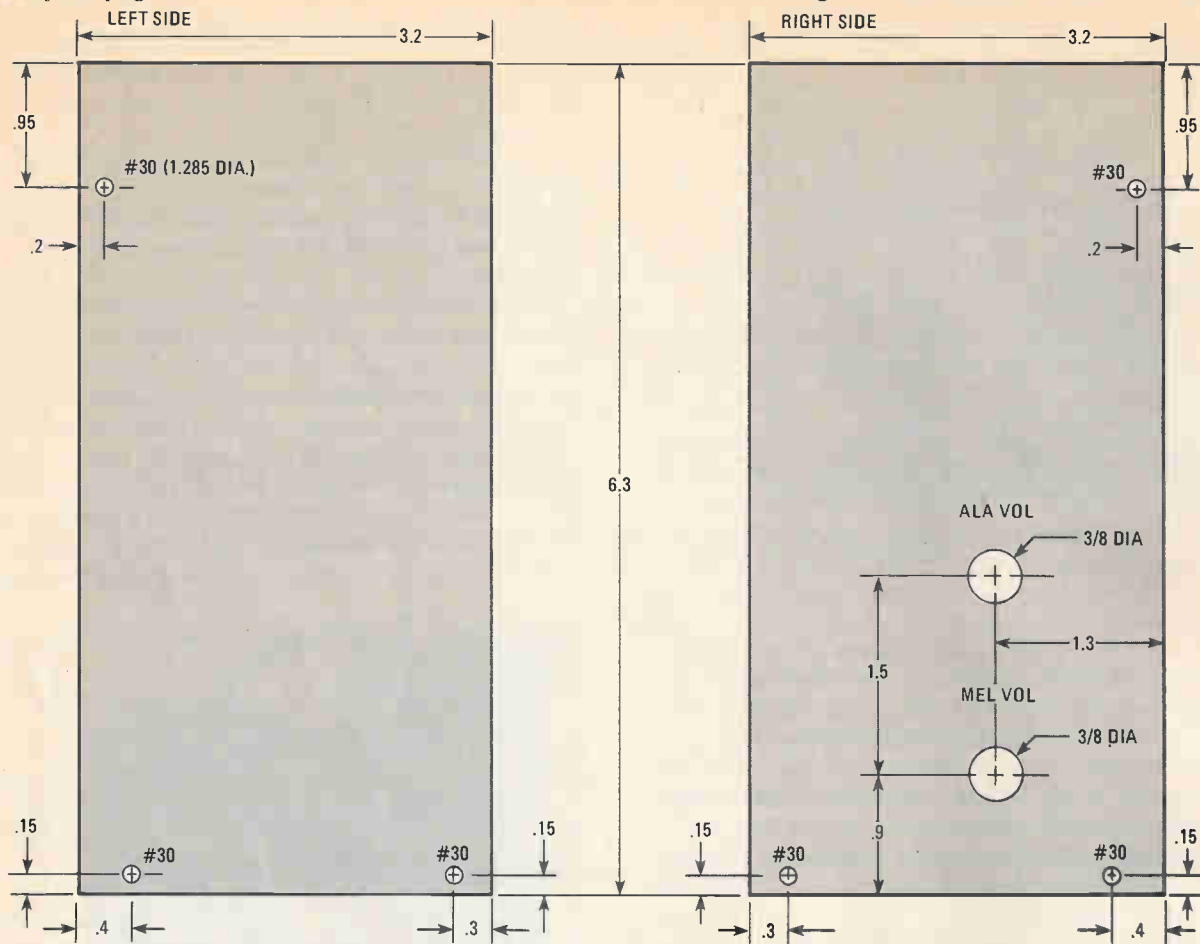

brackets from the underside at the back and two at the front. The short leg of the back brackets are secured by using two 3/16-in. screws. The long leg of the front brackets are secured by using two 3/16-in. screws.

Close up the back panel and set the top panel in place. Make sure that all holes and brackets line up. Set the top panel aside for now.

Initial Tests

Before applying power to the Kerber Klock it's a good idea to give it one last visual inspection. Unplug the front plate and circuit board assembly, and check for the following:

Are all the IC's inserted correctly? Pin 1 of the IC must be toward the notch as shown on the component location drawings—Figs. 8 and 11.

Are all ICs in their proper socket?

Are all diodes installed correctly? The end with the band around it (cathode) must be mounted toward the bar end of the diode symbol.

Are all electrolytic capacitors installed correctly? The positive end must be mounted as shown.

Make sure that the righthand rotary switch (Sa) is in the BAT OFF position and all toggle switches are down. Plug in the front plate and circuit board assembly and connect the 9-volt battery clip. Install a 3-ampere fuse in the fuse holder.

WARNING: Hazardous voltages are exposed in the Kerber Klock III when the enclosure is open and the line cord is plugged into an AC outlet.

Plug the line cord into a standard 118 VAC outlet. The displays will come on at 00:00:00 (24-hour display). A melody will start to play at one second past the hour.

In case of difficulty, refer to schematic diagrams in Figs. 1 through 4 and use standard troubleshooting techniques for electronic circuits. Use a high impedance oscilloscope and voltmeter (20,000-ohms/volt or better). The negative lead of the 4700- μ F capacitor is circuit common for the test equipment. Check the following:

The output of 7805-1 and -2 should be $+5 \pm 0.25$ volts.

The Vcc pin of all IC's should be +5 volts except the 4049 and 50240 which should be +12 volts.

Pin 2 of 50240 should be at $2.38 \text{ MHz} \pm 0.1 \text{ MHz}$.

Pin 4 of 6802 should be at 60 Hz.

Check for solder bridges especially between IC pins.

Isolate the problem and replace IC's as necessary.

Secure the back panel to the side panel using two 3/16-in. screws. Then, secure the top panel using four 3/16-in. screws. That completes the assembly of your Kerber Klock III.

Kerber Klock III Features and Functions

The two display modes are 12 hours (12:00:00) or 24 hours (00:00:00). Either option is selected by the 12 HR or 24 HR switch. When in the 12-hour mode, an LED in the upper lefthand corner will go on indicating time is AM. Switching between 12 HR and 24 HR position changes the display instantly.

The calendar is displayed for two seconds every ten seconds. The date is displayed in the form MM:DD:YY: where MM is the month; DD, the day; and YY, the year. The correct number of days are displayed for any particular month. Leap year is calculated by dividing the year by four. If it divides evenly, 29 days are displayed for February; if not, 28 days are displayed. In either case, March 1st will be the next day to be displayed.

PARTS LIST FOR KERBER KLOCK III

(Throughout this list the quantity of the item will be given first and then the description of the item will follow.)

INTEGRATED CIRCUITS

- 1—2532 or 2732 (4K × B) 32K EPROM
- 1—4001 quadruple 2-input NOR gate
- 1—4011 quad 2-input NAD gate
- 1—4049 hex inverting buffer
- 3—4050 non-inverting buffer
- 1—50240 top octave frequency generator
- 1—MM5369 programmable oscillator divider
- 1—6802 microprocessor
- 1—74LS14 hex Schmitt-trigger inverter
- 3—74LS75 4-bit bistable latch
- 2—74LS138 3-TO-8 line decoder/multiplexer
- 2—74LS244 octal buffer/line, driver/line receiver
- 3—74LS251 data selector/multiplexer
- 6—744LS259 B-bit addressable latch
- 1—74LS393 dual 4-bit binary counter
- 2—LM340T-5 or 7805 + 5-V regulator integrated circuit, TO-220 case

OTHER SEMICONDUCTORS

- 2—1N914 or 1N44148 signal diode
- 1—1N759A 12-V Zener diode
- 6—1N4001 silicon diode
- 4—XC209R small LED (light emitting diode)
- 1—XC556R large LED (light emitting diode)
- 6—7-segment LED display, common anode (Litronix DL747 or DL3400, or Hewlett Packard HDSP-3400)
- 3—2N2222A switching transistor

RESISTORS

(All fixed resistors are 5%, 1/4-watt units unless otherwise noted)

- 1—12 ohm, 1%, 3-watt, wire-wound, power
- 1—10-ohm, 5-watt, sand- or ceramic-type, power
- 2—27-ohm
- 1—47-ohm, 1/2-watt
- 1—100-ohm, 1/2-watt
- 50—160-ohm
- 1—300-ohm
- 5—1200-ohm
- 1—3600-ohm
- 23—5600-ohm
- 1—10,000-ohm
- 2—10,000-ohm, single-turn, linear-taper potentiometer
- 2—1,000-ohm
- 3—100,000-ohm
- 1—20-Megohm

CAPACITORS

- 3—33-pF, ± 10%, disc
- 18—0.01 or 0.0-μF, 50-WVDC disc
- 4—4.7-μF, 20-WVDC tantalum
- 1—4700-μF, 16-WVDC aluminum electrolytic

RADIO SHACK PARTS

(The following have Radio Shack part numbers. An equivalent part may be substituted)

- 1—Transformer: 117-VAC pri. winding; 12.6-VAC-CT, 1.2-amperes (273-1505)
- 1—AC socket, chassis mount (270-642)
- 1—Fuse holder, panel-mount (270-364)
- 1—Fuse, 3AG (AGC) 3-ampere (270-1276)
- 1—Battery holder for six AA batteries (270-384)
- 1—9-volt transistor-battery connector (270-325)
- 2—2-pole, 6-position, single-deck, non-shorting, 1/4-in. shaft, rotary switch (275-1386)
- 4—Knobs with pointer for 1/4-in. shaft (274-414)

ADDITIONAL PARTS AND MATERIALS

- 1—12-volt DC relay (Guardian 1345-1A-12D or 1345-1C-12D, IDEC REIV-3, Essex MS64-5-Amp, or American Zettler AZ3P-1C-12D or AZ3P-ICH-12D)
- 1—3.579545 MegaHz TV color-burst crystal, PC board mount (HC18/U Case)
- 1—8-ohm speaker (See text)
- 1—8-pin IC socket
- 6—14-pin, low-profile IC socket
- 19—16-pin IC socket
- 7—24-pin, low-profile IC socket
- 1—40-pin IC socket
- 1—Perfboard (See text—size to match speaker)
- 4—Rubber grommets (See text)
- 1—22/44 edge-card connector with solder eyelets and mounting ears.
- 1—Line cord 2/#18 AWG, 6-feet long
- 4—Rubber mounting feet with #6 screw hole
- 2—Hinges, brass; 3/4-in. × 1-in. (Brainerd Mfg Co., East Rochester N.Y., 14445 Part No. 7075X)
- 12—Angle brackets; 7/16 × 9/16-in. (See text)
- 6—Spacers, insulated; 1/4-in. dia. × 1/4-in. long, #6 clearance hole
- 4—Spacers, 1/4-in. dia. or 1/4-in. hex × 5/8-in. long, 6-32-threaded hole
- 1—Strain relief, line-cord
- Assortment of 6-32 panhead screws and matching nuts and lockwashers, wire, solder, etc.

VENDOR LIST

The following items are available from the author. Price includes shipping and handling within continental United States. Send orders to: R.J. Kerber, 36117 Hillcrest Drive, Eastlake, OH 44094.

EPROM Listing: \$5.00.

EPROM Preprogrammed: \$20.00

Set of two printed-circuit boards, undrilled: \$30.00 All holes drilled to size: \$50.00.

The following vendors are capable of supplying many items listed in the Parts List.

Active Elect. Sales Corp., P.O. Box 8000, Westborough, MA 01581. Tel: 800/343-0874

B. G. Micro, P.O. Box 280298C, Dallas, TX 75228. Tel: 214/271-5546

ETCO Electronics, North Country Shopping Center, Rt. 9 North, Ptatsburgh, NY 92040. Tel: 518/561-8700

Jameco Electronics, 1355 Shoreway Road, Belmont, CA 94002. Tel: 415/592-8097

Mouser Electronics, 11433 Woodside Ave., Santee, CA 92071. Tel: 714/449-2222

All Electronics Corp., 9055 S. Vermont Ave., Los Angeles, CA 90006. Tel: 213/380-8000

DIGI-KEY Corp., Highway 32 South, P.O. Box 677, Thief River Falls, MN 36701. Tel: 800/346-5144

Edlie Electronics, Inc., 2700 Hempstead Turnpike, Levittown, NY 1117566-144443. Tel: 516/735-3330

JDR Microdevices, 1224 S. Bascom Ave., San Jose, CA 955128. Tel: 408/995-5430

Quest Electronics, 2322 Walsh Ave., Santa Clara, CA 95051. Tel: 800/538-8196

Many other parts suppliers are advertised in **Radio-Electronics**. Space prevents us from listing all of them here.