



# RECORDING engineer/producer

relating recording science • to recording art • to recording equipment

11217CPCNCAS7DC  
D CORNYEITZ  
EGO-LDS. CONCEPTS  
357 DEAN STREET  
BROOKLYN  
NY 11217

10:08  
85:8  
95:8  
10:81

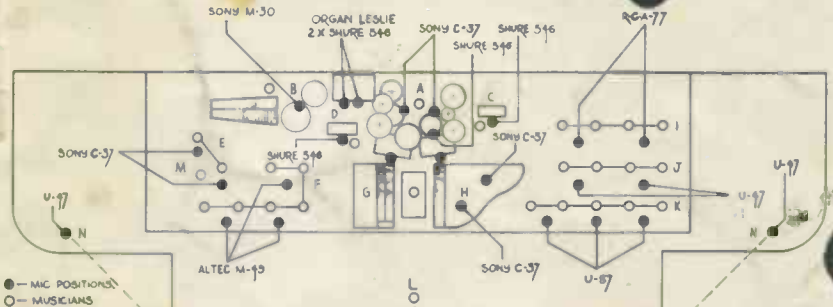

in this issue: **WALLY HEIDER**  
recording **SAMMY DAVIS Jr.** Live ...

... **QUADRAPHONICS SEPT '70**  
-Studio Design; Mercury in  
New York, Nashville, San Francisco

-A Quadraphonic Microphone  
Development

... **RECORDING TECHNIQUES 'phasing'**



# Scotch 206/207

BRAND



## New Music Mastering Tapes.

They give you maximum flexibility for multi-track recording, 3 db more dynamic range to work with. Choose increased signal-to-noise, more headroom or combination of both to suit your sound. Longer wearing, with built-in protection against handling damage. Hear the full advantages from your "Scotch" Brand representative. Or write Magnetic Products Division, 3M Center, St. Paul, Minn. 55101.

"SCOTCH" IS A REGISTERED TRADEMARK OF 3M CO.

**3M**  
COMPANY

# We have a studio wherever you are!



*The most modern 8 or 16 track mobile recording unit in the world.  
For more information call: Larry Dahlstrom or Aaron Baron at (212) 586-8565.*



**Location Recorders, Inc.** 429 West 46 Street New York, N. Y. 10036

Circle No. 102



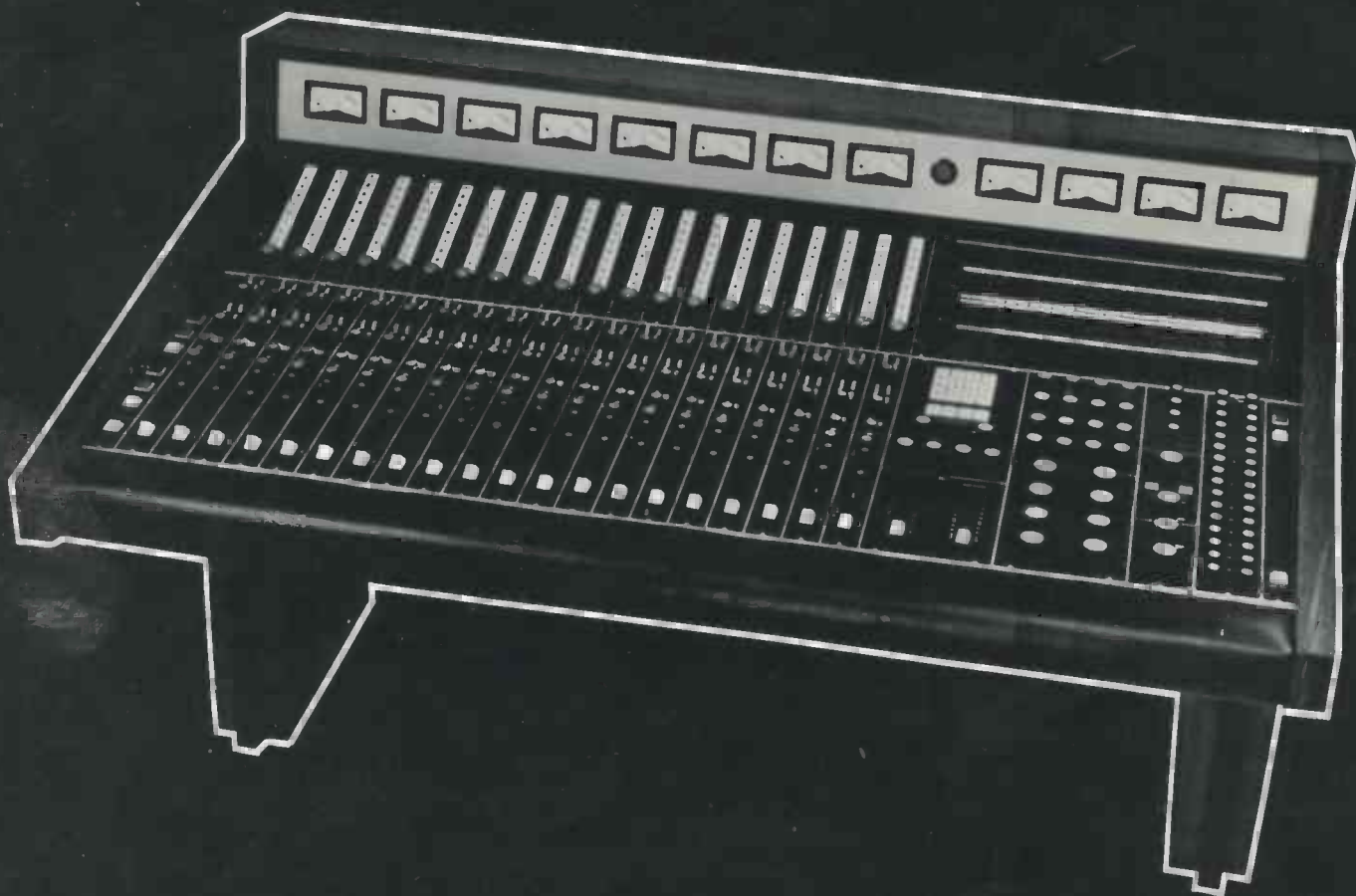

SPECTRA SONICS is pleased to announce that new "Beyond the State of the Art" audio control consoles are now in production. First exhibited to the professional audio industry at the Spring Audio Engineering Society Convention in Hollywood, these SPECTRA SONICS consoles have become, overnight, the ultimate standard to which all electronic performance is compared. Already installed and in operation at the RECORD PLANT WEST, LARRABEE SOUND STUDIOS, and MGM RECORDS in Hollywood, the SPECTRA SONICS Audio Control Console Model 1020-8/16 has received such immediate industry acceptance and acclaim, that continuous production of this console has been initiated.

Like the Model 101 Audio Amplifier (the basis of the console electronics) these SPECTRA SONICS Consoles are guaranteed to outperform any console in the world in distortion, noise, frequency response, square wave response, and peak overload! For detailed specifications, and immediate delivery on "Beyond the State of the Art" audio control consoles, contact SPECTRA SONICS at 770 Wall Avenue, Ogden, Utah 84404 (801-392-7531) or at 6430 Sunset Blvd., Hollywood, California 90028 (213-461-4321).

**SPECTRA SONICS**

LEADER IN ADVANCED TECHNOLOGY





**RECORDING**  
engineer/producer

—the magazine to exclusively serve the recording studio market . . . all those whose work involves the recording of commercially marketable sound.

—the magazine produced to relate . . . RECORDING ART to RECORDING SCIENCE . . . to RECORDING EQUIPMENT.

*Editor/Publisher* . . . MARTIN GALLAY  
*Managing Editor* . . . WILLIAM WOLF  
*Associate Editor* . . . . . PETE SENOFF  
*Associate Editor* ROBERT NORBERG  
*Business/Circulation*  
*Manager* . . . . . SHEILA BERNSON  
*Art Director* . . . . . G. J. SADOWSKI

RECORDING engineer/producer is published bi-monthly from the offices at 6430 Sunset Blvd., Hollywood, California 90028. Re/p is sent free to qualified recipients in the United States. Subscriptions for other than qualified individuals or companies may be purchased at \$5.00 per year. (All foreign subscriptions: \$6.00 per year.) Material appearing in Re/p may not be reproduced without written permission of the Publisher. Copyright© by RECORDING engineer/producer 1970.

Controlled circulation postage paid at Los Angeles, California.

WALLY HEIDER  
recording SAMMY DAVIS, JR.  
'LIVE' at the "NOW GROVE" 13 *by chris huston*

QUADRAPHONICS—SEPT. '70

STUDIO DESIGN FOR  
QUADRAPHONIC RECORDING;  
MERCURY IN NEW YORK,  
NASHVILLE and SAN FRANCISCO 17 *by allan parachini*

A QUADRAPHONIC MICROPHONE  
DEVELOPMENT 23 *by chris huston*

the legal mis-adventures  
of SAM STUDIO . . . PAUL PRODUCER  
and 'THE WALLAQUOIS INDIANS' 25 *by william storm hale*

RECORDING TECHNIQUES

'PHASING' 27 *by jerry ferree*

AN EASY 'VSO' 28 *by brian ingoldsby*

AES AGENDA 29

LETTERS 10

NEW PRODUCTS 31

CARTOON 36

CLASSIFIED ADV. 36

credits — cover: TRICI VENOLA  
cartoon: WAYNE YENTIS  
Allison Research, L.A.

# Every studio has its own ups and downs.

No two studios look alike in size, shape and location of speakers—in acoustic environment. So naturally no two studios look alike in frequency response either—in acoustic response.

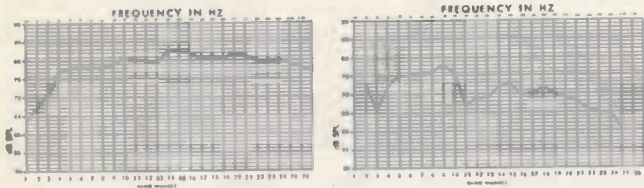

You hear different sounds in Studio A than in Studio B.

Acousta-Voicing® takes the ups and downs out of studios.

Acousta-Voicing makes all studio monitors alike as far as the sounds you hear from them at your ears.

## Highs and lows are in perfect balance with mid-ranges.

Acousta-Voicing doesn't remove any of the usable program material.

Instead, it takes all the over-emphasized frequencies and equalizes them with all the normal responding tones in the room.

Acousta-Voicing lets you hear exactly what was recorded when tracks are played-back.

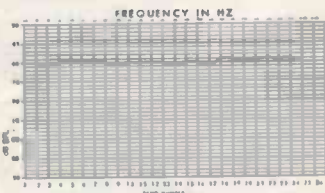

You hear the same sounds in all studios.

## Acousta-Voicing is performing at many major studios.

Just some of the places Acousta-Voicing is performing include Century Records, Capitol, Universal/Decca Recording Studios and the Academy Awards Theater.

And recently Brent Albright, the Administrative Engineering Manager at Universal/Decca Recording Studios, told us, "Finally we have a single reference point of perfect sound to work from in all our recording studios... Acousta-Voicing takes the educated guesswork out of balancing tracks."

## Here are some Acousta-Voicing specifics.

Acousta-Voicing is the only sound equalization system of its kind to use calibrated, fully-adjustable, critical, bandwidth, band rejection filters.

This allows each loudspeaker to be individually tuned in the room where it's installed. So the sound quality is vastly improved. So the sounds you hear from all your studio monitors are identical.

## Now you can give artists exactly what they want.

- Acousta-Voicing produces honest sounds —because it's the only accurate way to neutralize acoustical environments in all studios.
- Acousta-Voicing retains these honest sounds all the way to the final track—because equalization can be performed at various stages along the way



without having to go back to the original recording room.

- Acousta-Voicing frees your studios for more recording dates—because time-consuming dub-downs are eliminated.



A QUALITY COMPANY OF LTV LING ALTEC, INC.

## Get a free demonstration of Altec Acousta-Voicing right in your own studio.

To: Altec Lansing, 1515 South Manchester Ave.  
Anaheim, California 92803.

I'd like to have a free demonstration of Altec Acousta-Voicing in my studio—including a frequency response curve that will show me all the ups and downs. Please have an Altec Sound Contractor contact me to set up a demonstration date.

Please send me your free Acousta-Voicing literature.

NAME \_\_\_\_\_  
POSITION \_\_\_\_\_ STUDIO \_\_\_\_\_  
ADDRESS \_\_\_\_\_ PHONE \_\_\_\_\_  
CITY \_\_\_\_\_ STATE \_\_\_\_\_ ZIP \_\_\_\_\_

**Altec Acousta-Voicing.  
For the perfect balance of sound.**



# CONSOLE YOURSELF (and your pocketbook)

ELECTRODYNE'S NEW MODEL ACC-1608C AUDIO CONTROL CONSOLE STILL COSTS LESS WHETHER YOU BUY THE BASIC UNIT ALONE OR WITH DESIRED OPTIONS

OPTIONS: 2-4 Gang Masters • Stereo Mixing • Mono-Overdub • Preview Monitor System • Patch Panel • Additional input modules with channel select switches

With over 150 consoles in use throughout the world, the name ELECTRODYNE is synonymous with proven acceptance, profitable experience, company and product reliability. The first Electrodyne ACC-1608 was an innovation in its day. The ACC-1608B brought it up to date. Now, Electrodyne's unsurpassed ACC-1608C IS the state of the art. Compare these features: Wired for 20 inputs, supplied with 12. Eight-frequency equalization with reciprocal curves on all inputs.

Individual submasters, all 8 buses. 4 gang master controls, complete mono overdub bus with VU meter and master control optional. Pan pots on 2 channel mixdown for program and individual pan pots on echo send for all 8 buses. Same reverb on tape playback as on bus when recording dry, but monitoring with reverb with "Preview" monitor option. Separate echo switching. And many, many more.

Compare prices too. Check the competition. Especially their table top console. It hasn't a leg to stand on. Your authorized Electrodyne Distributor has the facts. Contact him, or us.

**ELECTRODYNE CORPORATION**  
An MCA Tech. Company, 7315 Greenbush Ave.  
North Hollywood, Calif. 91605 • Phone 213/875-1900



# Play at 15 i.p.s.

## Yamaha C7 Grand.

When you're laying down the master, you'd better be sure your piano is air quality. That's what the Yamaha C7 Grand is all about. It's a 7'4" concert instrument that ranks among the world's great pianos. Just ask the talent at your next session.

## Yamaha U1-D Upright.

The closest you can come to a grand piano without a grand piano. Four feet high and nearly five feet wide, it has full, rich tone and response crisp enough to please the most finicky talent. It stays that



way through month after month of masters, rehearsals and spilled drinks, too.

## Yamaha Electone E-3.

It's a symphony orchestra in a box for just \$2,395. With fewer controls, the E-3 gives you more

sounds, more music than organs costing as much as \$8,000. What's more, it's a regular sound effects machine. Think about *that* the next time you have to synthesize some sounds.



# YAMAHA

YAMAHA INTERNATIONAL CORPORATION  
P.O. Box 54540 • Los Angeles, California 90054

Send for complete specifications and dealer information.

- C7 Grand Piano Name \_\_\_\_\_
- U1-D Upright Piano Business \_\_\_\_\_
- E-3 Organ Address \_\_\_\_\_
- Other \_\_\_\_\_ City \_\_\_\_\_ State \_\_\_\_\_ Zip \_\_\_\_\_

Circle No. 106

## Letters

From: J. Jerrold Ferree,  
V.P., Chief Engineer  
United/Western Recorders

The interview with Bones Howe was most interesting. Many aspiring engineers would do well to adopt or at least try some of his engineering methods. There is one area of the interview which could stand some clarification however.

Since Mr. Howe chose to name Western Recorders directly I feel justified in an attempt to set the record straight. When Bones referred to the "cribbage board" patch bay we must assume that he was referring to a pin matrix board which we use to provide a means of programming several functions which do not require patching and which if actually included in the patch bay would just clutter and enlarge it unnecessarily. These functions include reverboration send and receive buss assignment and monitoring preselection for several monitor switch positions. These parameters are set up before a session and are rarely changed once the date is under way. We incorporated a standard tip-ring-sleeve patch bay for operational patching (such as inserting limiters, filters, and for ease of maintenance) just as everyone else does.

We agree with Bones on the subject of concentric controls which is why we use a type of knob and switch combination which while concentric, cannot be switched accidentally during operation. It is practically impossible to eliminate this type of control completely as the knobs would become either awkwardly small (another one of Bones' pet peeves) or consoles would be so spread out one would need binoculars to see the meters. To keep the console from becoming too deep and to allow putting those controls which are in constant use as close as possible to the mixer's span of reach, we chose to put the buss selectors to one side of the console next to limiters and patch bay. Still within his reach.

*We would like to comment on both the preceding and the following letter, particularly regarding the interpretation of highly subjective editorial material.*

*Highly subjective comment is the very essence of any discussion of an ART.*



Re/p re-affirms the keystone belief that 'RECORDING' is, in major part, an ART. Consequently, our authors write, for the most part, subjectively, about their own art... 'RECORDING'.

Among others, what Mr. Ferree and Mr. Klabin say is true. What we suggest is that experimentation with the techniques, the methods, the ideas which are in, and which will appear in Re/p are the genes from which the newest of audio mutations may be derived.

ed...

From: George Klabin  
Chief Engineer & Gen. Mgr.  
Sound Ideas Studio

The one danger in presenting the "practical" approach appears in the interview with Bones Howe. In some of his statements his views are so totally personal and dependent on the physical environment he records in that they could be very misleading to a less experienced person trying to gain some guidelines in recording. I refer to his statement "Obviously, if you're recording bass you don't roll off the bass." This statement, taken as it is, is really incorrect. There are many instances when rolling off a certain bass frequency, either in a shelf or dip, gets rid of "muddiness" or "boominess" which could be produced by the bass itself.

Mr. Howe's explanation of the usefulness of a baffle is so tempered by his personal dislike for them that he neglects to state the true usefulness of a baffle, which is to shield a microphone from pickup of sound from other instruments than the one being miked. Also, if a very absorbent padded baffle is used around an instrument, it will not affect the sound picked up from the instrument, provided the usual close miking techniques are employed. I feel baffles should be used sparingly, since they take away from the artistic or creative atmosphere in the studio by shutting people up into little rooms within rooms. However, there are instances where small baffles, employed around guitar amps or Leslie speakers, are very useful in cutting down leakage of the amps into the room, and leakage onto the mikes recording those amps.

Mr. Howe's statement that the RCA 77 makes the human voice sound "nicer than it usually does" is too personal to be of much value, other than as an idea for trying that mike on a voice. In that sense, it is helpful and perhaps that is exactly what Mr. Howe intended. However, one must be aware of the fact that his choice is based on several "subjective" factors,

such as the speakers he monitors on, the room he records and monitors in, and his general "taste" as to what comprises a "nice" sound. So I want to make the point that, while these personal interview articles are great and very useful, it would be very helpful to the novice if you made it a point to explain that these views are subjective, and that they cannot be taken as 100% universal fact.

Anyway, congratulations on a great magazine. Keep up the work. Hope your next step will be to add a section with news from the studios across the country, stating new equipment they have installed, new additions, etc. You could have a correspondent in each major section of the country who would give monthly reports on the studios in his area.

## "High quality pressings begin with quiet lacquer masters"—

John Eargle, Chief Engineer of Mercury Records.

"We should never forget the impact that a low-distortion, low-noise master tape can have on the sound of a well made pressing. Recent studies\* have shown that pressings benefit from the use of the Dolby System even under the ideal conditions of cutting master lacquers from original low-noise tapes. Under more usual conditions the cutting is done from tapes once and even twice removed from the original, and in these cases the benefits of noise reduction are all the more apparent."

\*John M. Eargle, "Performance Characteristics of the Commercial Stereo Disc," J. Audio Eng. Soc. 17, 416 (1969).



Write for full technical details and advice on how the Dolby System can be of value in your own professional audio recording or transmission application.

### **DOLBY LABORATORIES INC**

333 Avenue of the Americas New York N Y 10014  
telephone (212) 243-2525 cables Dolbylabs New York

for international inquiries:

346 Clapham Road London S W 9 England  
telephone 01-720 1111 cables Dolbylabs London



## Wally Heider and friend.



When Wally Heider, the internationally known master of the art of location recording, talks about recording techniques, we're very frank to admit that we listen! Imagine how pleased we were to hear him talking about our own SM53 unidirectional dynamic microphone in terms such as these: "The loudest guys in the world, screaming into them, won't break them up"; or "They sound good on any assignment"; or "The front-to-back characteristics are excellent"; or "Whenever I'm not locked into a performer's own pet microphone, I prefer to use the SM53." We can tell you about eight provable advantages that can make the SM53 your most effective and reliable recording microphone. Write Shure Brothers Inc., 222 Hartrey Ave., Evanston, Ill. 60204.



**SHURE**

10:30 PM . . . the 'NOW GROVE'

. . . the comedy team has slipped back behind the curtain . . . the room is hushed . . . expectant . . . apprehensively darkened . . . unaware that tonight's performance is to be, too, a live taping of material for Sammy Davis' new Motown album . . . SAMMY DAVIS JR LIVE AT THE GROVE.

# WALLY HEIDER RECORDING SAMMY DAVIS, JR. LIVE at the "NOW GROVE"



Heider

Huston

*by Chris Huston*

Connected umbilically to the GROVE by some 400 yards of audio and coax cable, in a strangely unmarked, workman-like panel truck, a big man, in reputation for this sort of thing, as well as in physique, WALLY HEIDER easily swivels left, then right from his position full in front of the complete 16-track console, 'punching-in' both 16-track recorders.

For the next hour and thirty minutes, as the two-inch 3M 206 tape winds, Wally operates in his acknowledged specialty: CAPTURING THE LIVE PERFORMANCE.

At odd times during that day, as time occurred during the set-up, we talked with WALLY HEIDER about Remote Recording, and particularly how he intended to work this date. "This job started," said he, "last night, (the opening night of Sam's four-day engagement), when we saw the show completely and began to work out the basic planning and strategy. We got a pretty good idea of the things Sam wanted to record; sound levels, and how the band was used."

The best 'Remotes,' we were to learn, happened when the performers were as nearly unaware of the recording process as that is possible. We watched as Wally and his set-up crew took every possible

precaution so that Sammy and the 23-piece George Rhodes band, on the 30' x 12' stage would in no way be impeded. The essence of Wally's secret, if it is a secret, is that the twenty-seven (27) mikes, many boxes, and yards and yards of cable in no way detracted from the flow of the performance.

Earlier on the day of the 'taping,' Wally prepared a sketch of the stage, as well as the instrument placement of the band, and the house Public Address systems. An inventory of the mikes he wanted to use followed. The set-up crew working from these plans wired the stage and hung the mikes accordingly.

## RHYTHM SECTION MIKING

Although no special problems occurred, a good bit of time was spent at the heart of the band, the very tightly-grouped rhythm section at the center of the stand. So that the drums were not obscured, the piano lid had been completely removed. The decision, thus, was to 'close-mike' the piano, top and bottom, with two Sony C-37's mulcted together before they reached the console input. Normally, Wally would have preferred to mike the piano with a single mike a couple of feet above and away from the piano, to effect a better blend of highs and lows. A second

continued/



alternative, if a woody, funky sound was desired, would have been to place a mike directly into one of the sound holes.

Having heard the repertoire the night before, Wally decided to go with the 'above and below' close-miking which, as it happened, gave remarkable tone. Separation was distinct even from the double bass drums located directly behind the piano.

Wally preferred to mike the drums very much the same as they would have been, had they been recorded in a studio. He used two Sony C-37's overhead. The snare was close-miked with a Shure 546, as well as two more 546's close-miked on the bass drums.

Still in the rhythm section, the bass amp was close-miked with a Shure 546 milted with a 'direct-box' on the electric bass. The guitar amp, likewise, made use of the highly directional qualities of the 546.

The Leslie tone cabinet, directly to the drummer's right, was miked, too, using the Shure 546 on both top and bottom, milted into one input.

Suspended above the total percussion section was an overhead Sony C-37 for blend.

#### STRING SECTION MIKING

Especially in the Big Band context, miking the strings is always critical. While strings easily hold their own during soft or moderate passages, they tend to lose their identity or are completely drowned out in passages which feature brass and woodwinds. This is so even when the sections are on opposite sides of the stage.

Wally's decision was to mike the strings with Altec M-49's. Characteristically the M-49's have good ability to capture brilliance and lend themselves to "Riding" which Wally planned for the heavy parts.

The complement of mikes used on the section was three M-49's milted into one input on the six strings. Two Sony C-37's close-miked the two celli.

#### BRASS AND WOODWIND MIKING

The horns and woodwinds were seated in three tiers; the five saxophones down front, the four trombones behind and above, with the trumpets on the third tier.

As he related, Wally is very high on the U-87 as one of the finest all-around condenser microphones. He used three U-87's to really absorb the tone and blend of the woodwinds. Two U-47's easily handled the dynamic range of the strong four-piece trombone section. RCA 77's, two of them, captured the four trumpets to complete the miking of the band stand's left side.

#### VOCALIST AND AUDIENCE MIKING

As has probably long been known, Sammy Davis possesses a 'golden' Shure SM 58, which he regularly uses for appearances. Wally had planned for Sam to use a standard SM-53 with a newly-developed, larger 'pop-filter.' The Artist, however, was reluctant to switch without some rehearsal with the new mike resulting in the decision to go with the golden '58 for the performance that night, and to switch to the '53

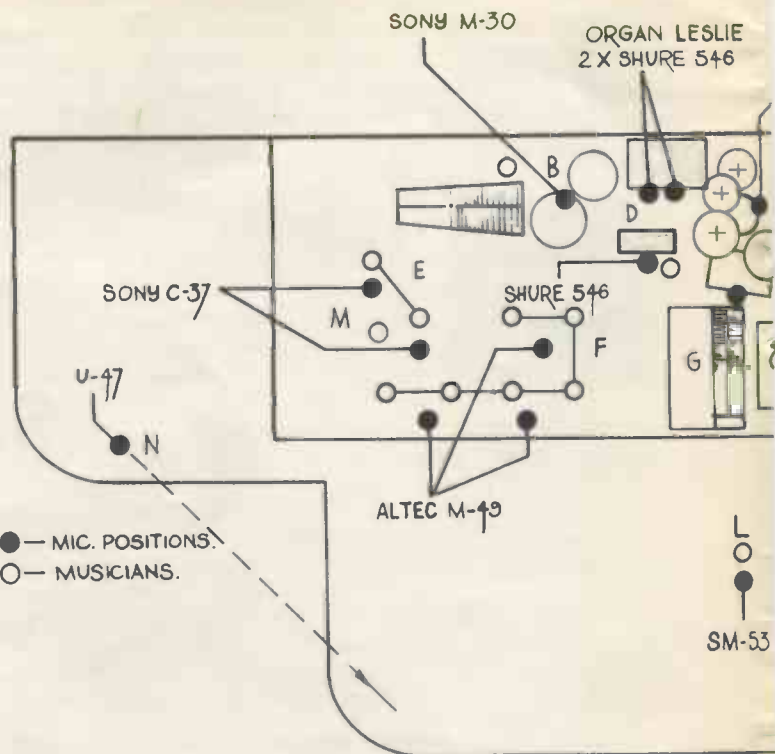

## MIKING / STAGE

with the enlarged pop-filter for the following night after some rehearsal with it.

The audience mikes used were U-47's because of their broad, flat response curves. They were placed at each side of the stage facing in, at an angle, toward the center of the room.

#### RECORDING

'Levels' were pretty much set during the two dance sets prior to show-time. The only unforeseen problem encountered was an A/C signal on a couple of the mikes attributable to the stage lights. This was easily taken care of.

Davis' show opened with "Spinning Wheel." The tune with its rich horn parts, solid rhythm, and good volume, was a good one with which to finally measure and establish settings and balance for peaks.

With everything running smoothly, and all instrument channels balanced, Heider was free to devote most of his attention to the 'tracking' of the vocal. He did not, at this point, elect to use a Limiter. His feeling was that if he used a Limiter, it would have allowed a good bit of the band sound to get on to the vocal track over the limited signal.

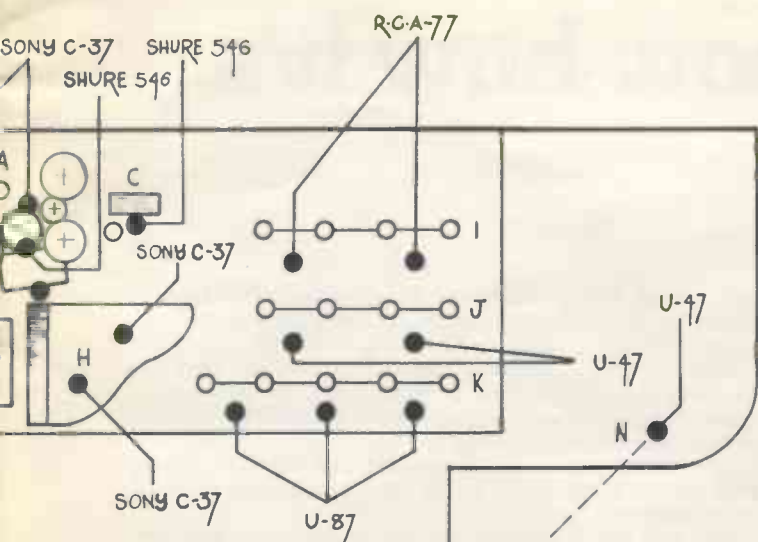

- A - DRUMS.
- B - TIMPS/PERC./VIBES.
- C - GUITAR AMP.
- D - BASS AMP.
- E - CELLI (2).
- F - STRINGS (6).
- G - ORGAN.
- H - PIANO (BABY GRAND).
- I - TRUMPETS (4).
- J - TROMBONES (4).
- K - SAXOPHONES (5).
- L - VOCAL
- M - VIOLA (1).
- N - AUDIENCE MICS.

## LAYOUT

By keeping the vocal level up, really watching for peaks, limiting later in the mix-down would provide all the control needed.

If he had had a track to spare, Wally might have used an alternative method he likes very much for doing vocal remotes without using Limiters. This involves paralleling the vocal signal into two channels at once. One of the channels is set-back, perhaps, 3-5 dB from '0.' In his words, "it provides a safety in the event of sudden peaks and eliminates the need for limiting, while accomplishing the same objective."

## RECORDING TRACK LAYOUT

- |                     |                   |
|---------------------|-------------------|
| 1 Sammy Davis Vocal | 9 Right Trombones |
| 2 Violins           | 10 Piano          |
| 3 Celli & Viola     | 11 Guitar         |
| 4 Left Reeds        | 12 Drums          |
| 5 Right Reeds       | 13 Drums          |
| 6 Left Trumpets     | 14 Percussion     |
| 7 Right Trumpets    | 15 Left Audience  |
| 8 Left Trombones    | 16 Right Audience |

## THE TRUCK

As diagrammed, the remote facility Wally has been using is built around the shell of an ALTEC console with Universal Audio equalizer and pree-amp. The eight busses are supplemented by eight auxiliary busses which are in reality the echo busses. Each of the 16 channels has its own mute control for easy monitoring.

The first sixteen (16) input positions are switchable to any of the first eight busses. Positions 17-24 are permanently wired into the eight auxiliary busses.

The monitor system consists of four (4) ALTEC 604 E's in narrow cabinets.

The monitor system is powered by MC 275 power amps. An essential part of his monitoring system is the closed circuit TV monitor located just to the left of the console.

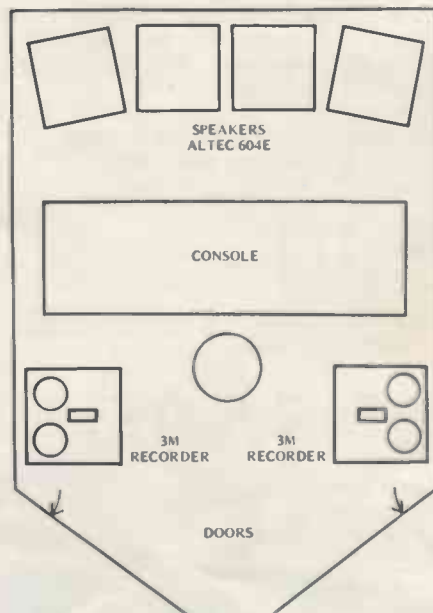

As this issue of Re/p goes to press, let's call it "WALLY ON WHEELS 'II'" is about to be christened. The new enlarged remote facility will be reported on in the next issue.

END

### About the author:

With this, his first article, Chris Huston adds the title 'Author' to the many others which describe his current occupations as well as former activities: producer, engineer, mixer, session-man, studio-owner/manager, graphic artist, etc., etc.

Re/p is delighted to publish this story by Chris at about the same time that he is receiving more recognition for having just engineered the Eric Burdon/War #1 single "SPILL THE WINE"... as well as the album.

A Huston produced/engineered group "SWEETWATER" releases an album on Warner's in October.

-ed

# If you buy a "stock" console, be sure you know how it's stocked

By the time you finish adding what you really want, your "stock" price is a long way off your budgeted figure.

That's why we don't have a "stock" console. Nobody keeps things like consoles just sitting around. Instead, we have a basic plan. The RC 168. And it's a lot less basic than anybody else's.

First of all, our basic plan is really *planned*. Thoroughly. From every standpoint.

For instance, it comes with complete patching. And, any input may be audexed with any output channel. And, the wiring is all concealed. And, there are three-knob equalizers on all the inputs.

Moreover, this is one basic plan that stays effective for a long, long time. It's a *true* 8-track . . . meaning it will record all 8 channels plus stereo and monaural at

once! And we've designed in an expansion plan to give you up to 24 inputs at minimum cost and no additional wiring.

What's more, we never forgot that a mixer only has so many fingers, so long a reach, and can only see so many things at once. So, we made it easier for him. It's called "human engineering."

Like eight pan pots. And slide pot monitor mixing. And an eye level meter turret. And a complete monitoring system. And more.

You can buy a console for less. But you get less console.

We'd like to tell you more about our RC 168. Because there's lots more to tell. And when you hear our prices, you'll know it's worth hearing about.



Drop us a note, or call us collect.

**AUDIO  
DESIGNS**  
and Manufacturing, Inc.

**COMPONENTS  
& CONSOLES**  
for audio recording

15645 Sturgeon • Roseville, Mich. 48066 • Phone: (313) 778-8400



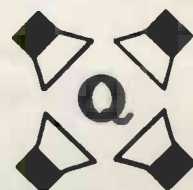

STUDIO  
DESIGN  
for  
QUADRAPHONIC  
RECORDING

*Mercury in N. Y., Nashville, S.F.*

by  
*Allan Parachini*

The quadrasonic revolution carries with it the mandate that record companies prepare for any eventuality by designing and constructing technical facilities now that will accommodate quadrasonic or multiphonic progress for years to come.

The necessity to anticipate the development of recording techniques still in their infancy has led to intriguing experimentation in many quarters.

One major label, Mercury Record Corp., is now completing a total program of studio remodeling construction that the firm hopes will allow it to meet any challenge of the new system of reproduction.

While Mercury has not yet officially announced its plans for marketing quadrasonic product, either on

disc or tape, technical personnel have given the label total quadrasonic capability through design and research at three Mercury owned or affiliated studios—New York, Nashville and San Francisco.

In New York, Mercury has completed renovations

*continued/*



**The best  
microphone money  
can buy.**

The Sony C-500 Studio-Standard Condenser Microphone is the only studio microphone able to surpass the technical capabilities of all other equipment in today's advanced recording studios. Its dynamic range—in excess of 130 dB—permits distortion-free recording of extremely dynamic works of music. No other microphone even approaches its distortion-free performance—less than 0.1% (I.M. or T.H.D.) at or below 134 dB SPL, and its maximum sound pressure level is a devastating 154 dB, without significant increase in distortion. All other performance characteristics are equally impressive, thus justifying the C-500's title: STUDIO-STANDARD. \$395.00.

**The best  
microphone buy  
for the money.**

Now Sony enhances studio capability with the new incredibly low-priced ECM-377 cardioid condenser microphone—the outstanding successor to the popular Sony C-37A. The ECM-377 surpassed the performance of all existing condenser microphones except Sony's new C-500. It is compatible with all "phantom power" systems or may be powered by an internal battery. You can use it anywhere. Outstanding performance at a remarkably low price—\$195.00—The Sony ECM-377.

The Sony ECM-377 and the Sony C-500 are available at select Sony/Superscope dealers. For their names, as well as complete details and specifications, please write Special Application Products Division, Sony/Superscope, 8132 Vineland Ave., Sun Valley, Calif. 91352.

**SONY** SUPERSCOPE

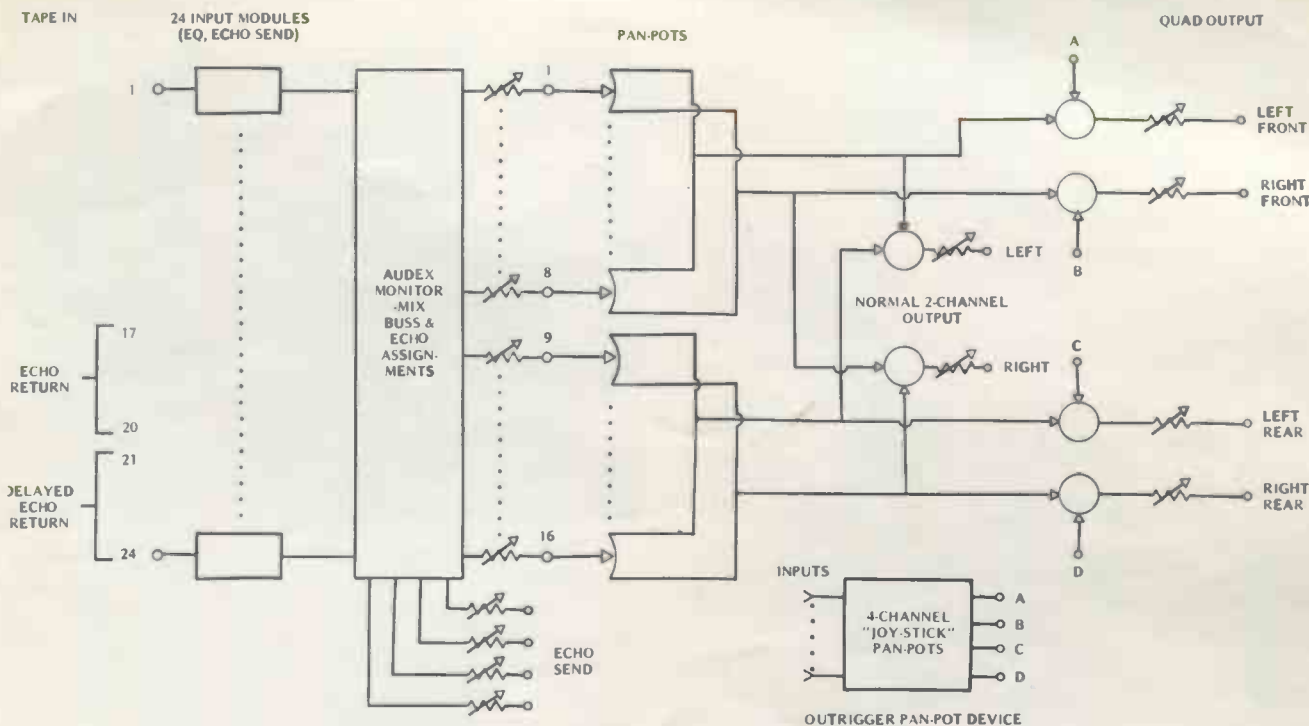

## AUDIO DESIGNS 24/16 CONSOLE

of its two studios and control rooms, to include one of the first control/mixing rooms in the city designed around the quadrasonic concept.

"We knew that quadrasonic sound was going to be a requirement when we started the design work for our remodeling program in November of 1969," said John Eargle, Mercury's technical director.

"What we did was design and build a control room that is also quite suitable as a remixing room and which gives us all the tools we need to make either mono, stereo or quadrasonic recordings."

(Eargle, something of a speech precisionist, feels that the term "quadrasonic" is a linguistic contradiction, utilizing Greek and Latin roots. The uniform Latin form of the word should be "quadrasonic," said Eargle, while "tetraphonic" would be the Greek derivative.)

To begin with, Eargle designed a patching system that allows speakers to be placed in any configuration around the room to provide monitoring capability for quad mixing.

"We're operating a little in the dark this way," said Eargle, "because we don't know what configuration the speakers in home-type quadrasonic units will take.

"They may be in an arc or they might be positioned one to each corner. We can mix either way or in combination in our new control room, but at this point, we're just guessing."

For quad mixing sessions, the regular studio Altec monitors are disconnected and four home-type speaker units substituted, usually two in front of the console and two behind.

The central unit in the Mercury control room is an

Audio Designs 24-channel quad board that was built under Eargle's supervision. It features 24 input channels and 16 output channels. The board has been in operation since early June.

Eargle's design breaks the 16 monitor-mix pan-pots into two groups. (See Figure 1) Outputs 1 through 8 are assigned to a pair which represents front-left and front-right, while outputs 9 through 16 are fed to a pair representing rear-left and rear-right. Any input, be it an output of a tape machine, a reverberation device, or any other signal processor, can then be assigned to any of the four quadrasonic outputs. Left-right panning is available for both the front and rear groups, if necessary.

In addition to the built-in panning capabilities of the console, Eargle has designed and built an outrigger device containing a number of "joy-stick" pan-pots. Like their two channel counterparts, these quadrasonic pan-pots operate on the basis of equal acoustical energy level at all positions; that is, for a constant input, the *sum of the squares* of the output amplitudes is also constant. "With the stick in the center position," explained Eargle, "all four outputs are equal and the program is essentially panned into the middle of the room. By rotating the stick around its periphery a program can be panned around the room. The effect at any other position is proportional to the position of the stick."

Any program channel requiring this degree of panning flexibility is patched directly from its source into the device, and the outputs are fed into the quadrasonic busses.

The Audio Designs console also provides for the complex time-delay techniques essential in creation



## MERCURY STUDIOS

/Continued

of the correct ambiance for quad sound. The 24 high-level inputs to the console would normally be fed from a 16-track machine, 4 echo returns, and the same 4 returns delayed. Or, if there are more delay devices available, echo returns 17 through 20 could be delayed, say 20-25 milliseconds and the returns 21 through 24 delayed 40-50 milliseconds. Mercury uses an Ampex slave, modified for 30-60ips operation, as a time-delay device. The unit is driven by a variable frequency oscillator and can provide delays of the order of 25 milliseconds.

"For example," Eargle explained, "let a brass track be assigned to one of the first 8 monitor-mix busses and panned to front-right. This same track is delayed, assigned to a stereo EMT-140, and the two returns assigned to front-left and rear-right. One of the reverb channels is further delayed and then assigned to the left-rear channel. Now, if the time-delays are appropriately short and the reverb of good quality, then the effect will be one of the brass performing in a 'live room;' a sound front will move from front-right to left-rear in a more or less natural way, and the reverb from the three speakers will be sufficiently incoherent to create the illusion of a naturally reverberant environment."

Eargle believes that the future of pop quadrasonic sound lies in the exploitation of techniques such as this. "What we are trying desperately to do is avoid committing the worst possible sin in the quadrasonic field—using four channels just to pipe out two more mono channels."

Despite the technical advances involved in the Mercury remodeling operation, Eargle still feels that much more development work needs to be done before quadrasonic becomes a meaningful force in sound reproduction.

"With our multitude of techniques and lack of clearcut artistic direction, the individual label has what amounts to a solution in search of a problem."

## STUDIO "A" NEW YORK



## SAN FRANCISCO STUDIO



"We have to try to anticipate what will actually go on in the home once quad units and material are available. Right now, we're creating material in sort of a vacuum."

Eargle feels, however, that material now being recorded and even some that has been recorded within the past 10 to 15 years can be made into suitable quadrasonic recordings.

Among his present projects, for instance, are attempts to reprocess quadrasonic masters from old three-channel classical recordings already in Mercury's vaults.

"There's really no reason why, with the correct mixing technique, you can't make some of these old tapes into good quad masters," said Eargle. "In your mixing, you must use a 'direct-reverberant' concept."

"By this we mean an attempt to convey the image of a symphony orchestra on stage with reverberant sound coming from all directions."

Eargle said that any well-made 16-track popular recording should offer the capability of being mixed down to quadrasonic. "If you can't make a good four-channel mix-down from such a tape," he continued, "there's something wrong."

Construction of Mercury's present four-channel equipment offered no special problems, Eargle said. The control room itself is acoustically no different from its two-channel counterparts. "The only thing is that through all of this, we've been trying to get the equipment to do more than it is designed to do," he continued.

Eargle feels that the quadrasonic movement is now in its gimmickery stage but that the future of the medium demands "that we proceed by intuition now, to a large degree."

Eargle said workable quadrasonic versions of prerecorded tapes should be commonplace by the middle of 1971 but would make no prediction as to the advent of the quadrasonic disc recording.

The end result, he went on, should be that quad sound will not substantially increase recording costs, although mixing time as the technology develops will probably be longer until the technical processes involved are mastered.

*continued page 35*

A hearing aid for good ears.



**KEPEX**™

keyable program expander



7120 SUNSET BOULEVARD  
HOLLYWOOD, CAL. 90046

BOOTHS 67-68

# It's MCI's new breakproof, spillproof, convertible, total-logic JH10.

The logic is so total, not even a power failure (much less an engineer failure) can break or spill the tape.

Shuttling is as fast as you can push a button.

"Sudden" is the most accurate word we can find for JH10's acceleration from "Stop" to any commanded tape function.

And for its conversion time from one- to two-inch, and vice versa.

(Still, there must be a better word for it somewhere.)

Practically everything is plug-in for fantastically simplified maintenance and expansion, from, say, 8 to 24 tracks.

Constant, electronic (not mechanical) tension control sensing reduces head wear, wow, flutter and speed variations.

Prices start at \$3,500.

Write: MCI, 1140 North Flagler Dr., Ft. Lauderdale, Fla. 33304. **MCI**

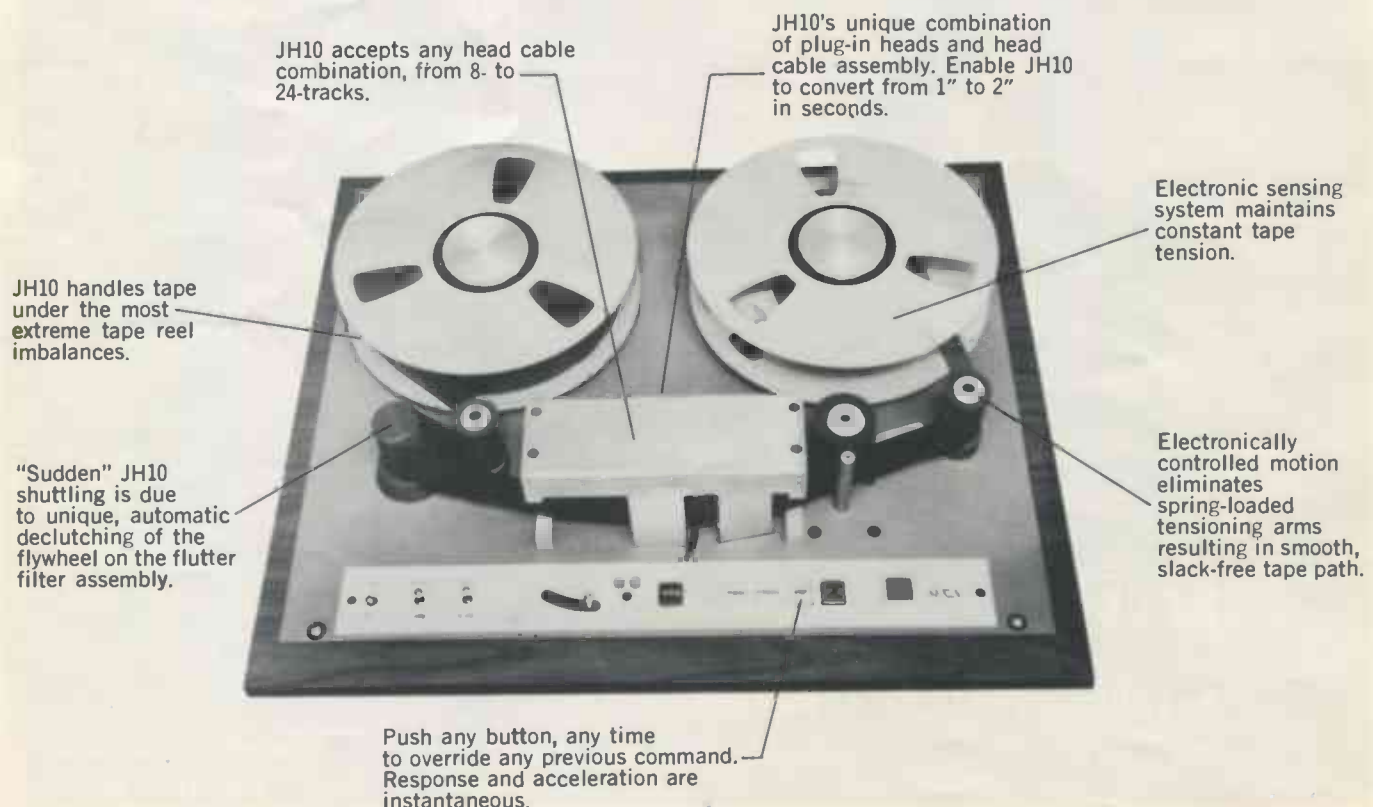





# A QUADRAPHONIC MICROPHONE DEVELOPMENT

by Chris Huston

As a complete oversimplification, a microphone is an instrument which measures differences in air pressure.

It is not surprising that somebody would, in light of the interest in Quadraphonic sound, experiment and perfect an instrument which would measure and transduce the differences in air pressure around a full 360° . . . to effectively create a quadraphonic microphone.

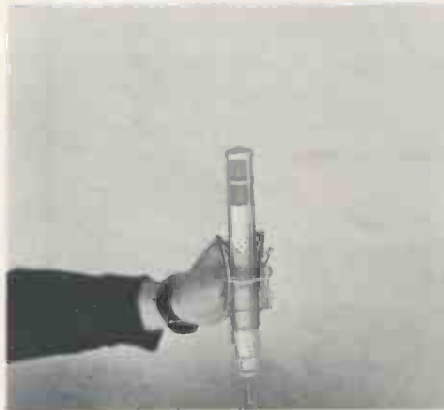

FIGURE 1

Such a truly Quadraphonic device, developed by engineer Carl Countryman and producer Brad Miller, is in external appearance no different than the several models of standard microphones. (See Figure 1) This Quadraphonic microphone has been designed and built using the case and chassis of a Neumann SM-2, into which four independent microphone heads have been built to provide full 360° pick-up.

The pick-up patterns (Figure 2) are cardioid, front and back, and figure eight at the sides. Although the obviously complicated matrixing data are proprietary, and unavailable for publication, the discussion of pick-up patterns, generally, yields an understanding of how the design provides excellent separation and naturalness of sounds.

Cardioid, also sometimes called unidirectional, is a heart shaped response. It is the resultant of an omnidirectional and figure eight pick-up. The signals are superimposed on each other; at the rear they are anti-phase, and so cancel out. At the front they are in phase, hence the tapering heart shaped response toward the rear.

Figure eight, or bi-directional pick-up patterns are the result of two directional pick-up patterns, one in phase, and the other anti-phase. The output at the front and the back are equal, although opposite. As the input signal moves to the side, the output is gradually reduced until at 90° the two patterns have, to all intent and purpose, cancelled each other out.

Figure 3 diagrammatically shows the microphone capsules as they are arranged in the microphone head. 'Front to Back' and 'Left to Right' are one above the other at 90° to each other.

Three demonstrations, one very spontaneous, served to convince that development of the unit is very nearly complete.

The microphone was hung in Miller's back yard garden, surrounded by about 200° of sound source emanating from a

/Continued

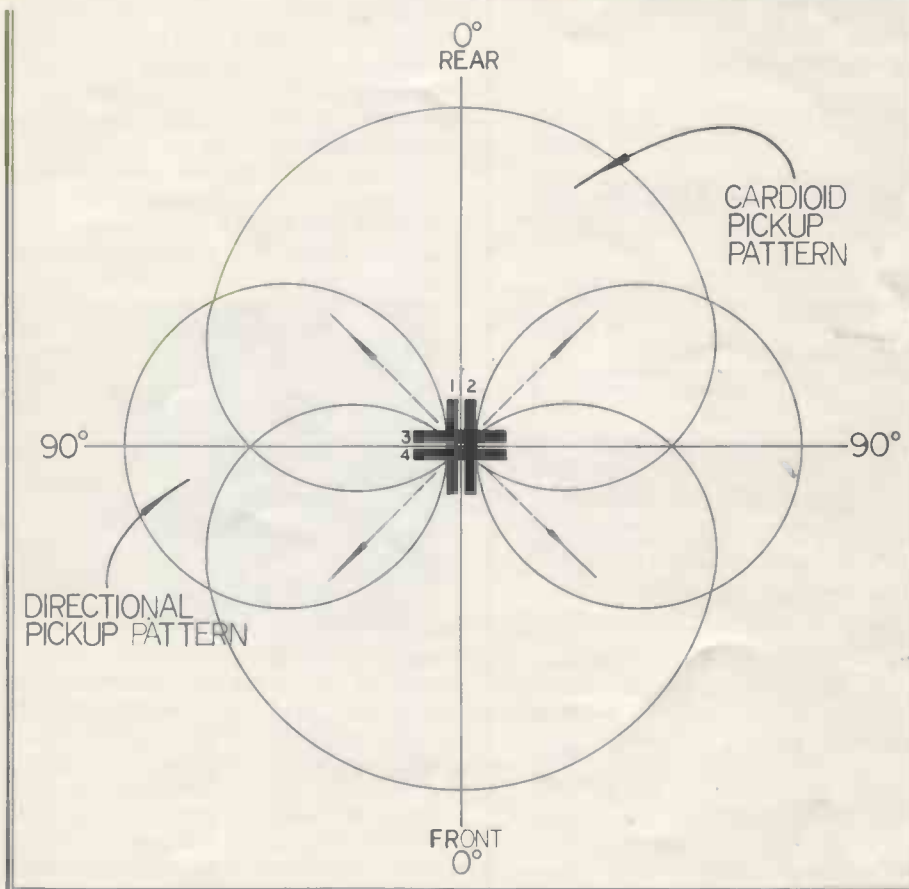

FIGURE 2

# ATTRACT CREATIVE CUSTOMERS

## NEW WESTREX DISKMASTER SYSTEM GIVES THEM COMPLETE TECHNICAL AND CREATIVE FLEXIBILITY

The Diskmaster is another link in the artistic chain. Much more than a simple one-to-one transfer system, it has all the components and all the controls needed to produce the kind of finished master that makes the most of the original material.

The complete Diskmaster system includes the new Westrex 3D II system; a Scully automatic lathe and its accessories; complete tape playback equipment; a console that has two inputs, signal processing, and two outputs with the preview signals processed identically and simultaneously to duplicate the program processing. There's much more. Write for complete description and specifications.



DIVISION OF LITTON INDUSTRIES

1136 North Las Palmas Avenue  
Hollywood, Calif. 90038  
Phone: (213) 466-7795

Circle No. 113

## THE ENTERTAINMENT INDUSTRY SERIES *indispensable references for the recording studio and producer office:*

- 1. THE RECORD INDUSTRY BOOK**  
*(Daily Variety: "It will be classed (as is Blackstone & Gray's Anatomy in the legal and medical professions) as the supreme authority for those in the recording industry.")* \$30.00
- 2. THE MUSIC INDUSTRY BOOK**  
*(Sid Asher in New York: "The point behind this encyclopedic tome is simple—how to make money in the music industry! It covers everything . . . from behind the scenes to contracts, and from people who have made fortunes to people who have been gypped . . . \$35.00, but I do know it is most certainly worth many times that amount.")* \$30.00
- 3. THE PUBLISHER'S OFFICE MANUAL**  
*(Library Journal: "The weighty tome . . . pearls of wisdom . . . often illustrated . . . stories . . . special & sometimes mysterious language . . . reproducing forms for contracts, copyright registration certificates, publishers' clearance forms, and so on.")* \$30.00
- 4. THE U.S. MASTER PRODUCERS & BRITISH MUSIC SCENE BOOK**  
*(Southern California Law Review: ". . . problems of record promotion, business and money promotion, recording contracts . . . sample contracts, Special attention is given to description of the music industry in England . . .")* \$30.00
- 5. THE MOVIE INDUSTRY BOOK**  
*(Back Stage: "The valid purpose of this hefty, large format tome is to assist businessmen in maximizing their profits from the motion picture industry, a goal it fulfills effectively & without illusions. In practical terms, it outlines the pitfalls in every area of the industry, giving specific advice and factual information on what and whom to watch. Producers, distributors, exhibitors, packagers, corporate lawyers are dissected mercilessly, but with humor, knowledgeability and care, and their business activities are described in practical & informative detail . . .")* \$40.00

to/REP BOOKS 6430 SUNSET BLVD HOLLYWOOD, CA. 90028

Enclosed is check : money order : for \$ \_\_\_\_\_ in full payment for the books ordered as checked:

- 1 The Record Industry Book . . . . . \$30.00
- 2 The Music Industry Book . . . . . \$30.00
- 3 The Publisher's Office Manual . . . . . \$30.00
- 4 The U.S. Master Producer's & British Music Scene Book . . . . . \$30.00
- 5 The Movie Industry Book . . . . . \$40.00

California residents add 5 1/2% sales tax.

Name \_\_\_\_\_ Address \_\_\_\_\_  
City \_\_\_\_\_ State/Zip \_\_\_\_\_

Circle No. 114

## QUAD MIKE/continued

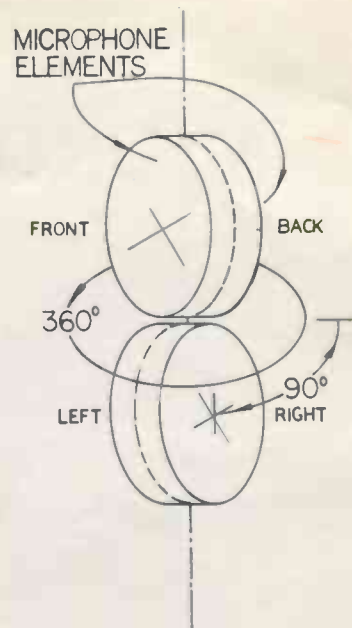

FIGURE 3

waterfall with various small tributary streams flowing from it. It presented an excellent opportunity to 'hear' the complete environment; the waterfall in stereo on the two speakers in 'front', and from behind, the beautiful ambiance of the total environment and the reflected sound.

Several minutes into the demonstration, on the Southern Pacific tracks bordering the rear of the Miller garden a slow moving freight train ambled by. The completeness of the sound, the way it engulfed the listening room, is difficult to describe. It was totally complete . . . almost frighteningly so.

Miller completed the demonstration by playing a 4 track tape of his 'MYSTIC MOODS ORCHESTRA' on an especially adapted Sony. The machine (Figure 4) has been adapted for 4 track, in and out,



FIGURE 4

and will be able to accommodate 10" reels of 2" tape. The machine is the forerunner of a new design from the Countryman/Miller collaboration which will weigh in the vicinity of 20 pounds.

The MYSTIC MOODS piece only served to further impress that Quad or Multi is certainly on the way . . . with an endless spectrum of sound combinations and tonal effects. END

The adventures of Paul Producer, Sam Studio and the "Wallaquois Indians."

# BEWARE OF FORM CONTRACTS

by William Storm Hale

About the author: William Storm Hale is the pseudonym of a prominent nationally known lawyer. He has co-written THE RECORD INDUSTRY BOOK, THE U.S. AND BRITISH MUSIC SCENE, THE MOVIE INDUSTRY BOOK, among others. In writing under the pseudonym Mr. Hale explained, "I can write more truthfully about the recording business and the legal aspects of the industry by using the fiction story style, rather than by using the non-fiction brief style. In this way there is no danger of violating confidences, invading privacy, or committing libel."

Paul Producer, Sam Studio and The Wallaquois Indians are figments of Mr. Hale's imagination, and any similarity to any specific persons or group is purely coincidental.

This article is part of a forthcoming book.

Paul Producer, an independent record producer, and Sam Studio, the owner and manager of a recording studio discussed mutual problems—lack of money.

Paul told Sam that he just couldn't afford the rates for 16 track recording, although he could get groups to play at sessions without getting paid immediately.

Paul propositioned Sam Studio; "Why don't you and I become partners? I'll provide the musicians and you supply the studio facilities. I'll peddle the masters, and we will split the gross amount we get for them 50-50."

Sam Studio considered the proposition: "The studio does have some dead time. Why not contribute that time to a recording project. If the masters are sold we will be paid for the studio time; if the masters are not sold, we will have lost only the cost of engineer's wages, tape and dubs, and a little wear and tear on the studio equipment. Paul Producer has a good track record; it's quite likely that he will sell the masters."

Paul Producer had a copy of THE MUSIC INDUSTRY BOOK, and found the page which contained a sample JOINT VENTURE CONTRACT.

Paul said, "Let's fill in the blanks of the sample contract. Then if we like what we see, we can show it to our respective lawyers to make certain that the printed contract applies to our situation."

Paul and Sam filled out, wrote-in, crossed-out portions of the sample JOINT VENTURE CONTRACT as follows:

**JOINT VENTURE CONTRACT  
(PUBLISHER) (MASTER PRODUCER)**  
LOS ANGELES, CALIFORNIA

The undersigned, desiring to enter into a joint venture, agree as follows:

- The name of the joint venture shall be: PAUL PRODUCER—SAM STUDIO PRODUCTIONS #1
- The character of the business shall be:
  - The publishing of music recorded by the two parties;
  - The production of two phonograph record masters and phonograph records;
  - ~~The promotion and distribution of phonograph records;~~
  - All other business necessary and related thereto.
- The location of the principal place of business shall be: 8999 Sunset Boulevard, Suite 40404  
Los Angeles, California 90069
- The name and place of residence of each of the undersigned is:
  - Paul Producer
  - Sam Studio
- Each of the undersigned shall contribute cash and property, and shall receive percentages of the net profit of the joint venture as follows:
 

NAME	Contribution: CASH PROPERTY	% OF NET PROFIT
a. <u>Paul Producer</u>	<u>As much cash as is required to pay all vocalists, musicians, related taxes and union costs.</u>	<u>50%</u>
b. <u>Sam Studio</u>	<u>Such studio facilities and tapes as are required for two (2) sides.</u>	<u>50%</u>
- Each of the undersigned may make additional contributions to, or withdrawals from, the capital of the joint venture as may from time to time be agreed upon by all the partners.
- The joint venture shall continue as long as the undersigned desire.
- In the event of retirement, expulsion, bankruptcy, death or insanity of a member of the joint venture, the remaining members shall have the right to continue the business of the joint venture under the same name by themselves, or in conjunction with any other person or persons whom they may select.
- The members of the joint venture have the right to admit additional members by unanimous decision only.
- The members of the joint venture do not have the obligation of bringing new artists to the attention of the other members of the joint venture. This joint venture only concerns the publishing and lease rights of masters featuring the following artists:  
\_\_\_\_\_  
\_\_\_\_\_

IN WITNESS WHEREOF, the undersigned members of the joint venture have hereunto set their hands this day: \_\_\_\_\_

PAUL PRODUCER \_\_\_\_\_ SAM STUDIO

/Continued



# Expanding Sound

## Is SSI! It's

expanding in that more and more studios are switching to or installing ultra-reliable professional audio products from SSI. It's expanding in that systems from SSI embody the ultimate in sophisticated state-of-the-art design—from a single channel speech unit to a 16-channel professional system for full orchestration. And, it's expanding in that we've designed-in a modular building block approach that lets any user custom-tailor or expand a system to meet his own particular requirements... now and in the future. For existing installations, complete functional upgrading is easily achieved on an as-you-need-it basis—switching, signal transfer, mixing, level correction, impedance matching, added channels, echo send, cueing, etc. Each of SSI's "interface modules" are completely compatible and easily installed. If you require a special purpose, multiple-channel control system, SSI engineers will custom design it to meet your specific audio and physical needs.



A division of  
**A&R Recording, Inc.**  
Dept. C  
4956 Wyaconda Road  
Rockville, Md 20853  
Phone: (301) 933-7788

Circle No. 115

The proposed contract looked pretty good to Paul Producer and Sam Studio. They knew that each *should* have a lawyer of his own choice look over the contract.

Paul contended, "Sam, if you take this to your lawyer he will delay our deal, cost you money, and possibly want to change everything. Let's just shake hands, sign the contract, find the artists, record them, and make money."

Sam Studio, who should have known better than to use a form contract not previously cleared by his attorney, decided to sign **THE JOINT VENTURE CONTRACT**. Paul signed, as well.

Paul Producer, true to his word, found a group worth recording. The group signed a recording agreement with the joint venture, **PAUL PRODUCER—SAM STUDIO PRODUCTIONS #1**. The contract provided that the joint venture would employ the group, record them, pay them union scale, pay them royalties, render statements, etc. The group, for their part, agreed to record exclusively for the joint venture. The group was named, "THE WALLAQUOIS INDIANS".

The group rehearsed in Sam Studio's studio, and eventually cut a single, and then an album.

The album had a tentatively commercial sound in the opinion of a major record company. The record company bought the album, and signed the Wallaquois Indians as artists along with Paul Producer as their producer.

The record company paid \$7,000 in front to the joint venture, Paul Producer—Sam Studio Productions #1.

According to the terms of the payment the producers warranted that costs to produce the album had been paid by the joint venture. Paul had prepared 'A.F. of M.' paperwork showing that the album had been recorded in two sessions—Sam's 'A.F. of M.' recording license was used.

Paul Producer and Sam Studio, per their agreement to equally split the gross receipts for any master sold, each took \$3,500 as their share.

Even considering the 60 hours of studio time it took to record the album, and the fact that the contract with the record company called for Paul Producer to receive the producers percentage of future productions, Sam was satisfied with the \$3,500 he had received for his part in the joint venture.

Sam's happiness was short lived. A call from the local business agent of the 'A.F. of M.' lodged a claim on behalf of the musicians for at least 60 hours of recording time, in addition to rehearsal time, overtime, doubles, cartage. "There are 4 members of the Wallaquois Indians", said the business agent, "one is leader, so we

can calculate them as costing about the same as 5 musicians. The cost of 5 musicians for twenty 3-hour sessions: \$85.00 per session, per man, is \$8,500."

"The 8% 'A.F.M.E.P.W.' fund contribution on \$8500 is \$680.

"You also have to pay employer taxes to the United States and to the state.

"Sam, you have a recording license. You agreed to live up to the union contract and pay union scale.

"It's going to cost you about \$10,000 to clear this rap."

Sam was stunned. He argued, "I was not the producer. Paul was the producer. I only rented Paul my facilities."

The business agent trumped Sam. "I have already had Paul Producer in my office. He gave me a copy of your joint venture contract. As joint venturers, or partners, both of you are fully liable for the full amount of partnership or joint venture debts. Paul says that he has already spent his proceeds from the record. That means, Sam Studio, that on behalf of the musicians I am going to get the money from the member of the joint venture who is more vulnerable, namely: You. Sam Studio, when would you like to come down to the local's business office and give me the musicians' payroll checks and EPW check for those twenty sessions?"

(The moral of the story is: If you are in the business of renting studio time and facilities, then let your speculative contracts stick to terms concerning renting facilities, rather than in terms of joint venture.)

(The second moral of the story is: Don't use any form contract unless your lawyer has approved its use for the specific instance for which you want to use it.)

Follow the further legal misadventure of Paul Producer, Sam Studio, and The Wallaquois Indians in the next issue of *Relp*. **END**

### Another MOSER module: **ELECTRONIC ATTENUATION** \$50.00 per channel



Now a new approach to attenuating several signals simultaneously in multi-track recording systems with the MOSER solid state electronic attenuator.

- extremely low distortion
- noiseless
- each module 3/4" x 2-3/8" x 1"
- as many units as required can be ganged together for remote operation

**MOSER DEVELOPMENT CO.**  
10751 Chandler Bl., No. Hollywood, CA. 91601  
(213) 769-0283

Circle No. 116

# RECORDING TECHNIQUES

## “PHASING”

by Jerry Ferree

Everyone who listens to pop music has at some time heard that weird swishing effect swooping down through a drum solo or a vocal group making them sound rather like a long distance short wave broadcast. Most engineers will tell you that this is caused by phasing, yet most have only a vague idea of the mechanics involved and fewer still are able to produce a controlled effect. Lets take a quick look at what happens to produce this effect and then show some ways to accomplish it.

Phasing effects, like the sound of short wave broadcasts, are created by the addition of multiple signal paths, some of which are very slightly delayed from the original. When the quantity of this delay causes the two signals to be phased 180 degrees from one another, cancellation occurs causing a notch to be formed in the spectrum. This notch varies in depth and width, randomly (unless controlled), causing the swoosh as it travels up and down the spectrum.

In the case of audio phasing, a delay is introduced by speeding up or slowing down a tape machine in one of the information channels. This enables the two signals to be lined up electronically. As the signals at the gaps of the playback heads begin to line up in relation to time, a point will be reached for each frequency when it is 180 degrees out of phase with the original signals thus cancelling them. The particular frequency depends on the playback head gap width and also the degree of displacement of the two signals. The farther apart, the higher the notch frequency and the

narrower the notch. As the two signals approach 180 degrees delay, the notch becomes wider and deeper. This is why *fixed* bandwidth tunable notch filters have been generally unacceptable for this use.

The block diagram of Fig. 1 shows a simple but effective way to produce a controllable phasing effect. These effects are usually added when combining to the finished product. They may also be added during live recording but since the adjustment is rather critical, most engineers prefer to wait until dub-down when they can give more attention to obtaining the desired effect.

The delay recorder “A” of Fig. 1 may be eliminated if the source recorder is equipped for “sel-sync” operation and you have an unused track available. Simply re-record the track or a mix of the tracks you wish to phase on the available track. Then place this track in “sync” position (playback from record head) and connect as shown in Fig. 2. By speeding or slowing the delay recorder the track can be positioned so that it phases with

the original tracks.

Since the amount of delay necessary to produce the desired phase shift is very small, close speed regulation is essential. Control of oscillator frequency must be smooth and precise. It should be accomplished in such a way that fractions of a cycle may be adjusted. One way to do this is to use a vernier knob on a stable oscillator. 360 degree rotation of this knob should change the frequency one of two cycles at the most. This will enable you to accurately align the two signals for the proper effect. Many kit type oscillators can be adapted to this use. Some type of frequency meter will be very helpful (but not absolutely necessary) in adjusting the frequency of the oscillator.

The methods suggested here are not the only ones that can be used, but are among the simplest to implement. Some very complicated lash-ups can be used, but will not produce any better effects while being much harder to adjust. Remember, the simpler you can keep *any* hookup, the easier it is for you to control.

END

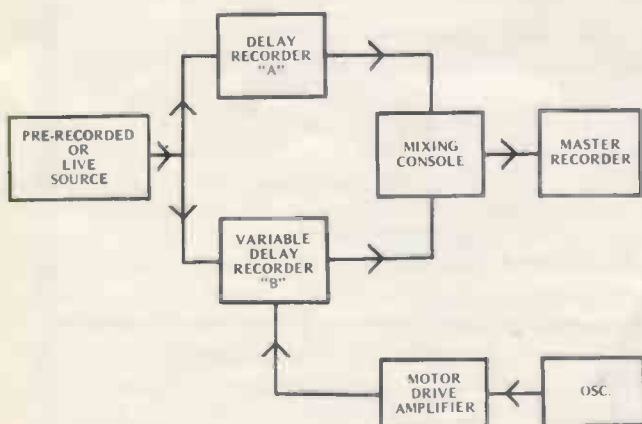

FIGURE 1

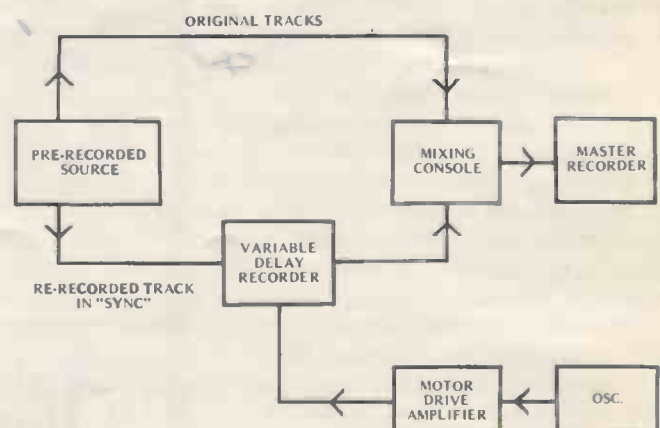

FIGURE 2



# NEW IM ANALYZER

## ADVANCES STATE OF THE ART

Extended measuring range and high-speed readings are the outstanding features of a unique new Intermodulation Distortion Analyzer introduced by Crown International recently. The American firm is known for its line of Crown precision professional tape recorders.

This analyzer was developed to meet the production line requirements of the Crown DC300 lab standard amplifier. The first need was for accurate measuring capability through 0.01%. This analyzer guarantees a residual IM level of less than 0.005%, with seven full-scale ranges from 100% to 0.1%.



The second requirement was for an instrument simple enough to be operated by production-line personnel and rapid enough to make sequential readings across the entire power band. The Crown analyzer meets the challenge by reducing measuring time from minutes per reading to just seconds. This is accomplished by a "tracking" function, using two meters and a ganged input/output gain control. The input level is set using the calibrate meter, and distortion is immediately read on the percentage distortion meter. Successive readings at 5db increments take under five seconds each. The entire operation is completed in less than one minute.

Solid state construction, utilizing FETs, makes the Crown analyzer highly stable and uniquely compact, measuring 7x19x7 inches. Rack mount list price is \$595. Write for spec sheet to CROWN, Dept. XX-XX, Box 1000, Elkhart, Indiana, 46514.

Circle No. 117

## AN EASY 'VSO'

by Brian Ingoldsby

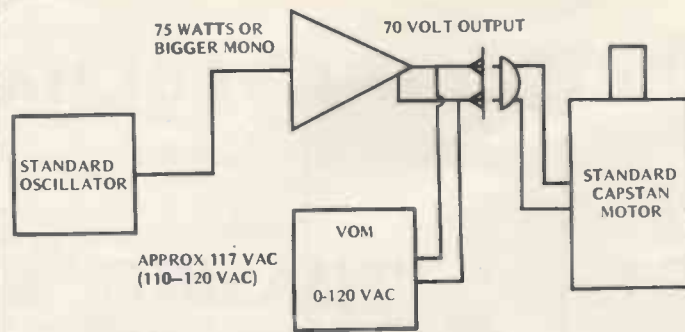

The VSO (variable speed oscillator), sometimes called VFO (variable frequency oscillator) has become a widely used studio tool. Phasing, vocal enhancing, and adjustable echo (tape delay) are but a few of the many effects available with this simple device. Using equipment normally found in most recording studios, set-up as shown, a basic VSO can be constructed.

The output from a standard oscillator (at least +4dbm output) is connected to the input of an audio amplifier (minimum 75 watts mono). The amplifier must have 70v output terminals (standard on most PA amps) which are connected directly to the capstan motor. By bridging the ampli-

fier output with a VOM, as shown, voltage to the capstan motor can be maintained at line voltage (110v-120v). Now, varying the oscillator frequency in the neighborhood of 60Hz will alter the capstan velocity, which is the desired effect.

The degree of flexibility required in the oscillator controls depends on the VSO application. Usable tape delay effects can be achieved with oscillators equipped with step-type frequency controls. Phasing and other more complicated effects require more fine tuning capabilities (see *Recording Techniques* by J. Ferree, this issue). **END**

## PATCH IN ON BIGGER SAVINGS



PCS-241A

**IMMEDIATE DELIVERY**

### AUDIO PATCHING EQUIPMENT

JACKS PLUGS CORDS BAYS

Two conductor shielded patch cords manufactured to Western Electric specifications, with a braided grey nylon jacket and woven braid tinned copper shield connected at one end only. Delivery: maximum two weeks; F.O.B. Los Angeles.

PCS-310A (single 3 conductor plug each end)		PCS-241A (double 2 conductor plug each end)	
1 ft.	\$5.85 ea.	2 ft.	\$8.05 ea.
2 ft.	6.05 ea.	3 ft.	8.40 ea.
3 ft.	6.40 ea.	4 ft.	8.65 ea.
4 ft.	6.65 ea.		

OTHER LENGTHS & COLORS ON REQUEST

All items fully Guaranteed  
Both New & Reconditioned

"Call us First"

THE **Telectric** co.

1218 Venice Boulevard  
Los Angeles, California 90006  
213/748-2281 Cable: TELETRIC

Circle No. 118



# PROGRAM: 39th CONVENTION . . . EXHIBITION OF PROFESSIONAL PRODUCTS AUDIO ENGINEERING SOCIETY OCTOBER 12-15, 1970 HOTEL NEW YORKER, NEW YORK, NEW YORK

## SCHEDULE OF EVENTS

Sunday, October 11—Welcoming  
Cocktail Party  
6:00 to 7:30 P.M. Terrace Room

## REGISTRATION

Mezzanine

Monday, Oct. 12th—8:00 A.M. to 8:00 P.M.  
Tuesday, Oct. 13th—8:30 A.M. to 8:00 P.M.  
Wednesday, Oct. 14th—9:00 A.M. to 5:00 P.M.  
Thursday, Oct. 15th—9:00 A.M. to 5:00 P.M.

## TECHNICAL SESSIONS

Terrace Room: Sessions A, B, D, E, F, H, I, J,  
L, M  
New Orleans Room: Sessions C, G, K

### MONDAY, OCTOBER 12

9:00 A.M.—Annual Business Meeting  
9:30 A.M.—A—Transducers  
2:00 P.M.—B—Electronic Music  
2:00 P.M.—C—Standardization of Stethoscopes  
and Audio in Medicine—1970  
7:30 P.M.—D—Four-Channel Recording and Re-  
producing Techniques  
7:30 P.M.—Workshop on Stethoscopes (See  
Bulletin Board)

### TUESDAY, OCTOBER 13

9:00 A.M.—E—Disc Recording and Reproduc-  
tion I  
2:00 P.M.—F—Disc Recording and Reproduc-  
tion II  
2:30 P.M.—G—Broadcasting  
7:00 P.M.—H—Studio Recording Techniques  
Today

### WEDNESDAY, OCTOBER 14

9:30 A.M.—I—Magnetic Recording and Repro-  
duction  
2:00 P.M.—J—Sound Reinforcement and Archi-  
tectural Acoustics  
2:30 P.M.—K—Audio Instrumentation and  
Measurements  
7:00 P.M.—Social Hour—New Orleans Room  
8:00 P.M.—Awards Banquet—Terrace Room

### THURSDAY, OCTOBER 15

9:30 A.M.—L—Audio Transmission Systems:  
Theory, Standards, and Practice  
2:00 P.M.—M—Amplifiers and Audio Circuitry

## BANQUET AND SOCIAL HOUR

Social Hour—7:00 P.M.—New Orleans Room  
Banquet—8:00 P.M.—Terrace Room

## LADIES PROGRAM

9:30 A.M.—Monday, Tuesday and Wednesday—  
Coffee Hour—AES Suite

## AUDIO ENGINEERING SOCIETY EXHIBIT

Booth Nos. 1-85—Mezzanine Floor  
Panel Room, Parlors and other Booths—3rd Floor  
Demonstration Rooms—5th Floor

## EXHIBIT HOURS

Mezzanine, 3rd and 5th Floors  
Monday and Tuesday, October 12 and 13—1:00 to 9:00 P.M.  
Wednesday and Thursday, October 14 and 15—11:00 A.M. to 5:00 P.M.

## BOOTH Nos.

Abphot Corp.	1	Melcor Electronics Corp.	528
AKG Microphones, North American Philips Corporation	7 and 523/524	R. A. Moog Inc.	Parlor C
Allison Research Company	67/68	Nagra Magnetic Recorders, Inc.	11
Ampex Corporation	74/75/76	Olive Electro Dynamics Inc.	56
Audio Designs & Manufacturing, Inc.	80/81/82	Pentagon Industries Inc.	83
Audio Devices, Inc. A Subsidiary of Capitol Industries	23	Philips Broadcast Equipment Corporation	27/28/29
Automated Processes, Inc.	52/53	Pickering & Co., Inc.	527
BASF Systems Inc.	10	QRK—Rek-O-Kut	78/79
B & K Instruments	45	Quad-Eight Electronics	57/58
The R. T. Bozak Mfg. Company	9	RCA Commercial Electronic Systems	5/6
Caddco Audio Industries Corporation	86	Rectilinear Research Corporation	17
Capps & Co., Inc.	8	Revox Company	72
Crown International	43	Scully Recording Instruments Company	25/26 36-39
Daven Division, McGraw Edison	49	Sennheiser Electronic Corporation (N.Y.)	19
Dolby Laboratories, Inc.	21/22	Shure Brothers Incorporated	24
Dukane Corporation	54/55	Spectra Sonics	84/85
Electrodyne Corporation—MCA Technology	60-63	Stanton Magnetics, Inc.	51
Electro Sound Inc.	30/31/32	Suburban Sound, Inc.	72/73
Electro-Voice, Inc.	Parlor A	Superscope, Inc.	47/48
Elpa Marketing Industries, Inc.	59	Taber Manufacturing & Engineering Co.	2
Fairchild Sound Equipment Corporation	69/70	Tandberg of America, Inc.	87
Daniel N. Flickinger & Associates, Inc.	3/4	Tape-Athon Corporation	88
Gately Electronics	18	Teac Corporation of America	71
Gotham Audio Corporation	Panel Room	3-M Company	33/34/35 and 40/41/42
Harvey-Radio Co., Inc.	20	Tonus, Inc.	532
Institute of Audio Research, Inc.	Parlor B	United Recording Electronics Industries	13/14
Ionic Industries Incorporated	519	United Research Laboratories	46
Koss Electronics, Inc.	44	Vega Electronics Corp.	64/65
James B. Lansing Sound, Inc.	525/526	Victor Company of Japan, Limited (JVC America, Inc.)	529
Mann Cassette Industries	50	Westrex, Division of Litton Industries	66

**Excellence**



**Excellence  
you can  
afford**

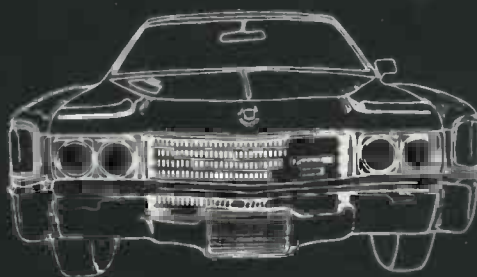

**Excellence  
—economy  
size**



**If it's more than you can use ... you don't need it!**

In automobiles—as in almost everything—excellence is seldom limited to the most prestigious, or the most expensive. Excellence comes in many sizes.

At Gately we believed that most “name” audio systems were overfeatured—at Rolls prices—for the majority of studios. So Gately research went to work and developed the “Cadillac” class of audio equipment—our Series Eight BUILDING BLOCK module system.

The Building Block system allows a studio to buy for today's needs with an eye on tomorrow. When you want to increase the capability of your Series Eight System, just add one or more affordable Building Block modules. Wiring connections are elementary and may be done by the average studio engineer—at additional cost savings up to

75%! Today your needs may dictate an 8-input, 2-output console, for instance. This can affordably be expanded to 24 inputs for 8- or 16-track work merely by adding the appropriate building blocks.

For those studios requiring excellence in economy size we offer the Gately Series Seven—4- or 8-channel mixer-equalizer capabilities at really low prices . . . with no sacrifice in quality or performance.

So before you pay Rolls prices for features you may never use, check with Gately. You'll be greatly impressed with our systems, our prices, our individual attention to your requirements. Let Gately Electronics, or one of our dealers, put you in the driver's seat—the one that fits you best!



**GATELY ELECTRONICS**

57 WEST HILLCREST AVENUE, HAVERTOWN, PENNSYLVANIA 19083 • (215) HI 6-1415

... have you checked Gately lately?

# NEW PRODUCT NEWS



Circle No. 120

NEW QUADRASONIC PANNER FROM AUTOMATED PROCESSES. Precise, four channel sound control is offered by a new Quadrasonic Stereo Panner from Automated Processes, Inc., 35 Central Drive, Farmingdale, New York 11375.

Moving the finger tip control "joystick" creates any type of desired motional effect. The position of the joystick is also a visual indication of the phantom location of the sound source. Effects obtained range from 360° "sound in motion" to simple static positioning. Sequeways between stereo programs, and stereo dry to reverb sound combinations are also possible with this device.

Designated Model 480, the new stereo panner has infinite (stepless) resolution. It splits a signal to four separate outputs by means of multiple-finger precious metal contacts wiping on conductive plastic panning elements. Action is noiseless and accurate.

Tracking accuracy is  $\pm 0.5$  dB, or 5° of indicated position. Insertion loss of this passive device is 1 dB, maximum. The unit measures 3" wide x 3½" high x 3 5/8" deep.

AUTOMATED PROCESSES, INC., 35 CENTRAL DRIVE, FARMINGDALE, NEW YORK 11375.

AUTOMATIC FADER. A new Automatic, Electronic Attenuator that makes possible smooth, stepless control of any number of channels simultaneously by the press of a button is announced by Moser Development Company.

The speed of the fade is adjustable from 0 to 30 seconds and noise-less operation is assured by use of solid-state circuitry. There are no moving parts and no maintenance is required.

MOSER DEVELOPMENT COMPANY, 10751 CHANDLER BOULEVARD, NORTH HOLLYWOOD, CALIFORNIA 91601.



Circle No. 121



Circle No. 122

NORELCO MD CONSOLE SERIES INCLUDES A NEW, LOW COST, EIGHT-OUTPUT CHANNEL MODEL. Tailored to the requirements of the recording industry, the console provides 16 mix channels, each switchable to any combination of 8 output channels. By using floor level terminals any Norelco mixing console can be operational in a matter of hours.

This new console, MD 16RF8, is a supplement to the Norelco MD series which now offers combinations from 8 mix channels with 1 output to 16 mix channels with 8 outputs. These easily handled mixing consoles have the most advanced switching facilities and flexibilities for sound control in audio recording and radio and television production as well as in mobile broadcast units.

A basic feature in the design of the MD series of solid state mixing consoles is the use of channel blocks. This system was adopted because it is the only one affording wide flexibility, increased assembly and switching possibilities plus ease of maintenance and servicing, while allowing quantity production techniques. The consoles are constructed as a combination of standard plug-in blocks and amplifiers mounted together in a standard frame.

The MD consoles utilize current dependent mixing. All input and output channels are provided with insertion points so that additional audio equipment such as equalizers, compressors, limiters and effects filters can be switched into the circuitry. Pan pots are standard on all input channels. Pushbutton switches are used extensively to insure speed and ease of operation.

Each MD console is competitively priced, starting at \$6,930.

PHILIPS BROADCAST EQUIPMENT CORP., ONE PHILLIPS PARKWAY, MONTVALE, NEW JERSEY.



# NOW! A NEW SOLID STATE LA-2A (THE LA-3A)



new half-rack size (3½" high) \* lower noise \* new low price (under \$400.00)

## THE NEW TELETRONIX LA-3A LEVELING AMPLIFIER

The LA-3A is all new! The only thing left untouched was the exceptional performance characteristics of the LA-2A. The electro-optical attenuator, that made the LA-2A so popular, remains the same, but that is where it ends. Improvements in overload characteristics, and signal-to-noise ratio add to its performance. We've squeezed its size. Two LA-3A's can now be mounted side by side in only 3½" of rack space. The all solid state LA-3A has more output power (+25dBm, vs. +18dBm in the LA-2A). The new contemporary styling will look great with your existing equipment. Send for complete technical details today!

# Urei

11922 Valerlo Street, No. Hollywood,  
California 91605 (213) 764-1500

Exclusive export agent:  
GOTHAM AUDIO DEVELOPMENT  
CORP., NEW YORK, N.Y.

Circle No. 126

ALTEC 9713A COLORFLO' MODULITE. Designed to replace the old-style VU Meter, Altec's new volume level display is a peak reading device containing a vertical array of seven lights.

The display occupies less than one inch of width, allowing up to 24 displays to be easily arranged in less than two feet of panel space.

According to Arthur C. Davis, vice president, Audio Controls and designer of the display, "The conventional approach of monitoring console outputs cannot be effectively used when modern sound reproduction techniques require eight, sixteen or, on many occasions, twenty-four channel recordings."

"This new Altec volume level display answers these multi-track monitoring problems by providing a volume indicator device that is virtually instantaneous in following the audio envelope. It is very simple for the eye to follow a multiple array of colored lights as opposed to watching many meter needles."

The Altec VU indicator is calibrated in modulation percentages, 6%, 16%, 25%, 40%, 63%, 100% and overload, using respectively blue, four green lights in stepped succession, yellow and red. The unit measures 1" (W) x 4½" (H) x 3½" (D).

ALTEC LANSING, 1515 SOUTH MANCHESTER AVENUE, ANAHEIM, CALIFORNIA 92803.



Circle No. 127

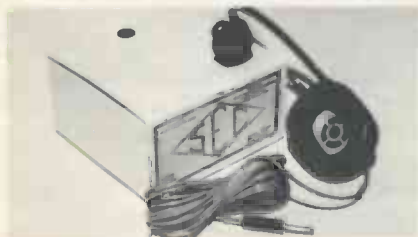

Circle No. 128

NEW 'MRH' HEADSET ANNOUNCED BY STUDIO ENGINEERING CONSULTANTS. For studio applications requiring multiple headphones such as motion picture scoring, sweetening, etc., the headset features 2,000 ohm impedance to bridge low impedance cue lines.

The Model 'MRH' is supplied with a 20 foot cable and standard phone plug, and padded vinyl ear cushion.

Price: \$13.45 professional net. STUDIO ENGINEERING CONSULTANTS 6508 GROSS AVE., CANOGA PARK, CA.



Circle No. 129

TELECTRIC TO DISTRIBUTE CMC 905 FREQUENCY COUNTER IN WEST... At \$460 the Computer Measurements Corp. Model 905 provides frequency measuring capabilities in excess of 15MHz with crystal accuracy. The automatic trigger level and simplified controls make the 905 equally at home in production or laboratory environments. The I.C. design of the Model 905 combines increased reliability and decreased heat dissipation. Power requirements being reduced to a minimum (8 watts typical) have eliminated the need for a chassis fan. The 905's small size makes it ideal for the modern space conscious engineer while at the same time optional rack hardware enables it to be mounted in a standard 19" rack.

For additional information write THE TELETRIC CO., 1218 VENICE BLVD., LOS ANGELES, CA 90006.

NEW ELECTRODYNE AUDIO EQUALIZER-AMPLIFIER INPUT MODULES. The new Model 711L is the first of a new series of low-noise Audio Equalizer-Amplifier input modules for microphone and/or line level inputs. It consists of a microphone pre-amplifier, a straight line attenuator, input selector switch, Eq. amplifier and a program amplifier.

Front panel controls allow 12 db boost and attenuation and reciprocal equalization curves for each of 8 frequencies permitting equalization of the low, mid range and high frequencies. Four high frequency and two of the low frequency curves can be selected as shelving or peaking curves. A phase reversal push button switch is provided to give 180° phase shift to the incoming signal. One echo send pot and selector switch provides the choice of echo send from ahead of attenuator, ahead of attenuator but after equalization, or after attenuator and equalization.

Equivalent input noise is -127 dbm, with gain rated at 70 db. Two microphone input impedances, 50 and 200 ohms, are provided. Line input impedance is 10K ohm bridging. All output impedances are designed for 600 ohm lines. Actual output impedance is less than 50 ohms.

Even greater flexibility is offered through the input selector lever—a dual concentric switch—which allows selection between microphone and line. There are two positions for the line with a 20 db pad to compensate for high level input signals.

A microphone pre-amp gain control is provided, allowing up to 50 db gain in the microphone position. Other positions provide 10, 20, 30 and 50 db attenuation. The latter (-50 db) position is desirable for handling the high signal levels of modern condenser microphones. This position will allow signal levels as high as +18 dbm. The size of the module is 14" x 1½" x 4¼". ELECTRODYNE CORPORATION, AN MCA TECH COMPANY, 7315 GREENBUSH AVENUE, NORTH HOLLYWOOD, CALIFORNIA 91605.

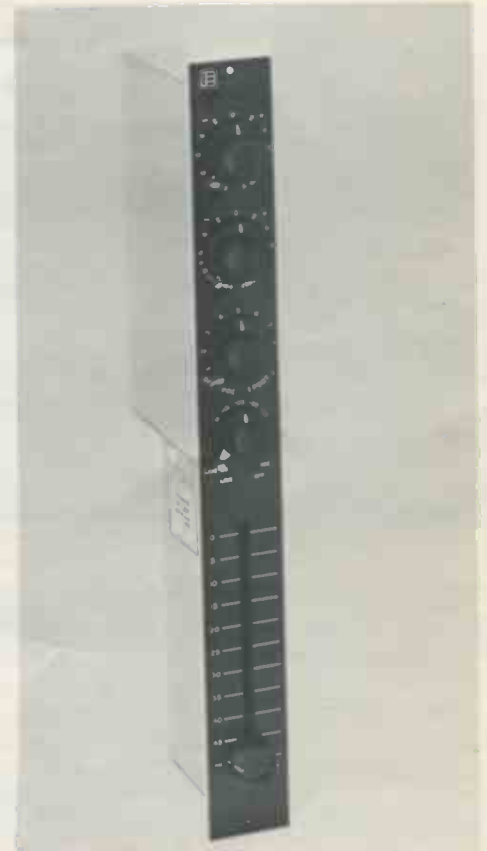

Circle No. 130

NEW DIGITAL METRONOME. Now available for use anywhere in the world, operates on either 50 or 60Hz, the new International Model 963 Digital Metronome from Universal Audio provides the musical director with 320 different precise tempo beats to aid in producing live music scores for motion pictures. The beats are selectable from 1 to 40 frames per beat in 1/8 frame steps, based on the standard sound speed of 24 frames per seconds. The beats may be "synced" with other equipment by using an externally generated start signal, or can be started and stopped manually from buttons on the front panel. The 963 has no noise-producing elements and can be operated on the scoring stage or in the studio.

Three thumbwheel switches on the front panel are used to select the desired tempo. A control switch adjusts output volume. Earphones may be driven directly or through an external amplifier. The output is a sharp, uniform, audio "click", without any distracting background noise usually present in film-loop devices.

The 963 fits standard rack mounting, and is only 3½" high. UREI, 11922 Valerio St., North Hollywood, Ca. 91605.



Circle No. 131





Circle No. 129

**TELECTRIC TO DISTRIBUTE CMC 905 FREQUENCY COUNTER IN WEST...** At \$460 the Computer Measurements Corp. Model 905 provides frequency measuring capabilities in excess of 15MHz with crystal accuracy. The automatic trigger level and simplified controls make the 905 equally at home in production or laboratory environments. The I.C. design of the Model 905 combines increased reliability and decreased heat dissipation. Power requirements being reduced to a minimum (8 watts typical) have eliminated the need for a chassis fan. The 905's small size makes it ideal for the modern space conscious engineer while at the same time optional rack hardware enables it to be mounted in a standard 19" rack.

For additional information write THE TELETRIC CO., 1218 VENICE BLVD., LOS ANGELES, CA 90006.

**NEW ELECTRODYNE AUDIO EQUALIZER-AMPLIFIER INPUT MODULES.** The new Model 711L is the first of a new series of low-noise Audio Equalizer-Amplifier input modules for microphone and/or line level inputs. It consists of a microphone pre-amplifier, a straight line attenuator, input selector switch, Eq. amplifier and a program amplifier.

Front panel controls allow 12 db boost and attenuation and reciprocal equalization curves for each of 8 frequencies permitting equalization of the low, mid range and high frequencies. Four high frequency and two of the low frequency curves can be selected as shelving or peaking curves. A phase reversal push button switch is provided to give 180° phase shift to the incoming signal. One echo send pot and selector switch provides the choice of echo send from ahead of attenuator, ahead of attenuator but after equalization, or after attenuator and equalization.

Equivalent input noise is -127 dbm, with gain rated at 70 db. Two microphone input impedances, 50 and 200 ohms, are provided. Line input impedance is 10K ohm bridging. All output impedances are designed for 600 ohm lines. Actual output impedance is less than 50 ohms.

Even greater flexibility is offered through the input selector lever—a dual concentric switch—which allows selection between microphone and line. There are two positions for the line with a 20 db pad to compensate for high level input signals.

A microphone pre-amp gain control is provided, allowing up to 50 db gain in the microphone position. Other positions provide 10, 20, 30 and 50 db attenuation. The latter (-50 db) position is desirable for handling the high signal levels of modern condenser microphones. This position will allow signal levels as high as +18 dbm. The size of the module is 14" x 1½" x 4¼". ELECTRODYNE CORPORATION, AN MCA TECH COMPANY, 7315 GREENBUSH AVENUE, NORTH HOLLYWOOD, CALIFORNIA 91605.



Circle No. 130



Circle No. 131

**NEW DIGITAL METRONOME.** Now available for use anywhere in the world, operates on either 50 or 60Hz, the new International Model 963 Digital Metronome from Universal Audio provides the musical director with 320 different precise tempo beats to aid in producing live music scores for motion pictures. The beats are selectable from 1 to 40 frames per beat in 1/8 frame steps, based on the standard sound speed of 24 frames per seconds. The beats may be "synced" with other equipment by using an externally generated start signal, or can be started and stopped manually from buttons on the front panel. The 963 has no noise-producing elements and can be operated on the scoring stage or in the studio.

Three thumbwheel switches on the front panel are used to select the desired tempo. A control switch adjusts output volume. Earphones may be driven directly or through an external amplifier. The output is a sharp, uniform, audio "click", without any distracting background noise usually present in film-loop devices.

The 963 fits standard rack mounting, and is only 3½" high. UREI, 11922 Valerio St., North Hollywood, Ca. 91605.



Eargle feels that the cutting of 16-track quad master tapes should involve techniques no different than those now in practice. To provide the best possible facilities, however, the Mercury renovation program included complete refurbishment of the label's two studios in New York.

The main room, Studio A, is 45x32x18 feet and features a full range of instruments including organs, pianos, chimes, etc. A number of Dolby units are permanently on the premises and Eargle adds others temporarily when sessions demand.

The main studio was completely retreated acoustically and Eargle said the final touch of the remodeling—an elaborate system of colored effect lights,—will be added soon, to provide as comfortable studio surroundings as possible for any conceivable recording act.

Mercury has also been active in quadraphonic experimentation in its San Francisco studio, a brand new facility that has been in operation since last spring. The label recently leased the entire plant to Coast Recorders, Inc.

Two studio rooms have been completed in San Francisco along with one control room.

There are plans to equip a second control room especially for quadraphonic mixing.

Eargle has given chief engineer George Horn and assistant Mark Harmom great latitude for experimenting with equipment. Harmom said the board in the present control room—a Bushnell Electronics model featuring 20 input channels and 16 output channels—offers panning capabilities intrinsic to the board itself.

Both Harmon and Horn, however, have designed their own panning equipment which patches into the board. One of Harmon's most recent models was a device that utilized two rotary switches to achieve overhead and between-channel effects.

Horn said the studio design—in part mandated by a peculiarly-shaped existing structure—has provided excellent sound quality for all types of master—from mono to quad.

The ceiling is angled with an off-center roof peak. The ceiling, thus, prevents direct line reflection from floor to ceiling. Horn said the ceiling design eliminates the problem of standing waves interfering with recording quality.

In addition to the ceiling design, the San Francisco studio offers an acoustically isolated floor, achieved by means of a floating subfloor.

A strong point of the Mercury product line recently has been country and western music. The label's popularity in this field and the growing scarcity of studio time in Nashville led Mercury and other interested parties to initiate construction of a new building, which is owned and operated by the Metropolitan Music Co.

Metropolitan vice president and chief engineer Tom Sparkman speaking about the relationship of quad sound to country music said that while country music will probably be the last musical field to

introduce quadraphonic recording techniques, adequate provision was made in the design of the new studio to incorporate quad equipment when necessary.

The control room—featuring a Universal Audio board with 20 input channels and 16 output channels—offers the capability for quick adaptation to quad mixing. Sparkman said the board was designed with quadraphonic reproduction in mind.

"To use it for quad would be no problem," he said, "considering the quad requirements we anticipated when we originally designed the board." Sparkman explained that quadraphonic mixing can be done through the board's present panning facilities.

As it is, the Nashville studio is the most modern facility in the city. It reflects a recent trend toward 16-track master recording that has now become common in Nashville.

The huge studio, which measures 50x36x18 feet, is finished in Western Cedar with inlaid carpet panels. A two-foot air-space separates the interior walls and ceiling from the interior structure of the cement block building.

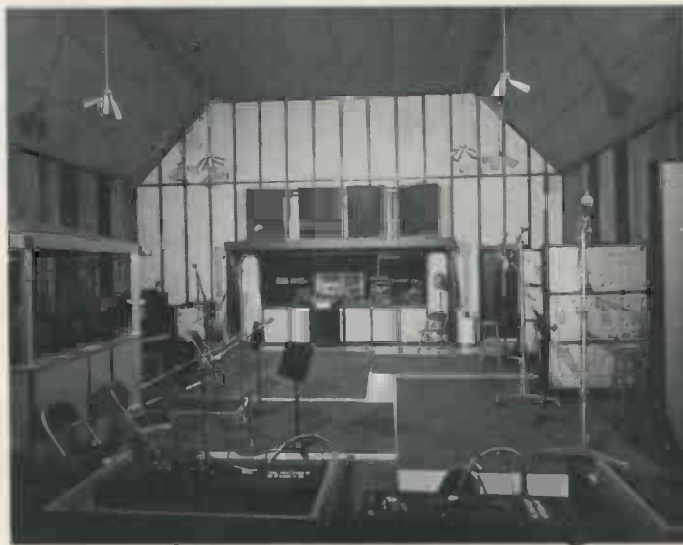

NASHVILLE STUDIO

Sparkman said the first recordings in the new studio—by such artists as Roger Miller, Bobby Bare, Roy Drusky, Linda Gail Lewis, Linda Meadors and Roy Bayum—convinced him that the room is "acoustically a dream."

All of the recent Mercury activity, of course, is only indicative of the great importance of quad sound not just to the Mercury label but to the industry at large.

"This new technology," said Eargle, "offers incredible potential. You can offer almost frighteningly convincing shifting of sounds from one channel to another and even overhead. We must learn to work with the new medium."

Mercury is typical of the recording industry in its concern over the future of the quad revolution. The pace of the revolution itself is largely in the hands of the consumer who will decide what type of quad sound he wants to hear.

John Eargle's reference to "a solution in search of a problem" could not be more appropriate. END

# CLASSIFIED

**FOR SALE**  
**8 TRACK AMPEX**  
 Rebuilt/Complete—Deck—Amps—Selsync/In  
 Walnut Console/Minus Heads/Or Will Sell,  
 Trade, Lease For Interest In Studio. Rob  
 DeMars, 5746 Cazaux Dr., Hollywood, CA.  
 90028 Ho 5-2005

**FOR SALE:** nearly new "Crown DC 300", nets  
 at \$685.00. Will sacrifice for only \$475.00.  
 Paramount Recording Studios  
 (213) 464-1818

## NOTICE

**INDIVIDUALS** seeking employment in  
 the recording industry may submit their  
 qualifications for **FREE** publication in  
**RECORDING engineer/producer.**

Listings will be limited to 30 words,  
 and will be limited by available space.  
 Listings will be selected for publication  
 on the basis of earliest postmark. Listings  
 will not be automatically repeated or  
 carried over to the succeeding issue.

**STUDIO OWNER-ENGINEER** desires position  
 with union studio. Previous broadcasting ex-  
 perience with accent on master recording and  
 disc cutting. Musical background. Contact—  
 John Sutton, R1422 Adams Avenue, Dunmore,  
 Pa. 717-343-1470.

**ENGINEER 31**,—fully experienced in audio-  
 education field, primarily cassette production.  
 Mixer, quality-control, editing. Experience with  
 world's largest, oldest audio publication com-  
 pany. A. Pochel, 521 N. Madison Ave., Los  
 Angeles, Calif. 90004. 664-1552. Presently em-  
 ployed.

**RECORDING ENGINEER** seeking employ-  
 ment, 3 yrs. experience 4 trk studio, 2 yrs  
 studio mgr., prefer Pa. but will relocate. Mr. L.  
 M. Ziemba, 1536 Roseberry St., Pgh, Pa. 15216  
 412-343-8454

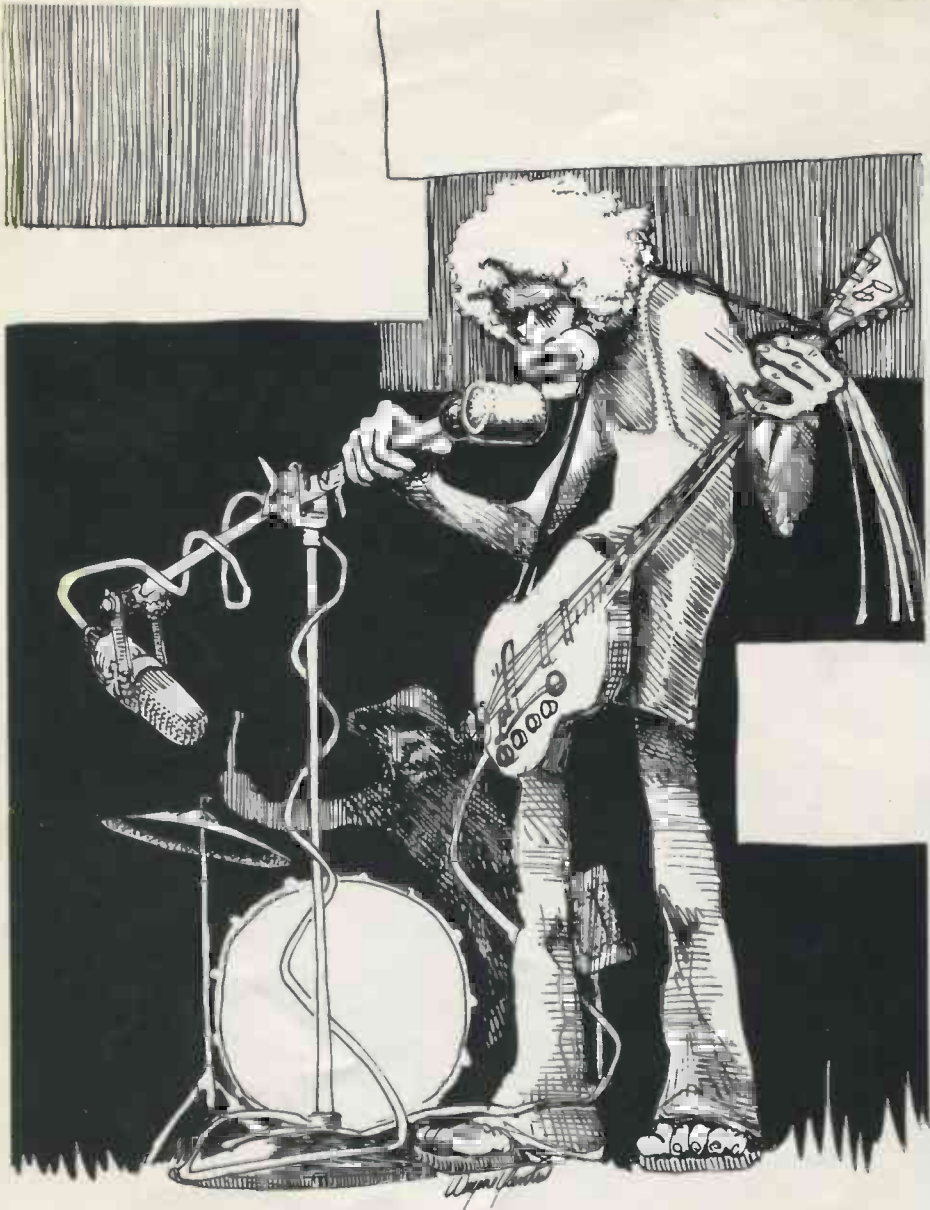

“TASTING—1—2—3—4 . . .”

ADVERTISERS INDEX	PAGE		PAGE
ALLISON RESEARCH	21	SHURE BROTHERS	12
ALTEC-LANSING	8	SPECTRA SONICS	6
AUDIO DESIGNS	16	SUBURBAN SOUND	26
CROWN INTERNATIONAL	28	SUPERSCOPE	18
DOLBY LABORATORIES	11	3-M MAGNETIC PRODS	Inside Front Cover
ELECTRODYNE	9	TEAC CORP.	Inside Back Cover
ELECTRO-VOICE, INC.	Back Cover	TELECTRIC	28
GATELY ELECTRONICS	30	UREI	33
LOCATION RECORDING	5	WESTREX	24
MCI	22	YAMAHA INTNL	10
MOSER ELECTRONICS	26		



**TWO-INCH TAPE EDITING BLOCK**, hard  
 anodized aluminum with satin finish. 7 3/4"  
 by 2 3/4" by 1/2". Immediate delivery; \$55.00.  
**STEPHENS ELECTRONICS, INC.**, 2302  
 NORTH ONTARIO STREET, BURBANK,  
 CALIFORNIA 91504



# ANY NUMBER CAN PLAY.

The time is tomorrow. The name is TEAC. The machines are the Simul-trak™ Series TCA-40. And they're here today.

This series of tape decks combines the best features of high-quality quarter-track, two-channel operation with four-channel stereo capability. It's the best of two worlds, in three versions, four channels.

All three models feature four-channel playback, as well as regular two-channel playback with auto reverse. What's more, Models 40 and 41 can be modified later to the full four-channel capability of Model 42, at moderate cost. Meanwhile, any one of these machines is compatible with your present equipment; no modifications or reassembly are necessary.

So what are you waiting for?

Simul-trak™ surrounds you with sound – and gives you a headstart on tomorrow.

## TEAC

TEAC Corporation of America • 2000 Colorado Ave. • Santa Monica, Calif. 90404

### General Specifications

- Speeds – 7½ and 3¾ ips
- Motors – 1 hyst. sync., 2 outer rotors
- Wow and Flutter – 0.12% @ 7½ ips
- Freq. Response – ±3 dB 50-15,000 Hz @ 7½ ips
- S/N Ratio – 50 dB
- Crosstalk – 48 dB

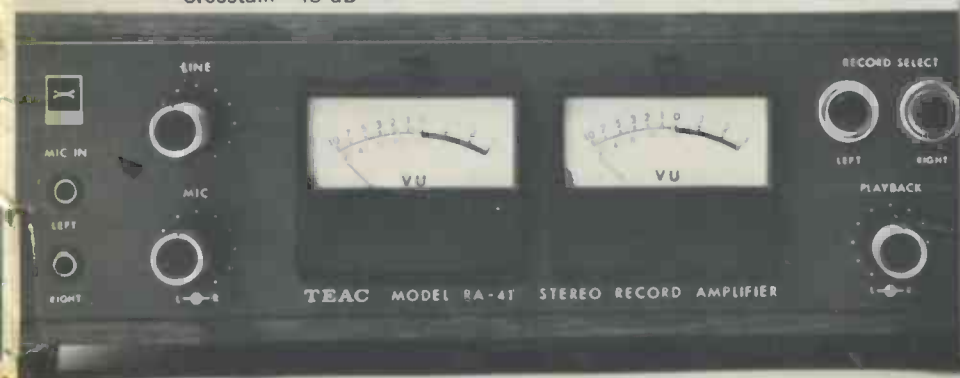

### TCA-40

- ¼-track, 2-channel stereo playback, plus 4-channel stereo playback (in-line)
- ¼-track, 2-channel erase and record heads for future "step-up" • Automatic reverse for uninterrupted playback of conventional 2-channel tapes • Readily modified to TCA-41 or 42 • Built-in solid-state preamplifiers • Ideal for duplication master or copy deck

### TCA-41 *(Illustrated)*

- ¼-track, 2-channel stereo playback, plus 4-channel stereo playback (in-line) • ¼-track, 2-channel record
- Automatic reverse for uninterrupted playback of 2-channel tapes • Readily modified to future 4-channel recording capability, or TCA-42 • Solid-state playback and record preamplifiers • Off-the-tape monitoring selector

### TCA-42

- ¼-track, 2-channel stereo playback, plus 4-channel stereo playback (in-line) • ¼-track 2-channel stereo record and 4-channel stereo record (in-line) • Automatic reverse for uninterrupted playback of 2-channel tapes • Total of 8 separate solid-state playback and record preamplifiers • Off-the-tape monitor selectors

Circle No. 136

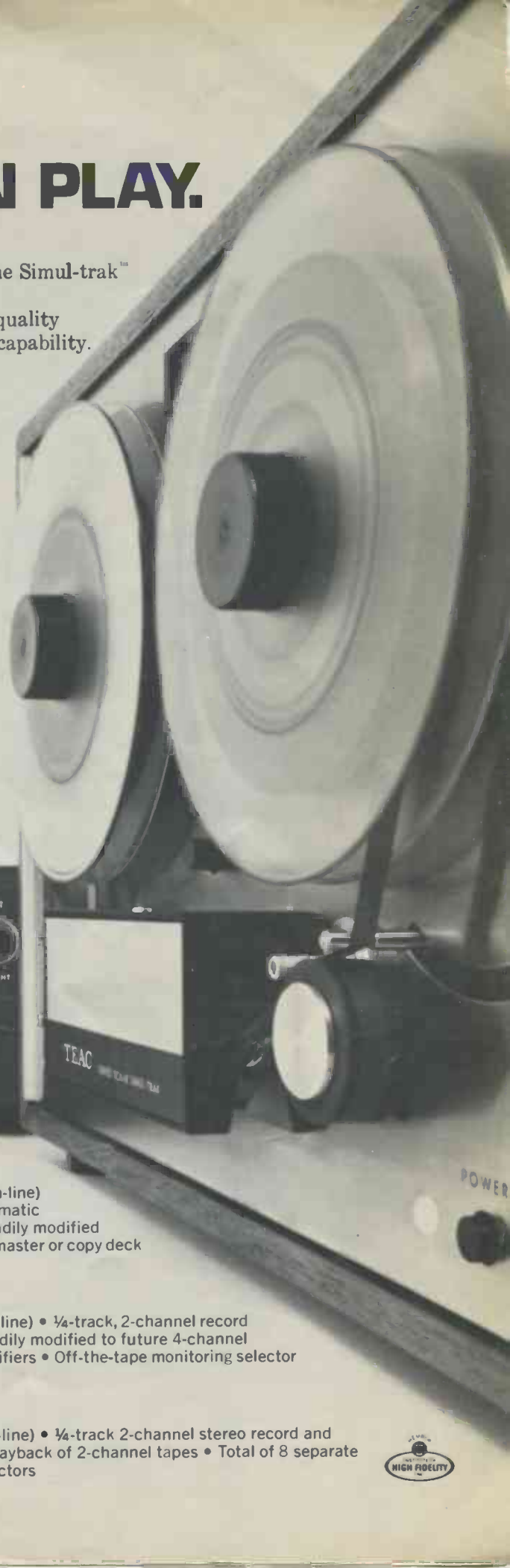



# How do you pick up sound without noise?

## Pick up the new RE50 and the new RE85 quiet microphones.



Model RE50 omnidirectional dynamic \$120 list. Model RE85 lavalier dynamic \$133 list. Less normal trade discounts.

**E-V** Introducing two microphones that aren't "microphonic". That are unexcelled for hearing air-borne sounds, but shrug off contact noises. The new hand or stand RE50 and the lavalier RE85 dynamics.

Small, light, and just barely larger than the smallest microphones of their type. Yet both use a unique double-wall construction that is more effective in reducing microphone noise than any other we have tested.



Let's look into the RE50 first: A cutaway shows that inside each RE50 nestles the familiar 635A, case and all. It's shock-mounted at top and bottom to the outer case. Even the connector is isolated from the actual microphone. And the problems

of mass and resonance have been worked out (with the aid of our computer) so that contact noises and cable rustling never reach the Acoustalloy\* diaphragm.

The result is remarkable isolation from all but air-borne sound, even in hand-held applications where microphone movement is uncontrolled. And when you add the extra protection of the built-in Acousti-foam\* blast and pop filter, this is one of the quietest omnidirectional microphones you can find. Yet response, output level, and polar pattern are essentially the same as the 635A (one of the most popular professional microphones of all time).

But if noise can be a problem with hand-held and stand microphones, it is a plague to lavalier types. Clothing rustle, cord noise, and accidental contact with hard surfaces are common troubles. Ex-

cept with the new RE85. Again, we have created a microphone within a microphone. But we've gone even farther. A special low-noise grille, for instance. And even the hard, smooth paint finish was chosen to reduce small rubbing noises.

The result is virtually noise-free operation even with inexperienced performers. And at no expense to sound quality. Like all E-V lavaliers, output of the RE85 is peak-free and natural. Each RE85 comes complete with neck cord, tie clip, and a belt clip to help control the cable. The RE50 is supplied with a Model 300 stand clamp.

Both the RE50 and the RE85 are now available at your E-V microphone headquarters. In this noisy world, it's a relief to know that help has quietly arrived.

•E-V Trade Mark  
ELECTRO-VOICE, INC., Dept. 801 RP,  
674 Cecil Street, Buchanan, Michigan 49107

# Electro-Voice®

A SUBSIDIARY OF GULTON INDUSTRIES, INC.

high fidelity systems and speakers • tuners, amplifiers, receivers • public address loudspeakers  
• microphones • phono needles and cartridges • aerospace and defense electronics