



# RECORDING engineer/producer

relating recording science, to recording art • to recording equipment

## REFERENCE DATA for

## Recording Engineers Page 15

FIG. A3

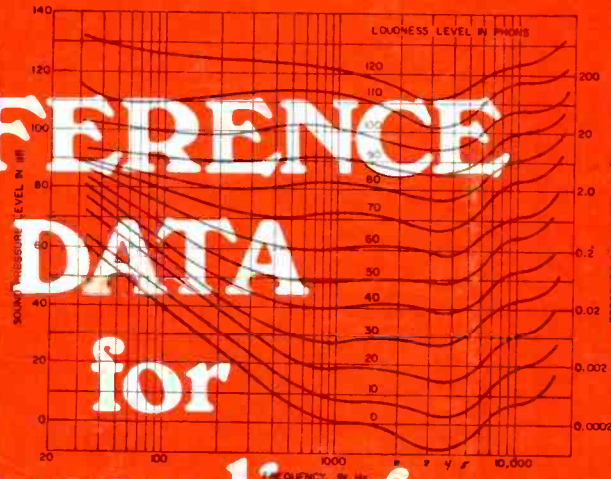

Fletcher-Munson curves (USA). (Courtesy, Acoustical Society of America)

FIG. A4

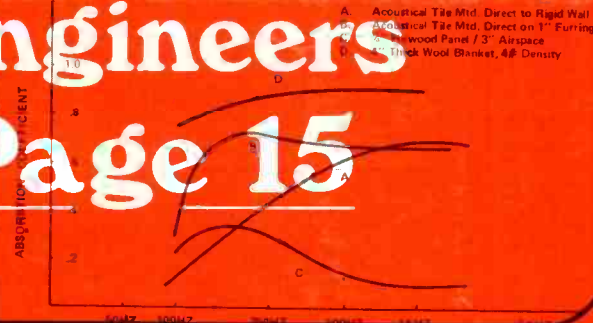

A. Acoustical Tile Mid Direct to Rigid Wall  
B. Industrial Tile Mid Direct on 1" Furring  
C. Wood Panel / 3" Airspace  
D. Thick Wool Blanket, 4# Density



Microphone  
Techniques  
Page 32

11201PMEBL93DD  
DOUG POMEROY  
COLUMBIA RERDS  
193 RAL TIC ST  
BROOKLYN

NY 11201

## DC CONTROL

## ON A

## BUDGET

Page

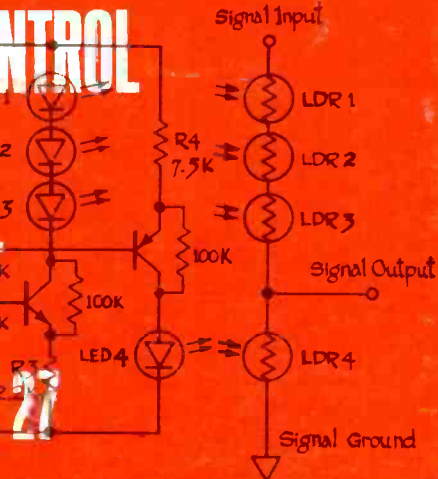

## REMOVING the LESLIE ORGAN SPEAKER

Page 35

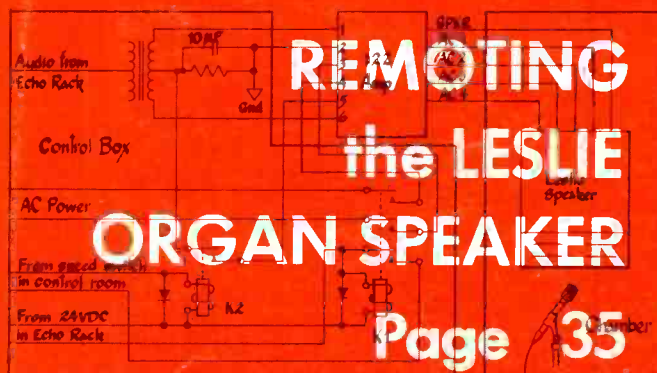

**SYSTEMS ..**



**MOD-N-32**

- REMOTE ACCESS AND PROGRAMMABLE SOLID STATE SWITCHING
- DC CONTROL FOR AUTOMATION
- FULL 32 INPUT ASSIGN TO ANY TRACK
- 32 OUTPUT PLUS SIMULTANEOUS QUAD-STEREO-MONO OUTPUTS
- SOLID STATE 32 TRACK PROGRAMMABLE BOARD & MONITOR MASTERS
- AUTOMATIC SYNC SWITCHING
- PREVIEW PUNCH-IN MONITOR CONTROL
- QUAD-PAN ON ALL INPUTS
- SELECTABLE PROGRAMMABLE MUTING
- 3 RANGE STEPLESS RECIPROCAL AND SHELving EQ
- FULL PLUG-IN CONSTRUCTION
- SOLO INPUT-SOLO MONITOR-MUTE INPUTS
- PEAK OR RMS LEVELITES
- FOUR CUE SYSTEMS
- 68 INCHES WIDE

**...AND COMPONENTS**

**...and now, AUTOMATION...**

in plain talk...no fancy trade names...**FLICKINGER** has the most advanced \_\_\_\_\_

**DIGITALLY ATTENUATED, REAL TIME PUNCH-IN**

**AUTOMATION** systems\*

(\*console installed, or in a variety of retrofit and outrigger formats.)



**DANIEL N. FLICKINGER & ASSOCIATES, INC.**

40 SOUTH OVIATT STREET

HUDSON, OHIO 44236

(216) 656-2000

*Sansui*

*presents*  
*the*

**QMS**

REGULAR MATRIX

*professional four-channel*  
*encoder/decoder*

# *Believe* *4-channel* *like*

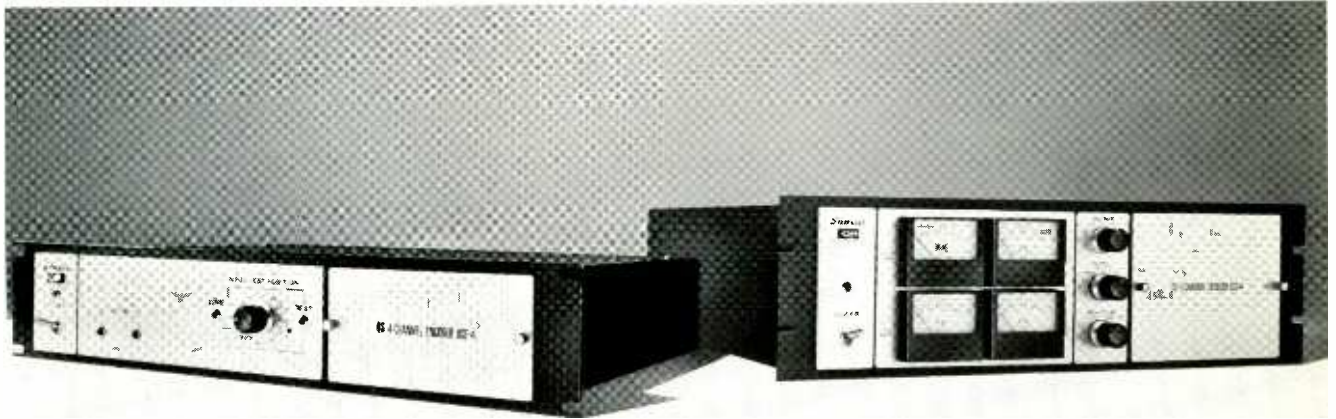

THE PAIR PAR EXCELLENCE

THE SANSUI QSE-4 ENCODER

THE SANSUI QSD-4 DECODER

It took a large investment in effort, time and money, a great deal of experimentation and devotion, of testing and ingenuity. But it's here now: the QSE-4 Encoder and its complementary QSD-4 Decoder are ready for your ears. Are your ears ready for them? Are you prepared to make A-B comparisons between a discrete four-channel original and the QS-encoded and decoded version of the same material—*without being able to tell the difference?*

Sansui's QS Regular Matrix System, from the beginning, was the only matrix that could accurately pick up and reproduce sound from any direction of the sound field and at any point within the sound field, including dead center, in the same way that could be done with a discrete source. It fell short only in not being able to offer optimum separation.

Today, with the exclusive j-shift technique and all the other original technology of the symmetrical system faithfully retained, the addition of the totally new Vario-Matrix technique now provides that separation. Full four-channel separation. The complete psychoacoustic effect, to match any other four-channel medium. With none of the complication or obsolescence inherent in so many other systems.

Tool up with the new QSE-4 Encoder and QSD-4 Decoder. If you want to get started in four-channel recording, why not start at the top?

# *your ears. finally sounds 4-channel.*

## **Advantages of the Sansui QS Coding System:**

- 1 THE QS SYSTEM** prevents directional error or the loss of any information in the encoding process. It therefore places no limitations on the right of the recording or broadcast engineer to experiment freely with new studio placement of performers.
- 2 THE QS SYSTEM** is the only matrix system that permits, at the decoding end, reproduction of sound anywhere in a full circle and at the dead center of the sound field. There are no weak locations in this completely symmetrical system.
- 3 THE QS SYSTEM** does not in any way degrade any current standards of high-fidelity sound reproduction, whether they involve noise, distortion, dynamic range, frequency response or anything else.
- 4 THE QS SYSTEM** offers dual compatibility with existing two-channel stereo equipment. On the one hand, when an encoded recording or program is played back on standard two-channel stereo equipment, the depth and dimension of the normal stereo presentation are enhanced. This makes it possible to produce a single version of any recording—one disc serves as both the four-channel and enhanced two-channel version. On the other hand, when a standard two-channel disc or other source is played through the decoder, a superb four-channel effect is synthesized.
- 5 THE QS SYSTEM** avoids the use of a high-frequency subcarrier. Resultant encoded material can thus be reproduced effectively even by a simple speaker matrix. The system is therefore easily and economically popularized.
- 6 THE QS SYSTEM** is a complete, all-purpose, all-media encode/decode process, with total compatibility with all equipment and standards. That applies to disc recording and broadcasting. Even to tape recording.

*For full details on obtaining the new Encoder/Decoder or more background literature, contact your nearest Sansui office.*



*For full details,  
contact your nearest Sansui office now.*

**SANSUI ELECTRONICS CORP.**

Sansui Electronics Corp.

New York

55-11 Queens Blvd., Woodside, N.Y. 11377. Tel.: (212) 779-5300. Cable: SANSUIECNEWYORK

Telex: 422633 SEC UI.

Sansui Electric Co., Ltd.

Los Angeles  
Tokyo

333 West Alondra Blvd. Gardena, Calif. 90247. Tel.: (213) 532-7670.

14-1, 2-chome, Izumi Suginami-ku, Tokyo 168, Japan. Tel.: (03) 323-1111. Cable: SANSUIELEC.

Telex: 232-2076.

Sansui Audio Europe S.A.

Belgium

Diacem Building Vestingstraat 53-55. 2000 Antwerp. Tel.: 315663-5. Cable: SANSUIEURO ANTWERP.

Telex: ANTWERP 33538.

Germany, W.

6 Frankfurt am Main, Reuterweg 93. Tel.: 33538.

# We admit... we have created a generation gap!



1954  
D-24

1971  
D-124

1954  
D-19

1971  
D-190

When it comes to cardioid dynamic microphone developments AKG is purposely creating a generation gap.

We have to, because we insist on staying far ahead.

Imitation is the sincerest form of flattery and while others attempted to equal the acoustical properties and duplicate the design appearance of the D-19 and D-24, AKG continued in setting the pace by developing a new family of transducers with superior performance characteristics.

The D-19 and D-24 are the finest microphones in their

class, as thousands of owners will attest. However, new techniques and materials made fundamental design changes possible. Gone is the complicated "plumbing" within the microphone requiring slots or holes along the microphone body, and these essentials are improved: smoothness of response, uniformity of directional characteristics, front-to-back ratio at all frequencies and ruggedness.

The AKG D-124 and D-19C are the newest generation of cardioid dynamic microphones, designed for today's requirements.

For detailed information,  
see your authorized  
local AKG dealer  
or write to us.



## MICROPHONES • HEADPHONES

DISTRIBUTED BY  
NORTH AMERICAN PHILIPS CORPORATION  
100 EAST 42nd STREET, NEW YORK, NEW YORK 10017

AKG-17



# RECORDING

**engineer/producer**

—the magazine to exclusively serve the recording studio market . . . all those whose work involves the recording of commercially marketable sound.

—the magazine produced to relate . . . RECORDING ART to RECORDING SCIENCE . . . to RECORDING EQUIPMENT.

Editor/Publisher MARTIN GALLAY

Associate Editor WAYNE YENTIS

Engineering Editors . . . RON MALO  
WILLIAM ROBINSON  
CHUCK DAVIS

Business/Circulation  
Manager . . . . . V. L. GAFFNEY

Art Director . . GERRY SADOWSKI

RECORDING engineer/producer is published bi-monthly and is sent free to qualified recipients in the United States. Subscriptions for other than qualified individuals or companies may be purchased at \$5.00 per year. (All foreign subscriptions: \$6.00 per year.) Material appearing in Re/p may not be reproduced without written permission of the Publisher.

*RECORDING engineer/producer is not responsible for any claim made by any person based upon the publication by RECORDING engineer/producer of material submitted for publication.*

Controlled circulation postage paid at Los Angeles, California.  
RECORDING engineer/producer  
6430 Sunset Boulevard  
P.O. Box 2287  
Hollywood, CA 90028  
(213) 461-7907

SEPTEMBER/OCTOBER-1972  
VOLUME 3 — NUMBER 4

REFERENCE DATA FOR RECORDING ENGINEERS Part I Towards a Better Understanding of Terms Regarding Sound and Acoustics	15	M. T. PUTNAM
DC CONTROL ON A BUDGET	27	TOM LUBIN
MICROPHONE TECHNIQUES	32	RON MALO
REMOVING THE LESLIE ORGAN SPEAKER	35	DON FOSTER

Letters & Late News	10
New Products	40
Classified	45

## NOTES ON SELECTING YOUR NEXT CONSOLE, and YOUR NEXT CONSOLE BUILDER.

by Bob Bushnell

### CUSTOM BOARDS AND VCA's:

Can we put VCAs in your next board? Are we using VCAs now? Yes, on both counts.

The use of VCAs will increase as technology and understanding increases. The major problem lies not in the VCA itself, but the system you'll be using with the VCA. The July/August issue of R-e/p has an excellent group of articles concerning automation. Including the VCA within the console is no trick, determining the compatible system will require lots of decisions within the recording industry. It's like the early days of magnetic recording, Magnecord and Ampex, but the problems are greater. The industry needs VCAs for the difficult task of mixdowns, but there must be a standard, a yardstick. As custom board builders, we can do the best for you by assisting in usage and applications rather than develop our own system. We'd like to see a standard established; we're willing to help in setting that standard.

### ANSWERING LETTERS

We're busy building boards for customers like you. In preparation is a new catalog and data sheets on the boards we've built. But we're a small company, not building the most boards, but building the best. (At least our customers think so.) Between the seven of us (yup, that's all there are!), you're keeping us busy. Therefore, our apologies to you that have marked the reader service cards or written to us. We haven't forgotten about you!

### REPEAT CUSTOMERS

When you buy one board from us, that's a wise choice; when you buy two boards from us, that's good praise, indeed. Four customers have bought their second board or more from us. We thank them for the opportunity of supplying them with good equipment. To the many people who've bought their first board from us, we thank them for their decision.

### WARRANTIES

We'd like to stress our warranty. The warranty that appeared in the March/April issue of R-e/p is extended where possible to provide labor as well as parts for the one year period. Would you like that warranty? Ask us.

BS lb

# BUSHNELL

ELECTRONICS CORPORATION

19210 STAGG STREET, VAN NUYS, CALIFORNIA 91405

(213) 989-2740

## LETTERS and LATE NEWS

From CHUCK DAVIS

In a general answer to the individual questions asked about the \$5.00 LINE AMPLIFIER published in the May/June issue of R-e/p, the correct value of the feedback resistor from output to input, as many who have written suspected, should have been 51K not 5.1K.

The value of the resistor to ground from pin 3 (non-inverting input) of the amplifier is 4.7K.

### STOLL NEW INDUSTRIAL SALES MANAGER AT CROWN.

CROWN International of Elkhart, Indiana announces the appointment of Michael H. Stoll as Industrial Sales Manager of its Industrial Products Division. He was formerly a staff electrical engineer with the Aerospace Research Application Center of Indiana University. Previously he held positions as Marketing Manager for Deltek, Inc. and Assistant Manager of Field Service for the Custom Design Section of Sarkes Tarzian Broadcast Equipment Division. At CROWN he will be responsible for all industrial products, and the new Variable Speech Control Player to be offered to the educational, professional audio and broadcast markets.

### RCA RECORDS ANNOUNCE NEW MOBILE CAPABILITY

During an interview with G. Allan Ballantine, Manager of Facilities and Engineering Planning for RCA Records, he announced that RCA has received a new transportable sound control console from Rupert Neve Incorporated of Bethel, Connecticut. This 32 input, 16 bus output console is built in 4 sections

### From the READERS

*An editorial material rating of  
the most useful feature article, as  
gathered from the Reader Service  
Cards received prior to press time.*

### JULY/AUGUST ISSUE:

RECORDING SHAFT AT STAX	38.4%
TODAY'S MAGNETIC RECORDERS . . . . .	33.6%
AUTOMATION . . . . .	27.9%



which permit air shipment virtually anywhere for remote recording sessions.

Ballantine also said that while on the east coast the console will be truck mounted permitting responsiveness to clients within several hundreds of miles of New York.

Neve has made a number of advancements in engineering in order to meet RCA specifications. The component density, performance standards, and reliability all are of significance in the Neve design.

**CUSTOM FIDELITY CO APPOINTED NATIONAL DISTRIBUTORS FOR PAK 16-24 TRACK RECORDERS.**

Custom Fidelity Company, Inc., Hollywood, California, based custom record production and professional audio equipment sales firm, announces its appointment as National Marketing Distributor for the completely new 16 and 24 track professional magnetic tape recorders and custom audio mixing consoles designed and manufactured by PAK Associates, Santa Ana audio engineering and development company. Products are said to represent state-of-the-art technical developments in the highly creative and fast moving recording industry.

For many years acknowledged nation-



Bill Jones

ally as a quality leader in disc mastering and custom record production, Custom Fidelity in recent years has also become a major in-depth stocking distributor of professional audio equipment. Ellis Fertig, manager of the Professional Audio Sales Division announces formation of a new department of the division to market and showcase the new PAK product line and other products now under development. The new department, appropriately named "Studio Systems Department" will be headed up by William F. (Bill)

Jones who brings with him a broad background of experience in the marketing of sophisticated recording studio components and systems.

**NEW BUSHNELL ELECTRONICS PLANT TO TRIPLE FIRM'S AUDIO ENGINEERING AND PRODUCTION CAPACITY.**

Effective November 1, 1972, according to a statement by Bob Bushnell, president of the console and monitor system design and manufacturing firm, the company will have moved to their new address at 15801 Stagg Street, Van Nuys, California 91406.

In a further statement Bushnell explained the company's need to enlarge as being necessary to insure the shortest possible lead times between customer commitment for new equipment, and the custom design, manufacture, installation and final customer acceptance of the equipment. According to Bushnell, "The studio which needs a new system is already paying for it by not having the new equipment's capability to offer to its customers. We realize that obsolete equipment is already costing the studio a part of the purchase price of the new gear."

# Mixdown tonight. 16 track. How's your memory?



## compumix™

The Number's Game.

Check our bingo number and, in addition to complete technical data on Compumix™ we'll send you a free copy of "Automation Arithmetic - or How to Slice-up the Automation Pie". It discusses the basics of digital information storage as applied to audio. We hope it will help you understand this new technology for sound recording.

Active, the Compumix™ controller. Our memory helper. Trust it. It's designed to interface any mixing console to our digital processor. 46" long, 16" deep, and 2" thick. Small. Everything's there. More than enough level and switching control for the heaviest 16 track mixdowns.



**quad/eight  
electronics**

# PRICE BREAK

FOR THE FIRST TIME IN THE INDUSTRY

16 CHANNEL CONSOLE FOR \$29,950

(... it used to cost \$40,000)

**We just got rid of \$10,000 in wiring  
and now offer the most trouble-free  
console in the business**

We've cut costs dramatically in redesigning this total 16 channel full-featured console . . . without sacrificing quality and performance. Use of trouble-free printed circuitry let us eliminate literally miles of costly hand wiring. In this new NRC Series Console you still get the high reliability Audio Designs engineers into its custom consoles, with such features as three Cue Busses, two Solo Systems, complete Sync System, complete Tip, Ring and Sleeve Patching, Full Quadraphonic Capability with four Joy Sticks, and many more features. And you get the flexibility and convenience of interchangeable plug-in modules. But now you get these deluxe features for thousands of dollars less. There are no other consoles on the market like the NRC Series for anywhere near the price, whether you require an 8 or 16 channel model. And all have expansion capabilities of up to 24 inputs. Write or call collect today for the complete money-saving story. (Unless, of course, you're willing to pay for wiring you don't need.)

**AUDIO DESIGNS  
CONSOLES  
FEATURE  
PLUG-IN  
MODULES  
TO PROVIDE  
COMPLETE  
FLEXIBILITY**

# THROUGH!

## YOU CAN BUY A FULL-FEATURED

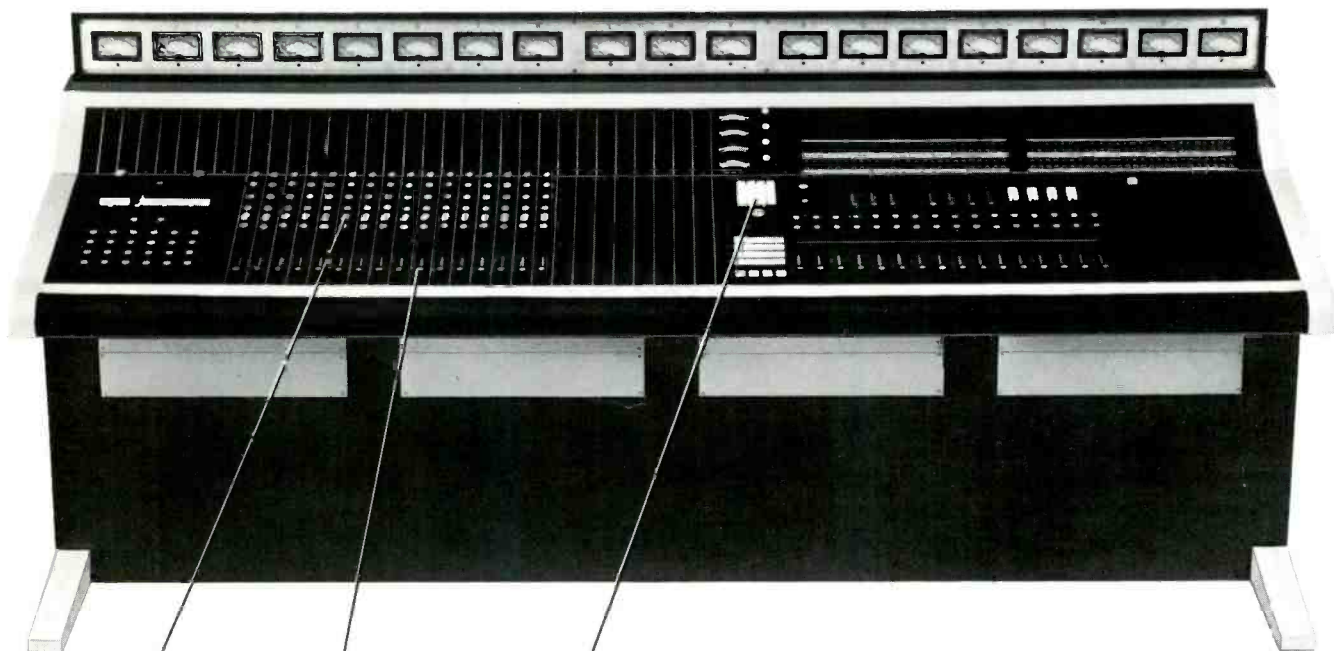

Model NRC-1616



INPUT MODULES



SLIDEX

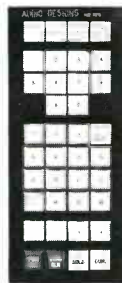

AUDEX\*

### INPUT MODULES

Versatile input strip features op-amp circuitry and four-section equalizer. Input overload light and Solo button are also included. Everything required at an input is in one convenient plug-in module.

### SLIDEX

Unique, noise-free attenuator uses sealed elements. No contacts to clean. Even spilled coffee won't cause noise problems. Guaranteed free from noise or other defects for five years.

### AUDEX\*

Ultra-reliable switching system uses magnetic reeds governed by this compact control panel. Switch modules, mounted above inputs, include illuminated readouts for instant reference.

\*U.S. Patent Nos. 3626097, 3631470

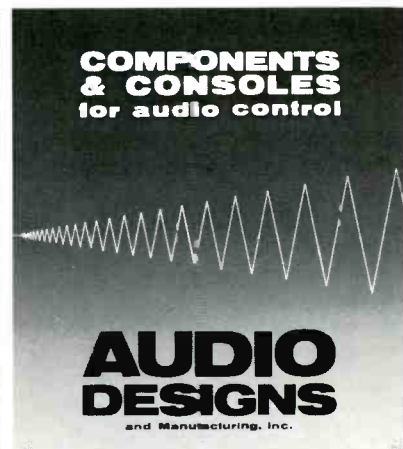

## AUDIO DESIGNS and MANUFACTURING, INC.

16005 Sturgeon  
Roseville (Detroit), Michigan 48066  
Phone (313) 778-8400



RE 15

RE 10

RE 11

RE 16

NEW Model RE10 \$166.00 shown on Model 421 desk stand \$20.00. Model RE15 \$283.00 shown with Model 307 suspensic mount \$37.00. NEW Model RE11 \$177.50, shown with Model 311 snap-out stand adapter \$7.00. NEW Model RE16 \$294.50, shown on Model 421 desk stand \$20.00. List prices shown. Normal trade discounts apply.

# Freedom of choice!

**EY** Professional sound has entered a new era. It started with the Electro-Voice Model RE15. And now there are four E-V dynamic cardioid microphones that share its distinctive advantages — with some unique benefits of their own.

## Unaffected by Distance . . . Angle

Basic to all of these microphones is Exclusive Electro-Voice Continuously Variable-D\* construction. Now it offers something you've never heard before with any microphone: no matter what you do, microphone response never varies!

Whether performers almost swallow the microphone, wander far off-mike . . . or even move around to the back . . . you'll still get the same smooth response. Only the level changes.

Once you set equalization it remains constant. You have full assurance that tonal balance won't change between the dress rehearsal and the final performance, no matter what the talent does.

## Improved Cardioid Pattern

Only acoustics and noise can limit you. Yet even here these new E-V microphones gain an advantage from the super-cardioid pattern that provides better sound control than ordinary cardioids. With maximum rejection 150° off axis, it is easier to eliminate unwanted sound while maintaining normal stand or boom microphone positions. There's also an integral bass-tilt circuit to cut rumble below 100 Hz. when needed.

## Now Select from Four Models

In addition to the original RE15, we've added the RE16. The same fine microphone with an external "pop" filter to solve the problems of ultra-close miking.

The new RE10 is the economy version of the RE15. The same concept and quality, but for slightly less rigid requirements. And the RE11 is the lower cost twin to the RE16.

These four great cardioid microphones give you new freedom to head off sound problems before they start. Your E-V microphone headquarters has them waiting. Choose today.

\*U.S. Patent No. 3,115,207. Trade mark registered.

ELECTRO-VOICE, INC., Dept. 921RP,  
674 Cecil Street, Buchanan, Michigan 49107

a Gulton  
COMPANY

**Electro-Voice®**

# REFERENCE DATA for Recording Engineers

PART I - "TOWARDS A BETTER UNDERSTANDING OF TERMS REGARDING SOUND AND ACOUSTICS."

by M.T. (Bill) Putnam, President  
the URC Companies:  
United Recording Corp.  
Western Recorders  
Coast Recorders  
UREI

An enhanced knowledge of the behavioral characteristics and basic physical laws of sound and acoustics can be of value to anyone engaged in almost any technical phase of the recording industry. Some practical examples, both the good and bad of these phenomena can improve one's technical performance in mixing, dub downs and in general pave the way for removing some of the "mystery" associated with this facet of the recording process.

Many terms are commonly incorrectly used relating particularly to delay, echo and reverberation. The behavior of a particular size studio and its characteristics which make it suitable for a certain style of recording and less desirable for another, can be more easily understood, and this knowledge then can be applied in a constructive and ingenious way to develop our own techniques which improve the sound quality of the end product.

Within this Part I outline of simplified terms and definitions, there lies the foundation for the understanding of the basics.

FIG. A1

## RANGE CHART FOR BAND AND ORCHESTRA INSTRUMENTS SHOWING PRACTICAL RANGES COMMONLY USED

C. G. CONN, LTD.

A CCM Company  
OAK BROOK, ILLINOIS

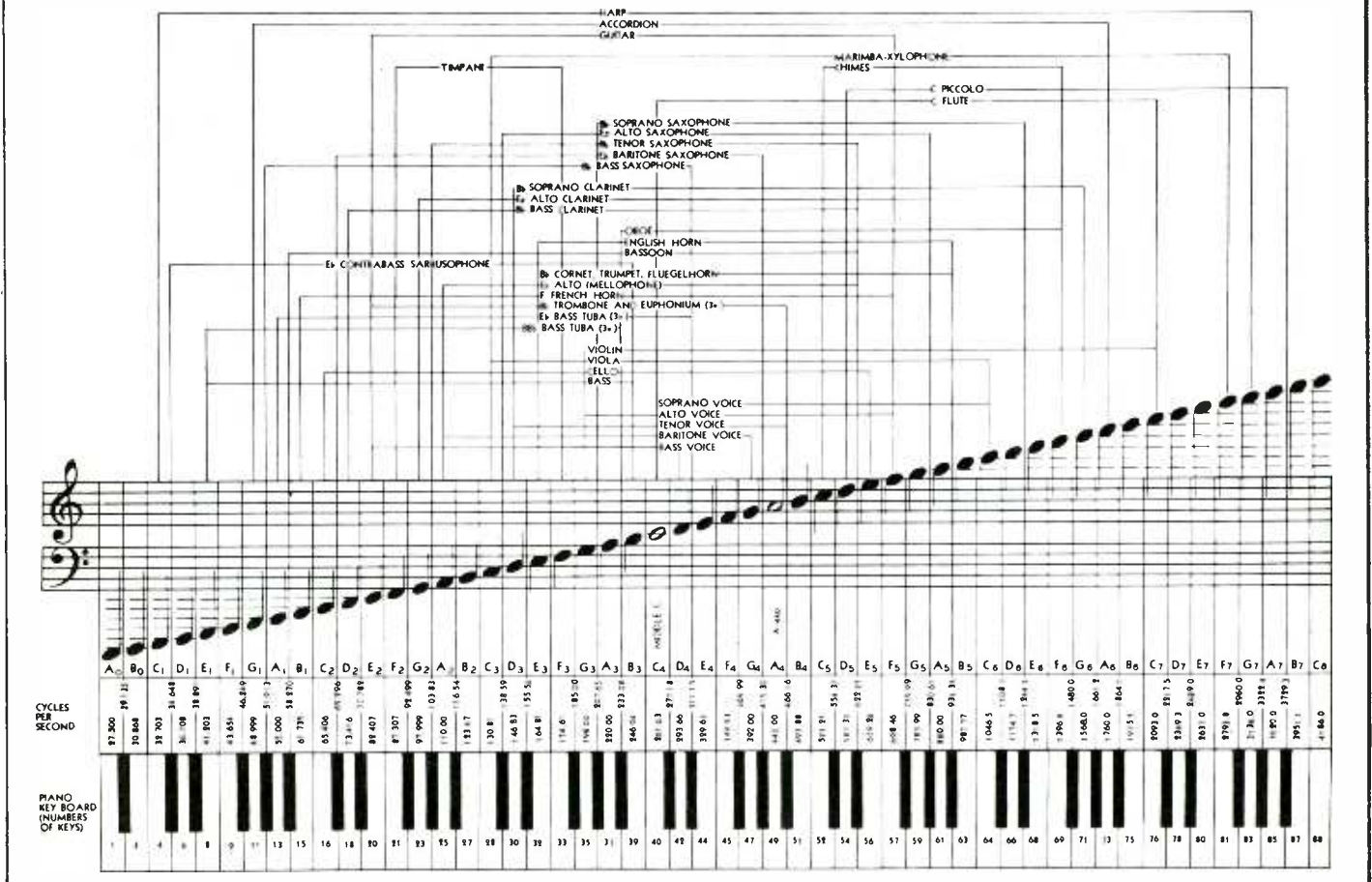

# Crown

## PROFESSIONAL STUDIO EQUIPMENT

Specs	15ips	7½ips
w. & fl.	0.06%	0.09%
f. resp. +2dB	40Hz to 30kHz	20Hz to 20kHz
S/N	-60dB	-60dB

3 speeds - 15, 7½ & 3¾ips; hysteresis synchronous drive motor

computer logic controls for safe, rapid tape handling and editing; full remote control optional

torque reel motors

"capable of providing the most faithful reproduction of sound through the magnetic recording medium to date" - Audio magazine, 4/68

optional Trac-Sync

individual channel equalizers

third head monitor with A/B switch; meter monitoring of source, tape, output and source+tape; sound-with-sound, sound-on-sound and echo

2 mixing inputs per channel

individual channel bias adjust

"construction rugged enough to withstand parachute drops" - Audio magazine, 4/68

\$1790 for basic rack-mount half-track stereo deck, about \$2300 with typical accessories; Formica floor console \$295, rugged portable case - \$69

modular construction with easy access to all 10 moving parts and plug-in circuit boards; deck rotates 360° in console, locks at any angle

## RECORDERS & REPRODUCERS



**SX711** Claimed by its pro audio owners to be the finest professional tape recorder value on the market today - price versus performance

- Frequency response at 7½ips ±2dB 20Hz-20kHz, at 3¾ips ±2dB 20Hz-10kHz
- Wow & flutter at 7½ips 0.09%, at 3¾ips 0.18%
- S/N at 7½ips -60dB, at 3¾ips -55dB
- Facilities: bias metering and adjustment, third head monitor with A/B switch, sound-with-sound, two mic or line inputs, meter monitoring same as CX822, 600Ω output
- Remote start/stop optional, automatic stop in play mode
- \$895 for full-track mono deck as shown, \$995 for half-track stereo deck



**SP722** Ideal reproducer for automation systems

- Meets or exceeds all NAB standards
- Remote start/stop optional, automatic stop in play mode
- \$595 for half-track stereo reproducer

## STUDIO MONITOR AMPLIFIERS



### D60

Delivers 30 watts RMS per channel at 8Ω

- Takes only 1¾" rack space, weighs 8½ lbs.
- IM distortion less than 0.05% from 1/10w to 30w at 8Ω
- S/N 106dB below 30w output
- \$229 rack mount



### D150

Delivers 75 watts RMS per channel at 8Ω

- IM distortion less than 0.05% from 0.01w to 75w at 8Ω
- S/N 110dB below 75w output
- Takes 5¼" rack space, weighs 20 lbs.
- \$429 rack mount



### DC 300

Delivers 150 watts RMS per channel at 8Ω

- IM distortion less than 0.05% from 0.01 w-150w at 8Ω
- S/N 110dB below 150w output at 8Ω
- Lab Standard performance and reliability
- "As close to absolute perfection as any amplifier we have ever seen" - Audio magazine, 10/69
- \$685 rack mount

## CX822

Crown tape recorders and reproducers are available in 42 models with almost any head configuration, including 4 channels in-line. Patented electro-magnetic brakes maintain ultra-light tape tension and never need adjusting. They are made by American craftsmen to professional quality standards, with industrial-grade construction for years of heavy use.

All Crown amplifiers are warranted three years for parts and labor. They are 100% American-made to professional quality standards. All are fully protected against shorts, mismatch and open circuits. Construction is industrial-grade for years of continuous operation.

For more information, write CROWN, Box 1000, Elkhart, Indiana 46514

# REFERENCE DATA for Recording Engineers

FIG. A2

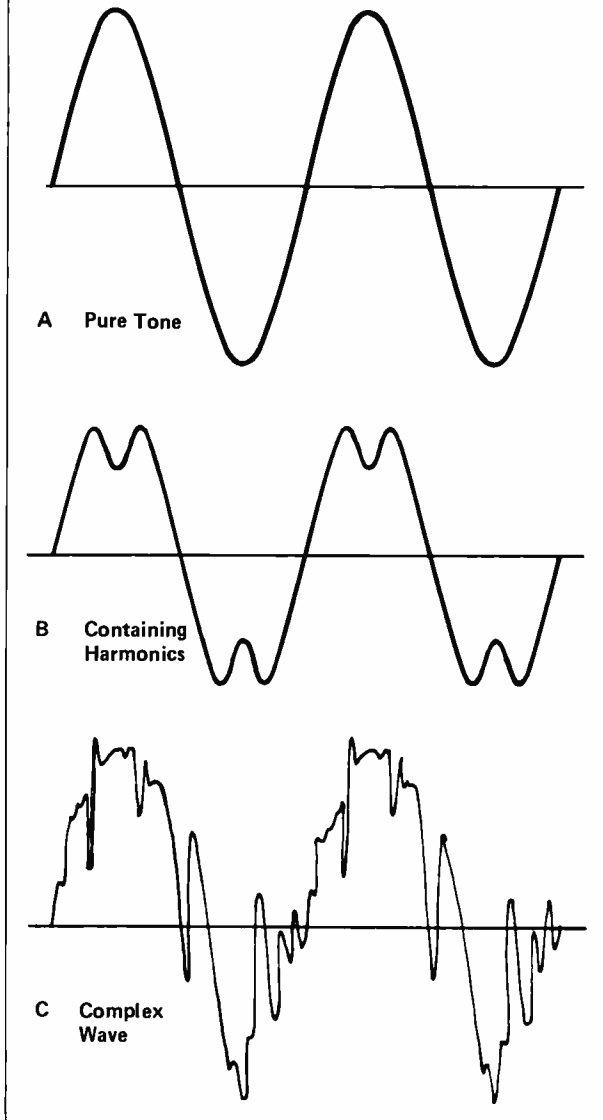
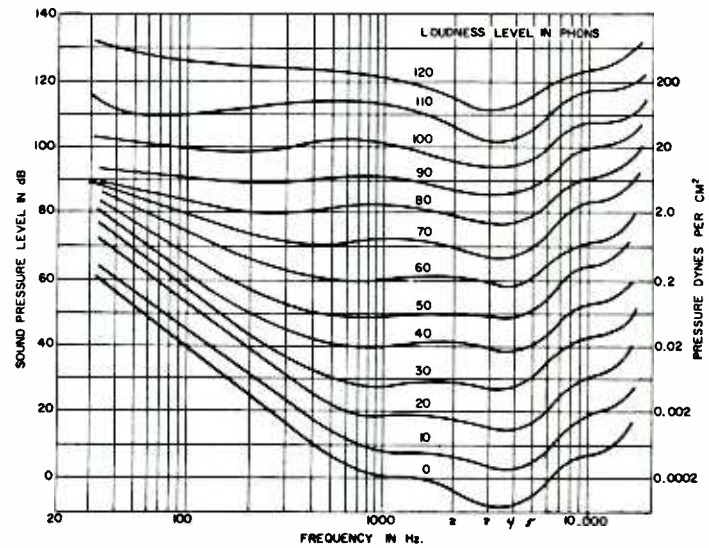
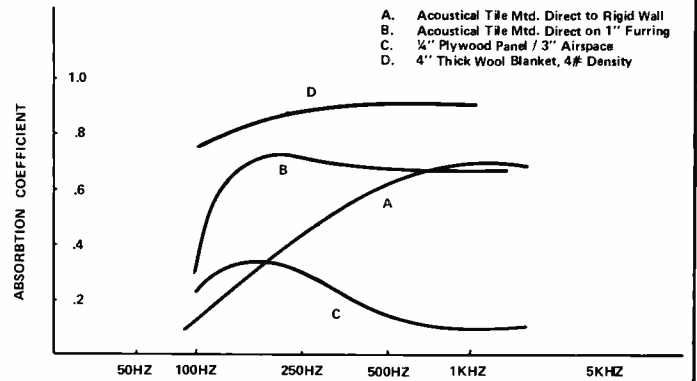

FIG. A3



Fletcher-Munson curves (USA). (Courtesy, Acoustical Society of America)

FIG. A4



## I. Properties of Sound

### A. Simplified definition of sound:

1. Sound is an alteration or change of pressure.
2. It is propagated to the receiver through some elastic medium, such as air.

B. A sound, once received by the ear, becomes a "sound sensation" or a "sound happening".

C. Sound is produced when air or some other medium or body is set into motion or vibration.

D. Sound is not transmitted through a vacuum.

E. Noise is a characterization of certain types of sound and is a term sometimes subjective in its use.

1. Generally it is used in the context of describing something that is non-rhythmical or non-musical, or,
2. Is interfering or unwanted in a specific circumstance.

### F. Sound propagation:

1. As a body vibrates, the air layer around it is compressed and the density is increased in the first layer or "ply", and since this first layer pressure is greater, the molecules move and propagate their movement to the next "layer" which in turn causes the same effect in the next layer, and so on, etc., etc.
2. Rarefaction follows each cycle of compression which produces a wave motion.

### G. Frequency of Sound:

1. The number of vibrations per second of a moving body determines the frequency (usually stated in cycles per second). See Fig. A1.

The relationship of velocity, frequency and wave length are expressed as follows:

$$C = \text{freq.} \times \text{wave length}$$

where C = velocity or speed of sound which is approx. 1130 ft/sec in air at 70° F.

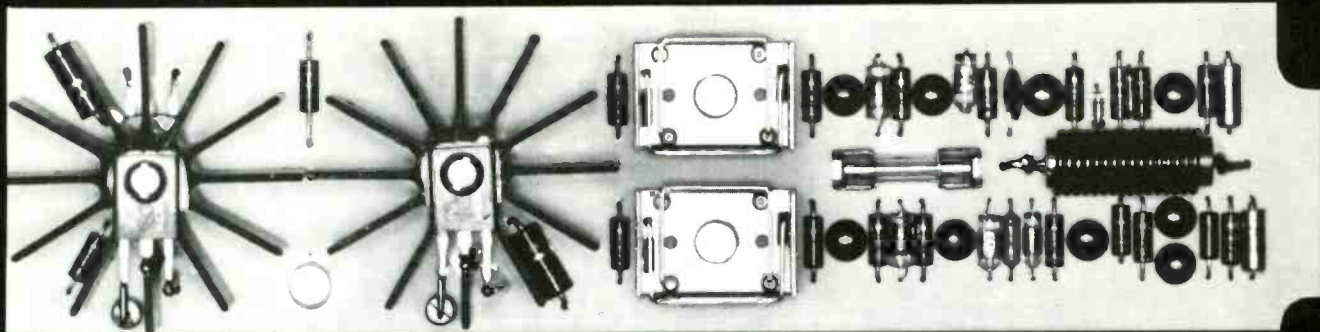

Today's requirement for hi-power/hi-intensity sound cannot be accomplished with yesterday's amplifier.

Today you will need the amplifier of today!

The all new SPECTRA SONICS Model 700 Amplifier is . . . . . **Beyond the State of the Art**

- **New Specifications . . . . .**
  - Continuous Power Output . . . . .** 60 watts delivered to a load
  - Bridged Configuration . . . . .** (2 amplifiers) 120 watts delivered to a load
  - Power Response . . . . .** Within  $\pm$  .1dB, DC to 20kHz into 8 ohms at full output
  - Total Harmonic Distortion . . . . .** Unmeasurable—less than 1/100th of 1% DC to 20kHz at full output
  - Signal-to-Noise . . . . .** Better than 100dB below 30 watt unweighted, 20Hz to 20kHz typically better than 120dB
  
- **New Flexibility . . . . .** A modular design concept, the SPECTRA SONICS Model 202PC Card Holder offers flexibility of design for bi-amp, tri-amp, quad-amp or multiple speaker installations. Modular additions in the field can be accomplished with ease for upgrading to higher power requirements. Less mounting space is required. Eight Model 700 Amplifiers mount in 3½" of rack space. The total result is less cost per unit and overall savings.
  
- **New Crossovers . . . . .** The SPECTRA SONICS Model 505 Electronic Filter improves the damping factor and eliminates inductive and capacitive reactance loading on power amplifiers. An additional bonus of the Model 505 Filter is reduced weight, no iron core inductor, and no power loss. More power is transferred directly to the voice coil. Each Model 505 Filter has two inputs and four individual outputs, and is available in all standard crossover frequencies.
  
- **Outstanding Results . . . . .** In just a few short months the list of satisfied users of SPECTRA SONICS sound has grown. It now includes many of the leaders in recording studio, and performing art centers around the world. London Decca, Vienna — Toronto Pavilion, Canada — Blossom Center, Ohio — Hollywood Bowl, California — National Public Radio, Washington, D.C. — Denver Symphony, Colorado — Motown Record and Larrabee Sound, Hollywood, California.

770 Wall Avenue  
Ogden, Utah 84404  
(801) 392-7531

6430 Sunset Blvd., Suite 1117  
Hollywood, California 90028  
(213) 461-4321

**SPECTRA SONICS**

LEADER IN ADVANCED TECHNOLOGY





We can readily determine the wave length from this expression which gives the following examples

Freq. in Hz	Wave length in feet	
	or inches	
50	22.6 ft.	
100	11.3 ft.	
500	2.26 ft.	
1000	1.13 ft.	
5000	0.226 ft.	

2. Wave length is the distance sound travels to complete one cycle.

H. Speed of sound in air is approximately 1130 feet per second at room temperature.

1. It has a positive temperature coefficient of approximately 1.1 foot per second per degree "F".
2. The speed of sound does not appreciably increase with frequency or intensity.
3. Sound travels faster in water (approximately 5000 ft/sec.) and in some solids (approx. 10,000 ft/sec.).

I. Wave forms:

1. The period of the wave with the greatest amplitude defines the pitch.  
(See Fig. A2)

J. Sound levels and power: (See Figure No. A5)

K. "Sound level" usually and conventionally refers to "sound pressure" level such as measured by the sound level meter. "Sound Pressure" has been accepted to mean effective sound pressure which is a R.M.S. value stated in dynes per square centimeter.

L. "Sound Intensity" or power refers to the rate of flow of sound energy through a unit area in the perpendicular plane.

M. Assuming an environment free from reflecting surfaces, *sound pressure* (spherical sound wave) is *inversely proportional to the distance* from the source.

N. *Sound Intensity* is inversely proportional to the *square of the distance* from the source.

## II. Basic Acoustic Terms

A. Absorption coefficient:

1. Efficiency of a given material in absorbing acoustical energy at a particular frequency.
2. Defined as the percentage of incident sound wave energy that is absorbed. Fig. A2 shows the absorption coeff. of different materials and the effect of the method in which the material is mounted.

B. Decibel: (dB) a logarithmic ratio between two power levels. The base for comparison of sound

# REFERENCE DATA for Recording Engineers

pressure levels is 0.0002 dynes per sq. CM. (\*0 dB)  
\*threshold of normal hearing at 1 kHz. See Figure A3.

C. Diffraction: The distortion or "bending" of sound waves as their path is interrupted by some physical object.

D. Diffusion:

1. The degree of diffusion which exists in a room relates to the number and density of random reflection paths of the sound waves.
2. During the "growth" period or decay period, diffusion increases the uniformity of these transient conditions.
3. During "steady state" condition, diffusion tends to equalize the sound pressure throughout the room.

E. Echo:

1. An echo is a "wave that has been reflected or otherwise returned with sufficient magnitude and delay to be detected as a wave distinct from that directly transmitted".
2. Empirical data shows that sounds delayed by approximately 30 to 50 M.S. (milliseconds) or longer are distinguishable as individual echoes.

F. Flutter Echo: is a rapid succession of reflected pulses resulting from a single initial pulse.

G. Noise Reduction Coefficient: "NRC" is the average of the absorption coefficient to the nearest multiple of 0.05 at 256, 512, 1024, and 2048 cycles.

H. Reverberation time: The reverberation time is the time required for the mean-square sound pressure level therein, originally in a steady state, to decrease 60 dB after the sound source is stopped. See Figure A6 showing reverberation time at various frequencies for a large room.

I. Sabine: A "sabine" is a square foot unit of absorption having an absorption coefficient of 100%. ("The amount of absorption offered by an open window one foot square" — Sabine)

J. Transmission loss:

1. (T.L.) is expressed in decibels and represents the sound isolative properties of a wall, ceiling, or partition.
2. The term "isolating" is usually used in describing attenuation of solid borne sounds and "insulating" is used in the case of air-borne sound energy. See Figure A7. For example.

## III Fundamental Acoustical Design Considerations

The requirements and/or design goals for good acoustical performance as they relate to the recording studio are:

A. Satisfactory sound isolation of the studio from outside interference and provisions for the required isolation

# total tape duplicating with "BUILDING BLOCK" simplicity

## CASSETTE TO CASSETTE, REEL TO CASSETTE, REEL TO REEL

The Telex series 235-1 is more than just another tape duplicating system. It is a concept based on modular "building blocks" which complement each other and provide total flexibility for tape duplicating. It solves the problems of interfacing between open reels and cassettes. It is a system designed for future expansion. Engineered to make tapes of true, professional quality. And it's priced within your budget.

The Telex system consists of only five basic units.

1. Solid state modular electronics containing amplifiers, meters and controls. This unit works with any combination of ten cassette or reel slaves.
2. Cassette master play transport.
3. Open-reel master play transport.
4. Cassette slave record transport. Records three cassettes simultaneously.
5. Open-reel slave record transport.

The five units are totally compatible. Intermix cassette and open-reel master or slave transports to suit your duplicating requirements: cassette to cassette, reel to cassette, reel to reel, or even cassette to reel. All units fit into table top consoles of uniform size so when your requirements change, you just add more units. It's that simple. Telex series 235-1 is heavy duty equipment with hysteresis synchronous motor tape drives, momentary push button controls and time delay circuits for smooth, positive tape handling. Selected premium grade duplicator heads provide long life and excellent frequency response. And fail safe, automatic features enable non-technical personnel to operate the system efficiently. Telex "building blocks" make a totally flexible and complete duplicating system. It's the sensible approach, designed to meet your needs today, next month and in the years to come. Made in the U.S. to professional standards.

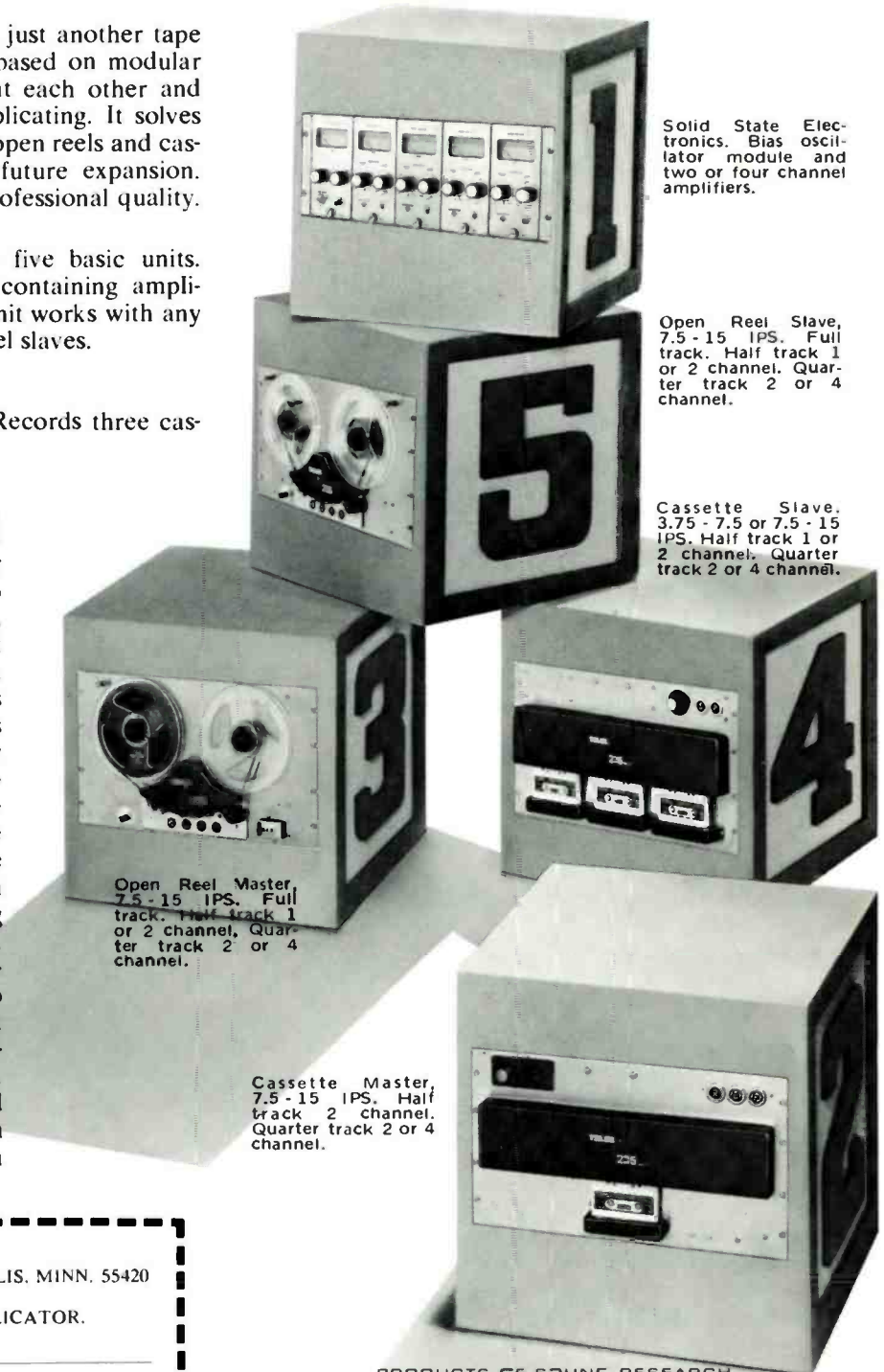

Solid State Electronics. Bias oscillator module and two or four channel amplifiers.

Open Reel Slave, 7.5 - 15 IPS. Full track. Half track 1 or 2 channel. Quarter track 2 or 4 channel.

Cassette Slave, 3.75 - 7.5 or 7.5 - 15 IPS. Half track 1 or 2 channel. Quarter track 2 or 4 channel.

Open Reel Master, 7.5 - 15 IPS. Full track. Half track 1 or 2 channel. Quarter track 2 or 4 channel.

Cassette Master, 7.5 - 15 IPS. Half track 2 channel. Quarter track 2 or 4 channel.

TELEX COMMUNICATIONS DIVISION  
9600 ALDRICH AVE. SO. • MINNEAPOLIS, MINN. 55420  
REP  
PLEASE SEND INFORMATION ON DUPLICATOR.

NAME \_\_\_\_\_

TITLE \_\_\_\_\_

INSTITUTION \_\_\_\_\_

ADDRESS \_\_\_\_\_

CITY \_\_\_\_\_ STATE \_\_\_\_\_ ZIP \_\_\_\_\_

PRODUCTS OF SOUND RESEARCH

**TELEX**®

COMMUNICATIONS DIVISION

9600 ALDRICH AVENUE SOUTH • MINNEAPOLIS, MINNESOTA 55420

CANADA: DOUBLE DIAMOND ELECTRONICS, LTD., 34 Progress Avenue, Scarborough 4, Ontario  
EXPORT: ROYAL SOUND COMPANY, INC., 409 North Main Street, Freeport, N.Y. 11520

# REFERENCE DATA for Recording Engineers

FIGURE A5

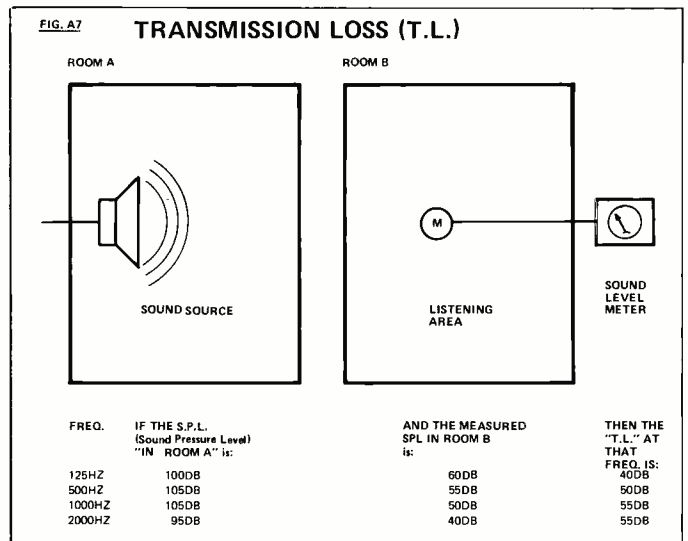
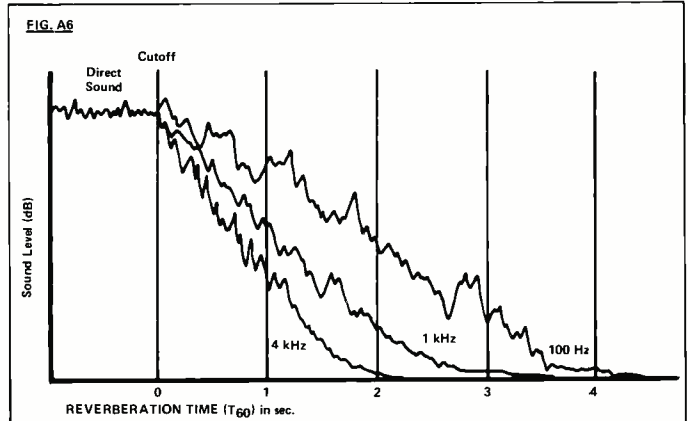
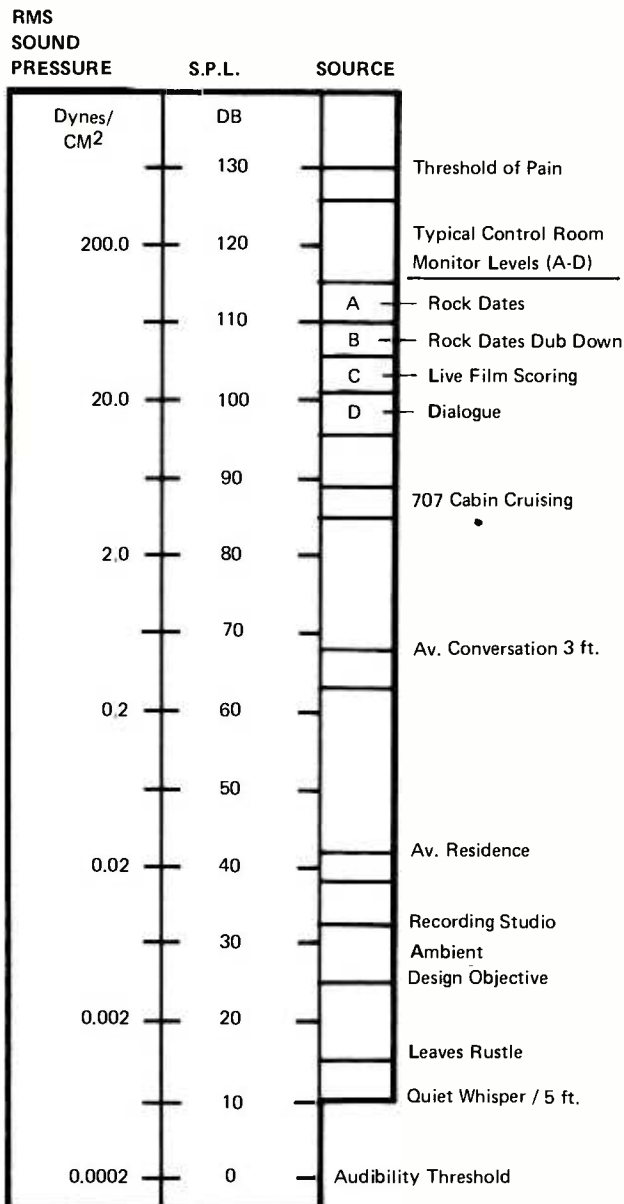

from the studio to the control room, as well as the control room to the external area. This requires attention to the control of air-borne, solid, or mechanically conducted sound, bilaterally.

B. The physical size of the room should be appropriate to the use intended relative to the average needs as defined by the style or type of recording to be performed. The shape and geometrics of the room should provide adequate diffusion and minimize the coloration which may be created by careless selection of H.W.L. ratios.

C. The reverberation time, as a function of frequency, should be optimized, based on the distillation of data relative to the volumn, style of intended use, and other empirical weighting factors unique to a specific field of recording.

D. The smoothness or regularity of the growth and decay characteristic of the reverberation regardless of how short it may be, should be adequately controlled not only by reflective geometric diffusion, but also by the random "scattering" of absorbing elements.

E. The acoustical environment as well as the aesthetics and cosmetics of the studio, must create not only a comfortable surrounding environment in which to perform, but must also create a pleasant and artictically stimulating atmosphere.

In subsequent Parts of this "Reference Data for Recording Engineers" series more specific detail concerning studio and control room planning and design measurement methods, reverberation devices and operational techniques relating to the application of this knowledge will be discussed.

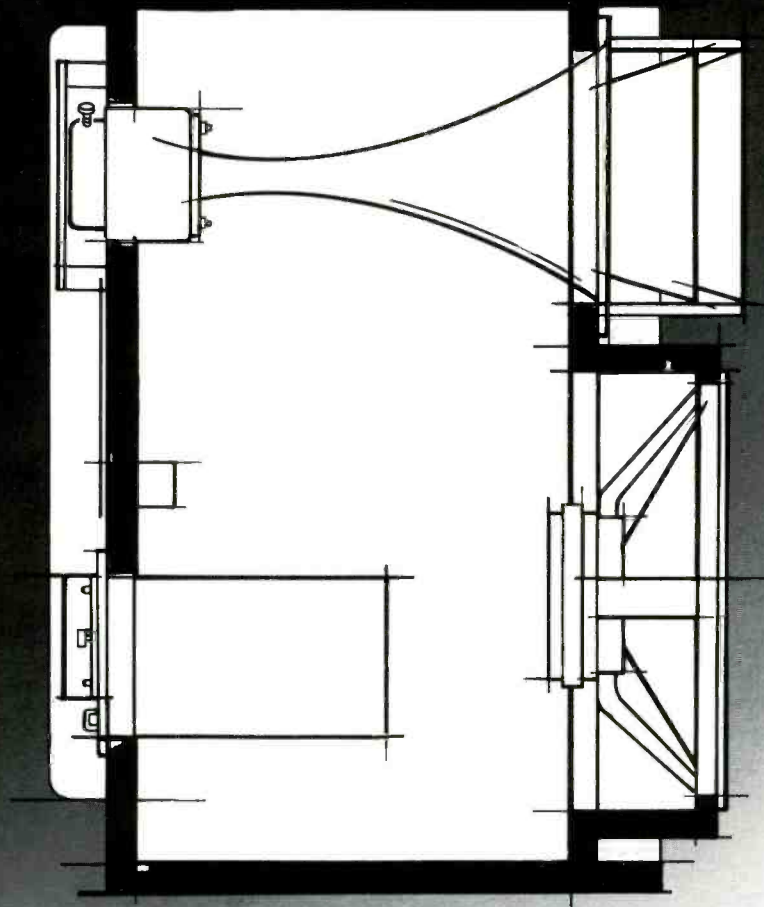

- Maximum  
acoustical output:** 112 db SPL @ 4 ft., equalized for flat response (pink noise), 40 to 15,000 Hz, in a free field.
- Dispersion:** 40° vertical x 90° horizontal.
- Amplifier:** Altec Model 771 B. Input sensitivity: .5 VRMS-60 Kohm unbalanced input for full output. .1 VRMS-600 ohm balanced input for full output.
- Crossover:** 500 Hz, 12 db/octave.
- Noise (both sections):** 80 db below rated output.
- LF section:** 60 watts, continuous sine wave power, 0.3% THD.
- HF section:** 30 watts, continuous sine wave power, 0.3% THD.
- Dimensions:** 26.5" wide, 31" high, 23.5" deep.
- Weight:** 112 lbs.
- Finish:** Grey epoxy with black grille fabric.

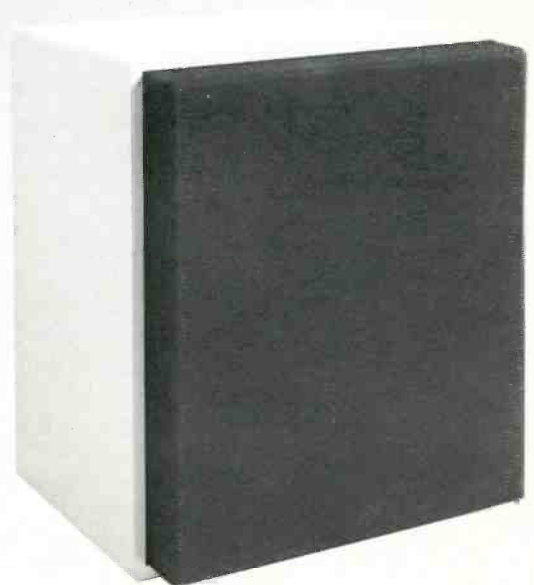

## The New Altec 9846 Biampified Studio Monitor Speaker System

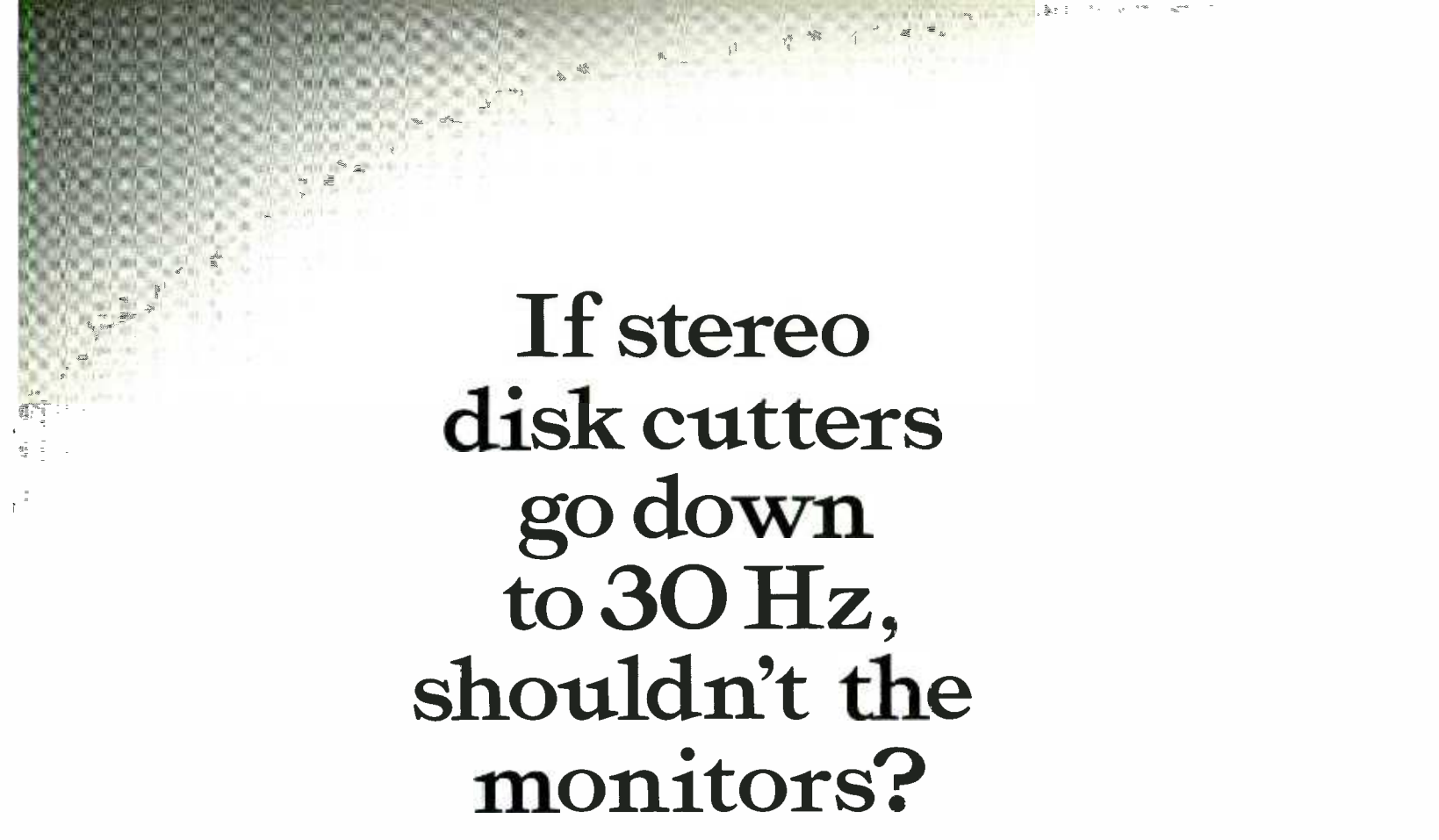

# If stereo disk cutters go down to 30 Hz, shouldn't the monitors?

## Yes. Because the music goes down that far.

You should hear everything when you're laying down tracks or you might not really know what you've got. Why wait till you play a test cut to find out what's at the low end? You don't have to with our new monitors.

What have we done differently to get that low end? First of all we're using sealed boxes. No more ports or bass reflex cabinets. We've gone to a very high-compliance speaker with a big magnet structure. It's well damped so that it responds accurately to signals down to 30 Hz. There's very little distortion. You can't get this with ported boxes.

Above 500 Hz things are different too. There's far more smoothness than in previous designs. Notice the proximity of the woofer and the HF horn. They're within inches of each other. This creates a smooth transition from one source to the other as you go up the spectrum.

Have you ever wondered why good monitor systems are two-way systems? It's because they guarantee transient accuracy. They don't have the inevitable problem of source displacement that occurs in systems with separate tweeters. And they don't burn out, as tweeters in most 3-way systems are prone to do, with the super highs present in much of today's music. Few drivers are capable of such a wide frequency range. Because so few speaker builders use the kind of phasing plug which makes this possible.

To make the system work, power has to be delivered. Biamping is the only solution. So we built a biamp right into the enclosure. It provides more than enough power to make the components produce more than enough sound. Depending on the music, the 90 watts of available power may be equivalent to three or four times that amount when compared to single amplifier systems.

This is truly a new recording tool.

Write for further information on the 9846 Monitor Speaker system. Altec, Professional Studio Products, 1515 South Manchester Avenue, Anaheim, California 92803.

PROFESSIONAL STUDIO PRODUCTS

**ALTEC**

# Automated Mixing is NOW!

## AN OPEN LETTER TO STUDIOS CONSIDERING AUTOMATION

It would seem that the audio industry is again taking a major step forward as it has done many times in the past. The step is into **automation of the mixdown process**. We, at Automated Processes and Allison Research, take cognizance of this and have jointly endeavored to create equipment and systems which are capable of making the step successful. In doing so, we feel a strong obligation to the industry both in the design of our hardware and in the philosophy of its use. What we have developed is the product of five years of research and planning, both in the laboratory and in the mixdown room.

In general, we feel that functional automation, whether for music, film or commercials, requires that the mixdown console or separate mixdown console self-program all relevant control functions in real time. In other words, the equipment must be capable of normal manual operation, but with the additional capacity to remember what was done, when it was done, and how it was done. It must then be able to precisely re-create the original mix any number of times without degradation while individual controls are readjusted to alter or improve any portion of the recording. Since we are dealing with a new technology, there are new terms and new considerations in choosing the equipment. We believe that these considerations must be made clear to the industry if the technology is to be successfully used.

Obviously, the first consideration is that the system work reliably, not only in theory, but in production form. If you were in attendance at the September 1972 AES Convention in New York City, you had the opportunity to witness a production package Allison/Automated system perform under the most demanding conditions. We estimate that between 300 and 400 passes of the same 16 track master tape were put through the console with flawless results. We weren't concerned about putting on such a demonstration, because we had confidence that the Programmer would perform even after the tape was worn.

The second consideration is that the system you buy today must be readily expandable to fit tomorrow's needs. It is easy to claim that a method of programming can be expanded to provide 22 kilofunctions of automation should the need arise. Fine, perhaps the method can, but what about the piece of hardware you purchased? How much expansion can it provide before you run out of room, or power supply, or counting capability? And most important, can it be expanded without making obsolete the data code you laid down in mixing today's tape? Can it provide expansion while maintaining suitable updating rates?

We call our programmer "Model 256E/D", because it is basically a 256 function device. It contains a 256 function card frame, 256 function power supplies, physi-

cal space, connectors, card guides, etc. You may buy it as a 16 function programmer at a 16 function price if you like, but you've still got yourself a 256 function CAPABILITY device.

How do you expand it? Simply add a Model 16E and Model 16D plug-in card for each additional 16 functions. That's all!

The importance of expansion will become apparent when you consider the following utilization format which is based on present or future 24 track capability.

- Function 1-24, individual channel gain
- Function 25-48, individual channel echo send
- Function 49-72, individual channel stereo panning (left/right)
- Function 73-96, individual channel quad panning (front/rear)
- Function 97-192, individual channel equalization (four functions per channel)
- Function 193-216, master levels, echo returns, etc.
- Function 217-256, future functions

Another consideration is updating speed. We believe that updating must be fast enough to faithfully follow the control manipulations of the mixing engineer, yet not so fast as to respond to spurious noise.

When a channel is placed in the WRITE or UPDATE mode, only that channel's control data is changed, while all other data is re-recorded intact. However, to avoid the possibility of error due to signal degradation after multiple passes, all data is completely regenerated each time. This assures that what you hear is what you have stored on the tape.

What about standardization? If you program only fader levels on a tape in Studio A today, what happens a year from now when you attempt to play that tape in Studio B where faders, echo, panning and EQ have all been automated? With the Allison/Automated system, Studio B's decoder knows what Studio A's encoder did, and it performs accordingly and accurately. It permits you to keep the fader level information you programmed a year ago while you now program echo, panning, and EQ if you desire. You can even take the tape back to Studio A and expect the fader level information to still be valid and accurate. In short, all Allison/Automated systems are compatible. This is no accident. We engineered them that way!

There are a lot of other considerations in automation, ranging from performance of the voltage control amplifiers, voltage control panners, etc., through human engineering and interface aspects, to overall system concepts. We have them covered, and are prepared to discuss any aspects of automation with you. We invite and encourage questions regarding specifications of the components in our system.

Sincerely,

**ALLISON RESEARCH, INC.  
AUTOMATED PROCESSES, INC.**

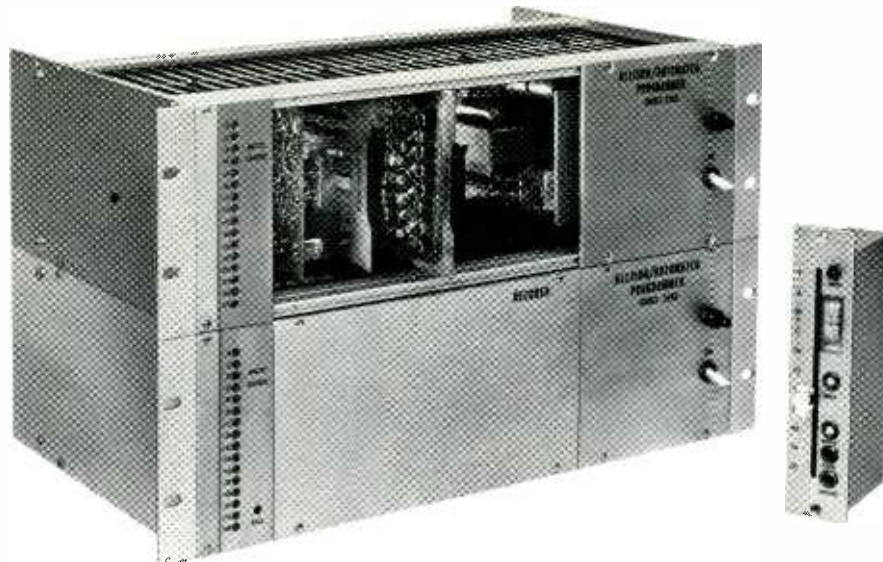

### MODEL 256 PROGRAMMING UNIT

At the heart of the system is the Allison/Automated Programmer, designed to avoid obsolescence by being capable of encoding up to 256 channels for recording on any conventional tape recorder. The Programmer contains independent Encoder and Decoder units, each of which employs state of the art analog and digital circuitry. This approach achieves the infinite resolution (stepless) control associated with analog systems while maintaining the error detection capability of digital circuitry.

The Model 256E Encoder consists of a 5¼" x 19" card frame, and is supplied with the Master Encoder module, one Model 16E switching card for 16 functions, and the required power supply modules.

The Model 256D Decoder, a separately packaged card frame with the same dimensions as the Encoder, contains the Master Decoder module, one Model 16D switching card for 16 functions, and the required power supply modules.

Both units can be expanded at any time in multiples of 16 functions by simply plugging in additional 16E and 16D switching cards. The expanded system will continue to decode tapes made prior to expansion. No other adjustment is necessary on either the programmer or the tape machine. In fact all tapes and programmers are interchangeable without adjustment so that tapes made in one studio may be played in any other studio having similar equipment.

### MODEL 256 PROGRAMMER SPECIFICATIONS

**NUMBER OF FUNCTIONS:** 16 to 256 expandable in groups of 16 by means of plug-in circuit cards.

**UPDATING RATE:** 800 Micro sec/function.

**ACCURACY:** ± .2 dB, 0 to - 40  
± 2 dB, 0 to - 60  
+0 - inf @ - 80

**BANDWIDTH REQUIRED:** 5 kHz (35 dB S/N)

**RECORDING LEVEL:** - 20 to - 5 (actual level or level variations have no effect).

**DROP-OUT AND SPLICE PROTECTION:** Any occurrence of sufficient magnitude to cause decoding error causes device to hold prior information until error signal is removed (Average of 30 sec.).

**COMPATABILITY (System to System):** Compatability within ±1 dB. Decoder automatically senses the number of encoded functions present and adjusts its cycling rate accordingly. Decoder also displays (via LED array) the number of encoded functions as an aid to determining the degree of automation on tape of unknown origin.

**PACKAGING:** Decoder and encoder separately packaged for remote control applications.

Decoder: 5¼" x 19" rack panel.

Encoder: 5¼" x 19" rack panel.

Both units: 10" deep. Self powered.

### MODEL 940 AUTOMATED FADER

The Automated Fader is a self-contained channel level control module capable of either manually or automatically setting audio levels. It contains all the electronics and front panel controls necessary to record, play back, and update channel fader settings. In addition, it may be used as an automated master fader, or may be externally controlled for gate or mute functions. An Auto/Manual switch is provided, which allows the module to operate as a normal audio fader, bypassing the automation electronics entirely. The module incorporates a conductive plastic slide attenuator of the same quality and reliability that has made our Model 440 and 475 faders so popular.

The Model 940 Automated Fader fits in the space normally occupied by a conventional fader so that no additional console panel area is required in retro-fit applications.

Electrical performance characteristics are compatible with the Model 256 Programmer. Power requirements are as follows: ±15V @ 50mA, +5V @ 10mA, and lamp power of 5 to 6V @ 30mA.

Mounting Dimensions are: 7" high x 1½" wide x 3¾" deep over mating connector.

You can automate your studio NOW with the Model 256 Programmer and the Model 940 Fader Modules, or with a pre-wired, ready-to-use 16 or 24 channel mixdown automation consolette . . . and there's more to come!

We'll describe the Model 950 panning module and Model 960 echo module in our next automation advertisement.

 **AUTOMATED PROCESSES, INC.**  
80 MARCUS DRIVE, MELVILLE, NEW YORK 11746 • 516-694-9212



**ALLISON RESEARCH, INC.**  
2817 ERICA PL. PO Box 40288  
NASHVILLE, TENN. 37204

Dial (615) "ALLISON" Or (615) 385-1760



# 8-IN, 4-OUT: \$1890. Plus Tax.

Here's what \$1,890 buys you:

One each floor-standing TASCAM Model 10 Mixing Console. Manufactured by TEAC Audio Systems.

Eight input modules, each providing a 3-position input pad, feedback-type mic attenuator, line attenuator, 3-position input selector, hi- and lo-pass filters, hi, lo and mid-band equalizers, complete echo-send and receive circuitry including pre- and post-selection, channel and pan assignment pushbuttons, a pan pot, and a unique straight-line fader.

Four sub-master modules, each providing a straight-line fader, source / tape monitor control, and separate monitor level controls.

One master module with a straight-line fader. Four 4" VU meters with fast-acting LED peak indicators.

Plus, pre-wired facilities for up to four additional input modules and other optional accessories including talkback, remote transport control, quad panner, and headphone monitor.

And if all that seems like an awfully good buy for your money, here's what \$1,770 for our Series 70 Recorder/Reproducer buys you:

1/2" transport, 4-channel modular electronics, with overdub, plug-in head nest with ferrite heads and scrape filter, remote control connector, touch-button solenoid/relay controls with anti-spill circuitry, heavy-duty 6-pole torque motors, and indirect drive 2-speed hysteresis-synchronous capstan motor.

Both units available with studio line impedances optionally.

Since you're still impressed by these values, don't forget the sales tax. That's the one accessory that's not optional.



1/2" with Overdub  
**\$1770**  
Less console.

**TASCAM CORPORATION**  
5440 McConnell Avenue  
Los Angeles, California 90066  
(213) 390-3566



Paul Buff's article a few months ago in R-e/p covered very well a number of uses for a D.C. Control attenuator. I might add that it could be used in the feedback chain of a limiter or compressor. What Paul failed to mention was the high cost of this kind of control.

Now if you're not C.B.S., or Electric Lady, or Warner Bros. chances are you're going to read articles on voltage control, see the few consoles in the big cities that may have it, or are getting it, and go to the A.E.S. convention and moon over \$85,000 consoles that their manufacturer promises will remember everything you do except wash your socks.

Now, on the other hand, you could be such a financially poor studio that when somebody says they want to do a stereo date you have to get out two more cups and bigger ball of string, then no matter what the cost you're not going to be able to afford D.C. control. Let's face it, if you're doing two track work there are a lot better places to spend your money than D.C. control.

However, if you have a few bucks then there is a cheap way to do a seemingly expensive job.

The basic principle is similar to the Fairchild Lumitrons but without the

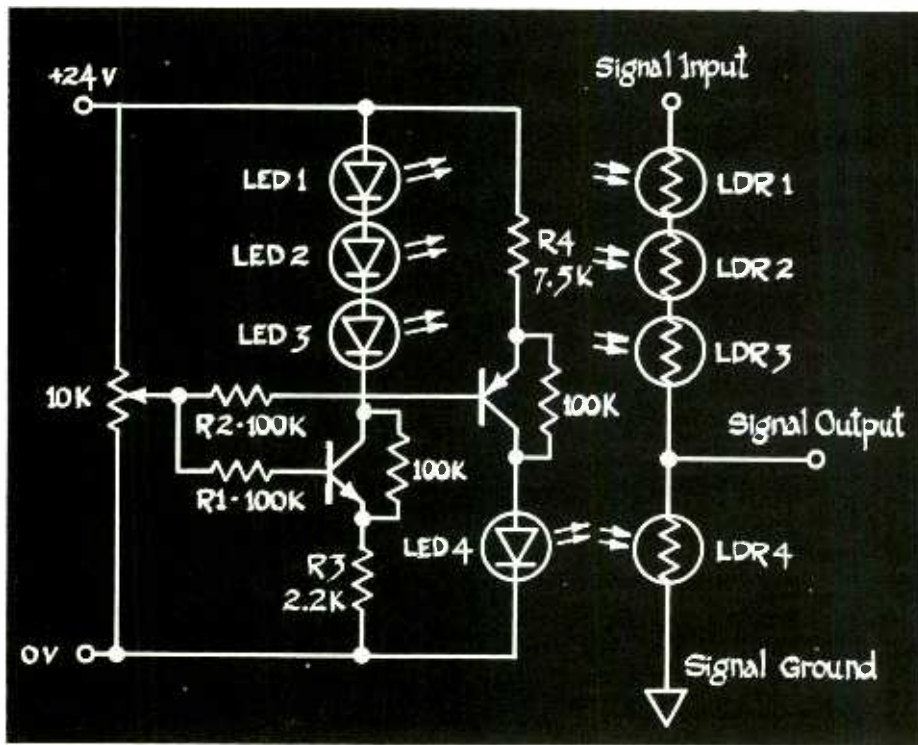

# DC CONTROL ON A BUDGET

by  
**TOM LUBIN**

# THINK SYNC!

**SYNCHRONIZE ANY  
TWO MAG TAPES . . .  
MULTI-CHANNEL AUDIO**  
sprocketed or unsprocketed  
**QUADRUPLEX VIDEO  
HELICAL VIDEO**

EECO's new "Sync Team" is **RIGHT ON** for such assignments as . . .

- Converting a 16 track and 8 track to 24 track.
- Synchronizing TV and stereo FM simulcasts.
- Precision sync in audio sweetening of video tapes.

The EECO synchronizer has an initial capture range of  $\pm 30$  seconds and maintains sync, or manually adjusted offset, for any length of time regardless of tape stretch or shrinkage.

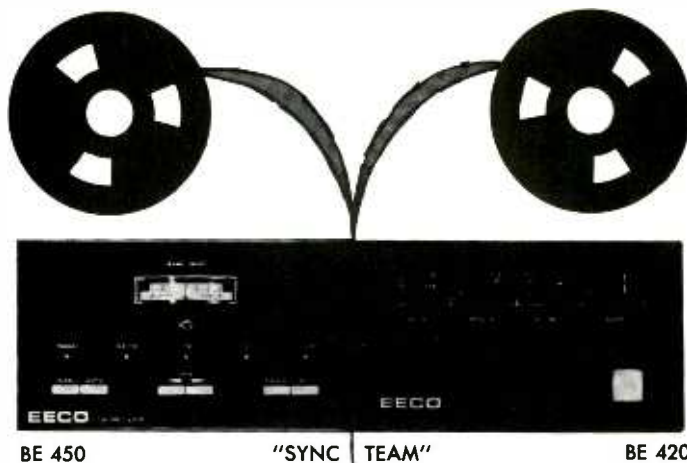

BE 450

"SYNC TEAM"

BE 420

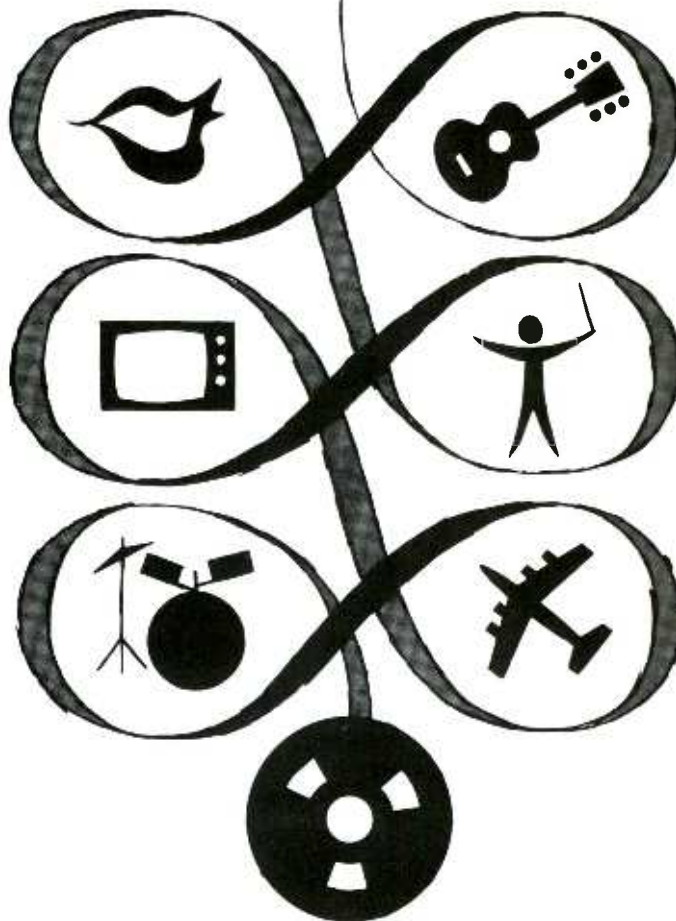

**SEND FOR INFORMATION TODAY!**

Discover how the new EECO "SYNC-TEAM" . . . BE 450 Synchronizer and BE 420 Edit Code Reader . . . can solve your particular tape synchronizing problems and help you tackle challenging assignments with digital electronic precision.

# EEECO

**ELECTRONIC ENGINEERING COMPANY OF CALIFORNIA**  
1441 East Chestnut Avenue • Santa Ana, California 92701  
Phone: (714) 547-5651 TWX: 910-595-1550 Telex: 67-8420

problems that the Lumitrons have had in the past, such as brown outs due to the filament breaking down with time, and burn out from short lamp life. The light sources in this circuit are L.E.D.'s.

The circuit is a passive circuit made up from a hell of a lot of variable resistance. The advantage of this as opposed to a D.C. control amplifier is that it has a very high overload point, (test generator could supply +30db) can be used balanced or unbalanced, signals lower than line level can be used with no problem because the circuit has no real noise of its own. It does, however, have 1/4db loss. That's about its only real drawback.

The circuit requires 4 LED/LDR's, three for line resistance, and one for shunt resistance to ground. The entire circuit being latched together using a complementary pair of Darlington Transistors and four resistors. Total cost is between \$20.00 and \$22.00. Cheaper if you buy more than one.

A 24vdc supply was used but the supply voltage can be almost anything. The circuit as shown will work well with a supply voltage down to +10 vdc, but the voltage can be much lower by decreasing the values of R3 and R4. The LED's will function with almost any voltage because they're dependent on current not voltage. These particular LED's (fig. 2) will take about 40ma before they'll blow, but from about 15ma plus the LDR doesn't change resistance much due to its apparent logarithmic input current/output resistance curve. (fig. 3)

The taper of the circuit can be altered, as can the worst case load resistance and value of the output resistance of LDR4 by changing the value of R3 and R4. This changes the current flowing through the LED's of the various cells. This same method can be used to alter the amount of gain reduction possible depending on

### INPUT CHARACTERISTICS

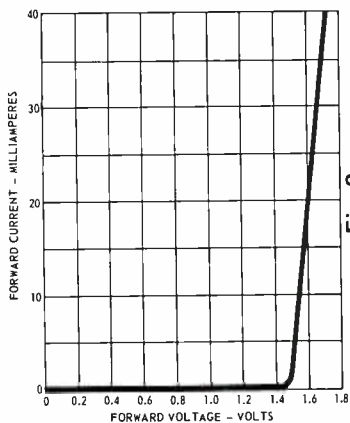

Fig. 2

### MODEL VTL2C2

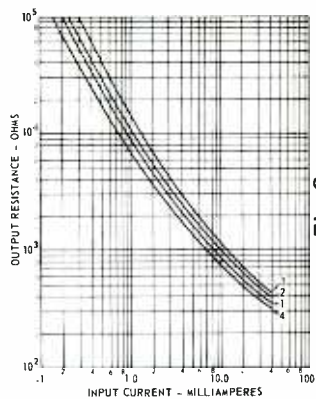

Fig. 3

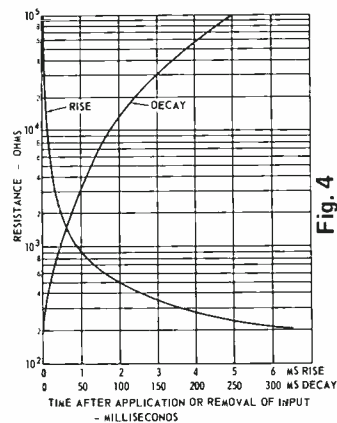

Fig. 4

### MODEL VTL2C3

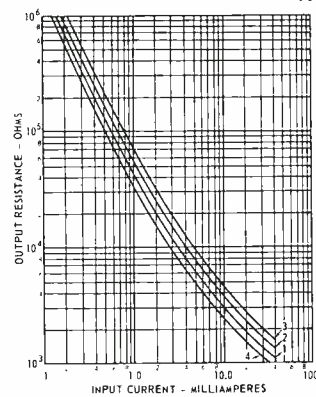

Fig. 5

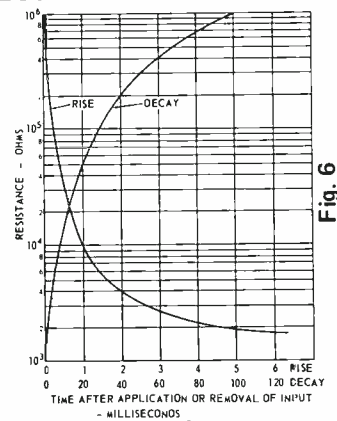

Fig. 6

what you plan on doing with the circuit. As illustrated it can be used as a standard 10k potentiometer, the worst case load of the circuit being 10k. This worst case point is where the resistance of LDR 1, 2 and 3 equal LDR4. From there, which is about the mid point of the fader, movement in either direction will result in the load resistance going up to about 100meg ohm. The output resistance varies from around 2.2k when the signal is being shut down to several meg ohm when the attenuator is passing signal. The resistance in the signal side of the attenuator is about 2.6k when it's passing signal to around a billion ohms when the series LDRs are off.

There is a certain amount of rise and decay time in the photo resistors (fig. 4), but this is in the millisecond range and can be used to an advantage. Explanation: this unit when used with a stepped attenuator as the voltage controller tends to round off the individual steps of the attenuator making the steps in the signal level considerably less apparent than if the same attenuator were used to process the signal. This same soothing effect can be used to cut the cost of the computer interface DtoA and AtoD converters. In many DC controlled amplifiers the rise and decay time is

instantaneous. In order to avoid hearing the individual steps in the signal introduced by the DtoA control voltage an 8 or even a 10 bit converter must be used. However, due to their rise and decay times, the LED/LDR unit could utilize a 6 bit converter and still get a good smooth resolution without detectable steps. A 6 bit converter gives 64 increments (which is about the same as a stepped attenuator) and is about 1/3 to 1/4 the cost of an 8 bit converter. The ten bit converter costs quite a bit more than the 8 bit. (No pun intended.)

In actually building the unit care must be taken in grounding the cases of the LED/LDR's. All resistors are 1/2 w and close tolerance resistors would be advisable for uniformity of taper and tracking. The tracking of the individual cells are quite good and quality is kept quite high. (fig. 3, 5)

The device as designed has a taper identical to that of the control fader. By changing the taper of the control fader the audio attenuator's taper will be altered similarly.

The value of the control pot can be most anything because it's used as a voltage divider to vary the potential on the two transistors. Because an effort was made to make the circuit where it could

# 3M Introduces the Series 79 Professional Audio Recorders.

With Servo Control. And an Optional Synchronizer.



**They're the first  
audio recorders that  
won't become obsolete.**

3M combines Isoloop® differential drive with a unique packaging concept to produce the smallest, lightest 24, 16 and 8-track recorders you can buy. Standard features include: servo control; selectable 7-1/2, 15, 30 ips speeds; 5 to 45 ips variable speeds; 50-60 Hz. 110V or 220V input for easy adaptation to domestic or overseas applications; remote transport control; broad equalizer ranges; single electronics card per channel; separate equalization for synch; remote that can be integral or at console.



*And they're updatable.* Series 79 won't become obsolete. Space is provided for state-of-the-art noise reduction circuitry. *They're expandable, too.* 16 and 8-track models can be quickly and easily expanded to 24-track. *With an optional, rack-mounted synchronizer.* It synchronizes to quadruplex or slant-track VTR, sprocketed machine, or another audio tape recorder.



So if you've been looking for recorders that can grow, and not grow old, take a look at 3M's new Series 79. Send for our information package. Professional Audio Products, 300 South Lewis Road, Camarillo, Calif. 93010. Telephone (805) 482-1911.

PROFESSIONAL AUDIO PRODUCTS  
**Mincom Division** **3M**  
COMPANY



# Microphone Techniques : SOLVING THE PROBLEM OF RECORDING THE ARTIST WHO IS BOTH PIANIST AND VOCALIST

by RON MALO ... TOTAL CONCEPT SOUND...

Recording an artist who is both the vocalist and the pianist during a live recording session often presents the engineer/producer with the need to make a series of, perhaps, unhappy compromises due to several problems.

Presented here is just one technique which eliminated the need to compromise either the piano or the vocal. The technique was most recently used during the sessions recording the MGM-Sunflower Records artist Randy Edelman at the Devonshire Sound Studios in North Hollywood, CA. Before describing the technique which uses a pair of super-cardioid mikes, head to head (X-Y technique), facing the rear of the piano, along with a standard cardioid dynamic for the vocal, it might be wise to outline the problems to be solved, and

the reasons for the unacceptability of other techniques.

... How can the vocalist be recorded with the least amount of piano leakage on his track?

... How can the vocal leakage into the piano mikes be kept to rock bottom minimums without completely shrouding the piano in blankets, thereby restricting the piano to a closed, compressed, boxy sound?

... How can the piano be recorded in stereo while still maintaining the natural perspective of the instrument without having it sound 10 feet wide?

... How can the vocalist's mike be kept from picking up the other instruments in the band?

... How can we eliminate the phase problem and time delay of the stereo

pick-up of the piano by two spaced microphones?

The piano was the first problem. Spaced microphones, one at the high end of the piano and one at the low end produced a stereo piano that was so wide that it engulfed the vocalist. It also sounded like two pianos, one on the left playing the low end, and one on the right playing the high end parts. When the stereo sides were combined to mono for a phase compatibility check the balance of the keyboard changed drastically from what was heard in stereo. This method of spaced microphones was unacceptable.

In moving the two spaced microphones close together the time/phase problems would be minimized, but the stereo perspective would not be very good. Also, how much vocal would be getting into the Piano Mikes? Not at all good, if the vocalist was forced to do an over-dub later.

## The Super Parametric Equalizer



Of the many Equalizers available today, the ITI ME-230 Parametric Equalizer is the only one that offers you all these truly outstanding recording features—

- **All controls are continuously variable.** No more working with arbitrarily fixed positions. With the ITI Parametric Equalizer—you record using your mind and ears, with your hands only transmitting the orders of what you hear.
- **Remarkable frequency range.** 10-800 Hz, 100-8,000 Hz, and 400-25,600 Hz, each accurately calibrated, with boost or cut up to 12db about any center frequency.
- **Continuously variable Selectivity or "Q".** From 4 to 14dB/octave with no effect on the absolute magnitude of the center frequency.
- **No inductors used**—In the Parametric sections. Ringing on transients is virtually non-existent.

The ME-230 Parametric Equalizer—our Super Equalizer—is for all those who want more than "just good enough" sound recording. We invite you to call or write for more details about its high degree of flexibility and superb performance.



**INTERNATIONAL  
TELECOMM, INC.**

McCormick Road and Schilling Circle  
Hunt Valley, Maryland 21031  
Telephone: 301/666-7770

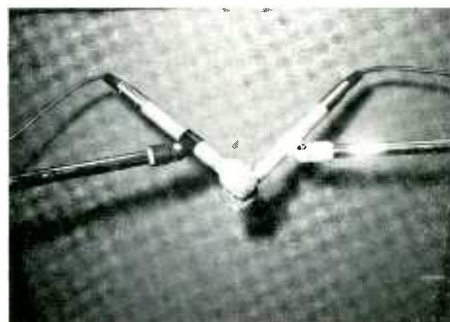

### THE X-Y PIANO RECORDING TECHNIQUE

The X-Y recording technique described here, and used on the session, utilized a pair of RE-15 super cardioid microphones mounted at 90° to each other, with the heads touching . . . one on

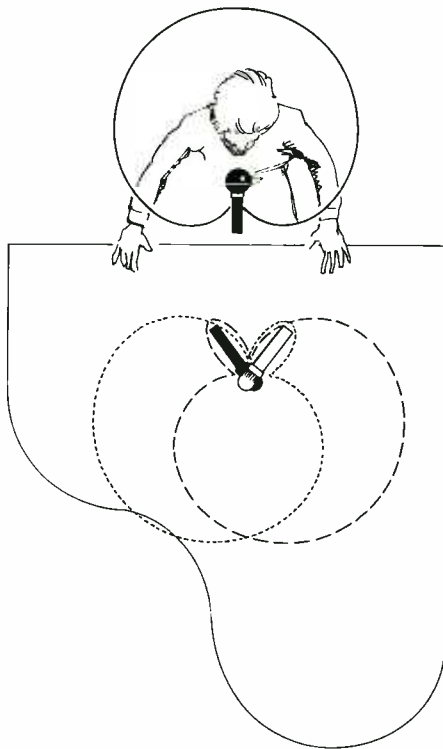

top of the other. Any pair of good cardioid mikes could have been used, but these were chosen for another reason. When the stereo pair were placed over the piano, as seen in the photographs, the back of the microphones were toward the vocalist. The fact that these were super-cardioid meant that the maximum rejection point is approximately 120° off axis, not 180°... and that point for both microphones was centered, generally, at the point where the vocalist's head would be, in front of the keyboard.

Very, very little of the vocal could be heard on the piano tracks.

#### MIKING THE VOCAL

Realizing that the vocalist would have to be very close to the microphone to eliminate leakage from the other instruments on the session, and that the piano being so close would require maximum rejection, we had to look for a standard cardioid mike with a maximum rejection at 180° to the main axis. A choice of any professional quality cardioid mike would have done the job. Our choice was a RE-20 with an additional Acoustifoam wind screen. This windscreen's lack of proximity effect greatly reduced popping and over-bass problems. This set-up produced the best rejection of the piano on the vocal mike, and at the same time reduced the phase reflection problems that are caused by the music holder on the piano. (See PHASE AND THE SINGLE MIKE, Malo, R-e/p, Volume 2, Number 6.)

BEEP ANNOUNCES ELECTRONIC MUSIC WORKSHOP FEB. 19 – MAR. 2, 1973

BEEP (Boston Experimental Electronicmusic Projects) in a statement by director Robert Ceely describes the Workshop, as a non-mathematical, non-academic approach to Electronic Music. As an opportunity for performers, composers, teachers, technicians and filmmakers to learn about Electronic Music.

The Workshop will include five two hour in-studio lab sessions during the first week, with one individual studio hour

arranged during the second week.

BEEP's equipment includes voltage controlled amplifiers, filters and oscillators; voltage sampler; envelope generators; dual trigger delay; white sound source; keyboard controller; 29 stage touch-activated voltage source; 24 stage sequencer; 64 stage digital sequencer, ring modulator; envelope follower; maxi-moog; mini-moog; electro comp synthesizers; tape recorders; reverberation units; monitoring facilities; etc. Cost of Workshop is \$75.00.

Robert Ceely, BEEP, 33 Elm Street, Brookline, Mass. 02146.

## "The Silencer"

**WIPES OUT TAPE SOUND**

### TABERASER

**WIPES OUT** sound from all magnetic tapes, cartridges, cassettes, magnetic film stock too. Up to 2".

**WIPES OUT** sound with minimum residual noise because the field automatically diminishes at the end of each 30-second cycle.

**NO OVERHEAT** because internal blower activates automatically to keep unit below 71°C.

**BUDGET PRICED** at only \$395.00.

*For the distributor in your area –*  
 Call or Write: **TABER** MANUFACTURING & ENGINEERING CO.  
 2081 EDISON AVE. • SAN LEANDRO, CALIF. 94577 • PHONE: (415) 635-3831

## New from Dolby

### The M16: a compact sixteen-track noise reduction unit

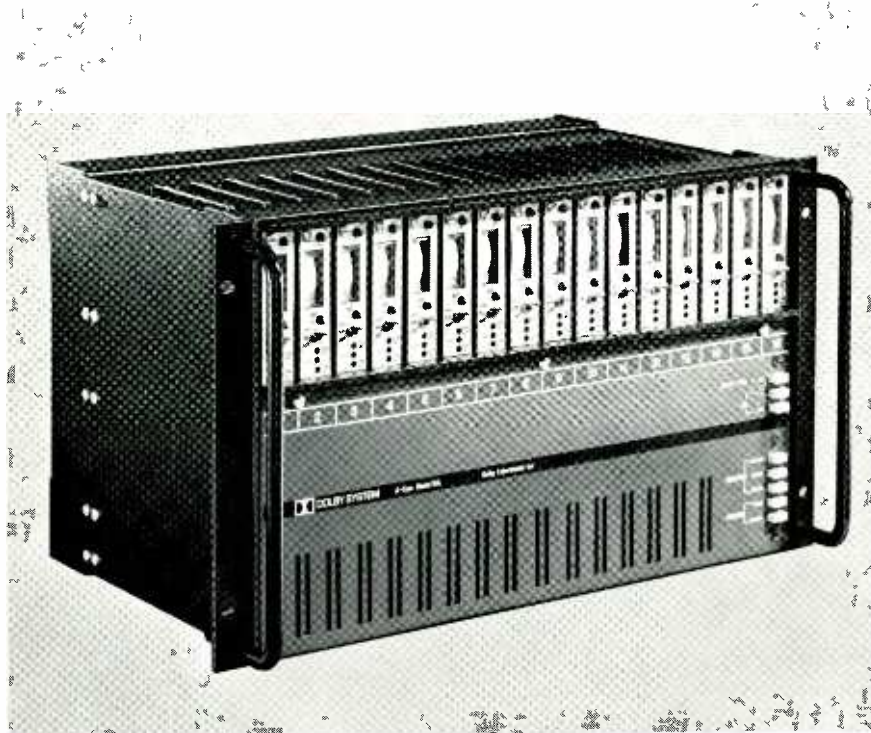

**New monitoring facilities in record, play, and recorder rest modes.**

**All solid-state control logic and signal switching.**

**Simple remote operation of all functions from console and recorder.**

**Standard Dolby A-type noise reduction characteristics.**

The Dolby system has become an integral part of modern multi-track professional recording practice. A new unit, the M16, has been developed for these applications and is now in production.



**Dolby Laboratories Inc**

1133 Avenue of the Americas  
New York NY 10036  
Telephone (212) 489-6652

346 Clapham Road, London SW9  
Telephone 01-720 1111

Tiger Building 30-7 4-Chome Kuramae  
Taito-Ku Tokyo  
Telephone 03-861-5371

**New, simplified line-up procedure.**

**Complete self-contained power supply and interface circuitry.**

**Add-on A8X provides simple expansion to 24-track operation.**

**Only \$8,000 for full sixteen-track capability.**

In addition to the obvious economy of space, installation time, and maintenance which the M16 offers, its cost per channel is substantially lower than that of other Dolby noise reduction units.

Full information about the M16, including accessories, auxiliary and independent eight-track units, and prices, available upon request.

'Dolby' and the double-D symbol are trade marks of Dolby Laboratories Inc.



# REMOTING the LESLIE ORGAN SPEAKER

by DON FOSTER

SINCE THEIR INTRODUCTION SEVERAL YEARS AGO THE LESLIE ORGAN SPEAKER HAS BEEN USED, APART FROM ITS USUAL HAMMOND B3 ORGAN, BY MANY RECORDING STUDIOS AND MUSICIANS TO PRODUCE A VARIETY OF SPECIAL AUDIO EFFECTS. ESSENTIALLY THESE EFFECTS INVOLVE SENDING A VOCAL OR AN INSTRUMENTAL SOLO THROUGH THE ROTATIONAL MECHANISM SPEAKERS OF THE LESLIE TO ACHIEVE A FASCINATING DOPPLER SOUND. THE EFFECT IS MUCH MORE THAN JUST A VIBRATO OR TREMOLO EFFECT.

THIS ARTICLE WILL DESCRIBE A WAY TO PUT THE LESLIE SPEAKER SOMEWHERE ELSE . . . OTHER THAN IN THE RECORDING STUDIO . . . YET, WHERE IT CAN STILL BE FULLY CONTROLLABLE FROM THE CONSOLE IN THE CONTROL ROOM.

**FEEDBACK . . .** A problem when the Leslie is used in the studio:

To achieve the desired Doppler effects with the Leslie operating in the recording studio, except if an electrified instrument is being taken direct, the set-up required would be similar to a typical public address system set-up. This arrangement would be prone to the typical feedback problems engendered in any situation where the microphone and the speaker are both operating in a common, high sound level, acoustic environment; where it is difficult to achieve good isolation between mike and speaker.

Recordings we have listened to; some released product, as well as our own test recordings where the Leslie was used right in the recording studio, did not seem to

take as much advantage of the unique Leslie effects as recordings made with the Leslie in some remote environment.

The specific application presented here illustrates how at Bolic Sound, Ike and Tina Turner's studio, we achieved the best effects we have heard using the Leslie, by putting it in one of the echo chambers (not the tiled one). Too, by using certain combinations of baffles in the chamber with the Leslie speaker we found that we could additionally control the reverberation time of the effect.

## POWER AMP OVERHEATING IN THE ECHO CHAMBER:

In moving the Leslie out of the recording studio, for the previously stated

reasons, had we operated the unit with its integral power amplifier in any other well ventilated atmosphere we probably would not have had to separate the power amp from its speaker cabinet. However, as a precaution against overheating of the Leslie power amplifier, since the echo chamber in which we placed it is practically airtight, it was deemed necessary to remove the amplifier from the speaker . . . there being no way of knowing just how long the power to the unit might be left on. The power amp in the Leslie is a tube amplifier — push/pull, 6L6 output — so it could get rather warm in a confined area with no ventilation. So the amplifier was removed to a storage area near the chamber where a small muffin fan is used to cool it.

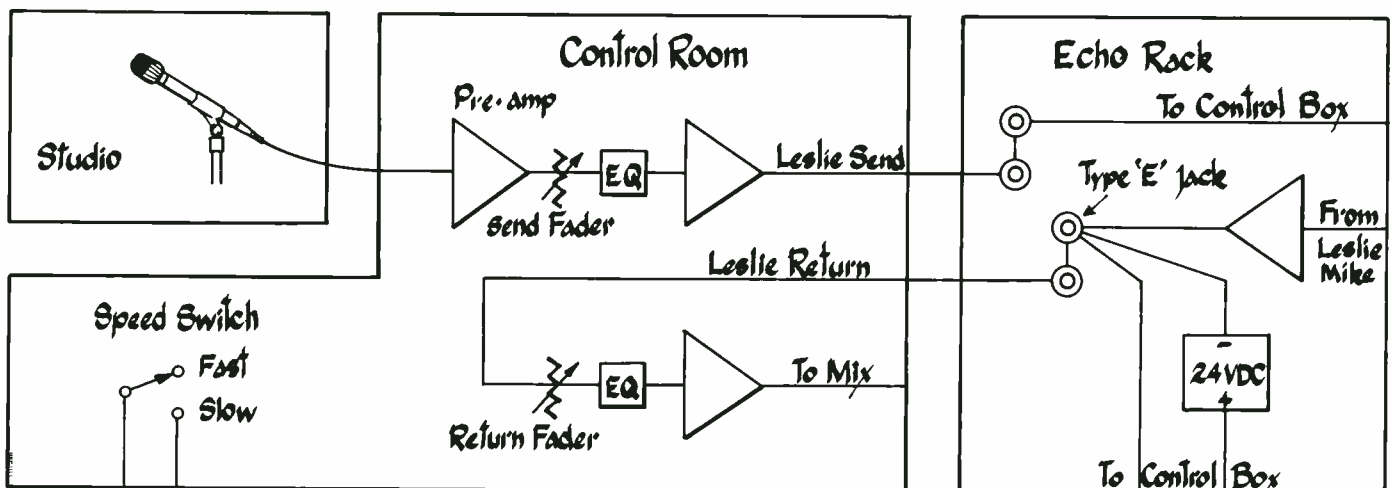

# The Quad/Eight Gate

NS-120

The fast, accurate,  
flexible  
noise gate.

\$98.



**quad/eight  
electronics**

11929 Vose Street, North Hollywood, California 91605  
Telephone: 213/764-1516

Circle No. 120

"What I need is a recording console that's expandable to 26 in., 16/24 out; with full quad capability; and FET logic automatic rec./play mode switching. But it would cost me \$36,000 or more."

"What you need is Auditronics!

## "Son of 36 Grand"

It's got everything you need for about half the cost."

For more information on the Son of 36 Grand, write Auditronics, P.O. Box 12637, Memphis, Tenn. 38112.



**auditronics. inc.**  
MEMPHIS TENNESSEE

Circle No. 121

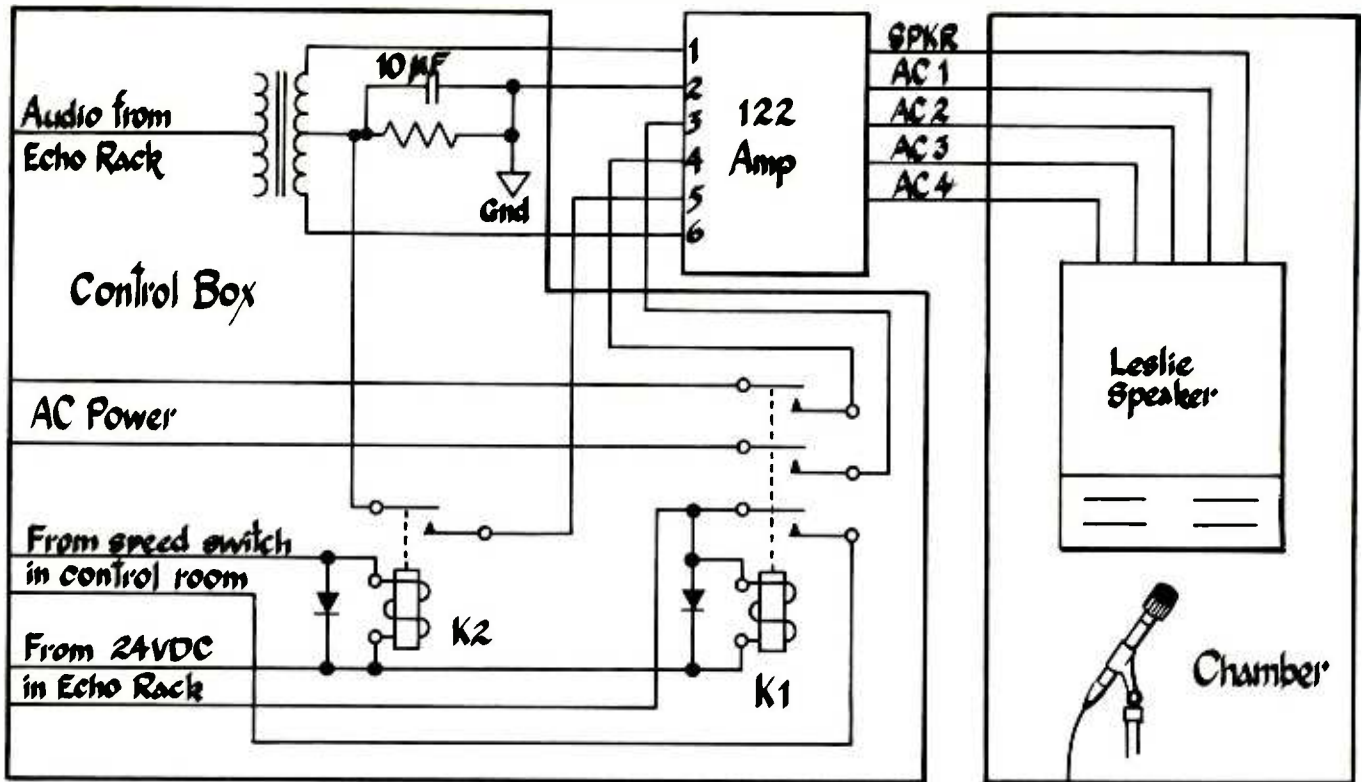

### THE REMOTE CONTROL

To remotely control both the power amplifier and the Leslie speaker it was necessary to do certain connection modifications and to design a remote control box which we will now describe, and which are shown in the illustrations.

To power the remote control it was decided to use 24 volts DC, which we have available at the echo rack. The jack field was altered slightly so that a form "E" jack was placed in the Leslie sound return, so that an additional pair of contacts are closed when a patch is made to this jack. Closing these contacts energizes a relay (K1) at the remote control box. This relay now connects AC to the power amplifier, the power amp internally connects AC to the speed control motors in the Leslie as it stands in the echo chamber.

It was also decided that it would not be practical to run the speed control through the jack field, so a separate line was installed from the control room to the control box. This too ended up using a relay to change the speed of the Leslie motors.

From the diagram (figure 4) the model 122 Leslie has a speed change-over relay built internally into the amplifier. The relay action is controlled by 1/2 of a 12AU7 tube. The other half of the 12AU7 as noted is unused. The Leslie speed control DC is phantomed down the audio lines to the model 122 amplifier. This is done in such a way that the audio

signal is not disturbed by the DC.

The input connector to the model 122 amp is a standard 6 prong plug.

Note the socket connections:

Pins 1 & 6 – Audio input – large changeover

pins

Pins 3 & 4 – AC input

Pin 2 – Chassis ground

Pin 5 – DC control for relay

**MCI**

... in the great northeast!

**audiotechniques, inc.**

121 hamilton avenue  
stamford, conn.

- sales • service
- installation • leasing

"Just 45 minutes from Broadway"

... is audiotechniques, inc.,  
your headquarters in the Northeast for MCI  
and all your pro audio requirements.

From Virginia to Maine,  
we service what we sell!

**MCI**

**audiotechniques, inc.**  
121 hamilton ave.  
stamford, conn. 06902  
(203) 359-2312

# MIX MASTERS

The virtues of Yamaha Grands can be heard on hundreds of thousands of feet of tape. Clarity. Power. Rich, full tone. Textural versatility. Dynamic versatility. Yamaha Grands (like this C-7) will help you get it all down, exactly the way you and your talent want it.

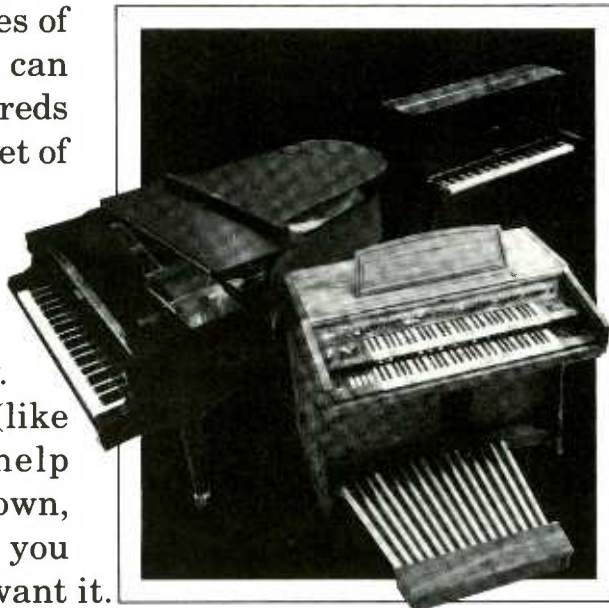

The Yamaha Electone E-3 is more than a complete professional organ. It's literally a control center for hundreds of colors, rhythms, sound effects, and textures—some unavailable in organs costing twice as much. It can help keep unexpected problems or surprises in a session from turning

into glaring holes.

Yamaha Verticals are the closest you can come to grand pianos without grand pianos. The U1-D, for instance, has impeccable tone quality and response quick enough to please the most finicky talent. And Yamaha Verticals are made to endure, session after session, year after year.

ing into glaring holes.

 **YAMAHA**

Yamaha International Corp., P.O. Box 6600, Buena Park, Calif. 90620

<input type="checkbox"/> C7 Grand Piano	Name _____
<input type="checkbox"/> U1-D Upright Piano	Business _____
<input type="checkbox"/> E-3 Organ	Address _____
<input type="checkbox"/> Other	City _____ State _____ Zip _____

Send for complete specifications and dealer information.



**Variable-directivity  
condenser studio  
microphone provides  
130 dB dynamic range.**



**Dynamic range (130 dB)  
+ noise level (24 dB)  
= max. spl (154 dB)**

Sony's variable-directivity (Omni-Uni) C-37P\* contains an advanced FET amplifier. A switchable attenuator is placed between the capsule and amplifier to prevent distortion even at extreme sound pressure levels.

The combination of proven excellence in sound quality, and the very latest in semiconductor technology makes the Sony C-37P indispensable in today's quality-oriented recording studio.

Also Consider:

Studio standard condenser microphone model C-500.\*



\*Must be powered by Sony AC 148A or equivalent power source.

©1972 Superscope, Inc., 8132 Vineland Ave., Sun Valley, Calif. 91352. Send for free literature.

**NEW PROD**

**PAK PROFESSIONAL MULTI-TRACK  
TAPE RECORDER FROM CUSTOM  
FIDELITY**

The new 16 track model at \$16,500 includes a number of features usually available only as options on similar models by other manufacturers, features such as, digital footage counter, electronic peak reading V.U. indicators, variable speed control with I.P.S. counter, automatic rewind and built in resolver for external sync.

The new Ferraflex record, erase and playback heads, featuring low phase shift, and fixed azimuth and zenith are incorporated in the unit with the first stage of amplification adjacent to the heads for improved signal-to-noise ratio.

The deck is a fully D.C. servo controlled, dual capstan, closed loop system requiring no tape lifters and assuring minimum flutter and short unsupported lengths of tape across the heads.

Equalization is supplied set and ready for operation per NAB or CCIR equalization standards and requires no alignment.

The bias oscillator is crystal controlled at a frequency of 150 KHZ. Bias adjustment for all 16 channels is set by one control on the master bias control



panel, one bias board and one V.U. meter is common to all channels.

Although a 24 track model is in production, the Pro Master 24, a conversion kit from 16 to 24 track is available as an option. Other options include an over bridge containing 16 V.U. meters (normal or peak reading variety), a remote control panel and in development is a conversion kit for 8 track, 1 inch operation.

STUDIO SYSTEMS DEPARTMENT,  
CUSTOM FIDELITY COMPANY, INC.,  
7925 SANTA MONICA BLVD.,  
HOLLYWOOD, CALIFORNIA 90046.

Circle No. 125

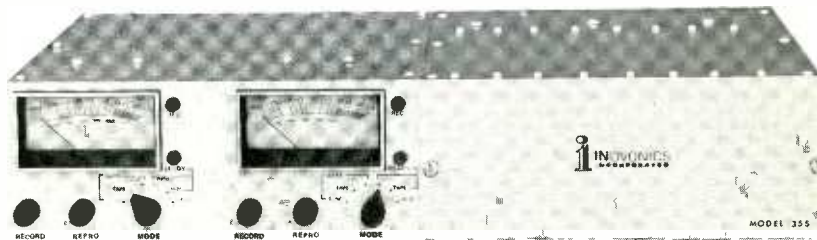

**INOVONICS MODEL 355 TAPE  
RECORDING ELECTRONICS**

The Inovonics Model 355 is a mastering-quality, 2-channel tape recording electronics package which achieves highest performance in an unusually compact form through optimal use of discrete and IC circuitry. Features include 3 speed equalization for any combination of NAB or IEC characteristics, remote selectability of operating modes and monitor functions, 250 kHz bias, separate sync playback amplifiers, adjustable

linearization and phase compensation to minimize recorded distortion, and sufficient overload margin to realize the full potential of present-day mastering tapes. The 3½ inch rack-mount package is equally suited for new multi-track systems, or for updating outmoded recorders.

Accessories: remote control panel, 1A and 5A power supplies, line matching transformers. Price: \$1150.

INOVONICS, INC., 1630 DELL AVE., CAMPBELL, CA 95008.

Circle No. 126

## DOLBY INTRODUCES NEW COMPACT MODEL M16 FOR MULTI-TRACK RECORDING

Only 10½ inches high, the M16 is part of the new third generation Dolby M series, and will reduce the cost of multi-track noise reduction installations by nearly a third for most studios. The M Series utilizes the standard Dolby A-Type professional noise reduction characteristic, now employed on over 8,000 recording tracks throughout the world. In addition to the standard Dolby Cat.22 noise reduction modules used in the new series, a new modular all-solid-state interface has been designed, eliminating relays and incorporating switching logic which minimizes operational errors. Also available is an eight-track version and an add-on unit to expand from sixteen to twenty-four tracks, all using the same M Series modular approach. The new units are small enough for mounting on or in many multi-track recorders.



Sixteen channels of noise reduction used to take up 70 inches of rack space with Dolby's original Model A301, and this space requirement was reduced to 28 inches (40% of A301) with the second generation Model 361. With the M16, the same number of tracks will now fit into 10½ inches, which represents 37.5% of the 360 Series space requirement (or 15% of A301 space). Likewise the price for sixteen tracks of noise reduction has dropped from \$19,000 in 1967 to \$15,360 in 1968, to \$11,840 in 1970, and to \$8,000 with the new third generation model.

DOLBY LABORATORIES, 1133 AVENUE OF THE AMERICAS, NEW YORK, NY 10036.

Circle No. 127

## NEW EECO ELECTRONIC SYNCHRONIZER FOR AUDIO AND VIDEO TAPE RECORDERS.

Designed to synchronize an audio tape recorder (ATR) to a quad or slant track video tape recorder (VTR), or another ATR, the EECO BE 450 Synchronizer keeps two mag tapes in frame to frame lock regardless of normal tape stretch or slippage.

The Synchronizer compares identical SMPTE edit codes recorded on any two mag tapes — quad, slant track, sprocketed or unsprocketed audio. If the tapes are within 30 seconds of synchronization, the BE 450 automatically adjusts control voltage to one of the recorders until tapes are in perfect sync. It then keeps the tapes in sync, or manually adjusted offset, in a frame to frame lock.



The BE 450, with identical SMPTE edit code indexing on each tape, can provide exact synchronization between ATR and VTR tapes, as audio is recorded to match visual material on the VTR monitor, and subsequently as the new audio material is recorded on the original video master. When a production requires more audio channels than the largest ATR on hand, the Synchronizer can also synchronize two ATRs so they serve as a single ATR.

BE 450 is EECO's fourth in a series of "mini-modules" produced for precise electronic indexing and editing work with video and audio tapes. The other three EECO mini-modules are a SMPTE Edit Code Generator, an Edit Code Reader and a Video Character Generator. The Video Character Generator converts the SMPTE Edit Code to a visual display on monitors and in video tape dubs.

ELECTRONIC ENGINEERING COMPANY OF CALIFORNIA, BROADCAST PRODUCT GROUP, 1441 E. CHESTNUT AVE., SANTA ANA, CALIFORNIA 92701.

Circle No. 128

## Sound pressure levels up to 137 dB.



Sony's new condenser microphones; ECM-64P (Uni) and ECM-65P (Omni) handle sound pressure levels up to 137 dB, with less than 1% distortion.

Both microphones shield the capsule with a unique double windscreen to reduce pop susceptibility when close miking is employed. In addition, they're designed to filter out unwanted extreme low frequencies, all but eliminating the proximity effect that can severely impair the performance of a hand-held microphone. Primarily designed for Phantom power the ECM 64P/65P operates equally well from a self contained battery.

**SONY SUPERSCOPE®**

©1972 Superscope, Inc., 8132 Vineland Ave., Sun Valley, Calif. 91352. Send for free literature.

# Sony's award presenting microphone.\*

\*Used at Academy Award and Emmy Award T.V. presentations 1972.

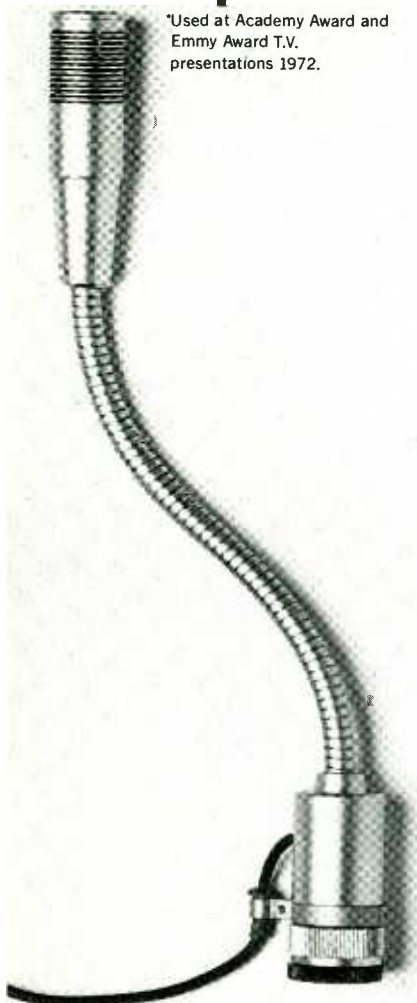

Featuring a high-performance condenser capsule of electret design, the ECM-53 is specifically designed for broadcast, recording studio, public address and similar applications.

The cardioid capsule assembly contains a permanently charged condenser capsule and FET/IC amplifier. A Cannon connector houses the battery supply.

- Frequency Response: (Frontal  $\pm 3$  dB): 40 Hz to 16 kHz
- Output Impedance (at 1 kHz  $\pm 20\%$ ): 50, 250, 600 ohms Balanced
- Maximum SPL (1 kHz): 134 dB

Also Consider:

Tie-tack/lapel condenser mic ECM-50.

Telescopic (from 7 $\frac{3}{4}$ " to 17 $\frac{1}{2}$ ") condenser mic ECM-51.

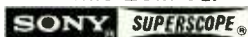

©1972 Superscope, Inc., 8132 Vineland Ave., Sun Valley, Calif. 91352. Send for free literature.

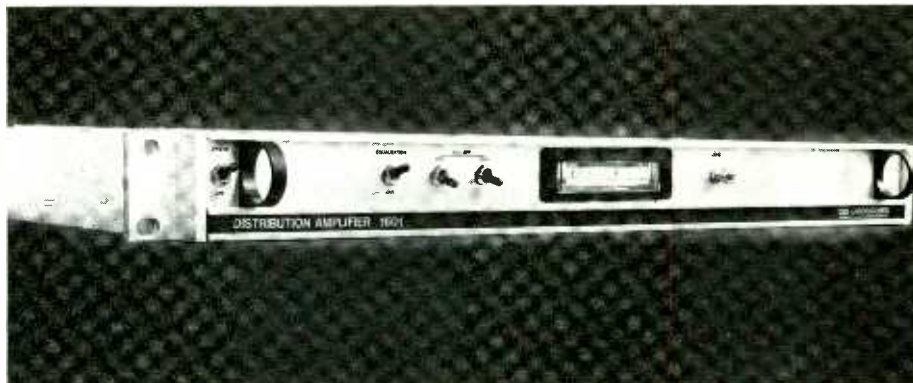

## CBS LABORATORIES INTRODUCES A NEW AUDIO DISTRIBUTION AMPLIFIER.

The Model 1601 has 16 balanced audio outputs from one high or low impedance bridging input. Op-amp integrated circuits are used, and the unit provides 40dB gain with isolation between outputs in excess of 80dB. Only one-rack unit high, the Model 1601 eliminates costly, bulky modular audio distribution systems.

CBS Laboratories new Audio Distribution Amplifier provides high frequency boost and roll-off equalization for a

variety of special applications, such as, high-frequency compensation for telephone line loss.

Studios will find the Model 1601 particularly useful for distributing program and monitor circuits throughout studios, control rooms, conference rooms, etc.

The 1601 is also ideal for public address audio distribution in auditoriums and theatres, transportation terminals, government and educational installations.

Unit price: \$395.

CBS LABORATORIES, 227 HIGH RIDGE RD., STAMFORD, CT 06905.

Circle No. 131

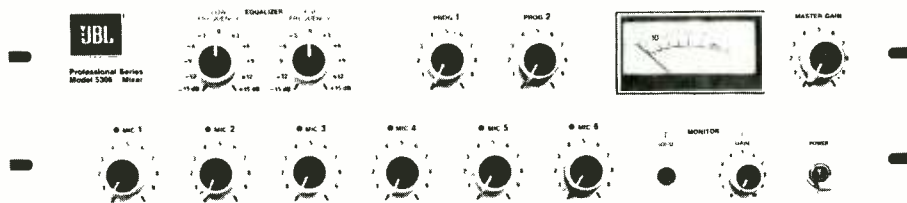

## PROFESSIONAL MIXER FROM JBL

The JBL 5306, designed for professional sound reinforcement applications, is a solid-state mixer/preamplifier capable of integrating two program channels and six microphone inputs. It features an indicator light for each microphone input that flashes before overload distortion reaches audible levels, providing the operator with ample warning to make proper gain adjustments. In addition, the 5306 utilizes a JBL-designed preamplifier circuit whose operational characteristics are changed as the gain control is adjusted, permitting greater input without clipping the output signal. The 5306 master gain control also incorporates this voltage reduction circuit to accommodate the extreme loudness variations generated

by today's music groups.

Additional 5306 features include the ability to increase the capacity of the unit from six to fourteen channels with the addition of the optional JBL 5306 Expander; acceptance of microphones having an impedance between 50 and 600 ohms balanced, with input transformers supplied; detented equalizer controls providing 3dB increments of boost or cut to a maximum of  $\pm 15$ dB; separate monitor output, accessible from the front or rear of the unit; and lighted VU meter.

The unit is currently available through JBL franchised Professional Products dealers for a net price of \$675.

JAMES B. LANSING SOUND, INC., 3249 CASITAS AVENUE, LOS ANGELES, CALIF. 90039.

Circle No. 132



**NEW B & K SOLID-STATE DIGITAL MULTIMETER INTRODUCED BY DYNASCAN CORPORATION, \$169.95.**

Dynascan Corp. has added a new, solid-state digital multimeter to its B & K line of test instruments. Called the Model 281, Dynascan says it was designed to meet the requirements of 99% of all measurements in industry, labs, schools and servicing. Features include a large, ultra-stable 2-1/2 digit numerical display with automatically positioned decimal point, 100% overrange capability, full overload protection, positive overrange and wrong polarity indication, high sensitivity, 1% accuracy and 10 megohms input impedance.

The digital multimeter is being used in more and more applications, because of its unquestioned superiority over analog multimeters in ease and speed of reading, and accuracy of readings.

The 281 gives very positive overrange indication as follows: The first digit remains off and the second and third digits flash ON/OFF together. Wrong polarity is vividly indicated thus: The first digit stays ON, while the second and third digits blank out, making it impossible not to be aware of a wrong polarity situation. And if the polarity is wrong — there's no need to reverse the leads; just flip the FUNCTION switch to the polarity-reversal position.



The large readout is easily read at a distance, making it unnecessary to be right on top of the unit to take a reading. This is a great advantage at all times, but especially when monitoring — you can be working on something else and still be able to read the 281 without being close to it.

The 281's 32 ranges include DC and AC volts (0-1 KV), DC and AC current (0-10.0 amp) and resistance (0-10.0 megohms). All ohms ranges are constant-current, a feature not found on conventional, analog meters. DC accuracy is  $\pm 1\%$  of reading,  $\pm$  digit. On the lowest ACV and DCV ranges, the 281 reads 100 mV full-scale. And test voltage on the lowest ohms ranges is only 100 mV,

eliminating the danger of harm to components in low-resistance circuits.

The 281 is lightweight and easily portable; the convenient 5-position handle doubles as a stand, for comfortable eye-level viewing. Size is 3-1/2"H x 7"W x 9"D. It operates from 105-125 VAC, 50-60 Hz and is supplied with test leads and B & K's PR-21 probe with switchable 100K ohm isolation resistor that prevents capacitive loading when measuring DC in RF circuits.

DYNASCAN CORP., 1801 W. BELLE PLAIN AVE., CHICAGO, IL 60613.  
Circle No. 133

**NEW STELLAVOX PORTABLE STEREO MIXER**

Gotham Audio Corporation announces the availability of its STELLAVOX AMI Portable Stereo Mixer. This miniature unit is completely self-contained within the identical size package of the STELLAVOX Sp-7 Recorder and features five microphone inputs each with AB condenser mike powering, low frequency roll-off, presence boost, stereo pan-pot and full high and low frequency equalization.

Two peak indicating output meters follow the two master faders and line

MAIL TO: Recording engineer/producer

Box 2287 hollywood, calif. 90028

Please include a Recording engineer/producer address label whenever you write to us about your subscription. The numbers on your address label are essential to insure prompt and accurate service.



**CHANGE OF ADDRESS**

Please let us know six weeks before you move. Place your current Recording engineer/producer address label in the space provided above and print your new address below.

Name .....

Address .....

City .....State .....Zip .....

**Don't come to New York in January ...to learn about recording technology.**

On January 8th, 1973 we're coming to Hollywood to present our accelerated 4-week professional development course, **STUDIO TECHNOLOGY & PRACTICE**.

This studio training course is now longer (70 hours), and includes studio field trips as well as texts and printed materials.

The course beginning January 8th will meet each day, Monday thru Friday for four weeks.

- Either morning or evening classes are available.
- Total fees for the course—\$375.00.
- Registration closes December 11th, 1972.

The regular 10-week term of **STUDIO TECHNOLOGY & PRACTICE** begins February 7th, 1973 in New York City. For course information, write or call.

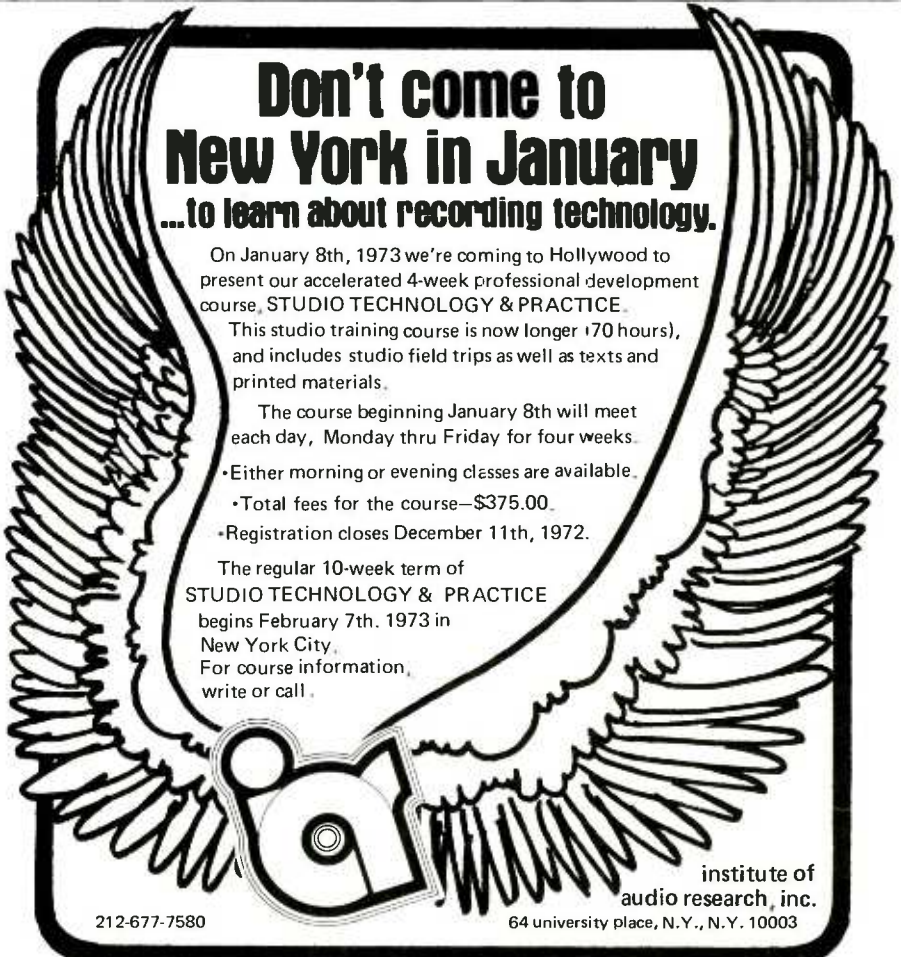

institute of audio research, inc.

212-677-7580

64 university place, N.Y., N.Y. 10003

amps. A switch permits insertion of two gain control modules in mike channels 4 and 5. Inputs are switchable to mike, mike at -20 dB sensitivity, and line input.

The Mixer is self-powered from 12 size AA pen light cells or external power supply which also serves as the charger for the Nicad cells, if used. This remarkable instrument is unique as far as its size and weight are concerned: 7 pounds including batteries.

Availability is from stock. A technical brochure is offered.

Price: \$1620.00 without batteries.

GOTHAN AUDIO CORPORATION, 2 WEST 46 STREET, NEW YORK, N.Y. 10036.

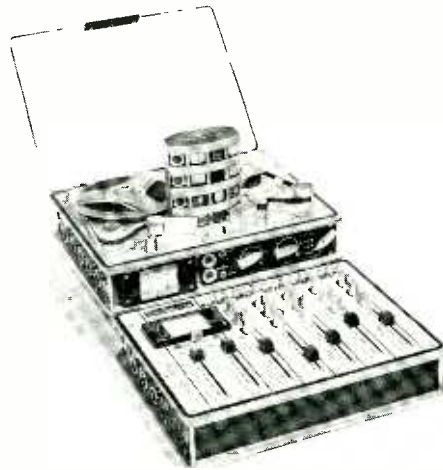

Circle No. 135

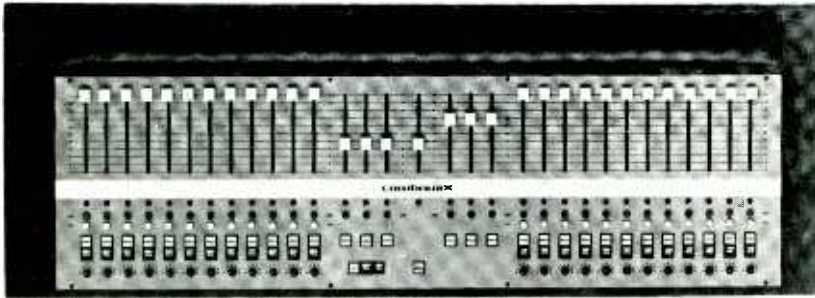

QUAD-EIGHT ELECTRONICS ANNOUNCES ITS NEW, ALL ELECTRONIC "COMPUMIX"(TM) COMPUTERIZED MIXING SYSTEM...

This is an all electronic line level piece of equipment designed to be added to present consoles or mixers for fully automated mix-down.

Its operation is described as follows: As you change the positions of your faders and/or switches to obtain a mix-down... a real time recording is made of those functions along with various pulses which facilitate sync and timing... This recording is done on any ordinary multi-track audio recorder.

The recorder information is then reconverted to control voltages and will automatically re-perform all of the level, mixing and switching functions

previously performed.

With this system correction of any errors in level or switching is accomplished by updating any individual or particular set of channels without affecting the rest of your mix. As an added advantage the preceding mix is always retained. Nothing is added to or taken from the audio in any way and so the full limits of the console, tape machine and peripheral equipment can be realized.

In addition, six sub-mixing or grouping faders are provided... They are selectable from any channel and the system is then capped off with an overall master fader for those positive repeatable fades.

QUAD/EIGHT ELECTRONICS, 11929 VOSE STREET, NORTH HOLLYWOOD, CALIFORNIA 91605.

Circle No. 136

ADVERTISERS' INDEX

AKG	8	EECO	28	Sansui	5-6-7
Allison/API	24-25	E-V	14	Shure	4th CVR
Altec	22-23	Flickinger	CVR 2	Spectra Sonics	18
Audio Designs	12-13	Heavy Sound	44	Superscope	40-41-42
Audio Techniques	39	Inst. of Audio Res.	43	Taber	33
Auditronics	36	ITJ	32	Tascam	26
Bushnell	10	McGrew	44	Telex	20
Crown	16	Quad-Eight	5-36	3-M	30
Dolby	34			Yamaha	38

CLASSIFIED

Send for FREE Catalog and Audio Applications



OPAMP LABS

172 S. Alta Vista Blvd.  
Los Angeles, Calif. 90036  
(213) 934-3566



Circle No. 137

MULTI-TRACK

8 and 16

TRACK RECORDING CONSOLES  
THE SOUNDEST DOLLAR SPENT  
IN PRO AUDIO TODAY

1965 CHEREMOYA AVE.,  
HOLLYWOOD, CALIF. 90028  
P.O. Box 3187, Hollywood, CA. 90028  
(213) 467-7890

Circle No. 138

EQUIPMENT AVAILABLE

America's Largest Selection of New and Used RECORDING EQUIPMENT

Bought, Sold, Traded — Write for Free Listing

THE MAZE CORPORATION

P. O. Box 6636, Birmingham, Alabama 35210

ONE STOP FOR ALL YOUR PROFESSIONAL AUDIO REQUIREMENTS. BOTTOM LINE ORIENTED.

F. T. C. BREWER COMPANY

P. O. Box 8057, Pensacola, Florida. 32505

PROFESSIONAL NATIONWIDE STUDIO DESIGN, INSTALLATION, AND SERVICING. PLAN BEFORE YOU SPEND!

THE MAZE CORPORATION

P. O. Box 6636, Birmingham, Alabama 35210

AUDIO EQUIPMENT NEW AND USED whatever your needs. Whether you're building a new studio or re-modeling your present one, check us first for a package price. We will not be undersold. AMBOY AUDIO ASSOCIATES, 236 Walnut St., South Amboy, N.J. 08879. (201) 721-5121

AMPEX parts, head stacks and head assemblies, complete inventory — write for price quotation. ACCURATE SOUND CORP., P.O. Box 2159, Garland, Texas 75041. Tel. (214) 278-0553.

STUDIO TAPE ELECTRONICS

Advanced design incorporates all the desired features for updating or expanding outdated recorders or building new systems. Prompt delivery. INOVONICS, INC., 1630 DELL AVE., CAMPBELL, CA. 95008

284-8 Scully Recorder. Mint condition, very low hours with sync master. \$8,000. FOB Omaha. GRANT SCHAINOST, Sound Recorders, (402) 553-1164.

MCI 16-12-8 TRACK RECORDER  
 JH-10 Deck, JH-8 Electronics and Power  
 Supply, 16 Track Head included, 2 years  
 old. Excellent condition — Extra  
 Machine \$10,900. Record Plant  
 (213) 653-0240

Synthesizer, ARP 2600-P  
 ARP Odyssey, ARP 2500  
 CHARLES M. SOLAK  
 6 Van Ness Road  
 Binghamton, New York 13905  
 (607) 797-3909

FAIRCHILD 663 Limiters — five  
 available at \$100. each. Fairchild Model  
 675 Dynamic De-esser — one available at  
 \$100. ACCURATE SOUND CORP., P.O.  
 Box 2159, Garland, Texas 75041 Tel.  
 (214) 278-0553.

SPECTRA SONICS 502 EQUALIZER,  
 one month old, \$185. G & K STUDIOS,  
 247 W. Hillside, Mesa, Ariz. 85201.

**FOR SALE**

12 in 8 out Universal Audio Tube  
 console. Excellent Condition. As is  
 \$6,000, installed anywhere in  
 Continental US \$6,500.  
 (615) 327-9301

**EMPLOYMENT OPPORTUNITIES**

**EMPLOYMENT OPPORTUNITY**

Leader in advanced audio design,  
 engineering, and fabricator of high  
 quality audio systems desires sales  
 oriented individual. Must have audio  
 experience and education in electronics.  
 Position is in Los Angeles area. Salary +.  
 All replies in strictest confidence. Send  
 resume (include position history) and  
 salary requirements to DEPT. CM,  
 R.E/P, Box 2287, Hollywood, CA 90028

LEON RUSSELL  
 and DENNY CORDELL

are looking for FULL TIME  
 STUDIO BALANCE ENGINEER and  
 STUDIO MAINTENANCE ENGINEER  
 for their superb  
 SHELTER RECORDS Recording Complex  
 in TULSA, OKLAHOMA  
 Contact Miss Eileen with particulars at  
 213:660-1605, SHELTER RECORDING  
 CO. INC., 5112 Hollywood Blvd., Los  
 Angeles, CA.

**FOUR-CHANNEL "UNIVERSAL  
 DECODER" I.C. CHIP AVAILABLE  
 FROM ELECTRO-VOICE**

Electro-Voice, Inc., a Gulston  
 subsidiary, has announced that its  
 patented Universal four-channel Decoder  
 circuitry is now available to original  
 equipment manufacturers in miniature  
 integrated circuit chip form. The  
 universal circuitry accurately decodes any  
 four-channel matrixed material including  
 E-V STEREO-4, CBS SQ, and all other  
 present systems without manual  
 switching. The Electro-Voice I.C. chip

contains all circuitry necessary except  
 power supply and a simple phase shift  
 network. The I.C. can be utilized at  
 different points in the audio circuit  
 depending on the extent of control vs.  
 economy desired. The original  
 "STEREO-4" I.C. chip is also still  
 available from E-V.

Purchase of the I.C. chip from  
 Electro-Voice includes any applicable  
 license fees or royalties. A recently  
 announced agreement in principle  
 between Columbia Records and  
 Electro-Voice allows E-V to produce  
 chips to decode records made for the SQ  
 system. U.S. Patent number 3,632,886,  
 for which Electro-Voice is exclusive  
 licensee, covers "all current or announced  
 matrixing systems," according to  
 company officials.

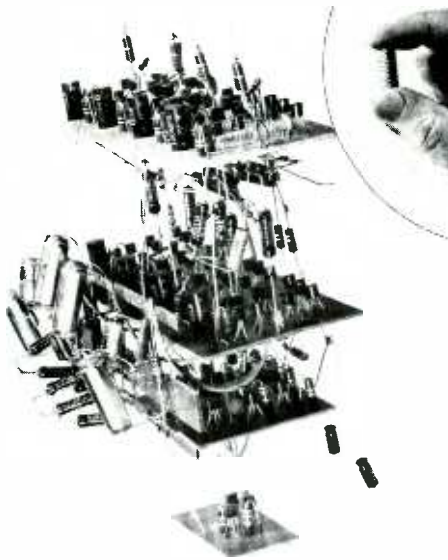

*decoder chip vs. equivalent components*

Inquiries about the E-V Universal  
 Decoder circuitry, including purchase of  
 chips, should be directed to Mr. Marc  
 Johnson, vice president o.e.m. sales,  
 Electro-Voice, Inc., 600 Cecil Street,  
 Buchanan, Michigan, 49107.

**NEW SMPTE EDIT CODE BOOKLET**

Uses, advantages and format of the  
 New SMPTE Edit Code are covered in a  
 new 12 page booklet available from  
 EECO (Electronic Engineering Company  
 of California).

Proposed as the industry standard for  
 electronic indexing and editing of  
 magnetic tapes, the SMPTE Edit Code is  
 being rapidly adapted by the  
 manufacturers of editing equipment.

Copies of the booklet are available  
 from: Electronic Engineering Company  
 of California, Dept. RP, Broadcast  
 Product Group, 1441 E. Chestnut  
 Avenue, Santa Ana, California 92701.

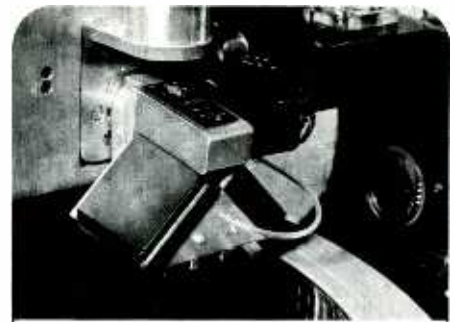

**Cut it  
 in half** ... Half the cost, time,  
 and worry, at  
 Dick McGrew  
 Recording Service  
 in Dallas.

Dick beats the  
 competition with record master costs like \$30  
 per side for stereo 12 inch 33 1/3 rpm, and  
 \$10 per side for 45's. The day he receives  
 your tape, he'll groove your master with the  
 Neumann SX 68 cutter, the ultimate in cutting  
 machines. Dick'll give it the individual and  
 expert attention of a man who does a lot of  
 producing himself.

For no extra charge, Dick will provide equal-  
 ization, reverberation, or other special services  
 at your request. And he's used to giving atten-  
 tion to problem tapes.

Interested in album pressing or singles?  
 Dick's got a competitive price list for these  
 services, too. Let us hear you!

**Dick McGrew**  
 recording service

7027 TWIN HILLS AVE. • DALLAS 75231 • 214 691-5107

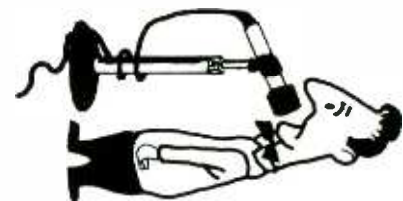

**ISN'T IT HARD TO PERFORM YOUR BEST  
 WITH REMOTE COSTS SO HIGH?**

It's pretty hard to get into the right frame of mind to do the  
 best performance when you are running up high remote  
 recording costs. One mistake can cost you many dollars in  
 recording time. The Heavy Sound Company changes much  
 less than half of most companies.

We have recorded for just about every major recording  
 company and have recorded 75% of all radio concerts in  
 Southern Calif. We record in 4 channels that sound like 16.  
 Remote 8 channels coming soon. Check our quality - check  
 our rates. Then the only thing you'll have to think about is  
 performing your best.

**HEAVY SOUND COMPANY**

5706 Lankershim Blvd. • No. Hollywood, Calif. 91601  
 (213) 387-5645 • (213) 893-5442 • (213) 769-9234  
**WE RECORD ANYWHERE!**

Circle No. 139

Circle No. 140



## Wally Heider and friend.



When Wally Heider, the internationally known master of the art of location recording, talks about recording techniques, we're very frank to admit that we listen! Imagine how pleased we were to hear him talking about our own SM53 unidirectional dynamic microphone in terms such as these: "The loudest guys in the world, screaming into them, won't break them up"; or "They sound good on any assignment"; or "The front-to-back characteristics are excellent"; or "Whenever I'm not locked into a performer's own pet microphone, I prefer to use the SM53." We can tell you about eight provable advantages that can make the SM53 your most effective and reliable recording microphone.

Shure Brothers Inc.  
222 Hartrey Ave., Evanston, Ill. 60204.



Circle No. 141