

FEBRUARY 1975
VOLUME 6 - NUMBER 1

INCLUDING: CONCERT SOUND REINFORCEMENT

RECORDING

engineer/producer

1002 2POME ROYDD
DOUG POMEROY
COLUMBIA RECORDS
49 E 52ND ST
NEW YORK

NY 10022



RELATING RECORDING SCIENCE • TO RECORDING ART • TO RECORDING EQUIPMENT

EVERYTHING AUDIO



Studios by design...

not by accident

Accept our invitation to contact us and discuss your studio needs. 14045 Sherman Way, Van Nuys, California 91405 / (213) 873-4447

INSTALL IT AND FORGET IT!

WE BUILD AND TEST EACH AMPLIFIER WITH THE CONVICTION THAT WE'LL NEVER SEE IT AGAIN

That's why 25% of our people work in inspection and verification. And we have this confidence in our amplifiers because our people make sure you receive a better amplifier than you ordered. You'll find the Crown line of power amplifiers unique in both specifications and operation. And that kind of confidence you can pass on to your clients.

Output Power: 30 watts per channel minimum RMS (both channels operating) into an 8 ohm load over a bandwidth of 35 Hz—15 KHz at a rated RMS sum total harmonic distortion of 0.05%.
Dimensions: 19" wide by 8 $\frac{3}{4}$ " deep by 1 $\frac{3}{4}$ " high.
Weight: 10 lbs.



The Crown D-60 stereo amplifier, small in size, big in value and adaptability. Its uses include headphone power supply for system monitoring; ideal power for high-efficiency speakers; can be easily used in bi-amping and tri-amping situations and can be field modified to produce 25 volt monaural output power for industrial sound distribution systems.

Output Power: 75 watts per channel minimum RMS (both channels operating) into an 8 ohm load over a bandwidth of 1 Hz—20 KHz at a rated RMS sum total harmonic distortion of 0.05%.
Dimensions: 17" wide by 8 $\frac{3}{4}$ " deep by 5 $\frac{1}{4}$ " high.
Weight: 24 lbs.



The D-150 medium power amplifier, is by design an ideal audio amplifier with the kind of rugged reliability needed in portable sound systems. Especially where one to one amp/speaker ratios are used. Well known Crown protection circuits are an integral part of the D-150. Protection from mismatched or shorted loads is provided, and a series limiting resistor protects against excessive input signals. Controlled slewing-rate voltage amplifiers protect against RF burnouts. And a thermal switch cuts AC line power if overheating occurs from improper ventilation.

Output Power: 155 watts per channel minimum RMS (both channels operating) into an 8 ohm load over a bandwidth of 1 Hz—20 KHz at a rated RMS sum total harmonic distortion of 0.05%.
Dimensions: 19" wide by 9 $\frac{3}{4}$ " deep by 7" high.
Weight: 45 lbs.

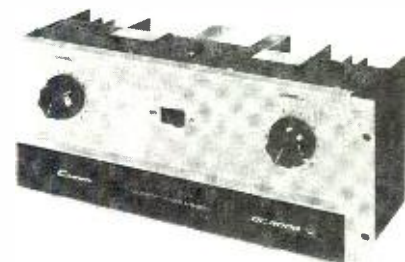

The Crown DC-300A. High power is first thought of when referring to a "super" amplifier. However, this Crown amplifier is also super in its reliability; super in its capability to deliver sound without distortion, and super in its ability to power any type of load, from 2.5 to 16 ohms, resistive or reactive! And whether it powers a multi-speaker theatre system or is on line with a group of twenty or thirty DC-300A's for an outdoor rock session, this amplifier delivers 100%. And we know that in whatever application you use it, the DC-300A will give you the kind of reliability you're looking for.

Output Power: 600 watts minimum RMS into an 8 ohms load over a bandwidth of 1 Hz—20 KHz at a rated RMS sum total harmonic distortion of 0.05%.
Dimensions: 19" wide by 16 $\frac{1}{2}$ " deep by 8 $\frac{3}{4}$ " high.
Weight: 92 lbs.



The Crown M-600 power amplifier was designed specifically for applications requiring relatively high power levels. The M-600 maintains all the exacting Crown laboratory performance standards, plus featuring built-in cooling for continuous full power operation.

The M-600 also features Crown's patented protection circuitry allowing it to drive highly reactive and low impedance loads without adverse effects. A newly patented output bridge circuit permits extremely high power levels to be sustained safely.

If by this time you do not have enough power to do the job, consider the M-2000, DC-1200 or the DC-4000. These configurations are combinations of the M-600 and are specifically designed for applications where huge amounts of power (2 kilowatts plus) are needed.

Crown amps are widely known for superior performance and reliability, and like every Crown product are covered by a comprehensive warranty which includes parts, labor and round-trip shipping for three years.

 **crown**
BOX 1000 • ELKHART, IN. 46514 • 219 / 294-5571

PROFESSIONAL MIXERS FROM INTERFACE ELECTRONICS



SERIES 100 four track mainframes are fully wired with input and output connectors, power supply, VU meters, and masters, for Series 100 plugin modules listed below, in the Model 8X4, also in the 16X4 and 24X4, which are folded aluminum pans for console or trunk mounting. Modules include:

Model 100D—Basic module with track-switching, panpot, echo send, high and low equalizers, high and low rolloffs, solo switch, slider attenuator, gain set switch with input pad, line/mike switch.

Model 100B—Similar to the model 100D but with three equalizers with a choice of three frequencies on each.

Model 100C—Input module with 40 db compressor with high compression ratio to ride gain on varying signal to hold constant record level, includes equalizers, track-switching, gain set pot, slider, echo send.

Models 100AQ and 100CQ—Single input modules with four-way pan between the four tracks; CQ also has compressor as above.

Model 100R—Combination sound-system and stage monitor module feeds stereo sound system through panpots plus independent monitor feed to four monitor busses plus echo send, equalizer.

Model 100J—Stage monitor module provides eight monitor sends from each input plus three equalizers with a choice of frequency on each, rolloffs, gain set switch with input pad position, line/mike switch, mute.

SERIES 200 two track stereo mixers come in standard 8 x 2 portable two track panpot mixer with Baxendall equalizers, echo send, conductive plastic sliders, setup oscillator, master and VU meters; can be slaved to give 16 or more inputs, also nicad battery option, 16 or 24 input versions on special order.

SERIES 300 offers eight track 16 and 24 input fully wired mainframes with power and XLR type input and output connectors, plug-in input modules with nonexclusive pushbutton track selection, panpot, echo

send, cue (which doubles as monitor-only solo), three octave-wide peaking boost or cut equalizers with a choice of three frequencies on each, adjustable input gain and input pad, line/mike switch, and a six inch conductive plastic slider. Each module is provided with balanced 200 ohm mike input and bridging single ended line input, as well as module output. Using module outputs, more than eight tracks can be fed. The fully modular system also includes masters and setup oscillator on the output module, and up to three mixdown-monitor modules with automatic transfer of cue to monitor if desired, and mixer-playback switch; the talk-slate module includes slate track select and talkback/slate microphone.

ALL INTERFACE ELECTRONICS mixers are capable of performance comparable to the finest professional equipment, and insure reliability through the use of plug-in integrated circuits, plug-in modules, conductive plastic sliders, gold plated card and IC connectors, tantalum or computer-grade condensers.

COMMON SPECIFICATIONS FREQUENCY RESPONSE:

± 1 db 20—20,000 Hz

EQUALIZING:

± 12 db at specified frequencies

DISTORTION:

less than 0.1% THD @ 400Hz, + 3 VU

NOISE:

less than 0.6 microvolts equiv. input

INPUTS:

MIKE: 200 ohms balanced, XLR type connector max. level 0.5 volts RMS max. level 5 volts with int. pad

LINE: 10K unbalanced phone plug

OUTPUTS:

TRACK: approx. 1 volt RMS at zero VU unbalanced, to not less than 600 ohms, XLR connector

ECHO: same as track, but phone plug

ECHO RETURNS:

1 volt RMS into 5K required, phone plug

Shown below, the **Model 24X8 Series 300 mixer**, a 24 input eight track mixer with pushbutton track-switching, multifrequency equalizing, echo send, panpot, cue/solo, 6" conductive plastic sliders, monitor mixdowns, masters, VU's, talk/slate, module outputs, fully wired and ready to operate. Also available in 16 and 30 input mainframes. Used for studio recording up to eight tracks (more using module outputs,) mixdown of up to 24 tracks; also suitable for large sound systems, wherein the track masters may be used for submasters and the mixdowns used to give one or two grand masters.

Interface Electronics products may be ordered direct from Interface Electronics or from any of our dealers.

Dealerships are still open in some areas.



Model 8X4-100 Series 100 portable eight-input four track mixer shown above includes trackswitching, echo send, equalizing, panpot, conductive plastic sliders, VU meters, and options including interchangeable modules, internal reverb. Used for remote or small-studio recording on up to four tracks, mixdown of up to eight tracks, small sound systems (with up to four submasters), stage monitoring, production work. The Series 100 also comes in 16 and 24 input mainframes.

INTERFACE ELECTRONICS

3810 Westheimer, Houston, Texas 77027, (713) 626-1190

ALSO AT:

CALIFORNIA: Tri-Tronics, Los Angeles, (213) 985-6616

CANADA: Noresco Manufacturing, Toronto (416) 249-7316

FRANCE: Studio Equipment, Paris 225-7674

ILLINOIS: Gill Custom Palos Hills (312) 598-2400
Milam Audio, S. Pekin (309) 348-3112

ITALY: Audio Products International, Milan 292-478
MASSACHUSETTS: Terry Hanley Audio, Roxbury (617) 445-0833

MISSOURI: Armadillo Sound, St. Louis (314) 869-7842

NEW YORK: Martin Audio, New York (212) 265-6470
Boynton Studio, Morris (607) 263-5695

PENNSYLVANIA: Gordon Associates, Leola (717) 656-9226

TENNESSEE: Carlo Sound, Nashville (615) 356-0202
WISCONSIN: Satterfield Electronics, Madison (608) 257-4801

- the magazine to exclusively serve the recording studio market . . . all those whose work involves the recording of commercially marketable sound.
- the magazine produced to relate . . . RECORDING ART to RECORDING SCIENCE . . . to RECORDING EQUIPMENT.



Editor/Publisher . . . MARTIN GALLAY
 Managing Editor . . . WAYNE YENTIS
 Engineering Editors RON MALO
 WILLIAM ROBINSON
 GARY DAVIS
 Business Manager V.L. GAFFNEY
 Circulation Manager LARRY DOUGLAS
 Reader Service
 Manager SHARON LARSON
 Assistant Editor . . MARGE ANDERSON



RECORDING engineer/producer is published bi-monthly and is sent free to qualified recipients in the United States. Subscriptions for other than qualified individuals or companies may be purchased at \$6.50 per year. (All foreign subscriptions: \$7.50 per year.) Material appearing in R-e/p may not be reproduced without written permission of the Publisher.



RECORDING engineer/producer is not responsible for any claim made by any person based upon the publication by RECORDING engineer/producer of material submitted for publication.



Controlled circulation postage paid at
 Los Angeles, California.
 RECORDING & BROADCASTING
 PUBLICATIONS
 RECORDING engineer/producer
 1850 Whitley, Suite 220
 P.O. Box 2449
 Hollywood, CA 90028
 (213) 467-1111

where superior recordings begin:

ALIGNMENT
 part 1: The Tools 19 Steve Katz

the whirlwind tour that
 brought COUNTRY MUSIC
 to the
 SOVIET UNION 36 Tom Moores

MUSIC PUBLISHING
 . . . a sometimes missed
 opportunity 45 Walter E. Hurst

a transformerless
 BALANCED to UNBALANCED/
 UNBALANCED to BALANCED
 Line Converter 49 Peter De Blanc

EDITING
 . . . a nifty idea 49 Wayne Yentis

Letters and Late News 10
 New Products 53
 Classified 59

THE COVER: A fisheye view of a nearly circular control room, an experimental room, designed by Tom Hidley and built by Westlake Audio for Kendun Recorders in Burbank, CA. Another step in exploring the possibilities of acoustic geometry for creating the ideal critical listening environment.

Photography: Wayne Yentis

ADVERTISERS INDEX

AENGUS	20	INTERFACE	6
ALLISON	16-17	KELSEY	48
ALTEC	8-9	LA SALLE AUDIO	58
AMBER	14	LUMIERE	56
AMPEX	54	McGREW	63
AUDIO DESIGNS	29	MRL	50
AUDIO INDUSTRIES	12	MIC MIX	59
AUDIO TECHNIQUES	10	MODULAR AUDIO	41
AUDIO TEK	39	ORBAN/PARASOUND	13
AUDITRONICS	52	OTARI	42
BGW	15	SCULLY	23
BOSE	51	SESCOM	62
CETEC	43	SOUND GENESIS	46
COMMUNITY LT & SND	60	SHURE	CVR 4
COUNTRYMAN	51	SPECTRA SONICS	24/27
CROWN	5	STUDER	36
E-V	18	TEAC/TASCOM	44
EVENTIDE	57	UREI	11/63
EVERYTHING AUDIO	CVR 2	WESTLAKE AUDIO	31-34/47
FRAP	49	WHITE	27
INOVONICS	53		

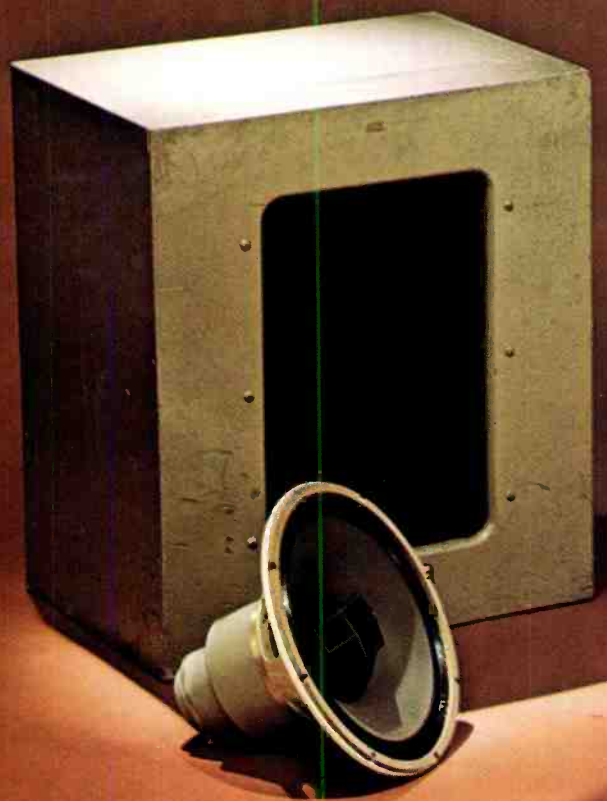

Goodbye old paint. Hello Oak.

Goodbye leader. Hello new generation.

Our new generation 604-8G has inherited quite a kingdom from the leader. We changed the 604 after 20 years as the standard monitoring reference source. We added a new dividing network that smooths the response in the crossover region, changed the frame and improved the high frequency diaphragm (it's now up 6dB at 15 kHz).

But the 604 is still the 604. The same duplex speaker delivering sparkling highs, clean midrange and exceptional low frequency transient accuracy from a single point source.

Then we developed the new 620A cabinet for the 604 speaker. The 620A replaced our painted old classic 612. Recording studios were spending thousands of dollars to sound and look beautiful. So we made the 620 enclosure beautiful on the outside. In rift-out oak. Add the 604-8G, and it sounds beautiful. In fact, the new combination delivers another full octave of usable low bass to help meet the requirements of the new generation of music. And it's loud, louder, loudest — even after a full recording day.

The 604-8G and the 620A. Together they make beautiful music.

If you want more information write us or call (714) 774-2900.

1515 S. Manchester Avenue
Anaheim, California 92803

ALTEC
the sound of experience.



Sealed Bid Sale

Audiotechniques, Inc., will accept sealed bids postmarked prior to March 25, 1975, for:

MCI JH 10 16 Track Recorder With Autolocator

This professional 16 track tape recorder was traded-in for a new MCI JH 16 recorder by a major record company. It is 5 years old and originally cost over \$19,000. The recorder is in operational condition, but requires technical ability to maintain that condition, and is sold "as is". The unit is available for inspection at the Audiotechniques' office.

Terms & Conditions

All bids must be accompanied by a certified check for 10% of amount bid. No checks will be deposited, except winner's. Checks will be returned to all unsuccessful bidders. Winning bidder will be notified both by phone and registered mail, and will then have 14 days to complete payment by certified check. Bid winner may pick up unit at Audiotechniques. For \$275, crating and delivery can be arranged to any location in the continental U.S.

To Submit A Bid

1. On 8½ x 11 paper, write bid in even dollar amounts. The minimum acceptable: \$6,000.
2. Put down your name, company name, address and telephone.
3. Enclose certified check for 10% of amount bid payable to: Audiotechniques Sealed Bids.
4. Address your bid to:
Audiotechniques, Inc.
Sealed Bids
142 Hamilton Avenue
Stamford, CT 06902

For more information, call ...

audiotechniques
142 Hamilton Ave., Stamford, CT
Telephone: 203 359 2312

Letters & Late News

From: John Calder
Smoke House Studios
Minneapolis, MN 55404

(From his letter describing his experiences while recording in London. Mr. Calder was the author of, 'THE EL-CHEAPO MIKE CORD TESTER' in the March/April 1974 issue of R-e/p. ED)

London is a special city to visit even if you don't happen to be in the music business. Piccadilly, Trafalgar, Westminster, Hyde Park, Buckingham, and the Thames are all places that evoke a sense of tourist-type awe. If you are in the music business, London is even more special because of its concentration of singers, musicians, songwriters, producers, and the recording facilities which serve them.

I had the opportunity to visit two well-known English recording studios during the course of a working vacation with a Minneapolis artist, Dale Menten. We went to London to overdub strings, brass, and backup vocals on his album, for which I had engineered the rhythm sections and lead vocals. Trident Studios (orchestral recording) and Island Studios (vocal recording) were used for the sweetening sessions. The people that I spoke with were very open and helpful and I only



String session at TRIDENT

wish that I could have reported on more than two studios.

Trident was our first stop. Amid the musical ghosts of the Beatles, the Mahavishnu Orchestra, and Elton John, we recorded a twenty-nine piece group of violins, violas, cello, trumpets, trombones, saxes, flutes, an oboe, and a harp. The three-hour session encompassed the arrangements for four songs, which meant working fast. We did! The group set-up, as pictured, allowed for the twelve violins to be split into four parts, the violas into two parts, and the cello into three parts. The Trident board (built by Triad, a division of Trident) has the feature of panning an input module's output between any two selected tracks of 24 which let us achieve a very good stereo balance on the strings while using only two tracks. The brass, oboe, and harp were spread across two more tracks, and Peter Kelsey, the engineer, did a commendable job of keeping it all straight. Incidentally, the panning feature mentioned was built into many boards that I saw. It seems like an excellent idea to me, and I, for one, would like to see it on

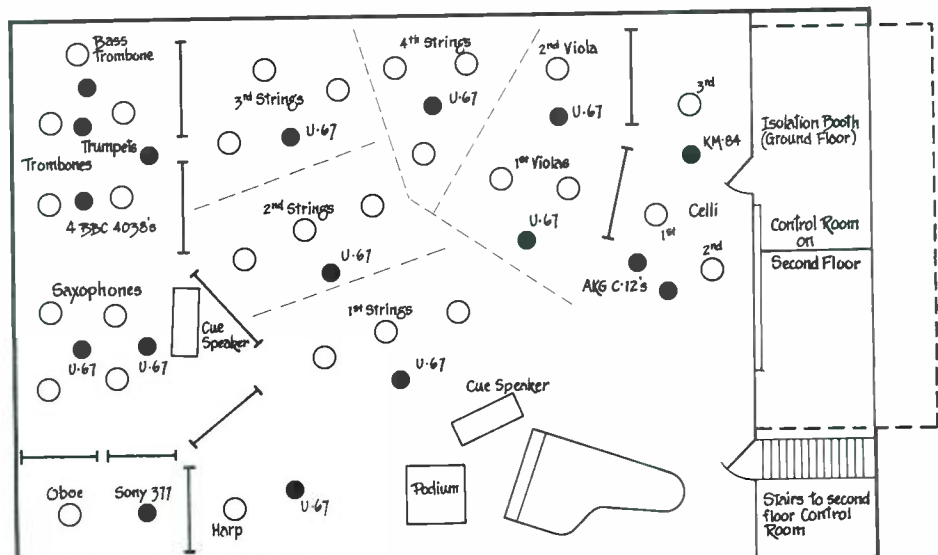

String session set-up at TRIDENT

American boards.

Trident's tape machines are 3M (16 and 24 track) and Studer (2 and full track); the control room monitors are JBL; and aside from the everpresent multi-track Dolby and a few limiters, everything else was either in the board or upstairs in the Reduction Suite (mix room to those of you unaccustomed to the Queen's English). Although I was in the mix room only briefly, it seemed quite well equipped. The monitors in this room are Caddac, the board is a bit of everything (soon to be a Triad reduction board), and there was an endless assortment of effects devices on hand. In addition, the room had a comfortable atmosphere.

Our string and brass session went well, partially because the arrangements were good (written by Dale Menten), partially because the London musicians are excellent, and also because of the studio and its staff. I spoke with Bob Hill (studio manager) and Peter Kelsey (engineer) after the session. The following excerpts are from that interview:

JOHN CALDER — *What do you feel is the trend in recording studios?*

BOB HILL — I think basically that the majority of users of recording studios are becoming far more professional in their approaches to recording; that is, producers in the past, when I first started working at the studio three and a half years ago, were perhaps not musically inclined or technically inclined. They were more people from ex-bands or something like this. But now, producers are becoming far more aware of the technicalities and the music that is involved, so the product is improving in those two areas. You are getting a better technical and musical product.

JOHN CALDER — *How does your studio differ from others?*

BOB HILL — Certain studios have a charisma which is very difficult to pinpoint. I think that there are three or four factors. One of the major factors in this particular studio is the fact that it was opened at the hayday of British pop music when the Beatles were very big and when Apple Corporation was being formed. They didn't have a studio of their own so the Beatles started using this studio. The persons involved in starting this studio have an attitude which is ideal for the pop music business and entertainment in general. They are easygoing but professional in the way they handle a situation like this. I think the building and the shape of the building and its peculiarities, which every studio has, contributes very much and I also think that the staff and the engineers contribute very much. So I think it is a combination of management, building, and staff, and of course, the equipment. We have always had a policy of having the most up-to-date equipment.

Does Your Speaker System Have

Tweeter - Woofers Troubles?



Passive filters often have excessive phase shift, are inefficient and soak up power. Woofers begin to tweet and tweeters woof.

Try our new 521 Active Crossovers. They let you select the optimum crossover frequencies for your two or three way speaker systems. No need to change fixed components. Our 521 plug-in cards are continuously tunable from 200 Hz to 2 kHz (521-L) and 1 Hz to 10 kHz (521-H). Filter attenuation is 12 dB per octave or 18 dB per octave (optional). UREI quality, of course.

The 521-P shown below holds four crossover cards with its own internal power supply. For larger installations, up to eleven cards can be mounted in 3-1/2" of rack space.

521's ahead of your own good power amps increase efficiency and quality of all two and three way speaker systems.

Available from your UREI dealer.



11922 Valerio Street, No. Hollywood, California 91605 (213) 764-1500
Exclusive export agent: Gotham Export Corporation, New York

JOHN CALDER — What do you feel makes a good engineer?

BOB HILL — Several things. One is a very good ear for music and sound perfection. Another one is a logical approach. One who can keep cool under pressure and one that can get on with clients, which is very important. I think that is possibly the most important factor.

JOHN CALDER — What do you think are the most important aspects of a good studio?

BOB HILL — A good studio, you must remember, is a facility and it is catering for clients; the very hypercritical requirements that the clients have and, therefore, that one must be technically aware, technically competent, and also he must have the type of personnel that are easy to get along with; so they must be very well managed, very tightly controlled, but it mustn't be apparent to the clients that there is a tight management control, so it must have a relaxed atmosphere, but be very well handled.

JOHN CALDER — Can you describe your acoustics and how they effect your sessions?

BOB HILL — The acoustics are not ideal in this studio. They are ideal for the type of sound we are renowned for. We have the peculiar advantage of having a unique sound and this is probably due to the construction of the studio itself. Our control room is an awkward shape, due to

the access to the studio, so we have had to build a corner into it so that the control room is basically only useful for recording sounds and is only useful if it is recorded with an engineer who is aware of the peculiarities of the room acoustically. The reduction room is probably the secret, in total, to the acoustics success we have had in recording music. The reduction room has completely flat response.

JOHN CALDER — What do you feel are the major differences between English and American studios?

BOB HILL — It is a peculiar situation insofar as most people in the American music business figure that the British sounds are better and vice versa, but I think, fundamentally, what the difference is is that the British music industry has recently taken a dramatic change and has become important on a worldwide basis, which is in the last ten years, the last decade, on the back of such acts as the Rolling Stones and the Beatles, and consequently, we tend to have a very much younger engineer than the average in the States. Like an engineer's life in this country usually ends at the age of twenty-five. They have done their whole trip and they start at about the age of twenty so they are more aware of what is currently in vogue and they usually add their own creativity to the recording. I think the British music industry is still so much in

its infancy that a lot of control and a lot of the functions of management and production and engineering is fundamentally basking, whereas the American music industry is typical of all American industry, it is run on very efficient lines which not necessarily is correct. It is not necessarily the correct atmosphere for creativity. *JOHN CALDER — Do you feel in general that British studios are eclectic, that they seem to have less of the "new-building-million-dollar-facility-polish" that several American studios have gotten?*

BOB HILL — I am not sure that a large capital expenditure makes necessarily a good result. I think that possibly one should look at what one requires and find something to accommodate it, rather than construct something around your requirements. If one builds a studio from scratch, you tend to build it clinically perfect, you lose all of the ambience and the feel and the coloration that British studios have. They are all in buildings that were used for other purposes long since.

JOHN CALDER — What qualities do you feel make a good engineer?

PETER KELSEY — He has to have a good personality to be able to get on with the producer and the artist and everything. He also has to have enough technical knowledge to get the stuff onto tape and get past any kind of breakdowns that he might encounter; and a good ear.

FROM INPUT TO OUTPUT... YOU GET MORE THAN A CHOICE OF ONE · ONE · ONE · ONE

AKG ... Ampex ... UREI ... Crown ... Beyer ... MCI ... Neumann ... EMT ... Cetec
Shure ... Sony ... Vega Wireless ... Atlas ... Bozak ... Electrodyne ... JBL ... Sparta
Langevin ... Allison Research ... Fairchild ... Gotham Audio ... Thorens ... Eventide
Quad Eight ... Soundolier ... Parametric ... Bogen ... Ortofon ... Dukane ... Dolby
Countryman ... Multisync ... Pultec ... Orban/Parasound ... Revox ... Ampex Tape
Sennheiser ... DBX ... Tascam ... Uher ... McIntosh ... Maxell Tape ... David Clark
SAE ... Community Light & Sound ... Koss ... Tannoy ... Electro Sound ... Pandora
Studer ... QRK ... 3M Tape ... SME ... Electro Voice ... Micmix ... Nakamichi

HIGH INTENSITY SOUND SYSTEMS—

ADVANCED TECHNOLOGY TURNKEY STUDIO INSTALLATIONS

Get fast delivery ... and selection-in-depth from **audio industries'** vast inventory of professional equipment. National networks, major studios and special audio users do and they save time and dollars. **The AIC Difference is Satisfaction**



Just One Call Does It! (213) 851-4111 ■ Rent, Lease or Buy ■

audio industries corporation

1419 N. LA BREA AVENUE ■ HOLLYWOOD, CALIF. 90028 ■ TELEX 67-7363

JOHN CALDER — *Having seen the way you set up for strings and brass, I'm interested in what mics you use for rhythm sections.*

PETER KELSEY — For drums I use an AKG D-25 on bass drum, the Sony mics that we have downstairs (C 330) on the snare, AKG C-28's on toms, and either Beyer on the top kit or C-28's. On piano I use two U-67's (Neumann) away from the hammers but not over the sound holes, more toward the strings. On vocals I prefer U-67's or U-87's, although I have used AKG C-12's or Sonys.

JOHN CALDER — *Do you think it is important for an engineer to have a musical background or an electronic background or both or what?*

PETER KELSEY — I'd think he needs some type of musical background because of the fact that in some cases he will play a part in the production role.

JOHN CALDER — *Do you do most of your equalization during the recording of the tracks or do you EQ mostly in the mix?*

PETER KELSEY — I try to do as much as I can while I am actually recording, but leaving it full enough so that if you want to change something when you get to the mix, you can do it.

JOHN CALDER — *Would you say that you EQ quite a bit or very little? What type of EQ generally?*

PETER KELSEY — I think I EQ quite a

bit. I generally add top end because of the room being bright; therefore, when you take it out of there it tends to lack top, so I add perhaps a little more than you would like to hear so that when you take it out, it sounds better.

JOHN CALDER — *Can you describe the acoustics of your studio and how they relate to your sessions?*

PETER KELSEY — The control room, in addition to being bright, also tends to cover up low bass. When you take it out of there, you find you have got more really low bass than you anticipated. The actual studio itself — I really don't know how to describe it.

JOHN CALDER — *Are there sections you use for liveness and sections for deadness?*

PETER KELSEY — Yes, we use the end where the brass were today — it is more live down at that end and I would tend to put them down there.

JOHN CALDER — *You have a drum isolation room and it looks quite live — is it?*

PETER KELSEY — It is not really very live. If I wanted a more live sound I would put them down in the end where the brass were today and completely block the whole end off from the rest of the studio.

JOHN CALDER — *Do you have any favorite or unique special effects?*

PETER KELSEY — I do use some special effects — delays mainly, delayed echo quite a lot, ADT (Automatic Double



Peter Kelsey Dale Menten at Trident

Tracking), using the Gotham Audio, which can make something sound quite live. Also an effect where you can get something to leap from side to side. Using two tape loops and feeding them into each other you get a similar effect to tape echo, but moving from side to side.

Our next stop was Island Studios for a few vocal overdubs with a pair of extraordinary people — Sue and Sunny. If you are unfamiliar with their names, look in the credit sections of albums by Cat Stevens, Elton John, Tom Jones, and countless other top artists. These two sisters know every vocal lick under the sun (or clouds in England), and they use them well. They were very easy to work with, and Phil Brown (the engineer) has worked with them many times, which made the session even easier. We recorded in Island's Studio Two, a small room with a relaxed atmosphere. The control room has a Helios board (or "desk"), Tannoy

Introducing the \$299 Stereo Synthesizer.

We cut the fat from the package.

We redesigned the circuit with state of the art components.

We built in larger quantity.

The result: we were able to cut 60% off the old price without sacrificing performance.

Now the smaller FM stereo station can afford to process old records, announce mikes, and mono spots, while eliminating phase cancellation problems in mono reception. And any recording studio can save tracks by recording strings, drums, or horns in mono and spreading them in the mix.

The synthesizer will stereoize a mono reverb device (like our own model 106CX). And it's ideal for reissuing old mono masters in synthesized stereo.

The output is fully stereo/mono compatible — just add the outputs to obtain the original mono

input. Setup is a snap, and the unit can be adjusted in seconds for different kinds of program material.

At \$299, the new Orban/Parasound model 245E is an essential addition to your collection of audio processing gear. An explanation of its operating principles and an extensive collection of applications are detailed in our brochure, available on request.

Also inquire about our Spring Reverb, De-esser and Parametric Equalizer, all with outstanding price performance characteristics.

orban/parasound

680 Beach Street
San Francisco, Calif. 94109
(415) 776-2808



Now every professional who needs stereo synthesis can afford the best.



monitors, and a healthy compliment of limiters, delay lines, EQ, phasers, and the like. The tape machines are 3M (16 and 24 track) and Studer (2 and full track) with Dolby.

Both of their studios (one upstairs, one downstairs) have nearly identical control rooms. If you know one control room, you are familiar with both of them.

Again we did four songs in three hours, and again the session went well. After the session, I interviewed Phil Brown and the following are excerpts from our conversation:

JOHN CALDER – *Aside from the U-87 used on the vocal session today, what do you use for your instrumental miking?*

PHIL BROWN – On drums I use four

U-87's, 2 overhead and the other 2 for the tom-toms; an AKG D-20 for bass drum and an AKG 224 for snare. The two overheads are set up for stereo, picking up hi-hat, cymbals, and general liveness. It will obviously vary if it is a big kit. On piano I usually use U-87's, over the strings, one up to the highs on the left pointing towards the highs and the other towards the bass end, and you can get quite good stereo.

JOHN CALDER – *What about strings and brass?*

PHIL BROWN – AKG D-20's for cello and standup double bass, but then again usually 87's for the rest of the string section. I am a lover of 87's. I put them quite high up, about six feet overhead for large string sections, and I usually work one between about three violins. I am still kind of experimenting finding good mics for horns. I use 87's to a degree on things like trumpets, but saxes and trombones I often use D-20's – I shift between those two.

JOHN CALDER – *Do you do most of your equalization during the recording of the tracks or do you EQ mostly in the mix?*

PHIL BROWN – I don't actually use a lot of EQ. I use a fair amount when we are working merely to get it say 80% the way I want it, and I know when we come to mixing with a bit more EQ, I can get the sound I want.

JOHN CALDER – *What type of EQ do*

you usually use?

PHIL BROWN – I like brights. I usually boost a fair amount of top at 10K, middle I like using around 100 for guitars, things like that, and bass end I usually use 60 or 100.

JOHN CALDER – *Can you describe the acoustics of your studio and how they relate to your sessions?*

PHIL BROWN – This studio down here has plaster walls with curtains so you have it fairly dead or if you open the curtains you can get a live sound, so you have a choice; but mainly I work, because of the size of the studio down here, with the curtains closed as a dead sound, but I like mainly working in studios that are fairly semi-live. I don't like dead sounds as such.

JOHN CALDER – *Do you try and go for a certain area of the room live or dead?*

PHIL BROWN – Yeah, I usually open the curtains up behind the drum kit so that the drums are crisp and live but the bass, piano and other things you have got to have a fairly dead sound.

JOHN CALDER – *How about the studio upstairs?*

PHIL BROWN – It is quite a large studio up there, but with baffles and other sundry things like that, damping the piano down, you can work quite easily with it.

JOHN CALDER – *So you have a favorite special effect?*

Why does Studio Tempo use the Amber Audio Spectrum Display?

Studio Tempo uses an Amber Audio Spectrum Display in their Montreal recording studio.

Michel Lachance, Chief Engineer, explains why:

"I use the display primarily during mixing to prevent problems later on in mastering. I constantly watch the display during a mix to ensure my tape does not have excessive high or low frequency energy. If I want to highlight a particular instrument I can see the effects of equalization or other forms of processing. The peak responding characteristics of the display give far more information about what's on a tape than a VU meter.

"One very handy thing I use the display for is verification of performance of equipment. I'm very particular about alignment, and I like to put a sweep tape on our 24 track before each session and read each track with the display. It shows exactly in dB any response errors and all 24 tracks can be checked in minutes."

See for yourself. Contact Amber for the name of a nearby dealer and arrange for a demonstration in your studio – it really works.

Amber model 4550 Audio Spectrum Display
\$1,800 US List

AMBER ELECTRO DESIGN LTD
1064 CHEMIN DU GOLF
MONTRÉAL QUÉBEC CANADA
H3E 1H4

amber 751-769-2739

PHIL BROWN — I enjoy using these ADT machines on vocals and different things to fatten up the tracks and you can adjust it and get a live-ish sound and even if something is dead, you can put life back in it.

JOHN CALDER — *What do you feel are the major differences between English and American studios?*

PHIL BROWN — Well, mainly the desk I have picked up as the biggest difference. The desks over there are literally just basic, I mean they give you the EQ which is often very good, the EQ usually hits a different frequency than over here. You have to plug in just about everything else you want. The studios themselves, on the whole, are dead and a completely different assortment of mics, which has been quite interesting to get into different mics. There have been some really nice mics over there that I have never even seen.

JOHN CALDER — *The main difference between English and American engineers?*

PHIL BROWN — I think American engineers may be more technically concerned. I noticed a lot when we were working over there, there are scopes and gadgets around the desk telling you if you were in phase or distorting or overloading and this kind of thing, whereas over here you very rarely see that, it is down to your ears, if you hear it or not, which you should.

After finishing the session and interview at Island, I went on to visit four other studios (AIR London, EMI, Olympic, and Ringo's new studio, Startling). Each studio had its own identity, atmosphere, and sound (or sounds), and my preconceived ideas of the "English Sound" went down the tubes. I think more audio differences exist between artists and engineers than between countries or cities. It is becoming harder and harder to tell where something was recorded and that is a good sign to me. Little do I expect everyone (anyone?) to agree with me, but the English vacation was very enjoyable, even if I'm wrong. I wonder what the studios in France are like . . .

HEIDER RECORDING, BROADCAST ELECTRONICS JOINED IN FILMWAY'S BROADCAST AND SOUND SERVICE GROUP

Mr. Richard L. Bloch, President and Chairman of the Board of Filmways, Inc., announces the establishment of the Broadcast and Sound Services Group.

This action brings together under one executive group head two Filmways subsidiaries: Broadcast Electronics, Inc. of Silver Spring, Maryland and the Wally Heider Recording Studios of Hollywood and San Francisco, California. Andrew Szegda, President of Broadcast Electronics, Inc., becomes the group president of this new Filmways division.

AMPEX—BURWEN MARKETING PACT

Ampex Corporation today announced it had reached agreement with Ohmtec Corporation to distribute Burwen Laboratories Dynamic Noise Filters used in broadcasting, recording studios and communications.

The agreement gives Ampex exclusive distribution rights in international markets and non-exclusive rights within the United States.

Charles A. Steinberg, Ampex vice president — general manager of the audio-video systems division, said the contract with Ohmtec, the parent company of Burwen Laboratories, begins January 27, 1975.

"The Burwen line of professional products is ideal for reducing the noise on audio signals and is expected to expand sales of Ampex recording equipment," Steinberg said.

"By joining in distribution of the Burwen noise filters we make maximum use of our worldwide sales force by selling devices that complement our own product lines," he said.

Burwen president Dick Burwen said Ampex's worldwide marketing strength will expand marketing and sales of Burwen products internationally.

continued on page 50

An Event...





A Mark Robson - Filmmakers Group Production
A UNIVERSAL PICTURE • TECHNICOLOR • PANAVISION

SHOOK YOU USING BGW POWER AMPLIFIERS

Universal Studios' professional sound experts consider BGW amplifiers reliable, safe and powerful enough for their great new movie sensation.



Hundreds of BGW Model 750A's have been installed in theaters around the world for

SENSURROUND™

This same amplifier will create unbelievable sound in your home system.



BGW Systems
P.O. Box 3742
Beverly Hills
CA 90212
(213) 391-0320

BGW has five other power amps and two studio quality preamplifiers making BGW the critics' choice.

NEWS FLASH!!

Friday, February 1, 1975

Creative Workshop, Nashville, Tenn. decided they would like to have automation *in the console* for their grand opening on February 8. The console was a Sphere 20 by 16, in a brand new Westlake room, interfaced by Valley Audio Services of Nashville.

Thursday, February 7, 1975

We, together with Valley Audio Services, made the installation of a 16 track Memories Little Helper system. Since the console used card edge connectors on the faders, we were able to complete the installation in just over 3 hours, without cutting a wire.

Friday morning, February 8, 1975

A producer from New York City called us. He had some 16 track mixdowns to do and he wanted our automation. We mentioned the installation at Creative Workshop.

Friday afternoon, February 8, 1975

Creative Workshop informed us that the producer from New York had just booked 50 hours of automated mixdown time!



**allison research inc.
nashville, tennessee
(615) 385-1760**

P.S. The grand opening was a howling success. Just ask one of the hundreds of Nashville music people who attended.

P.P.S. Welcome two new active Memories Little Helper sales organizations:
Valley Audio Services, Nashville, Tenn. (615) 889-7603
Sigma Sound Studios, Philadelphia, Pa. (215) 561-3660

**pick up one of our new automated mixdown
demo records (at your local record shop)**

THAD JONES & MEL LEWIS
MIGHTY CLOUDS OF JOY
THE SOUL SURVIVERS
JOHN LEE HOOKER
THE ISLEY BROS.
THE BLUE NOTES
THE PERSUADERS
THE MANHATTENS
STEVIE WONDER
JOHN COLTRANE
THE INTRUDERS
LEON RUSSELL
THE SPINNERS
QUINCY JONES
THE TRAMMPS
BILLY PAUL
BLUE MAGIC
PEGGY LEE
THE TYMES
MANDRILL
BB KING
SYREETA
OJAYS
MFSB



**allison research inc.
nashville, tennessee
(615) 385-1760**

**you, too, can automate your console with
memories little helper
for as little as \$9250.00**

For sheer reliability, few things can beat our RE15 microphone:

And we're conceding only the slightest of edges to the sun.

Because the RE15 is one mike you can always count on to give you the same reliable response at any distance, any angle. It's a Continuously Variable-D® cardioid microphone—an exclusive E-V design*. Once you've set your equalization, all that varies is the level.

Unwanted noise is no problem, either. Not with a super cardioid pattern that provides maximum rejection at 150° off axis. So when the mike is tilted in its most natural position—30° from horizontal—you'll be sure of getting maximum rejection in the horizontal plane. And there's a 100-Hz cutoff "bass tilt" switch for boom use and

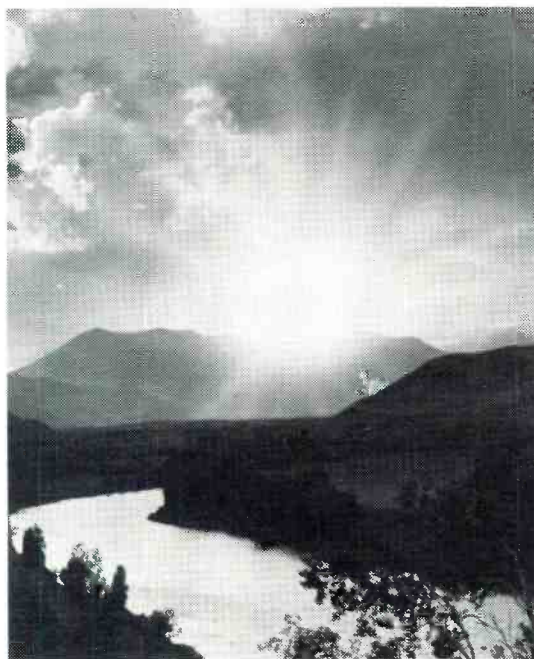

other long reach situations.

Other features abound. Like a "hum buck" coil to supply an extra 25 dB of hum rejection. And a rugged design that stands up to shock and mechanical abuse.

The Electro-Voice RE15. So you can work with confidence in the most demanding professional applications.

RE15...\$180.00. RE16...(with blast filter) \$190.20. And for slightly less demanding situations, RE10...\$110.10. RE11 (with blast filter)...\$120.00. Suggested Resale Net Prices. Slightly higher in Western States.

*U.S. Patent Number 3,115,207. Trade mark registered.

Electro-Voice INC
a **gulton** company

Electro-Voice, Inc., Dept. 251RP
674 Cecil Street, Buchanan, Michigan 49107



WHERE SUPERIOR RECORDINGS BEGIN:

ALIGNMENT

PART 1: THE TOOLS

BY STEVE KATZ

The new generations of high performance recording media, as well as equipment, offers, today, the promise of truly incredible levels of audio recording fidelity. These remarkable recent developments demand, if their potentials are to be fully exploited, a parallel sophistication in

Before we even get into a discussion of test tapes and their uses there is a question I'm sure is on everyone's mind. Why did you choose to make your test tapes at 200 nWb/m as opposed to the Ampex standard of 185 nWb/m?

J. McKNIGHT: Our reference fluxivity of 200 nWb/m was chosen from the list of Preferred Numbers, ANSI Standard Z17.1, which includes the preferred numerical values of 160 and 200.*

From an operating point of view, the present tapes have generally higher saturation fluxivity and lower distortion than those available when Ampex determined their reference fluxivity of 185 nWb/m at 700Hz. While the older tapes gave 1% harmonic distortion at 185 nWb/m at 700Hz, present day tapes have less than 0.7% distortion under the same conditions. Therefore it seemed most reasonable to choose the next higher preferred number, 200, rather than the next lower number, 160.

You not only chose a different flux level, but a different reference frequency.

J. McKNIGHT: In designing the MRL test tapes, we were faced with the decision of making a test tape which would be directly interchangeable with existing commercial USA test tapes, or of making what we felt would be an improved format. We chose the latter course, feeling that these test tapes would be in fact enough better in convenience of use, and also in uniformity of manufacture.

continued on page 25 . . .

**Author's note: This standard refers to a method of deriving a series of numbers which are convenient to use in audio work. The series is developed by taking the number $10^{1/10}$ (which equals approximately 1.26) to successive powers and rounding off. Thus $1.26^{22} = 160$, $1.26^{23} = 200$, and $1.26^{24} = 250$. This series also corresponds to the frequencies commonly found in 1/3 octave filters.*

studio operation – more specifically, an increased understanding and ability to optimize the performance of every piece of equipment in the recording chain.

As we began to consider various approaches to serializing a compilation of suggestions for “peaking” (calibrating) the recording chain it became obvious that the entire subject is levered by the calibration standards which exist.

Discussion, here, of these standards by STANDARD TAPE LABS' Bob Morrison, and MAGNETIC REFERENCE LABS' J. McKnight, both the eminent authorities on the subject, combines a general background understanding of what is involved as well as very helpful day-to-day operational guidelines.

Future discussions will relate to the understanding that this article may have supplied.

Steve Katz is an applications engineer for Dolby Laboratories, located in Los Angeles, where he is concentrating on development of noise reduction for the film industry. He had previously been chief engineer at Sound Exchange Studio in New York, as well as having been associated with Studio Supply Co., and Burwen Laboratories.

Why do you choose to follow the 185 nWb/m reference level for the STL test tapes?

BOB MORRISON: As you have indicated, the primary theme of this article, is a discussion of tape operating levels particularly as related to the use of Dolby equipment, I should therefore get right to the heart of the matter and state the reasons for our STL test tapes being referenced to 185 nWb/m. At the risk of oversimplifying, I'll list them:

(1) Twenty five plus years of masters have been made at the 185 nWb/m level. Most of the studio masters are referenced to this level including those Dolbyized.

(2) Thousands of Dolby channels have been set up TO FACTORY RECOMMENDATIONS at the 185 level. (Please consult the Dolby Set Up sheet which we quote here verbatim:

“You will need three things:

(1) A test tape with level setting tone either at Ampex (NAB) operating level (185 nWb/m) or at DIN level (320 nWb/m). DO NOT USE TEST TAPES AT ANY OTHER LEVEL” etc., etc.

Also please refer to specification sheet for Model 361 on Page 3.2 of the Dolby manual, under Panel Meter where the above specification is repeated.

(3) It is hard to justify a change which we would consider less than significant, for example changing 185 to 200 nWb/m. A change of less than a dB falls in my opinion into the classification of a confusion factor rather than a legitimate improvement to the state of the art.

The user who wants to change has to remember to recalibrate when playing an old master from practically any source – or ignore the difference – or perhaps more to the point, buy new test tapes, which may have some significance as to motive for a change.

(4) Continuing customer desires for the retention of the 185 nWb/m reference. Overwhelming preference on the part of our customers, follows the fact that MOST

aengus

sound equipment for really picky guys.

Take your pick.



Eight Band — Graphic Equalizer. Standard equipment in all Aengus console systems. Also available as a "plug-in" replacement for most 1½" x 5¼" equalizers.



"Four-Pack" — Graphic Equalizer System. Four self-powered channels of Aengus Graphic Equalizers housed in a portable fine grain wood cabinet. LED indicator on output of power supply. Available with XLR or terminal strip connectors for instant application.

Aengus offers a complete line of stock modular components available singly or in a wide variety of configurations to suit any application.

Along with our concept of offering the finest pre-engineered expandable stock console systems and components, ranging in scope from 8 to 24 track, Aengus offers you the benefits of flexibility, reliability and financial growth control.



"Eight-Pack" — Graphic Equalizer System. Self-powered 19" rack-mount equalizer system featuring eight channels of Aengus Graphics with built-in power supply unit.



Plug-In Patchbay Modules. An exclusive Aengus engineering design composed of ¾" plug-in modules for rapid expansion. Another standard design feature in our console systems.

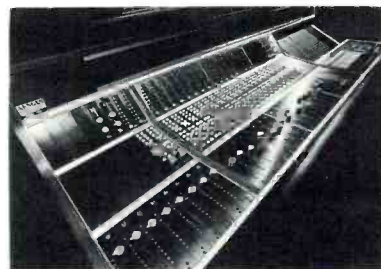

For full information and local authorized dealer, call or write.

T & D INDUSTRIES, INC.

583 Berlin Road, Marlboro, Mass. 01752 Tel. (617) 485-3658

ROBERT K. MORRISON

Before becoming president of Standard Tape Laboratory, Inc., in 1969, Robert K. Morrison was manager of the Standard Tape Operation at Ampex Corp. for ten years. Earlier in his career, he was a member of the "Voice of America" in New York, and previously for Ampex in Redwood City on a special project involving tape duplication before beginning a six year association with Central California Broadcasters, Inc., where he was Chief Engineer until his return to Ampex in 1959. Born in Madera, California, Mr. Morrison received his B.A. from the University of California's College of Letters and Science at Berkely in 1949. During his undergraduate years, he was involved in disk and film recording with Picto-Sound Company in San Francisco, where he worked with the short-wave operations of the company on behalf of the Office of War Information.

to be Chief Consultant to our lab, produced the first so called *test tape* which was made widely available to the industry for standardization. As a matter of fact, Frank Lennert's voice was heard on the first Ampex test tapes. I don't want to go on and on about the history and origins of the machinery, that's certainly been very well spelled out by Harold Lindsay and Jack Mullin in their talks and papers. Lindsay, Mullin, Lennert, and Walter Selsted were the people most responsible, I feel, in bringing the audio tape medium dramatically and quickly to the professional market. Their determinations as to appropriate flux levels and equalization characteristics proved valid and useful in the long term view.

How did you determine the reference level being used today?

BOB MORRISON: Originally *operating level* was the 1% 3rd harmonic distortion level at about 15 mil wavelength (1000Hz at 15 ips) on the old 111A tape. An adequate supply of the old tape stock was kept in a vault and the operating level could be redetermined within a 1/4dB accuracy. Years later, this operating level was measured by so-called *absolute* methods, including vibrating sample magnetometers, and later, a special flux measuring

head, (Ampex part number 4991005-1). This flux measuring head has been described many times in the journals. It is interesting to note that while the various methods of measurement gave varying absolute values of flux – 210 to 185 nano Webers/meter for the operating level – the measurements became more reliable, and fortunately, the level was still determined by comparison with copies of tapes made by the old method. So, in effect, the level did not change, however, the measuring techniques did.

When did you begin using the 700Hz reference tone as opposed to the 1000Hz?

BOB MORRISON: It has been our common practice to use 700Hz tones for 7½ and 15 and 30 ips speeds since about 1959. The choice of 700Hz is a compromise for convenience, it is high enough in frequency to reduce low frequency *fringing* effects when reproducing full track tapes on multiple track equipment, yet it is low enough in frequency not to be affected by the tape recorder's playback equalization.

There seems to be some confusion in peoples' minds regarding the configuration of alignment tapes – i.e., whether these tapes are full track or discrete (multi-

TAPE EQUIPMENT IN SERVICE TODAY IS SET TO THE 185 LEVEL.

I will tell you that we produce many custom test tapes. We, therefore, would be delighted to produce any reference level a customer may desire. The requests for 200 nWb/m tapes have been nil – as a matter of fact the common question asked by a purchaser is: "Is this the same 185 level that we are accustomed to?" "Good! That's the one I want."

Could you tell us a bit about the first alignment tapes and how they came into being?

BOB MORRISON: Permit me to preface my remarks on the first alignment tapes with a look at the situation at the time of entry of professional magnetic tape equipment into the audio market in the U.S.A. Admittedly, techniques of measurement were primitive, and, as a matter of fact, even understanding of the magnetic recording process was sparse. The available medium, i.e., tape, certainly left little choice as to characteristics. The homogeneous oxide plastic German tape and the early paper tapes had given way to the coarse brown oxide which was applied to acetate base film. This material formed the basis for determination of machines' performances. Enter, of course, the always-present battle between noise and distortion in the recording system, and you have the stage at which some very capable engineers determined appropriate operating parameters. One of these men, Frank Lennert, who happens

**LOSS DUE TO AZIMUTH DISAGREEMENT
250 MIL FULL TRACK**

1 Mil Wave Length		½ Mil Wave Length		¼ Mil Wave Length	
Loss in dB	Azimuth Error In Minutes	Loss in dB	Azimuth Error In Minutes	Loss in dB	Azimuth Error In Minutes
0.5 dB	2.5	0.5 dB	1.3	0.5 dB	0.64
1.0 dB	3.6	1.0 dB	1.8	1.0 dB	0.89
2.0 dB	5.0	2.0 dB	2.5	2.0 dB	1.25
3.0 dB	6.0	3.0 dB	3.0	3.0 dB	1.52
4.0 dB	6.9	4.0 dB	3.5	4.0 dB	1.73
5.0 dB	7.6	5.0 dB	3.8	5.0 dB	1.91
6.0 dB	8.3	6.0 dB	4.0	6.0 dB	2.07
7.0 dB	8.8	7.0 dB	4.4	7.0 dB	2.20
8.0 dB	9.3	8.0 dB	4.7	8.0 dB	2.33
9.0 dB	9.7	9.0 dB	4.9	9.0 dB	2.43
10.0 dB	10.0	10.0 dB	5.0	10.0 dB	2.53

**LOSS DUE TO AZIMUTH DISAGREEMENT
75 MIL TWO TRACK**

1 Mil Wave Length		½ Mil Wave Length		¼ Mil Wave Length	
Loss in dB	Azimuth Error In Minutes	Loss in dB	Azimuth Error In Minutes	Loss in dB	Azimuth Error In Minutes
0.5 dB	8.52	0.5 dB	4.26	0.5 dB	2.13
1.0 dB	11.98	1.0 dB	5.99	1.0 dB	2.99
2.0 dB	16.75	2.0 dB	8.37	2.0 dB	4.18
3.0 dB	20.27	3.0 dB	10.13	3.0 dB	5.06
4.0 dB	23.12	4.0 dB	11.56	4.0 dB	5.78
5.0 dB	25.53	5.0 dB	12.76	5.0 dB	6.38
6.0 dB	27.61	6.0 dB	13.80	6.0 dB	6.90
7.0 dB	29.44	7.0 dB	14.72	7.0 dB	7.36
8.0 dB		8.0 dB	15.53	8.0 dB	7.76
9.0 dB		9.0 dB	16.26	9.0 dB	8.13
10.0 dB		10.0 dB	16.91	10.0 dB	8.45

track)? Could you explain the differences between and the proper application of these two kinds of tape, as well as the advantages or disadvantages of using one over the other?

RM: The standard garden variety test tape normally found in recording studios is a full track tape. A full track tape has the ability to be compatible on any track configuration, e.g., a 2" full track tape can be played on a 16 or 24 track machine. If you use a discrete track tape, you need one tape for each configuration. With a full track tape, there is less chance for error in regard to machine azimuth level and high frequency equalization. We do produce a number of discrete track test tapes, particularly for consumer equipment manufacturers, for example, 8 track 1/4 inch, vertical height adjustment tapes. Discrete track test tapes offer added vertical head to tape reference, and are free from low frequency fringing. One way to get around low frequency fringing from full track tapes is to set the low frequency playback EQ control while recording. If your machine has both record and play low frequency adjustments, you need to use a fringing calibration chart.

As the quality of the magnetic recording tape improved, were there corresponding early attempts to improve the signal to noise ratio?

RM: When the original operating level was determined relative to old 111A tape, the 3rd harmonic was at 1%. Subsequent changes to the oxide brought about a lower distortion recording for the same flux levels, for example, in the late 50's or early 60's common oxides including the then designated 111 tape measured about .7% at operating level. Other types of recording equipment, such as disk cutters and film equipment and so forth, also improved as to distortion and noise. Some attempts were made to improve signal to noise at that time through an additional boost in the presence range for master recording. A proprietary mastering curve came into being, called the AME (Ampex Mastering Equalization) curve, and while prevailing for some time, was later abandoned. This offers a very good example, by the way, of what happens when the ultimate user determines the efficacy of a practice after considerable experience. Invariably, if the method is worthy it gains acceptance; if not, it is ultimately abandoned. The AME curve simply didn't work with many kinds of program material — ask any recording engineer who was in the business in the early 1960's and he can describe the disaster he encountered in trying to record brassy or latin american music, for example.

What are your views on the potential of currently available tape types, particularly

the new high output tapes?

RM: Originally, we had very little differences in raw tape characteristics. The available tape types now range from thin oxide super long-playing tapes aimed at slow speed, short wavelength recording to thick oxide high-output low noise, with or without high polish surfaces — the latter of course, aimed at master recording, that is, speeds of 15 or 30 ips (380 or 760 mm/sec.). This last variety has allowed an increase of 3dB above the 185 nWb/m level with a distortion level of 1%. The very latest materials allow a further increase of another 3dB for the same distortion. These are average, convenient, rounded numbers. Some tapes allow an additional 4dB, etc. Our experience has shown that many professional users would rather remain at the 185 nWb/m level, thereby enjoying the inherent low distortion with the greater headroom. Others elect to choose the higher operating level, 369 nWb/m (6dB above 185 nWb/m), for example, for greater signal to noise ratio.

We have all heard the expressions *tape limited*, or *electronics limited* as applied to various machines. The attempt has been to keep the electronics better than the limitations imposed by the available tape. A word of caution here, some machine electronics are not capable of greater record levels without exceeding their headroom, or safety margin, and this is an important point when people are discussing various ways of gaining signal to noise. We said earlier, available tapes have become more varied as to characteristics. One can also say that presently encountered program material is also of a greater variety as related to spectral response and dynamic range. Pre-equalization techniques, wider band microphones, and contemporary music styles of acoustically or electronically produced music have given us an entirely different set of requirements. We are not recording as predictable original material as in the past. Often the added headroom provided with the newer tapes is employed along with a noise reduction system, such as the Dolby A system, thereby providing low distortion and improved signal to noise ratio.

What are common misuses of alignment tapes?

RM: The most often misunderstood standards, we find, have to do with test tapes with flux levels intended to calibrate peak reading equipment. (320 nWb/m, or 4.76dB above 185 nWb/m. This is the european level known as the DIN standard.) These tapes provide a practical and useful means for setting up equipment which is subsequently used to read program levels on a peak reading basis. If the user attempts to set up equipment with a common VU meter to these peak reading test tape levels and then

reads average program material on the meter, he will be operating at too high a level with resultant tape compression. It is a case of an inappropriate tool for the job.

What is the definition of a good test tape?

RM: The standard audio or reproducer alignment tape, the most common variety of test tape, is normally used to supply a certain medium wavelength flux reference with enough information at long and short wavelengths to establish defined equalization characteristics of the reproducer channel under test. Azimuth reference, reference level, and equalization are the most common elements in a reproducer alignment test tape. Important elements of any test tape accepted by the user include: convenience, that is, it must be usable with his existing equipment; consistency, that is, similarity of one tape to another; and compliance of the tape to accepted standards.

How do you maintain these standards?

RM: Our own laboratories' efforts in this area employ methods that we have developed over some 16 years. For calibration, we use flux measurement heads, vault references, re-recording techniques on referenced blank stock, and controlled combinations of the above as insurance against drift. High frequency characteristics are determined with the help of special repro heads, which are calibrated by classical methods, and reserved for this purpose, in conjunction with electrical channel measurement and frequent comparative check with vault and lot samples. The frequency of recalibration in the manufacture of audio test tapes is keyed to the wavelengths involved. Some of the calibration goes on constantly during the manufacture of the tapes. Certain other elements require special methods for standardization, e.g., the control reference head. To simplify the latter, small or narrow track heads found in normal use would require recalibration at frequent intervals to maintain constant results, therefore we employ special and usually very large *mechanically constant* heads made for our purpose.

Our proprietary production technique maintains the tone levels within specification during manufacture. (Specifications fall within normal metering capability parameters i.e. specifications attached to commercial Vacuum Tube voltmeters.) Most of our customers prefer tapes which have been set to the appropriate levels i.e. plus or minus ¼ dB at time of manufacture.

Certain tapes supplied to equipment manufacturers are produced *hands off* that is, without electrical or manual correction. These are supplied with a graphic level recorder chart which may be used to provide correction factors for each tape segment. This technique is often used as an economy measure and we find it con-

Now There's An Easier Way To Get The Perfect Tape. Scully's 280-B.

Why make the job of recording tougher than it has to be? Operating a recorder/reproducer is so easy with solid state control switching, plus straight line threading for fast editing. A motion sensing system like OPTAC™ which helps prevent tape spill or damage. And you don't even have to use the stop button when changing transport modes.

That's the kind of easy operation you get in Scully/Metrotech's 280-B.

And why be an acrobat when it comes to adjusting and maintaining equipment? All that bending and reaching can be eliminated with a pull-out control drawer that houses the mother-daughter boards to give full access to all set-up and equalizer adjustments. Would you believe no extender boards needed?

You enjoy this convenience in the 280-B, too.

But to really take it easy on the job, you need assurance that sound is being recorded to perfection. So we made sure that the efficient, clean-looking electronics of the 280-B deliver the goods — and then some.

An outstanding S/N ratio assures cleaner sound in progressive generations.

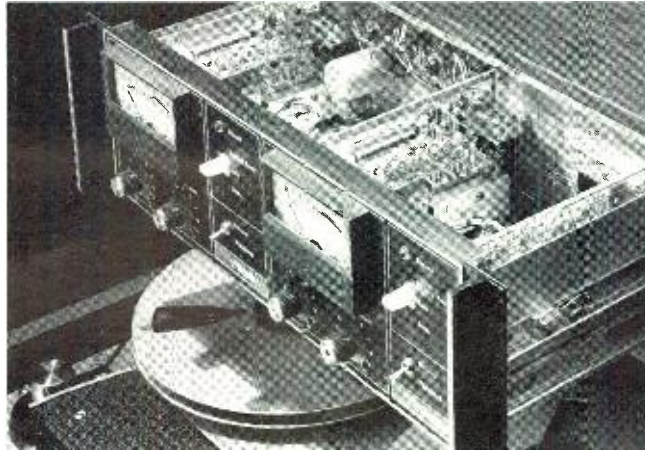

Up to 72dB on full track .25" tape at mastering speed. And 68dB on two-track .25" and four-track .50".

Flat frequency response usually exceeds published specifications: $\pm 2\text{dB}$, 30Hz to 18 kHz. You'll find reliable selective sync switching in the

280-B, with sync response equal to normal play response. But you won't find noisy push-buttons in the audio circuits. For easy insert, our function switch provides the ability to punch "in and out" of the record mode on any channel without disturbing tape motion.

The payoff is a superior end product — the perfect tape. And for long-playing tapes, the 280-B is now available in a 14" configuration. Clearly, this recorder/reproducer provides your transmitter with a perfect recording. When recording masters, the result is just as outstanding.

So get the facts. Then get the best — at a reasonable price. Contact your Scully/Metrotech field office in Los Angeles (213) 387-4252, Nashville (615) 244-1546, New York (212) 354-0623 or Chicago (312) 583-7878 for details on the 280-B

series with up to 4 channels, or write: Scully-Metrotech, 475 Ellis Street, Mountain View, California 94040. Telephone (415) 968-8389. TLX 345524.

▶ Scully/Metrotech Division of Dictaphone

Designers and manufacturers of a full line of tape recorders, reproducers for broadcast and master recordings, super slow speed voice logging recorders with time generators and readers.

Scully/Metrotech and Optac are registered trademarks of Dictaphone Corporation, Rye, New York, U.S.A.

SOUND POWER

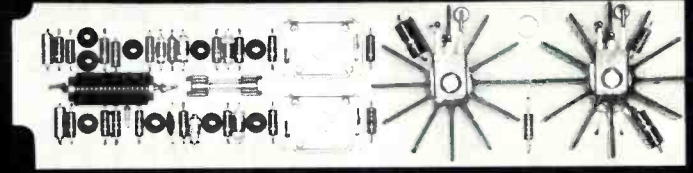
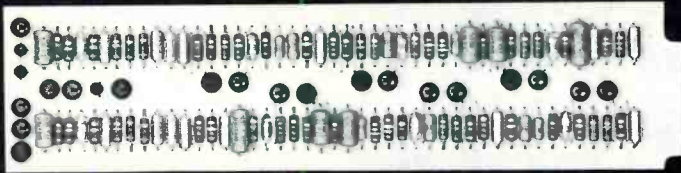

Model 505 Electronic Filter: 18dB/octave filter; integral power regulation, two complete crossovers for Bi-amplification or as a three-way filter for Tri-amplification; imperceptible transition; standard frequencies; S/N better than 100dB below +4dB output, 20Hz to 20kHz, unweighted.

Model 700 Power Amplifier: 60 watts continuous (120 watts, bridged configuration); unmeasurable THD; S/N better than 100dB below full output, 20Hz to 20kHz, unweighted.

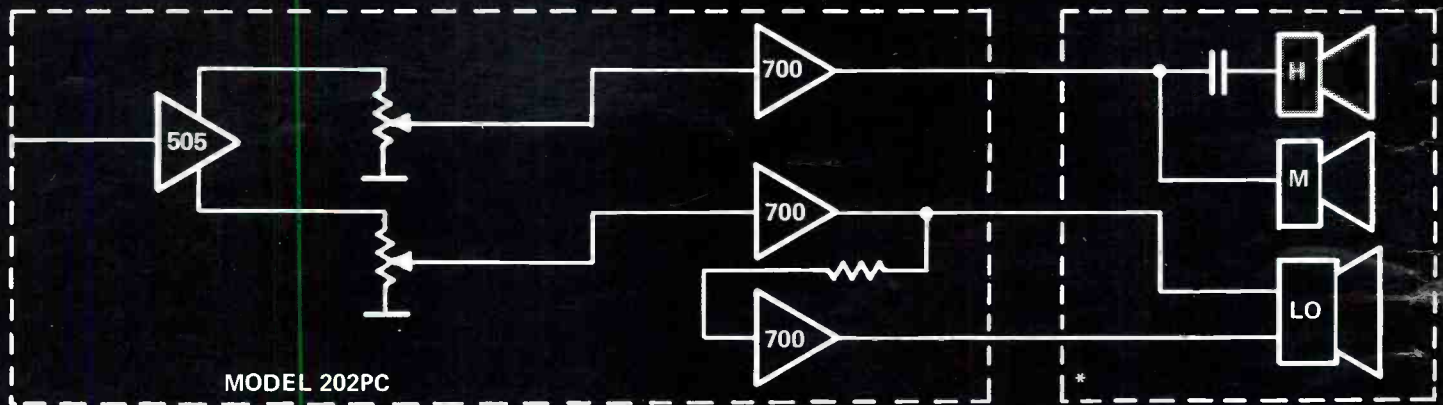

Model 202PC Card Holder: designed to accept Model 505 and Model 700 for an efficient, compact, integrated system to provide unequalled sound power.

*Speaker systems by SPECTRA SONICS are matched to system configuration.

SPECTRA SONICS Models 505 and 700 are a powerful combination for the truest sound reinforcement. These SPECTRA SONICS audio components may be arrayed for bi/tri/quad amplification to produce kilowatts of power at pre-inflation prices! Data on a sound reinforcement system, GUARANTEED to produce outstanding performance, to meet your specific requirements, may be obtained by contacting SPECTRA SONICS at:

770 Wall Avenue
Ogden, Utah 84404
(801) 392-7531

6430 Sunset Blvd., Suite 1117
Hollywood, California 90028
(213) 461-4321

SPECTRA SONICS

LEADER IN ADVANCED TECHNOLOGY



venient when tones are short or in the case of low cost high production test tapes made at double speed.

Efforts involving the production of wide band instrumentation test tapes, i.e., a high frequency content of a factor of 6 in comparison to the audio tapes, involve a controlled record process with subsequent correction information provided relative to either a specified defined head, or to a theoretically ideal head.

We and others have described many of the azimuth measurement techniques practiced such as the oxide to oxide print method, symmetrical front gap – rear gap head, controlled angle middle frequency alternately displaced tone. (Which, by the way, was, I believe, first used in the 1940's when we encountered a special optical film variable density center track recording. Noise, etc., was so bad that we resorted to off azimuth tones, with film turnover and re-focusing for azimuth determination).

Fortunately there are now available some optical instruments capable of resolving 1 minute of arc displayed on a visible tape pattern. Should one get involved in this process I'd like to offer the following suggestions:

(1) Employ indicator fluid of the finest grain and

(2) Use pulse generators to produce the sharpest *bar pattern* for the optical measurement. A pulse recording is far better than a normal sine wave pattern.

We favor the optical method plus a two track through-the-base phase check with a special two track minimal gap-scatter-head.

It is very important to realize that even a *self proving* perfect azimuth reference tape is nearly worthless in practice if its physical measurements are unlike the raw stock to be used.

For example, we know of a number of so called *self verifying* azimuth tapes recorded on tape 245 mils wide. They are fine if you intend to use raw stock 245 mils wide. However, the majority of professional users encounter tape about 247 mils in width.

The test tape should be produced on stock physically identical to the raw stock to be used. Not only is width important but also tape thickness as it affects head contact and therefore spacing loss.

The critical requirements for test tape standards maintenance in my opinion are:

(1) A captive magnetic head production facility.

(2) Rather extensive optical instrumentation such as tool maker's microscopes of various powers. Comparators with 1 minute of arc readout.

(3) The usual electrical instrumentation including graphic level recorders, wave analyzers, etc.

(4) Mechanical hardware capable of instrumentation standards.

On what basis do you decide which type of tape to make?

RM: Primarily we are governed by the expressed requirements of our customers. From a handful of test tape types a few years ago, we've been steered by our customers' requests to provide about 50 regular items, and an equal number of semi-custom varieties for regular customers to meet their individual requirements.

To give you some idea of the variety involved we have specifically designed for broadcasters Sweep cartridges with 50 ms bursts 500Hz to 15kHz for phase alignment as well as frequency response measurement. We have supplied these to several network organizations. Other requirements include Sweep tapes made at specific chart drive speeds so that playback calibration may be made with the aid of a chart recorder at comparable chart drive speed. Low flutter and timing tapes are supplied to audio and instrumentation end users.

Which tapes are requested most often?

RM: Most of our customers want to retain the 185 nWb/m operating level. Others have requested plus 3 and now plus 6 levels. Because of this customer preference, these are the tapes we provide. Generally the customer appreciates options that are significant and easily read on commonly available equipment. He dislikes fractional decibel readings. He's become comfortable with 0, which to him means 185, and +3, and now +6.

Ethically, I believe, our responsibility is to provide products required to do the various jobs the most efficiently. I specifically feel that we should avoid any position afforded us as test tape makers to dictate what the user should or must use.

McKNIGHT:

continued from page 19

The reference frequency of 1000Hz was chosen because many users have specifically asked for it. This frequency is also the basic frequency in ANSI Standard S 1.6, "Preferred Frequencies for Acoustical Measurements" (also ISO/R 266). It is unfortunate that this frequency is high enough to be affected by the standard playback equalization, but studios and equipment manufacturers seem to be adamant on this matter. Besides, there is less fringing than at lower frequencies.

Combining the difference in playback equalization (for the frequencies of 700 and 1000Hz) and the fluxivities of 185 and 200 nWb/m, what is the difference in absolute reference levels between MRL

test tapes and tapes of other manufacture?

J. McKNIGHT: When the fluxivities and frequencies for the various test tapes are modified by the standard reproduce equalization curves, we would find that a properly equalized reproducer would give the following output levels from the various test tapes:

MRL (200 nWb/m at 1000Hz, 7½ and 15 ips)	0 dB
Ampex (185 nWb/m at 700Hz, 15 ips)	-0.9 dB
NAB (approximately 150 nWb/m at 400Hz)	-2.8 dB

You can see the NAB reference fluxivity does not correspond to the Ampex value, and, in fact, there is no *unique* value of reference fluxivity used in the USA. Insofar as music or program recording goes, in my opinion the .9 dB difference between the Ampex and MRL reference fluxivities is not very significant.

Just what is the significance of the NAB reference level compared to the Ampex operating level?

JMc: The NAB open reel standard of 1965 specifies a reference fluxivity in terms of a 400Hz reference recording held by the NAB Subcommittee Chairman (R. C. Moyer, then of RCA). He has compared this recording to an Ampex test tape, and believes that the NAB reference recording is approximately 150 nWb/m. Note, however, that this value was determined primarily for use in 3¾ ips recording, although NAB also recommends it for the 7½ and 15 ips speeds.

We hear about "nanowebers per meter" these days. What are they? What are they for? Do they replace something else?

JMc: The magnetic recording process stores the sound signal as a magnetization of the tape coating. This magnetization produces a magnetic flux which flows thru the reproducing head core in playback. The coil of wire around the core transforms changes of this flux into a voltage which is amplified and equalized to produce the output voltage.

With that background, you can see that the quantity for the amplitude of the recorded signal on the tape is the *tape flux*. The unit for flux (in the International Systems of units) is the *Weber*, and the unit symbol is *Wb*. The Weber replaces the old *egs* unit for flux, the Maxwell (Mx). (1 Mx = 10 nWb)

The wider the recorded track is, the more the total flux available. But in sound recording we'd rather know where we are relative to tape saturation, or to a certain amount of distortion. Therefore we get rid of the width effect by dividing the total flux by the recorded track width. We call this "flux per unit track width," and the unit is the Weber per meter. This unit is much too large for practical tape recording, so we normally

JOHN G. McKNIGHT

John G. (Jay) McKnight was born in Seattle in 1931. He received a B.S. in electrical engineering from Stanford University in 1952.

He was with Ampex Corporation from 1953 to 1972, with the exception of the years 1954-56 when he was assigned to the engineering staff of the U.S. Armed Forces Radio Station in New York. At Ampex he was a member of the Research Staff, Magnetic Recording Group, of the Research and Advanced Technology Division.

Mr. McKnight left Ampex in 1972 to accept the position of Engineering Vice President of Magnetic Reference Laboratory, Palo Alto, a manufacturer of precision Test Tapes, and is now President of that corporation. He is also a consultant on audio systems and magnetic recording.

He is a Fellow of the AES, recipient of the AES award, a member of its Editorial Board, a Governor two times, and has been Chairman of its Standards Committee; a Senior member of IEEE, having been a member of the G-AE Adcom, member of the IEEE Transactions on Audio and Electroacoustics Editorial Board, and Chairman of the IEEE Standards Sub-Committee on Recording and Reproducing; and is now a member of standards committees on audio engineering and magnetic sound recording of the American National Standards Institute, the NAB, the EIA, the IEC, the SMPTE, the RIAA, and the CCIR.

use the nanoweber per meter (nWb/m), which is an American billionth part of a Weber per meter.

Several methods exist for measuring tape flux, but the only *standard* method uses a special calibrated ring-core head. The technique directly measures the flux at medium wavelengths and is superior to magnetometer and *single-turn head* methods which have been used in the past. The ring-core head is commercially available to any laboratory at a reasonable cost, it is easily used, and requires no specialized auxiliary equipment. A further advantage of this method over magnetometer methods is the elimination of errors inherent in making the *transfer* recording which is necessary for a magnetometer measurement.

Is this head suitable for measuring flux at all wavelengths?

JMc: No, the present standard measurement is only for *medium wavelengths*. A standard method for measuring short circuit flux at long as well as short wavelengths is under consideration.

Why are there several "standard" reference fluxivities?

JMc: Different values of reference fluxivity are appropriate to the various types of recording tape and the various applications commonly encountered. A reference fluxivity of 200 nWb/m of track width is appropriate and commonly used in home and broadcasting applications in the USA, when program levels are monitored with a standard volume indicator (VU meter) and when the recordings are made on a standard or extra-play general purpose tape such as 3M 177 or Ampex 345. A reference fluxivity of 250 nWb/m is ap-

TABLE 1

Review of Advantages and Disadvantages of Full-track versus Multi-track Test Tapes

System	Advantages	Disadvantages
MULTI-TRACK TEST TAPES	Eliminates fringing error for that particular reproducer track configuration.	A given test-tape may be used only for the specified track format, therefore many different types must be manufactured and stocked, increasing cost. Frequency response and gain-setting errors occur if reproducing head height is incorrectly set.
FULL-TRACK TEST TAPES	Simple manufacturing and stocking: no cost increase. Height error of reproducing head does not introduce gain setting or response errors.	Accurate measurement requires some means of fringing correction.
1) Ignoring fringing correction.	Requires no time or thought.	Large errors in equalization and in gain setting.
2) Supplying fringing correction table with test tape.	Tape is correct for full-track reproducers and a table can be supplied for any type of reproducer track configuration. This scheme is therefore appropriate when a test tape is to be used with several very different track configurations.(a)	Many engineers and technicians do not read the instructions, and are unaware of the need for correction; or else they find it too time-consuming. Therefore, the same disadvantages as "ignore fringing correction."
3) Applying compensation in recording test tape.	Eliminates fringing error for that particular reproducer track configuration, without user needing correction table. Correction tables can be used for other track configurations. This scheme is therefore appropriate when a test tape is to be used mainly with one particular reproducer track format.(b)	The correction tables necessary to use this test tape with other than the track format for which it was designed are time consuming.

a) This case applies with 6.3mm (0.25") tapes, where reproducers of all track formats are common — full-, 2-, 4-, and 8-track. Even for a given track configuration, head constructions (core widths and shield placements) vary greatly from one manufacturer to another, and different amounts of compensation would be required.

b) This case applies for wide tapes, where one track format is mainly used — 1.8mm core width, with 0.5mm distance to the adjacent shield.

TABLE 2

Fringing Compensation Applied in Recording MRL Wide Reproducer Alignment Test Tapes

Frequency/(Hz) For a tape speed of			Compensation*/(dB)
190 mm/s (7.5 in/s)	380 mm/s (15 in/s)	760 mm/s (30 in/s)	
—	—	31.5	-3.6
—	31.5	63	-3.5
31.5	63	125	-3.1
63	125	250	-2.6
125	250	500	-1.8
250	500	1000	-1.1
500	1000	2000	-0.6
1000	2000	4000	-0.3
2000	4000	8000	-0.1

**"Compensation" is the amount by which the recorded fluxivity is reduced relative to the standardized fluxivity, in order to compensate for anticipated fringing of a multi-track reproducer.

appropriate and commonly used in mastering studios in the USA when program levels are monitored with a standard

volume indicator, and when the recordings are made on a high output tape such as 3M 206 or Ampex 406.

In Europe still other reference fluxivities are appropriate when peak program indicators and somewhat different tapes are used.

Test tapes for multi-track reproduction present a practical dilemma for the track configuration to be used. What are the relative advantages of using a full track test tape as opposed to one recorded with discrete tracks?

JMc: Table 1 lists the advantages and disadvantages of the various possibilities. I feel that the most satisfactory choice for wide (one and two inch widths) test tapes, from our viewpoint and the users' viewpoint alike, is the full-track configuration with a built in correction for the fringing effect. Fringing causes an apparent rise in the low frequency response of the reproducer, so the low frequency response of the MRL wide test tapes is rolled off according to the compensation indicated in Table 2. These values were calculated for a head whose core width is 1.8 mm, and distance to nearest shield is 0.5 mm. These dimensions are typical of Ampex, 3M, and Nortronics heads for 4 tracks on 1/2 inch tape, 8 tracks on 1 inch tape, 16 tracks on 2 inch tape.

These same compensation values are also within approximately 0.5dB for 24 track recording on 2 inch tape. This holds at and above for 31.5Hz at 380 mm/s tape speed for the Ampex heads, and at and above 125Hz for Nortronics and 3M heads. These values are approximate at best. The correction for 250Hz and above seems to be quite consistent between all kinds of heads. But at the very low frequencies (63Hz and 31.5Hz; and sometimes even 125Hz) the correction factors are often 1dB to 2dB too great, so that the measured response may be too small (instead of too large, with no correction).

So what should the user do if he can't count on the calibration tape at low frequencies - either with or without the fringing corrections?

JMc: Lots of engineers ask that very question, so I'm writing a technical paper to discuss it in detail. In brief, IF the recorder manufacturer has designed and/or adjusted his low-frequency recording equalizer correctly, the best way to set the low-frequency reproducing equalizer (or measure the reproducer response if there's no adjustment) is simply to make an overall recording-reproducing response measurement by slowly sweeping your test oscillator from 20Hz upward to 500Hz. Set the repro low frequency equalizer for flattest response. After doing this, by the way, you can play your full-track calibration tape, and measure the output from the calibration tape when

COMPLIMITER™



MODEL 610

Used in recording studios; disc mastering studios; sound reinforcement systems; TV, AM, FM broadcast stations to maintain a sustained average signal at a level significantly higher than that possible in conventional limiters, and with performance that is seldom attained by most linear amplifiers. Rack mounted, solid state, functional styling, the Model 610 is in stock for immediate shipment.

Specifications are available from:

SPECTRA SONICS

770 WALL AVENUE, OGDEN, UTAH 84404
(801) 392-7531



Circle No. 117

A REAL TIME ANALYZER SOLID STATE DISPLAY

FEATURES:

- Simultaneous 28 channel display
- 1/3 Octave coverage 40 Hz to 16k Hz
- Calibrated SPL readout
- Built-in pink noise generator
- Double-tuned high resolution filters
- High-gain mic preamp
- Portable or rack mount
- Optional 3 mic multiplexer for averaging



SIZE:
19 3/4" x 10" x 4 1/2"

Measure your total acoustical response... in real time:
Equalization - Noise Masking
- Program Analysis

With unique LED DISPLAY
The Model 140 REAL TIME ANALYZER
Less than \$2500

Ask for bulletin 140 and free booklet on equalization.

White

Call or Write — White Instruments, Inc.
P.O. Box 698, Austin, Texas 78767, Phone 512/892-0752

Circle No. 116

you know that the reproducer is properly equalized. Then you can later play this calibration tape, and so long as you repeat these readings, you know the reproducer is still ok.

How about that big IF – if the recorder manufacturer has designed or adjusted his low-frequency equalizer correctly?

JMc: That's a tough question, because the measurement requires measuring the recording head current, and that means you have to get rid of the bias current so it doesn't mess up the readings. This direct measurement requires a current probe and a filter – and few studios have these. There are clever ways to do it with an ordinary lab voltmeter, but the technique is different for each kind of machine. You have to either have some time and circuit know-how to do it yourself, or else ask the manufacturer. The maintenance manuals do not tell you how, unfortunately.

I personally feel that the low-frequency boost is wrong for many reasons, one being the problem of "is the equalizer designed and built right?" If you use the flat low end like the AES 30 ips curve, and the IEC curves, then you can be pretty sure that the recording response is right – that is, flat. So this method of measurement that I described before is especially applicable to the AES 30 and the IEC systems.

How do you maintain constant flux level over the entire tape width when making full track test tapes?

JMc: In conventional manufacture of test tapes, total tape flux level is visually

monitored and manually corrected. No record is maintained of either the amount of the correction, or of the actual recorded tape fluxivities.

If the recording head becomes contaminated, the correction usually results in proper total flux, but an uneven distribution across the tape width. If the monitoring head becomes contaminated, the correction results in increased total flux. Thus, the commonly used correction process may produce greater error than was present in the uncorrected recording.

To prevent this, MRL employs no corrections during the manufacture of the test tape. Instead, a continuous recording of the tape flux is made on a graphic level recorder. If the tape flux varies beyond tolerance, the tape is rejected and the source of error determined before production is resumed.

The recording system is originally set so as to give constant output voltage on the calibrated reproducing system that drives the chart recorder. Even with tape selected for minimum sensitivity variations, however, unavoidable variations in the tape sensitivity of about ± 0.2 dB may sometimes be seen on the graphs of the test tapes (see Table 3).

On a full track tape, how do you verify that all tracks are at the same level?

JMc: The MRL wide test tapes are recorded with a full track recording head whose recording sensitivity across the width of the tape is very uniform (± 0.1 dB). In order to detect drop-outs which might occur on only one narrow track, the recordings are monitored with a standard format head (16 tracks on 2

inch tape widths, etc.). One of these tracks is used for making the chart record of Table 3. All of the other tracks' outputs are automatically and continuously compared with this reference track. The comparator detects any dropout of amplitude greater than 0.5dB and duration longer than 100 ms, and signals the operator. If a dropout is indicated, that test tape is rejected. Thus the user is assured that all tracks are within 0.5dB of that shown on the calibration graph.

In general, what procedures are followed in using a typical alignment test tape?

JMc: Before putting any test tape on the machine, the heads and tape guides should be cleaned and demagnetized. Heads should be visually checked for lips at the edge of tape travel, and for wearthrough at the gaps. While running a tape, look to see that it is tracking properly and that the heads are not obviously misadjusted. The relative height of the tape guides and heads should be such that the tape is symmetrically located over the head face. The space between the edges of the tape and the outside shields should be the same for both edges of the tape.

The first tone on the tape is the reference level tone, and is used to set the playback sensitivity of the reproducer.

Setting reference level is only one use of an alignment tape. It can be used also to adjust the head azimuth and intertrack phase alignment. Which of these two parameters is the more significant in assuring proper head alignment?

REPRODUCER ALIGNMENT TEST TAPE CALIBRATION GRAPH

Catalog Number 41J116 Serial Number 7911

Speed 190 mm/s (7.5 in/s) 380 mm/s (15 in/s) 760 mm/s (30 in/s)

Equalization NAB IEC AES Special

Full-track recording, corrected for multi-track reproduction (see accompanying instructions).

Date of Calibration 19750129

This graph shows the frequencies, levels, and durations of the signals recorded on this test tape. Deviations from the "0 dB" or "-10 dB" levels calibrate this tape for deviations from the standardized values of response and reference fluxivity that are given in the Table overleaf. In other words, these are the voltage levels that would be measured on a perfect "standard" reproducer. A properly adjusted reproducer should ideally give the same response as that shown on this calibration graph. One millimetre on the level scale corresponds to a level difference of 0.2 decibel. One millimetre on the time scale corresponds to a time of 1.5 seconds for 12.5 mm (1/2 inch) tape width; 2.0 s for 25 mm (1 inch) tape width; and 3.0 s for 50 mm (2 inch) tape width. The dynamic response of the graphic level recorder used here corresponds to that of the "Standard Volume Indicator" (vu meter) of ANSI C16.5 1954, R 1961.

Tape Fluxivity Level re Value in Table (overleaf)/[dB]

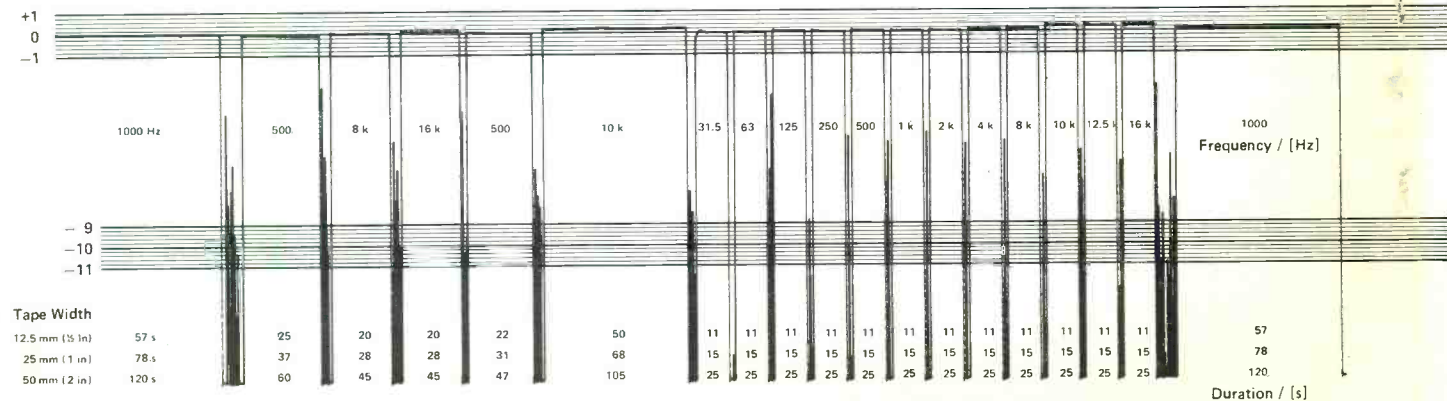

Acoustical Guarantee

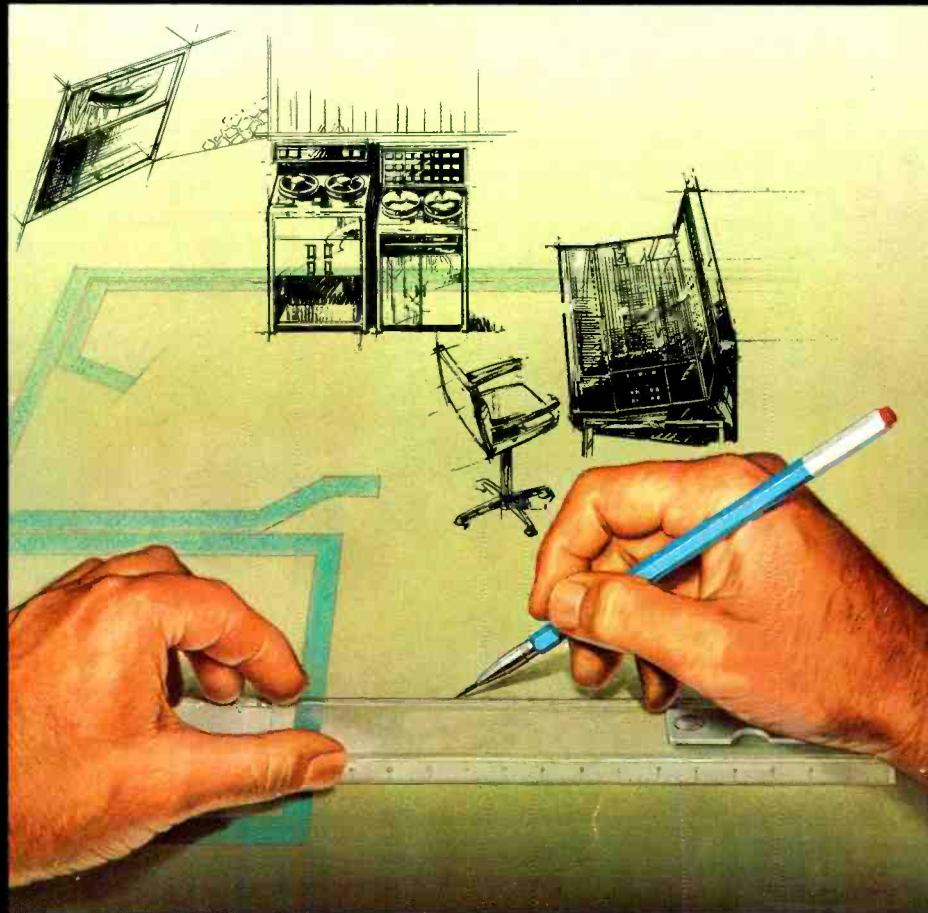

Performance Specifications

from acoustic design
to down beat...

**Westlake
Audio**

"The control room sounds good here but not over there. Stand up and you've lost your mix. Lean back in your chair and all the bass is gone. The monitor has to be loud to hear it. Turn your head and big changes occur. The stereo image moves."

"The drum leakage in this studio is terrible. The strings sound great but the bass is loose and muddy. This room is so dead the sound isn't happening and the musicians can't get into it."

These are subjective observations which producers and engineers have made and lived with for years in many studios. We at Westlake are prepared to talk to you about a guarantee *against* those things happening in your studio.

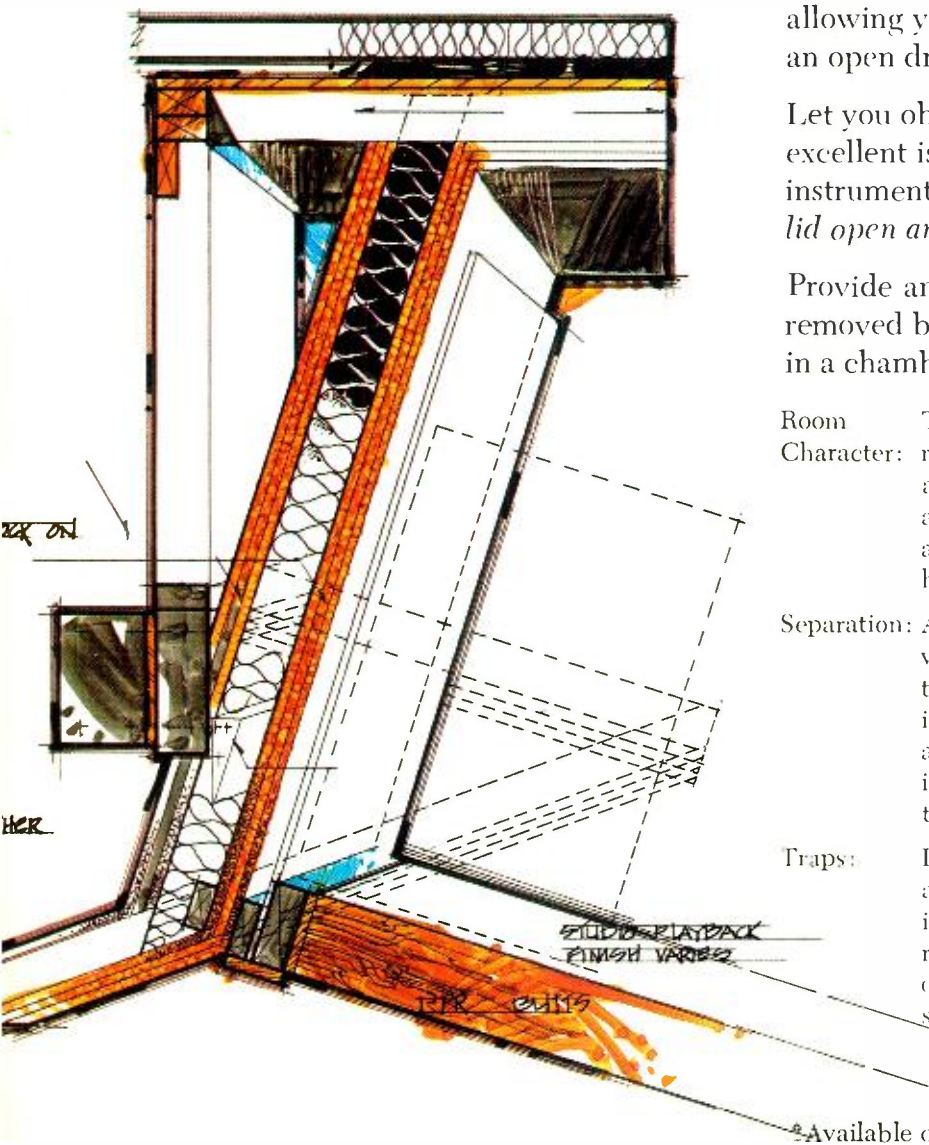

Guarantee of Acoustics by Westlake Audio*

WE WILL GUARANTEE YOU A STUDIO WHICH WILL:

Have a tight rhythm sound under all recording conditions yet allow the producer and engineer the option of changing the midrange character anywhere from "dead" to "very live" in less than sixty seconds. — *Any location in the room.* —

Provide drum cages which are live inside, something that the drummer can get into, allowing you to get a bright drum sound from an open drum cage.

Let you obtain a natural piano sound with excellent isolation from loud electronic instruments. — *With the piano in the room, lid open and not caged in.* —

Provide an echo chamber with low end "mud" removed by trapping in the chamber, resulting in a chamber that "sings."

Room Character: The characteristic "room sound" which results from recording in a three dimensional area is eliminated by the utilization of an active ceiling. From 40 Hz up, this produces an infinite third dimension such as would be present in an amphitheater.

Separation: Active traps are built into the studio walls which allows "in-studio" vocals, eliminating the need for the usual vocal booth. 30 dB of isolation can be provided between the band and a vocalist only 10 feet away, resulting in 30 dB of isolation @ 40 Hz or tuned frequencies.

Traps: Drum cages, bass traps and broad band attenuators will provide in excess of 24 dB isolation @ 40 Hz. The piano can be recorded in the studio while still providing over 20 dB broadband rejection of unwanted sound to the piano mikes *with lid open!*

*Available on all new projects from Jan. 1975 on.

al Performance Specifications

WE WILL GUARANTEE YOU A CONTROL ROOM WHICH WILL:

Allow you to stand . . . sit . . . lean forward or back . . . move left or right and subjectively not change your mix.

Let you accurately pinpoint any musical instrument within a 360° quad listening environment.

Permit monitoring loud or soft while retaining a tight and musical sound.

Keep your stereo “locked center” on all instruments panned to the middle.

Response: ± 3 dB upon speaker installation, 31 Hz-16 KHz measured with B & K $\frac{1}{2}$ octave pink noise source. *Between speakers*, ± 1 dB.

Dispersion: ± 2 dB @ 10 KHz across a minimum 10 foot horizontal plane at the console (from left of the engineer to the right of the producer or vice versa) from any one of the four monitors, measured with pink noise source.

± 2 dB @ 10 KHz across a minimum 10 foot horizontal plane front to back in the mixing area from any one of the four monitors, measured with pink noise source.

± 2 db @ 10 kHz from 6" above console vertically to 6" down from ceiling.

Power: 116 dB SPL minimum, linear scale, with broadband pink noise source from one monitor measured at the mixer's ear. The control room potential with four monitors is a minimum of 128 dB SPL.

Source Location: Within 2 dB of *total sum* from any two sources in the 360° quad circle environment.

THE CONTROL ROOM AND THE STUDIO ARE YOUR TOOLS AND SHOULD WORK FOR YOU... NOT AGAINST YOU.

THAT'S WHAT AN ACOUSTICAL GUARANTEE IS ALL ABOUT!

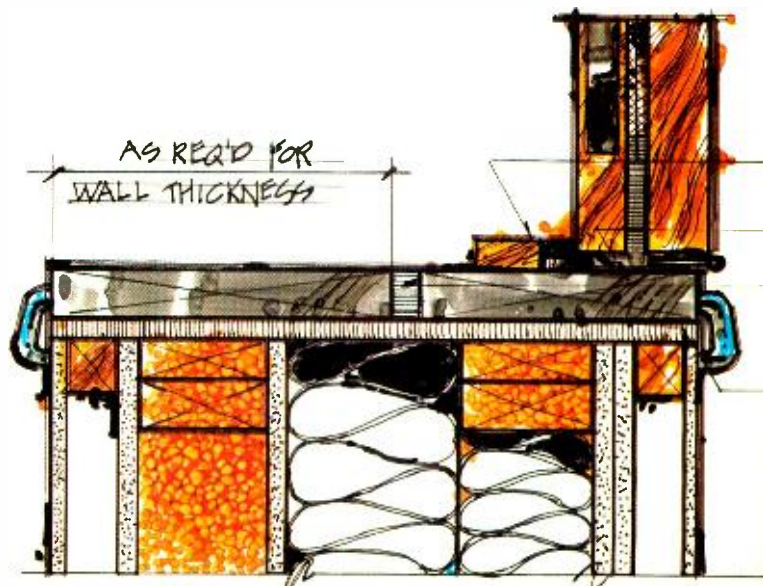

DOOR JAMB DETAIL

Kent R. Duncan, President, Kendun Recorders, Burbank, California:

"The new room has been in operation for six months now and our success is as much a tribute to Westlake Audio and Tom Hidley as it is to our long hours and attention to detail (and possibly some good engineering). Our Westlake room made us a 2 studio operation but instead of just doubling our gross, we went from \$12,000 a month to \$60,000 a month. The incredibly accurate planning of our Westlake turnkey installation resulted in completion exactly on time, response precisely as promised, all equipment functioning within one day of installation, and all within budget! In the past six months we have mastered such acts as Stevie Wonder, Bob Dylan, America, Buddy Miles, Fleetwood Mac, Rick Nelson, Tower of Power, Livingston Taylor, Isley Bros., Rod McKuen, Nitty Gritty Dirt Band, Emitt Rhodes, Richard Greene, El Chicano, Nana Mouskouri, Cleo Laine, Bola Sete, San Sebastian Strings, Jo Stafford, Maxayn, Pharoah Sanders, Archie Shepp, Ballin' Jack, Vickie Lawrence, Maureen McCormick & Chris Knight, Don McLean, Vikki Carr, Bill Medley and even Rodney Allen Ripppy. Over half these acts were recorded on Westlake monitors in various studios around the country, attesting to the fact that truly, you are the professional."

Christopher Stone, President, Record Plant Recording Studios,

Los Angeles: *"As you know, we have used Westlake Audio and yourself since the inception of the company for all of our studio design, construction, electrical interface and implementation. During the past four years you have designed and implemented eight studios for us in New York City, Los Angeles and Sausalito. Obviously we are known as a Westlake-designed operation. We have built our total reputation around your studio design and have always been happy with our decision to utilize you on an exclusive basis for all our acoustical requirements and equipment consultation. The success of your design speaks for itself in the form of our success as an independent studio operation."*

John Sandlin, Vice President A & R, Capricorn Records, Macon,

Georgia: *"Words alone cannot express my appreciation for the friendly and courteous atmosphere I enjoyed while at Westlake mixing Bonnie's (Bonnie Bramlett) album.*

It was really a pleasure to work with such extremely competent and dedicated people. Thank you for giving me an opportunity to experience the automated mixing facilities and to work around the type of people I love and can relate to.

Take care of Baker, he's incredible."

John Boylan, John Boylan, Inc., Hollywood, California:

"First of all, this is my third project in a row to be mixed on your monitors and once again it looks like we have a winner — a record that sounds as good at home as it did in the control room. From a producer's nontechnical viewpoint, this ability to trust a studio monitor and come out with even results is extremely satisfying. Secondly, the Westlake Monitor never seems to vary in any substantial way from studio to studio, in the control rooms that you've designed. So I have no worries about consistency in today's widely dispersed recording scene."

WE PUT OUR MONEY WHERE OUR MOUTH IS!

Below are excerpts from a typical acoustical system acceptance from a client authorizing the release of the final portion of the construction monies from a trust account.

SYSTEM PERFORMANCE ACCEPTANCE

In accordance with the terms set forth in that certain agreement contained within Westlake Audio's invoice number 3930 dated March 1, 1974 mutually accepted by Westlake Audio, Inc. and Sounds Interchange, the undersigned hereby:

1. Acknowledges receipt of and accepts a final sound measurement report from Westlake Audio, Inc.
2. Agrees that Westlake Audio has, as relates to the design and construction of the Sounds Interchange studio facility in Toronto, Canada, met or exceeded all performance specifications as set forth in the Westlake Audio brochure entitled Acoustical Design The Key To The Success Of Your Studio as amended and signed by T. L. Hidley on February 8, 1974.
3. Acknowledges that all work has been completed in a satisfactory manner and that all materials have been delivered.
4. Acknowledges the fact that Westlake Audio, Inc. has complied with and fulfilled all the terms set forth in a certain Letter of Credit drawn in favor of Westlake Audio, Inc. and hereby instructs the advising bank — Bank of America, Westlake Boulevard, Westlake Village, California, U.S.A. to honor and pay at sight said Letter of Credit on or after December 6, 1974.

SOUNDS INTERCHANGE LTD.

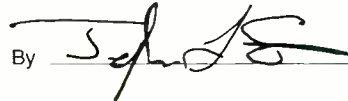
By 
Dated DEC 6/74

**THAT'S WHAT AN ACOUSTICAL
GUARANTEE IS ALL ABOUT!**

Complete, unedited photocopies of these and many other testimonial letters are available on request from Westlake Audio.
Phone or write direct to Tom Hidley, President.



**Westlake
Audio**

6311 Wilshire Blvd
Los Angeles, California 90048
(213) 655 0303

2) The amount of tape used at 30 ips is twice that for 15 ips. So both the cost of the tape, and the amount of storage space are doubled.

3) The total recording time on a given reel is cut in half at 30 ips, so that maximum *take* length is reduced to 15 minutes with a *standard play* (2500 foot) reel. You can bring this back up to 22 minutes by using *extra play* tape (3600 foot). But this tape with the thinner backing will further increase the amount of print-thru.

4) The low-frequency response of the reproducing head is effectively worse at the higher speeds. The response ripple *head bump* and cutoff that commonly occur around 30 Hz at 15 ips now move up to around 60 Hz.

5) Low-frequency modulation noise-- the so-called *dc noise*-- move up to frequencies of greater audibility.

So 30 ips has some definite advantages, but is not an unmixed blessing. You have to decide the best tradeoff for your own applications.

Recording studios frequently use the 30 ips speed with the AES response characteristic, but may not have the corresponding AES response calibration tape for that speed. However most studios will have a NAB response calibration tape for use with 15 ips speeds. The questions naturally arises, "Suppose I reproduce my 15 ips calibration tape at 30 ips. What output level readings should I adjust my equalizers for to correspond to *flat* output from the 30 ips AES response calibration tape?" Table 5 shows these values. Note that all of the frequencies as actually reproduced will be twice the frequency that is announced (the announcements come out as *monkey chatter*).

Complete alignment can be a time consuming process. Is there any way to speed it up?

J.Mc: Alignment of a tape machine requires several mechanical as well as electrical adjustments, and most of these adjustments interact with one another. The usual reproducer alignment test tape contains a series of discrete frequencies. To perform these adjustments often requires rewinding and replaying the test tape several times in order to obtain proper mechanical and electrical performance.

A considerable simplification and time saving is achieved in this alignment procedure by using a test tape containing rapid frequency sweeps. This signal is viewed on an oscilloscope, or on a real time 1/3 octave spectrum analyzer. It gives the appearance of a continuous display of all frequencies at once; thus the effect of all adjustments and their interactions is immediately apparent. A 1/3 octave real time spectrum analyzer may be used to read the output at

particular frequencies. Note that the power spectrum of the rapid sweep is the same as that of a pink noise random signal. The sweep has the advantage that it can be read out with either the oscilloscope or the real time spectrometer, whereas the random noise signal can be read out only with the spectrometer.

A normal discrete tone test tape is necessary, however, for obtaining data below 500 Hz, and for all cases where the readout is to be performed on a meter when no oscilloscope is available.

Do you have any recommendations on the care and storage of test tapes?

J.Mc: Physical damage, especially edge damage, will make any test tape useless. Edge damage in long time storage can be prevented by playing the tape in one pass *without stopping* under a moderate tension and evenly spaced between reel flanges. Set the tension according to the machine manufacturer's instructions.

Winding the tape under a very low tension may allow subsequent interlayer slippage in the tape pack, possibly resulting in edge damage.

For storage, leave the tape in the played condition, or *tails out*, and fast wind only before using. The tape should not be wound in contact with one reel flange or upon warped or bent reels as this may result in irreparable damage to the test tape.

Tapes should be stored at room temperature in a non-condensing atmosphere and never be exposed to temperatures above 50°C (122°F). Exposure to equipment radiating magnetic fields such as motors, transformers, solenoids, magnets, etc., should be avoided to preclude possible loss of calibration.

When a reproducer test tape is used for continuous check-out purposes, such as in production line work, usage and wear often become the primary sources of inaccuracy.

End



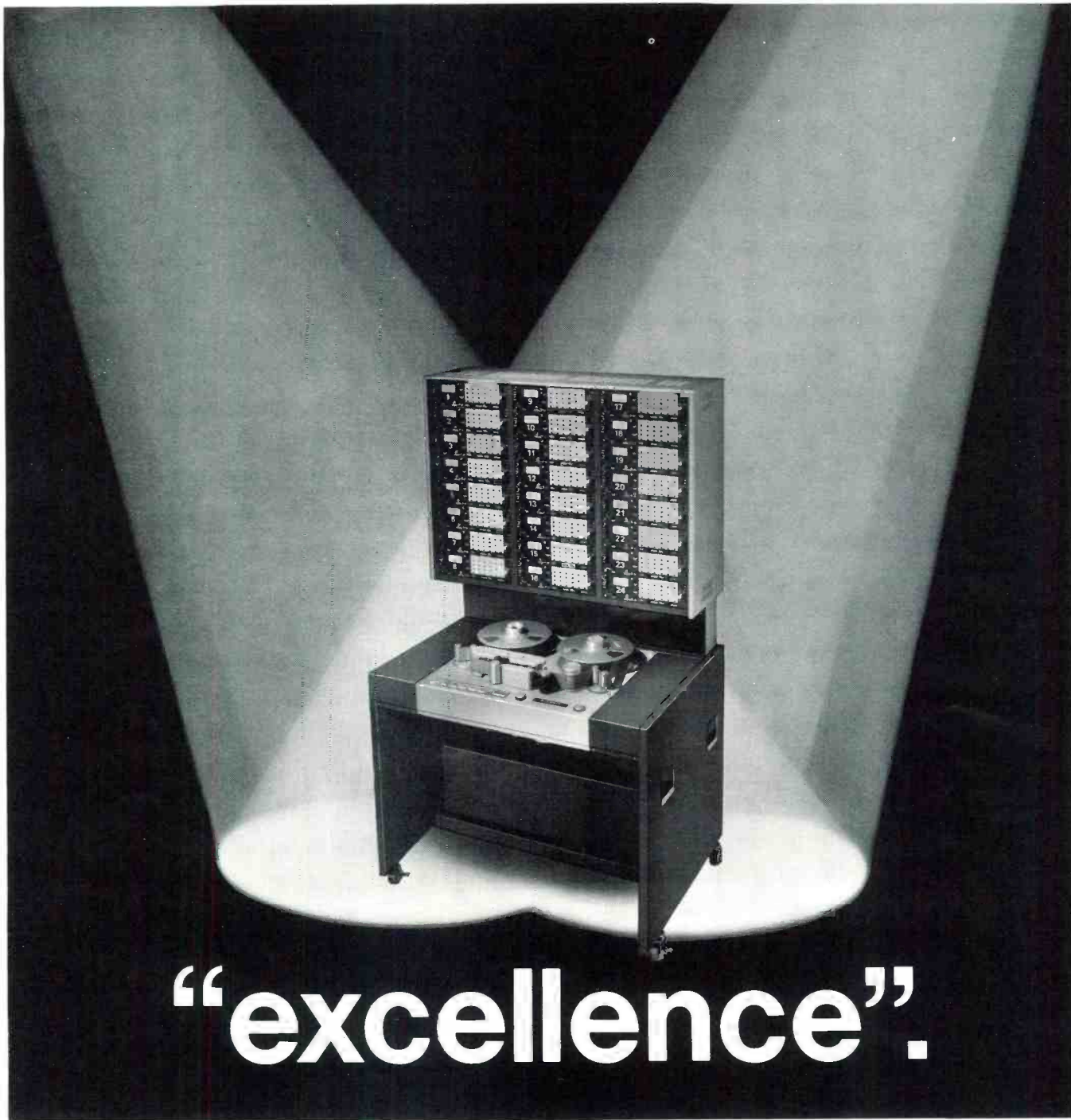

“excellence”.

For over twenty-five years the *Studer* name has stood for excellence. Through the years Studer tape recorders have come to be recognized throughout the world as a standard of the broadcasting and recording industries. Studer's A80/VU Recorder was developed for use in recording systems where only the highest quality is acceptable. The great care taken in the design, development and construction of the A80/VU is reflected in its unusual reliability and stability. A superior transport combined with a

versatile electronics system and high-precision heads allow studio personnel to work surely. With the recorder a stable, predictable instrument, the energies of the mixer and producer can be applied totally to the creative aspects of their work. For complete information contact . . . WILLI STUDER AMERICA, INC., 3916 Broadway, Buffalo, New York 14227—phone 716 681-5450. (In Canada: WILLI STUDER CANADA, LTD., 416 423-2831)

WILLI
STUDER
AMERICA

Introducing Our \$75,000 Tape Duplicating System

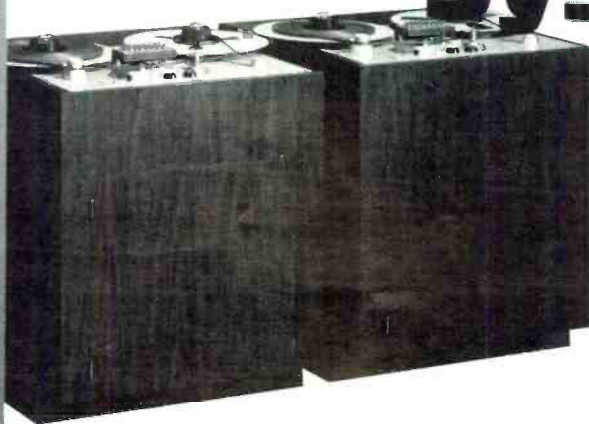

For years, people have told us, "Your equipment is priced too low. A \$40,000 system can't possibly be as good as a \$75,000 system." Even though we offer the same features, speed, versatility, quality, and durability in our Model 1100B 8-track duplicator that you'll find in systems costing twice as much.

But we finally solved the problem. Now, with our

gold-plated, diamond-studded nameplate, we can sell the Model 1100B for a price that's right up there with our competitors.

Of course, if you want a stripped-down Model 1100B (that's the one with the plain nameplate), we can still sell you one for about \$40,000. But don't tell anyone what you paid for it. After all, we've got our reputation to think of.

Mfg.	Model No.	Tension Control	Tape Speeds (ips)	Freq. Response	Interchangeability of Heads	Ferrite Heads	Price*
Audio/Tek	1100B	Yes	240 master 60/120 slave	50-12,000 Hz ±2db	Yes	Yes	\$39,875
Gauss-Cetec	1200	Yes	120/240 master 30/60/120 slave	30-12,000 Hz ±2db	Yes	No	\$80,900
Ampex	BLM200	Yes	240 master 60/120 slave	50-10,000 Hz ±2db	Yes	Yes	\$51,695
Electrosound	6000 8LF	Yes	240 master 60/120 slave	40-12,000 Hz ±2db	Yes	Yes	\$69,730
Otari	DP-6000	No	240 master 60/120 slave	30-10,000 Hz ±3db	Yes	Yes	\$57,100

*Prices based on one-inch loop-bin master and five slaves, all items equipped with tension control (if available) and eight-track heads for 32:1 duplicating ratio.

For more information about quality duplicating equipment at a price that makes sense, call or write:

AT AUDIO/TEK INCORPORATED

503-F Vandell Way, Campbell, CA 95008 (408) 378-5586

Circle No. 121

www.americanradiohistory.com

R-e/p 39

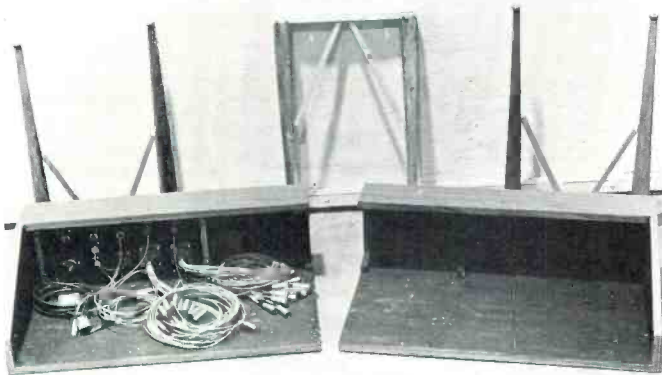
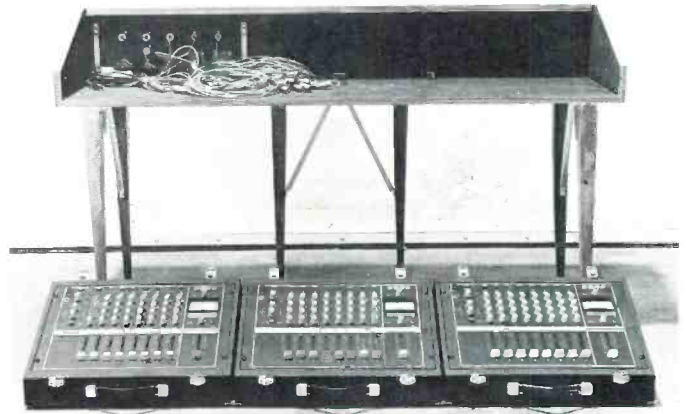
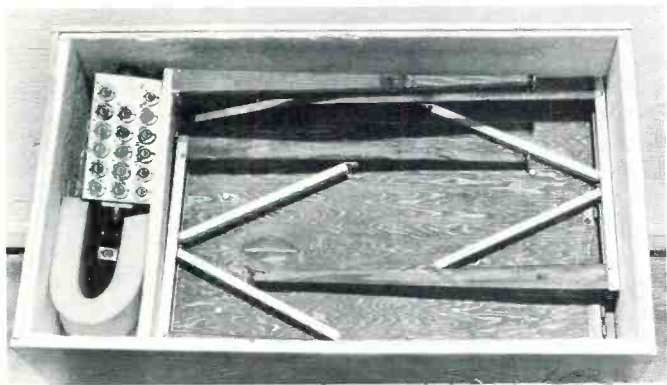
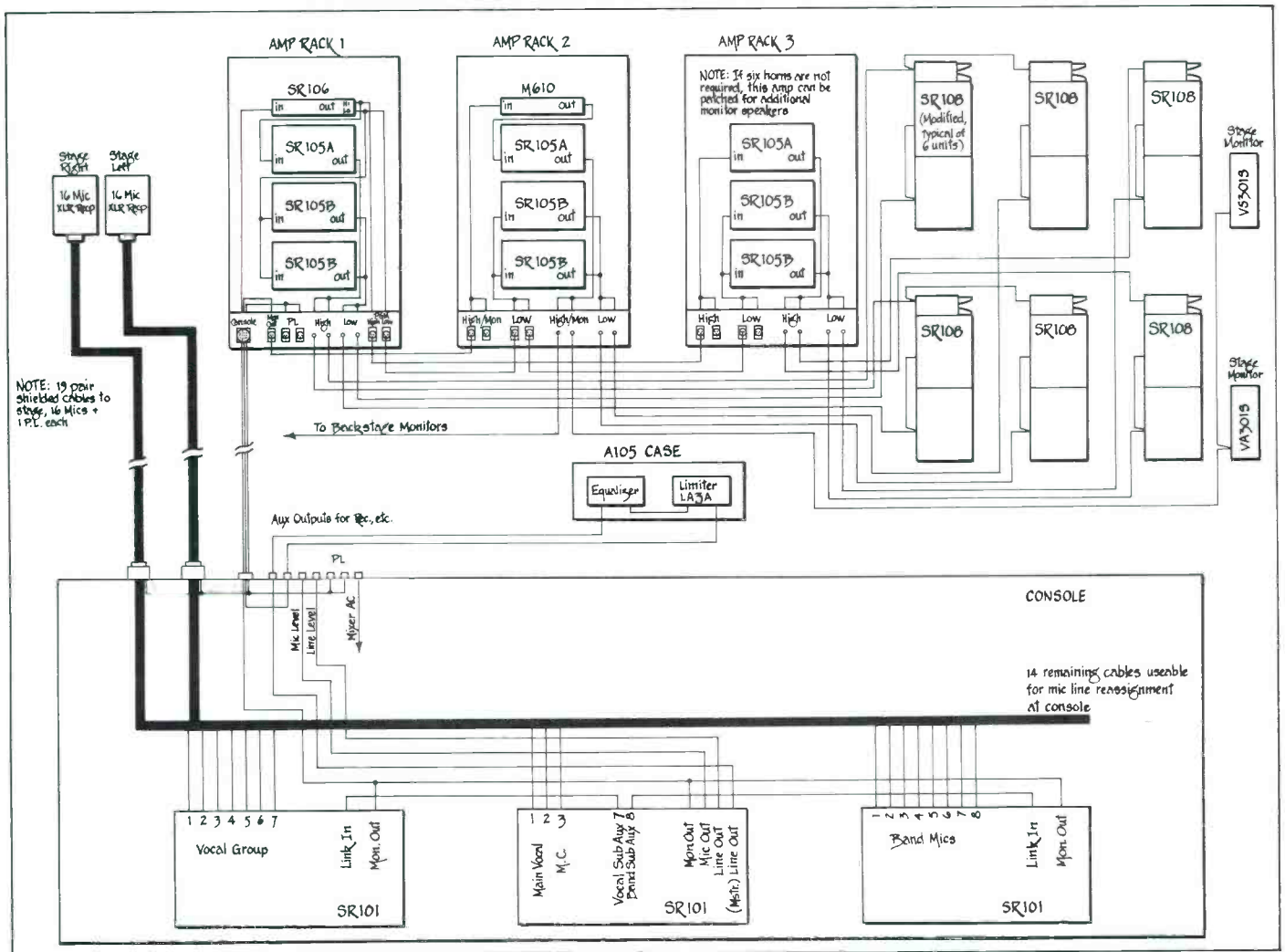

• Console unpacking and assembly sequence culminating in set-up console in Tbilisi. White area on back of each seat is a small speaker to supplement house sound system. (unused for these concerts.)

move the containers around, caster receptacles were put on slightly more than half of them. In this way, it was possible to snap casters on the bottom of a container, stack another box on top of it and wheel them away.

I never regretted the many, many hours we devoted to planning, phone calls, equipment selection and packing – they paid off at every stop on the tour.

Another important part of our planning involved specific set-up procedures at each theater. To make the best possible use of the time once at a theater, a specific schedule of procedures was established.

On arrival, we contacted the person in charge of the theater. With diagrams of the individual theaters in hand, we investigated two or three possible locations for setting up the console. The manager would then show us a location which kept us out of the audience's way and also conformed with the extremely strict fire safety restrictions that prevailed in every theater.

After a location for the console was established, cases were sorted and unpacked. Working in teams, some of us would set up speakers while others assembled the console, laid cable, put the power amplifier racks together and began checking the hall for special acoustical conditions.

When all components were in position and ready to go, I played a tape to check sound level throughout the theater, positioning speakers for even sound coverage of the audience. Speakers were elevated in each hall to have the sound come down on the audience.

Determining the number of speakers for each theater was simply a matter of listening for the best possible combination of bass and horn enclosures.

Equalization, however, was a little more technical. I used a one-octave equalizer to find the most gain-before-feedback setting. To do this, microphones were positioned in the worst possible conditions that could prevail during the show, then equalization was adjusted to roll off the frequencies where the house tended to produce feedback. In this way, the system could be equalized for maximum gain before feedback

tour's voltage transformer and three power amplifier racks, with crossovers and a feedback controller

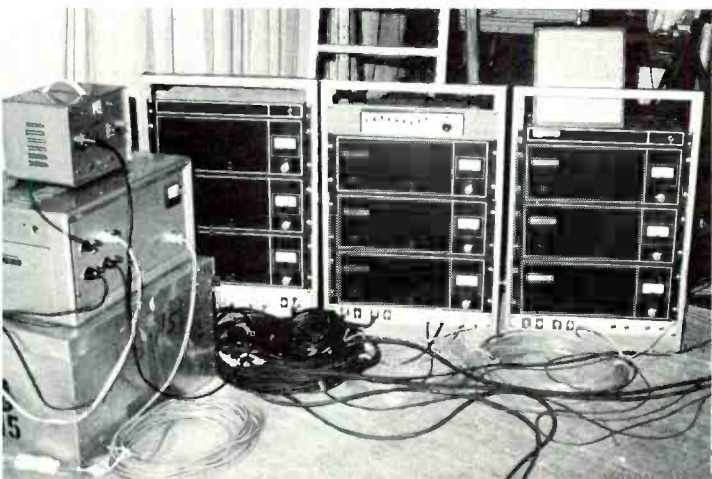

MODULAR AUDIO PRODUCTS

Graphic/Shelf Equalizer with REPEATABLE EQUALIZATION

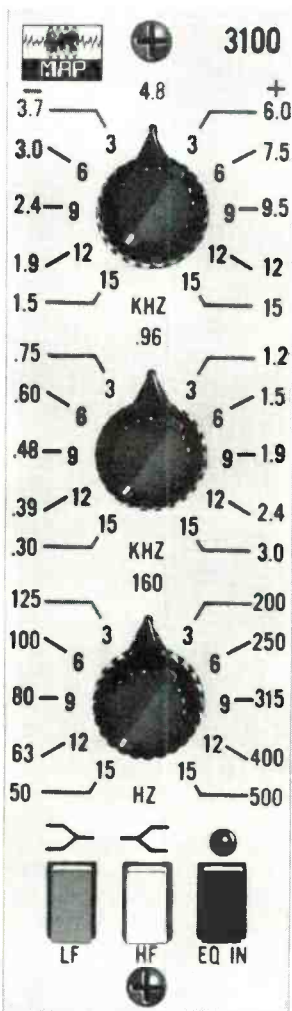

Model 3100 ■ Actual Size

- Three independent overlapping frequency ranges; 50Hz to 500Hz, 300Hz to 3KHz and 1.5KHz to 15KHz, with 11 detented center frequencies per range.

- Selectable Bell shaped or Shelf response curves on high and low frequency ranges.

- -15dB to +15dB cut and boost, 11 detented positions.

- Silent equalization in-out switch with LED indicator.

- High output capability, up to +27dBm into 600Ω, TYP THD .05%.

- Low noise, -90dBm unweighted, 20Hz to 20KHz.

- Frequency
- Level
- Curve Shape

Modular Audio Products is an engineering oriented company providing a complete line of console and studio components. In addition to supplying the finest quality products, we also provide the technical and application backup to go with them.



Call or write us today for information on this and other state-of-the-art units.

MODULAR AUDIO PRODUCTS, Inc.

A UNIT OF MODULAR DEVICES, INC.

1385 Lakeland Ave. ■ Airport International Plaza
Bohemia, New York 11716 ■ 516-567-9620

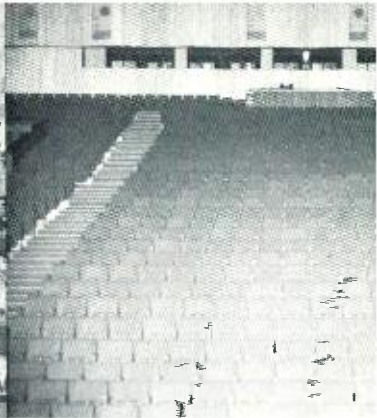
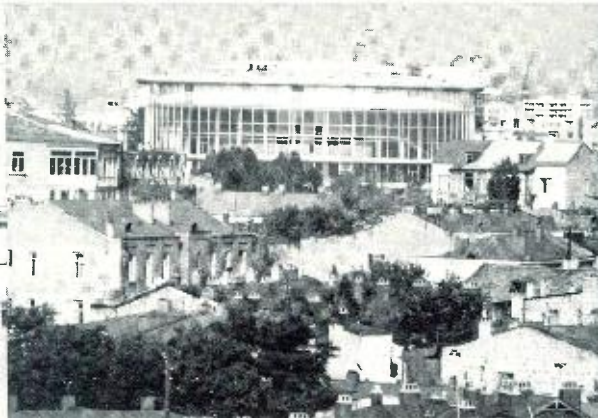

Theater in Yerevan,
first stop on the tour

Second stop,
the 2300 seat theater in Tbilisi.

Audience area in the
2300 seat theater in Baku

without any deterioration of program material. Most theaters tended to have a low-frequency resonance that would produce feedback, normally right in the lower end of the vocal range. Because much of the show was vocal material, a compromise was made at the point of sufficient gain before feedback without damage to vocal sound quality.

This process was repeated in each theater. But in Leningrad, a strange thing happened.

Each show's opening had dancers coming on stage from both sides to join Tennessee Ernie Ford midstage. At previous theaters, we found the ideal location for the opening to be the deepest part of the stage. This proved to be the best location as far as our normal sound amplification was concerned.

In Leningrad, however, that location gave us feedback problems.

After the first show, I searched for the cause. Much to my surprise, the problem was a unique feature of the theater's curtain. When the curtain went up, it went behind an 18" trap door in the ceiling which then closed flush against the ceiling. During testing, I found that if this trap door was left open, feedback was not present. Apparently, when the trap door closed, sound funneled off the back wall, and to the back portion of the stage. By leaving this trap door open when the curtain was raised, this unusual problem was eliminated.

During the show itself, controlling the individual Shure SM54 microphones was made considerably easier through the use of Shure colored wind-screens.

By color-coding microphones to their appropriate inputs, a visual method of microphone control was achieved. Without these colored windscreens, the show would have been extremely difficult to do because microphones were constantly being passed from performer to performer. With these colored windscreens, it was simple to associate a microphone to its color-coded control without any guesswork.

In each city visited, there was a tremendous amount of interest in our equipment. Unfortunately, I didn't have time to talk at length with Russian technicians about the Shure "SR" sound components and how they worked. The most common questions they had were about the amount of power the "SR" components could produce and how many microphones the system could accommodate.

They were all curious about the use of a 600-ohm line, a high impedance line and a microphone line-level in one system. Apparently, their systems are such that only one line impedance goes between the stage and the console. Another major difference between our system and theirs was their lack of monitor speakers in the control room. I had to set up my own monitors in each city.

Particularly impressive were the house systems in

The Sensible Alternative MX-7300-8

■ Under \$7,300—save 24 to 32% ■ Compatible one-inch/eight-track format ■ Motion sense logic prevents tape damage ■ Optional remote synchronous-reproduce

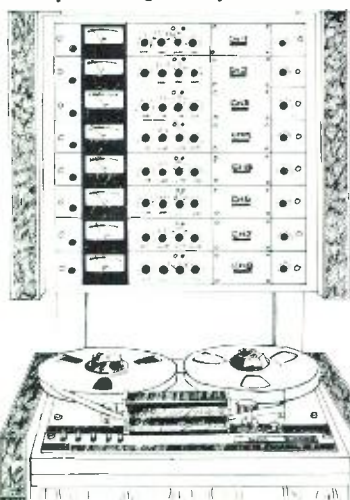

on all channels ■ Professional type 600 ohm + 4dB outputs and XL connectors ■ 7½/15 or 15/30 ips.

OTARI

Otari Corporation
981 Industrial Road
San Carlos, CA 94070
(415) 593-1648
TWX: 910-376-4890
In Canada: Noresco



Hotel Russia, Moscow,
last stop

all the Russian theaters. They appear to rely on multiple speakers a great deal. In fact, the theaters in Tbilisi, Baku and Leningrad all had small speakers mounted in the back of each seat so that each person has an individual speaker right in front of him, in addition to the house speakers. It should be noted that while the Russian theater systems were all very impressive, we used only our Shure "SR" components wherever we appeared.

Russian audio consoles were rather large and, in general, employed tubes instead of solid state circuitry. In fact, the television station in Moscow was the only place where I saw any solid state equipment.

Looking back again, there are some specific "do's and don'ts" for any soundman making a similar trip.

Pre-planning is the most important part of such a trip. As you're planning the sound system, write down everything you might possibly need — even the most obvious, taken-for-granted pieces of equipment.

Make certain your equipment is totally self-contained, with enough replacement parts to last the trip. We took sufficient parts to replace about 75% of all our electronic equipment.

Take a total sound system with you rather than using part of your own equipment and part of any house system. For example, while we found the Russian equipment to be excellent, it would have been impossible for us to tie in our components because their connectors and their microphones were different, their impedance levels were different, and their signal levels were obviously different.

If I had it to do over again, my equipment list would be the same: the Shure "SR" system performed beautifully and without fail at every theater. Despite the large amount of handling and bouncing around the system encountered during the trip, we had no problems that could be considered significant.

But there are some things I most certainly would add to my next inventory list. They are Coke, instant tea, Moon Pies, potato chips and American cigarettes. They're impossible to find over there and make excellent trading material.

STOCK REDUCTION CLEARANCE!

CETEC IS CLEARING THE SHELVES OF OUR LANGEVIN & ELECTRODYNE SPECIAL ITEMS. YOUR CHANCE TO PICK UP THESE ITEMS AT A SAVINGS DURING THIS ONE TIME SALE — QUANTITIES ARE LIMITED AND SUBJECT TO PRIOR SALE. THIS IS THE ONLY TIME THIS WILL BE RUN, SO SAVE THE AD IF YOU MUST — BUT REMEMBER. TIME IS RUNNING OUT!

QUAN.	DESCRIPTION	PRICE
1	Electrodyne 210L Input Module Line Only — No EQ	\$150.00
1	Electrodyne 310L Input Module MIC/Line — No EQ	
1	Electrodyne 609L Input Module Line Only — W/EQ	
6	Electrodyne 709L Input Module MIC/Line — W/EQ	
4	Electrodyne ACN 2P10 Combining Network 31 inputs with 10 dB gain	
3	Electrodyne ACN 2P20 Combining Network 31 inputs with 20 dB gain	
4	Electrodyne 610 SEQ Input Module. Line Only with EQ and additional Echo Output and Cue Attenuator	\$250.00
18	Electrodyne X4 4 Watt Modular Power Amp OTL	
1	Electrodyne XS1 Special Line Amp	
150	Langevin Attenuators — T, H, Potentiometers, Various Steps and Losses and Some Special Impedances.	

NOW'S YOUR CHANCE TO SAVE ON NEW, DISCONTINUED UNITS. ROTARY AND STRAIGHT LANGEVIN FMT, FNH, FNVU NETWORKS. MOSTLY 600/600. VARIOUS LEGS AND LOSSES.

SAVE!

(WE ARE LOSING ON THESE TOO — YOUR GAIN.)

Call: DON KING • (213) 875-1900

Cetec Audio
A Division of Cetec Corporation

13035 Saticoy Street, North Hollywood, California 91605



Save \$500.00 to begin with, then you write the ending.

From the time you conceive a musical idea until its final expression, you'll be struggling with the art. There's no way to avoid that. But using the technology available to your best advantage — getting it down on tape — doesn't have to be a problem. And it certainly doesn't have to be an expensive problem.

The Professional Alternative. For the price of their 4-track recorder alone, you can buy ours, plus a board, and still have money left over.

\$4,600.00...plus tax. That's the total cost of a half-inch 4-track Series 70 Recorder/reproducer and an 8-in, 4-out Model 10 Mixing Console. You save \$500.00 on the package, based on current user net prices.

You need it. Now you can afford it. These days, when even 4-track budgets are either being slashed or forgotten, remember there is an alternative. A very affordable one. The art is always a struggle. Access to the technology doesn't have to be, and your TASCAM dealer can demonstrate why. To find the one nearest you, call (800) 447-4700* We'll pay for the call. *In Illinois, call (800) 322-4400



TASCAM
TEAC PROFESSIONAL PRODUCTS

TEAC Corp. of America, 7733 Telegraph Rd., Montebello, Calif. 90640.

A
SOMETIMES
MISSED
OPPORTUNITY

MUSIC PUBLISHING

BY
WALTER
HURST

CHECKLIST OF FORMS & CONTRACTS WHICH PUBLISHERS DEAL WITH.

- 1) **Songwriter-Publisher Contract**
 - a. Copyright assigned to publisher
 - b. Publisher promises to pay royalties
- 2) **Publisher-Record Company Contract**
 - a. Publisher gives permission to use song on records
 - b. Record Company promises to pay royalties
- 3) **Songwriter-BMI Relationship / Publisher-BMI Relationship**
 - a. BMI receives "small performance rights"
 - b. BMI pays royalties to songwriters and publishers
- 4) **U.S. Publisher - Foreign Publishers Relationship**
 - a. U.S. Publisher sells or licenses rights in song to one or more foreign publishers for various territories
 - b. Foreign Publishers pay advances, royalties to U.S. Publisher
- 5) **Publisher-Variou s Users Relationship**
 - a. Publisher licenses users to print sheet music, song books, to use in motion pictures, in night clubs, etc.
 - b. Users pay one-time fees or royalties.
- 6) **Publisher-Copyright Office Activities**
 - a. Publisher sends Form E to register the song
 - b. Publisher sends Form U to give notice that the song has been recorded.

A Songwriter, often not having either the inclination or the ability to sell his product to prospective users, will sell or assign his rights in a song to the middleman, the Music Publisher.

The Music Publisher, after duly securing rights to a song, attempts to commercially exploit the song, and his acquired rights to that song.

What exactly has the Music Publisher acquired with which he can amass well earned profits?

1) The most obvious right that the publisher owns in a song is the right to record that song, either as a demo, a master, or a sound track. This right, in turn, may be the subject of negotiations with a master producer or a record company.

2) A second right that the publisher owns is the right to mechanically reproduce the song on records or tapes. A contract between a publisher and a record company concerning the right to mechanically reproduce the song is called a *mechanical license*.

3) A third right that the publisher owns in a song is the right to print and distribute the song in written form; piano score, school and professional arrangements, fake-books, song books, etc. This right is of interest to sheet music publishers, who may negotiate for printing rights.

4) A fourth set of rights that the publisher owns are the so-called *synchronization* rights; the rights to record the song for a motion picture sound track and to play the motion picture sound track in theaters and elsewhere. These rights are of interest to motion picture producers.

5) There are other uses which can be made of songs. Generally, the publisher as copyright proprietor of the song licenses and permits use of the song by any user, and the user promises to pay an agreed upon fee to the publisher.

THE COPYRIGHT

At this point it is probably time to discuss the essentials of what it is that the Songwriter transfers to the Music Publisher and what the Music Publisher transfers to others; rights to the copyright (copy-right/n: the exclusive legal right to reproduce, publish, and sell the matter and form of a literary, musical, or artistic work.). Claims to copyright can be filed by writing to the Register of Copyrights, Library of Congress, Washington, DC, 20559, and requesting Form E (Application for Registration of a Claim to Copyright), filling it out and returning it along with the filing fee of \$6.00 and one lead sheet if the song is unpublished or two copies of the best edition of the music if the music is already published.

As the proper assignee of the copyright from the Songwriter, the Music Publisher owns the copyright in the United States, as well as in the territory of some over 50 other countries who are signatory to the Universal Copyright Convention. The Music Publisher may, for practical reasons, sell or assign rights to the song to publishers in these or other countries.

Again, the practical value of the copyright is that the holder or assignee is the only party legally entitled to commercially exploit the song, that is, collect fees, royalties and other payments for licensed use of the copyrighted material.

SONGWRITER-PUBLISHER NEGOTIATIONS

Publishers love to use forms with official sounding titles: OFFICIAL SONGWRITER CONTRACT, STANDARD SONGWRITER AGREEMENT, POPULAR SONGWRITER-PUBLISHER CONTRACT.

The usual contract has lots of small print, spaces for 1. Date, 2. Name of song, 3. Publisher's name and address. 4. Writer's name and address. The songwriter is offered lots of time to read the contract, but the usual songwriter's eyes become too tired to read more than five or six lines, so he simply signs the contract.

If the usual songwriter tries to negotiate with the publisher to improve the deal, the publisher may say, "My lawyer told me to change nothing. Maybe your lawyer can convince my lawyer to change something." The usual songwriter forgoes two major difficulties: one, his paying a lawyer; two, his lawyer changing the mind of the publisher's lawyer.

Or, the publisher may use the computer argument. "Sorry, son; I would love to pay you more than the standard royalties, and I would love to pay you more often. But my computers are set up to pay semi-annually and to pay the royalties set forth in the agreement. For me to change the computer tapes to pay you special rates or quarterly would cost me a fortune. I just can't do that, much as I would like to." The songwriter, overawed by computers or worn out by listening to so much talk, usually surrenders.

The publisher may offer two co-songwriters, one of whom wrote the lyrics, the other having written the music, whether they want to be paid (choice one) for his respective contribution [for example, the lyricist is paid when words are used, is not paid when only music is used, shares his share with a translator when the lyrics are translated into another language], or (choice two) the songwriters share equally all amounts payable by the publisher to either of them, half for the lyricist and half for the composer. The

AT LAST!

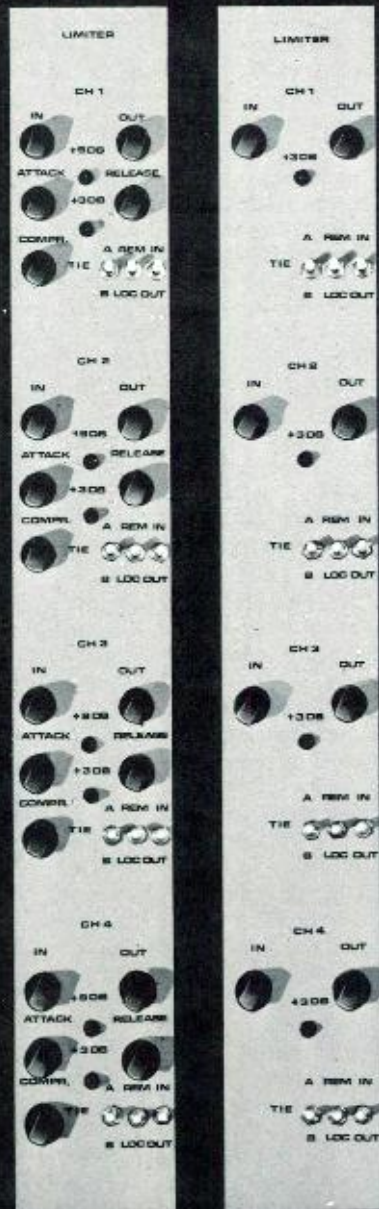

L-150T

L-100T

4-channel limiters
for TASCAM consoles
(compatible in
price and design)

manufactured by

sound genesis
INCORPORATED

445 Byrant Street
San Francisco, CA 94107
Telephone 415/391-8776
a TASCAM dealer



lyricist thinks of the possibility of his receiving nothing if some jazz or other instrumentalist records music-without-lyrics. Usually the two songwriters agree to share royalties equally.

BARGAINING

The songwriter can, theoretically, easily become a publisher. Publishing consists of paperwork and song pushing. Paperwork can be learned. Song pushing generally consists of making the contacts to achieve getting the song recorded. These activities are often performed by songwriters as songwriters for the songwriters' share of receipts. The same songwriter may be able to do a little bit more paperwork, a little bit more song pushing, and become a music publisher.

The songwriter, in dealing with a publisher, can easily mouth the words, "If you don't give me co-publishing, I won't give you the copyright." The publisher may orally agree.

The publisher who will administer the song (do the paperwork, negotiate the contracts with users and foreign publishers) is called the *administrative publisher*. The other publisher is called the *co-publisher*.

There is no standard contract between the administrative publisher and the co-publisher.

Concerning ownership of the copyright — the contract may provide either that the copyright belongs only to the administrative publisher OR the contract may provide that the two parties co-own the copyright.

Concerning payment from ASCAP or BMI or Harry Fox Agency — the contract may provide that the payors shall pay the administrative publisher OR the contract may provide that the payors shall pay 50% directly to the administrative publisher and the other 50% directly to the co-publisher.

Concerning time(s) of payment — the contract may provide that the administrative publisher shall pay the co-publisher semi-annually OR quarterly OR within two weeks after receipt of money from any source, OR other variations.

Concerning amounts the administrative publisher may deduct *off the top* to compute the *50% of profit* payable to the co-publisher, some of the expenses *off the top* which can be negotiated about are: 1. 15% of gross receipts in lieu of itemized overhead. 2. 10% of publishers' share of receipts from all sources other than performance rights societies. Publishers' share equal gross receipts minus songwriters' share. 3. Costs of collection. 4. Legal expenses. 5. Bookkeeping, accounting, royalty computing expenses. 6. Copyright registration expenses. 7. Costs of production of demo. 8. Cost of dubs and sample tapes. 9. Costs of promotion, advertising, publicity. 10. Etc.

The negotiation points discussed herein

are only examples; there are many other points of negotiation.

RECAPTURING RIGHTS

Sometimes a songwriter may deeply regret having assigned the copyright in a song to a publisher (because the publisher failed to achieve a recording of the song or the release of a record containing the song, or because the publisher failed to pay royalties, or other reasons).

At such times the songwriter looks at the songwriter-publisher contract he signed, in order to learn whether the small print mentions possible return to the songwriter of the rights in the song.

Many songwriter-publisher contracts have no applicable provision.

Some contracts provide that if there has been no commercial recording or commercial sheet music on the market within a year after the date of the contract, the songwriter can demand that the copyright be returned.

Many professional songwriters insist that the songwriter-publisher contract contain a clause such as "This contract will become effective only if a record (containing the song as recorded by American Federation of Musicians who were timely paid full union scale) is released within three months of the date of the contract."

Professional songwriters should explore the activities of the American Guild of Authors and Composers and should study the pro-songwriter form contract prepared by AGAC for use by its songwriters and publishers. The contracts go into extensive detail, and are so pro-songwriter, that some publishers refuse to use it.

PERFORMING RIGHTS ORGANIZATIONS

What we have described so far are the essential dealings of the Publisher with the Songwriter, as well as with individual potential users of the song; record companies, master producers, motion picture producers and studios, etc. However, it would be obviously impossible for all the Music Publishers to deal individually with all of the thousands of *remote* potential users of songs.

It is to satisfy this need that the performing rights organizations, BMI (Broadcast Music, Inc.), and ASCAP (American Society of Composers, Authors and Publishers), and others somewhat less known, were founded. The performing rights organizations, then, are another form of middleman type of structure to be used by songwriters and Music Publishers to insure that payment is made for performance of their materials.

A Songwriter may join only one performing rights organization. But a Music Publisher may join both ASCAP and BMI. Thus, songs written by ASCAP songwriters will be placed by the Music Publisher into his ASCAP publishing company, and songs written by BMI writers will be placed by the Music Publisher into his BMI publish-

ing company. Simply stated, it then becomes the job of the performing rights organizations, to whom thousands of publishers and songwriters have assigned performance rights, to issue licenses and performance permits to thousands of users for all of the material in their respective catalogs. Each licensed user is supposed to pay the performing rights organization either an annual fee or every time licensed material is used. A share of this royalty is periodically paid to the Music Publisher and to the Songwriter.

EXPENSES OF THE MUSIC PUBLISHER

The essence of a good and binding contract between any two parties, in this case the Songwriter in assigning his copyright to the Music Publisher, is an exchange of value. The terms of contracts between songwriters and publishers usually state that payment to the Songwriter be in the form of royalties (roy-al-ty/n: payment made to an author or composer for each copy of his work sold). The royalty rate to the composer or songwriter is often approximately 50% of the amount the Music Publisher receives.

This, then, is a major cost to the Publisher. Other costs may include costs of the copyright, costs of preparing lead sheets and copies for registering the copyright, costs of form contracts between the publisher and the persons he deals with, and secretarial costs related to these

activities. These costs to the Music Publisher need not be large expenditures.

Music Publishers also incur additional expenses, overhead expenses; and promotion and sales expenses. Overhead includes the normal expenses of housing and operating a business; rent, telephone, accounting, etc. Promotion and sales expenses are those incurred normally for travel, entertainment, publicity, advertising, etc.

It is readily seen that these overhead and promotion expenses can be minimal or high, depending on the desires and abilities, and scope of operation of the publisher. However, where the publishing business is an adjunct of another enterprise, such as a recording studio, or a production company, where a good many of these costs are already being expended, the addition of publishing activities may add very little increase to the established overhead.

THE RECORDING STUDIO AS MUSIC PUBLISHER

The recording studio and/or individual recording engineers getting into the music publishing business have several ways to go:

- 1) Acquire full publishing rights in one or more songs.
- 2) Acquire co-publishing rights in one or more songs.
- 3) Acquire a percentage share (points) of certain royalty amounts, i.e., a percentage of the publisher's receipts pertaining

to the song, less the amount paid to the writer.

Generally when a recording studio or recording studio personnel become involved in music publishing, the rights acquired are in exchange for recording services, or all or a portion of various studio and production costs.

STARTING A MUSIC PUBLISHING COMPANY

A music publishing company is in no way or sense unique as a business operation. It can be, according to the choice of its operators, a sole proprietorship, a partnership, or any of several forms of corporation. All Federal and state laws applying to business operations apply equally to music publishers.

The paperwork involved in music publishing is simple and well established, and is completely covered in handbook form in works such as THE PUBLISHERS OFFICE MANUAL, Seven Arts Press, Inc., \$30.00, available from Recording Engineer/Producer Magazine, Box 2449, Hollywood, CA 90028.

Well, then, this has been an introduction to Music Publishing . . . and it is just that, an introduction. It is a field that is certainly more complicated than we have indicated, but only in practice. Music publishing can be a very high return business, from only very modest expenditures. What are you doing about getting into it?

Wattnott Product Generator

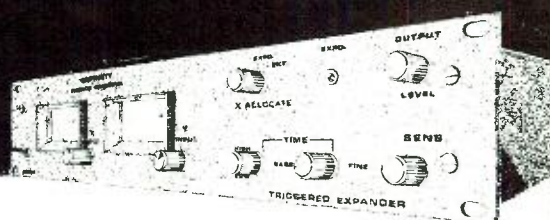

The Wattnott, a package of effects that goes beyond the scope of present day signal processing equipment. By generating the product of two incoming signals (X and Y) vibrato effects, tone modulation, triggered expansion as well as V.C.A. applications for synthesizers are achieved. Special introductory offer for a limited time only \$495.00. Ask about our offer on the remarkable V.S.O. Resolver.

from acoustic design
to down beat...

**Westlake
Audio**

6311 Wilshire Blvd
Los Angeles, California 90048
(213) 655-0303

Westlake Audio V.S.O.

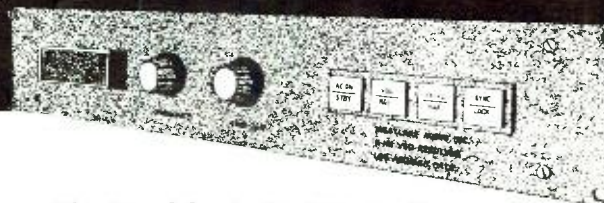

The Westlake Audio V.S.O. offers a system which combines a solid state power amplifier, variable frequency oscillator and digital read out in one compact 19" rack mount package. Available with optional machine selector panel. Available thru Westlake Audio Special introductory offer for a limited time only \$495.00. Ask about our offer on the remarkable Wattnott Product Generator.

from acoustic design
to down beat...

**Westlake
Audio**

6311 Wilshire Blvd
Los Angeles, California 90048
(213) 655-0303

HOME COOKIN'..

8 track style

For the pro musician..., the ultimate 8 track studio package at a price that really makes sense.



In fact, if you've been spending more than \$300 a month for studio time, you can now afford to have your own 8 track studio! Making use of the fantastic value offered by the TASCAM Model 10-4 channel mixer, Audio Concepts has developed a hybrid 8 track TASCAM mixing console, Model 210, with a full 16 input modules and 8 output submaster modules (each with its own VU meter), a talk back module with 8 track slate, and a stereo monitor mixdown module with separate mono head phone mix (not shown) all in one piece. And in addition, some exclusive features you can't get in a stock TASCAM, such as LED overload indicators on each input module, improved signal/noise specs by using special built-in low "Z" mic transformers with chassis mounted XLR connectors, and a special new beefy power supply. As options, the Model 210 will accept the stock TASCAM accessories such as the quad paner and transport remote control modules. For your multi-tracking needs, the incredible TASCAM

8 track Model 701 - 1/2" Recorder with sel sync, comes in a matching rosewood roll around console with rack front mounting for two dbx RM 157 noise reduction units, and it has lots of room for other goodies, such as monitor amps, limiters, reverb, etc. Specs on the Model 701-8 track/dbx 157 combo will deliver an amazing signal/noise ratio of 86+ dB as compared to most pro 1" machines with a Dolby "A" at 75 dB, and there is *no* tape hiss. Now you can even have three or four generations without any noise penalty. About all you really need to bring it all home is to plug in your favorite mics.

What's it all cost? Less than 1/2 of what you'd expect to pay. The Audio Concepts/TASCAM Model 210 Mixing Console (fully modified) and TASCAM Model 701-8 track 1/2" recorder in console with 2 dbx RM 157 noise reduction units can be leased for as little as \$300 per month or you can buy the whole package for \$15,200... less than the cost of a 1 inch 8 track with noise reduction.

For complete information on this package or any of the other fine products from TASCAM or dbx, stop by Dave Kelsey Sound in the Southern California area, or if you're anywhere else, get in touch with the crew at Warehouse Sound.

WAREHOUSE SOUND Co.

PROFESSIONAL PRODUCTS GROUP

Railroad Square • Box 5 • San Luis Obispo • California 93405

(805) 544-9020

DAVE KELSEY SOUND

6912 Melrose Avenue • Hollywood • California 90038

(213) 937-1335

See us for all your professional needs: High-Level Sound Reinforcement & Recording Equipment

A TRANSFORMERLESS BALANCED TO UNBALANCED LINE CONVERTER, AND AN UNBALANCED TO BALANCED CONVERTER.

BY PETER DeBLANC, 'db' LABORATORIES, SAN RAFAEL, CA

Want to convert some of those single ended studio lines to balanced? Need to isolate unbalanced remotes, instrument direct boxes, etc.? And you can't afford transformers (or don't want to use them)? Try this. A pair of integrated circuit op amps are used to provide a balanced output from a single ended (unbalanced) input, one op amp functioning as a simple voltage follower and the other as a voltage inverter.

A single op amp can be used to convert from a balanced line back to unbalanced for driving equipment with single ended inputs. With this converter (as with a suitable transformer) any hum or noise picked up in the balanced pair and will self cancel in the converter, providing a noise free single ended output.

The op amps used can be any that are suited for audio work when strapped for unity gain.

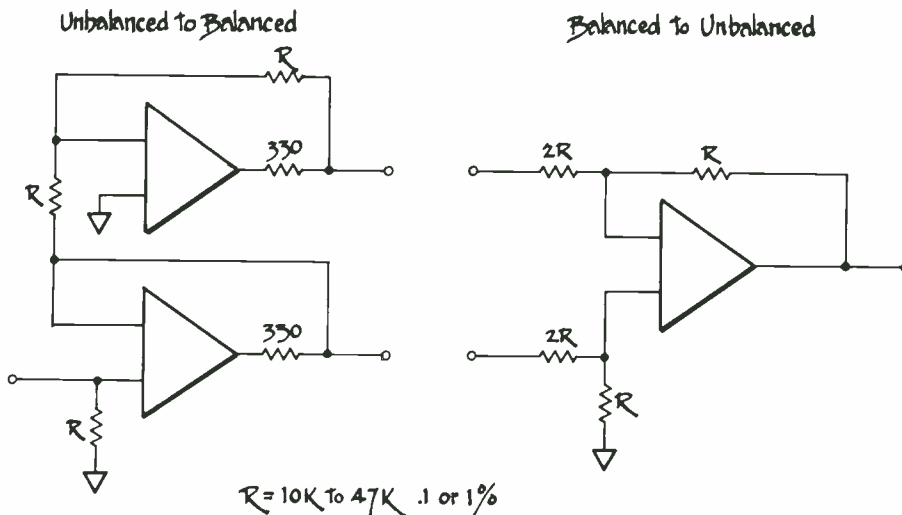

EDITING: A NIFTY IDEA by WAYNE YENTIS

Everyone knows how to splice and edit tape, and of course your method is the best for you, but . . . here's a tip that saves time and trouble, and can eliminate some confusion when you get interrupted in the middle of it.

When marking the tape for cutting, there are several advantages to marking the cut at a reference point to one side or the other of the actual place of the cut, instead of right over the gap of the play head. For one, it's not too hard to see how particles from the marking pencil can lodge on the head itself, besides the general undesirability of poking around on the head surface with anything at all.

Instead, on most machines there is a tape guide within an inch or so of the

play head which makes an ideal reference point for marking the tape. It's an easy matter to measure the distance between the gap of the play head and the tape guide and to put a prominent mark on your splicing block a corresponding distance from the angled cutting slot. Then, when you put the marked tape in the splicing block, line up the mark on the tape with the mark on the block. The cutting slot will then be directly under the desired cutting point.

Now, when you're in the middle of an editing job and you've got a short length of tape to be spliced in somewhere and the phone rings, or you drop the piece of tape on the floor, or *something* happens

and you lose track of which end of the piece of tape is which, a glance at one end will tell you . . . the marked end is the tail, at the head end of the piece the mark is cut off.

While we're on the subject, it won't hurt to mention that if you're using tape with the dull black backing (Scotch 206, 207, 208, 209, 250, Ampex 406, 407, Grandmaster, etc.) the only satisfactory splicing tape is Scotch 620, all other types of splicing tape adhere too stubbornly to the dull black backing and make it difficult to repair bad splices. But Scotch 620 will peel off easily, even after years. Also it is uncommonly strong and resistant to tearing, and tape dispensers with serrated cutting edges won't cut it smoothly . . . use a razor or scissors to avoid grief.

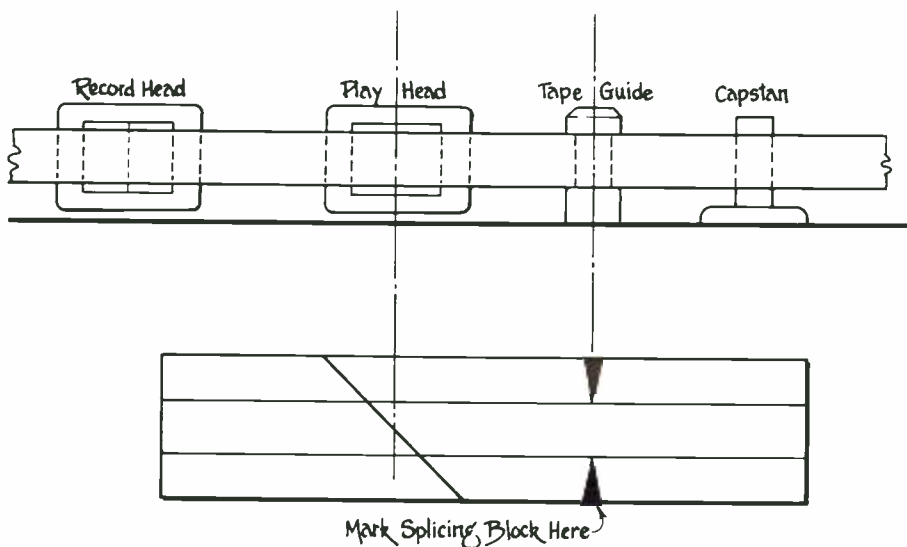

THE MOST ACCURATE PROFESSIONAL
PICKUP IN THE WORLD!



FOR GUITAR, PIANO, BASS . . .
ANY ACOUSTIC INSTRUMENT.

FOR INFORMATION WRITE OR CALL:

FRAP
FLAT RESPONSE AUDIO PICKUP
A DIVISION OF SPROBOTRONICS, INC.
Box 40097, San Francisco 94140 • (415) 824-2223

Included in the agreement with Burwen are professional audio products. Burwen also markets a consumer line of noise filtering systems and is located in Burlington, Massachusetts. Under the contract, Ampex will market the following:

The Burwen DNF 1500A — with bandwidth 10Hz to 8kHz — designed for broadcast stations and other communications using class A telephone lines.

The Burwen DNF 1500D — with bandwidth 250Hz to 4kHz — for radio and television stations using class D telephone lines for remotes or talk shows.

The Burwen DNF 1100 — with bandwidth 10Hz to 30kHz (one channel) — for stations and recording studios, reducing hiss up to 14dBm master tapes, cutting channels and program lines.

The Burwen DNF 1100 — with bandwidth 10Hz to 30kHz (two channel).

Burwen Dynamic Noise Filters require no pre-encoding making them free to work on all program sources.

CHARLES LINK NAMED PRESIDENT OF ELECTRO SOUND

Charles Link has been named president of Electro Sound, Inc., it was announced by David Piercz, president of Viewlex, the parent company of Electro Sound.

Mr. Link joined Viewlex in 1972 as director of business affairs for that company's Custom Service Division which provides record pressing, record jackets, and tape duplicating services to the recording industry. In 1973 he was promoted to vice president of financial operations for that division, and in September, 1974 he was named vice president and general manager of Electro Sound.

Electro Sound manufactures a line of premier professional audio tape recorders, tape mastering and high-speed duplicating equipment and theater sound systems for



the broadcast, recording studio, tape duplicating and theatrical markets. The company received an award for technical excellence from the Academy of Motion Picture Arts and Sciences for the development of high quality sound systems which are in wide use in theaters.

MIDWEST ACOUSTICS CONFERENCE TO COVER DIGITAL TECHNIQUES IN AUDIO

"Digital Techniques in Audio: Recording, Processing, and Generation" is the topic of the ninth annual Midwest Acoustics Conference to be held April 5, 1975 at Northwestern University, Evanston, Illinois.

This full day session will include technical presentations, demonstrations, and manufacturers' exhibits covering the applications of digital techniques to audio processes. A variety of topics will be discussed covering the recording, processing, and generation of audio signals. Electronics and acoustical engineering personnel from twenty Midwestern states are expected to attend this timely conference.

The Midwest Acoustics Conference was founded in 1967 in response to the need

to bring high quality technical papers on current developments in acoustics to the large number of engineers and other technical personnel employed in acoustics related industries in the Midwest area. At the same time, it was recognized that other technical personnel in industries not directly related to the subject may have an interest in acoustics.

For this reason, the Conference has always attempted to reach technical personnel in both categories with its conference announcements and publicity.

The Midwest Acoustics Conference is sponsored by The Institute of Electrical and Electronics Engineers Group on Acoustics, Speech and Signal Processing; The Chicago Acoustical and Audio Group; The Chicago Regional Chapter of the Acoustical Society of America; and the Chicago Chapter of the Audio Engineering Society.

Further information can be obtained by contacting: ROBERT B. SCHULEIN, president, Midwest Acoustics Conference, Shure Brothers Inc., 222 Hartrey Avenue, Evanston, IL. 60204. (213) DA 8-9000.

NEW BOOKLET AVAILABLE: "A LAYMAN'S GUIDE TO AUDIO VISUAL JARGON"

The Dutchman, revealing his periaktos, took a mere nanosecond to streak through the nose room for a TD.

Nonsense? Of course. The sentence above is a composite of terms from the arcane argot of audio-visual specialists.

The terms were selected from a sometimes amusing booklet published by The Multimedia Forum, one of the nation's most advanced audio-visual communications centers. The Forum is in Crown Center, a city-within-Kansas City, Mo.

The 60-page booklet is titled, "A Layman's Guide to Audio-Visual Jargon."



Magnetic Reference Laboratory

Whether you're using low noise or high output tape, with or without Dolby, from 1/4" to 2", 3 3/4 to 30 ips, you'll choose MRL . . . because only MRL guarantees every test tape they manufacture.

Their dependability and accuracy have made MRL the world wide choice of most major recorder manufacturers . . . and, after all, they would know what test tape is best for their recorders, they're the people who design and build them.

Distributed exclusively through
B. W. Associates, 415 W. Fullerton Pkwy.
Chicago, Illinois 60614 (312) 935-4900

Exclusive Export Agent: Gotham Export Corp., New York, N.Y.

A copy can be obtained free by sending a self-addressed, stamped envelope to: The Multimedia Forum, Crown Center, P.O. Box 1435, Kansas City, Mo., 64141. Each additional copy costs a dollar.

Now let's explain the terms in the whimsical first sentence:

A *Dutchman* is a strip of canvas used to cover the seam in a section of a backdrop on a stage. A *periaktos* is a triangular piece of scenery that can be turned on a swivel base. A *nanosecond* is one-billionth of a second. *Streaking* is a TV term used to describe a picture in which objects seem to be extended horizontally beyond their normal boundaries. *Nose room* is the space between a person's nose and the side of the television frame when he is being shot in profile. A *TD* isn't a touch-down here, it's a technical director.

"Few vocations have the spread and depth of jargon as the audio-visual divisions of media," the booklet explains in its introduction. "While this glossary of terms is limited to film, television and sound/slide presentations, it makes no pretense of completeness. It is intended, rather, to serve as a guide — a starting point — through the land of Broads, Bazookas, Butterflies, and Brutes."

The Multimedia Forum is a bi-level center that covers 35,000 square feet. It was designed to be rented by business groups, for sales meetings and training sessions. It contains facilities for multi-screen slide and film presentations, closed-circuit color TV, audio-video recording, and a unique electronic audience-response system.

WATERS OFFERS NEW AUDIO CONTROL CATALOG

Waters Manufacturing, Inc., Wayland, Massachusetts, has published a new catalog describing its line of professional audio controls featuring "stepless" attenuation. Included in the catalog are specifications, curves, photographs of all fader models, and dimensional diagrams. Accessory items including escutcheon plates, knobs, and inserts are also pictured.

Copies of the catalog are available by writing: MR. ROBERT A. WATERS, WATERS MANUFACTURING, INC., DEPT. RP, LONGFELLOW CENTER, WAYLAND, MASSACHUSETTS 01778.

NEW 1975 HEATHKIT CATALOG IS FREE FOR THE ASKING

A card, letter or coupon to Heath Company, Benton Harbor, Michigan 49022 will bring you the new '75 Heathkit catalog describing the world's largest selection of electronic kits.

There are over 350 kits described in the new Heathkit catalog, for virtually every do-it-yourself interest — TV, radios, stereo and 4-channel hi-fi, fishing, marine, R/C modeling, home appliances, electronic organs, automotive, test instruments . . . and more.

THE PHASER

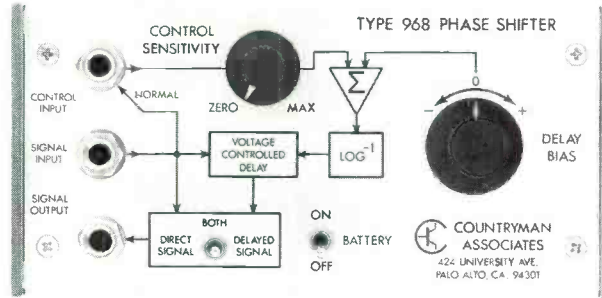

Would you use phasing and flanging effects more often if they were less difficult to obtain? Now you can produce these effects without tape machines, reproducibly and with complete control.

The Type 968 Phase Shifter electronically delays an input signal and then mixes the delayed and undelayed versions together. It allows you to add the striking "turning inside out" effect of Phase cancellation to any audio signal live or recorded, in the studio or in performance, in minutes instead of hours.

 **COUNTRYMAN ASSOCIATES**

424 University Avenue
Palo Alto, Calif. 94302
Phone 415-326-6980

Circle No. 132

Be heard the way you really sound.

natural

Only the BOSE 800 allows the real you to come through — clean, clear, dynamic. Only the BOSE 800 lets you sound as natural live as you'll sound recorded.

And today, that's important. How many groups do you know that sound more like a sound system than like themselves?

BOSE 800. The performer's speaker system with true high fidelity sound.



Please send information on the BOSE 800 to:

Name _____
Address _____
City/State/Zip _____
(BOSE The Mountain, Framingham, MA 01701 Dept. EP)

Circle No. 133

61 CHANGES LATER SON OF 36 GRAND STILL LOOKS THE SAME.



Son-of-a-gun!

We're forever making our products better. Better in all kinds of ways that affect overall sound reproduction and performance. Not to mention value and economy.

At Audiotronics we're never satisfied with something just merely good. Grandson, not quite a year old, is undergoing this same evolution. Audiotronics PEQ-82, Program Equalizer, still looks the same, but inside there's more performance and value.

Audiotronics products are the work of perpetual progress. Shouldn't you have this working for you? Call or write today.



audiotronics. inc.

P.O. Box 12637 · Memphis, Tenn. 38112 · (901) 276-6338

New Products

SYNTHESIZER EXPANDER MODULE

The Oberheim Synthesizer Expander Module is a versatile new device which allows low-cost expansion of electronic music systems. It contains all the basic circuitry of an electronic music synthesizer in a small, flexible, economic module.



Two voltage controlled oscillators, a voltage controlled filter, a low frequency oscillator, two envelope generators and a voltage controlled amplifier are combined with multi-function potentiometers and switches to form a unit which can be used in numerous ways to increase the capability of electronic music synthesizers and systems.

OBERHEIM ELECTRONICS INC., 1549 9TH ST., SANTA MONICA, CA 90401.

Circle No. 135

IMPROVED 'AUDIO/TEK' DUPLICATING SYSTEM INTRODUCED

Audio/Tek, Inc., has introduced the Model 1100B, an improved version of its cartridge/cassette duplicating system.



The new model features a 32:1 duplication ratio with a master tape speed of 240 ips.

Other refinements include a short-circuit-proof, 2 MHz, 45-watt bias system.

Level, equalization, and bias controls are easily accessible from the front of the master panel, while record level and bias controls for each slave are built into the quick-change head assemblies.

The removable loop bin has been redesigned for easier loading and unloading and smoother tape movement.

The Model 1100B will duplicate 4- or 8-track 1-inch or 4-track 1/2-inch masters on 4- or 8-track cartridges, 2- or 4-track cassettes, or 2- or 4-track reel-to-reel tapes. AUDIO/TEK, INC., 503-F VANDELL WAY, CAMPBELL, CA 95008.

Circle No. 136

GRAPHIC/SHELF EQUALIZER WITH REPEATABLE EQUALIZATION

A new state-of-the-art graphic/shelf equalizer with repeatable equalization is available from Modular Audio Products, a unit of Modular Devices, Inc.

Known as Model 3100, the new unit is the latest in a series of equalizers and joins Modular Models GME-20, AE-20, SME-20 and 3000. The new Model 3100 features three independent overlapping frequency ranges — 50Hz to 500Hz, 300Hz to 3kHz, and 1.5kHz to 15kHz with eleven detented

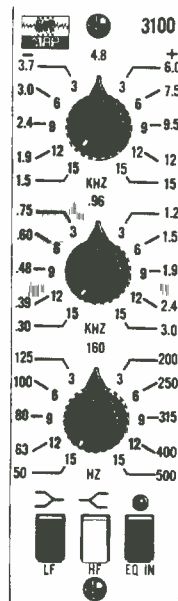

center frequencies per range.

Other features include — selectable Bell shaped or Shelf response curves on high and low frequency ranges, -15dB to +15dB cut and boost with eleven detented posi-

versatile

THE LIMITER FOR ALL NEEDS □ For recording, mastering, broadcast, film, sound reinforcement □ Average level and peak limiting functions operate simultaneously but independently □ Front-panel controls for all functions □ Variable peak attack/release time and average response action □ Unique open-loop control and distortion-reducing circuitry □ Model 201 Average and Peak Responding Limiter: \$480.

1630 Dell Avenue, Campbell, CA 95008 (408) 374-8300

**AMPEX HAS A ONE-WORD ANSWER TO
FOUR QUESTIONS ABOUT COMMERCIAL
RECORDING EQUIPMENT:**

AG-440C

Q: Our program material is *monaural*. Our budget is small. What's the best all-around recorder/reproducer for our station?

A: Get an AG-440C. You'll appreciate the way it handles 10½" reels of tape. With capstan servo, end-to-end timing for 30- and 60-minute programs is always reliable enough to bring you up to the network hour marker, and years after you've amortized the investment, your AG-440C will still be delivering top professional performance. Features and options are the same for all one-, two-, and four-channel machines. It's the best value on the market.



Q: We're *mixing down* for stereo releases, and we can't afford to lose the sounds we worked so hard to get. What's the answer?

A: Get an AG-440C. It'll handle everything on the master tape, from the lowest frequencies right up through the top. At 15 ips, response is virtually flat to 25 kHz. And the capstan servo will deliver flutter and wow performance that is as close to the original as can be achieved on any commercially available mixdown recorder. Low noise figures, too, assure optimum mixdown/dubbing.



Q: Our work involves original production for *quadraphonic* material. We need a recorder that can get us started without making any compromises at all in sound quality. How can we get rolling?

A: Get an AG-440C. The four-channel version is a fully professional half-inch multitrack mastering machine with the latest solid-state electronics for extended high-frequency response. You'll appreciate motion sensing, the easy-to-read VU meters, the large level-setting controls, and the high-visibility record and ready indicators. Your tape will be protected, perform better, too, because the heavy-duty transport has an improved tape guidance system for reduced skew.



Q: We've got to squeeze a *multichannel* production recorder out of this year's tight budget, and those 2-inch recorders are just too rich for our blood. How can we expand?

A: Get an AG-440C. The 8-channel version with Sel-Sync™, automatic monitor switching, automatic tension adjustment, capstan control options, transport remote control, and tenth-of-a-second start/stop will make you a big-leaguer in the one-inch circuit. And, of course, when you go all the way with an AG-440C-8, you'll be ready for all of the previously listed studio operations. Just drop in the right head assembly and get on with the profitable activity.



Information about all the Ampex AG-440C models is available from your local Ampex distributor. Many configurations are now available from



Ampex Corporation
Audio-Video Systems Division
401 Broadway, Redwood City, CA 94063, (415) 367-2641

stock. Ask for a demonstration today or send for our literature. Ampex has the answer to every sound recording question, and the answer is AG-440C.

tions, silent equalization in-out switch with LED indicator, high output capability of up to +27dBm into 600 Ω , TYP THD .05%, and low noise of -90dBm unweighted, 20Hz to 20kHz.

The Modular Model 3100 is only 1½" w x 5¼" h x 5¼" d and is ideal for a wide variety of audio applications. Delivery is from stock to 30 days.

MODULAR AUDIO PRODUCTS, 1385 LAKELAND AVENUE, BOHEMIA, NY 11716.

Circle No. 139

INTERFACE ELECTRONICS ANNOUNCES AVAILABILITY OF NEW PRODUCTS

In the Interface Electronics Series 300 eight track mixers, new mainframes denoted MODEL 16X8A and MODEL 24X8A provide for 16 and 24 inputs and incorporate inclined four inch lighted VU meters meeting industry standards and have all connections on the rear panel. These mainframes are otherwise similar to the Models 16X8 and 24X8 in being powered and fully wired with input and output connectors and are ready to operate. Modules simply plug in; two types of input modules (308A and 308B) are available as well as monitor mixdowns, master, and talk-slate modules. Output options include single ended one volt or balanced +8dBm 600 ohms. Foam lined cases are also available.



For the Interface Electronics Series 300 eight track mixers the new MODEL 308A input module provides seven equalizer controls permitting boost or cut of up to 12dB at 100, 300, 600, 1200, 2500, 5000, and 10,000Hz. At maximum boost or cut the equalizer curves have a bandwidth that is approximately equal to the center frequency. Module also provides nonexclusive pushbutton trackswitching, solo button which places the cue signal solo on the monitors only, mike/line input switch, concentric cue/monitor and echo send pots each with a pre6post slider switch, panpot, gain set switch with input pad position, and the six inch conductive plastic slider attenuator. Modules plug into the Series 300 mainframes.

For the Interface Electronics Series 100 four track mainframes, the new MODEL 100J plugin module is intended for stage monitoring. It provides up to eight different mixes plus equalizing which can be switched in or out at each

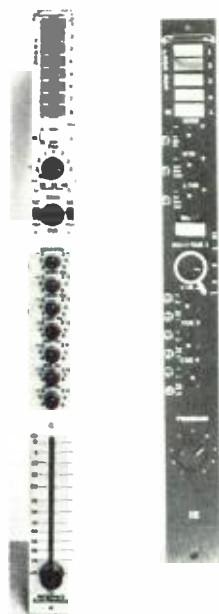

cue send and a mute button to permit setting the controls and then muting the module until the input is active. Model 100J uses all rotary pots, Model 100K has one slider attenuator but is otherwise similar. Modules plug in to Series 100 mainframes, and a special output control panel with eight VU meters and masters is a no charge option.

INTERFACE ELECTRONICS, 3810 WESTHEIMER, HOUSTON TEXAS 77027

Circle No. 140

RAMKO'S "E" SERIES TURNTABLE PREAMPS

Ramko's new "E" series turntable preamps provide unusually high sensitivity, inaudible distortion and RFI suppression.

Designed for both versatility and professional performance the MP-8E (mono) and SP-8E (stereo/cual mono) will provide at least +4dBm out with as little as 500uV in @ 1kHz. Adjustments are provided to enable the preamps to accept up to 100mv in before distorting. In addition to the individual front panel level controls, the units have rear terminals for remotely switching to one of three modes of operation. RIAA response ± 1 dB, scratch filter or brilliance boost.



The "E" series feature balanced 600 ohm outputs capable of at least +21dBm out, signal/noise ratio of -77dB, distortion less than 0.05% and greater than 70dB channel separation.

Units contain their own internal power supply and may be either table top or

bracket mounted.

Price: SP-8E \$137.00, MP-8E \$86.00.
RAMKO RESEARCH, 3516-C LA-GRANDE BLVD., SACRAMENTO, CA 95823.

Circle No. 141

LOW NOISE MIKE PREAMP

The Custom Sound microphone preamplifier uses the latest monolithic integrated circuit, the LM381A, developed by National Semiconductor Corp. specifically for use in noise-critical amplification of low-level audio signals. Better performance is obtained than with conventional op amps or discrete transistors.

Typical specifications: Input Noise 10 kHz, 0.55 microvolt; total harmonic distortion, 0.1%; supply rejection, 120dB; input, 0.3V max, balanced mic.; output, 13V max, unbalanced; power supply, 40V optimum (dc).

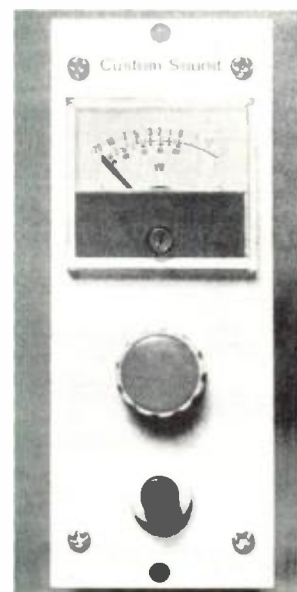

The device employs tantalum capacitors, carbon-film resistors, a G-10 glass-epoxy circuit board, and a Dixon VU meter to provide long-term reliability, failsafe operation, and professional engineering. When connected to the high-level input of an existing audio console, the Custom Sound microphone preamplifier will improve the console's input noise characteristics to a significant extent. Eight units fit into a rack adapter which mounts in a standard 19" equipment rack. Delivery is 4-8 weeks after receipt of order.

CUSTOM SOUND PRODUCTIONS, 119 BANK ST., NEW YORK, NY 10014.

Circle No. 142

NEW VOLTAGE SENSING LAMP WITH VERY SHARP OFF TO ON TRANSITION

Designed to be used as a built-in battery voltage tester for cameras, radios, test instruments, appliances and other portable, battery-operated devices, this new solid state lamp snaps on sharply at

a nominal 2.5 volts, ± 10 millivolts. The very high sensitivity to the threshold voltage makes the Hewlett-Packard Model 5082-4732 VSLED also ideal for applications where precise voltage level indication is required, such as logic level indicators, V-U meters, and other voltage indicating arrays. With the use of an external diode, zener or resistor, the threshold voltage can be increased as desired.



This voltage sensing LED combines an integrated circuit and a red Gallium Arsenide Phosphide LED to provide a voltage sensing function in a standard T-1 package. The lamp is temperature compensated and has a typical temperature coefficient of -1 millivolt per degree C.

Price of the HP 5082-4732 VSLED is 68¢ in quantities of 1000. Delivery is from stock.

HEWLETT-PACKARD COMPANY, 1501 PAGE MILL ROAD, PALO ALTO, CA 94304.

Circle No. 143

FOUR-CHANNEL LIMITERS DESIGNED FOR COMPATIBILITY WITH TASCAM MODEL 10 CONSOLES

Either of these Sound Genesis 4-channel limiters, the L-100T or the L-150T, fits directly into a double module space in the TASCAM Model 10 console.



Each channel of the L-150T 4-channel limiter/compressor has controls for input level, output level, attack and release times, and compression ratio. This versa-

tile tool allows the shaping of dynamics and gives protection from transient overload. Through the use of the attack and release controls, the engineer may allow some transients to pass unlimited to retain dramatic impact and still compress to give maximum "sound power" to the material.

The L-100T is the basic 4-channel unit with fixed rather than variable compression, attack and release times. This unit provides high ratio peak limiting aimed at leaving the bulk of program material unaffected and protects from transient overload saturation.

Both the L-100T and the L-150T use LED's to give the rapid response necessary in limiting threshold indication and use the TASCAM's existing meters for output level indication.

SOUND GENESIS INC., 445 BRYANT STREET, SAN FRANCISCO, CA 94107.

Circle No. 144

OTARI INTRODUCES ONE-INCH EIGHT-TRACK PROFESSIONAL RECORDER FOR UNDER \$7,300.00

Designated the MX-7300-8, the recorder incorporates entirely new electronics and transport. Key features are:

Compatible eight-track one-inch tape format matches the track configuration found on the great majority of eight track recorders in use today.

Completely redesigned electronics offer greater compactness and operator/service conveniences. Two complete amplifiers are contained in a single 5¼ inch rack panel with the two meter stacked one above the other for faster reading and interpretation. The electronics cards are plug-in front accessible for ease of set-up and maintenance. A standard reference level calibrate position and two-frequency

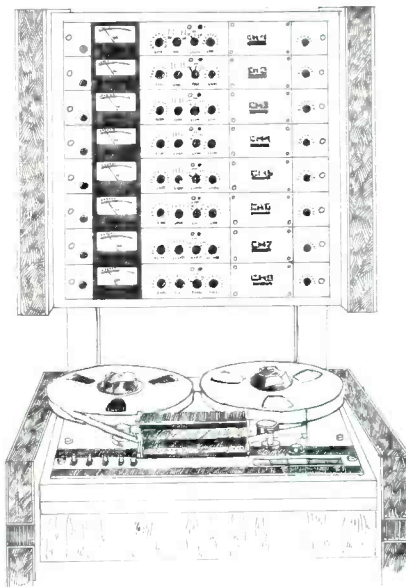

test oscillator are also provided for convenient alignment. Master bias oscillator, power supply, and test oscillator are located in the transport console to save space and provide electrical isolation from

Clear-Com intercom systems

Product mix...and match.



You can custom design the exact intercom system you need. Whatever your application. Our full line of intercom products are interchangeable and compatible. And our engineers will be happy to help. Call us. Our product mix makes a good match.

Dealers nationwide, Canada and England.

Clear-Com Division of Lumiere Productions, Inc.
759 Harrison St., San Francisco, CA 94107 (415) 989-1130

the signal electronics. Outputs are professional 600 ohm +4 dB. Input and output signal connectors are XL type.

Transport features include newly designed control logic with motion sensing. This allows switching from any mode to any other mode without unnecessary delays or damage to tape. For example, you can go directly into drive from either fast forward or rewind without pressing the stop button and with no delay or danger of throwing tape loops or stretching tape. Tape is driven by a direct drive hysteresis capstan motor which requires no belts, pulleys, linkages, or other flutter producing elements. A dc capstan servo speed control system is optionally available. Tape speeds are 15 and 7½ or optionally 30 and 15 ips.

Operational flexibility for the performer has been provided by remote synchronous reproduce capability on all channels. This optional feature allows selection of any track for synchronous reproduce or tune-in monitoring from the remote control unit.

For ease of editing, both Edit and Cue control are provided on the transport.

Price of the MX-7300-8 is \$7,250.00 for the rack mounted version. Delivery is 60 to 90 days ARO.

OTARI CORPORATION, 981 INDUSTRIAL RD., SAN CARLOS, CA 94070.

Circle No. 146



EVENTIDE OMNIPRESSOR, MODEL 2830

Eventide is pleased to announce that the NEW Omnipressor, model 2830 is in production. The 2830 is a substantial improvement over the older model in that it retains its old features: complete control of compression and expansion ratio including infinite compression, dynamic reversal and selection of control range up to 60dB, and adds several new features:

SEPARATE CONTROL OF ATTACK AND RELEASE TIMES (Attack varies from 100 microseconds to 100 milliseconds, release from 1 millisecond to 1 second), LED indicators to show instantaneous limiting action which the 60dB range meter cannot follow.

Parabolically calibrated function control to allow compression/expansion ratio adjustment without reference to meters.

And input threshold adjustable over -25 to +15dBm range.

With the improvements, the Omnipressor can now be used as a fast limiter as well as a special effects and standard compressor.

EVENTIDE CLOCKWORKS, INC. — 265 WEST 54TH STREET, NEW YORK, NY 10019.

Circle No. 147

NEW FLEXIBLE NOISE BARRIER MATERIAL REDUCES NOISE AND PERMITS VISUAL MONITORING

Consolidated Kinetics Corporation announces a new heavy-duty transparent, flexible PVC noise barrier material that effectively reduces noise transmission by an average of 22 to 28dB (STC), while permitting visual monitoring of the noise source.

EVENTIDE ANNOUNCES!



NEW DIGITAL AUDIO DELAY LINE FOR \$1199.00!

Above price includes 30 milliseconds of delay—unlimited additional delay available with plug in modules.

Dynamic range: 10 bit quantization with pre- and de-emphasis giving equivalent 70 db range for most program material. Quality quite sufficient for voice and almost all sound reinforcement and music applications.

For recording studios, sound reinforcement, and musical groups.

Write for further information on the model C200.

A new, very improved, and even more versatile Omnipressor is in production. Write for specs.

EVENTIDE CLOCKWORKS, INC.

265 W. 54th STREET, NEW YORK, N.Y. 10019 (212) 581-9290

Clear-View Noise Barrier, Type KNB-C, is recommended for applications where both a high degree of noise reduction and visual contact with the noise source are required. It can be used as completely transparent noise curtain enclosures, see-through panels in nontransparent noise curtain systems, stationary enclosures, windows in stationary enclosures, or transparent door covers to block off noisy areas.

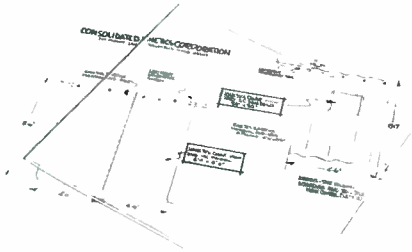

Clear-View Noise Barrier material is available in two thicknesses and weights with sound transmission class (STC) ratings of 22 and 28dB, respectively.

Clear-View resists scratches, abrasion, punctures and tears, and can be easily cleaned with commercial cleaners to maintain its transparent properties. It is available in rolls, cut-to-size sheets, die-cut parts, or custom-fabricated curtain panels,

systems, and enclosures. CONSOLIDATED KINETICS CORPORATION, 249 FORNOF LANE, COLUMBUS, OHIO 43207.

Circle No. 149

NEW LED METERS FROM QUAD-EIGHT

Quad-Eight Electronics has announced two new additions to their "PK Series" of L.E.D. indicating meters. In addition to the PK-16 vertical scale and PK-14 arc-scale meters the line now includes the PK-100 with the same amplifier electronics of PK-14/16 which converts con-

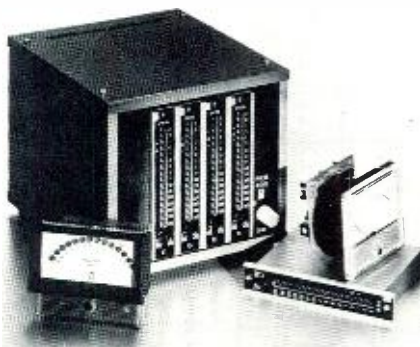

ventional VU meters into Peak Level monitoring instruments. The circuit board module features simple attachment to existing meter terminals and mating con-

nectors, shallow behind-meter profile, accessible adjustments for electronic change of integration time, fall-back and tracking.

The PKM400 has four independent channels of L.E.D. indicating level monitoring. The alternate mode PK-16 is utilized in a self-powered, small portable "console top" package. XLR input connectors, and a built-in display brightness control are additional features.

The full line is now available for any professional sound monitoring application. Full pricing, technical data, and application information is available from the manufacturer.

QUAD-EIGHT ELECTRONICS, 11929 VOSE STREET, NORTH HOLLYWOOD, CA 91605.

Circle No. 150

METER AMPLIFIER/PEAK INDICATOR

Providing isolation, gain, and remotely adjustable peak level detection with L.E.D. readout, the PEAK-VU, a new PC module by db LABS mounts directly on the terminal studs of any VU meter (with 1 1/4" to 1 1/2" spacing). An output for an L.E.D. peak overload indicator is provided on the card. Use of the module between the line being metered and the VU meter eliminates crossover distortion introduced by the non-linearities of the meter rectifier. The L.E.D. output may be remotely set by a dc voltage to flash on at any level from -24dBm to +24dBm. The modules are guaranteed for 5 years by the manufacturer.

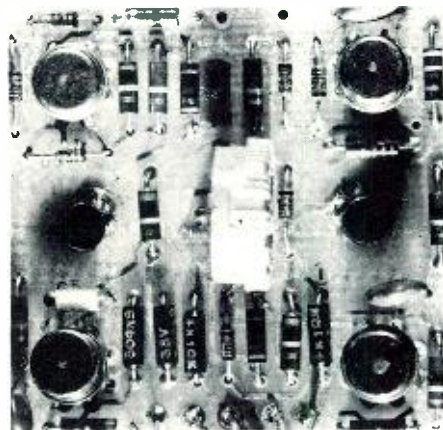

Price: 1-4 only \$50 each, 5-8 \$45, 10-20 \$40, 25-99 \$35 and 100 up \$30. 10% discount for cash with order. Credit to rated firms.

db LABS, 206 MARIN STREET, SAN RAFAEL, CA 94901.

Circle No. 151

NEW STEREO 'FRAP' UNIT DESIGNED FOR USE WITH PIANO

The FS-200 includes 2 transducers, adhesive wax, and a preamp. The preamp contains the same high quality state-of-the-art electronics as the other studio FRAPs, a built in super quiet LRN-69 Power Supply, outputs for stereo and/or

La Salle
Audio provides
professional audio
design, consultation, sales,
installation and service for the
convenience of the broadcast and
recording engineer

740 N. Rush Street
Chicago, Ill. 60611
Phone: 312-266-7500

P.O. Box 373
Teaneck, N.J. 07666
Phone: 201-692-0010

mixed mono, and built in Variable Low Frequency Roll-Offs for each channel. Since many customers prefer using 2 FRAPs to pick up piano, the FRAP people developed this versatile stereo unit. The FS-200 can plug right into an AC outlet. It has subsequently proved effective for picking up guitar, harp, and other instruments. It has proved very effective for working with uneven instruments. The two transducers can be used on two different instruments then run through either the separate stereo outlets or mixed through the mono outlet.



This unit uses the same high quality transducers that FRAP is known for. It is quickly and easily attached and moved by virtue of the inert adhesive FRAP wax. The specifications (available from the FRAP Co.) are the same as for the other Studio FRAPs. The built in Variable Low Frequency Roll-Offs on each channel can roll off the lows at 6dB per octave from approximately 30 to 300 Hz, thus filtering out low frequency body resonances and eliminating that common cause of feedback. (These Variable Low Frequency Roll-Offs are also available from the Frap Co. for use with the F-100, F-200, and

F-250 FRAPs.)

FRAP systems are available at most places where professional music and audio equipment are sold or they may be ordered direct. The Stereo/Piano FRAP retails at \$650.00. The Variable Low Frequency Roll-Off retails at \$25.00. FRAP, BOX 40097, SAN FRANCISCO, CA 94140.

Circle No. 153

Classified

CLASSIFIED ADVERTISING RATES

Prepaid* with submitted copy:
 One column inch (1" x 2 1/4") ... \$20.00
 1/2 column inch (1/2" x 2 1/4") 14.00
 *(If billing is required add 20%.)

SERVICES

Location Recording and Very Private "Studio By the Pond." A lakeside Basement equipped with 9' Steinway, RT3 Hammond, 5 other keyboards, amps, EMT. Using Remote Trailer of Lee Hazen Recording Service. Wet Monitoring W/ separate expanded Tascam Record and Monitor Boards. MCI 16, Ampex 4, 2 & 1. Only 25 mi. from Nashville. Relax, fish, swim and ski. Record 16tr for \$45/hr days. Call (615) 824-2311 anytime. Write Rt. 2, Hendersonville, Tenn. 37075 Try it, you'll like it!

YOUR INTRODUCTION TO FILM/TV Copyrights, Contracts and Other Law by Johnny Minus and William Storm Hale.

\$10.00
 R-a/p, P.O. Box 2287
 Hollywood, CA 90028

EQUIPMENT

ONE STOP FOR ALL YOUR PROFESSIONAL AUDIO REQUIREMENTS. BOTTOM LINE ORIENTED.
F. T. C. BREWER COMPANY
 P. O. Box 8057, Pensacola, Florida. 32505

Send for FREE Catalog and Audio Applications



OPAMP LABS

1033 No. Sycamore Ave.
 Los Angeles, CA 90038
 (213) 934-3566



LOWEST PRICES IN THE COUNTRY on microphones, power amps, speakers, musical instruments, PA equipment, including Peavey, Heil, JBL - huge stock, top brands only.

GRACIN'S 110, 606 ROUTE 110
 Huntington, NY 11746 516-549-5155

FOR SALE: Tascam 4-track tape recorder with remote control. Excellent condition, 6 months guarantee, \$2,200. Call: **JOHN - 2000 Beck Building** Shreveport, LA 71101 (318) 424-2678.

Choice

(n) That which is most excellent

In reverberation, what choice do you have?

For the very finest in performance, your choice would have to be the Master-Room or a European import.

For a moderate price, your choice would have to be the Master-Room or other American made product.

For features not found in any other echo chamber, your choice can only be the Master-Room.

Choice. In reverberation, do you really have any choice except



... That which is most excellent.



MICMIX AUDIO PRODUCTS, INC.

9990 Monroe Drive - Suite 222
 Dallas, Texas 75220
 (214) 352-3811

See your dealer or contact the factory for full details.

Circle No. 154

www.americanradiohistory.com

R-e/p 59

We have a few competitively priced used Revox A77 decks available. These have been completely reconditioned by Revox, are virtually indistinguishable from new and have the standard Revox 90 day warranty for rebuilt machines. Satisfaction guaranteed. One example is an A77 Dolby for \$675 plus shipping. Please write stating your requirements to ESS1, Box 854, Hicksville, N.Y. 11802 (212) 895-9257

FOR SALE: New 14" NAB Ampex aluminum flanges have never been removed from original box. Package of 10 - \$8.00 prepaid. **SOUND INVESTMENT CO.,** POB 338, DUNWOODY, GA. 30338.

MULTI-TRACK

- ★ SERIES "B" MIXING CONSOLE
- ★ VARI-BAND 5 SECTION PARAMETERIC EQUALIZER
- ★ DUAL EQUALIZED REVERB
- ★ LONG & SHORT THROW SLIDE FADERS
- ★ HIGH BALLISTIC VU METER

P.O. BOX 3187
HOLLYWOOD, CA 90028
(213) 467-7890

One Way Noise Reduction (10-14dB) for cutting rooms / tape copies; + monitor equalizers at \$75/channel; + free room equalization with purchase of 1/3 octave filters; + 1000's of state of the art studio products, customized - aligned - calibrated - biased, etc. **Music & Sound Ltd.,** 11½ Old York Rd., Willow Grove, PA 19090. (215) 659-9251.
All Shipped Prepaid/Insured

AMPEX MODIFICATION. Update old Ampex units with new capstan drive, tension control for better freq. response/overall performance. \$795 for Model 300, 3200, 3300. Prices on request for others.

AUDIO/TEK INC.
503-F Vandell Avenue
Campbell, CA 95008
(408) 378-5586

SACRIFICE: Two NEW JBL 4350 Studio Monitors (without crossover networks or Bi-Amps) Studio Grey \$1000 each. Two NEW Altec 9846-B (Bi-Amplified) Studio Monitors \$550.00 each. In original factory cartons. One Ampex/Inovonics 4 track ½" console mounted mastering recorder \$3550.00. One Ampex ¼" rebuilt AG-440-2 console mounted \$2650.00. One NEW Ampex AG-440-2C rack mount \$3275.00.

Call Steve (714) 796-1471 or write
25240 La Mar Road
Loma Linda, CA 92354

FOR SALE: Scully record playback 280 series - Magnatech optical reproducer, speaker, mikes, mixer, etc.

Call: **MARK**
(213) 466-5111 (days)
(213) 654-0449 (evenings)
7026 Santa Monica Bl., Hollywood 90038

USED EQUIPMENT - Audio Designs console components. 10 model 700 input modules, 6 model 770 input modules, 2 model 668 line amps, 1 model 660 master module, 1 PS-10 supply and 2 Altec 9062 graphics. Components or assembled in portable touring console.

SENECA SOUND inc.
116 Killewald, Tonawanda, NY 14150
716-695-3500

AUTOMATED QUAD PANNING

THE UNIQUE AQC SYSTEM (PAT. APPLIED FOR)
CAN DO WHAT HANDS CANNOT

4, 8, 16 & 24 INPUTS
VIDEO & AUDIO ARTISTRY CORP.
p.o. box 4571, boulder, colorado 80302
(303) 499-2001

King model 800S tape winder (hub). Pre-recorded tape winder, will wind either ¼ in. or 150 mil. widths. As new condition. Also used Rangertone resolver. As is. Contact Gary E. Taylor, Continental Film Productions Corp. P.O. Box 6543, Chattanooga, TN 37408

AMPEX 300, 3M ELECTRONICS IN CONSOLE, ¼ TRACK STEREO, 7½-15 IPS. \$995.
(805) 482-8322

CROWN CX844 4-Track Recorders (2). Many extras including VSO, Remote, Dolbys (4), custom cabinets. Low time, excellent condition. Any reasonable offers considered.
P.O. Box 9245 - Berkeley, CA 94709
(415) 527-4043

NEW YORK'S LEADING PRO AUDIO/VIDEO DISTRIBUTOR FOR AUDIO, VIDEO, BROADCAST, PUBLIC ADDRESS & HI-FI STEREO SYSTEMS.

* Representing over 130 audio/video manufacturers, featuring such names as:

AMPEX SCULLY, TASCAM, SONY, J.B. LANSING, NEUMANN, ALTEC, McINTOSH, AKG, DYNAIR, T.V. MICROTOME, UREI, 3M and other major brands.

* The largest "in stock" inventory of equipment, accessories and parts.
* Competitive discount prices.

Write for FREE CATALOG!

factory authorized

**SALES - SERVICE - PARTS
SYSTEMS DESIGN - INSTALLATION
MARTIN AUDIO/VIDEO CORP.**

320 WEST 46 STREET
NEW YORK, N.Y. 10036
(212) 541-5900

ELECTRONIC BRICKS

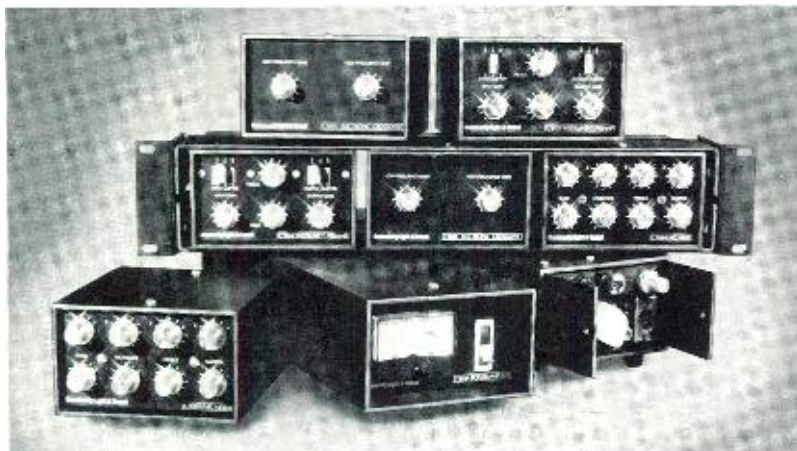

A 120 Watt power amplifier, a four channel mic mixer with three position EQ, a two-way electronic crossover, and pre-amplifier for electric instruments—all in rugged extruded cases that will stand the most demanding service. The C100 Series from Community is a group of high quality electronic building blocks that greatly simplify sound system construction. Straightforward design and careful test procedures insure uniform quality and remarkable dependability. Write for full specifications.

Community Light & Sound

P.O. Box 21759, Philadelphia, Pa. 19146 • 215-468-2001

10½" Reel Specialists: Boxed 10½" NAB ¼" reels \$3.00@ flanges \$1.25@. 10½" Precision reels \$6.50@, flanges \$2.25@ Heavy duty or Tapered. Wanted: used ¼" NAB & Precision hubs. **SOUND INVESTMENT CO.,** POB 88338, ATLANTA, GA. 30338.

FOR SALE: SpectraSonics Model 1020-8/16. 14 buss, 20 input, 16 trk. monitor, quad, all factory wired, mint cond. \$20,000.00. Contact: **BRIAN PARAMOUNT RECORDING, L.A.** (213) 461-3717

Used Scully 280 — 8 track new heads, in console, excellent condition. Sennheiser mics. **NEW MODELS:** Ampex AG440C 2-track; servo capstan motor; Scully 280B. Immediate delivery from stock. **USED AG440Bs.**

Malaco Recording, Jackson, Miss.
(601) 982-4522

For Sale: Ampex 440-8-B, 8 track recorder, with remote control, excellent condition, spare electronics, 1½ yrs. old, 6 mos. guarantee. **\$7,300.00.**

Also, Electrodyne 1204 Mixing Console, 12 in 4 out, with 8 track play back, one Cetec graphic equalizer input module, one spare input, recently overhauled by factory, excellent condition, 6 months guarantee. **\$7,000.00.** Call: **JOHN,** 2000 Beck Bldg., Shreveport, La., 71101
318-424-2678



Cut it in half

Half the cost, time, and worry, at Dick McGrew Recording Service in Dallas.

Dick beats the competition with record master costs like \$30 per side for stereo 12 inch 33½ rpm, and \$10 per side for 45's. The day he receives your tape, he'll groove your master with the Neumann SX 68 cutter, the ultimate in cutting machines. Dick'll give it the individual and expert attention of a man who does a lot of producing himself.

For no extra charge, Dick will provide equalization, reverberation, or other special services at your request. And he's used to giving attention to problem tapes.

Interested in album pressing or singles? Dick's got a competitive price list for these services, too. Let us hear you!

Dick McGrew
Recording Service

7027 TWIN HILLS AVE • DALLAS 75231 • 214 891-5107

High Intensity tuned sound reinforcement systems, including narrow band (5Hz) feedback suppression, detailed regenerative response room equalization ±1dB, <15% articulation loss of consonants. 1000's of customized professional products, all shipped prepaid/insured. **Music & Sound Ltd.,** 11½ Old York Rd., Willow Grove, PA 19090
(215) 659-9251
Inventors / Engineers

MIXER MODULES — Modular construction provides economical route to studio type mixer. Inexpensive modules for mic/line input with plastic element slide fader and pan plus a module for Equalization allow construction of mixer with number of inputs to suit your application. Send for catalog to —
Wall of Sound — 2406 Mountain Road
Pasadena, Maryland 21122

FOR SALE — USED EQUIPMENT

- | | |
|-----------------------------|----------|
| 1 MCI JH-416 Console 16x16) | |
| 1 Studio Supply Producers) | |
| Desk | \$15,000 |
| 2 JBL 4320 Studio Monitors | 1,200 |
| 1 Ampex/MCI 2 track | 2,000 |
| 1 Revox A77 2 track | 700 |
| 1 AKG BX-20 Echo Chamber | 2,600 |
| 1 EMT 140S | 4,000 |
| 2 AKG D-224E Mics | 300 |
| 1 Neumann U-87 Mic | 400 |
| 2 AKG D-190E Mics | 80 |
| 2 AKG D-202E Mics | 180 |
| 1 Shure SM-53 Mic | 135 |
| 1 Ampex/MCI 8 track | 6,500 |

We also have in stock for immediate delivery: Scully 280-B's, Monitors: Sentry III, 604E, Cornwall, Hersey, JBL, Phillips GA-212 Turntables, and MCI 16 Track.

STUDIO SUPPLY COMPANY
1918 DIVISION STREET
P.O. BOX 280, NASHVILLE, TN. 37202
(615) 327-3075

EMPLOYMENT

Free Lance engineer with background in music and electro-acoustics seeks staff position with 16-24 track studio in or around Los Angeles. Very high standard of quality control and creative imagination. XInt. qualifications and refs.

Contact: **BRUCE SCHAFFER**
6227 Fountain Ave., Hollywood 90028
(213) 464-4622

GERMAN R-e/prod. (R&B, Pop, Jz) & electron. eng., over 20 years in studios. 24 & 16 trk., maintenance & design perfect, built & directed studios in Germany, M-East, Lat. Am., Caribe etc. 4 languages. Seeking steady employment with bigger organization.

R-e/p, Dept. GHN
Box 2287, Hollywood, Ca. 90028

WANTED: Experienced Senior Recording Engineer with solid following to join forces with growing top quality studio. Terms: Negotiable. Contact:

JERRY KORNBLUTH
A&J AUDIO VISUAL SERVICES
119 W. 57th St., New York, NY 10019

The Case For Coherent Room Equalization

Sonipulse is the newest approach to measuring sound reinforcement or playback systems including their environments. It provides complete analysis of frequency response over the full audio spectrum in less than three minutes. Self contained generator produces a pulsed coherent signal, no averaging time required. Ideal for recording studios, auditoriums, theaters, road shows. . .small, compact, portable UREI quality, of course.

Sonipulse combined with UREI Active Graphic Equalizers provides complete room analysis and correction.

Available through your UREI dealer.



UREI "Instrumental in Audio"

11922 Valerio Street, No. Hollywood, California 91605
(213) 764-1500
Exclusive export agent: Gotham Export Corporation, New York

HIGH QUALITY AUDIO TRANSFORMERS SESCOM'S NEW "MI-SERIES"



- Low Distortion Typical <.2%
- All Popular Secondary Impedances
- Electro-Magnetic Shielded
- Electro-Static Shielded
- Four Power Levels — 30dbm, —10dbm, +18dbm, & +30dbm.
- Low Cost
- Stocked for Quick Delivery

(Send For Complete Catalog)



Quality Engineered Sound Products
SESCOM, INC.
P. O. Box 590, Gardena, CA 90247 U.S.A.
(213) 770-3510 • TWX 910-3286189

FOR FURTHER INFORMATION DIAL-A-SOURCE
TOLL-FREE PHONE 800-645-9200
IN NEW YORK STATE CALL COLLECT (516) 294-0990

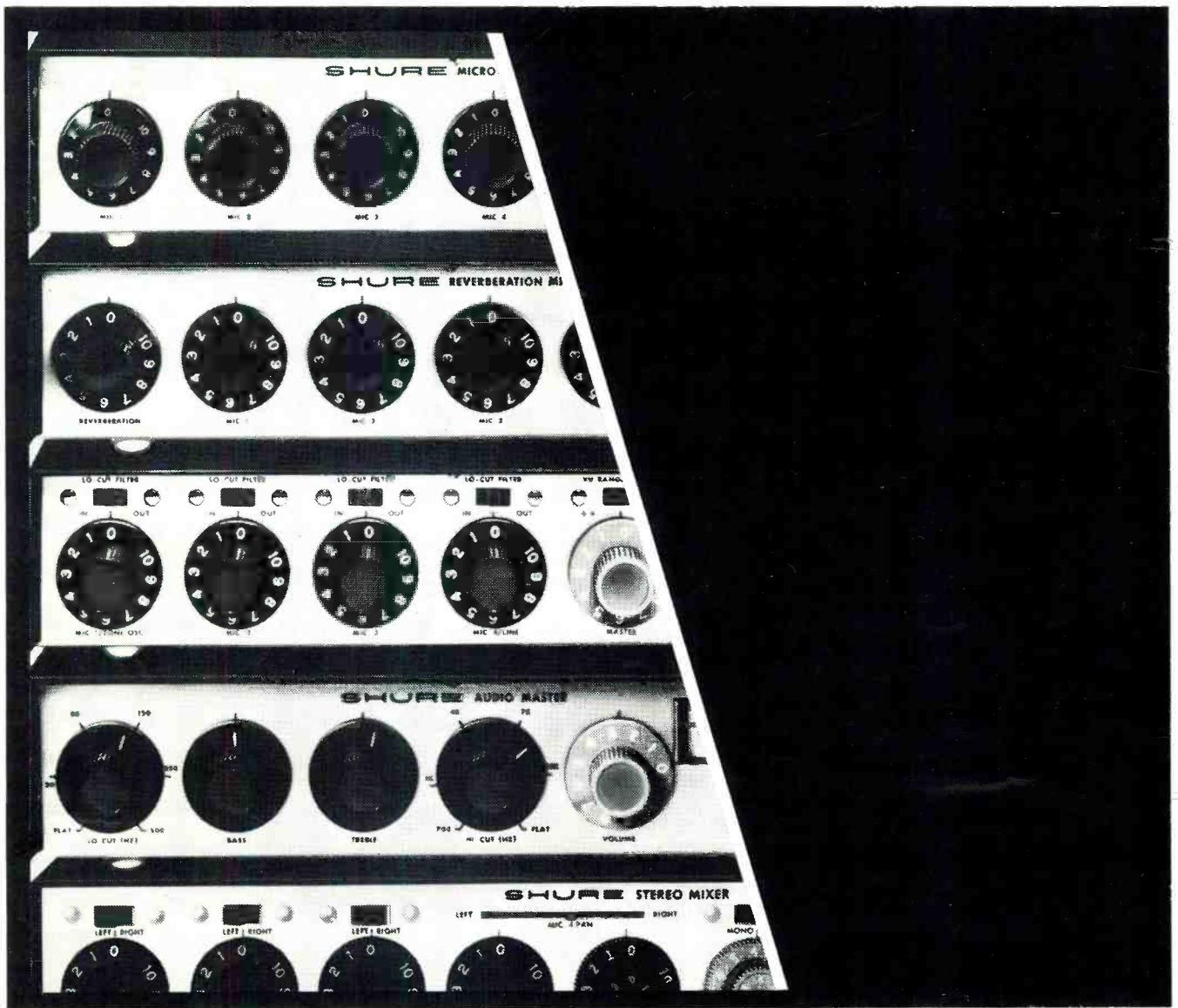

Panel full of miracles.



Shure mixers, audio level controllers, and feedback controllers are all designed to deliver more audio control, more features, and more performance dollar for dollar than any other components with similar audio features. Their compact size and modular "stackable" design mean they can be easily combined in various configurations in even the smallest spaces. And they're versatile—their input-output flexibility equips them for an extremely wide range of audio applications, giving you control you never thought possible without bulky, expensive installations. You can easily put together a system that's exactly right for your precise needs without putting extra dollars into built-in features you really don't need. For the details on our entire line of miracle workers, write:

Shure Brothers Inc.
222 Hartrey Ave., Evanston, IL 60204
In Canada: A. C. Simmonds & Sons Limited



Manufacturers of high fidelity components, microphones, sound systems and related circuitry.

Circle No. 159