

April 1989

Recording

ENGINEER/PRODUCER

The Applications Magazine for Audio Professionals

\$4.00

AN INTERTEC PUBLICATION

Broadcast Production

A38100-----LUNBE6691 XXXX REQ
F1052688000000 25 06 1
THOMAS D LAUNE REC ENGR
ARDENT RECORDINGS INC
669 S BELVEDERE (REAR)
MEMPHIS IN 38104

We Didn't Just Design
We Changed The



A New Microphone. Future Of Sound.



The Beta 58 represents a significant advance in dynamic transducer design and a major breakthrough in microphone performance. Every measurable parameter has been optimized for unprecedented sound quality.

The Beta 58 microphone is the first to combine the extra-hot output of Neodymium with a true supercardioid pattern. The unique three-stage directional tuning network eliminates the irregular off-axis response displayed by other microphones. The result: greater working flexibility and extraordinary gain-before-feedback.

No other dynamic microphone has more usable power.

Another new performer is the Beta 57 instrument microphone. The Beta design provides outstanding isolation from unwanted sounds and freedom from off-axis coloration. All for more impact and separation in the mix.

Hear how a Beta Microphone can change the future of your sound. For our new brochure and the nearest dealer, call 1-800-257-4873. In Illinois, 1-800-624-8522. Shure Brothers Inc., 222 Hartrey Ave., Evanston, IL 60202-3696. The Sound Of The Professionals®... Worldwide.

SHURE[®]
New Beta 58[™]

Circle (2) on Rapid Facts Card

CONTENTS

Broadcast Production

Audio Tapes for TV and Video Production

An examination of some problems encountered when preparing audio tracks for a video production.

By Roy W. Rising 18 ▼



Digital Audio, Dynamic Range and the Real World

Issues related to program dynamics in contemporary audio and A/V production.

By Marvin Caesar 26

Analog Signal Processing for Digital Recording

Never before have limiters, compressors and sibilance controllers been so useful, nor the correct application of them so important.

By Michael Morgan 32

Digital Satellite Production for the Media Recording Facility

Satellite transmission of digital audio has made its mark, particularly in the field of national radio and TV ad campaigns.

By John Brady 40 ▼



Other Features

NAMM Show Wrap-up

This year's Anaheim NAMM show offered some innovative and intriguing new products.

By Paul D. Lehrman 48 ▼



Departments

Editorial	4
Letters	6-8
News	10-12
Managing MIDI	14
SPARS On-Line	16
Engineer/Producer Index	54-60
Tracks	61-63
Studio Update	64-65
The Cutting Edge	66
New Products	68-76
Classified	77-79
Advertisers' Index	80
Engineer/Producer Index Reply Form	81
Tracks Reply Form	83
Rapid Facts Cards	85
New Subscriber and Address Change Cards	87

Volume 20, No. 4

RECORDING ENGINEER/PRODUCER (ISSN 0034-1673) is published monthly for \$26 to qualified readers, \$30 to non-qualified readers per year by Intertec Publishing Corporation, 9221 Quivira Road, Overland Park, KS 66215. Second-class postage paid at Shawnee Mission, KS and additional mailing offices. POSTMASTER: Send address changes to Recording Engineer/Producer, P.O. Box 12960, Overland Park, KS 66212.

◀ On the Cover

Production room A at KEY1-FM, Austin, TX. Photo courtesy of RAMSA/Panasonic.



NOTHING REFRESHES A MIX LIKE A SIX PACK OF MIDIVERB II'S



Mixing is no picnic. Especially when you're in the hot seat. Consider the pressure. The fatigue. The late nights. And all the agonizing over what outboard to use on what tracks.

If you've ever sweated out a mix thirsting for more effects, the Alesis MIDIVERB II is pure refreshment. Whether it's the perfect room simulation for the hi-hat, or the perfect chorus texture for a last minute synth overdub, MIDIVERB II delivers. And, at an astonishing \$269, it's no wonder pro engineers are using multiple units to strengthen their processing 'front line.'

With 16 bit linear PCM, 15K bandwidth, and tons of musical character, MIDIVERB II is the #1 selling

signal processor in the business.* That'll only surprise you if you've never used it. Those who have used it love the sound so much they can't resist buying several more. With 99 programs — 50 reverbs, plus choruses, flanges, delays, and innovative special effects — MIDIVERB II redefines the meaning of cost-effectiveness.

So after today's mix, you deserve something refreshing.

Ask your Alesis dealer to break open a sixpack of MIDIVERB II's. Your next mix could be a picnic.



LOS ANGELES: Alesis Corp. P.O. Box 3908, Los Angeles, CA 90078 LONDON: 6, Letchworth Business Center, Avenue One, Letchworth, Hertfordshire SG6 5HR

*Based on Music and Sound Retailer's monthly survey of 1,200 audio dealers

Circle (3) on Rapid Facts Card

Splat

Ssssss. Fffff. Splatter. Zzzzz.

Sound familiar? It will if you regularly listen to almost any broadcast medium or have purchased any one of a large number of albums in the last few years. What you are hearing is the accumulation of sibilant products caused by one or more of the following:

1. The nature of digital clipping.
2. A lack of experience or knowledge in recording vocals.
3. The electronic pre-emphasis circuitry present throughout the recording/reproduction chain.
4. The monitoring environment.

Lack of attention in these areas has produced recorded material that contains far too much level in the sibilance bands (2kHz to 3.5kHz for speaking and 6kHz to 7kHz and 9kHz to 12kHz for singing). This overabundance follows the material from recording through mastering and pressing, and eventually to the broadcaster/listener.

Adding the pre-emphasis found in both TV and FM audio, and used in high-speed commercial cassette duplicating, and you have as an end result vocals and other high-frequency information that makes a big fat splat when reproduced.

This grating distortion begins (as it must) at the recording stage. The absence or improper use of dynamic control systems and absence of sibilance controllers, coupled with the fact that the digital recording medium has an overload margin of zero, produces vocal tracks with both level and frequency content problems. Attempts to correct this at the mix stage lead to excessive EQ (designed to bring the vocals forward in the mix) or further runs with the dynamic limitations of the digital recording medium. Often, the problem gets even worse when it reaches the CD or disc mastering stage.

Faced with excessive sibilance, the mastering engineer has to choose between the lesser of two evils: selectively reduce the excessive sibilant levels (costing the client big bucks in time/rework charges), or attempt to reduce the overall level on the disc, sacrificing

something else to make room for the peaks. Neither is necessary, if proper production practices are followed before the material reaches this stage.

With high-quality analog, we all discovered the wonderfully linear nature of tape saturation. For some, recording with the meters in the red was a common practice and one that was designed to take advantage of the medium's soft, easy overload characteristics. However, whether in the analog or digital domain, sibilance is still sibilance. Even with current-generation analog technology, if you don't control or correct it, your material will still go "splat" sooner or later.

And with digital equipment, engineers and producers who run the meters into the red are due for a rude shock. The "0" reference (wherever it may be set) is a brick wall and there is no room beyond this point. If you overdrive these systems, they hard-clip, chopping off the information and adding unwanted harmonic components.

Couple this with improper microphone technique and a misunderstanding of the dynamic range of the human voice and you have a collection of technical obstacles waiting to trip the unwary.

Now, add a monitoring environment that does not accurately reflect the spectrum of the mix and you end up with a master tape that would give any cutting engineer or CD premastering house nightmares. (A related point for another time is the hearing damage/loss that may contribute to over EQing, further worsening the situation.)

Apparently, many engineers and producers are either unaware of what they are releasing or they don't realize what is happening to their material out in the real world. As a result, we are seeing a proliferation of releases in which the vocals (and more often than not, other tracks) are excessively sibilant, to the point of being unlistenable.

My intent is not to criticize unfairly those involved in the production of recorded program material. In fact, the problems outlined are relatively easy to correct, and technology can offer many potential solutions.

The key is the intelligent application of selective solutions for specific problems. Digital recording systems require considerably more attention to small details if they are to deliver their full potential. Problems in analog that either could be ignored (low-frequency rumble not repro-

duced because it was at or below the noise floor) or were, to a degree, self-correcting (overdriven channels to tape) are glaringly apparent with digital systems. By offering wider bandwidth reproduction, they also open the door to a wider range of problems and will require engineers, producers and artists to learn the limitations of the technology.

Sampling rates are fixed, so as frequencies increase, the number of available samples drops. This can limit the ability of the system to correct and handle signal variations. Members of the production community who are unaware of the electronic limitations imposed by any system can, indeed, create a product that contains problems that cannot be corrected. It is incumbent upon us all as professionals to educate ourselves and understand what happens to our material outside of our own facilities, so that what we render as a final product is representative of what the consumer hears.

I cannot believe that artists, engineers and producers do not care enough to realize that their long, expensive projects are now just 40 minutes of annoying sibilant noise. Given the obvious fact that a number of productions do not exhibit these problems (and used the same technology), the technology itself cannot be held totally accountable. Only its misapplication, or worse, non-application, can be found at fault.

No recording/reproduction medium is perfect—all have limitations. It's working at the edge of these limits with maximum creativity that separates the professionals from the crowd.

Frederick J. Ampel
Editorial Director

REP

Selecting a high performance music recording console used to mean that you went with one of two major manufacturers—ending up one of a thousand. Not any more.

Studer—one of the largest manufacturers of professional sound mixing consoles in the world—now gives you a *real* choice, one that will set you apart from the competition. Like Studer's first large music recording console for a prominent LA studio, Lighthouse.

The separate monitor section with full multitrack capabilities, the external custom patch bay, the 62 inputs (each with moving fader automation, 4-band semi-parametric equalization and 10 aux sends)—to mention only a few of its powerful features—make the

Lighthouse Studer 905 console the exclusive choice. Add superior noise and cross talk performance, and the 905 becomes *the* console to use for digital recording.

But specs can't tell the whole story. Listen to it perform... The Lighthouse 905 has opened to rave reviews from some of LA's top producers who praise the board's great sound.

Now that you've got a real choice, choose to be one of a very few instead of one of a thousand. Call us or write. Let Studer custom-build a console for you.

STUDER REVOX

Studer Revox America, Inc.
1425 Elm Hill Pike
Nashville, TN 37210
(615) 254-5651

Los Angeles, (818) 780-4234. New York (212) 255-4462.
Chicago (312) 526-1660. Dallas/Ft. Worth (817) 861-1861.
In Canada, Toronto (416) 423-2831.

Circle (4) on Rapid Facts Card

The exclusive choice. At Lighthouse.



For bookings
at Lighthouse Studios,
call (818) 506-8942.

LETTERS

Electronically controlled speaker systems

From: Mike Joseph, manager, pro audio marketing, Electro-Voice, Buchanan, MI.

I would like to commend you on "Electronically Controlled Speaker Systems" in the January issue. It was gratifying to note author David Scheirman's concern in presenting the facts as clearly and objectively as possible, on a subject where manufacturer's and user's emotions seem to rule the day.

There appear to be many myths associated with "processed" speaker systems (a badly misused word, as David pointed out), some promulgated by manufacturers themselves. Case in point: the article's accompanying sidebar penned by Mark Gander, Garry Margolis and John Eargle of JBL. As we have recently entered the electronically controlled speaker system arena, I would like to comment on the conclusions presented therein.

The concept of tailoring an audio signal to compensate for limitations or non-linearities inherent in mechanical devices and transmission/reception processes is not new. Frankly, it is quite amazing that it causes a stir at all. Tape deck manufacturers were "pre-distorting" the audio record signal on their consumer and professional machines years ago in order to get a linear signal cleanly through their physics-limited, non-linear tape heads.

For decades, the broadcast industry has been modifying the input signal to transmitters in order to compensate for non-linearities and performance ceilings in the transmission process. Analog tape deck noise reduction has long been accepted, with systems that do all manner of signal modification to correct for losses and limitations in that specific mechanical/electromagnetic medium.

Let us note that the goal has always been lower distortion and greater dynamic range of the end product, whether the listener may be monitoring on an FM receiver, the output of a cassette deck, or a 10kW speaker stack. Physics is physics and parts are parts, but sometimes a signal chain must ultimately be judged as a system, from the early input (say, a microphone) through to the last output (say, acoustics in the room). If total system performance can be improved by modi-

fying a signal in a given middle stage somewhere, whether by EQ, signal delay, high-pass filtering, etc., then it is difficult to judge that action bad, *assuming the action contributes no detrimental sound qualities to the final output.* This, of course, is the key. One cannot judge the concept or goal as bad merely because certain past designers' interpretations or attempts at sound and reliability improvement have subjectively "failed," aesthetically speaking, in their first generational stage of product development.

We, as others, chose to introduce only things that would improve the sound and reliability above and beyond the performance available, using high-quality components alone. With this in mind, it is difficult to stand mute and quietly accept the comments of those who, to be gracious, seem to be responding in a factually unaware, "knee-jerk" manner. My comment to them: Please educate yourselves.

Objectively, it is difficult to understand any bias at all against electronic signal setup in high-power sound systems. Is not a 1/3-octave EQ signal processing? Is not signal delay for component alignment in a crossover band also processing? How about compressor/limiters on the drive rack feed? I cannot recall the last time I saw a large, high-powered system that did not have a multifunction steep slope analog crossover, with some signal delay integral for component alignment; a multitude of dbx 160X or equivalent compressors and limiters on the drive rack program inputs or crossover outputs; 27- or 30-band graphic equalizers, most with adjustable high-pass filtering, etc. What is electronic speaker control if not the incorporation of these devices into one integral, low-noise, properly gain-staged unit?

Do away with the "one-trick" compressor/limiters and substitute a high-quality, low-distortion, low-noise VCA for variable-state, emergency-only limiting via amplifier sensing to protect devices from overexcursion, voice-coil heat buildup and amplifier clipping, and you have an improved system that safeguards components in a way that is much quicker and more accurate than a human operator with a fixed-point limiter could ever be. You do not wrest aesthetic control from the mixer. You add to his box of tools.

It might be suggested that anyone who indicates that a properly designed and realized electronically controlled speaker system "sounds funny" is merely proving their unfamiliarity with current designs;

the point at which a DeltaMax device, for instance, starts to "sound funny" is typically several decibels beyond where anybody's raw components in a box would have jumped the gap, slammed the backplate, smoked the coil, shattered the diaphragm or in some way failed catastrophically. Choose one. This is especially in light of QSC 3800, Crown Macro 2400 and Crest 8000 power sources (to randomly sample), all unavailable several years ago.

All of us are part of a relatively young industry, always growing, always searching for new and technically superior ways to accomplish our goals. It is painful to witness the evidence of closed minds and tiny attitudes. It is difficult to understand those who would lump many diverse approaches and techniques together, then dismiss them summarily. To all the critics I say: Gentlemen, here is the idea. It works. There are myriad ways to realize its application. It is the future. Can you apply the concept better? Then by all means, feel free. If you choose not to, then at least respect those who are pushing the limits of the envelope.

John Eargle, Mark Gander and Garry Margolis reply:

The article in question presented both benefits and liabilities associated with individual characteristics used in the available "processed" speaker systems. Rather than "responding in a factually unaware 'knee-jerk' manner," the curves and descriptions presented were the result of extensive measurements and listening evaluations on a broad range of systems.

To paraphrase Mr. Joseph, there are myriad ways to realize these systems. All of the manufacturers in the main article, including EV, exhibit their own distinctly different combination of functions, representing each of their differing philosophies.

As David Scheirman pointed out in the preface to the sidebar, JBL also has electronic products designed to integrate with loudspeaker systems that incorporate a specific combination of the various functions available, and choice of parameters for each of these functions. Rather than being "the evidence of closed minds and tiny attitudes," they are simply the embodiment of JBL's current design philosophy.



WHAT YOU DO WITH THE M-600 MIXER IS YOUR BUSINESS.

That's why we've designed it to meet or exceed your most demanding requirements. And made it the easiest, most flexible professional mixing console you'll ever work with.

The M-600 is modular. Which means you can custom configure the console to *your* audio or video production needs. The M-600 lets you choose up to 32 input channels, or you can start with 16 or 24 input channels and expand the board as your needs change. Optional stereo modules can also be added to provide even more line inputs for MIDI instruments and video production convenience.

Installation and wiring is exceptionally easy. The M-600 is the only modular mixer that's available with all the necessary finished cables and installation hardware. And that can eliminate a lot of installation hassles and expense. At the same time, no other mixer at its price gives you multi-pin, computer-type connectors for quieter, more secure connections.

But the real pleasures of the M-600 will only be evident after it's in your studio. Up to 64 stereo or 128 mono inputs can be accessed directly from the top panel. A patch bay can be added for fast, flexible routing. That's convenience.

The M-600 has all the features you'd expect in a professional mixing console. Like balanced insert patch points on all inputs, PGM busses as well as the stereo master buss for increased signal processing capability. Plus sweep-type parametric EQ, balanced inputs and outputs, phantom power, talkback/slate channel and all the audio performance you'll ever need. Without the exorbitant price you don't need.

So check out the M-600 modular mixing console. It's ready for fame when you are.

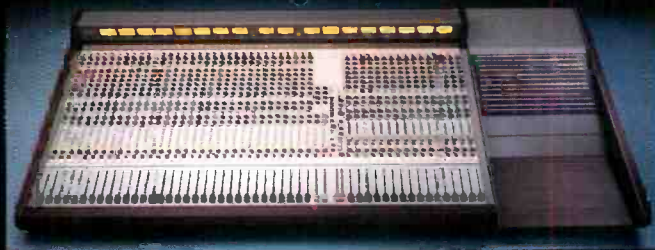

TASCAM

© 1987 IFAC Corporation of America, 7733 Telegraph Road, Montebello, CA 90640 213 726-0303

Circle (5) on Rapid Facts Card

LETTERS

Professional users will ultimately make their choice from available system concepts based on component and engineering integrity and, above all, sonic performance.

Employment trends

From: Timothy N. Nichols, San Diego.

I wish to take issue with William Moylan's article "Employment Trends" [December issue]. I offer this rebuttal not in the spirit of a personal "sob story," but as an example of what can, and does, happen to people who think it is part of their jobs to gauge trends in the professional audio industry.

I was the audio teacher at San Diego State University, which is one of the largest 4-year institutions in California, for more than three years. While this university is not noted as a particularly astute audio school, I did instruct up to five audio classes in two departments (music, and telecommunications and film) each semester. This gave me a yearly average of between 220 to 250 students. Many of these students, I am proud to say, are now employed in various fields of the audio business throughout the nation.

I was proud to stand in front of a class and pontificate on various aspects of the audio industry, and I am also proud to say that I was always honest in giving personal opinions when it was relevant and asked for by the students. When I was asked to predict possible employment opportunities, I would reply that for each job opening in the industry, there were *at least* 100 qualified applicants. And if someone was lucky enough to get a job, there would always be *at least* 200 unscrupulous people trying to take it away. You must be either lucky or unscrupulous to work in an industry so overcrowded. Being rich enough to start your own business is covered by luck. I think that it is dishonest to give students, or the general audio community, false hopes of employment.

The truth of this philosophy was brought home to me when a qualified, but very unscrupulous, individual stole my job in one of the previously mentioned departments. The remaining class load was insufficient to support me financially, so I had to give up teaching.

While this was disappointing, I could foresee no real problem in finding another job at equal or higher salary. In the mean-

time, I signed on to "extra call" with IATSE as a part-time sound man.

Even with all of the contacts that I have established in more than 12 years in the audio industry, I have not been able to find any audio-related job in Southern California in the past 12 months. My income as an IATSE extra will fall far short of reaching even the 5-figure barrier.

While I support Dr. Moylan's right to offer an opinion, I very strongly feel that the content of the opinion is wrong and does a disservice to those who are considering a future career in the audio industry.

Mega-Monster clarification

From: Todd Wilson, Rack Attack, Hollywood.

I thought I should shed some light on the Mega-Monster rack from Smoketree Studios, mentioned by Patrick O'Hearn ["A Five-Year Look into the Crystal Ball," December, page 44]. While it is true that we deliver, it is not true that Smoketree Studios rents out that system. Rather, our company does. (We just happen to have our office in the same complex as Smoketree Studios.)

Since the article, Smoketree has received numerous calls regarding the system. They are most gracious about transferring calls, but I think it would be better if people had the correct information and phone number.

Contact Rack Attack at 3249 Cahuenga Blvd. W., Hollywood, CA 90068; 818-998-1024—Ed.

Recording schools: hidden impact?

From: Geoffrey P. Hull, chairman, Recording Industry Management, Middle Tennessee State University, Murfreesboro, TN.

Your second annual Salary Survey [November issue] makes a subtle, but perhaps overlooked, statement about the impact of recording programs and schools as training grounds for audio professionals.

The data indicates that about 30% to 35% of respondents received their first audio experience in a college/university

program or recording school. That may not seem all that significant by itself, but one must consider that these programs have only been around since about 1973. Thus, anyone with more than 15 years of experience could not have acquired their first experience in a formal audio program.

If we look only at those with less than 15 years experience in the professional audio industry (47.7% in management staff, 55.8% of technical staff and 63.6% for production staff) and compare those figures with those who say their first audio experience was acquired in a college/university program or recording school, we would find that 71.1% of management people, 53.2% of technical people and 54.7% of production people must have got their first experience in audio in a formal educational setting.

To put it another way, more than half of the recording professionals who could have received their first audio experience in a college/university program or recording school did so!

Maybe we educators aren't doing too badly after all.

The only question remaining is whether the above are lies, damned lies, or merely statistics!

FDR, not JFK

From: Matthew Mattingly, MIT Language Lab, Cambridge, MA.

Jeff Burger should not be too concerned about computers forcing him to be accurate and detail-oriented ["Understanding Computers," January]. Franklin D. Roosevelt, not John F. Kennedy, made the statement, "The only thing we have to fear is fear itself."

RE/P

Send letters to RE/P, Suite C, 8330 Allison Ave., La Mesa, CA 92041. Letters may be edited for length and clarity.

WE CARE

Professionals know
the best choice is

AGFA



Whether they're duplicating a smash movie or a chart-breaking audio cassette, mastering a superstar's new song or sweetening a sound track, audio and video professionals want a tape that delivers.

They choose AGFA.

Producing magnetic tapes for production and duplication, AGFA's consistency makes it the best choice for the audio-video professional.

But you know that—you're a pro.

AGFA magnetic tape — from research and development, through manufacturing, to delivery and service — we care!

Agfa Corp., 100 Challenger Road,
Ridgefield Park, NJ 07660 Telephone (201) 440-2500

AGFA 

AUDIO VIDEO PROFESSIONAL

Circle (6) on Rapid Facts Card

www.americanradiohistory.com

CompuSonics suspends manufacturing operations

CompuSonics has ceased manufacturing its desktop digital audio disk recorders/editors and will concentrate solely on licensing and contract engineering. The company changed direction after it analyzed its capital structure, capabilities and business operations and realized that it could be profitable through licensing and engineering work, said chairman David Schwartz.

Digital Trends Inc., Concord, CA, has been licensed to manufacture the existing CompuSonics line in the United States. Ferrograph Ltd., an English manufacturer, has exercised its option to extend its DSP 1000 manufacturing license to include the hard and floppy magnetic disk machines.

QSC expands, renovates manufacturing facility

QSC Audio Products has expanded and renovated portions of its manufacturing facility, responding to increased product demand. The PCB assembly and quality control areas have been expanded, and a new flow solder machine, automatic power conveyors, workstations and lighting have been installed. Sam Kazemi, QSC's senior manufacturing engineer, said that the improvements would result in better material and product flow.

AES conference to cover digital audio

With last year's digital audio conference laying the groundwork, this year's conference, with the theme "Audio in Digital Times," is intended to advance the technology. The conference is scheduled for May 14-17 at the Royal York Hotel in Toronto.

The first day will start with opening remarks from Ken Pohlmann, conference chairman, and will conclude with a tutorial session. The second day will cover various storage and processing technologies. The intention of these two days is to lay the groundwork and start the attendees on an equal footing.

The last two days will include overlapping morning sessions, which will allow attendees to choose from presentations toward recording studio technology or digital signal processing applications. Evening sessions will be directed to the end applications of digital audio and will focus on consumer products and digital distributed applications, such as broadcast, film and cable.

For more information, contact the AES at 60 E. 42nd St., New York, NY 10165; 212-661-2355.

New England Conservatory schedules summer workshops

The New England Conservatory has scheduled three workshops this summer on MIDI and electronic music. "Controlling Your MIDI," June 16-18, will cover digital workstations for composition, control and synthesis of digital and analog sound. Robert Ceely is the instructor. Cost is \$280 for one credit, \$175 for non-credit and \$550 for NEC graduate students. The "Electronic Music Workshop," June 19-23, will cover the basic principles of sound, analog synthesis, frequency modulation and digital sampling. The course also will survey various computer music programs. Cost is \$560 for two credits, \$350 for non-credit and \$1,100 for NEC graduate students.

Also scheduled is "Musicians and Technology," June 23-25, which will be an overview of current music technology and its application in musical life. Cost is \$280 for one credit, and \$175 for non-credit.

For additional information, contact Mary Street, director of summer school, at 290 Huntington Ave., Boston, MA 02115; 617-262-1120.

DAR starts training workshops

Digital Audio Research has initiated a 3-day training course on the Soundstation II. Subjects include hands-on training, technical overview, and integrating the system in an all-digital studio. Speakers will include John Watkinson, author of "The Art of Digital Audio," and DAR directors and engineers. For more information, contact DAR's U.S. office at 213-466-9151.

Forum to discuss sound for motion pictures

UCLA Extension will present a 1-day program, "Toward the Ultimate Sound System for Post Production: A SMPTE Forum," on Saturday, May 6. Presented in cooperation with SMPTE, the seminar will emphasize the impact of emerging technology, particularly the advent of random-access storage using computers.

The seminar will be taught by Tomlinson Holman, corporate technical director of Lucasfilm Ltd. and assistant professor at the USC School of Cinema-Television. Scheduled guest speakers include loan Allen, vice president, Dolby Labs; Chris

David, film products manager, Solid State Logic; Brian Keely, audio and editing systems engineer, Lucasfilm; J.A. Moorer, vice president, audio development, Sonic Solutions; and Eddy Zwaneveld, the National Film Board of Canada.

The forum will be held at the Directors Guild of America West building, 7950 Sunset Blvd., in Hollywood. The fee is \$95. For more information, contact UCLA extension at 213-825-9064.

News notes

"For You, Armenia," the benefit record to support the Armenian Relief Society's Earthquake Relief Fund, was recorded in January at the **Record Plant**. According to president Chris Stone, it was the single-biggest session at the facility, using more than 100 tracks.

Yamaha has selected **Offbeat Systems** to be one of the development teams to write software for the C-1 music computer. Offbeat's Streamline software will soon be available on the C-1 as a fully integrated hardware/software package.

DIC Digital has unveiled a promotional effort for its digital audiotape. With every 20 cassettes purchased until June 30, DIC will provide a T-shirt, and purchasers will be registered in a drawing to win a DAT player suitable for use in a car sound system. DIC has also introduced new product packaging featuring black, red and gold designs.

LD Systems has added the IMS Dyaxis and the Lexicon Opus to its inventory. Products from Alesis, Monster Cable and Bryston have also been added. The company has also completed an installation for Moffett Productions, for a 3-room complex for video post.

Little Feat's "Let it Roll" album, engineered and produced by George Massenburg, was extensively recorded with **Bruel & Kjaer** microphones. Type 4004s were used for drum overheads and ambient room pickup. A 4006 was used for guitars and mandolin, and a pair of 4011s were used for a variety of applications.

Booth space for **APRS '89** exhibition is almost sold out. As of February, the only space available was on the upper floors. The exhibition is scheduled for June 7-9 at the Olympia Exhibition Centre, London. For more information, contact APRS at

The Essentials of Recording.

The Model 363 is engineered to be an essential component of the recording process. We've incorporated practical, time-saving features for easy studio use while delivering the sound quality expected from Dolby.

The model 363 is our first unit to offer Dolby SR Spectral Recording and Dolby A-type noise reduction in one package. Dolby SR provides a substantial extension

of available headroom, increased signal-to-noise ratio, and distortion-free recording at a cost far below the digital alternative, with the convenience and speed of editing that only analog tape allows.

The Model 363 contains: two channels in a 1-U high frame, record/play switchable either from the tape recorder or locally, transformerless balanced and floating input and output circuits, Auto Compare test facility with built-in noise generator and LED metering, and a hard bypass facility.

All audio facilities—music recording, video post-production, broadcast and film—will find the Model 363 is simply the most compact, essential unit available for outstanding audio.



100 Fremont Avenue, San Francisco, CA 94105-4377 Phone: 415 564 0200 Telex: 34401 Facsimile: 415-863-1373
246 Cuckham Road, London SW9 6AP Phone: 01 894 1111, Telex: 994393 Facsimile: 01 720-1118 Dolby and the Double-D symbol are trademarks of Dolby Laboratories Licensing Corporation. © Dolby Laboratories Inc., 1989, SBN 8545

Dolby

Circle (7) on Rapid Facts Card

NEWS

163a High St., Rickmansworth, Herts WD3 1AY England; 0923 772907; fax 0923 773079.

FM Acoustics has acquired Precision Cable Technology, the Swiss manufacturer of Forcelines cable.

Revox has selected **Ampex** as the tape supplier for its new generation of audio and instrumentation tape recorders. Ampex tape will be marketed alongside the new Revox recorders. Current plans call for the machines to be initially marketed in Europe, with eventual worldwide distribution.

Gentner Electronics has announced that its second quarter of fiscal year 1989 was its eighth straight quarter of profitability.

Sigma Alpha Entertainment, owner of Sigma Studios in Philadelphia, has formed a record and publishing company, part of a 5-year expansion plan in which the studio operations will be de-emphasized and downsized.

Frazier has appointed two rep firms to market its products. Design Factors, Hacienda Heights, CA, will cover Southern California and southern Nevada. Meyer & Ross, Burlingame, CA, will cover Northern California, northern Nevada and Hawaii.

ARX Systems has opened a U.S. office, managed by Algis Renkus, to handle distribution, marketing and service backup for its products. The office's address is Box 842, Silverado, CA 92676-0842; 714-649-2346; fax 714-649-3064.

Sonosax has moved to 1162 St-Prex, Switzerland; 021 806 02 02; fax 021 806 02 99.

QSC Audio Products has named Applied Audio Marketing as its 1988 representative of the year.

Amek has moved into its new 13,000-square-foot factory, acquired as part of its purchase of the Regent Trading Estate in Salford, England.

A TV show with 208 audio tracks? "Round the Bend," a children's TV series in Britain, is one such show, said to be the first TV show in England with all-digitally created, recorded and post-produced music, dialogue and sound effects. Tape Gallery, London, is the facility doing the post work, using a **New England Digital** Tapeless Studio.

Amek/TAC US has appointed **Westlake Audio** as its Southern California dealer. Westlake has also added Larry Deeds to

the staff as an audio/MIDI systems design specialist.

People

Terry Hoffmann has been named president of Centro Corporation.

Korg USA has announced several appointments. **Robert Tyro** has been named product support specialist. **Patrick Mazie** has been named national sales manager. **Jordan Rudes** and **John Martin Lehmkuhl** have been named regional product specialists. **Lawrence DeMarco** has been named product development manager.

Arnie Christensen has been named sales manager at Apex Systems.

George Stage has been named director of engineering at Orion Research.

New York Technical Support has added **Dan Zellman** to the service staff.

Alpha Wire Corporation has appointed three vice presidents. **Grant McLennan** has been named vice president of marketing. **Edward H. Gowett** has been named vice president of sales. **Larry G. Myers** has been named vice president of national accounts.

REP

EDITORIAL

Michael Fay, *Editor*
Frederick J. Ampel, *Editorial Director*
Dan Torchia, *Staff Editor*
Tom Cook, *Senior Managing Editor*
Linda Stuckey, *Associate Editor*
William Abrams, *Editorial Assistant*
Pamela S. Fleener, *Editorial Assistant*
Pat Blanton, *Directory Issues Editor*

ART

Alecia Wright, *Graphic Designer*

BUSINESS

Cameron Bishop, *Group Vice President*
Dennis Milan, *Publisher*
Evelyn Hornaday, *Promotions Manager*
Cynthia Baker, *Marketing Coordinator*
Laurel Cash, *Executive Consultant*
Dee Unger, *Advertising Business Manager*
Tami Bartocci, *Advertising Coordinator*

Sales offices: See Advertisers' Index.

ADMINISTRATION

R.J. Hancock, *President*
Chuck Rash, *Corporate Circulation Director*
Jane J. Powell, *Circulation Director*
Jo Ann DeSmet, *Circulation Fulfillment Manager*
Barbara Clare, *Reader Correspondent*
Kevin Callahan, *Creative Director*

CONSULTING EDITORS

Jeff Burger, *Computers*
Paul D. Lehrman, *Electronic Music*
John Monforte, *Technical Consultant*
David Scheirman, *Live Performance*

RECORDING ENGINEER/PRODUCER is edited to relate recording science to recording art to recording equipment, as these subjects, and their relationship to one another, may be of value and interest to those working in the field of commercially marketable recordings and live audio presentation. The editorial content includes: descriptions of sound recording techniques, uses of sound recording equipment, audio environment design, audio equipment maintenance, new products.

CORRESPONDENCE

Advertising and Subscription:
9221 Quivira
Overland Park, KS 66215
913-888-4664
Telex: 42:4156 Intertec OLPK
Fax: 913-541-6697

Editorial:
Suite C
8330 Allison Ave.
La Mesa, CA 92041
619-464-5577
Fax: 619-464-2643

SUBSCRIPTIONS

Qualified:
United States (Domestic Only).....\$26.00
Foreign.....\$50.00
Non-qualified:
United States (Domestic Only).....\$30.00
Foreign.....\$60.00

Optional airmail for non-qualified readers is also available for an additional \$55.00 per year. Foreign subscriptions are payable in U.S. funds only by bank check or money order. Adjustments necessitated by subscription termination at single copy rate.

Recording Engineer/Producer is not responsible for any claim by any person based on the publication by **Recording Engineer/Producer** of material submitted for publication.

Photocopy rights: Permission to photocopy for internal or personal use is granted by Intertec Publishing Corporation for libraries and others registered with Copyright Clearance Center (CCC), provided the base fee of \$2.00 per copy of article is paid directly to CCC, 21 Congress St., Salem, MA 01970. Special requests should be addressed to Cameron Bishop, group vice president.
ISSN 0034-1673 \$4.00 + \$0.00.

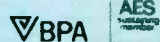

Member, Business Publications Audit of Circulation
Sustaining member of Acoustical Society of America
Member, International Communications Industries Association
Associate member of Society of Professional Audio Recording Services



©1989. All rights reserved.

The Essentials Defined.

Two-channels of SR and A-type noise reduction.

Three cards available: Cat. No. 300—SR and A-type module; Cat. No. 350—SR module only and the Cat. No. 450—A-type module only.

Multi-turn level controls on each channel for setting all levels.

Balanced transformerless input and output circuits.

Provides SR users with accurate verification of decode calibration levels and playback frequency response.

Relay-controlled "hard" bypass of all circuitry.



Generates Dolby tone for A-type or Dolby noise for SR; also activates Auto Compare mode for SR alignment.

Allows checking of the non-decoded signal from tape during recording or playback.

Four element LED calibration displays.

Front panel control of record/play switching. Can also be switched under tape recorder remote control via connector on rear panel.

Toggle switches allow selection of A-type, no processing, or SR.

Model 363

100 Potrero Avenue, San Francisco, CA 94103-4813, Phone 415 558-0200, Telex 34409, Facsimile 415-863-1172, 346 Clapham Road, London SW9 9AP, Phone 01-720-1111, Telex 919108, Facsimile 01-720-4118. Dolby and the Double-D symbol are trademarks of Dolby Laboratories Licensing Corporation, © Dolby Laboratories Inc., 1981, S89/8546

Dolby

Circle (8) on Rapid Facts Card

MANAGING MIDI

By Paul D. Lehrman

Taking MIDI to Multitask

Every year or so, a new buzzword creeps into the world of MIDI. For a while, it catches everybody's attention, and then it fades away—either disappearing, or settling quietly into musicians' and engineers' toolkits.

We've had "system-exclusive," "SMPTE conversion," "controller chasing," "intelligent tape sync," "MIDI Time Code," and maybe a few others I've forgotten. This year's buzzword, without a doubt, is "multitasking."

As is usual with a new catch-phrase, the precise definition of multitasking is a little hazy to some. Broadly put, it's the ability of a computer to perform more than one job at a time—more specifically, to run multiple programs simultaneously.

A computer that can download a file over a modem while working on a different file (editing text, crunching numbers or whatever) is multitasking. So is a computer that lets you print one document while you edit another.

Some computers are built for multitasking from the beginning (like the Commodore Amiga and IBM's new OS/2 line), while others have been dependent on operating-system improvements to allow them to multitask. Switcher and Multifinder are two examples of a "pseudo"-multitasking system being imposed on a computer: These programs were designed by Apple for use with the Macintosh long after the computer was available, and were included in various versions of Apple's system software.

Switcher (which has since been discontinued) was not true multitasking because, although it gave you instant access to a number of different applications, you couldn't leave one program while it was actually *doing* something to go work in another. Multifinder is better in that it allows certain background tasks (like printing, downloading, and in some cases, even MIDI generation) to go on after you start working in a different program. On the

Atari ST, a similar "shell" to Multifinder is Dr. T's Multi Program Environment (MPE), which, likewise, allows instant window-based program switching in a machine large enough to handle multiple applications simultaneously.

The disadvantage of an individual developer coming out with a multitasking system is that other developers are under no obligation to write their programs so that they respect it. In fact, there's nothing to stop them from coming out with their own, completely incompatible multitasking environment.

But is this type of not-really-multitasking appropriate for music? Sometimes the answer is yes—music programs can often take advantage of multitasking just like conventional office-oriented programs. In the office, if two programs need to get to the printer, one of them just waits in line until the other is finished. Same with a modem—Gaston can start uploading tomorrow's sell orders after Alphonse is finished downloading today's commodities quotes.

In the music studio, if you are running a sequencer and a patch editor, under Multifinder or MPE you can stop the sequence, tweak one of your voices, and start the sequence again. Similarly, if you want to load a file created by an algorithmic composing program into a sequencer to look at it and edit it, or into a notation program to print it out, then as long as you have enough RAM, there's no problem having all those programs in the computer at the same time.

If they're going to work together *in real time*, however, music applications need a different kind of multitasking environment. What happens if you want to generate music from a sequencer and an algorithmic composition program at the same time, say, with the sequencer providing the rhythm track, the algorithmic program doing piano fills, and the sequencer recording your smoking solos? Under most existing systems you can't do it. What happens if you want to tweak that patch while the sequence is actually playing? Same thing.

Here's a more serious example: Digidesign's Q-Sheet program for the Macintosh allows you to time and trigger MIDI events for sound effects, Edit Decision List-style and also provides time code-based automation of MIDI-controllable mixers, processors, etc. By

itself, it's a useful program, but it may strike the small-studio owner as a waste to tie up a Macintosh just to do effects and automation.

But what if you had that same computer handling all the sequencing at the same time? One computer would be controlling every piece of gear in the studio in real time. MIDI can handle it, especially if you have two different MIDI lines going, which the Mac can deal with easily. Unfortunately, once again, there's currently no way to do it.

The reason there's no way to do it is because all of these various programs, although they may co-exist on the screen very nicely, do not communicate with each other at the level they must to share a MIDI port. Unlike a printer or modem, you can't just stop sending MIDI data from one program for a few seconds or minutes to make way for the output of the other program.

You also can't just impose one data stream onto another, for the same reason you can't use a Y-adaptor to mix two MIDI lines: if one command gets interrupted by another command, all MIDI Hell breaks loose.

Therefore, a computer, if it is to be truly MIDI multitasking, has to have the intelligence to mix MIDI data streams without interrupting them. It also has to have some kind of overall timer that can control all of the programs while they run, so that they don't go in and out of sync. It would also help if all of the programs involved could use one common MIDI driver—the software module that handles the job of actually putting the MIDI data out the port—so that any potential discrepancies in the way the programs generate MIDI are eliminated.

This type of multitasking, not surprisingly, requires its own special operating system. It also requires the writers of the software that's going to run under it to design their software strictly according to the requirements of the operating system.

At NAMM, there were two MIDI-multitasking systems on display: M.ROS from Steinberg on the Atari ST (with versions for the Macintosh and IBM PC promised), and Apple's MIDI Manager. Both have the potential to take MIDI software one giant step forward, *if* the other software developers agree. If they succeed, then once again, today's buzzword will evolve into tomorrow's tool.

REP

Paul Lehrman is RE/P's electronic music consulting editor and is a Boston-based producer, electronic musician and free-lance writer.



Sign with a major label

When it comes to hitting the top of the charts, the choice is Ampex Grand Master® 456 studio mastering tape.

It's not surprising, when you consider that our continuing refinements allow Grand Master 456 to always deliver unequalled performance.

No other mastering tape provides such consistent quality and reliability, or commands such respect from musicians and studio professionals alike.

More top performers have signed with Ampex tape than any other tape in the world. While opinion may vary on what it takes to make a hit, there's no argument on what it takes to master one.

AMPEX

Ampex Corporation, Magnetic Tape Division
402 Broadway, Redwood City, CA 94063, 415/367-3800

Circle (9) on Rapid Facts Card

SPARS ON-LINE

By John St. John

Price, Speed and Quality in Commercials

I was once told that there are three parameters in commercial recording: price, speed and quality—and that you can never have more than two of the three at a time. As an axiom, it is very useful when discussing budgets. The conversation might go as follows:

"How much will my commercial cost?"

"Well, if you have a limited budget [polite approach], it may take some time if you want quality. If you need the spot right away, it'll cost ya!"

Though striving for quality, most advertising agencies tend to be in a desperate hurry. Unlike record production, there's usually a deadline attached to commercial projects. You often hear statements like, "It airs this afternoon on WCAR's drive-time show."

I've always believed that good audio production takes time. This belief was put to the test a few years ago when I met (shudder, shudder) the Syndicator! The syndicator, for those of you who have not yet met him, is the character who takes generic commercial spots and customizes them for use all over the country. The commercials are marketed by a kind of boilerroom operation, at whatever price the market will bear—usually cheap. To make a profit, the production has to be inexpensive, fast and of acceptable quality. In other words, you'd better forget the opening axiom.

If you are familiar with the usual talent calls, music searches, copy changes, retakes, punch-ins, mixes and mastering that accompany a great spot, the habits of the syndicator will terrify you. While you've had the luxury of three hours or more to complete a single spot, the syndicator wants and gets as many as 200 spots in three hours, complete with sound effects, multiple talent, music, dubs and cassette.

First, you must have a good, cheap voice talent—\$5 to \$10 a spot is average. Armed with a stopwatch, the talent must be able

to read anything flawlessly, correcting for punctuation and spelling errors as they read. They must also be able to speed or slow their delivery on demand. Seasoned radio announcers are very popular.

Second, the studio must have remote controls on everything, including the cassette deck, or you'll find yourself doing the 10km studio run.

Finally, cart machines are a standard requirement, though I have managed to use samplers in their place. These devices contain the generic "cart lines" (the previously recorded copy), which don't require customization. An example of a live announcer/cart line dialogue might be:

Announcer: "Hi there Mr. President, how's that ol' Duesenberg doing?"

Cart: "Well, actually, I was thinking of buying a new roadster."

Announcer: "Have you heard of the great deals down at Joe Blough Imports? They've got a great selection of..."

For this kind of production, you need at least two limiters, one for the announcer's mic and one for the cassette deck. The mic line limiter should be set to accommodate anything from a yell to a whisper, with an optimum output. Use a fast attack and a medium-to-fast release. The limiter on the cassette deck should be set to ensure loud playback so the spot can be heard over the telephone when it is played for client approval. Use a fast attack and medium release.

Audio elements are now pre-prepared like hamburgers in a fast-food restaurant. You can expect the ingredients to be used for weeks, months or even years, so when averaged, the time spent on preparation is very short.

Put the music on ¼-inch tape in the order it will be used, then pre-edit (to 60 seconds), leader and carefully label. Avoid noise reduction so that when the time comes, it will be easy for the syndicator to go elsewhere. Put sound effects on cart or use multiple CD players.

The *master* is usually the broadcast dub. If more copies are required, run a second tape recorder. 7.5ips is the common speed.

Finally, label the mixer and faders for the incoming microphone, cart machine, music and sound effects channels and levels. The output will go simultaneously to both the dub and cassette. You will be allowed one trial run to set levels, so get them right immediately. Otherwise, you will find yourself in a billing haggle.

Now, think "real time." The process is very similar to old-time live radio, only more hectic. You'll be flying by the seat of your pants, following the script and feverishly pressing buttons for the different machines in real time. It's the 60-second "trauma" test. If you're lucky, you may get half a minute of rest between spots while the machines recycle and the announcer takes a drink of water. Make your restroom pit-stop before the session commences. Assistants can be helpful for cutting off the dubs and reloading the tape and cassette machines.

This is fast, cheap production, and by the time you add up all the cassettes and dubs, the money can be good. If all goes well, you can expect the syndicator to be back for other sessions, but don't be lured into a long-term relationship. No one in his right mind wants to keep the syndicator around too long. It can lead to a bad reputation with legitimate agencies. One syndicator leads to another, and they can monopolize your entire operation. Health problems and your 19th nervous breakdown will soon follow. To get rid of the syndicator, just jack up the price. They are used to being squeezed out and will leave quietly, knowing that you'll welcome them back when business is slow.

A lot can be learned from the syndicator. Adding sound effects in real time during a session can really help the talent with timing and delivery. The use of cart machines and samplers can be invaluable if all the talent cannot be scheduled at the same time. Cart lines can be recorded separately (with a phone patch to the agency, if necessary) and assembled in real time at the main session.

Working in this fashion speeds up production, even if all the elements are on separate channels of a multitrack and a final mix is required. Using some of these accelerated techniques will endear you to producers and agencies. Once exposed to your skill and efficiency, they will spread the word to other busy clients. With a little luck, your studio will be booked by quality clientele, you will enjoy the luxury of an occasional coffee break, and, if a budget question arises, you can just remind your clients of the axiom: two out of three.

REP

John St. John is a SPARS member and president of 27th Dimension in Jupiter, FL.

THE POWER OF SIX.

The MA 6 Flexible
Six-Channel Amplifier.

We know what you're probably thinking. Why six channels?

Think about this for a minute. If almost every sound system out there uses more than two amplifier channels, wouldn't it make sense to put a bunch of channels in one box and save space, weight and cost?

We thought so. That's why we invented the MA 6.

Dollar-per-watt-per-pound-per-rack-space it's a killer. This one amp can drive an entire stereo 100/300 watt bi-amp speaker system. It can drive six passive monitor wedges with separate programs. Or two tri-amped side-fills. Or six separate background music zones. No matter how your sound system requirements change, the flexible MA 6 is an investment that never becomes obsolete.

If less weight, less space, less cost and greater flexibility sound good to you, then go with the power of six. The MA 6: 900 watts of innovation from Rane.



RANE

10802-47th Ave. W.,
Everett, WA 93204
(206) 355-6000.

Circle (10) on Rapid Facts Card

Audio Tapes for TV and Video Production

By Roy W. Rising

An examination of some problems encountered when preparing audio tracks for a video production.

“**A**American Bandstand” was the prototype TV show for lip-syncing to prerecorded music. Although some guest artists did perform live, most acts synced to their own records. The dance segments also used disc playback for sound.

The format served dual purposes. When

heard on the air, the records sounded the same as they did on the radio. No “special mixes” were used that might hamper the familiarity of the sound. Secondly, there was no added cost for tape transfers or handling. “Bandstand” was truly a DJ-type situation.

Late in its network life, the show stopped using discs for guest artist appearances. Instead, the artists were asked

to supply 7.5ips, ¼-inch tapes of their songs. This is where format (and rights) problems began. Sometimes the tape that came in was a quick copy someone with the group had made on a home, ¼-inch machine. If detected, the disc (usually available) would be played instead. Now and then, special mixes would arrive. These were advantageous when long songs had to be shortened—good editing being better than a fade to get out on time. But there was a hitch.

The networks and other TV stations pay annual ASCAP and BMI fees for use of commercial recordings on air. The American Federation of Musicians allows these recordings to be played without payment to the session musicians who made them. But if a special mix is used—say, one without lead vocal for a live-to-track performance—the show is required to have all the musicians present or to pay them as if they were. “Bandstand” had to be careful not to violate AFM’s rules.

The format question

If the act or artist that you are working with is planning to make a TV appearance, the best ¼-inch format to deliver to the studio is full-track mono or 2-track stereo. If the show is not recording in stereo, a mono tape is safer. Some TV facilities will play the 2-track tape on a full-track machine. Head wear and azimuth anomalies can make this an undesirable way to combine the two channels.

The common speeds at TV studios are

Roy Rising is an audio systems engineer and production mixer at ABC TV in Hollywood, CA.



Photo 1. ABC Studio 59 where “Dolly” was mixed. Console is 36x16x4. L, M, R.

7.5ips and 15ips. Don't send 30ips tape thinking it will sound better. In all likelihood, it will be half-speed dubbed (from 15ips to 7.5ips) and played at 15ips for the show. Clearly, this route corrupts REC/PB EQ standards. For safety, a copy of the disc should be sent, too. CD players are slowly beginning to appear in TV facilities, but don't bet on finding one when it's urgently needed.

Audio cassettes

The progress in cassette quality suggests that they might be suitable backup—don't believe it. Some TV houses classify audio cassettes in the same way they classify Beta videocassettes: sub-standard or unusable. Another problem with audio cassettes is format. A really good cassette will be recorded with Dolby HX or dbx, but can the TV house decode it? Probably not.

Cassettes do have value in their use with special mixes. When a song must be edited for time, both the artist and the TV production benefit from a cassette copy of the edited version. The artist can use it to rehearse and the director can plan camera angles and shots. If circumstances permit a live-to-track performance, the artist might need two versions for rehearsals: one with and one without vocal. The director's copy needs to have the vocal tracks.

Pre-production recording and time code

So far we've been looking at conditions for acts doing guest appearances on TV shows. Now let's consider the activities of a network or syndicated music-production show. Last year's "Dolly," Dolly Parton's excursion into music/variety/comedy television, will serve as our example.

Typical of these shows, there was a house band in addition to guest acts. In the bygone era of this kind of show, the house band usually worked live. For "Dolly," like many shows today, the band was on tape.

The show was produced in stereo and used full, double-system recording. This means that while the video machines recorded two channels of stereo sound, a 24-track ATR was recording the separate elements for probable remix.

The theme music, backing tracks, some underscore and other incidental material was delivered on 15ips 1/2-inch 4-track non-Dolby tape—non-Dolby because television doesn't yet use this form of noise reduction. Tracks 1 and 2 were stereo L/R. Track 3 had count-offs and an occasional protection vocal (laid down in the pre-recording session and used as a backup in case of emergency). Track 4 was non-drop frame SMPTE time code.



Photo 2. Right wing of console area.



Photo 3. Left wing of console area and side car.

During the mixdown from 16- or 24-track to 4-track, a time code generator was running on the same 60Hz reference as the ATRs. When the 4-track was played back at the TV studio, the machine was locked to video sync (color vertical-drive at 59.94Hz), to guarantee exact pitch among the different takes that might later be intercut. (The accompanying sidebar

discusses the relationship between SMPTE TC and NTSC video sync.)

The time code journey

Let's assume the video editor has specified non-drop frame code on the source tape—in our example, the 4-track.

While the tape is being played back at the TV facility, three time code-related

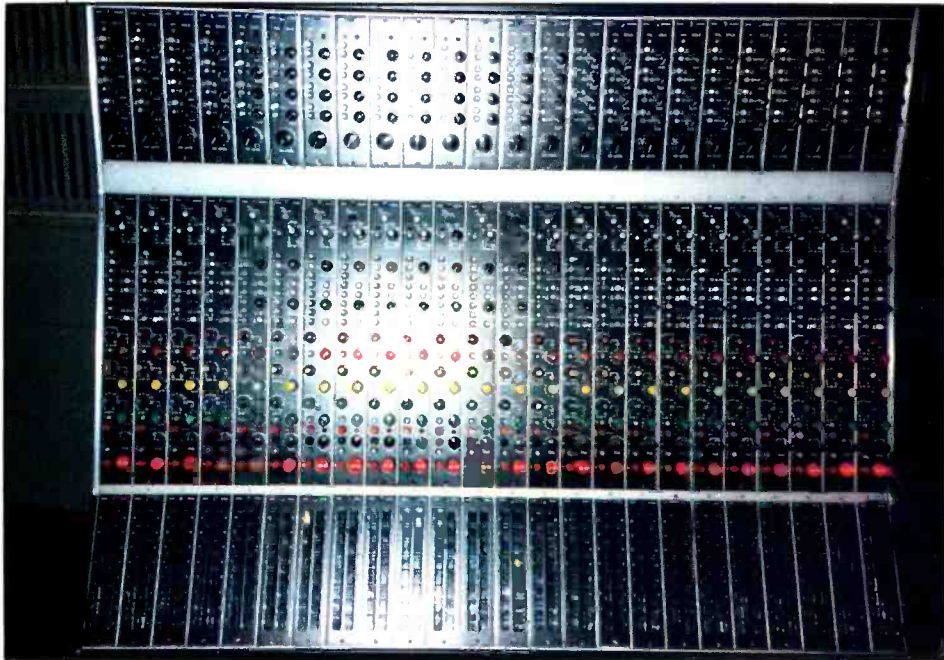

Photo 4. Side car add-on pre-mixer 24x16.



Photo 5. Console right utility area.

things are happening. Code is being used to synchronize the 4-track playback machine so that each take will be at the same pitch. It is also being transferred to a separate track of the double-system 24-track ATR. Thirdly, the 4-track's code, now referred to as "audio tape code," is being combined into the TV system's time-of-day (take-by-take) code as "user area

numbers." This integrated time-of-day code is drop frame, to permit accurate timing. It's sent to the VTRs and to a separate track of the double-system ATR.

When SMPTE standardized EECO's time code, it wisely allowed some extra space for user needs. Known as "user bits," this space may contain a simple house identifier or an entire second set of timing in-

formation. The latter has become the usual practice.

For shows such as "Dolly," the audio code is embedded in the time-of-day code. During various post-production activities, time-of-day code is used to identify the take, while user bits are used to locate verses or other material that might need to be intercut.

Double-system reworks

On "Dolly," it was not unusual for the 24-track tape to be returned to the music recording studio before it went to the video post-production facility. If there had been a time crunch during shooting, a backing track might only have received a rough mix. Or sometimes a replacement vocal was needed because of problems with the wireless body mics used in some segments. One instance involved an actress who should never have been asked to sing. (When the show aired, I'll bet she thought she heard her own voice.)

Upon leaving the TV studio, the 24-track contained three tracks of synchronized information. Track 24 contained both the time-of-day and the non-drop audio tape code from the 4-track. Track 23 held "restored" 4-track ATR code. Time code reader/restorers are used to display current locations. They're also used to regenerate code that may have been damaged by the analog recording process.

Track 22 carried modified "vertical drive." Because the digital pulse-train of time code may cross-talk into an adjacent track, it's a good idea to leave a guard track between it and any program material. Some studios don't have code-based synchronizers, but can use 60Hz as a reference. The signal on Track 22 is a rounded image of the 59.94Hz square pulses of the vertical drive. One way to get this rounded waveform is to saturate a transformer with vertical drive. The useful result is a "poor man's" sine wave.

After various enhancements, corrections and replacements were completed, the 24-track tape was sent to the post-production house, where the double-system audio master had to be attached to the edited video master somehow.

The process in audio post-production uses time code-driven automation to accomplish a polished remix of the audio elements. An additional pass adds the work of an audience augmentation (sweetening) expert. The main purpose here is to bridge some edits and punch up the reactions where necessary.

Getting it home

Once all the elements are in place, the lay-back to videotape occurs, and the product is ready for delivery to the final



This is only the first problem it solves.

With the Panasonic SV-250 portable DAT recorder the world is your studio. It weighs less than 3.5 pounds with battery pack, measures a compact 9" by 5 $\frac{3}{8}$ " by 1 $\frac{3}{4}$ " and has a built-in lead-acid battery that's good for over two hours of continuous recording.

Professional features include: XL-type mic/line inputs industry standard sampling/replay frequencies 14dB mic pad peak limiter 60-times search mode high-precision metering headphone monitoring dual MASH A-to-D converters and 64-times oversampling digital filters for enhanced audio quality.

With these features, the only problem you have left is where to get the SV-250. But we can solve that one, too. For the name of your nearest dealer, write to Panasonic AVSG, 6550 Katella Avenue, Cypress, CA 90630, or call (714) 373-7278.

Panasonic
Professional Audio Systems

Circle (11) on Rapid Facts Card



Photo 6. Machine room.

playback. In the case of a network program, this means on-air.

For most shows, there are some steps yet to be taken. A protection copy of the master is made and subsequently intercut with commercials. Luckily, this process uses video/audio punch-ins, so the program material doesn't lose another generation.

But other practices are not so benign. For example, on shows that originate in Hollywood, the integrated master is sent by satellite to New York for playback to the network. Some breaks might be updated in New York, so the L.A. viewer will

likely be hearing a later satellite rebroadcast of the show.

Preserving the quality

What can be done to preserve the integrity of your efforts? Three specific areas can be addressed: levels, equalization and effects.

When you ship a tape for TV use, remember the many downstream transmission links that complete the chain. The audio operator at the TV facility probably won't use a leveling amp on previously mixed material. Nonetheless, the final product can be expected to en-

counter such devices at several places down the line. Every transmission link will typically impose some kind of level-protective device.

The worst case is that of a West Coast production as heard on the West Coast. "Dolly" was sent by satellite to New York—one leveling amp. Then it was returned to the West Coast by satellite—a second leveling amp. ABC-Hollywood distributed the show to their regional affiliates—a third leveling amp. Local stations sent the program to their transmitters—a fourth leveling amp.

This is clearly a case where less is better. To prove the thesis, take any two of your levelers and cascade them. Play something through the path and note that the first one does all the gain control work. The second one is hardly active. When levels are correctly controlled, there are little or no excursions to activate the latter device(s).

So how can you accomplish this protection? Ship levels that don't exceed the reference established by your tape's head tones. You'd be surprised how often the levels in a mix range beyond reference. For records, this can be OK—the tape can take it and the mastering lab leaves some room, too. Video and television are less forgiving, so take control upstream to protect the product. (For more information, see "Digital Audio, Dynamic Range and the Real World," pg. 26.)

Balance protection

EQ and balance are another question. You might ask: If special considerations are required for broadcast, why do pop record mixes generally sound so good on television? We've already answered part of the question.

"American Bandstand" played discs to avoid confusion. Those records (and their acetate test cuts) had been mix-tested on small loudspeakers, car radios, juke boxes and home systems prior to final mastering. Of course they sounded good on television!

Another question might be: Why go to all the trouble to get a good sound when the results are going to be heard on a 3-inch speaker? The answer is really quite simple. People listen comparatively, and it's relatively easy to discern a good mix from a bad one on any playback system.

Once everything sounds good on your monitors and mix-test systems, the EQ has been finalized for the mix. The best way to preserve this linearity is with complete and consistent head tones. The conventional 100Hz, 1kHz and 10kHz are OK within the regular dubbing and mastering loop. But broadcast television's bandwidth is specified as 50Hz to 15kHz. It's not a bad idea to deliver head tones of 50Hz,



Fortunately, there is one
tape company that's as demanding as you are.



In this business, people are always striving for perfection. Always raising their standards and expectations. At 3M, we share that commitment. Because we realize that you can't afford a tape problem. And neither can we. So when it comes to products and service, we have one primary goal. We won't be satisfied until you are.

3M

Color and B&W Compatibility

You need to understand both "drop-frame" and "non-drop-frame" time code. Unlike MIDI, whose extensive internal integrity presents no conflicts, SMPTE code must bridge the historical gap between B&W television and NTSC color standards.

Television's first "sprocket holes" were introduced by EECO. EECO numbers were the first broadly used timing system for video. Their basis was B&W video, which ran at 30fps on a sync frequency of 60Hz.

To make NTSC color television compatible, a subtle adjustment of the sync was required. Instead of 60Hz, the frequency became about 59.94Hz, an even divisor of the color reference frequency of 3.58MHz. Think of this reference as analogous to the 19kHz stereo pilot tone for FM radio.

When SMPTE decided to standardize EECO's time code, it had to accommodate both references. Non-drop-frame time code is for 60Hz B&W. If this rate is used with the slower NTSC color rate of 59.94Hz, a 1-hour show will appear to run slightly longer than 60 minutes. By programming the generator to skip (drop) certain frame numbers, it's possible to make the absolute times match.

Most time code equipment provides a 2-position switch to set the frequency. The question of which switch-position should be used can only be answered by someone downstream. Some video editing systems use only non-drop code; others can use either.

100Hz, 500Hz, 1kHz, 2.5kHz, 5kHz, 7.5kHz, 10kHz, 12.5kHz and 15kHz.

Your local oscillator might not provide all of these frequencies, but because there might be several tape generations, it's worth trying to print several throughout the range, if possible. The 50-100Hz area is where your kick drum and bass fundamentals live. If they're wrong on the first pass, they'll never make it to the home set. VTR record EQ gets sloppy in the 5-10kHz range. A few generations of damage here can really corrupt the bass-treble balance.

Guarding your effects

Reverb and other effects can be critical. TV production stages look better than they sound. Even when your tape is a lip-sync "total track," there might still be some audience reaction mics open. The result is added reverberation, so it's a good idea to use less reverb, or none, on a TV mix.

When the artist will be live-to-track, it's important to convey some information about reverb, DDL times and harmonizer settings. These make it easier to replicate the record mix. It is also helpful to give the TV audio operator a guide mix.

Getting it there on time

Early delivery of program and reference materials is valuable. During production, the cost per minute is staggering. Major video productions can cost about 50 times more than your studio rate card. Late delivery is unacceptable. On-time arrival is OK, but the audio operator (AO) won't get much chance to fine-tune any special elements of the mix. More lead time and information and the AO might be able to obtain special effects equipment that can make an important difference.

Finally, if you can get the time, go to the session. If you haven't spent time in the video or post-production world, some interesting sights await you. We all tend to get caught up in our day-to-day situations, gleaning information about other areas from second-hand reports like this one. The best way to find out what your tapes might encounter is to follow them along. Most TV mixers won't be offended by your attendance, especially if you let them know you're there to learn (and help if possible).

The better we all understand each other's problems, the more easily we can serve a medium in which the picture seems to be the only product!

RE/P



Photo 7. Left wing and side car with P.A. and intercom racks in background.

In an age of disk and digital, why buy analog?

We know there are some applications where our 32-channel digital machine, the DTR-900, is the only answer. But if your business is such that you can do anything you want to do in the analog domain, and at the same time do less damage to your budget, then our brand new analog 24-channel MTR-100A may be the perfect machine for you.

When you consider that the MTR-100 will literally *change forever* the way engineers interface with audio machines, and

transport is pinchrollerless to give you the legendary tape handling ballistics of our MTR-90.

What's more, with its optional EC-103 chase synchronizer, the MTR-100 maintains frame-lock in forward and reverse from 0.2X to 2.5X play speed, and will typically park with zero frame error.

Then, there's the sound. New cylindrical-contour heads built by Otari especially for the MTR-100 result in remarkably low crosstalk and outstanding low-frequency performance. Pre-amps are located directly beneath the heads to further improve frequency response, and HX-Pro* is built-in for enhanced high frequency headroom. (An optional internal noise reduction package houses Dolby* SR/A.) Add all these features to gapless, seamless, punch-in, punch-out, which is also built-in, and your

MTR-100's sonic performance will rival, or beat any digital machine in the world.

So there you have it. With these powerful benefits available in analog, does it make sense to go digital? Sure, for some applications. But analyze your needs carefully before you buy. For many applications, a hot

analog tape machine like the MTR-100 is the right choice.

And because we can see both sides of the question, put us to work. We have information that can help you make the right decision. Call (800) 338-6077 x 101 to speak to your Otari representative.



Reel motors that approach one horsepower are driven by pulse width modulation amplifiers to tape speeds up to 474 ips.



The MTR-100's auto-alignment saves you hours of time by eliminating constant tweaking and re-tweaking between sessions.

that this new way will save you hours spent in non-productive time, the analog choice begins to make even more sense. You see, the MTR-100 features full Auto-Alignment that allows total recalibration of the record and reproduce electronics. This means you can compensate for different tapes in a *fraction* of the time that it previously took, and your studio is not bogged down with constant tweaking and re-tweaking between sessions.

And if you think digital machines have a corner on high performance transports, think again! The MTR-100's new transport incorporates reel motors that approach one horsepower—you'll get fast wind speeds of up to 474 inches per second! Of course, the

OTARI



*Trademark Dolby Laboratories Licensing Corporation

Digital Audio, Dynamic Range and the Real World

By Marvin Caesar

An examination of some of the issues related to program dynamics in contemporary audio and A/V production.

A lot of us thought the pinnacle of audio fidelity had finally arrived when digital recording came on the scene. At last, we were forever liberated from the worry of dynamic range control. Never again would we have to shoehorn our signals into that all-too-narrow gap between the noise floor and the overload ceiling of our equipment. With headroom to burn, we could simply set our meters at -10VU or -20VU , relax and rejoice in the unprocessed purity of the sounds we were capturing.

Well, as often happens, digital didn't work out quite the way we expected. Slowly, the difficulties involved in dealing with digital's dynamic range have become clear. In retrospect, it is clear we were naive in thinking that our worries were over—in the age of multimedia entertainment, how we manage the dynamics of our programs has become more critical than ever.

This article examines some of the issues related to program dynamics in contemporary audio and A/V production, and puts forward the philosophy that:

1. In most audio productions, some

dynamic processing is either necessary or desirable, but

2. It shouldn't create any noticeable effect on the program.

Terminology

One of the problems when talking about dynamic-range processing is terminology. People use different words to mean the same thing and the same word to mean different things. In particular, the terms "limiter," "compressor" and "leveler" are often used interchangeably. For clarification, the following definitions are suggested:

Limiter—A signal processing device that operates to reduce the instantaneous amplitude of signal peaks, leaving average levels undisturbed. Typically used to ensure that the peak ceiling is not exceeded. Has little or no effect on perceived loudness, but may overreact and "suck holes" in a signal if driven too hard.

Compressor—A device that acts to reduce the short-term variation in the average level of a signal. Used to control the apparent loudness of a signal and to ensure that it fits within the *useful* dynamic range of the listening environment.

Leveler—A device that adjusts its gain to maintain a relatively constant long-term average signal level, with no effect on signal peaks. Because of its very slow action, gain changes usually are not noticeable.

Density—A psychoacoustic parameter that is related to the amount of short-term variation in the average signal level. Programs processed by many conventionally designed compressors have little variation and sound "dense."

Peak Ceiling—This is the highest instantaneous value that an audio signal may have. It is either impossible (in the case of digital audio), illegal (in broadcasting), or inadvisable (in conventional magnetic tape recording) to drive the signal waveform any higher than the peak ceiling. Note especially that this parameter is independent of frequency; it is concerned with instantaneous level only.

Usable Dynamic Range—The difference (in decibels) between the noise floor of a system and the onset of peak clipping (with sine wave signals).

Useful Dynamic Range—The dynamic range that may be delivered to a listener in a given setting. Essentially, the difference between the ambient noise level

Marvin Caesar is president of Apex Systems, North Hollywood, CA.

PERFECT PARALLEL



With over 300 Series 80's giving flawless performance in film, video and recording installations world-wide, we approached its redesign with great care. This pursuit of perfection led to the 80C – a handsome heir to a proud tradition. Incorporating the legendary Trident sound and the sophisticated features you expect, the 80C boasts more than just visual appeal. It is the only reasonably priced split console capable of monitoring two 24 track recorders in parallel, a 32 track or the new 48 track machines – without the compromises of in-line designs. Perfect by design, the 80C has no parallel.

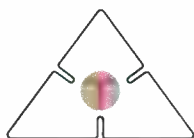

TRIDENT

Circle (13) on Rapid Facts Card

TRIDENT AUDIO DEVELOPMENTS LTD

Trident House, Rodd Estete, Govett Avenue, Shepperton, Middlesex TW17 8AQ, England ♦ Phone 0932-224665 ♦ Fax 0932-226721 ♦ Telex 8813982 TRIMIX G

TRIDENT AUDIO USA

2720 Monterey Street, Suite 403 Torrance, California 90503, USA ♦ Phone 213-533-8900 ♦ Fax 213-533-7072 ♦ Telex 5106000019 TRIDENT USA

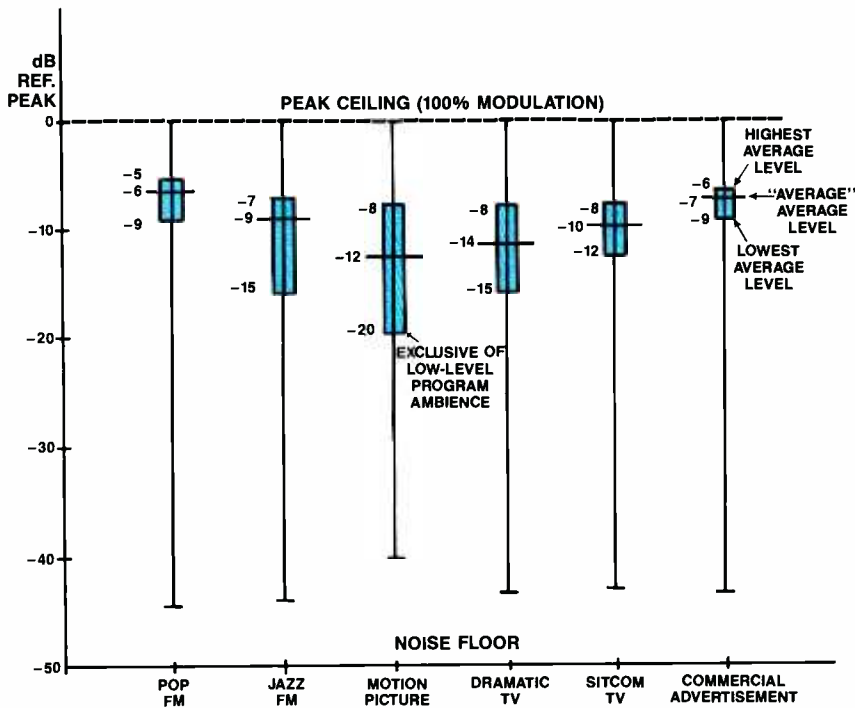

Figure 1. Dynamic profiles of audio distribution media (typical).

and the threshold of equipment overload or listener discomfort (whichever is lower). Note that various psychoacoustic and program-dependent variables are involved in determining useful dynamic range.

Dynamic Profile—A characteristic of a given audio distribution format that shows the relationship between peak ceiling, noise floor, long-term average signal level and short-term average level variation. (See Figure 1.)

If you don't do it...

Dr. John's hit of a few years ago contained the refrain, "If I don't do it, I know somebody else will."

Engineers and producers would do well to remember this at all times. Whether the finished product is intended for records, CDs, television, radio, or film, you can bet that another engineer, somewhere down the line, is going to feel the need to limit, or at least "monitor," the dynamics of your program. (See "Audio Tapes for TV and Video Production" pg. 18.)

Probably the worst offenders are FM broadcasters who, for marketing reasons, want the loudest possible signal, but risk an FCC penalty if they overmodulate too blatantly. Thus, they often take compression, peak limiting and clipping to extremes—with side-effects that are plainly audible, and not exactly flattering.

To put it bluntly: How do you keep the station's audio "crunch boxes" from doing

a hatchet job on your material? By supplying source program material that's properly "packaged" within the station's dynamic profile. That, of course, means careful management of dynamic range. Better for you to do the dynamics processing in the controlled environment of the recording/production facility, than to have a station process your signal in a heavy-handed and completely unpredictable fashion.

Here, it's important to consider the station format when making production decisions. Figure 1 shows typical dynamic profiles of several different radio formats (as well as other media). Looking at a typical pop music station, we see that the maximum average signal level will be around 5dB below the peak ceiling with the overall average level no more than 4dB below that. What this means is that the typical pop station defines its useful dynamic range as 5dB to 9dB below the peak ceiling.

Given these constraints, the idea of fruitfully exploiting a digital recorder's dynamic range of more than 90dB (for pop productions) begins to seem a little absurd. If you deliver a mix with too high a peak/average ratio, the most likely consequence is that the station will turn up the input to the processors, raising the average level and causing their limiter to suck a hole in the program on every transient peak.

However, you don't have to squeeze all the life out of your program to fit it into this profile. What saves you is the fact that perceived loudness is only loosely related to the reading on the station's modulation meter.

The key is to preserve short-term variations in average level. In effect, gain changes are restricted to small, well-defined time "windows" when the current average input level deviates from the historical average. By avoiding constant gain "slewing," the device generally preserves the natural envelopes of the program material.

Digital: the unforgiving domain

The digital medium demands a lot in exchange for its wide dynamic range. For one thing, its overload margin is exactly zero. While analog tape has a wonderfully soft saturation characteristic—one that many producers exploit deliberately—digital overload means only one thing: hard clipping of the signal. The old analog practice of recording with the meters well into the red is a giant no-no with digital.

The answer is simple, right? Just back the levels down so there's no chance of overload. You'll still have a much better signal-to-noise ratio than with analog tape.

But, of course, there's a "gotcha." It's called quantization. Every 6dB reduction in signal level effectively "throws away" one bit of each sample, so that at 24dB below peak level, our 16-bit system has suddenly become a 12-bit system. And most audio engineers would agree that 12 bits simply isn't enough resolution to meet professional standards. Besides adding "grit," low-resolution sampling aggravates the "quenching" or gating effect on note decays and reverb tails caused by low-order bit quantization.

It's also important to realize that when a CD master is made from an analog tape, the recorded level of the entire disc is referenced to the highest peak level on the master tape. If a single transient peak that is 6dB higher than everything else on the master is allowed to get through, the level of the entire CD has effectively dropped 6dB!

To overcome these problems, a recommended strategy is to keep program levels to at least the 14-bit level (-12dB) and to use a good peak limiter to avoid digital overload.

It's interesting to note that this kind of dynamic pre-processing must be done in the analog domain—at least until 18-bit and, more likely, 20-bit A/D converters and processors are available—because once you've digitized a low-level signal, the damage is done. No subsequent digital tinkering can undo it!

APPRECIABILITY

GML CLIENTS SPEAK FOR THEMSELVES

RESPONSIVE

"It just works. The system is virtually transparent to the user. No complicated displays...No time consuming keystrokes."

TOM McCORMACK, THE BURBANK STUDIOS, CA

DEPENDABLE

"Reliability is a major concern in day to day operation. The GML system has been nearly flawless."

TETSU TAKAHASHI, SEDIC STUDIOS, TOKYO

PRECISION

"Fader and Mute accuracy so precise, my confidence in the system to reproduce every detail is unquestioned."

BRUCE SWEDIEN, MIXER, CA

COMPATIBILITY

"GML's ability to convert SSL and Necam mix disks allows us to maintain compatibility, assuring room to room flexibility for our clients."

STEVEN BRAMBERG, ATLANTIC STUDIOS, NYC

ENGINEER ENGINEERED

"For the mixer, the operation is effortless and intuitive. When complex problems do need to be addressed, the Editor provides an easy to use off-line function for any eventuality."

MICK GUZAUSKI, MIXER, CA

PALETTE-ABILITY

"It provokes an environment that enhances the creative process..."

CHICK COREA, ARTIST, PRODUCER, CA

ORTHOGENETIC

"GML's system architecture assures that our investment will remain on the cutting edge of technology for years to come."

STEPHEN FLOOD, MASTERROCK STUDIOS, LONDON

GML
GEORGE MASSENBERG LESS

THE AUTOMATION STANDARD

7921 BURNET AVENUE, VAN NUYS, CALIFORNIA 91405, FAX 818 781 3828, TELEPHONE 818 781 1022

SEE US AT NAB BOOTH 7333

Circle (14) on Rapid Facts Card

The Aphex Dominator and Compellor

Aphex is concerned with what sounds pleasing and natural to the listener. Our signal processing devices are designed to control dynamic range without removing the "air" and "life" from the program. The Aphex Compellor and the Aphex Dominator are two examples of "intelligent" gain reduction devices that employ sophisticated sidechain circuitry in pursuit of "invisible" dynamic processing.

The Dominator is a multiband peak limiter that allows a substantial increase in average output level.

With it, for example, you can control levels that might otherwise overload the front end of A/D converters.

The Aphex Compellor is a compressor/leveler that exploits such parameters as perceived loudness to create a compressed signal that doesn't sound processed. To achieve this, it relies on that marvel of signal processing—the brain—and its ability to use psychoacoustic cues to "reconstruct" a wider apparent dynamic range than actually exists in a program.

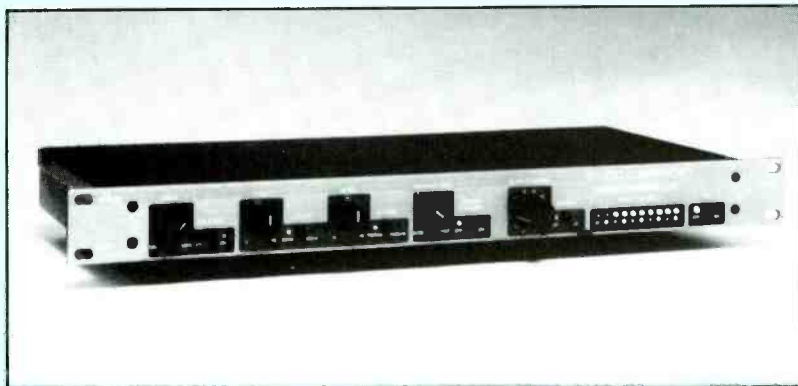

The Dominator limiter.



The Compellor compressor/leveler.

How much dynamic range can you use?

People generally listen to music while doing something else—talking with friends, driving, eating dinner or any number of other things. Under such conditions, they find it distracting, even an-

noying, to have too much variation in the average program level.

Research has shown that a 6dB to 10dB average level variation is about the maximum that most listeners are comfortable with in typical situations. In an automobile, with its high ambient noise

level, even this may be too much. Once again, use of "intelligent" compression and leveling techniques can maintain a pleasingly consistent average level without removing desirable program dynamics.

A completely separate issue is the performance limitations of most consumer playback equipment. Despite advertising claims about "digital-ready" speakers (whatever that means), the fact is that most home stereos have nowhere near the headroom required to reproduce the full dynamic range of unprocessed digital sources. Probably the worst possible scenario would be a laser videodisc with a digital soundtrack played through a TV set's amplifier and speaker.

In cases like this, the choice becomes either to limit dynamic range during production, or to have the consumer's power amplifier do it for you. It should be very clear which is the preferable alternative.

Mastering for release on videocassette provides a classic example of the need for dynamic range management. Because most VHS releases now include both a lo-fi linear audio track as well as a VHS hi-fi stereo track, some tradeoffs are inevitable. It's necessary to have a high average level to mask background noise on the linear track, but at the same time to reward hi-fi-track listeners with the best possible audio fidelity. Here, a high-quality compressor can be invaluable because it can "package" the audio to fit within the constraints of the linear track while maintaining the natural-sounding dynamics of the original cinematic release.

Conclusion

I hope the preceding thoughts will prove useful in your creative efforts. Modern entertainment productions pose some daunting challenges to the audio engineer. These days, it's rare to mix solely for a record, CD, FM broadcast, TV broadcast, videocassette or film. More often, the finished product has to accommodate several of these media—each with its own set of requirements and limitations. In such an environment, well-chosen dynamic range processors can be a great time-saver, if not a lifesaver.

RE/P

IT'S THE LITTLE THINGS ABOUT THE IL SERIES THAT YOU'LL APPRECIATE.

Take a close look at the Soundtracs IL Production console. An outstanding console that's achieving acclaim amongst commercial recording studios around the World. Designed to meet a production climate that's radically changing with engineering that matches efficiency with vision.

More important, though, listen to the way it sounds. This 32 bus console offers very low noise, minimal crosstalk and a degree of sonic transparency that sets new standards.

Combine these attributes with a sensitive yet effective equaliser section to create one of the sweetest sounds to be found anywhere, perfect for high quality track laying.

And while our crystal clear layout is free of gimmickry, we've included a number of unique features and sophisticated circuit designs which, together with Soundtracs Tracmix fader automation, provides versatility to set your creativity free.

Little things in themselves. But in the Soundtracs IL, add up to a rather special production console.

Circle (15) on Rapid Facts Card



SOUNDTRACS PLC, 31 EWELL ROAD, SURBITON, SURREY
KT6 6AH ENGLAND. TELEPHONE (01) 399 3392/8101
FAX: (01) 399 682 TELEX: 8951073 STRACS G

SPECIFICATIONS:

- 48 OR 36 CHANNELS □ 104 OR 80 INPUTS ON REMIX
- INTERCHANNEL CROSSTALK BETTER THAN -88dB @ 1kHz
- MIX NOISE 32 INPUT ROUTED BETTER THAN -82dB

EXCLUSIVE US DISTRIBUTOR:

SAMSON[®]
Technologies Corp.

SAMSON TECHNOLOGIES CORPORATION, 485-19
SOUTH BROADWAY, HICKSVILLE, NY 11801, USA
TELEPHONE: (516) 932 3810 FAX: (516) 932 3815

Analog Signal Processing for Digital Recording

By Michael Morgan

Never before have limiters, compressors and sibilance controllers been so useful, nor the correct application of them so important.

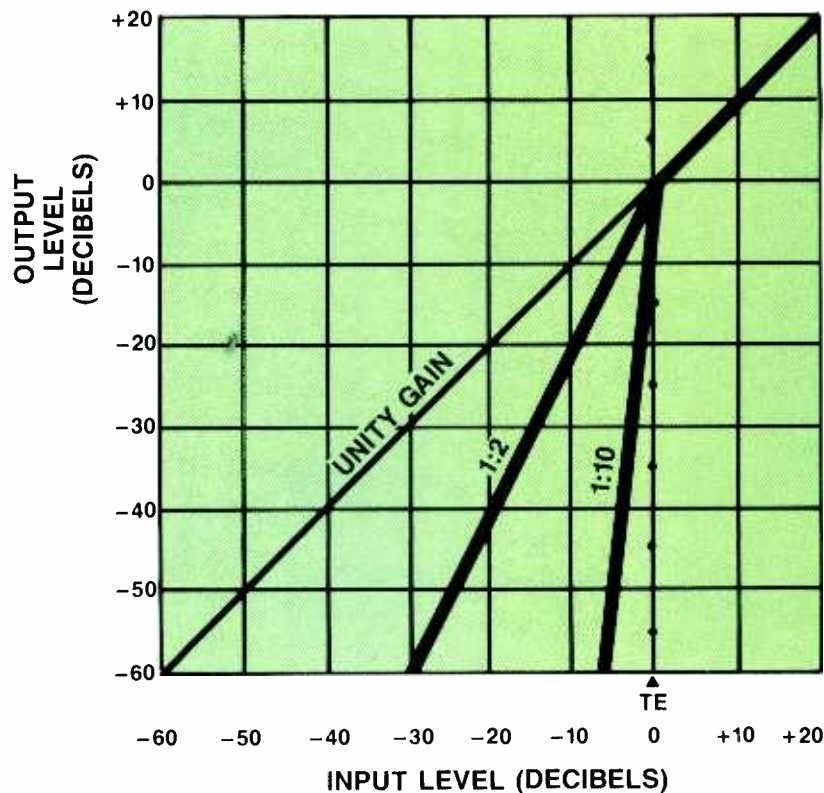

Figure 1. Input vs. output voltage levels of a steady state tone through an expander with threshold at 0dB, slopes of 1/2 and 1/10.

Since the introduction of professional digital recording equipment and the popularization of the compact disc with the promise of 90dB and more of usable dynamic range, many engineers and producers have adopted the attitude that traditional signal processors such as compressors, limiters, expanders and noise gates have become less necessary.

On the contrary, never before have they been more useful, nor has the correct use of them been so important. While it is true that digital technology has theoretically unlimited flexibility (problem-solving and enhancement ability), in practice, it imposes a more stringent set of performance requirements. We will never be ready for more bits and faster sampling rates and all the rest of digital audio's promised potential if we don't stop thinking about it as a reason not to control the *quality* of the recording process.

Problems with digital's greater dynamic range

The same attributes that make digital storage of audio information vastly superior to existing analog storage also

Michael Morgan is an independent audio consultant in Nashville and is former vice president of technical operations at Valley International. He is also an experienced recording and mastering engineer.

make for unique problems. For example, the concept of greater dynamic range is valid only when we compare the digital medium under discussion with its analog counterpart. While the theoretic 96dB dynamic range provided by a linearly encoded, 16-bit PCM tape machine is a vast improvement over the 70dB or less provided by a well-maintained and correctly operated analog machine, it is somewhat poorer than the 105dB to 110dB available in state-of-the-art analog circuitry.

In addition, keep in mind that analog circuits and magnetic analog storage media are much more tolerant of signals that exceed their ranges of linear response. Moderate amounts of analog clipping or tape saturation, especially during transient peaks, may be noticeable, but are not particularly offensive to the average listener. This is not necessarily the case with the digital conversion or storage process, as anyone who has heard the unmistakable sound of digital clipping can attest.

Because of its extended dynamic range, digital conversion and storage *seem* to exaggerate the slightest extraneous noises. The word *seem* is important because the effect is not so much a result of any peculiar property of the process as it is a psychoacoustic reaction. The brain can "process out" such ambient noises as air conditioner wind-noise, low-frequency rumble from outside street traffic and common piano pedal noises. This is possible because it knows those sounds are unavoidable and ultimately of no consequence.

These same noises are certainly noticeable during the analog recording process, but we must listen more critically when recording digitally, or when recording for digital mastering, because much less information will be lost in subsequent processing. This is not the case when we transcribe the information to a lacquer master recording or to cassette tape where we pay a considerable penalty in information loss.

In addition, we must keep in mind the extended frequency response of most digital conversion and storage schemes. Because humans do not hear well in the very low-frequency portions of the normally accepted audio spectrum, we tend to ignore such sounds as room rumble in our acoustic environment, *and* we sometimes cannot hear low-frequency sounds because of shortcomings in monitoring. Most digitizing schemes are flat down to 10Hz. This means we run the chance of sacrificing bits to replicate sounds that cannot normally be reproduced by most loudspeaker systems.

Because the vast majority of professional recording is still accomplished us-

STATE OF THE ROAD.

The most powerful ultra-lightweight amplifier in the world. The Carver PM-2.0f delivers 1,200 watts, yet weighs under 11 pounds!

Magnetic Field Amplifier Technology, the choice of touring professionals.

CARVER
PROFESSIONAL



Carver Corporation, P.O. Box 1237, Lynnwood, WA 98046

For more information or the dealer nearest you,
call 1-800-443-CARV

ing analog tape machines and mixed through analog circuitry, we must remain aware of the special requirements of digital transcription and use appropriate tools and techniques to achieve consistently high-quality mixes prior to the digital mastering process.

During the course of researching this article, I spoke with many mastering engineers about common problems they encounter that can be solved by the proper use of traditional signal processing. The most frequent comment was that engineers and producers were inappropriately using the extended dynamic range of a digitally recorded mix, or were anticipating the digital mastering process by using inappropriate equalization and insufficient transient control when mixing to an analog or digital 2-track format.

Inappropriate use of EQ

A realistic appraisal of the listening environment in which the music will be heard is quite important. In the case of inappropriate EQ, the premise is that most popular music, be it hard rock or country, is heard in the home or, more likely, in an automobile. We gain nothing by mixing a song so that it contains musically significant material over a 60dB dynamic range if we know that it will likely be heard in an environment where the ambient noise level is 60dB to 70dB SPL.

It often falls on the mastering engineer to decide what constitutes an acceptable listening level, and to control the dynamic range of the stereo master to provide peak level control and a listenable peak-to-average-level ratio when transcribing to a digital master. This job is accomplished much more easily during mixdown, or by judicious use of limiting or compression during recording. (For more information see "Digital Audio, Dynamic Range and the Real World," pg. 26.)

In the case of insufficient transient control, we are sometimes guilty of adding unnecessary equalization, usually in the high midrange, to accentuate the presence of vocals. This results in problematic sibilance and even some cases in which vocal glottal stops take on a clicking or popping sound. The best rule of thumb is to keep the vocal tracks clean and flat. Treat sibilance early in the process, preferably during recording. If that is not possible, treat it during mixdown.

Another common problem is getting down into the noise floor with an extended fade. This serves no purpose except to frustrate the mastering engineer and make his job harder. Be aware that you may need to control the noise level in your analog 2-track format, using expansion or noise reduction whenever feasible.

Of the problems cited above, the common thread is simply failure to control

dynamic range adequately in the recording process and during mixdown. This is an easy task when undertaken early in the recording process, but becomes more difficult as the product moves toward its final form.

Even the imminent arrival of sophisticated digital dynamic processors on the mastering scene will not completely solve these common problems. Having heard digital compression in its most sophisticated form, I can assure you that any nastiness you leave in the mix is going to be glaringly obvious if the mastering engineer has to compress your mix in the digital domain.

Digital compression picks out fine detail in a mix, so that even such sounds as hammer strikes in the piano tracks had better be clean. Those lip smacks and breath noises in the vocal had best be gone, too, if they aren't wanted in the final mix.

Here are some suggestions to optimize noise and distortion performance when using signal processors. Although the old hands among you know these things, they bear repeating in light of the difficulties that mastering engineers still frequently encounter when preparing digital masters for CDs.

When recording the percussion kit, pay particular attention to tape saturation or clipping on hot tracks. If necessary, use a fast peak limiter when tracking cymbals or drums. Insert the limiter in the patch point immediately following the microphone pre-amplifier. In some consoles, this may be a line send/line return patch; on others, it may be the pre-fader patch point. Set for rapid recovery times, and *do not* add excessive gain in the microphone pre-amp to hit the limiter consistently, nor should you add gain to the output of the limiter. The secret of using the peak limiter unobtrusively is to set the threshold at a point just below tape saturation (or a few decibels below 100% modulation for digital recorders) and to set the mic pre-amps for sufficient gain to cause gain reduction only upon a very hard strike.

If you are consistently getting more than 6dB of gain reduction, readjust the pre-amp gain. The idea here is to control only the peak levels, not to homogenize the sound. The lazy man's way to do this is simply to allow clipping or saturation on peaks, but control is better, assuming you have a limiter that is up to the task.

The use of noise gates when tracking the percussion kit is well established, the purpose being to minimize leakage between the tracks assigned to the various microphones on the kit. No gate can compensate for careless placement of microphones or the use of an inappropriate microphone on a particular

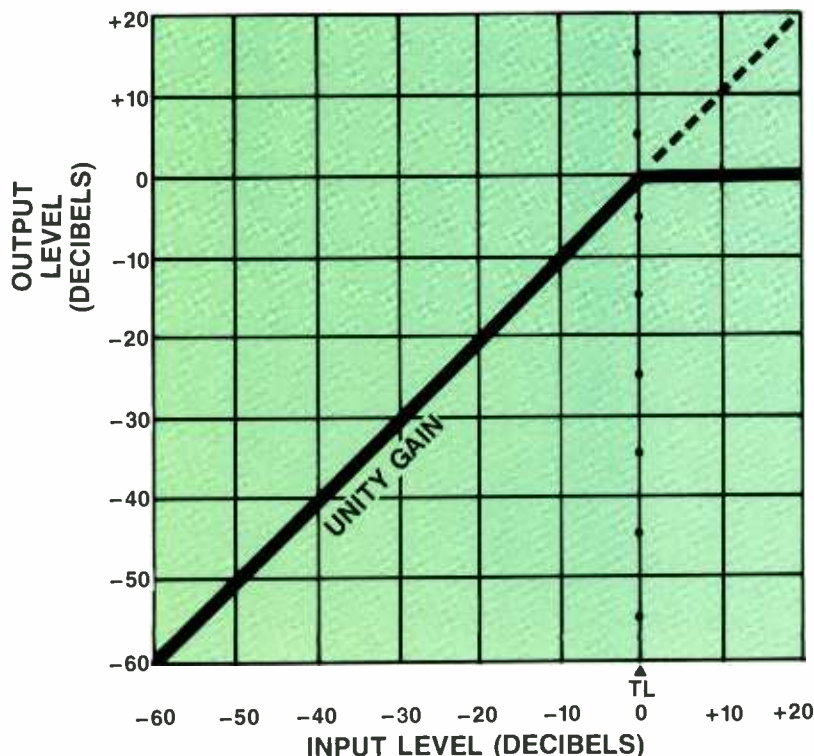

Figure 2. Input vs. output voltage levels of a continuous tone signal through a limiter with threshold at 0dB.

★ LEGAL DAT TODAY ★

Are You Ready To Enter The True Digital Domain?



A DAT Recorder Is Like Having Your Own Home/Portable Recording Studio.
Master Quality Sound Production With No Distortion! No Tape Hiss!

- English Operating Manuals
- All Connecting Cables
- AC Converters



SONY PCM-2500
Professional two piece studio standard

- Wireless remote control
- Fully programmable
- Switchable sampling freq. 32/44.1/48 khz

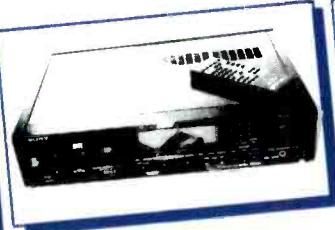

SONY DTC-500ES
Sony's second generation bestseller

- Direct digital-to-digital
- Transmission capability
- Switchable sampling freq. 32/44.1/48 khz



SONY TCD-D10
Sony's #1 consumer portable

- High-speed (near-instant) index search
- Built-in clock/calendar
- Stereo microphone and windscreen

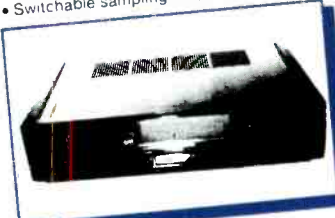

TECHNICS SV-D1100
18 Bit high resolution DAT

- Full function remote
- 6-speed CRV digital servo system
- Reduce conversion error by 75%



PANASONIC SV-250
A masterpiece of miniaturization

- 9 - 1 3/4 - 5 1/2, under 4 lbs.
- MASH A/D converter w/ 64X O. Samp.
- Digital-to-digital editing



CLARION DAC-2000 CAR STEREO

- Full-logic transport
- High-speed music search
- Intro tape scan



KENWOOD KDT-99R CAR STEREO (not pictured)

- Din-size, Dual-chassis
- Wireless remote control
- Direct track access

Did You Know:

- **DAT** recorders offer you better sound quality than CD players, plus all the benefits of a cassette recorder.
- **DAT** cassettes are half the size of standard analog cassettes, and are a higher quality tape.
- **DAT** recorders are fully programmable, with high speed (up to 300 times playback speed) indexing and music search.

CHOOSE FROM THE FOLLOWING:

- Sony • Panasonic • Technics • Tascam
- Kenwood • Pioneer • Akai • Sharp • Alpine
- Nakamichi • Denon • Yamaha

Knowledgeable, Friendly Customer Service.

FLEXIBLE LEASING PROGRAMS
START AT

\$69 per month

- NO MONEY DOWN
- QUICK APPROVAL
- COMMERCIAL ACCTS WELCOME

- USA Written Warranty
- Nationwide Service Centers
- Pro User Extended Warranties

American International Audio Video



DAT HOTLINE
609-888-4414

609-888-2930
FAX ORDERS

127 ROUTE 206 TRENTON, NJ 08610

Circle (16) on Rapid Facts Card



Dynamic Sibilance Processor

Sibilance is a recurring problem cited by mastering engineers as common to both analog and digital mastering formats. Many recording engineers are misinformed as to the nature of the problem, believing that the presence of the fricative phoneme "sss" is problematic. The obvious solution to this problem, again proceeding on the same faulty premise, is the use of a device that will limit or remove energy in the high-frequency portion of the spectrum when the "sss" sound is present.

Enter the de-esser, a type of high-frequency limiter designed to control the splatter caused by sibilant speech. Originally designed for use by broadcasters, the primary concern was bandwidth limiting, of sorts, but de-essers have a tendency to eliminate "esses" all together. The logic is, no "esses," no sibilance.

These devices soon crossed the border into professional recording, where they were unjustly maligned as a necessary evil in the control of sibilance—recognized for their value in suppressing "ess" sounds (and, only coincidentally, the sibilance therein), but universally despised for their propensity to create holes in the tracks to which they were applied.

With the evolution of analog circuitry, attempts were made—with varying degrees of success—to adopt the basic premise of the de-esser design and to improve its characteristics by adding split-band limiting. This was made possible by the availability of high-performance integrated operational amplifiers, and the accompanying ease of designing filters and gain-controlled stages.

Defining sibilance

In response to repeated requests from friends in the recording and mastering professions, an engineer having a background in linguistics undertook a statistical study of sibilance using live subjects and recorded material. Some of the results were surprising.

The first and most basic discovery was that frication in speech (the audible friction caused by the passing of breath through a narrow aperture in the vocal tract), was generally not problematic and could be easily reproduced by even

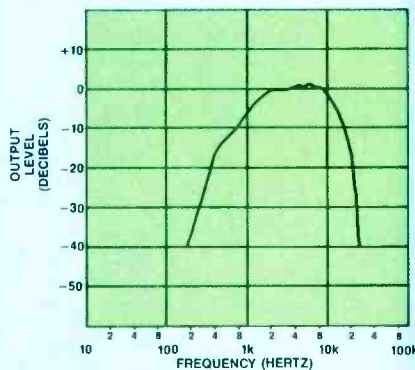

Figure 4. Spectral distribution of normal frication.

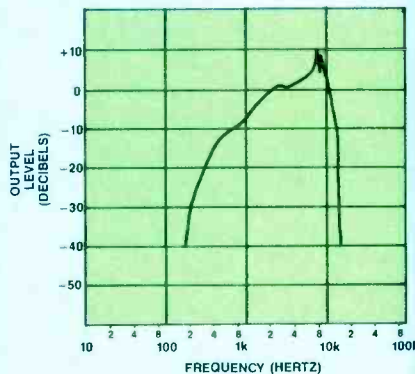

Figure 5. Spectral distribution of sibilant frication.

highly equalized signal chains of the type found in recording and playback technology. This is because the spectrum of frication resembles white noise with relatively even amounts of energy per unit bandwidth from about 2kHz to as high as 9kHz. In other words, it just looks like noise passed through a filter set.

In addition, phonemes are enunciated at a much lower power level than utterances can be produced and are, thus, quite unlikely to exceed the headroom of electronics set to reproduce speech or song. (A phoneme is any sound that separates utterances in speech. Vowel sounds are utterances. For the word *mama*, the *ms* are phonemes and the *as* are utterances.) (See Figure 4.)

The problem is caused by the production of a nearly sinusoidal energy peak in or slightly above the portion of the spectrum occupied by frication. Simply stated, when

we make an "ess" sound, we sometimes whistle. This is quite noticeable when the whistling sound is within the frequency range of our greatest aural acuity, but really starts to wreak havoc in electronic signal chains when it occurs in the higher frequencies, because most transcription and broadcast chains are pre-emphasized. (See Figure 5.) The second discovery was that the frequency bands in which sibilance is produced do not vary widely between individuals, and are primarily dependent upon the volume of that portion of the vocal tract defined by the point of friction and the surrounding surfaces of the teeth and/or lips, depending on the specific sound enunciated. The volume of this "resonant cavity" does not vary widely in a population of individuals of like age and sex because humans are structurally more similar in terms of size than, say, stringed instruments.

Sibilance in the spoken word tends to occur in the 2kHz region for males, and in the 3.5kHz region for females. Sibilance in musical vocals tends to occur in the region of 6kHz to 7kHz for males, and in the 9kHz to 12kHz region for females. Not all friction is accompanied by sibilance, and sibilance may accompany phonemes other than friction. One example is that of a male vocalist of popular note who creates a sibilant "chirp" when enunciating the dental "t" sound.

By using the information gained in this study, Valley International developed the Dynamic Sibilance Processor, which is a processor capable of distinguishing sinusoidal information in its passband from the more complex information inherent in friction. When correctly applied, it can isolate and cancel the sibilant in a fricative without changing the nature of the fricative. In this manner, the processor can remove sibilance from a vocal track and usually even a full mix, without noticeably affecting the quality of the remaining sound, or creating a hole in the material.

drum or cymbal, so do the groundwork first and consider gating as processing appropriate for mixdown if you are unsure of the equipment, the room or have limited experience with these devices. I prefer to operate noise gates post-EQ since they also attenuate most of the channel circuit noise in that position. On some very old consoles I have even applied the noise gates post-fader to quiet first generation VCAs, but modern VCAs have much more respectable noise characteristics than did the old Class AB designs.

"Soft" noise gates

Another very useful device in this general class of "gating" processors is the downward expander, or "soft" noise gate. The theory of operation is similar to that of a gate—that is, a signal exceeding a preset threshold causes the device to exhibit unity gain—but when the input signal falls below the threshold, unlike a gate, the expander causes a controlled amount of gain reduction that is a function of the expander's slope. Thus, if the expander has a slope of 1:2, a 1dB decrease in input signal level below the threshold setting will cause a 2dB decrease in the output level. (See Figure 1.)

This piece of gear is great for controlling breath noises and smacks on vocal tracks or to hush tube-noise and hum when micing a guitar amplifier. Use one any time a gate would be noticeable. High-quality expanders feature variable time constants for attack and release, as well as a variable slope.

Compression and limiting

Compression is a frequently used processing function, but few engineers agree upon what a compressor is and precisely what it does. Though a common perception, the difference between limiting and compression cannot be based on the ratio at which a device operates. The ratio is simply a comparison of the increase in input level over a given threshold setting and the resulting increase in the device's output level. A limiting ratio of 20:1 means that an increase in input level of 20dB over the threshold will cause a 1dB increase in the output level. (See Figure 2.)

What the ratio doesn't tell you is what is happening to the signal below the threshold, and that information is necessary to determine whether the device is limiting or compressing. Strictly speaking, a limiter does not add gain to the signal passing through it; thus, if the threshold is set for -20dB, any signal entering the device above -20dB will be reduced in level by an amount determined by the limiting ratio. It may be argued that a perfect limiter possesses a ratio of $\infty:1$, and that limiting at ratios such as 2:1 is

"...Right now, I'm mixing my record"

**Trevor Rabin of "YES"
on J.L. Cooper Automation**

"Since I installed J.L. Cooper's MAGI Mixdown Automation System, I've found myself with quite a bit more leisure time on my hands."

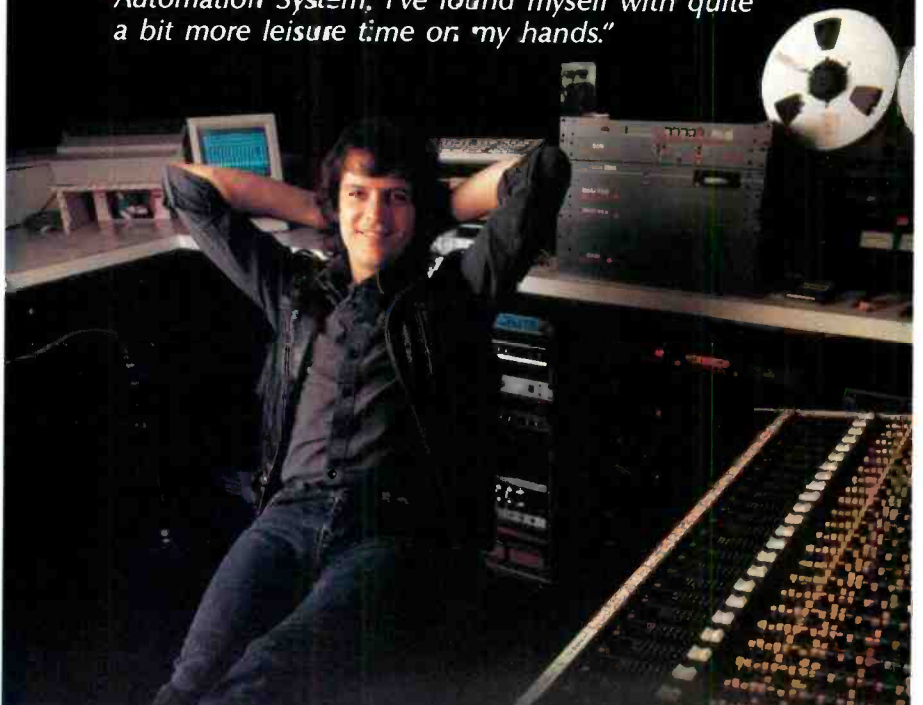

"For the last 10 years I've been very involved in studio production as both producer and engineer. These projects have involved a number of very high priced and sophisticated automated recording consoles. I am amazed at the flexibility and simplicity of J.L. Cooper's automation system. They have managed to design a real user-friendly system at a more than reasonable price. I'm also astounded by the quietness of the VCA units. The bottom line is that it works perfectly, without the need of a sequencer or sync box. MAGI has saved me numerous hours mixing."

The MAGI System is comprised of several components which can be mixed and matched to meet your individual requirements. High quality automation for the 16 to 56 input console has never been more affordable. Prices start at just \$3468.00!

Also available from J.L. Cooper is MixMate! Eight channel, self contained fade and mute automation for the 8 to 16 track studio and audio/video post production facility. Many applications, one low price - \$995.00!



See and hear what automation can do for your mixes!

JL COOPER ELECTRONICS

13478 Beach Ave., Marina del Rey, CA 90292
(213) 306-4131 • FAX: (213) 822-2252

International Distributors: Switzerland, Austria, W. Germany: Jacques Isler AG 41-1-432-1444 • England: Evenlode Soundworks 44-99-387-3484 • Italy: M.L.S.E. Sound Technology 39-2-9501-8031 • Belgium, Holland: Synton 31-34-65-67424 • Sweden: AB Greg Fitzpatrick 46-8-308070 • Australia: Tradapower Intl 6-3-560-9111 • Denmark: New M.L.Sik 45-6-190099 • Norway: Pan Studios 47-6-84-33-30 • Israel: RBX Intl 972-3-298252 • Malaysia: Meteor Sound 603-291-6559 • Singapore: ParaDi 65-3388-252

Circle (17) on Rapid Facts Card

really compressing. Not so, since we may adjust the limiter threshold downward and cause a corresponding decrease in output level. This is not the case if the device is a compressor.

A compressor has one attribute that no limiter possesses: a rotation point. This is the point in the compressor transfer function where the compressor operates at unity gain—as defined by an internal reference that is independent of the threshold or the ratio of the compressor. A simple way to explain it is to say that regardless of the threshold or ratio settings, when a signal enters a compressor at a level corresponding to the rotation point, it exits the compressor at unity gain.

To maintain its rotation point, the compressor, unlike a limiter, may add gain to signals when the threshold is set below the rotation point. The amount of gain is directly proportional to the ratio and inversely proportional to the threshold setting. Thus, a compressor with a rotation point of 0dB when the threshold is set to -20dB and the ratio is 20:1 will add 19dB of gain to the signal chain to maintain its rotation point. Change the ratio to 2:1, and the compressor gain drops to 10dB. Now reset the threshold control to -10dB, and the compressor gain drops to 5dB. (See Figure 3.)

The compressor begins to reduce gain as the input signal exceeds the threshold, even if the threshold is set below the rotation point. Gain reduction proceeds according to the compression ratio just as it does in a limiter, with this important difference: when the threshold is adjusted downward, the compressor increases gain to maintain its rotation point.

By this point, it should be clear that using a compressor when you really need a limiter or a limiter when you really need a compressor is a big mistake. Use compression when you need to control the average level of a track. A good example is the recording of a guitar or electric bass. Because the frequency response of the pickup may be lacking in the extreme low end and, at the same time, have a pronounced bump in the next octave higher, if we seek to record the instrument at a consistently high level, we must add gain to the low-volume passages, as well as reduce gain during high-volume passages. The same is true with strings or vocals—*don't limit if you really intend to compress (level out) the dynamic range.*

Conversely, if you intend to limit peak levels, you don't want other gain changes to be performed by the processor. Many engineers resist the use of compressors because of the noise "rush-up" that occurs

when the compressor releases, but better compressors include an interactive expander as part of the package, and some operate as limiters when the threshold is set at any point above the rotation point.

Sibilance

Sibilance is the whistle that may accompany fricative sounds such as "sss," "fff" and "zzz." The severity of the sibilant is dependent upon many factors including the type and placement of the microphone used by the vocalist, the presence or absence of pre-emphasis and the TIMD (transient intermodulation distortion) performance of the signal chain. Surprisingly, the bands of frequencies in which sibilance is found are relatively consistent from performer to performer, and for a specific individual performer, a given micing setup will produce sibilance in a predictably narrow bandwidth.

The point of all this is that sibilance is reasonably easy to deal with if you address the problem when it occurs. Several kinds of devices exist to deal with sibilance, ranging from de-essers, to more complex sibilance controllers.

Any time you allow a tape with a sibilance problem to go to mastering, you lose. As one well-known mastering engineer put it: "The tapes come in here with terrible sibilance and the client says, 'we didn't have a de-esser on this session,' like it's no big deal. That's kind of like saying you forgot your pants that day, but it was no big deal." Maybe being billed for an extra few hours of mastering time is no big deal to you?

All the problems cited in this article are easily solved by the judicious use of the appropriate processing equipment. Antiquated dynamics processors are not going to make the cut, nor are engineers who have not mastered the use of such simple devices as limiters, gates and compressors. Those skills should be as much an engineer's stock-in-trade as basic micing technique.

REP

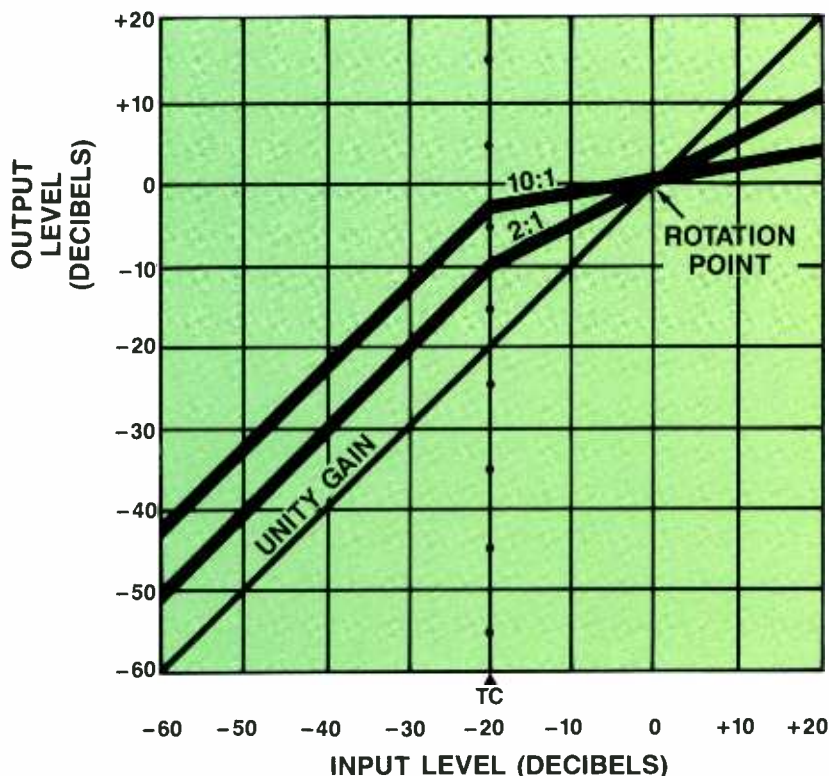

Figure 3. Input vs. output voltage levels of a continuous tone signal through a compressor with threshold at -20dB.

Photo and diagrams courtesy Valley International.

The First MTR Capable of MIDI Control.

- ✓ Can slave to MIDI and run automatically.
- ✓ Can synchronize to video via SMPTE Time Code.
- ✓ Built-in full function Remote Control.
- ✓ Fully programmable— 10-position memory.
- ✓ Under \$2900.*

*Actual retail prices are determined by individual Fostex Dealers.



The optional MTC-1 plugs into this MIDI port, your access to the world of MIDI. With a sequencer that supports our System Exclusive you'll be able to control all transport functions and make the R8 operate as a slave in your MIDI programming.



The R8 works with all major synchronization systems, but best of all, use the R8 with our complete line of generators, processors and controllers — all software based, therefore always current.



The entire front panel is removable, so you can control all functions — more than ever before — right from your working position. Once you set up your R8 it acts like any other computer. Tell it what to do, and it does it. Faithfully.



Program up to ten memory points and you'll have Auto Locate, Auto Play, Auto Return, Preroll, and Zone Limiting commands right at your fingertips. The memory is fully accessible so you can change cue points and functions easily.

R8

The 8-Track Computer with the Built-in Remote.

FOSTEX®

©1989 FOSTEX 15431 Blackburn Ave. ■ Norwalk, CA 90650 ■ (213) 921-1112

Circle (18) on Rapid Facts Card

www.americanradiohistory.com



Digital Satellite Production for the Media Recording Facility

By John Brady

Satellite transmission of digital audio has made its mark, particularly in the field of national radio and TV ad campaigns.

Transmission of digital audio by satellite is still, to a large degree, in its infancy. Generally, real-world applications of new technology are hard to come by, but recording facilities that specialize in work for mass media have found an important use for digital satellite transmission.

Among the country's most successful recording operations are facilities specifically geared to meet the needs of the media

industry. Advertising agencies, creative services for radio and TV commercials, and producers of industrial programs all support a growing number of studios that serve the specialized market of ad production.

Satellite transmission of digital audio has made its mark in just such studios, most notably for its use in the recording of voice-overs for ongoing national radio and TV campaigns. With it, studios can serve their clients with CD-quality audio to or from almost any ad market in the coun-

try and soon anywhere in the world.

Background

In the course of an advertising campaign, changes and deletions are often made to commercial spots. New commercials are also produced, so to maintain consistency and recognizability, the campaign generally relies on a single voice talent. Even so, except for the initial sessions, it is unlikely that the talent, producer and client will all be together in one studio. In addition to scheduling and

John Brady is a media engineer and the studio manager for Fred Jones Recording Services in Hollywood, CA.

What LA's

Largest

Pro Audio

Dealer

Can Do

For You

With over 200 different brands of pro audio/video equipment, we offer you the best selection in the west. And we carry a much larger inventory so chances are we have what you need in stock.

We'll keep you abreast of new developments, new options, and updates for your equipment so you're always current and usually ahead of the rest of the industry.

New Demonstration Rooms

Since we moved to larger quarters here in Burbank we've opened two new fully equipped showrooms. In the Pro Room are three complete, operating production systems—consoles, monitors, tape machines (including 32 track digital), and signal processing/effects gear. Our second room has three more complete production systems set up to hear and compare. This room caters to the

audio/video needs of musicians and production studios.

Just the Facts, Ma'am

Things change quickly in pro audio. To make sure everyone here knows all the facts about the latest equipment, we've added a Product Specialist to our staff. His *only* job is researching equipment—reading brochures and tech manuals, going to trade shows, talking with manufacturers—and sharing that knowledge with our customers.

New Central Location

We're easy to get to from Hollywood, LA, and the valleys. And with more room, we've enlarged our technical and parts departments for even better service and support.

Come by and visit us in our new building. Turn some knobs in the demo rooms. Or just call and we'll be happy to discuss your pro audio needs.



Office Staff (l to r): Niki Simpson (Accounts Payable), Carol Gumbel (Controller), Shanah Metzelaar (Receptionist), Darrin Miller (Purchasing), Michele Schwartz (Accounts Receivable), Jim Kropf (Delivery), Front Brian Cornfield (President)



Sales Staff (l to r): Nat Hecht, Paul Freudenberg, Paul Svenson (Sales Manager), Karyn Thomas (Sales Assistant), Philip Celia, Mark Lever, Vanessa Perea (Tape and Accessories), Garth Hedin, Robert Corn, Ben Ing (Product Specialist), Constantino Psorakis



Our Pro Demo Room: Three different fully operating production systems, plus a vast array of outboard gear



Technical Staff (l to r): Steve Smulian (Service Manager), Paul Hulse (Senior Technician), Rik Shannon (P.O.M.P.), Greg Dougan (Parts Manager), (Not Pictured: Nello Torri)



Sales/Service/Design

ea Everything Audio
Advancing with Technology

2721 West Burbank Boulevard • Burbank, California 91505
Phone (818) 842-4175 or (213) 276-1414 • Fax (818) 953-2908

Circle (19) on Rapid Facts Card

logistic difficulties, the cost of bringing them all together is often prohibitive. As a result, it has become more and more common for the producer to direct subsequent sessions remotely, via a phone patch.

Facilities that specialize in recording commercials usually have as part of their standard outboard gear a device that allows a phone line to be "patched in" to the recording console. This level/impedance matching device enables the pro-

ducer, the voice talent and the engineer all to communicate over long-distance phone lines. It is similar to devices that permit a caller on a radio talk show to be heard over the air.

When a phone-patch session is needed, the producer books time at a studio and arranges for the talent to be there. Then, at the appointed time, the producer calls in from a remote location and directs the talent over the phone. Once a take has been selected, a decision is made either

to build the finished spot at the facility where the voice-over was recorded or, as in the majority of sessions, ship it out for post-production elsewhere. In either case, the tape generally does not arrive until the next day at the earliest.

A new alternative

Through such companies as IDB Communications Group, instant digital satellite communications has become accessible and cost-effective. IDB is a supplier of sat-

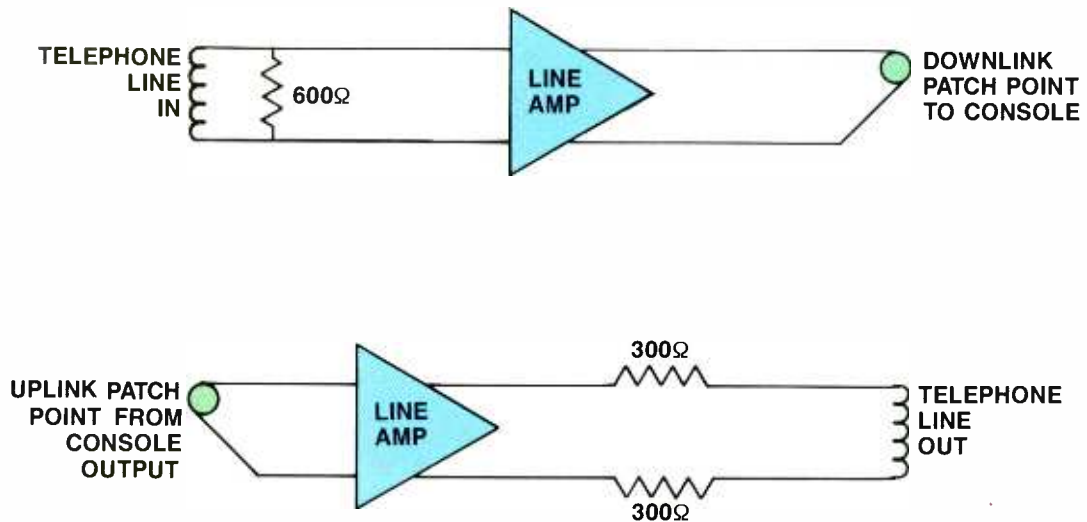

Figure 1. Circuits used to match the impedance of telephone lines to the studio.



Figure 2. IDB satellite interconnect map.



JEFF BAXTER AND DIC//DAT

TAKE MUSIC TO THE Nth DEGREE.

THE DIC//DAT Musician's Musicians Series #1



PHOTOGRAPH: KOPITCHINSKI
LOCATION: SOUNDTRACK NY.

The title on the album read "Can't Buy a Thrill." But the music inside proved just the opposite. Steely Dan gave the world a thrill for the price of a record. And the guitar player that gave Steely Dan its thrills through three gold albums was Jeff "Skunk" Baxter.

Behind the console or in front of the mike, Skunk Baxter lets nothing get between him and his music. That's why his trademark clear plexi guitar synthesizer clearly isn't just for show. Its thermoplastic body means virtually zero resonance. Which means virtually zero interference. The purest sound. Music to the Nth Degree.

Like DIC//DAT. The definitive digital audio tape. The surface: Ultra-high density metal particles. The dispersion: Ultra-uniform. The result: Unsurpassed digital signal receptivity. And an unbelievable range and clarity way beyond vinyl. Beyond analog cassette. Beyond any way you've ever heard recorded music before.

The sound of the future. Available now to discerning pros.



DIC//DAT™
TAKING MUSIC TO THE Nth DEGREE.

2 University Plaza, Hackensack, NJ 07601

1-800-DAT-1-DIC

© DIC DIGITAL SUPPLY CORPORATION, 1989

DIC Digital
DAT
Digital Audio Tape

Circle (20) on Rapid Facts Card

www.americanradiohistory.com

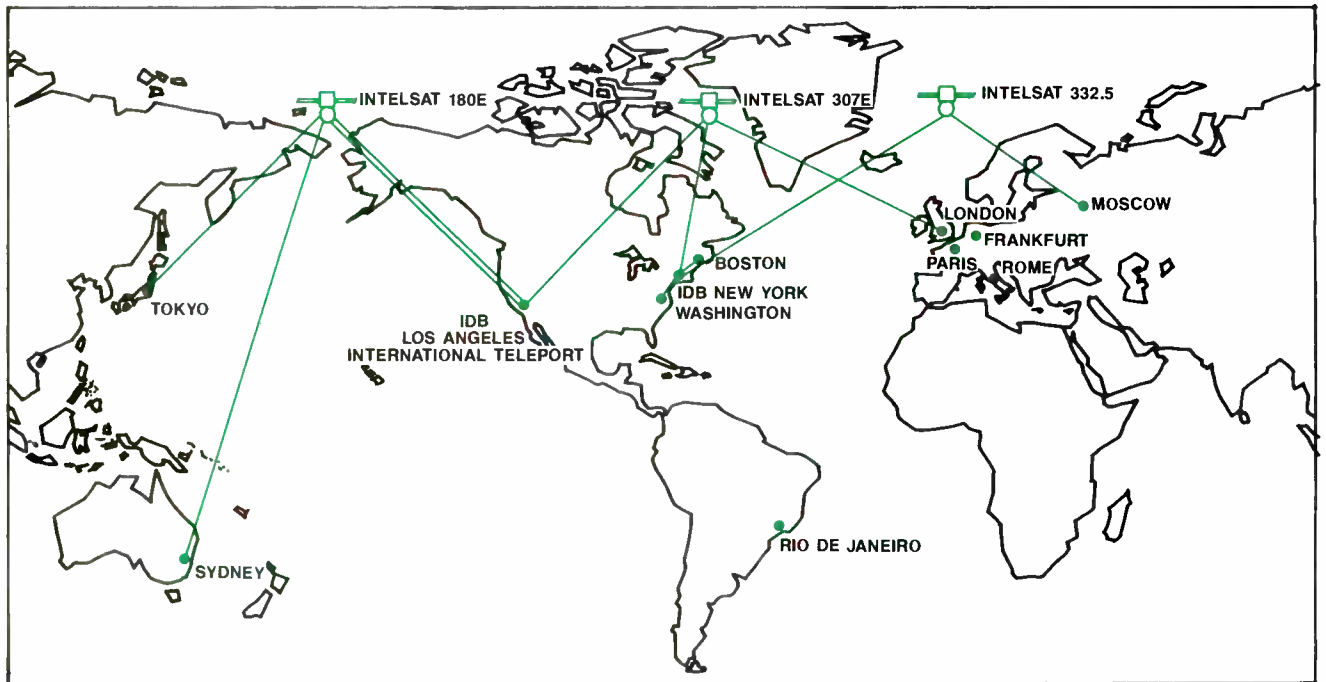

Figure 3. IDB international digital audio transmission (IDAT) routes.

ellite transmission services for the news, entertainment and sports divisions of TV and radio networks, and the only company currently doing digital satellite transmission in volume. The IDB satellite communications network currently consists of 55 earth stations in the United States. (Satellite audio can be received by more than 4,000 earth stations, not just those operated by IDB.)

Satellite service with the older analog technology was attempted by a few facilities. Their individual attempts to bring this service to their clients proved complicated and expensive. Then a small company called Landco Labs created an easy, cost-effective solution: a network of media recording facilities linked to digital satellites.

Landco was established to fill the needs of media recording studios. The president of Landco, Bob Landers, is an established voice-over talent. Over the years his stature in the industry grew to the point that he could conduct most of his voice-over work via phone patch from his San

Diego-area home studio. However, his curiosity with satellite recording was aroused when he was asked to go to Los Angeles for a session.

"It was for Sears paint," recalls Landers. "I did the voice-over at Waves Recording Studio and the people in Chicago were taping me even as I talked in L.A. It was very exciting! I thought, 'Boy, I've got to get this!'"

At that time, there were few ways to transmit high-quality audio via satellite. Studios could use the analog facilities of National Public Radio or they could rent time on a TV satellite and use the audio subcarrier.

Landers negotiated with IDB, then a small audio satellite company, to install a system in his home studio. At first he only broadcast to the studio of one New York client. Not long afterward, he began using the system for other accounts, and inquiries started coming in.

Soon he had installed systems in two of the largest media recording facilities in the nation: Howard Schwartz Recording in

New York and L.A. Studios in Los Angeles. Landco now serves a network of 22 studios.

Landco supplies the equipment to interface with the satellite companies. The network consists of high-fidelity 15kHz land lines operated remotely from Landco. Landco absorbs all the cost of running the lines to and from the recording facility. The cost to the facility is a monthly rental fee for the use of the land lines and satellite charges for any time used. A satellite single hookup is either to or from the studio, so a mono send/receive system would require two lines: one uplink and one downlink.

The signal output from the studio must be impedance-matched to the land lines that are rented from the phone company. The phone company demands a source impedance of 600Ω and anticipates a termination impedance of 600Ω. In modern recording and broadcast facilities, the equipment usually has an impedance of about 150Ω.

Landers suggests that if a facility is us-



ing a regular line amplifier, it should determine its impedance, then use build-out resistors to match the phone company's 600Ω source or termination impedance. If this is not installed, the facility may experience a rise of 3dB to 4dB around 10kHz.

In most major cities, local switching centers are used to assign and, when necessary, reroute the assignment of land lines. The switchers are Ramko Research RS-1616s, controlled via a proprietary circuit—developed in cooperation with Monroe Electronics of New York—that can be operated remotely by Touch-Tone phone. Landco feeds tone on a continuous basis to all subscribing studios. In return, the studios are requested to feed the tone back through the corresponding uplink/downlink. This establishes continuity and allows Landco constantly to monitor every link of the transmission for potential breakdowns.

Because the audio remains analog until it reaches the uplink, many facility engineers think the weakest link in the system is the phone company's land lines. Like regular lines, even the high-quality phone lines are subject to occasional distortion, breakage and loss of fidelity over long distances. Ron Rose Recording in Southfield, MI, built its own satellite receiving station to access the digital satellite network and avoid the 15 miles of analog land lines between the local NPR station and its facility.

Landers believes that normally the analog lines are quite good, and while he couldn't speak for all phone companies regarding the maximum distance between studio and satellite, he said that most phone traffic that goes through two or more central offices is digitized and, therefore, immune to analog distortion.

The lines lead to satellite stations that are either owned or contracted by IDB. The signal is digitized and then beamed to Intelsat 307E, a geosynchronous satellite 22,300 miles above the earth. The uplink/downlink process travels a total of 44,600 miles between studios, all with CD-quality audio.

The session

When a satellite session is needed, a studio first places a call to Landco. The time is booked just as it is at a recording studio. Landco has blocks of satellite time that it can allocate and confirm on the spot. Next, the studio places a call to the remote facility it will be working with—the studios actually book each other. Instead of the old phone-patch method where one studio was booked, now two facilities are in use and being paid. The downlink usually arranges and is billed for

the satellite time. The uplink, in addition to its regular studio rate, usually charges a nominal fee for the use of the land line. The client is charged only a one-way satellite fee.

It's recommended that five minutes before the session begins, the two engineers on the date get in contact with each other and do a tone sweep and level set from uplink to downlink.

The session is conducted in similar fashion to the phone-patch sessions. Two-

way communication is established by phone. Using a phone-patch device, the talent, who's located at the uplink facilities, takes direction from the producer over the phone, while at the downlink facility, the producer listens to the final product being recorded.

Steve Weisbrot, engineer at The Mix Place in New York, says, "For TV spots, 99% of the time, the voice is recorded, and while the session is still on-line with the satellite, the track is dropped into the

Silence is Golden and less work with telcom c4.

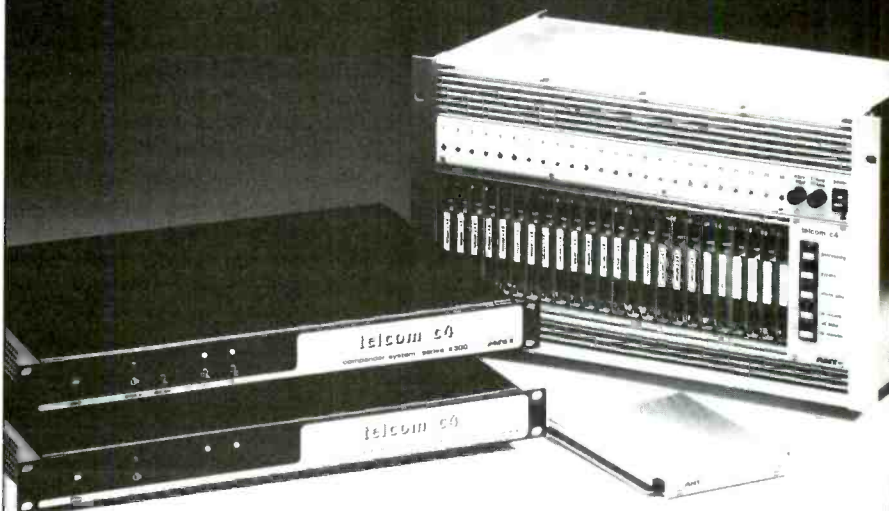

The NR system you just set and forget.

- A product of ANT Telecommunications, Inc.
- No wasting time lining up — not even for tape exchanges.
- Up to 118dB dynamic range — the widest dynamic range available in any noise reduction system today.
- Over 15,000 channels in use worldwide. ■ No pre or post echo.
- No breathing or pumping.
- No overshooting.

telcom c4

Silence by Design

Distributed by:

RAM BROADCAST SYSTEMS INC.

346 W. Colfax Street, Palatine, IL. 60067

New York (516) 832-8080

Chicago (312) 358-3330

Tennessee (615) 689-3030

Circle (21) on Rapid Facts Card

April 1989 *Recording Engineer/Producer* 45

Studios on the Landco Satellite Network

Conventionally, the studio that books the session also books the satellite and the remote studio. Markups vary. Landco helps link studios together, but does not participate in any studio fees or other arrangements. For more information, call one of the studios listed below.

Boston

Soundtrack Studios, 617-367-0510
Professional Sound Film & Video,
617-423-0007

Chicago

Chicago Recording Co. (downlink
only), 312-822-9333
Streeterville Studios (downlink
only), 312-644-1666
Universal Recording Studios
(downlink only), 312-642-6465

Cleveland

Beachwood Studios (downlink on-
ly), 216-292-7300

Dallas

Omega Audio & Production
(downlink only), 214-350-9066
Real to Reel (downlink only),
214-827-7170

Detroit

Ron Rose Productions (downlink
only), 313-424-8400

London

Abbey Studios, 011-44-1-286-1161*
BBC, 011-44-1-927-4175*
Capital Radio, 011-44-1-388-1288*
Molinare Studios,
011-44-1-439-2244*
*011 = international exchange
44 = Great Britain
1 = London

Los Angeles

Bell Sound Studios, 213-461-3036
Fred Jones Recording Studios,
213-467-4122
LA Studios, 213-851-6351
Tele-Talent (uplink only),
213-466-8517
WAVES Sound Recorders,
213-466-6141

New Orleans

4WWL Production (downlink only),
504-529-6234

New York

DB Sound Studios, 212-764-6000
Howard Schwartz Studios,
212-687-4180
The Mix Place, 212-759-8311
New Sounds, 212-581-5025
Soundtrack Studios, 212-420-6010
Voices, 212-935-9820

Seattle

Steve Lawson Productions
(downlink only), 206-443-1500

multitrack, in sync with picture, music and effects." In this way, even though the final mix takes place after the satellite session is through, the client has a better idea of how the entire spot will work and is reassured that the voice-over is going to be "right" before the link is broken and the talent released.

In many sessions, the voice-talent has to read to picture. On or before the day of a session, a window dub copy of the master video is delivered to the uplink facility. Michael Laskow, former manager of Howard Schwartz Recording in New York and current manager of LA Studios in L.A. states, "About 50% of the sessions I did in New York were to a 3/4-inch workprint." During the session, the source engineer counts down the time code to the first frame of picture using a talkback circuit that is routed through the satellite. The downlink facility can set its videocassette on a preset time code number and can use the phone-feed countdown to start its playback. With a little trial and error, you can get both picture playbacks relatively in sync.

If exact sync is required, the uplink can feed a preroll of time code through the satellite and the downlink can slave to it. The downlink, if equipped to do so, can jam-sync through its time-code generator, and slave the machines. In Boston recently, a singer sang on a jingle in sync with a 24-track that was recording her voice in New York.

A digital satellite link can have its problems too. While transmitting setup tones, an engineer at an uplink in Los Angeles noticed, through the phone patch, that it was coming back from New York at a different frequency. He did a tone sweep and (to everyone's amazement on both coasts) found that the higher the frequency he sent, the lower it was received in New York. The problem was traced to a new transponder that had not been aligned properly. The session was rerouted through another transponder and the session proceeded as scheduled. "We have three digital transponders," Landers says, "each with 20 channels. We can route our feeds to or from CBS, ABC or United Stations Radio Network."

Universal Recording in Chicago is also on the network. Studio manager Foote Kirkpatrick says, "One of our biggest clients works with a jingle writer who lives in New York. So the producers come here, and we open our stereo satellite lines to New York. They are able to direct it as if they were there, because it sounds as though the musicians are just on the other side of the glass."

Universal has used the system to overcome other logistical problems as well. "We recorded Betty White while she was



Photo 1. A digital audio control room used to route digitized audio to the transponders coordinating the uplink and downlink.

on a break from 'Golden Girls,' explains Kirkpatrick. "We were called by our client and told that she was going to take a half-hour break. They asked if we could record her, and I said 'sure.' First I called Landco, then a studio Betty White could get to. We brought up the fader and there she was. I don't think 45 minutes had elapsed from the first phone call."

Facilities in the Midwest, unlike those on either coast, seem to book satellite sessions further in advance. These agencies and studios seem to use the satellite system more as a production tool, rather than as a technology to be used only in emergencies. For the ad agencies, it's cost-effective compared to flying in one or more people and putting them up in a hotel.

Laskow says, "From my perspective, the people who benefit most from the whole satellite system are those from the Midwest and smaller advertising markets, who want to use the New York and L.A. talent." As for its impact on the facilities themselves, he adds, "The basic difference between New York and Los Angeles is that New York does more post-production after the satellite session. In L.A., we are almost always uplinking and very rarely downlinking. I don't see the benefit that I saw in New York and Chicago—that after the facilities finished an hour or so on the satellite, they also sold three hours of post-production time right after it."

One of the unexpected benefits of the satellite network has been a developing spirit of cooperation between facilities. Because the two studios booked for a session are not competitors in the same market, the facilities can think of each other as allies instead of competitors. Laskow says, "The studios that are on the network all do a similar kind of business, and the engineers have all had similar training. I think it's a real kick for engineers to get on the satellite and do a session with a colleague in another city."

The most difficult satellite session Landco has handled was done between Israel and New York. Richard Crenna, the voice for a Jeep Eagle campaign, was in Israel for the filming of "Rambo III" when the ad agency needed him right away.

The arrangements were challenging not only because of the time difference, but also because the shooting schedule for the movie was constantly changing. After many phone calls and innumerable fax communications, talent, downlink and a double-hop satellite connection were finally secured. The downlink facility was Howard Schwartz Recording in New York and Howard Schwartz himself was the engineer on the date. The session was a complete success.

Conclusion

New technology can go unnoticed for years while businesses search for applications. Satellite transmission of digital audio is an exception, having found quick acceptance as a communication tool. In addition to its commercial success, digital satellite transmission has challenged our perception of distance. In most previous modes of electronic communication, distortion was a function of distance; if a radio signal or phone connection came in garbled, we assumed that it was received

from far away. In a sense, distortion was a way to quantify distance and the size of our world. With digital satellite technology, that is no longer the case. Distance can now be conquered without distortion. Through digital satellite technology, the earth is now smaller than it has ever been.

RE/P

Photos and Figures 2 and 3 courtesy of IDB.

EXCEPTIONAL FREQUENCY RESPONSE

AT 1 7/8 IPS (REAL TIME)

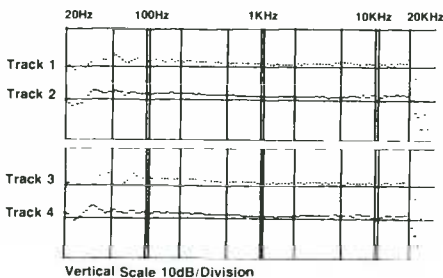

TEST METHOD A 40KHz to 20Hz sweep at -20dB from a Sound Technology 1510-A was recorded at 1 7/8 ips in a KABA slave deck on TDK SA tape. The tape was played back at 1 7/8 ips in the KABA master control deck and the output displayed on the Sound Technology. The curves represent the SUM of the record and playback response of the KABA system at 1 7/8 ips.

AUDIOPHILE QUALITY DUPLICATION SYSTEMS

KABA Research & Development
(a division of Kenneth A. Bacon Associates)
Toll Free (800) 231-TAPE

24 Commercial Blvd., Novato, CA 94949
in CA call (415) 883-5041

EXCEPTIONAL FREQUENCY RESPONSE

AT 3 3/4 IPS (DOUBLE TIME)

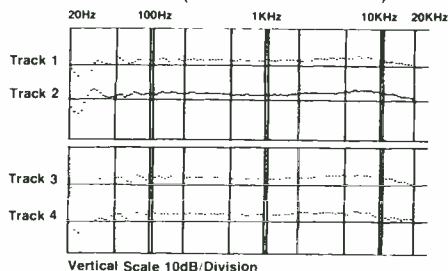

TEST METHOD Same as above except the sweep was recorded at 3 3/4 ips on the KABA slave deck and played back at 1 7/8 ips on the master control deck. Highest frequency on playback was 20KHz so there is no response beyond 20KHz.

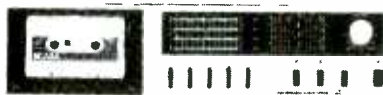

RTDS-4TM MASTER CONTROL DECK



RTDS-4TS DUAL TRANSPORT DECK

FOUR TRACK REAL TIME AND 2X DUPLICATION SYSTEM

Circle (22) on Rapid Facts Card

April 1989 *Recording Engineer/Producer* 47

NAMM Show Wrap-up

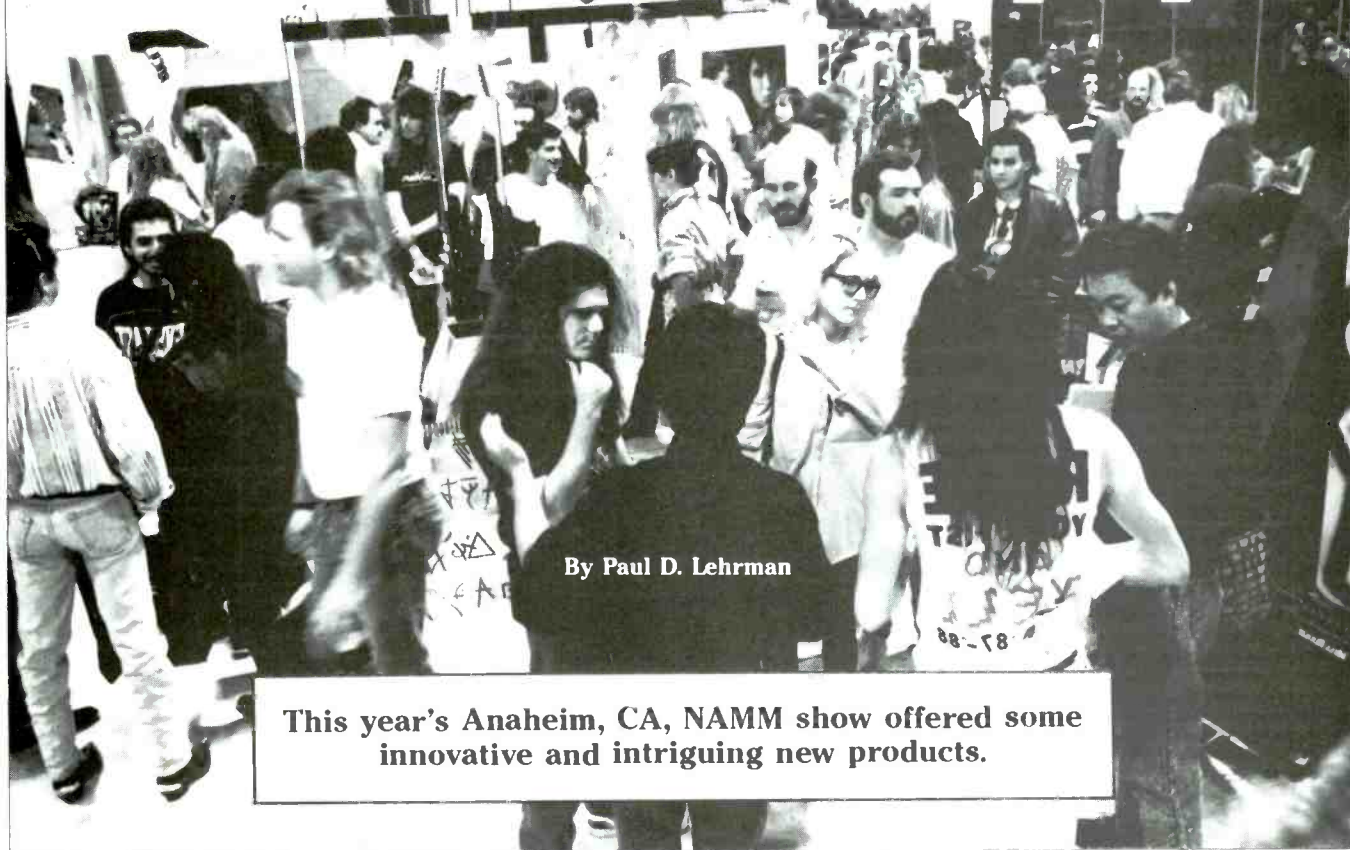

By Paul D. Lehrman

This year's Anaheim, CA, NAMM show offered some innovative and intriguing new products.

The 1989 winter NAMM show, for many, was one of the most successful music trade shows in recent memory. Exhibitor space and hotel rooms were both sold out weeks in advance, and anticipation ran high. Major advances in hardware, software and accessories were abundant, and the parties weren't bad, either. A prominent trend was "doing more for less money," as the professional recording, semipro, and musical instrument technologies markets continue to merge. The following represents a sample of some of the new products on display at the show.

Signal processing

Nowhere is this merging more evident than in the area of signal processors. When you think of how few years ago it was that the first, 5-figure cost, "Porsche-console," EMT digital reverberator arrived on the scene, the amount of bang for the buck available in digital signal processing today is nothing short of miraculous.

ART had three new products on display,

Paul Lehrman is RE/P's electronic music consulting editor and is a Boston-based producer, electronic musician and free-lance writer.

all due out in March. The Multiverb II can handle four effects simultaneously, and pitch shifting is now included. The unit has extensive MIDI implementation, allowing up to four individual parameters within a preset to be controlled, in real time, over MIDI—and the configuration, or patching, of the effects themselves can also be externally controlled. The price is \$600. The Multiverb EXT, for an extra \$75, includes a 2-second delay line and sample recorder that can be triggered manually or via MIDI. The SGE, at \$650, allows nine simultaneous effects, including the usual delays and reverbs, but also dynamic processing (compression/expansion/gating), distortion and overdrive, envelope filtering, and something the company calls a harmonic "exiter," presumably because Aphex holds the rights to the word with a c in it!

DigiTech has updated its DSP 128 to the DSP 128 Plus, allowing four simultaneous effects, and expanding the bandwidth to 20kHz. The unit is available for \$480, and a chip to upgrade older models to the current spec was scheduled for release in March. Also scheduled for March release was the MSP 4, another 4-at-a-time pro-

cessor, with a slightly smaller vocabulary of effects, at \$370.

Alesis has begun shipping its QuadraVerb, which provides four simultaneous effects, including 3-band parametric and 11-band graphic EQ, pitch shifting, and real-time MIDI control, for \$450.

A company that has not been taken too seriously in the studio processing market, but may be soon, is **Peavey**. Known primarily for guitar amps and P.A. systems, Peavey has been quietly developing some pro-level products. The QFX 4X4, from the company's Audio Media Research division, contains four effects modules in one unit, which can be accessed separately or chained together. Price is \$1,150. The AEQ 2800 is a 1/3-octave graphic-style digital EQ with 128 MIDI-accessible program memories. In addition, separate MIDI continuous controllers can be assigned to each of the bands for real-time adjustment. The boost/cut resolution of each faders is 0.5dB (within the first 6dB of its range). From 6dB to 12dB, the resolution is 1dB. Price is \$450. Both devices are scheduled to be available this month.

Equalizers were also on display at the

Rane booth, including the MPE series of programmable graphics, which comprises three models: the MPE 28, a 28-band, 1/2-octave unit; the MPE 14, a 2-channel, 14-band, 2/3-octave unit; and the MPE 47, with four channels of 7-band, 1-octave EQ. All of the models have equalization from +12dB to -15dB on each band, internal memory for 128 curves—accessible via MIDI program change commands—and can be edited using MIDI system-exclusive commands. The speed at which the curves change is user-definable, and two curves can be combined to form a new curve. The units are scheduled to ship in June, with prices between \$600 and \$800.

Automation, control and synchronization

The integration of MIDI into the post-production studio continues at a furious pace with a growing number of companies developing systems to link sequencers, video recorders, audio recorders, and processors—using various types of control signals and time codes.

Tascam showed its highly anticipated MTM-1000 MIDlizer, a 2-machine transport synchronizer and SMPTE-to-MIDI converter. It can store 20 transport cue points, displayable either in absolute time or in



ART Multiverb EXT.

measures and beats, based on its internally programmable tempo map. The tempo map—used for SMPTE-to-MIDI clocks and pointers conversion—can contain 999 changes and can be constructed by punching in the numbers from the front panel, tapping in the tempo as a tape plays, or by playing it in real time from a sequencer that generates MIDI clocks. Maps can be stored on external RAM cards. The device will also output MIDI Time Code.

Tascam showed the unit hooked up to two of its own multitrack tape recorders—one reel-to-reel and one cassette. They say that it is usable with any video or audio tape deck equipped with serial ports for transport control, although some will require a converter box, which the company

plans to have available soon.

Tascam also showed its CD/CR701 compact disc-based post-production system. The CD701 is a player, while the CR701 is an editing controller that can handle up to four players. The system is designed to set up and isolate individual sounds for entering into a sampler or recording on an effects track. Cuing is instantaneous and the pitch can be altered up to ±6%. Loops can be set up as long as three minutes, and an internal RAM buffer stores enough audio that the loops are completely glitch-free. The units are scheduled to ship in March.

Fostex introduced new software for its FAME automation system running on a Macintosh, which provides computer con-

50 year old ballistics are incapable of monitoring today's state-of-the-art audio equipment.

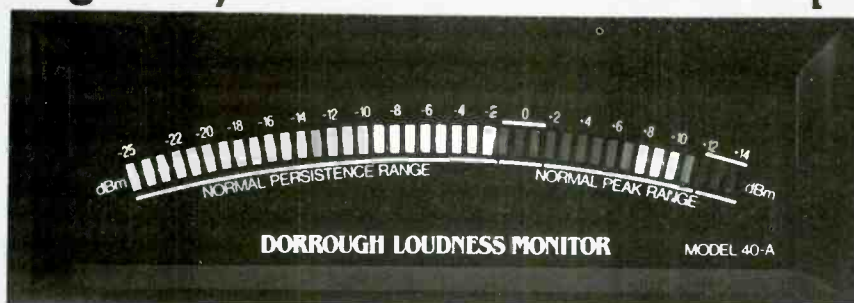

Dimensions: 8 1/4" x 2 7/8" x 6 1/2"

Model 40-A

Simultaneous display of peak and average on a single scale.

Never before has a gain riding display been able to show what is taking place acoustically and electronically. Through its unique electronics, the 40-A allows the eye to see a one-half cycle excursion at 15kHz, thus helping to keep the audio peaks within the headroom of the equipment.

This meter correlates all types of program material and has led the way to open and clean programming throughout the system.

Specifications

Scale: 40 units in 1dB steps
 Input Level: -30 to +2Cd3m
 Input Impedance: 20k bal, 10k unbal.
 Power: 120V/220-240V/50-60Hz

dorrough

Dorrough Electronics • 5221 Collier Place • Woodland Hills, CA 91364 • (818) 999-1132 • Telex: 3791292

Circle (23) on Rapid Facts Card

April 1989 *Recording Engineer/Producer* 49

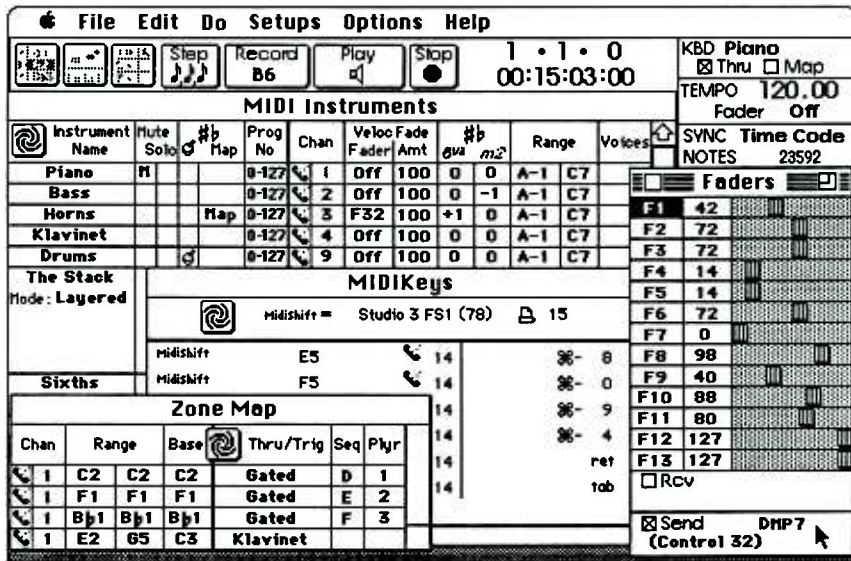

Screen dump of Opcode Systems Vision software showing the instrument map, zone map, Midikeys and faders.

control over its 4030 synchronizers. The software provides an EDL-like environment with up to 999 cues per list. It will remotely control the company's 4035 controller switches and 4010 SMPTE reader/generator, with dedicated dialogue windows for each device. Edit lists can be manipulated, sorted and printed out like any database. There is also a version for the IBM PC.

Also shown was a desk-accessory program called "MIDI Remote" for controlling all of the functions of the R8 8-track reel-to-reel deck via MIDI, in conjunction with the company's MTC-1 interface. This program is available for the Mac, IBM or Atari ST. A product that is still only in the prototype stage, but that holds great promise, is the 4020 MIDI event controller, which will read MIDI or timing cues and trigger up to 999 events, either over MIDI or an 8-channel parallel cable for transport and trigger control.

Peavey's Sync Controller is an update of the pioneering SMPL system developed originally by Synchronous Technologies. The system, which is priced at less than \$1,000, provides SMPTE-based control over two transports and will lock them together. In addition, it generates SMPTE code and converts SMPTE-to-MIDI clocks and pointers (although there is no provision for a tempo map, so MIDI is output at a constant tempo). Up to 99 program-mable events can be stored. The company will be providing cables to interface the system with a wide variety of tape machines. The system programming is EPROM-based, which will allow it to be easily upgraded.

A newcomer to the field of music production (which took many at the show by surprise) was **Sansui**. The company was showing the WS-X1, which combines a 6-track double-speed cassette deck, a 2-track cassette deck, and an 8-channel mixer into one unit—selling for less than \$2,000. The device has Dolby B and C noise reduction, $\pm 20\%$ pitch control on the multitrack transport, a built-in, adjustable, digital reverb, two balanced mic-level inputs, a mono-out/stereo-in effects loop, and patch points for effects insertion between the mixer and the 2-track deck. The transport can be synchronized to another Sansui deck or to a Fostex or Tascam system using a \$300 control box, which also contains a MIDI-to-FSK converter. A rack-mountable version of the 6-track deck alone goes for \$1,300.

Aphex has entered an entirely new market with its Studio Clock, designed by Michael Stewart. From almost any source, the device can detect where the beat is by looking at the segments of the signal exhibiting the fastest rise times. The device will also generate MIDI clocks in real time from audio triggers. It was scheduled for delivery in late February, and is priced at about \$600.

Aphex has also taken over Stewart's "Feel Factory," first seen at last year's NAMM. This device can subtly alter MIDI rhythm tracks and doubles as a Macintosh-MIDI interface. The newest version of the product was scheduled for shipping in late February, at a price of \$795. (More information on these Aphex products can be found in the March "Cutting Edge" column on pg. 70.)

And speaking of MIDI interfaces, **Opcode Systems** combined its Studio Plus Two Macintosh interface and its SMPTE-to-MIDI Time Code converter into a single rack-mount box called the Studio 3. The new box, which sells for \$459, has two independent MIDI ins, six assignable MIDI outs, and jacks for footswitches, which can be assigned using the new Vision software (more about this later) to various control functions, including punching and tempo tapping.

Samplers and sample players

There were no revolutions in samplers at this NAMM, but there were a few important upgrades to existing lines. **E-mu** was showing several additions to its Emax. Hyperflex, from **Data Technologies**, is a 20Mbyte disk drive that uses removable data cartridges, each of which can hold 35 Emax sound banks. The drive can load a bank into the sampler in less than seven seconds. A rack-mountable 45Mbyte drive with removable cartridges, the RM45, is also available. Also new is a SCSI port for the instrument, which increases the speed of exchanging samples with a computer dramatically and allows up to eight external drives to be on line simultaneously.

Casio showed an "advanced" version of the FZ-10M, the FZ-20M (rack-mount only), with a SCSI port that allows direct access to an Apple hard disk. New disk-based software for the device allows automatic loop and fade optimization when editing samples.

Korg's S1 "Production Workstation" (the first company to drop the "W" word from their product line will win an award from me) combines 1Mbyte of ROM for drum sounds with 512K of RAM (expandable to 2Mbytes) for user samples. The sampler is stereo, 12-voice polyphonic, and allows resampling. The S1 also contains a MIDI sequencer (32 channels, 192 ppq resolution, 120,000-note storage), a SMPTE generator, and a disk drive for file storage and software upgrades. Reportedly, the unit will be available at the end of the summer, for around \$2,500. Options will include extra audio outputs, a SCSI port, CRT and ASCII keyboard interfaces, and AES/EBU digital I/O.

Fans of the old Prophet series of samplers will be interested in knowing that **Yamaha**, which purchased Sequential Circuits not long ago, was discreetly handing out literature offering SCI Prophet 3000s for the fire-sale price of \$1,999, including a 1-year warranty.

The hit of the show, arguably, was not a true sampler at all, but a "playback-only" unit, the Proteus from **E-mu**. Proteus uses 4Mbytes (expandable up to 8Mbytes) of ROM to store some of the more-popular

16-bit sounds developed on the Emulator III. The unit provides extensive editing functions, as well as the ability to map up to 40 of a sound's parameters to incoming MIDI commands or internal LFOs and envelopes. The device is multitimbral, with 32-voice polyphony assignable to six audio outputs. All this for \$995. Delivery is expected for late spring. E-mu has been working closely with Opcode Systems, and the latter plans to have editing software for the Proteus that will run on both Macintosh and Atari ST computers by the time the unit is available.

As for other play-only samplers: **Kurzweil**, whose 1000 series expanders were a big hit at last year's show, has not been standing idly by. The company introduced the 1000 AX, an orchestral-oriented sample-based expander with the improved front panel and software introduced in the PX Plus late last year. Even more significantly, **Opcode** announced a Macintosh editing program for the series, which should go a long way toward realizing the potential of the instrument.

Computer sampling and recording

With the advent of the Macintosh II and Atari Mega, and the falling prices of hard-disk storage, the computer itself is taking over more of the functions of a sampler, and is moving into the area of hard-disk recording so far dominated by such companies as Fairlight and New England Digital. As always, the trend is more for less.

Digidesign's Sound Tools is a system for stereo sound editing on the Mac II or SE. It uses the company's Sound Accelerator D/A converter card for playing back sounds directly from the Mac, their new AD IN A/D converter for recording (obviating the need for a separate hardware sampler), and their Sound Designer II software. The software features assembly list editing, and events can be triggered from MIDI Time Code. File length is limited only by the amount of hard-disk storage available.

Editing functions include file merging, real-time, 7-band parametric equalization, non-pitch-shifting time compression, and various crossfade algorithms. All editing is non-destructive. In addition, the program supports file transfers among many different samplers. On an SE, the sampling rate is 32kHz, while on a Mac II or the new SE/30, the sampling rate is a full 44.1kHz. The system was scheduled for March delivery, at a price of \$3,285, not including the computer. The various components are available separately, and a combined digital input/output card, called DATIO (pronounced "datty-o," of course), is scheduled for released later in the year.

Not to be outdone, **Blank Software**



Half-rack. All Symetrix.

The SX200 Series



SX201
Parametric Equalizer/Preamplifier



SX202
Dual Microphone Preamplifier



SX203
Telephone interface



SX204
Four Channel Headphone Amplifier

The Symetrix reputation for *reliability, versatility, and ease of operation* continues in the SX200 Series. Backed by *fourteen years* of signal processing experience, Symetrix offers this solid approach to the half-rack format. Watch in '89 for the introduction of new SX200 Series products, which include the SX205 PRECISION AUDIO METER and the SX206 MULTI-DYNAMICS PROCESSOR.

Symetrix

Signal processing at its best

4211 24th Ave. W., Seattle, WA 98199, USA
TEL. (206) 232-2555
FAX. (206) 233-3504

In Canada call S.F. Marketing
(514) 733-5544

Circle (24) on Rapid Facts Card

For more information on the products in this article, use the Rapid Facts Cards in the back of this issue and the following Rapid Facts numbers:

Alesis QuadraVerb	(100)
Aphex Feel Factory	(101)
Aphex Studio Clock	(102)
Apple MIDI Manager	(103)
ART Multiverb EXT	(104)
ART Multiverb II	(105)
ART SGE	(106)
Blank Software	
Alchemy 2.0	(107)
Blank Software Alchemy	
Apprentice	(108)
Casio FZ-20M	(109)
Data Technologies	
Hyperflex	(110)
Digidesign Sound Tools	(111)
DigiTech DSP 128 Plus	(112)
DigiTech MSP 4	(113)
E-mu Proteus	(114)
E-mu RM45	(115)
E-mu SCSI port for	
Emax	(116)
Fostex FAME automation	(117)
Fostex MIDI Remote	(118)
Korg S1	(119)
Kurzweil 1000 AX	(120)
Opcode Systems	
Studio 3	(121)
Opcode Systems Vision	(122)
Peavey AEQ 2800	(123)
Peavey QFX 4X4	(124)
Peavey Sync Controller	(125)
Rane MPE 14	(126)
Rane MPE 28	(127)
Rane MPE 47	(128)
Resonate Portrait	(129)
Sansui WS-X1	(130)
Sequential Circuits 3000	(131)
Steinberg Cubit editor	(132)
Steinberg M.ROS	(133)
Tascam CE/CR701	(134)
Tascam MTM-1000	
MIDizer	(135)
Zero One Research	
Editor	(136)

showed version 2.0 of its Alchemy software for the Macintosh. Besides time compression without pitch shifting, it can do the reverse: change the pitch of a sample without changing its length. Another new feature is the ability to detect pitch differences and automatically correct them when samples are being spliced together. The program supports Digidesign's Sound Accelerator card, as well as more than a dozen different samplers, whether they conform to the MIDI Sample Dump Standard or not. The price is \$695, and it is scheduled to be out in late spring. Mean-

while, Blank has dropped the price on the original version of Alchemy, which will now be called "Alchemy Apprentice" and sell for \$345.

Composition software

The best thing about the plethora of composition software on display in this NAMM's "MIDI ghetto" was that there were fewer "me too" sequencers, and quite a few ambitious and adventurous approaches to the art of making music.

The two most impressive programs were both for the Macintosh. Vision, from **Opcode Systems**, combines the live-performance orientation of the company's previous sequencers with comprehensive graphics and list editing of MIDI events. Hosts of advanced functions are included, including note mapping according to key or mode, sequence chaining, loop recording, and system-exclusive recording and playback. Controllers can be displayed as graphic "faders" and operated directly from the screen—in real time. The program stretches the Mac interface a bit with its use of submenus, but it looks quite intuitive. It should be shipping by the time you read this, and is priced at \$495.

Portrait, from **Resonate**, is another multimode approach to sequencing. It provides a "multiple-staff" environment, in which selected tracks and types of data can be shown simultaneously—using different formats for items such as velocity, controllers, notes, and text events. One particularly attractive feature is a "Touch Tool," which lets you perform a user-definable function (e.g., shorten duration by 30%, transpose up an octave, etc.) only on notes that you specify. Another is that notes can be entered first and bar lines inserted later. The MIDI input buffer is always active, so if you're noodling along with a track and play something you like, you can easily add it to the sequence.

One of the authors of Portrait, Geoff Brown, is also the author of the notation program Deluxe Music Construction Set, and files can be exchanged between the two programs directly. Portrait should also be out by the time this appears in print, and will cost \$495.

Multitasking

The biggest news in software development is multitasking MIDI: the ability to have several programs running on the computer *and* recording or putting out MIDI data at the same time. The Amiga has been able to do it, more or less, since it first appeared, but the more popular music computers have lacked the ability, until now.

Steinberg, the German software company, showed "M.ROS" (for "MIDI Real-Time Operating System") running on an

ST, with a new multidimensional sequencer called Cubit, an editor for the Korg M1, and their Mimix hardware-based automation system, all operating at the same time. The system handles events, timing and I/O, and is smart enough to not break up long command strings such as system-exclusive data dumps. According to a spokesman for Russ Jones, the company's American marketing group, the operating system has also been written for the Macintosh and the IBM, although there are no definite plans yet, either from Steinberg or any other developer, to write programs that will run under it on those machines.

A couple of companies showed Macintosh desk-accessory patch-editing and librarian programs that can run at the same time as a sequencer. **Zero One Research** had a desk-accessory editor for the Roland MT-32 running along with Mark of the Unicorn's Performer. It was scheduled for release in early February, at a price of \$160, with versions for the D-10, D-110 and D-20 synths to follow at the end of the month, at \$200. **Opcode** announced a series of desk-accessory librarians for the Mac that will run simultaneously with Vision. Prices have yet to be determined.

But the product with the most potential was being shown very quietly at **Apple's** booth. The MIDI Manager is scheduled to be included with Apple's next system software upgrade for the Macintosh, and is already being licensed to a number of third-party developers. It will allow any number of MIDI programs to be run simultaneously under MultiFinder, from a common clock—either internal or external—and in any configuration. It will also merge data from multiple programs intelligently, so that commands don't interfere with each other.

For example, an algorithmic composing program might output data directly into a sequencing program without any external hardware connection, and then the sequencer can play its notes at the same time that an edit-list manager like Digidesign's Q-Sheet is putting out controller data, and at the time that Alchemy is retrieving audio tracks from a hard disk. It will also allow direct linking of music to graphics and will work with Apple's own internal Sound File format.

The important difference between this and other attempts at MIDI multitasking is that MIDI Manager is being developed by Apple. Therefore, there is almost no question that every developer of music and sound software for the Mac will eventually support it. I can predict with utmost confidence that in the next few years, MIDI Manager will play a major part in redefining the role that computers play in music production.

REP

27th Dimension Inc • 3M MAG/. Tape Division • A & M Recording Studios • A/T Scharff Rentals • AGFA-GEVAERT • Airshow, Inc • Alpha Audio • Ambience Recording, Inc • Amigo Studios, Inc • Ampex/Mag. Tape Division • Appletree Sound, Inc • Ardent Recording • Atlantic Studios • Audio Animation, Inc • Audio Facilities, Inc • Audio Intervisual Design • Audio Maintenance Services • Audio Rents Inc • Audiocom • AudioTechniques Inc • Audiovisions • Audisee • Axis Studios, Inc • Bell & Howell/Columbia Pictures • Benchmark Associates • Berklee College of Music • Bermuda Sound td. • Bija Production Corp • Blue Jay Recording Studio • BMG Music • Brigg's Bakery • Brigham Young University Music Dept. • Capitol Records • CBS Records • Cereus Recording Inc • Charisma Sound Productions Inc • Chaton Recordings • Chicago Audio Works Inc • City Spark (Rockhill Group Inc.) • Clinton Recording • Colorado Sound Recording • Columbia Recording (CBS) • Constellation Recording Co • Cook Sound and Picture Works • Crawford Audio Services • Creative Audio Recording Services • Criteria Recording • CRS Recording Studio • dbx, Inc • Design FX Audio • Digital Audio Research • Digital Creations Software Lab • Digital Sound Recording • Discronics, Inc • Dolby Laboratories, Inc • Doppler Studios • Downtown sound • Dreamland Recording • Editel-Chicago • Fairlight Instruments USA • Fanfare Studios • Fanshaw College/Music Industry Arts DI042 • Fanta Professional Services • Fantasy Studios • Francis Daniel • Frankford/Wayne Mastering • Free Reelin' Sound • Full Sail Recorders, Inc • Galaxy Sound Studios • Gentle Synergy • Gordon Enterprises Ltd • Grammie's House Recording Studios • Haas & Wilkerson Insurance • Harrison Systems Inc • Hausmann Service Corporation • Henri van Dam • HIP Pocket Recording Studios, Inc • Hitsville • Howard Schwartz Recording • Hutchinson Area Vo-Tech • I.N.S. Recording, Inc • IAN Communications Group, Inc • Image Recordry • Indian Hill Audio/Video Production • Institute of Audio Research • Institute of Audio/Video Eng. • JBL Professional/Soundcraft/UREI • JDH Sound • John B. Anthony Co. • JRF/Magnetic Sciences Inc • K-Disc Mastering • Kalisa, Inc • Kampo Cultural Center • Le Mobile • Lexicon • Lincoln Park Soundstage • Little World Studio • Manhattan Center Studios • Manhattan Recording Co • Marc Graue Recording • Martin Audio Video • Martin Audio/Video Corp • Martinsound, Inc • Mason Hall Recording Studio • Master Sound Astoria • Masterdisk • Masterfonics • MCA Records - Nashville • Megaphone • Micro-Point Inc • Minot Sound Studios • Mitsubishi Pro Audio Group • Moon Recording Company • Mount Zion Productions • Music Anec, Inc • Nevin Consulting and Recording • New England Digital Corporation • New River Studios • New York Tech. Support • New York University, Music Dept • Nola Recording • Nomad Productions, Inc • North Star Audio/Video Corp • Northeast Community College • Ocean Audio Inc • Omega Audio • Omni Technology • Optimus Inc • Original Music Media Production, Inc • Otari Corp • Pearlman and Associates • Perception Inc • Platinum Island Recording Studios • Polon Research International • Polygram Records Inc • Post Sound Corp • Power Play Studios • Power Station • Pro Sound Film & Video Inc (PSI) • Prosound Labs, Inc • QuickSilver • Record Plant Studios • Reelsound Recording Co • Right Track Recording • Rivendell Recorders, Inc • Rupert Neve • Saber Sound Systems, Inc • Sanctuary Recording Inc • Secret Sound L.A. • Servisound Inc • Sheffield Audio-Video Productions • Sierra Audio Acoustics, Inc • Sigma Sound • Sintonia, S.A. • Skip Saylor Recording • Skyline Studios • Sleepy Hollow Sound, Inc • Solid Sound, Inc • Solid State Logic • SONY Professional Audio Products • Sound on Sound Recording, Inc • Sound Recording Organization, Inc. SRO • Sound Works • Soundscapes • Soundtrack Inc • Soundwave Inc • Sprocket Systems Division/LucasFilms • Star Base Studio • Steve Lawson Productions • Streeterville Studios • Studer Revox • Studio A Recording, Inc • Studio C • Studio Services • Studio Solo/Inter Music Corp • Sunset Productions Inc • Syn-Comp Prod. Inc • Sync Sound Inc • Tachyon Productions • Tamarand Digital Recording Studios • Technetronics • The Cutting Room • The Enterprise Arts • Triad Productions Inc • Trianon Recording • Triplex Records Recorders • Trutone Records • Ultra-Live, Inc • Unique Recording • Universal Recording • University of Colorado at Denver • University of Lowell • University of Southern California • VCA Teletronics • Village Recorder • Voices: Other Media Inc • Wally Cleaver's Recording Services • WaveFrame Corporation • Waves Sound Recorders • White Instruments • Yamaha Corporation of America • Yamaha Studios

Your name should be here.

**Society of Professional
Audio Recording Studios**

For membership information:
4300 10th Avenue North
Suite 2
Lake Worth, Florida 33461
(407) 641-6648

Recording, Inc
• The Recording Workshop
• The Rental Company, Inc
• The Terminal Marketing Co. Inc • The Toy Specialist
• Trebas Institute of Recording

ENGINEER/PRODUCER INDEX

A

Jim Anderson (E/P): 86 Dexter Ave., Watertown, MA 02172; 617-926-6914.

Credits: Beat Surrender (MP-AT), "One Fine Day" (Sound Techniques); Mickey Bones (MP-A), "Mickey Bones" (Sound Techniques); B. Frank (MP-A), "White Lies" (Sound Techniques); Roy Doolittle (PP-CI), Digital Equipment Corp. (Sound Techniques); Ideaworks (PP-CI), General Cinema Corp. (Sound Techniques).

Patrick Arnold (E): Box 12, Charleston, WV 25321; 304-744-5164.

Credits: Larry Groce (MP-A), "A Rustle in the Leaves" (SoundTracs Recording); Raedon Entertainment Group Inc. (MP/PP-F), "Chillers" (SoundTracs Recording); West Virginia Department of Culture and History (MP-AR), "The Music Never Dies" (SoundTracs Recording); Fahlgren & Swink (CP-R), West Virginia Lottery ads (SoundTracs Recording); Willard & Auge (CP-R/TV), "Go For Go-Mart" (SoundTracs Recording).

Key

Name (Title Code): Address; Phone Number.

Credits: Client/Artist (Credit Code-Subcode), Project Title (Facility Used).

Title Codes:

E (Engineer); P (Producer); E/P (Engineer/Producer).

Credit Codes:

CP (Commercial/Advertising Production).
Subcodes: R (Radio); TV (Television).

MP (Music Production).

Subcodes: S (Single); A (Album); AT (Album Track); AR (Album Remix); SR (Single Remix).

PP (Post-Production).

Subcodes: F (Film); MV (Music Video); CI (Corporate/Industrial).

Note: Starting with the January issue, reply cards contain lines to list the facility used for each individual project. Some respondents listed this month filled out older cards, so this information was not available.

B

Michael Bard (E/P): 2315 S.E. Lincoln, Portland, OR 97214; 503-230-8880, 503-233-9421.

Credits: Dan Balmer/CMG Records (MP-A), "Becoming Became"; Purina/Will Vinton (CP-TV), "Indian"; Gerber Advertising/Computerland (CP-TV/R), "Confusion?"; Payless Drugs (CP-TV), "Smile Shop."

Brian Basilico (E/P): Box 1491, Bolingbrook, IL 60439; 312-759-9311.

Credits: Scott Thomas (CP-R), St. Margret's Hospital (Body Electric); Jim Raddatz (MP-A), "Suburban Surreal" (Body Electric); Ed Dunn (MP-S), "Merry in My Christmas" (Body Electric); Matt Sisson (MP-S), "Ain't Comin' Home" (Body Electric); Donna McAfee (MP-S), "If" (Time Zone).

Paul Bauman (E/P): 696 Main St. E., Hamilton, Ontario, Canada L8M 1K5; 416-544-7572.

Credits: The Dik Van Dykes (MP-A), "Waste Mor Vinyl"; The Wetspots (MP-A), "Wake up With the..."; Parts Found In Sea (MP-A), "Every Soul's House"; The Dik Van Dykes (MP-A), "Nobody Likes..."; Henry Rollins (MP-A), "Live."

Bob Blank (E): 1597 Hope St., Stamford, CT 06907; 203-968-2420.

Credits: Columbia Records/Paquito D'Riviera (MP-A), "Paquito and Strings" (Hip Pocket, Blank Productions); RCA Records/Peter Moffit (MP-A), "Second Album" (Blank Productions); Vinylmania/LOLA (MP-S), "Just Like High School" (Blank Productions); McCann/Erickson/Opel (CP-R/TV), "Making It" (Blank Productions); Atlantic Records/Release (MP-S), "Now or Never" (Blank Productions).

Chuck Burge (E/P): Box N, Winder, GA 30680; 404-867-8133.

Credits: WBPS FM (CP-R), underwriter spots, station promos; Pastor Rodney Queen (CP-R), "Jewels of Truth."

Paul Butterfield (E/P): 762 Baffie Ave., Winter Park, FL 32789-3377; 407-647-1177.

Credits: Days Inn (CP-TV), "The Weather Channel Business Planner" (Van Der Kloot, Atlanta); Southern Bell (CP-TV/R), "The Real Yellow Pages" (Rice Produc-

tions, Atlanta); Walt Disney World, HRD (CI), management presentation (Disney/MGM); WUCF-FM (MP-SR/AR/R), "The Folkshow" (Overland Media, Winter Park); Florida Department of State Folklife Programs (MP-AT/AR), "Florida Traditions" (Overland Media).

C

Eugene S. Canevari (P): Eucan Productions, 4466 Montgomery Drive, Santa Rosa, CA 95405; 707-539-2349.

Credits: Carm Canevari (MP-A), "Lullabies and Starry Skies"; Village Hopecore International (CP-TV/R), "Kiraithe"; Santa Rosa Junior College (CP-TV/R), "Isn't it Time You Went to or Back to College?"

Chris Cassone (E/P): RD #2, Pudding St., Carmel, NY 10512; 914-225-1733.

Credits: Duke Ellington (MP-AR), "The Unknown Ellington"; Ace Frehley (MP-A), "Frehley's Comet"; Larry Chance and the Earls (MP-A), "The Earls Live"; Charles Schwartz with Freddie Hubbard (MP-AR); U.S. Orienteering Federation (PP-CI), "Orienteering—All Welcome."

Robert Chickering (E): 7317 Split Rail Lane, Laurel, MD 20707; 301-206-3023.

Credits: WGAY Radio, Air Studio construction; WGAY Radio, post-production studio construction; WRL Radio, news production studio construction; WGAY Radio, dubbing studio.

Alex Cima (E): 1501 E. Chapman Ave., #100, Fullerton, CA 92631; 714-680-4959.

Credits: Sixtieth Parallel (MP-A), "Into Bliss."

Scott Cochran (E): 1615 Rancho Ave., Glendale, CA 91201; 818-507-7982.

Credits: Hoppy Hallman (PP-F) two Disney movies of the week; MGM (PP-F), main title for "Group One Medical"; MGM (PP-F), main title for "Heat of the Night"; Mazda (PP-CI), National Sales Convention 1989; KROQ FM-Los Angeles (CP-R), 1989 IDs.

Michael Collins (E/P): 2105 Maryland Ave., Baltimore, MD 21218; 301-685-8500.

Credits: When Thunder Comes (MP-A), "Animal Pride" CD; W.B. Doner & Co., Baltimore (CP-R), Arby's campaign; WJZ-TV, Baltimore (CP-R) "Evening Magazine"/ABC lineup; Various Artists (MP-A), "Essential Attitudes," Vol. 3.

The Sweetest Mix...

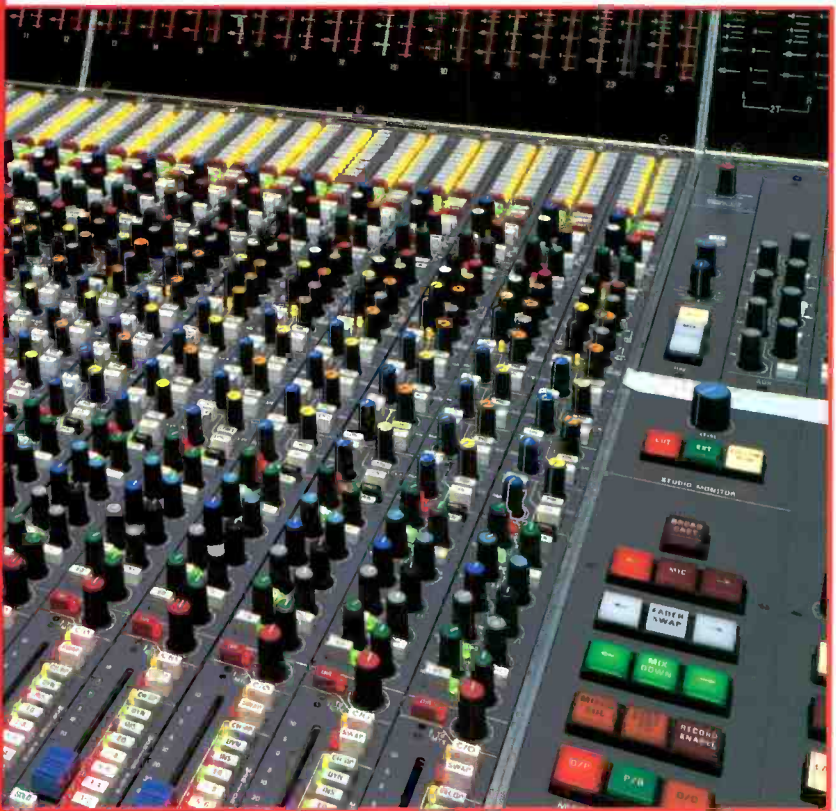

The Neve V Series

- Only console with 48 balanced multitrack busses and 48 track monitoring, *PLUS*
- Famous Neve four-band parametric EQ with $\pm 18\text{dB}$ on all bands
- Powerful Dynamics section with limiter/compressor and gate/expander
- Revolutionary Flying Faders - the fastest automation system available
- Incomparable Grouping and Linking for absolute control



See us at NAB, Booth #2407



A Siemens Company

BERKSHIRE INDUSTRIAL PARK, BETHEL, CONNECTICUT 06801, U.S.A. • TELEPHONE: (203) 744-6230.
 260 WEST 52ND STREET, NEW YORK, NY 10019, U.S.A. • TELEPHONE: (212) 956-6464.
 6353 SUNSET BLVD., HOLLYWOOD, CALIFORNIA 90028, U.S.A. • TELEPHONE: (213) 461-6383.
 1221 16TH AVENUE SOUTH, NASHVILLE, TENNESSEE 37212, U.S.A. • TELEPHONE: (615) 329-9584.
 MELBOURN, ROYSTON, HERTS SG8 6AU, ENGLAND • TELEPHONE: ROYSTON (0763) 60776.
 POSTFACH 326 A-1031, VIENNA, AUSTRIA • TELEPHONE: 43-222-72930.

Full Sail
 The Official Training Center
 for Neve V Series and Flying Faders

Circle (26) on Rapid Facts Card

www.americanradiohistory.com

ENGINEER/PRODUCER INDEX

Jack Connors (E/P): 505 Piccadilly Row, #171, Antioch, TN 37013; 615-360-9950.
Credits: The Murphy Brothers (MP-S), "Peace on Earth"; Jade (MP-A), "EP"; The Burdons (MP-A), "The Burdons."

Warren Crawford (E/P): Box 1192, New Smyrna Beach, FL 32070-1192; 904-427-6626.

Credits: WFTV, Channel 9, Orlando (MP-TV) "They Love Me, They Love Me Not"; WFTV (MP-TV), "Victims of Crime/Victims of Justice?"; WFTV (MP-TV), "Give Me Shelter"; WFTV (MP-TV), "Aging, Disease of Destiny?"; WFTV (MP-TV), "I Grow Old, I Grow Old."

D

David Dachinger (E): 127 W. 78th St., New York, NY 10024-6750; 212-496-0049.
Credits: Roberta Flack (MP-AT), "Oasis"; Keith Sweat (MP-AR), "Make it Last Forever"; Michael Bolton (MP-AT), "The Hunger"; Was (Not Was) (MP-AR), "What Up, Dog?"; Arnold Schwarzenegger (MP-AT/AR), "Full Body Workout."

Joe Dixon (E/P): 694 Holly St., Memphis, TN 38112; 901-327-4293.

Credits: Sherrye Advertising (CP-R), Rice College; Federal Express (PP-CI), "Overnight"; Federal Express (PP-CI), "International Procedures"; WKNO-TV (CP-R), "Action Auction"; Gary Topper (MP-AR), "Earth Tones."

Mitch Dorf (E/P): 120 Interstate North Parkway East, Suite 164, Atlanta, GA 30339; 404-956-7956.

Credits: Sinclair Productions (MP-A), "Sinclair"; J. Russie & Associates (CP-R), "Toyota Spotlight"; Institute of Nuclear Power Operations (PP-CI), "Simulator Instructor Training"; The Bams (MP-A), "In Your Eyes"; MCA Records (MP-A), "The Producers."

Tom Dubé (E/P): Box 444, Back Bay Annex, Boston, MA 02117; 617-266-1460.

Credits: Too Happy/Playtime (MP-A), "Too Happy"; Treat Her Right/RCA (MP-A), "Tied to the Tracks"; East of Eden (MP-A); The Walkers (MP-A), "One Step Two Step"; Dogzilla (MP-A), "Lunch With Ed."

E

Gary Epstein (E): 981 Black Canyon, Simi Valley, CA 93063; 805-527-8613.

Credits: Patrick O'Hearn (MP-A), "River's Gonna Rise"; Wind River Prod./Patrick O'Hearn (PP-F), "The Destroyer" soundtrack; Patrick O'Hearn (MP-AT), "Between Two Worlds."

Jim Ervin (P): 29836 W. Rainbow Crest Drive, Agoura Hills, CA 91301; 818-715-2268.

Credits: Eva Boyd Harris (MP-A), "Little Eva—Back on Track"; Glen Duncan (MP-S), "The 12 Days of Freddy."

F

Ray Fister (E/P): 8339 S. 76th St., Milwaukee, WI 53132; 414-425-5482, 414-291-9666.

Credits: Miller Lite Beer (CP-R), "Sports Rap" with Bob Uecker"; Milwaukee Admirals Hockey (CP-R), "It's a Hockey Night in Milwaukee"; Hot Beds Music Factory (CP-R/TV), "Hot Beds Music"; Great American Homes (CP-TV), "Great American Homes"; Robb & Stucky Furniture (CP-R/TV); "Robb & Stucky Christmas."

Del S. Fox (E/P): Forth Wall Productions, Box 3098, Cocoa, FL 32924; 407-636-4661.

Credits: Stage America/American Airlines (CP-TV), "Celebration"; WRES-TV (CP-TV), "Places and Faces"; Brevard Community College (CP-R), "BCC Communique"; Fiddlesticks (CP-TV), holiday promotion; Migual Kertsman (MP-AT), "Migual Live."

Jeffrey M. Friend (E/P): 1526 Arrowhead Trail, Xenia, OH 45385; 513-372-9359.

Credits: National Cash Register (PP-CI), "The Key to Success"; Celotex (PP-CI), "You, the Very Best"; WCPO Channel 9 (CP-TV), "Who Dey" (Bengals rap); Ludlow Cellular (CP-R), "No One Does What We Do Better!"; American Diamond Brokers (CP-R), "More, More, More."

G

Paul Goldberg (E): 1806 Warfield Drive, Nashville, TN 37215; 615-298-4436.

Credits: Don Bluth/Steven Spielberg (PP-F/AT), "Rock-A-Doodle" animated movie; Alabama (MP-A), second through 12th albums; Tom T. Hall (MP-A), "Country Songs for Kids"; Glen Campbell (MP-A),

"Letter to Home," "No More Night"; Lou Rawls (MP-A), "Wind Beneath My Wings."

Morris D. Golodner (E/P): 8946 Ellis Ave., Los Angeles, CA; 213-836-4028.

Credits: Legend (MP-A), "Legend Live"; Dr. Frank E. Stranges (PP-F), "UFOs"; Morris Golodner (MP-MV/A), "Young Mr. Q"; Adeem & Raashmeen (MP-A), "Flowers From India"; Institute of Human Services (PP-F), "Homeless in USA."

Dave Gordon (E/P): 3941 W. Wrightwood Ave., Chicago, IL 60647; 312-252-5552.

Credits: Dave Gordon (MP-A), "Green Things"; Steve Laxton (MP-A), "Steve Laxton"; Medical Media Systems (PP-CI), "The Guide to Heart Sounds"; Doctor Music (PP-CI), United Airlines, Safety Kleen Industries, Lilly Pharmaceuticals; Lovett Productions (PP-CI), Allied Aftermarket Division project.

Rob Gough (E): The Recording Workshop, 455 Massieville Road, Chillicothe, OH 45601; 614-663-2544.

Credits: Rose Alley (MP-S), "Virgin Snow"; State of Mind (MP-S), "Don't Quit Your Job."

R. Darroll Gustamachio (E/P): 23 Sherwood Drive, Westport, CT 06880; 203-454-2004, 212-877-4829.

Credits: Whitney Houston/Arista Records (MP-AT), "Whitney"; Johnny Kemp/CBS Records (MP-A/AR), "Secrets of Flying"/"Just Got Paid"; George Benson/Warner Bros. Records (MP-AT), "While the City Sleeps"; Billy Ocean/Jive/Arista (MP-A), "Love Zone"; Dionne Warwick/Arista (MP-AT), "Reservations for Two."

H

C.D. Hart (E/P): 223 15th St., Brooklyn, NY; 718-965-1143.

Credits: Sin City (MP-A), "Sin City Live"; NKB's (MP-AT), "NKB's"; The Edge (PP-F), "The Edge"; MK's Niteclub, New York, live sound; Tunnel Niteclub, New York, live sound.

Curtis Heckwolf (E/P): 102 Otter Creek Apts., Rutland, VT 05701; 802-773-8622.

Credits: Edgewood Entertainment (CP-TV), "New England Tonight" theme; OZA Productions (PP-F), "Fit to Kill" theme; LAM Productions (CP-TV), "Aliens—Peace"; Karilar Productions (PP-CI),

DON'T GET STUCK WITH TIME ON YOUR HANDS.



SMART SYNC™ IT.

You don't have time to try to salvage a major project once you discover the sound transferred to your 59.94 time coded master was locked to 60 Hz line frequency. Or, when your client hands you the *revised* picture, sped up 10%, expecting you to lock it with the original multi-track. With our exclusive, patent pending, Smart Sync feature (SoundMaster Auto Restored Timebase SYNChronization™), set your varispeed by entering four digits, establish your offset *anywhere* in the show, roll and record. Your Soundmaster™ Integrated Editing System will treat that tape *exactly* as any other. How is the miracle performed?

IT'S THE SOFTWARE.

That's right. As the time code is read from tape, everything is handled for you automatically by some sophisticated software. *Everything*. Your machine is synchronized while running off its standard speed. And, here's the clincher. Even though the time code on your tapes is divergent, with the real world difference changing every frame, Smart Sync maintains a constant system offset. So you can start and stop anywhere in the show, and pick-up locked with confidence. How does Smart Sync do it?

IT'S THE HARDWARE.

Our Syncro™ machine controller can synchronize, not just chase, from a fraction of, to several times play speed. With Smart Sync, *you* control literally thousands of varispeed

settings. Syncro is easily the most sophisticated and versatile synchronizer around, yet so simple to use. There are absolutely no manual adjustments. All parameters are loaded by software. Why can we do the impossible with such simple hardware and sophisticated software?

IT'S THE SYSTEM.

Only the Soundmaster Integrated Editing System offers you auto restored timebase synchronization. The PC based controller, the revolutionary Syncro, and our highly sophisticated software combine to perform miracles that are impossible with any other system available today.

No, Soundmaster won't leave you stuck with downtime on your hands. It will be *profitable* time instead. Why not take a moment, right now, and give us a call. We'd love to show you the true power of the Soundmaster system.

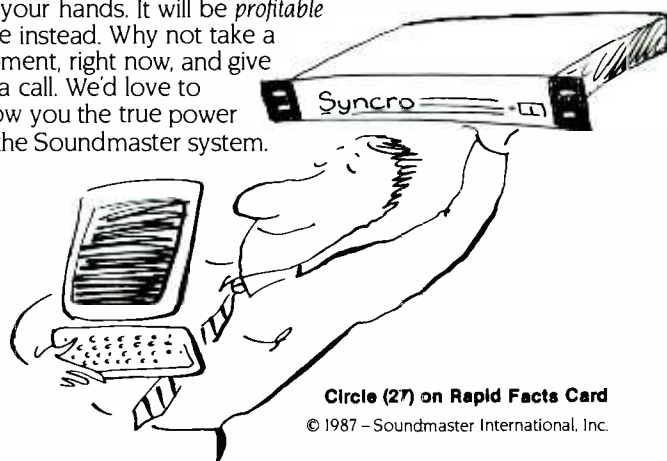

Circle (27) on Rapid Facts Card

© 1987 - Soundmaster International, Inc.

soundmaster usa inc

Soundmaster International Inc., 500 Alden Rd. #11, Markham, Ont. Canada L3R6H5
Soundmaster USA Inc., 1124 Stoneshead Court, Westlake Village, CA 91361
Soundmaster USA Inc., 120 West 88th St., New York, N.Y. 10024
Soundmaster Europe Ltd., 3 A Warwick Rd., Beaconsfield, England HP9 2PE

Tel: 416-479-8101
Tel: 805-494-4545
Tel: 212-787-5832
Tel: 44-494-570154

Fax: 416-479-8105
Fax: 805-494-4936
Fax: 212-787-8888
Fax: 44-494-677042

ENGINEER/PRODUCER INDEX

"Homes by Owners"; LAM Productions (CP-TV), "Dream Landscapes of Midwest."

Gary S. Hickinbotham (E/P): 213 A Pat Garrison, San Marcos, TX 78666; 512-396-4352, 512-396-1144.

Credits: Noise International/Watchtower (MP-S), "Dangerous Toy" (Fire Station Studios, San Marcos); Antone's Records/Doug Sahm (MP-A), Doug Sahm LP (Fire Station Studios), Superbeet/Augie Meyers (MP-A), "Sausalito Sunshine" (Fire Station Studios); Silverstar/John Legg (MP-A), "Pillar of Stone" (Fire Station Studios); Silverstar/The Nelsons (MP-AR), "The Nelsons" (Fire Station Studios).

Dewell K. Holmes (E/P): 2351 Carnes Ave., Memphis, TN 38114; 901-324-1955.

Credits: Big Star (CP-TV), "Free Groceries"; Tiger Bookstore (CP-R), "Bahamas Trip Giveaway"; 56Q/Montesi Supermarket (CP-R), "Thanksgiving Promotion"; 56Q/Dos Amigos Restaurant (CP-R), "Monday Night Football"; 56Q/Various Sponsors (CP-R), "Working Women Week."

Barry Hufker (E/P): 3026 Aberdeen, Florissant, MO 63033; 314-921-9075.

Credits: Kathleen Thro/One Accord (MP-A), "Pleasure Tunes My Tongue"; St. Louis Brass Quintet (MP-A), "Baroque Brass"; Les Arts Florissants (MP-R); Amabile Piano Quartet (MP-AT), "Amabile Piano Quartet"; National Public Radio (MP-R), "Czech Music Festival."

L

Patrick Lacey (E/P): 511-B Victor St., Saddlebrook, NJ 07662; 201-368-2909.

Credits: Two Colors (MP-A), "Two Colors"; Ines Sikiric (MP-AT), "Ines"; Marathon (MP-A), "Marathon"; Stacy Cullen (MP-S), "Stacy"; Mike Sesta (MP-A), "One on One."

M

Rich Macar (E/P): 455 E. 86th St., #5A, New York, NY 10028; 212-439-9615.

Credits: Dave Kolin (PP-R), "Dr. Dave's Comedy Service/Laugh Attack"; Michael Bacon Music (MP-TV) "Man Hunt"; Elsinore Productions (MP-F), "In a Pig's Eye"; Rich Macar Music (CP-TV), "Mutual of America"; Michael Bacon Music (MP-TV), "Trackdown"/ABC-TV.

Randy Mahon Jr. (E): 1697 Broadway, 14th Floor, New York, NY 10019; 212-582-5473.

Credits: Full Force Productions/Cheryl "Pepsi" Riley (MP-A); Full Force Productions/La Toya Jackson (MP-A); Full Force Productions/Cheryl "Pepsi" Riley (MP-SR).

Russ Maier (E/P): 6065 Scenic Ave., Hollywood, CA 90068; 213-464-0007.

Credits: Lorimar Telepictures (CP-TV), "Family Medical Center"; Council on Foundations (PP-CI), "AIDS in the Workplace"; MCA/Glenn Frey (MP-TV), "Soul Searchin'" ("True Love"); The Zikes (MP-S), "Newsday Blues."

Robert P. Majors (E/P): Box 95187, Seattle, WA 98145; 206-367-7770.

Credits: 7th Wave Productions (PP-MV), "Another Footpath"; Manson Kennedy (PP-F), "24 Sur (Round the Clock)"; Prentice/Hall (PP-CI), "Sound Advice."

Scott Martinez (E/P): 8935 SW. 21st Terr., Miami, FL 33165; 305-226-7272.

Credits: Ira Sullivan Jr., (MP-S), "Under the Gun"; James Larsen (MP-S), "Keep on Movin'"; Tony Fuentes (MP-S); "I Wanna Know"; Tony Fuentes (MP-S), "Undecided"; Tony Fuentes (MP-S), "Back Home."

David Mazmanian (P): Armedia Communications, Box 257, Postal Station C, Toronto, Ontario M6J 3P4 Canada; 416-530-4676.

Credits: RCA Records (CP-TV/R), various; Ontario Greenhouse Marketing Board (CP-R/TV), "From Our House to Your House" (English and French versions); First Choice/Superchannel (CP-TV), "Free Weekend at the Movies"; Pindoff Record Sales (CP-TV), "The Nice Price"; Ontario Ministry of Energy (CP-CI/TV), "The Conserving Kingdom" (English and French versions).

Michael McKern (E/P): 1651 Hoyt Ave E., St. Paul, MN 55106; 612-771-1006.

Credits: Aspen Records/Peter Lang (MP-A), "American Stock"; Replacements/Sire/Warner Bros. (MP), demo; Johnny Ray (MP) "Blueprints"; Simitar Video (PP-MV), "Rockin' and Four-Wheelin'"; 3M (CP-R), Ag. products.

Bronlow K. Miller (E/P): Grapevine Recording Studios, 2525 Imlay City Road, Lapeer, MI 48446; 313-664-1995.

Credits: J. Grondin (MP-S), "Ballad of the American Taxpayer"; Jon Andrews (MP-

AT), "The Harvest Song"; Laurie Good (MP-A), "Sweeter (As the Days Go By)."

Roger Moutenot (E/P): 810 Garden St., Hoboken, NJ 07030; 201-659-7112.

Credits: Bill Frisell (MP-A), soon to be released; Ambitious Lovers (MP-A), "Greed"; Ryuichi Sakamoto (MP-A), "Live at the Beacon Theatre"; Caetano Veloso (MP-A).

Robert B. Mugrdechian (E/P): 300 Glen Ave., Palisades Park, NJ 07650; 201-461-0750, 201-461-0812.

Credits: WHYZ/Z-100 Radio (MP-SR), Duran Duran, "I Don't Want Your Love"; WHYZ/Z-100 Radio (MP-SR), The Escape Club, "Wild, Wild West."

Ken Mullenix (E): Box 5027, Ft. Lauderdale, FL 33310; 305-748-0885.

Credits: Studio Centre Productions/A&W (CP-TV/F), "Star Bear"; The Home Show/ABC (CP-TV), "Back to Basics"; State and Local Government Labor-Management Committee (CP-TV), "Together They Serve"; AFT Productions (PP-F), "The Disturbance"; Donna Allen (CP-MV), "Serious."

Richard D. Myers (E/P): 512 N.W. 97th Ave., Plantation, FL 33324; 305-370-6195.

Credits: WKPX-FM (CP-R), "Modern Music" liner package; Some People's Children (MP-AR), "Dot to Dot"; Atomic Pictures Inc. (PP-F), "Cool World"; X-Band (MP-S), "Dangerous Radius."

N

James Nelson (E/P): 2155 Bennett Creek Road, Cottage Grove, OR 97424; 503-942-5877.

Credits: Jimmy Blue & Data (MP-F), "Welcome to the Future"; Goldstar Productions (CP-TV), "Game of the Week"; Data Studios (PP-F), "Data Turns Your World Around."

P

Ken Pine (P): 4 Horizon Road, Suite G21, Fort Lee, NJ 07024; 201-224-0043.

Credits: Gym Corp. (CP/MP-A/MV), Gymboree—"Zoo Safari" (Ted Spencer's, New York); Uniworld Group Inc. (CP-R), Burger King "Nitefeeders" (Atlantic Studios); ABC Sports/D. Stern (MP-MV), Winter Olympics '88, "My Small Town"

(Power Station); NBA Productions (CP-TV) "Deefense" :30 (Ted Spencer's); ESPN/David Stern (CP-TV), Citicorp Gold Hall of Fame Classic (Metropolis Sound).

Sam Prager (E/P): 4500 Tapscott Road, Baltimore, MD 21208; 301-484-7597.

Credits: Vigil/Chrysalis Records (MP-A/S), "The Escape Artist" (Sheffield A/V); Vigil/Chrysalis Records (MP-AT), "Nightmare on Elm St. Part 4" (Sheffield A/V); Interface Production Support (MP-A/AR/SR), "The Lunatic Fringe" (various facilities); Major Records (MP-SR), "Deff Chronics" (Black Pond, High Heel); Michael Sciuto (MP-AR/SR) "Certain Damage" (High Heel, Sheffield).

Bill Prentice (E/P): 7479 S. Teller St., Littleton, CO 80123; 303-972-4255.

Credits: The 40th Day (MP-A), "Something Hidden Here" (Audio Works Recording); Andy Salas (MP-A), "Andy Salas Group (Audio Works Recording); Gary McKnight (MP-A), "The Dial Tones" (Audio Works Recording); Caught In The

Act (MP-A), "...If You Can" (Audio Works Recording); Ron Williams (MP-A), "Silent Partners" (Audio Works Recording).

R

Mark Richman (E): 11016 S.W. 15th Manor, Davie, FL; 305-476-3530.

Credits: CBS/Epic/Will To Power (MP-AT), "Baby I Love Your Way"; Vision/Betty Wright (MP-A), "Mother Wit"; CBS/Epic/Miami Sound Machine (MP-A), "Primitive Love"; CBS/Epic/Nicole (MP-AT), "Ruthless People" soundtrack; Black & White Records/Secret Society (MP-AT), "You Said That You Loved Me."

Jim Robinette (E): 531 Rocky Step Road, Winfield, WV 25213; 304-744-5164.

Credits: Larry Groce (MP-A), "A Rustle in the Leaves" (SoundTracs Recording); West Virginia Department of Culture and History (MP-AR) "The Music Never Dies"; (SoundTracs Recording); West Virginia Public Broadcasting (CP-R), "Mountain

Stage" (West Virginia Public Broadcasting); Fahlgren & Swink (CP-R), "West Virginia Lottery Ads" (SoundTracs Recording); Willard & Auge (CP-R/TV), "Go For Go-Mart" (SoundTracs Recording).

Tom Root (E/P): 1555 S. Beverly Drive, Los Angeles, CA 90035; 213-277-6235.

Credits: A&M/Chuck Gentry—The Fit (MP-A), "Just Havin' Fun"; Capitol/Durrell Coleman (MP-A), "Durrell Coleman"; Solar/Dynasty (MP-SR), "Way Out."

S

Bill Scanlan (E/P): 13411 Oriental St., Rockville, MD 20853; 301-946-8533.

Credits: DC-101/Radio (MP-A), "Best of Greaseman" cassette; DC-101 (CP-R), "Best of Greaseman" show; DC-101 (CP-TV), TV spots.

Alan Silverman (E/P): 330 E. 58th St., New York, NY 10022; 212-223-3295.

Credits: Bill Evans & John McLaughlin

10,000 PERFECT CONNECTIONS — MINIMUM!

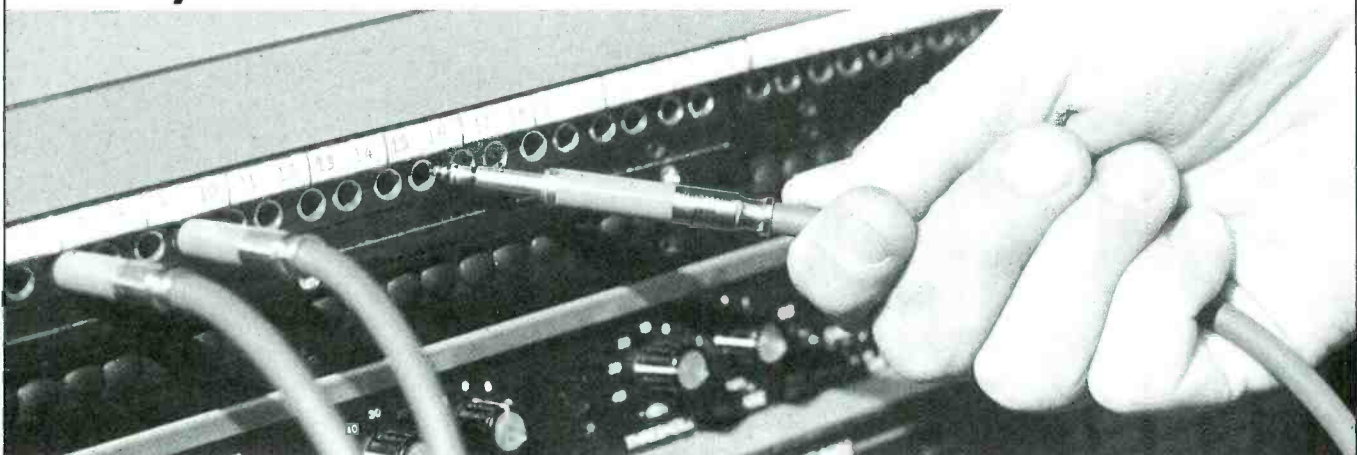

NEUTRIK PATCH BAY PLUGS — TESTED 10,000 TIMES

That's once a day for over 27 years before your Neutrik patch bay plugs would begin to show signs of wear.

The reason? Neutrik plugs have a new *Optalloy™* plating giving you more than 10 times the wear potential of unplated brass plugs. Of all the things you've got to worry about during a session, your patch bay plug doesn't have to be among them.

There's more. Neutrik's exclusive solder-or-crimp screwless connection and superior strain relief system are easy to assemble—every part fits with Swiss precision. The screw-on sleeves are even available in a wide range of colors for instant visual identification. It all adds up to the most functional and reliable patch bay plugs you can use.

Make the perfect connection...
Choose Neutrik.



Neutrik USA, Inc. • 1600 Malone Street • Millville, NJ 08322
TEL: 609-327-3113 • FAX 609-825-4804

CONNECTORS • PLUGS • JACKS • ADAPTERS • GOOSENECKS • TRANSFORMERS

Circle (28) on Rapid Facts Card

ENGINEER/PRODUCER INDEX

(MP-AT), "The Alternative Man"; Miki Howard (MP-AT), "Love Confessions"; Judy Collins (MP-A), "Trust Your Heart"/"Sanity & Grace"; David Mamet (MP-F), "House of Games"/"Things Change"; McCann-Erikson (CPTV), Coca-Cola Classic and Nabisco; Foote Cone Belding (CP-TV), Coors Light.

Jim Szyplik (E): Box 5, Glen Ellyn, IL 60138-0005; 312-495-3790.

Credits: College of DuPage Jazz Ensemble (PP-CI), "Jazz Era"; Buffalo Theatre Ensemble (PP-CI), "Praying Mantis"; Midwest Chinese Alumni Services (PP-CI) (PP-CI), concert; Buffalo Theatre Ensemble (PP-CI), Beckett plays; College of DuPage (PP-CI), "Man of La Mancha."

T

Harley Toberman (E): 2325 Girard Ave. S., Minneapolis, MN 55405; 612-377-0690.

Credits: 3M Leisure Products (PP-F), "Hunting for Turkey"; Maytag (PP-CI),

"Gone With the Wash"; Norwest Corp. (PP-CI), "Norwest Center"; Northwest Airlines (PP-CI), "The Spirit of Northwest"; Honeywell (PP-CI), "Reach for the Stars."

Gary Tole (E/P): #3115, 13827 100th Ave., Surrey, British Columbia, Canada V3T 5L2; 604-589-1789, 604-525-3423.

Credits: Word Records/Crosssection (MP-AR), "After the Fire"; Michael Godin Managment/Jeff Sutherland (MP-AT); Sam Feldman Associates/Frenzy (MP-A); Tokyo Television/Bon Jovi (TV), "Studio Hits Deluxe (live MV); Tokyo Television/Brian Adams (TV) "Studio Hits Deluxe" (live MV).

W

Chris W. Warren (E/P): 35-H Crossings Circle, Boynton Beach, FL 33435; 407-734-4657.

Credits: Lady Sabre (MP-A), "Strange Spell"; Lady Sabre (MP-A), "The Calm Before the Storm"; Iron Overload Diseases Assn. (MP-S), "Iron Overload"; American

Lung Association (CP-TV); Bob Rice (MP-A), "Domo Erectus."

Mark Wolfson (E/P): 11115 Magnolia Blvd., North Hollywood, CA 91601; 818-505-0001.

Credits: Island Records (MP-S); Sire/Ice T (MP-A/SR), "Power"; Warner Bros./Orion (MP-A/F), "Colors"; Manhattan Records (MP-AT), "Everlasting"; Warner Bros. (MP-A/F), "Stop Making Sense."

Jonathan Wyner (E/P): 50 Amory St., Cambridge, MA 02139; 617-547-7973, 508-753-1192.

Credits: Rykodisc/Marty Willson Piper (MP-S), Promo LP; Royal Crescent Mob (MP-A), "Omerta"; The Stompers (PP-MV), "Live Your Dream for Real"; Gussie Miller (MP-S), "She Said"; Pro Arte Orchestra (MP-A), "Wilson, Kupferman Concerti."

REP

Editor's note: The Engineer/Producer Index is a monthly department. To be listed, fill out the postage-paid reply card located in the back of this issue.

BE THERE!

All that's new in the international recording industry comes together at APRS 89. The technology, the products and the services. Simply the latest and the best.

From 7th-9th June next, at Olympia 2 in London, APRS 89, the 22nd annual exhibition of professional recording equipment will draw technically qualified visitors from around the world.

BE THERE!

For more information please contact the organisers:

Association of Professional Recording Studios Ltd,
163A High St, Rickmansworth, WD3 1AY, England. Tel: (0923) 772907 Fax: (0923) 773079.

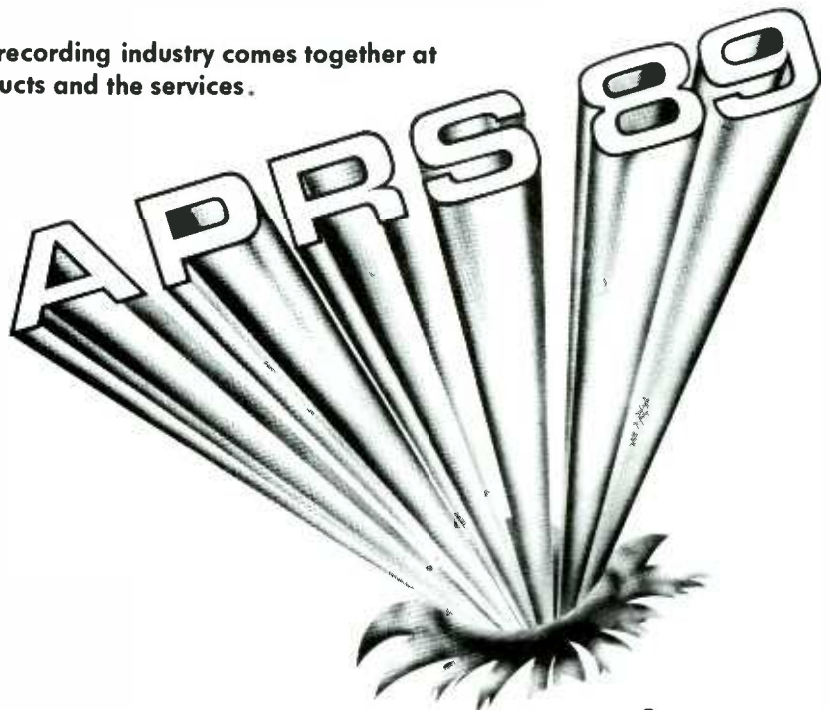

APRS
the professional
recording association

TRACKS

A

AudioWorks Recording: 7479 S. Teller St., Littleton, CO 80123; 303-972-4255; Bill Prentice, owner.

Credits: Artistic Commercial Enterprises (CP-R/TV), "Channel 12" (RE: Bill Prentice; ME: Bill Prentice, Tom Pittman, Rich Ciparro; AE: Rich Ciparro); Ready Personnel, (CP-R/TV), "ACE" (RE: Bill Prentice; ME: Bill Prentice, Rich Ciparro; AE: Tom Pittman); Sir Speddy (CP-R), "Fred Ward" (RE: Bill Prentice; ME: Bill Prentice; AE: Cindy Bolas); Decorate Interiors (CP-R), "Spring Fling" (RE: Bill Prentice; ME: Bill Prentice; AE: Cindy Bolas); Cokesbury Books (CP-R), "Cokesbury" (RE: Bill Prentice, Cindy Bolas; ME: Bill Prentice; AE: Cindy Bolas).

B

Blank Productions: 1597 Hope St., Stamford, CT 06907; 203-968-2420; fax

203-329-7193; Bob Blank, owner.

Credits: BBD&O Advertising (CP-R/TV), Pizza Hut, "Making It Great" (RE: Bob Blank; ME: Bob Blank; AE: Kenny Blank); McCann Erickson Advertising (CP-TV), Opel, "Making It" (RE: Bob Blank; ME: Bob Blank; AE: Kenny Blank, Kristin Stone); Sunday Productions (CP-TV), New York Life campaign (RE: Bob Blank; ME: Bob Blank; AE: Kenny Blank); Associated Production Music (PP-CI), "Coombe Sampler" (RE: Bob Blank; ME: Bob Blank; AE: Kenny Blank); Teledisc USA (PP-CI), "Boston Pops Compilation" (RE: Bob Blank; ME: Bob Blank; AE: Kenny Blank).

Body Electric Studios: Box 1491, Bolingbrook, IL 60439; 312-759-9311; Brian Basilio, owner.

Credits: Video Network (CP-PP), Ed Napelton Dealers (RE: Brian Basilio; ME: Brian Basilio; AE: Bruce Dickert); AT&T (CP-CI), "Metro Digital Transition" (RE: Brian Basilio; ME: Brian Basilio; AE: Tim Collins; AT&T (CP-CI), "We All Win," RE: Brian Basilio; ME: Brian Basilio).

C

Candlewick Productions: 1161 N. Highland Drive, Hollywood, CA 90038; 213-462-7979; Larry K. Smith, president. **Credits:** ESTV (PP-TV), "Great Escape"

Key

Facility Name: Address; phone; contact name/title.

Credits: Client (Credit Code-Subcode), Project Title (Recording Engineers; Mixdown Engineers; Assistant Engineers).

Codes

CP (Commercial/Advertising Production).

Subcodes: R (Radio) TV (Television).

PP (Post-Production).

Subcodes: F (Film) MV (Music Video) CI (Corporate/Industrial).

DON'T LET STEREO PHASE YOU!

AM-3B PHASE MONITORS make it easy!

The totally new AM-3B PHASE MONITOR gives you all of the features you have come to expect from B & B SYSTEMS. Complete monitoring of your stereo audio signal via the AM-3B's unique X/Y CRT display shows you, in realtime, the in-phase/out-of-phase relationship of the actual audio signal. Mono compatibility, stereo phase and correct level are now easily maintained.



With two independent sets of three channel inputs, selectable A/B, and a built-in power amplifier with headphone and speaker outputs, the AM-3B is the ideal tool for all MTS and BTSC applications.

Creative tools for stereo audio.

B & B SYSTEMS, INC.

28111 NORTH AVENUE STANFORD, VALENCIA, CA 91355

IN CALIFORNIA 805-257-4853

OUTSIDE CALIFORNIA TOLLFREE 800-345-1256

Call to arrange a hands-on demonstration!

TRACKS

(RE: Kris Jergenson; ME: Kris Jergenson; AE: Dale Jergenson, Randy Perry); TBJ Files (PP-F), "The Game" (RE: Kris Jergenson; ME: Larry K. Smith, Kris Jergenson; AE: Dale Jergenson, Randy Perry); Chelmar Productions (PP-CI), Coke/Diet Coke industrials (RE: Kris Jergenson; ME: Larry K. Smith; AE: Dale Jergenson; Dennis Lofgren Productions (PP-TV) "Hush Little Baby" special (RE: Kris Jergenson; ME: Larry K. Smith, Randy Perry); Gemini Productions (PP-TV), "Ski Dazzle" series (RE: Larry K. Smith, Dale Jergenson; ME: Larry K. Smith; AE: Randy Perry).

Commercial Sight & Sound: 106 College Ave., LaGrange, GA 30240; 404-884-4400; Pat Patten, owner.

Credits: Milliken & Co. (CP), "Partners of Excellence" Theme '89 (RE: T. Dumas/P. Patten; ME: P. Patten; AE: T. Dumas); Milliken & Co., (PP-CI), "Hospitality National Sales Meeting" (RE: P. Patten; ME: T. Dumas; Mansour's (CP-R), "January Baby Clothes Sale" (RE: P. Patten; ME: P. Patten); Mansour's (CP-TV), "Valentine: Heart to Heart" (RE: P. Patten; ME: P. Patten); Basset/Partain Advertising (CP-R/TV), Ken Thomas "EYT" (RE: P. Patten; ME: T. Dumas/P. Patten).

Creative Professionals Inc.: 1245 N. Water St., Milwaukee, WI 53202; 414-291-9666; James Kagan, manager.

Credits: Lance Robarsun Productions (CP-TV), "Great American Homes" (RE: Ray Fister; ME: Mark Kagan; AE: Dave Michuda); Miller Lite Beer (CP-R), "Sports Rap With Bob Uecker" (RE: Ray Fister); Briggs & Stratton (PP-CI), "Run With the Winners" (RE: Mark Kagan, Jim Kagan); Milwaukee Admirals Hockey (CP-R), "It's a Hockey Night in Milwaukee" (RE: Ray Fister; AE: Dave Michuda); IDF (PP-CI), "International Design Forum" (ME: Ray Fister, Mark Kagan; AE: Victoria Ray).

Crystal Sound Recording Inc.: 220 W. 19th St., Sixth Floor, New York, NY 10011; 212-255-6745; Abigail Reid, studio manager.

Credits: Josh Selman/McCann Erickson Inc. (CP-TV), Coca-Cola (RE: Steve Vavagiakis; ME: Steve Vavagiakis; AE: Abigail Reid); Dan Snyder/RangeWars (MP-A), "Range Wars" (RE: Larry Buksbaum; ME: Larry Buksbaum; AE: Nicole Kelly); Hamid Khan/Khan Int'l Films (PP-F), "The Dance Goddess" (RE: Steve Vavagiakis; ME: Steve Vavagiakis; AE: Abigail Reid); Reggie Segers (MP-AT),

"Homeless Not Helpless" (RE: Larry Buksbaum); Billy Kirsch (MP-A), "Billy Kirsch" (RE: Larry Buksbaum; ME: Steve Vavagiakis).

D

Data Studios: 2155 Bennett Creek Road, Cottage Grove, OR 97424; 503-942-5877; James Roger Nelson.

Credits: Jimmy Blue and DATA (PP-F), "Welcome to the Future" (RE: Jimmy Blue, John Eastman, Valerie E.C.; ME: Jimmy Blue, Valerie E.C.; AE: Mark Coombs, David Allen Lynch); Gold Star Productions (CP-TV), "Game of the Week" (RE: John Eastman, Valerie E.C.; ME: Valerie E.C.); Jimmy Blue (CP-TV), "Calling Rock 'n' Roll" (RE: Jimmy Blue, Valerie E.C.; ME: Valerie E.C.); Leonard Burns Productions (PP-CI), "Airborn 1930" (RE: Valerie E.C., David Allen Lynch, Mark Coombs; ME: David Allen Lynch).

F

Forte Audio: 1129 W. Roland, Flint, MI 48507; 313-238-8228, 313-238-5043; Brian Phillips.

Credits (all sound reinforcement): Phil Keaggy/Randy Stonehill, spring tour (ME: Brian Phillips; AE: Dan Greer); Margaret Becker (ME: Brian Phillips; AE: Dan Greer); Servant (ME: Brian Phillips); Noel Paul Stookey & Body Works (ME: Brian Phillips); Michael Card (ME: Brian Phillips).

G

Scott Gordon Enterprises: Box 791, Paramus, NJ 07653-0791; 201-670-0054; Scott Gordon, CEO.

Credits: Floyd Vivino (CP-R), "The Italian-American Serenade" (RE: Scott Gordon; ME: H.S. Buehlmeier); Colavita Pasta and Olive Oil Co. (CP-R), "The Colavita Music Hour" (RE: Scott Gordon; ME: H.S. Buehlmeier).

H

HG Studio: 21332 7 Mile Road, Franksville, WI 53126; 414-425-3885; Don Hunjadi, owner.

Credits: National Auto Dealers Assn. (CP-R), "Holiday Safe Driving Tips" (RE: Don Hunjadi; ME: Don Hunjadi); Allied Van

Lines (CP-R/CI), "Movin' On" (RE: Don Hunjadi; ME: Don Hunjadi).

K

Kren Studios: 6553 Sunset, Hollywood, CA 90028; 213-461-5781; Russell Bracher, chief engineer.

Credits: Chris Young (PP-F), "The Fly II" (RE: Jeff Vaughn, Russell Bracher; ME: Jeff Vaughn, Russell Bracher); Chris Young (PP-F), "Hellraiser II/Hellbound" (RE: Jeff Vaughn, Russell Bracher; ME: Jeff Vaughn, Russell Bracher; AE: Ron Manus); Virgin Records (PP-MV), Paula Abdul, "The Way That You Love Me" (RE: Russell Bracher; ME: Russell Bracher; AE: Ron Manus); Virgin Records (PP-MV), Paula Abdul, "Straight Up" (RE: Russell Bracher; ME: Russell Bracher; AE: Ron Manus).

L

Le Studio Inc: 715 Boylston St., Boston, MA 02116; 617-267-2825; Samuel Boroda, president.

Credits: Hill Holliday (CP-TV), Labbatt's beer (RE: Sam Boroda; AE: Robert Flynn); Bed and Bath (CP-TV), "Dropping" (RE: Sam Boroda; AE: Robert Flynn); 3M (PP-F), "Ideas in Hand" (RE: Sam Boroda; AE: Robert Flynn); Form in Teak (CP-R), "Winter Sale" (RE: Sam Boroda); Fisons Co. (PP-CI), Annual Sales Meeting (RE: Sam Boroda; AE: Robert Flynn).

Logical Emotion: 19139 Seminole, Redford, MI 48240; 313-537-1281; Jeff Ceja, owner.

Credits: Diamond Tim Productions (PP-MV), "Harlot: Virgin Wings" (RE: Jon Hall, Brian Berg; ME: Brian Berg); David Danielle (PP-MV), "Videotunes Live" (RE: Jeff Ceja; ME: David Danielle, Jeff Ceja).

M

David Mark Audio: 3781 Silsby Road, Cleveland, OH 44118; 216-321-4321; David Mark, president.

Credits: WERE Radio Whiz Quiz Program (CP-R), Come-in Music (RE: David Mark, Jim Mehring; ME: David Mark); Kovach & Co. (CI), "Nested Boxes & Metamorphosis" (RE: David Mark; ME: David Mark); Magic by Adam (CI), "Stage Show Music" (RE: David Mark; ME: David Mark); Gold Mountain Corp. (CI), Stage Show

Play-on (RE: David Mark, Jim Mehrling; ME: Jim Mehrling); Elyria Savings and Trust National Bank (CP-R), various radio commercials (RE: David Mark).

Bob Moulton Audio: Ellsworth Hill Road, Wentworth, NH 03282-0141; 603-764-9324; Robert Moulton, owner.

Credits: Trinity Pulpit (R), syndicated weekly broadcast (RE: R. Moulton; ME: R. Moulton); Wentworth Baptist Church (CP-R), commercial series (RE: R. Moulton); Shalom International (CP-R), Shalom broadcast (RE: R. Moulton; AE: F. Eiklor); New Sound Concerts (CP-R), Amy Grant, Concert on Common (RE: R. Moulton).

O
On Trak Productions/Magic Moonlight Recording Studio: 314 Sumner St., Elyria, OH 44035; 216-322-5560; David W. Holt Sr., owner.

Credits: HSA Inc. (CP-R), "Catering to You" (RE: David W. Holt Sr.; ME: Philip J. Costello Jr.); Baby Doll Band (PP-MV), "Transatlantic Jet Airliner" (RE: Edward R. Minnich, David W. Holt Sr.; ME: Edward R. Minnich; AE: Philip J. Costello Jr., Vivian M. Terry).

S
Sound Innovations: 5520 Lake Otis Parkway, Suite 104, Anchorage, AK 99507; 907-563-8273; Bruce Graham, owner/engineer.

Credits: Mystrom Advertising/Alascom (CP-R/TV), corporate and product advertising (RE: Bruce Graham; ME: Bruce Graham); Husky Advertising/Anchorage Chrysler (CP-R/TV), ongoing product advertising (RE: Bruce Graham; ME: Bruce Graham); NYE Ford (CP-R/TV), "In the Mood" jingle package (RE: Bruce Graham; ME: Bruce Graham; AE: Vinnie Palazzotto); Isenson Associates/Alaska Film Studios/Alaska Department of Education (PP-F), "Home in Alaska," "Alaskan Geography" film series (RE: Bruce Graham, Mike Kruzan, Jeff Owens; ME: Bruce Graham, Mike Kruzan); Arco Alaska (PP/F-CI), info and safety programs (RE: Bruce Graham; ME: Bruce Graham).

REP

Editor's note: This is the first installment of Tracks, a monthly column featuring commercial and post-production projects in facilities around the country. To have your facility listed, fill out the reply card located in the back of this issue. Please note that this department is for facilities; individual producers and engineers should fill out the Engineer/Producer Index reply card, also located in the back of this issue.

BRING
NEW LIFE
TO YOUR WORN HEADS
WITH OUR REFURBISHMENT SERVICES

24 HOUR TURN-AROUND • SUPERIOR QUALITY • COMPETITIVE PRICING



FILM
REEL TO REEL
AUDIO FOR VIDEO
VOICE LOGGER
NEW REPLACEMENT HEADS
AVAILABLE
WE STOCK PARTS FOR ALL
MAJOR RECORDERS

15720 Sloop Street Van Nuys, CA 91406 Phone: 818-994-6602 Fax: 818-994-2153 Tele: 745239

New York Office: 2275 East Meadow New York 11554 Phone: 216-731-9711 Fax: 516-731-5943

SPRAGUE
MAGNETICS INC.

1-800-553-8712 or **1-800-325-4243**

Circle (31) on Rapid Facts Card

Affordable, 1/3 Octave, Real Time Analyzer With Memories & SPL Display Under \$1000.

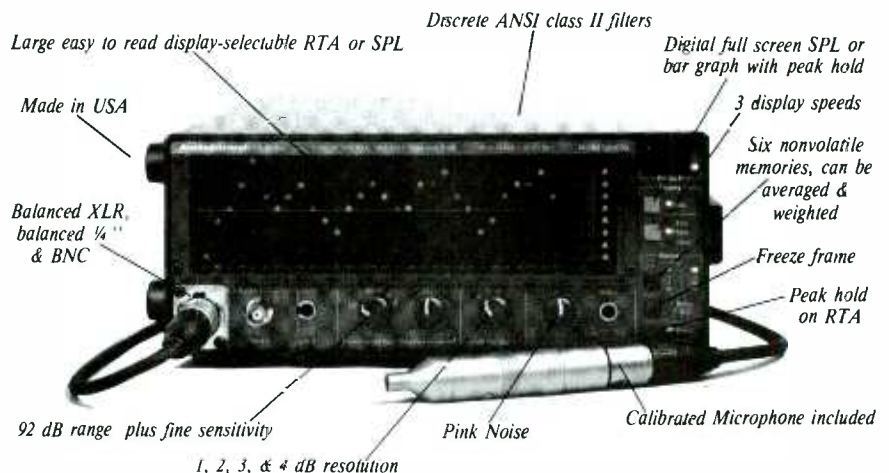

Options: • Printer (parallel) interface • Internal, rechargeable battery pack
• Rack mount • Carry case

**The SA-3050A from Audio Control Industrial
Call today for more information!**

Audio Control Industrial™

22313 70th Ave. West Mountlake Terrace, WA 98043 (206) 775-8461

Circle (32) on Rapid Facts Card

April 1989 *Recording Engineer/Producer* 63

LISTEN

"It would be hard for the producers to imagine maintaining as refined and transparent a sound on the latest Little Feat album, "Let it Roll", without B&K microphones."

George Massenbug
Engineer, Producer
and founder of
GML



BRUEL & KJÆR
PRO AUDIO
THE INTERNATIONAL
STANDARD
IN MICROPHONES

1-800-445-1218, ID-04000#

Circle (33) on Rapid Facts Card

STUDIO UPDATE

Northeast

Blank Productions (Stamford, CT) has added Kristin Stone to the staff as a music production assistant. 1597 Hope St., Stamford, CT 06907; 203-968-2420; fax 203-329-7193.

The Toy Specialists (New York) has marked its fifth year in business as a musical computer and pro audio rental company. The company also plans to expand its technical support services to 24 hours a day, seven days a week. 333 W. 52nd St., New York, NY 10019; 212-333-2206; fax 212-262-4095.

Bair Tracks (New York) has expanded its MIDI room. New equipment includes an Apple Macintosh with Performer software, Opcode's Studio Plus Two and Timecode Machine, and AKG 414, Electro-Voice RE20 and Crown PZM mics. Box 1162, New York, NY 10009; 212-529-1954.

A&J Recording Studios (New York) has added 16mm magnetic film recording and transfers, allowing clients to record directly to 16mm film, and then transfer to and from ¼-inch and ½-inch audiotape or ½-inch or ¾-inch videotape. 225 W. 57th St., New York, NY 10019; 212-247-4860.

39th Street Music Productions (New York) has added a variety of equipment, including a Korg M1-R, Roland MKS-20, Eventide H3000, Akai S950, J.L. Cooper MSD Plus Rev. II and a Publison 21-second memory expansion. 260 W. 39th St., 17th Floor, New York, NY 10018; 212-840-3285.

Omega Recording Studios (Rockville, MD) has acquired a Dyaxis digital recorder/editor with 1-hour capability. 5609 Fishers Lane, Rockville, MD 20852; 301-230-9100.

Midwest

SoundStage 1 Productions (Battle Creek, MI) has added Jonathan Frazer as senior engineer. 13270 6½ Mile Road, Battle Creek, MI 49017; 616-979-1532.

General Television Network (Detroit) has installed two Grass Valley 200 switchers. The facility also reports that its annual revenues have increased by at least 15% for the third straight year. Income reached \$13 million in 1988, including the sale of video and audio equipment.

Southern California

Aire L.A. Studios (Glendale) is the new name of the former Yamaha Research and Development studio. Aire has three working rooms, with an SSL 4064 G Series console in Studio A, a custom Neve 8038 in Studio B and an SSL 4048 E Series in a pre-production room. The owners are Craig Burbidge, Dude McLean and Raymond A. Shields II. 1019 S. Central, Glendale, CA 91204; 818-500-0230; fax 818-241-3348.

Creative Media (Cypress) has marked its 19th year in business with a move to a new facility, featuring two control rooms with 16-track capability. Client areas have been expanded to include a conference room, kitchenette and more seating in the control rooms. The facility provides audio production for businesses and advertising/communication agencies. 11105 Knott Ave., Suite G, Cypress, CA 90630; 714-892-9469; fax 714-897-0824.

Larrabee Sound (Los Angeles) has installed a 72-input SSL G Series console in Studio A. 8811 Santa Monica Blvd., Los Angeles, CA 90069; 213-657-6750.

Realtime Studios (Van Nuys) has opened a Fairlight-based pre-production and scoring room, run by Michael Dosco and Craig Aloisio. 14511 Delano St., Van Nuys, CA 91411; 818-994-9973.

Northern California

Different Fur Recording (San Francisco) has reached a management agreement with Mobius Music, also of San Francisco. Susan Skaggs, Different Fur's vice president and general manager, will now co-manage and handle bookings for Mobius. With Different Fur having an SSL 4056 console with Total Recall and Mobius having a Neve 8068 board, the agreement presents clients with a wider choice of equipment, rates and studio availability. 3470 19th St., San Francisco, CA 94110; 415-864-1967.

Northwest

Spectrum Sound Studios (Portland) has acquired the Hybrid Arts ADAP I digital audio workstation. The facility's three custom consoles have also been modified to make them smoother and quieter. Spectrum engineer Jim Baer has been elected president of the Oregon Media Production

Association. 1634 S.W. Alder St., Portland, OR 97205; 503-248-0248.

Steve Lawson Productions (Seattle) has acquired the New England Digital PostPro system, the first studio in Seattle with the system. It will be installed in its own suite and interfaced with a digital console to ensure that all projects can be produced in the digital domain. New to the staff is Matthew Sutton, who is head of technical support. Sixth and Battery Building, 2322 Sixth Ave., Seattle, WA 98121; 206-443-1500.

Canada

Trax One (Toronto) has celebrated its first anniversary. Owned by Magnetic Fax, Trax One provides audio services for commercial, corporate and long-form broadcast video clients. A mid-priced 24-track room, Trax Two, is being planned and is expected to be up and running by the summer. 550 Queen St. E., Suite 205, Toronto, Ontario M5A 1V2 Canada; 416-367-8477; fax 416-367-8356.

Wellesley Sound Studio (Toronto) has added a Dyaxis digital audio workstation. 106 Ontario St., Toronto, Ontario M5A 2V4 Canada; 416-364-9533.

Manufacturer announcements

Focusrite has delivered modules to the following studios in the United Kingdom: AIR London, Music Works, Olympic, The Church, Fisher Lane Farm and Swanyard.

Neotek has announced the following console installations: Last Chance Recordings, London, 32-input Elite; Coley Sound Productions, Los Angeles, 36-input Elite; Soundworks Recording, Las Vegas, NV, 36-input Elan; Viz-Wiz, Brookline, MA, 28-input Elan; Ron Rose Productions, Southfield, MI, its second Elite with 56 channels and Audio Kinetics Mastermix automation; and Cegep College's recording program, Drummondville, Quebec, 28-channel Elan.

Soundcraft has installed consoles at the following facilities: 30 Second St., Albuquerque, NM, 200B; the Roxy Theatre, Hollywood, 24-channel 200B; Color Zone Productions, Novato, CA, 44-channel 6000 with Twister Automation; and Wizard Lighting and Sound Equipment, Cortland, NY, 40-channel 500.

RE/P



A SIGHT FOR SORE EARS.

If ears could talk, they'd scream for SONEX.

The only patented acoustic foam with a specially sculptured anechoic design can replace traditional studio materials for a fraction of the cost. SONEX absorbs sound, controls reverb, eliminates stray reflections, and kills standing waves. What's left is true sound. Your ears know. Listen to them. Simple to apply and economical to buy, SONEX blends with almost any decor and looks clean, sharp, professional. Call or write us for all the facts and prices.

SONEX is manufactured by Illbruck and distributed exclusively to the pro sound industry by Alpha Audio.

Alpha Audio

2049 West Broad Street
Richmond, Virginia 23220 USA (804) 358-3852
Telex: 469037 (ALPHAUD CI) FAX: (804) 358-9496

Acoustic Products for the Audio Industry

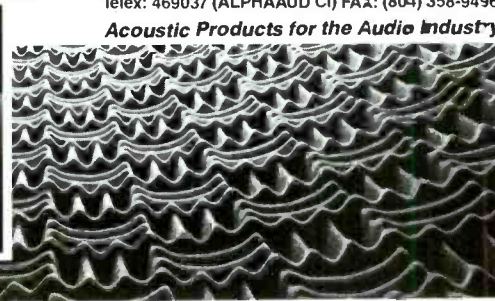

See us at MAB Booth #3455

Circle (34) on Rapid Facts Card

C2

Free Catalog of Professional SOUND recording & duplicating SUPPLIES

POLYLINE™ EMPTY REELS & BOXES

BLANKLOADED CASSETTES

BOXES ALBUMS LABELS

AGFA AMPEX 3M Scotch TDK maxell tapes

now from STOCK in CHICAGO and L.A.

Call Polyline
312 / 298-5300
8:30 am - 5 pm Central Time

Polyline Corp.
1233 Rand Road
Des Plaines, IL 60016

Circle (35) on Rapid Facts Card

THE CUTTING EDGE

By Laurel Cash

Audio Paragon introduces Playstation



Audio Paragon's Playstation is a modular rack and shelving system for a variety of production applications.

The Playstation is a modular rack and shelving system for MIDI pre-production, recording studio, A/V production and post-production, as well as video post, media and broadcast use.

It's for anyone whose production equipment organization is out of control and who is tired of trying to fix it with another rack. The Playstation offers a complete organized production environment and can be scaled down from there. Should you require more slide-out shelving and fewer patchbays, you can have them. The setup depends on your needs and how you want your room to go together. You can start small and expand as your needs do. The Playstation is a distillation of 15 years of commercial and personal studio use, and was codesigned by Emmitt Siniard and Jackie Cartwright.

"With the advent of the personal use studio, space is at a premium," Cartwright says. "The aesthetic design and attractive finish already have gained an acceptance, and best of all, assembly requires only a screwdriver."

"It was obvious to us a system was needed to satisfy a problem of too much gear and too little space," Siniard adds. "By wrapping the user in both the horizontal and vertical planes, the equipment can effectively be used and monitored at the same time."

Several configurations are available, including the Mothership 200, which contains 200 rack-equivalent spaces, enhanced speaker imaging and a considerable complement of rack and shelving capability. Other models include the Rackman, which contains 88 rack-

Laurel Cash is RE/P's executive consultant and a free-lance writer based in Los Angeles.

equivalent spaces in less than 7.5 feet of floor space, and the Spinnet 167, designed for 88-note master keyboards with 54 rack-equivalent spaces.

In late January, Audio Paragon created Playstation Products, which will manufacture and distribute this product line. The Playstation design team is also available to studios, producers and artists who would like to integrate the Playstation into a redesign of their facility. Services include space planning and interior design.

Circle (97) on Rapid Facts Card

DAR changes, upgrades and marketing moves



Digital Audio Research's Soundstation II is now available in 4- and 8-track versions and has a variety of enhanced features.

For the first time at a European AES convention, Digital Audio Research is scheduled to demonstrate a Soundstation II with eight channels and an optical disk backup system. The 8-channel operation is relatively new (the system is now available in 2-, 4- or 8-channel units), and is a true 8-in, 8-out system. It should offer even more control and flexibility over extremely complex audio recording, editing and post-production tasks.

The Optical Disk subsystem provides high-speed backup of audio data and edit decision to 800Mbyte, ISO-standard, write-once optical disks. Each can store one hour of stereo audio. On-line editing, playback and audio archiving are also available from the subsystem.

Some new and enhanced features include a Stereo Time Warp (high-quality time compression and expansion), and Line and Unlink operations for assembling and disassembling multitrack operations. There are Fix and Unfix keys for locking or unlocking segments to time code, and a user-defined organization of segment directory with a Find command.

The system also has drop-in recording; project reels containing multitrack sequences can be instantly saved or recalled. The company says that users can play

back from, and edit in, the directory, as well as scroll the playback display. There are instant segment looping and copying commands, and chase synchronization and time code in the remote mode. Also, sampling rates can be locked to external time code or digital clocks.

As reported in previous issues of RE/P, DAR recently sold a system to Autograph, a London-based theater sound production company, and to the BBC. The company is also setting up regional offices in many major U.S. cities.

Circle (98) on Rapid Facts Card

Symetrix DPR-100 Digital Processing Recorder

Symetrix, well-known for its widely used signal processing equipment, has entered the digital workstation market with the DPR-100. Symetrix considers this a true second-generation product because it does not require the traditional separation of a signal recorder and signal processor. Instead, the DPR-100 does it all.

The DPR-100 is said to provide a studio with digital domain recording, mixing and signal processing in a compact, modular system with a throughput of 50 million instructions per second. The system uses multiple 24-bit DSP ICs, the Motorola 56001. With this much DSP power on-line, simultaneous real-time effects include level, pan and 3-band parametric EQ, all of which can be automated.

Other types of processing can be loaded into the system and run "off-line." The first off-line software offering will be a time squeeze/expand program. User interface is through an Apple Macintosh computer (Mac+, Mac SE or Mac II).

The DPR-100 is presented in two basic "track" formations: 4- and 8-track. The 4-track format permits simultaneous 2-track recording and 4-track playback, while the 8-track format allows for simultaneous 4-in and 8-out. The system is also field-expandable in both tracks and record time.

The SMPTE/AES/EBU module reads VITC and house sync, reads and writes longitudinal time code and provides a stereo AES/EBU input and output.

According to Dane Butcher, Symetrix president, the DPR-100 will be aggressively marketed to film and video post-production, and recording and broadcast production facilities later this year.

Circle (99) on Rapid Facts Card

RE/P

\$10,000

“~~\$2500~~ Says You Can't Find a Better Gate!”

Marvin Caesar, President

At Aphex we have a problem with the President. Marvin Caesar wants everything the company makes to be the “best.” Marvin is *not* an engineer, he is an audio zealot who doesn't understand the word “impossible.”

When engineering approached him with a design for a gate, he wasn't satisfied. He wanted the ultimate gate, an *expander/gate* that was extremely fast, perfectly click-free, loaded with features, with traditional Aphex audio quality.

Impossible with available technology they said. Marvin wasn't satisfied.

So, the engineers developed a new VCA, the Aphex VCA 1001. Then they created the Aphex 612 Expander/Gate. Marvin was finally satisfied.

In fact, he is so confident that the Aphex 612 is the world's best expander/gate he is offering \$2500 to the person who finds a better one. If you think you

know of a commercially available expander/gate that can begin to compete with the Aphex 612, write for full details of this offer.

If you would rather spend your time more usefully, contact your professional audio dealer for a demo of the best!

Here are a few highlights of the world's best expander/gate:

- Attack time—variable from less than 4 μ Sec (with no clicks!) to 100mSec
- Ratio—variable from 1.2:1 to 30:1
- Range—0 to 100dB
- Bandwidth—5Hz to 100kHz, + 0, - 0.2dB
- THD @ + 20dBm—0.006%
- IMD (SMPTE) @ + 10dBm—0.006%
- Noise and hum—fully attenuated - 94dBm
- Servo-Balanced Transformerless Inputs and Outputs

Can you beat that?



APHEX SYSTEMS LTD.

Aphex Systems Ltd. • 13340 Saticoy Street • North Hollywood, CA 91605
(818) 765-2212 • TWX: 910-321-5762

Circle (36) on Rapid Facts Card

www.americanradiohistory.com

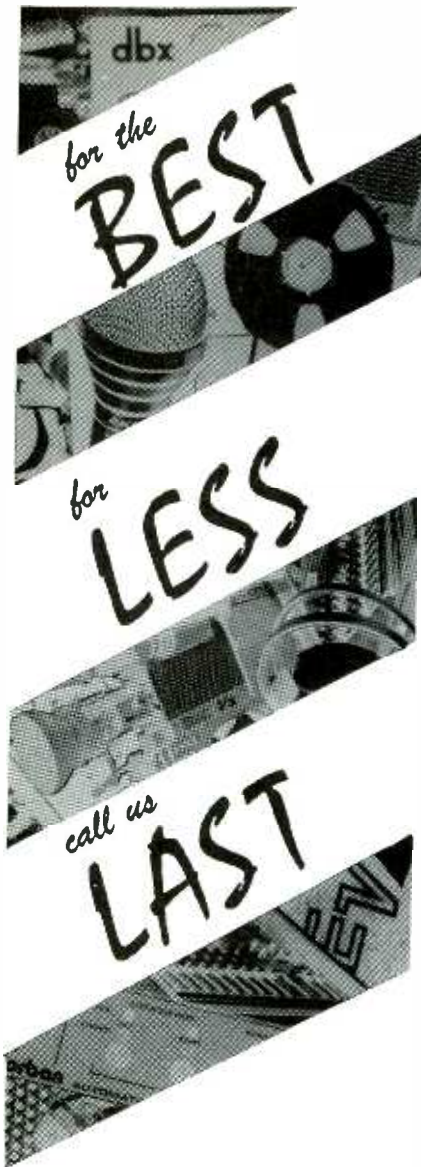

*Audio & Video
Equipment & Supplies*

Toll Free
(800) 356-5844

Wisconsin: (800) 362-5445
Consultation: (608) 271-1100
Fax: (608) 273-6336



6729 Seybold Rd. Madison, WI 53719
Circle (37) on Rapid Facts Card

NEW PRODUCTS

Shure Beta Series mics

The series contains two models. The Beta 58 is designed for vocal applications, while the Beta 57 is designed for musical instrument micing, particularly drums, cymbals, horns and instrument amplifiers. According to the company, both mics have exceptional gain-before-feedback characteristics because of a "true supercardioid" polar pattern that stays uniform at all frequencies. A new pneumatic shockmount system minimizes handling and stand noise. User net price for either mic is \$258.

Circle (160) on Rapid Facts Card



Prosonus Studio Reference Disc

The 70-minute CD turns a CD player into a test generator for all audio needs. The disc includes two sets of 17 different sine wave calibration codes, four bands of different sine wave sweeps, pink and white noise, two different control room tests, polarity check, left/right test, musical pitch references and acoustic piano listening tests. Because of the CD format, the material can be programmed or be repeated in any order. Price is \$49.95.

Circle (150) on Rapid Facts Card

Passport Designs Encore software

For use on the Macintosh, Encore is a music composing and printing program that lets composers think and work directly with music notation in an interactive environment. Music can be entered into the system using a mouse or MIDI keyboard, in real or step time. Symbols can be placed anywhere on the page. Master Tracks Pro and Jr. sequences, MIDI files or live MIDI input is transcribed and printed out. Suggested retail price is \$495.

Circle (151) on Rapid Facts Card

Rainbow monitors and mains

Rainbow Productions has introduced two monitoring systems. The RYHO-12-12T is a 12-inch 2-way system featuring two titanium drivers coupled to a single horn of proprietary design. Frequency response

is 60Hz to 21kHz (-3dB); power handling is 300W long-term. Mains are available in an all-in-one design, the 1510MB, or a split system, the 1015MB-S, with each pair in a sealed compression chamber coupled to a focused, expanded flare. Highs are handled by four titanium drivers manifolded to a single horn. All systems use Electro-Voice components.

Circle (152) on Rapid Facts Card

CMT Mac n' Rak

Available from Current Music Technology, Mac n' Rak is a 4U system that is based on the Apple Macintosh that includes 20Mbytes of hard disk storage. A built-in Opcode MIDI interface has two MIDI Ins and six MIDI Outs, which eliminates transporting the extra component and helps with cable clutter. A SMPTE time code converter is optional.

Circle (153) on Rapid Facts Card

Audio-Technica AT833R mic

The studio condenser mic has a uniform, unidirectional polar pattern that helps provide isolation between the sound source and unwanted sounds. Standard features include a removable foam windscreens, internal shock-mounting and a carrying case. Specs include 30Hz to 20kHz frequency response, 150Ω balanced output, 141 SPL handling capability and -45dBm sensitivity.

Circle (154) on Rapid Facts Card

A-T cables

Audio-Technica has introduced a line of Full Audio Transfer cables, made of oxygen-free copper wire for maximum signal transfer. They are available in two diameters and in pre-cut lengths of 30 and 50 feet, or in 500-foot bulk rolls.

Circle (155) on Rapid Facts Card

dbx 120X stereo subharmonic synthesizer

The 120X-DS is a 1U rack-mount unit that processes frequencies between 100Hz and 55Hz and synthesizes new bass one octave lower, from 55Hz to 27Hz. Level faders for the new bass frequencies, centered on 28Hz, 34Hz, 40Hz and 50Hz, enable fine control of the synthesized harmonics. The unit also contains a phase-coherent subwoofer crossover output, adjustable from 55Hz to 210Hz. A subwoofer output level control is provided. Suggested retail price is \$349.

Circle (173) on Rapid Facts Card

Renkus-Heinz RH-23

The RH-23 is a stereo processor designed to be used with the company's Dyna-Gard FRS and SMS series speaker systems. The processor can also be used with other 2-way passive crossover speakers. Automatic level-dependent loudness compensation is front panel-adjustable, and HF level controls are provided so that an accurate balance can be achieved with a variety of speaker enclosures. The signal and protection status is monitored by color-coded LEDs. By sensing the signal sent to the speaker, the protection circuit allows the speaker components to be safely used at their maximum levels. Suggested resale price is \$1,650.

Circle (144) on Rapid Facts Card



Audio Kinetics ES Penta

ES Penta is an ESbus controller/autolocator capable of controlling up to five machines in conjunction with five ESbus synchronizers. When used with Audio Kinetics' ES 1.11 synchronizer, all of the enhanced AK-ESbus specifications can be used. Ten loops or GOTO points can be stored and identified as music cues on a scribble strip. Four offset functions offer maximum user flexibility and a true FIT function provides controlled expansion or compression of material within a standard loop. The system has full event firing capability when interfaced to the ES SSU system service unit.

Circle (141) on Rapid Facts Card

Passport Designs Sound Track System

Passport Designs has bundled several of a film and TV composer's most valued tools into a cost-effective system. The Sound Track System consists of an Apple Macintosh, MIDI Transport, Master Tracks Pro 2.0 and Clicktracks. The system offers fully integrated sequencing, SMPTE synchronization, time calculation software and is MultiFinder-compatible. The company plans to release similar systems for other computers later in the year.

Circle (142) on Rapid Facts Card

WE'RE IN CONTROL!

See Synchronous Control of

PCM 501 and PCM 2000 R-DAT

NAB Booth Number 7632

editron

The Complete System

Circle (38) on Rapid Facts Card

NEW PRODUCTS

East-West CD drum sampler

The sampler contains more than 700 digitally sampled drum and percussion sounds, including matched kits, for pop-rock and dance music production. Sounds range from close, dry sounds to heavily processed sounds. Most sounds will require additional reverb, the company says, because long sounds with reverb take up too much sampling memory and it assumed that users would want to add effects themselves. A track-select is included at every 11th sound. Price is \$99 plus shipping and handling.

Circle (171) on Rapid Facts Card

Yamaha SPX900 processor

Designed for a variety of uses, the SPX900 contains 50 professional effects presets in ROM, including 13 multiple programs that allow up to five effects at once. New effects include a new reverb algorithm that provides user control of room dimensions, 2-D panning effects, distortion combina-

tions and programmable early reflections. Users can modify effects and store them in 49 on-board RAM locations. Selected parameters may be controlled via MIDI or other control devices. The optional RCX1 remote control is also available.

Circle (170) on Rapid Facts Card



Milli-Chart from Lo Bianco Enterprises

Milli-Chart is a wall or tabletop reference chart showing the relationship between digital delay time settings and musical tempos. It was designed to alleviate computing delay times with a stop watch and a calculator. The chart gives delay times in milliseconds for tempos from 60bpm to 250bpm, for quarter, eighth and 16th notes, quarter- and eighth-note triplets and beats per second. It can also be used to

compute tempos and the number of beats within a fixed time frame, such as a 30-second commercial. The chart is plastic-coated, measures 10"x17" and costs \$15.95.

Circle (165) on Rapid Facts Card

MIDI programming book from M&T Books

"MIDI Programming for the Macintosh," by Steve De Furia and Joe Scacciaferro, is for programmers and musicians who want to write their own Macintosh music software using MIDI conventions. The book contains an introduction to MIDI and Macintosh programming, covering such topics as MIDI devices, the Mac user interface, program design, Mac programming languages and tools, and MIDI code resources. The book also covers the basics of programming the Macintosh's ROM-based Toolbox. Price for the book is \$22.95; the book with an accompanying disk is \$37.95.

Circle (174) on Rapid Facts Card

TIMECODE EDITING... LIVING DANGEROUSLY?



Not if you have the new ADx-02 Timecode Analyzer. This is a sophisticated test instrument, as well as a fully functional reader-generator with video Key and L.E.D. displays. It can save you time and money. Finding timecode errors on tape before an edit is attempted, or matching color frames and Sch phase, or tracking on a Betacam is easy. For the engineer, it can be the quickest way to set tape speed, realign video play-back heads or check an audio synchronizer for wow. Each timecode bit is displayed graphically.

The ADx-02 is being used around the world in a variety of environments and applications. But the diagnostics function is not the end of the story, the ADx-02 is a very versatile timecode reader-generator-insert, with multiple screen displays, selectable fonts, three jam-sync modes, stable code generation, full speed range read and much more. So why buy just a timecode reader-generator?

The ADx-02.

The only timecode unit that can safely save you money.

ADx Systems Inc.
274 Madison Avenue, New York, NY 10016
The World Leader in Timecode.

For more information contact your local dealer or call us at 1-800-444-4-A-D-X.

Circle (39) on Rapid Facts Card

AES 7th International Conference AUDIO in DIGITAL TIMES

A 4-day Conference covering
all technical aspects of digital audio

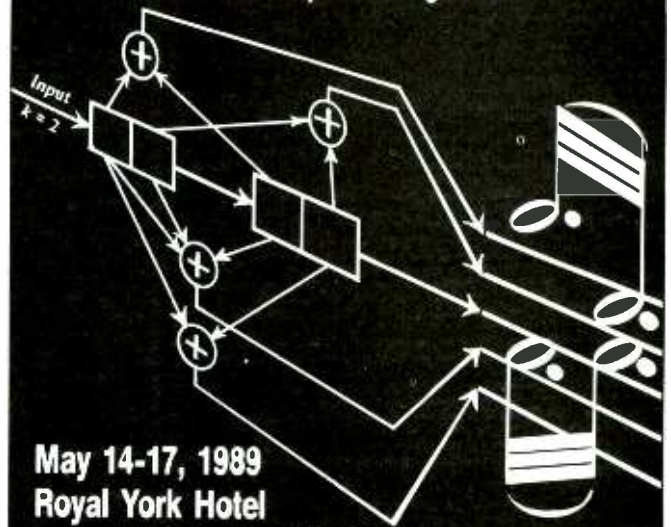

May 14-17, 1989
Royal York Hotel
Toronto, Ontario, CANADA

AUDIO ENGINEERING SOCIETY

60 East 42nd Street, Room 2520
New York, New York 10165

Phone: (212) 661-8528 or FAX: (212) 682-0477
(800) 541-7299 (N. America, except NY)



MASTERING THE NEW AGE



01 DIGITAL PRODUCTION CENTRE

Mastering and editing are as important to the quality of a record as the final mix. With the emergence of CD as the dominant consumer software medium, a new approach is needed to bring the quality of service traditionally provided by the vinyl disc mastering room to the digital domain.

01 provides all the sonic processing, editing and final assembly facilities required for

this task, with no loss of digital integrity. Combining the advantages of a hard disk recorder with familiar multi-channel console controls, 01 is immediately accepted by engineers, editors and producers.

More importantly, by extending creative control over the mastering process, 01 enables a quality of production to match the new age of release formats.

SSL DIGITAL

Solid State Logic

Begbroke, Oxford, England OX5 1RU (0865) 842300

Paris (1) 34 60 46 66 • Milan (2) 612 17 20 • New York (212) 315 1111 • Los Angeles (213) 463 4444 • Tokyo (81) 3 320 1101
U.S. TOLL FREE NUMBER 800 343 0101

RADIAN

The New Source for
PREMIUM QUALITY
Loudspeaker Systems
and Components

- Innovative Speaker Systems
- New Coaxial Loudspeakers
- High Performance Components
- Replacement Compression Driver Diaphragms

Contact Radian for details and
the name of your nearest dealer.

RADIAN

AUDIO ENGINEERING, INC.

162 E. Orangethorpe
Placentia, CA 92670
714-961-1213 • FAX 714-961-0869

© 1989, Radian Audio Engineering

Circle (41) on Rapid Facts Card

**BUY A
DENECKE, INC.
"FATHER TIME"
T-SHIRT**

8.00

(Plus shipping & Handling)



DENECKE, INC.

5417-B Cahuenga Bl., No. Hollywood, CA 91601
(818) 766-3525

Circle (42) on Rapid Facts Card

NEW PRODUCTS

Bose 302 Series II Acoustimass bass system

The second generation of the Bose 302 bass system, the 302 Series II is designed specifically for use as bass reinforcement with the Bose 802 loudspeaker. It features the company's Acoustimass speaker technology and a new woofer. According to the company, the result is greater output and purer bass sound. Each unit contains two MB-12 woofers, both in discrete Acoustimass enclosures. The system can handle up to 600W and a maximum SPL of 124dB.

Circle (145) on Rapid Facts Card



U.S. distribution for Seck mixing consoles

The live and studio consoles are now available through JBL Professional and are available in 2- and 8-bus versions. They feature 3-band mid-sweep EQ, up to six aux sends and numerous effects returns. Available versions are six, 12, 18 and 24 inputs.

Circle (140) on Rapid Facts Card

Modem Security Device from B&B Electronics

The 232MSD protects computers or bulletin board systems from hackers and computer viruses by using the callback method of protection. After a user calls in and gives the proper password, he must hang up; the unit will then call the phone number stored in its memory. The user at that number is then allowed access to the system. The unit works with most stand-alone modems that are AT Command Set-compatible.

Circle (158) on Rapid Facts Card

Biamp studio mixer

The MAXXAM 8+8 is a rack-mount mixer designed for users with large electronic musical instrument setups. The 6U mixer has 16 input channels, with eight channels

designed to handle stereo input signals. Also included are two unassigned low-noise mic pre-amps with XLR connectors and ¼-inch phone assign jacks, allowing the pre-amp signals to be assigned to any of the input channels with a short patch cord. Four sends are included, one of which is selectable pre/post fader on each channel, as are four stereo returns.

Circle (159) on Rapid Facts Card

Kinometrics/Truetime time code unit

The 800 Series consists of three units: the 814 time code generator, the 820 time code translator/display, and the 840 translator/generator. Features include generation and/or translation of all IRIG time codes and most special codes, parallel BCD, and RS-232 and IEEE-448 interfaces. User I/O ports can be provided with band-pass filters, 50Ω drivers or most any custom interfaces/levels needed. Prices are \$475 for the 814, \$550 for the 820 and \$475 for the 840.

Circle (163) on Rapid Facts Card

Blank Software metal percussion sounds

"Anatomy of an Automobile" is the first sound collection in the Macintosh Audio IFF format, and contains sounds by, in, on or around an automobile. All sounds have been captured and constructed using high-fidelity digital sampling techniques and equipment. The library is available on CD-ROM or in 45Mbyte removable cartridges.

Circle (164) on Rapid Facts Card

Siemens Crossmatic D audio routing system

Crossmatic D contains 16(32)-bit microprocessors and computer control for single and multi-user systems. Up to 16 levels, including stereo, SAP, feedback monitoring, intercom, TC and remote control, with electronic crosspoints or relays are possible. It can be controlled by a personal computer via a Centronics interface or by specific keyboards, data terminals and external hosts via RS-232/-422 interfaces.

Circle (167) on Rapid Facts Card

dbx 929 hiss-reduction module

The 929 is a single-ended noise-reduction system that requires no encoding but eliminates constant hiss without sacrificing musical high frequencies. The module

provides two channels of one-step hiss reduction. A control for each channel enables the dynamic filter's action to be adjusted for maximum effectiveness and flexibility. As musically meaningful high frequencies enter the system, a sliding filter network opens and allows them through. Suggested retail price is \$399.

Circle (168) on Rapid Facts Card

Processor Sciences NTSC video overlay

The VGAvision video overlay board adds full NTSC video to an IBM PC, XT/AT or compatible computer equipped with any VGA board. The fully programmable board features non-interlaced video output at VGA frequencies to produce a flicker-free, high-resolution image. Test, graphics, full-motion video and live video within windows can be integrated. System requirements are one computer slot and two I/O ports; the system uses no PC memory space or internal connections. List price is \$1,299.

Circle (161) on Rapid Facts Card

ASA auditory demos on compact disc

Issued jointly by the Acoustical Society of America, the Institute for Perception Research and Northern Illinois University, the discs demonstrate various characteristics of hearing. A text booklet is provided with each disc, containing introductions, narrations of each topic and bibliographies. A total of 39 sections are presented in seven areas, including frequency analysis and critical bands, sound pressure, power and loudness, masking, pitch, timbre, beats, combination tones, distortion and echoes, and binaural effects. Cost is \$20 per disc; cost for bulk orders of five or more is \$17 per disc.

Circle (162) on Rapid Facts Card

Akai XE8 drum expander

The XE8 features 16-bit samples of a variety of drum and percussion sounds in a single rack-space design. Sixteen different sounds reside in internal ROM, with two slots provided for additional ROM cards. The unit can produce up to eight sounds simultaneously, and each sound in a program can be routed to a Mix output, or to one of eight separate outputs. The unit can be triggered by any MIDI controller, and the Akai ME35T can be used with electronic pads, miced drums or any audio triggers. Retail price is \$899.95.

Circle (148) on Rapid Facts Card

Audio-Technica ATM25 mic

A wide-range, moving coil dynamic mic with a hypercardioid pickup pattern, the ATM25 is designed to be used with highly dynamic instruments that generate high SPLs, such as kick drums, timpani, acoustic and electric bass, harp, piano and tuba. The narrow acceptance angle of the pattern allows the mic to focus on a desired sound source, control feedback and provide more flexible mic-to-instrument working distances. Frequency response is 30Hz to 15kHz, balanced output is 600Ω and sensitivity is -57.8dBm.

Circle (149) on Rapid Facts Card



Roland compact disc

"Roland: A Sound Approach" features 12 selections in a variety of styles created by Roland product specialists and affiliated artists. Roland equipment was exclusively used, the intent being to show the equipment's capability. A 24-page book accompanies the disc, which includes the techniques used to produce the music, such as the type of signal processing used and sequencer/synchronizing techniques. Retail price is \$11.95.

Circle (156) on Rapid Facts Card

Gotham GAC-2 mic cable

GAC-2 cable features double Reussen shielding, 48-strand No. 2 conductor and a PVC separation tube between the two twisted conductors and the two shields. The result, according to the company, is lower capacity, higher flexibility, greater strength and more effective handling. It is available in seven colors in spools of 328 feet (100 meters).

Circle (169) on Rapid Facts Card



USE ONE COMPUTER TO FIND YOUR SOUND EFFECTS AND CONTROL YOUR SYNCHRONIZERS.

The **SC SERIES** synchronizer controller software from Kelly Quan Research and **THE M&E ORGANIZER SYSTEM** from Gefen Systems join forces to centralize and simplify your audio post production.

The SC series software controls any Lynx, Phantom, Shadow, Otari or Zeta synchronizers. Perform ADR loops, set and store Edit points, trigger events, read CMX compatible EDL and use programmable USERKEYS to perform multiple key strokes.

The M&E Organizer System provides you with a database for sound effects and production music libraries as well as the playback of CD libraries using one or more Sony CDK-006 CD changers. The sound effects used can be integrated with

the EDL of the SC series controller.

Optional Features include:

Site License : Pay for one set of software and use it in multiple computers on the same site.

Multi M&E System: Access CD changers from multiple computers.

LYNX is a trademark of Timeline Inc.
PHANTOM & SHADOW are trademarks of Cipher Digital Inc.
ZETA is a trademark of Adams Smith Inc.
SONY is a trademark of Sony Corporation
OTARI is a trademark of Otari Corporation

PHONE:
818-884-6294
FAX:
818-884-3108



**5068 SAN FELICIANO DRIVE
WOODLAND HILLS CA 91364**

Circle (43) on Rapid Facts Card

AmEx VISA
MASTERCARD
10 AM - 7 PM DAILY

The
DA
Digital Audio Tape
STORE

2624 Wilshire Blvd. Santa Monica, CA 90403
(213) 828-6487 • FAX: (213) 470-6176

DIGITAL AUDIO TAPE RECORDERS

**PROFESSIONAL
PORTABLE
HOME**

ALL BRANDS IN STOCK NOW!!!

**FULL WARRANTY • ENGLISH MANUALS
TRANSFORMERS, TAPES and
ACCESSORIES AVAILABLE**

Shipping VIA UPS/FED-EX

Circle (44) on Rapid Facts Card

**YOU DEMAND THE BEST
WE SUPPLY THE BEST.**



**Cal Switch And Switchcraft®
The Popular Demand**

- Audio Connectors
- Cable Assemblies
- Jack Panels
- Multi-Switch® Switches

(800) CAL-SWCH

CAL SWITCH
13717 S. Normandie Avenue
Gardena, California 90249

Circle (45) on Rapid Facts Card

NEW PRODUCTS

Hardware and software updates

New software for AMS AudioFile

Version 8 software for the AudioFile provides major operational enhancements for both new and existing systems, according to the company. Some of the new features include varispeed through the digital port, digital outputs available in all pages, faster lockup, digital de-emphasis, dc offset removal, high-resolution metering and simplified screen structures. Several additional hardware upgrades are available, including 2x oversampled A/D conversion with Apogee filters, R-DAT backup, full 701 I/O and a ProDigi interface.

Circle (175) on Rapid Facts Card

New automation software for Trident Di-An

AUTOMate II software gives console user's automated dynamic control of all console parameters in real time, with replay triggered by time code. The software also features Personalized System Setup, which lets a first-time operator create and permanently store presets for initial console configurations in tracking, mixdown and overdub modes; D-Line, which allows two or more channels to be grouped together and operated by a dedicated master; and D-Copy, an enhanced editor allowing selected desk parameters to be copied to one or more additional channels. AUTOMate II is compatible with existing Di-Ans; the upgrade is free to existing users and does not affect the base price of new consoles.

Circle (176) on Rapid Facts Card

Leonardo Professional Librarian update

Version 3.0 of Leonardo's Professional Librarian software runs under a windowing environment with pull-down windows. New and enhanced features include searches, roll listings and clipboards configured as individual windows; pull-down menus to allow access to most functions from all parts of the program; Quick Keys that can be defined to select items from menus without pulling down the menu; and "point and shoot" selection of various items from a list. The new version is priced at \$995; an upgrade for existing users is \$100.

Circle (187) on Rapid Facts Card

Forte Music Mentor MIDI processor

The Mentor has been updated to include six MIDI inputs and six independent MIDI outputs, which will address up to 96 different synthesizers of sound modules. Internally, the unit consists of eight fully independent, programmable MIDI processors, each capable of a wide range of functions. New software improves performance for sequencer applications. Any of the eight data processors may be set to pass all 16 channels of MIDI data. New system-exclusive program load and store functions may be used to save preset data in a personal computer. Suggested retail price is \$995.

Circle (191) on Rapid Facts Card

Video of C-ducer Drum Wizard mic

An instructional video explaining the capabilities of the C-ducer Drum Wizard mic is now available. The system contains eight mics/triggers, an 8x2 audio mixer, two MIDI outputs and a 100 MIDI program facility. The video show how an acoustic kit can be used to trigger electronic percussion using the system. Cost is \$10.

Circle (193) on Rapid Facts Card

New options for TC graphic EQ

The TC Electronic 1128 programmable EQ/spectrum analyzer now has a PC board option, which can be installed in the unit. This allows the original display to be viewed on a computer monitor with an RCA video input. The other option allows the unit to read and generate SMPTE code, allowing the unit to change EQ settings by reading code. The SMPTE cue list can be edited and dumped out for external storage.

Circle (194) on Rapid Facts Card

Hard drive interface for Akai S950

The IB105 interface board doubles as the port for connecting a hard disk drive and as a direct digital input from DAT and CD. Atari or Supra disks can be used, and up to eight drives can be cascaded to allow massive storage of sounds. Dumping sounds from CD or DAT into the S950 avoids an A/D conversion required in normal sampling. Suggested retail price is \$169.95.

Circle (188) on Rapid Facts Card

SCSI interface for E-mu Emax

The high-speed serial interface allows the use of external sound storage devices, such as the Data Technology Hyperflex removable cartridge disk drive, and will load an Emax sound bank in less than seven seconds. Newly developed Emax SE SCSI software allows the access of up to eight external SCSI devices at once from the Emax front panel. The interface will be shipped standard on all Emax SE samplers; suggested list price is \$3,495. It is also available as an update from authorized service centers for \$195 plus installation.

Circle (183) on Rapid Facts Card

Mac II color edition of Opcode Cue software

The latest version of Cue includes color capabilities accessible on the Mac II, and also uses the computer's ability to use various "gen-lock" boards, allowing the software to send information to a standard NTSC color TV monitor. Other features include reprogrammed operations designed to the computer's 68020 processor.

Circle (184) on Rapid Facts Card

Memory expansion for Akai S950 sampler

The EXM006 memory expansion board adds 750k of RAM to the S950. The unit has two slots available; with two boards added, the sampler's maximum sampling time can be expanded to just under 30 seconds. The board retails for \$499.95.

Circle (185) on Rapid Facts Card

Focusrite ISA131 module

The ISA131 dynamics processor module is a dual-channel version of the company's ISA130 module, and shares its performance specifications. It provides two channels of compression/limiting and noise gating, and it also incorporates a new Stereo Link facility.

Circle (190) on Rapid Facts Card

Protective covers for JBL Performance Series

JBL has introduced protective covers for this line of speaker systems. Made of heavy-duty Naugahyde, the covers are custom-tailored to fit all models and protect the speakers during transit and storage.

Circle (179) on Rapid Facts Card

DON'T GET ZAPPED!

Investing in a Control Room or Studio?

PROTECT YOUR INVESTMENT

Model JPC
115-8-A-951

Power up with... **Z-LINE**®



Protect your expensive equipment with our
Z-LINE AC Power Distribution and Control System.

POWERFUL • AFFORDABLE • STACKABLE • EASY TO INSTALL
COMPACT • QUIET • LIGHTWEIGHT • EMI/RFI FILTER
GROUND ISOLATION • SPIKE AND SURGE PROTECTION

Order now . . . Priced at only \$160.00

Distributor Inquiries Welcome

PULIZZI ENGINEERING INC.

3260 S. Susan St., Santa Ana, CA 92704-6865

(714) 540-4229 FAX (714) 641-9062

Circle (46) on Rapid Facts Card

The Industry Standard For Excellence

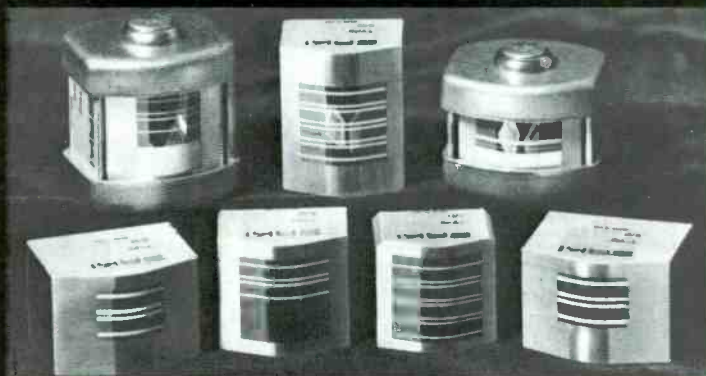

Saki Ferrite Audio Replacement Heads

Hot-pressed, glass-bonded ferrite for superior sound and long life. Fully compatible with original manufacturer. 1/4" and 1/2", 2 and 4 track applications. For Ampex, MCI, Mincom, Otari, Revox, Scully, Studer, Technics, and others. Call now to order.



SAKI MAGNETICS, INC.

26600 Agoura Road, Calabasas, CA 91302

Phone (818) 860-4054 Telex 244 546 FAX (818) 860-6242

Circle (47) on Rapid Facts Card

NEW PRODUCTS

Leslie emulator from Avalanche Effects

The Brianizer Leslie emulator uses a phase-compensated active crossover followed by speed-dependent tremolo, flange and Doppler shift circuitry in the horn and bass rotor channels. Both the input level and the effect intensity are



switch-selectable. The unit's motor accelerations and decelerations have been modeled, allowing users to employ classic techniques based on the Leslie's motor inertia.

Circle (157) on Rapid Facts Card

Pacific Digital DM-1 digital audio workstation

Said to be the first portable digital audio workstation for film and video post-production, the DM-1 has a storage capacity of more than 760Mbytes, allowing users to store thousands of effects. Sound effects can be spotted to SMPTE hit points on the fly and fine-tuned with the mouse or keyboard. The DM-1 can send MIDI commands at exact time code points, allowing synchronized control of effects. It is also available with AES/EBU digital interface and direct-to-disc capability, making it available for R-DAT editing.

Circle (143) on Rapid Facts Card

Korg A3 performance signal processor

The A3 is equipped with 40 different types of effects, including reverb, delay, exciter, chorus, distortion, compressor and rotary speaker. All processing is digital, and up to six can be selected and combined. A total of 20 of the more common combinations have been programmed in the internal preset memory. An additional 200 user program memory locations, 100 in internal memory and 100 in memory card, can be used for storing custom effects settings. Additional effects and combinations can be added with optional ROM cards.

Circle (172) on Rapid Facts Card

Aphex Impulse interface

The model 810 Impulse is an "intelligent" interface for triggering electronic percussion from analog input signals. The unit has 12 independent analog inputs that may be driven from live or recorded drum signals, or with contact pickups mounted in a conventional drum kit. When triggered, each of the input signals generates a corresponding MIDI Note On message, with user-programmed MIDI channel and note numbers. A total of 50 user patches can be stored, each allowing reassignment of MIDI channel and note numbers for each input.

Circle (166) on Rapid Facts Card

RE/P

HOLDS UP ON THE ROAD

TYPE 85 FET DIRECT BOX

AMP. INST. PICKUP
INPUT SPEAKER

CA COUNTRYMAN ASSOCIATES INC.
417 STANFORD AVE. - REDWOOD CITY, CA. 94063 - PHONE 415-364-9988

Circle (48) on Rapid Facts Card

EXCELLENCE is the result of uncompromising dedication to quality and service.

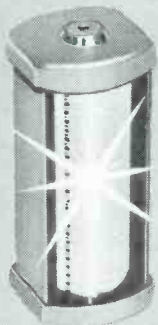

JRF is proud of its reputation as a leader in the field of magnetic heads. Our technical and engineering staff is committed to providing the finest products and services:

- Magnetic Head Refurbishing
- Optical/Digital Assembly Alignment
- Full line of replacement heads IN STOCK
- MCI/Sony parts dealer
- 3M parts dealer
- Technical Assistance
- Fast, reliable service that's unmatched for quality

Responsive to the needs of the recording industry, we at JRF feel there can be no substitute for EXCELLENCE

JRF
MAGNETIC SCIENCES

Kennedy Road • P.O. Box 121 • Greendell, NJ 07839
Tel: (201) 579-5773 • Fax (201) 579-5021 • Telex 325-449

Circle (49) on Rapid Facts Card

CLASSIFIED

FOR SALE

THE "POP ROCK" DRUM SAMPLE COMPACT DISC

"Chock-full of the most useable drum sounds we've heard yet, with enough variety to suit many different styles of music".
Keyboard review Oct. 88.

AVAILABLE NOW AT \$99 FROM
EAST-WEST

8515 Hollywood Blvd, Los Angeles
CA 90069 U.S.A.
Phone (213) 650-8972
Facsimile (213) 654-4539

FOR SALE OTARI 16 & 24 TRACK RECORDERS

New MTR-90 Series II/2" 24 track
and MX-70/1" 16 track. Both full
warranty. Used MTR 90 Series
II/2" 24 track. Excellent condition.
Call for details 215-426-7354.

FOSTEX RECORDING EQUIPMENT MACINTOSH & IBM Computers & compatibles MUSIC SOFTWARE Monitors & Printers DISCOUNT PRICES DATAWARE INC.

(we ship world wide)
P.O. Box 1122
Hollywood, Ca 90078-1122
(213) 465-9750

NEW

19" ADC tt Patchbay panels, balanced/normalised, 144 points each. Cost \$300—Sell \$175 each, 2 for \$300 or 3 for \$400.

Call Roger Cordell, (818) 763-8301.

Phone
Renée Hambleton
for
Classified Advertising
Information
(913) 888-4664

FOR SALE

AVR

AUDIO VIDEO RESEARCH THE STUDIO STORE

(617) 924-0660

The Only Call You Have To Make For:

AKAI
AKG
ALLEN & HEATH
APHEX
SYSTEMS
ARIES
ART
ASHLY
ATARI

BBE
BEYER DYNAMIC
BIAMP
CANARE CABLE
CROWN
DIC DAT Tape
EVENTIDE
HYBRID ARTS

MARK OF THE
UNICORN
MRL
MILAB
NADY
OPCODE SYSTEMS
ORBAN
PANASONIC
RAMSA

SHURE
STUDIOMASTER
SUMMIT
TANNOY
TC ELECTRONICS
TELEX
US AUDIO
WHIRLWIND

Exclusivamente para o Brasil, oferecendo instalacao e assistencia tecnica:

dbx JBL/UREI LEXICON
HARRISON KURZWEILL OTARI TRIDENT

AUDIO VIDEO RESEARCH 106 Main St. Watertown, MA 02172

Circle (60) on Rapid Facts Card



THE REEL DEALS ARE IN DC.

Otari MTR-10CT Recorder- \$9.9K
Otari-MTR-12CT Recorder- \$10.9
Otari MK-III & BQ Series Recorders
TAC Matchless 36 x 24 Patchbay- \$25K
TAC Scorpion 40 x 8 w/ 8 Aux- \$17K
Soundtracs ERIC w/ Auto- Call
Soundcraft 8000 40 Input PA- \$20K
AHB Sigma Series 36 x24- \$26K
Quad 8 Coronado Console- \$22K
Dolby 361SR- 1.4K
UREI & Crest Power Amps
Sony, Sharp, Ramsa R-Dat In Stock
Washington Professional Systems
11157 Viers Mill Rd. Wheaton, MD 20902

301-942-6800

BASF CrO2

in SHAPE MK-10 shell C-90

99¢

100 LOT

AGFA MAGNETITE-12

in SHAPE MK-10 shell C-90

1.05*

100 LOT

ALSO ... A/V supplies/equipment/parts. STUDIOFOAM acoustic foam (\$19.99/sheet, 2+ lot), cleaning fluids, HI-DEFINITION speaker cable, DAT, Switchcraft, CD jewel boxes, editing blades, MRP computers, Hewlett Packard Laserjets/Plotters, HOSA patch cards & MORE! Air personality voice talent available, too.

CARTUNES

PO Box 20384, Indianapolis, IN, USA 46220 (317) 257-6776
Serving professionals since 1977

*CODD price Tax/SH extra. Other lengths/types available at similar savings.

BLEVINS AUDIO EXCHANGE INC.

"The South's Largest Pro Audio Broker"

"Your unused equipment is requested for our Nashville, TN showroom."

We have in stock consoles, tape machines, outboard equipment, microphones, etc. Available immediately, the following items:

Sony JH24's EMT 250 Reverb
MCI JH400, JH500 and JH600 consoles
Otari MRT 90's Studer 24's

And lots more.

(615) 391-0429
(615) 391-0456 FAX

SERVICES

Record Mastering, Plating & Pressing Cassette Duplication Compact Disks

The oldest established audio recording company in the industry
Complete, one-stop packaging - printing, assembly and fulfillment
CD Master Prep

COOK

Cook Laboratories, 231 Wilson Ave, Norwalk, CT 06854

**1-(800)553-COOK, in Connecticut 854-5900,
FAX (203)866-2755**

Circle (61) on Rapid Facts Card

April 1989 *Recording Engineer/Producer* 77

CLASSIFIED

SERVICE/REPAIR

RCA MICROPHONES—Repair service on all models. Complete sound and cosmetic restoration. 35 yrs. experience with RCA. ENAK Microphone Repair, 420 Carew Avenue, Pitman, NJ 08071. (609) 589-6186.

EQUIPMENT FOR SALE

NEW EQUIPMENT FOR SALE: (1) Akai MG1214, \$6,000; (2) Akai MPX 820, \$850 each. (1) Sanken CMS-2 w/matrix and power supply, \$2200. Lexicon LXP-1, \$379 each; Lexicon MRC, \$299 each. Orban 642B EQ, \$699; Orban 787A mic processor, \$1399.

USED EQUIPMENT FOR SALE: (2) In-ovonics 500 Spectrum Analyzer w/AGK 451 mic and cables, \$2500 each. (2) MCI JH-110, Best Offer; Vega PRO wireless mic, \$300.

STUDIO SUPPLY COMPANY
(615) 391-0050

FOSTEX RECORDING EQUIPMENT
MACINTOSH & IBM Computers
& compatibles
MUSIC SOFTWARE
Monitors & Printers

DISCOUNT PRICES
DATAWARE INC.

(we ship world wide)
P.O. Box 1122
Hollywood, Ca 90078-1122
(818)996-1161

EQUIPMENT FOR SALE

USED EQUIPMENT

Monitors

RM-780 Fostex 8" co-ax, \$420 pr.;
7258 Gauss 15" co-ax studio, \$800 ea.;
811 Urei 15" co-ax studio, \$800 ea;

Recorders

280B Scully 15ips 2 track 1/4", \$2,400;
ATR102 Ampex 30 ips 2 track 1/4", \$7,000;
ATR104 Ampex 30ips 2 + 4 track 1/4 + 1/2",
\$7,500;
JH-110 MCI 30ips 2 track 1/4", \$3,200;
MTR-90 Otari 2" 24 w/remote & stand,
\$34,950;
MTR-12 Otari 30 ips 2 track 1/4", \$6,500;
JH-24 MCI 2" 24 track w/AL111, \$20,500.

OPUS

RECORDING & EQUIPMENT CO.
4262 Grand Avenue, Gurnee, IL 60031
"The Midwest Recording Center"
(312) 336-6787
FAX (312)336-6895

NEW, USED, DEMO EQUIPMENT

Trident 28 x 24 w/pbay, Soundcraft 6000
28 x 24 w/bay, Aries mixers, Ampex
MM1100 16TK xint cond, Tascam MS-16,
Otari MTR-10 2TK, DBX 900 24ch Type
I, Urei 811's, Dolby 363SR, Sony
PCM-2500, Urei 811A monitors, Dyaxis
systems, xint prices on studio pkgs. Ex-
perienced staff/factory service—lease
packages available.

EAR Professional Audio-Video
(602) 267-0600

Phone
Renee Hambleton
for
Classified Advertising
Information
(913) 888-4664

EQUIPMENT WANTED

WANTED: PULTEC EQ's

We will pay \$1,000 for almost any
Pultec program EQ models. Also
wanted: Fairchild 670's and 660's any
tube or ribbon microphones and
limiting amps. Please call or write to:

Dan Alexander Audio
2944 San Pablo Ave.
Berkeley, CA 94702
(415) 644-2363
FAX: (415) 644-1848

Wanted Items

Used Manhasset Music Stands
Used Atlas SB36W Mic Stands
Used AKG or Sennheiser Headphones
Contact
AIRE BORN RECORDING
317-876-1556

REPRINTS

Interested in ordering article reprints out of this or another issue?* Reprints can be excellent learning tools for your technical staff and great marketing tools for your sales staff. Call or write Cindy Baker at Intertec Publishing Corp., P.O. Box 12901, Overland Park, KS 66212; (913) 888-4664.

*Minimum order 500 copies.

CLASSIFIED

BUSINESS OPPORTUNITIES

Recording Studio for Sale

Private recording studio complex w/reception/office/production rooms/waterfall/sundeck. Under remodeling. Includes 3-bedroom house. \$175,000. Equipment extra. So. Calif. Ask for Danny. 619-352-5774.

Great Studio Opportunity in Atlanta, GA.

Move into a complete studio featuring a Sphere console, a Studer 24-track, dolby and dbx noise reduction, two pianos, a Hammond B-3, and lots of miscellaneous microphones and outboard equipment. The equipment is for sale as a package, and the building lease can be assumed. Available immediately! Call Randy Blevins for more details at (615) 391-0429.

MISCELLANEOUS

VERSADYN

CASSETTE DUPLICATORS
for the demanding professional

- High speed loop-bin systems
- Affordable prices
- Excellent leasing program

504-D Vandell Way, Campbell, CA 95008
(408) 379-0900 FAX (408) 379-0902
Telex: 28-8826

AUDIO AFFECTS

STUDIO EQUIP. FOR HIRE
Technician on staff 7a.m.-1a.m.
Open 7 days a week
Digital Tape Machines,
Synclavier Systems,
Effects Processors, Reverbs
(213) 871-1104 (818) 980-4006

MAGNETIC RECORDING HEADS—RELAP/REPLACE—
MENT for Audio, Video, Time Code, Duplication. 29 years of head design experience. IEM, 350 N. Eric Dr., Palatine, IL 60067; tel. (312) 358-4622.

MISCELLANEOUS

ENDLESS WORD™

ADVERTISING PROMOTIONS
VOLUME IN STORE P.O.P. and TELEPHONE
ON HOLD MESSAGES
IDEAL FOR HI-SPEED or REAL-TIME
DUPLICATING



- Made in U.S.A. & Quality tested before shipping.
 - Lengths from 20 sec. to 20 min.
 - Special non-stretch tape.
 - Plays vertical or horizontal.
 - Clear case permits visual cueing.
 - Ask about our new volume discount pricing & low cost endless cassette promotional players and new F.C.C. approved multi-line telephone adapter for messages on hold tape players.
- MANN ENDLESS CASSETTE INDUSTRIES**
P.O. Box 1347 • San Francisco, CA 94101
(415) 221-2000 Ext. 2
Fax: (415) 387-2425

Caution DAT Buyers!

Some dealers are offering DAT equipment that is not designed for use in the U.S. and is not covered by a legally binding written warranty. You need to know the facts on DAT - Call the DAT hotline today! 609-888-4414.

EUROPADISK, LTD.

AUDIOPHILE QUALITY

DMM MASTERING/PRESSING
CASSETTE DUPLICATION

On Finest European
HX-Pro Equipment

CD & GRAPHICS PACKAGES
DIGITAL TRANSFER STUDIO

CD Master Tapes

Neve Digital Console

Sony Digital Editing

Europadisk, Ltd.

76 Varick Street, New York, NY 10013
(212) 226-4401

Circle (82) on Rapid Facts Card

Stamp Out SCR Buzz. Forever.

Diff amps may work - when far from SCR dimmers and RF transmitters. When you're up close, you'll need a good transformer.

jensen transformers
INCORPORATED

10735 Burbank Blvd. • North Hollywood, CA 91601
FAX (818) 763-4574 Phone (213) 876-0059
TELEX 6502919207 MCI UW

(Mon-Thurs, 9am-5pm Pacific time)

Circle (63) on Rapid Facts Card

MISCELLANEOUS

THE MOST COMPLETE
SELECTION OF

AUDIO TEST TAPES

All formats including cassettes
Write or phone for free catalog

STL

STANDARD TAPE LABORATORY, INC.

26120 Eden Landing Road #5, Hayward, CA 94545

(415) 788-3546

Circle (64) on Rapid Facts Card

ESP

EASTERN STANDARD PRODUCTIONS
26 BAXTER ST., BUFFALO, NY 14207

- AUDIO CASSETTE DUPLICATION
High Quality Real Time
- VIDEO CASSETTE DUPLICATION
All Formats
- CUSTOM PRINTING & PACKAGING
Labels - Inserts - Shrink Wrap
- DIRECT ON CASSETTE PRINTING
- CUSTOM LOADED BLANK
CASSETTES

CALL TOLL FREE
1-800-527-9225

Circle (85) on Rapid Facts Card

ACOUSTIC FOAM



GIANT
54" x 54"
\$19.99
Per Sheet!!

KILL NOISE QUICK! Soundproof studios, vans, rooms with super-effective, E-Z mount, 2" thick studio gray Marker-foam. Immediate shipping. Add \$3.50 sheet shipping. NYS residents add 7% tax. MC Visa Amex COD Check Terms. 3" sheets also available at \$29.99.

800-522-2025

(In NY 914-246-3036)

America's most unique
catalog for the professional!

MARKERTEK™
145 Ulster Ave. Saugerties
New York 12477 USA
VIDEO SUPPLY

Circle (86) on Rapid Facts Card

ADVERTISERS' INDEX

SALES OFFICES

	Page Number	Rapid Facts Number	Advertiser Hotline
ADX Systems	70	39	212/532-5576
Agfa Corporation	9	6	201/440-1500
Alesis Corp.	1	2	
Alpha Audio	59	34	804/358-3852
American International Audio Video	35	16	609/888-4414
Ampex Magnetic Tape Div.	15	9	415/367-3809
Aphex Systems Ltd.	67	36	818/765-2212
APRS	60		
Audio Control Industrial	63	32	206/775-8461
Audio Engineering Society	70		800/541-7299
Audio Video Research	77	60	617/924-0660
B&B Systems	61	30	805/257-4853
Bruel & Kjaer — Denmark	64	33	
Cal Switch	74	45	213/770-2330
Carver	33		818/442-0782
Cook Laboratories	77	61	800/553-COOK
Cooper, J L Electronics	37	17	213/306-4131
Countryman Associates	76	48	415/364-9988
The DAT Store	74	44	213/828-6487
Denecke, Inc.	72	42	818/766-3525
DIC Digital Supply Corp.	43	20	800/DAT-IDIC
Dolby	11,13	8,13	415/558-0200
Dorrrough Electronics, Inc.	49	23	818/999-1132
Editron	69	38	213/464-8723
Eastern Standard Prod.	79	65	800/527-9225
Europadisk, Ltd.	79	62	212/226-4401
Everything Audio	41	19	818/842-4175
Fostex Corp. of America	39	18	213/921-1112
Full Compass Systems	68	37	800/356-5844
Gefen Systems	73	43	818/884-6294
GML	29	14	818/781-1022
Jensen Transformers, Inc.	79	63	213/876-0059
JRF Magnetic Sciences, Inc.	76	49	201/579-5773
Kaba Research & Development	47	22	800/231-TAPE
Klark-Teknik Electronics, Inc.	IBC	1	516/249-3660
Markertek Video Supply	79	66	800/522-2025
Neutrik U.S.A., Inc.	59	28	609/327-3113
Neve, Inc.	55	26	203/744-6230
Otari Corp.	25		415/341-5900
Panasonic (Ramsa Div.)	21	11	714/895-7278
Polyline Corp.	65	35	312/298-5300
Pulizzi Engineering, Inc.	75	46	714/540-4229
Radian Audio Engineering, Inc.	72	41	714/961-1213
Ram Broadcast Systems, Inc.	45	21	312/358-3330
Rane Corp.	17	10	206/774-7309
Saki Magnetics, Inc.	75	47	818/880-4054
Shure Brothers, Inc.	IFC-1	2	312/866-2228
Solid State Logic	71		
Soundcraft USA	BC		818/893-4351
Soundmaster U.S.A., Inc.	57	27	805/494-4545
Soundtracs Division	31	15	
Spars (Society of Professional Audio Recording)	53		407/641-6648
Sprague Magnetics, Inc.	63	31	800/553-8712
Standard Tape Laboratory, Inc.	79	64	415/786-3546
Studer Revox/America	5	4	615/254-5651
Symetrix	51	24	206/282-2555
TASCAM Div./Teac Corp.	7	5	213/726-0303
Trident USA, Inc.	27	13	213/533-8900
3M/Magnetic Media Division	23	12	

OVERLAND PARK, KS

Mary Tracy
913-541-6637
P.O. Box 12901
Overland Park, KS 66212
Telephone: 913-888-4664
Telex: 42-4256 Intertec OLPK
Telefax: 913-888-6697

SANTA MONICA, CA

Herbert A. Schiff
213-393-9285
Jason Perlman
213-458-9987
Chris Woodbury Leonard
213-451-8695
501 Santa Monica Blvd.
Santa Monica, CA 90401
Telefax: 213-393-2381

NEW YORK, NY

Stan Kashine
212-702-3401
29th Floor
866 Third Ave.
New York, NY 10022
Telefax: 212-702-7802

OXFORD, ENGLAND

Nicholas McGeachin
Roseleigh House
New Street
Deddington, Oxford
OX5 45P England
Telefax: (0869) 38040
Telephone: (0869) 38794
Telex: 837469 BES G

FREWVILLE, SOUTH AUSTRALIA

John Williamson
Hastwell, Williamson, Rep.
Pty. Ltd.
109 Conyngham Street
Frewville 5063
South Australia
Phone: 799-522
Telefax: 08 79 9735
Telex: AA87113 HANDM

TOKYO, JAPAN

Mashy Yoshikawa
Orient Echo, Inc.
1101 Grand Maison
Shimomiyabi-Cho, 2-18
Shinjuku-ku, Tokyo 162, Japan
Telephone: 03-235-5961
Telex: J-33376 MYORIENT

AMR²⁴

Track Record

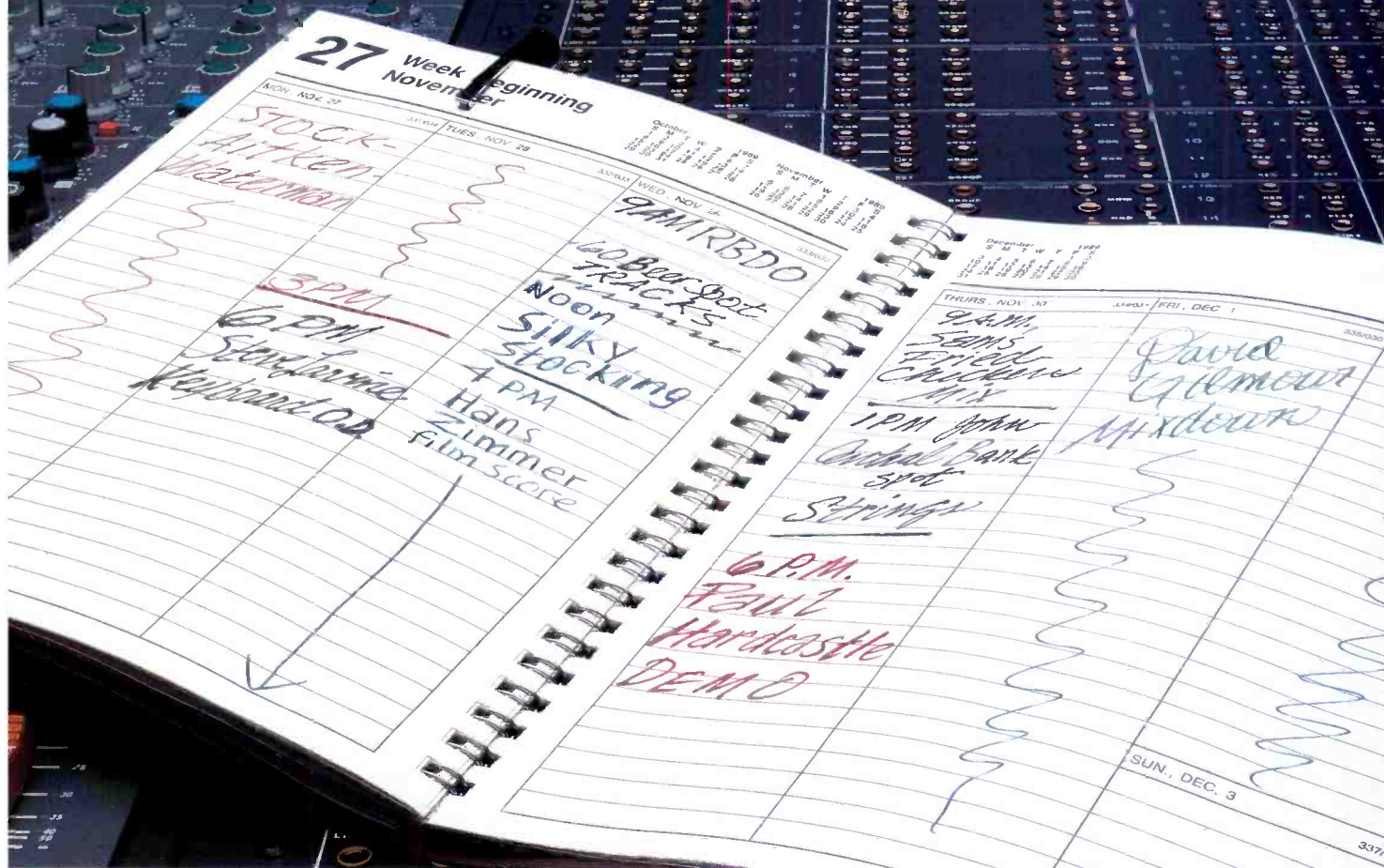

BUSY

Today, some of the world's busiest studios are built around the AMR 24 console. Designed for a higher standard of performance, the AMR 24 offers more inputs, more flexibility and the highest levels of audio quality for day-to-day recording and mixdown.

TRACKING

As a tracking console, the AMR 24 consistently achieves superior results the *first time* — no re-recording required. With exceptionally low crosstalk and noise, and a total dynamic range of

100 dB, it is fully compatible with digital audio.

MIXDOWN

Configured for mixdown, the AMR 24 offers unrivaled flexibility. It handles all kinds of inputs — up to 84 of them in a standard format. Just push *one button* and the 24 Track Select switch changes the monitor returns to full-function line returns normalled to a second 24 track or to synchronized MIDI "virtual tracks." Simple switching creates an additional 24 inputs through the cue faders for effects returns.

Up to 64 channels can be automated with a wide range of factory fitted systems available.

Of course, these DDA design innovations are complemented by the highest quality components and designs that *feel right*.

INVESTMENT

Studio owners know why the AMR 24's track record represents an impressive return on their creative and financial investment. If that news sounds interesting, write us on your letterhead for full information.



Klark-Teknik Electronics Inc., 30B Banfi Plaza North, Farmingdale, NY 11735 (516) 249-3660
Unit #1, Inwood Business Pk., Whitton Rd., Hounslow, Middlesex, UK TW3 2EB 011-441-570-7161

Circle (1) on Rapid Facts Card

Circle #097 on Reader Service Card

This is the mixing console that will cause a revolution in 24 track studios.

The world's first Dual Mode mixing console.

With the advanced features and performance of a desk you'd expect to cost a great deal more than it actually does, it's a remarkable achievement. Take Dual Mode.

When you record with the TS12, its in-line monitoring means you create a control room mix on the main faders.

In mixdown this becomes the basis for your master mix. Saving time and helping you keep a train of thought as to how the final mix will sound.

Unlike other in-line desks, though, the TS12 also allows true stereo subgrouping on long-throw group faders.

In this mode the routing matrix offers either six stereo groups or four extra auxiliary sends – totalling ten sends – plus four stereo groups.

No other console in the world provides such versatility.

The TS12 is an open-ended investment, with optional disc-based SMPTE automation for faders, mutes, EQ in/out and auxiliary on/off. Again, at the price it's unique.

And fittingly, audio performance is superb.

Recent Soundcraft advances in summing amp technology, and in grounding and decoupling systems, make the TS12 one of the cleanest and quietest consoles ever.

The mic amplifiers, a critical factor in console quality, create less than 0.01% distortion at 10kHz at 70dB of gain. (Easily exceeding 16-bit digital specifications.)

Standard features are impressive, to say the least. Six auxiliary sends, seven stereo line inputs or effects returns, a 'musician friendly' headphone mix, an extensive 19" metal frame patchbay – and the option to create a massive total of 102 inputs.

Quite a line-up.

Attention to detail is equally stringent with modular PCBs, no dual concentrics and a clear, logical layout that belies the sophistication inside.

But the most remarkable feature of the new TS12 is without doubt the price.

We suggest you call us today to find out just how remarkable.

ALL THE FEATURES YOU'D EXPECT IN A \$50,000 CONSOLE, EXCEPT ONE THE PRICE.



Soundcraft
TS12