

SHORT WAVE CRAFT

Edited by HUGO GERNSBACK 1933

July

Best Short Wave Station List of the World

When to hear the Foreign Stations

ALL IN THIS ISSUE



SHORT WAVE COMFORTS DE LUXE

NOW 25¢
IN CANADA 30¢

A COMPLETE RADIO SERVICE FOR DEALERS

THE HOUSE OF MANY BARGAINS—EVERYTHING AS ADVERTISED



The Champion AC-DC

For home, office, farm, AUTO. 6 volt, 32 volt, 110 volt. 25 and 60 cycle.

Write for particulars—you can now have an auto radio at very little cost.

The Champion is interchangeable—AC or DC current or with batteries. Latest type tubes, bestness cord. Latest features are employed in making this set the most versatile and economical set ever built. Type tubes used are 30-38-78-12Z3.

\$9.45

Price complete with tubes. Auto cable for use in car.....\$1.59

INTERNATIONAL TUBE TESTER AND REJUVENATOR



Actually rejuvenates tubes, and an efficient tube tester. A 2-unit outfit in one! Increase your tube sales with this profitable making item.

\$15.00

Dealers: Write for quantity Prices.



Pioneer Gen-E-Motor Auto "B" Eliminator

The original Gen-E-Motor. A highly efficient, improved dynamotor for auto-radio and farm use. Self-lubricating, built in filter. Absolutely noiseless—very compact. Dimensions are 3 3/4" x 5 1/2" x 5 1/2". Weighs only 10 lbs.

\$9.70

Your Price.....

International Short Wave Converter. Will operate on any type of antenna and radio having a normal broadcast range of 500 miles or over. Actually operates on ten meters wavelength. Can be made a special order to operate on 220 volts, 32 volts, or 6 volts.

Operates on AC or DC, 60 cycle or 25 cycle—4 position wavelength switch. Comes in attractive metal cabinet (Beautiful walnut cabinet \$1.00 extra). Complete with 2 latest type tubes.....

\$6.95

Champion All-Electric Auto Radio

A five tube super-heterodyne—automatic volume control and full electrodynamic speaker. Carter remote control. Only one bolt to fasten and one wire to connect. Installed in a jiffy. Latest type tubes used. 6A7-6B7-41-78-84. Complete with suppressors and R. C. A. tubes.

Your Price..... **\$19.95**



Jefferson sealed audio frequency transformer 2 to 1 and 3 to 1 ratio.

Your price.....65c Fully shielded Philco output transformer.....52c



Audio Transformer 3 to 1—small size, will fit anywhere. Your price.....

25c

Thorndarson 3 1/2 to 1 fully shielded transformer. Your Price.....

25c

San gomo—push pull speaker output transformer. Your Price.....

45c

Power Transformer No. 9593R—



carries the following tubes—7-24 or 27; 2-45 or 47; 1-80 or 83 and 750 V.C.T. This transformer fully shielded and can be used for as many as 12 tubes. Your Price

\$1.95

Limited Quantity

Dongan all enclosed Push-Pull output and input transformer.....Your Price 65c Donzani chokes to match.....Your Price 45c 800 volt condenser block total 800 M.F.D.....Your Price 75c

A 25% deposit required with each order. Balance C. O. D. All items advertised. Satisfaction guaranteed.

Service Carbon Resistors—RMA Color-Coded.



Can furnish in all values from 100 ohm to 3 meg ohm.
1/2 and 1/3 watt.....3c each. \$2.50 per 100
1/4 watt.....4c each. \$3.25 per 100
1 watt.....5c each. \$3.95 per 100
Assorted sizes in 1000 lots.....\$29.50



AC Grooved Toggle Switch 1/2" sleeve—single pole
Your Price **9¢** each

E-Z Toon Vernier dial.
Black and Brown—3".....**10c**
1/4" hole for shaft—5".....**17c**



Tung-Sol multiple condenser in cans. 4, .1, and .5 Dual-condensers—1. 300 volts.....Your Price 25c
Condenser—small size in cans .1.....Your Price 15c
Condenser—small size in cans .3.....Your Price 7c
Condenser—small size in cans .5.....Your Price 5c

Power packs— Filter packs— Power supply packs

ZE-182—25 Cycle—Power Pack
ZE-18—60 Cycle—Power Pack
ZE-18X—60 Cycle—Power Pack
ZE-18—Filter Pack—25 cycle
ZE-15—Power Pack—25 cycle
ZE-13—Power Pack—25 cycle
ZE-12—Power Pack—60 cycle
ZE-12X—Power Pack—60 cycle
ZE-10—Power Pack—60 cycle
ZE-8—Filter system for 8 tube loop elec-



tric set
ZE-81—Filter system for 8 tube loop electric set
ZE-4—Power supply for Model 27 receiver
ZE-3—A Battery Eliminator 15 volt—60 M. A.
Your Price. **\$3.95**

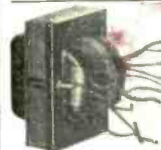

Balkito Audio Transformer, 3 to 1 ratio.....**49c**
Balkito 30 henries, 80 M.A. choke.....**49c**



Transformer No. 1443—2 1/2 volt set 8 amps, 5 volt at 3 amps. for 83 tube, 750 V.C.T., 60 cycle.

\$1.45

Same as above in 25 cycle.....**\$1.65**

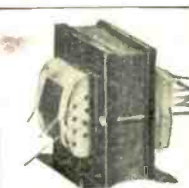
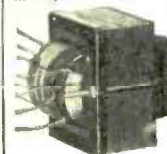

Thorndarson No. 3022A—carries the following tubes—4-20's; 2-27's; 2-71's; 1-80. Limited Quantity. Your Price **\$1.75**

Thorndarson No. 3773—full shielded carries the following tubes—2-20's; 2-81's; 6-tube type tubes—1200 V. C. T. Your Price **\$3.95**

DEALERS: We carry many more wonderful bargains. If you don't see what you want, write to us. That's part of our service to you.

SERVICE MEN'S SALES CO.

1621 So. Michigan Ave.

Dept. SWC-7

Chicago, Ill.

Book Review

Practical Television, by E. T. Lerner, with a foreword by John L. Baird. Size, 5 1/2"x8 3/4"; 224 pages; 127 illustrations; published by the D. Van Nostrand Co., Inc., New York, N. Y. Price \$3.75.

This is a very excellent handbook on the practice and theory of television, written by a member of the Engineering Department of the General Post Office, London. Mr. Lerner illustrates very nicely with photos and diagrams the basic optical phenomena on which television is based, including several diagrams and descriptions of some of the early attempts at the solution of the television problem. Later chapters take up selenium and selenium cells; diagrams and descriptions of European and American television systems, including a description of the Moore crater tube; Alexanderson's apparatus; the cathode ray television; the John L. Baird system; the Baird color television system; stereoscopic television; stereoscopic color television. The book concludes with a chapter on the construction of a simple television broadcast receiver, with scanning disc dimensions. It has a good index.

The Radio Amateur's Handbook, by A. Frederick Collins; cloth covers; size 5 1/2"x8"; 420 pages; 107 illustrations, including a complete vacuum tube chart and table showing socket connections; published by Thomas Y. Crowell Co., New York, N. Y. Price \$2.00.

No radio amateur's library or book-shelf is complete without this really excellent handbook written by Mr. Collins, who was one of the first to build and demonstrate wireless telephone apparatus in this country. Mr. Collins possesses the happy faculty of explaining radio subjects in the correct technical sense, which are at the same time susceptible of clear understanding by the youngest reader. This popular book on Amateur Radio appeared among the first, and has been continuously reprinted and revised, not only to meet the demand but also to present constantly a work that should be accurate and up-to-date. Although previous editions were thoroughly revised, the sixth was in many essentials a new work. It was entirely reset, with new and clearer cuts. New chapters are included—among others: the Hammarlund "Hi-Q 30" Broadcast Receiver; A 245-Pushpull Radio and Phonograph Amplifier; New Developments in Vacuum Tubes; A Low-Power Telegraph Transmitter; A Combination 10-Watt Telegraph and Telephone Transmitter; The Construction and Use of Wavemeters; Radio-division—the Amateur's Next Job; and Radio in Other Fields. The Seventh Edition contains the following new material: Chapter XIX-A, "Further Developments in Vacuum Tubes"; Chapters XXVIII, XXIX, and XXX, "Radio and Talking Motion Pictures," "The Photoelectric Cell and Its Uses," "Ultra Short Waves." Additions have been made to Chapter XXVI: "Cathode Ray Television," and "The Peck Television System." The illustrations have been augmented by four new half-tone plates, sixteen new line cuts, and an elaborate "Characteristics Chart." By their aid almost any amateur ought to be able to work out his own radio salvation. In fact, both the amateur and the expert will find this book a species of Radio Bible.

When to Listen In

(Continued from page 139)

N.B.C. Short-Wave Station News

During the period of daylight saving time, the schedule of the National Broadcasting Company short-wave stations, W2XAF and W2XAD, Schenectady, New

York, will be as follows: W2XAD, 19.56 meters, Monday, Wednesday, Friday, 3:00 to 4:00 p.m., E.S.T., and Sunday, 2:00 to 4:00 p.m., E.S.T. W2XAF, 31.43 meters daily from 6:45 to 10:00 p.m., E.S.T.

Because of the fact that Daylight Saving Time is not universally used, we are making no attempt to translate any time schedules into Daylight Saving figures, as a great deal of confusion would inevitably result. It is a very good idea for short-wave "fans" to keep a separate clock near their receivers adjusted to the standard time of their zone rather than to the Daylight Saving Time. This makes the calculation of listening schedules much easier.

* * *

Here's the "Dope" on KEZ, Bolinas, Calif.

We are indebted to Mr. E. F. Stephens, 516 W. Island Avenue, Redlands, Calif., for a letter of acknowledgment received from the Radio Corporation of America in regard to Station KEZ, Bolinas, Calif., which operates on 10,400 kc. We are publishing this letter in full because we receive so many inquiries about the commercial telephone stations and their methods of operation.

"This will acknowledge receipt of your letter dated January 4, 1933, in which you report the interception at 0130 GMT, January 4, 1933, of radiotelephone transmission from station KEZ.

"This station is located at Bolinas, Calif., and is operated on its assigned frequency of 10,400 kilocycles. It is a point-to-point communication station, not a broadcasting station, and is one unit of the public service world-wide communications system of R.C.A. Communications, Inc., a subsidiary of the Radio Corporation of America, through which direct radiotelegraph circuits are maintained between the United States and 43 foreign points. Supplementing its radiotelegraph services the company also operates transoceanic point-to-point radiotelephone services for the transmission of addressed program material between the United States and points abroad.

"The program material so transmitted is specifically addressed to the organization abroad which is to make use of it. It is not intended for general public reception and use. Regular schedules are not maintained, transmission is effected when and as the program material is offered by a customer for transmission, and the station or frequency utilized is dependent upon the propagation phenomena of the season, time of day, direction, and distance of the foreign point to be reached. The power varies from one to forty kilowatts according to transmission conditions and usually a directional antenna is employed.

"The transmission which you intercepted may have been either addressed program material or point-to-point transmission for observation at a specific foreign terminal. In either case it is classified by international treaty and United States law as point-to-point communication concerning which an obligation of secrecy is imposed, both upon us and upon any chance intercepting listener. Such communication is 'correspondence of a private nature' of which 'the unauthorized reception,' 'the unauthorized divulging of the contents or simply of the existence' or 'the unauthorized publication or use' is in violation of the secrecy provisions of the International Radio Convention.

"With this in mind you will no doubt appreciate that we may not supply any confirmation of material transmitted by our stations."

Yours very truly,

Lloyd A. Briggs.

"P. S. KEN, 6845 kc., is one of our stations located at Bolinas, Calif. W6XI is one of our special experimental stations located at Bolinas, Calif."

Here It Is!

The finest and most ingenious STATION FINDER and RADIO MAP of the World

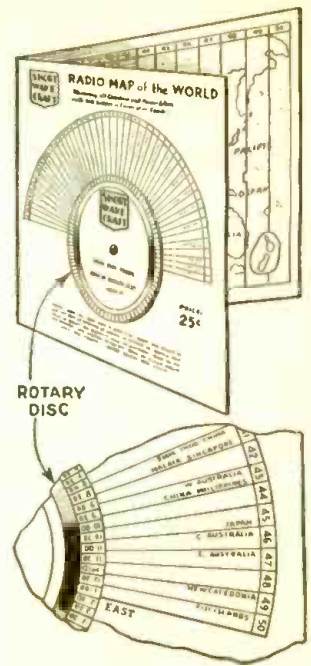

Here is a device that no radio man should do without. It lends that professional dignity to your den. It instantly shows you the exact time in any foreign country.

Professional short wave listeners are never without this station finder because they do not twiddle the dials needlessly in trying to fish for stations which may not be on the air due to time difference.

This handy device is printed on heavy yellow board; on the front there is the automatic time converter, which rotates; you can set it for any time of the day in fifty different zones in the world. On the inside are illustrated the fifty zones showing the principal countries of the world. All the important cities are shown, and inasmuch as they are all zoned, the exact time can be converted within a few seconds.

The size of the station finder and radio map of the world is 11x22.

The price of this handy device is 25c prepaid.

However, it is sold only to members of the Short Wave League. Outsiders cannot buy it.

We refer you to page 68 for order blank. Take advantage of this opportunity at once, and get rid of your present annoyance in calculating the time for the different countries.

SHORT WAVE LEAGUE

98 Park Place

New York, N. Y.

BARGAINS ON ARMY and NAVY RADIO SURPLUS

An ideal combination for the experimenter and Amateur learning the code. This Headphone Receiver and Transmitting Key.

ARMY HEADPHONE RECEIVER
100 ohm. \$7.50
Transmitting key, army air corps. Silver M contacts, with blinker light. Reduced to..... \$1.50

EDISON STORAGE BATTERIES
All Types—1.2 Volts per Cell

A-4	Amps. 175	Per cell	\$3.50
A-6	Amps. 225	Per cell	4.00
A-8	Amps. 300	Per cell	5.00
B-4	Amps. 90	Per cell	3.50
M-8	Amps. 11	Per cell	1.00
L-0	Amps. 25	Per cell	1.50
J-3	Amps. 37	Per cell	3.00

Special buy on Western Electric Relay with adjustable Platinum contacts. Capable of controlling a local circuit with a very low primary consumption (6-volt battery) only a few left. Special \$3.50

WRITE FOR OUR BARGAIN BULLETIN

MANHATTAN ELECTRIC BARGAIN HOUSE
105 Fulton St. Dept. 5 N. Y. City

3 Years Hence

You will be interested in tracing the early developments of Short Waves. Your best source of information will be SHORT WAVE CRAFT. Back numbers may be had at 25c per copy. Address: SHORT WAVE CRAFT, 96 Park Pl., New York.

Radio Operating—Radio Servicing

Prepare for the new Government Radio Operating license examinations: Radio Operator, Marine and Broadcasting. Also Radio Amateur Telegraph and Telephone. Resident courses. Write for booklet.

"Opportunities In Radio"
West Side YMCA Trade & Technical Schools
18 West 63rd Street New York City

an old timer says—

San Francisco, Calif.

Gentlemen:
 Allow me to congratulate you on Myron F. Eddy's "How to Become an Amateur Radio Operator." I have been a "ham" since 1909 and have worked up from the open crashing sparks of "Old Betsy's" and took sullenly to these new fangled gadgets and had to park "Betsy" in the junk heap under the eaves to go in for tubes. I'm too old now to dabble in the game very much but in my teaching a bunch of ether disturbing young squirts here—all Boy Scouts, I still get a certain "kick" out of it. I purchased nine copies for my gang and I suppose five or six others got them because they saw ours—had to send to Oakland for three additional copies. They're GREAT!

One of the "Old Men" of Radio
 Ex. Lieut. Al. A. Weber (Retired)
 1153 Capp St., San Francisco, Calif.



50c
 EACH



THERE is not a radio man in the field, experimenter, service man or dealer who will not want to read these two books. Right up to the minute with outstanding developments in short-wave radio—new methods and apparatus for quickly learning how to become a practical radio operator. Each book is authoritative, completely illustrated and not too highly technical. The text is easily and quickly grasped.

How to Become an Amateur Radio Operator
 We chose Lieut. Myron F. Eddy to write this book because his long years of experience in the amateur field have made him pre-eminent in this line. For many years he was instructor of radio telegraphy at the R.C.A. Institute. He is a member of the I.R.E. (Institute of Radio Engineers), also the Veteran Wireless Operators' Association.

If you intend to become a licensed code operator, if you wish to take up phone work eventually, if you wish to prepare yourself for this important subject—this is the book you must get.

Partial List of Contents

Ways of learning the code. A system of sending and receiving with necessary drill words is supplied so that you may work with approved methods. Concise, authoritative definitions of radio terms, units and laws, brief descriptions of commonly used pieces of radio equipment. This chapter gives the working terminology of the radio operator. Graphic symbols are used to indicate the various parts of radio circuits. General radio theory particularly as it applies to the beginner. The electron theory is briefly given, then waves—their creation, propagation and reception. Fundamental laws of electric circuits, particularly those used in radio are explained next and typical basic circuits are analyzed. Descriptions of modern receivers that are being used with success by amateurs. You are told how to build and operate these sets. Amateur transmitters. Diagrams with specifications are furnished so construction is made easy. Power equipment that may be used with transmitters and receivers, rectifiers, filters, batteries, etc. Regulations that apply to amateur operators. Appendix, which contains the International "Q" signals, conversion tables for reference purposes, etc.

How to Build and Operate Short Wave Receivers

is the best and most up-to-date book on the subject. It is edited and prepared by the editors of SHORT WAVE CRAFT, and contains a wealth of material on the building and operation, not only of typical short-wave receivers, but short-wave converters as well. Dozens of short-wave sets are found in this book, which contains hundreds of illustrations; actual photographs of sets built, hook-ups and diagrams galore. The book comes with a heavy colored cover, and is printed throughout on first-class paper. No expense has been spared to make this the outstanding volume of its kind. The book measures 7½x10 inches. This book is sold only at such a ridiculously low price because it is our aim to put this valuable work into the hands of every short-wave enthusiast.

We know that if you are at all interested in short waves you will not wish to do without this book. It is a most important and timely new radio publication.

Over 150 Illustrations in Each Book

72 Pages 7x10 Inches Heavy Colored Covers

Not Sold on Newsstands

SHORT WAVE CRAFT

98-98 Park Place, New York, N. Y.

Amateurs who made good

Pierre Boucheron

● THE name of Pierre "Pete" Boucheron first became known in radio circles in 1908, when the "wireless" bug first bit him. Subsequently, he was heard from as an editor and also as the author of innumerable articles on radio and allied subjects. Later he became even more widely known as an important sales and advertising executive of the largest radio organization in the world.

It was in 1908 that Boucheron learned the code, bought the necessary equipment and became a dyed-in-the-wool "ham." With a 1-inch untuned spark coil and a hundred-foot aerial on the top of an apartment house in the East Forties of New York, he became "PX" to other amateurs within a radius of fifty miles. At the time he was one of only three amateurs in New York. His receiving apparatus consisted of a galena, carborundum, perickon, or Marconi magnetic detector and a tuning coil. As an amateur he held frequent converse via the air waves with such notables as Edwin Howard Armstrong, of superheterodyne fame; George Eitz, now of the Continental Radio Corporation; Walter Burchardt, John Grinan, Dr. Hudson and others.

Boucheron plied his hobby as a "ham"

Pierre H. Boucheron was once a dyed-in-the-wool "Ham." You will find most interesting the history of his rise to the position of advertising manager and sales promotion director of the R. C. A. Victor Company.



until 1912, when he diverted his radio proficiency into more practical channels by going to sea as a wireless operator. After four eventful years at sea, he enrolled in the United States Naval Reserve as Second Class Radio Electrician, and in 1919 was released from active duty with the rank of Ensign. Hugo Gernsback then engaged him for the staff of the original Radio News Magazine, of which he soon became Managing Editor, and was one of those who helped build this pioneer publication to the point where it was the leader in its field.

At the invitation of Mr. David Sarnoff, another famous amateur, who was then vice president and general manager of the Radio Corporation of America, Boucheron took over the position of advertising and publicity manager for the largest radio organization in the world. After eight years in this important capacity, he was placed in charge of RCA's Atlanta District sales office and of the entire Southern sales territory. With the formation of the RCA-Victor Company, and the unification at Camden, New Jersey, of the RCA and Victor organizations, Mr. Boucheron was appointed manager of advertising and sales promotion, which position he now holds.

Second only to radio is Pierre Boucheron's love of the sea and all its implications. He is an ardent motorboat enthusiast, and has kept up his interest in U. S. Naval Reserve activities. Recently Mr. Boucheron was notified by the United States Navy Department at Washington of his promotion to the rank of Lieutenant Commander in the U. S. N. R.

SHORT WAVE CRAFT
 98-98 SWC Park Place,
 New York, N. Y.

Gentlemen: I enclose herewith \$.....
 for which please send me, prepaid a copy
 of the book checked.

() HOW TO BUILD AND OPERATE
 SHORT WAVE RECEIVERS—50c
 () HOW TO BECOME AN AMATEUR
 RADIO OPERATOR—50c

Send money order, check, cash or new
 U. S. stamps. Register letter if it
 contains stamps or currency.

Name

Address

City..... State.....

SWAPPERS

SWAPPERS are swappers of correspondence. During the past few years we have noted that Short-Wave enthusiasts love to get acquainted with each other by mail in order to swap experiences.

Use a postcard only. Never write a letter. Address postcard as follows:
SWAPPERS, c/o SHORT WAVE CRAFT, 96-98 PARK PLACE, NEW YORK, N. Y.

On the blank side of the postal PRINT clearly your name, address, city and State; nothing else! No charge for this service.—EDITOR.

- JOSEPH A. ADAMS
2735 Haskins Avenue, Chicago, Illinois
- WALTER R. ANDREWS
East Side—St. Charles Ave., Ridgewood, Relay P.O., Md.
- BILLY BAKER
1717 Wilmer Ave., Anniston, Ala.
- V. H. BAUER
338 Peshine Ave., Newark, N. J.
- RAMON E. BAUZA
Bertoly G. Ponce, P. R.
- ARTHUR BEAM
319 E. Livingston Street, Celina, Ohio
- RUSSELL BECK
14500 Northfield, E. Cleveland, Ohio
- WALTER G. BORNEMANN
9055 S. Carpenter Street, Chicago, Ill.
- H. ELLSWORTH BOSTWICK
91 Fenwick Avenue, Springfield, Mass.
- W. E. BURNHAM
5400 Lexington Ave., Hollywood, Calif.
- E. J. CASTRA
1368 St. Marks Ave., Brooklyn, N. Y.
- DUNCAN CHAFFEE
New Melrose Theatre, Melrose, Mass.
- W. C. CLARK, W4BJX
1420 Boulevard, N. E., Atlanta, Ga.
- E. C. LA COOK
62 E. Rosewood Street, Akron, Ohio
- EDMUND H. DAVENPORT
R. F. D. No. 1, Pittsford, Vt.
- ROY DAVIS
P. O. B. 109, Orange Park, Fla.
- ALBERT DOCKING
407 Market Street, Bangor, Pa.
- RAMON DRURY
Box 72, Prentice, Wis.
- E. L. FELDER
P. O. B. 91, Tylertown, Miss.
- F. E. FOLCK
128 E. Reel Ave., Vincennes, Ind.
- ROBERT GEDNEY
36 Sanford Street, Rye, N. Y.
- C. GERARD
1 Strong Street, E. Haven, Conn.
- W. E. GDTT
2520 S. Logan Ave., Milwaukee, Wis.
- J. F. HAGELE
21 Elm Place, Rye, N. Y.
- CARL HILL
11 Dutcher Place, Poughkeepsie, N. Y.
- C. R. HIRSEKORN
202 Rounds Ave., Buffalo, N. Y.
- M. A. HOLLEY, W1FHM
31 Lexington Parkway, Pittsfield, Mass.
- GEORGE HOSKINSON
Glendale, Ky.
- LEWIS HYETT
2223 Catharine Street, Philadelphia, Pa.
- THEODORE R. JACOBS
3416 Minnesota Ave., Duluth, Minn.
- W. F. JAHN, JR.
957-12 No., Seattle, Wash.
- FRANK KINDLER, JR.
217-7th Avenue, N., St. Cloud, Minn.

- CHARLES E. MAAHSEN
1732 6th Street, Prospect Hgts., Trenton, N. J., R. F. D. No. 36
- HOUSTON McCLURE
1900 Broadway, Paducah, Ky.
- GEORGE MCKINLEY
1936 Maud Avenue, Chicago, Ill.
- W. A. MEAD
Cor. Mason Ave., N. Billerica, Mass.
- H. H. MEHL
P. O. B. 78, Congers, N. Y.
- D. MELE
39 Foxon Road, East Haven, Conn.
- JACK NAJORK
Doris Avenue, Northport, N. Y.
- HERBERT E. NELSON
144 West 54 Street, New York, New York
- O. INGMAR OLESON
Ambrose, N. Dak.
- DICK C. OVERHOLT
710 Clayton Street, San Francisco, Calif.
- F. V. PEARCE
211 Oak Street, Georgetown, Ill.
- J. H. POLETES
14 Hamilton Street, Pawtucket, R. I.
- M. J. POLUTNIK
1711 E. 30 Street, Lorain, Ohio
- WALTER ROBINSON
445 Circle Avenue, Washington C. H., Ohio
- GEORGE ROCHE
15 Prospect Street, Amesbury, Mass.
- ALFRED ROSENBERG
14516 Northfield Ave., E. Cleveland, Ohio
- IVAN ROSS
69 Messenger Street, St. Albans, Vt.
- SIMON H. SASSER, JR.
P. O. B. 46, Hawthorne, Fla.
- RAY J. SCHULTZ
R. No. 3, Mt. Clemens, Mich.
- CARL SCHULTZ
71 Seventh Avenue, Paterson, N. J.
- RAY T. SCHULTZ
R. No. 3, Mt. Clemens, Mich.
- J. L. SCHWARTZBERG
84 Neptune Ave., Woodmere, N. Y.
- LOUIS SELTZER
2310 Margaret St., Philadelphia, Pa.
- NIONEL SIMONEAU
Arlington Street, Bristol, Conn.
- STEPHEN SLUKA
20 Spring Street, Trenton, N. J.
- Q. J. SMART
Box 54, Quinter, Kansas
- JACK SNELSON
1515-21st Street, Galveston, Texas.
- H. M. SMITH
P. O. B. No. 212, Monroe, N. C.
- MATTHEW J. SOKOTOWSKI
14 Hamilton Street, Pawtucket, R. I.
- CHARLES SOVATSKY
169 West Ridge Street, Nanticoke, Pa.
- RODERICK SOUTHWORTH
169 Park Place, Brooklyn, N. Y.
- MARTIN L. STAHL
612 Roberts Avenue, Glenside, Pa.
- WILLARD THIEL
Valders, Wis.
- RICHARD THULL
108 Library Avenue, Rutland, Vt.
- LEWIS N. TILLEY
Box 203, Grand Cane, La.
- HEATH WAYNE
R. R. 3, Yorkville, Ill.
- EARL S. WELLER, W9GCV
224 Van Buren Street, Litchfield, Illinois
- M. WENTZ, W8EEQ
618 W. Hardin Street, Findlay, Ohio
- FRANK WILLIAMS, W9KIT
746 N. 14th Street, E. St. Louis, Mo.
- HAROLD F. WINTER
128 Scotch Plains Avenue, Westfield, N. J.
- MELVIN YOUNGMAN
Eureka, Illinois.
- THOMAS YOUNT
204 C. N. B. Bldg., Sedalla, Mo.
- TOMMY L. YOUNT
204 C. N. B. Bldg., Sedalla, Mo.

FREE 104 Page RADIO and SHORT WAVE TREATISE



Avail yourself now of the opportunity to receive the free 1933 in ter edition of our Radio and Short Wave Treatise, No. 26, 104 solid pages of useful information, radio items, diagrams, illustrations, etc. Considerably larger and more instructive than our No. 25 issue. If you had our treatise No. 25 and incidentally all our previous issues, you are familiar with the type of book we publish; but the new No. 26—what a book! The entire editorial section is new from beginning to end—not an old word remains. Considerable space has been devoted to articles for the radio beginner. This alone is worth its weight in gold. The Superheterodyne principle is thoroughly explained in this issue in clear, simple language. No. 26 is not just another catalog. It contains more valuable and up-to-date information than can be found in any radio text book on the subject.

Over 100 New Hook-Ups, Etc. 1000 Illustrations.

Write Today. Enclose 4 cents for postage. Treatise sent by return mail.

RADIO TRADING CO.
100A Park Place New York City

ELIMINATES STATIC NOISES PURIFIES RECEPTION SHARPENS TUNING

YOU CAN MAKE BIG MONEY by selling this remarkably efficient Selectivity Intensifier and Inter-Station Noise Suppressor to every set owner you call on. Our Agents sell as many as 25 weekly. You make a \$1.00 profit on each sale! Installed in a jiffy—No Wiring Changes necessary. Takes the place of complicated Wave Traps, Band-Pass Filters, Noise Eliminators, etc. Provides "Super-Het" "DX" Range and Razor-Edge Selectivity for any receiver. Brings in all distant programs. Acts as an efficient REMOTE VOLUME CONTROL and "SQUELCHER." Eliminates objectionable advertising propaganda. Approved by Leading Set Manufacturers. Guaranteed. \$1.00 Complete, Postpaid. Send Cash or Money Order.

AGENTS-SERVICE MEN! Make BIG MONEY! Sell on Sight! Your Profit ONE DOLLAR per SALE!

RADIO COMPONENTS MFG. CO. 63 S. West 24th ST. N.Y.C.

The 59-A Triple-grid "Output" Tube

(Continued from page 150)

to mention that to have two of these tubes develop the rated output of 20 watts, a good, "heavy" (strong) signal is needed—which means an additional stage of audio.

For the sake of completeness, the data for this mode of connection is appended: heater voltage, 2.5; heater current, 2 amperes; plate voltage 400; control-grid voltage, 0; screen-grid voltage, same as control grid voltage; plate current, 15 ma. with no signal; amplification factor, 6; load impedance, 6,000 ohms (for 2 tubes); power output, 20 watts, for two tubes connected as in Fig. 1D.

The socket connections are shown, looking down on the socket, in Fig. 2. The chart below compares some characteristics of the different modes of connection:

Connection	Grid-Bias Resistor in Ohms	Ratio of Out. Trans. (Pri. to Sec.)
Triode, Class "A"	1,000	22.3:1
Triode, Class "B"	0	24.5:1*
Pentode, Class "A"	515	24.5:1

*For two tubes.

From this table, it is clear that the pentode connection will result in better all-

around performance than any of the other connections.

To replace your present output tube with the 59, then, proceed as follows: first, be sure that the tube you are now using has a filament rating of 2.5 volts; if it has not, then be sure that your power transformer has a spare winding (some transformers have more filament windings that are used in some sets); second, replace your present socket with one of the seven-prong type, and wire accordingly; third, secure a different output transformer to match the type 59 tube. Note: if you are using a type 247 tube now, the same output transformer may be used provided the pentode connection is used. The input transformer remains the same in all but the class "B" connection. Change the bias resistor to one of 500 ohms (nearly).

Now, go to it, and let's know how you make out!

Police Thriller

(Continued from page 164)

quickly connected to any broadcast receiver. The coils in the police call thriller are specially wound to respond to the low wave band on which most of the police calls are heard. An extra attachment comprising a wafer and a length of wire is provided for connecting the device to triodes (27's for instance). Arrows in the photo indicate the tuner and also the wafer.

FREE

13th ANNIVERSARY RADIO CATALOG

132 pages containing the most complete listing of radio items for the amateur and experimenter at real bargain prices.

Send for your copy now!

AMERICAN SALES COMPANY
Wholesale Radio Distributors
SW-44 W. 18th St., N. Y. C.
The Oldest Amateur Supply House, Est. 1919

Patents—Trade-Marks

All cases submitted given personal attention by members of the firm.

Form "Evidence of Conception" and instructions "How to Establish Your Rights"—Free

LANCASTER, ALLWINE & ROMMEL
Patent Law Offices
434 Bowen Bldg. Washington, D. C.

At Last!

OFFICIAL SHORT WAVE LEAGUE LOG AND CALL BOOK

WE ARE happy to present to the thousands of short wave fans this new Log and Call Book, which enthusiastic readers of Short Wave Craft have been urging us to publish. Here is a book that you will feel proud to possess because it reflects your patience and perseverance in logging distant stations. It is a record you will be proud of in days to come. That, however, is not all. The Log and Call Book is the finest and most complete book of its kind ever published. There is nothing like it on the market now, nor was there ever a book published like it before.

PARTIAL CONTENTS

1. It contains the largest listing of short wave stations in the world, a much larger list in fact than the list published in SHORT WAVE CRAFT, or any other magazine. Due to space limitations, no regular magazine can publish all the world stations. There are so many short wave stations, such as telegraph stations, experimental stations, ship stations, and others, which normally cannot be included in any monthly magazine list, but frequently you hear these calls and then you wish to know from where they originate. The OFFICIAL LOG AND CALL BOOK gives you this information, besides a lot of other information which you must have.
2. A large section of the book is set aside where the calls can be listed in a proper manner. This log section gives the dial settings, time, date, call letters, location, and other information. Thus, when you hear a station, you make a permanent record which is invaluable.
3. Another section has squared-paper pages on which you can fill in your own frequency (wavelength) curve for your particular receiver. This helps you to find stations which otherwise could never be logged by you.
4. A distance chart showing the approximate distances between the principal cities of the world.
5. A meter to kilocycle conversion chart. Many of the short-wave broadcasters announce their frequency in the latter scale when signing off and many listeners do not know the relation between them.
6. A list of international abbreviations used in radio transmission.
7. The complete Continental code used in all radio work.
8. A list of International Call Letter Assignments; Around the Clock Listing Guide.
9. In addition to this, you will find included a map of the world, with time indications and a host of other useful information which aids you in logging distant stations thousands of miles away.

Published Quarterly

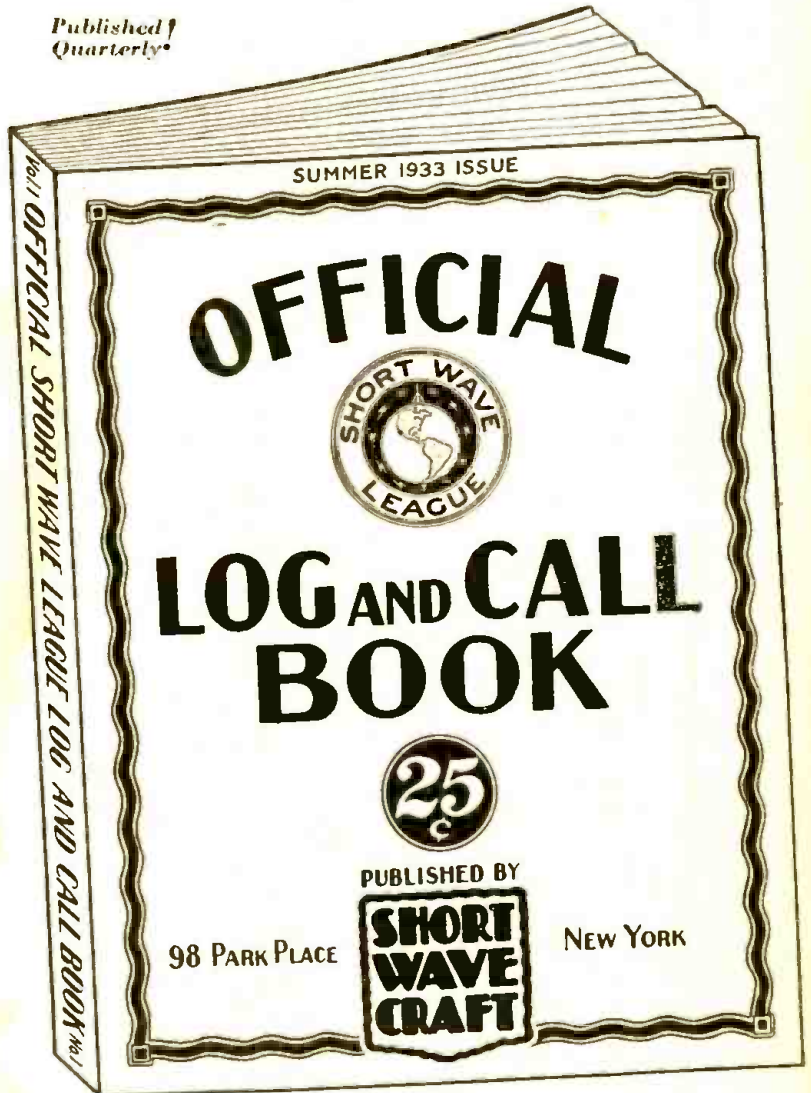

This is one of the finest books that the publishers of SHORT WAVE CRAFT have ever turned out. You will be proud to possess it.

The size of this book is 9x12 inches, same size as SHORT WAVE CRAFT magazine. It is printed on a good grade of paper, and has a heavy durable cover.

Mail this Coupon Today!

SHORT WAVE CRAFT
96-98 Park Place,
New York, N. Y.

Gentlemen: I enclose herewith 25c for which send to me prepaid, immediately upon publication a copy of your new book OFFICIAL SHORT WAVE LEAGUE LOG AND CALL BOOK. (Send money order, check, cash or new U. S. Stamps. Register letter if it contains stamps or currency.)

Name.....
Address.....
City..... State.....

SW-733

READY JUNE 25th!

This Book Will Be for Sale on the Principal Newsstands on or about June 25th

PRICE
25c

As only a limited quantity is printed for the first issue, be sure to ask your newsdealer to reserve a copy for you. Should you not be able to secure a copy at your newsstand, use the handy coupon.

SHORT WAVE CRAFT

96-98 PARK PLACE

NEW YORK, N. Y.

World-Wide Short-Wave Review

(Continued from page 161)

ing frequencies. This is difficult to obtain if the plate of this tube is shunt fed by means of an R. F. choke.

It is quite practicable to "gang" the two tuning condensers, the operation of the receiver thus being simplified by single-dial control. As both the grid and plate circuits of the R. F. tube are tuned, care must be taken with shielding and layout to prevent self-oscillation in this stage.

The coils used were specially designed by the writer, and by their use it has been found possible to obtain a range of 15 to 85 meters using .00015 mf. condensers for tuning; tuning is not too sharp. Each coil has two taps; on the first tap, the range is from 15 to 30 meters; on the second, 25 to 55 meters; and when the whole coil is used, 40 to 85 meters, approximately. By a special arrangement of the feedback winding, it has not been found necessary to tap the plate coil, providing satisfactory regenerative effects over the whole range of wavelengths. The fact that the coil units are individually shielded has been found to possess several advantages.

The set is primarily a loudspeaker set, the strength of most signals being too great for phones.

OPERATING THE SET: The trimmers on the ganged condensers are set at minimum capacity and, with the semi-variable condenser C1 nearly at maximum, the semi-variable condenser C11 is adjusted so that the oscillation is as smooth and even as possible on each of the three wave bands.

The coupling condenser C11 will be found to exercise an effect on the regeneration control. If the receiver oscillates too freely on one of the ranges, C11 should be reduced slightly.

With this, as with all short-wave receivers, it is essential that the ground lead be made as short as possible; otherwise trouble may be experienced with body capacity, particularly on the lowest wave-range.

Kit of Midget Resistors

● In line with the growing popularity of midget sets, the International Resistance Company is featuring a kit of midget, space-saving resistors. This is known as Handy Certified Kit No. 3 and contains twenty IRC Metalized 1/2-watt Resistors. Resistance values have been carefully chosen to meet the replacement demands of the most popular and commonly used small sets. Thousands of additional values are possible by using the resistors in series or in parallel. Thus, the kit enables servicemen to render prompt, accurate replacement service on practically any small set.

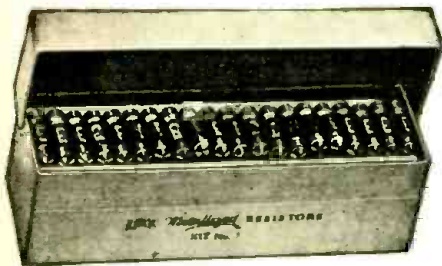

Handy Kit of midget, space-saving resistors recently brought out for the use of the set-builder and service-man.

Name and address of manufacturer supplied on receipt of stamped envelope. Mention No. 109.

A New 5-Meter Receiver

(Continued from page 175)

generation when receiving I.C.W. signals on the 10 meter band will greatly improve sensitivity.

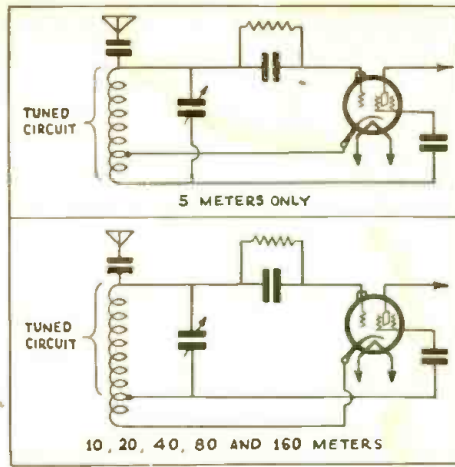

Note the difference in the tuned circuits for 5 meters and above.

The heater circuits must be supplied from a D.C. source, such as a storage battery, in order to eliminate A.C. hum.

If A.C. operation is desired on these bands, it will be necessary to change the tubes to the 2.5 volt type. A 24 may be substituted for the 36, a 27 for the 37, and a 2A5 for the 89—altogether this last substitution will require some rewiring of the output tube socket. The bias resistor required for the 2A5 tube is approximately 500 ohms and should replace the 1000 ohm resistor used for biasing the 89.

Due to the fact that as a general rule superregeneration cannot be used on the low frequency bands, the sensitivity of the receiver will be considerably less than on the 56-60 mc. band and it is, therefore, advisable to use headphones connected in the output circuit instead of the loud speaker.

ADDITIONAL HIGH FREQUENCY COILS—Additional coils are available for covering the frequency range between 40 and 75 megacycles (7 1/2 to 4 meters).

Amateur Band.....	5	10	20	40	80	160
Tuned Circuit Turns	2 1/4	5 1/4	12 1/4	27 1/4	43	98
Cathode Tap Turns	3 1/2	2	2 1/4	2 1/4	2 1/4	2 1/4
Coil Diameter.....	1"	1"	1"	1 1/2"	1 1/2"	1 1/2"
Wire Size.....	#18	#20	#20	#26	#26	#30
Length of Winding...	1/8"	1/4"	1/2"	3/4"	1"	1 1/2"

Capacity of main tuning condenser is 18 mmf. (.00018 mf.)

"Master Composite" Correction

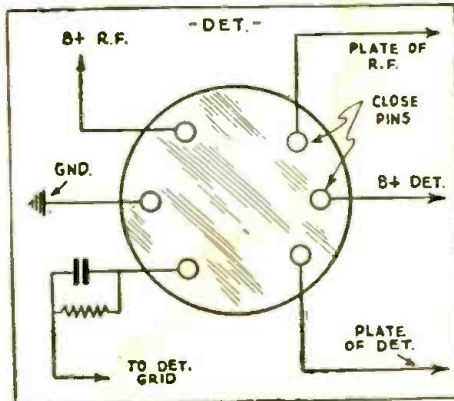

Those who read the article describing how to build the "Master Composite" receiver, in the last number, will find that the coil connections as given in the schematic and the large picture diagram correspond. A corrected diagram for the "detector coil socket," as shown at the bottom of page 83, is given above. Those following the main schematic and picture diagrams will have found no difficulty; they may use the various pins as they so desire.

FREE—C. S. Code Guild Sked. Daily C. S. practice programmes on amateur bands.



You Can Become a Fast, Capable RADIO OPERATOR at Home

With the Famous CANDLER Scientific System

FREE short wave press schedules. Learn to copy px from Candler trained ops, sending out of principal px stations. Amazing results in short time. **FREE ADVICE IF "STUCK."** Write Candler. No obligation. Junior Course for beginners. Advanced Course for ops with speed of 10 wpm or over who want to get in 30 to 45 wpm class and copy behind. Also Radio Typing Course. Save time and money by sending for **FREE BOOK** today.

CANDLER SYSTEM CO., Dept. 2-A, 6343 S. Kedzie Ave., Chicago

World's Only Code Specialist

"Candler training enabled me to copy 56 1/2 wpm for the all-time record."—T. R. McElroy, Official Champion Radio Operator of the World, 46 Everdean St., Boston, Mass.



SLIDE RULES •• Midget 5 in 1 Circular Type:

Metal 4" Dia. Price \$1.50 Case 50c extra

1.234 = ? √50.41 = ?
 1.24 = ?
 Tan 8° 3' = ?
 Cot 79 1/2° = ?
 4 1/2 × 1/4 = ?
 Log 56.25 = ?
 6% of 145.9 = ?
 5.16 - 11 + 1.78 = ?

Solve easily all these and dozens of other mathematical problems without pencil and paper—by means of the Midget Slide Rule. This rule solves any problem in multiplication, division, addition, subtraction, and proportion. It also gives roots and powers of numbers. The "Trie" scales give the sines, cosines, tangents and cotangents of all angles; also logs of numbers. Add and subtract fractions. Approved by colleges.

RADIO Slide Rule Short Wave Type

Price 50 cts.

Printed on white bristol board: Size 7 1/4". Every short wave and radio student must have this in. Inductance, capacity, and "coil-dimension" slide rule. It will answer such questions as: What is inductance of coil one-inch in diameter, winding two inches long and having 30 turns per inch? What winding length of No. 24 S. C. C. wire must be put on a form two inches in diameter, to obtain an inductance of 100 microhenries? To what frequency and wavelength will 35 microhenry coil tune with a 50 mmf. condenser?

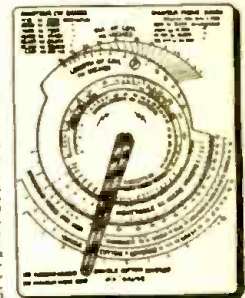

Dataprint Co., Box 322, Ramsey, N. J.

200 PAGES OF SHORT WAVE HOOKUPS AND INFORMATION FOR 35c

Published Sept. 1932 by the American Radio Relay League at \$1.00. All about Coil Winding, Antennas, Rules, Short Cuts, Hints, etc. Over 180,000 sold since 1926. 1933 Edition \$1.00.

ALUMINUM PANELS Genuine 1/16" "ALCOA" /16

7x10—40c. 7x12—49c. 7x14—58c. 7x18—75c. Any size to order—postage extra. **SOMETHING NEW! MARKINGS FOR YOUR PANELS, on BLACK ALUMINUM Ribbon. LOOKS LIKE ENGLISH. ING. 5c each. Sample 8c. Exact Size →**



We do not issue catalogues. **BLAN, The Radio Man, Inc., 177 Greenwich St., N. Y. C.**

..... SHORT WAVE ESSENTIALS FOR MEMBERS OF THE SHORT WAVE LEAGUE

THE following list of short wave essentials has been prepared from the suggestions to the LEAGUE by its members. A number of months were consumed in creating these short wave essentials for members of the SHORT WAVE LEAGUE. All essentials listed are approved by headquarters of the LEAGUE.

A FEW WORDS AS TO THE PURPOSE OF THE LEAGUE

The SHORT WAVE LEAGUE was founded in 1930. Honorary Directors are as follows:

Dr. Lee de Forest, John L. Reinartz, D. E. Replogle, Hollis Baird, E. T. Somerset, Baron Manfred von Ardenne, Hugo Gernsback, Executive Secretary.

The SHORT WAVE LEAGUE is a scientific membership organization for the promotion of the short wave art. There are no dues, no fees, no initiations, in connection with the LEAGUE. No one makes any money from it; no one derives any salary. The only income which the LEAGUE has is from its short wave essentials. A pamphlet setting forth the LEAGUE'S numerous aspirations and purposes will be sent to anyone on receipt of a 3c stamp to cover postage.

One of the aspirations of the SHORT WAVE LEAGUE is to enhance the standing of those engaged in short waves. To this end, the SHORT WAVE LEAGUE supplies members with membership letterheads and other essentials. As soon as you are enrolled as a member, a beautiful certificate with the LEAGUE'S seal will be sent to you, providing 10c in stamps or coin is sent for mailing and handling charges.

Another consideration which greatly benefits members is that they are entitled to preferential discounts when buying radio merchandise from numerous firms who have agreed to allow lower prices to all SHORT WAVE LEAGUE members. The radio industry realizes that, the more earnest workers there are who boost short waves, the more radio business will result therefrom; and a goodly portion of the radio industry is willing, for this reason, to assist SHORT WAVE LEAGUE members by placing them on a professional basis.

SHORT WAVE ESSENTIALS LISTED HERE SOLD ONLY TO SHORT WAVE LEAGUE MEMBERS

All the essentials listed on this page are never sold to outsiders. They cannot be bought by anyone unless he has already enrolled as one of the members of the SHORT WAVE LEAGUE or signs the blank on this page (which automatically enrolls him as a member, always provided that he is a short wave experimenter, a short wave fan, radio engineer, radio student, etc.).

If, therefore, you order any of the short wave essentials without filling out the blank (unless you already enrolled as a LEAGUE member), your money will be returned to you.

Inasmuch as the LEAGUE is international, it makes no difference whether you are a citizen of the United States or any other country. The LEAGUE is open to all.

Application for Membership SHORT WAVE LEAGUE

SHORT WAVE LEAGUE (7-33)
98 Park Place, New York, N. Y.

I, the undersigned, herewith desire to apply for membership in the SHORT WAVE LEAGUE. In joining the LEAGUE I understand that I am not assessed for membership and that there are no dues and no fees of any kind. I pledge myself to abide by all the rules and regulations of the SHORT WAVE LEAGUE, which rules you are to send to me on receipt of this application. I consider myself belonging to the following class (put an X in correct space): Short Wave Experimenter Short Wave Fan Radio Engineer Student

I own the following radio equipment:

Transmitting _____
Call Letters _____

Receiving _____

Name _____
Address _____
City and State _____

Country _____
I enclose 10c for postage and handling for my Membership Certificate.

SHORT WAVE LEAGUE LETTERHEADS

A beautiful letterhead has been designed for members' correspondence. It is the official letterhead for all members. The letterhead is invaluable when it becomes necessary to deal with the radio industry, mail order houses, radio manufacturers, and the like; as many houses have offered to give members who write on the LEAGUE'S letterhead a preferential discount. The letterhead is also absolutely essential when writing for verification to radio stations either here or abroad. It automatically gives you a professional standing.

A—SHORT WAVE LEAGUE letterheads, per 100..... **50c**

OFFICIAL SHORT WAVE LEAGUE LOG AND CALL BOOK

Here is the finest book of its kind ever published. It contains the largest listing of short wave stations in the world, much larger in fact than the list published in SHORT WAVE CRAFT and other magazines. All experimental stations, no matter where located, are listed. A large section is provided where calls can be listed in a proper manner. This log section gives dial settings, time, date, call letters, location, and other information. Another section has squared-paper pages on which you can fill in your own frequency curve for your particular receiver. It helps you to find stations which otherwise you could never log. It is the only book of its kind published.

B—Official Log and Call Book..... Prepaid **25c**

RADIO MAP OF THE WORLD AND STATION FINDER

The finest device of its kind published. The world's map on heavy board is divided into 23 sections, while the rotary disc shows you immediately the exact time in any foreign country. Invaluable in logging foreign stations. Also gives call letters assigned to all nations. Size 11"x22".

C—Radio Map of the World and Station Finder..... Prepaid **25c**

GLOBE OF THE WORLD AND MAGNETIC COMPASS

This highly important essential is an ornament for every den or study. It is a globe, 6 in. in diameter, printed in fifteen colors, glazed in such a way that it can be washed. This globe helps you to intelligently log your foreign stations. Frame is of metal. Entire device substantially made, and will give an attractive appearance to every station, emphasizing the long-distance work of the operator.

D—Globe of the World..... Prepaid **\$1.25**

SHORT WAVE LEAGUE LAPEL BUTTON

This beautiful button is made in hard enamel in four colors, red, white, blue and gold. It measures three quarters of an inch in diameter. By wearing this button, other members will recognize you and it will give you a professional air. Made in bronze, gold filled, not plated. Must be seen to be appreciated.

E—SHORT WAVE LEAGUE lapel button..... Prepaid **35c**

EE—SHORT WAVE LEAGUE lapel button, like the one described above but in solid gold..... Prepaid **\$2.00**

SHORT WAVE LEAGUE SEALS

These seals or stickers are executed in three colors and measure 1 1/4 in. in diameter, and are gummed on one side. They are used by members to affix to stationery, letterheads, envelopes, postal cards and the like. The seal signifies that you are a member of the SHORT WAVE LEAGUE. Sold in 25 lots or multiples only.

G—SHORT WAVE LEAGUE seals..... per 25, Prepaid **15c**

SHORT WAVE MAP OF THE WORLD

This beautiful map, measuring 18x26 in. and printed in 18 colors is indispensable when hung in sight or placed "under the glass" on the table or wall of the short wave enthusiast. It contains a wealth of information such as distances to all parts of the world, political nature of the country in which a broadcast station is located, etc., and from the manner in which the map is blocked off gives the time in different parts of the world at a glance.

F—SHORT WAVE Map of the World..... Prepaid **25c**

PLEASE NOTE THAT ABOVE ESSENTIALS ARE SOLD ONLY TO MEMBERS OF THE LEAGUE—NOT TO NON-MEMBERS.

Send all orders for short wave essentials to SHORT WAVE LEAGUE, 98 Park Place, New York City.

If you do not wish to mutilate the magazine, you may copy either or both coupons on a sheet of paper.

SHORT WAVE LEAGUE, 98 Park Place, New York, N. Y.



G—15c for 25



F—25c each

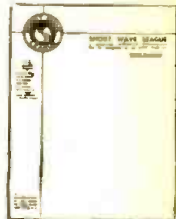

A—50c per 100



B—25c per copy



C—25c each



C—25c each



D—\$1.25 each



E—35c each

SHORT WAVE LEAGUE, 98 Park Place, New York, N. Y. Gentlemen:

I am already an enrolled member in the SHORT WAVE LEAGUE

I am a new member and attach my application in this coupon

Please send me the following short wave essentials as listed in this advertisement:

.....
.....
.....

for which I enclose \$..... herewith.
(The LEAGUE accepts money order, cash or new U. S. Stamps in any denomination. Register cash and stamps.)

Name.....
Address.....
City and State.....
Country.....

(7-33)

"Air-Rover" Hauls 'em In

(Continued from page 159)

terminal strip. You will note that these holes are supplied in the chassis, so that all parts will fit together readily and accurately. Slip the edge of the tuning dial into the wedge drive of the tuning control shaft, and slide the tuning condenser into place after two 5" lengths of wire have been connected to the soldering terminal and the rotor soldering lug terminal. Do not depend on the chassis as a return circuit for the tuning circuit. Run wire to all points in the high frequency circuit. This is necessary if the maximum results are to be obtained.

Placing the Set in Operation

To place the set in operation connect the two dry cells to the "A" leads and the "B" battery to the B leads. Be sure that the "C" battery is connected as shown in Fig. 1. Insert the phones or loud speaker into terminals 4 and 5; connect the antenna to either 1 or 2 and the ground to 3, as indicated in Fig. 1 or Fig. 3. Place the tubes in the sockets, turn the filament rheostat up; if a voltmeter is available, check to see that 2 volts are supplied to the filaments of the two tubes. When the dry cells are new it will be necessary to place the contact arm of the filament rheostat on the first turn of wire; as the batteries age, it will be necessary to move contact arm around so that less resistance is in the circuit. Slip the small coil of wire around a piece of bus-bar, which goes to make up the antenna series condenser (See Fig. 3) until it is in the position shown in the photograph. This should be adjusted to every antenna—once adjusted, it can be left alone. Experimentation will indicate the proper value for this small condenser. Advance the regeneration control to the right until the tube goes into oscillation. If the receiver goes into oscillation too quickly, it will be necessary to increase the coupling between the antenna by means of condenser C-1 which is a series antenna condenser.

Some types of short wave coils go into oscillation more readily than others, as the average short wave coil has too many plate turns. If it is not felt that the set builder wishes to take turns from the coil, it will be necessary to reduce the size of the grid leak so that satisfactory operation and smoothness of regeneration control is obtained. One or two turns off will be sufficient generally.

Operation of Receiver

After all the batteries have been connected and the tubes placed in sockets, insert the plug-in coil with the greatest number of turns in the winding. This coil tunes from 200 down to about 80 meters. This coil, of course, will be placed in the coil socket on the left of the chassis. Slowly turn the tuning dial and advance the regeneration control towards the right. Stop turning the regeneration control when the set goes into oscillation. Keep turning the tuning condenser until a station is heard. If it is a phone station, the speech will be indistinct and accompanied by a whistle. Turn the regeneration control back until the signal clears up and a voice or music is heard clearly. Try and work the set always below the point of oscillation, so as not to cause annoyance to your neighbor, who may also have a short wave receiver. It is possible that he may pick up some of the energy which is present in the antenna due to the power generated by the detector tube when it is oscillating.

Fine regeneration control depends upon having the proper filament voltage on the tubes and proper adjustment of the small condenser used for the series antenna condenser plus the proper value of grid leak.

After testing all the wave bands to see that the set is operating and oscillating, adjust the small antenna series condenser so as to eliminate dead spots and give smooth regeneration over the entire wave bands which are to be covered. Coils are available which will permit this receiver to

tune from 200 meters down to 15. Additional coils may be obtained for use with this tuning condenser which will permit tuning any of the stations in the broadcast band in wavelength ranges of 200 to 550 meters.

If the receiver does not oscillate, reverse the terminals XX in the diagram, shown in Fig. 1. In general, all these plug-in coils have their socket terminal connections made as shown in Fig. 1, i.e., P goes to plate. B+ goes to radio frequency choke; G to grid condenser, and F goes to ground. Coils made by the Alden Mfg. Co. must have B+ socket connections to the plate and P connections to the R.F. choke. Normal connections on these coils are for radio frequency amplification, and unless this point is understood the connections as used for other coils will not give the regenerative effect which is so desired.

This receiver offers the short-wave beginner a truly satisfactory device that can be purchased at low cost, and is so designed electrically that satisfactory operation can be obtained by anyone. Mechanical construction is so complete that the only tools necessary for the construction are a pair of cutting pliers, a screw-driver and a good soldering iron. This little receiver, while not exactly a beginner's job, can be built by the beginner due to the fact that most of the mechanical work is done for him, and the material and parts go into place easily in the proper manner and place. This receiver can be put together in a few hours and will give good results in any location that is half-way decent at all.

Parts List for "Air-Rover"

- Acratest Triple Binding Post, Aerial & Ground Connections
- Acratest Twin Phone Tip Jack, Speaker or Phone Connections
- 1 1/4" Piece of Bare No. 14 Wire wound over with appx. 14 turns of No. 18 insulated push-back hook-up wire.
- Set of Four Plug-in Short Wave Coils. These are accessories. Not furnished with kit.
 - Coil A—200 to 80 meters
 - Coil B—80 to 40 meters
 - Coil C—40 to 20 meters
 - Coil D—20 to 10 meters
- A four-prong wafer type socket, for the short-wave plug-in coil, is riveted to the chassis
- Acratest Short Wave R.F. Choke
- High Impedance Acratest Audio Choke
- 2 meg., 1/4 watt Resistor
- 75,000 ohm Potentiometer
- 150,000 ohm, 1 watt Resistor
- 1 meg., 1 watt Acratest Resistor
- 6-ohm Acratest Rheostat
- .00015 mf. Acratest Variable Tuning Condenser
- .0001 mf. Acratest Mica Condenser
- .00025 mf. Acratest Mica Condenser
- .01 mf., 400 volt Acratest Cartridge Condenser
- .5 mf., 200 volt Acratest Metal Case Condenser
- Four-Prong wafer-type socket, marked for '32 Tube, riveted to chassis
- Five-Prong wafer-type socket, marked for '33 Tube, riveted to chassis
- Four-Conductor Battery Cable
- Drilled Metal Chassis and Drilled Metal Front Panel, three sockets riveted to chassis
- 1-Screen grid clip
- Three Knobs
- Dial Escutcheon Plate
- Hook-up Wire
- Piece of Bare No. 14 Wire for Item 3
- Spaghetti
- Hardware Assortment

You'll Never Guess

What Type of
New "S-W" Set
Will be described as the
August Cover
Feature!

WALLACE HOOVER CUP PRIZE SET USES BRUNO COILS

Now Bruno Offers Genuine

Wallace Coils To Set Builders

They're the most efficient short wave coils made today. Secondary wound with wide flat ribbon having 2 1/2 times more surface conductivity for r.f. currents. Ribbon is highly silvered to further decrease coil resistance to an absolute minimum and guarantee sharpest tuning. New bakelite rib-form reduces dielectric contact. Non-hydroscopic; constant under all weather conditions. Connections brought out to four prong UX base. Primary center tapped. Precision made; sturdy construction. Set of four coils covers 15 to 200 meters.

NEW BRUNO MIKE SAYS

Mississippi NOT Mis-s-i-ssippi

You can build this fine CONDENSER microphone, at little cost, with our new assembly kit. A real professional instrument that doesn't lisp or stutter. Made with micrometer accuracy and tested thoroughly over the entire audible range. No hissing; no extraneous noises. Overtones and colorings are reproduced perfectly. The spoken voice is lifelike and natural. This microphone is the equal of much more expensive instruments. Price of kit, including instructions for easy assembly—\$5.00. Introductory price, this month only, **\$3.10**

INCLUDING POSTAGE

Bruno division of

AMPERITE Corporation
561 BROADWAY NEW YORK

The Hottest Buy of All Times!

GYPSY AUTO RADIO, 6-TUBE, using latest type tubes, with mounting brackets and cables (less accessories and speaker). LIMITED QUANTITY * * * WHILE THEY LAST

\$10.00

Public Address! Public Address! Public Address! LOFTIN-WHITE AMPLIFIERS! Licensed by Electrad, built by Sprague Specialties for Home Talkie outfit, 224A 1st stage, 245 2nd stage, 280 rectifier. Amplification curve flat clear up into the supersonic and R.F. regions. Plenty of amplification, extremely small bulk, self-contained power pack, special at \$6.95 SONOCHORDE 8" dynamic speaker, 25,000 ohm field, specially designed for above amplifier \$3.95

OUR SPECIAL BARGAIN—NATIONAL SW-5 All AC, factory wired and tested—tuned RF, detector, 1st AF and PP output—runs speaker on SW broadcast—COMPLETE with four sets of coils, tubes and power pack \$43.75

NATIONAL SW-3, very latest in ham receivers, Universal AC or DC, TRF detector and 1 audio, uses latest series tubes, complete with three sets coils.....\$23.25
Power pack for National SW-3 sets, humless, provides all voltages for above receivers, each \$10.50

Power pack for National SW-5 sets, our SPECIAL NET PRICE.....\$12.50
WRITE IN FOR OUR HOT HAM SHEETS RIGHT OFF THE PRESS WITH THE MOST SENSATIONAL HAM BARGAINS EVER KNOWN.

WE CARRY ONE OF THE LARGEST, MOST COMPLETE AND DIVERSIFIED RADIO STOCKS IN THE WORLD AND HAVE OVER 35,000 SQUARE FEET OF SPACE DEVOTED ENTIRELY TO SHORT WAVE TRANSMITTING APPARATUS. WHEN IN TOWN, WHY NOT STOP IN AND SEE US? WE CAN ASSURE YOU OF A HEARTY WELCOME AT ALL TIMES. WATCH OUR SPECIALS CLOSELY. IF YOU WANT THE LOWEST PRICES IN THE COUNTRY FOR MERCHANDISE WHICH IS UNCONDITIONALLY GUARANTEED AT ALL TIMES TO BE AS REPRESENTED.

UNCONDITIONAL GUARANTEE ON ALL OUR RADIO SUPPLIES

UNCLE DAVE'S
RADIO SHACK
356 BROADWAY, ALBANY, N. Y., U.S.A.

NEW SENSATIONAL OFFER
Learn **RADIO**
PAY FOR TRAINING AFTER YOU GRADUATE



To a few honest fellows I am offering an opportunity to get a training and pay for it after they graduate in easy monthly payments. You get Free Employment Service for life. And if you need part-time work while at school to help pay expenses, we'll help you get it. Coyne is 33 years old. Coyne Training is tested—You can find out everything absolutely free. Just mail the Coupon for My Big Free Book.

Jobs Leading to Salaries of \$50 a Week and Up

Jobs as Designer, Inspector and Tester—as Radio Salesman and in Service and Installation—as Operator or Manager of a Broadcasting Station—as Wireless Operator on a Ship or Airplane, as a Talking Picture or Sound Expert—Hundreds of Opportunities for fascinating Big Pay Jobs!

10 Weeks' Shop Training AT COYNE IN CHICAGO

We don't teach you from books. We teach you by Actual Work on a great outlay of Radio, Broadcasting, Television, Talking Picture and Code equipment. And because we cut out useless theory, you get a practical training in 10 weeks.

TELEVISION Is Now Here!

And Television is already here! Soon there will be a demand for Television Experts! The man who gets in on the ground floor of Television can have dozens of opportunities in this new field! Learn Television at Coyne on the very latest Television equipment.

Talking Pictures A Big Field

Talking Pictures, and Public Address Systems offer golden opportunities to the Trained Radio Man. Learn at Coyne on actual Talking Picture and Sound Reproduction equipment.

Get the Facts

Don't spend your life slaving away in some dull, hopeless job! Don't be satisfied to Work for a mere \$20 or \$30 a week. Let me show you how to make Real Money in Radio—the fastest-growing, biggest money-making game on earth! Get my big Free book and all details of my pay after graduation offer. Mail the coupon today.

H. C. LEWIS, President
Radio Division, Coyne Electrical School
500 S. Paulina St., Dept. 63-2K, Chicago, Ill.

Dear Mr. Lewis:
Send me your big Free Book; details of your Free Employment Service; and tell me all about your special offer of allowing me to pay for training on easy monthly terms after graduation.

Name

Address

City..... State.....

How I Operate my Little Station NRH

(Continued from page 181)

bucks"; and many good friends among your American radio manufacturers have given little NRH very ample support, and have supplied many pieces of apparatus, tubes, etc., without charge, for all of which the writer is duly thankful. Some boys operating their little short-wave stations in your country and others have sent a nickel, others a dollar, and so forth. Gifts have even been received from girls. Thus, my dear Mr. Gernsback, you have greatly aided the writer with your editorials in your magazines and even at this great distance you have indeed been a great teacher. Many engineers in the United States have helped me to solve numerous problems; among many of my good radio friends I want to mention Mr. Joseph Brown Sessions of Bristol, Connecticut, to whom goes the honor of having been one of the finest friends I have, thanks to short-wave radio, and whose friendship has been the keystone of all the hard work and perseverance which has made NRH's broadcasting successful.

150 Watts—New Transmitter

Thanks to the many helping hands all over the world a better and more efficient NRH has been developed. The short-wave transmitter has been enlarged and improved and it is now operating with twenty times as much power as that used with the glorious old 7½ watt set. The station equipment now boasts a transmitter rated at 150 watts of power and during this year this transmitter has been operating with very fine success. Hundreds of letters have been received from Alaska to the Argentine, reporting the fine reception of the beautiful Spanish programs which we have been broadcasting from 4:30 to 5:30 P. M. Central Standard Time, on 31 meters.

NRH today, with its two De Forest 503-A "bottles" and 845 modulators connected in push-pull style, is pounding in like a "local" and with the same constancy as the old 7½ watt transmitter, but with far less fading and with less "skip distance" effects. This I know from the reports which have been coming in from nearby listening stations in Canada, and all the way down to Peru.

Amando Cespedes Forms a Club

With all these thousands of contacts with short-wave fans I have built up a great NRH membership club throughout the Spanish American region and the Union Radio Americana, or American Radio Union, of which the writer is the creator and director, for stimulating the development of short-wave radio in Central America. We are publishing a little magazine called "URA," which is helping greatly to extend the activities of our short-wave broadcasting and particularly the work of NRH, the first Spanish transmitter built for broadcasting in Spanish America and the only amateur broadcasting station which has accomplished such a great range with so tiny a power.

In closing I can only give my heart-filled thanks to the many friends NRH has made, also for the special concerts broadcast in honor of NRH by New York stations, not to mention the program dedicated to NRH by the famous KDKA, when they called NRH the "little sister to KDKA." (This was in the special program given last February 10.)

(Editor's note:—The many friends of Amando Cespedes Marin and his station NRH, the world's tiniest short-wave broadcaster, will undoubtedly be happy to know that his native city of Heredia, on May 4, decreed a gala holiday and held a great festival in honor of Mr. Marin and his station NRH, celebrating, as only a Spanish city can, the fifth consecutive year of uninterrupted broadcasting to the world—"not only with the smallest power, but with the greatest aim to please.")

DATAPRINTS

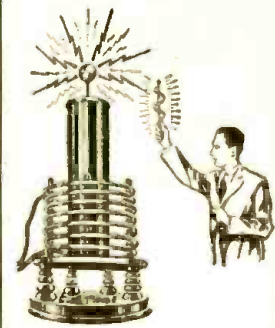

Give Technical Information on the Building of Worthwhile Apparatus

Dataprint containing data for constructing this 3 ft. spark Oudin-Tesla coil.

..... \$75
Includes condenser data.

OTHER "DATAPRINTS"

- TESLA OR OUDIN COILS**
- 36 inch spark data for building, including condenser data \$0.75
 - 8 inch spark data for building, including condenser data 0.75
 - Violetta type, high frequency coil data; 110 volt A.C. or D.C. type; 1" spark; used for giving "violet ray" treatments 0.75
 - How to operate Oudin coil from a vacuum tube oscillator 0.75
- TRANSFORMER DATA**
- Any size, 200 to 5000 watts. (1 primary and 1 secondary voltage data supplied—Specify watts and voltage desired) \$1.00
 - 1 k.w. 20,000-volt transformer data, 110-volt, 60-cycle primary. Suitable for operating 3 ft. Oudin coil 0.50
 - ¼ k.w. 15,000-volt transformer data, 110-volt, 60-cycle primary. Suitable for operating 8-inch Oudin coil 0.50
 - Induction Coils—1 to 12 inch spark data 0.75
- MAGNET COIL DATA**
- Powerful battery electro-magnet; lifts 40 lbs. \$0.50
 - 110 Volt D.C. magnet to lift 25 lbs. 0.50
 - 110 Volt D.C. solenoid; lifts 2 lb. through 1 inch 0.50
 - 110 Volt D.C. solenoid, lifts 6 lb. through 1 inch 0.50
 - 12 Volt D.C. solenoid, lifts 2 lb. through 1 inch 0.50
 - A. C. Solenoid, powerful, 110-volt, 60-cycle 0.50
 - MOTOR—1/16 H.P., 110 volt A.C. 60 cycle (suitable for driving 12" fan or light apparatus), constructional data 0.50
 - 1200 cycle Synchronous motor 0.50
 - 60 cycle Synchronous motor 0.50

TELEGRAPHONE—Records Voice of "Code" signals on steel wire by magnetism. Code can be recorded "fast" and translated "slow". Construction data (special) \$0.50

CLOCKS—Electric chime ringer. How to make one to fit on any ordinary clock 0.50

- MISCELLANEOUS DATAPRINTS—**
- Electric Ice Skates—How to make 0.50
 - How to Thaw Pipes by Electricity 0.75
 - 20 motor circuits—hook-ups 0.75
 - 20 practical telephone hook-ups 0.50
 - Treasure Locator 0.50
 - 100 mechanical movements for inventors 0.50
 - Polarized Relay—Ultra Sensitive 0.50
 - Electro-medical coil (shocking coil) 0.50
 - REFRIGERATION MACHINE — Dataprint —**
How to Make Data 1.00

- SLIDE RULES—Specially Selected**
- Students' 10-inch wood slide rule, accurately engraved (prepaid) \$1.10
 - ELECTRICAL Slide Rule, 10 inch size, with special electrical law ratios and indexes, wood with white ivory scales, prepaid 5.75**
 - 5" "Pocket" slide rule 4.00
 - "Circular Pocket" slide rule. Fits vest pocket. 2½" diameter, leather case 4.00
 - Student's circular slide rule 1.50

(Postage 10 cents extra on last three slide rules.)
The DATAPRINT COMPANY
Look Box 322 RAMSEY, N. J.

WAVE HEADQUARTERS

Sets Which Work At Your Command

And NOW The *Electrified* Official Doerle

2 And 3 Tube Receivers

Operate On Either A. C. or Batteries—May Also Be Had For 2-Volt Operation



3-Tube Doerle Signal Gripper REAR VIEW of A. C. Model — 2-volt Model does not have Tube shields

Only \$14.20

And Now These Doerle Sets Have Been Completely Electrified

Short-wave receivers have come and gone, but never have there been produced short-wave receivers which have taken the entire country by storm as have the famous Doerle Receivers.

Mr. Doerle described his first receiver, the now famous 2 TUBE 12,500 MILE RECEIVER in the Dec.-Jan. issue of *Short Wave Craft*, and his 3 TUBE SIGNAL GRIPPER in the Nov. 1932 issue.

If you are a reader of this magazine, you have undoubtedly been surprised at the great number of fan letters published in *Short Wave Craft*, praising these receivers to the skies—and for good reason! We have sold many hundreds of these sets, and they are still going strong.

They are low-priced, yet pull in short-wave

stations from all over the world REGULARLY, in practically ANY LOCATION, not only in this country, but anywhere! These two receivers EMPLOY THE 2-VOLT, LOW-CURRENT CONSUMPTION TUBES, and are, therefore, most popular with people living in rural districts where electric service is scarce.

For the thousands of fans however, who enjoy the benefits of electric service, we have developed the 2 and 3 Tube A. C. Doerle sets. These sets, employing the latest type triple-grid tubes, are naturally more selective and infinitely more sensitive than the original Doerle receivers.

Furthermore, not only can they be used on alternating current, but with batteries as well. The 2 tube 12,500 Mile Electrified Doerle Receiver employs a Type 57 triple-grid detector tube, which is resistance-coupled to the type 56 output tube. For operation on batteries the 57 is replaced with a 77-tube and the 56 with a 37. This set actually works a loudspeaker on all local and many distant stations. The 3 Tube Electrified Doerle Signal Gripper employs a 58 triple grid tube as a radio-frequency amplifier, followed by a type 57 detector, and finally, a 56 output tube. For battery operation the Type 78, 77 and 37 tubes are used. This receiver, in its sensitivity and DX ability, equals many expensive 5 and 6 tube short-wave sets.

Improved Circuit and Design

Despite the remarkable performance of the Doerle receivers, our technical staff felt that they could obtain better results by making slight modifications of the circuit. This is especially true of the 3 Tube Signal Gripper, both the new A. C. and 2-volt models. In the 2-volt model, the first type 30 R. F. tube was replaced by a type 34, which is a special-purpose screen-grid R. F. amplifier. In the A. C. model, a type 58 triple-grid, high-gain R. F. tube is employed. Furthermore, in this latter model the Antenna trimmer condenser has been eliminated through the use of inductive coupling. The detector plug-in coils are of the six-prong type, each having three separate windings. This means that the R. F. Stage is inductively coupled to the detector. Yet, despite these various changes, we have not increased the price of these receivers, to you.

By special arrangements with the publishers of *Short Wave Craft*, we have been given the exclusive right to manufacture and sell the Official Doerle Receivers, both the earlier 2-volt and the latest A. C. models—so that now, all short-wave enthusiasts who have ever wished to own any of these fine sets can buy them without the slightest doubt in their mind but what they will perform 100%. This means that all the usual "bugs" have been ironed out by us in such a way that in practically every location, anywhere, they will "do their stuff."

Only First-Class Parts Are Used

It may be possible to buy the parts or completed sets at a lower price—we admit this at once—but without concern. For we have used only the best parts available in the construction of our sets. We have done away with all usual "losses" which are incidental to the use of poor components. In these receivers, only the best tuning condensers, and that means Hammarlund—are used! These sets could be produced for a considerably less amount if we used cheaper condensers. We refrained from doing so, however, because then we COULD NOT GUARANTEE RESULTS! And this goes for everything else in these sets. . . .

If you are skeptical of the results obtained with these receivers, read the letters from our many short-wave fans and friends printed on the opposite page.

Our Own Tests

Every one of these Doerle receivers, without exception, is tested in our laboratory under actual operating conditions. We refrain from giving you the astonishing list of stations which we, ourselves have worked during the course of our tests; for we do not wish to let our enthusiasm run away with us! We would much rather have you and our many other short-wave friends talk about the results. Incidentally, we have yet to receive a single complaint on any of these sets although we have sold many hundreds of them. Each receiver is accompanied by schematic diagram and wiring blueprint, as well as a pamphlet of detailed instructions.

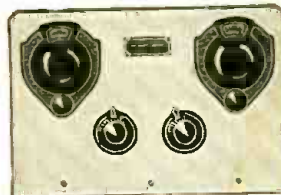

FRONT VIEW showing general appearance of all Doerle receivers

Special Short-Wave Hum-Free A. C. Power Pack

Designed Especially For The Doerle Receivers

\$6.25



No. 2149 Special Short-Wave Hum-Free A. C. Power Pack, Including 280 tube.

\$6.25

Everyone knows that an A. C. short-wave set is no better than the power pack which supplies its power! A power supply for short-wave use must be constructed with extreme care. It must be absolutely free from hum or other disturbances caused by insufficient filtering, poor wiring, or faulty equipment.

This unit has a two-section filter circuit, employing two-heavy duty 30 Henry chokes and a tremendous amount of capacity. This assures PURE D. C. with practically no ripple at all.

The power pack supplies 250 volts at 50 ma for the plates of the tubes, 22½ volts for the screens, and 2½ volts at 5 amperes for the filaments. These various voltages are obtained from convenient binding posts on the side of the pack. Furthermore, provisions are made for energizing the field of a dynamic speaker. Any speaker having a field resistance of from 1500 to 2500 ohms may be thus energized. All the component parts of this pack are built into a sturdy, metal base which is black, crackle finished. The power transformer and one of the chokes are the only units which are mounted on top of the chassis. The pack employs a type 280 full-wave rectifier which is inserted in a socket on top of the base. A convenient on-off switch is mounted on the side. The pack is sold complete with four feet of connecting cord, terminating in a special Belden soft rubber plug. Measures 7½" long x 4" wide x 4½" high overall. Sold complete with 280 tube. Ship wt. 10 lbs.



Only \$8.90

2-Tube 12,500 Mile Doerle Set Rear View—Both A. C. and 2-Volt Models look alike

SPECIFICATIONS

- No. 2174. Electrified 2 Tube 12,500 Mile Doerle Receiver, completely wired and tested, less tubes. Measures 7" long x 6" high x 6¼" wide. Shipping wt. 5 lbs. **YOUR PRICE \$9.45**
- No. 2175. Electrified 2 Tube 12,500 Mile Doerle Receiver in kit form, less tubes, but including blueprints and instructions. Ship. wt. 5 lbs. **YOUR PRICE \$8.25**
- No. 2176. Complete set of tubes for above: either one—57 and one—56 for A. C. operation, or one—77 and one—37 for battery operation. **YOUR PRICE \$1.80**
- No. 2177. Electrified 3 Tube Doerle Signal Gripper, completely wired and tested; less tubes. Measures 10½" long x 7" high x 8¼" wide. Ship. wt. 7 lbs. **YOUR PRICE \$14.20**
- No. 2178. Electrified 3 Tube Doerle Signal Gripper in kit form, including blueprints and instructions; less tubes. Ship. wt. 7 lbs. **YOUR PRICE \$12.75**
- No. 2179. Complete set of tubes; either one—58, one—57 and one—56 for A. C. operation or one—78, one 77—and one—37 for battery operation. **YOUR PRICE \$2.70**

BATTERY SETS

- No. 2140. TWO TUBE 12,500 MILE 2-VOLT DOERLE SHORT WAVE RECEIVER, completely wired and tested. Ship. wt. 5 lbs. **YOUR PRICE \$8.90**
- No. 2141. TWO TUBE 12,500 MILE 2-VOLT DOERLE SHORT WAVE RECEIVER KIT, with blueprint connections and instructions. Ship. wt. 5 lbs. **YOUR PRICE \$7.70**
- No. 2142. COMPLETE ACCESSORIES, including 2 No. 230 tubes; one set of Brandes Headphones; 2 No. 6 dry cells; 2 standard 45-volt "B" batteries complete, ship. wt. 22 lbs. **YOUR PRICE \$5.40**
- No. 2143. THREE TUBE 2-VOLT DOERLE SET, completely wired, ready to use **YOUR PRICE \$11.85**
- No. 2144. THREE TUBE 2-VOLT DOERLE SET IN KIT FORM, with blueprint connections and instructions. Ship. wt. 7 lbs. **YOUR PRICE \$10.50**
- No. 2145. COMPLETE ACCESSORIES, including 2 No. 230 tubes; and one type 34, one set of Brandes Headphones; 2 No. 6 dry cells; 3 standard 45-volt "B" batteries; 1 B. B. L. 9 inch Magnetic Loudspeaker. Shipping weight 32 lbs. **YOUR PRICE \$11.00**

FREE Short-Wave BOOKS YOUR CHOICE

of either one of books illustrated herewith—FREE OF CHARGE—with the purchase of any of the short-wave receivers listed in this advertisement.

Book No. 866 explains in a most thorough-going manner the ways and means of obtaining an amateur transmitting license. Furthermore, all government rules regulating amateur transmissions are reviewed.



Book No. 866



Book No. 830

Book 830 is a comprehensive and thorough compilation of the most prominent short-wave receiver circuits published during a period of two years. Build up your radio library with one of these books.

FREE 100 page Radio and Short Wave Treatise. 100 hook-ups, 1,000 illustrations. Enclose 4c for postage. Treatise sent by return mail.

RADIO TRADING COMPANY, 100A Park Place, New York City

Skeptical of Short Waves? we actually Guarantee Results



BUY FROM SHORT

These Are Fool-Proof Short-Wave Sets READ WHY WE CAN GUARANTEE RESULTS

When a manufacturer offers such a broad guarantee—a guarantee which is almost unconditional—he must have a lot of confidence in his products. We have that faith in our short-wave receivers, because they are fool-proof. They are fool-proof because they are simple. EACH RECEIVER EMPLOYS A MINIMUM NUMBER OF PARTS TO MAKE ITS RESPECTIVE CIRCUIT OPERATIVE. ALL FANCY EMBELLISHMENTS, USUALLY FOUND ON "EXPENSIVE" SETS, HAVE BEEN ELIMINATED. If properly adjusted and carefully tuned, they will bring in most anything on short-wave worth hearing, not only in this country, but anywhere.

Furthermore, only first-class parts have been used throughout. We realize that the separate parts for our sets can be obtained elsewhere, at a lower price, but we do not manufacture and sell sets employing cheap parts; for such receivers are not reliable; they may work, but erratically. We feel, therefore, quite safe in guaranteeing these wonderful sets to perform fully as represented.

And here are letters from those who have actually tried these Short-Wave sets:

THE OSCILLODYNE

HOW IT WORKS

I have constructed the OSCILLODYNE RECEIVER and boy! how it works!

The first day without any trouble I received Spain, England, France, and other foreign countries. Amateurs! why I never knew there were that many until now. With the one tube Oscillodyne, I bring in more stations on one plug-in coil than with a set of coils on different short-wave sets.

IF ANY ONE IS TRYING HIS LUCK ON SHORT-WAVE SETS, IT WILL BE WORTH WHILE TO CONSTRUCT THE ONE TUBE OSCILLODYNE.

PAUL KORNEKE, JR., N. S. Pittsburgh, Pa.

A PEACH

The oscillodyne receiver, believe me is a "peach." I get short-wave stations from Germany, France, Spain and Italy—not to mention the American stations, including amateurs all over the United States.

I heartily recommend this set to any Short-Wave fan.
HENRY TOWNSEND, Ramsey, N. J.

THE DOERLE RECEIVERS SOME LIST!

Have just completed your Doerle two-tube. I received the following on the loudspeaker: XDA, LQA, GMB, VEGDR, VEGGW, KKQ, W1XAZ, W2XAF, W3XAL, W3XAU, W8XK, W8XAL, W9XF, W9XAA; Bermuda, Honolulu, Budapest, Hungary, and "hams" in 34 states.

MAURICE KRAAY, R. F. D. 1, Hammond, Ind.

THIS IS GOING SOME!

Today is my third day for working the Doerle set, and to date I have received over fifty stations. Some of the more distant ones I shall list. From my home in Maplewood, N. J., I received the following: WVLT, Atlanta, Ga.; WCK, Ohio; W8BHM, Ft. Wayne, Ind.; W9AYS, Elgin, Ill.; W8ERK, Girard, Ohio; and best of all, XDA, Mexico; PZA, Surinam, South America; TIR, Cartago, Costa Rica; G2WV, Leicester, England. I have also received stations WDC and PJQ, which I have not found listed in the call book.

JACK PRIOR, 9 Mosswood Terrace, Maplewood, N. J.

A DOERLE ENTHUSIAST

I have just completed my two-tube Doerle, and it surely is a great receiver! It works fine on all the wave-bands. Nobody could wish for any letter job than this one. I can get W8XK and W9XAA to work on the loudspeaker at night, and the code stations come in with a wallop behind them.

SAMUEL E. SMITH, Lock Box 241, Graving, Mich.

FRANCE, SPAIN, ETC., ON LOUDSPEAKER

I hooked up my two tube Doerle Kit and I received France, Rome, Spain, Germany and England on the loudspeaker as well as over 100 amateur phone stations.

I am very pleased with the receiver and would not part with it for anything. I have listened to many factory built short-wave receivers, but believe me, my DOERLE is the set for me.

ARTHUR W. SMITH, Springfield, Mass.

REGULAR FOREIGN RECEPTION

A few days ago, I purchased one of your TWO TUBE DOERLE WORLD WIDE SHORT WAVE RECEIVERS. I just want to tell you that this set does all you claim. In the short time I have had the set, I have brought in stations in England, Germany, France and South America; Davanshire, England, and Nauens, Germany can be picked up daily with very strong volume. THE DOERLE IS A FINE SET.

ARTHUR C. GLUCK, Brooklyn, N. Y.

THRILLED BY DOERLE PERFORMANCE

I am very much pleased with the DOERLE S.W. radio I received; the local amateur stations come loud and clear. The first foreign station I received was DJA, Zeemsen, Germany. I certainly received this station with a thrill. Your for success.

RANDOLPH GRAY, Quincy, Mass.

Order From This Page

Send money order or certified check, C. O. D. only, if 20% remittance accompanies all orders. Order NOW—TODAY.

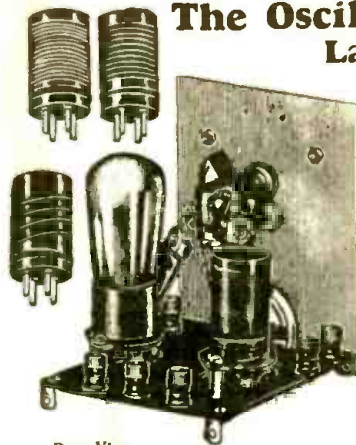

Rear View

Here, then, is a set which brings in stations thousands of miles away; a set which frequently brings in Australia, loud enough to rattle your phones, and with power to spare; a set which, if you do not wish extreme distance, will bring in stations several thousand miles away without aerial or ground.

In our estimation, the Oscillodyne is one of the greatest recent developments in radio circuits, and the editors recommend it warmly to all readers.

The Oscillodyne 1 Tube Wonder Set Latest Short-Wave Development

This Is The Ideal Beginner's Set

If you have never operated a short-wave set before, this is the one with which to start! If, on the other hand, you are already a hard-boiled short-wave fan (and are therefore aware of the shortcomings of the average short-wave set), the Oscillodyne is the set which will install you with new confidence. It is a set which will convince you that foreign stations CAN be tuned in whenever they are on the air.

We have acquired the sole rights from the publishers of Short Wave Craft to manufacture exclusively the Official Oscillodyne 1 Tube Set, as described in the April 1933 issue. Read what the editor of Short Wave Craft says in that issue:

A REALLY NEW CIRCUIT

We are pleased to present to our readers an entirely new development in radio circuits. Under the name of the "Oscillodyne," Mr. J. A. Worcester, Jr., has developed a fundamentally new circuit. This circuit, which is of the regenerative variety, acts like a super-regenerative set although it does not belong in that class. Its sensitivity is tremendous. The editor, in his home on Riverside Drive, New York City, in a steel apartment building, was able to listen to amateurs in the midwest, using no aerial and no ground. With the ground alone, a number of Canadian stations were brought in, and with a short aerial of 40 feet many foreign stations were easily pulled in.

ABSOLUTELY FOOL-PROOF

This set, as we sell it, may be had either completely wired, or in kit form. There is absolutely nothing to go wrong with the Oscillodyne. Simple directions and blueprints show you how to build and operate the set for best results. It may be used either on A. C. or with batteries. If A. C. is employed, a type 227 tube is used in conjunction with a suitable A. C. power pack (such as the one listed on the opposite page.) 2 1/2 volts will be required for the filament of the tube, and 90 volts for the plate. If batteries are employed, a 227 tube should be used in conjunction with either a storage battery or four No. 6 dry cells and two 45 volt B batteries.

Only first-class parts are used throughout. The panel is of aluminum, and the sub-base of Bakelite. There is no guess-work with this receiver—no disappointment.

Oscillodyne Wonder Set

The set is exactly as illustrated here, size of aluminum panel is 6" high by 4 1/2" wide, base 5 1/2" long by 4 1/2" wide. List of materials used:
No. 2146. Official One-Tube Wonder Set, completely wired and tested as per above specifications. YOUR PRICE \$6.20
No. 2147. Official One-Tube Wonder Set, but not wired, with blueprint connections and instructions for operation, complete shipping weight 3 lbs. YOUR PRICE \$5.35
No. 2148. COMPLETE ACCESSORIES, including the following: one 6 month guaranteed Neontron No. 237 tube; one set No. 6178 Brandes matched headphones; four No. 6 Standard dry cells; two standard 45-volt "B" batteries, complete shipping weight 22 lbs. YOUR PRICE \$5.10



Front View

The Oscillodyne 2 Tube Loudspeaker Set NO PLUG-IN COILS

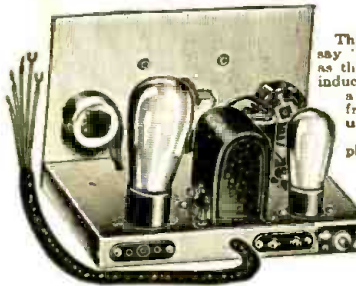

Rear View

The principle of the Oscillodyne circuit is a new one. It is of the regenerative variety, yet acts like a super-regenerative set, although it does not belong in that class. Its sensitivity and selectivity are tremendous. The special band-selector switch affords complete band coverage in four overlapping stages.

Only parts of the highest quality, such as Hammarlund condensers, Yazley switches, Kurz Kaseh vernier dials, etc., have been used. These parts are mounted on a sturdy cadmium-plated metal chassis which measures 9" long x 6 1/4" wide x 6" high. Complete set of blueprints and instructions included.

No. 2197. 2-Tube Oscillodyne Loudspeaker Set, Completely wired and tested. Ship. wt. 9 lbs. YOUR PRICE \$10.85

No. 2198. 2-Tube Oscillodyne Loudspeaker Set in kit form. Ship. wt. 9 lbs. YOUR PRICE \$9.85

No. 2199. Complete accessories for this receiver, including 1—type 56 tube, 1—type 47-1—special short-wave hum-free AC power pack, No. 2149; 1—type 280 rectifier tube for the power pack; 1—B. B. L. magnetic loudspeaker. Ship. wt. 14 lbs. YOUR PRICE \$11.20

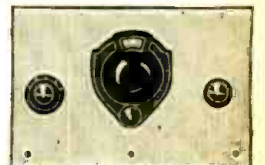

Front View

RADIO TRADING COMPANY, 100 Park Place, New York City

How I Operate My Little Station NRH

(Continued from page 137)

Hoped to Broadcast 100 Miles!

In short-waves my early purpose was to try and reach at least 100 miles, and thus make little NRH known at Port Limon, a gate city of my country, and in which one of the first wireless telegraph stations was built in 1900. Although the operators at that station tuned very carefully, listening for my broadcast, they were not able to hear me; so I followed the work with many trials and tribulations and always hoped to get a reply from the station at Port Limon that they had heard NRH. My efforts were finally rewarded when I received, eleven days later, the anxiously awaited report from Sergeant Karr, located at the radio station in Gatun, Panama Canal Zone. That was a great day for little NRH and "yours truly." I kept on broadcasting every day, hoping to hear more reports from distant points of at least 100 miles away, and suddenly the second report arrived from Guayaquil, Ecuador!

If Gatun was 300 miles east of Heredia, Guayaquil was 1200 miles south of NRH, and it was sure enough the greatest record at that time for broadcasting on a 7½ watt "bottle" (tube). Then came Salvador and Guatemala in Central America; next came Cuba, and in November I had the great happiness to know that NRH was at last "knocking on the door" of the great United States, for I began to receive reports from your country and one of the first I received was from a station 2500 miles to the north, in the "keystone" city—Philadelphia.

As cited in the letters of many friends, who now began to hear NRH broadcasting, it was noted that the voice was not always clearly understandable but they could hear clearly the "bugle calls" given between numbers. Even though they could not hear the announcement giving the location of the station, these "bugle calls" became known everywhere as the signature of that little station at Heredia, Costa Rica. I cannot pass by the opportunity to thank the thousands of radio listeners who have taken the time and trouble to write me and explain how they enjoyed the programs of NRH.

Newspapers in various countries have published articles on NRH and after telling about the station, the editors frequently ask the question—"Why is this little NRH broadcasting?"

The writer and his family and friends have had great "fun" in operating NRH, and we also feel that we are doing a fine piece of work in furthering better relations between Costa Rica and all other countries; from Alaska to the Argentine, from Australia to Spain, from Moscow to the Philippine Islands, and we feel proud and well repaid by the many honors and words of greeting and praise which have been sent to us by people in many different countries who have listened to the music and voice of "little NRH." It really is wonderful to think that with such tiny power as 7½ watts, that we have been able to demonstrate to the scientific world, through station NRH, that with this little power it is possible to broadcast music and the spoken voice all over the world. In fact, as many letters have testified, NRH has been heard as strongly thousands of miles away from Heredia, as were the most powerful short-wave transmitting stations, using up to 50,000 watts.

It is a wonderful feeling of time and labor truly well spent, when you contemplate the nearly 17,000 letters I have received from all parts of the world, some of the letters containing words of approval and praise, while still other letters contain gifts of money which were doubly welcome to be sure, for no broadcast station, even "tiny little NRH," can keep up the good work without money.

The clipping files of station NRH contain over 1,000 newspaper clippings con-

taining notices of NRH, sent to the writer by readers in every country imaginable. Some of the clippings quote the admiring remarks of famous people in science and eminent newspaper editors.

One of my principal aims has been to prove to the world that short waves can go anywhere on this world of ours, on only 7½ watts, and also that this can be done with great constancy, day in and day out. Heredia, from which these globe-circling broadcasts have radiated, on the insignificant 7½ watts, lies among large coffee plantations, 3800 feet above sea level, a distance of 110 miles from the Atlantic seaboard and 60 miles from the Pacific Ocean to the west. Maybe one of the secrets of station NRH's really remarkable performance lies in the fact that the antenna system is located approximately 4000 feet above sea-level, in fine clear air and with two great oceans lying to either side, thus giving a clear sweep to the radio waves. Also we have clear cool air every night, which is also an aid, at least so far as a minimum of static is concerned.

The letters NRH signify the "Newest Radio Home" and it is the real radio home indeed, as attested by the myriads of letters received from people everywhere and also by the personal visits of people who have come to Heredia, anxious to see station NRH.

Yes! Yes! The Finances!

Now that I have told you some of the interesting technical and personal details of how little station NRH is operated, you undoubtedly are asking yourself the question—"but how is it financed?" Your humble servant was the creator, designer, and also the builder of NRH and while I was listening to the music of the outgoing programs and also watching the meters on the transmitter, I was also thinking of the financing and cost of operating. With money I had saved I purchased from time to time phonograph records containing the better class of musical selections and had accumulated an extensive file of these records. Some of my good friends have also contributed dozens of fine records to my library. Thus you see I am also the "program builder" and the engineer-of-all-trades besides being the announcer, the logger, the director, the typist and the "whole music man." And I am also the teacher to my children, for they will have to continue this great effort to keep little NRH entertaining short-wave listeners the world over.

Speaking of finances, I have been relieved of any worry with regard to bills for the electric current consumed from the city supply mains for the operation of station NRH; the municipal government of Heredia doing NRH and its humble director the great honor "as the ambassador of the air" to provide NRH, without charge, with 20 amperes of electric current.

To defray the expenses incurred in mailing verification cards to the thousands of listeners who write to NRH, the government of Costa Rica, in recognition of the "diplomatic service" and "good-will" rendered by station NRH, issued a decree whereby the official postage stamps are affixed to all mail issuing from NRH without charge to the station or its director. Thus, so far as the writer knows, this is the first time that a government has so highly appreciated any radio broadcast station and NRH answers no less than 200 letters every week. With these two important items of electric current and postage thus disposed of, a great part of the financial worries of any broadcast station director have been removed.

When it comes to the cost of apparatus required for NRH, I want to mention the fine financial support accorded NRH by the hundreds of amateur short-wave listeners who have sent as much as "twenty

(Continued on page 184)

Short Wave Specials

RESCO 3 RECEIVER
 Tube 1-34 Screen Grid and 2-30 tubes, constructed of quality parts throughout, aluminum chassis and panel, Vernier dial, range 15-200 Mc.
 Assembled, Wired and Tested
\$9.75 less tubes

Resco S. W. 5 Tube A. C. Receiver
 using (2) 57" (2) 56's and (1) 280 rectifier. Aluminum chassis and panel with Vernier dial. Special
\$17.95 less tubes

SHORT WAVE BARGAINS
 1 Tube Oscillodyne Kit \$3.95
 2 Tube Oscillodyne Kit 6.95
 New Hammarlund Easy Midset Condensers: 6 Plate 40c;
 7 Plate 40c; 13 Plate 55c; 23 Plate 60c.
 Electro-Voice Condenser Mike 11.95
 24 V. 8 amp. fil. trans. cased 1.69
 Set of 4 short wave plug-in coils 1.79
 Biley Crystals, 40-40-160 meter 4.50
 Class B Transformers Type 46, per pair 4.95
 Class B Transformers Type 203 A, per pair 9.65
 Telegraph Key80
All Merchandise Guaranteed
Radio Electric Service Co., Inc.
 N.E. Cor. 7th & Arch Sts. Philadelphia, Pa.

LEARN AT HOME TO BE A

Good Radio Operator



It's Easy
with The NEW MASTER TELEPLEX
 Code Teaching Machine
 Pleasant, interesting work. No experience necessary. We guide you step by step—furnish you Complete Code Course and lend you The New Master Teleplex. Teleplex has instructed more students in the code in the past ten years, than all other systems combined. It is the only instrument ever produced that will record your own sending in visible dots and dashes, and then repeat it to you audibly on headphones. Used by U. S. Army and Navy, R. C. A., A. T. & T. Co. and others. Get started NOW. Low cost, easy terms. Write for folder SW-7 giving full details.
TELEPLEX COMPANY
 76 Cortlandt St. New York, N. Y.

THE "PRIZEWINNER"



You'll Want This AC-DC Short Wave Receiver
 Completely Self-Powered Latest Type 77, 43, 2525 Tubes 15 to 200 Meters
 THE PRIZEWINNER is complete. No extras, such as power supply, coils, etc. to buy. Power supply is built-in and will operate on EITHER AC OR DC! (Four coils included) cover all bands, 20,000 KC to 1,500 KC.
 Complete kit of PRIZE WINNER parts identical in every respect with those used in built-up models, complete in every detail including hardware, hookup wire, solder, coils, etc. and also \$8.95 the cabinet and dial. Price..... \$3.75
 Set of RCA tubes for above. Assembled, wired, tested and enclosed in beautiful crackle finish, or Cadmium Plated, metal cabinet ready to plug into your power line. Complete with four coils..... \$10.95
 Send for full particulars and Diagram
ALAN RADIO CORP., 83 S. Cortlandt St., New York City
 THE HOUSE OF DEPENDABLE SERVICE

FORDSON'S NEW LOW COST SUPER

30 DAY TRIAL
SIX TUBE Goldentone TRADE-MARK Superheterodyne \$9.95
 Six Tube Chassis and Dynamic Speaker
 30 DAY FREE TRIAL
 With automatic volume control using the new duplex diode triode type 55 tube and Class A power pentode using the new seven-prong type 59 Pentode tubes. SEND FOR FREE CIRCULAR

FORDSON RADIO MFG. CORPORATION
 170 Silver Lake Avenue, Detroit, Michigan
 Send me FREE circular giving complete details and prices on the GOLDENTONE radio.
 Name.....
 Address.....
 City..... State.....

"HAM" ADS

Advertisements in this section are inserted at 5c per word to strictly amateurs, or 10c a word (8 words to the line) to manufacturers or dealers for each insertion. Name, initial and address each count as one word. Cash should accompany all "Ham" advertisements. Not less than 10 words are accepted. Advertising for the August issue should reach us not later than June 17.

PLUG-IN COILS. SET OF FOUR WOUND on bakelite four prong forms. 15-210 meters with .0001 condenser 75c. Coils wound to order. Variable condensers 50c. Noel, 809 Alder, Scranton, Pa.

FILTER CONDENSERS: REAL HE-MAN jobs. Heavy steel cases. All voltages working potentials. Tested 50c overload. Compare! 2 mfd. 2000 volt, \$3.95; 3000 volt. \$6.95; 4000 volt. \$9.95. J. S. Huffman, W5AUB, Tupelo, Miss.

SHORT WAVE LISTENERS CARDS: JUST what you need for reporting the stations you hear. Write for free samples today. W1BEF, 16 Stockbridge Avenue, Lowell, Mass.

BEST OFFER GETS N. R. I. RADIO COURSE. Write for details. Herbert Cushing, 1371 Candia Road, Manchester, N. H.

PYREX LEAD-IN BOWLS-DOLLAR PAIR (four bowls) postpaid. W9CKB, Fort Wayne.

2,000 VOLT GENERATOR WITH 3 PHASE motor, rating 2,000 volts, 1 Amp. motor, 3 h. p. 220 volts. F. O. B., Wilmington, Del. Address Clair McCollough, 8 W. King St., Lancaster, Pa.

QSL CARDS, NEAT, ATTRACTIVE, REASON- ably priced, samples free. MILLER, Printer, Ambler, Pa.

HAIRD TELEVISOR, 60-LINE, PERFECT condition, cost \$40 new; make offer. L. F. Dienst, 1629 Northland, Lakewood, Ohio.

TRANSFORMERS AND COILS REWOUND or made to order. Transformer laminations for the experimenter. Inclose 3c for prices and data sheets. Pembleton Laboratories, 921 Parkview, Fort Wayne, Indiana.

SELL OR TRADE—PRACTICALLY NEW 301-A Stewart-Warner converter complete with two Arcurus tubes, instruct. W. Koeller, 5244 Division, Chicago.

DIZZY CARTOON FOR QSL OR SHACK. Send \$2 with your rough idea for large original pen drawing. W1AFQ, Harwich, Mass.

FOR SALE: PILOT A. C. SUPER WASP, complete, \$25 cash. John Bakwell, Mt. Carmel, Ill.

WORLD SUPREME BROWNING DRAKE 4 S. W. Receiver. Tuned R. F. Stage. 4 different views of receiver. Sketch blue print. Complete instructions 60 cents (coin). Amlie D. X. Receiver sketch blue print 15 cents. Oliver Amlie, 54th City Line Ave., Overbrook, Philadelphia, Penna.

PILOT A. C. WASP, 15-550 METERS, tubes, coils \$10.00. With power pack \$18.00. W6GWL, 3018-14th Ave., Oakland, Calif.

SWAP: ALL-WAVE BOSCH MODEL 260, (as described April SHORT WAVE CRAFT) for a National S. W. 58 or a Hammarlund Comet Pro. George Epps, 693 Tenth Ave., New York City.

CODE MACHINES, TAPES AND COMPLETE instructions for beginners or advanced students, both codes, for sale or rent reasonable. Rental may apply on purchase price. Extra tapes for all machines. Instructograph, 912 Lakeside Place, Chicago.

SWL AND QSL CARDS. FREE SAMPLES. Radio Press, Springdale, Penna.

SELL D C PILOT SUPER-WASP \$15.00. Loos, 121 E. Curtis St., Linden, N. J.

1—\$18.00 CROSSMAN AIR GUN, \$7.50. \$75.00 Victoreen B.C. Superheterodyne, 5 volt D. C. model, 8 tubes, for \$15.00, includes Weston meter. 1—National B.C. Screen Grid Tuner (110 v. A.C.) and Thordarson Power pack, 8 tubes, make offer. 1—6 foot R.A.C. Victor Exponential Horn with electric pick-up, make offer. Satisfaction guaranteed. Dataprint Company, Ramsey, N. J.

ANSWER FACTORY CAN HELP YOU WITH that receiver, transmitter, antenna. Send problem and ask for quotation. All work supervised by Robert S. Kruse, RFD No. 2, North Guilford, Conn.

R. F. Chokes

(Continued from page 157)

on these leaks, for you can readily remove the cap from the glass tube by judiciously applying a hot soldering iron. Remove the "internals" in this manner and put your insulating space washers on the glass tube. Use narrow strips of gummed paper (two layers) to form separate bushings between the washers. Replace and resolder the cap, which was removed to allow the washers to slide on to the glass tube.

Solder the wire to the cap after passing it through the hole in the end washer. The technique for the remainder of the work is the same as in Fig. 1.

The writer found that the solder used in these old leaks held the cap firmly on the glass tube, even when the old resistance strip was removed.

Fig. 3 is self-explanatory. The base is made from scraps of old radio panels, found in the junk-box, with the aid of hack-saw, breast-drill and file. The clips can be cut with a hacksaw or tin snips and bent to shape with pliers or in a vise. You may even find knurled nuts from old dry cells with No. 8-32 thread for binding posts, or may use another size of terminal screw to fit the nuts from old batteries.

Do not try to make a shorter unit by assembling clips with the terminals towards the center, because the clip holds the choke firmer when you try to bend the near right angle more nearly vertical, than when you arrange the clips so as to straighten them out somewhat when you insert the choke.—W. E. Jennings.

8-Year Old Girl Gets License

(Continued from page 141)

ting and receiving, with the call letters W3BAK, and Jean's 14 year old brother, Roland, is also a licensed operator. Roland has a portable station license for Boy-Scout work—call W3AXP.

Now regarding Jean—she is just a normal child and is eight years old—has blue eyes and light hair and not very large for her age. She was born in San Gabriel, California, July 21, 1924 and lived there until 1933 when her folks came East to live. She is in the third grade in school, plays a violin in the school orchestra and blows a trumpet.

Jean began by playing with the telegraph key—then she learned the code and soon was able to copy at a fair speed. Her father and brother then gave her some regular code practice. She soon was able to draw wiring diagrams and later could write out on paper how transmitters and receivers work. "She took to it so naturally that we helped her learn something of radio laws and regulations," said her father. "By this time we figured that she was an 'old timer,'" states Dad, even at her age, so they decided to let her take the amateur examination which she did on April 26, at Fort McHenry, Baltimore.

Jean is very proficient in the use of a typewriter, as she uses the touch system and writes thirty-five to forty WPM (words per minute) and is very accurate, especially when her age is considered. When using the typewriter she can copy code blindfolded just as fast as when she can see, which is a lot better than many amateurs can do.

"The blindfolded stunt is better than I can do," says her Dad, "despite the fact that I made my living for 18 years as a Morse telegraph operator. But it must be remembered that Jean lacks the experience that is necessary to make a finished operator, but being able to handle the typewriter so well makes it easy for her to copy 20 words per minute. The whole secret seems to be that Jean has grown up naturally, in an air of amateur radio, and it has been fun for her and ourselves to watch her progress, as it has never been necessary to consider her studies as a task."

FREE

This Regular 50c Manual

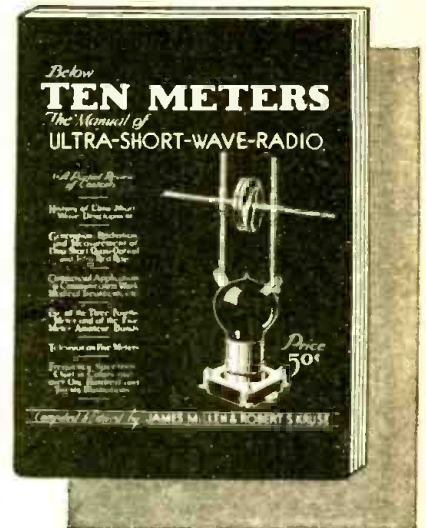

Here is your chance to read up on an ultra short wave radiol "Below Ten Meters" is by far the best compilation of technical data on the very short waves, which are now becoming increasingly popular and important. There are 68 pages—all clearly presented in understandable form. Compiled and edited by these famous short wave experts, James Millen and Robert S. Kruse.

Given FREE

This book is given to you absolutely free with a One Year Subscription to SHORT WAVE CRAFT. Twelve big issues which bring you an entire year's information on the latest developments in short wave radio. Your first copy of SHORT WAVE CRAFT will be sent promptly . . . the Short Wave Manual will reach you in a day or two.

Send \$2.50 in check or money order for a year's subscription to SHORT WAVE CRAFT. Register letter if it contains stamps or currency. (Canadian and foreign 50c extra.)

SHORT WAVE CRAFT
96-98 Park Place New York, N. Y.

SOLEX CALIBRATED LIGHT SOURCE FOR TELEVISION



TYPE 15

IDEAL FOR TELEVISION ENGINEERS AND EXPERIMENTERS. INDIVIDUALLY CALIBRATED AND EACH LAMP FURNISHED WITH COMPLETE DATA AND CHARACTERISTIC.

COLD CATHODE ANY DIAMETER APERTURE RED—GOLD—WHITE

SOLEX LIGHTS

5064 Broadway, New York City

Dear Short Wave Fans:
Do you know you can now build the famous "Air Raider" Short Wave Receiver for less than \$10? Universal, All D.C. or battery, 15 to 500 meters, Build the World Receiver. You can get full details by writing

POSTAL RADIO
CORP
135 LIBERTY STREET - NEW YORK, N. Y.

curvature is, for type I, about 13 inches; for type II about 31 inches. Also by the construction indicated there we avoided the occurrence of unpleasant transition resistances at the contact points of the outside conductor pieces. The current losses increased by the current crowding, which occur chiefly on the inner conductor, can be kept small in the case of the high frequency cable designs in question, by providing an ample diameter to the inner conductor and by a favorable selection of this in proportion to the diameter of the outer conductor. Besides, through the favorable choice of the dimensions, a high voltage security has been attainable, to which the avoidance of all points with sharp edges has greatly contributed. The test voltage of the cable of type I is for a 15 meter wave 1500 volts; of type II for the same wave 5000 volts.

Burying H.F. Cable

To be able to lay the *high frequency* cable normally in the earth, the above described electrically active part of the cable has a lead mantel pressed on, then a layer of jute, then strip iron, over which comes another jute covering which is asphalted. If it is not to be laid in the earth, then the bare lead mantel remains without armoring. Since the pliability is equal to that of ordinary cable, it can be

transported on the usual cable drums and laid in the familiar way in cable ditches. Connections however are to be made otherwise than with ordinary cable. To correspond to the manifold uses, special connectors were constructed for high frequency cable. In the case of the end connection (Fig. 5), which is suited for interior or open air mounting, the high frequency conductor is connected by the bolts provided. Connecting two pieces of cable in the earth is done by the usual cable connection sleeves. For cases where it is a matter of making a connection of two cable ends outside the cable channel, which in case of need can be also separated or switched, a coupling and counter-coupling end connection was constructed, which is of the greatest value for operative switching over of high frequency cable conductors.

In all cases where the radiation resistance of the transmitting or receiving antenna is not the same as the wave resistance of the high frequency cable, a proper adjustment of resistance must be made. For this purpose special high frequency transformers are particularly suitable, which consist of two coils, which must be tuned, with regard to the high frequencies, to the operating wave, and whose coupling is so adjusted that the required transformation ratio results.—*Radio Amateur*

Try This 2-Tube Regenerative-Oscillodyne

(Continued from page 144)

- C₁—25 mf. Dry Electrolytic Condenser, with Mounting Strap. Type DR-275.
- C₂—0.005 mf. Molded Mica Condenser, type MC-1218 or NM-1283.
- C₃—5 mf. Tubular By-Pass Paper Condensers, type BB-2050 (Concourse).
- L₁, L₂—5 Hammarlund 4-prong isolantite coil forms, type CF-4.
- 40 feet No. 22 enameled magnet wire.
- 35 feet No. 26 double-silk covered wire.
- 100 feet No. 34 double-silk covered wire. (See Text for Winding Details.)
- L₃—Hammarlund 8 mh. R.F. choke, type CH-8.
- T₁—National Impedance Coupling Unit, type S-101.
- R₁—Lynch 2 megohm Metallized resistor, 1/2 watt, type LF-4 1/2.
- R₂—50,000 ohm Volume Control (Potentiometer).
- R₃—20-ohm Rheostat.
- R₄—Wire-Wound Pigtail Resistor, 700-ohms.
- 2—Eby 4-prong isolantite sockets.
- 1—Eby 4-prong wafer socket.
- 1—Eby molded Twin Binding Post Assembly.
- 1—Eby Molded Twin Speaker Jack Assembly.

- 1—National Type B Dial (0-100-0)
- 1—Midget Jack Switch, S.P.S.T.
- 1—Midget Jack Switch, D.P.S.T.
- 1—Alden (Na-ald) 4-prong socket, type 424.
- 1—Alden (Na-ald) Connectorald Plug, type 94.
- 1—Blau Aluminum Subpanel, 1/16", 8 1/2" x 8 1/2". (Folded and drilled as described.)
- 1—Blau Aluminum Panel, 6" x 9".
- 3 feet of 4-Conductor Battery Cable.
- 2—Triad type 230 tubes.
- 1—Roll Hookup wire (solid).

IF
you ever wanted the data on a good S-W "SUPER-HET" don't miss the conclusion of Mr. Shuart's article on the "S-W Band-Spread Converter" in the NEXT ISSUE.

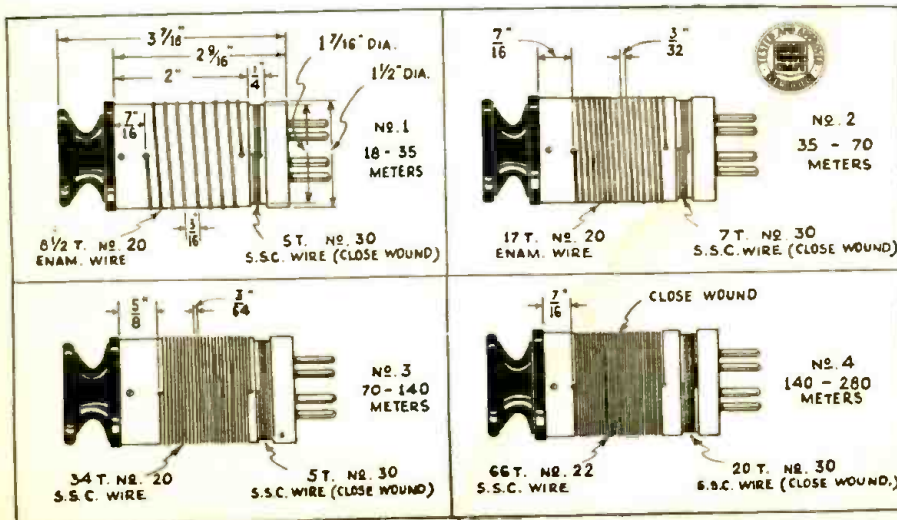

Coil Data for Regenerative-Oscillodyne.



STOPPANI BELGIAN COMPASS

Being a Precision instrument, the Stoppani Compass lends itself admirably for use in the Radio Experimenter's test laboratory. It affords an ideal means of determining the polarity of magnets, electro-magnets and solenoids carrying current. Since the compass needle is itself a magnet having a North-seeking pole (which is actually the South pole) and South-seeking pole (which is actually the North pole); and since, as we all know, like poles repel each other and unlike poles attract each other, it is merely necessary to bring the compass in the vicinity of the magnet under test. The North pole of the compass needle will then point to the North pole of the magnet under test or the South pole of the needle will point to the South pole of the magnet depending, of course, upon their relative positions.

May Be Used As a Galvanometer

Because of its uniform magnetic properties, high sensitivity, and delicate frictionless bearings, the Stoppani compass may be utilized to advantage as a highly precise galvanometer for detecting electric currents in experimental or conventional radio circuits. The Compass is easily and readily converted into said galvanometer by merely winding several turns of ordinary radio wire completely around the face and lower case of the compass; leaving small spaces between turns to observe the movement of the needle. The ends of the wire are brought out as test leads to be inserted in series in circuits under test. A deflection of the compass needle in either direction indicates the presence of an electric current. Incidentally the intensity of the current may be closely approximated since the force with which the needle swings is proportional to the intensity of the current flowing through the wire.

Stoppani Compass is an ideal SURVEYORS instrument with elevated sights. It is made of Solid BRONZE. Parkersized, non-rusting, graduated in 1/10. Ruby Jewelled. 4 inches square. Fitted in a hardwood case, with set screw in corner to hold needle rigid when not in use. The United States Government paid more than \$30.00 for this precision instrument.

OUR PRICE \$4.50

Gold Shield Products Company
112 Chambers Street SWC New York, N. Y.



IT'S FREE!

Here you are! The newest and one of the most genuinely helpful service aids IRC has ever presented—an attractive house magazine brimful of authentic, well-written radio service kinks and methods. You'll not only enjoy reading it but you'll profit from every issue. Mailed monthly—FREE—to bona fide service men only. Get your name on the IRC mailing list today!

THE LATEST IRC SERVICE HELP

Use This Coupon

INTERNATIONAL RESISTANCE CO.,
2006 Chestnut St., Philadelphia, Pa.

Sure—I'm a radio service man. Please send the "IRC Servicer" regularly—at no cost to me.

Name.....
Street.....
City..... State.....

Remarkable Freedom from NOISE...by use of LYNCH

Short Wave Antenna System



Mr. Arthur H. Lynch, March 27, 1933
Lynch Manufacturing Co., Inc.,
General Motors Bldg., New York, N. Y.

Dear Mr. Lynch:
A few days ago I installed in my store one of your new Lynch Doublet Short Wave Antenna Kits.

Up to the time of installing this new system it had been impossible for us to get short wave reception in this location which was in any way satisfactory. Since installing this new antenna, I have been able to pull in new stations, Germany, Rome and England with remarkable freedom from noise and with unusually high signal strength and unusual regularity.

Your new doublet antenna is without question the finest short wave system I have ever seen. I say this after having compared the new system with five other different types of antenna systems which I am using at present. I can foresee an unlimited field for this type of antenna in every case where consistently satisfactory short wave reception is imperative.

Very truly yours,
R. G. Scell

R. G. Scell
R. G. Scell

RGS/MES

Complete Kit..... \$5.00
At All LYNCH Jobbers and Dealers

If your Jobber, Dealer or Serviceman cannot supply you, order direct from us. Sent postpaid, with instruction Booklet for \$5.00.

Free Descriptive Folder upon request.
LYNCH MANUFACTURING CO., Inc.
711 R.P. General Motors Bldg., New York, N.Y.
Makers of the Famous Metallized Resistors

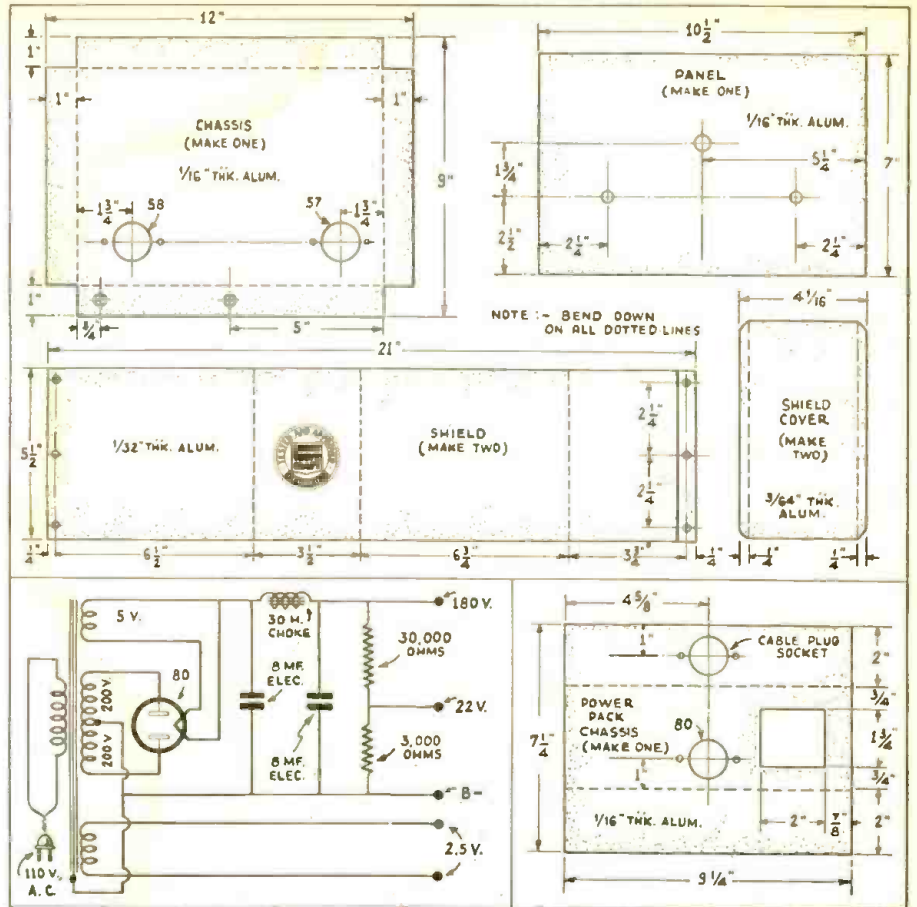

Chassis details and schematic diagram of power supply unit for Mr. Shuart's S-W converter.

(Continued from page 177)

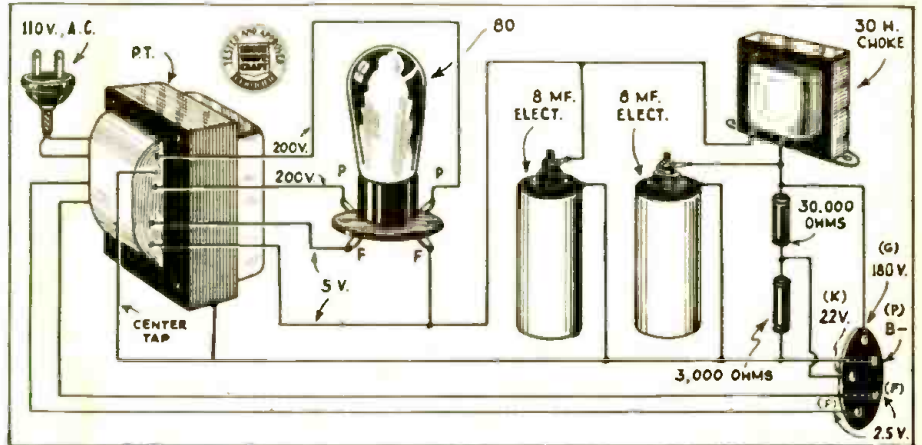

Picture diagram of power supply unit for band-spread converter.

High Frequency Cable for Connecting Antennas

(Continued from page 145)

armored cable. Lately this has been achieved in the design of the special high frequency cables.

Already types of high frequency cables have been developed, which are suitable for short, medium, and long waves, and accordingly they can be successfully used in all cases coming into practical question. The special construction of this cable not only assures slight losses but also affords high voltage security and great flexibility. In the types described there is used as inner conductor either a solid copper conductor of (.2 inch) diameter (Fig. 3) or a hollow copper "rope" of .6 inch outside diameter (Fig. 4), while the outside conductor consists of short, rigid pieces of copper tube, which are connected together by specially formed ball-joints. The in-

ternal diameter of the outer conductor is, in type I (see Fig. 3) .7 inch in the case of type II (Fig. 4) 1.9 inch; inner and outer conductors are mutually insulated by flat insulating rings of a special highly efficient low-loss material inserted in the ball joints. Since the electric field of this cable runs in air between every two such insulations, on the greatest part of the cable length there can be no dielectric losses. The natural capacity of type I is from 55 to 60 mmf., that of type II from 60 to 65 mmf., per running meter, (3.28 ft.) and the wave resistance of both types is about 63 ohms. By the above mentioned joint construction, the same pliability is attained for the high frequency cable as in the ordinary low or high tension ground cables. The smallest admissible radius of

WINDS LIKE A WATCH

Are you "gauge-minded"? Then write with the sackless Conklin Nozac (no sack)—the new deal in pens. Full visibility of ink supply. Filled by the positive mechanical action of a new filling device tested by over two years of general use. \$5.00 and more. Ask your dealer.



VISIBLE INK SUPPLY

Another new Conklin with visible ink section \$3.50. You can buy a good Conklin (rubber sack) pen today for as little as \$2.75. Pens \$1.00.

THE CONKLIN PEN COMPANY
Chicago, Toledo, San Francisco

Conklin NOZAC
SATISFACTION GUARANTEED

This Converter Spreads Bands Over Dial

(Continued from page 155)

loosened to about half capacity. Then tune the main tuning condenser and the detector trimmer condenser until some form of signal is picked up. (Assuming the converter has been connected to the broadcast set and the B.C. tuner set at 550 kc.) The next procedure is to tune the output filter to 550 kc. When this has all been done the next job is getting the oscillator and first detector to track. This is accomplished by the adjustment of C2 and C3 of the oscillator and C2 of the detector. If the coil values have been followed exactly the setting of the two condensers C2 will be at half capacity, and C3 set at almost full capacity.

Antenna To Use

The antenna for this set can be anything from a 10 foot wire to a "doublet" with transposed feeders. With a fairly good broadcast receiver and a ten foot wire used as an antenna, foreign broadcast stations were brought in on the loud speaker with ear-splitting volume! However, if one has the space, a doublet antenna using the Lynch transposed feeder system is recommended. The two flat-top sections of the doublet should be about 25 feet in length for each section. The length of the feeders, of course, depends upon the location of the antenna in relation to the receiver.

For those not having a power supply to run the converter an idea of what is required is shown in the diagram, together with a list of parts.

An I.F. unit, together with its beat oscillator and audio amplifier, will be described by the author in the next issue of this magazine for those wishing to build a complete short wave Superheterodyne.

- #### List of Parts in Diagram
- C1—Two gang National 150 mmf. (270 degrees)
 - C2—100 mmf. National Midget Tuning Condenser
 - C3—.001 mf. Hammarlund Variable Padding Condenser
 - C4—.01 mf. Fixed Condenser
 - C5—.5 mf. By-pass
 - C6—.01 mf. Fixed
 - C7—100 mmf. Fixed
 - L5-L6, C8-C9 all included in Hammarlund I.F. Transformer
 - R1—5000 ohm Resistor
 - R2—50,000 ohm Potentiometer
 - R3—5,000 ohm Resistor
 - R4—50,000 ohm resistor
 - R5—100,000 ohm resistor
 - L1-L2-L3-L4 See coil table
 - T1—Type 57 tube
 - T2—Type 58 tube

- #### Parts List for the Converter
- 1—Blau Aluminum Chassis and Panel
 - 2—National Six Prong Isolatite Sockets
 - 2—National Six Prong Special Coil Sockets
 - 1—National Type B 270 Degree Dial
 - 1—National 150 mmf. 270 Degree Two Gang Condenser
 - 2—National 100 mmf. 180 Degree Single Tuning Condensers
 - 8—National R39 Coil Forms (6 prong)
 - 1—Hammarlund .001 mf. Padding Cond.
 - 1—Hammarlund 465 kc. I.F. Transformer
 - 2—.01 mf. Fixed Cond.
 - 1—.5 mf. By-Pass Cond.
 - 1—100 mmf. Fixed Cond.
 - 1—5,000 ohm Resistor (1 watt)
 - 1—50,000 ohm resistor (1 watt)
 - 1—100,000 ohm resistor (1 watt)
 - 1—50,000 ohm Potentiometer
 - 1—57 tube
 - 1—58 tube

- #### Parts List for Power Supply
- 1—Blau Chassis
 - 1—Alden 5 Prong Socket
 - 1—Alden 4 Prong Socket
 - 2—8 mf. Electrolytic Condenser
 - 1—Radio Trading Co. 30 Henry Choke
 - 1—Radio Trading Co. Power Transformer
 - 1—30,000 ohm resistor (5 watts)
 - 1—3,000 ohm resistor (5 watts)
 - 1—Type 80 Rectifier Tube

Band	DET. COIL				OSC. COIL		
	Grid Turns	Turns Spaced	Ant. Turns	Tickler Turns	Turns	Spaced	Tapped
160	38	1/64"	5 1/2	5	30	1/32	9th
80	18	1/16"	3 1/2	5	17	1/16	6th
40	10	3/32"	2 1/2	5	10	3/32	4th
20	5	3/16"	1 1/2	4	5	3/16	2nd

Coil forms, National, 6-pin. diameter 1 1/4 inches.
 All Antenna and Tickler Coils Wound with No. 34 Silk Covered Wire.
 160 Meter Grid Coils Wound with No. 26 Enameled
 80 Meter Grid Coils Wound with No. 24 Enameled
 40 Meter Grid Coils Wound with No. 24 Enameled
 20 Meter Grid Coils Wound with No. 24 Enameled
 See diagram of power unit on page 178

3 Unusual Short-Wave Hook-Ups

(Continued from page 156)

selves into small modifications of one or other of the circuits that we have already dealt with, and may therefore be left out for the present.

We have more important things to deal with, among them the question of screened-grid R.F. tubes for short waves.

The author is content with showing what, in his opinion and experience, appears to be the only really practicable arrangement for a screened-grid R.F. stage (Fig. 3). There is nothing unorthodox about the circuit, but he has found most definitely that one must use a parallel-fed arrangement of this kind. So many people who have tried S.G. on short waves and given it up in disgust, have only tried a series-fed circuit of the "tuned-plate" type.

With the arrangement shown, the coupling condenser from the plate of the S. G. tube is a small adjustable condenser which is taken to the top end of the detector grid coil. In cases where the detector uses the popular capacity-coupled aerial, one only has to remove the aerial from the coupling condenser and hitch on the plate of the S. G. tube instead!

This has practically no damping effect upon the detector circuit—if the coupling capacity is kept small enough—and there is very little "pulling" between the S. G. and detector tuned circuits.

The aerial coupling to the R.F. stage should be fairly tight, and may be either inductive (as shown in the diagram) or capacitive, by means of the usual "pre-set" condenser.

If the aerial coupling is adjusted to the right degree the tuning of the S. G. grid circuit can be made quite flat.—*Popular Wireless (London).*

DON'T MISS
the article in next issue
"Electrified 3-Tube
DOERLE"

Allied Radio

**TODAY—
as always—
BEST**

for
SERVICE

QUALITY

PRICE



WORLD'S FAIR ISSUE

**YOU NEED THIS CATALOG
SEND FOR IT TODAY**

ALLIED RADIO CORP.

833 W. Jackson, Chicago

Please send me FREE the new WORLD'S FAIR issue of your Dealers' Radio Catalog.

Name

Address

City State

Allied Radio

SCHWARTZ

offers the following Sensational BARGAINS—
and many more—Write for new bulletin

National FB-7 Superheterodyne Receivers less coils and tubes—brand new—net.....	\$26.65
National type R-152 R.F. Choke Isolantite Mounting—latest model—each.....	1.32
National Air-Dielectric Tuned L.F. Transformers—each.....	2.94
National SW-3 Short Wave Receivers—brand new—less coils and tubes.....	14.10
National FLX Crystal Filter Model—less coils.....	38.20
Hammarlund Comet "Pro" Superheterodyne Short Wave Receiver—complete in cabinet with R.C.A. tubes—latest model—net.....	\$5.00
Hammarlund Midget Condensers with Isolantite Insulation:	
MC20.....	\$0.88
MC35.....	.88
MC50.....	1.00
MC75.....	1.18
MC100.....	1.35
MCD140 Dual.....	2.04
Two-Button MICROPHONE (gold plated diaphragm) mounted on cast aluminum desk model stand, with your call letters cast in stand—complete.....	
866 H.V. Rectifiers—guaranteed.....	1.40
210 Power Amplifier Oscillators—guaranteed.....	1.15
SPRAGUE Wet 8mf. Electrolytic Condensers—during June only—each.....	.29
8 mid. Dry Electrolytic Condensers—Aluminum Cans (plain or enameled) Max. D.C. Peak 600V., each.....	.59
Dry Electrolytic Condensers in square cardboard containers—Max. D.C. Peak 600V.:	
2mf.....	\$0.35
4mf.....	.45
8mf.....	.50
15mf.....	.59
LOW PRICES ON POWER, PLATE and FILAMENT TRANSFORMERS!	
DRY ELECTROLYTIC CONDENSERS!!!	
Write for our lowest prices ever offered the Amateur and Serviceman on DRY ELECTROLYTIC CONDENSERS. Tubular and square types in cardboard containers also in ALUMINUM cans—ALL CAPACITIES. Twenty per cent deposit with all orders—balance C.O.D. Orders F.O.B. Schenectady. Postage stamps not acceptable. More foreign orders solicited. Write for our latest bulletin.	
Open Evenings	
Maurice Schwartz & Son	
710-712 Broadway Schenectady, N. Y.	
Be a TELEVISION EXPERT	
 <p>During the next few years, thousands will become rich in Television, the amazing new major industry. Will you be one of these? There is only one way for you to get into Television and that is with specialized training. Television experts are needed right now and this marvelous new business has hardly started. If you are over 17 years of age, send your name and address for full information about our plan whereby you may step out of the world's greatest Television School—occupying the three top floors of Missouri's tallest skyscraper—into a high pay position. Write Today.</p> <p style="text-align: right;">Sid Noel, President FIRST NATIONAL TELEVISION 293 Power & Light Bldg. Kansas City, Missouri</p>	

www.americanradiohistory.com

The Denton "Economy Three"

(Continued from page 147)

NOW MAYO MICROPHONES for Short-Wave fans—

Improved now a thousand-fold so that short wave enthusiasts can also have the benefit of using MAYO Microphones in experimental broadcasts. Expertly designed to fulfill most exacting requirements—rigid in construction so as to be adaptable to rough handling and long service. You will find that results are much better with MAYO Microphones.

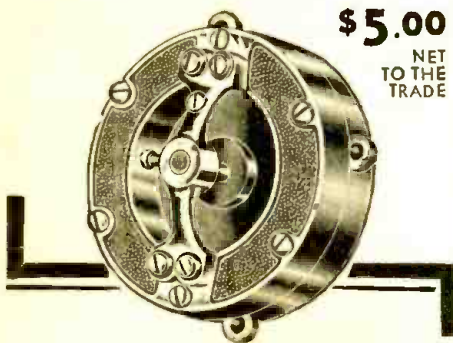

\$5.00
NET
TO THE
TRADE

Here is the biggest value ever offered in commercial type microphones. An extra large, two button microphone extremely rugged in construction, designed especially for broadcast purposes, public address systems, recording, etc. This new design, which has a stretched cushion diaphragm of special heat treated duralumin, gives this microphone a frequency response of from 30 to 5,000 cycles. This microphone has pure gold contacts on button and diaphragm. The model is 2 1/4" thick by 3 3/4" in diameter. It is rated at 100 ohms per button or is furnished with 200 ohms per button if required. MAYO Microphones are beautifully finished in polished chromium.

MAYO "mikes" are superior in comparison with others—excellent in workmanship—better in tone quality. More than 50,000 MAYO Microphones have been made and sold since January 1, 1933. There must be a reason.

Write to Dept. SW for booklet illustrating the complete line of MAYO quality microphones.

Maylux Mfg. Corp.

281 East 137th St. New York, N. Y.

SUPER TESTING KIT!

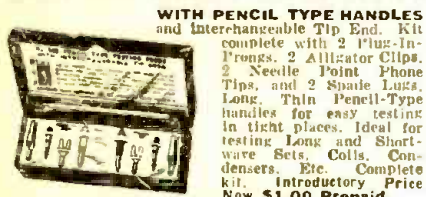

WITH PENCIL TYPE HANDLES and Interchangeable Tip End. Kit complete with 2 Plug-In Prods. 2 Alligator Clips. 2 Needle Point Phone Tips, and 2 Spare Leads. Long, Thin Pencil-Type handles for easy testing in tight places. Ideal for testing Long and Short-wave Sets, Coils, Condensers, Etc. Complete kit. Introductory Price Now \$1.00 Prepaid.

AMERICAN RADIO HARDWARE CO. 137 Grand Street New York, N. Y. Agents Write for Exclusive Territory

DO IT NOW

PATENT YOUR IDEAS REGISTER YOUR TRADE-MARK BY **Z. H. POLACHEK** 1234 BROADWAY 31st. NEW YORK REG. PATENT ATTORNEY PROF. ENGINEER WHAT IS YOUR INVENTION? Send me a simple sketch or model for CONFIDENTIAL ADVICE

for more than a year of steady use. In some instances, when making tests in different locations, it was noted that improved results could be obtained with the use of tube shields on the first R.F. and detector tubes. If the constructor wishes to go to the expense, it would be a very good idea to include the two additional tube shields on the 34 and 32 type tubes.

Experiments with the 34 tube in the detector socket have been quite satisfactory, resulting in very smooth control of regeneration, but with an apparent falling off the sensitivity of the receiver, although the difference in sensitivity is not enough to cause the person testing the set to say that the 34 tube could not be used in this position with satisfaction.

Operation

Place the 34 type tube in the R.F. socket, a 32 type tube in the detector and 33 tube in the output tube socket. Connect the ear-phones, connect up the battery cable to the battery supply, adjust the filament volts to exactly 2 volts, and leave this at this point. The fact that these tubes work best at 2 volts from an electrical standpoint also means that they will last the longest at 2 volts from the standpoint of life. Therefore, always keep tubes in this 2 volt class at the rated 2 volts for satisfactory long-life operation.

Set S.W.1 and S.W.2 to the same identical tap, so that both coils can be tuned to resonance. Turn the regeneration control, which is mounted on the left-hand side of the panel, to the right and see if the detector tube will oscillate. If the detector tube will not oscillate, reverse the lead marked "X" in Fig. 1. If the tube oscillates, slowly turn the tuning dial which drives condenser C-2 and C-6. Keep the regeneration controls in position for maximum sensitivity. Vary C-3 for the maximum signal, as this condenser is used to enable condenser C-2 and C-6 to track throughout the band. If the condenser C-2 and C-6 does not track satisfactorily by means of condenser C-3, it will then be necessary to change the coils slightly so that the tuning characteristics of the coils will coincide. If the 32 tube regenerates too quickly and not smoothly, vary resistance R-1 and reduce the capacity of condenser C-9, generally testing the value between .0001 and .00025 for C-9 and start at 5 megohms for R-1 and work down to 1 meg. if necessary. Variations between condenser C-9 and resistor R-1 are to be so adjusted that the regeneration control R-3 is about between 1/4 and 1/2 way over to the right for maximum control of regeneration. An increase in size of R-2 or variation in R-2 will change the portion of the operating curve of R-3 for the maximum convenience.

Most experimenters are familiar with the problems to be encountered at this point and there should be no difficulty with a few hours of final adjustment with this receiver to obtain the smoothest operation possible. No set of this kind can be thrown together, of course, and have real satisfactory regeneration control right off the bat without a great deal of luck. Generally it takes time to get a set working smoothly.

Construction Pointers

There is little to be said about the construction, as the photographs clearly show the placement of the parts as well as most of the wires in such a manner that the set should go together with very little trouble.

Some mention should be made of the method of supporting the coils within their shields. This is done in a simple manner and although several methods were tried out this works out the best.

Cut two pieces of brass or thin aluminum as shown in Fig. 3 and bend into shape. Then spread a thin coat of PDQ Plastic Metallic Solder on the metal surfaces that contact the inner wall of the tube shield base; allow this coating to

harden for a short time and then place a greater amount of the solder on the inside of the shield socket and allow the bracket to rest in place for as long a time as possible. It is a good idea to let the solder harden all night, if possible.

Of course the tap-switch and the tube shield socket have to be fastened to the panel before this can be done. If the hardening process is left for 24 hours the results will be perfect. No heat is necessary when using this solder.

Fasten everything in place. Those parts mounted by means of pig-tail connections should have good mechanical support without the aid of soldering. The best operation, when it comes to short waves, occurs when the set is free from noise. Noisy sets will ruin reception and most noise comes from loose connections.

Tighten up all nuts and bolts used to hold the chassis in place. Loose nuts and bolts here will cause noise.

Use care in soldering to the switch connections and do not permit soldering flux to drop down between the contacts, as this will cause losses; this is a common fault of constructors when soldering to tap switches. R2 is twenty thousand ohm resistor.

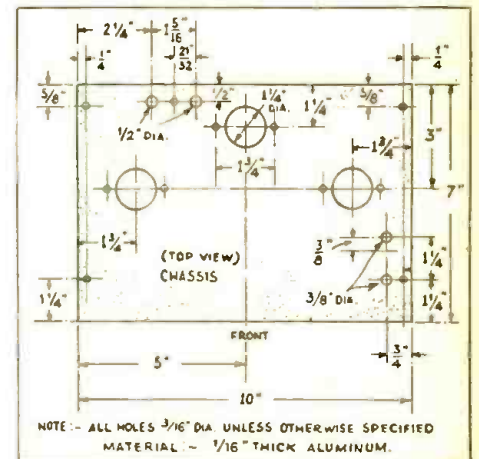

Top view of chassis.

Portable Test Oscillator

(Continued from page 164)

cuit, checking the frequency responses of the I. F. stages in a superheterodyne receiver, checking the range covered by various plug-in coils, checking and calibrating frequency meters, checking other oscillators, etc. When using the Power-tone Test Oscillator for short-wave tests, the manufacturers recommend that the operator first determine roughly the frequency to be measured or checked. This may be readily determined by finding some commercial or short-wave broadcast station of known frequency; the next operation is to beat this signal with that from the test oscillator and determine the order of the harmonic. Example: 6000 kc. is the fourth harmonic of the 1500 kc. dial position. When this is known, it becomes easy to spot both ends of the dial range in the apparatus being tested. By calibrating your receiver by means of such a calibrated oscillator, the proper dial setting for any desired station can be quickly and accurately determined.

The primary scale is calibrated from 550 to 1500 kc. On the secondary scale the popular intermediate frequencies are clearly marked: 175, 260, 400, and 450 kc with 177.5—175—172.5 spotted. Frequencies not marked on the scale can be obtained by means of harmonics by simply dividing the desired frequencies by small whole numbers to obtain the nearest scale frequency. In an actual test it has been found that sufficient signal strength is available for checking purposes up to the fiftieth harmonic and beyond.

In many cases strong steady signals have been obtained up to the one hundred and fiftieth harmonic.

A New 5-Meter Receiver

(Continued from page 151)

work, it may be advisable to omit the 89 tube and operate the receiver with headphones. The circuit is such that the 2-volt tubes cannot be employed.

POWER SUPPLY—The heater circuit requires approximately 6 volts at .9 ampere. The voltage is not critical and may be between 5.5 and 6.5 volts. The supply may be either A.C. or D.C. except as noted under instructions for the *Low Frequency Coils*.

The plate supply voltage normally required is 180 volts and this may be obtained either from "B" batteries or from an A.C. operated power supply. The National type No. 5886 AB power unit fulfills these requirements and is supplied with a single receptacle for the 4-prong cable plug. As little as 135 volts of "B"-battery may be used with good results, provided the 25,000 ohm resistor, mounted near the center of the chassis (underneath) is changed to 10,000 ohms. Fair results may be obtained with 90 volts of "B"-battery, in which case this resistor should be "shorted" out entirely.

OUTPUT CIRCUITS—The output tip jacks for speaker operation are located at the back of the receiver on the righthand side. The speaker requirements are not at all critical and any conventional *magnetic* or *dynamic* type of unit will give good results. The output impedance of the receiver is approximately 7,000 ohms, requiring a speaker impedance of between 3000 and 15,000 ohms.

The phone jack for headphone operation is located in the left-hand side of the front panel and is connected to the plate circuit of the detector tube by means of a step-down auto-transformer.

CAUTION: At all times when the heaters are lighted and when "B" power is connected to the receiver, either the headphone jack must be plugged in or a loud-speaker connected to the output terminals. If this is not done, the 89 tube may be seriously damaged.

ANTENNA—The antenna binding post is located at the left hand side of the receiver, the lead being brought through the rubber bushings beside the post. A series antenna coupling condenser is located directly below the antenna post near the chassis. The success of any 5-meter work depends largely upon the receiving antenna and antenna coupling employed. In most cases it is advisable to experiment with several antenna arrangements, but as a general rule the antenna described herewith will be found efficient.

The antenna proper should be as high as possible and may be a single vertical wire approximately 8 feet in length. The lead-in consists of a single wire connected to the antenna 1 1/2 inches from the center and should be run at right angles to the antenna for a few feet before being brought down to the receiver. The length of the lead-in is not critical in any way but should be well insulated and sharp turns should be avoided. It should not be shielded!

When the receiver is put in operation with certain types of antennas, it may be found that the detector will not oscillate over certain portions of the range. This indicates too much antenna coupling and the coupling condenser plates should be spread apart slightly until the *dead-spot* just disappears.

When the more conventional type of *untuned* antenna is used, the coupling condenser plates should be moved closer together for best results.

As a general rule, a ground connection is not necessary but under certain conditions its use may be beneficial.

LOW FREQUENCY COILS—Coils are available for covering the 10, 20, 40, 80 and 160 meter bands. When using these coils the low frequency oscillator (37) should be removed from the socket. Under certain circumstances the use of superre-

(Continued on page 187)

It Takes Time to be RIGHT

HAMMARLUND isn't always first to make "improvements"—but they quickly take first place when they are made.

That is the way with all really fine things—it takes time to be right.

Hammarlund Transmitting and Receiving Condensers, R.F. Chokes, AIR-Tuned I.F. Transformers, Isolantite Coil Forms and Sockets, and the famous COMET "PRO" Short-Wave Superheterodyne Receiver—all are products of more than thirty years of doing things just a little better than may be necessary.

But that extra care to be RIGHT has rewarded Hammarlund with leadership. And it will reward you with better results in all of your construction work.

Mail Coupon for Catalog

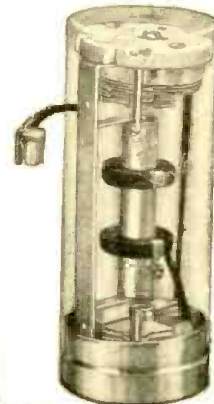
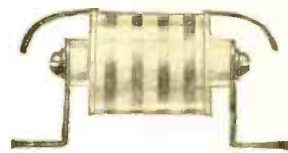
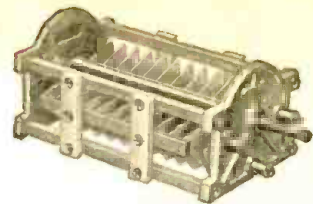

HAMMARLUND MANUFACTURING CO.,
424-438 33rd Street, New York, N. Y.

Check here for folder on Air-tuned I. F. Transformers.

Check here for General Catalog "33."

Name _____

Address _____

SW-7

89° SALE!

of VALUABLE REFERENCES for HOME, OFFICE and SCHOOL

Postage 11c per book. Postage FREE if 5 books are ordered. (Formerly \$1.50 to \$7.85)

A Genuine Friend in Need!

89c (Formerly \$6 in 4 vols.)



Right at your finger-tips are instant answers to every question. Get the book! Get the book! In the Index! A bad cold? Feel bad all over? Stomach upset? Feel tired, run down? Here you find out what's the matter, what to do in ordinary illness; how to treat until Doctor gets there in serious cases.

In half a million American homes this New Home Medical Adviser is a daily guide, counsellor and friend. It is kept handy beside atlas, dictionary, almanac, Bible and other references so everyone can quickly refer, read, learn, understand and KNOW. Sixteen medical specialists here in 1 handy book. The leading home medical authority for 25 years. Authentic, proven, newly revised and up-to-date on latest medical practice.

How to Diagnose and Treat:

Anemia, Heart Trouble, Diarrhea, Billiousness, Indigestion, Worms, Nervous Debility, Gout, Delirium Tremens, Nervous Collapse, Insanity, Apoplexy, Colds, Toothache, Diphtheria, Heat Stroke, Food Poisoning, Earache, Rheumatism, Lumbago, Stiff Neck, Hives, Itching, Rupture, Piles, Tumors, Typhoid Fever, Malaria, Smallpox, Vaccination, Erysipelas, "Pink Eye," Deafness, Earache, Measles, Sex

Hygiene, Gonorrhea, Syphilis, Sexual Functions, Abuse, Duties of Parents, Marriage Relations, Bright's Disease, Puberty, Menstruation, Leucorrhea, Childbirth, Children's Diseases, Croup, Bowlegs, St. Vitus' Dance, Personal Hygiene, Skin, Hair, Teeth, Diet, Home Exercises, Rest, Weight and Height, Emergency Treatment for Burns, Fractures, Bites; Lightning Stroke, Sunstroke, Poisons and all Accidents.

1. NEW HOME MEDICAL ADVISER. 472 pages. Fully illustrated, many in color. Full-page body charts. Well bound gold stamped, size 5x7 1/2. Complete in 1 handy vol. (Formerly in 4 vols., \$6.) **89c** Our Bargain Price (postage 11c extra)

2. FAMOUS WOMEN. When Cleopatra was 18 she bore Caesar a son! Curious and hitherto unknown facts at last revealed in these 499 short biographies of famous (and infamous) women. Sentiments to Mary Pickford. 328 pages. 32 full-page portrait illustrations. (Formerly \$3.) Our Bargain **89c** Price (postage 11c extra)

3. GRAPHOLOGY, or, Character Analysis from Handwriting. Easy to discover truth about friend or enemy if you have his signature. Easy to read, understand and apply. Valuable in business, love affairs, society. This book is the recognized authority. 200 pages, cloth bound. (Formerly \$3.) Our Bargain Price **89c** (postage 11c extra)

4. THE SECRET OF GOLD. By Robert Collier, world-renowned writer and teacher of practical psychology. How to realize money by easy psychology methods. Anyone can read, use, learn and benefit. (Formerly 7 vols., \$7.85.) Same text now in 1 vol. Bright red artwork, handsomely embossed. Our Bargain Price (postage 11c extra)

FREE BOOK WITH EVERY ORDER

While our 236 copies last, we will include in your shipment without extra charge 1 copy of "The Winning Principle of Success" (value \$1). Rush order to make sure of getting this free book. POSTAGE FREE if you order 5 books (\$4.45 worth). Stock up NOW for season's entertainment and study. Mail this coupon TODAY!

SCIENCE PUBLICATIONS, 94 S. PARK PLACE, NEW YORK, N. Y.

Please send me the books I have circled below for which I enclose \$_____ to cover purchase price and postage. I understand that my money is to be refunded on any unsatisfactory purchase.

1 2 3 4 5 6 7 8 9 10

Name _____

Address _____ City _____ State _____

(POSTAGE FREE if 5 or more books are ordered. Otherwise include 11c per book postage with remittance.)

The NATIONAL SHORT-WAVE LIBRARY

The Manual of... Vol. II
Short Wave Radio
THE HOW AND WHY OF LONG DISTANCE SHORT WAVE RECEPTION
50¢ Vol. 2

Below TEN METERS
TEN METERS
THE MANUAL OF ULTRA-SHORT-WAVE-RADIO
50¢ Vol. 3

ULTRA-SHORT WAVE AMATEUR BAND COMMUNICATION
25¢ Vol. 4

PEAK EFFICIENCY DESIGN ON THE SHORT WAVES
10¢

AN INEXPENSIVE RADIOPHONE TRANSMITTER
10¢

THE NATIONAL AGS COMMUNICATIONS TYPE SHORT WAVE SUPERHETERODYNE
10¢

MANUALS

- Vol. 2 **The Manual of Short Wave Radio. The How and Why of Long Distance Short Wave Reception**.....50c
- Vol. 3 **Below TEN METERS. The Manual of Ultra Short Wave Radio**.....50c
- Vol. 4 **ULTRA SHORT WAVE AMATEUR BAND COMMUNICATION. Practical Data on the Utilization of the 3/4 Meter and 5 Meter Bands**.....25c

ENGINEERING BULLETINS

- No. 4 **WORLD WIDE SHORT-WAVE RECEPTION** with the ACSW-58 and DCSW-34.....10c
- No. 5 **AN INEXPENSIVE RADIOPHONE TRANSMITTER.** For the 1750 kc. Amateur Band.....10c
- No. 6 **PEAK EFFICIENCY DESIGN ON THE SHORT-WAVES.** Engineering a Universal A.C. and D.C. Receiver for the Amateur Bands.....10c
- No. 7 **THE NATIONAL "AGS" COMMUNICATIONS TYPE SHORT-WAVE SUPERHETERODYNE**.....10c

Sent Prepaid on receipt of price
NEW 16-PAGE CATALOG No. 210.....FREE
6c to cover postage

Mail Coupon NOW!

NATIONAL CO. INC.
61 Sherman St., Malden, Mass.

Please send me Vol 2 Vol 3 Vol. 4

No. 4 No. 5 No. 6 No. 7,

Catalog 210 (check which); for which I enclose \$..... (cash, stamps or money-order).

Name

Address

SW-7-33

The "Ace High" Band-Spread

(Continued from page 153)

List of Parts

- C1, 3 5 plate midget (Cap.—.000015 mf.)
- C2, 4 23 plate midget (Cap.—.0001 mf.)
- C5, 6, 7, 14 .1 mf. Concourse tubular pig-tail condensers. (300V)
- C8, .00025 mf. Solar mica pigtail condensers
- C9, 10, 13 .0001 mf. Solar mica pigtail condensers
- C11 .01 mf. Solar mica condenser
- C12 5 mf. Solar electrolytic (50V)
- R1, Acratest 1 watt 300 ohm
- R2 Wire-wound 10,000 ohm variable
- R3, 4 25 watt 20,000 ohm with one tap
- R5 50,000 ohm variable
- R6 Acratest 5 megohm 1/2 watt
- R7 Acratest 500,000 ohm 1/2 watt
- R8 Acratest 1 megohm 1/2 watt
- R9 Acratest 2,000 ohm 1 watt
- Ch1 National S.W. choke (2.5 millihenrys)
- Ch2 National S.W. choke (90 millihenrys)
- Ch3 Audio transformer with primary and secondary connected in series
- 8 NaAld 5 prong coil forms (dia.—1 1/4 inches)
- 2 Eby 5 prong bakelite sockets
- 2 Eby 6 prong wafer sockets
- 1 Eby 5 prong wafer socket
- 1 National drum dial, with pilot light
- 2 Knobs
- 2 small dials
- 2 tube shields (National)
- 4 feet, 4 conductor cable
- 1 4-prong plug
- 1 Eby 3-post connector
- 2 grid clips (National)
- Connection wire
- Coil winding wire
- Aluminium (Blan-the-Radio-Man)
- Nuts and bolts, etc.

All secondary windings about 1 1/4" long. 20 and 40 meter coils space wound. All primary windings close wound 3/8" from ground end of secondary.

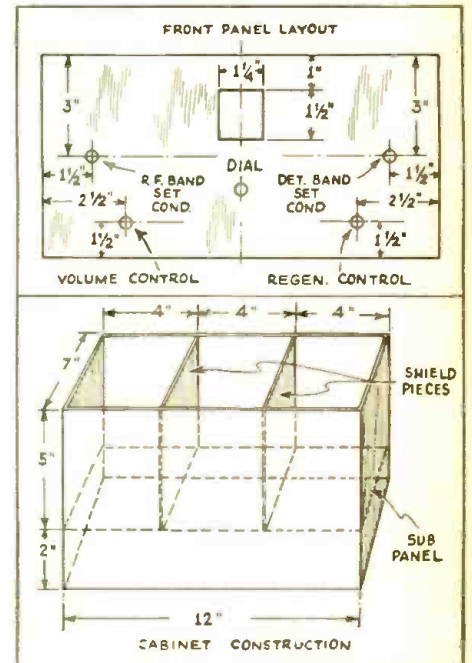

Details of Shield Box and Panel for Mr. McEntee's Set

COIL TABLE

Band	Turns and Wire Size				Tap	Approx. Set. of Band Spr.	Band Spread
20	3 No. 28DSC	6 No. 18E	6 No. 28DSC	6 No. 18E	3/4 turn	3/4 full	30 divs.
40	6 No. 28DSC	15 No. 22E	12 No. 28DSC	15 No. 22E	3/4 turn	3/4 full	50 divs.
80	8 No. 28DSC	34 No. 24DCC	25 No. 28DSC	34 No. 24DCC	1 1/4 turn	3/4 full	Full scale
160	12 No. 3488C	68 No. 28DSC	50 No. 3488C	68 No. 28DSC	4 turn	Tune with Band Set Cond.	

The Famous Doerle "2-Tuber" Electrified

(Continued from page 149)

extreme increase in signal strength over the two-volt tubes.

The regeneration condenser is the one mounted on the left, the tuning condenser being mounted on the right. The antenna used with this receiver should be anywhere from 25 to 100 feet long, the longer antenna usually adds little to reception, other than an increase in background noise. If the set refuses to oscillate in some portions of the bands and oscillates well in others, it can be laid to absorption by the antenna. This can be readily overcome by an adjustment of the antenna trimmer condenser. If this condenser is coupled too closely the set will refuse to oscillate at all. The best setting as a starter, is about half way unscrewed.

For coil data refer to article on the "Air Rover" receiver; see page (158)

- 1—Set of "Genwin" Plug-in Coils (15 to 200 meters)
- 1—57 or 77 tube (Triad)
- 1—56 or 37 tube (Triad)
- 1—Completely drilled A.C. Doerle chassis (Radio Trading Co.)

This S-W Receiver Suits Me

(Continued from page 156)

- R1—Variable grid leak.
- R2 and R3—0-500,000 ohms
- R4—100,000 ohms.
- R5—One megohm.
- R6—2000 ohms.
- R7—1500 ohms.
- R8—20 ohm C. T.
- V1—'35 tube.
- V2—'27 tube.
- V3—'45 tube.

The R.F.C. is 85 mh. A. F. T.—3 1/2 to one ratio—W. P. Tucker, Jr.

Short Waves Kill Weevils

(Continued from page 139)

Aside from the fact that temperatures lethal (deadly) to animal life can be obtained under proper conditions without necessity of elevating the host material to such temperature, there are other factors contributing to the demise of animal life, such as the effect of invisible light, sound or other rays, neutralization or amplification of the natural potential of the insect, the maintenance of which within relatively narrow limits may be essential to life, etc.

vertically to the middle of the dial, but if he deviates to the right or left the needle swings to the corresponding side of the dial. For following the aural beacon, the pilot listens to dot-dash signals in his head phones.

When the pilot reaches the immediate vicinity of the airport (see fig. 1), and passes directly over the radio range beacon transmitting station, his receiving apparatus indicates this fact. He then returns his set to the frequency of the runway beacon and makes a wide circle of the field in a counterclockwise direction in order to pick up the signals of the runway beacon. He also throws a switch which places a second receiving set in operation to pick up the signals of the landing beacon.

To follow the signals of the runway beacon, the pilot watches the same needle that he has been using in connection with the main radio range beacon. As before, the needle points vertically to the middle of the dial to show on course, and to the left or right to show deviations from the true course. Upon orienting himself along the runway course—generally 3 to 5 miles from the field—the pilot begins to make use of his second radio receiving set, designed to pick up the signals of the landing beam for vertical guidance. By means of the signals of this beam, received in his second set, the airman gets an indication on a second needle pointer on the same dial with the radio range indicator. This second needle is the horizontal pointer on the combined instrument.

Approach to Field

Continuing toward the airport, and flying at about 5 miles per hour faster than normal landing speed, the pilot keeps the needle of the runway beacon at the middle of the dial, pointing vertically, and the needle of the landing-beam indicator pointing horizontally. He does this by flying so that the needles cross over the circle in the center of the dial. He is following the center line of the course marked by the runway beacon, but with respect to the landing beam, his indicator directs him along a curved line in the under part of the ellipsoidal beam. If he were to follow the axis of the landing beam in the line of greatest signal intensity, the signals would become increasingly stronger and the needle would rise above the horizontal. If he dropped too far below the beam the signals received would be weak and the needle would fall. The course followed is a curved one underneath the beam's axis where the signal strength remains constant, and which brings him downward in a sweeping glide, flattened at the end, which is correct for a landing. The landing path is so adjusted as to clear all obstructions.

Following this unseen radio path, the airman approaches the field. About 1,000 feet before he reaches the edge of the field, notice is given him by a signal from a marker beacon on the ground below him, reproduced as a buzz in his ear phones. Just at the edge of the field a signal from a second marker beacon reaches him and is reproduced as a different sounding buzz. This gives him warning of the exact moment at which to level off for landing. He thereupon throttles his engine and maneuvers his airplane to follow the landing beam accurately to the point where he is to make contact with the ground.

An important feature of this blind-landing system is that a minimum of equipment is necessary for use on the airplane. The runway beacon signals are received by the regular aircraft receiver which is used along the airway. Reception of the signals from the landing beam and marker beacons require additional receiving equipment as these transmitters operate on high frequencies whereas the runway beacon operates on a medium frequency. For the regular receiving set the ordinary receiving antenna is used, and for the landing-beam receiver, a short horizontal antenna. One power source suffices for all receiving sets.



We've Done It!

They said it couldn't be done! That the 12,500 MILE TWO TUBE short wave receiver could not be sold at a lower price and still be composed of high grade parts! BUT WE'VE DONE IT! Our kits are an improved version of the Original 12,500 Mile receiver described in January '32 Short Wave Craft and which has proven phenomenally successful. (See our ad in the March issue!) Actual tests and hundreds of letters from purchasers of our kits prove that they outperform the original! And they are better "DX" getters than any other one or two tube set under \$10.00! These complete kits contain HAMMARLUND Condensers, large oversize transformers, polymer rheostats, metal vernier dial (which further insures against "hand-capacity" effects), color-coded battery cable, precision coils covering 15-200 meters, and all other parts of superior grade. The sockets, coils, and all RF insulation are genuine Bakelite, keeping down losses! The heavy metal chassis and panel efficiently shields all components and its baked crystal finish is drilled. The instruction sheets are so ample and clear that anyone can easily build this receiver and obtain real results.

Only by purchasing material in enormous quantities are we enabled to offer these remarkable kits at such an amazingly low price! **\$4.15**

BATTERY MODEL
Uses two 230 or 01-A tubes. **Complete Kit \$4.15**
(Specially priced for limited time)

SEND FOR FREE S. W. CIRCULAR
Neat metal cabinet with hinged lid. Fits either model \$1.00
AC Power Pack. Complete Kit \$4.85

AC MODEL
Uses two 27 or 56 tubes. May be run on power pack or filament transformer and B Batteries. **Complete Kit \$4.95**

THREE TUBE AC-DC Short Wave Receiver
This receiver is a Universal All-Electric set. Tuned 15-200 meters. Complete, it is ready to plug into the house line, whether AC or DC. Due to the use of latest tubes (1-322, 1-76, 1-43), and advanced design, this receiver gives remarkably superior reception. This set is recommended to all who want a compact quality DX getter at a low price. Complete with coils, ready to plug in. \$10.95
Set of matched tubes \$3.20
Complete kit, clear instructions \$7.80

Send For Our New BIG CATALOG MANUAL
84 pages check full of information of interest to everyone! Detailed descriptions of thousands of items with real Wholesale Prices. Three full pages of tube characterized Antenna suggestions! Care of mercury vapor rectifiers. And many other valuable features. A DIFFERENT Short Wave Catalog from any you have ever seen. It is a book that you will want to keep for years!
It is yours. FREE on request! No obligation! All we ask is that you send three 3c stamps or a dime to help cover the cost of handling. **Send for it now! Don't Delay.**

The three tube "GEN" receiver we advertised last month makes an excellent **PORTABLE S W RECEIVER**
as all batteries fit inside the compact, sturdy metal case! Complete kit \$7.95
Look at our previous Short Wave Craft ads! Thousands of items at sensational money saving prices!
Order NOW!
Satisfaction Guaranteed! Please F.O.B. N. Y. Deposit required.

HARRISON RADIO CO.
★ ★ THE HOME OF FOUR STAR SERVICE ★ ★
Dept. C-21 New York City
142 Liberty Street

The Mayflower

PLYMOUTH



On the Ocean at Manomet Point
One of New England's Finest Resort Hotels
Surprisingly Inexpensive
Special Vacation Tour 9 days \$60.00 up including transportation, Hotel accommodations, sight seeing, etc.
Smooth Sandy Beach . . . Surf Bathing . . .
Warm Sea Water . . . Swimming Pool . . .
Tennis Courts . . . Golf Course . . . On Hotel Grounds
UNDER SAME MANAGEMENT
MAYFLOWER HOTEL
HYANNIS
CAPE COD'S NEWEST HOTEL
CHARLES A. DOOLEY, MGR.



CAPE COD in MASSACHUSETTS

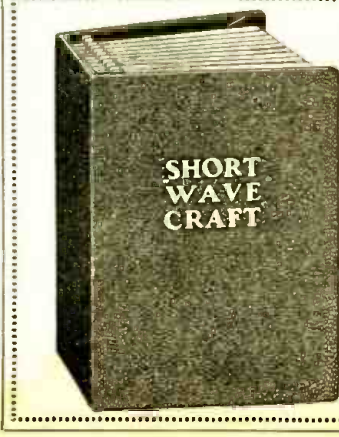

Short Wave Craft is not the sort of magazine that you read and then discard.
Readers keep their copies for years as a steady reference and thousands of letters attest to this.
It is now possible to save your copies and for this purpose we designed a splendid binder for you which holds twelve copies. It is made of heavy substantial material and is covered with black grain leatherette. The name of the magazine is stamped in gold on the cover.
An ingenious mechanical arrangement is provided which makes it possible to hold the copies flat when reading from the binder.
SHORT WAVE CRAFT Binder as described, prepaid in the United States. **\$1.25**
Canada and foreign countries 25c extra. We accept money order, check, stamps or cash.
Short Wave Craft, 98 Park Pl., New York, N. Y.

Don't Go West Go Western

EVERY SPORT THAT THE HEART CAN
DESIRE

- ... Surf and Fresh Water Swimming
- ... Lake and Deep Sea Fishing
- ... Shooting
- ... Tennis
- ... Golf

The Golden West 55 Minutes
from Broadway

Rodeo Champions will instruct you in
HORSEBACK RIDING—

Dancing—Modern and Old Fashioned
and a good glass of beer in a
real old time WESTERN MUSIC HALL



For a complete rest or strenuous holiday and rates affine with the times

G. BAR B. RANCH

For Descriptive Booklet Write Three Lakes, Stamford, Conn., Tel. Sta. 4-6694

RCA INSTITUTES

Recognized Standard in Radio Instruction Since 1909

Technical Training Courses in Radio and Associated Electronic Arts

- Practical Radio Engineering
- Sound Engineering
- Broadcast Transmission
- Radio Servicing
- Commercial Radio Operating

Resident Schools at New York and Chicago

EXTENSION COURSES for HOME STUDY under new "no obligation" plan, with privilege upon graduation of 2 weeks' intensive practical training without charge at either Resident School.

Mail Coupon for Illustrated Catalog

RCA INSTITUTES, INC.,
Dept. SW7
75 Variek Street, New York, N. Y.
1154 Merchandise Mart, Chicago, Ill.

Please send with no obligation to me:

() Illustrated catalog and information about resident school courses.

() Information about extension courses for study at home, together with illustrated catalog.

Name..... Age.....

Address.....

City..... State.....

In a third series of tests, the marker beacons will operate on a frequency in the aircraft communication band, 3,000 to 6,000 kilocycles, in order that the high-frequency communication receiving set commonly carried on aircraft may be utilized for receiving the marker beacon indications. Control equipment has been provided to the end that both the communication signals and the marker beacon signals may be received during a landing with minimum effort on the part of the pilot.

The landing-beam equipment is located adjacent to the runway localizing beacon. The transmitter employs a transmitting circuit arrangement specially designed for ultra high-frequency operation, 100,000 kilocycles. The transmitting antenna array consists of 12 half-wave horizontal antennas, so grouped as to give the necessary directivity of beam in the vertical plane while spreading the beam out in the horizontal plane to afford service in the 40° sector to be covered. This results in a fan-shaped beam which provides vertical guidance for all orientations of the runway beacon course within the limits specified. The antenna array is 16 feet high, by 10 feet wide, by 2.5 feet deep overall.

The theory of operation of the landing beam is readily understood. Maximum field intensity is produced along the inclined axial plane of the beam. The aircraft does not fly along this plane, however, but on a curved path the curvature of which diminishes as the ground is approached. This path is the line of equal intensity of received signal below the inclined axial plane. The diminution of intensity as the aircraft drops below this plane is compensated for by the increase in intensity due to approaching the beam transmitter. Thus by flying the aircraft along such a path as to keep the received signal intensity constant, as observed on a microammeter on the instrument board, the pilot descends on a curved path suitable for landing. If the aircraft rises above this path, the microammeter deflection increases, while if it drops below the path the deflection decreases.

Receiving Equipment

The receiving installation required is a medium-frequency receiving set of the type commonly used by air transport operators for the reception of radio range beacon signals and airways weather broadcasts. This set is augmented by a reed converter and automatic volume-control unit for use with the signals from the runway localizing beacon. Visual course indication is given the pilot by means of the vertical pointer of a "combined instrument." (See fig. 2.)

The vertical pointer of this instrument, which is described later, is pivoted about the lower end and swings left or right depending upon whether the aircraft is to the left or right of the runway course. A reversing switch is provided in order that the deflection of the pointer and the direction of the deviation of the aircraft may correspond whether the aircraft is flying away from or toward the runway beacon.

The marker beacon receiving set required when the marker beacons operate on a radio-frequency of about 10,000 kilocycles employs two tubes, a detector and an audio-frequency amplifying tube. The output signal is aural and is heard through the head phones when passing over the marker beacons. The set is coupled to the same receiving antenna as is used with the medium-frequency receiving set, the coupling arrangement being such that the tuning of each set is independent of the other.

The landing beam receiving set employs a detector tube, an audio-frequency amplifying tube, a reed filter, and a cuprous-oxide rectifier. The receiving antenna is of the half-wave horizontal type with a reflector and is mounted above the center section. The voltage induced in this antenna by the landing beam is fed to the detector stage of the receiving set by means of a shielded parallel-wire trans-

mission line. After detection and amplification, the signal is rectified and the output current fed to the combined instrument, the landing path indications being given by the horizontal pointer of this instrument. During landing, this pointer is maintained in the horizontal position. A rise of the pointer above this position indicates that the aircraft is above the proper landing path, while the reverse is true if the pointer falls below its horizontal position.

Radio Control Panel

The radio control panel contains the usual tuning and volume controls for the medium-frequency receiving set, a switch for operating this set with either automatic or manual volume control, and the reversing switch for the vertical pointer of the combined instrument, the function of which is described in the foregoing. There is also provided an adjustment for altering the steepness of the landing path to suit the particular airplane, a push button for testing the landing beam receiving set, and a "flight-land" switch. In the "flight" position this switch connects the horizontal pointer of the combined instrument to the output of the reed converter, thereby indicating volume of received signal in the output of the medium-frequency receiving set. This indication is for the purpose of informing the pilot that his receiving set and the beacon transmitter are functioning properly. Otherwise the vertical pointer, which indicates the beacon course, being of the zero-center type, might read "on course" with the beacon signal off or the receiving set not functioning. In the "land" position this switch turns on the landing beam and the marker beacon receiving sets and connects the horizontal pointer of the "combined instrument" to function as the landing path indicator, as described in the foregoing.

In addition to the combined instrument the pilot has a second radio instrument called an approximate-distance indicator. This instrument is operated by the medium-frequency set in conjunction with the automatic volume-control unit, and indicates the approximate distance from the runway localizing beacon.

The combined instrument consists of two separate instrument movements mounted in a single case of standard aircraft dimensions and with the pointers of the two movements crossed at right angles. Two reference lines intersecting at right angles are provided on the face of the instrument, the vertical reference line corresponding to the proper directional course and the horizontal reference line to the proper landing curve. A little consideration will show that the point of intersection of the two pointers indicates the position of the aircraft with respect to the proper spatial landing path. When the two pointers intersect at the central circle as shown at 2 in Figure 2, in airplane is on both the runway localizer course and the landing curve. When the point of intersection is as shown at 1 in Figure 2, the airplane is to the left of the course and above the landing curve. On the other hand, when the point of intersection is as shown at 3 in Figure 2, the airplane is to the right of the course and below the landing curve.

Landings Made With Radio Aids

Landing according to the directions of the radio aids is accomplished in the usual manner with the difference that the pilot, instead of orienting himself by watching the horizon and the ground beneath him, guides his plane by watching the dials on his instrument board and listening for the signals of the marker beacons through his head phones.

Approaching an airport during a period of no visibility, the airman follows the main radio range beacon, which may be either the visual or aural type. If he is following a course marked by a visual beacon, the indicator is the vertical needle of the combined instrument. As long as he is on his course, the needle points

How Ultra Short Waves Guide Planes

(Continued from page 140)

the practicability of the system through the medium of an extensive series of hooded landings, conducted by the Aeronautics Branch at its experimental flying field at College Park, Md. The third stage of the development, which involves the testing of the complete system experimentally under the conditions obtaining at a commercial airport, is now under way at the Newark Municipal Airport where the city of Newark has cooperated in the installation of the system.

The Newark Installation

The installation of radio landing aids at Newark Airport includes three elements, a runway localizing beacon, a set of two marker beacons, and a landing beam. The runway localizing beacon, in addition to providing definite means of locating the airport, gives indication of the directional position of the aircraft and permits keeping the craft directed to and over the desired landing runway.

The marker beacons give the longitudinal position of the aircraft when approaching the airport. One marker beacon is located about 2,000 feet from the landing area while the other marks the boundary or edge of the field. The landing beam provides vertical guidance. It employs an ultra-high-frequency radio beam, of the order of 100,000 kilocycles (3 meters), directed at a small angle above the horizontal, and thereby marks out a convenient gliding path for the landing aircraft, clearing all obstructions.

Transmitting Equipment

The transmitter used for the runway localizing beacon operates on a frequency in the neighborhood of 300 kilocycles (999.4 meters) and is similar to the visual-type transmitters designed for the radio range beacon stations on the Federal airways system. The use of a visual-type transmitter facilitates automatic volume-control reception on the aircraft. This is quite essential since the pilot, in making a landing, is concerned with so many things that the burden of close manual adjustment of receiving-set sensitivity should be eliminated. Small crossed-loop transmitting antennas are employed in order that the runway beacon may be located near one end of the runway without constituting an obstruction to flying. The loop antennas consist of seven turns of wire on wooden frames 10 feet high by 12 feet in length and are housed in the same building as the transmitting set. A goniometer is provided to the end that the runway localizer course may be swung to take care of different wind directions. At the Newark Airport the wind, under conditions of poor visibility, is usually from the northeasterly quadrant. The runway beacon accordingly is located at the northeast end of the field. Thus by swinging the course over an arc of 40° it is possible to accommodate practically all wind directions pertaining at times when the visibility is low.

The marker beacons are located at the southwest end of the airport. As noted in the foregoing discussion one marker beacon is provided about 2,000 feet from the field while a second marker defines the boundary of the field. The marker beacons are very simple, each consisting of a low-powered transmitting set and a long, low horizontal antenna. These transmitting sets operate directly from the commercial power supply. Each set employs three tubes, a radio-frequency oscillator, an audio-frequency oscillator for modulating the radio-frequency oscillator at the desired audio-frequency, and a rectifier tube for providing plate power supply to the two oscillator tubes. Different modulation frequencies are employed for the two marker beacons to facilitate ready identification of the marker beacon being passed over; the one at the field boundary having a modulation of about 250 cycles per second while the other has a modulation of approximately 1,000 cycles. The

PRECISION-MADE FOR SHORT-WAVE WORK

AIR-DIELECTRIC TUNED I. F. TRANSFORMERS



Redesigned with Velvet Vernier micrometer tuning . . . All peaking adjustments from top of coil, self-locking rotors, isolantite insulation . . . New type Litz coils . . . 450 to 550 kc. range . . . Variable mutual inductance . . . U. S. pat., Nos 1,656,532; 1,713,146. Others pending.

SW-3 AMATEUR RECEIVER



The famous NATIONAL Thrill Box, made for amateurs. High signals - to - noise ratio . . . High R. F. gain through use of '58 tubes . . . Genuine single control. Because original tooling and engineering cost is now written off,

the SW-3 is offered at new low list of \$24.50, less coils. Band spread coils, \$4.75 per pair. Full line of standard R-39 coils for complete coverage from 9 to 2000 meters. (Usual trade discounts apply.)

EMP CONDENSER

A split-stator condenser for receivers and low power push-pull transmitters. Isolantite stator insulators, 1200 v. Single spaced. Standard size 100 mmf. per sect. Available up to 350 mmf. per sect.

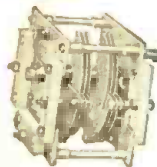

BX VELVET VERNIER DIAL WITH VERNIER INDEX



Has standard NATIONAL Velvet Vernier B-Dial drive, variable ratio, 6-1 to 20-1, —and with new Vernier Index reading accurately to 1/10th division. Ideal for service men's oscillators, etc.

TYPE R-152

Radio Frequency Choke



Isolantite insulation on metal base. —10,000 v. insulation; continuous universal winding in 5 tapered sections; inductance 4 mh.; distrib. cap. 1 mmf.; DC resistance 10 ohms; current ratings:—continuous 0.6 amp., intermittent 0.8 amp. For both high and low powered transmitters and laboratory oscillators.

TYPE R-100 R. F. CHOKE

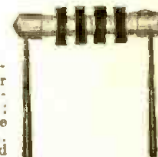

Isolantite mounting, continuous universal winding in four sections. For pictorial connections or standard resistor mountings. Ind. 2½ mh.; distrib. cap. 1 mmf.; DC resistance 50 ohms; Current rating, 125 M.A. For low powered transmitters and all types of high frequency receivers.

NATIONAL SOCKETS

Isolantite coil and tube sockets, glazed upper surface for sub-panel or base mounting in 4, 5, 6 or 7 prong types. Exclusive locator-groove makes tube insertion easy.



MIDGET CONDENSERS



NATIONAL makes a full line of midget condensers for short and ultra short-wave work. Send for special Bulletin giving specifications and prices.

NATIONAL PRECISION SHORT-WAVE PARTS AND RECEIVERS

COUPON

NATIONAL COMPANY INC.
61 Sherman Street
Malden, Massachusetts

Gentlemen:

Please send me your latest 16-page catalogue. I enclose 6 cents to cover mailing costs.

NAME.....

ADDRESS.....

SW-7-33

transmitting antenna for each marker beacon consists of a horizontal wire a few feet above the ground and extending across the southwesterly approach to the landing area a sufficient distance to intersect the path of the aircraft for all orientation of the runway beacon course.

Experiments at Newark

The experiments at Newark will include the determination of the most suitable radio-frequency (from the viewpoint of an

airline operator) on which the marker beacons should operate. A radio-frequency of about 10,000 kilocycles will be used in some of the tests, in which case a simple marker beacon receiving set is required aboard the aircraft.

Tests will also be conducted with the marker beacons operating on the same radio-frequency as the runway beacon, thus permitting their reception on the medium-frequency receiving set normally available on the aircraft. The need for a special marker beacon receiving set is thereby obviated but careful adjustment of marker beacon power output is required to prevent interference with the runway beacon course indications when the airplane is directly over a marker beacon. The severe requirements imposed upon the system in the experiments at College Park, both by the small dimensions of the field and the obstructions in the approach, did not permit the successful use of this arrangement.

**S-W "LOOP"
RECEIVER!
Brand New!
Fully Described
In August Issue**

SHORT WAVE QUESTION BOX

DETECTOR POTENTIOMETER

Louis Harris, Portland, Me.

(Q) I read somewhere that a potentiometer connected across the filament of a detector tube (not in the screen circuit) is helpful. Can you tell me just how this instrument is placed?

(A) The diagram marked Fig. 1 shows how a high resistance potentiometer is connected to best advantage in a battery operated short-wave receiver. Note that the grid-leak is removed from its usual position across the grid con-

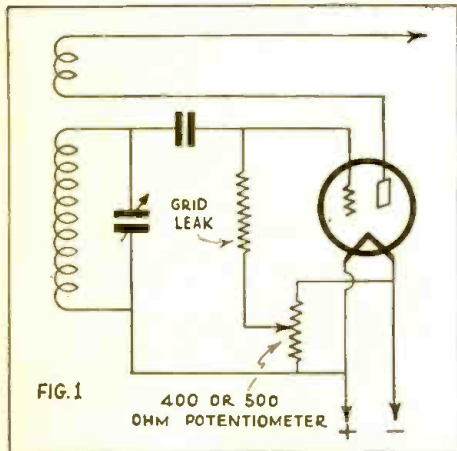

Fig. 1—A potentiometer connected as shown in the detector circuit is a great help in controlling regeneration.

denser, the bottom end being connected to the arm of the potentiometer.

As the potentiometer is directly across the filament leads, it will draw some current. However, this is very slight and will impose no appreciable drain on the filament battery. Of course, you simply adjust the potentiometer for best volume and smoothest regeneration.

MAGNETIC SPEAKER WITH POWER TUBE

L. F. P., Minneapolis, Minn.

(Q) Is it possible to use something other than a dynamic speaker with a set containing a 47 output tube? I have a set containing a 47 and I can pick up a very good magnetic speaker for very much less than what a cheap dynamic costs.

(A) It is quite practical to use a magnetic speaker with any of the standard power tubes that are usually fed into dynamics. All you have to provide is a suitable coupling transformer. The primary is placed in the plate circuit of the power tube in the usual manner and the secondary connects directly to the magnetic speaker. Transformers of this kind are standard and may be obtained without trouble.

CUTTING DOWN VARIABLE CONDENSERS

Henry Bloomer, Cleveland, Ohio

(Q) Is there any reason why .0005 and .00035 mf. variable condensers cannot be used for short wave work if plates are removed? I have a lot of good condensers of these sizes on hand and I want to use them.

(A) There is absolutely no reason at all why you cannot use your condensers for short-wave work if you reduce their capacity by removing plates. Incidentally, it is not necessary to remove both rotor and stator plates. You can remove either. With some condensers it is more convenient to pull off the rotor plates, with others it is easier to take out stator plates. Of

Because of the amount of work involved in the drawing of diagrams and the compilation of data, we are forced to charge 25c each for letters that are answered directly through the mail. This fee includes only hand-drawn schematic drawings. We cannot furnish "picture-layouts" or "full-sized" working drawings. Letters not accompanied by 25c will be answered in turn on this page. The 25c remittance may be made in the form of stamps or coin.

Special problems involving considerable research will be quoted upon request. We cannot offer opinions as to the relative merits of commercial instruments.

Correspondents are requested to write or print their names and addresses clearly. Hundreds of letters remain unanswered because of incomplete or illegible addresses.

course, if you want to do a neat job and if the construction of the condenser allows it you can remove both rotor and stator plates.

IS THE GROUND NECESSARY?

C. E. Smith, Boston, Mass., asks:

(Q) I have constructed several A. C. short-wave receivers, and I discovered accidentally that the ground connection in most cases makes absolutely no difference. I thought at first that the ground wire itself was broken, but this is not so. Can you explain why this is possible?

(A) An actual connection to the usual steam or water pipe is not necessary with most A.C. short-wave receivers for the simple reason that the set is already quite thoroughly grounded through the A.C. power lines. As you can readily find out by means of an ordinary lamp, one side of practically all A.C. circuits is conductively grounded. The additional connection between the set and a water pipe simply parallels the existing connection.

ADDING R.F. TO THE GLOBE TROTTER

R. Smith, Trenton, N. J.

(Q) Quite a number of people have asked for a circuit showing the addition of an untuned R.F. stage to the popular "Globe Trotter" receiver described in the November, 1932, issue of SHORT WAVE CRAFT. The diagram appears herewith in Fig. 3. As the original plug-in coils contained only two windings, a grid coil and a tickler, it is necessary to make a slight revision in the detector circuit in order that plate voltage may be fed to the R.F. tube. Note also that the grid-leak now runs between grid and filament instead of across the grid condenser. The .01 mf. blocking condenser must be a good one with mica insulation. It is too large to

have any detuning effect, but it closes the detector tuning circuit and at the same time prevents the "B" battery from short-circuiting to the filament.

Different values of leaks should be tried between the grid and the ground of the added R.F. tube, which is of the 34 type. This tube should be covered with a grounded shield can.

Incidentally, with 135 volts of "B" available, it is a good idea to use a 33 output pentode in the audio stage, as this will give greater output than the original 30.

HAND-CAPACITY EFFECTS

Arthur Elbert, Hoboken, N. J.

(Q) I have constructed a 3-tube short wave receiver with aluminum chassis, front panel and shields. I have followed the usual precautions, but in spite of all the shielding I can detune the set slightly by running my hand up and down the phone cord. How can I cure this trouble?

(A) Hand-capacity troubles of this kind are invariably due to an inefficient radio frequency choke coil in the detector plate circuit. This allows some R.F. energy to creep into the audio amplifier.

The likelihood is that your choke was made for the higher wavelengths and has too much distributed capacity, for short-wave work. We would suggest that you purchase one of the special small chokes using a number of separated winding sections. The actual inductance value is not critical and may run between 2½ and 30 millihenries. Also, be sure that you use a small mica fixed condenser between the "hot" side of the choke and the chassis.

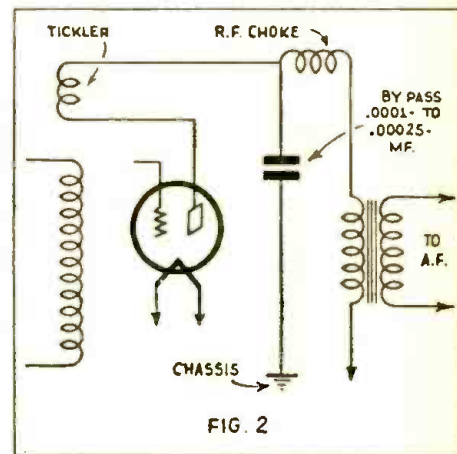

Fig. 2—Circuit recommended to help in eliminating "hand-capacity" effects.

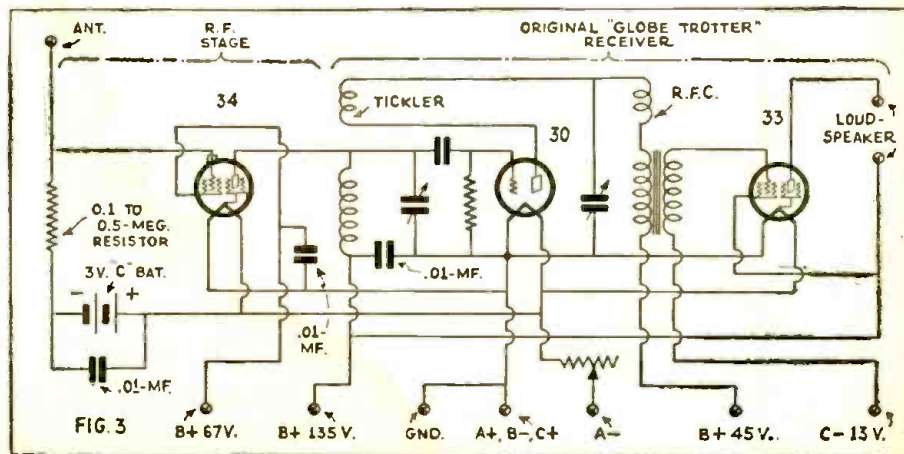

Fig. 3—Many requests have been received for a diagram showing how to add an R.F. stage to the "Globe-Trotter" receiver described in the November issue.

SHORT WAVE LEAGUE



HONORARY MEMBERS

- Dr. Lee de Forest
 - John L. Reinartz
 - D. E. Replogle
 - Hollis Baird
 - E. T. Somerset
 - Baron Manfred von Ardenne
 - Hugo Gernsback
- Executive Secretary*

Suggestions For Summer Activities

Send in Club Pictures

● LETTERS received from the secretaries of many Short Wave League chapters indicate that the attendance at some meetings is quite large. Some chapters have fitted up small but well equipped "radio shacks" in which the members do considerable experimenting.

Send in pictures of these meetings and "labs". We will publish them to show what is being done in various parts of the country. Most clubs have an amateur photographer on the roll; get him to bring his camera, tripod and a couple of photo-flood bulbs down to the next meeting and "shoot" the gang. We can use clear prints on glossy paper as small as post-card size, but the bigger the better. An 8 x 10 inch enlargement will cost only about fifty cents—and it's a nice thing to have anyway.

What To Do in the Summer

The summer offers many opportunities for short-wave activity. We would like to see more of the delightful "field days" that British amateurs have been holding with great success for many years. Instead of staying indoors during the sunny weather, make up a Sunday party to fill as many automobiles as are available, gather up a few battery-operated receivers and "B" batteries, and make for some "high spot"—away from electric power lines. String short aeriels, long aeriels, aeriels on the ground and in the sky. Take along a kite and send it up on the end of No. 24 or 26 wire, and you'll understand why Marconi used a kite for his historic experiments in Newfoundland in 1901, when he received the first trans-Atlantic radio signal.

A week-end picnic of this kind is highly interesting and instructive, because the tests are made under conditions altogether different from those usually encountered in cellars or attics. The effects of height in particular are very noticeable.

Incidentally, look around for wire fences. In some districts these fences contain miles of heavy, galvanized wire, which is a pretty good conductor of electricity. If the fence posts are dry this wire may make a wopping good aerial.

Topics For Talks

There is always a lot of extemporaneous lecturing at club meetings, but it is a better idea to think up definite topics in advance and to assign one or more members to read up on the subjects and come around to the next meeting prepared to answer questions. This is an excellent method of self-instruction and encourages profitable reading of otherwise dry textbooks. Rotate the assignments from meeting to meeting so that everyone, even the rankest tyro, gets a chance to talk.

Here are some suggestions as to subjects that are given considerable space in good radio textbooks: Which Are Better, Large or Small Diameter Coils? Transformer vs. Resistance Capacity Audio Circuits. Directional Effects of Aerials of Different Shapes. Causes and Cures of Hand-Capacity Effects. Volume Control Methods. Magnetic vs. Non-Magnetic Shielding Materials. Dynamic Speaker Construction.

Set Demonstrations

A suggestion to club secretaries: keep in touch with your local dealers, particularly those who handle short-wave parts or sets. They may be able to arrange for demonstrations of new receivers, as they come out, before a meeting of the whole club. Some of the larger S. W. specialty manufacturers have technical field men or representatives of the engineering department who make a regular practice of this sort of thing.

While the manufacturer's interest in the matter is obviously commercial, the demonstration itself and the lecture by the demonstrator are usually exceedingly interesting and instructive. The field man is invariably a "ham" himself and will answer questions.

Getting Publicity

There may be a lot of people in your own town who are interested in the short waves and don't know of the existence of your chapter of the SHORT WAVE LEAGUE. A day before each meeting, send a neatly typed or hand-written notice to your local newspaper. This is legitimate news and the editor will be glad to run it. Emphasize the fact that the club is purely fraternal and scientific in nature.

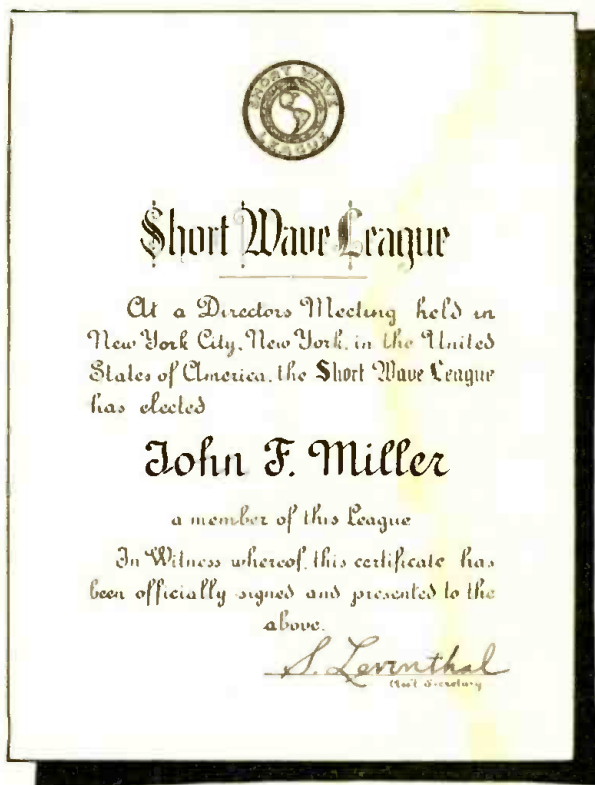

This is the handsome certificate that is presented to all members of the SHORT WAVE LEAGUE. The full size is 7 1/4" x 9 1/2".

Get Your Button!

The illustration herewith shows the beautiful design of the "Official" Short Wave League button, which is available to everyone who becomes a member of the Short Wave League.

The requirements for joining the League are explained in a booklet, copies of which will be mailed upon request. The button measures 3/4 inch in diameter and is inlaid in enamel—3 colors—red, white, and blue.



Please note that you can order your button AT ONCE—SHORT WAVE LEAGUE supplies it at cost, the price, including the mailing, being 35 cents. A solid gold button is furnished for \$2.00 prepaid. Address all communications to SHORT WAVE LEAGUE, 96-98 Park Place, New York.

LETTERS FROM S-W FANS

SUCCESS WITH 2 R.F. JOB

Editor, SHORT WAVE CRAFT:

I receive your publication regularly and think it everything that a magazine of its kind should be. May SHORT WAVE CRAFT live and prosper forever!

In your April, 1932 issue there was an article by Mr. Clifford E. Denton and Mr. H. W. Secor on the construction of a "2 R.F. Pentode Receiver." Never having built a short-wave receiver before, I decided to build this one "just for fun."

The receiver was finally completed, and to say I was "overcome" with its results would be expressing my feelings very mildly. In my opinion both Mr. Denton and Mr. Secor are geniuses.

I have received the following stations with enough volume to make the loud speaker "dance." VK3ME, G5SW, DJA, EAJ, and W8XAL.

Will you or one of SHORT WAVE CRAFT'S readers enlighten me as to why I can only bring in the above five stations? Try as I may, the set refuses to give me a "look-in" on any other stations, with the exceptions of course, of police calls, "ham" conversations and airport stations.

Kindly publish this letter in SHORT WAVE CRAFT so that I may hear from a reader who will put me on the right track to broaden my sets "five-track mind."

J. N. SMOOT,
3010 Wisconsin Ave.,
Washington, D. C.

(The editors were very much interested in your letter as was Mr. Denton, joint designer of the "2 R.F. pentode receiver" which you so successfully built and which brought in such distant stations as G5SW, VK3ME, EAJ, etc., with loud-speaker volume. It seems very peculiar that you should have such phenomenal success in picking up stations several thousand miles away, and that, at the time of writing your letter, you were only successful in bringing in these five stations. It is rare that we have seen or heard of a set which acted in such a way; usually it is caused by what are known as "dead spots"; one of the remedies for removing these dead spots on the tuning dial is to readjust a variable midjet condenser, connected in series with the antenna, whenever you strike a place on the dial when the set seems to go "dead" or does not oscillate. In other cases, it has been found advantageous to increase the potential applied to the plates and screen grids applied to the tubes. One of the principal troubles we have found when investigating some of the complaints of short wave fans, has been that they were applying incorrect voltages to the screen-grid terminals of their tubes. Possibly other readers, who have built and operated the

"2 R.F. Pentode Receiver," will write to you direct or else to the editor, so that we can publish their suggestions for the benefit of all concerned. Let's hear from you, short-wave fans, who have built the "2 R.F. Pentode" job.—Editor.)

DENTON SUPER IS A WOW!

Editor, SHORT WAVE CRAFT:

Well, I suppose you were expecting another "first timer" to mention the Doerle job. That's just what I am going to do.

To me that set is a "jinx." I have had it laying around now for five or six weeks, and every once in a while I get ambitious and hook it up and the only station I have ever received in its many trials is W8XK in "Pittsy." Maybe the thing didn't like the way I put it together but it doesn't work! But to get to the more pleasant side of life. That Denton Super is a wow! Anything on the air is possible with that "box"; by the way, I built two of them to make sure the first one wasn't a dream and they both worked!

But the best yet was that Binneweg contraption. To tell you the honest truth I wouldn't put anything past that set, no, not even G5SW. All together I have built twenty-two of your sets since last December. Some worked and some didn't, but I won't kick—it's all in a life time.

What I would like to find out is how to obtain a license for 160 meter phone. I built that "Leuck" transmitter and now I want to use it.

I've looked this town over for someone who even knew what short waves are, but I couldn't find anyone, so I am asking you to print this and maybe someone can give me a "lift."

I still have every one of the sets I built and they are a "motley looking crew," but most of them have "hearts of gold."

In closing I just want to say that of the five radio magazines I get each month, SHORT WAVE CRAFT is the only one I save.

HAROLD VOLMER,
Box 57A, R. R. No. 2,
Littleton, Colo.

(Brother Denton, the editors, and the office cat, all thank you heartily for your unusual letter. We say "unusual" from the fact that practically every one we have heard from has had some sort of success with the Doerle receiver. It does seem peculiar that you couldn't get it working smoothly, but there is probably some little thing not working at its full efficiency. Have you tried reversing the tickler winding terminals—more short wave sets fail to "perk" for this one reason, than you would ever dream of—and we hope you didn't put a lot of "heavy shellac" on the coils. That has "killed" many a set that

we know of from first-hand experience, especially if the shellac is of the thick kind which seems never to dry out. We felt much happier when we came to the next part of your letter in which you report such phenomenal success with the Denton Super and also with the Binneweg set. Our new book, HOW TO BECOME AN AMATEUR RADIO OPERATOR, by Lieutenant Myron Eddy, will give you the information you require for obtaining a 160 meter phone license; you should also send for license application blanks to your nearest Radio Inspector's office, 538 Customs House, Denver, Colo.—Editor.)

A DANDY TRANSMITTER AND RECEIVER

Editor, SHORT WAVE CRAFT:

I noted where you were asking for photos in the May SHORT WAVE CRAFT. I am sending two photos, one of the receiver and myself, the other of the transmitter.

The transmitter consists of a 210 crystal-controlled oscillator, entirely shielded; a 210 buffer amplifier, which excites a 203A Class "C" modulated amplifier. I use three stages of speech amplification with a double-button mike. A 56 resistance-coupled first stage is fed into a 27 tube, transformer-coupled into a pair of 45's in push-pull. The output of the amplifier swings the grids of a pair of 845's for modulators. Three separate power supplies are used, using 866's for rectifiers. A half wave Zeppelin antenna, with 60 foot feeders, is used for the radiator.

A converter with a 24 first detector and a 27 oscillator is coupled to an eight-tube broadcast chassis, which makes a super-het short-wave receiver.

This station first went "on the air" in July, 1929, with 210's and was rebuilt in 1931, using xtal (crystal) control, with the layout just described. All districts in the United States, Canada, and several in Mexico have been "worked" on 3500 and 3900 KC fone.

I find your magazine very interesting and like it a lot, having built a number of your circuits and getting good results each time. Wishing you plenty of good luck, I am, Yours truly,

NORMAN L. SWAYNE, W8AOL,
316 E. 10th St.,
Tyrone, Pa.

(A "bang-up" station we call it, Norman. We hope to receive many more interesting descriptions and clear photographs of your short-wave transmitting and receiving stations. Be sure the photo is not smaller than 4" x 5" and preferably 5" x 7" or larger—and it must be "sharp" and "clear!" If you do not appear in the photograph of the station or set, send along a separate photo of yourself.—Editor.)

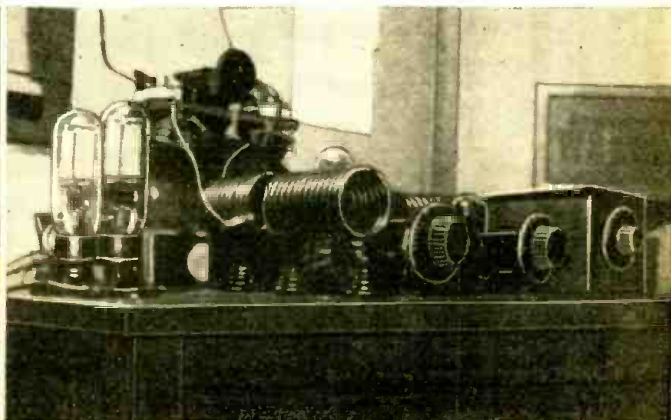

Here's a crackerjack "Ham" station. Norman L. Swayne, W8AOL, is the happy owner and operator. Receiving apparatus appears at left; transmitting equipment at right.

POLICE RADIO ALARM STATIONS

By Frequency and Wavelength

<p>2506 kc.-120 m. KGZE San Antonio, Tex.</p>	<p>WPEG New York, N. Y. KGPH Okla. City, Okla. KGPO Tulsa, Okla. KGZP Wichita, Kans. KGZF Chanute, Kans. KGZP Coffeyville, Kans. KGZP Honolulu, T. H.</p>	<p>KGPG Vallejo, Cal. WPEK New Orleans, La. WPDW Washington, D. C. WPFJ Jacksonville, Fla.</p>	<p>KVP Dallas, Tex. KGPL Los Angeles, Cal. KGJX Pasadena, Cal. WPDU Pittsburgh, Pa. KGPC St. Louis, Mo. KGZI Wichita Falls, Tex. WPFA Newton, Mass. KGZL Shreveport, La. WPEH Somerville, Mass. WPEP Arlington, Mass. KGZB Houston, Tex. WPFJ Hammond, Ind. WPFN Fairhaven, Mass. KGZQ Waco, Tex. WPET Lexington, Mass. WPEI E. Providence, R. I.</p>
<p>2470 kc.-121.5 m. KGOZ Cedar Rapids, Ia. KGPN Davenport, Ia. WPDZ Fort Wayne, Ind. WPDT Kokomo, Ind. WPEC Memphis, Tenn. KGPI Omaha, Neb. WPDJ Philadelphia, Pa. KGPD San Francisco, Cal. KGPM San Jose, Cal. KGPM Salt Lake City, U. WRDQ Toledo, Ohio WPFL Gary, Ind. PPFQ Swathmore, Pa. WPFQ Knoxville, Tenn. WPFQ Johnson City, Tenn</p>	<p>2442 kc.-122.8 m. KGPM Denver, Col. WPDF Flint, Mich. WPEB Grd. Rapids, Mich. WMDZ Indianapolis, Ind. WDDL Lansing, Mich. WPDE Louisville, Ky. KGPP Portland, Ore. WPDH Richmond, Ind. KGZH Klamath Falls, Ore. WPEC Muskegon, Mich. WPFQ Reading, Pa. KGZR Salem, Ore.</p>	<p>2416 kc.-124.1 m. KGPM Minneapolis, Minn. WPDS St. Paul, Minn.</p>	<p>1574 kc.-189.5 m. WRDS E. Lansing, Mich. WMP Fram'gham, Mass. WPEW North'pton, Mass. KGPM Shreveport, La. WPEL W. Bridgewater, Mass. WPEV Portable, Mass.</p>
<p>2458 kc.-122.0 m. WPDO Akron, Ohio WPDN Auburn, N. Y. WPDV Charlotte, N. C. WRDH Cleveland, Ohio WPDH Rochester, N. Y. WPEA Syracuse, N. Y. WPEA Asheville, N. C.</p>	<p>2430 kc.-123.4 m. WPDI Columbus, Ohio KGPP Portland, Ore. WPDH Dayton, Ohio KGZD San Diego, Cal. WPFQ Highland Park, Ill. WPFQ Toms River, N. J. WPFK Hackensack, N. J.</p>	<p>2414 kc.-124.2 m. WPDY Atlanta, Ga. KGPS Bakersfield, Cal. WCK Belle Island, Mich. WPDH Detroit, Mich. WRDR Grosse Pt. Vil. Mich. WMO Highland Pk., Mich. KGPA Seattle, Wash. WPDA Tulare, Cal. KGZM El Paso, Tex. WPFH Baltimore, Md. KGZM Tacoma, Wash. WPFQ Columbus, Ga. WPFM Birmingham, Ala. WPFQ Clarksburg, W. Va. WPFQ Santa Barbara, Cal.</p>	<p>1534 kc.-196.1 m. KGHO Des Moines, Ia.</p>
<p>2450 kc.-122.4 m. WPKD Milwaukee, Wis. WPEE New York, N. Y. WPEF New York, N. Y.</p>	<p>2422 kc.-123.8 m. KSW Berkeley, Cal. WMJ Buffalo, N. Y. KGPE Kansas City, Mo.</p>	<p>1712 kc.-175.15 m. KGPM Beaumont, Tex. WPDB Chicago, Ill. WPDC Chicago, Ill. WPDD Chicago, Ill. WKDU Cincinnati, Ohio</p>	<p>257 kc.-1123 m. WBR Butler, Pa. WJL Greensburg, Pa. WBA Harrisburg, Pa. WMB W. Reading, Pa. WDX Wyoming, Pa.</p>

POLICE RADIO ALARM STATIONS

Alphabetically By Call Letters

<p>KGHO Des Moines, Iowa 1534 kc. KGJX Pasadena, Cal. 1712 kc. KGOZ Cedar Rapids, Iowa 2470 kc. KGPA Seattle, Wash. 2414 kc. KGPM Minneapolis, Minn. 2416 kc. KGPC St. Louis, Mo. 1712 kc. KGPD San Francisco, Cal. 2470 kc. KGPE Kansas City, Mo. 2422 kc. KGPG Vallejo, Cal. 2422 kc. KGPH Oklahoma City, Okla. 2450 kc. KGPI Omaha, Neb. 2470 kc. KGPM Beaumont, Tex. 1712 kc. KGPL Los Angeles, Cal. 1712 kc. KGPM San Jose, Cal. 2470 kc. KGPN Davenport, Iowa 2470 kc. KGPO Tulsa, Okla. 2450 kc. KGPP Portland, Ore. 2442 kc. KGZP Honolulu, T. H. 2450 kc. KGPS Bakersfield, Cal. 2414 kc. KGPM Salt Lake City, Utah 2470 kc. KGPM Denver, Colo. 2442 kc. KGPM Shreveport, La. 1574 kc. KGPM Wichita, Kans. 2450 kc. KGZB Houston, Tex. 1712 kc. KGZD San Diego, Cal. 2430 kc. KGZE San Antonio, Tex. 2506 kc. KGZF Chanute, Kans. 2450 kc. KGZH Klamath Falls, Ore. 2442 kc. KGZI Wichita Falls, Tex. 1712 kc. KGZL Shreveport, La. 1712 kc. KGZM El Paso, Tex. 2414 kc. KGZM Tacoma, Wash. 2414 kc. KGZP Coffeyville, Kans. 2450 kc. KGZQ Waco, Tex. 1712 kc. KGZR Salem, Ore. 2442 kc.</p>	<p>KSW Berkeley, Cal. 2422 kc. KVP Dallas, Tex. 1712 kc. WBA Harrisburg, Pa. 257 kc. WBR Butler, Pa. 257 kc. WCK Belle Island, Mich. 2414 kc. WDX Wyoming, Pa. 257 kc. WJL Greensburg, Pa. 257 kc. WKDU Cincinnati, Ohio 1712 kc. WMB W. Reading, Pa. 257 kc. WMDZ Indianapolis, Ind. 2442 kc. WMJ Buffalo, N. Y. 2422 kc. WMO Highland Park, Mich. 2414 kc. WMP Framingham, Mass. 1574 kc. WPDA Tulare, Cal. 2414 kc. WPDB Chicago, Ill. 1712 kc. WPDC Chicago, Ill. 1712 kc. WPDD Chicago, Ill. 1712 kc. WPDE Louisville, Ky. 2442 kc. WPDF Flint, Mich. 2442 kc. WPDH Richmond, Ind. 2442 kc. WPDI Columbus, Ohio 2430 kc. WPKD Milwaukee, Wis. 2450 kc. WPDH Lansing, Mich. 2442 kc. WPDH Dayton, Ohio 2430 kc. WPDN Auburn, N. Y. 2458 kc. WPDO Akron, Ohio 2458 kc. WPDJ Philadelphia, Pa. 2470 kc. WPDH Rochester, N. Y. 2458 kc. WPDS St. Paul, Minn. 2416 kc. WPDT Kokomo, Ind. 2470 kc. WPDU Pittsburgh, Pa. 1712 kc. WPDV Charlotte, N. C. 2458 kc. WPDW Washington, D. C. 2422 kc. WPDH Detroit, Mich. 2414 kc. WPDY Atlanta, Ga. 2414 kc.</p>	<p>WPDZ Fort Wayne, Ind. 2470 kc. WPEA Syracuse, N. Y. 2458 kc. WPEB Grand Rapids, Mich. 2442 kc. WPEC Memphis, Tenn. 2470 kc. WPEE New York, N. Y. 2450 kc. WPEF New York, N. Y. 2450 kc. WPEG New York, N. Y. 2450 kc. WPEH Somerville, Mass. 1712 kc. WPEI E. Providence, R. I. 1712 kc. WPEK New Orleans, La. 2422 kc. WPEL W. Bridgewater, Mass. 1574 kc. WPEP Arlington, Mass. 1712 kc. WPET Lexington, Mass. 1712 kc. WPEV Portable, Mass. 1574 kc. WPFA Newton, Mass. 1712 kc. WPEC Muskegon, Mich. 2442 kc. WPFQ Highland Park, Ill. 2430 kc. WPFQ Reading, Pa. 2442 kc. WPFQ Toms River, N. J. 2430 kc. WPFQ Jacksonville, Fla. 2442 kc. WPFH Baltimore, Md. 2414 kc. WPFQ Columbus, Ga. 2414 kc. WPFJ Hammond, Ind. 1712 kc. WPFK Hackensack, N. J. 2430 kc. WPFL Gary, Ind. 2470 kc. WPFM Birmingham, Ala. 2414 kc. WPFN Fairhaven, Mass. 1712 kc. WPFQ Knoxville, Tenn. 2470 kc. WPFQ Clarksburgh, W. Va. 2414 kc. WPFQ Swathmore, Pa. 2470 kc. WPFQ Johnson City, Tenn. 2470 kc. WRDH Cleveland, Ohio 2458 kc. WRDR Grosse Pt. Village, Mich. 2414 kc. WRDQ Toledo, Ohio 2470 kc.</p>
--	---	--

AIRPORT RADIO STATIONS

Alphabetically by Call Letters

The number in parenthesis following the location indicates the frequency group in which the station operates. See preceding page for these figures.

KBTY Butte, Mont. (2)	KGUB Houston, Tex. (8)	KNWC Pembina, N. D. (6)	WMDV San Juan, P. R. (10)
KEU Burbank, Calif. (1)	KGUD San Antonio, Tex. (5)	KOE Cheyenne, Wyo. (1)	WNAO Newark, N. J. (1)
KFM Sacramento, Calif. (1)	KGUE Brownsville, Tex. (5)	WAEC Pittsburgh, Pa. (2)	WNAK Cleveland, Ohio (1)
KFO Oakland, Calif. (1)	KGUF Dallas, Tex. (5)	WAED Harrisburg, Pa. (2)	WNAL Brookville, Pa. (1)
KGE Medford, Ore. (1)	KGUG Big Spring, Tex. (5)	WAEF Camden, N. J. (2)	WNAM Bellefont, Pa. (1)
KGGUC Ft. Worth, Tex. (1)	KGUH Waco, Tex. (5)	WAEF Newark, N. J. (2)	WNAT Orlando Twnshp., Ill. (1)
KGJW Brownsville, Tex. (10)	KGUK Shreveport, La. (5)	WAEG Cresson, Pa. (2)	WNAU Moline, Ill. (1)
KGQZ San Diego, Calif.	KGUL Abilene, Tex. (4)	WAEH Milwaukee, Wis. (6)	WQDQ New Orleans, La. (5)
KGSB Alameda, Calif. (2)	KGUM Frijole, Tex. (5)	WAEI Detroit, Mich. (7)	WQPD Atlanta, Ga. (5)
KGSP Denver, Colo. (3)	KGUN Douglas, Ariz. (5)	WAEJ Springfield, Ill. (5)	WSDC Newark, N. J. (4)
KGSR Pueblo, Colo. (3)	KGUO Tuscon, Ariz. (4)	WAEK Mobile, Ala. (4)	WSDD Boston, Mass. (4)
KGT Fresno, Calif. (1)	KGUP Phoenix, Ariz. (5)	WEEB Baltimore, Md. (9)	WSDI Birmingham, Ala. (4)
KGTA Winslow, Ariz. (2)	KGUR Indian, Calif. (5)	WEEC Charleston, S. C. (9)	WSDJ Louisville, S.C. (5)
KGTD Wichita, Kans. (2)	KGUS Burbank, Calif. (5)	WEEF Spartanburg, S.C. (9)	WSDG Chicago, Ill. (5)
KGTE Wichita, Kans. (1)	KGUS Blythe, Calif. (8)	WEEG Greensboro, N.C. (9)	WSDH Memphis, Tenn. (5)
KGTH Salt Lake City, U. (3)	KGUT Robertson, Mo. (5)	WEEH McRae, Ga. (9)	WSDI Duluth, Minn. (6)
KGTJ Las Vegas, Nev. (3)	KGUZ Ponca City, Okla. (1)	WEEJ Jacksonville, Fla. (9)	WSDM Albany, N. Y. (5)
KGTL Kingman, Ariz. (2)	KKO Elko, Neva. (1)	WEEM Miami, Fla. (9)	WSDO Buffalo, N. Y. (8)
KGTN Las Vegas, Nev. (2)	KMP Omaha, Neb. (1)	WEEN Linden, N. J. (9)	WSDP Columbus, Ohio (5)
KGTO Springfield, Mo. (2)	KMR No. Platte, Nebr. (1)	WEEQ Orlando, Fla. (9)	WSDQ Berea, Ohio (5)
KGTR Robertson, Mo. (2)	KNAS Kansas City, Mo. (1)	WEEQ Atlantic City, N. J. (9)	WSDS Chicago, Ill. (6)
KGTS Omaha, Neb. (5)	KNAT Dallas, Tex. (1)	WEER Richmond, Va. (9)	WSDT Nashville, Tenn. (5)
KGTV Beaumont, Tex. (4)	KNAU Tulsa, Okla. (1)	WHG Columbus, Ohio (2)	WSDZ Indianapolis, Ind. (5)
KGTX Pocatella, Idaho (2)	KNAV Okla. City, Okla. (1)	WHM Indianapolis, Ind. (2)	WSID Cincinnati, Ohio (5)
KGTZ Spokane, Wash. (1)	KNWA St. Paul, Minn. (6)	WKDL Miami, Fla. (10)	WUCG Chicago, Ill. (1)
KGUA El Paso, Tex. (5)	KNWB Fargo, N. D. (6)		

TELEVISION STATIONS

Television transmission at the present time is highly experimental in nature, and for this reason it is difficult to give operating hours, scanning speeds, lines per second, etc., with any degree of accuracy.

<p>According to frequency and wavelength</p> <p>1600-1700 kc. 176.5-187.5 m.</p> <p>W2XR—Radio Pictures, Inc. Long Island City, N. Y. 1000 watts. 60 lines</p> <p>W1XAV—Short Wave & Television Co. Boston, Mass. 1000 watts. 60 lines</p> <p>W8XN—Sparks-Withington Co. Jackson, Mich.</p> <p>200-2100 kc. 142.9-150 m.</p> <p>W9XAO—Western Television Corp. Chicago, Ill. 500 watts. 45 lines</p> <p>W6XAH—Pioneer Mercantile Co. Bakersfield, Cal. 1000 watts. 60 lines</p> <p>W9XK—Iowa State University Iowa City, Iowa 100 watts. 60 lines</p>	<p>W8XF—Goodwill Station Pontiac, Mich. 1000 watts</p> <p>2100-2200 kc. 136.4-142.9 m.</p> <p>W3XAK—National Broadcasting Co. 5000 watts. Portable</p> <p>W2XBS—National Broadcasting Co. New York, N. Y. 5000 watts</p> <p>W6XS—Don Lee Broadcasting Corp. Gardena, Calif. 1000 watts</p> <p>W9XAP—National Broadcasting Co. Chicago, Ill. 2,500 watts</p> <p>W9XAK—Kansas State College, Manhattan, Kans. 125 watts</p> <p>2200-2300 kc. 130.4-136.4 m.</p> <p>W9XAL—First National Television Corp. Kansas City, Mo.</p> <p>2750-2850 kc. 105.3-109.1 m.</p> <p>W9XG—Purdue University W. Lafayette, Ind. 1500 watts. 60 lines</p>	<p>W2XAB—Atlantic Broadcasting Corp. New York, N. Y. 500 watts</p> <p>43,000-46,000 kc. 6.52-6.98 m. 48,500-50,300 kc. 6.00-6.20 m. 60,000-80,000 kc. 3.75-5.00 m.</p> <p>W9XD—The Journal Co. Milwaukee, Wis. 500 watts</p> <p>W9XE—U. S. Radio & Tele. Corp. Marion, Ind. 1000 watts</p> <p>W8XF—Goodwill Station, Pontiac, Mich.</p> <p>W3XAD—RCA-Victor Co., Camden, N. J. 2000 watts</p> <p>W2XBT—National Broadcasting Co. Portable 750 watts</p> <p>W1XG—Short Wave & Television Co. Boston, Mass. 200 watts</p> <p>W2XR—Radio Pictures, Inc. Long Island City, N. Y. 1000 watts</p>	<p>W2XF—National Broadcasting Co. New York, N. Y. 5000 watts</p> <p>W6XAO—Don Lee Broadcasting System Los Angeles, Calif. 150 watts</p> <p>W3XE—Philadelphia Storage Battery Co. Philadelphia, Pa. 1500 watts</p> <p>W2XAK—Atlantic Broadcasting Corp., New York, N. Y. 50 watts</p> <p>W10XX—RCA-Victor Co., Portable and Mobile. 50 watts</p> <p>W8XAN—Sparks-Withington Co., Jackson, Mich. 100 watts</p> <p>W8XL—WGAR Broadcasting Co., Cuyahogo Hts., Ohio. 200 watts</p>
--	---	---	---

SHORT WAVE STATIONS OF THE WORLD

SECTION TWO

The lists that appear here-with comprise Section Two of the SHORT WAVE CRAFT index of the world's short wave stations, which has proved very popular with S.W. fans everywhere. As compared with Section Two published in the May, 1933 number, it represents many additions and corrections. A member of the staff of SHORT WAVE CRAFT

Section One of this list, which appeared in the June, 1933 number, contained a "grand" list of short wave relay broadcasting, experimental and commercial radiophone stations. It will reappear in the August, 1933 number, with further additions and last minute corrections.

made a special trip to Washington, D. C., to obtain authentic data directly from the Federal Radio Commission. Please write to us about

any new stations, changes in schedules or other important data that you learn through announcements over the air or correspondence with the stations themselves. A post card will be sufficient. We will safely return to you any verifications that you send in to us. Communications of this kind are a big help in tracking down new stations.

AIRPORT RADIO STATIONS

The airport stations do not follow any fixed schedules, and are likely to be heard anytime of the day or night. They operate very "snappily," and engage only in quick, brief conversations with pilots aloft. The airplane transmitters are usually heard on the same wavelengths. The stations are listed alphabetically according to cities within ten groups of wavelength ranges. The stations in each group are likely to be heard on any of the waves listed.

Group One

94.86 m.-3160 kc. 53.83 m.-5570 kc.
94.56 m.-3170 kc. 53.74 m.-5580 kc.
93.29 m.-3215 kc. 53.64 m.-5590 kc.
52.98 m.-5660 kc.

Bakersfield, Calif. KQK
Bellefonte, Pa. WNAM
Boise, Idaho KRA
Brooksville, Pa. WNAL
Burbank, Calif. KEU
Cheyenne, Wyo. KOE
Chicago, Ill. WUCG
Cleveland, Ohio WNAK
Dallas, Tex. KNAT
Des Moines, Iowa KQM
Elko, Nevada KKO
Fort Worth, Tex. KGUC
Fresno, Calif. KGT
Iowa City, Iowa KQQ
Kansas City, Mo. KNAS
Lincoln, Neb. KRF
Medford, Ore. KGE
Moline, Ill. WNAU
Newark, N. J. WNAO
North Platte, Nebr. KMR
Oakland, Calif. KFO
Okla. City, Okla. KNAV
Omaha, Nebr. KMP
Orlando Twsp., Ill. WNAT
Pasco, Wash. KR D
Ponca City, Okla. KGUZ
Portland, Ore. KVO
Redding, Calif. KUT
Rock Springs, Wyo. KQC
Sacramento, Calif. KFM
Salt Lake City, Utah KQD
San Diego, Calif. KGQZ
Seattle, Wash. KZJ
Spokane, Wash. KGTZ
Tulsa, Okla. KNAU
Wichita, Kans. KGTE

Group Two

103.23 m.-2905 kc. 60.15 m.-4990 kc.
97.63 m.-3070 kc. 54.45 m.-5510 kc.
97.15 m.-3090 kc. 52.88 m.-5680 kc.

60.39 m.-4970 kc. 52.7 m.-5690 kc.
52.45 m.-5720 kc.

Alameda, Calif. KGSB
Albuquerque, N. M. KSX
Burbank, Calif. KSI
Butte, Mont. KBTY
Camden, N. J. WAEE
Columbus, Ohio WHG
Cresson, Pa. WAEG
Harrisburg, Pa. WAED
Indianapolis, Ind. WHM
Kansas City, Mo. KST
Kingman, Ariz. KGTL
Las Vegas, Nev. KGTN
Newark, N. J. WAEF
Pittsburgh, Pa. WAEC
Pocatello, Idaho KGTX
Robertson, Mo. KGTR
Springfield, Mo. KGTQ
Tulsa, Okla. KSY
Wichita, Kans. KGTD
Winslow, Ariz. KGTA

Group Three

103.23 m.-2905 kc. 60.15 m.-4990 kc.
97.63 m.-3075 kc. 54.45 m.-5510 kc.
97.15 m.-3090 kc. 53.83 m.-5570 kc.
94.86 m.-3160 kc. 53.74 m.-5580 kc.
94.56 m.-3170 kc. 53.64 m.-5590 kc.
94.26 m.-3180 kc. 52.98 m.-5660 kc.
93.29 m.-3215 kc. 52.88 m.-5670 kc.
60.39 m.-4970 kc. 52.7 m.-5690 kc.

Denver, Colo. KGSP
Las Vegas, Nev. KGSTJ
Pueblo, Colo. KGSR
Salt Lake City, Utah KGTH

Group Four

93.09 m.-3220 kc. 86.52 m.-3470 kc.
92.8 m.-3230 kc. 86.08 m.-3490 kc.
92.52 m.-3240 kc. 61.00 m.-4920 kc.
92.09 m.-3250 kc. 53.55 m.-5600 kc.
87.02 m.-3450 kc. 53.45 m.-5610 kc.
86.77 m.-3460 kc. 53.26 m.-5630 kc.

Abilene, Tex. KGUL
Beaumont, Tex. KGTV
Birmingham, Ala. WSDE
Boston, Mass. WSDD
Mobile, Ala. WAEK

Newark, N. J. WSDC
Tucson, Ariz. KGUO

Group Five

129.63 m.-2315 kc. 86.08 m.-3490 kc.
127.33 m.-2355 kc. 63.29 m.-4740 kc.
93.09 m.-3220 kc. 61.00 m.-4920 kc.
92.8 m.-3230 kc. 53.55 m.-5600 kc.
92.52 m.-3240 kc. 53.45 m.-5610 kc.
92.09 m.-3260 kc. 53.26 m.-5630 kc.
87.02 m.-3450 kc. 45.87 m.-6540 kc.
86.77 m.-3460 kc. 45.8 m.-6550 kc.
86.52 m.-3470 kc. 37.43 m.-8015 kc.

Albany, N. Y. WSDM
Atlanta, Ga. WQPD
Bera, Ohio WSDQ
Big Spring, Tex. KGUG
Brownsville, Tex. KGUE
Burbank, Calif. KGUR
Chicago, Ill. WSDG
Cincinnati, Ohio WSID
Columbus, Ohio WSDP
Dallas, Tex. KGUF
Douglas, Ariz. KGUN
El Paso, Tex. KGUA
Frijole, Tex. KGUM
Indianapolis, Ind. WSDZ
Indio, Calif. KGUQ
Jackson, Miss. KSDB
Little Rock, Ark. KQUU
Louisville, Ky. WSD F
Memphis, Tenn. WSDK
Nashville, Tenn. WSDT
New Orleans, La. WQDQ
Omaha, Nebr. KGTS
Phoenix, Ariz. KGUP
Robertson, Mo. KGUT
San Antonio, Tex. KGUD
Shreveport, La. KGUK
Springfield, Ill. WAEJ
Waco, Tex. KGUH

Group Six

112.44 m.-2670 kc. 98.83 m.-3040 kc.
112.27 m.-2675 kc. 55.79 m.-5380 kc.
105.11 m.-2850 kc.

Chicago, Ill. WSDS

Duluth, Minn. WSDL
Fargo, N. D. KNWB
Madison, Wis. WSDR
Milwaukee, Wis. WAEH
Pembia, N. D. KNWC
St. Paul, Minn. KNWA

Group Seven

111.19 m.-2680 kc. 51.5 m.-5820 kc.
102.1 m.-2935 kc.

Detroit, Mich. WAEI

Group Eight

129.63 m.-2310 kc. 45.87 m.-6540 kc.
127.33 m.-2355 kc. 45.8 m.-6550 kc.
86.52 m.-3470 kc. 45.73 m.-6560 kc.
63.29 m.-4740 kc. 37.45 m.-8010 kc.

Blythe, Calif. KGUS
Buffalo, N. Y. WSDO
Houston, Tex. KGUB

Group Nine

126.1 m.-2380 kc. 63.22 m.-4740 kc.
101.83 m.-2950 kc. 53.07 m.-5650 kc.
100.46 m.-2990 kc. 45.52 m.-6590 kc.
72.11 m.-4160 kc. 45.45 m.-6600 kc.

Atlantic City, N. J. WEEQ
Baltimore, Md. WEEB
Charleston, S. Car. WEEC
Greensboro, N. Car. WEEG
Jacksonville, Fla. WEEJ
Linden, N. J. WEEN
McRae, Ga. WEEH
Miami, Fla. WEEM
Orlando, Fla. WEEO
Richmond, Va. WEE R
Spartanburg, S. Car. WEEF

Group Ten

113.29 m.-2650 kc. 45.59 m.-6580 kc.
104.53 m.-2870 kc. 37.43 m.-8010 kc.
97.32 m.-3080 kc. 36.5 m.-8220 kc.
55.5 m.-5400 kc. 24.33 m.-12,330 kc.
53.64 m.-5700 kc. 18.47 m.-16,240 kc.
45.66 m.-6570 kc. 18.24 m.-16,450 kc.

Brownsville, Tex. KGJW
Miami, Fla. WKDL
San Juan, P. R. WMDV

WHAT'S NEW

The short-wave apparatus here shown has been carefully selected for description by the editors and has been tested also in our laboratory.

In Short-Wave Apparatus

Interference Eliminator

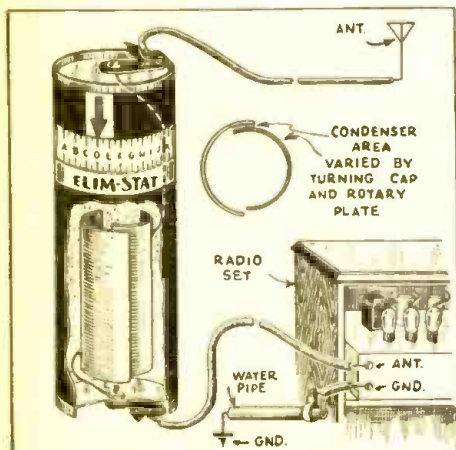

A simple eliminator of interference and "man-made" static. (No. 100)

● ONE of the newest noise and unwanted station interference eliminators is that shown in the accompanying picture. It is a small calibrated capacity device, which the operator connects in series with the antenna; the aerial lead-in wire is connected to one end of the device, while the terminal on the other end of it is connected to the antenna post of the short (or broadcast) wave receiver. The outer case of the interference eliminator is calibrated with a scale, marked from A to J, and also an arrow is placed on the upper rotatable part of the case, enabling the operator to always readjust the device for any desired wave elimination, etc. The device was tested by the editors and found to work very efficiently indeed. Frequently you will have interference from some strong station, whether it be amateur or commercial, which spoils the reception of the desired short-wave station, when the simple interposition of one of these devices will be found to cut out the interfering signal. The usual ground wire is left connected to the ground post of the receiving set. This device is being featured by the Radio Components Manufacturing Company, New York, N. Y.

Portable Test Oscillator

● THE general service test oscillator shown in the accompanying photo is fitted into a small and very neat portable carrying case; this oscillator is also furnished in a walnut cabinet for laboratory use. It is available for use with a battery tube or with a 56 type tube, so that it can be plugged directly into a 110 volt, 60 cycle circuit. The oscillator is completely wired and tested, but comes less tubes. In the Powertone battery-type oscillator, a 30 type tube is used and the battery therefore lasts an extremely long time. This model only requires a 22½ volt, small-size, B battery unit and 4½ volt small-type "C" battery. The batteries fit inside the case.

These oscillators are very useful to short-wave experimenters and "ham" stations. They are used for a variety of tests, such as checking up the tuning of any L-C circuit. (Continued on page 176)



A portable test oscillator which has many uses. (No. 101)

Police Thriller



The "police-call" auxiliary tuning device connected to a midget "broadcast" receiver. (No. 102)

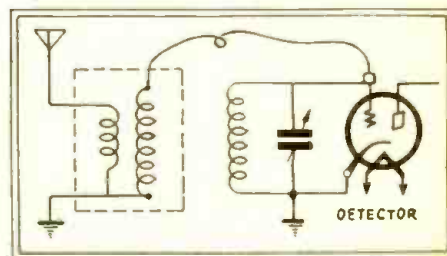

How device connects to "BC" Receiver.

● ONE of the simplest police call auxiliary tuning devices is the "Air Cop" illustrated above and designed by C. H. Smith. It comprises an auxiliary tuning coupler mounted in a small box, provided with spring binding-posts so that it can be (Continued on page 189)

Silver-Coated Ribbon-Wound Coils

● THE very newest high-efficiency plug-in coils for use in short-wave receivers are those here illustrated. They are wound with a pure copper ribbon which has been silver-plated. One of the advantages of winding the coils with the thin flat copper strip is that the capacity between turns as compared to the ordinary round wire is considerably reduced, as only the extremely thin edges of the adjacent turns face each other and the resulting electrostatic fields between adjacent turns are reduced to a minimum.

The new Bruno ribbon-wound coils have the turns of tightly wound turns of flat ribbon supported on thin ribs of a new low-loss insulating material, the ribs being molded on the form. The coils are wound by special machinery which spaces the turns with extreme accuracy, which of course is an important factor for any short-wave coil. The silver plating on the ribbon is a very clever piece of manufacturing technique and it serves to greatly lower the resistance to the high-frequency short-wave currents, silver being one of the very best conductors of electricity. Furthermore, currents oscillating at frequencies of one-half million cycles or more per second do not penetrate into the interior of a solid round wire, with which most coils are wound, but only penetrate a few ten-thousandths of an inch below the surface. (No. 103)

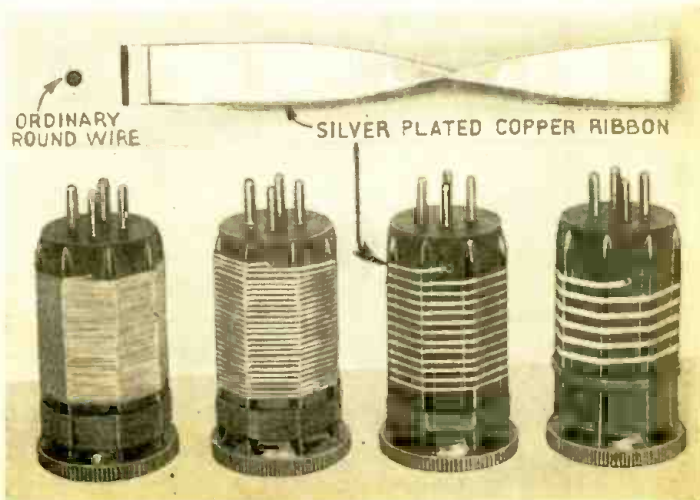

(Names and addresses of manufacturers furnished upon receipt of stamped envelope; mention No. of article.)

SPACE-WINDING S. W. COILS
\$5.00 Prize Winner.

The type of twine used to space the turns of wire is of the waxed variety, such as is used by electricians in tying several insulated wires together. Any other kind can be used but this type is preferred.

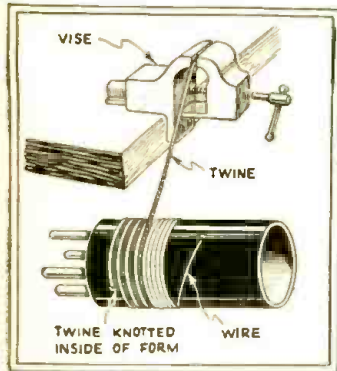

Cut the proper length of wire to be wound, run one end through the first hole in the form, and solder to the prong in the usual way. Clamp the free end of the wire in a vise, and holding the form in both hands, stand away from the vise until the wire is taut. Put on the desired number of turns, close together, by turning the form toward the vise.

When all the turns are on, and the other end of the wire has been passed through the further hole in the form and soldered to its prong, take a piece of waxed twine somewhat longer than the wire, run one end through the hole at the start of the winding, and knot the end of it so it will not pull through. Clamp the free end in a vise, and wind it between the turns in the same way that the wire was put on.

It will slip easily between the turns of the wire, forcing them apart. The accompanying sketch shows how the coil will look when about half the turns have been spaced. It can be seen that when the remaining five turns of wire have been spaced by the twine, they will be moved toward the further hole where the end of the wire is secured.

When all the turns of twine have been put on, the end of the twine can be fastened to any convenient point on the form to hold it in place until any other windings are placed on the same form.

When the coil is entirely finished, the twine is carefully removed, and because the wire was put on fairly tight and the turns close together in the first place, it will be found that the twine, in forcing them apart, has strengthened their position on the form.

If waxed twine is used, it should always be removed before the coil is placed in operation. If this is not done, its dielectric quality will increase the distributed capacity of the coil and the original advantage in space winding is lost.—R. S. Peitler.

STAND-OFF INSULATORS

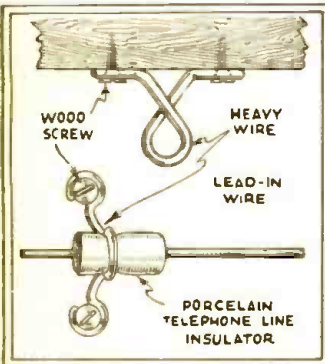

A good aerial system must have a good insulation system. The lead-in must be kept away from the sides of buildings at all times. A good "stand-off" insulator may be made from an old telephone line insulator or porcelain insulator knobs. Take some heavy wire and make one turn around the grooved part of the insulator; then spread the legs apart and fasten to the sides of the building with wood screws. The lead-in may be then run through the hole. This provides a sturdy and inexpensive insulator for the short-wave set.—Y. H. Mori.

TUBE-BASE COIL FORM

Here is a novel idea for making short-wave coil forms from old tube-bases. Each form is made, for instance, of two

\$5.00 For Best Short Wave Kink

The Editor will award a five dollar prize each month for the best short-wave kink submitted by our readers. All other kinks accepted and published will be paid for at regular space rates. Look over these "kinks" and they will give you some idea of what the editors are looking for. Send a typewritten or ink description, with sketch, of your favorite short-wave kink to the "Kink" Editor, SHORT WAVE CRAFT.

tube-bases cemented together in the manner shown. A handle is formed from a piece of wire soldered into two of the pins

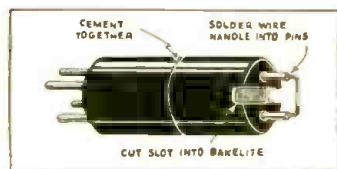

left on the upper base, the other two pins have been cut away to reduce dielectric losses.

WINDING TRANSMITTER COILS

A few hints are given in the accompanying illustration on how to wind condenser tubing and strip for transmitter inductances. Copper tubing may be wound "cold" around a cylindrical form, one end of the tube being held in a lathe chuck for example, if a lathe is available. Flat

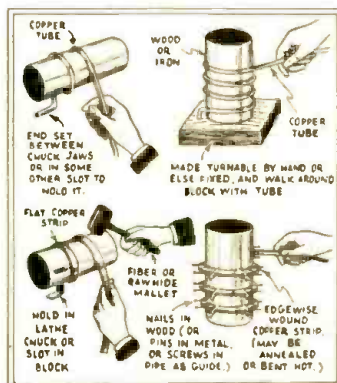

copper strip is wound around a form and the operation aided by means of a fibre mallet. Tubing may also be wound by walking around a stationary form with it. Copper strip may be "edge-wise" wound between nails driven into a wooden form as shown, (or pins or screws in a metal drum or piece of pipe).

HANDY MIDGET CONDENSER

Double adjustment is provided in the midget condenser design here suggested. First, one of the circular plates is adjusted by means of the threaded rod and

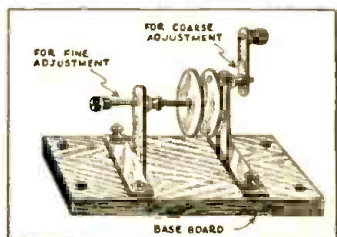

check-nut shown at left of the condenser. The second plate, at the right, may be moved side-wise by means of the lever and insulated button.

LEAD-IN INSULATOR

Many different types and styles of lead-in insulators have been designed and

suitable form and when it has cooled remove it; the ends may be glued if found necessary. The tube may then be glued on to a vacuum tube base and a wooden knob provided at the top, the knob being turned out on a lathe.—John Hengel.

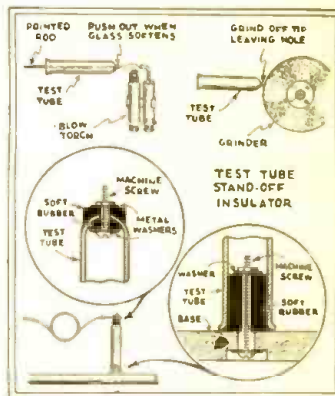

TEST-TUBE STAND-OFF INSULATOR

Making the hole in the closed end of the test tube is the hardest part of the whole job. A small spot on the end is heated with a small sharp flame (a Bunsen burner and a small blow-pipe work out very well). While the glass is still soft a pointed rod is used to form a little tip as shown in the diagram. Now care must be taken to allow the test tube to cool very slowly because rapid cooling will cause it to crack. After it has cooled thoroughly the tip is carefully ground off on an ordinary bench grinder. A fine grade abrasive wheel is best for this work.

The rubber washers at the top of the test tube should be carved out slightly to give a better fit. The rubber stopper used in fastening the tube to the base should come down to the base to give a firm mounting. At neither end should the pressure used be greater than absolutely necessary, because remember that you are still working with glass. Use "Pyrex Glass" test tubes if possible, because they are much stronger mechanically and are not as likely to crack from heat.

Test tubes come in quite a range of sizes and various sized insulators can be made for different purposes. If well made these supports will add to the attractiveness of any job.—Joseph Keiser, W9GEC.

sold on the market, and also described by various experimenters, but here is one that is simple to make and which can be made from parts usually available at slight cost. This lead-in insulator is made from the porcelain block obtainable from an old spark-plug. It is feasible, where thick walls are encountered, to use two of these, one on each side of the wall.—Christian Jorgensen.

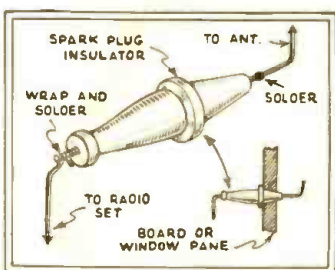

TUBE SHIELD

The accompanying drawing shows one way to improvise tube shields—this idea calling for the use of a piece of cardboard mailing tube. The tube may be boiled in molten paraffin wax to render it non-hy-

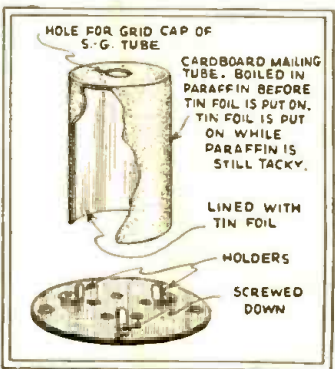

groscopic and after that a layer of tin-foil is placed around the tube while the paraffin is still tacky. A tin-foil disc is cut out for the cap and this is lapped over the tin-foil on the cylinder.—Norman Harris.

COIL FORMS FROM RECORDS

As the sketches reproduced herewith show, very good coil forms may be made from discarded phonograph records. The

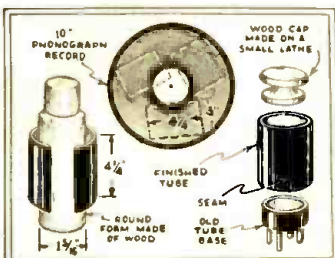

record is heated over a gas flame until it is soft, when you will find it possible to cut out square pieces with a knife. While still warm, wrap the flat piece around a

PORTABLE BATTERY CASE

When the amateur "set-builder" takes his portable short-wave receiver with him on trips he frequently finds difficulty in setting up and connecting his "power supply." He has several dry batteries that must be disconnected and packed up every time he moves his location; here is an original stunt that will do away with all of this bother.

Take any kind of a box which is provided with a handle; the box that was used was of tin, rather deep and longer

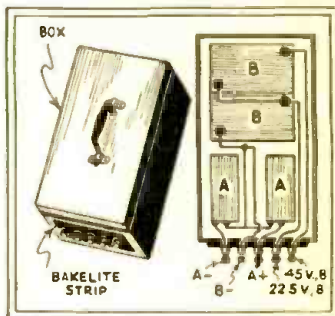

than it was wide. A square opening was cut in one end and a bakelite panel was placed there; binding posts were set in this panel.

The batteries that are placed in it are the smallest types that can be used efficiently in the ordinary portable set. The "A" batteries of which there are two, are No. 4 dry cells and are only two inches square by four inches high. The "B" batteries, of which there are also two, are of the 22½ volt size; together they supply 45 volts. They measure 3¼x2x2½ high. There are five posts.—A, —B, +A, 22.5 v. "B" and 45 v. "B". Of course, the same size batteries need not be used and more "B" batteries may be added. However, this makes a compact, portable power supply and all connections can be made simply between the set and the batteries by means of the various binding posts.—Y. H. Mori.

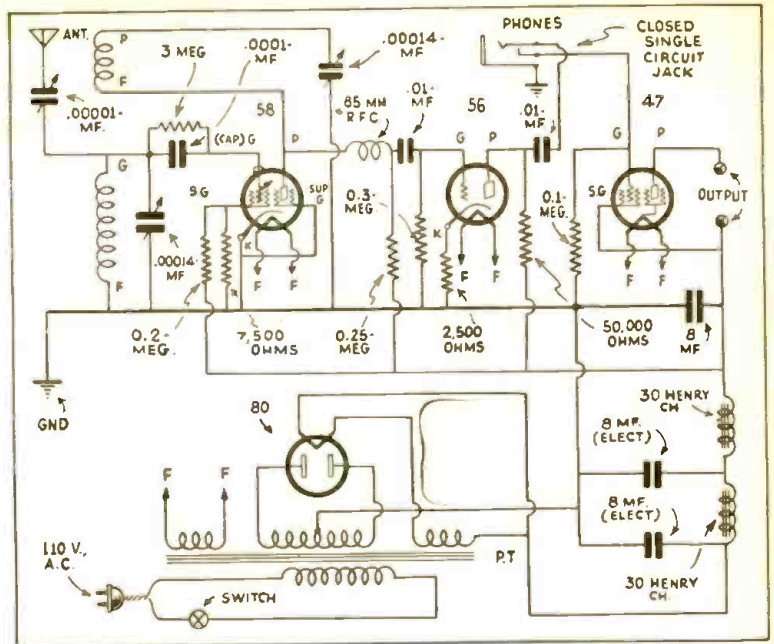

Above—we see the handsome appearance of the new A.C. operated short wave 4-tube receiver here described, as well as diagram showing the efficient arrangement of the circuit. (No. 105)

The "Powertone" A. C. Short-Wave 4

● A SMOOTH-TUNING short wave receiver covering the usual S-W bands below 200 meters is the new Powertone here illustrated. This receiver employs 4 tubes, an 80 rectifier, a 47 output tube, a 58 radio frequency amplifier tube and a 56 as a detector. This set was designed by Mr. Herman Cosman and Frank Grimes. Mr. Grimes was formerly connected with the United States Signal Corps, while Mr. Cosman has been connected with radio designing and manufacturing problems for many years. Both of these experts know just what the short-wave "fan" desires in a smoothly operating and "DX-getting" receiver and they have combined their technical ideas in the present set here illustrated.

Plug-in coils of the Bruno ribbed-form type are used and as the high frequency losses are reduced to a minimum, due to the wire being supported on the ribs of these coil-forms, the maximum efficiency is realized from the tuned circuit of the set. The plate supply for the tubes in the circuit is furnished by means of the 80 type rectifier tube, which operates in connection with a well-designed filter circuit. The control of the regeneration is effected by means of a liberal

sized *throttle* condenser.

The whole set is mounted on a strong metal chassis and this in turn fits into a neatly designed and beautifully finished metal cabinet, the top cover of which is hinged, thus facilitating the removal and replacement of plug-in coils. Tube shields are pro-

vided to eliminate stray fields reacting on the tubes. Due to the careful design of the shielding features, the set is unusually selective and free from interference from nearby electrical disturbances. The average short-wave signal as picked up by the Powertone S-W receiver will work a speaker.

New 5-Meter Coils

● A special tuning inductor and an R.F. choke intended for use in five-meter super-regenerative receivers have been brought out by a New England manufacturer. The inductor consists of two 7-turn coils of No. 14 bare copper wire, mounted on a polished bakelite base measuring only 2 3/4 inches long by 1/4 inches wide. Convenient soldering lugs are provided. The choke is 2 1/2 inches long and 1/4 inch in diameter and is space-wound so as to have low distributed capacity.

The constructor starting to investigate the mysteries of the ultra short waves will find these units very useful.

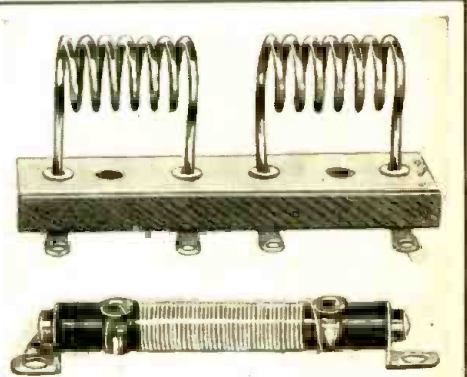

The newest 5-meter tuning coils as well as R.F. choke. (No. 104)

Names and addresses of manufacturers of above apparatus supplied on receipt of stamped envelope. Mention Number.

\$20.00 Prize Monthly For Best Set

● THE editors offer a \$20.00 monthly prize for the best short-wave receiver submitted.

If your set does not receive the monthly prize you still have a chance to win cash money, as the editors will be glad to pay space rates for any articles accepted and published in SHORT WAVE CRAFT.

You had better write the "S-W. Contest Editor," giving him a short description of the set and a diagram, BEFORE SHIPPING THE ACTUAL SET, as it will save time and expense all around. A \$20.00 prize will be paid each month for an article describing the best short-wave receiver, converter, or adapter. Sets should not have more than five tubes and those adapted to the wants of the average beginner are much in demand.

Sets must be sent PREPAID and should be

CAREFULLY PACKED in a WOODEN box!

The closing date for each contest is sixty days preceding date of issue (July 1 for the September issue, etc.).

The judges will be the editors of SHORT WAVE CRAFT, and Robert Hertzberg and Clifford E. Denton, who will also serve on the examining board. Their findings will be final.

Articles with complete coil, resistor and condenser values, together with diagram, must accompany each entry. All sets will be returned prepaid after publication.

REQUIREMENTS: Good workmanship always commands prize-winning attention on the part of the judges; neat wiring is practically imperative. Other important features

the judges will note are: COMPACTNESS, NEW CIRCUIT FEATURES, and PORTABILITY. The sets may be A.C. or battery-operated. Straight Short-Wave Receivers, Short-Wave Converters, or Short-Wave Adapters. No manufactured sets will be considered; EVERY SET MUST BE BUILT BY THE ENTRANT. Tubes, batteries, etc., may be submitted with the set if desired, but this is not essential. NO THEORETICAL DESIGNS WILL BE CONSIDERED! The set must be actually built and in working order. Employees and their families of SHORT WAVE CRAFT are excluded. Address letters and packages to the SHORT WAVE CONTEST EDITOR, care of SHORT WAVE CRAFT Magazine, 96-98 Park Place, New York, N. Y.

WAVE REVIEW • Edited by C. W. PALMER

80 meters, the authors decided to carry out a series of experiments and with this end in view, a really efficient single-tube short-wave receiver, in which super-regeneration could be introduced at will, was constructed.

The receiver itself, without the super-regenerative attachment (the part enclosed by the dotted line in the circuit diagram) is a highly efficient "straight" short-wave receiver and is very stable in operation.

The tuning coils are wound on six-pin low-loss forms; suitable windings for the 15 to 85 meter wavelengths are given in the table below.

W. L. BAND	Aerial COIL	Grid COIL	Plate COIL
15	3 turns	5 turns	5 turns
25	4 turns	9 turns	10 turns
40	7 turns	18 turns	16 turns

The two lower wavelength coils are space wound with No. 14 B & S enameled wire and the other with No. 24 B & S double silk covered wire. The exact range of each coil will, of course, vary with the spacing of the wire, etc., but the table will serve as a rough guide, and these windings should cover the wavebands with some overlapping.

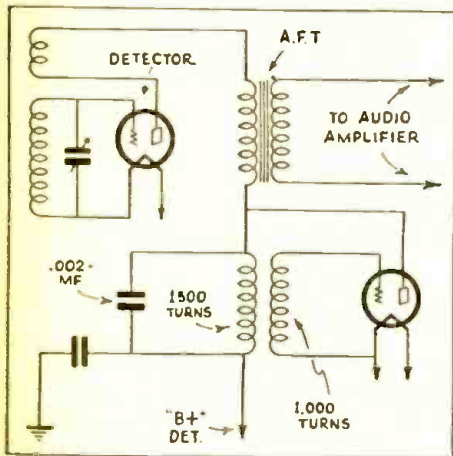

A super-regenerative short-wave attachment which can be easily tried with any regenerative receiver.

Although it was customary in the early Armstrong circuits to use 1250 and 1500 turn "honeycomb" coils in the low frequency circuit, when the quenching frequency was audible in the phones as a high-pitched whistle, it is much better to employ coils of considerably fewer turns, say 600 and 750, so that the quenching note will be above audibility.

When operating a receiver built on these lines, it should first be tried out as a straight circuit. To do this, it is only necessary to short circuit the two low frequency coils. A switch might be incorporated for this purpose, or U shaped short-circuiting plugs may be inserted in the sockets of the two honeycomb coils.

When the set is working satisfactorily, the two low-frequency coils may be plugged in the coil sockets. As the quenching frequency will be above audibility, perhaps the best indication as to whether these coils are connected correctly to produce oscillations is a milliammeter in the plate circuit of the tube.

The set is now in a condition for super-regeneration and should be tuned in the usual way, except that a much higher setting of the regeneration condenser will be required than normal.

A Super-Regenerative Short-Wave Attachment

(From World-Radio—London, England)

● THE purpose here is to provide a simple and inexpensive device which can

be added to almost any short-wave receiver to convert it into a "super-regenerative" set.

The circuit shows the simple and ingenious arrangement. It consists of an oscillating tube connected to the detector of the ordinary regenerative short-wave receiver. It will be noticed that the plate circuit of the new tube is tuned instead of the grid (in the usual manner). This is done so that the amplitude of the oscillations developed in the plate circuit will be as great as possible.

The inductances present little difficulty and may be constructed with the simplest tools. Three discs, each 2 inches in diameter are cut from plywood and are bolted together with wooden spacing discs 3/4 inch long and 1/2 inch in diameter fitted between the discs. To wind the coils a small hand-drill is gripped in a vise and the bolt through the coil form is gripped in the chuck of the drill. The number of turns is then ascertained by multiplying the number of revolutions of the handle of the drill by the gearing ratio of the drill.

In one of the slots is wound 1500 turns of number 34 D. C. C. copper wire and in the other 1000 turns of the same wire. Each completed coil is then covered with a layer of insulating tape to protect it.

It will be seen that the 1500 turn coil is shunted by a .002 mf. condenser which tunes it to approximately 16 kilocycles. The tube may be any triode that will oscillate freely, such as the 30, 27, 56, etc., depending upon the source of filament supply used in the regular set.

When trying the unit, the first thing is to test for oscillations. Connect a milliammeter in the "B plus" lead and then short-circuit the grid coil of the oscillator. An increase in the plate current should result from this action. It may be necessary to reverse the connections to the grid coil to obtain oscillations.

When oscillations are obtained, the unit is ready to work. First short-circuit the 1500 turn coil to disconnect the oscillator from the circuit and tune in a short wave station. Remove the short-circuit and an increase in signal strength will result; then the regeneration control may be turned up further than usual with a further increase in signal strength. It is found that a station which is of good headphone strength, without the unit, is raised to loudspeaker strength with it.

One precaution must be observed when the super-regeneration is employed. If any "decoupling" condenser is used in the receiver it must be connected at the "B plus" side of the unit—otherwise, it will short-circuit the unit to ground and stop oscillations.

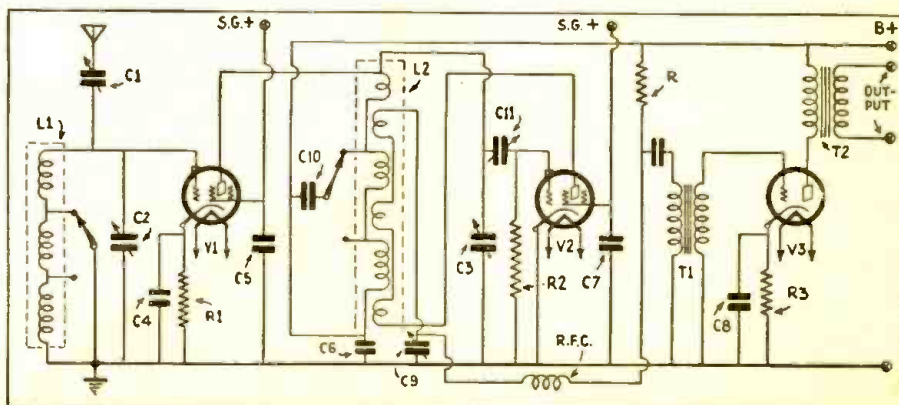

Circuit diagram of the receiver. C1, 0.0001 mf. pre-set; C2, C3, 2-ganged 0.00015 mf.; C4, C5, C6, C7, C8, 1 mf. non-inductive; C9, 0.00015 mf. regeneration condenser; C10, 0.1 mf. non-inductive; C11, 0.0001 mf. pre-set; R1, 250 ohms; R2, 2 meg.; R3, 300-500 ohms.

Radio-Toulouse Is Dead—Long Live Saint-Aignan

(From L'Antenne TSF—Paris, France)

● AN interesting report—one that will concern many short-wave fans—is the account of the burning of the famous short-wave station Radio-Toulouse, in France. Many short-wave fans have picked up the transmissions of this station on their sets and some may have missed them.

This station, which started to burn while a 70 piece symphony orchestra was broadcasting, was completely demolished. Fortunately for short-wave enthusiasts, though, it has been replaced by a new station in Saint-Aignan, which will probably become as famous as its predecessor.

Tapped-Coil S-W Receiver

(From World-Radio—London, England)

● THE object of this article is to describe an A. C. power operated three-tube receiver, employing 3-range shielded coils, giving a wave range of approximately 15-85 meters. Single dial tuning is provided by means of a ganged con-

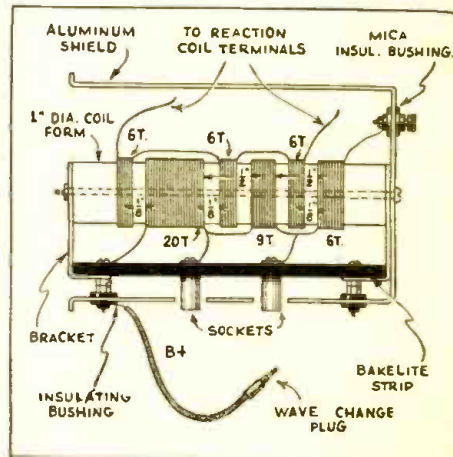

Details of the plate and regenerative (tickler) coils. The plate coil is wound with No. 22 D.S.C. and regeneration (tickler) coil with No. 38 D.S.C. The aerial coil is similar to the plate coil, except that the bottom of the coil is connected direct to the screen.

denser. A tuned S. G. radio frequency stage is used together with a S. G. detector and a triode output tube.

By using the tuned plate arrangement with feedback from the detector, a reasonably high impedance is obtained in the plate circuit of the R. F. tube at all work-

(Continued on page 187)

WORLD-WIDE SHORT-

A Magnetron Oscillator for Ultra-Short Wavelengths

(From *The Wireless Engineer and Experimental Wireless*—London)

● THE limitations of the conventional triode oscillator at very short wavelengths have led to an investigation of the practical possibilities of other circuits. Of these, the magnetron circuit, in which a special vacuum tube is operated in a strong magnetic field, has been found particularly satisfactory.

The tube used consists of a cylindrical diode system with the plate divided into two equal segments and operates with a magnetic field in the direction of the electrode axis. The oscillatory circuit is connected between the plate segments. The plate and filament leads of the tube are brought out at opposite ends and the electrode system is arranged so as to introduce the least possible capacity, inductance and resistance into the oscillatory circuit. The bulb is made of low-loss hard glass.

The circuit of the magnetron oscillator is shown below. The wavelength is

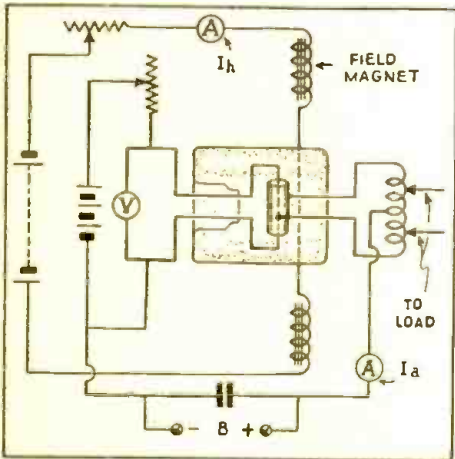

Magnetron oscillator circuit.

determined by the constants of the circuit between the two plate segments. The plate voltage is supplied via the electrical center of this circuit. No R. F. choke is required. For wavelengths above two or three meters it is quite practical to use "lumped" inductance and capacity in the tuned circuit, owing to the low capacity of the tube. For shorter wavelengths, a Lecher wire tuning system is preferable.

Apart from the wavelength adjustment, the behavior of the circuit can be entirely controlled by means of the filament and field current resistors. In the sense that it controls the oscillation strength and the efficiency of the oscillator, the field con-

● The editors have endeavored to review the more important foreign magazines covering short-wave developments, for the benefit of the thousands of readers of this magazine who do not have the opportunity of seeing these magazines first-hand. The circuits shown are for the most part self-explanatory to the radio student, and wherever possible the constants or values of various condensers, coils, etc., are given. Please do not write to us asking for further data, picture-diagrams or lists of parts for these foreign circuits, as we do not have any further specific information other than that given. If the reader will remember that wherever a tuned circuit is shown, for instance, he may use any short wave coil and the appropriate corresponding tuning condenser, data for which are given dozens of times in each issue of this magazine, he will have no difficulty in reconstructing these foreign circuits to try them out.

rol is analogous to the regeneration control in the ordinary triode oscillator. The fact that this control is outside the radio frequency part of the circuit is an appreciable advantage at very short wavelengths.

The maximum output depends on the filament emission. As the space charge saturation current is much greater than the maximum permissible plate current, the output increases continuously with filament emission in the working range.

The magnetic field is supplied by a field magnet. The tube is mounted between the poles of this magnet with the electrode axis in the direction of the magnetic lines of force.

OPERATION

The following figures give typical operating data for a magnetron of the type described.

- Normal plate voltage—500 to 1000.
- Maximum plate voltage—1200.
- Maximum plate current—80 milliamperes.
- Maximum plate loss—50 watts.
- Maximum field strength required—about 1000 c. g. s. units.
- Maximum power output—50 watts at 10 meters—40 watts at 3 meters—10 watts at 1 meter.

A Novel D.C. All-Wave Receiver

(From *Radiowelt*—Vienna)

● AN interesting system for operating a superheterodyne receiver on both "long" and "short wave" bands appeared in this publication. The set was made to operate from 220 volt D. C. lines. It contains five tubes, of which the first is a radio frequency stage, the second is a combined first detector and oscillator, the third the I. F. tube, the fourth the second detector and the fifth the pentode audio tube.

The R. F. tube is employed only on the long waves. When short-wave signals are being received, the aerial connection Ak is used and the coil Lk tunes the grid of the frequency changer. The oscillator in-

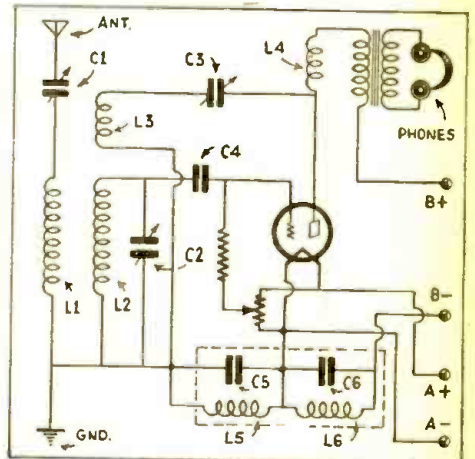

The circuit of the super-regeneration receiver. The components and their values are here given: C1 Pre-set .0003 microfarad (max.); C2 .00015 microfarad (max.); C3 .00025 microfarad (max.); C4 .0002 microfarad (fixed); C5 and C6 .003 to .005 microfarad (fixed); L1, L2, L3, Six-pin coil; L4, 600 and 750-turn choke; L5 and L6, 400 and 750-turn plug-in coils; 1 megohm leak to potentiometer.

ductances are tapped to cover the three wave bands that the set covers—i. e., the short wave band, the broadcast band and the long waves, which, of course, are used extensively abroad.

The interesting part of the set is the switching arrangement mentioned above and shown in the circuit diagram. The fact that a separate inductance is used for the short-wave tuning coil to avoid losses and the use of a ganged wave change switch for the oscillator and the long and intermediate bands makes the set an extremely flexible one.

While the values of all parts are not given, the switching arrangement can easily be substituted by the ingenious experimenter into one of the sets described in *SHORT WAVE CRAFT* and the same effects achieved.

Super-Regeneration in a Short-Wave Receiver

(From *Amateur Wireless*—London, England)

● IN view of the very great theoretical efficiency of the super-regenerative system on wavelengths of the order of 15 to

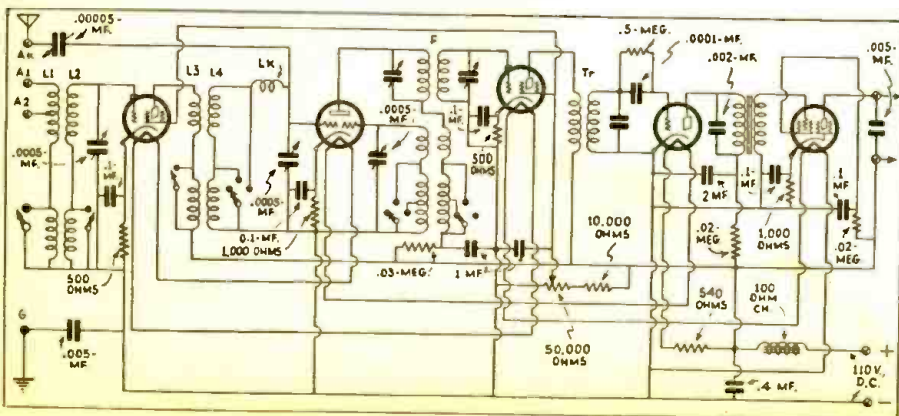

Diagram of D.C. "All-Wave" receiver

'Em In On Two "2-Volt" Tubes

tain 2 volts on the filament constantly. If the voltage is increased over the normal operating of 2 volts, the life of the tube is reduced proportionately. For long life and maximum sensitivity it is well to be sure that no more than 2 volts is applied to the filaments of these tubes.

Quiet Dial a Great Help.

An additional post is furnished on the antenna ground strip so that changes can be made in the antenna connections and various types of input employed for the maximum signal strength. Several connections can be made if the chassis of the receiver is not grounded. (See Fig. 3.) As high gain coils are used with the tuning condenser having a fairly large capacity, .00015 mf., it is necessary that a reasonable tuning ratio be employed so that satisfactory tuning control can be obtained. The tuning condenser tunes by means of a very ingenious tuning dial, giving a very satisfactory ratio of dial movement, and has the added distinct advantage of being very quiet in operation. Most dials used on short wave receivers become extremely noisy below 20 or 30 meters, especially when the gain due to regeneration is pushed up to receive very weak signals. The dial used in this receiver is very quiet in operation.

Due to the high gain of the screen grid type tube, satisfactory operation, inasmuch as sensitivity is concerned, can be obtained, and all of the important stations in the principal countries of Europe and South America, have been heard with regularity, depending on atmospheric conditions. Even under the conditions of very high back-ground noise, the signal strength ratio is satisfactory enough with this receiver so that the programs are understandable, which speaks well for the receiver.

The Chassis

The chassis for the receiver comes already drilled with the sockets mounted in place. These sockets are held in place with rivets so that there will be no danger of loosening at some future time.

The tuning condenser is equipped with stay bolts that are slipped into the holes provided for them in the chassis. Before mounting the panel on the chassis it is important that the small drive unit of the tuning dial be inserted into place, as it will be impossible to put this on after the panel is bolted to the chassis. After fastening the small tuning drive unit into place mount the panel to the chassis by means of the two small 6/32 round-head screws which are furnished with the kit; then mount the 75,000 ohm regeneration control on the right-hand side of the front

This receiver, the "Air-Rover," represents one of the very latest developments in economical, low-cost S-W receivers designed by the well-known expert, Mr. Denton. This receiver has been given the "third degree" and has proved its ability to bring in the "Europeans" as well as other far-distant short-wave stations. The editors have been deluged with letters asking for more 2-volt tube receivers —well, boys, "here's how!"

panel, and mount the rheostat on the left-hand side. Make sure that all parts are mounted securely. Mount the output terminal strip on the rear, as well as the antenna-ground (Continued on page 185)

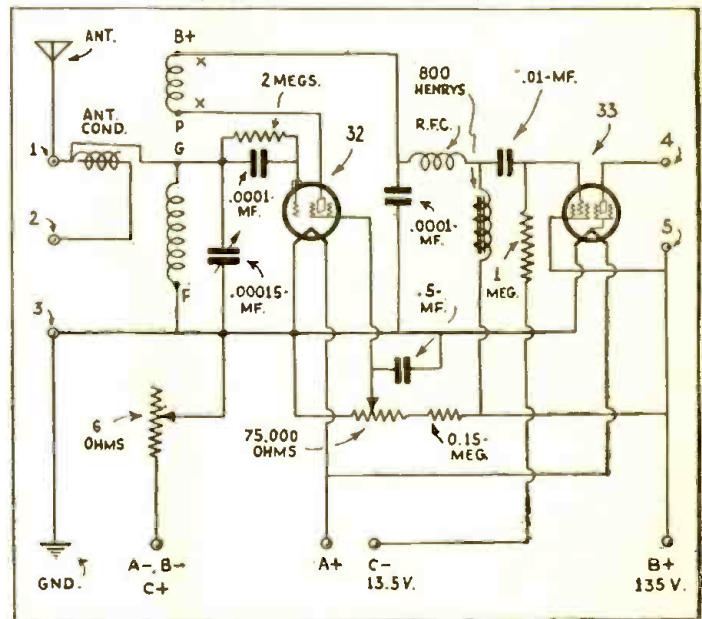

Wiring diagram which you can easily follow, even though you are a beginner.

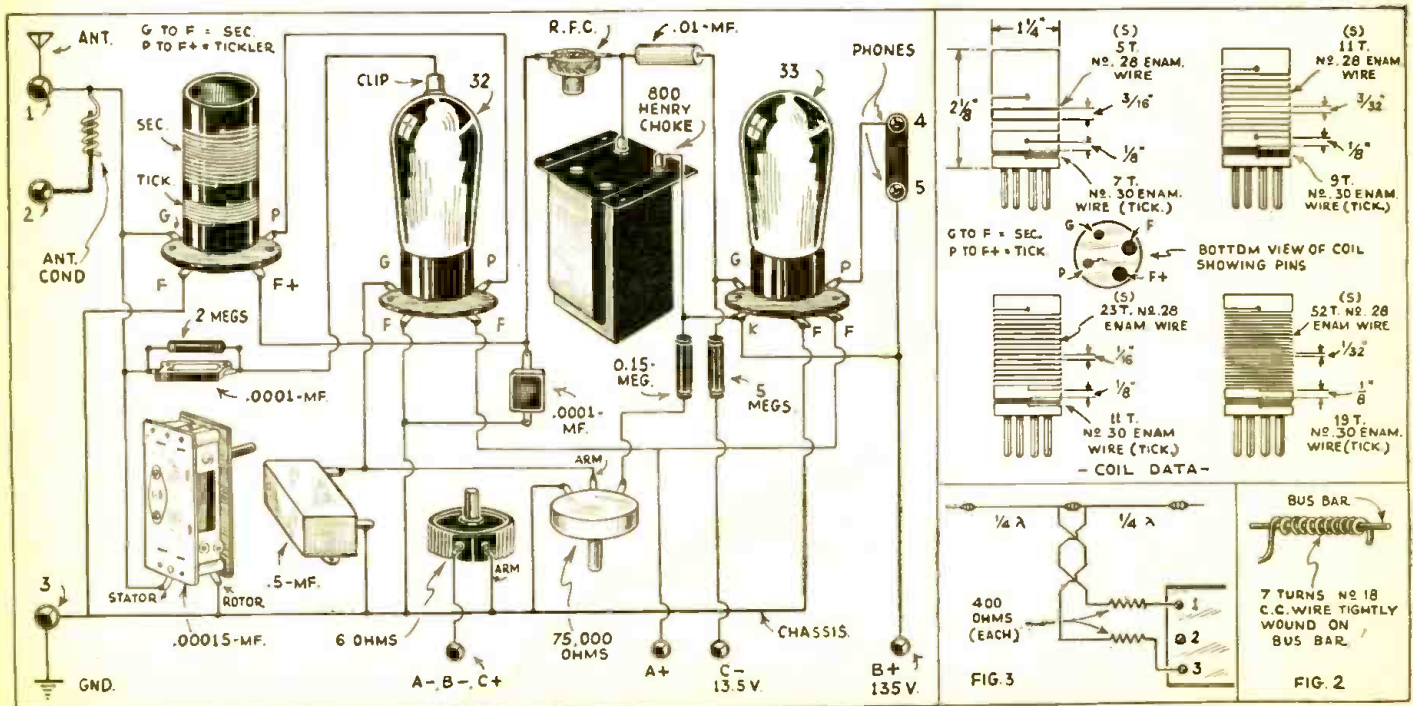

Perhaps you would rather follow the "picture" wiring diagram, when you start building the "Air-Rover" 2-tube short-wave receiver here described by Mr. Denton.

"AIR-ROVER" Hauls

By CLIFFORD E. DENTON*

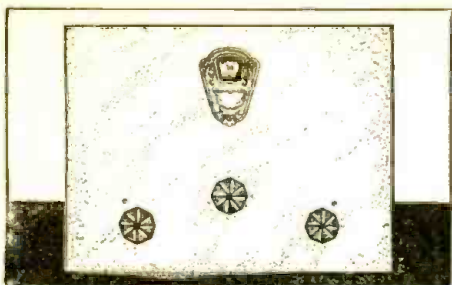

Front - panel appearance of the new "Air-Rover" short-wave receiver, designed by Mr. Denton, and which is not only of extremely low "first-cost," but it is also unusually economical in "operating cost."

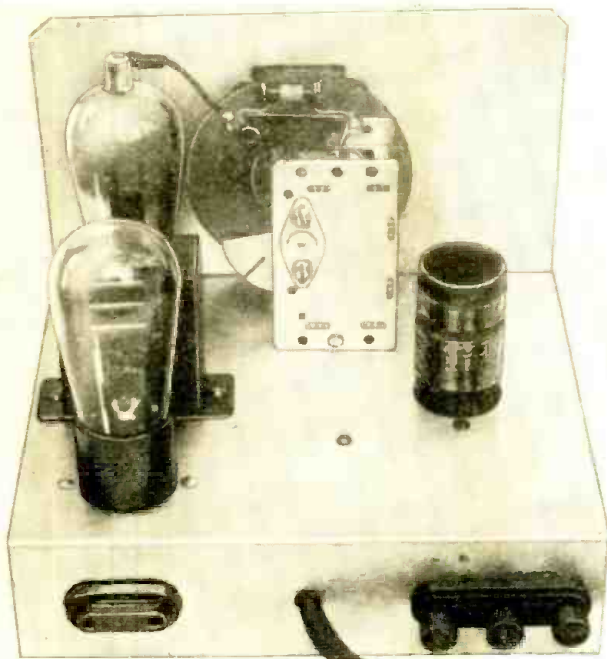

Rear view of the Air-Rover short-wave receiver.

© THE popularity of the two-tube short-wave receiver, especially with those who like to put their own sets together, has been so great that this interesting receiver has been developed in kit form for people who have not had the opportunity of testing and obtaining for themselves the remarkable results which can be obtained on two tubes at the higher radio frequencies.

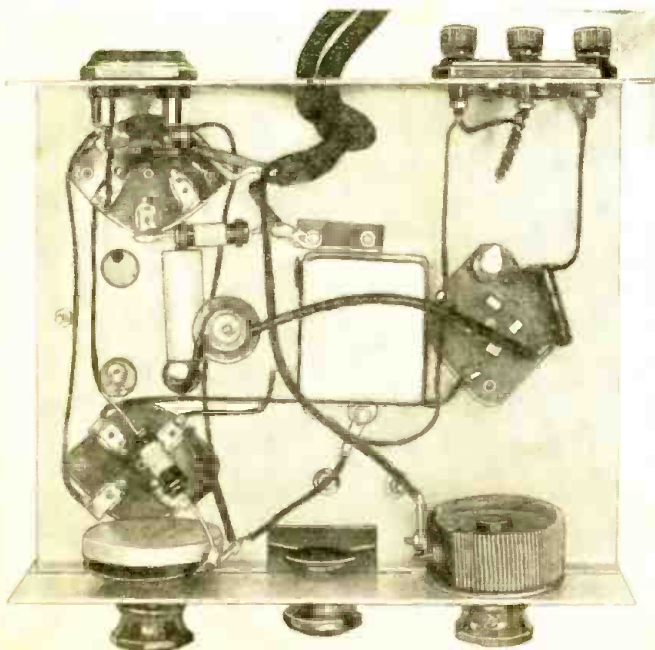

A view from "down under" the Air-Rover, showing the neat arrangement of the relatively few parts needed to build it.

The tubes used in this receiver are the so-called high gain screen grid and pentode types. In the detector socket the 32 is used; this is a two-volt screen grid tube, which is well liked by short wave fans for sensitivity. The 33 is used as a high gain audio power tube.

Circuit Used.

The circuit of the Air-Rover is similar to countless other short wave receivers and represents the type of circuit which has met with the approval of short wave fans for years. Several refinements, both mechanical and electrical, enable the builder to obtain the maximum gain from each of the tubes with a minimum of associated parts. The "B" supply maximum should be 135 volts, although very satisfactory operation can be obtained with 90 volts. The filaments are supplied from two No. 6 dry cells, and these when used with the 32 and 33 type tubes are very economical in operation. Of course, if the set-builder has one of the air cell batteries, the low current rate of this set will give year-round operation without having to bother about the "A" supply at all.

It is necessary to use a "C" battery in the grid circuit of the 33 pentode output tube, and this is normally 13½ volts. Some constructors use two 7½ volt C batteries in series, and others take the nearest voltage tap to 13½ that they can obtain on the standard block size 22½ volt "B" battery.

A pair of high impedance phones is an advantage with the pentode, although the maximum results will be obtained with a coupling transformer designed to match the 33 type tube.

Conventional Feed-Back Used.

The circuit of the Air-Rover is very simple. A small antenna coupling condenser conducts the incoming energy to the tuned circuit, which is made up of the plug-in coil and the .00015 mf. tuning condenser. Grid-leak and condenser detection is used and the grid return of the 32 detector is connected to the negative end of the filament. The conventional feed-back coil is in the plate circuit and R.F. energy is prevented from getting into the audio section by means of the R.F. choke and the .0001 mf. mica by-pass condenser.

Regeneration is controlled by means of the 75,000 ohm potentiometer connected between the negative end of the filament of the 32 detector and the 150,000 ohm series resistor which runs to the maximum plate voltage. Any R.F. energy in this circuit is carried away from the batteries and potentiometer by means of the ½ mf. by-pass condenser connected between the middle arm of the potentiometer and the ground.

How Smooth Regen. Control is Achieved.

Smooth control of regeneration is obtained by means of this method and has the added advantage of minimizing the detuning of the tuned circuit. The critical point or the maintenance of smooth regeneration can be best obtained by variation of the grid leak which in most cases seems to be most satisfactory when a 2 megohm value is used with this receiver, and variations of the capacity of the antenna series condenser. Of course, the variations in capacity of antenna series condenser is dependent on the antenna used, which should be carefully adjusted for the smoothest operation and the greatest signal gain in the earphones or speaker.

This set has been designed for use with earphones, but due to the use of the high gain tubes, very satisfactory loud speaker results have been obtained.

800 Henry A.F. Choke Helps "Gain"

The maximum gain is obtained from the 32 type detector by means of the specially wound 800 henry inductance, which makes up the plate load of the detector tube. A .01 mf. coupling condenser and a 1 meg. grid resistor completes the coupling arrangements between the detector and the 33 pentode.

Critical control of the filament voltage is provided by means of a 6 ohm rheostat. Successful operation of the 2 volt tubes depends on the ability of the operator to main-

*Chief Engineer, Federated Purchaser, Inc.

R. F. Chokes - How to Make Them

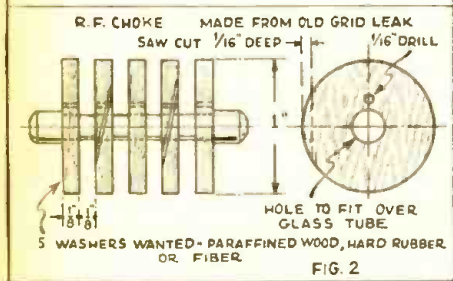
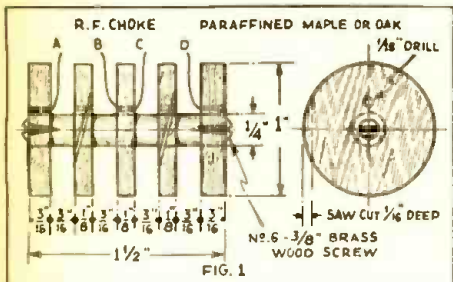

It is a simple matter to make forms on which to wind R.F. chokes by following the ideas given above.

● R.F. CHOKES of various inductances are now used in practically every lead from the power-pack and the experimenter needs a cheap and handy method of substitution of these values in his trial hook-ups.

One method published some time ago, provided for mounting the R.F. choke in the base of a burned out tube, which allowed the unit to be plugged into a socket. This socket is made for four or five prongs, but only two are required for our R.F. choke.

and the socket takes up a space on the subpanel approximately 2"x2" or four square inches, whereas a sturdy grid-leak mounting, such as shown in Fig. 3, only requires 1 3/8 square inches of "floor space."

In Fig. 1, is shown a wooden form turned from an old broom-handle or chair-leg. These are made up in lots of six to twelve. Well seasoned wood is used and these are boiled in melted paraffin wax for about an hour to remove the moisture. After drying, drill about a 1/16" hole lengthwise through the partitions as shown. Use an awl or the same 1/16" drill to make a hole about 3/8" deep in the middle of each end and insert the No. 6x3/8" round-head, brass wood-screws. Pass the wire A through the hole in the end partition and either solder it to a washer under the screw head or directly to the screw head and "jumble" (i. e. irregularly; not in even layers) wind the required number of turns of wire in the left-hand slot. Do the same in the right-hand slot with the wire D. Note about what length of wire is used to wind one slot and draw a little more than that length through the hole in the center partition (wire B-C). Now wind these slots one at a time, in the same direction, (which can be readily done) with the required number of turns. It is important, of course, that all the sections be wound in the same direction. You can start either clockwise or counter clockwise, but maintain whichever direction you start with.

Next a hack-saw cut about 1/16" deep is made in partitions two and four and the end of the coil B is laid in one

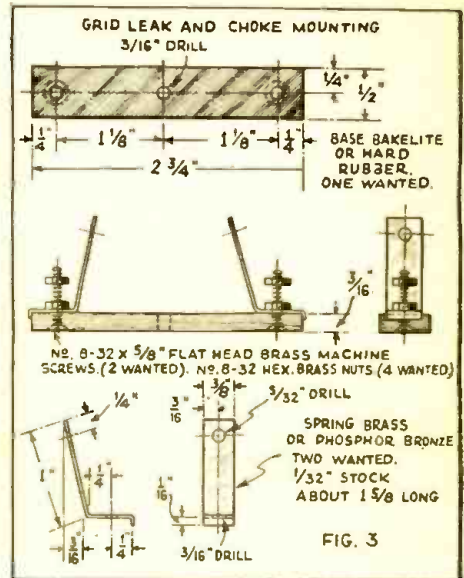

Simple spring mountings for R.F. chokes are here illustrated.

slot and C in the other slot. The ends of coils A and B are cleaned, twisted together and soldered and the same is done to C and D. And there you are. You have a handy, substantial and interchangeable R.F. choke. The size of the wire is not critical. No. 28 is a convenient and readily obtainable size. Nos. 30 and 32 are also good.

Fig. 2 supplies a use for some of your old grid-leaks. The manufacturers evidently used a low-melting solder (Continued on page 180)

How to Multiply Voltmeter Range

● ONE of the most popular and widely used measuring instruments in the hands of short wave fans and experimenters is the Weston Model 489 high resistance voltmeter, with scales read-

ing 0-50 and 0-250 volts. Thousands of these meters must have been sold a few years ago when the "B" eliminator came into use and a high resistance voltmeter became necessary for dependable measurement of plate voltage.

At that time plate voltages rarely exceeded 180 volts, so the meter was perfectly adequate. Today, however, values run much higher. The "fan" who is just getting into the interesting transmitting game especially feels the need for a higher range instrument.

Fortunately, the Model 489 lends itself very conveniently to the use of standard, easily obtainable multiplier resistors. The writer fixed up his own meter on a little bakelite panel measuring 4 1/2 x 6 inches, with five tip-jacks, and mounted it in a little wooden box for the protection of the resistors. The latter are two International Resistor Company precision wire-wound units, one of 250,000 ohms, for doubling the 250-volt scale reading, and the other of 750,000 ohms, for quadrupling the readings. The values just happen to work out to these even figures, which is something of a blessing.

For making connections between the meter and power-packs, transmitters, etc., a pair of Radio Trading Company test prods is used. These have phone tips on one end, for insertion in the tip jacks on the meter box, and long, insulated handles at the other. The handles are fitted with tiny chucks that

hold phonograph needles. The extremely sharp points on the latter will pierce the insulation of ordinary wire without leaving a permanent hole, and are therefore very valuable in taking readings along a circuit without scraping away a lot of rubber.

The resistors themselves are supported under the bakelite panel by simple "L"-shaped brackets. The details of the assembly and wiring are very clear in the illustrations and diagram.—Robert Hertzberg.

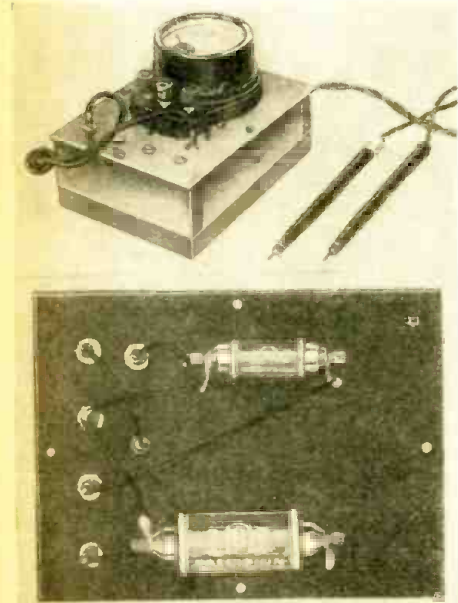

Handy test voltmeter and prods; lower photo shows bottom view of the voltmeter as "revamped" with additional resistors to multiply range.

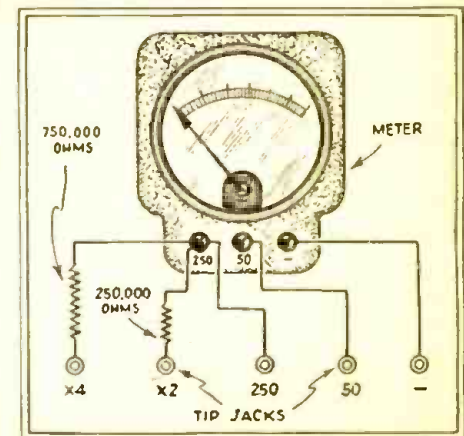

How two resistors are added to the voltmeter as explained in the text, in order to multiply the range of voltages which can be read with it.

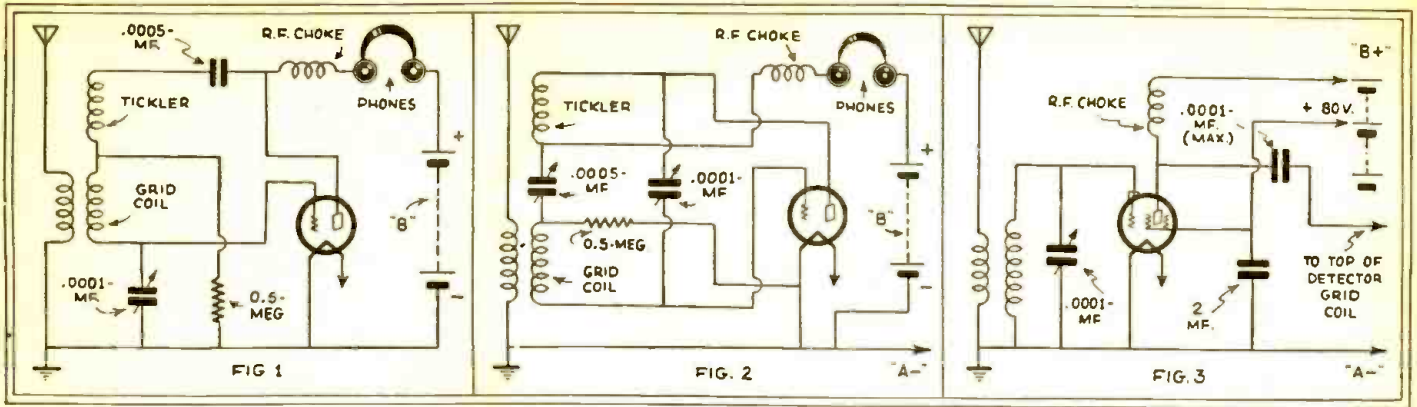

Fig. 1—It is a cross between an Ultraudion and a Colpitts—but it oscillates right down to 5 meters with great gusto!

Fig. 2—Both sides of the tuning condenser are “live.” But you must remember that it is a “lively” circuit!

Fig. 3—You should certainly have a “go” at this S.G. circuit. It has virtually no damping effect on the detector following it.

3 Unusual Short-Wave Hook-Ups

● THE three very interesting regenerative circuits shown herewith will undoubtedly be tried by hundreds of short-wave “fans,” if they have not already tried these or similar hook-ups. They are recommended in an article which appeared in an English magazine, and one of the circuits at least is claimed to oscillate with great gusto down to five meters!

Figure 1 shows a circuit of the “mongrel” class that the writer of the article in question has always found to work very well from the start. It is a cross between the two circuits known as the “ultraudion” and the “Colpitts,” and although it looks at first sight as if it shouldn’t work at all, the ease with which it may be made to oscillate, right down to 5 meters and below, is surprising.

Readers will note that there is no grid condenser and that the grid-leak is taken from the bottom end (although in the diagram it looks like the top end!) of the grid coil.

When the author first made the 5-

meter receiver which was exhibited at the *Olympia* Radio Show, he used the normal regeneration circuit and had difficulty in making it oscillate smoothly. The mere removal of the grid condenser and inclusion of the leak in the position shown put matters right at once.

Figure 2 shows the proper “Balanced Colpitts” circuit. The only disadvantage here is that both sides of the tuning condenser are “live.” *Hand capacity* effects are, therefore, troublesome unless we either mount the condenser back from the panel and “remote-control” it, or use a double condenser and ground the center point. There is no need for a separate diagram of that—a series gap condenser with one set of fixed plates going to the plate, the other to the grid, and a soldered earth connection on the moving plates, will do the job beautifully.

Don’t be frightened by the rather strange appearance of the circuit. It is very straight-forward really, but it happens to “draw” in rather a queer

way. The layout can be made simply beautiful by mounting the detector tube socket immediately behind the tuning condenser. The .0005 mf. fixed condenser that “splits” the tuning coil may be used as a support for the two “middles” of the winding. Control of regeneration in both circuits is effected by varying the plate voltage by the inclusion of a variable resistance in the “B” plus lead.

The “outers” go to plate and grid, the tuning condenser across the whole thing, and the only remaining connections are the grid-leak—on to one side of the fixed .0005 mf.—and the R.F. choke—on the other side of the same component.

This nice, symmetrical layout is doubtless the reason for the successful working of this circuit on 5 meters, where every centimeter of excess wiring become a serious matter.

There are other detector circuits in use, but most of them, when carefully redrawn and analyzed, resolve them-

(Continued on page 177)

This S-W Receiver Suits Me!

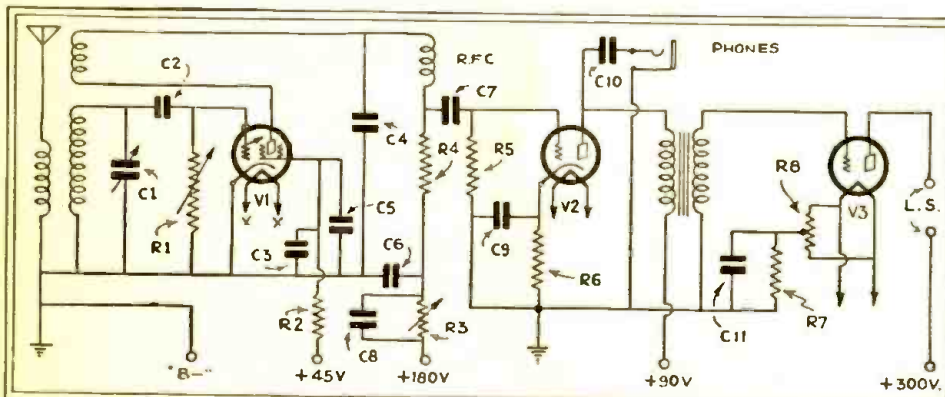

A simple and effective 3-tube short-wave receiver circuit suggested by Mr. W. P. Tucker, Jr.

● AM enclosing herewith a sketch of a short-wave receiver that has been highly satisfactory.

You will no doubt recognize it as a combination of a set by Ed. Palguta of Youngstown that was printed in the October, 1931, issue of *RADIO-CRAFT*, and one by Robert Hertzberg in the Feb.-Mar., 1932, issue of *SHORT WAVE CRAFT*.

Truly, I have logged no foreign stations as yet, since I am mostly interested in the “ham” bands, where at present the receiver is working better than anything I have tried.

In the afternoon I can tune W9BHM, Ft. Wayne, Indiana, with room volume on the loudspeaker. W4’s-2’s-1’s plus 3’s in the order named are in evidence

everywhere, and 3XAL sounds like WJAS (about two miles away).

I put the set in a 6x7x10 aluminum case and had to sub-panel it on account lack of space, but got no ill effects as I had heard I would.

For a power unit I used the diagram that Mr. Hertzberg suggested in *SHORT WAVE CRAFT*; I only added ½ mf. condensers (2) in series with center grounded across the 2½ filament winding. There is very little hum.

My coils are wound on Pilot coil forms, as per the specifications of the Pilot company.

List of Parts

- C1—.00014 variable condenser.
- C2—.0001 mica condenser.
- C3—.02 mica condenser.
- C4—.002 mica condenser.
- C5—.5 by pass condenser.
- C6—.5 by pass condenser.
- C9—.5 by pass condenser.
- C10—.5 by pass condenser.
- C11—.5 by pass condenser.
- C7—.01 condenser (in Pilot 500 Resisto Block).
- C8—1.0 by pass.

(Continued on page 174)

Bands Over Tuning Dial

By **GEORGE W. SHUART,**
W2AMN-W2CBC

thread or wire of the proper thickness for the coils having a large number of turns. Of course the ones with fewer turns can be spaced by hand quite easily. National six-prong coil forms are used for both the detector and oscillator coils. All six prongs are used in the case of the detector coil, but only three are needed for the oscillator winding.

verters found on the market today. The high-frequency coil is designed to place the 20 meter amateur band on the low capacity end of the tuning scale, resulting in a spread of more than 18 degrees!

"Band-Spreading" Achieved at Last!

Although no direct band-spreading method is incorporated in this converter, an effort was made to arrange the capacities and inductances of the different circuits, together with the 270 degree tuning range of the National condenser, to present a "happy medium." This is best shown by the fact that the 80 meter phone band is spread over 10 degrees of the dial, the entire 80 meter phone and C.W. band having a 35 degree spread! The 40 meter amateur band has a spread of 25 degrees compared with the usual 5 degrees on ordinary short-wave con-

verting the converter to work is not an easy job and requires quite a bit of patience. If a 465 kc. I.F. transformer is used as the output-filter of the converter, the tuning condensers of this unit should be
(Continued on page 177)

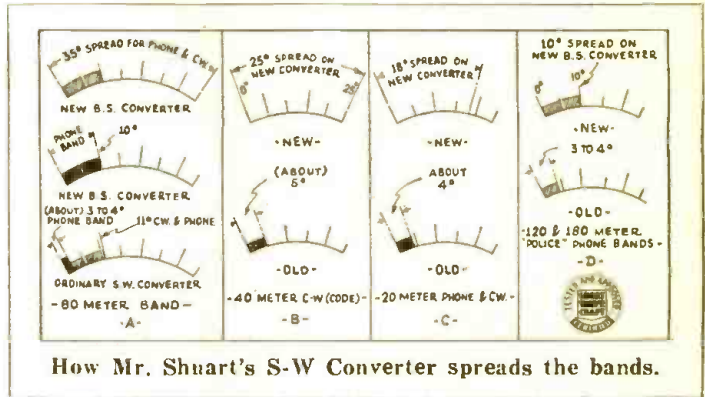

How Mr. Shuart's S-W Converter spreads the bands.

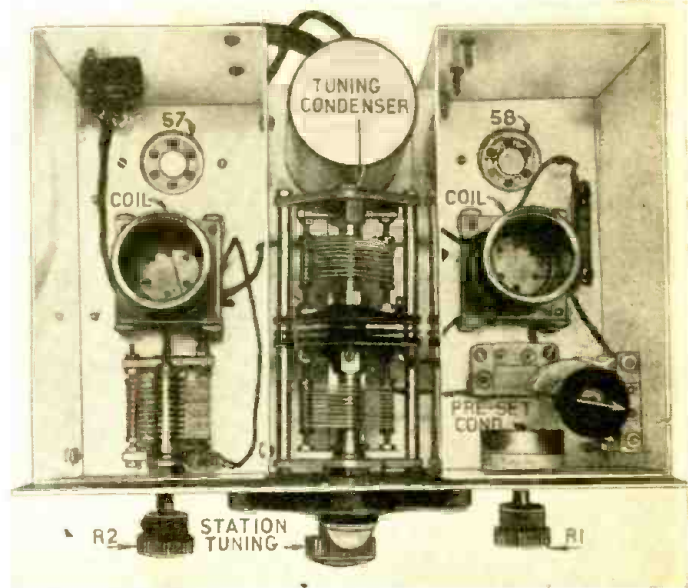

Top view of the "band-spreading" S-W converter here described in detail. This converter may be used with any "broadcast" receiver for tuning in the S-W stations. Next month we will describe super-het "I.F." second-detector, and "A.F." stage unit to work with it.

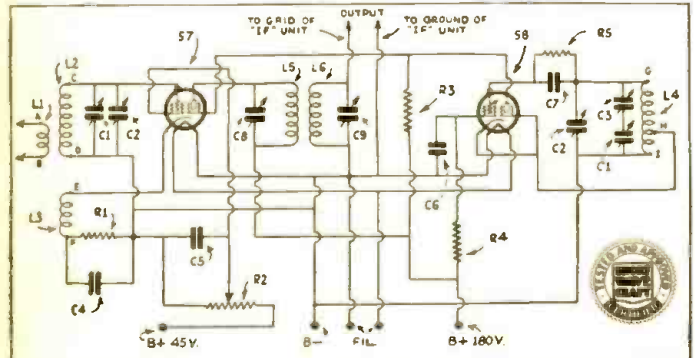

Schematic wiring diagram for the "Band-Spreading" S.W Converter.

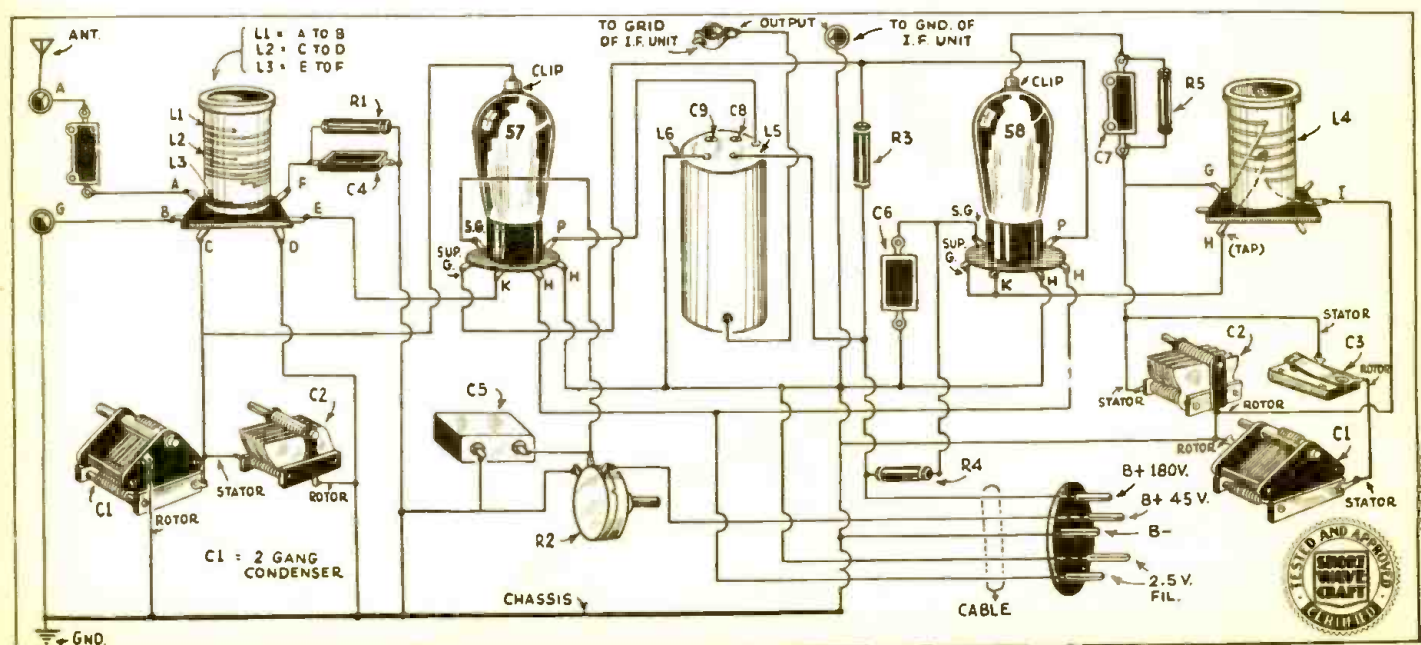

Picture wiring diagram which can be easily followed by those not so well advanced in short-wave mechanics. The various parts should be placed in shielded compartments, in the manner shown in the photos.



This Converter Spreads

PART ONE

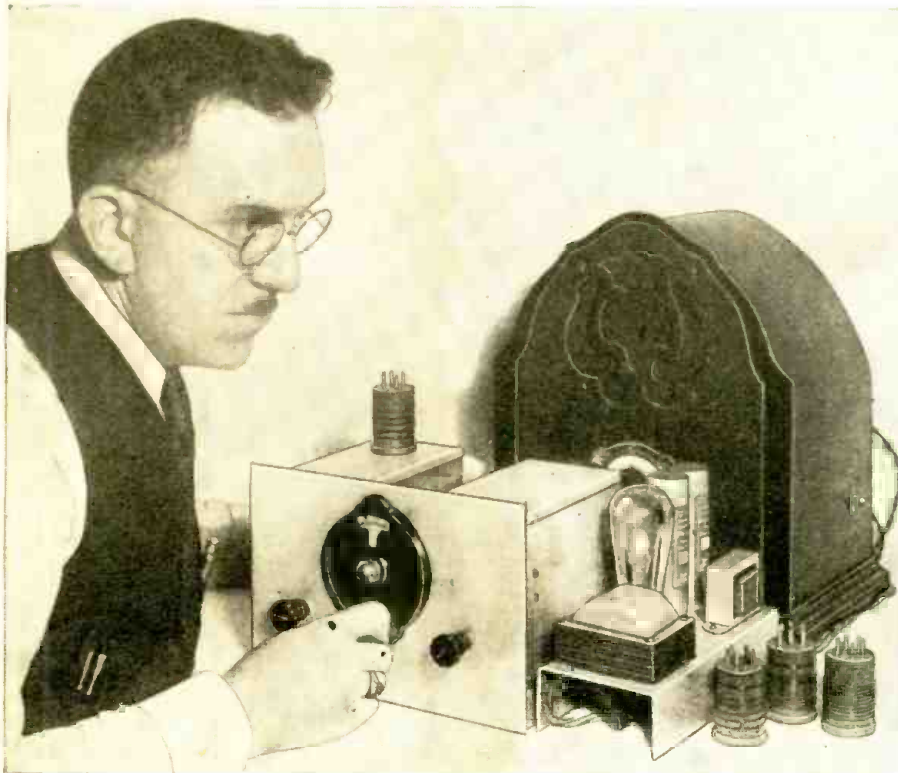

The ideal short-wave converter, to provide easy and selective tuning, should provide band-spreading so that the stations in the crowded bands such as the 80 meter phone can be weeded out when desired. Mr. Shuart's "Band-Spreading" S-W converter is shown connected to a small "broadcast" receiver. Yep! You hear 'em on the speaker!

● THE short-wave converter about to be described in the following pages is the result of much experimenting. The requirements were comfortable tuning, simplicity, compactness, high sensitivity, high selectivity and nominal cost. In order to obtain simplicity, only two tubes were used. This required some method of bringing up the sensitivity and selectivity; the first thought naturally was toward *regeneration*, as it has always been.

The coil used for *feed-back* is connected in the cathode of the circuit of the detector, leaving the plate circuit free to be tuned to the intermediate frequency. Tuning the plate circuit in this manner adds considerably to the gain and selectivity of the converter. Where other converters use capacitive coupling to the antenna binding post of the broadcast receiver, this one uses a regular I.F. (intermediate frequency) transformer for the purpose, the primary being connected in the plate circuit of the detector and the secondary forming the grid coil of the broad-

cast receiver. The way this is done is to remove the grid clip on the first R.F. tube of the broadcast set and attach the lead on the converter marked "grid output" in its place, the ground lead in the output circuit going to the chassis or ground post. In B.C. receivers having an untuned stage of R.F. this is an extreme advantage, as it makes a tuned unit out of it, increasing its selectivity and efficiency to a considerable degree.

The grid coil of the first detector is

Mr. Shuart has solved the problem of spreading the various short wave bands over the tuning dial of a converter—the problem that has baffled set-builders the country over. The short-wave converter has had many good points to commend it, but the average converter tunes the higher frequency bands so sharply that it is frequently almost impossible to select a certain station out of the half-dozen or more heard. What was sorely needed was some method of spreading over the dial such bands as the 80 meter phone, so that one would have a chance to select any one of the several stations that might be heard at a given time in that particular region. This, the author has succeeded in accomplishing by means of the circuit here described in full detail. You'll be "tickled pink" with the performance of the converter here described, with its power supply unit; in the next issue an I.F., second detector and A.F. stage will be described, thus providing a complete S-W "superheterodyne" receiver. The S-W converter here described will bring in the short-wave stations on your regular broadcast receiver, on the loud speaker—and with unimaginable tuning comfort.

spaced in order that the antenna coil may be wound in between its turns. This manner of coupling is used because it allows a high degree of coupling with few antenna turns, giving little loading effect, which is a benefit when regeneration is used.

The regeneration coil is wound at the ground end of the grid coil and spaced $\frac{3}{8}$ of an inch from it. All coil data are contained in the coil table. It will be found, if the dimensions of the coils are followed carefully, that the first detector will not oscillate on any bands except the two lower frequency bands, slight feed-back being all that is required. The feed-back and volume can be controlled with the potentiometer controlling the screen-grid voltage of the detector tube. Be sure to put the cathode bias resistor on the ground side of the tickler coil and *not between the cathode and the tickler*. The oscillator circuit is of the *electron-coupled* type and is very stable in operation.

Plate voltage is fed to the oscillator tube through a 5,000 ohm resistor; this enables the plate to be coupled directly to the suppressor grid of the detector tube, which is a very efficient means of coupling. The oscillator tunes 550 kc. higher in frequency than the detector, which is known as the *high-beat*. This requires some means of slowing up the tuning of the oscillator in order to get it to track with the detector for single dial tuning. This is done by using a .001 mf. condenser in series with the oscillator tuning condenser; a Hammarlund variable padding condenser is used for this purpose. The variable condenser "C2" in the oscillator circuit is mounted inside the shield compartment, and need only be adjusted once, as it is used only to obtain enough capacity to give stability in the electron-coupled circuit of the oscillator. The potentiometer R2 is mounted in the oscillator compartment to give a well-balanced appearance to the panel. C2 of the detector stage is mounted in the same position, in the detector compartment, with C1, the two-gang tuning condenser mounted between the two compartments.

No further directions as to layout will be given. The photographs give a general idea of how the different parts can be mounted. The output filter can be seen between the two shields, directly behind the main tuning condenser.

Making the coils for this set is quite a task and it may well be stated here that unless the directions are followed carefully the two tuned circuits will not track. The best way to space the different windings as shown in the coil table is to use string,

HIGH" Band-Spread 3

Uses three A.C. tubes, two 58's and one 56—spreads stations over dial—brings in "Foreigns"—No interlocking—Electron-coupled detector—High-C tuning circuits for greater stability—Latest tubes and provision for "doublet antenna"—No interference to other S-W receivers due to detector oscillation—Nominal cost and easy to build.

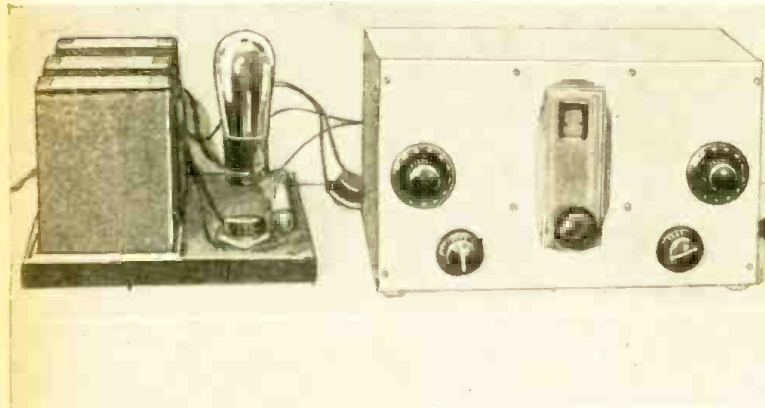

Mr. McEntee's 3-tube, band-spread S-W receiver was tested by the editors and found to be AA1. Plug-in coils are used and the winding data for making these coils as developed by Mr. McEntee is given in the text. A plate power-supply unit is shown at the left of the receiver.

changed or the band setting condenser of the detector is changed and assures that the two R.F. circuits are in good alignment.

Due to the high-C circuits and the special detector circuit, oscillation will be found very stable. A good "B" supply is absolutely essential. The writer uses an old Majestic Super-"B" unit which is very good and absolutely

humless. Any voltage up to 250 can be used with better sensitivity on the high voltages. However, 180 volts gives very fine results.

Foreign Countries Heard

This set has been in direct comparison tests with several other short wave sets, including one very well-known commercial "ham" set, and out-per-

formed them all, principally in steadiness of oscillation, so anyone who constructs it will be assured of a set which gives about the maximum possible results from a T.R.F. set with the number of tubes used. On short-wave amateur work, about 26 countries have been heard in about a month, including Australia, Chile, Spain, and Sweden.
(Continued on page 174)

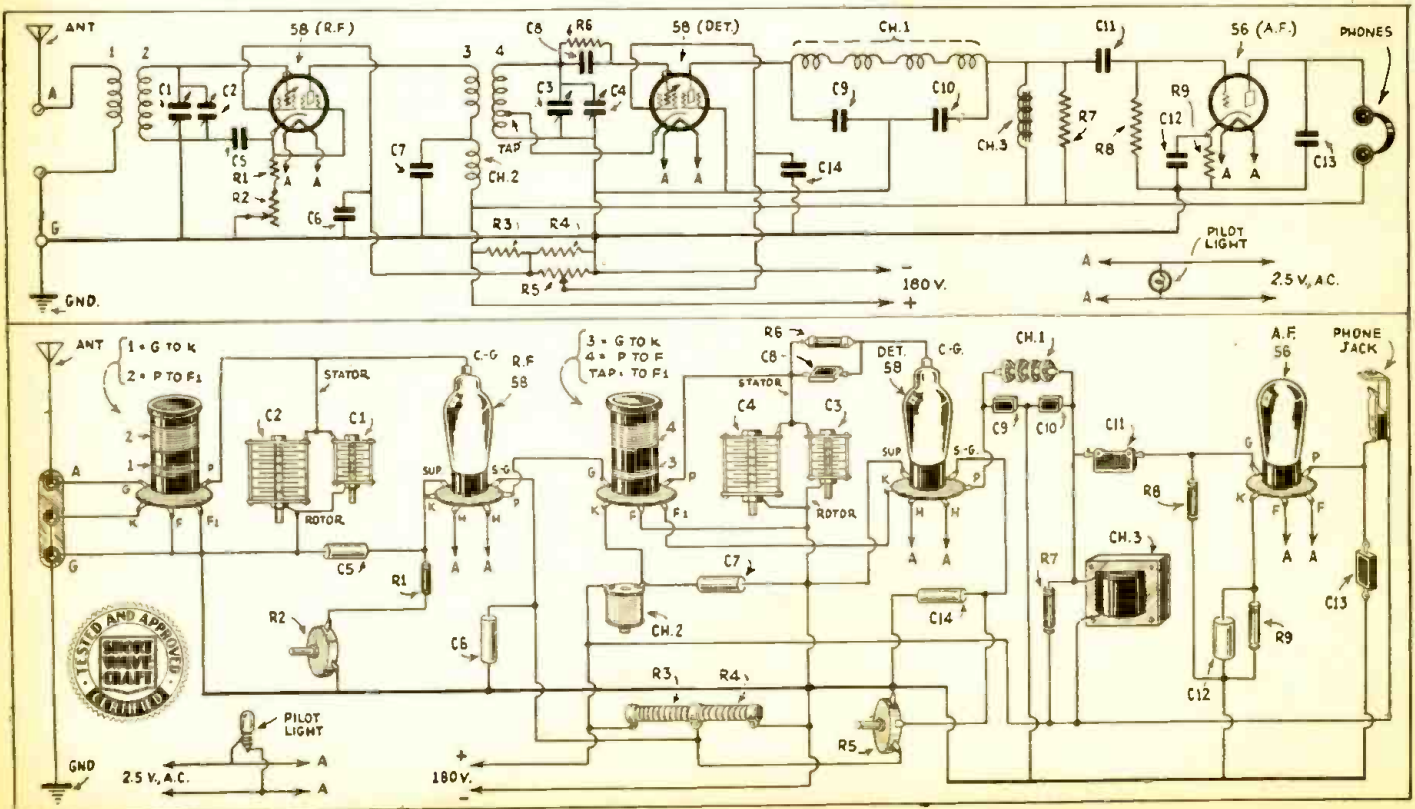

Physical as well as schematic wiring diagrams for the McEntee "Ace High" 3-tube, band-spread set are given above.

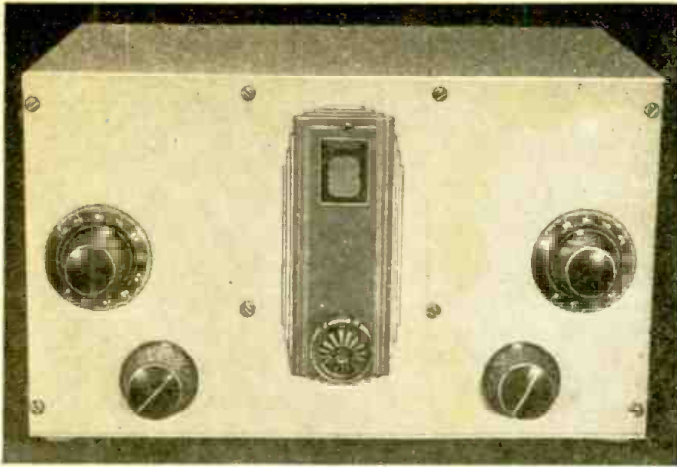

The handsome appearance of Mr. McEntee's 3-Tube "Ace High" Band-Spread receiver, which was finished in gray Duco with the dial painted with green Duco, cannot be appreciated from a mere photograph—and the set "worked" as well as it "looked."

● THE set here illustrated was designed primarily for the shorter wave bands—below 80 meters. It will work very efficiently, however, all the way up to and even through the broadcast band. Due to the type of coupling used between the detector and audio tubes, the tone quality on phone is very fine.

The other features may be listed as follows:

1. Electron coupled detector.
2. High-C tuning circuits for greater stability.
3. Ease of band-spreading and setting, due to use of parallel tuning method.
4. Provision for "doublet" antenna connection.
5. Latest type tubes.
6. Voltage divider in set, so only four leads needed for power supply.
7. No interlocking.

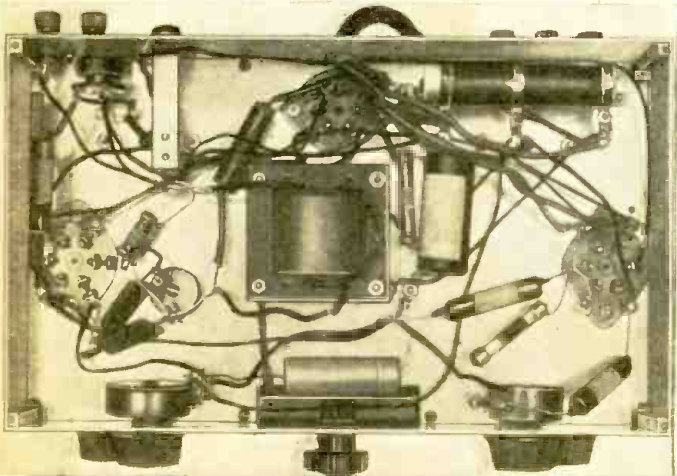
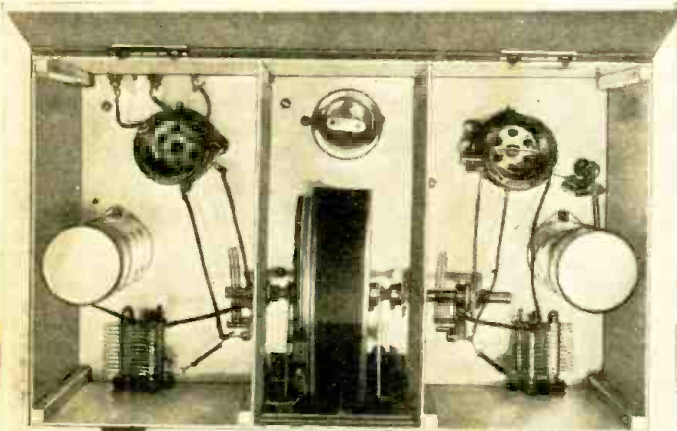

Above, we have top and bottom views of the McEntee 3-tube band-spread receiver, ideally suited for "CW" or "phone" reception, as demanded by the experienced "Ham" or also for general short-wave broadcast reception.



The "ACE"

By HOWARD G. McENTEE

8. No interference to other S.W. sets from detector oscillation.

Incidentally, the set was designed and has been used almost exclusively on the 20 and 40 meter ham bands. It has been tested on all the bands, however, and on police calls, airplane stations and all general short-wave work and has been found very satisfactory.

If the set is to be used for short-wave broadcast work exclusively, the main tuning condensers should be made larger, a range of 50 to 75 mmf. being satisfactory. This will give easier tuning, since the condensers in the set were made very small in order to spread the 20 meter "ham" band over a large section of scale. No other changes in coils or spreading condensers are necessary. Also for short-wave broadcast use a power pentode such as 47, 59, or 2A5 could be used in place of the 56 audio tube to give powerful speaker operation. The 56, however, will give surprisingly loud signals, due to the high gain in the R.F. section of the set.

Making Aluminum Cabinet

The first thing in assembling the set is to make the aluminum cabinet. Unless you have access to a number of power tools, it is advisable to buy the aluminum all ready cut. This doesn't add much to its cost and makes the job a hundred times easier as well as insuring a fine looking case. The corner posts of this particular set are of dural, but brass is easier to work and a bit cheaper. An electric drill is the only power tool necessary in the construction and is a big help since there are some fifty holes in the corner posts alone. All pieces are held together with 6/32 round head screws, the ¼ inch size being the best.

First fasten the front, back and sides together. Then fit in the sub-panel and next the shield partitions; the top and bottom come last. The bottom should have four rubber feet on it, while the top is held on by two one-inch brass hinges.

Painting Aluminum

After the case is all fitted properly, mark all pieces and corner posts so you will know how to put them together correctly. Then disassemble and paint the pieces with a single coat of French Gray Lacquer. This is very light gray and gives a beautiful appearance, effectively covering all scratches and other marks on the aluminum.

Before painting, however, the various holes on the front panel should be cut. Also cut the rear piece for phone jack, power cable and three post aerial and ground terminal block.

While the paint is drying, the subpanel may be cut and drilled for the sockets, etc. There will also have to be a cut out for the drum dial. The coil sockets are raised on bakelite posts ⅜" diameter and ¾" high.

The small tuning condensers used in this particular set are old Hammarlunds and are no longer available. In another set just like this one, Pilot condensers were used throughout and are entirely satisfactory. When making the final set assembly, mount all sockets and variable condensers in place and assemble the cabinet, but leave the back and bottom off. Wire up the tuning section above the sub-panel, first making all connections as short as possible. Then put the back in place and complete the wiring. All connections which go to common ground, such as on the side of the tuning condensers, etc., should be wire connected to ground, as the aluminum provides a very uncertain R.F. contact. *This is very important!*

Testing and Operating

We now come to the testing and operating procedure. The table given in this article shows the approximate settings of spreading condensers as well as winding data for the coils. There is considerable overlap so that a complete wave coverage is afforded. The 160 meter band coil goes quite a way into the broadcast band, so it makes a good one to try the set on. Set the band setting condenser for the detector at about the value recommended on the table. Then, with the regeneration control set so that the detector just oscillates and with the volume control at maximum, turn the R.F. band setting until an increase in background noise is heard. Sometimes the detector stops oscillating at this point and sometimes it oscillates a bit stronger, either case necessitating a slight readjustment of the oscillation control. This procedure is followed whenever the coils are

A New 5-METER Receiver

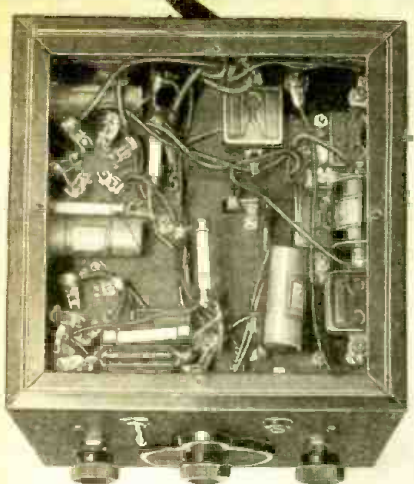

Bottom view of the new super-regenerative 5-meter receiver: coils from 40 to 75 mc. being available.

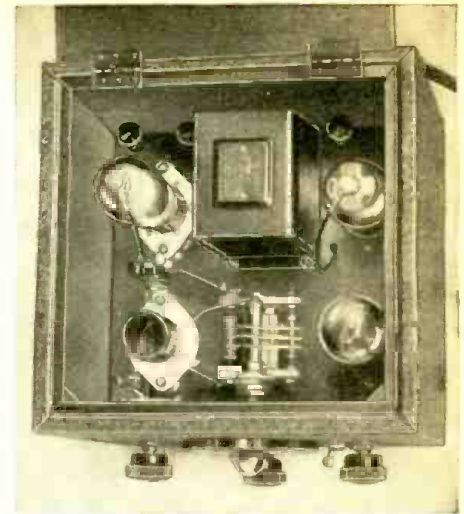

Front view of new super-regenerative receiver, coils for which are available covering all the bands.

● THERE are now hundreds of amateurs and experimenters operating daily in the amateur 56 to 60 megacycle (5 meter) band. The increasing popularity of this band has indicated the desirability of improving existing apparatus and it is with this in mind that the National Type "SRR" receiver has been developed.

The conventional 5-meter receiver, employing series tuning, while very efficient, has several shortcomings which seriously impair its overall performance. Its tuning is extremely broad, and, due to the fact that the circuit capacities are so small, long wave disturbances are apt to cause considerable interference.

Another type of interference, which almost every 5-meter experimenter has noticed, is the presence of local broadcast stations at various points on the receiver dial when a nearby 5-meter transmitter is operating. This type of interference is readily understandable to anyone familiar with superheterodyne principles. If, for instance, a 5-meter transmitter is operating at, say, 57,000 kc. and a local broadcast station has a frequency of 1000 kc., the two will beat together, producing both "sum" and "difference" frequencies, at 56,000 and 58,000 kc.

These signals will be picked up by the receiver and are often extremely bothersome when duplex work is being attempted. This interference may be eliminated only by improving the selectivity of the receiver input circuit with respect to longwave signals and to do this practically requires the use of a parallel tuned circuit. This type of circuit, if properly designed, can be made to have excellent operating characteristics in the ultra high frequency range, especially if the type of feed-back usually associated with electron-coupled oscillators is employed to secure regeneration. In many ways this is definitely superior to the more conventional series-

Here is the latest National receiver, designed for 5 meter operation on the super-regenerative principle. The set operates with 3 tubes and ordinarily employs a 36 as the detector, a 37 as the low frequency oscillator and an 89 as the output amplifier. Phone or loud speaker operation is provided for; the tuning while sharp is not over-critical, due to the careful balancing of the various electrical components in the circuit used. Also 24, 27 and a 2A5 tubes may be substituted for the 6-volt tubes. Plug-in coils are available covering the 10, 20, 40, 80, and 160 meter bands and also coils covering the range between 4 and 7½ meters.

tuned arrangement, since regeneration is practically constant throughout the range of any given coil. Another advantage of the parallel-tuned circuit is its flexibility, as it allows the use of plug-in coils to cover the lower frequency amateur bands.

A Study of the Circuit

Referring to the circuit diagram, Fig. 1, a number of rather unusual features will be noted, including those discussed above. The interruption-frequency oscillator, employing the type 37 tube, is arranged in a split Hartley circuit with the grid at ground potential. Grounding the grid in this manner produced a maximum plate swing and as the plate is connected directly to the screen-grid of the detector it, in turn, produces the maximum interruption frequency coupling.

The .001 mf. condenser connected from the screen-grid of the detector to

ground acts not only to complete the detector circuit but also to furnish the necessary tuned circuit capacity for the interruption frequency oscillator.

It may also be noted that the regeneration control is wired in such a way that the detector screen voltage and the oscillator plate voltage vary together. This gives a constant and efficient degree of superregenerative action, regardless of the operating point of the detector.

Progressing to the detector output circuit, it will be seen that impedance coupling is used. The choke coil is of special construction and has a total inductance of 700 henries. A tap is brought off at the correct point in the winding so that headphones, when plugged in the phone jack, correctly match the plate impedance of the 36 tube due to the auto-transformer action of the plate choke.

The audio volume control at the input of the 89 tube is very useful, especially if the operator desires to connect a pair of phones in the output circuit.

An interesting precautionary measure may be seen in the wiring of the phone jack. Most experimenters are familiar with the fact that if an output pentode is operated with voltage on all elements *except the plate*, the various grids almost immediately get red hot and the tube is seriously damaged. For this reason, the phone jack is so wired that when the phones are inserted, voltage is automatically applied to the plate of the 89 tube.

Installation and Operation

The type SRR is a 3-tube superregenerative receiver designed primarily for use in the amateur 56-60 megacycle band. The tubes employed are as follows:

- Detector36
- Low Frequency Oscillator37
- Output Amplifier.....89

If maximum economy of operation is desirable, as in portable (Continued on page 175)

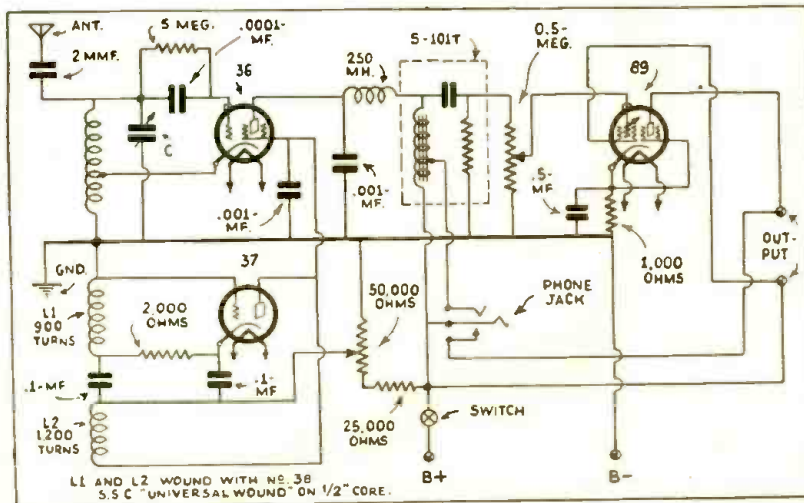

Here we have the interesting circuit diagram of the new National 5-meter super-regenerative receiver, the other popular bands being covered when desired by the use of suitable plug-in coils, including the 4 to 7½ meter band.

The 59:

A 59 type amplifier tube is one of the newer tubes which has found much favor with the designers and builders of short-wave receivers. The tube is a 2.5 volt heater type and draws two amperes. A plate voltage of about 250 is recommended and the power output is 2.5 watts, when used as a pentode. This tube requires a suitable impedance-matching output transformer.

A Triple-Grid "OUTPUT" Tube By LOUIS MARTIN

A new "hot" tube to boost your Audio output

● IT is significant that the choice of tubes for the broadcast receiver differs from that for the short-wave set. In the latter, it is imperative that the power sensitivity be high in order that maximum signal output be delivered with a minimum signal input. (Power sensitivity is the ratio of the power delivered by a tube to the signal voltage applied.) In the broadcast receiver, where plenty of pre-amplification is usually used, the power sensitivity of the output stage may be low, an additional stage of A.F. amplification compensating for the decreased sensitivity of the tube.

The radio industry was first introduced to the triode class "A" amplifier, which has served a long and useful purpose—and still does, in the opinion of the writer. It was then afflicted with the class "A" pentode amplifier, and is now paralyzed with the triode class "B" units. Each of these classes has meritorious features of its own, and so, in order that the design engineer have all three in a single "bottle," the type 59 tube was introduced some time ago. This tube has a heater, a cathode, three grids, and a plate; and, unlike the pentode, each grid is brought out to a separate base-pin connection. Thus, a seven-prong socket must be used, since there is no cap on this tube.

The Grids

In a class "A" amplifier the tube operates so that the variations in plate current follow exactly the variations in grid voltage impressed on the tube. This type of amplification does not yield maximum power, but has the advantage of low distortion and the fact

that conventional audio apparatus may be used. In using the 59, then, as a class "A" triode, the screen and suppressor grids are connected directly to the plate as shown in Fig. 1A. When used in this manner, the following ratings obtain:

Heater voltage, 2.5; heater current, 2 amperes; plate voltage, 250; control-grid voltage, -28; screen and suppressor grids are tied to the plate; therefore they have the same voltage as the plate; plate current, 30 ma.; amplification factor, 6; load impedance, 5000 ohms; power output, 1.25 watts.

When used as a class "A" pentode, this tube has the suppressor grid tied to the cathode and the screen-grid tied to a voltage lower than that of the plate, as shown in Fig. 1B. With the pentode connection, the tube develops more power output with a smaller signal, as may be seen by comparing the data for this tube for the pentode connection with that given for the triode class "A" connection. The data follows:

Heater voltage, 2.5; heater current, 2 amperes; plate voltage, 250; control-grid voltage, -18; screen-grid voltage, 250; plate current, 35 ma.; amplification factor, 6; load impedance, 7000 ohms; power output, 2.5 watts.

In the class "B" connection, the screen-grid is tied to the control grid, and the suppressor grid is tied to the plate, as shown in Fig. 1C. The grid bias is zero and the input grid draws considerable current, which would introduce distortion if conventional audio apparatus were used; but the tube develops about 10 watts (really, 20 watts when two tubes are in push-push). Now, the drawback here is that first,



Appearance of the new 59 power amplifier tube of the triple-grid type. Several ways of operating this tube are discussed by the author in the present article.

two tubes must be used if the output (on an oscillograph) is to resemble the input to any extent at all: if you want music instead of "hash"; second, the power unit supplying this tube when connected as a class "B" amplifier must have excellent regulation: it must be able to supply large variations in plate current with small variations in its output voltage; third, the grid circuit must have a low resistance and the input transformer a low leakage reactance in order that the signal keep its original wave form. All these difficulties increase the cost of production to such an extent that the writer does not recommend this type of connection for short-wave work. It might also be well
(Continued on page 189)

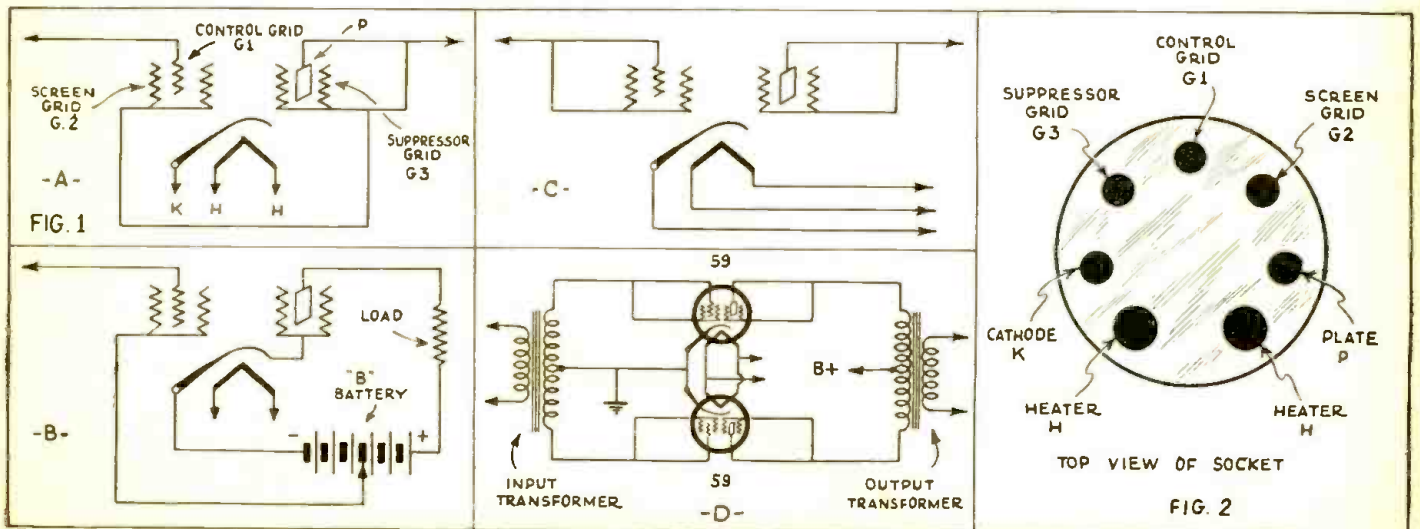

In using the 59 as a class "A" triode, the screen and the suppressor grids are connected directly to the plate as in Fig. 1A. Fig. 1B shows connection of 59 tube as a class "A" pentode. Fig. 1C—connection of tube for class "B" amplifier. Fig. 1D shows connection of two 59 tubes in push-push. Fig. 2, at right, shows socket connections for the 59 tube.

"power supply" is recommended; this should furnish 2.5 volts A.C. for the filaments, the *high-voltage* section supplying 180 volts, with a low voltage tap at 22 for the screen. This *screen voltage* is a very important point, as we are not controlling regeneration with a potentiometer in the screen-grid circuit, as is done in many other receivers. If this voltage is any higher than 22 volts the sensitivity of the receiver will be affected to a very great extent. Therefore one must remember, when the "throttle" condenser method of regeneration control is used with screen-grid tubes, the screen-grid voltage must be checked very carefully; otherwise poor results are liable to be experienced.

"B" Batteries May Be Used

If one wishes to use the 2.5 volt tubes and does not have on hand a regular power supply, a 2.5 volt filament transformer can be used to furnish the filament voltage with ordinary "B" batteries for the plate, (three, 45-volt batteries will operate the set very nicely and last for a long time, as the plate current of this set is in the order of 7 milliamperes. The foregoing paragraphs will give the builder an idea of just how flexible this set really is.

Wiring the set is a very easy task, and if the diagram is followed carefully no difficulty should be experienced in getting the set to "perk." All connections should be soldered with rosin-core solder and a *hot and well-tinned iron*. File the sides of the iron when they become corroded and retin by rubbing the hot iron in flux and solder. Rubbing it in sal-ammoniac or rosin and then applying solder is one of the old plumbers' tricks.) Only enough solder should be used to make a se-



Probably no other short-wave receiver of the 2-tube type has become so popular as the famous "Doerle," described about a year ago in this magazine and letters praising which you have read in practically every issue since. Thanks to the use of the new type screen-grid pentode tubes, extreme increase in sensitivity is attained. Also the 6 volt D.C. tubes can be used, with no change in the circuit. Hundreds of S-W "fans" have requested data on how to rewire the Doerle receiver for 110 volt A.C. operation.—

Well, Boys, here's how!

cure electrical connection. When the wiring is completed all connections should be traced and "double-checked" to make sure that no error has been made.

The standard coils that come with the receiver are used, however it may be necessary to remove a few of the tickler turns on each coil, as the new tubes oscillate more easily than the type 30's formerly used in the set.

This is best done by experimenting after the set has been tried. The symptoms of too many tickler turns are *violent and erratic operation* of the *detector* when it goes into oscillation as the regeneration condenser is turned towards maximum capacity. Otherwise the operation of the receiver will be the same as before it was changed, the only difference being an

(Continued on page 174)

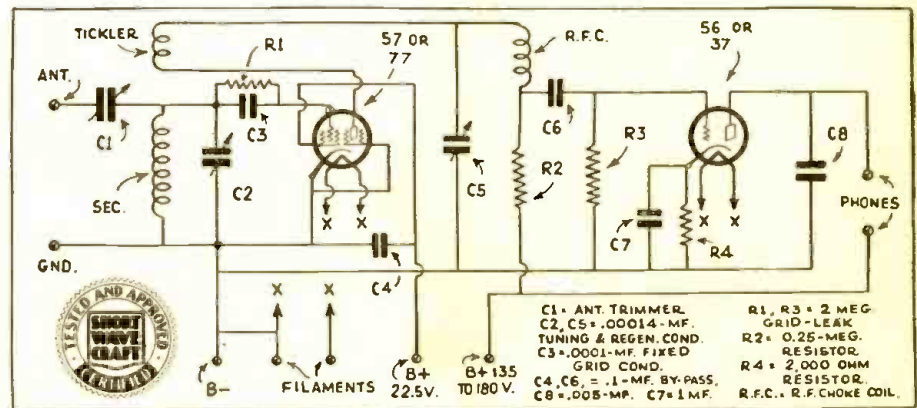

Here's the gratifyingly simple hook-up of the few parts used in constructing the A.C. operated "Doerle" set.

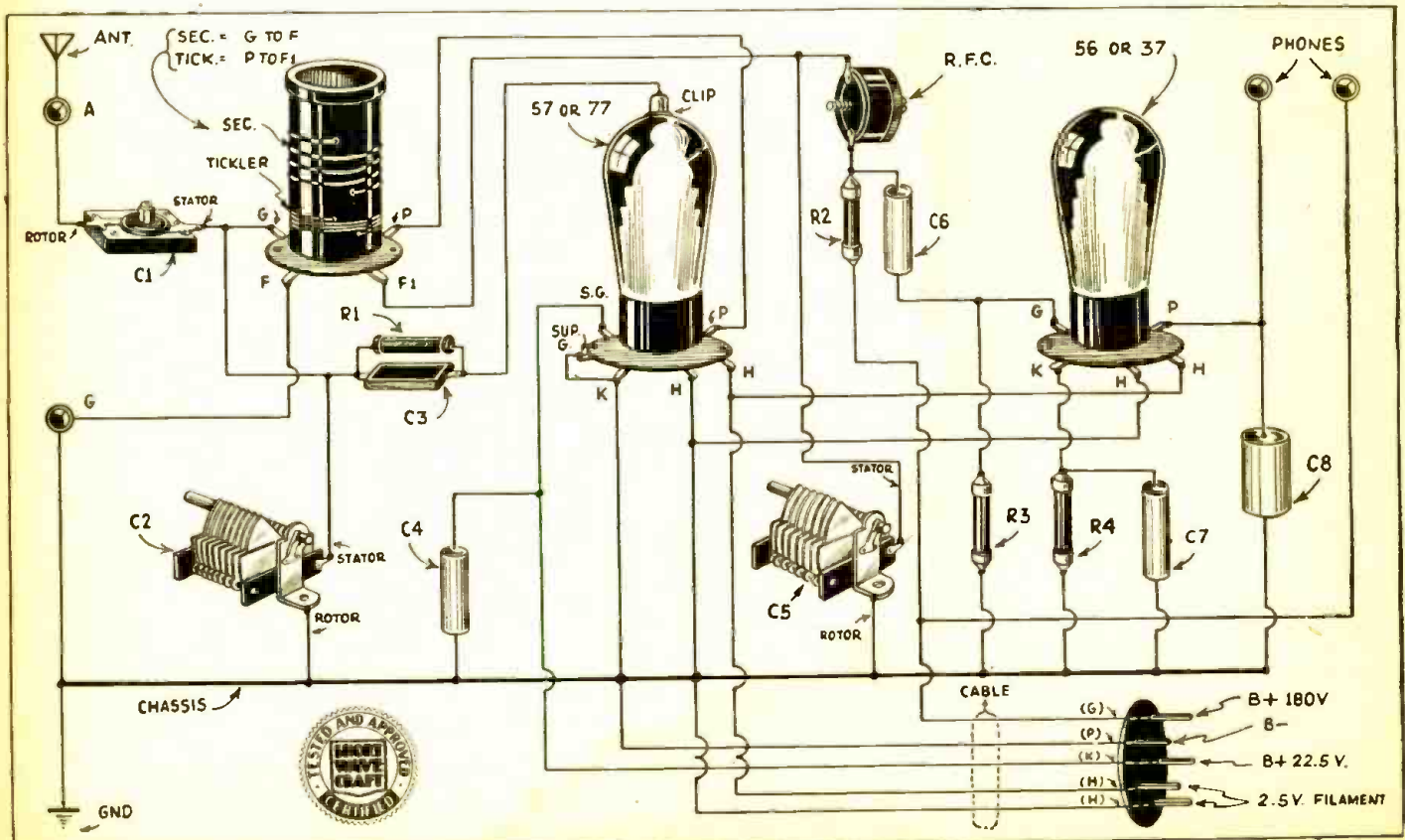

And in the event that you are not a dyed-in-the-wool short-wave "hound," who devours half a dozen R.F. chokes and a dozen plug-in coils for breakfast every morning, here's a "picturized diagram" which should make the construction of the A. C. Doerle a cinch!

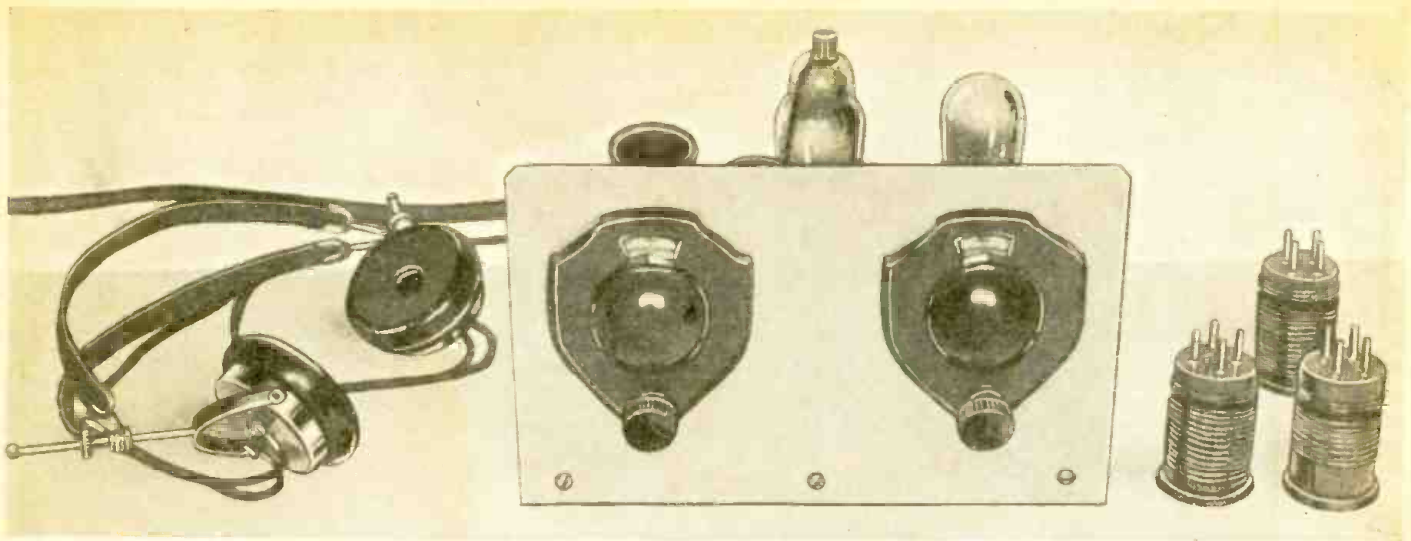

Looks like a very simple short-wave receiver to build, doesn't it? And it is, as you will agree, after reading the clearly written article by Mr. Shuart, well-known short-wave expert.

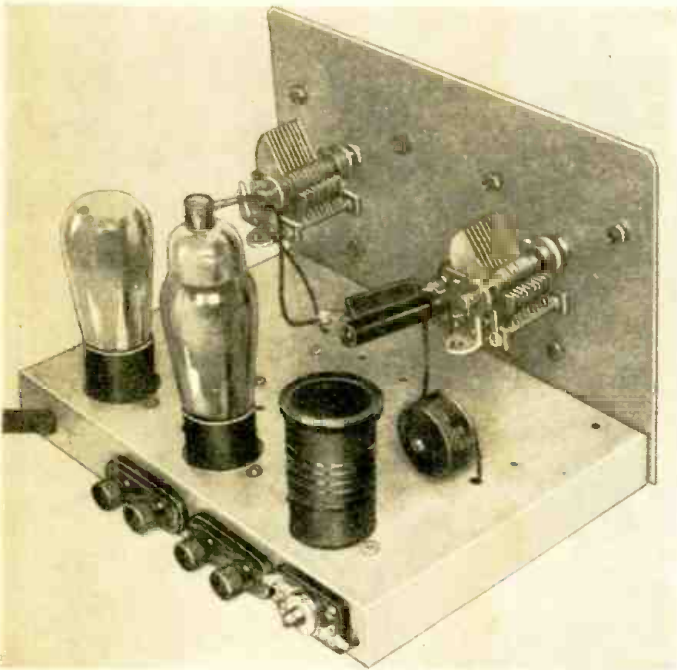

Rear view of the 110 Volt A.C. operated, 2-tube "Doerle" receiver. It provides world-wide reception as numerous tests have demonstrated.

The Famous DOERLE "2-Tuber" Adapted to A. C. Operation

\$20.00 April Prize Winner

By **GEORGE W. SHUART**
(W2AMN-W2CBC)

● WITH all the fine reports from users of the famous "Doerle" receivers, the author decided to convert one of these receivers for A.C. operation using the new screen-grid pentode tubes. The results were so gratifying that it was decided to pass the information on to the readers of this magazine.

One of the latest models of this receiver was obtained for this purpose. This model uses two type 30, two-volt tubes; one as regenerative detector and another as transformer-coupled audio amplifier. The first operation is to remove all wiring, the two four-prong sockets for the two type 30 tubes, the filament rheostat, and the audio transformer; the four prong coil socket remains.

It might be well to mention at this point the list of parts necessary to do the job. They are as follows:

- 1-6-prong Wafer Socket
- 1-5-prong Wafer Socket
- 1-Screen-Grid Tube Shield, Type 50
- 1-2,000 Ohm Fixed Resistor, 1 watt

- 1-250,000 Ohm Fixed Resistor, 1 watt
- 1-2 Mex. Grid-Leak Type Resistor
- 2-1 mf. By-pass Condenser
- 1-.005 mf. Fixed Condenser
- 1-1 mf. By-pass Condenser
- 1-Terminal Strip-5 lugs

The first of the above parts to be mounted are the two tube sockets. The six-prong socket is mounted in the center hole and the five-prong socket in the hole nearest the phone terminal strip.

Next mount the terminal strip with the five lugs on it in the center of the base on the under side. The one mf. by-pass condenser is mounted on the top side of the base in the position formerly occupied by the audio transformer. We are now ready to wire the set.

Hook-up "OK" for 2.5 or 6 Volt Tubes

Referring to the diagram it will be seen that the circuit is a straightforward regenerative one, with resistance-coupled audio amplifier stage and "throttle" (condenser) control of

regeneration. There are no changes in the circuit originally used in the Doerle receiver, other than those necessary to the use of the new type tubes. Either the 2.5 volt or the 6 volt tubes can be used in the new receiver, with no change in the circuit being necessary, the results being the same in either case. If the builder wishes to stick to batteries, and still have the benefit of the new type tubes with their high "gain," the use of the 6 volt tubes is recommended. In this case the detector should be the type 77, with a type 37 for the audio. This is very practicable as the set will operate on as low as 90 volts on the plates, although better results are obtained with from 135 to 180 applied to the tubes. A storage battery is used for filament supply for these tubes and lasts quite some time due to their low filament current rating.

Plate Supply

For 110 volt A.C. operation a



This 3-tube short-wave receiver does away with the necessity of removing and replacing plug-in coils; it employs instead a newly devised switching system, whereby the most used bands, the 20, 40 and 80 meter, can be tuned in by merely turning a pair of switches.

THREE' — No Plug-in Coils—All Common Wave-Bands Tuned in by Switches Using New Circuit

be necessary to remove as much as a single turn on L-3. Due tests of the set will enable the constructor to judge the advisability of any coil correction.

After these corrections have been made, it is wise to apply small amounts of collodion, or some other high-grade insulating material, which will hold the windings.

The signals are fed into the receiver by means of the antenna connection to the home-made antenna series condenser. This home-made antenna series condenser is familiar to all of the readers of SHORT WAVE CRAFT. It consists of a simple two-inch long piece of bus-bar with No. 18 push-back wire wound around it in the form of a spiral spring and simply moved back and forth to increase or decrease the capacity in the antenna circuit.

Wave selection is given by means of the two switches S.W.1 and S.W.2. The input circuit to the first radio frequency tube has a tuned circuit, being tuned by condenser C-2, which is ganged to condenser C-6, tuning the

detector circuit. This condenser-leak method of detection is employed and C-7 and R-1 form an exit to this circuit. The return of the grid in the detector tube is directly to the chassis.

A typical regeneration circuit is employed,—control of screen voltage being the method whereby oscillation is controlled. The plate winding or feedback coil is divided into three equal windings of six turns each, interposed between the No. 22 tuning coil winding, so that satisfactory regeneration control can be had on all the bands with the switch in any position. Of course, with the switches S.W.1 and S.W.2 at the bottom of L-1 in both the input circuit and output circuit of the 34 R.F. tube, the receiver will tune to the shortest wavelength band. By moving the switch down to the tap N.L.2 this will tune to the next shortest band, and by moving still further so that the moving arm of the switch rests on an open contact, indicated near L-3, the complete coil is in the circuit and the highest wave bands will be covered.

The plate circuit of the 32 type tube which is used as the detector is bypassed to ground by means of condenser C-9 and the radio frequency choke. The detector is resistance coupled into the grid circuit of the 33 type tube, which has given excellent results, especially as far as power sensitivity is concerned. C-11 is used to equalize variation in the Pentode plate load impedance.

R-6 is mentioned, although it is not shown in the actual set. This is a 6 ohm rheostat used in series with the "A" supply when two dry cells are used in series, it being necessary to drop one volt in the rheostat to supply the two volts normal to the tubes in the receiver. If a 6 volt storage battery is to be used, an additional resistance must be inserted in the circuit so that the current to the filaments will not exceed the rated value.

In many cases sets of this type are equipped with Eveready Air-Cell batteries, which will give steady performance (Continued on page 176)

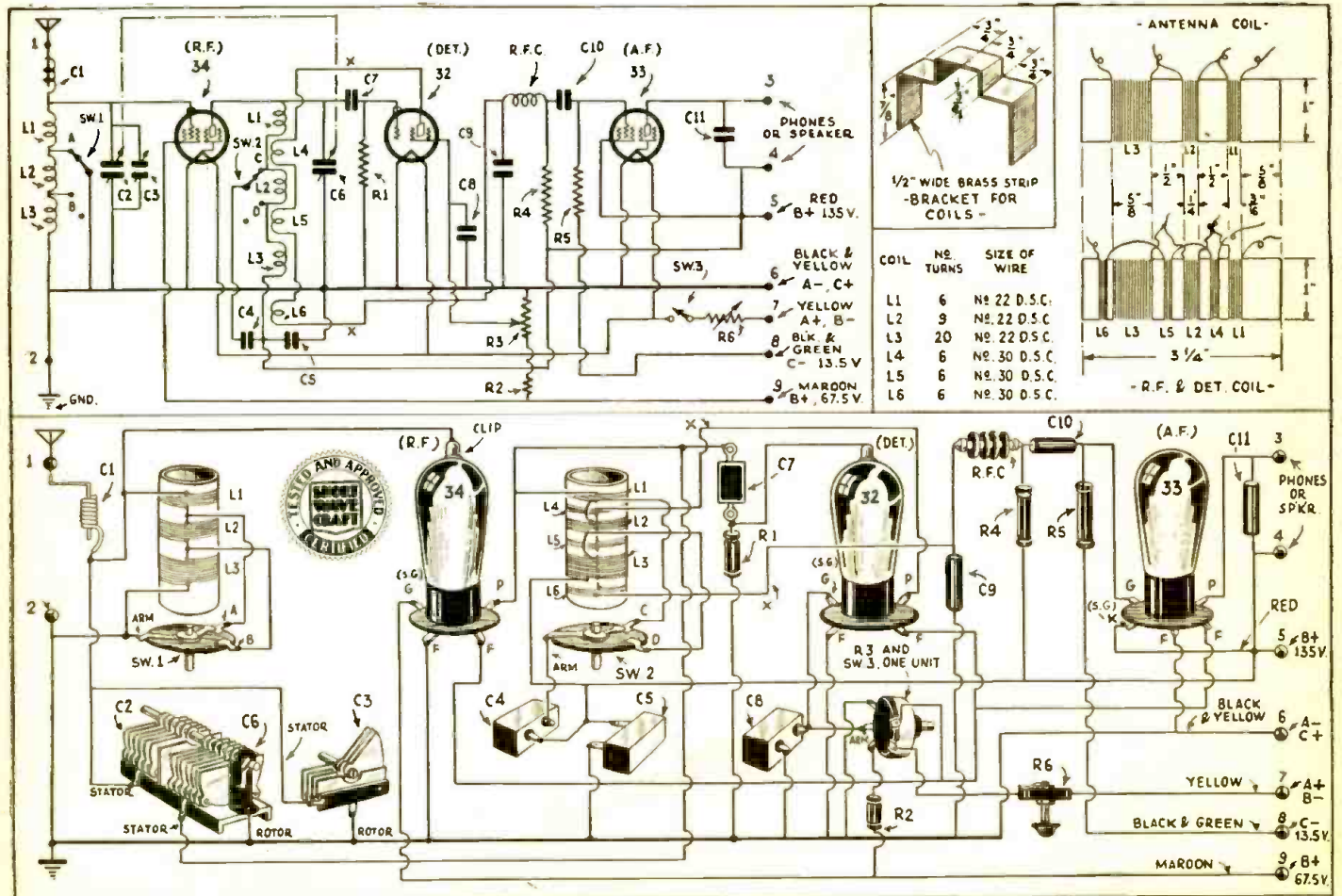

Both schematic and picturized wiring diagrams are shown above for those interested in building the Denton "Economy Three" receiver. This set employs three battery tubes are shown above for those interested in building the Denton "Economy Three" receiver. This set employs three battery tubes and switch-type inductances instead of plug-in coils, to cover the most used bands, the 20, 40, and 80 meter bands.



Here's a 3-tube short-wave receiver that you will derive a lot of pleasure from—it is up to the minute, with all controls mounted on the front panel, while switches change the wave bands.

The DENTON "ECONOMY"

By CLIFFORD E. DENTON

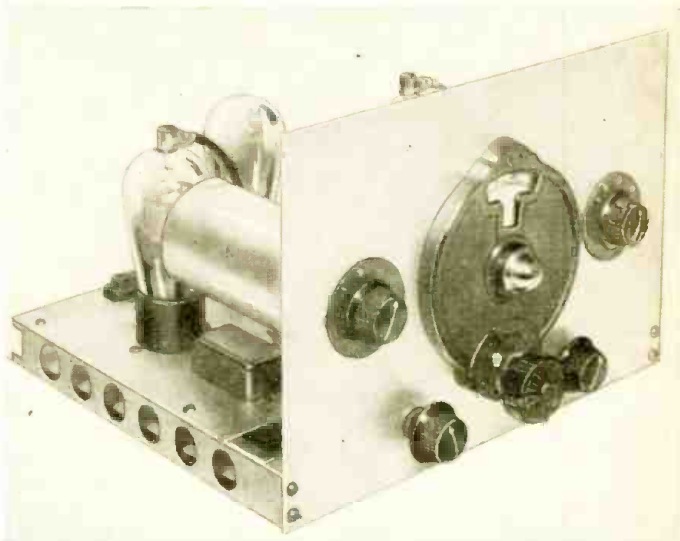

Another view of the Denton "Economy Three" which utilizes the latest discovery in an efficient inductance-switching system for changing the wave-bands, without resorting to plug-in coils.

● **THREE** tube short wave receivers are very popular today. The results that can be obtained with a properly designed and constructed set are the reason for their popularity.

Most set builders use one stage of radio frequency amplification and a high-gain detector tube. This is the most satisfactory method of radio frequency amplification and detection.

If more than one radio frequency stage is used, then the problem of adequate shielding runs the cost of the set up so far that the average pocket-book will not stand the strain. With ordinary equipment now available tuned radio frequency below 20 meters will not offer high enough amplification to justify the cost.

A screen grid detector is used in the "Economy-3" because it offers the maximum sensitivity, coupled with smooth regeneration control, for the minimum cost.

As it is wise to have an audio stage and the cost of the additional parts for its construction is so little, a "high gain" pentode type tube is used, the output of which can be connected to a loud speaker or used in conjunction with phones, as desired. For the best results with this tube, use *high impedance* phones so that greater signal strength may be developed. If possible use an output-matching transformer for this purpose.

Circuit Description

In the outward appearance of the circuit diagram the receiver will have

Parts List

One Hammarlund Tuning Condenser Type MCD-140-M (140 mmf. cap. per section). (C2, C6)
 One National Tuning Dial 4" Type VBD
 One National R.F. Choke Type 100 (RFC)
 Three Ily-pass Condensers .25 mf. (C4, C5, C8)
 One Tubular Condenser .003 mf. (C11)
 One Tubular Condenser .00025 mf. (C9)
 One Tubular Condenser .015 mf. (C10)
 One 50,000 ohm potentiometer with power switch (R3, SW3)
 One Aeratest Midget Condenser 25 mmf. capacity (C3)
 Three Aeratest 4 prong sockets
 One Aeratest 20,000 ohm, .5 watt resistor.
 One Aeratest 1 meg. .5 watt resistor (R5)
 One Aeratest .25 meg., .5 watt resistor (R4)
 One Aeratest 5 meg. resistor .5 watt (R1)
 One Aeratest .0001 mf. mica Condenser (C7)
 Two Aeratest Tube shields, type 7268 (for the coils)
 Two 1" diameter bakelite tubing 3/4 inches long
 One 1/4 pound spool No. 30 D.S.C. wire
 One 1/4 pound spool No. 22 D.S.C. wire
 Two Aeratest Selector switches (SW1, SW2)
 One Eby Type 17 moulded twin-jack for phone or speaker connections (3, 4)
 One Eby Antenna-Ground Type 22s Molded twin-posts (1, 2)
 One Blan aluminum panel and chassis
 One pair of Blan Brackets
 Aeratest grid-leak clips, Type 3892
 Two Aeratest 1" diam. black knobs
 One Aeratest 6 wire cable. (5, 6, 7, 8, 9)
 One Type 33 Output Pentode (33) Triad
 One Type 34 R.F. Variable-Mu Tube (34) Triad
 One Type 32 S.G. R.F. Tube (32) Triad

a familiar look. After all, the old time "tried and found good" are the best. The problem is simply one of obtaining the most for the capital involved.

The coils are home-made, in fact the coils cannot be bought ready made for this set at all. The set constructor will have to follow the coil-winding directions as given in Fig. 2. There is no great job in winding these coils and it can be done in an hour; simply follow the directions carefully.

By the use of the two taps it is possible to cover three wave-length ranges. The first band will extend from 40-85 meters, the second band from 25-55 meters and the lowest band from 15-30 meters. Due to variations in the windings of the tuning coils when done by hand, there will be some differences in the bands covered, as well as differences in tuning condenser settings, due to change in constants and electrical values of the antenna and the detector coil. Experience in winding several sets of these coils indicates that this variation will not be so great that it cannot be corrected very simply.

One way to bring the antenna and detector coil circuits into alignment, so that resonance will be obtained with the single control dial tuning arrangement, is to spread the turns of windings L-1 and L-2 by prying them apart until repeated tests show that resonance is established fairly evenly over all of the bands. If there is a very great difference in the tuning range, due perhaps to differences in the tube shields used as coil shields, then it may

High FREQUENCY Cable For Connecting Antennas

By B. KLEEBINDER, E. E.

European investigators have developed a high frequency cable suitable for use as a conductor of R.F. currents with a minimum of radiation loss. The general principle involved is that any external electromagnetic field outside of the conductor is eliminated by placing the "live" conductor within a grounded metal tube or sheath.

UP to a few years ago it was customary in the case of transmitting and receiving stations to erect the antenna directly over the transmitting or receiving building. By this arrangement however certain losses were caused in radiation energy and effective antenna height, which had to be accepted. If several transmitters or receivers were put in one station, the installation of these took place without regard to the antennas; then the antennas were mostly not very far apart, so that they had to be mutually *uncoupled* by means of special means. When the evolution of short-wave technique led to the building of *directional* antennas, the antenna feed or the antenna lead-off wire became a more difficult matter, for the directional antennas for perfect action required a space free from large masses of metal, buildings, trees, etc. It was therefore necessary to set up the different directional antennas of a short-wave station (whether transmitter or receiver) at fairly great distances from the station building and to conduct the high frequency power from the transmitter to the antenna, or, as the case might be, from the antenna to the receiver, via special *energy conductors*.

Principal Requirement

The principal requirement of such an *energy conductor* is that there shall be no noteworthy losses through radiation. Practical experience with the energy conductors evolved was so favorable that these have since been generally used, also for longer waves and for radio broadcast transmitters. Today therefore one can arrange the antennas, independent of the position of the transmitting or receiving building, at that locality which seems most favorable for transmission or reception.

Before we discuss the high frequency cable as the form of such an energy conductor, let us first speak of the *Concentric copper-pipe* lines serving as energy conductors, also the *parallel wire conductors*. A so-called *parallel wire conductor* consists of two or four parallel wires, insulated from the ground. (Fig. 1). Normally these are run on suitable wooden poles; an absolute freedom from radiation is theoretically only obtainable, when the currents flowing in the conductor produce no electromagnetic field at all, outwardly. With the parallel wire conductor this condition is not exactly possible of fulfillment, for the electrical fields originating outside of the conductors reflect on the conductors which then do not perfectly neutralize each other, even if care is taken that the current strengths and potentials in the conductors be absolutely equal and opposite in phase at every point, i. e.,

perfectly symmetrical electrically. If the *electrical symmetry* is not present, then a strongly increased radiation of the energy power results. In the case of the arrangement of Fig. 1 in practice, in spite of the most careful mounting, the maintaining of a perfect electrical symmetry was found impossible. With *directional antennas* a radiation of the energy conductor has however, as a consequence, not merely the corresponding loss in energy, but it also causes a varying distortion of the directional diagram of the antenna, since the additional radiation of the energy conductor is not exactly defined. With reception systems the parallel wire conductor had the further disadvantage that through the "pick-up" of the conductors there again appeared reception disturbances, which were made ineffective through the disturbance-eliminating effect of the directional antenna.

Concentric Copper Pipe

Accordingly the engineers changed over to a better design, which was in the form of the *concentric copper-pipe* conductor. (Fig. 2). The two pipes serve as conductors for the high frequency currents and it is clear that at very high frequencies (short waves) there is induced on the inside of the outer pipe a current strength which absolutely must be equal to the negative current strength on the outside of the inner pipe. By grounding the outer pipe at several places it was then easy to ensure that no current flowed or was set up on the outside. Therefore there is no electromagnetic field *outside* of the conductor, i. e., the radiation of such a concentric copper-pipe conductor is actually equal to zero! By the grounded shielding of the outer pipe this type of energy conductor is also not receptive to disturbances from without. The principle disadvantage is the high cost of manufacture and the expensive mounting. The copper-pipe conductor must be formed of short pieces of pipe (of factory length) which again require complicated connection pieces ("sleeves") and arrangements for taking care of heat expansions. Both copper pipe and also parallel wire conductors have the common disadvantage that they must be mounted *above* the ground, whereby they also interfere with one's crossing the terrain or else the possibility of manipulating the antennas is made difficult.

Practice therefore showed the distinct need for a form of *energy conductor* uniting the highly efficient electrical principle of design of the concentric copper-pipe conductor (i. e., perfect freedom from radiation and good high frequency conductivity) with the simple installation possibilities of ordinary

(Continued on page 178)

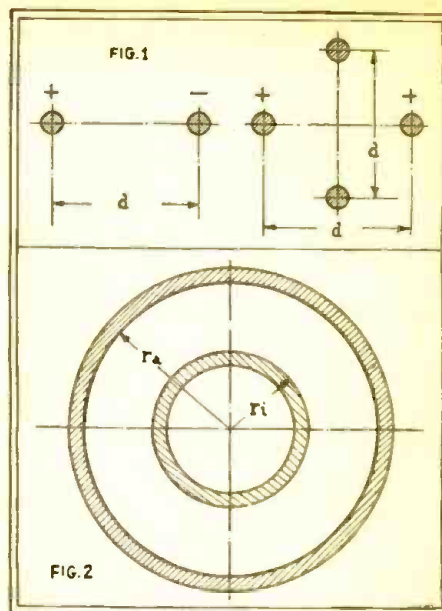

Diagram showing relative arrangements of the parallel-wire, high-frequency conductor system and the concentric R.F. copper pipe conductor. I. e., one tube within the other, the outer pipe being grounded.

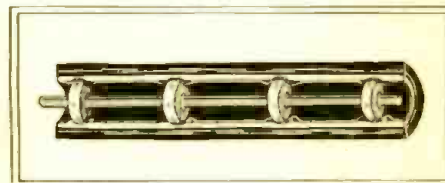

Fig. 3.

One form of the new high frequency cable employing a solid copper conductor within a copper outer tube.

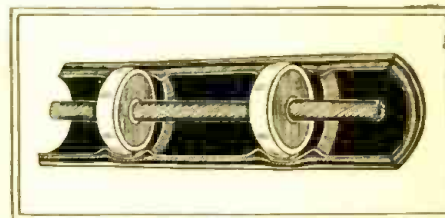

Fig. 4.

In this section showing another form of the new high frequency cable, the inner conductor consists of a hollow copper "rope," the outer grounded conductor consisting of short rigid pieces of copper tube which are connected together by specially formed ball joints. The inner and outer conductors are mutually insulated by flat insulating rings made of some R.F. low-loss material, such as isolantite.

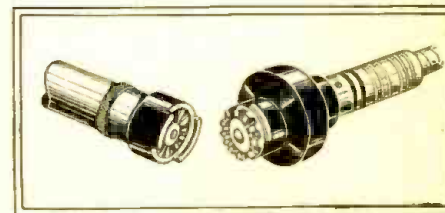
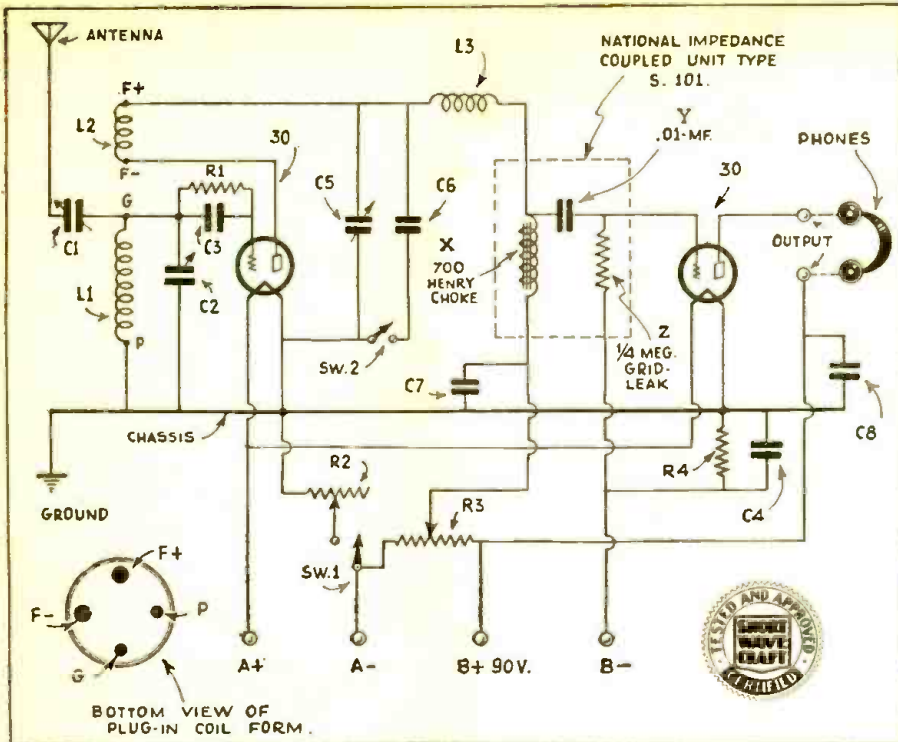

Fig. 5.

One form of insulated joint coupling used with a new high frequency cable and permitting the inner and outer conductors to be firmly connected, while maintaining the insulation between them.



Schematic wiring diagram for Mr. Worcester's newest brain-child—the "Regenerative-Oscillodyne" Receiver. Not only is the wiring diagram very simple and the parts easy to assemble, but a valuable feature indeed is the fact that the cost of building this receiver is very low.

Insert either coil No. 1 or No. 2 in the coil socket and turn the set on. The filament rheostat should be turned up about half way and if at all possible should be accurately set to 2 volts by means of a voltmeter. Turn the

left-hand switch to the "on" position, thus making the oscillodyne connection. By turning the potentiometer control about half way up the set should break into irregular oscillation. Now, adjust the antenna compensating condenser

C₁ until the set oscillates irregularly over the entire tuning dial. This will necessitate setting this condenser at close to its minimum value (plate "all out"). It should now be possible to receive numerous code and broadcasting stations.

In order to adjust the set for regenerative reception turn the switch to the "off" position and adjust the condenser C₆ until the set breaks into oscillation at about the same position of the potentiometer dial, that the set breaks out of irregular oscillation when using the oscillodyne connection. In the writer's receiver, this necessitated turning the plate of the condenser C₆ nearly "all in." These condensers can then be left alone for reception on coils Nos. 1, 2 and 3 except when it is found necessary to shift a dead-spot, which can be done by adjusting C₁.

For reception on coils 4 and 5, the capacity of condenser C₁ will have to be increased materially. Also, since the operation of these coils with the oscillodyne connection was not anticipated, the number of turns on L₂ is just sufficient to permit regenerative operation when the switch is turned to what is normally the oscillodyne connection (switch "on").

Parts Required for Regen.-Oscillodyne Set.

- C₁, C₂—Hammarlund Adjustable Padding Condenser, 10-70 mmf., type MICS-70.
- C₃—Hammarlund Midline Midget Condenser, 140 mmf., type MC-140-M.
- C₄—.0001 mf. Molded Mica Condenser, pigtail leads.

(Continued on page 179)

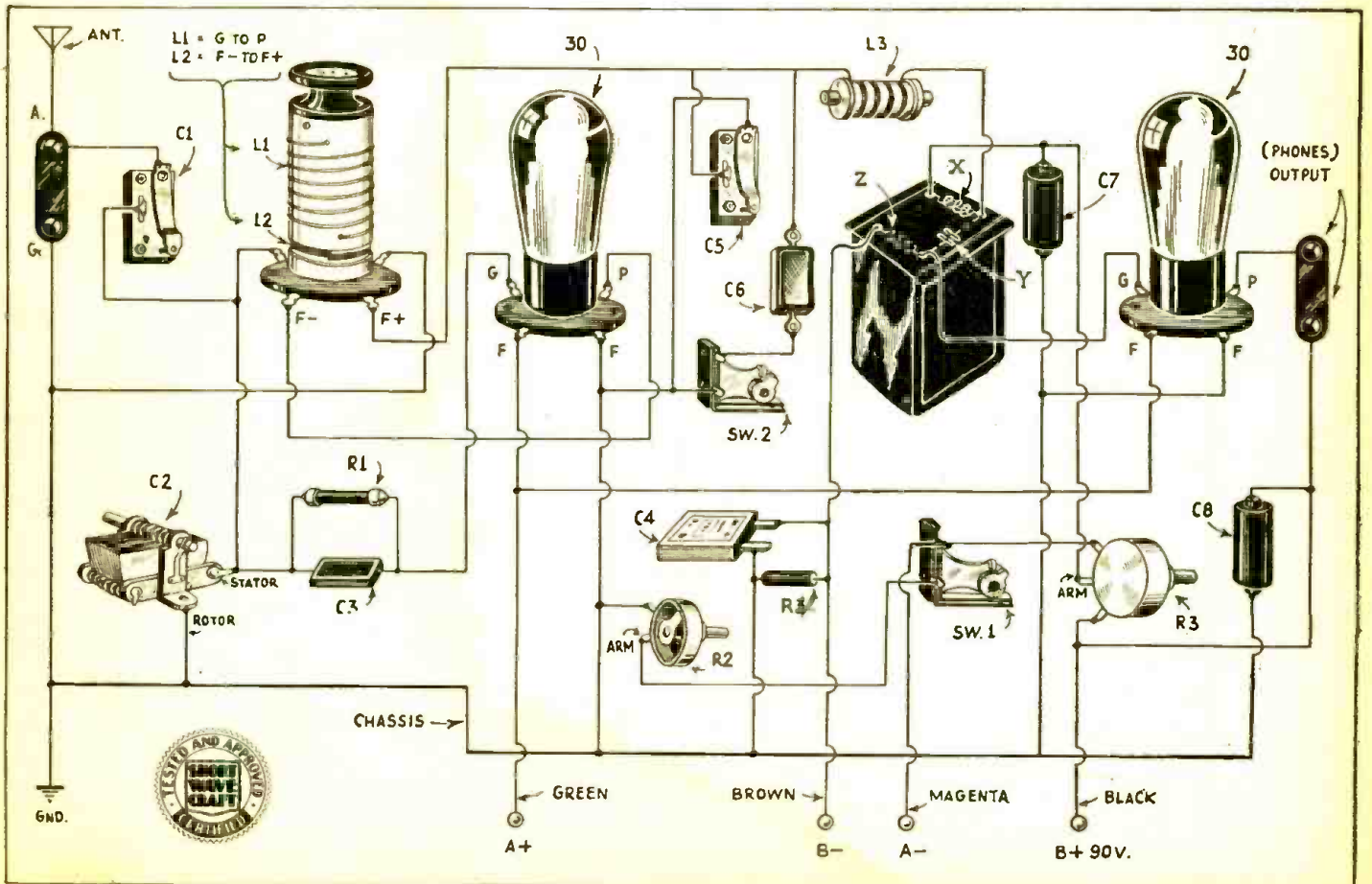

If you are not so well acquainted with the usual schematic wiring diagram, shown above, you will find this picturized wiring diagram, immediately above, to fill your requirements nicely.

Regenerative-Oscillodyne

A Real "DX" Getter—Uses 2-volt Tubes—Combines Features of Regenerative and Oscillodyne Receivers—Gives Surprisingly Powerful Amplification for Only Two Tubes—Complete Coil-Winding Data and All Other Constants Given

mounted two small switches. One, a single-pole, single-throw, is mounted beneath the potentiometer on the left side and selects the desired circuit, while the other, a double-pole, single-throw, breaks both the filament circuit and the potentiometer return, thus preventing "B" battery drainage when the set is not in operation.

The parts visible on the top of the chassis include the Eby *isolantite* coil and detector tube sockets, the laminated wafer type amplifier tube socket and the National impedance coupling unit.

At the rear are mounted the Eby twin binding post and speaker jack assemblies and the Alden 4-prong socket to which battery connections are made.

An inspection of the under side of the chassis will reveal the location of the various parts mounted in that location. The two Hammarlund padding condensers are mounted directly behind the twin binding post assembly, as shown. A $\frac{1}{8}$ " hole is drilled above each screw adjustment, thus making this adjustment accessible from the top. The 25-mf. dry electrolytic condenser is mounted by means of a strap furnished for this purpose. The Hammarlund R.F. choke is mounted directly behind the SPST switch as shown. The remaining parts, which include the .5 mf. by-pass condensers, the Lynch 2 meg. grid-leak, 700-ohm resistor and the .0001 mf. and .005 mf. fixed mica condensers are mounted directly by their pigtailed and held in place by the wiring.

Coil Construction.

The coils for this receiver are wound on Hammarlund 4-prong *isolantite* coil forms. The windings L_1 and L_2 have the number of turns and wire sizes specified in the accompanying table. It will be noted that winding L_1 for coils Nos. 1, 2 and 3 is *space-wound* with No. 22 enameled wire. The spacing is sufficient to make the length of the winding equal to $1\frac{1}{2}$ ". For coils Nos. 4 and 5 this winding is *close-wound* and has the number of turns and wire sizes specified in the table.

The winding L_2 is wound in the same direction as L_1 and has the number of turns specified. No. 34 D.S.C. wire is used for this purpose.



By
J. A. WORCESTER, Jr.

Operating Notes.

Battery connections are made by a four conductor battery cable which connects to the set by means of a 4-prong connectoral plug. After these connections are made, the headphone plug inserted in the jack, and the antenna and ground connected, the set is ready to be put in operation.

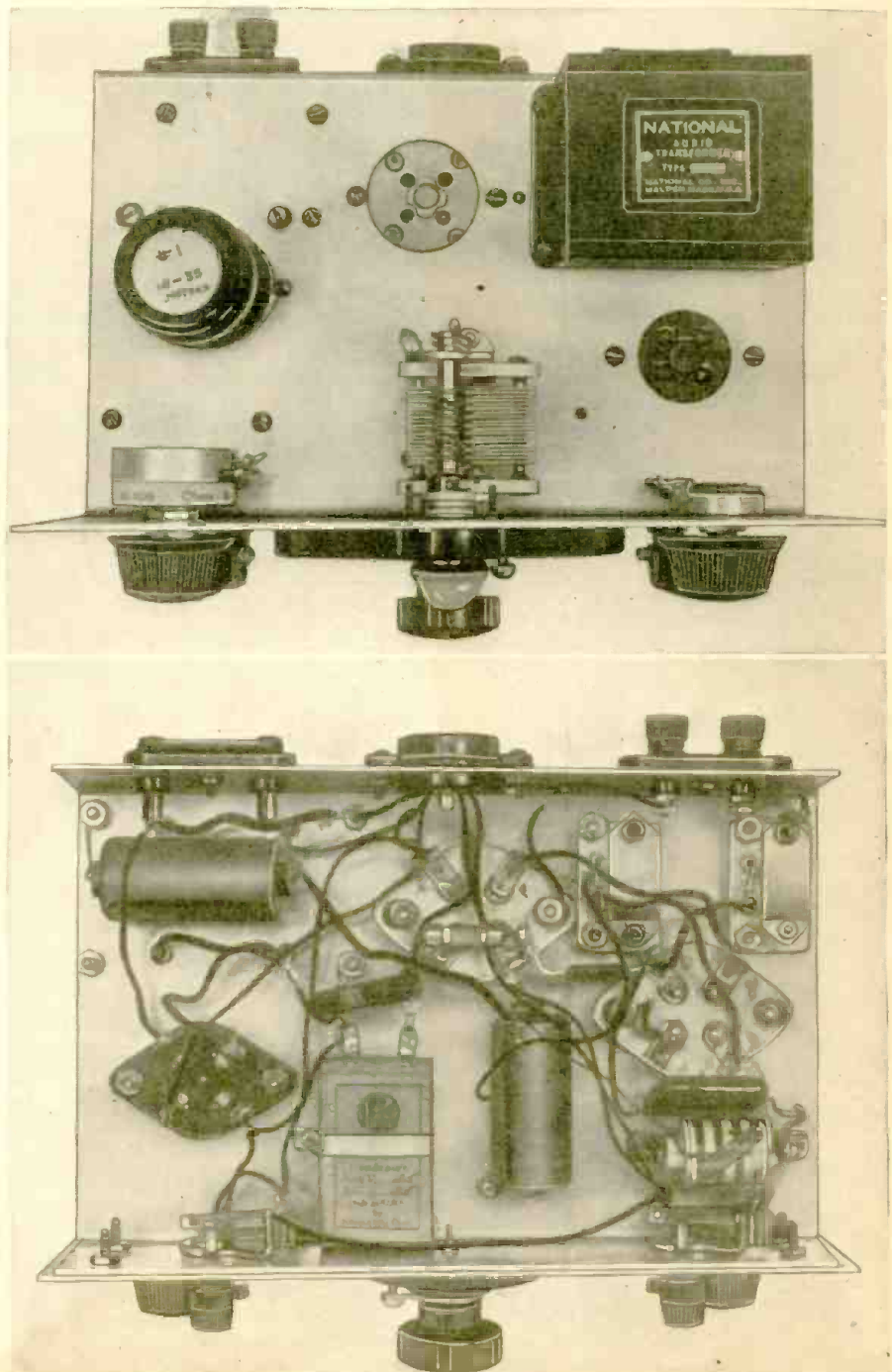

The top photo—the "Regenerative-Oscillodyne" as it looks from above. Lower photo shows bottom view of the "R-O" receiver.

COIL DATA

Coil No.	Wavelength range (Meters)	L_1		L_2	
		No. Turns	B. & S. Wire Ga.	No. Turns	B. & S. Wire Ga.
1	18-35	* 8.5	22 En.	5	34 D.S.C.
2	35-70	* 17.0	22 En.	7	34 D.S.C.
3	70-140	* 34.0	22 En.	12	34 D.S.C.
4	140-280	66.0	26 D.S.C.	20	34 D.S.C.
5	280-560	130.0	34 D.S.C.	20	34 D.S.C.

*Turns spaced to make length of winding equal to $1\frac{1}{2}$ inch.

Try This 2-Tube



The latest concoction of Mr. Worcester, who has already given you several excellent designs of the "Oscillodyne"—a receiver embodying a newly discovered principle of regeneration—is the 2-tube combination "Regenerative-Oscillodyne" illustrated above. This receiver is a "live-wire" and you will be astonished at the way in which it "steps out and rolls them in." DX holds no terrors for this unique receiver which operates on batteries or from well-filtered "A" and "B" eliminators.

● AFTER experimenting for several months with various *oscillodyne* and *regenerative* receivers, the writer has come to the conclusion that the ideal receiver for the average "short-wave" fan should comprise a combination of these two circuits. With this idea in mind the receiver described in this article was evolved. The set was designed for headphone reception and utilizes two type 30 dry cell tubes. The power supply consists of two 1½ volt dry cells and one 90 volt "B" block (or two 45 volt blocks).

It is possible, by simply turning a switch on the front panel, to obtain either the *regenerative* or *Oscillodyne* circuit connection. The writer finds, in his location and available antenna system, that the *regenerative* connections work better from about 70-560 meters, while the *oscillodyne* connection gives better results from 18-70 meters. It will be noted that in this latter range fall practically all of the short-wave broadcasting stations.

"Foreign" Stations Heard Fine.

The writer in his test of this receiver, comprising three days of casual tuning, was able to pick up numerous "foreign" stations with this set while employing the *oscillodyne* connection including: EAQ, I2RO, FYA, GSA, GSB, GSC, GSF, DJA, DJB, YV2BC and others which were not identified.

It proved an interesting experiment to tune in a foreign station with the *oscillodyne* connection and then attempt to bring in the same station with the *regenerative* hook-up. Unfortunately, it is not possible to switch from one circuit to the other without a slight readjustment of the tuning condenser and, of course, the regeneration control. Using this procedure it was possible to tune in EAQ, GSA and GSB of the above list with the *regenerative* connection and some of the others could also be brought in faintly by "zero-beating" the signal and leaving the tube in an oscillating condition. The volume of all foreign stations was much less with the *regenerative* connection and the tuning operation was

much more difficult. It might be pointed out, however, that the writer's antenna equipment is possibly not ideal for *regenerative* reception as it is not possible to obtain a good ground connection.

The wiring diagram of the receiver's connections is shown on page 144, while the general layout of the parts can be seen from the photographs. The set was designed primarily to be an efficient *regenerative* receiver, with the *oscillodyne* feature a secondary consideration, as it does not require such refined design for satisfactory opera-

tion. With this point in view, *isolantite* coil forms, coil socket and detector tube socket were employed as well as other high-grade material wherever its use would result in improved operation from a regenerative standpoint.

A. F. Amplifier is Impedance-Coupled.

The *audio frequency* amplifier is impedance-coupled, which makes it possible to match the rather high plate impedance of a 30 tube when employed in the *oscillodyne* connection. Of course, this condition could also have been met by resorting to resistance type coupling but impedance-coupling will result in substantially greater volume and has other advantages as well. For this purpose, a National S 101 impedance-coupling unit is employed, which consists of a 700 henry choke, together with a .01-mfd. coupling condenser and a 250,000-ohm grid-leak, all mounted in a single container.

Set Construction Details.

The panel for this receiver, which is made of ¼" aluminum, 6 inches high and 9 inches long, is bolted to an aluminum chassis 1½ inches high, 8¾ inches long and 5½ inches deep. This chassis is made by folding an 8¾" x 8½" sheet to these dimensions.

On the front panel are mounted the Hammarlund variable condenser and the National dial associated with it. On either side is mounted the useful 50,000-ohm potentiometer, used as an oscillation control for both the *regenerative* and *oscillodyne* connections, and the handy 20-ohm rheostat used to maintain the filament voltage at 2 volts. Beneath these controls are

● THIS combination "Regenerative-Oscillodyne" Receiver, especially designed and built by Mr. Worcester himself for the benefit of the thousands of readers of SHORT WAVE CRAFT, marks the last word in a simple and economical 2-tube receiver, utilizing but two dry-cell type tubes. The plate supply may be furnished either by a well-filtered "B"-eliminator or by a 90 volt "B"-battery.

This receiver was tested by the editors and it sure is "hot"! Its performance backs up the author's statement that on such S-W stations as those across the Atlantic, a marked increase in the strength of the received signal is at once noted when the switch on the front panel is thrown from "regenerative" to "oscillodyne." By means of this switch the special merits of the two forms of receiver on different wavelengths is at all times instantly available. This receiver is sure to prove a "winner."

S-W Transmitter VE9GW

● THE well-known Canadian transmitter, VE9GW, was first put into service on a regular schedule in April, 1930. This transmitter went through a number of changes in the past three years and is now rated at 200 watts. VE9GW has been heard in practically every clime; one of the purposes and aims of the management of this station was to provide short-wave service towards the north, taking in those sparsely settled regions in northern Ontario and Manitoba, wherein lie the outposts of the Royal Canadian Mounted Police.

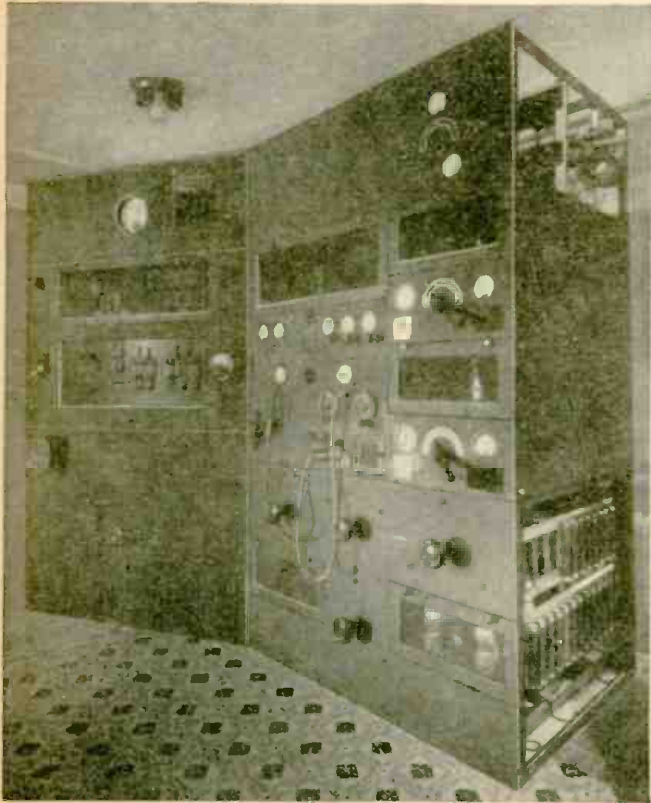

The transmitter at the famous Canadian short-wave transmitting station, VE9GW.

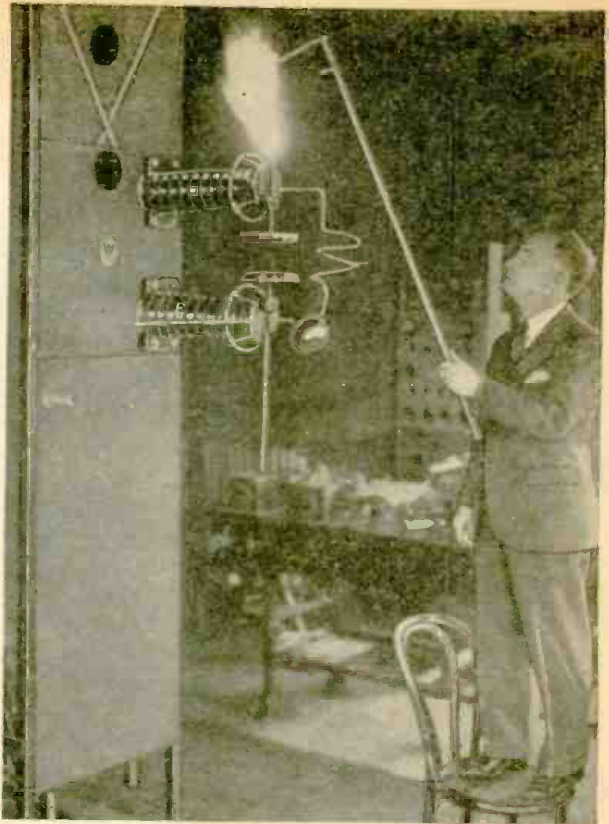

15 Kw. 5 Meter Transmitter

● THE photo, above, shows the spectacular flame discharge of high frequency current produced between the insulated electrode held by the gentleman standing on the chair, Dr. Dayton Uray, of the Westinghouse Research Laboratories, when he demonstrated the power of a new 15 kw., five-meter transmitter. Note the giant ribbed insulators of special type, needed to guard the very unruly high frequency current developed in a 5 meter transmitter of such unusual power as 15,000 watts.

8-Year Old Girl Gets License

● HATS Off, Boys, to little Jean Hudson, the precocious daughter of Edgar L. Hudson of Laurel, Delaware, who recently was awarded one of Uncle Sam's amateur radio licenses, after taking the usual prescribed test. Her father has a "cracker-jack" ham station, for both transmit-
(Continued on page 180)

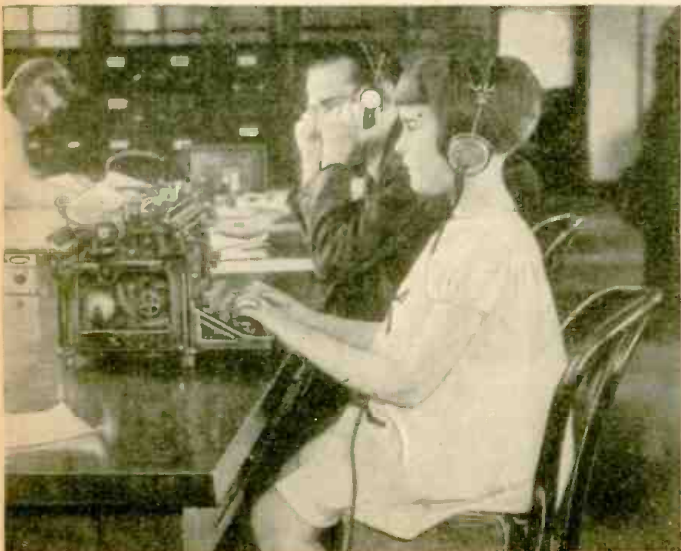

The world's youngest licensed radio operator, 8-year-old Jean Hudson.

Marconi Opens Vatican Station

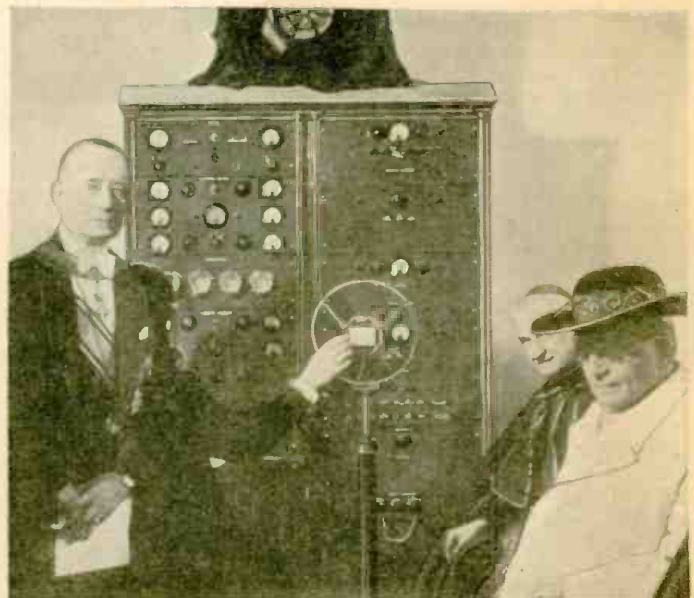

● IN the accompanying photo we have the maestro of short-wave radio—Signor Guglielmo Marconi and Pope Pius, who was present at the recent opening of the new ultra short-wave station built by Signor Marconi in the Vatican at Rome. The ultra short-wave transmitter utilizes one of the new parabolic antennas devised by Dr. Marconi, the antenna being mounted on the roof of the Vatican radio station.

How Ultra Short Waves GUIDE PLANES In "Blind Landing"

Utilizing short waves with a frequency of 100,000,000 cycles per second or a wavelength of 3 meters, Uncle Sam's radio experts have devised a remarkable scheme, recently tested successfully, by means of which planes can land "without seeing the ground"—of tremendous importance in cloudy weather.

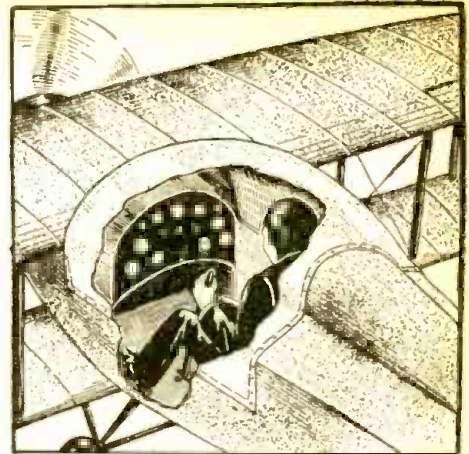

When about to make a "blind landing" by means of the new ultra short-wave system, the pilot looks principally at the two instruments indicated by the white dots under them.

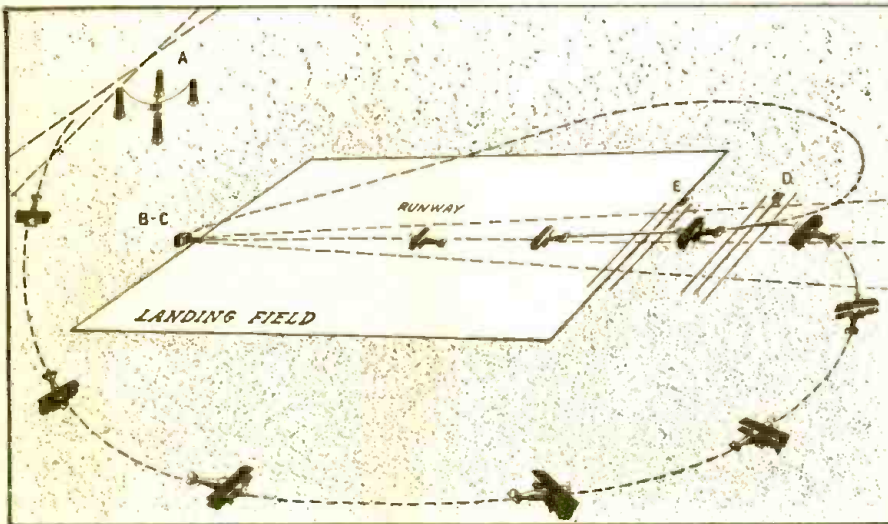

Figure 1.—Diagram of airplane landing by means of radio system for blind landing. A indicates location of main radio range beacon; B and C, the runway localizing beacon and landing beam; and D and E the marker beacons.

stringent a test in actual practice, as visibility is not often so poor that the pilot can not see the ground just before landing.

As now constituted the radio system for blind landing of aircraft gives direction in three dimensions—lateral, longitudinal, and vertical—which is the information that the pilot must have to make a landing. Lateral direction is given by a runway localizing beacon, longitudinal direction by marker beacons, and vertical guidance by a landing beam. (See fig. 1.)

Work on this research project was divided into three stages, the first of which consisted of fundamental experiments and research to develop the basic component parts of the system, including the runway localizing beacon, marker beacons, landing beam, and suitable radio receiving and indicating apparatus for use in the air. The second stage consisted of the practical development of these component parts, fitting them together to form a complete system, and finally demonstrating

(Continued on page 171)

● A RADIO system for the *blind landing* of aircraft has reached the stage of development by the Aeronautics Branch of the Department of Commerce which permits its use at a busy terminal airport for service tests in fog and under other conditions of poor visibility. A demonstration of this system was given by the Aeronautics Branch on March 1 at the Newark Municipal Airport, Newark, N. J., with a pilot in a hooded (covered) cockpit.

The flights were made by James L. Kinney, Aeronautics Branch test pilot. During the past year and a half over 100 blind landings have been made in connection with the research work on this radio system for blind landing of aircraft which has been developed by the Aeronautics Branch through its research division, organized at the Bureau of Standards. While this system makes possible a completely blind landing, it will seldom be subjected to so



Figure 2.—The dial of the "combined instrument" with the needle pointers in three different positions.

Left:—Instrument panel of the "blind landing" airplane. Using the radio aids for blind landing, the pilot watches the dial "1" with crossed pointers at the lower center of the board. The vertical needle is actuated by a runway localizing beacon and the horizontal pointer by a landing beam. Keeping the two needles crossed over the small circle in the center of the dial, the pilot maintains the correct course for descent to a landing. To the right of this dial is a vibrating reed indicator "2" for receiving visual radio range beacon signals (it may also be employed to receive the runway localizing beacon). To the left is a distance indicator "3" showing the pilot his approximate distance from his objective. In addition to the signals of the runway localizing beacon and the landing beam, the pilot gets a signal from a marker beacon, showing the edge of the landing area, by means of his radio headphones. On the auxiliary panel at the right of the pilot's seat are switches "4" and dial knobs for the radio sets.

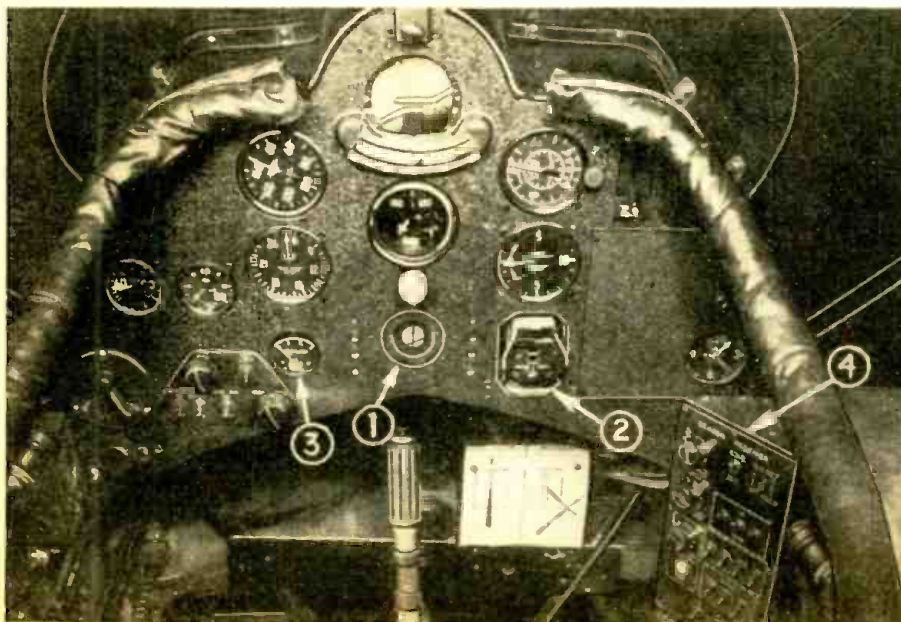

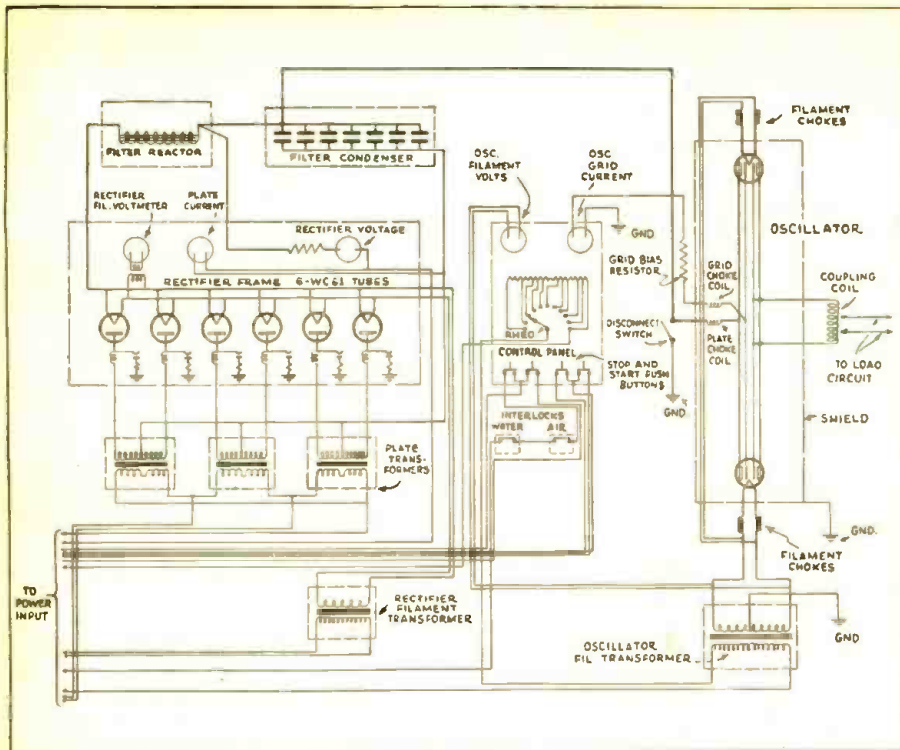

This diagram shows the arrangement of the high frequency (short wave) apparatus.

the circuit used, and the accompanying photographs show various parts of the equipment employed and the results of grain treated by this method, as contrasted with grain from the same lot untreated and which has been destroyed.

Hundreds of tests have been made at this experimental plant, using infested materials of various kinds and under various conditions of field strength at the treator and various periods of exposure, with the material both in motion and stationary. The following are examples of tests on wheat taken at random from the records.

(Continued on page 174)

Time Exposure Seconds	Plate Amperes	Oscillator Plate Volts	Temperature of Grain:		Number of Weevils Used	Number of Weevils Killed
			Before Treatment Degrees F.	After Treatment Degrees F.		
5	7.	8800	88	120	13	13
5	5.5	7800	86	125	10	10
5	5.5	9100	86	131	6	6
3	7.5	7000	84	138	10	10
3	8.	8000	87	140	9	9
9	5.4	7800	86	138	See note 1	
5	6.	7800	86	142	See note 2	

Note 1—Untreated grain highly infested with weevil. All live weevils killed by treatment. No indications of further weevil development.

Note 2—Untreated grain highly infested with weevil. All live weevils killed by treatment. No indications of further weevil development to date, a period of 6 months.

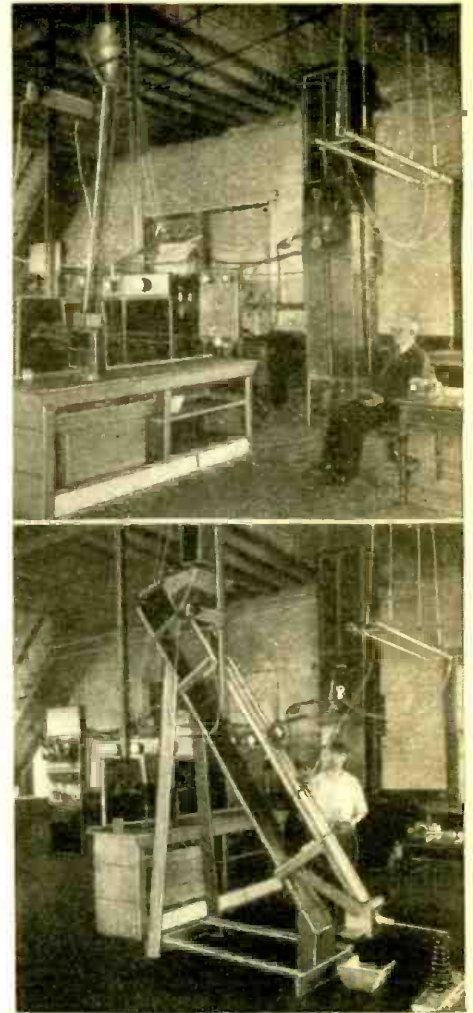

The upper photograph shows the boxed type plate-glass treator; lower photo shows the copper tubular concentric type treator.

When To Listen In

"B. B. C." News

● The "British Empire" short-wave stations are undergoing so many operating changes that the British Broadcasting Corporation has decided to omit definite call letters and wavelengths from the weekly programs that appear in its own official organ, "World Radio." We have emphasized in past issues that listeners should wait carefully for announcements, as this world-wide service is not yet fully stabilized. The Empire stations normally transmit on 2 wavelengths simultaneously.

The transmissions are divided into five zones. Zone 1 covers Australia, New Zealand, Pacific Islands, Papua, Sarawak, North Borneo; another section of Zone 1 takes in Hong Kong and Borneo. Zone 2 covers India, Ceylon, Malaya and Burma. Zone 3, Africa, except West Africa, Aden, Perim, Seychelles, and Malta. Zone 4, West Africa. Zone 5, Canada, Labrador, Newfoundland, and West Indies. The transmissions of Zone 5 naturally are the ones that American listeners are most interested in. The station that seems to have been coming through with the greatest volume and consistency is GSA, on 49.59 meters, or 6050 kilocycles. At the time this issue went to press the best time for reception of the British stations was between 6:00 and 8:00 p.m., Eastern Standard Time.

It is interesting to note that many American listeners have been able to pick

up beam transmitters that are not aimed at the United States at all. This does not mean that the beam transmitters are not working properly. They concentrate a major portion of the radiated energy in one direction, but enough energy leaks off around the sides and back to make DX reception on sensitive receivers possible.

* * *

U. S. S. R. on the Short Waves

That the Russians are wide awake to the international possibilities of the short waves is indicated by the promptness and thoroughness with which they acknowledge reports of reception. Mr. Seymour Lampel, 1446 East 98 Street, Brooklyn, New York, heard RV59 on 50 meters, wrote for verification and received the

following material, all in one envelope: two postcard views of Moscow, a typed letter in excellent English, a list of the principal radio stations in the U. S. S. R. and a program of English broadcasts for the whole month of March. The correct address for letters is as follows: Moscow, Solianka 12, Trade Union Radio Station, Palace of Labour, U. S. S. R. Short-wave transmissions are made every day including Sunday from 2:00 to 5:00 p.m., E.S.T. In addition to Russian, various announcers also use German, Dutch, Czechoslovakian, English, French, Swedish, Hungarian, Spanish.

Of the thirteen stations on the list, only two are short-wave.

1. Moscow—Comintern, RV-1, 1000 meters, 100 kw.
2. Moscow Experiment Transmitter, RV-2, 720 meters, 20 kw.
3. Moscow Radio Station of the All Union Council of Trade Unions of the U. S. S. R., RV-49, 1304 meters, 100 kw.
5. Moscow "Short-Wave" Stations of the Central House of the Red Army, 45.39 meters, 10 kw.
6. Leningrad I, 1000 meters, 100 kw.
7. Leningrad II, 351 meters, 10 kw.
8. Minsk RV-10, 11.05 meters, 35 kw.
9. Kiev RV-9, 1034.5 meters, 40 kw.
10. Odessa RV-13, 453.2 meters, 10 kw.
11. Kharkov, 937.5 meters, 20 kw.
12. Stalin Station, 424.3 meters, 100 kw.
13. Tiraspol, 358 meters, 4 kw.

(Continued on page 191)

Our \$500.00 Prize Contest

The contest for the best titles suggested for the cover picture on the May issue of SHORT WAVE CRAFT closed at midnight, May 30. Several thousand entries were received and the winners will be announced in the August number.

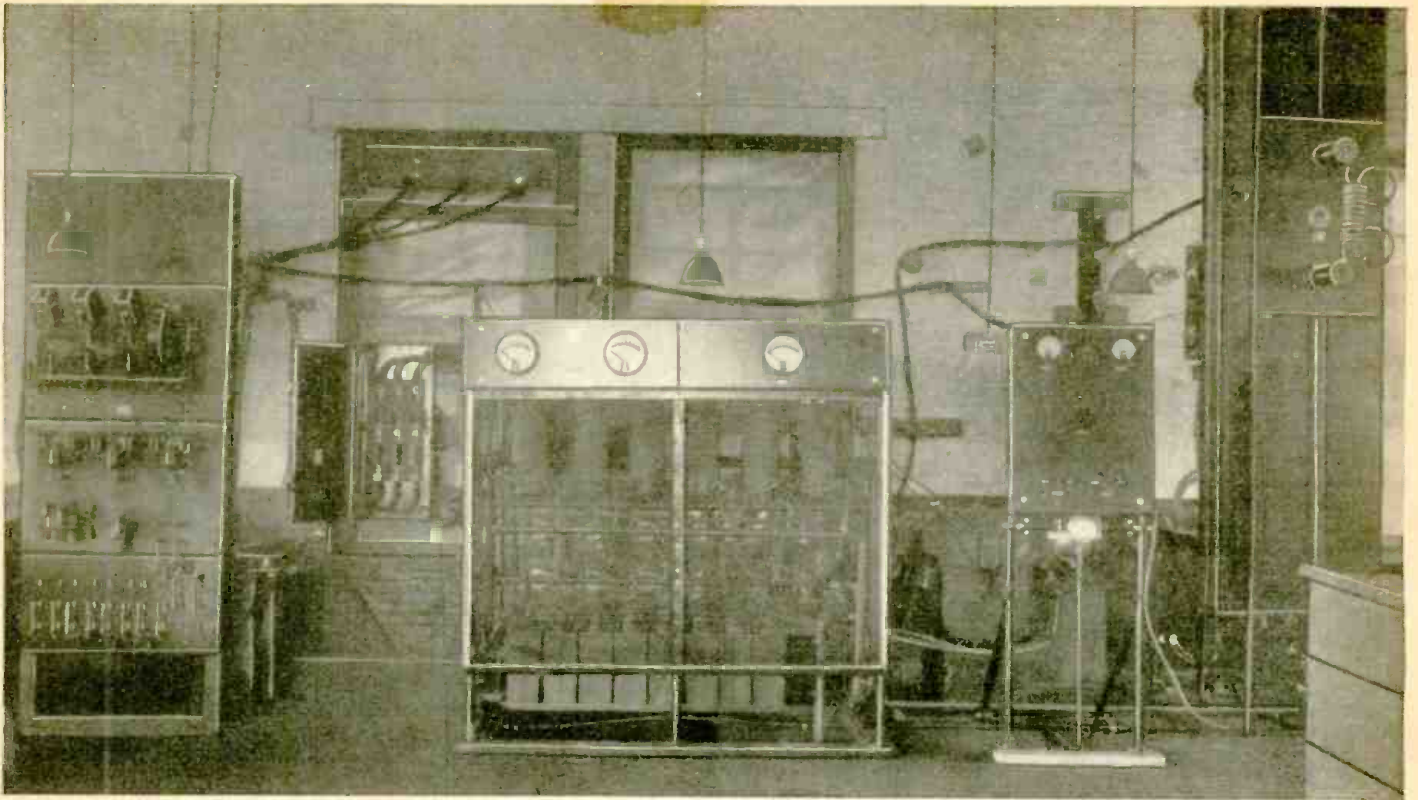

Above we have an interesting picture showing the unusual high-power short-wave apparatus which produces an extremely powerful, high-frequency field for treating insect-infested grain in bulk.

Short Waves Kill Grain Weevils

By J. H. DAVIS

Chief Engineer-Electric Traction,
Baltimore and Ohio Railroad Company.

● Intensive research during the past two or three years has brought to light important new uses of high-power short waves which appear to offer very promising possibilities. Insects in all of their stages from eggs to adults, infesting relatively dry

● A remarkable new method of rapidly killing insects in grains, beans, fruit, etc., by means of high-power short-waves, involving the use of forty-two million cycle, twenty thousand watt oscillating currents.

treated, including wheat, corn, meal, flour, starch, tobacco, nuts, beans, peas, cocoa beans, flower and garden seed, dehydrated fruit, milled cereals in bulk and in packages, etc.

The accompanying drawing shows



Tube at left shows weevil-infested wheat, treated by Mr. Davis' system for six seconds, the weevils being exterminated. Tube at right contains wheat from same lot, but untreated—wheat destroyed.

● bulk material, are killed almost instantly when exposed to the radiations of such high-power, high frequency electrical oscillations in *treators* of proper design. No damage is done to the material itself but there are indications that the germinating properties of wheat and other seed treated by this method may be enhanced. There is also the possibility that the food value of edible products treated by this method may be improved.

This method of treatment differs fundamentally from all other methods of insect extermination for the treatment of materials in bulk. The 20,000 watt standing wave, 42,000,000 cycle oscillating equipment which is the equipment installed in Baltimore under authority from the Baltimore and Ohio Railroad Company, was furnished by the Westinghouse Electric and Manufacturing Company of East Pittsburgh and it is believed is the first plant of its kind installed. The plant has been intensively operated for more than a year and a wide variety of insect-infested material has been successfully



A typical example of the damage to wheat in storage caused by insect-infestation; it is now possible by Mr. Davis' system, to save millions of bushels of wheat by treatment with short waves.

Station "NRH"

The World's "Tiniest" SHORT-WAVE Broadcaster

By **AMANDO CESPEDES MARIN**

It's Creator, Constructor and Program Director

My First Transmitting Experience

So, in my desire to "talk by wireless," I at first thought to convert my regenerative receiver into a transmitter. I was successful in accomplishing this stunt and thus I furnished music to my many friends for whom I had built receiving sets. You might be interested in knowing that some of these receiving sets, including my own, were so efficient that we were actually able to hear English radio stations in 1924, and, I obtained a verification from Lynch's International Radio Test. All in all, I built around 70 different sets and I burned out over \$200.00 worth of tube of the 201 and 199 type—which is part of the cost of learning the radio game.

Then came the advent of amateur short-wave transmission and I began to read RADIO NEWS and Q.S.T. magazines. I became thoroughly engrossed in the ideas and articles published in those early days and I finally built a transmitting set by means of which I hoped to imitate the broadcasting of the famous KDKA, which I admired very much, particularly due to the fact that KDKA really represented the "cradle of broadcasting." At that time our rather "feeble" receivers designed for short-wave reception, permitted us to hear only such powerful stations as those located at Pittsburgh, Schenectady, Daventry and Eindhoven (Holland); it was surely a great event when we first heard PCJ (Eindhoven) broadcasting all the way across the Atlantic to Heredia.

First Broadcast in 1928

I became wildly enthusiastic to start "broadcasting" and I tried several dif-

ferent arrangements to "get out" on short waves; and I endeavored to find a place in the ether waves just under the frequency used by WGY. Finally I used a 2-volt lamp in checking circuit to see that the oscillations in my antenna system would be just below WGY's wave. I kept at it and I finally rigged up and adjusted my little "junk" transmitter after four months' trial, so that it would really "step out" and broadcast. After all my studies and hard work in testing and retesting, I was finally successful in making my first radio broadcast on May 4, 1928.

NRH at that time was a very small affair, the transmitter employing a single 210 type tube, which was modulated by another similar size tube, the microphone amplifier comprising the audio frequency stages in one of my receiving sets. The "mike" was mounted on the front of the tin horn of my phonograph and I used another hand-

type, single-button "mike" for announcing. All of this "junk" was part of the accumulation I had been using for broadcasting on 310 meters wavelength since 1922, during which time I was having a lot of fun locally, broadcasting music, etc., to my friends.

(Continued on page 181)

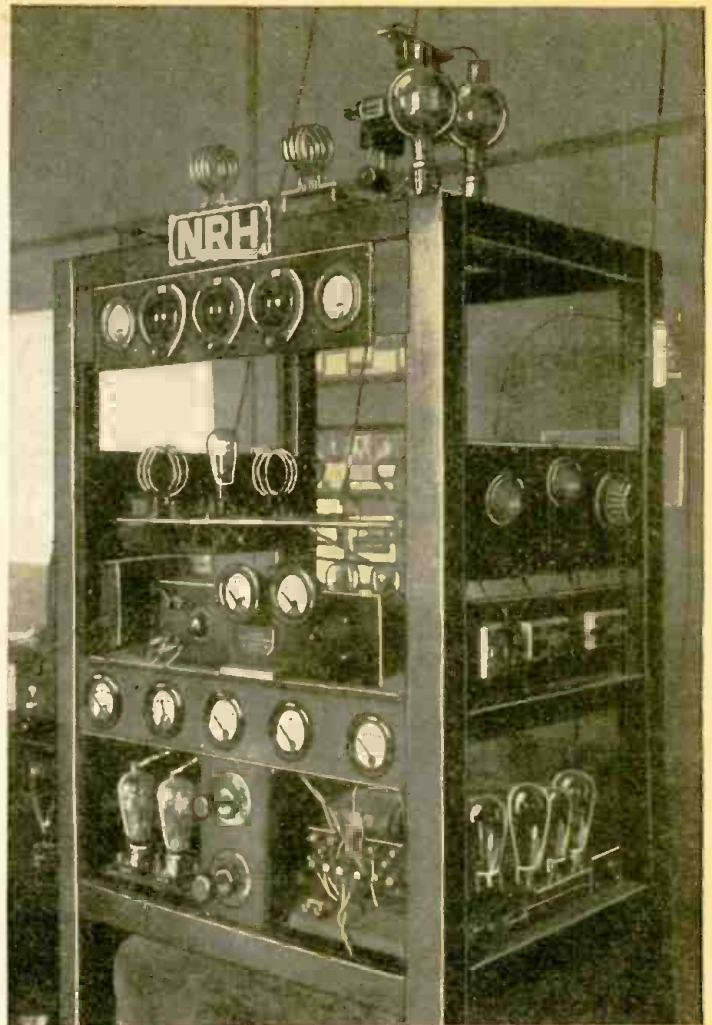

The new NRH transmitter rated at 150 watts and containing master oscillator and power amplifier.

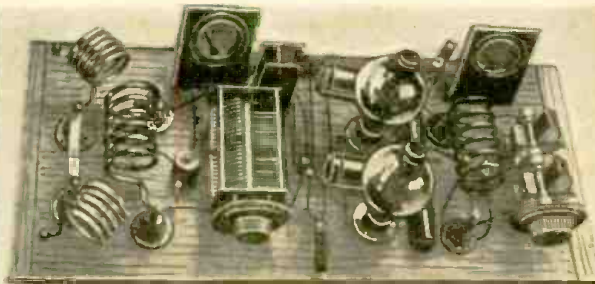

Above—the push-pull transmitting stage of TI4NRH.

Left—The secretary's corner in station NRH, operated by Amando Cespedes Marin, at Heredia, Costa Rica. Here the hundreds of letters received weekly from "listeners in" from all parts of the world are read and answered.

Right—a corner of the studio at short-wave broadcasting station NRH. Note the "mike" on the four-legged table to the right of the picture.

Here the famous Spanish programs from "little NRH" originate.



How I Operate My Little



Amando Cespedes Marin.

● Heard in every part of the world, little TI4NRH, more popularly known simply as NRH, the famous $7\frac{1}{2}$ watt short-wave broadcasting station located in Heredia, Costa Rica, Central America, has established for itself and its creator and owner, Amando Cespedes Marin, an international reputation and an ideal thoroughly worth striving for. Without a doubt Mr. Marin, by his persistent study and continual experimenting has accomplished greater transmission distances with the astonishingly small power of $7\frac{1}{2}$ watts, than has any other station in the world.

Mr. Marin's broadcasting has been mostly a "labor of love" as he tells you in this highly interesting story of his experiences. NRH is now using a new 150 watt transmitter, which, of course, is carrying its programs into places thousands of miles distant with less fading and greater clarity than was possible with the old $7\frac{1}{2}$ watt transmitter. You will be charmed indeed by this most unusual narrative of how Mr. Marin had the inspiration and the perseverance to keep "little NRH" on the air for five consecutive years—and she's now going stronger than ever!

● HOW can I best give you an interesting narrative of the world's tiniest short wave broadcaster, TI4NRH? For five consecutive years now, night after night, I have had great fun operating my little station NRH, as it is affectionately known to thousands of short-wave listeners all over the world.

Up to the present time, station NRH has been the recipient of nearly 17,000 letters and the writer is indeed grateful for the many fine articles which have appeared in newspapers and magazines in practically every country praising the ambitious aims of station NRH.

The power behind the throne of NRH can be summed up by stating that success in this endeavor, as in any other, is usually achieved only by hard work and "keeping everlastingly at it." In spite of the small size and low power of the transmitter used at NRH (most of its far-flung transmission over thousands of miles of space has been accomplished on a $7\frac{1}{2}$ watt transmitter!) NRH has accomplished a really worth-while piece of work in cementing good fellowship in Spanish America, as well as in the United States and other countries. Maybe some of the readers of SHORT WAVE CRAFT have read with interest my book entitled, "Me And Little Radio-NRH."

"Old Cespedes Marin is now 52 years old; perhaps at the narrow end of life"—(as the author quaintly puts it). In 1902, while visiting Nicaragua, I met a man who was endeavoring to start a wireless telephone company and I sure had a big laugh. Later I went to Buffalo, N. Y., and there I had the great good fortune to meet Thomas A. Edison, also the famous Santos Dumont. This was at the time of the great exposition being held at Buffalo, and I also had the pleasure of becoming ac-

quainted with the then unknown, but now world-famous Dr. Lee de Forest. Although at that time I, of course, admired the genius represented by the Vitagraph motion-picture projector and also the phonograph, and the spectacular stunts accomplished in that early day by Santos Dumont with the dirigible balloons, I was most profoundly impressed with the intriguing and then brand new offspring of the scientific world, the *wireless*. Later on, having been appointed as an attaché of the Costa Rica Commission to the St. Louis World's Fair, held in 1904, and admiring more than ever before the witchery of the beautiful electrical illumination at the Fair, and even more strongly the great perseverance of your Dr. de Forest and his radio developments, I contributed \$10.00 toward the radio art, as we might say, by purchasing ten "hundred dollar" stock certificates, which I later presented to a hospital in St. Louis, who realized the full face-value of the certificates.

Thus I followed the development of radio and electricity in those earlier years, meeting some of the world's famous men who gave me great encouragement. For many years my aim was to follow up the radio telephone; after many years of theorizing and thinking about it, I finally realized the goal of my dreams when I built my first transmitter, which started off with the call letters NRH.

First to Hear "KDKA" in Costa Rica

I will not take up space at this time to explain at any great length, the many hours of study I spent on radio set-building, but it may be interesting to the many thousands of "listeners-in" to NRH, that the writer was the first person in Costa Rica to hear the election returns as broadcast by KDKA at Pittsburgh, Pa. This was the famous first broadcast of election returns which were given by Frank Conrad, from a very unromantic looking studio built in a garage near Pittsburgh in 1920.

You would surely have laughed if you could have seen the receiver that was used to pick up this, at that time very remarkable, long distance broadcast from KDKA. The receiving set was a one-tube affair and among all its curling wires and other radio paraphernalia, two large paper funnels were fitted on to the phone caps, so as to increase the volume of sound and in this way let the whole family and many "unbelievers" hear the voice of the speaker in Pittsburgh. Some of the scoffers laughed and seriously inquired "Where have you hidden the phonograph?" Since that immortal day I have constantly become more interested in improving radiophone broadcasting around the world, and not caring particularly whether the apparatus was of the largest and up-to-date type, such as that used in the usual commercial broadcast stations.



The Home of little "NRH."

*"Me And Little Radio-NRH" is published by the author at Heredia, Costa Rica, C. A., the price of the book being \$2.50 in paper covers, and \$3.50 if leather bound. All contributions or monies realized from sales of Mr. Marin's book go towards defraying the operating expenses of his famous little station, NRH.



Celestial Short Waves

An Editorial by HUGO GERNSBACK

● WE, who are accustomed to think that radio waves always must be man-made, have frequently forgotten that after all radio waves, together with light waves, ultra-violet and X-rays, etc., belong to the same family; all being *electro-magnetic* waves. They are, therefore, "natural" waves and do not necessarily require apparatus or machinery to produce them. Radio waves and light waves, for example, are one and the same thing, except that they differ in their rate of vibration. The faster the vibration (higher frequency), the lower the wavelength. As is well known, the short-wave radio spectrum runs from about 2 meters up to 200 meters. Light waves, where the frequency is very much faster, run only a small fraction of a meter and they are, therefore, usually rated in ten-billionths of a meter ("Angstrom units") because the wavelength is so minute.

Once we have understood that all wave-motion of an electro-magnetic nature occurs freely in nature, we need no longer be surprised at the recent discovery that there are natural short waves abundant in the cosmos.

Recently, Mr. Karl G. Jansky of the Bell Telephone Laboratories discovered by means of a special, highly-sensitive short-wave receiver that a new kind of short radio waves are reaching us out of space. These interstellar radio waves differ from the cosmic rays (as well as from the phenomenon of "cosmic radiation" of light discovered by Slipher) in that the waves of radio come seemingly from a single direction, whereas the cosmic rays come from all directions.

Indeed, these new celestial short waves appear to come from the center of the Milky Way, and experiments carefully made for over one year have confirmed this finding. These short waves, which have been investigated during this period, are of the order of 14.6 meters, at a frequency of about 20 million cycles a second. The intensity of the received signal, is rather low; so that it is necessary to have delicate apparatus in order to detect it at all.

In a preliminary report, published in the *Proceedings of the Institute of Radio Engineers* last December, it was explained that tests showed the presence of three separate forms of "static": 1. disturbances from local thunderstorms; 2. atmospherics from distant thunderstorms; and 3. a steady "hiss type of unknown origin." It was the latter form of static which now appears to be short-wave energy coming to us from the direction of the center of the Milky Way.

Without going into the technicalities employed by the discoverer of these celestial short waves, it should be noted that the signal received is steady at all times of the year; in fact, on the 15th of May the National Broadcasting Company broadcast the sound made by these new short

waves as received on Mr. Jansky's radio set in the research laboratory at Holmdel, N. J. What the radio audience heard on a nation-wide hook-up was a low hiss, sounding like escaping steam.

While, at the present time the reception of these celestial waves can be only of theoretical importance, he would be a bold prophet who would now say that these waves may never have any practical application.

When Heinrich Hertz first experimented with short waves in the '80s, no one could have foreseen their application to world-wide radio. In the short span of fifty years a new and revolutionary art has been created, that of radio, all due to Hertz's original discovery.

Man, so far, has made very little use of the tremendous energy that abounds all around him; yet, though it happens to be invisible, is unfelt, and cannot now be utilized, there is no reason why at some later date such energy may not be found running our entire world.

The fact that these particular short waves take some 50,000 years to reach us, and that the original energy behind them must of necessity be in the order of 40,000 billion, billion, billions of horsepower, makes the problem all the more intriguing. There is no question that some use—an important one—will be found one of these days, perhaps not very far in the future, for these celestial waves. Just what the application will be, no one, of course, can foretell.

It only goes to show again how little we know about radio, and more particularly about short waves. The short-wave experimenter of today no doubt is pioneering, and, given the right equipment, both physical and mental, there is no reason why he should not conquer new worlds.

It is usually the careful experimenter, who also knows something about general physics, that will help to make the great discovery of tomorrow. It is all good and well to build a short-wave radio set and to listen in to "foreign" stations. *The far more important consideration is to listen to those mysterious extraneous sounds with which all short-wave listeners are so well acquainted.*

When your doctor listens to your heart, through his stethoscope, he hears all sorts of queer noises; each particular sound and noise has a meaning all of its own. When you listen to your short-wave set, the whole universe is throbbing in your ears. You may listen to signals of tremendous importance, if you can rightly interpret these sounds. Some day, we will know exactly what these sounds are and will have a special classification for them. And it would seem that short waves, particularly, will help us to become acquainted with those forces that abound around us, of which little is known, and which, someday, may change the very face of this earth.

SHORT-WAVE CRAFT IS PUBLISHED ON THE 15th OF EVERY MONTH

This is the July, 1933, Issue - Vol. IV, No. 3. The next Issue Comes out July 15th

Editorial and Advertising Offices - 96-98 Park Place, New York City

POWERTONE Modulated Oscillators

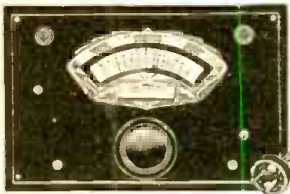

Cabinet Type

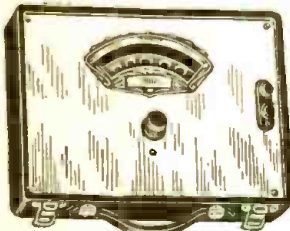

Portable Type

Portable & Cabinet Types— A.C. and D.C. Models

Directly calibrated frequencies. Continuous band 55-155 k.c. Popular frequencies 115, 130, 172.5, 175, 177.5, 260, 400, 450 K. C.

A.C. Model: Employs 56 tube—no batteries required. Provides a modulated signal. Simply plug in A.C. line.

D.C. Model: Employs 230 tube—1½ volt dry cell—22.5 volt "B"—"C" Battery. Radically new in design and construction. May be used to align any receiver whether T.R.F. or Superheterodyne design.

Provides a 100% modulated signal—sharp with no frequency drift. Fundamental frequency adjustable from 50 to 150 k.c.—average accuracy 1%—guaranteed accuracy 2%. Strong harmonics up to and including 10th, which covers the broadcast band 500-1500 k.c. Useful harmonics up to 28th used for frequency checking—particularly desirable for checking the coverage of short coil sets to insure overlapping ranges.

Portable Type—A.C. Model.....	\$8.95
Battery Model.....	8.95
Cabinet Type—A.C. Model with tube.....	\$6.50
Battery Model with tube, less batteries.....	\$6.50

4-Tube A.C. Short Wave Receiver 15 to 550 Meters

A "corking" good receiver that will receive a short wave station from all parts of the world on your loud speaker. With the aid of headphones this receiver is capable of logging short wave stations from all continents. Receiver is very simple to operate, and oscillation is always under full control of the operator. The full vision illuminated dial is accurate and alloted positions can be logged and found in their 1-58 triple grid amplifier. Uses 1-56 triode and 1-47 power pentode. 1-30 type rectifier enclosed in shielded metal cabinet. Comes complete kit of parts (4 OCTO form coils, tubes wired (OCTO-form coils, tubes)..... \$16.95
..... \$19.75

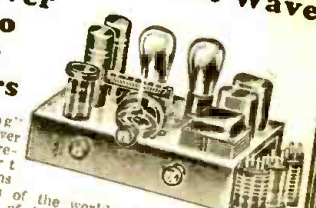

Send for Literature and Prices on the POWERTONE - WALLACE Hoover Prize Cup Winner, Short Wave Receiver. As advertised in the WALLACE Short Wave Manual.

"Radio News" Handy Portable 2-tube Short Wave Receiver

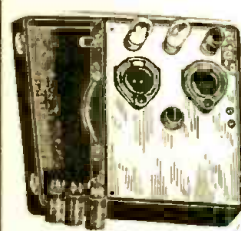

Designed for reliable long distance short wave reception.

CIRCUIT—Selective regeneration with one stage of flat response audio. Delivers excellent headphone reception when used on a good aerial. Supplied complete with plug-in coils covering 15 to 200 meters. Uses two 230 low current tubes for long battery life.

CASE—Handsome fibroid with detachable cover. Batteries self contained. Can be placed in operation in a very few minutes.

Kit of parts.....	\$9.95
Sylvania tubes.....	1.00
Lightweight headphones.....	.95
Set of batteries.....	1.75
Wired extra.....	1.50

UNIVERSAL A.C. & D.C. Short Wave Receiver

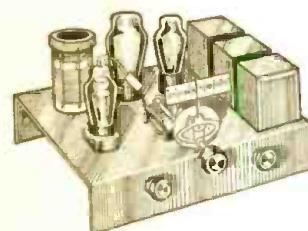

As Described in Radio World on May 13

A brand new number. For the first time you can have a short wave receiver that operates on either A.C. or D.C. Employs all recently released tubes. 1-78, 1-43, and 1-25-25.

Tubes operate at full efficiency due to the special voltage rectification circuit used. Laboratory tests with these receivers have resulted in reception from all parts of the globe. Uses plug-in coils for maximum efficiency and wide band spread. Absolutely harmless in operation. No external batteries required. Simply plug into any A.C. or D.C. light socket, attach aerial, ground and headphones or speaker and receiver is ready to operate.

Complete kit of parts, coils, blueprints.....	\$7.95
Wired and tested with coils.....	9.95
Set of R.C.A. Licensed tubes.....	3.25

R. C. A. Magnetic Chassis Speaker



The identical chassis used in the R. C. A. 100A-100B Speakers which list for as high as \$35.00. Note built-in output transformer which permits use of high voltage without distortion. Generous oversized magnet. The thick armature is accurately centered, the sturdy metal frame is lined with a special self-baffling fabric, greatly improving acoustic properties. Measures 9" outside diameter, 4½" deep overall.

\$2.75

TEMPLE BELL 6-tube Conso- lette Receiver



The Greatest Radio Value of The Year

A full sized console set at the price of an A.C.-D.C. midget. Produces remarkable tone quality with ample sensitivity for all requirements. Employs a highly developed T.R.F. circuit using latest type tubes—2-58, 1-37, 1-56, 1-2A5 and 1-80. Delivers 6 watts of undistorted output. Handsome walnut two-toned cabinet—exquisitely moulded. Measures 35½" high, 21" wide and 10½" deep.

\$14.95 complete with tubes

Rocket 2-tube Short Wave Receiver

An extremely competent receiver. Remarkable reception and simplicity of tuning make this a popular short wave set. Constructed of the finest parts. HAMMARLUND tuning and regeneration controls. CARPER rheostat. POWERBEST short wave plug-in coils (15 to 200 meters), and many other nationally known parts. Uses 2-230 type two volt tubes for perfect, and quiet reception. The kits come complete with every conceivable part necessary. Everything is already drilled ready for assembling.

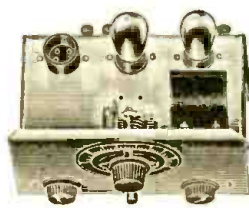

Kit of parts with blueprint.....	\$4.25
Wired.....	5.50

Powertone Short Wave Converter



The most economical and sure way to receive splendid short wave reception to be heard on any standard "broadcast-wave" receiver. This converter transforms any broadcasting receiver into a short-wave superheterodyne. Insures reception without "static." Connects to your house current. Uses three 27 tubes. Many owners report loud speaker volume of music from Germany, Mexico, South America, Africa, etc. All embodied in a handsome cabinet as illustrated.

Complete with tubes.....	\$6.95
--------------------------	--------

60% off Stancor Transformers

Beginner's Twin Short Wave Receiver As Described in the N. Y. Sun, Mar. 4th

Economical—Uses two, 2-volt 230 tubes.

Sensitive—Consistent tone & stance reception under all conditions.

Selective—Logs the station you want, excluding all others.

A well designed short wave receiver which covers all useful short waves—police calls, ship-to-shore, television, amateurs, etc. Constructed of the finest parts.

HAMMARLUND tuning condenser, regeneration control and drum dial.

POWERBEST meter calibrated coils (15-200 meters)

HIGH QUALITY audio transformer.

Kit with coils blueprint.....
 \$7.95 || Wired with Sylvania coils..... | 8.95 |
| Set of tubes..... | 1.00 |

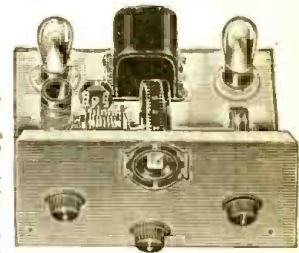

80% must accompany C. O. D. orders.

TRY-MO RADIO CO. INC. 85 Cortlandt St. New York

Dept. S-7, Branches—178 Greenwich St. (Nr. Dey St.) 179 Greenwich St. (Cor. Cortlandt St.) N.Y. City

Send for New 108 Pg. Catalog

Send for FREE 108 pg. Catalog



Mr. E. H. Scott is shown here aboard the R. M. S. Maunganui, en route to New Zealand. On this 20,000-mile cruise to the South Seas he made constant tests of broadcast band reception under greatest difficulties.

Consistent, clear reception with loudspeaker volume of stations all over the U. S. A. is the definite, verified record of Mr. Scott's spectacular test, which included ship-board operation under most trying circumstances.



IN FAR-AWAY SIAM

From Lakon Lampang, Siam, Mr. George Wyga tells of natives who called priests to expel devils which they believed kept his SCOTT silent when it had two faulty tubes. He is "pleased with the set."



A FAMOUS BAND LEADER

Columbia Chain listeners all know Frank Westphal and his music from Chicago's WBBM. He says of his SCOTT, "Such marvelous tone quality is a delightful revelation . . . it not only rivals nature, it is nature."

From All Over the World Comes
MORE AND MORE PROOF
of SCOTT Superiority

WHEN A RECEIVER consistently, day in and day out, year after year, receives the universal acclaim of owners scattered from one end of the globe to the other for the most startling spectacular performance in all radio history . . . THAT MEANS SOMETHING!

Upon the world-wide, unassailable, documentary endorsement of the legion of written, verified reports of SCOTT ALL-WAVE Deluxe owners everywhere . . . this receiver rests its case.

The few expressions reproduced here are typical of those which pour in upon us continuously. They give an inkling of how this laboratory-precision custom-built receiver stands with its owners.

World-Wide Reception Guaranteed

Because the SCOTT ALL-WAVE Deluxe is constructed by skilled engineers to give the very brand of performance reported . . . fidelity of reproduction, sensitivity almost beyond measurement, selectivity to conquer the congestion of broadcast the world around . . . it carries the strongest guarantee ever offered. It is guaranteed to receive daily, with loud speaker volume, short wave broadcasts from stations 10,000 miles or more distant . . . and its every part (except tubes) is warranted for five years.

E. H. SCOTT RADIO LABORATORIES, Inc.
4450 RAVENSWOOD AVE., Dept. S.W.C. 73, CHICAGO, ILL.



IN CENTRAL MEXICO

Baron v. Turckheim reports daily reception of broadcasts from Germany, France, Spain and Australia. "The tone is faultless," he writes from Mexico City, and then adds, "This is my first great radio."



IN THE PHILIPPINES

U. S. Army Sergeant Frank Sublette, Fort Mills, Cavite, P. I., says, "Russia, England, France come in just wonderful. Will never buy any other receiver but a SCOTT." . . . And tropic reception is "tough."

SEND COUPON AT ONCE FOR COMPLETE INFORMATION

The SCOTT ALL-WAVE Deluxe gives perfected performance on all wave bands from 15 to 550 meters. It incorporates every worthwhile development of radio engineering, including Automatic Volume Control, Visual Tuning, Static Suppressor, etc. For all technical data, price quotations, and performance PROOFS, send coupon.



E. H. SCOTT RADIO LABORATORIES, INC.
4450 Ravenswood Ave., Dept. S.W.C. 73, Chicago, Ill.
Send me at once, without obligation, complete information regarding the SCOTT ALL-WAVE Deluxe, including performance PROOFS, technical data, etc.

Name

Address

City State

**NOW
READY**

The Two NEW SHORT WAVE BOOKS

Here is Great News!

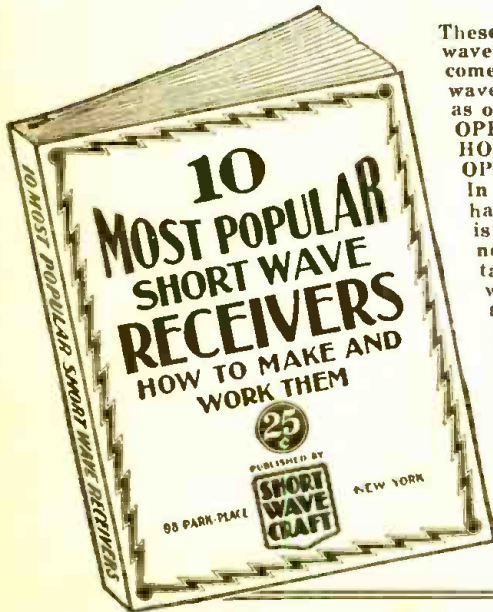

These new books contain everything on short waves worth knowing and the books will be welcomed by all short wave experimenters, short wave fans and short wave enthusiasts, the same as our former two books HOW TO BUILD AND OPERATE SHORT WAVE RECEIVERS, and HOW TO BECOME AN AMATEUR RADIO OPERATOR.

In conformity with the times these books have been priced at 25c instead of 50c, which is the price of our other books. Yet the two new 25c volumes that we are offering, contain a tremendous amount of information, with the type and illustrations chosen in such a manner as to give you almost as much for your 25c as you received for your 50c before. Only by increasing the press run enormously and making other printing economies has it been possible to price these books at such a low, popular price.

You make no mistake in getting either or both of these new and popular books and we know from our many years of experience with short wave enthusiasts that you will thank us for having made these books possible.

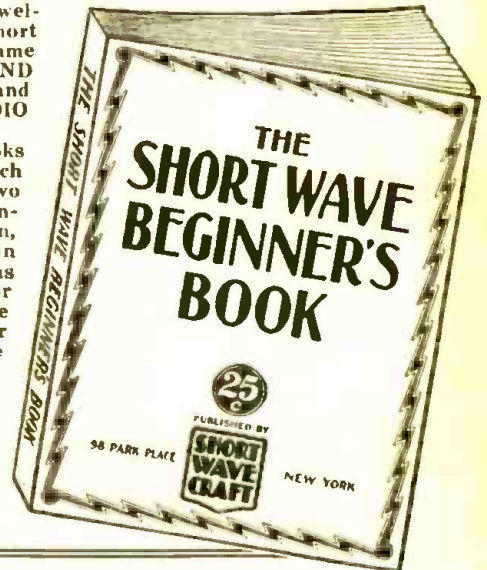

Ten Most Popular Short Wave Receivers. How to Make and Work Them

This new volume is a revelation to those who wish to build their own short wave receivers. The editors of SHORT WAVE CRAFT over a period of years have learned to know what short wave experimenters and set builders want. They have selected ten outstanding short wave receivers and these are described in the new volume. Everything worthwhile about every one of the ten receivers is described in the text. Each receiver is fully illustrated with a complete layout, pictorial representation, photographs of the set complete, hookup and all worthwhile specifications. Everything from the simplest one tube set to a 5-tube T. R. F. receiver is presented. Complete lists of parts are given to make each set complete. Select any or all receivers and know beforehand that you will be able to successfully build and operate such a receiver and not waste your money. You are shown how to operate the receiver to its maximum efficiency.

CONTENTS

- The Doerle 2-Tube Receiver That Reaches the 12,500 Mile Mark, by Walter C. Doerle.
- 2-R.F. Pentode SW Receiver having two stages of Tuned Radio Frequency, by Clifford E. Denton and H. W. Secor.
- My de Luxe S-W Receiver, by Edward G. Ingram.
- The Binneweg 2-Tube 12,000 Mile DX Receiver, by A. Binneweg, Jr.
- Build a Short Wave Receiver in your "Brief-Case," by Hugo Gernsback and Clifford E. Denton.
- The Denton 2-Tube All-Wave Receiver, by Clifford E. Denton.
- The Denton "Stand-By," by Clifford E. Denton.
- The "Stand-By" Electrified.
- The Short Wave MEGADYNE, by Hugo Gernsback.
- A COAT-POCKET Short Wave Receiver, by Hugo Gernsback and Clifford E. Denton.

Boy, Do They Roll In on this One Tube! By C. E. Denton.
The S-W PENTODE-4, by H. G. Cisin, M. E.
Louis Martin's Idea of A GOOD S-W RECEIVER, by Louis Martin.

IMPORTANT

THERE IS NO DUPLICATION BETWEEN THIS BOOK AND OUR OTHER VOLUME—"HOW TO BUILD AND OPERATE SHORT WAVE RECEIVERS." ALL THE MATERIAL PUBLISHED IN THE NEW BOOK HAS NEVER APPEARED IN ANY BOOK BEFORE.

**PRICE 25c PREPAID 40 PAGES
OVER 75 ILLUSTRATIONS**

The Short Wave Beginner's Book

Here is a book that will solve your short wave problems. It contains everything that you would wish to know in connection with short waves, leading you in easy stages from the simplest fundamentals to the present stage of the art as it is known today. It is the only low-priced reference book on short waves for the beginner.

The book is profusely illustrated with all sorts of photos, explanations and everything worthwhile knowing about short waves—the book is not "technical." It has no mathematics, no "high-faluting" language and no technical jargon. Wherever technical words are used, explanations are given. You are shown how to interpret a diagram and a few simple sets are also given to show you how to go about it in making them. Everything has been done to make it possible to give you a complete, fundamental understanding of short waves.

After reading this book, you will never be at a loss for short wave terms, or will have to consult other text-books or dictionaries. The editors of SHORT WAVE CRAFT who have edited this book have seen to it that everything has been done to make this volume an important one that will be used as reference for years to come.

It abounds with many illustrations, photographs, simple charts, hookups, etc., all in simple language. It also gives you a tremendous amount of very important information which you usually do not find in other books, such as time conversion tables, all about aeriels, noise elimination, how to get verification cards from foreign stations, all about radio tubes, data on coil winding and dozens of other subjects.

Partial List of Contents

- Getting Started in Short Waves—the fundamentals of electricity.
- Symbols, the Short Hand of Radio—how to read schematic diagrams.
- Short Wave Coils—various types and kinks in making them.
- Short Wave Aeriels—the points that determine a good aerial from an inefficient one.
- The Transposed Lead-in for reducing Man Made Static.
- The Beginner's Short-Wave Receiver—a simple one tube set that anyone can build.
- The Beginner's Set Gets an Amplifier—how the volume may be increased by adding an amplifier.
- How to Tune the Short-Wave Set—telling the important points to get good results.
- Regeneration Control in Short Wave Receivers.
- Audio Amplifiers for S. W. Receivers.
- How to Couple the Speaker to the set.
- Learning the Code—for greater enjoyment with the S-W set.
- Wave length to Kilocycle Chart.
- Wire Chart—to assist in the construction of coils.
- Kinks in the construction of S-W Receivers.

**PRICE 25c PREPAID 40 PAGES
OVER 75 ILLUSTRATIONS**

Mail Coupon Today!

SHORT WAVE CRAFT SW-7-33
58-98 Park Place, New York City.

- Gentlemen:
- I enclose herewith 25c. for which please send me prepaid, a copy of your new book "Ten Most Popular Short Wave Receivers. How to Make and Work Them."
 - I enclose herewith 25c for which please send me prepaid, a copy of your new book "The Short Wave Beginner's Book."
 - I enclose 50c for which please send me, prepaid, your two books, "Ten Most Popular Short Wave Receivers. How to Make and Work Them," and "The Short Wave Beginner's Book."

(Send money order, check, cash or new U. S. stamps. Register letter if it contains currency or stamps).

Name
Address
City State

ORDER DIRECT FROM THIS PAGE

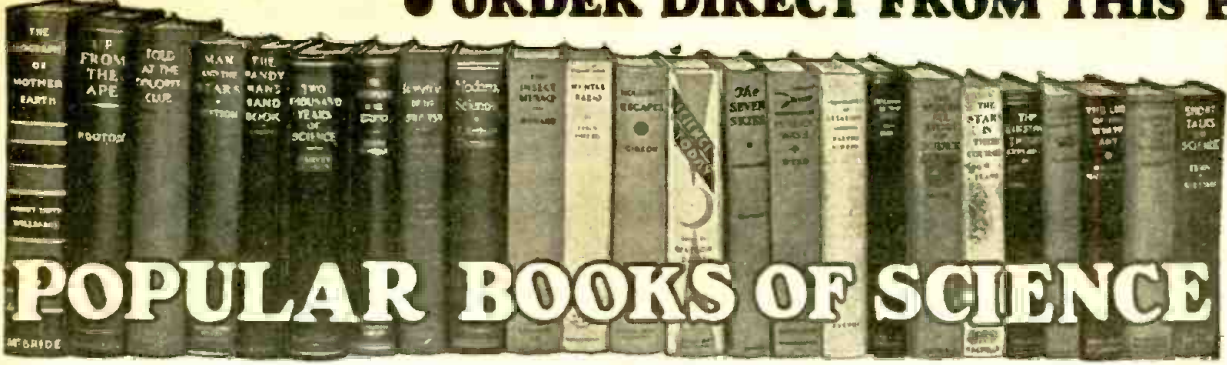

We herewith present the most complete collection of recent important popular Science books...

POPULAR BOOKS OF SCIENCE THIS LIST CHANGED MONTHLY. NOTE NEW LOW PRICES

- ASTRONOMY: MAN AND THE STARS, \$2.50; THE UNIVERSE AROUND US, \$4.50; THE STARS IN THEIR COURSES, \$2.50; POPULAR ASTRONOMY, \$6.00; AVIATION: WINGS OF TOMORROW, \$2.50; CHEMISTRY: THE AMATEUR CHEMIST, \$1.50; EXPERIMENTAL CHEMISTRY, \$2.00; HOW TO UNDERSTAND CHEMISTRY, \$2.00; POPULAR CHEMISTRY EXPERIMENTS, \$1.50.

- works, inks and paints, glass blowing, food analysis and electroplating... ELECTRICITY: THE BOOK OF ELECTRICITY, \$1.50; PRACTICAL ELECTRICALS, \$0.75; THE WIMSHURST MACHINE, \$0.75; INDUCTION COILS, \$1.50; GENERAL SCIENCE: TWO THOUSAND YEARS OF SCIENCE, \$3.50; EXPERIMENTAL SCIENCE, \$2.00.

- Science has found out—about the sun, moon, stars, the earth, light, electricity, the weather, germs... INVENTION: THE PSYCHOLOGY OF THE INVENTOR, \$3.00; PATENTS, INVENTIONS, \$0.35; MECHANICS: EXPERIMENTAL MECHANICS, \$2.00; THE HANDY MAN'S BOOK, \$4.00; THE HOME HANDY BOOK, \$1.50.

- MISCELLANEOUS: HOUDINI'S ESCAPES, \$3.00; NEW AND ORIGINAL MAGIC, \$3.00.

- MICROSCOPY AND PHOTOGRAPHY: SCIENCE AND PRACTICE OF PHOTOGRAPHY, \$2.50.

- SEXOLOGY: THE SEXUAL SIDE OF MARRIAGE, \$2.50; SEXUAL IMPOTENCE, \$3.00; COMPLETE BOOK OF SEX KNOWLEDGE, \$2.75.

- WOMEN, HER SEX AND LOVE LIFE, \$3.00; SANE SEX LIFE AND SANE SEX LIVING, \$2.00; MARRIED LOVE, \$1.00.

- THE BOOK OF THE MICROSCOPE, \$1.50; LOVE, A TREATISE ON THE SCIENCE OF SEX ATTRACTION, \$3.00; SEXUAL TRUTHS, \$3.00; BIRTH CONTROL OR THE LIMITATION OF OFFSPRING, \$2.00; SEX KNOWLEDGE FOR MEN AND BOYS, \$2.50; SEX, LOVE AND MORALITY, \$3.00; MARRIED LIFE AND HAPPINESS, \$3.00; AMERICA'S SEX AND MARRIAGE PROBLEMS, \$3.00.

How to order We cannot ship C.O.D. Our prices are net, as shown. Please include sufficient postage for Parcel Post, otherwise books must be shipped by express collect.

SCIENCE PUBLICATIONS 94SW Park Place New York, N.Y.

We can get ANY book in Science or Mechanics, Radio, etc. Just furnish us with Title and Author or tell us in which topic you are interested.

IN THIS ISSUE: PROMINENT SHORT-WAVE AUTHORS

Marin • Worcester • Denton • Shuart • Martin • McEntee

HUGO GERNSBACK
Editor



H. WINFIELD SECOR
Managing Editor

CONTENTS FOR JULY, 1933

FEATURES:

Editorial—Celestial Short-Waves, by Hugo Gernsback.....	135
How I Operate My Little Station—"NRH," by Amando Cespedes Marin, Heredia, Costa Rica.....	136
Short Waves Kill Grain Weevils, by J. H. Davis.....	138
When to Listen in, by Robert Hertzberg.....	139
How Ultra Short Waves Guide Planes in "Blind Landings".....	140
8-Year-Old Girl Gets Radio License.....	141
Try This 2-Tube Regenerative-Oscillodyne, by J. A. Worcester, Jr.	142
High-Frequency Cable for Connecting Antennas, by B. Kleebinder, E. E.	145
The Denton "Economy 3," by Clifford E. Denton.....	146
Doerle "2-Tuber" Adapted to A. C. Operation, by George W. Shuart, W2AMN-W2CBC	148
The 59—A Triple-Grid "Out-Put" Tube, by Louis Martin.....	150
A New 5-Meter Receiver.....	151
The "Ace High" Band-Spread 3, by Howard G. McEntee.....	152
This Converter Spreads Bands Over Tuning Dial, by George W. Shuart, W2AMN-W2CBC	154
Three Unusual English Short-Wave Hook-Ups	156
"Air-Rover" Hauls 'Em in—All on Two "2-Volt" Tubes, by Clifford E. Denton	158
World-Wide Short-Wave Review, Edited by C. W. Palmer	160
Powertone A. C. Short-Wave 4.....	162
\$5.00 for Best Short-Wave Kinks, Monthly.....	163
What's New in Short-Wave Apparatus.....	164
SHORT-WAVE STATIONS OF THE WORLD—Section 2	165
Letters from Short-Wave Fans.....	168
Short-Wave League, by Robert Hertzberg.....	169
Short-Wave QUESTION BOX.....	170

FEATURES IN NEXT ISSUE

Short Waves from Inter-Stellar Space—the remarkable work of Dr. Karl G. Jansky, with photos of apparatus.
The Doerle 3-Tube Receiver Adapted to A. C. Operation, by George W. Shuart, W2AMN-W2CBC.
The Story of "EAQ"—illustrated with photos of the station.
Hints on S-W Aerials and Receiver Circuits, by Dr. W. Möller.
Something New in Portable Short-Wave "Antenna-less" Receivers.
An Ultra-Short-Wave Adapter.
The Propagation of Waves Between 3 and 8 Meters.



Certified Circuits

• SHORT WAVE CRAFT goes to a large expense in verifying new circuits published in this magazine. Whenever you see the seal shown here in connection with any of the sets published in this and future issues of SHORT

WAVE CRAFT, this will be your guarantee that this set has been tested in our laboratories, as well as privately, in different parts of the country to make sure that the circuit and selected parts are right. Only "Constructional-Experimental" circuits are certified by us.

When you see our certificate seal on any set described you need not hesitate in spending money for parts, because you are assured in advance that the set and circuit are bona fide and that this magazine stands behind it.

SHORT WAVE CRAFT is the only magazine that thus certifies circuits and sets.

OUR COVER

"Short Wave Comforts de Luxe" is the title we have given this month's cover feature. It shows a typical short-wave "fan" well equipped to thoroughly enjoy himself. As will be observed he has at his command all of the latest *radio maps, time charts* and other "gadgets" to locate those distant stations.

COPYRIGHT, 1933, BY H. GERNSBACK

Published by POPULAR BOOK CORPORATION

HUGO GERNSBACK, President - - H. W. SECOR, Vice-President
EMIL GROSSMAN - - - - - Director of Advertising
Chicago Adv. Office - - - - - L. F. McCLURE, 737 No. Michigan Blvd.
Publication Office - - - 404 N. Wesley Avenue, Mount Morris, Ill.
Editorial and General Offices - - 96-98 Park Place, New York, N. Y.
London Agent: HACHETTE & CIE., 16-17 King William St., Charing Cross, W.C.2

Paris Agent: HACHETTE & CIE., 111 Rue Reaumur
Australian Agents: MCGILL'S AGENCY, 179 Elizabeth St., Melbourne

SHORT-WAVE CRAFT—Monthly. Entered as second class matter May 7, 1930, at the post office at Mount Morris, Illinois, under the act of March 3, 1879. Trademarks and copyrights by permission of H. Gernsback, 98 Park Place, N. Y. C. Text and illustrations of this magazine are copyrighted and must not be reproduced without permission. SHORT WAVE CRAFT is published on the 15th of every month. Twelve numbers per year. Subscription price is \$2.50 a year in the United States and possessions. Canada and foreign countries, \$3.00 a year. Single copies 25c. Address all contributions for publication to Editor, SHORT WAVE CRAFT, 96-98 Park Place, New York, N. Y. Publishers are not responsible for lost manuscripts. Contributions cannot be returned unless authors remit full postage. SHORT WAVE CRAFT is for sale at all principal newsstands in the United States and Canada. European agents: Brentano's, London and Paris. Printed in U. S. A. Make all subscription checks payable to Popular Book Corporation.

Make me PROVE that it's EASY

to learn at home
to fill a
BIG PAY
Radio Job



Here's Proof

Clip the coupon and mail it. I'm so sure I can train you at home in your spare time for a big pay job in Radio that I'll send you a sample lesson free. Examine it, read it, see how clear and easy it is to understand. Then you will know why many men with less than a grammar school education and no technical experience have become Radio Experts and are earning two to three times their former pay as a result of my training.

GET MY FREE SAMPLE LESSON

Mail Coupon

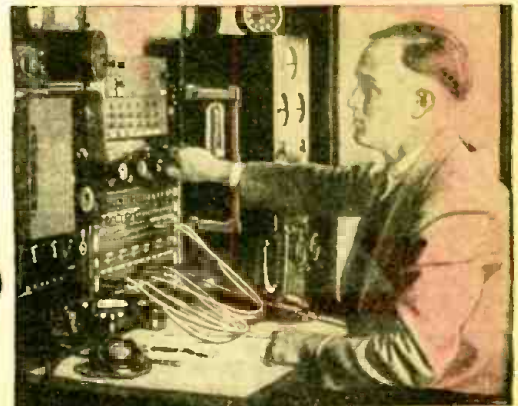

SPECIAL Radio Equipment for Broad Practical Experience Given Without Extra Charge

My course is not all theory. I'll show you how to use my special Radio equipment for conducting experiments and building circuits which illustrate important principles used in such well-known sets as Westinghouse, General Electric, Philco, R. C. A., Victor, Majestic and others. You work out with your own hands many of the things you read in our lesson books. This 50-50 method of training makes learning at home easy, interesting, fascinating, intensely practical. You learn how sets work, why they work and how to make them work when they are out of order. Training like this shows up in your pay envelope—when you graduate you have had training and experience—you're not simply looking for a job where you can get experience.



With N. R. I. equipment you learn to build and thoroughly understand set testing equipment—you can use N. R. I. equipment in your spare-time service work for extra money.

Made \$10,000 More In Radio

"I can safely say that I have made \$10,000 more in Radio than I would have made if I had continued at my old job."

VICTOR L. OSGOOD,
St. Cloud Ave.,
West Orange, N. J.



Many Radio Experts Make \$50 to \$100 a Week
In about ten years the Radio Industry has grown from \$2,000,000 to hundreds of millions of dollars. Over 300,000 jobs have been created by this growth, and thousands more will be created by its continued development. Many men and young men with the right training—the kind of training I give you in the N. R. I. course—have stepped into Radio at two and three times their former salaries.

Get Ready Now for Jobs Like These

Broadcasting stations use engineers, operators, station managers and pay up to \$5,000 a year. Manufacturers continually employ testers, inspectors, foremen, engineers, service men, buyers, for jobs paying up to \$6,000 a year. Radio operators on ships enjoy life, see the world, with board and lodging free, and get good pay besides. Dealers and jobbers employ service men, salesmen, buyers, managers, and pay up to \$100 a week. My book tells you about these and many other kinds of interesting Radio jobs.

Many Make \$5, \$10, \$15 a Week Extra in Spare Time Almost at Once

The day you enroll with me, I send you instructions which you should master quickly for doing 28 jobs common in most every neighborhood, for spare-time money. Throughout your course I send you information on servicing popular makes of sets. I give you the plans and ideas that have made \$200 to \$1,000 a year for N. R. I. men in their spare time. My course is famous as the course that pays for itself.

Talking Movies, Television, Short Wave Money-Back Agreement Included

Special training in Talking Movies, Television and Home Television experiments, Short Wave Radio, Radio's use in Aviation, Servicing and Merchandising Sets, Broadcasting, Commercial and Ship Stations are included. I am so sure that N. R. I. can train you satisfactorily that I will agree in writing to refund every penny of your tuition if you are not satisfied with my Lesson and Instruction Service upon completion.

64-page Book of Information FREE

Get your copy today. It's free to all residents of the United States and Canada over 15 years old. It tells you where Radio's good jobs are, what they pay, tells you about my course, what others who have taken it are doing and making. Find out what Radio offers you without the slightest obligation. ACT NOW!

J. E. Smith, President
National Radio Institute, Dept. 3GB3
Washington, D. C.



Runs Successful Radio Business

"I am a member of the firm of South Grand Radio & Appliance Co., which runs a very successful business. The greater part of my success I owe to N. R. I. Without your training, I could never have been successful in Radio."

J. A. VAUGHN,
Grand Radio & App. Co.,
3107 S. Grand Blvd.,
St. Louis, Mo.



Does Radio Work In Spare Time

"I am operating a 120-acre farm. Three nights a week I teach a Radio class. On the other nights I make service calls. Words cannot express my gratitude to N. R. I. Your training prepared me to earn nice sums of cash in spare time."

HOYT MOORE,
R. R. 3, Box 919,
Indianapolis, Ind.

I have doubled and tripled the salaries of many. Find out about this tested way to BIGGER PAY



FILL OUT AND MAIL THIS COUPON TODAY

J. E. SMITH, President
National Radio Institute, Dept. 3GB3
Washington, D. C.

I want to take advantage of your offer. Send me your Free Sample Lesson and your book, "Rich Rewards in Radio." I understand this request does not obligate me. (Please print plainly.)

Name..... Age.....

Address.....

City..... State..... "R"

The Famous Course That Pays For Itself

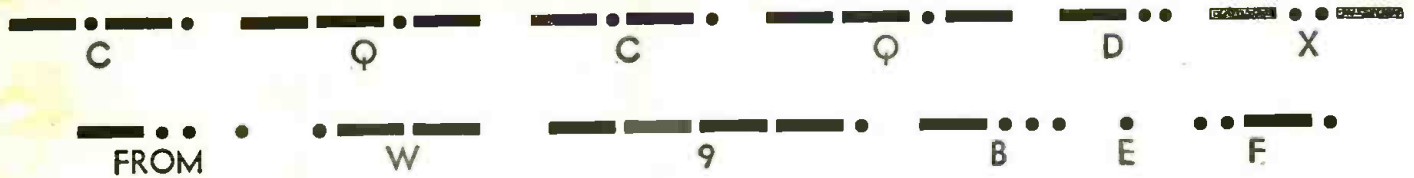

LINCOLN R-9

9-200 METERS

The Lincoln Super Powered R-9 strictly short wave receiver is tested on the air; not simply by tuning in to distant stations but by actual two-way communication where every word is absolutely necessary; no waiting over long periods for call letter identification, it must be positive and clear the first time, and all of the time.

Tests of this kind in actual work with a powerful short-wave transmitter guarantee to you the ultimate in world wide reception. Just remember! Commercial radio must have consistent dependable performance. Lincoln's dependable performance was proved on the last MacMillan Arctic Expedition when two-way communication was held between W9ABD Chicago and WDDE—Bowdoin Schooner, without missing a day; 348 messages were handled with Lincoln receivers at both ends of the transmission.

SHORT WAVE CONSULTANT ENTHUSIASTIC OVER R-9

The short wave consultant for the International DX'ers Alliance of Bloomington, Ill., writes; "I have never in all my years of radio seen anything to compare with it in operation. The quietness of operation, the marvelous tone quality, and the simple tuning. I am sure sold on the idea of band spread. To the eye it presents a wonderful piece of workmanship. Yesterday morning I received DJB, 12RO, Pointoise, DJA, Hilversum, LSG, Rabat, RXA, HJB, FTM and K6BAZ (20 meter amateur in Honolulu). Believe you me the oscillator sure handles the weak signals. The more I tune it the more I am convinced what it sure will do with the amateurs. I have spent more time on the 75 meter phone band than I

have heretofore, in order to just see how the stations are spread on the dial, and I have heard many operators complain of the QRM on the stations which they were working, while at the same time I could get both stations without any QRM whatever. I have never experienced an automatic volume control as effective as the system in the R-9. It is a great pleasure to tune a program without the customary fading on high frequencies."

FOREIGN RECEPTION WITH A "BANG" THROUGH HEAVY INTERFERENCE

"I was remarkably surprised with the operation of the receiver. It was a real pleasure to hear the carrier wave push to one side the background noise generated by trucks and busses. I live at the foot of the George Washington Bridge and the stream of busses and trucks with heavy ignition is constant. Foreign reception comes in with a 'bang' even though the location where the set is installed is anything but favorable for international short wave reception. I picked up with good signal strength, England, Spain, France, Switzerland, Germany, Venezuela, the first afternoon the set was installed.

"C. Lea, N. Y. City."

Why not put one of these receivers in your den where you can enjoy this kind of performance, and let friend wife tune the broadcast receiver to her heart's content? The price is very moderate in comparison; and full information "why" Lincoln receivers give dependable performance is yours for the asking.

Amateur station operators and servicemen write for information on how you can represent Lincoln in your city.

LINCOLN RADIO CORPORATION, Dept. L, 333 S. Wood St., Chicago

LINCOLN RADIO CORPORATION
 Dept. L, 333 S. Wood St., Chicago
 Send free information and prices on R-9 SW-33
 Name
 Street
 City..... State.....
 Amateur Call Letters.....



Just Another EXCLUSIVE FEATURE

OF THE **FB-7**



TRUE TRACKING

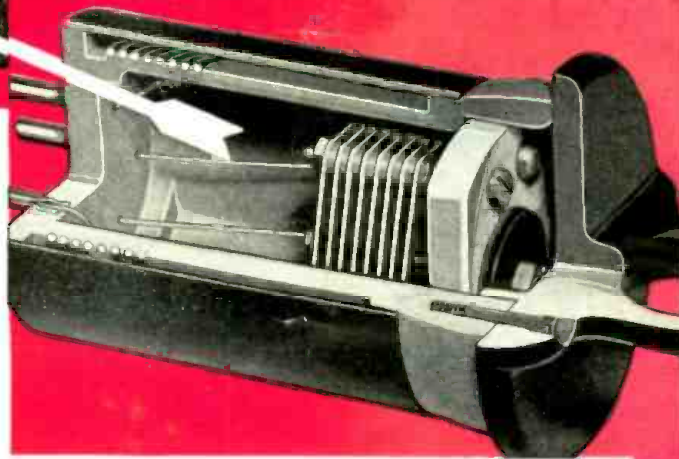

True Tracking is essential for maximum image suppression and sensitivity in precise single-control tuning of high-frequency superheterodyne receivers. • Only by advanced circuit engineering and the proper coordination of such specially developed components as shielded R39 inductances with individual air-dielectric adjustable padding capacitances, can permanent "drift-free" true tracking be obtained. • Permanent True Tracking is just one of the exclusive features of National FB-7, FB-X and AGS receivers.



NATIONAL FB-7 SHORT-WAVE RECEIVER



COUPON NATIONAL CO. INC.

61 Sherman Street,
Malden, Mass.

Gentlemen: Please send me
your new 16-page catalog giv-
ing full particulars of the FB-7.
I enclose 6c in stamps to cover
mailing costs.

Name

Address

SWC-7-33