

studio sound

June 1975 25p

AND BROADCAST ENGINEERING



QUADRAPHONY

Thinking of Updating?

If only the best is good enough...

...and for most people it is

then consider:

Reliability Flexibility Performance

Advanced technology.

A tool to work always for you—never against you.

The result is uncommonly distinguished.

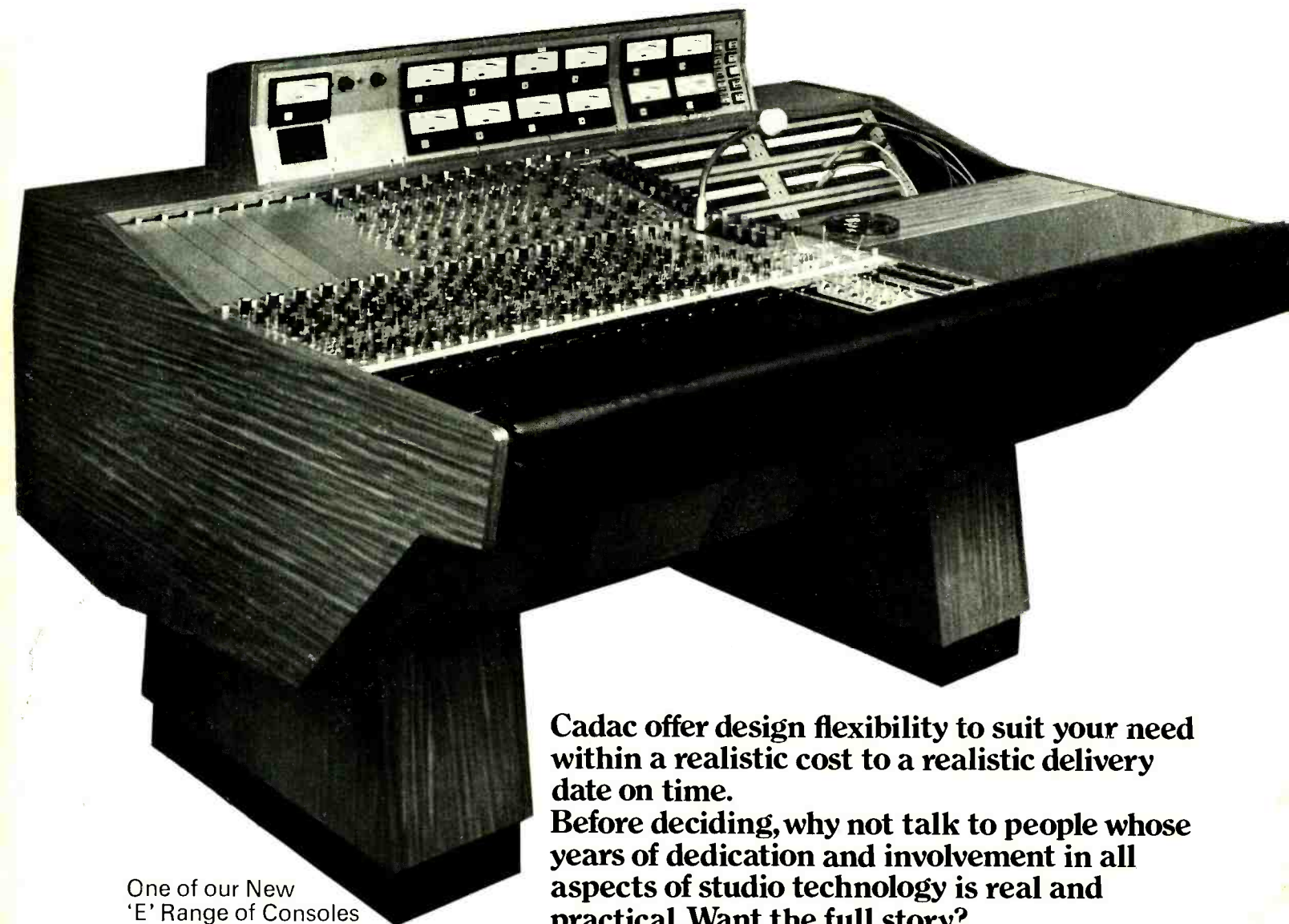

One of our New
'E' Range of Consoles

Cadac offer design flexibility to suit your need within a realistic cost to a realistic delivery date on time.

Before deciding, why not talk to people whose years of dedication and involvement in all aspects of studio technology is real and practical. Want the full story?

Phone, write or telex:

cadac

The established leaders in music recording consoles and techniques.

Cadac (London) Ltd.
141, Lower Luton Road Harpenden Herts. AL5 5EL
☎ Harpenden (STD 05827) 64351 Telex 826323

studio sound

AND BROADCAST ENGINEERING

EDITOR MICHAEL THORNE
ASSISTANT EDITOR FRANK OGDEN
EDITORIAL PRODUCTION DRUSILLA DALRYMPLE
ADVERTISEMENT MANAGER TONY NEWMAN
MAGAZINE SALES MANAGER DON BAILEY



THE LINK HOUSE GROUP

Editorial and Advertising Offices: LINK HOUSE, DINGWALL AVENUE, CROYDON CR9 2TA. Telephone: 01-686 2599

Telex: 947709

© Link House Publications Ltd 1975. All rights reserved.

CONTENTS

FEATURES

AES 50TH CONVENTION: A REPORT By John Dwyer, Frank Ogden, Michael Thorne	22
SQ QUADRAPHONIC DISC SYSTEM: THE PRODUCER'S VIEW By Benjamin B. Bauer	30
SCHOENBERG'S GURRELIEDER By Paul Myers and Bob Auger	38
UD-4: THE SYSTEM AND ITS USE By Toshihiko Takagi	42
CD-4: THE MIXER'S POINT OF VIEW By John Eargle	44
FOUR SIDES OF THE MOON By Alan Parsons	50
RECORDING TECHNIQUES FOR QS FOUR CHANNEL ENCODING By Susumu Takahashi	54

COLUMNS

NEWS	16
PATENTS	20
AGONY	52
WORK	60

STUDIO SOUND is published on the 14th of the preceding month unless that date falls on a Sunday, when it appears on the Saturday.

DISTRIBUTION

STUDIO SOUND, published monthly, enables engineers and studio management to keep abreast of new technical and commercial developments in electronic communication. It is available without charge to qualified readers: these being directors, managers, executives and key personnel actively engaged in the sound recording, broadcasting and cinematograph industries. Non-qualifying readers can buy *STUDIO SOUND* at an annual subscription of £4.17 (UK) or £4.20 overseas.

CORRESPONDENCE AND ARTICLES

All *STUDIO SOUND* correspondence should be sent to the address printed on this page. Technical queries should be concise and must include a stamped addressed envelope. Matters relating to more than one department should occupy separate sheets of paper or delay will occur in replying.

BINDERS

Loose-leaf binders for annual volumes of *STUDIO SOUND* are available from Modern Bookbinders, Chadwick Street, Blackburn, Lancashire. Price is £1.25 (UK and overseas). Please quote the volume number or date when ordering.

JUNE 1975 VOLUME 17 NUMBER 6

CONSIDERING the amount of publicity and effort put into multichannel sound reproduction by the factions concerned, it is quite amazing that the public at large remains so blissfully ignorant about the subject and about the possible gains and losses. Perhaps it has always been this way, and there has not been quite such an obvious target for misinformed abuse before. The situation could be better; naturally, the competition of four large companies, each of whom offers a viable system with its own particular inherent compromises doesn't help, and the step is considerable in terms of consumer commitment anyway. In turn, this reflects in the numbers in which studios are re-equipping for four-square monitoring capability, even though this is often a relatively simple step from a conventional four-front arrangement. At present there is no semblance of a standards committee to decide the eventual playback compromise, if any. We hope that consumer response will not be the only factor influencing that decision, for at present this largely reflects good marketing techniques and lack of consistently reliable discussion in the consumer press—it's too easy, sometimes, to write an article embodying a little controversy and a simplistic judgement.

Unfortunately, such attitudes have also read across into the studio world, and away from the larger and more forward looking organisations it is all too easy to find the easy rejection, the flip comment and the dismissal of the subject with ostrich self-satisfaction. Fair enough as a short-term expedient; but unfortunately it is obvious that some form of extended stereo reproduction will be the norm in some years' time. Recently, two-speaker stereo has become far more than just the province of the rich and the obsessed; the social conditioning step onwards from there is much less. Enough of these apologies, anyway. The responsibility of the recording business is presently not so much the decision of systems but rather a need to utilise the tools available to best advantage, which demands a considerable reshaping of technique and the reflex actions which develop from there. Hopefully, evolution may provide a route out of the impasse, and familiarisation with the production aspects will help it to be a good one.

This issue aims to present a practical collection of articles by authors closely involved with the subject, in the hope that these new techniques may become less of a mystique and more a basis for creative development and experimentation. In addition, it will be clear that, although we have acquired a new convention of 'quadraphony', it is by no means the only philosophy available. (An 'Ambisonics' studio techniques article will appear shortly.) Conversely, the strength of the 'compatibility' forces, which represent the inertia of large investments, cannot be underestimated, although it may be seen as counter to any progress which did not yield a prompt return in hard cash. No one will claim to present a clear and uncoloured judgement, on the present basis. Obviously an author will consider his approach superior if he is involved with the system for it will reflect his own aesthetic priorities, which is fair; but where attitudes conflict there is no ready independent solution, otherwise it might have been pointed out by now. Simply, we must use ears to form our own opinions, based on our own priorities, and if the process could be speeded so much the better. But in the meantime, there is a job to be done. And it may be obvious that it's a bigger problem than can be solved in an editorial of two-minutes-fifty-seconds-quick-fade.



Total average net circulation of 8,535 per issue during 1974. U.K. 5,663, overseas 2,872.

ITA— Britain's Leading Distributor

REVOX

REVOX A-700 SERIES



The new big Revox - ideal for all studio requirements. Highly sophisticated design features include servo tape tension, full deck logic, crystal controlled servo electronics, 3 speeds, tape footage counter.

Immediate delivery.

+ HS77 £306 + A700 £569 +

REVOX A-77 SERIES Mk4



The famous A77 has been consistently improved over the past 8 years and is now available in the latest Mk. 4 version.

The wide choice of specifications includes versions for duplicating and logging applications. Backed by UK's fastest service.

*Hire service.
Check our prices.
Immediate delivery.*

OTARI

OTARI MX-7000 MASTER RECORDER

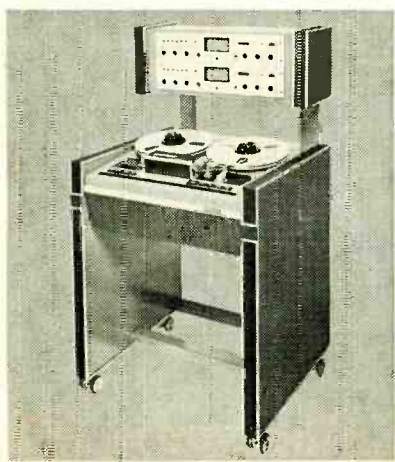

A field-proven master recorder from Japan's biggest manufacturer of professional tape recorders and duplicating equipment. Features include 3-speed operation, rugged construction, front panel EQ on record, play and bias, FET inputs, plug-in head assembly.

Track configurations: Mono, Stereo, 3-channel (NAB cartridge compatible), 4-channel 1/2 or 1/4 inch, 8-channel one inch.

Prices approx. 60% of comparable products.
Quick delivery.

of Studio and Broadcast Equipment

TEAC®

TEAC A3340(S) 4-CHANNEL RECORDER

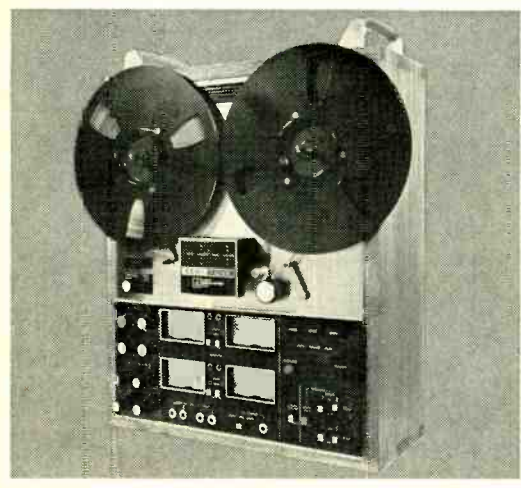

Industrial version upgraded to studio requirements, with increased signal to noise performance and improved reliability. Four totally independent channels each with sel sync, input mixing, switchable VU's and all the facilities for easy multitracking. This industrial model is in more studios than any other version.

Available only from ITA.
(Semi-pro version also available)
Immediate delivery.

ITA 10-4 MIXER

Ten balanced inputs; four output groups, 4 limiters; bass mid and treble EQ, modular construction, headphone monitoring. Extremely high quality construction only matched by mixers costing around £1000. **£590 + VAT.**

Twenty input version **£930 + VAT.**
Immediate delivery.
Also available for hire.



OTARI

OTARI DP-4050 CASSETTE COPIER



Ideal for one copy or ten thousand. Eight times copy speed, foolproof operation for non-skilled personnel, modular construction, servo-controlled direct capstan drive.

Immediate delivery.

+SCOTCH 207-LOWEST PRICES+

ITA

Industrial Tape Applications

5 Pratt Street, London NW1 0AE.
Tel: 01-485 6162 Telex: 21879



sound equipment
by **Grampian**

Grampian have manufactured high power sound equipments for over 40 years. Such experience backs a wide range of amplifiers, including Battery/A.C. supply types, microphones and loudspeakers.

GRAMPIAN REPRODUCERS LTD.
HANWORTH TRADING ESTATE, FELTHAM, MIDDLESEX,
ENGLAND. TEL: 01-894 9141

Master-Room

**A New Standard in Realism
From a Series of Reverberation Devices
That Don't Cost the Earth**

Three models giving optimised delay times of 2, 5 and 7 seconds.

Mono input (5k Ω Floating), stereo perspective output (2 x 600 Ω Balanced).

High external sound immunity—May be used in control rooms.

Lightweight and compact—Ideal for outside broadcasts and mobile recordings.

The Master-Room series of reverberation devices accurately synthesizes natural room, hall and auditorium echo.

For further information or a Master-Room demonstration, contact the sole European distributor:—

Scenic Sounds Equipment
27-31 Bryanston Street, London W1H 7AB
Tel: 01-935 0141

MIC MIX Audio Products Inc. USA

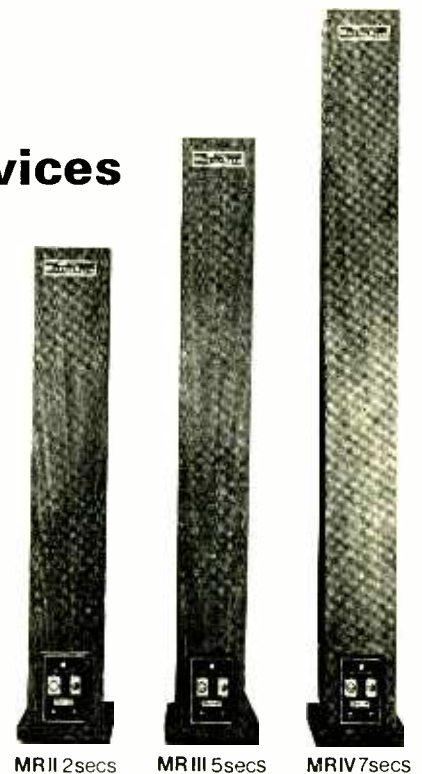

MR II 2secs

MR III 5secs

MR IV 7secs

Eventide

the next step

DIGITAL DELAY SYSTEMS

THE INSTANT PHASER

THE OMNIPRESSOR

*All by Feldon Audio Ltd
distributors of professional
audio equipment to the recording
and broadcasting industries*

FELDON AUDIO LTD
126 Great Portland Street
London W1N 5PH
01-580 4314 Telex: 28668

Alice IS BROADCASTING

SEE US ON
APRS 75
STANDS 4 & 5



AM/82B. Continuity Desk

A complete range of Ancillary Rack Mounting Equipment. Multitrack Mixing Consoles & Transcription Units are available at our usual speed & guaranteed deliveries.

Alice (Stancoil Limited) Alexandra Road, Windsor, England
Tel. Windsor 51056/7

LATEST MIXER PREAMP FROM ICE

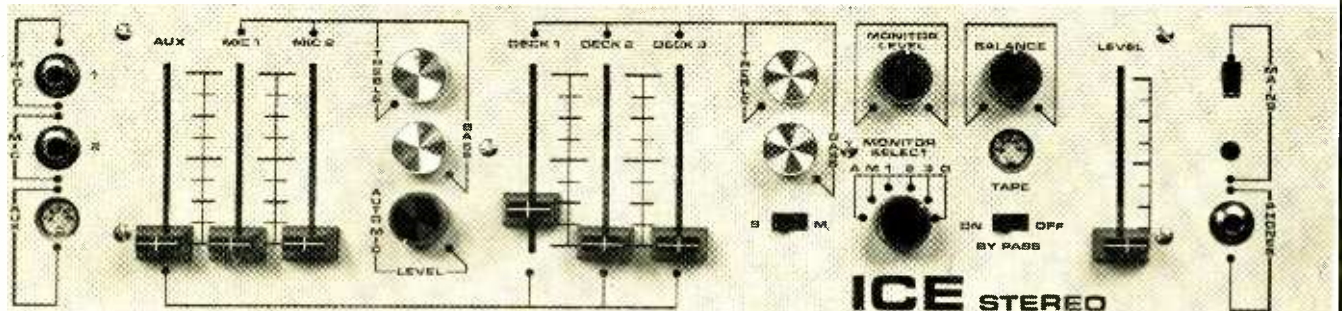

STEREO OR MONO VERSIONS AVAILABLE FROM YOUR
STOCKISTS

Icelectrics Limited

15 Albert Road, Aldershot, Hampshire.

Tel: Aldershot (0252) 28514

APRS 75

8th INTERNATIONAL EXHIBITION OF PROFESSIONAL RECORDING EQUIPMENT LONDON

THURSDAY JUNE 19

10.00—2100 hrs

CONNAUGHT ROOMS · GREAT QUEEN ST · LONDON

- *Audio & Design
- *Amity Shroeder
- *Ampex
 - Allen & Heath
- *Alice (Stancoil)
- *Altec/Theatre Projects
- *AV Distributors
- *AKG Equipment
- *Audix
- *Audio Developments
- *Allotrope
- *Agfa-Gevaert
 - "Beat Instrumental"
- *Brenell Engineering
- *BASF
- *F. W. O. Bauch
- *Bias Electronics
- *Cadac
- *Calrec Audio
 - Capitol Magnetics
- *Cetec Inc.
- *EMI Tape
 - Future Film
- *Ferrograph Professional Recorder
 - Farnell-Tandberg

- *Fraser-Peacock Associates
- *Grampian Reproducers
 - H/H Electronic
- *Helios Electronics
 - C. E. Hammond & Co.
- *Hayden Laboratories
- *Industrial Tape Applications
 - "International Musician & Recording World"
- *Jackson Recording Co.
- *Klark-Teknik
- *Lee Engineering
- *Lennard Developments
- *Leevers-Rich Equipment
- *Jacques Levy Professional Recording Services
- *Lockwood & Co.
 - Midas Amplification
- *3M
- *Magnetic Tapes
 - "Music Week/Soundscape"
- *Millbank Electronics Group
- *Macinnes Laboratories
- *Rupert Neve & Co.

FRIDAY JUNE 20

10.00—1800 hrs

HOLBORN TUBE STATION

- NTP Elektronik A/S
- North East Audio
- *Partridge Electronics
 - Penny & Giles
- *Pyral
- *Rola Celestion
- *J. Richardson Electronics
- *Raindirk
 - Racal-Zonal
- *Radford Electronics
- *Rugby Automation Consultants
 - "Studio Sound"
- *Sonaplan
- *Sound Developments
- *Studio Republic
 - Surrey Electronics
- *Scenic Sound Equipment
- *Shure Electronics
 - Soundcraft Electronics
 - Turner Electronic Industries
- *Trident Audio Developments
 - Tannoy Products
 - Tweed Audio Electronics
- *Vitavox

FREE TICKETS FROM

APRS

23 CHESTNUT AVENUE
CHORLEYWOOD HERTS
ENGLAND

EXHIBITORS AT TIME OF GOING TO PRESS

*APRS MEMBERS

Reliability and Simplicity...

... is what most of Britain's commercial radio stations, the BBC and a host of the major recording studios look for in the 3D Series reproducer cartridge machine and cartridges.

The 3D Series reproducer is the machine they now use, it has mechanical strength for continuous and reliable D.J. and broadcasting requirements, the minimum of controls for simplicity of operation and provides for either single or multiple deck capacity.

The best cartridges for the best machine. Our cartridges are the only ones with a proven acceptability to the commercial stations, studios and the BBC and have most of the market to prove it. NAB cartridges come in all types, lengths and are in stock now.

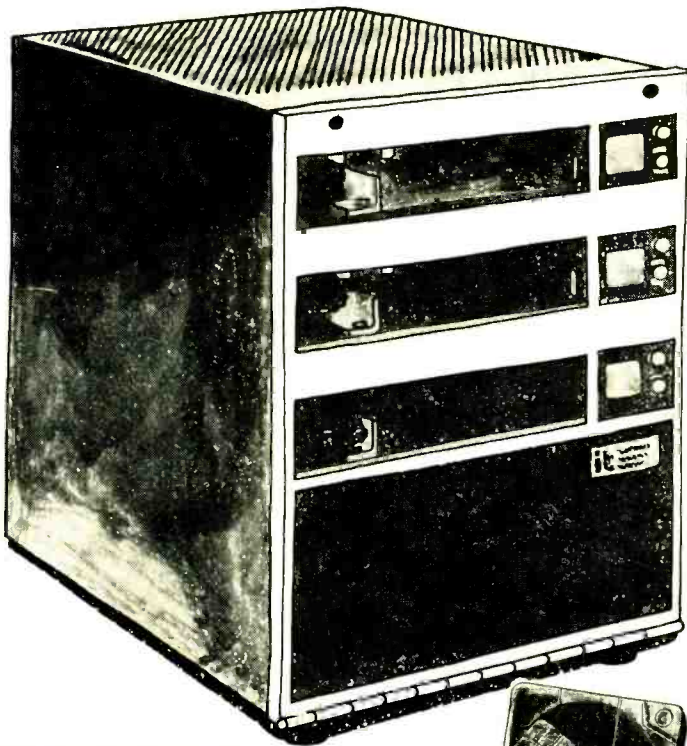

The best machines and cartridges from the company that has a reputation for reliability and service to the industry.

Short term hire of cartridge machines available.

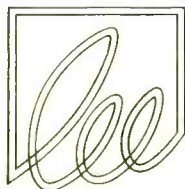

For further information contact — Chris Welsh

LEE ENGINEERING

Ashley House, Ashley Road,
Walton on Thames, Surrey, KT12 1JE
Tel: Walton on Thames 28783/4
Telex: 928475 Cables: LEETECH

A Mini Mixer with a true
PROFESSIONAL STUDIO SPECIFICATION



10 Input Channels, 4 Output Groups.

Auxiliary Sends and Echo Returns.

XLR Connectors to balanced Mic Inputs and Line Returns.

Normalised Insert Jacks.

Low Noise and High Output levels.

Portable.

Extension units, PPM's, Limiters etc. also available.

Standard Mixers ex-stock.

RAINDIRK LTD., Downham Market, Norfolk.
Tel. 2165 and 3617

for

**FULL INFORMATION
ON ADVERTISING IN**

**STUDIO
SOUND**

TELEPHONE
01-686-2599

and ask to speak to
TONY NEWMAN

or
MICHAEL JAMES

Ferrograph Professional Studio 8 Console

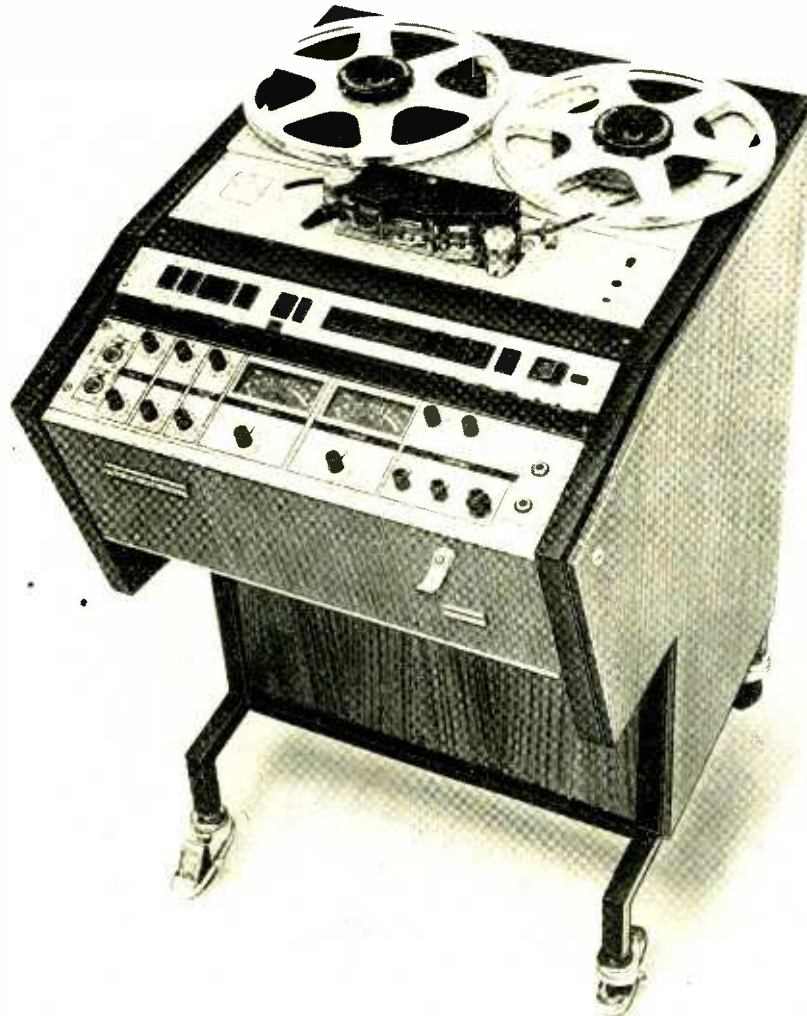

Full logic control. Tape motion sensing. Two speeds. Servo-controlled capstan. Constant tape tension. Direct-reading tape timer (minutes and seconds). Three editing modes. Provision for synchronisation, remote control and remote display panel. Available for line-in/line-out or with mixing and monitoring facilities. IEC or NAB equalisation. Full or

half-track mono, dual track or stereo. Easy access for maintenance. Also available in transportable and rack-mounted versions.

For full details contact Ferrograph Professional Recorder Company, 442 Bath Road, Slough SL16BB. Telephone Burnham (06286) 62511. Telex 847297. Cables Britferro, Slough.

THE *New* TANNOY

Monitor

HIGH PERFORMANCE DUAL

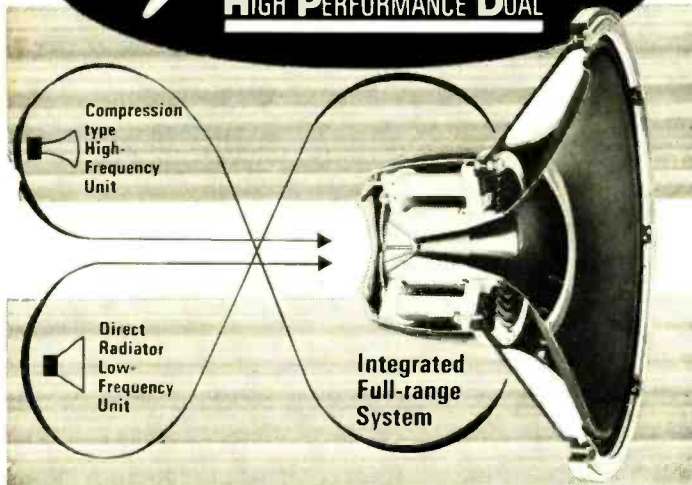

The Monitor H.P.D. represents a further outstanding improvement of a loudspeaker system which has become regarded as a quality standard over the last 25 years by Recording Studios throughout the world. There is a very good chance that your favourite records and tapes were monitored on Tannoy Dual Concentric loudspeakers, and to select these superbly engineered, individually hand-assembled speakers for your music system assures you of the same professional performance.

	260 mm 10"	310 mm 12"	410 mm 15"
Power Handling Capacity*	50W	60W	85W
Frequency Response	27-20,000 HZ	25-20,000 HZ	23-20,000 HZ
Intermodulation Products	less than 2%	less than 2%	less than 2%
Impedance via Crossover network	8 ohms (5 ohms min.)	8 ohms (5 ohms min.)	8 ohms (5 ohms min.)

*INTEGRATED PROGRAMME MATERIAL

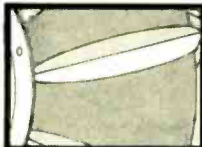

The Glidacoustic Cone improves frequency and transient response, gives much increased power handling capacity and greater mechanical stability.



The High Temperature Voice Coil assures absolute climatic stability and great mechanical strength together with much improved power handling capacity.



The Tanoplas Surround gives low bass resonance with excellent mechanical stability and freedom from edge reflections.



Patented Magnetic Shunt combined with specially treated and selected steel gives maximum magnetic flux in the unique Tannoy twin gap system. Improves sensitivity and damping.



Unique High Frequency Unit with separate diaphragm and voice coil coupled to the horn by a 19 element phase-matching system.

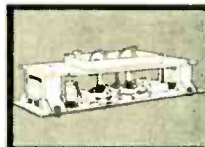

High Power Crossover Unit with solid dielectric condensers throughout, combined with treble and roll-off controls.

Designed to sound better - naturally...

TANNOY

NORWOOD RD. WEST NORWOOD SE27 9AB
Tel: 01-670 1131 Telex: 949755

SESCOM'S NEW CABLE TESTER

TESTS FOR:

- Continuity
- Opens
- Shorts
- Phasing



MODEL CT-1

Just plug a standard cannon type 3 pin male to female extension cord into box, depress three push buttons. Compact cast aluminum box. Uses standard 9V transistor battery. Professional Net \$21.50

Send for Spec Sheet

Quality Engineered Sound Products

SESCOM, INC.

P.O. Box 590 Gardena, CA 90247 U.S.A.
Telephone (213) 770-3510 / TWX 910-346-7023



-TURNER-

STEREO POWER AMPLIFIERS

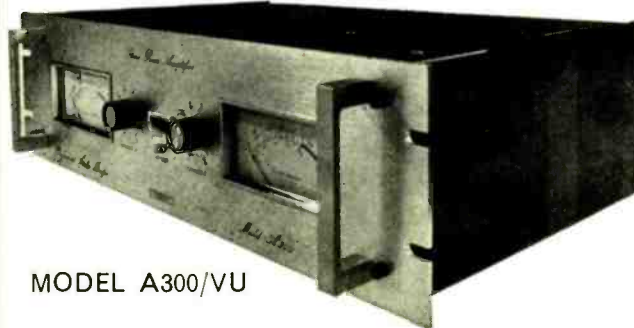

MODEL A300/VU

A range of professional stereo power amplifiers designed and manufactured to a very high standard.

The A Series (Professional Studio Monitor) amplifiers feature dual power supplies to maintain full RMS power on both channels.

The B Series (Professional) amplifiers feature single power supplies suitable for most music applications.

		STANDARD	WITH VU's
MODEL A500	250+250 watts RMS, 4 ohms	£380.00	£440.00
MODEL A300	150+150 watts RMS, 4 ohms	£262.50	£322.50
MODEL B300	150 watts RMS per channel	£210.00	£250.00
MODEL B200	100 watts RMS per channel	£170.00	£210.00

The above prices are list and exclusive of VAT.

Overseas Import Agents are invited to make their final applications for allocation of areas for our 1976 exports.

TURNER ELECTRONIC INDUSTRIES LTD
175 Uxbridge Road, London W7 3TH

Tel. 01-567 8472

SOUND STUDIO EQUIPMENT OF WORLD-WIDE FAME

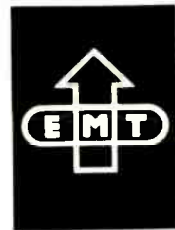

PROFESSIONAL RECORD PLAYBACK SYSTEM

EMT 928

- a proven concept - augmented for professional use
- uniquely powerful drive motor, fed from an electronically stabilized three-phase generator
- remote controllable to split-syllable accuracy
- auxiliary turntable with electrical brake and muting relay
- EMT pickup cartridge TSD 15 with micro-sensitive lowering device
- built-in equalizer/amplifier with balanced, low impedance, line level output.



AVAILABLE
FROM
STOCK



AUDIO TECHNOLOGY

EMT-FRANZ VG mbH.

P. O. B. 1520 · D-7630 LAHR-1

West Germany

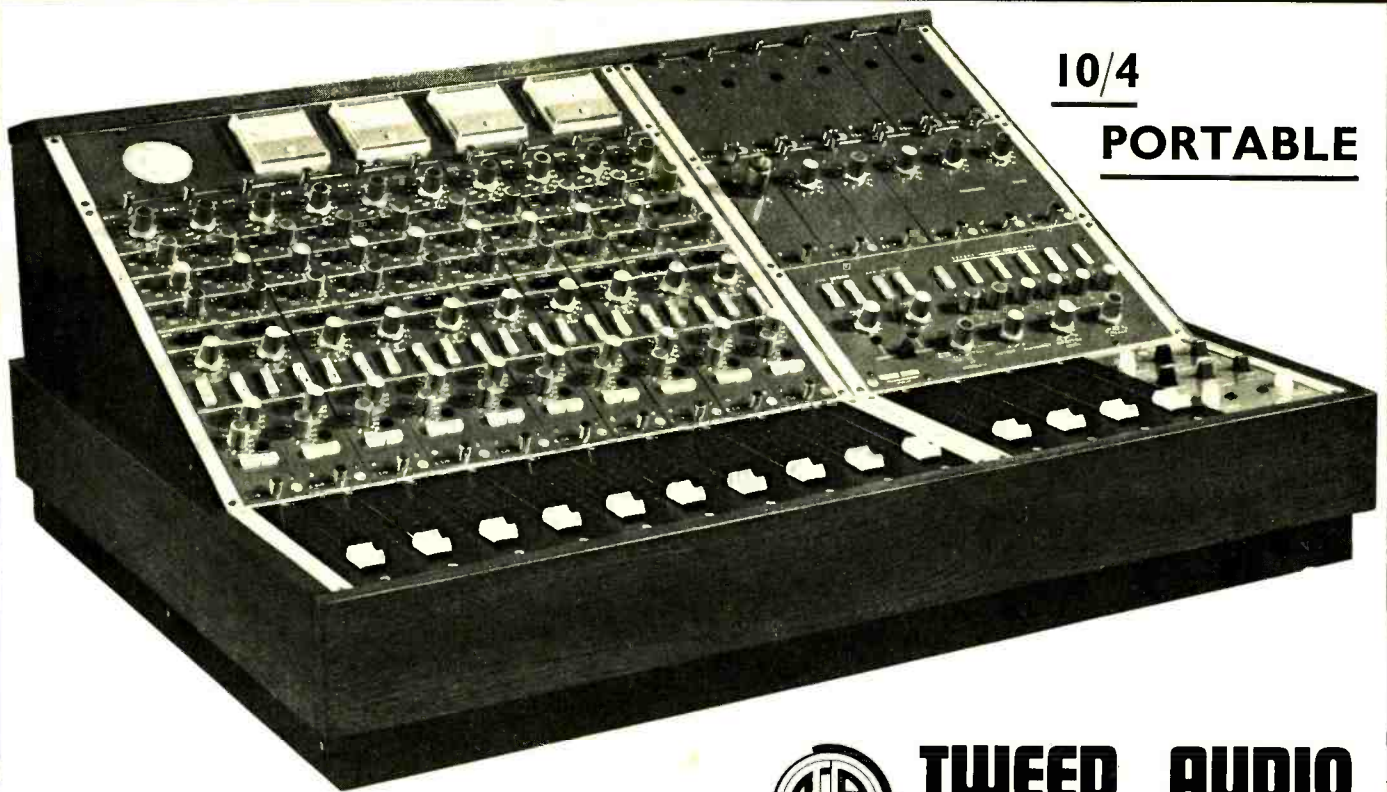

10/4
PORTABLE

PROFESSIONAL SOUND EQUIPMENT from—



TWEED AUDIO

ELECTRONICS

ROSEWOOD INDUSTRIAL ESTATE, KELSO, ROXBURGHSHIRE
SCOTLAND. TELEPHONE 2983 STD 057 32

BIAS RECORDERS

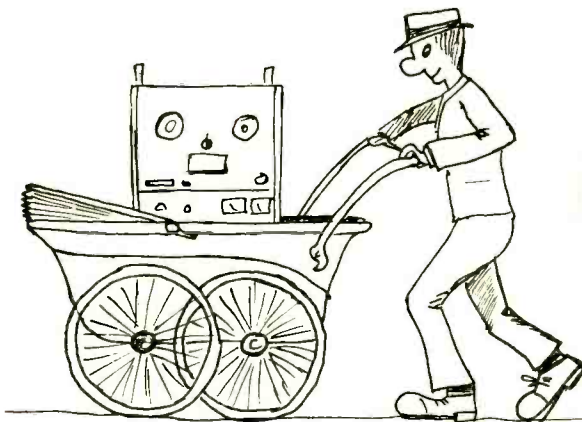

“The waiting is over”

See our new baby the BE1000 Mk.II Transportable Professional Recorder.

Stand 19, APRS 75.

NB. No longer available in pink or blue.

BIAS ELECTRONICS LTD.,
572 Kingston Road,
LONDON SW20 8DR. 01-540 8808

The Unique E560 Selective Limiter

The E560 provides a limiter that can *selectively attenuate* almost any part of the audio spectrum. LF content, sibilant areas or static pre-emphasis can be momentarily attenuated without modulation effects on remaining programme content. Besides *dynamic equalisation*, it gives *static parametric lift* of 20dB or > 30dB cut, over the whole audio range; with variable ‘Q’ from 1/10th to 5 octaves broad. Available in modular or rack formats.



AUDIO & DESIGN RECORDING

41 Prospect Street,
Caversham, Reading, Berks.
Tel: Reading (0734) 84487

Again and again and again

Given the time, the patience, and the money, one can connect* fifty 303 amplifiers nose to tail so that the programme goes through one after the other gradually deteriorating along the way.

Deteriorating? The fact is, that apart from a very slight background hiss – akin to a good tape recording – the programme will sound exactly

the same at the end as when it started.

*Of course one must fit an attenuator to reduce the signal back to its original level between each amplifier.

Send postcard for illustrated leaflet to Dept. SS Acoustical Manufacturing Co. Ltd., Huntingdon PE18 7DB. Telephone (0480) 52561.

QUAD

Products of The Acoustical Manufacturing Co. Ltd.

for the closest approach to the original sound

QUAD is a Registered Trade Mark



Sound 75 expo

IT'S ALWAYS SOMETHING of a pleasure to visit an APAE show—the relative informality of the event can come as rather a contrast when compared to the heavyweight approach of AES, or the fake glamour of the hi-fi exhibitions. Following hard on the heels of the 50th AES convention, 'Sound 75,' staged at the Bloomsbury Centre Hotel from March 11 to 13, proved no exception. The show was declared open some two hours after the actuality by Lord Darling of Hillborough under the watchful eye of the retiring president, the amiable Keith Monks. Keith caused amused embarrassment to all present by forgetting the dignitary's name. The situation was later rectified in the cocktail bar.

At the time of writing, the exact statistics for the show are not known. However, the new APAE president, Ron Walker of Johnson Brody, thinks that everything is up; this includes attendance, the number of exhibitors, the number of stands, and the cost per square foot. On the last point, talks are in progress to find ways of stabilising the cost of the exhibition. Suggestions include moving the show from the Bloomsbury to a provincial centre; at the same time, more local venues would be organised much in the style of the Leeds event. It is possible that one exhibition would be held in the centre of Scotland. No organisational changes will occur before 1977.

Regarding the exhibitors at Sound 75, the appearance of a ladder manufacturer and a name plate maker represented a departure from the norm; this was a deliberate attempt to broaden the scope of the show away from the narrow base of hardware manufacture, sales and service. Of special interest to STUDIO SOUND readers were the products displayed by a company rejoicing in the name of Emo Systems Ltd. These included a pocket led sound level meter, a 1600W custom amplifier (which was short circuited at full output to demonstrate the protection circuits), 400W per channel stereo amplifiers, an unusual 600W slave amp that used pulse width modulation (Class D) and weighed only 1 Kg, jingle machines, and a shift register digital delay line of 12 bit resolution. Quite a product line.

Even better, everything really worked.

Another exhibitor with a rather more modest range proved equally interesting. The ATC name is still relatively new, but their products deserve to become very well known. The company manufactures chassis loudspeaker units of 30 cm diameter rated at 75W. In this, there is nothing special. What is unusual, however, is that the Acoustic Transducer Co is the only British company to produce loudspeakers with edge-wound copper ribbon voice coils. When this method of construction is used on a 7.5 cm voice coil, the result is a direct competitor at an advantageous price (£55 retail) to similar products from better known American companies.



Above: The Clear-Com CS 100 and 200.

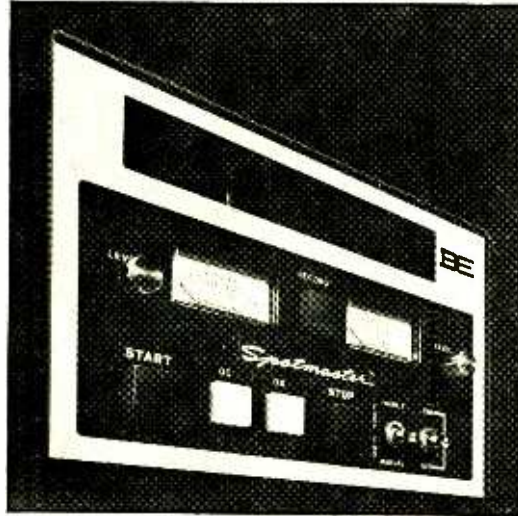

Left: Spotmaster 3000 (one of the range from Broadcast Electronics).

Cartridge machines

FOLLOWING THE RECENT introduction of the Spotmaster 2000 range, Broadcast Electronics has announced a new series of automatic release machines. The manufacturers claim that the low power consumption machines—less than 45W total—offer a performance exceeding the relevant NAB specifications on every parameter. In addition, they state that the head arrangements on the stereo machines have an azimuth control enabling very tight adjustment of relative track phase.

The 3000 series includes mono, stereo, record/replay, replay and delay machines. Broadcast Electronics Inc, 8810 Brookville Road, Silver Spring, Maryland 20910, USA. Phone: (301) 588 4983. UK

agents: Broadcast Audio (Equipment) Ltd, PO Box 31, Douglas, Isle of Man. Phone: 0624-4701.

Belt pack intercom

MANUFACTURED IN THE States by Cuniform, the Clear-Com CS 100 and 200 offer no hands communication for up to 30 operators working in high ambient noise levels. Divisible into two subgroups (CS 200) enabling independent communication within them, the belt packs connect to the rack mountable main station with conventional balanced line mic cables fitted with XLRs. In addition, a main station facility allows for control talk over on an A/B or A+B basis. The belt pack provides a connection suitable for either a swivel-to-talk mic headset or modified Beyer cans, an arrangement preferred by the importer.

UK prices for the equipment are CS 200 £195, CS 100 £160, remote belt pack (each) £50 and headsets (each) £33. Cable cost is pro rata. Cuniform Inc, 151 University Ave, Palo Alto, California 94301, USA. Phone: (415) 327 3254. UK agents: ESP Lighting Ltd, 38/40 Glasshill Street, London SE2 0OR. Phone: 01-928 8125/6/7.

Whoops

IN THE APRIL issue we gave the incorrect address for Naim Audio Ltd in the power amplifier survey listing. It is, in fact, 11 Salt Lane, Salisbury, Wiltshire SP1 1DT. Phone: Salisbury (0722) 3746. We offer apologies for the error.

Five-a-side earful

SEE ME, FEEL ME, touch me . . . hear me in the much vaunted 'Quintophonic' sound, the brain child of John Mosely. Intended to provide five channel sound for the cinema, the system uses a 4+1 format derived from a three track magnetic soundtrack. The first two are encoded QS matrix, the output driving four corner loudspeakers in a conventional 'quad' arrangement. The third track provides a discrete channel to drive the normal centre 'behind the screen' speaker. The

18 ▶



The Delta-T 102 Series with a 90 dB dynamic range

Four years ago Lexicon in cooperation with Gotham Audio introduced the industry's first all electronic audio delay system — the Delta-T Model 101. Practical experience and helpful suggestions from users accumulated since that time have enabled Lexicon to create the Delta-T 102 Series. The 102's offer a new level of performance and flexibility previously unavailable to the industry.

Using proprietary digital techniques the Delta-T 102 Series provides, along with other advances, a 90 dB dynamic range and significantly lower noise and distortion.

The 102 Series has been carefully engineered to meet a wide range of requirements:

For example, the system may contain 1 to 50 outputs, 2 ms to 3.2 seconds of delay, and remote console mounted controls and headroom indicator. Fully modular construction permits simple field expansion and maintenance by module plug-in. Three basic models in the 102 Series allow economic selection of frequency response and delay interval for sound reinforcement, studio and laboratory applications. All models feature a 5 position 40 dB headroom indicator which assures correct level setting.

And the cost of the 102 Series is revolutionary. Although providing the dynamic range of a 15 bit system, the 102's are priced competitively with present 10 and 12 bit units. Delivery is 45 days.

Contact in U.K., F.W.O. Bauch Ltd., 49 Theobald St., Boreham Wood/Herts WD6 4R2, Telephone 01-953 0091. Elsewhere in Europe contact Gotham Export Corp. 741 Washington St., N.Y., N.Y. 10014, U.S.A.

Announcing the second generation in digital delay systems...

Lexicon

Lexicon, Inc., 60 Turner Street,
Waltham, Massachusetts 02154, U.S.A.

NEWS

object of the exercise is to 'offer the film maker the facility for moving sounds around the auditorium, providing a highly effective and realistic modern sound performance'. We hope to publish a discussion of the technique by John Mosely in a subsequent issue.

Dose meter

OF SPECIAL INTEREST to recording engineers, a breast pocket instrument monitors the total noise exposure of the wearer, giving a digital readout in percentage terms of the maximum 'safe' limit as laid down in the Department of Employment code of practice. Manufactured by B & K, the 4424

noise dose meter runs from an internal battery which gives up to 80 hours of operation based on an eight-hour cycle. A simple push button enables the total exposure, accumulated to that time, to be indicated. B & K Laboratories Ltd, Cross Lances Road, Hounslow, Middlesex. Phone: 01-570 7774.

die-cast case, the unit is said to meet the IBA specification for equipment in the signal path. All connectors are of the Cannon type using male inputs and female outputs.

Designed to work into 600 ohms output load, the overall distortion is less than 0.1% from 30 to 20 kHz fully loaded at +10 dBm level. Worst case line stabilisation is claimed to be within 0.5 dB. The unit contains an internal power supply fed through an XM connector. The amplifier costs £94 from: Surrey Electronics, The Forge, Lucks Green, Cranleigh, Surrey GU6 7BG. Phone: 04866-5997.

Desert song—for Ampex who built the colour ob truck, fitted out with a VR1200 vtr destined for the Middle East. And for Trident who supplied the broadcast adapted 'B' series console.

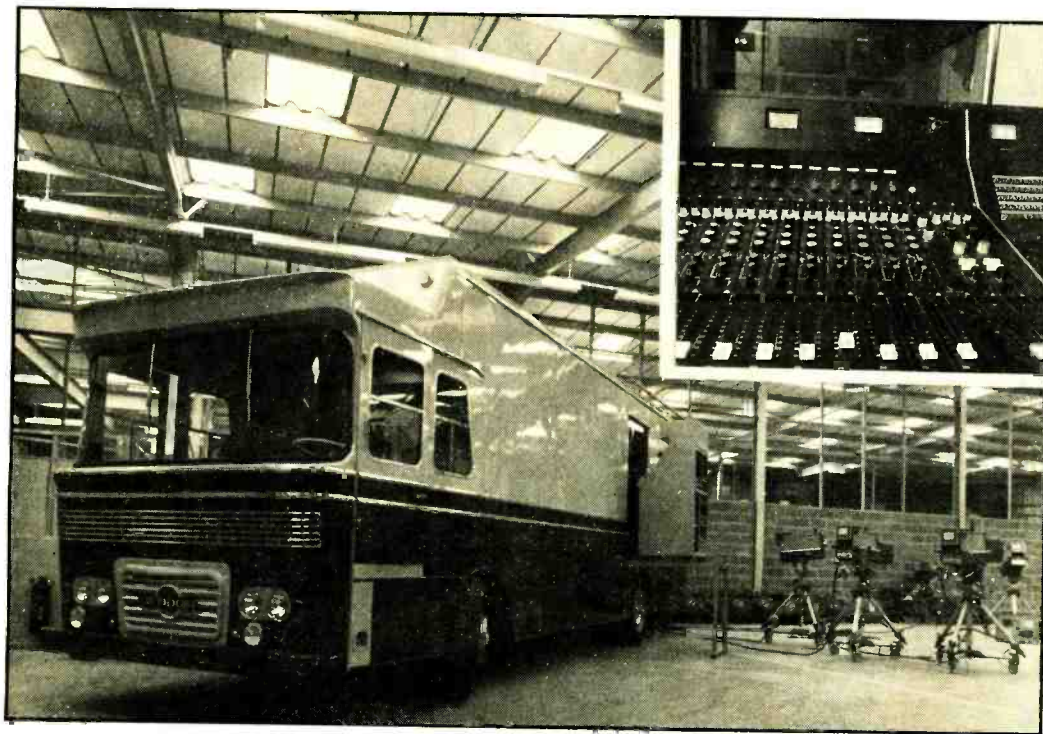

Sandy Brown

THE STUDIO BUSINESS is still young, and STUDIO SOUND seldom needs to carry obituaries. Sandy Brown was only 46 when he died on Saturday, 15th March. He was born in India, but grew up in Scotland and was educated at the Royal High School in Edinburgh, the College of Art, and Heriot-Watt University. He was with the BBC for 16 years and during that time designed many of their major studios. In 1968, he formed Sandy Brown Associates, and was, at the time of his death, working on the acoustics of the new Edinburgh Opera House.

His death has left several worlds considerably duller, for he carved a very individual niche not only in the studio, acoustic and architectural worlds, but also in jazz and journalism. And as regular readers will doubtless be aware, he was also a prolific writer of letters to the press. When an article touched on a subject in which Brown was involved, he would loose off a letter to the relevant correspondence column, which was usually better informed and more interesting than the article itself.

Brown was always a wonderful man for a quote. Journalists researching a story are usually infuriated by official spokesmen and experts who meticulously wrap every quotable comment in safe, libel-proof words and label everything 'off-the-record'. Sandy Brown just said what he thought about anyone or anything, in frank terms, and left it at that. 'Bloody vandals,' was his pithy summing-up of the tv top brass who erased some priceless jazz videotapes.

The story goes that at one of his New Year's Eve parties, a few of the guests were still there at six o'clock the next morning. 'If you don't go home now,' said Sandy, 'I shall hang myself, publicly'.

40 ►

Synthesizer modules

INTENDED FOR USE in musical synthesizers and manufactured by RSE, each module offers one of the three following functions: oscillator, multimode filter and envelope shaper. Using voltage control, they are claimed to be fully compatible with each other in terms of mechanical structure, power supply, signal level and control voltage range.

The oscillator provides sine, triangular and square wave outputs together with intermediate variations over the audible and sub-audible spectrum. Provision exists for external synchronisation to another oscillator through a control voltage derived from an internal phase sensitive detector.

The multimode filter contains two voltage controlled filters, one high and the other lowpass, which can be operated together or

independently. This provides the potential for the chosen function on two signal paths, or bandpass and bandstop through combination of the two filters.

The envelope shaper offers two trapezoid functions, the first controlling the attack, the second the decay. These can be independently triggered to modify the burst duration. Special feature of the shaper includes a control voltage output equivalent to the envelope shape offering further control of ancilliary units. C. E. Hammond & Co Ltd, Lamb House, Church Street, Chiswick, London W4 2PB. Phone: 01-995 4551.

Goodmans Loudspeaker

DETAILS OF A 'bookshelf' loudspeaker, which offers subjectively similar performance to the *Achro-*

mat 400, has been announced by the company. Designated the *Achromat 100*, a brief listening test indicated that it produced a clean sound with very little apparent colouration. Having a nominal impedance of eight ohms, the manufacturers claim a power handling capacity of 50W with a sensitivity of 12W for 96 dB at one metre. Goodmans Loudspeakers Ltd, Downley Road, Havant, Hants PO9 2NL. Phone: 070-12 6344.

Distribution amplifier

AVAILABLE FROM Surrey Electronics, the amplifier provides 10 independent outputs, all isolated by the use of separate windings on the output transformer, at unity gain relative to the input. Housed in a

THE 2-DAY WONDER.

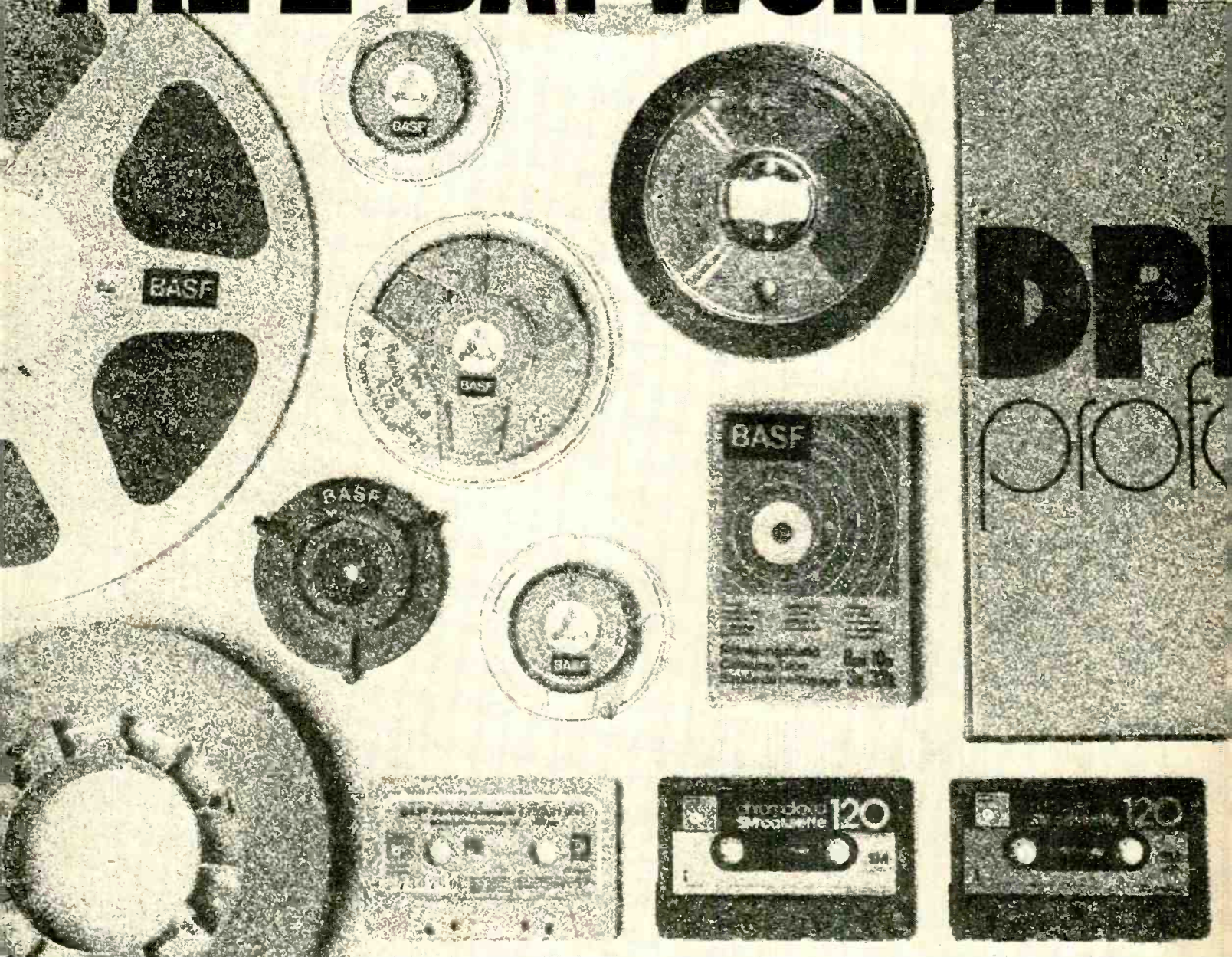

Anything BASF, anywhere in the country, in 48 hours. Guaranteed.

One of life's little ironies, it seems, is that the best is invariably the least accessible.

So it was with BASF's professional range of tapes and tape accessories.

The more specialist items have always been hard to come by – especially for small orders.

But now there's a new deal for professional sound people, from BASF and Audio Products.

Audio Products stock everything BASF produce in tapes, right down to Profi-NAB adaptors, calibration tapes and the weirdest-sized spools.

They'll service any order (by van in central London) in just 48 hours.

Even if it's only worth a fiver.

And they even offer special prices to professionals, studio people and freelance recordists. Into every life, a little sun must fall.

At last. Now tell me some of those low prices.

Name _____ Company _____

Address _____

AUDIO PRODUCTS



Audio Products, 16 Grosvenor Place, London SW1. Tel: 01-235 2537.

THE FOLLOWING list of Complete Specifications Accepted is quoted from the weekly *Official Journal (Patents)*. Copies of specifications may be purchased (25p) from The Patent Office, Orpington, Kent BR5 3RD.

March 5

1390493 Fuller, D. K. M.
Instructional apparatus for use in learning the construction of musical chords.
1390552 Absalom, R. R.
Electric sound-producing device.
1390613 Birch, R. W. B.
Gramophone pick-up guidance mechanisms.
1390794 Kombinat Zentronik VEB
Arrangement for pressing magnetic cards against a magnetic head.
1390815 Standard Telephones & Cables Ltd
Power oscillators.
1390905 Birch, R. W. B.
Gramophone pick-up guidance mechanisms.
1391003 Nippon Victor KK
Recording system for a multichannel record disc.
1391036 Cailliot, S. L. L.
Tape cassette.
1391143 International Business Machines Corporation
Magnetic transducer.

March 12

1391289/90 General Electric Co
Four channel stereophonic system.
1391335 Philips Electronic & Associated Industries Ltd
Apparatus for reading video and/or audio signals by optical means.
1391342 Matsushita Electric Industrial Co Ltd
Magnetic recording and reproducing apparatus for two or four-channel multitrack endless tape.
1391434 British Broadcasting Corporation
Television standards conversion.
1391452 Image Analysing Computers Ltd
Method and circuit arrangement for amplitude correction of video signal obtained by line scanning.
1391479 Lanier Electronic Laboratory Inc
Tape recording apparatus.
1391538 Honeywell Information Systems Inc
Electrical oscillators.
1391541 Philips Electronic & Associated Industries Ltd
Information carrier of disc form for sound and/or video signals.
1391617 Wurlitzer Co
Automatic chord playing apparatus.
1391686 Matsushita Electric Industrial Co Ltd
Magnetic recording and reproducing method and system.
1392054 Philips Electronic & Associated Industries Ltd
Apparatus for converting a tone of frequency f into a lower tone of frequency xf .
1392106 Telefonaktiebolaget L. M. Ericsson
Modulator circuits.

March 19

1392117 Loewe Opta GmbH
Circuit arrangement for regeneration of a stereo multiplex signal.
1392201 RCA Corporation
High density information records and playback apparatus therefor.
1392202 RCA Corporation
Information record playback systems.
1392203 RCA Corporation
Information records and method of making same.
1392204/5/6 RCA Corporation
Information records.
1392251 Hitachi Ltd
Domain switching element and method of producing the same.
1392372 Philips Electronic & Associated Industries Ltd
Recording and/or playback apparatus.
1392501 Optical Coating Laboratory Inc
Method of making a striped dichroic filter.
1392568 Matsushita Electric Industrial Co Ltd
Automatic tape winding devices.
1392609 Rover Co Ltd
Sound reproduction system for a passenger vehicle.
1392632 EMI Ltd
Styli.
1392645 RCA Corporation
Balanced mixer.
1392761 Nippon Victor KK
Tape auto-loading recording and reproducing apparatus.
1392787 Siemens AG
Carrier frequency data transmission systems.
1392796 Tokyo Shibaura Electric Co Ltd.
Optical signal reproducing apparatus.
1392814 RCA Corporation
Drum system.

March 26

1392863 Fuji Photo Film Co Ltd
Means for generating a signal capable of being used for reproduction of a multicoloured image by television.
1392893 Leslie, D. J.
Pulsato sound generation system.
1392975 Philips Electronic & Associated Industries Ltd
Conversion of image formation into magnetic information.
1392986 Nippon Victor KK
Compressing and/or expanding circuit.
1393013 Philips Electronic & Associated Industries Ltd
Television display apparatus employing convergence correction.
1393015 Cinemeccanica Spa
Motion picture projector.
1393081 Hazeltine Corporation
Antenna system having a reflector with a substantially open construction.
1393082 General Electric Co Ltd
Communication systems and to apparatus for

use in such systems.
1393128 International Standard Electric Corporation
Frequency selective signal receiver.
1393152 Philips Electronic & Associated Industries Ltd
Noise reduction circuit.
1393153 Eastman Kodak Co
Motion picture film cartridge.
1393160 Tiuri, M. E.
Travelling wave chain antenna.
1393216 Werk Fur Fernsehelektronik, Veb
Liquid crystalline nematic substance comprising diesters of two-substituted hydroquinone and applications thereof.
1393245 Plessey Co Ltd
Transmitter arrangements.
1393249 RCA Corporation
Vertical deflection current stabilization in colour television receivers.
1393323 International Business Machines Corporation
Multifrequency receivers.
1393384 Lorain Products Corporation
Amplifier circuit for transmission lines.
1393433 Eastman Kodak Co
Recording material.
1393447 Philips Electronic & Associated Industries Ltd
Deflection coil system in particular for a camera tube.
1393476 American Videonetics Corporation
Tape roll loading and centring device for tape transport.
1393532 Hawker Siddeley Dynamics Ltd
Viewing systems.
1393544 Walker & Walker (Patent Marketing) Ltd
Electronic keyboard instrument.
1393556 British Broadcasting Corporation
Television fault annunciator.
1393569 USS Engs & Consultants Inc
Apparatus for displaying a variable signal versus time relationship.
1393604 RCA Corporation
Home television receiver modified to operate as video terminal.
1393613 Matsushita Electric Industrial Co Ltd
Magnetic record apparatus.
1393634 Pelorex Corporation
Facsimile transmission systems.
1393647 Xerox Corporation
Data communication system.
1393653 Digital Equipment Corporation
Display device with means for drawing vectors.
1393667 Signetics Corporation
Variable frequency oscillator.
1393687 Ted Bildplatten AG AEG-Telefunken Teldec
Recording carrier for signal storage and a method for recording a signal on the recording carrier.
1393690 Burwen, R. S.
Variable frequency response filter and band-pass filter and dynamic noise filter employing same.

Take Neve transportables for great sound everywhere



Kelso

Take Melbourn or Kelso, names that professionals whose business is sound will want to remember. They're new multi-purpose portable sound mixing consoles in the Neve tradition of quality, reliability and service. Their value is not only in price but in versatility.

You can take them for high quality mono or stereo recording or broadcast programme production. Their technical performance and compactness make them ideal for location recording, mobile units or the smaller studio. You can almost take them everywhere and the sound is great.

Both are of compact construction using Neve 3000 slimline series modules in a rigid aluminium enclosure particularly suitable for transportable or mobile applications. Spare panel space is available for optional remote controls or customers' own ancillary facilities. All inputs and outputs are balanced and earth free and terminated on XLR or compatible connectors. With the Melbourn you get twelve channels and a choice of equalisation ; with the Kelso ten channels with LF and HF controls.

Whether you take the Melbourn or the Kelso, you get a lot of value for the money. And money is what you should be thinking about in this of all years.



Melbourn

Neve

The Sound of Neve is Worldwide

Rupert Neve & Co., Ltd., Cambridge House, Melbourn, Royston, Herts., SG8 6AU
England. Tel. Royston (0763) 60776 Telex 81381 Cables NEVE Cambridge
Rupert Neve Incorporated, Berkshire Industrial Park, Bethel, Conn. 06801, USA.
Tel. (203) 744-6230 Telex 969638
Hollywood: Suite 616, 1800 N. Highland Ave., Hollywood, Ca. 90028.
Tel. (213) 465-4822
Rupert Neve of Canada Ltd., 2719 Rena Road, Malton, Ontario, Canada.
Tel. (416) 677-6611 Telex 0696 8753
Rupert Neve GmbH 6100 Darmstadt Bismarckstrasse 114 West Germany.
Telefon (06151) 81764

AES 50th Convention: A Report

JOHN DWYER
FRANK OGDEN
MICHAEL THORNE

AS ONE OF the handful of recording centres in the world, it was appropriate that London should host the fiftieth AES Convention, even if Hammersmith does not, from a distance, exude the same charisma as other parts. In the event, apart from a hotel switchboard not measuring up to the demands of the situation, the last thing anyone could have complained about was communications or nearby facilities. Perhaps Londoners are used to grumbling at a half mile walk, whereas anyone else would think nothing of a five mile ride to anywhere else of interest.

The final number of delegates was not available at the time of writing, but was expected to work out at about 980, with an additional five or six hundred visitors to the exhibition. Financially, 'a small profit' accrued, which is automatically fed back into account towards future events. The AES is a non-profit-making body, and thus adjusts cost and expenditure to what it considers to be an appropriate balance.

The reactions to the organisation and facilities provided for the convention itself varied from the usual niggles to the enthusiastic; the former seemed to be largely outnumbered, notwithstanding the inevitable bias in that direction. As Raymond Cooke, Chairman of the British Section, pointed out, the facilities provided directly reflect the charge for admission to the convention. There had been some complaints about the relatively low pitch, which perhaps should have been higher; the charge of admission is small compared with the amount which would have to be spent elsewhere by a delegate for travel, rooms and living expenses for the four days, so a large increase here would not be so drastic overall but would noticeably improve administrative flexibility. Most of the grumbles heard could be traced to such compromise. For example, a delegates' list, despite the fact that 400 of the 980 had preregistered, was not available. A few press feathers were ruffled by the limited availability of the paper preprints; again, Cooke pointed out that the cost of these was high and that even speakers at the convention were required to pay the appropriate fee. In any case, the number of journalists genuinely interested was small. Despite their being circulated on the first day, the dailies were not interested which, due to lack of any sensation or consumer appeal, was understandable. It was not felt that, although the object of the AES Convention is to disseminate information, that propagation through more than a handful of journals was appropriate.

The preprinting of the papers was a useful innovation. However, despite the deadline being stretched from December 20 to mid February, many papers still missed out. The definitive edition should now be available at AES Convention Los Angeles or from the AES New York office (60 East 42nd Street, New York 10016) at \$12.50 including tax.

The lectures were presented in simultaneous sessions in adjacent halls. The intention had been to operate in strict segments, and thus enable delegates to switch from session to session but, due in one instance to a very English scene with the fire officer appearing at 10.30 on the Tuesday morning and declaring that the lecture would have to be stopped until the banks of KEF real time analysis equipment were made less obstructive, all was not too smooth. In any case, it is ambitious to expect such accurate

interlocking of people and time, although given a certain number of papers it is not easy to find a viable alternative. As with Copenhagen last year, the time signals from chairman to lecturer were not completely invisible sometimes rather undignified. The object is to tell the lecturer, but certainly not the audience, about impending end. The presentations themselves varied from sometimes rather basic discussions of topics which everyone seemed to know already to a majority of useful and thoughtfully presented subjects, some of which are covered later in this article. One of the biggest difficulties with such a convention is forcing any uneasy alliance between commercialism, which demands secrecy and promotion of the obvious, and academicism, which demands free spread of information from the growth points. The temptation to use the lectures as a platform for publicity is therefore great.

Whatever the written discussion, the lecture by G P Millward, 'The Isodynamic Principle' seemed of little value in terms of new material and was presented in such a way that it was reminiscent of standard press conference technique rather than academic discussion. Another blatant sales pitch came from EMI Tape, given by G. H. R. Taylor and D. L. Watson, 'An Improvement in the Sound Quality of High Speed Duplicated Musicassettes'. In presentation, this simply stated all the advantageous details of EMI Type 152 and Type 161 duplicating tape without setting these in any sort of balanced, overall context. In both these lectures, the audience was polite but far from enthusiastic. While Raymond Cooke reserved judgement on individual sessions, he emphasised that in his opinion 'the Conventions of AES should be taken seriously and on no account should become vehicles for commercial promotion.'

As to the sound, obviously any hint of breakdown provoked shrieks of laughter from all directions. With such audience sensitivity it was inevitable that some cracks were noticed even when operation was usually very efficient. The most ironic aspect was the usual inability of many speakers to use any standard microphone technique themselves; from the equipment side, the use of gated mics solved many problems but caused more by awkwardly set thresholds; some speakers did not have any such problems, by preferring to speak acoustically, but this made life impossible for those at the back.

The exhibition went smoothly and, perhaps surprisingly in view of the once-off nature of the exercise as far as London was concerned, business was brisk. We don't feel like repeating the preview, so have limited comments to additional details and information.

The awards banquet sent everyone home happy, the antique Guildhall ambience giving the American contingent something to think about. Honorary membership was conferred on Gilbert Briggs and J. L. Ooms, with citations for Donald Aldous, Titia Bakker, Rex Baldock and John Maunder.

THE FOLLOWING exhibitors were listed in the show preview as 'No information received', while others introduced equipment not mentioned in the preview (STUDIO SOUND, March 1975).

Allotrope's display centre piece was the portable A type noise reduction module intended for use with the Nagra IV tape machine. Using the cat no 22 Dolby card, the internally powered unit can be supplied with interface components suitable for use with other makes of machines. Having the same external dimensions as the Nagra recorders, it is available in mono or stereo. Other more familiar products on display included the Cannon range of connectors, drums of mic cable and assembled jack fields of varying sizes.

BGW Systems showed their range of earth shaking amplifiers (they're used to provide the earthquake via 'Sensurround' in the film of the same name) and provided practical proof that they can be short circuited at full output without detriment to future performance. For demo purposes, a model 750A powered a pair of Westlake monitors sourced via disc. In the main, it said more about the failings of this medium than the performance of the amplifiers.

Cetec offered a range of broadcast mixers utilising some of the very latest techniques in manufacture. Of particular interest was the use of edge connectors to the circuit boards interconnected by ribbon multi strip cable. This wiring system offers machine crimping of the cable to connector, cutting down assembly time. The only new product on display was compressor/limiter CA700 featuring variable compression ratios and comprehensive metering.

Schlumberger Instruments et Systems exhibited a range of essentially broadcast orientated gear including the UPS4000 modular mixer and a series of smaller units for ob vans. For recording, the company offered the three-speed F212 6.25 mm studio machine featuring a transport powered by dc servo control.

Shure offered a new range of sound reinforcement components—the SR series which comprises of master audio console, power amp, electronic crossover, portable and fixed speaker columns and other accessories. Also displayed for the first time was the SE22 professional r1aa preamp as part of an increasing line of electronic hardware manufactured by the company. There was one addition to the mic range, the SMS2, intended as a unidirectional instrument for broadcast applications.

Sescom, a small American company showing for the first time in the UK, displayed rarely thought about but often used products for the recording engineer—junctions and split feeds together with a range of impedance matching boxes. Sturdily built using diecast construction, they are fitted with XLRs and jack sockets where appropriate. The same manufacturer intends to distribute a range of mic and matching transformers under the Sescom name in a variety of specifications.

Cadac introduced their new 'E' type sound consoles designed with the musician in mind. Providing a performance to full recording standards, the compact nature of the desk enables use in a space less than the Albert Hall. Although the basic configuration is 16/8 with eight monitors, variations between 8/2+2 and 32/32+32 may be ordered. The basic desk contains most of the features of the larger cousins including comprehensive equalisation and a patch bay of over 200 positions. On a channel basis, facilities include mic input variable from -70 to 0 dB level, phantom

powering, line input, five section eq, hf and lf shelving, highpass filter, pfl, eight way routing, eq output to jack bay and postfade amplifier with independent output to the same place. On the integrated system, the monitor channels are fitted with vu metering (ppm to order), one in conjunction with a selector switch to read echo send, return, foldback and pfl. Other features include full talkback, slate, logic function indicators to show deployment of monitor functions and optional complimiter functions built into the console.

Beyer Dynamic (GB) Ltd gave a little eve-of-convention party to introduce a new series of radio microphones comprising a transmitter in a choice of package (TS160, SM1600) and a battery/mains receiver NE160. The TS160 is a pocket unit suitable for use with most dynamic mics and will operate directly with the capacitor lavalier mic KMA. In addition, the manufacturers state that the unit will accept a guitar input providing obvious benefits to kinetic superstars. The other transmitter is housed in a mic body which accepts a choice of mic heads. Both models use similar circuitry based on a narrow band fm system operating in the 170M Hz band.

The receiver features a fail safe device which reverts the unit to battery operation in the event of mains failure. A switchable meter indicates the state of the battery, the modulation index and the level of received rf signal strength. For frequency stable operation, both the transmitters and the receiver use crystal controlled rf oscillators. A squelch circuit in the receiver prevents the unit blasting high level hiss through the pa/mixer in the event of signal failure from the microphone.

Brenell displayed a 50 mm tape transport which will sell at a projected price of £1850 without heads. The show exhibit had obviously been rushed to the stand and as a result was lacking in finish. The manufacturers claim that production models produce less than 0.06% wow and flutter measured to the DIN 45507 weighted specification. Other features on the new deck include electronic servo control of back tension, control interlock, min/sec elapsed time indicator and optional remote control of all functions.

Lectures

The loudspeaker lectures, lasting a whole day, covered both aspects of design and quantitative assessment of performance. Three basic approaches to design were indicated by the relevant papers: the first dealt with the design and application in respect of driver units; the second covered similar ground on enclosures and the materials used to construct them, while the third specialised on phasing and crossover problems.

In the first section, four papers were presented. The first, entitled 'Theoretical and Practical Aspects of Loudspeaker Bass Unit Design', given by A. V. Garner and P. M. Jackson, offered a mathematical model of a bass loudspeaker. The authors laid down a series of equations covering the relationships between sensitivity, -3 dB point, enclosed volume, mass and compliance, driver diameter, and strength of flux gap. The authors provide flow diagrams to use the equations in a computer design programme.

The second paper, 'Holographic Investiga-

tion of Speaker Vibrations' by P. A. Fryer, dealt with nodal motion in speaker cones by examining the interference patterns induced by reflected laser light. The basic system requires the cone or radiator under investigation to be illuminated with laser light, part of which is reflected back to a photographic plate. The plate is also illuminated with light directly from the laser. The result is a holographic image reconstructed when the exposed plate is viewed with a laser light. If the unit under investigation is driven by a signal of given frequency, the resulting hologram exhibits apparent striations proportional to the time averaged relative movement of the radiating diaphragm. If strobed laser light is used, cone excursions can be examined anywhere in the duty cycle of the driving waveform. Generally, the author presented the findings of his work in terms of 'sandwich' constructed cones which display high uniformity over the entire area. So far, the technique has revealed the effect of asymmetrical lead out wires and the magnitude of break up occurring out of the passband. It also demonstrated that the break up point could be elevated by inserting an acoustically 'lossy' bung at the centre of the assembly without affecting sensitivity to any extent.

The third paper, 'Instability in Moving Coil Loudspeakers' by D. A. Barlow, refers to the effect of a speech coil moving out of the magnetic gap when driven with a low frequency continuous signal above a given level. The effect of this is obvious; the transducer induced distortion increases dramatically under these conditions. The parameters affecting the 'electrical-mechanical rectification' or mid point shift include system resonance, frequency, power input and the linearity of flux linked turns over the excursion length. In the past, it had been thought that the driving force lost through the coil coming out of the gap at one direction of travel was exactly offset by the increase occurring at the other end. The author showed that any movement from the mid point resulted in a reduction of the flux linked turns eventually showing up as an asymmetric displacement from mid point. All the solutions to the problem relate to increasing the linearity over the length of travel, or by increasing suspension stiffness which adversely affects sensitivity. Tackling the problem from the former aspect, improved results can be obtained with a short coil operating in long gap—particularly if the magnet centre pole has been barrel ground reduce flux at the mid point. This solution results in reduced sensitivity and thermal dissipation.

The fourth paper, 'A Novel Planiform Loudspeaker System' by R. C. Whelan, describes the design, development and construction of an electro-magnetic planar loudspeaker suitable for use in the mid/top end of the audio spectrum. The paper, offering acknowledgement to other manufacturers using a similar motor arrangement, considers that the size and geometry of the magnetic circuit affects acoustic performance more by acoustic loading than by changes in motor efficiency. The author offers some guidance as to the choice of conductor by describing a function to maximise efficiency. The author quotes a prototype spl of 100 dB at one metre from an input of 100W. Virtually identical

■ AES REPORT

ground was covered in a paper presented by G. P. Millward, 'The Isodynamic Principle,' which described the design factors in a magneto-planar headphone unit.

The second section, concerning enclosures and construction, comprised three papers. The first, 'Mechanical Design of Loudspeaker Cabinets' by H. D. Harwood, considers the effect of mechanical Q on various cabinet structures made from materials in common use including grp. Since most reached an effective Q of over 100, after damping, the initial choice of material made little difference. The paper suggested that it was possible to worsen the coloration by using thicker cabinet walls, the corollary being that damping compounds are more effective on thin walled structures.

The next two papers, 'Sound Radiated from Loudspeaker Cabinets' by William Stevens and 'The Sound Output from Loudspeaker Cabinet Walls' by D. Barlow, expanded on H. D. Harwood's theme. The first attempted a quantitative and subjective assessment of the problem and suggested well known remedies. The second author, using rather different test techniques, arrived at the same conclusions. In addition he claimed that 'tubular, and to a lesser extent spherical cabinets give greatly superior isolation with no bending resonance of coincidence effect. They resonate in direct stress only, at high frequencies. The isolation in the bass is equal to or better than 10 cm thick concrete.'

The third section comprised two papers. The first, 'Active and Passive Loudspeaker Crossover Networks Without Transient Distortion' by P. K. Wall, examines transient distortion originating from energy storage in cross-over networks. The author provides some heavy mathematical models of three- and four-way networks in both active and passive format. The active networks are considered in terms of negative impedance converters, although at the lecture, the author indicated



Above: Three dimensional cumulative Spectra for typical loudspeakers (KEF demonstration)

Below: MCI channel modules

Right: Schlumberger 16 mm machine

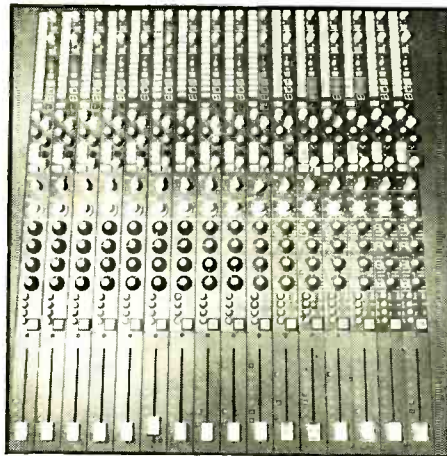

THE ULTIMATE IN TONE CONTROL

KLARK TEKNIK LTD
 Summerfield, Kidderminster, Worcs
 England DY11 7RE. Tel. 64027

BELGIUM
 A.R.C., rue Th. Decuyper, 134 1200
 Bruxelles. Tel. 771.30.63

HOLLAND
 P. BOLLEN, Hastelweg, 6, Eindhoven
 Tel. 40512.777

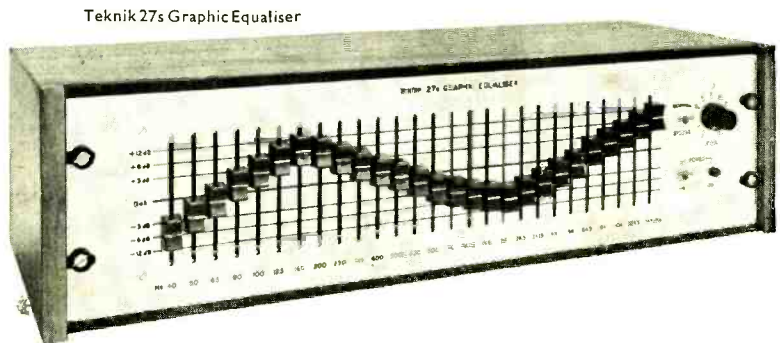

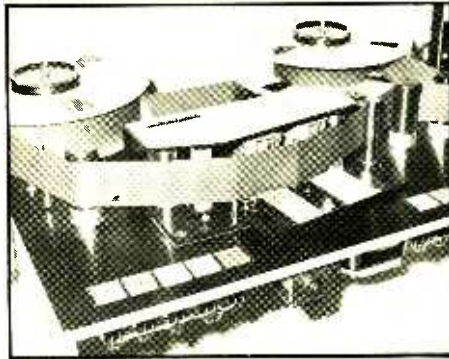

Above left: 24 Telefunken tracks

Below left: Scenic Sound's room

Above: 50mm Brenell transport

Below: MSR lathe



that he couldn't make them work because they were inherently too unstable.

The second paper, 'Loudspeakers—The Missing Link' by Eric Baekgaard, follows on from the previous one. It discusses the effect of cross-over on actual radiated sound pressure in terms of theoretical and practical examples. The author concludes that the best solution to the problems of uneven amplitude and phase

characteristics is to use a basically two-way system with a filler driver operating in the cross-over region.

Regarding loudspeaker assessment, two diverse papers were presented offering both quantitative and subjective performance analysis. The first, presented by L. R. Fincham, 'Loudspeaker System Simulation Using Digital Techniques,' offered an updated impulse

response test using computer analysis to detail the decay effects produced. The 'stored impulse response' produced by the analysis of a computer averaged series of received impulses from the loudspeaker under test, can be entered into a program designed to simulate the effect of the speaker system. This is done by digitising a free field recording, interacting it with the stored program of the characteristics of the loudspeaker under test finally reconstituting the modified digital recording to analogue form. This provides an accurate A-B comparison of the subjective effect caused by inserting the loudspeaker system in the reproduction chain.

The second paper, 'Loudspeaker Evaluation Using Digital Techniques' by J. M. Berman, provided graphical analysis of the computer averaged impulse response discussed in the preceding paper. The graphs, presenting a 3d image of the frequency/amplitude/time vectors, are displayed on either a computer controlled x-y plotter or CRT monitor. Analysis of the Fourier transform provides a computed frequency scale on the x axis; relative sound pressure level modulates the y axis with elapsed time on the z plot. The actual figure is created from a series of x-y plots occurring at regular intervals along the elapsed time scale. The maximum notable decay period relates to the arrival of the reflection from the test cell wall; this is no handicap since all the high energy overhangs inherent in the cabinet or drive unit occur normally within the first couple of milliseconds, well in advance of the first reflections arriving from surrounding objects. This implies that useful studies of resonance and internal echo (both easy to evaluate with this technique) may be undertaken without an anechoic chamber.

An interesting paper, 'Intermodulation Distortion Listening Tests' by P. A. Fryer, dealt with the determination of intermodulation distortion threshold by panel judgement. The im 'black box' split the signal into high and low frequency components fed into a balanced

26 ▶

Broadcast pattern audio jackfields from Future Film Developments

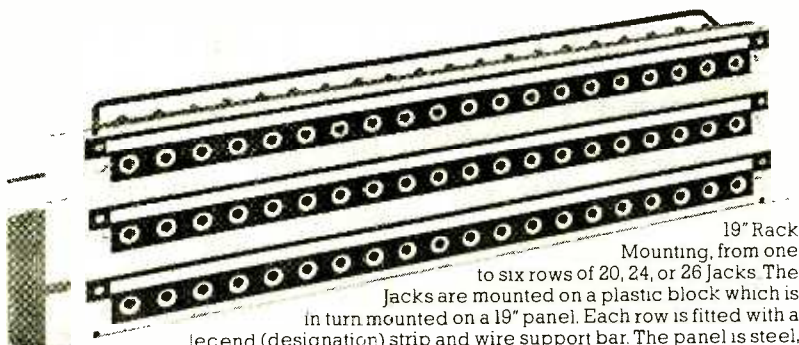

19" Rack Mounting, from one to six rows of 20, 24, or 26 jacks. The jacks are mounted on a plastic block which is in turn mounted on a 19" panel. Each row is fitted with a legend (designation) strip and wire support bar. The panel is steel, cadmium plated, chromate passivated and stove enamelled hammertone silver.

ALSO Audio Patch Cords • Microphone Cable • Installation Cable • Multiway Cable • Post Office & Render Jacks • Cable Markers • Lever Keys • Linear Faders • Cannon Connectors • Preh Connectors • Tuchel Connectors • Switchcraft Connectors • Military Tri-Lock Bayonet Connectors • Audio Attenuators • Wahl and Weller Soldering Irons • PML Microphone Accessories • Hellermann Sleeves and Tools • Crimp Terminals • Cable Drums • A.B. Engineering Wire Strippers and De-Solder Guns.

FUTURE FILM DEVELOPMENTS,

90 Wardour Street, London W1V 3LE.
Tel: 01-437 1892 Telex: 21624

25

■ AES REPORT

modulator. The split signal was then combined in an output mixer to which a known percentage of signal from the modulator could be added. Various a-b tests were conducted to determine the perception limits. Results varied from 0.25% for pure tones to about 5% for music. Results were rather lower for 'pop' music than for piano.

Roger Driscoll offered a late entry 'Narrow Band Transient Test Function' which described a computer generated function of exactly defined bandwidth. The graphical interpretation looks like a six-cycle train of sinewave having the first three cycles rising with the last three falling at a similar rate. The wave trains are separated by a fixed interval governing the fundamental harmonic. From there, 10 emission lines of constant amplitude occur at regular periods to a definite multiple of the fundamental; the last line has an energy content only 3 dB down on the first one thus creating a block of spectral energy. Other harmonics are many decibels below, even though the function is only quantified to 2⁻⁸. Further work by the author will include increasing the resolution to 2⁻¹² thus improving unwanted harmonic suppression. Potential uses of the function include amplifier and loudspeaker testing on transient and intermodulation performance. Since the paper forms the subject matter for the author's Ph.D, more details will be available after the appropriate presentations.

P. J. Walker and M. P. Albinson presented the only paper concerned with amplifier design 'Current Dumping Audio Amplifier' describing 'a new amplifier output stage, in which the linearity of the main current carrying output transistors has no bearing on the overall amplifier performance, hence the need for biasing and allied problems associated with crossover are eliminated'.

After briefly entering upon the need for higher quality amplifiers, the authors offer their solution to the problems of bringing in high power transistors without the discontinuity associated with this action. The paper suggests that, initially, a small class A amplifier should operate independently, supplying all the small signal current requirements of the load, via a series resistor. The small signal linearity of this arrangement requires no discussion. As current requirements increase, a pair of emitter follower transistors, driven from the class A amp output, turn on current into the load via a low value resistor in series with it. Feedback, taken from the junction of the 'dumper' emitters and the series resistor, is applied back to the input of the class A amp at such an order of magnitude as to exactly cancel out the change in mutual conductance due to the augment of the dumper transistors. This keeps the forward admittance, and hence the transfer characteristic of the total combination, constant resulting theoretically zero distortion. In practice, component tolerances and class A performance present the limiting factor.

Claimed advantages of the design are absence of cross-over distortion, no biasing problems, no performance changes caused by junction temperature variation, and no setting up. The authors suggest that, with normal program sources, the robust single diffused output

devices are quite fast enough to augment the class A amp under normal conditions. However, to achieve the fastest risetimes associated with squarewave input, high speed transistors could be used.

A paper, 'Improvements in Cutting Styli for CD-4 Discs' by J. Eargle, et al detailed recent developments in the design of cutting styli. The object of the work was to design a stylus which reduced the crosstalk between the carrier channels, thus lowering the risk of fm beat distortion. In addition, improvements were sought to reduce the effect of variation of carrier level with baseband excursions.

From experiments, the authors propose the following contour changes: shorten the cutting jewel by about 1 mm, decrease the back relief angle to 35° from 45°, increase the burnishing angle to 30° from 20°, and decrease the burnishing facet width from 0.004 mm to 0.002 mm. Early results indicate that the desired effect has been achieved; it also seems that the new stylus has something to offer for standard stereo disc cutting. Graphs, prepared by the authors, show a comparison between the ordinary and shorter jewel in terms of crosstalk and frequency response. The latter appears to give at least 15 dB more separation between 15 to 20 kHz as well as a flatter frequency response due to the lower moving mass. In addition, the increase in burnishing facet angle allows another 3 dB increase in cutting level for CD-4 with another 3 dB increase in baseband level permitted by the decrease in back relief angle.

Peter Craven and Michael Gerzon presented a paper, 'The Elimination of Scratch Noise from 78 rpm Records,' detailing a method anticipating the presence of an unwanted transient and switching out the signal source during that period. The differential between scratch noise and signal transient is obtained by playing the record with a stereo cartridge using the horizontal deviation for signal production and the vertical output for detection. This happens through scratches generally occurring on one groove wall only. To avoid switching on slow signals as might be caused by wear or tracing distortion, the error signal is fed through a hipass filter, rectified and processed through a threshold detector offset by a level proportional to the mean level of the signal. If the level of the detector is exceeded, a monostable triggers providing a 60 μs gating pulse to a sample/hold amplifier downstream of a 40 μs audio delay line in the main signal path. The sample/hold amp maintains the amp output at a level equal to that present before the onset of the scratch pulse. This arrangement offers far less waveform mutilation than a simple on/off noise gate.

On Thursday morning Keith Slaughter of Air Studios chaired 'pop forum', which began with a lecture presented by Ernst Voelker on pop music studios in German radio. He played musical examples, and displayed slides on a gigantic screen. In part, the paper presented the results of an investigation of the pop recording methods and conditions in four German radio studios. They had recorded and compared the volume, area, height, reverb times, surface/treatments equipment requirements and layouts of all the studios. The results have been published in the collected papers from the convention.

The examples were notably un-poplike. Later in the day, when Ernst Voelker was on the discussion panel, someone got up and, to applause from satellites sitting near him, asked why the lecture had been called pop music recording when it was nothing of the kind. Voelker said he was not going to be drawn into a discussion as to the exact delineation between pop and dance music, but said that he was sorry if there was any confusion and agreed that perhaps it would have been better if his lecture had been called 'dance music studios in German radio'. His interlocuter replied: 'I beg your pardon. It wasn't dance music, it was second rate.'

Next Peter Bown of EMI delivered a paper on multitrack recording techniques. The paper was largely historical and mainly concerned the multitrack progress of Abbey Road. He explained, in the light of the problems and possibilities offered by EMI's first four track recorder, a Studer J137A which had arrived in 1964, such terms as overdubbing, generation, selsync, bump track, drop ins, remix, reduction, phasing, double tracking, track split, and sweetener tracks. He described how EMI had improved the facilities offered by acquiring an eight track machine, in 1968, a 16 track and a 24 track machine. He showed slides of all these with the desks that had been developed to go with them. He noted that the use of a meter for each input made the 24/16 desk unique to EMI. He ended by trying to dispel some of the prejudices against multitrack techniques: 'Classical music has now reached the 16 track stage, but often a two track tape stereo is made at the same time and this may even be used in preference to the multitrack version . . . 24 track isn't the ultimate; the next step on the road is the digital tape machine. Multitrack recording should be regarded as progress. It is progress, and not an easy way out for inadequate musicians.' His final comment was that he now had to rush back to record a session on two track because there wasn't enough money to use multitrack.

The discussion panel advertised in the program consisted of David Harries of Air, Bill Price same, Mike King of Advision, Adrian Kerridge of Lansdowne, and Ken Shearer of Ken Shearer. Only Kerridge and Harries appeared, and were supplemented by Voelker of German Radio and Chris Thomas, producer of Bryan Ferry and others. The discussion covered automated mixing, recording a rhythm section, high sound levels in control rooms, adding ambience to recover image positioning, control room equalisation, television sound, disc cutting standards, and Dolby.

Adrian Kerridge put forward the view that although automated mixdowns were useful, particularly in 24 track mixes, the quality of voltage controlled amplifiers available prevented its coming into widespread use. Dave Harries thought there were two reasons why automated mixdown wasn't spreading more rapidly. The first was the cost of updating to 24 track, and the second was non-standardisation of the various systems. 'There's a great deal of interchange of tapes between studios and unless the various systems are compatible I can't see studios investing in automated mixing.'

The next questioner asked how you could

Ortofon groovemanship



Still think you have to
accept some loss in sound
when you cut a disc?

Ortofon says you don't.
Our DSS 732 cutting head
proves that you don't.
Commanded by the

non-compromising
GO 741 drive amplifier,
all sound components
from 10 Hz to 25 kHz
are transferred accurately.
Nothing is added.

Nothing removed.
It's all in the record, and
we'll be glad to send you
details if you will drop us a line.

ortofon
accuracy in sound
UK Agent: FELDON AUDIO LTD.

126 Great Portland Street, London W1N 5PH. Telephone: 01-580 4314. Telex: 28668

■ AES REPORT

split up a rhythm section for separation and yet retain musical cohesion. Kerridge replied: 'I don't like spreading a rhythm section across the studio, out, full stop, period. The musicians would have little visual contact because there are usually screens in the way and they usually have cans on as well. The playing becomes stilted and the feeling goes, and once that happens you may as well pack up and go home because for me that's what it's all about. I'd much rather lose a bit of separation than have a rhythm section that isn't together. I'd prefer to change my mic technique because a good recording starts with the rhythm section—the drums, the bass and the guitars—and if you've got a good rhythm section you can put anything on top and it'll come all right.' He said he thought the most difficult instrument to record as far as separation went was guitar, particularly jumbo guitar, where you had bass and drums going into it, but he thought even that could be solved, even if you had to put a *KMS4* inside it.

Chris Thomas remarked that there were usually long leads on guitar amps and the musicians could stand fairly close without any problems. Ernst Voelker remarked that lack of separation wasn't just a problem because of the actual reflections but because the reflections added coloration to the sound, 'so we like to separate very distinctly'.

The panel agreed that there was little evidence that engineers had suffered from ear damage,

though more research was needed. Kerridge said that the engineer had to use his common sense: 'Obviously no one in his right mind wants to hear a string quartet played back at 100 dB'. He said he thought 80 to 90 dB was a reasonable level over a long period. Voelker caused eyebrows to raise once again when he said: 'For our engineers we have set a limit on the sound of 93 dB. The engineers are asked to leave the control room if it's louder.' Dave Harries added that there was considerable evidence to suggest that members of rock groups, particularly those doing concert, were at risk, but that engineers were only hearing high levels during playback, which amounted to around 20 minutes in the hour. 'Then most of them turn it down when the group goes out.'

Mark Sutton of Sutton Sound Mobile Studios asked if they expected any difficulties from the relative phase positions of different instruments if a recent suggestion (*STUDIO SOUND* December 1974, p60) that adding reverberation to the sound could help make pinpoint location in the stereo image more precise when using a multi-microphone technique. Kerridge replied that he hadn't had any problem with this. If the azimuth were set up correctly, and things like stereo drums put on adjacent tracks, and if a phase correlation meter on the board was correctly used, there shouldn't be a difficulty. 'In any case in pop music the technique is almost entirely injection stereo and if you want any ambience you re-use the studio, use a cue circuit and pan it into position, getting the genuine room sound.'

Chris Thomas added: 'More often than not

you're concerned with creating an illusion rather than recreating an original sound'. Kerridge again: 'Don't forget you mustn't lose the artistic side. We are dealing with an art and the techniques can overshadow this at times.'

One questioner said he thought British and American pressings were declining in quality and asked the panel to comment. Kerridge said it depended on the cutting engineer, the cutting equipment, the processing and the material it was processed on, the vinyl. Thomas said: 'It's very important to follow all the processes all the way through to make sure it comes out exactly the way you want'. Some bands, he said, put out records they had made themselves and weren't too sure of what they were doing. The questioner was unwilling to name the records he was talking about but he discussed it with Thomas afterwards—Thomas was concerned that his own material wasn't suffering from complaints about pressings—and they agreed that the material now available for pressings was declining in quality.

The final question was: 'Does Dolby affect the sound of some instruments more than others?'. Could the panel give any tips as to what to be careful about? There was a long pause, after which Adrian Kerridge was heard clearing his throat: 'Generally, Dolby has no effect. There have been a lot of theories about this but nothing conclusive. All I can say is if you feel there's an effect, say, if the percussion instruments, say a tambourine, were being affected, then switch the Dolby out on that track.'

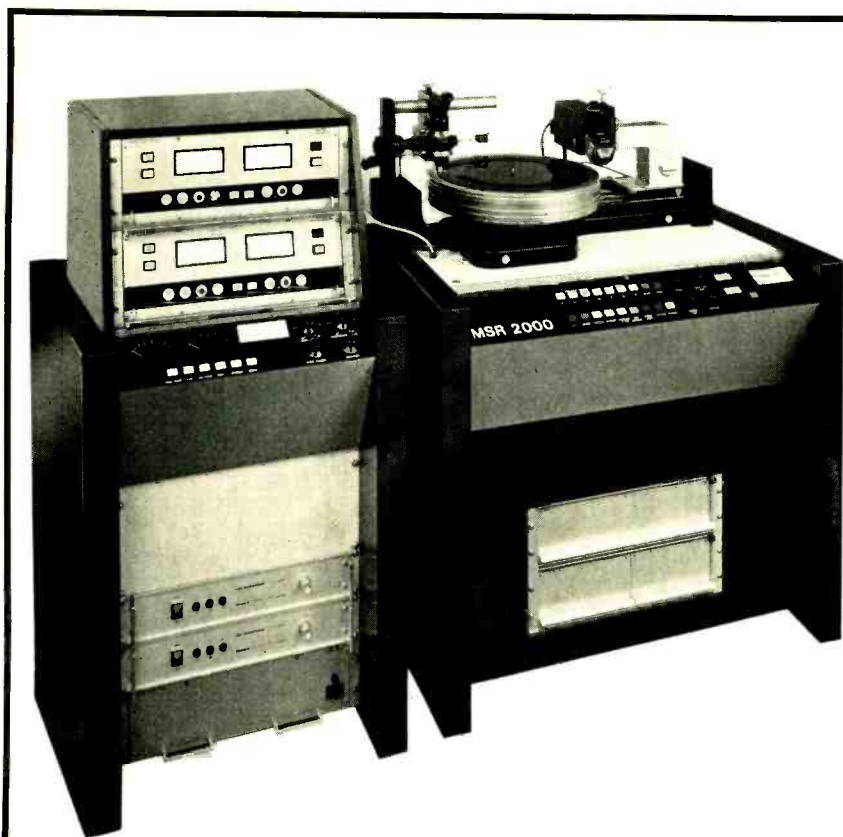

The only Mastering Lathe in the World that can offer you all these features

- The MSR 2000 cuts Mono, Stereo and Quadraphonic, with fully integrated varigroove operation.
- Push Button programming for all functions, speeds and diameters.
- Servo control on leadscrew, 4 speed turntable and cutterhead suspension.
- Automatic groove depth compensation for inner diameters.

Independent tests proved that after 12 months of operation the MSR 2000 met full original specifications.

MSR 2000

The Worlds most advanced Lathe System

MSR Electronics Limited

Balsall Common, Nr. Coventry, Warwickshire, England

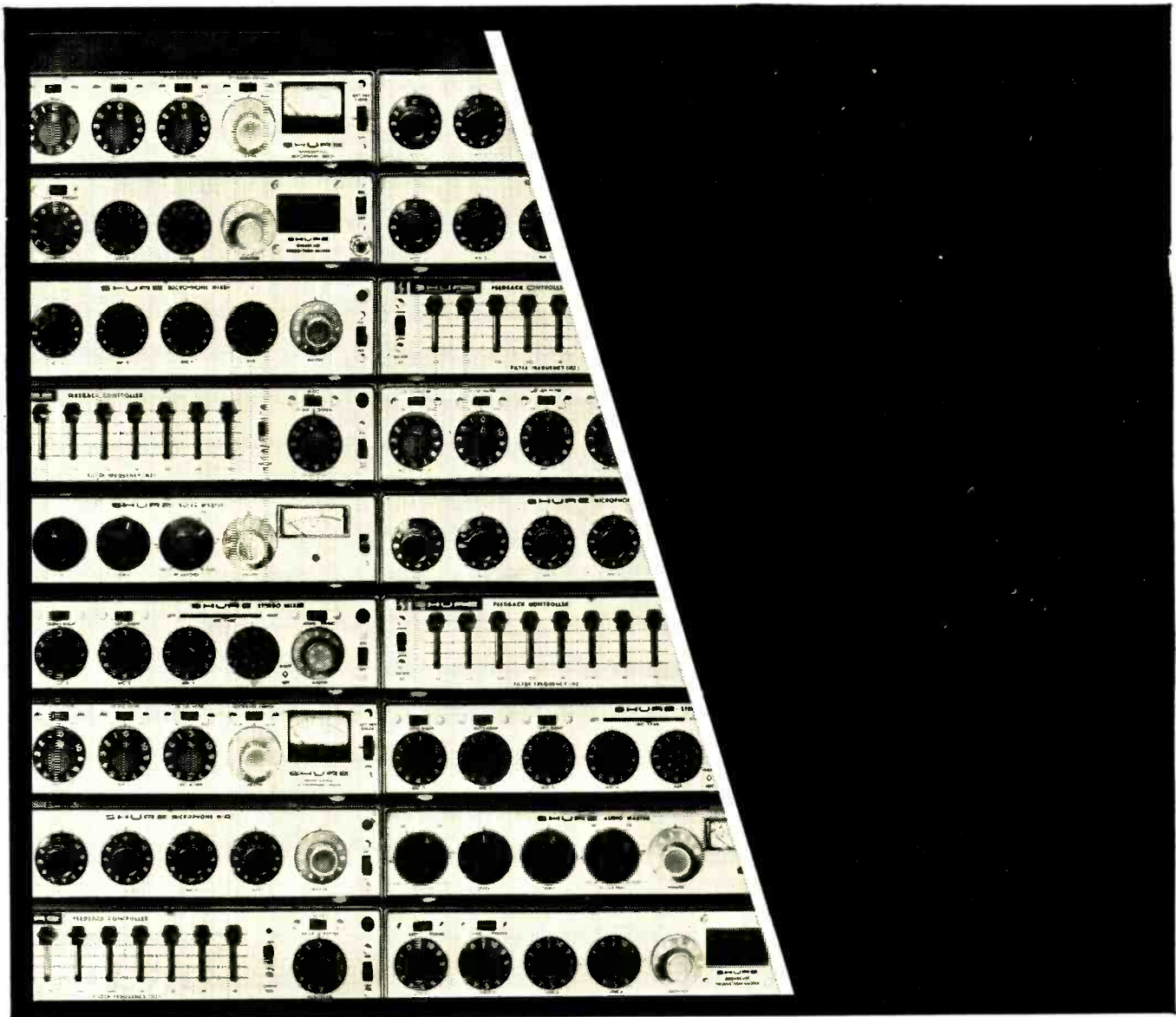

It's a mod, mod, modular world.



Simplify, simplify! Instead of paying more for bigger, bulkier audio control components, *pay less* for compact Shure modular components that— singly or in combination—handle critical functions flawlessly. Cases in point: (1) the *M67 and M68 Microphone Mixers*, the original high-performance, low-cost mixers; (2) the *M610 Feedback Controller*, the compact component that permits dramatically increased gain before feedback; (3) the *M63 Audio Master*, that gives almost unlimited response shaping characteristics; (4) the *M688 Stereo Mixer*, for stereo recording and multi-source audio-visual work; (5) the *M675 Broadcast Production Master*, that works with our *M67* to create a complete production console (with cuing!) for a fraction of the cost of conventional consoles; and (6) the *SE30 Gated Compressor/Mixer*, (not shown above) with the memory circuit that eliminates “pumping.” For more on how to “go modular,” write for the Shure Microphone Circuitry Catalogue.

Shure Electronics Limited
 Eccleston Road, Maidstone ME15 6AU
 Telephone: Maidstone (0622) 59881



Basic principles of four channel sound reproduction are presented in the light of the SQ matrix, its evolution and design. These are complemented by a discussion of sound mixing and general engineering applications, with examples of recent productions using the technique for eventual disc issue.

SQ quadraphonic disc system: the producer's view

BENJAMIN B. BAUER*

Introduction—why SQ?

SINCE ITS INTRODUCTION before the International Music Industry Conference (IMIC) at Montreux, Switzerland, in June 1971, the SQ Quadraphonic System has made remarkable progress: More than 500 different SQ record albums have been issued¹ on forty of the world's most respected labels performed in the classical repertoire by celebrated artists and conductors exemplified by Barenboim, Bernstein, Boskovsky, Boulez², Biggs, Frémaux, Martinon, Rostropovitch, Previn, Somáry, and Michael Tilson Thomas; and in the popular field by 'superstars' such as Lynn Anderson, John Baez, Blood Sweat & Tears, Chicago, Miles Davis, Bob Dylan, Pink Floyd, John Keating, Enoch Light, Billy Paul, Simon & Garfunkel, Buffy Sainte-Marie, Santana, Barbra Streisand, Andy Williams, Johnny Winter, and scores of others. More than 300 fm radio stations in the USA and elsewhere currently broadcast quadraphonically in SQ, fully compatibly with the needs of their stereophonic and monophonic listeners, by the simple expedient of placing SQ records on their existing turntables; and the well-known performing groups which broadcast 'live' in the USA—the Boston Symphony Orchestra, the Cleveland Orchestra, and the Chicago Lyric Opera—do so through SQ coders installed in their control rooms³. Without a question, SQ is the most widely adopted system of quadrphony in the USA, Great Britain and Continental Europe.

The SQ system is a 'matrix' system, ie, one in which the multiplicity of directional signals to be transmitted or recorded is combined or 'coded' into two signals, LT and RT, according to a set of mathematical matrix coefficients for the purpose of conforming with the stereodisc format. Upon replay, the two coded signals are re-combined or 'decoded' into four which are displayed on loudspeakers surrounding the listener. Interestingly, the progress of the SQ system has occurred despite intense competitive persuasion mounted by other systems proponents, some of whom find special virtues in the particular set of matrix coefficients they have espoused, while others assert that only with added carrier modulations can a disc record provide 'genuine' quadraphonic performance. In the light of this competition one can properly ask the question: 'Why SQ and not some other system?' Answering this question has the added advantage of laying the foundation for a study of the practices employed in producing SQ records and broadcasts.

Psychoacoustics of multichannel reproduction

To understand better the technical approach taken in connection with quadraphonic systems in general and the SQ system in particular, it is important that we learn a little about psychoacoustics of multi-speaker reproduction. A comprehensive discussion is out of the question in this brief paper, but some fundamental principles can readily be reviewed.

Anyone who has listened to a good stereophonic system knows that a sharp virtual acoustical image is perceived by the listener symmetrically facing a pair of loudspeakers emitting identical signals. We are so accustomed to this experience that we begin to think of it as being obvious; but, nevertheless, a theoretical proof is quite in order because it

explains some other not so 'obvious' observations. For this we use the convenient method of phasor analysis⁴.

Referring to fig. 1(A) let a sound source S travel in a circle from extreme left to the extreme right position around and in front of an observer, and let's consider the signals that must be applied by means of loudspeakers L and R placed at 45° and -45° in order to reproduce the sensation caused by the moving source. At the 90° position (a) the pressure at the left ear is portrayed by the phasor l in fig. 1(B) (a) and at the right ear by the phasor r . The pressure l is larger than r because the head acts as an obstacle or baffle, the fraction l/r being greater at shorter wavelengths (and hence, at higher frequencies). Also, there is a phase angle ϕ (90) between the left and right ear phasors corresponding to a time differential $t=d/c$ caused by the added distance d which the sound wave must travel around the head from the left to the right ear⁵, which is approximately .27m, c being the velocity of sound, approximately 344 m/s. The phase differential ϕ is $360fd/c$, degrees (where f is the frequency, Hz). Thus, at $f=262$ Hz, corresponding to the middle C on the piano, ϕ (90) is approximately 74°. At the left loudspeaker location (b) the fractional differential between l and r as well as the angle ϕ are both diminished because the relative obstacle effects as well as the differential distance both have been diminished, the latter by the factor, $\sin 45^\circ/\sin 90^\circ=.707$, as shown in fig. 1(B) (b); thence ϕ (45) now is 52°. At the position (c) in 1(A) the phasor relationship is as shown in 1(B) (c), with both pressure phasors being equal and in phase. As S advances to (d) and then to (e) the phasor relationship becomes similar to that which exists at (b) and (a), except that l and r are reversed.

Fig. 1(C) demonstrates that signals from L and R can properly reproduce S. For example, in fig. 1(C) (b) a signal is applied to L only. The pressure phasors at the left and right ears of the observer are lL and rL , obviously exhibiting the same relationship as when the signal S is located at the position (b) in fig. 1(A). A corresponding observation is made in connection with fig. 1(C) (d) which refers to the case when the signal is applied to R only.

Next, the resultant pressures with equal in-phase signals applied to both loudspeakers is depicted in fig. 1(C) (c), resulting in phasors l and r at the respective left and right ears, both of which are *precisely* equal and in-phase, as in the case of the real centre-front signal S. The observer listening to this arrangement behind an acoustically transparent opaque curtain insists that there exists a real, sharply defined source of sound precisely and exactly in the centre location.

Signals not in-phase

Let us now consider some not-so-obvious situations:

Fig. 1(D) (a) depicts what happens when the two signals remain equal in magnitude, but are not in-phase. Say R lags behind L by an angle $\gamma=30^\circ$. It is seen that in this case the resulting pressure r lags behind the pressure l by an angle ϕ ($\gamma=30^\circ$), as in the case of a time delay corresponding to a shift of the apparent source position towards the left, or the leading, loudspeaker⁶. But, we also observe that r has the *greater* magnitude, thus suggesting a shift

*CBS Laboratories, Stamford, Connecticut, USA

to the right! This contradiction gives rise to a measure of confusion as to the precise direction of sound arrival, causing the image position to appear to spread out or broaden and, since the time-of-arrival tends to be the major factor, also to shift the spread-out image toward the leading loudspeaker. Both these tendencies are exacerbated when γ is increased. With the $\gamma=90^\circ$ condition shown in fig. 1(D) (b), the $\phi(\gamma=90^\circ)$ and r against l differential both having increased, the positional uncertainty of the image is further increased and its centre of gravity becomes shifted approximately one third the angular distance toward the leading loudspeaker⁷. With $\gamma=180^\circ$ shown in fig. 1(D) (c), $\phi(\gamma=180^\circ)$ becomes 180° also, thus both the input signals and the pressure phasors are equal and antiphase, a situation not experienced when dealing with real sounds. The perceived direction of sound arrival is quite uncertain, and also there is induced the unpleasant 'pressure-in-the-ear' sensation.

The above analysis explains the compulsion of the recording engineer, who through experimental process has learned the importance of preserving the integrity of front stage images by carefully maintaining the in-phase relationship of stereophonic signals, and alternatively, to use delays and phase-shift devices to provide a spatial spread to signals which he desires to portray in a more diffused, or more distant manner⁸.

Side images

A further observation stemming from phasor

analysis, especially important to quadraphony, is depicted in fig. 2 which explains the uncertainty of localisation of images formed by the side loudspeakers LF and LB (or, by RF and RB). Let a discrete sound source S be placed at 90° to the line of symmetry, as shown in fig. 2(A). The phasor relationship for this case is shown in fig. 2(B) (a). Now, remove S and apply two equal signals to the loudspeakers LF and LB. Assuming for the moment that the observer has a front-back symmetry, the set of pressure phasors at his ears is shown in fig. 2(B) (b), each set corresponding to those we had determined in connection with fig. 1(C) (b). Now, it is obvious that no simple combination of these sets will alter their resultant relative amplitude or phase relationships. They will remain equivalent to phasors produced by signals proceeding either from the 45° or the 135° directions and this explains, in part, why the virtual side images are not as sharp or stable as the virtual front images. Moreover, it is known that man's localisation ability for side signals is not as good as for frontal sources. In addition, in what we have named 'front-source dominance'⁹ for the forwardly oriented listener, the side images do not appear to proceed from 90° , but rather from a direction near the front loudspeaker; and slight head motions tend to shift them from front to back. Some producers find this distracting and prefer not to utilise the centre side locations for soloists, but mainly to use them for portraying wide-area sources, such as choral or instrumental groups, or for reverberation.

The above argument applies equally well to SQ quadraphony; except that since the decoder allows some out-of-phase (not necessarily anti-phase!) signals to be transferred to the opposite channel pairs, this appears somewhat to increase the definition of the centre left and centre right locations; but not enough to make them especially attractive for solo placement. Thus, the traditionally-minded producers working with the SQ system frequently prefer to place the concert stage between the front loudspeakers, and to surround the listeners with the ambience; while others, more contemporary, actually prefer to place the instrumental groups around the listeners. This latter so-called 'surround sound' mode, of course, is *de rigueur* in certain musical works, such as Gabrieli's four-part choirs performing at St. Marco's in Venice. Nevertheless, some producers have been enormously successful in adapting this mode to all types of music, and have determined that it is most effectively carried out by placing the principal performers or instrumental groups directly at the loudspeaker locations, as well as in the front quadrant where stable images can be obtained; with the spill-over sounds and the reverberant effects acting as a unifying sonic force which binds together the quadraphonic performance, and causes the listener to feel that he is literally surrounded by sound.

Some other psychoacoustical phenomena especially applicable to matrix quadraphony are described in our earlier paper on this subject⁹.

SQ basics

While the language of mathematics often is used to describe the action of matrixes, I find that a portrayal in terms of stylus tip motions

32 ►

Fig. 1. Phasor Diagrams for Frontal Signals: (A) Experimental Arrangement; (B) Pressure Phasors at Listener's Ears with a Moving Sound Source S; (C) Pressure Phasors at Listener's Ears with In-Phase Signals Applied to Loudspeakers L and R; and (D) Pressure Phasors at Listener's Ears with Out-of-Phase Signals

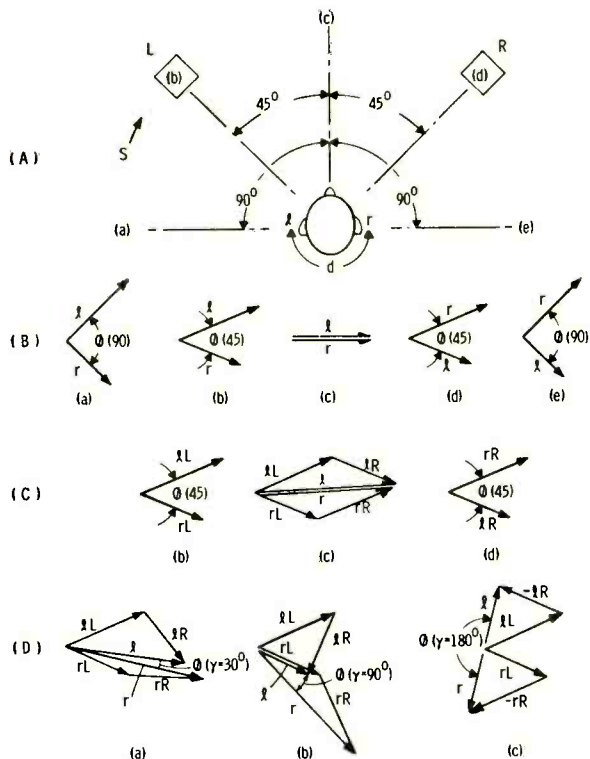
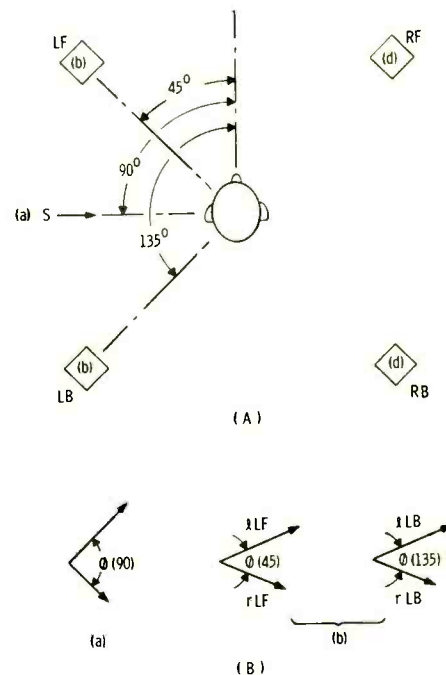

Fig. 2. Phasor Diagrams for Side Signals: (A) Experimental Arrangement; (B) Phasor Diagrams with Signals Applied to Loudspeakers LF and LB



■ SQ QUADRAPHONICS

is helpful in explaining graphically some basic differences in performance of various matrix systems. As a point of reference, **fig. 3(A)** portrays the performance of a conventional stereophonic recording: The stylus motions caused by signals applied to the left channel are at 45° , as depicted by the vector **L**; signals applied to the right channel cause the stylus to move at -45° , as shown by the vector **R**; and application of equal in-phase 0.707-magnitude signals to both channel inputs results in a lateral motion of the stylus, **C**. If the equal but not-in-phase signals are applied to the cutter, then **C** becomes an ellipse, and if the signals are at 90° , the ellipse turns into a circle. But, as explained before, out-of-phase signals generally are not intentionally used in stereo practice: Good coincident microphones are designed to preserve the phase integrity of the signals, and the in-phase relationship is naturally retained with proximate microphones 'panned' into the desired positions within the stereo field, assuring the portrayal of sharp solo signals, except for the special effects previously described⁸.

The well known fact that the stereo record is compatible with monophonic listening is demonstrated in **fig. 3(B)** which is a horizontal projection of the stereophonic vectors: it is noted that the **L** and **R** signal amplitudes are diminished by $\cos 45^\circ$, or 3 dB, while the magnitude of the centre signal **C** remains unchanged. Thus, there is a 3 dB relative imbalance in the favour of the centre solo; but since in monophony there is no positional discrimination to make the solo stand out, the above amplitude differential in favour of the soloist usually results in a welcome sonic improvement.

Fig. 3(C) shows the stylus motions caused by the application of cardinal directional signals to an SQ encoder, such as the CBS Laboratories encoder, Model 4211, shown⁹. It is noted at once that the front signals, **LF**, **CF** and **RF** are exactly and precisely equal to the equivalent stereo signals. Thus, all the procedures used by the artists and the producers with the traditional stereophonic practice, where the concert stage is defined by the two loudspeakers in front of the listener, are carried out exactly and precisely with the quadraphonic mode.

This felicitous attribute makes it extremely simple to produce SQ records which are fully compatible with their stereophonic counterparts. This is an enormous advantage which allows us to look forward to the day when SQ records will replace conventional stereodiscs, just as the latter have replaced the monophonic product.

The back channels in SQ are encoded as equal in-quadrature (phase at 90°) signals resulting in circular stylus motions. For the left-back (**LB**) channel the left coded signal leads the right signal describing a clockwise circle. To define the right-back (**RB**) channel, the right coded signal leads, resulting in a counter-clockwise circle. As explained in an earlier section, these signals in the stereo mode appear to be distributed in space and located at either side of centre of the stereophonic field. This is a very satisfactory spatial distribution for any discrete left and right back channel signals that may be present. The observer feels as if he were standing outside the quadrangle looking in. The signal spread is interpreted by the ear as defining image depth. Therefore, an SQ record played on stereo equipment provides an excellent stereophonic image.

A most important attribute of the circular back channel modulations is that their projections on the horizontal line are identical in magnitude to the horizontal projection of the signals **LF** and **RF**, as shown in **fig. 3(D)**. Therefore, with the SQ system, all four corner channels have exactly and precisely the same relative output levels in the monophonic mode as they do in the quadraphonic or the stereo mode. This is another indispensable attribute of the SQ system which, together with the total front channel isolation and in-phase reproduction of front channel signals constitutes the triplet of essential SQ characteristics so important for high fidelity and compatibility. These advantages are not shared with any other quadraphonic matrix proposal, which has led to the selection of the SQ system by many careful, quality-conscious broadcasters and record makers¹⁰.

Carrier disc quadrphony versus SQ

The earliest approach to disc quadrphony studied by CBS Laboratories employed two

carriers added to the audio basebands, the four channels being distributed among them in much the same manner as currently being practiced in the Japanese CD-4 system but using the more economical single sideband modulation¹¹. The maximum frequency one could record and reproduce on the disc, which had to be allocated between the basebands and the carriers, in practice limited the effective upper frequency response range of the disc to 15 kHz. And, because of the existence of tracing distortion in playback, there was considerable intermodulation between the basebands and the carriers, especially in the upper end of the spectrum. This meant that the recording level had to be kept low, and instruments rich in harmonics and partials—brass and percussion—had to be severely limited by electronic means, resulting in relatively colourless reproduction especially on the inside of the disc where intermodulation is greatest. An expensive, delicate, extended range pickup was needed to trace the ultrasonic modulation, which we judged to be quite out of reach of the mass market. The record itself had to be recorded at half speed, which made it slower and more expensive to make, and modulation noise limited its dynamic range capability. The choice of the SQ system, which has all the advantages associated with the stereodisc and which, when decoded with a full logic decoder, provides all the channel separation one needs in practice, for us was obvious.

SQ caveats

There are two caveats with the SQ system; one can be turned to advantage, and the other dealt with using conventional studio techniques.

1. A centre-back (**CB**) signal, that is, signal applied equally to the back coder channels, results in vertical modulation of the groove as shown in broken line in **fig. 3(C)**. This signal is reproduced antiphase in the stereophonic mode, and is cancelled in the monophonic mode. Therefore, it is not desirable to place soloists or other important performers in the centre back location. On the other hand, it is advantageous to 'mic' or 'pan' a part of the reverberation to the centre back which will cause it to disappear in the monophonic mode, with the beneficial effect that the total monophonic

34 ▶

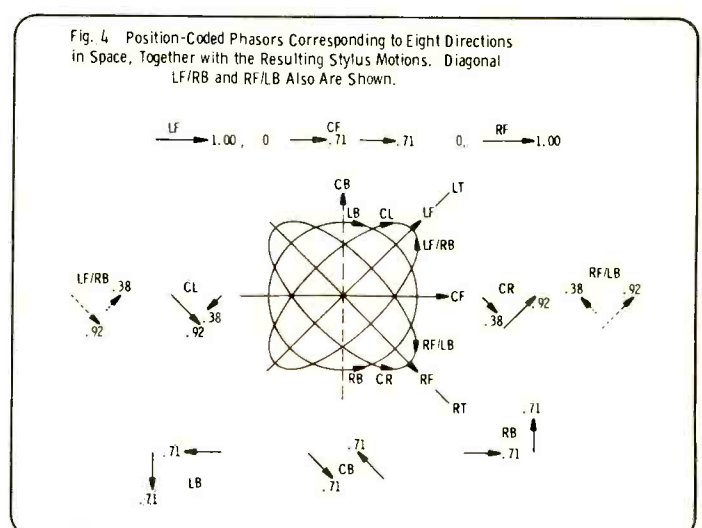
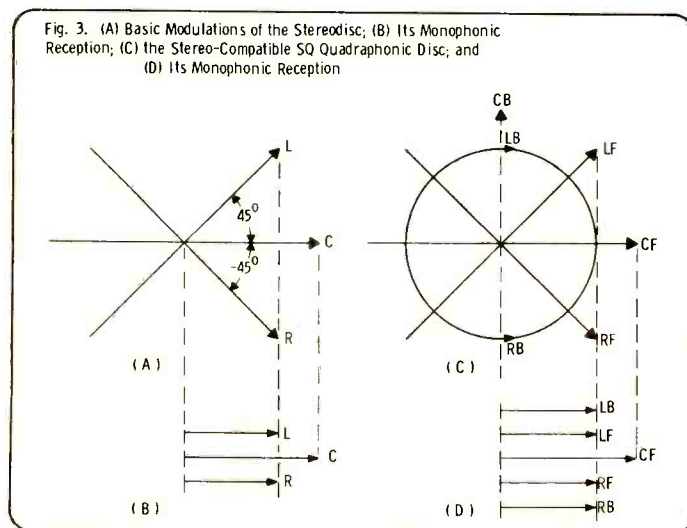



UREI~Instrumental in Audio

A comprehensive range of proven audio processing equipment, universally acclaimed and offering performance second to none.

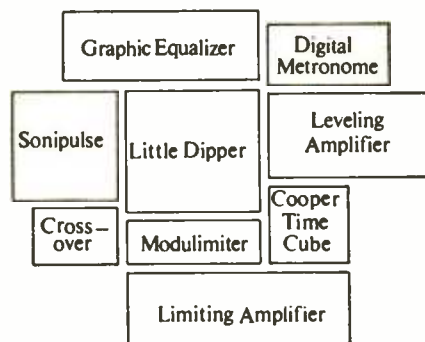

**UNIVERSAL
AUDIO**

F.W.O. Bauch Limited

49, Theobald Street, Boreham Wood,
Hertfordshire, Tel. 01 953 0091

■ SQ QUADRAPHONICS

reverberation is diminished. If it becomes imperative to place significant sounds between the back channels, then they should be 'panned' off centre, or fed to both channels with small (10-15 ms) delays to provide the desired incoherence. Of course, in those situations where monophonic reproduction is not a factor, there is no restriction on the use of the centre back location.

2. Signals applied coherently and equally to all four coder channels result in nonsymmetrical encoded outputs buildup. Such signals rarely occur in practice except with the overhead pan-pot position. If it is desired to provide an overhead signal, it is desirable to break up the coherence by feeding the back coder channels with the signals that have been delayed differentially by, say, 10 and 15 ms. The unequal delays provide the desired incoherence between front and back to prevent the coded channel nonsymmetry. It should be noticed, however, that natural concert hall reverberation picked up with several microphones is sufficiently incoherent to be reproduced as a periphonic decoded signal around and above the listener with total symmetry.

If the producer keeps the above caveats in mind during the acoustical pickup or during the studio mixdown procedure, the SQ coding of the master tape will present no difficulty. Decoded through a good full-logic SQ decoder, the coded record sounds remarkably similar to

the original four-channel tape. For greater convenience, especially when arranging surround-sound or popular compositions, the use of a special 'position encoder' module adaptor, Model 4212, which establishes the optimum SQ code 360° around the circle, is advisable¹². This code, together with the resulting stylus motions, is shown in fig. 4 for eight directions around the circle. It will be noted that the position encoder allows the choice of either panning around the quadrasonic circle, or panning a 'figure-eight' along the diagonals, which produces vectors shown in broken lines. In this latter mode the LF/RB or RF/LB modulations are defined and properly reproduced in decoding, a capability which is available only with the SQ matrix, and is one which popular arrangers occasionally find of significant interest.

When the SQ system is used for broadcasting live performances, it is convenient to employ the CBS Laboratories-designed, Sony-built, encoder-mixer Model *SQE-2000*. In addition to the basic SQ code, the *SQE-2000* offers some modified arrangements especially useful for solving some broadcasting problems. For example, the so-called 'forward-oriented' SQ coding mode transmits any unintentionally present centre-back signals monophonically without loss, as if they were centre-front signals. The 'forward-oriented' mode also is useful in allowing stereophonic records to be reprocessed to simulate a 'surround-sound' quadrasonic display¹³.

SQ decoder

Much already has been written about SQ decoders¹⁴, and a repetition of this material is not called for in this paper. Suffice it to say that a complete SQ decoder includes a decoding matrix and a separation-enhancing electronic logic. The basic SQ matrix restores full front and back interchannel separation but provides front-back separation on the sides of but 3 dB, and a nil centre-front centre-back separation. This latter attribute can be significantly improved through the provision of fixed blend across the front and the back channels, but for accurate SQ decoding it is essential to add an electronic logic to the matrix. Currently SQ logic system is available in the form of inexpensive ics. The logic increases the gain of the channels containing the desired signals almost instantaneously and at the same time diminishes the gain of channels containing undesired signals in such adroit manner that the ear accepts the decoded/enhanced signals as being substantially equivalent to the four-channel master tape; 20 dB front-to-back channel separation is readily obtained. If the artist and the producer feel that the decoded signal needs adjustment to better portray the desired quadrasonic presentation, then it is possible through minor alterations in the coding process to provide the desired improvement. The position encoder module is especially useful in this connection. In any event, the encoded disc and the decoded signal become the approved product of the artist and the pro-

Fig. 5. Quadrasonic Broadcasting Arrangement in the Boston Symphony Hall, in Boston, Mass., U. S. A.

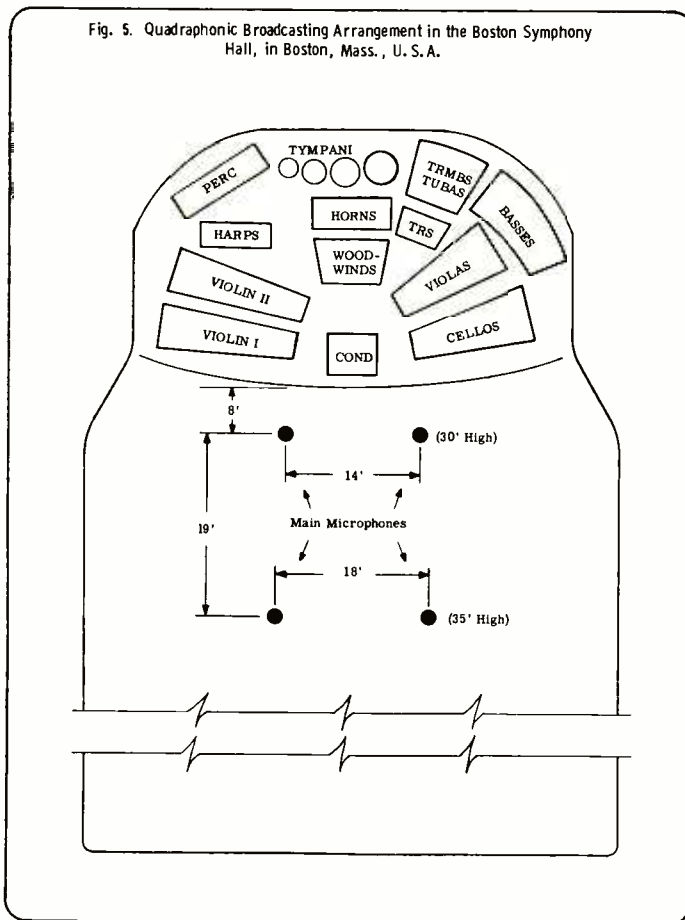
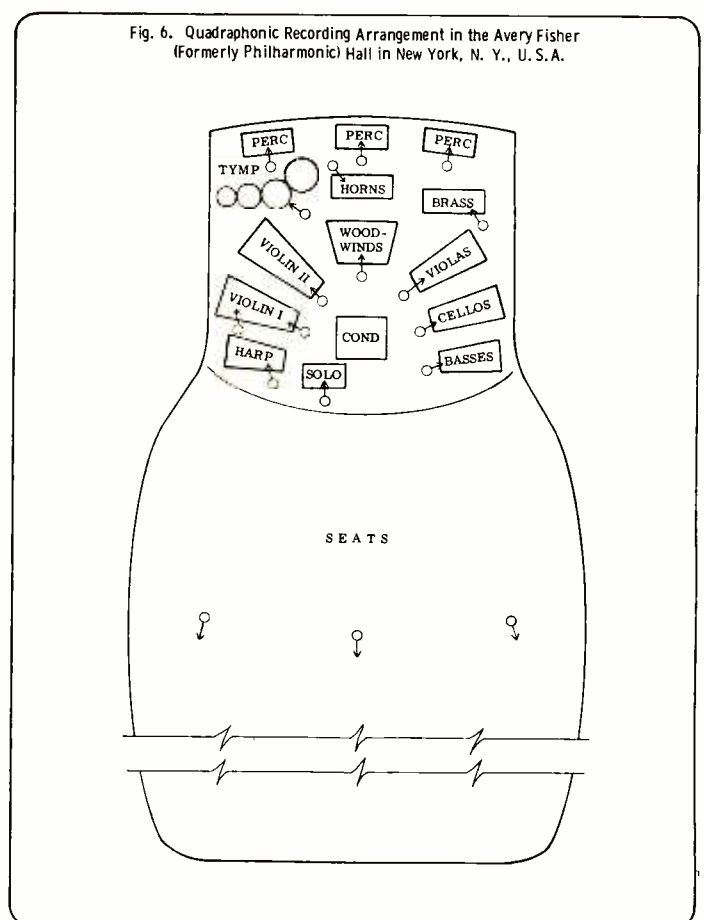

Fig. 6. Quadrasonic Recording Arrangement in the Avery Fisher (Formerly Philharmonic) Hall in New York, N. Y., U. S. A.



ducer and therefore any arguments about an alleged superiority of other possible methods of four channel disc recording become merely of academic interest.

An advanced high-performance logic design called a 'Paramatrix' logic currently is being field tested and evaluated in recording studios offering a capability for single-sound separations of 35-40 dB. The date for commercial introduction of paramatrix logic has not as yet been established.

The producer's viewpoint

Having described the principles of operation of the SQ system we have now arrived at the point where actual recording and editing procedures can be usefully described. Naturally there is no book of rules which ensures success in the recording art—endless practice is needed and, unfortunately for some who would aspire to enter this calling, a good measure of creative musical talent and even a little bit of luck as well. Nevertheless, many producers have been eminently successful and have turned out creditable performances year after year. I have obtained from them a description of how they go about broadcasting and recording for the SQ system. I was surprised to find out that the majority plan for *quadraphony*, not especially for SQ. The four channel master is directly encoded and any slight adjustments are made infrequently only when needed. Successful producers, of course, understand and observe the SQ caveats and find a way to use them to their advantage.

For the purpose of this paper I paraphrase recent interviews with a pioneer quadraphonic broadcaster, with a classical producer, with a 'pop' music producer and an outstanding quadraphonic remix engineer. These examples obviously are not exhaustive, but they give an idea of how successful producers go about their work. Others of equal eminence approach the problems differently and I regret only that space has necessitated limiting the number of examples given in this paper to three.

Quadraphonic broadcasting

The initial motivation for quadraphony arose from the vision of technically trained persons who also were close to music; it is not surprising therefore that from the outset, broadcasting has played an important role in the development of quadraphony. Among the earliest workers in this field was Mr. Richard Kaye, Managing Director of the Radio Station WCRB in Boston, Massachusetts, USA, who for several years has been producing quadraphonic broadcasts of the Boston Symphony Orchestra. The orchestra broadcasts 'live' during its concert season over WCRB using the SQ system. The coded tapes also are made available to more than 100 broadcasting stations in the USA and elsewhere. The arrangement of microphones is shown in fig. 5. The outputs of the four main microphones are conveyed to the corresponding coder inputs. After numerous experiments, Mr. Kaye has found it advantageous to use the 'front-oriented' coding mode. Pressure microphones are used, because cardioid microphones have been found to provide insufficient liveness. Coincident crossed-cardioid microphones were found not to provide adequate front-stage realism. In the case of a soloist, or when an accent is needed, auxiliary microphones are used on the stage

Fig. 7. Surround Sound Orchestral Arrangement for Recording *Carmina Burana* at the Masonic Temple, in Cleveland, Ohio, U. S. A.

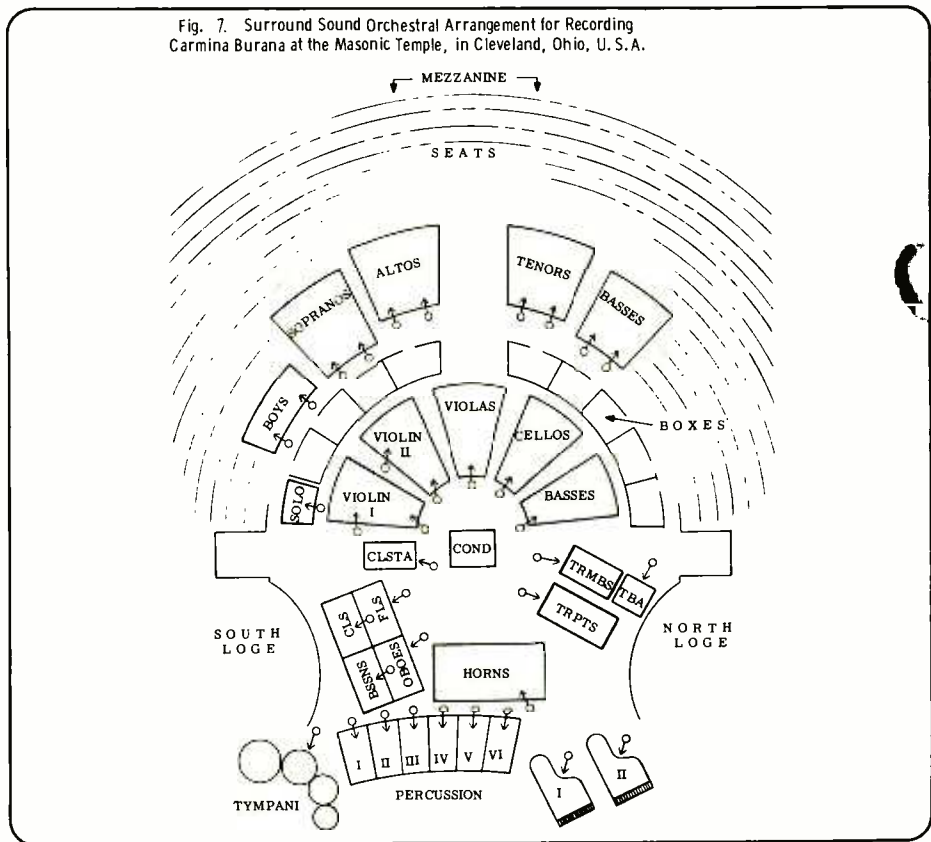

and they are mixed into the front channels.

In the early days of WCRB broadcasts, the back microphones were arranged approximately 3m behind the front ones, with the front pair transmitted over WCRB and the back pairs 'simulcasting' over the Radio Station WGBH, also in Boston. The listener employed two receivers to produce the quadraphonic effect. The simulcasting procedure ceased a year ago and the back microphones were moved to their present location to provide a more natural reverberation, the broadcasts being carried by WCRB solely in the SQ mode.

Classical recording

A foremost exponent of classical record production at CBS in New York is Mr. Andrew Kazdin, a graduate both of the Massachusetts Institute of Technology and the New England Conservatory of Music, who has been producing records for CBS for the past decade. Mr. Kazdin began producing quadraphonic records since the adoption of SQ by CBS, his early product being the conventional 'stage-in-front-hall-ambience-in-back' variety. These early recordings were made in Avery Fisher Hall (formerly called the Philharmonic Hall) at the Lincoln Centre in New York City. The Hall tends to be rather 'dry' and somewhat lacking in bass, and there has been a recent announcement that it will be completely rebuilt on the inside for improved acoustics. Nevertheless, Mr. Kazdin has found that he could produce outstanding recordings there (a good example of the record being better than real life) through a suitable orchestral and microphone arrangement, shown in fig. 6. It should be noticed that

the seating differs in some respects from the arrangement used when the orchestra plays before an audience. Since there is considerable 'spill over' between microphones, an attempt is made to group the instruments so as to facilitate the final editing procedure. For quadraphony, three microphones are added halfway down the hall, with the cardioid patterns facing toward the back. Excellent quadraphonic recordings were obtained in this manner.

Lately, he has been working with the surround-sound approach, and for this purpose, he has found the Manhattan Centre in New York City to be a favourable environment, because it allows the orchestra to be suitably placed around the conductor, which, in turn, helps to preserve the mood of the original performance. Mr. Kazdin is a purist and his productions are made without regard of the quadraphonic system finally to be employed. He avoids, of course, the SQ caveats, such as the placement of a soloist in the centre-back. But otherwise, he mixes the four channel tape and simply puts it through the basic SQ encoder.

Being an experienced producer, Mr. Kazdin always attempts to arrange the performing groups in such manner that they fit into his final plan. His recent spectacular production of *Carmina Burana* by the Cleveland Orchestra in Cleveland, Ohio, USA, with Michael Tilson Thomas conducting illustrates his point. In order to obtain a large enough area for proper acoustical control of sound pickup, the recording was done not at the Severance Hall, the

■ SQ QUADRAPHONICS

home of the Cleveland Orchestra, but at the Masonic Auditorium in Cleveland where the mezzanine seats blend into the main floor seats (which were removed, and the orchestra pit covered) to provide the desired floor plan, shown in fig. 7. The microphone outputs were suitably combined and recorded on a 16 track tape. The final arrangement used in editing is shown in fig. 8, the four circles representing loudspeakers. The arrangement, of course, differs from the original recording geometry. Nevertheless, one recognises that the proper relationship between violin I and violin II, piano I and piano II, sopranos and altos, tenors, basses etc has been retained. As these groups take on the principal performing role, they are placed in position of greatest effectiveness in the quadraphonic field. Mr. Kazdin uses here the simple pentaphonic arrangement utilising the four corner and the centre front locations which together with the acoustical 'spill over' and reverberation, provides an unbroken acoustical envelope. The battery is placed as may be appropriate in all four channels, displaying the wide variety of percussion effects for which the piece is famous.

Carmina Burana already has received extraordinary accolades from the critical New York press.

Producing pop recordings in SQ

Quadrphony is made to order to excite the imagination of the popular musician and the record producer. Since the introduction of the SQ system, 'pop' quadraphonic recordings at CBS have been under the general direction of the producer, Al Lawrence, with the assistance of the recording engineer Larry Keyes. As the SQ system gained in popularity an increasing number of other producers (many of them trained by Lawrence and Keyes) began making their own recordings and SQ mix-downs. Nevertheless, some of the original tapes still come to Messrs. Lawrence and Keyes for the final quadraphonic remixing, which is usually done with the advice of the artists and their producers. The time cycle in popular recordings is such that usually the stereo record is issued and placed on the market first and the quadraphonic release follows at a later date. Therefore, Messrs. Lawrence and Keyes often begin their work without a detailed knowledge of the original recording geometry. This is of no real concern, however, since the usual practice in popular recording is to isolate the various instruments either by 'close miking' or by acoustical baffling, or by sequential recording. The placement of instruments in the quadraphonic and stereophonic fields needs only to conform to the artistic taste of the moment. While the performance is arranged mainly with the four channel master tape in mind, the caveats of the SQ system are taken into account so that there will be a minimum of problems during the recording process.

As is commonly practised with stereo, the bass and the heavy percussion usually is placed at or near centre front where it will result in lateral disc modulation with minimum possibility of interrupting the continuity of the groove. The solo singer also usually is placed in centre front with instrumental accompaniment on the sides and more instruments and

subsidiary singers often placed in the back channels. Mr Lawrence found it most propitious to direct the echo returns to the original channels; albeit, the longer tape-produced delays frequently are shared between the various channels. The 'panpot', which was very much in vogue during the early days of quadrphony currently is being used very sparingly. When it is desired to produce highly 'discrete' effects the various instruments or instrumental groups are allowed to predominate for several bars in a single channel in order to give the listener sufficient time to focus on the source of sound. Soloists are seldom placed in the centre side positions because of the aforementioned lack of image stability.

Sometimes the above general procedures are observed in the exception, rather than the rule. The producer and the artist often use the SQ system as part of the overall process which recreates the atmosphere of electricity and excitement existing during the live performance. What distinguishes a great record from a good one is just this type of artistic insight which cannot be reduced to a simple set of equations.

Conclusion

In this survey paper I have attempted to portray accurately the present status of SQ Quadrphony, to explain the reasons for its wide acceptance, to review the basic principles of four channel sound reproduction, and to explain how they were taken into account in the design of the SQ system to provide an effective quadraphonic disc which also has excellent stereophonic and monophonic compatibility. This has led us into the description of some of the practices used by outstanding

producers of broadcasting programmes and records to convey their art to a large and heterogeneous audience.

One important question remains: after all this effort, is quadrphony worthwhile? To ascertain the answer, the noted high-fidelity writer and moderator of the radio programme 'Men of hi-fi' in the USA, Mr. Harry Maynard, has broadcast a poll to which several thousand hi-fi listeners replied. And, a remarkable majority of the replies—approaching 99%—answered this question with an enthusiastic 'yes'.

Fig. 8. Quadraphonic Mixdown Diagram for *Carmina Burana*

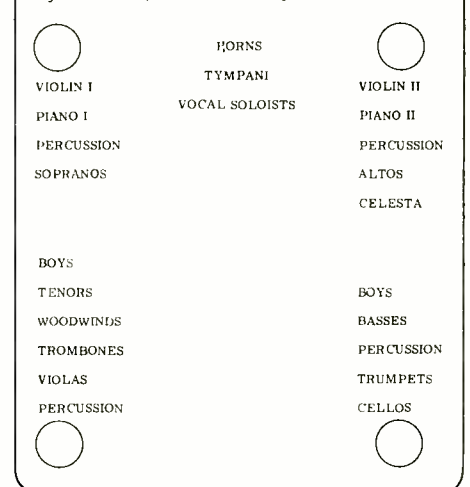

Comments and references

1 This number does not include the albums with the same content issued in different countries on different labels; if these were included the total count would be greatly increased.

2 In 1973, the SQ version of the *Concerto for Orchestra* by Bartok conducted by Boulez won the Grammy Award of the National Academy of Recording Artists and Sciences (NARAS) in New York, while in 1974, the SQ-coded *Le Marteau Sans Maitre* composed (1952) and conducted by Boulez won the coveted Prix Mondial of the Montreux Music Festival—thus far the only two quadraphonic records to be so honoured.

3 One of these three groups began broadcasting using a different system of matrix quadrphony, and after coping for a year with the problems described here switched to the SQ system.

4 Benjamin B. Bauer, 'Phasor Analysis of Some Stereophonic Phenomena,' J. Acoust. Soc. Am., Vol 33, pp 1536-1539 (Nov. 1961).

5 A comprehensive set of measurements of pressure differentials and delays caused by diffraction of sound around the human head is described by Abbagnaro, Bauer, and Torick in 'Measurements of Diffraction and Interaural Delay of a Progressive Sound Wave Caused by the Human Head, II,' to be published in the J. Acoust. Soc. Am.

6 While the phase angle θ corresponding to a time delay t is $360ft$, the time delay cannot uniquely be determined from a single value of phase shift. A more appropriate expression is $d\theta = 360t df$ from which $t = (d\theta/df)/360$.

7 T. Kei Matsudaira and Takeshi Fukami, 'Phase Difference and Sound Image Localization,' AES Journal, Vol. 21, pp 797-798 (Dec. 1973).

8 A description of some of the techniques is to

be found in Benjamin B. Bauer, 'Some Techniques Toward Better Stereophonic Perspective,' IEEE Trans. Audio, Vol. AU-11, No. 3, pp 88-92 (May-June 1963) (also published in AES Journal, Vol. 17, Aug. 1963).

9 Benjamin B. Bauer, Daniel W. Gravereaux, and Arthur J. Gust, 'A Compatible Stereo-Quadraphonic (SQ) Record System,' AES Journal, Vol. 19, pp 638-646 (Sept. 1971).

10 All other matrix systems either dilute the front channel separation in the stereophonic mode by 10 to 7.7 dB, or cause the centre front soloist to be displayed at 45° - 90° phase angle, or cause the loss of back-to-front channel balance by 4 to 7.7 dB in the monophonic mode. It is a source of constant wonderment to this author how some self appointed custodians of high fidelity virtues, who in the past would shrink in horror at the suggestion of even the slightest stereophonic channel dilution or violation of channel balance, now are ready to compromise their scruples when their favourite matrix system is being discussed!

11 B. Bauer, D. Gravereaux, E. Torick, U.S. Patent 3,839,583, Filed Aug. 5, 1971.

12 Benjamin B. Bauer, Gerald A. Budelman and Daniel W. Gravereaux, 'Recording Techniques for SQ Matrix Quadraphonic Discs,' AES Journal, Vol. 21, pp 19-26 (Jan./Feb. 1973).

13 Benjamin B. Bauer, 'A New Encoder for SQ Matrix Broadcasts,' Broadcast Management/Engineering (EM/E) (U.S.A.), Vol. 11, pp 76-80 (March 1975).

14 Benjamin B. Bauer, Richard G. Allen, Gerald A. Budelman, and Daniel W. Gravereaux, 'Quadraphonic Matrix Perspective—Advances in SQ Encoding and Decoding Technology,' AES Journal, Vol. 21, pp 342-350 (June 1973).

KLH

The Natural Choice

The new CBS recording of Schoenberg's massive "Gurre-lieder," winner of the French Grand Prix du Disque, involved musical forces of 500 singers and players. To capture the detail as well as the magnitude of such a recording, producer Paul Myers selected, as always, KLH speakers for the recording sessions. The complexities of such a task have again called for the finest assembly of men and technology. When only the best will do, KLH loudspeakers are the natural choice.

Webland International Ltd. Mirabel House 117-121 Wandsworth Bridge Road London SW6



Last autumn, in one of the most complex sessions London has seen, *Gurrelieder* was recorded by CBS for stereo and eventual quadrasonic release. The musical, production and engineering background is covered, from both stereo and quadrasonic viewpoints.

Schoenberg's *Gurrelieder*

PAUL MYERS*
BOB AUGER†

Part one: production

WE WERE LISTENING to a final playback of the two-track mix and, as the orchestra swelled to yet another huge climax (and our eyes scanned the vu meters nervously), Bob Auger smiled and said: 'Well, it certainly sounds expensive'. I suppose this was a slightly less than respectful comment, but I am sure you will understand our reaction. There seemed nothing more to add at the end of a long and tremendously difficult project—at times frustrating, at times awe-inspiring, but always exhilarating. And we had reached the penultimate stage; all that remained was to see whether the cutting engineers could transfer the information faithfully to a disc, despite sides lasting 29 and 30 minutes.

Schoenberg's *Gurrelieder*, a work just short of two hours and scored for six soloists, a gigantic orchestra and a battery of mixed choirs, must be one of the most challenging projects for any producer or engineer. Because of the size of the forces involved, it is seldom performed (although London has enjoyed two Promenade Concert performances, the last of which was the highlight of the 1974 summer season). However, perhaps because of these concerts and certainly in honour of the 100th anniversary of the composer's birth, a previously empty catalogue has seen the appearance of three recordings of *Gurrelieder*: a recent EMI issue, a re-issue from Deutsche Grammophon in their Privilege series, and the new CBS production. The other recordings are radio broadcasts, transcribed to discs (although I understand the DG version was compiled from several rehearsal and broadcast tapes). In the case of the CBS recording, the decision was taken about two years ago to make the first studio recording of the work, to appear in both stereo and quadrasonic 'surround' versions.

At the risk of offering superfluous information, let me add a few words of musical background to the piece. Schoenberg originally composed a set of songs after poems by the Danish botanist/poet/novelist Jacobsen and entered them in a competition in 1899. He was very short of money and, despite the fact that the songs did not win the hoped-for prize money, the composer decided to expand upon the original material. He set the entire Jacobsen cycle, re-scored it for the enormous forces mentioned, and added a few more sections of his own. The work was composed by 1901, but he only worked sporadically on the scoring, which was not completed until 1911. The première was given in Vienna in 1913, to a very enthusiastic audience and, although he was present, Schoenberg apparently took no great pleasure in the reception. He was already composing in his 'new' serial style, and receiving little praise or encouragement. *Gurrelieder* looked back to his earlier, discarded Romantic style. Its Wagnerian echoes, harmonically and even melodically, its use of *leitmotifs* and its great washes of sumptuous sound are almost diametrically opposed to the music that followed.

Gurrelieder is, perhaps, one of the last great Romantic masterpieces (and anyone who examines the score, perhaps adding the extraordinary analysis of the work by Alban Berg, will agree that it is a veritable masterpiece by a 26-27 year-old composer), but I have always

suspected that, the huge forces notwithstanding, it would have become far more famous and far more frequently performed had it been composed by any other man. For Schoenberg's later music has long struck terror in the hearts of average concert-goers, whose tastes run (and why not?) to more easily distinguishable melodies and readily familiar harmonies. His music may inspire and delight professional musicians, but its austere dissonances dismay audiences and empty box-offices. Only *Verklärte Nacht*, another early work from the same period as *Gurrelieder*, has attracted listeners with its instantaneous beauty, and there are one or two other, lesser-known pieces. But most Schoenberg, early or not, is generally avoided in case it proves to be similar to the last, atonal works: craggy, unrelenting pieces like the opera *Moses And Aaron*. I am not suggesting either that, if you like early Schoenberg, you will ever like late Schoenberg, but hope that, when confronted by an unfamiliar work by him, listeners will be tempted to check the date of the composition or see whether it bears a low opus number.

To return to the recording, perhaps the best way to sum up the major problem is to show what sort of an orchestra we used. The BBC Symphony Orchestra, suitably augmented, included 24 first violins, 20 second violins, 16 violas, 12 cellos, ten basses and four harps. In other words, the string section alone was as large as the average London orchestra. To this were added 25 woodwinds, 12 horns, 15 brass, two sets of timpani and a percussion section requiring ten players. The mixed choirs numbered well over 300, and the total number of musicians involved came to just under 500. The figures are not produced to dazzle, but point to a basic recording problem. Readers of this magazine understand the problems of reproducing the dynamic range of a normal orchestra for records, and the consequent compression of that 'real' range to reproduce a 'natural' recorded range, so I will not waste space with long explanations and diagrams. Suffice to say that I like to compare recording techniques with photography. An 80-piece orchestra can be reproduced on a record (or a tape) with the same degree of accuracy and fidelity to its 'natural' sound as a 2½ x 3½ in snapshot of the Grand Canyon reproduces a 300-mile hole in the ground. We accept that each suggests what it reproduces rather than actually reproduces it. The *Gurrelieder* makes use of an orchestra almost twice the size of a normal symphony orchestra (and the massed choirs), but there are many times when the singer is accompanied by little more than a string quartet of first chair players, or a small section of the orchestra. Somehow, the recording must convey (at a reasonable level) both the effect of the small group and of the full group, without asking the listener to sit next to his amplifier, suitably raising and lowering the volume controls. (Only recently, I read a review —of one of the other recordings —in which the critic made this particular comment, suggesting that this was the only way one could really hear the work. I hope we have persuaded him otherwise.)

The next problem was to find a hall that could accommodate an orchestra and choir of this size and still lend itself to recording with some sort of ambient acoustic. Most London

*Director, CBS International Masterworks
†Bob Auger Associates

halls, filled with these forces, would become totally 'dry' and unflattering. A natural choice was the Albert Hall (where CBS recorded the Verdi *Requiem* with Leonard Bernstein and the London Symphony Orchestra) but it was unavailable for the period, and we spent some harrowing weeks searching for anything from

hall proved to be one of the best I have ever worked in, with a glowing combination of great clarity and airiness, and I am quite sure that, like all fine recording halls, it would be just as excellent for recording a solo piano or a string quartet. Even with the forces we used, there was additional space, giving us the clear,



a cathedral to an aircraft hangar. Finally, Bob Auger came up with his own 'discovery': the Methodist Central Mission in West Ham, a large and superb hall, very similar in design to Kingsway Hall (but cleaner), with a circular auditorium, a domed ceiling, and a gallery that could accommodate up to 500 singers. The

open sound we wanted.

Faced by that frightening numbers of players, I elected to record the work on 16 tracks. I know that engineers will argue from now until the end of recording the relative merits of multiple-track recording (and, when all is said and done, there was a time when we had to

put it all on one mono track), but I favour making use of whatever new technology is available. As long as the final balance is satisfactory, it really makes no difference whether a classical recording is made on two tracks or 24, and I believe that the use of the Dolby system (on a well maintained desk) will achieve sound of the highest possible quality. Multiple-track recording permits one a second chance for the ideal balance during the remixing sessions, especially as there is never enough time during a recording session for the ideal number of musical 'takes' and balance rehearsals. With the support of a 16 track tape, and the possibilities of delicate re-balancing where necessary, a producer can undertake a work of this size and stature with an extra degree of confidence. (Perhaps I should add, as a happy afterthought, that when it came to remixing the 16 tracks, there were very few occasions when we had substantially to alter our original settings. The 16 slider settings on the Neve console made a straight line, which is no small tribute to the excellently modulated and controlled tapes that Bob Auger created during the sessions.) The further advantage of 16 tracks was that they enabled us to split the very large woodwind section into two tracks (needless to say, the strings had one track per section), instead of attempting to balance all of a physically widespread section on a single track. The track layout (selected by Bob, who also undertook the remix sessions) was as follows:

1. Horns
2. Flutes/clarinets
3. Oboes/bassoons
4. Brass
5. Percussion
6. Timpani
7. Harps/celeste
8. Solo Voice
9. 1st Violins
10. 2nd Violins
11. Violas
12. Cellos
13. Bases
14. Chorus
15. Chorus
16. Chorus

Because this was a recording for surround quadraphonic sound, it was necessary to re-arrange the orchestra in such a way that certain sections could be 'folded' round to the back speakers in the final four track remix, and I am grateful also that Pierre Boulez agreed to face an unconventional orchestral set-up. Although the listener hears the work in surround sound, I believe it is wrong to expect the conductor to manage a 'surround' orchestra (although it has been done, with many accompanying headaches). Therefore, borrowing a leaf from pages of pop recording sessions, we worked on the principle that loud instruments should not play into the microphones being used by soft instruments. (I remember seeing many pop orchestra sessions, in which the violins sat at the back, winds in front of them, and brass in the front, to achieve the same effect of separation.)

We were not looking for isolated separation in our recording, since a good classical sound depends upon a certain amount of cross-channel leakage, but enough presence and

GURRELIEDER

'accent' on each individual track to permit us to relocate the instrumental sections later. Therefore, we arranged the orchestra in a semi-circle, with the woodwinds on the outside left, the brass on the outside right, the strings and harps in the centre, the horns (blowing backwards!) to the rear left, with the timpani and percussion spread across the back of the hall. The choir was placed in the balcony above the orchestra. Our intention was, therefore, to have woodwinds, horns and timpani coming from the rear left speakers, and brass and percussion from the rear right; the orchestra was laid out in such a way that the natural leakage of sound between one section and another would only help to create a fully circular rather than 'cornered' effect. We did not listen to playbacks at the sessions in quadraphonic sound, but used four KLH speakers, strung across the front wall in a straight line. I must also mention the soloists, who were placed behind the conductor, facing the orchestra. This allowed them a certain degree of separation and certainly avoided too much orchestral leakage into their microphones during the larger musical climaxes.

Having written so much about the preparations for the recording, I must add the somewhat anticlimactic note that the sessions themselves went extremely smoothly and without any great problems. It took the conductor some time to adjust to the new balance of orchestral sound, especially the very large brass section playing in his right ear and without the usual benefit of distance to reduce their volume. The singers: Jess Thomas, Marita Napier, the superb Yvonne Minton, Kenneth Bowen, Siegmund Nimsgern and Günther Reich (who is both speaker and, for a few, wonderful notes, singer) performed supremely well. Each song/section was recorded complete, to maintain the musical flow of the work, and any re-takes were usually complete. It might be interesting to note that Jess Thomas and Marita Napier (the ill-fated Waldemar and Tove who are the Romantic lovers of the

piece, despite the fact that they never sing together) could not attend sessions during the same periods and, thus, never actually met throughout the recording of the work.

We encountered problems in only one area: with the choirs. In both the male chorus of Waldemar's Vassals and the final mixed chorus, the entire orchestra is called upon to play at full force, and the resulting sound was so gigantic that we had the greatest difficulty in picking up the chorus, despite its size. This was caused partly, I believe, by the reverberation of the building itself and, no matter how one tried to mask the choral microphones, gigantic attacks by the brass and percussion swamped them. During the first choral recording session, the chorus mikes were slung across the hall without even the mass of the balcony to mask them from the orchestra, and the results were disastrous, with the voices barely audible. Later, in the second choral session, the microphones were moved behind the rim of the balcony, with better results, even though some of the orchestra tended to seep through the structure of the building, interfering with the vocal effects. This proved to be a slight problem in the stereo re-mixing stage, but was surprisingly much easier to accommodate in the quadraphonic remixing. Those listeners who have a chance to compare the stereo record with the quadraphonic will perhaps be surprised by the additional power and volume of the chorus in quad, possibly because it is spread, between back and front, on either wall. Nevertheless, the problem was minor. I am happy with the overall result but, like any producer, could always have used that extra ounce more.

So, Schoenberg's *Gurrelieder* has been recorded, edited, mixed, cut (excellently!) and pressed. In the monthly release lists, it is just another entry and, since those sessions, Bob Auger and I have worked together on Schoenberg's opera *Moses and Aaron* and on two albums of operatic arias by Renata Scotto (with two different orchestras in two different churches). Bob has had many other recording sessions with other producers, and I have worked with several other engineers on any

number of projects, ranging from solo guitar to a full-length opera. That is the way our work goes, but I think we will always remember the *Gurrelieder* sessions with special affection, because they represented a special challenge in the recording of a unique work. Hopefully, if you have read this far, you will listen to the finished records, and judge the results for yourself. P.M.

Part two: engineering

For many years as a young and enthusiastic music lover, I discovered all kinds of learned books and journals (all beyond my comprehension) on orchestration and music appreciation. Practically all these worthy tomes had one thing in common however—when the authors wanted to mention a vast orchestral work as an example it was always *Gurrelieder*. In these days (during and just after the war) you had no chance of hearing what the writers were driving at so you had just to take the comments for granted and gradually become overawed at the potential of a piece of music which was never heard.

I didn't have the opportunity to hear the Prom performances Paul Myers referred to earlier and I decided not to listen to the Deutsche Grammophon discs when I was first approached by CBS to engineer the sessions in case some kind of prejudice set in; consequently I faced the first session with some apprehension. Some later Schoenberg I knew, but apart from the beautiful *Verklärte Nacht* I had no experience of his youthful work. I had a feeling that it was some sort of super-Wagner or even Mahler but that was all. These feelings were not dispelled when Paul sent me the orchestral and choral line-up to dwell on.

Having recently discovered the West Ham Central Mission from a recording point of view, I asked Paul to come and visit some sessions I was recording for another customer (always a delicate matter to suggest to both partners). I don't think I've ever seen a major decision made quite so rapidly. Immediately on entering the auditorium, Paul said: 'This

NEWS

is not, therefore, so surprising that his will specified 'No funeral, no flowers, no telegrams,' but left aside some money for 'drinks and a party'.

Sandy Brown leaves a widow and two children, to whom anyone who encountered him in his various walks of life will extend sincere sympathy. **Adrian Hope**

Errata—tape review Feb 75

THE FOLLOWING errors occurred in this article.

The 10% 10k im, dB ref weighted noise, NAB 19 cm/s figure of 3M 250 should read -63.75 dB, not 57.75 (this error can be seen from the printed mean). The 3M *Classic*

stability at 15 kHz should be described as 'good' not 'poor'.

On p23 (long play tapes) 3M 307 should read 207.

Pow ccrashh pokka pokka aaaaahh

'IF YOU'VE EVER spent the last few weeks trying to get hold of the sound of a dinosaur growling, or a vending machine regurgitating a cup of oxtail soup, look no further.'

This is the promise from Globesound Ltd, UK agents for the American Globe Effects Library. It features a comprehensive cross-referenced catalogue, together with a rapid location/retrieval system for individual titles. The company quote a typical charge, which includes search and transfer fees, of £4 for a 15s single effect reducing

pro-rata for a series. There are about 40 categories totalling over 2500 individual clips. Contact Andy Thring at Globesound Ltd, 39a London Road, Kingston-upon-Thames, Surrey KT2 6ND. Phone: 01-546 7276.

Performing Right Society

DONATIONS TOTALLING NEARLY £15 000 were given to the 47 successful applicants chosen by the society. These included The Park Lane Group, Macnaghten Concerts, Barry Summer School of Jazz, the Purcell School, and Music in Braille.

Although the PRS is a non profit making organisation (the revenues belong to the members) the charter allows for a small proportion of the income to be offered 'for any

purpose conducive to the improvement or advancement of the composition, teaching or performance of music'. Applications for financial support in 1976 must be received by December 75 and should be accompanied by the latest accounts and details of future plans together with financial estimates. 29/33 Berners Street, London W1P 4AA. Phone: 01-580 5544.

Moog distributor

IN THE SYNTHESIZER survey (May 75 p56) we wrongly listed the UK distributor. The distributors are: Henri Selmer & Co Ltd, Woolpack Lane, Braintree, Essex. Phone: Braintree 2191. Moog Technical Services are technical agents for the London area only.

is the place; it feels absolutely right'. We were, at that time, recording some reasonably avante garde orchestral pieces but, even though this was very different from the task to follow, Paul had no qualms about his decision.

There were many details to be taken care of and (as I never tire of reiterating in regard to recording on location) 50% of the problems occur before a single foot of tape passes the record head. The sheer physical problem of accommodating all those people for long stretches of time have to be considered: food, toilets, transport, heating and lighting all have their priority and are all problems concerning musicians and singers which are liable to be thrown at a busy engineer without warning. There is nothing more distracting than an irate clarinet player who hasn't got enough light when you are wondering why you can't hear the concert-master properly in his solos when the nearest microphone is only five feet away.

The actual placement of the orchestra and chorus in the church was carefully worked out in advance, and I must say that at this stage a lot of faith was placed in the directional capabilities of some of the microphones (particularly in regard to the surround pick-up for the quad mix).

One or two of the mics were switched to a 'figure-of-eight' characteristic since there is

'nothing so dead as the side of a figure-of-eight mic'. The stray pick-up from the rear of the mic is less troublesome than the spurious pick-up of next-door instruments; in particular, I refer to the possibility of picking up the clarinets on the first violin mics and the bass on the cello mics. As Paul has said, the separation available on the quad mix was most surprising and allowed us to place the instruments comfortably round to their session layout.

The drawing gives some idea of the layout and it will be seen that the resultant quad mix merely takes the listener into the orchestra to a position held by the conductor on the session, except for the fact that it was decided to keep the soloists in front of the listener and obviously altered the heard balance to some extent.

The problem of getting enough chorus sound over the huge orchestra was real enough. I doubt if they can be heard properly in concert but of course that is no criteria for recording, when the sound quality has to make up for the loss of visual impact. There were a few worrying moments here but, I think, in the end they were satisfactorily overcome—at least most of the reviewers have been kind enough on this detail.

Once the overall sound and balance had been arrived at on the first session, considerable

thought was given to the problem of dynamic range. It is now possible for the professional engineer to set his recording to accommodate the loudest sections of the music and let the quieter sections look after themselves.

This is not so bad with high quality monitor systems but the prime aim is to produce a tape suitable for transfer to disc and domestic equipment. Consequently, some gentle manual squeezing of the dynamics took place on the session and on the resultant mix down. You can only have 100% of volume at any time and how this 100% is shared out among 500 performers is a major problem, particularly when you consider that a solo pianoforte recording uses 100% for one musician most of the time. It's all a matter of perspective and I trust *Gurrelieder* doesn't sound too much as though looking at a landscape through the wrong end of a telescope.

It is not generally known that the *Gurrelieder* sessions were interrupted by the recording of the complete opera *Moses and Aaron* by the same composer. The only real problem for the engineers here was the fact that Paul decided to record this work with the orchestra turned through 180° compared with *Gurrelieder*. Sufficient to say that the last sessions of both works were carried out on the same day—but that's another story. B.A

FIG.1 SCHOENBERG: GURRELIEDER LAYOUT FOR RECORDING, NOVEMBER 1974, WEST HAM CENTRAL MISSION. PRODUCER PAUL MYERS ENGINEER BOB AUGER

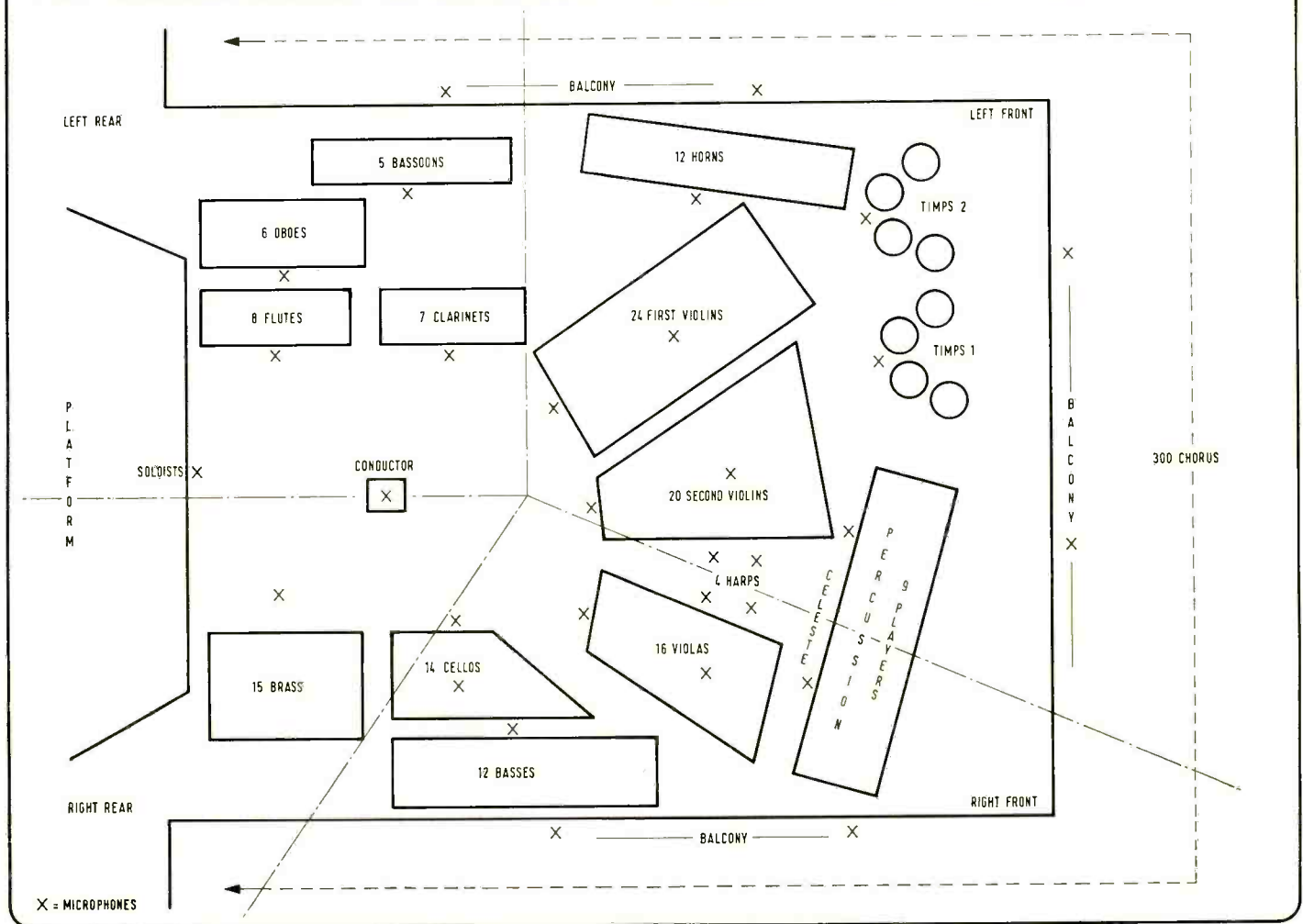

The UD-4 system is the most recent disc encoding system to be introduced commercially and represents a further extension of matrix/hf band techniques. The basic system is described, together with important aspects of cutting/pressing routines and other studio considerations.

UD-4: the system and its use

TOSHIHIKO TAKAGI*

WITH THE IMPROVEMENT of the recent sound recording and reproducing equipment, the matter of concern of studio engineers is extending to sound field effect from sound quality, in extending high fidelity. So it becomes important not only that reproduced sound quality is similar to the original sound quality but that the information existing in an original sound field is reproduced faithfully. One of the essential purposes of a quadrasonic system shall be to transmit the music sound information and the localisation information, which are in an original sound field like that of recording studio or music hall, or produced by panpot image by producer and engineer, into a reproduced sound field through a limited number of transmission channels. And the final purpose is to reproduce the transmitted signals effectively in the limited space of the domestic listening room.

The former quadrasonic systems have rested on the premise that four sound signals recorded with four microphones should be reproduced through four loudspeakers by using four or two transmission channels. But it is doubtful whether the directional information of the original sound field will be transmitted correctly into the reproduced sound field by such method. The directional information of sound sources should be presented uniformly in every direction, because the number of sound sources is not restricted to four in the real sound field. If four discrete transmission channels are used for the quadrasonic system, they should be expected to be used more effectively.

Thus, the 'Universal Matrix Theory' was invented by Dr D. H. Cooper (University of Illinois, USA) and Dr T. Shiga (Nippon Columbia Co Ltd, Japan). This theory suggests the way to make multi-channel trans-

mission signals effectively, by encoding sound signals with electrical phase angles among the transmission channels corresponding with each directional angle in the original sound field. Comprehensive research based on this theory of recording and reproducing systems has been carried out for the past few years at Nippon Columbia. And we succeeded in developing the Universal Discrete Quadrasonic System, 'UD-4', with new and unique technology.

UD-4 system

UD-4 is a quadrasonic practice based on 'Universal Matrix Theory' which uses the disc record as a transmitting medium. Fig. 1 shows the block diagram of the system from recording to reproducing. Audio signals from each source recorded on microphone in a studio, for instance, are multiplied by electrical phase and amplitude factors according to the directions in which each source should be reproduced, and are encoded into the four transmission signals by the encoder. The first and the second signals, TL and TR, are the base matrix signals that possess satisfactory compatibility in monophonic and stereophonic reproduction, and make two channel matrix quadrasonic reproduction (BMX) possible by using only a simple decoder. The third and the fourth signals, T_T and T_Q, are signals that further emphasise the localisation. Adding T_T signal to the base matrix makes 4-3-4 semi-discrete quadrasonic reproduction (TMX) possible, and adding T_Q signal still more makes 4-4-4: discrete reproduction (QMX).

In the cutting system, base matrix signals, TL and TR, are cut on each left and right groove wall as audio signals up to 20 kHz. T_T and T_Q signals are cut superposed on the TL and TR as fm signals of bandwidth 20 to 40 kHz. Fig. 2 shows the band allocation of the UD-4 disc. In

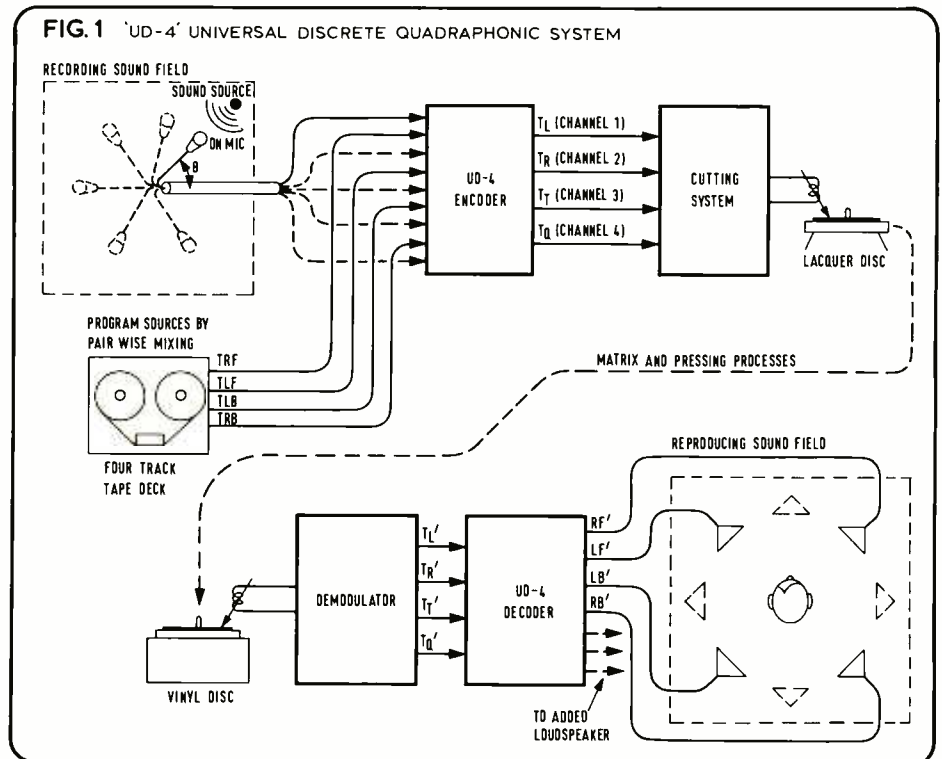

discrete quadrasonic reproduction, T_T and T_Q signals are recovered using a demodulator and then decoded with the T_L and T_R signals by the matrix decoder to drive loudspeakers. This decoder can be also modified to drive loudspeakers located in free positions, as well as conventional rectangular patterns.

UD-4 disc record²

Generally, a carrier disc confronts several problems such as: the beat distortion caused by carrier crosstalk between both the groove walls; the noise increased by adding the carrier channel; degraded separation by carrier distortion due to tracking angle error, tracing error and difficulty of tracing the carrier waves at high frequencies.

In the UD-4 system, those problems are reduced by the following techniques:

1. Band limiting of T_T and T_Q signals.

T_T and T_Q signals are not necessarily transmitted over the whole audio frequency range, because our subjective psychoacoustic assessment has suggested that for full localisation³ it is sufficient to transmit them in the frequency range from 100 Hz to 3 kHz. Therefore, this system employs a relatively narrow band for additional signals T_T and T_Q . Thus, the noise and the carrier beat distortion may be improved.

In addition, since the upper frequency limit of the modulated carrier band can thus be kept down to 40 kHz, the demands on pickup cartridges are not so severe.

2. Sum and difference modulation

The carrier waves are frequency-modulated by the sum ($T_T + T_Q$) and difference ($T_T - T_Q$) signals, equalised appropriately.

The modulated carrier waves are mixed with the base matrix signals and recorded on both groove walls. By adopting sum and difference modulation method and band-limiting of T_T and T_Q signals, both the carrier beat distortion and the carrier distortion due to tracing error can be reduced.

3. Tracing simulator

In order to reduce both the so-called carrier distortion and the harmonic distortion due to the tracing error, we adopt the tracing simulator⁵ employing the skew sampling method⁴ (SS method).

Encoding

For the purpose of setting correctly the sound image of each source according to its direction in the original sound field, or the requirement of the producer in laying out the quadrasonic stereo sound field, it is necessary to transmit correctly both sound and localisation information which are recorded in the studio etc to the reproduced sound field. In the UD-4 encoding, whatever the original direction of the sound sources, they are transformed into the transmission signals as the electric signals which contain their appropriate directional information; namely, four matrix encoded signals T_L , T_R , T_T and T_Q are encoded by making both the phase angle and the amplitude among the transmission signals alternate corresponding to the azimuth angle of the sound sources. The two signals T_L and T_R are basic matrix signals available as ordinary two channel stereo signals. And then T_T and T_Q signals are third and fourth signals for additional localisation information.

The producer or engineer can perform the directional mixing freely, deciding the direction

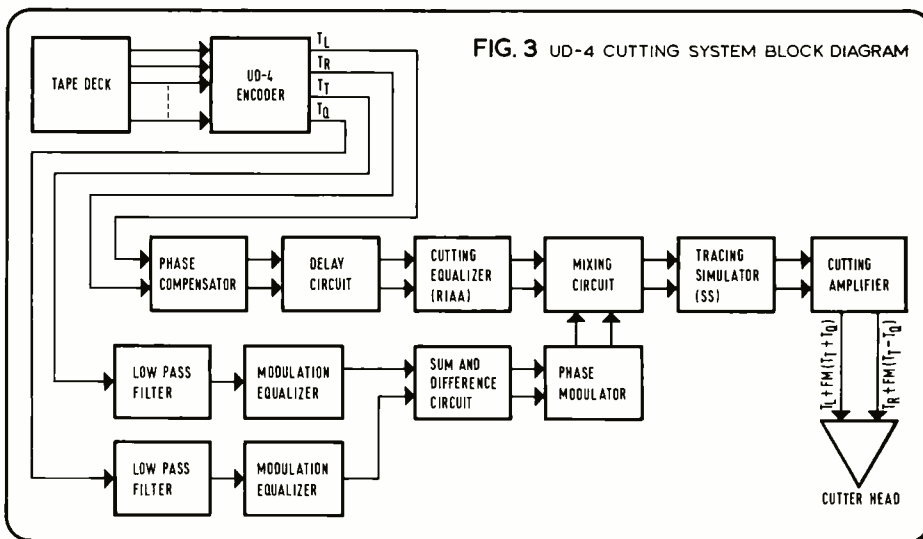
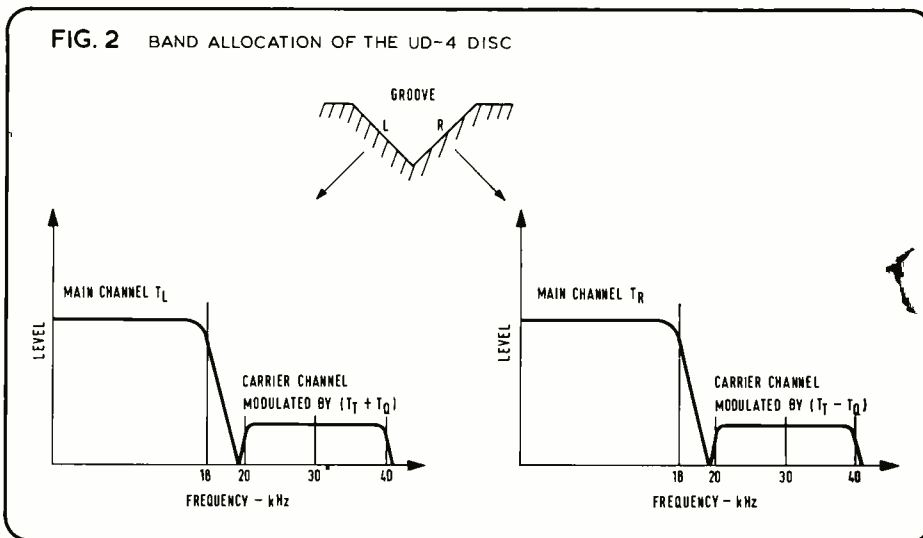

of the sound images of each instrument from multi-track source signals recorded by studio microphones with any necessary adjustment of the equalisation level. And they can produce their ideal multi-channel transmission signals which are correctly encoded by freely using the standard mixing and encoding techniques. Besides, in live recording, we can produce directly the UD-4 transmission signals obtained by the mixing operation with an omnidirectional microphone and two coincident tangential figure-of-eight directional microphones.

Further, four transmission signals (T_{LF} , T_{RF} , T_{LB} and T_{RB}) of the pairwise mixing used in ordinary quadrasonic recording, can be easily transformed into the encoded signals (T_L , T_R , T_T and T_Q).

Cutting

Fig. 3 shows the block diagram of the cutting system. T_L and T_R signals, which can be also used for monophonic, stereophonic and two channel matrix quadrasonic reproduction, are RIAA equalised. Then they are delayed

40 μ s relative to T_T and T_Q in the cutting process, thus compensating for the delay caused between base band signals and carrier channel signals in reproducing. T_T and T_Q signals are fed to the mixing circuits via 7 kHz low pass filters, the equalisers, the sum and difference circuit and the phase modulators, then mixed with T_L and T_R mentioned above. The phase shifts given to T_T and T_Q signals by low pass filters must necessarily be compensated with the phase equalisers of T_L and T_R signals. These two multiplexed signals are then fed to the cutting amplifier and then to the cutter head via the SS tracing simulator which is designed for stylus tip radius 7 μ m. (If other tracing simulators act as the distortion cancellers, they can be similarly included in the process.) The cutter driving amplifier must be able to drive a 5 cm/s carrier level. It is necessary for the cutter head to have flat response and reduced crosstalk up to 40 kHz, but it is difficult to satisfy such conditions. Therefore, discs are cut at half speed with the Neumann cutter head SX-74 which has a flat response up to 20 kHz.

Cutting and pressing considerations for CD-4 discs are discussed, together with an appraisal of system advantages, limitations and areas of progress as they affect the studio engineer. As with any system, the medium and its inherent properties must be fully understood before full benefits can be realised.

CD-4: the mixer's point of view

JOHN EARGLE*

THE BEST MIXERS have traditionally been those who have understood the precise nature of the final medium which reaches the consumer and who have shaped their mixes in ways which compliment that medium. For the most part, present day stereo disc transfer has become a routine operation, mainly because of the vast improvements which have been made in both stereo cutting systems and in phono pickups in the last four or five years. That small amount of signal conditioning which may be necessary can easily be handled automatically during the transfer operation itself, and the mixer does not really need to concern himself with the vagaries of the medium. It is important to observe that this was not always the case.

As we move into the realm of the quadraphonic disc, new imperatives are presented to the mixer. For the 4-2-4 matrix formats there are the inevitable problems of logic-directed

enhancement of separation and the 4-2-1 compatibility aspects of sound sources placed about the listener. Electromechanically, a matrix disc is a stereo disc, and there are no particular difficulties associated with simple storage of information on the disc other than those which may be caused by the significant vertical components in the signal.

CD-4 is more complex. Viewed as a stereo disc it is compatible; all images panned around the periphery exhibit no more than a 3 dB build up, and the same is true for its monophonic summation. As a quad disc, it involves interaction between the *baseband*, or normal stereo, signals and two *carrier* signals, and new imits, which cannot be described in familiar terms, are placed on the system. (As a point of comparison, reference level at 1 kHz is defined as a baseband velocity of 3.9 cm/s peak per channel and a corresponding carrier deviation

FIG. 1 Phase modulation of the carrier by the baseband signal. The stylus-groove wall contact point is moved either ahead or behind the neutral position depending on the slope of the baseband signal, resulting in phase modulation of the carrier by the baseband. In the cutting process this function is generated electrically and fed an additional input to the modulators out-of-phase, so that cancellation takes place on playback.

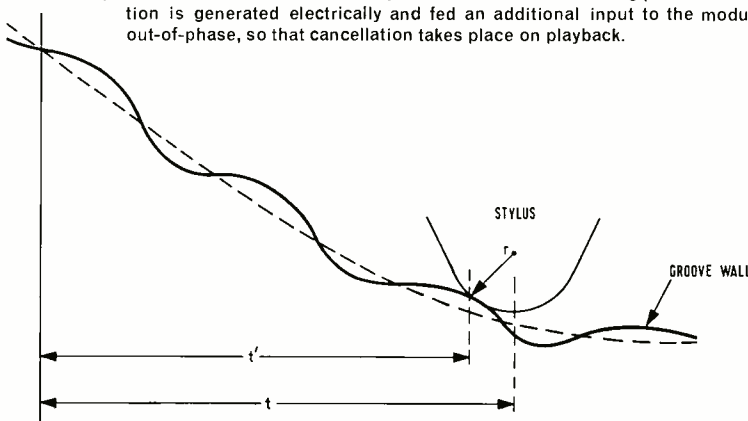
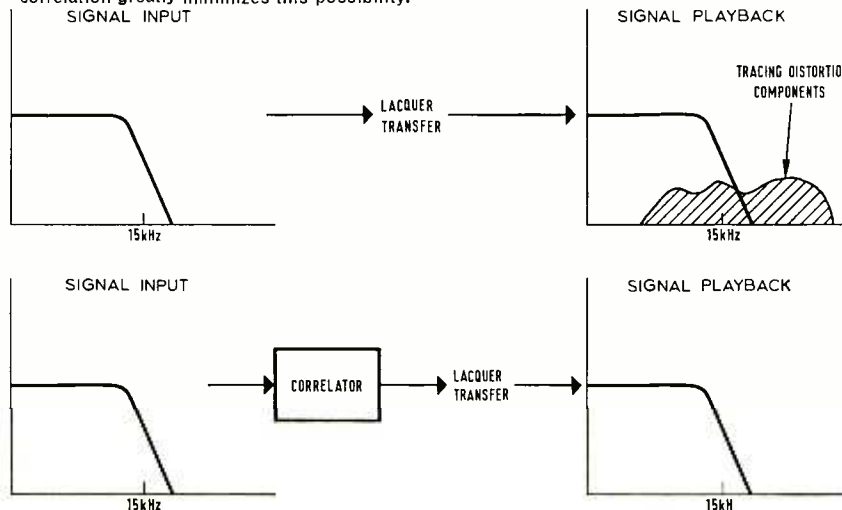

FIG. 2 Baseband tracing correlation in CD-4. Baseband tracing correlation results in lowered distortion of the baseband signal on playback, but its importance in CD-4 goes beyond this. Even though the signal input is band limited to 15 kHz, without correlation there can be significant out-of-band components at inner diameters which can interfere with proper carrier recovery. Tracing correlation greatly minimizes this possibility.



*JME Associates, Los Angeles

of ± 2.2 kHz about the 30 kHz carrier.) For all its complexities, the CD-4 disc yields an essentially discrete quadraphonic array. Newer designs for cutting systems include more signal conditioning devices, and this means that the mixer has less to be concerned about during the quadraphonic mix-down.

In the past, a significant problem area was interaction between the baseband and carrier components. Essentially, this interaction takes two forms. One is the phase modulation of the carrier by the baseband, as shown in fig. 1. Note that when the stylus is travelling 'up hill', contact is made at the front of the stylus. When

the stylus is going 'down hill', contact is made at the back, and this creates a degree of phase modulation of the carrier proportional to the slope of the baseband signals. The remedy for this is to generate the same function electrically and add it to the carrier signals at the correct amplitude and phase angle to cause its cancellation on playback.

Another function of baseband-carrier interaction is that produced by out-of-hand components interfering with proper carrier recovery. This is shown in fig. 2, and a remedy is found in generating tracing correlation of the baseband adjusted to the playback radius so

that the out-of-band components are significantly diminished. A further remedy has been found through the use of advanced muting techniques in the demodulator designs so that momentary carrier dropouts do not result in disturbing noises. The most difficult program material here is loud, tuned, percussive sounds, orchestral bells and the like, and with a high concentration of energy in the 1 to 3 kHz range. Muted trumpets can also be offensive here, as can electronic music with its essentially flat energy spectrum. Instruments such as cymbals exhibit a wider band of energy and rarely create problems in this area since the energy level is normally considerably lower.

In summary, the control of baseband-carrier band interaction is minimized through the following techniques:

1. Tracing correlation of the baseband signals.
2. The cross-feed of cancelling terms from the baseband to the input of the modulators.
3. Careful use of slope overload high frequency limiting in the baseband.
4. Maintenance of the proper scanning radius of the playback stylus.

Items 1 and 2 are often combined in a single wide-band processor. The general effect of these improvements in the system is to offer the mixer and producer considerably more freedom in the assignment of musical materials in the quadraphonic array and their final transfer to disc at competitive levels.

Current CD-4 product is, on the average, within 2 dB of its corresponding stereo product, as shown in fig. 3. It can be said at this point there are essentially no playing time limitations with current CD-4 product. With a 2 dB 'safety margin' below stereo, it becomes possible to maintain minimum ending diameter for CD-4 discs of 14 cm, while the corresponding stereo disc may have to end at somewhat smaller diameter, typically never less than 12 cm.

Another area of concern in mixdown has to do with considerations involving only the carrier channels themselves. The better cutting heads used today for CD-4 disc transfer exhibit cross-talk characteristics in the carrier range (15 kHz at half speed) of the order of 25 to 30 dB. This degree of separation has been achieved through attention to the mechanical details of cutter designs as well as by means of electrical cross-talk cancelling circuitry. The net result of this is the transfer to disc of carrier information exhibiting better cross-talk characteristics than most present playback cartridges can realise.

What is the effect of cross-talk between carriers? Those readers who are familiar with fm theory know that when two stations are on the same frequency, there can be a good bit of trouble unless one of them is sufficiently lower in level so that the louder signal takes over and swamps out the lower. This is the so-called capture ratio of the system. In the case of CD-4, we are dealing with a pair of carriers with a centre frequency of 30 kHz. During high levels, the deviation can be as high as ± 6 kHz, representing an extremely large percentage deviation. Because of the particular pre-emphasis curve used in CD-4, shown in fig. 4, the modulation index at low

FIG. 3 A comparison of playing time and level of CD-4 records and their stereo counterparts. Along the vertical axis is peak recorded level as read on vu meters. (0 vu is standard NAB reference level of 5 cm/s peak velocity per channel, or 7 cm/s peak lateral velocity at 1 kHz.) Along the horizontal axis is average playing time per side. The squares indicate CD-4 disc measurements and the circles their corresponding stereo versions. The average stereo level for the 17 discs is about 2.4 dB, while the average CD-4 baseband level is 0.8 dB, not quite 2 dB lower.

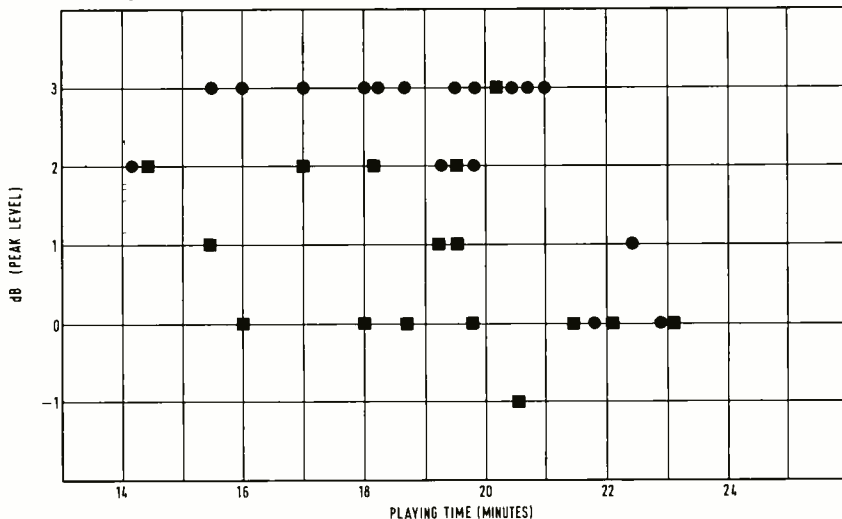
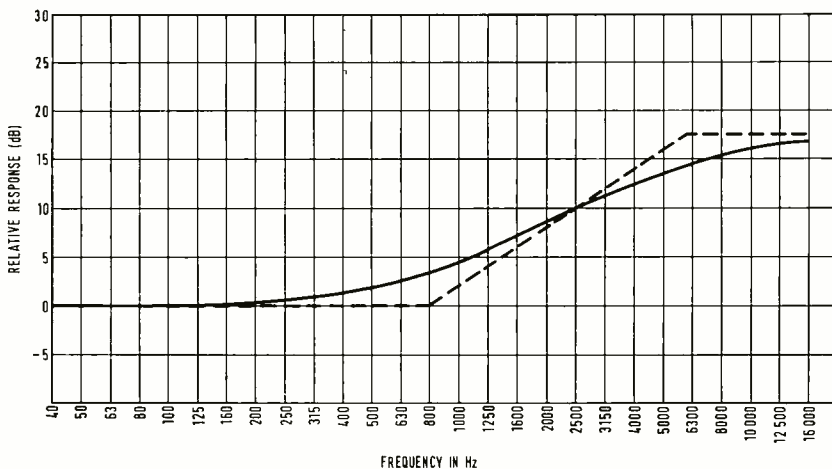

FIG. 4 Pre-emphasis curve used in CD-4 modulation. From 30 to 800 Hz the curve is constant frequency modulation; from 800 Hz to 6 kHz it is constant phase modulation, becoming constant fm above 6 kHz. Modulation index is the frequency deviation divided by the modulating frequency. Therefore in the fm portion of the curve below 800 Hz the modulation index doubles for each halving of frequency.



CD-4

frequencies can be extremely high. The modulation system is capable of an index of 81 radians at 30 Hz, and this represents the maximum deviation possible in the system. The interaction between carriers is greatest when the instantaneous phase difference between carriers is greatest, and this in turn implies that low frequency information will be the most troublesome. With a good play-back cartridge there is hardly any problem, but with a poor cartridge, one exhibiting perhaps only 10 to 15 dB separation in the carrier range, carrier interaction (also known as fm beat distortion) is characterised by a buzzing sound surrounding bass notes. The effect is very much like that of a snare drum vibrating in sympathy with a plucked bass, or the familiar buzzing sound characteristics of fm multi-path distortion.

As playback cartridges improve in their separation characteristics, it is expected that concern for this carrier interaction will diminish. In the meantime, however, it is wise to recognise its existence and to be concerned about it. It is a function of the *difference mode* between inputs to the carriers and will accordingly be a function of placement of the panned signal in the quadraphonic array. This is shown as a polar graph in fig. 5. Here we see a curve that looks like a four leaf clover, showing maximum values when a signal is panned directly into any channel. Let us pick one position, right front, for example; the information for this signal exists as a baseband component in the right channel and carrier deviation in the right channel. The left channel carrier has zero deviation since no signal exists there and the modulation index difference between the two carriers will be at maximum. Now, let us pan the signal to centre front. Here the signal will consist of equal in-phase baseband energy as well as identical carrier channels, both being modulated with the same deviation and in the same direction. The result is no modulation index difference between them, and hence no fm beat distortion. Panning the signal to centre right results in *zero* carrier information in the right channel and hence no net difference between the carrier modulation indices.

Many mixers recall the old days of mixing for stereo and being told that they should put the bass in the middle. After all, so the story went, it sounded better that way, and the record so produced exhibited a nice fat groove with hardly any skipping problems. The real necessity for this was, of course, due to inadequate pitch and depth control in many of the earlier disc transfer systems. Today, the producer feels free to put the bass anywhere in the stereo array, confident that the transfer system will handle it properly.

The newer CD-4 transfer systems include means of automatically determining the modulation index difference between carrier channels and operating on only the low frequency information to reduce this difference. The action is dynamic and is used only to the degree required to minimise the problem. This automatic low frequency control, if properly done, cannot be heard as such any more than skillful limiting of high frequency components in disc transfer systems is heard as such.

Another concern in quadraphonic mix-down procedure has to do with integrity of channel separation at high frequencies. Fig. 6

shows separation characteristics which are possible with state-of-the-art cartridges and demodulators with careful attention given to aspects of side band symmetry and total system phase shifts. The result is exceptional separation at high frequencies. A routine demodulator/cartridge combination on the other hand will have less separation at high frequencies.

How important is high-frequency separation in a quadraphonic array? To the engineer and producer whose common reference is a four track master tape, it is extremely important. Systems whose high-frequency separation in the quadraphonic mode are limited either by total channel capacity or by band limiting will never provide a consistent match to the master tape and will always be judged by engineers and producers as compromise approaches. With naive listeners, it is true that the above limitations of channel capacity or channel bandwidth may not be serious ones, and many tests have been performed which seem to indicate this.

But what these tests do not tell us is at what point a listener ceases to be 'naive' and becomes 'experienced' enough to tell the difference. In any event, the audio industry has always tended to set its prime system performance standards not in terms of what a cross section of the listening-public will *accept* but rather what a select group of fussy engineers and producers *demand*.

The seriousness of insufficient high-frequency separation in quadraphony is easily demonstrated by assigning a source rich in high frequencies to one of the back channels. Cymbals or tambourines will do nicely. In a discrete array the instruments will remain clearly at the assigned back channel, no matter what the azimuth angle of the listener's head may be. With even a small amount of leakage from the back channel into the corresponding front channel above, say, 3-6 kHz, the experienced listener will begin to hear the sounds out of both speakers. The leakage must be held to the range of 8-10 dB down or better before the effect becomes negligible.

The most important decision to be made by the lacquer transfer engineer at the cutting point is the setting of a suitable transfer level which will allow the disc to end at a diameter no less than 14 cm. If variable pitch and depth functions are properly aligned then there should be no problem with even the longest of sides if a baseband level 2 dB lower than the corres-

ponding stereo transfer is allowed.

Stated somewhat differently, if a long stereo side ends at a diameter of 12 cm (the minimum suggested by US standards), then a 2 dB redirection in level will always yield a side which ends at 14 cm or greater—again assuming that pitch and depth control are working properly.

The transfer engineer must also determine at this point the degree of signal conditioning he feels will result in a 'safe' transfer for a variety of playback situations. Some degree of signal conditioning is usually present at all times, but if the program exhibits excessive hf or lf carrier difference mode information, then additional baseband shape limiting or lf difference mode suppression may be called for. (The slope overload problem can be just as important in stereo as in CD-4, and improper attention to it is a sure sign of careless engineering. In stereo, the effect of shape overload may or may not be 'catastrophic', depending on the situation; in CD-4 the result will be momentary carrier loss, and the effect will depend upon how well the muting circuitry in the demodulator works.)

In making these decisions the transfer engineer will cut a number of short reference passages and play them back with a number of cartridges so that particular problems can be isolated. A CD-4 reference lacquer may be played quite a few times, perhaps 25, and still yield good quality. Noise, however, will start to increase from about the fourth or fifth play due to inevitable wear of the carriers.

Essentially, the demands of CD-4 record processing are the same as those of high-quality classical production. The significant difference is the use of a slightly harder compound with an anti-static agent added to it. If a pressing plant is used to quality work, then CD-4 will cause no significant problems. The adjustment to a new pressing cycle for the compound will not take long, but it will probably surprise the quality control manager that a disc which sounds perfectly good in stereo may sound noisy in quad. Significant noise components can sometimes be present in the 20-45 kHz range due to electroplating irregularities. Even the way a freshly pressed disc is returned from the press can affect noise in the carrier range. If a disc is separated from a stamper with a side-wise motion while the disc is still warm, there will be minute deformations caused, randomly disposed so as to produce additional noise components. Similarly, certain vinyls exhibit

48 ►

SPECTRUM SHIFTER



AN ENTIRELY NEW SOUND EFFECT

- * Audio shifts up or down by 0.1 to 1000Hz for weird music and speech effects.
- * 'EQUAL MIX' gives phasing and beating effects.
- * 1-10Hz range for versatile howl reduction applications.

SURREY ELECTRONICS

The Forge, Lucks Green, Cranleigh,
Surrey GU6 7BG. S.T.D. 04866 5997

MIDAS international;



A 'Comprehensive' 16-track music recording console supplied to Pepper Studios of Adelaide, Australia.

★ SEE US ON STAND No 74 AT THE APRS EXHIBITION ★

MIDAS AMPLIFICATION 54-56 STANHOPE STREET · EUSTON · LONDON NW1 3EX
TELEPHONE 387 7679

A SWITCH IN TIME SAVE NINE

It's happened to us all at some time. You've offended one of your most valued clients by failing to install on time, or with a breakdown in his equipment. You've lost his custom and respect. He's the customer who could easily lose you another nine prospectives.

Isn't it time you switched to **MUSTANG?**
Dependable **MUSTANG**

One of the very few who can offer reliable amplification almost ex-stock and mean it.

Manufacturers of mixers, integrated mixer amplifiers and slave amplifiers, studio power amplifiers, transformers lighting control equipment and cabinets for the home and export markets.
Contact us for fully illustrated technical brochures.

MUSTANG COMMUNICATIONS

Nelson Street, Scarborough,
North Yorkshire YO12 7SZ
England
Telephone 0723-63298



SALES and SERVICE

Telephone: Cardington 404
Specialist in Service and Repair of T.R.D. recorders.
All parts, motors, etc. available. Collection and delivery:— London and Home Counties.

TRAD

FOR SALE THIS MONTH

T.R.D. $\frac{1}{2}$ " 4 track sync. etc. **£550.**
4 Track Scully plus two track head block **£1,500.**
Stereo E.M.T. Plate **£1,200.**
Ampex 4 Track AG440b and two track head block **£2,000.**
Ampex 4 Track AG440b **£1,900.**
A.K.G. and Neumann Microphones.
Two Richardson 40 watt valve amps. **£45** the pair.
Mono TR90's **£95.** T.R.D. Stereo S/15 **£180.**
Allen and Heath Mixing Desk, 16 into 8.
Switchable 16 **£1,500.**

DOG HOUSE
COPEL · BEDFORDSHIRE
Telephone: Cardington 404

CD 4

property of relaxation after moulding, which can result in minute surface deformations sufficient to cause additional noise.

It is clear that with CD-4 we are dealing with random noise components arising over a frequency range *three times* that of a stereo disc, and all operations not normally monitored over that range must be properly assessed and controlled before good production can be taken for granted.

Stamper life for CD-4 production is hard to specify because of the many standards of performance among those plants currently making CD-4 discs. (1500 impressions per stamper have been reported for pop product). In general, a stamper is retired when it reaches some arbitrary noise level in carrier response, and it has

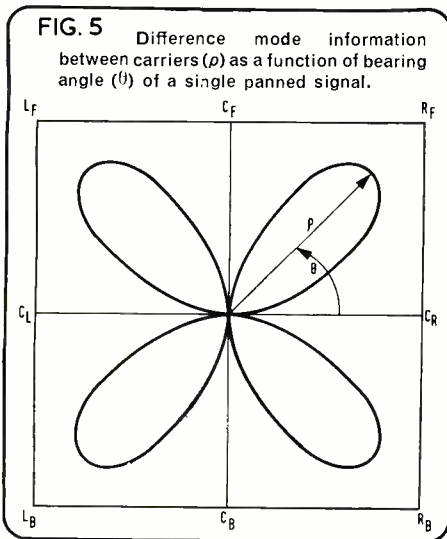

generally been noted that CD-4 stamper life for pop product is about the same as for stereo classical product.

Compound costs normally run about one cent (US) per record higher than normal compounds, and total processing time runs 10% to 15% longer than for normal stereo production.

Far from worrying about the peculiarities of the various quadraphonic mediums, the serious mixer who is concerned with musical values has good right to question many current practices in quadraphonic mixing. It should not surprise us that many people are in disagreement

FIG. 6 Front-to-rear separation. Side-to-side separation in CD-4 systems is a function of the inherent left-right separation of the playback cartridge, but front-to-rear separation is a function of carrier-baseband relationships. The dashed line in the figure shows typical response for consumer-type playback units. The solid line shows separation characteristics for a professional playback system (CD4-1000 demodulator and X-1 cartridge), with excellent separation maintained out beyond 10 kHz.

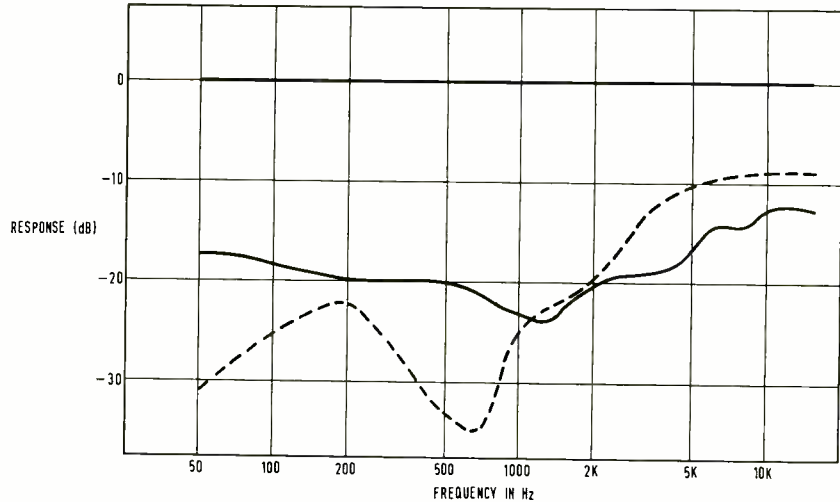

regarding what quad can and cannot accomplish. The medium is barely five years old, and as Michael Gerzon pointed out in these pages some months ago, it is incredible that the stereo industry is still in disagreement regarding some of its properties—and *that* medium is well over 40 years old!

Can quadraphony produce an azimuthal continuum of sound around the listener? Given the wide variety of listening set-ups, speaker placements, and, most important of all, the possible positions of the listeners, the answer is a practical *no*. True, given precise loud-speaker-listener geometry, phantom images can be produced at any position (not by normal panpots but through careful attention to phase as well as amplitude relationships between channels), but with the slightest relaxation of the listener's test position most of the phantom images will become vague or disappear altogether.

As it turns out, the only stable images in the normal quadraphonic array are those real images panned to the four loudspeakers and the array of phantom images panned into the front quadrant. Even though the three remain-

ing quadrants exhibit unstable phantom images, it is possible to create a fairly convincing impression of motion if images are panned rapidly around the periphery or diagonally 'overhead'.

Many mixers seem to have developed a bad habit, at least in the US, of panning a vocalist equally into all four loudspeakers. This is a technique which defeats the general purposes of a discrete quadraphonic system, and many listeners find it disturbing to confront a voice hanging wraith-like in the middle of the room. The position is best used sparingly and only as a special effect.

Finally, we should comment on one of the most successful of quadraphonic techniques, and that is the reproduction of a truly omnidirectional ambience resulting from essentially uncorrelated reverberant information in all four channels, such as may be recorded *via* four coincident microphones or as may be produced in the control room by appropriate signal processing techniques. So far, this technique seems to have been limited to certain experimental recording sessions, but its incorporation into pop-rock recording is eagerly awaited.

UD-4

Matrix and pressing processes

The processing and pressing of UD-4 records is as for stereophonic records. The disc is pressed using highpolymer vinyl chloride plastic. More care must be taken to avoid dirt than in ordinary processes. The stamper surface must be cleaned with soft velvet soaked in organic solution before pressing starts, and also subsequently during the pressing.

The features of UD-4

UD-4 system is based on the entirely new and

improved idea, 'Universal Matrix Theory' and, we suggest, produces the best sound quality and stable localisation by adopting the merits of matrix encoding and complementing the weak points of multiplex technology on disc.

The main features of UD-4 are 1) Low distortion 2) Low noise 3) Wide dynamic range 4) Symmetry of localisation 5) Clearness of sound localisation 6) Compatibility with monophonic and stereophonic reproduction 7) Availability of BMX matrix quadraphonic reproduction 8) Availability of TMX semi-discrete quadraphonic reproduction 9) Availability of QMX completely discrete quadraphonic reproduction.

References

1. D. H. Cooper and T. Shiga, 'Discrete-Matrix Multichannel Stereo'. AES Journal, Vol 20, pp 346-360 (June 1972)
2. D. H. Cooper, T. Shiga and T. Takagi, 'QXM Carrier-Channel Disc'. AES Journal, Vol 20, pp 614-624 (Oct 1973).
3. O. Kohsaka, E. Satoh and T. Nakayama, 'Sound-Image Localisation in Multichannel Matrix Reproduction'. AES Journal, Vol 20, pp 542-547 (Sept 1972).
4. D. H. Cooper, 'Continuous Delay Regulator for Controlling Recording Errors', AES Journal, Vol 14, pp 7-16 (Jan 1966), and IEEE Trans Audio Electroacoust, Vol AU-14, pp 16-26 (Mar 1966).
5. S. Washizawa, T. Nakatani and T. Shiga, 'Development of Skew-Sampling Compensator for Tracing Error', AES Journal, Vol 21, pp 630-634 (Oct 1973).

REWAUDIO CONTRACTS

LONDON'S LEADING CONSULTANTS AND DISTRIBUTORS FOR P.A., STUDIO AND PROFESSIONAL AUDIO EQUIPMENT

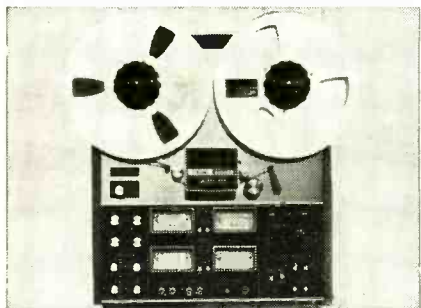

TEAC 3340 INDUSTRIAL

The Teac A 3340 professional model is a very high quality, 4 track (separate) recorder. Operating at 7½ and 15 i.p.s. with full built-in sel-sync facility. Potential 8 input source (4 line and 4 mic) incorporating separate mixing controls on front panel. In stock.
NETT PROFESSIONAL PRICE ON APPLICATION

MICROPHONES

REW Audio Contracts are able to offer the following microphones at professional prices (subject to stock), to bona-fide pro users.

AKG
SHURE
CALREC
BEYER
RESLO

SONY
ELECTROVOICE
DAN GIBSON
SENNHEISER

Phone for a fantastic quotation!

4 CHANNEL PRICE BREAKTHROUGH! New Dokorder 7140 Multi-Sync Recorder

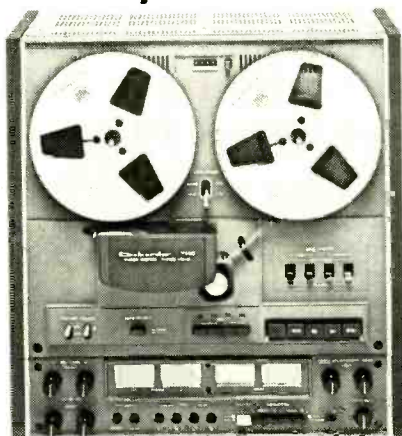

Similar facilities to Teac 3340. Three motors, 3 heads, solenoid operation, electronic echo. Speeds 7½ and 3¾ i.p.s. 7in. spools. Mic and linemixing.

PROFESSIONAL PRICE ON APPLICATION
also available Model 8140 with even more advanced specifications. Details on request.

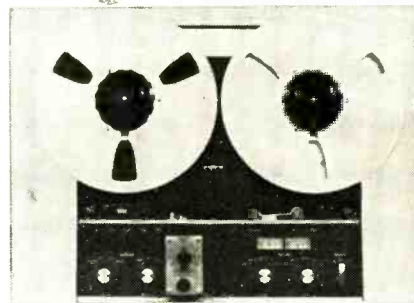

REVOX A77 Mk IV

The world famous A77 1102 Series III semi-professional recorder, available in 3¾ and 7½ i.p.s. or 7½ and 15 i.p.s. speeds+sel-sync and varipitch conversions. This machine proves a long standing favourite with the REW Audio Contracts range of mini-studios. In stock.

NETT PROFESSIONAL PRICE ON APPLICATION

**Visit our studio monitor
loudspeaker room Britain's
widest range on
comparative demonstration**

JBL 4311 Control Monitor 'Voice of the Theatre'
JBL 4310 Control Monitor Altec 846U
JBL 4321 3-way Monitor 'Voice of the Theatre'
JBL 4325 2-way Monitor Altec Mini-Monitor I
Electrovoice Sentry III Altec Mini-Monitor 2
Electrovoice Interface A Spondor BCI & BC2
Tannoy Mansfield HPD 15" Rogers BBC Monitor
Altec 9846 KEF Reference 104

All at special professional prices

AMCRON AMPLIFIERS Sole London Distributors

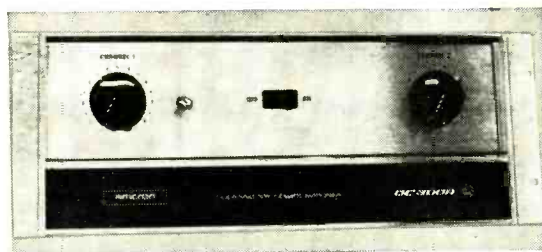

AMCRON DC300A
200 + 200 watts RMS
AMCRON D150
100 + 100 watts RMS

AMCRON D60
40 + 40 watts RMS
AMCRON VFX2
Electronic Crossover

NEW MODEL M600
750 watts RMS mono
**PHONE FOR LOWEST
PROFESSIONAL PRICES**

ALL PROFESSIONAL AUDIO EQUIPMENT AT

BRITAIN'S WIDEST RANGE OF MIXERS

All models ex stock

ALLEN & HEATH POP MIXER
16/2
ALLEN & HEATH MINI MIXER
6/2
ALLEN & HEATH MONO MIX
BOX 4/1
SOUNDCRAFT 12/4 (illustrated)
SOUNDCRAFT 16/2
ALICE AD62 6/2
AUDIO TECHNICS MM42 4/2
SONY MX16 8/4
HILL P.A. SYSTEMS
PORTABLE MIXER 10/2

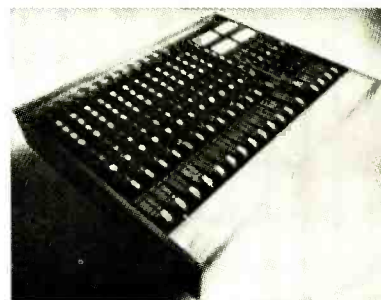

All at Special Professional Prices

*NOTE REW Audio Contracts and REW Video Contracts are registered trade names and are part of The REW Group of Companies.

REW Audio Contracts, 146 Charing Cross Road, London WC2. Tel: 01-240 3883

VIDEO, INDUSTRIAL AND STUDIOS AT

REW Video Contracts, 10-12 High St., Colliers Wood, London SW19. Tel: 01-540 9684/5 Telex 896194

Pink Floyd were among the earliest innovators to use four channel sound, and more recently Dark Side of the Moon has won many awards, including several for engineering. The author, who engineered these and many other sessions for the band, discusses the quadraphonic record production, and contrasts it with the presentation of multichannel sound on stage.

Four sides of the moon

ALAN PARSONS

MANY YEARS AGO, in the earlier part of their career, Pink Floyd had been experimenting with a device inscrutably known as the Azimuth Co-ordinator. It was not a magic box for aligning type machine heads as the name might suggest but a very glorified term for what we now know as a quad pan pot. Its use at live concerts at that time very likely inspired considerable audience interest in multi-channel sound systems and in a mild way may have contributed towards the now booming industry of quadraphony. Many groups have recently adopted quadraphonic pa systems for live shows, the size and power of which seem to be increasing. Quadraphonic record sales are also on the increase, despite the indecision both on the part of the public and record companies about which of the various systems provide the best results and compatibility.

Practically all non-classical recordings are made using close mic techniques in relatively dead studio acoustics and later remixed to a stereo master tape. Exactly the same recording procedures can apply for a quadraphonic record except that, because the master reduction is made to four channels rather than two, the multitrack layout must allow an effective distribution of sounds for adapting to quad. There are obviously more possible positions in a four channel remix, and conflict may arise with track groupings organised with stereo in mind. Although *Dark Side of the Moon* was monitored in studios equipped for stereo reproduction, many sections were recorded with regard to the eventual quadraphonic reduction, even though this took more track space than would have been necessary for stereo. For example, the clock sounds for *Time* were built in an imaginary quad picture on to four tracks of the 16 track master. The sounds heard on the introduction to *Money* were also distributed across four tracks to enable the spatial shifts of the quad reduction. This involved transfer from an edited tape loop on a four track machine to the 16 track for subse-

quent overdubs so that each sound issued from a different speaker.

Merely redistributing the sound for the quad mix, however, is not the end of the story. The various quad systems for which the album is intended have to be borne in mind. EMI have adopted the SQ system for disc issues. As with all matrix systems it has specific limitations. For example, if signals are positioned anywhere in the area between centre-of-the-room and centre back they are likely to be out of phase to some degree when encoded and cut in two disc channels. This results in a considerable drop in level, due to the difference channel limitations or even a total disappearance of the signal in mono, so this has to be avoided wherever possible, although a pan through this centre area might pass unnoticed since level variations would be less objectionable in a moving picture.

When approaching the quad mix of the album it had to be emphasised that the contents should be unchanged musically, but be a 'showcase' for the quad medium and avoid the more obvious gimmicks of panning etc. The requirements were a discrete master for tape systems, and an encoded SQ master for disc transfer. It was thought that two separate remixes would be the ideal situation, for in that case each system could be used to its fullest capabilities without compromise on account of the other. However, there might have been such huge differences in quad effect between the two that they might have been incompatible with each other musically; for example, in the effect of following disc and tape cartridge.

Another considered alternative was to remix to discrete and SQ simultaneously. This would have presented a considerable demand on machinery, especially as many other tape machines would be in use for quad echo delay, adt and so on. Every edit would then have to be duplicated on both systems; crossfades would be a nightmare, needing three four track machines and three stereo machines quite apart from the extra time involved and the multipli-

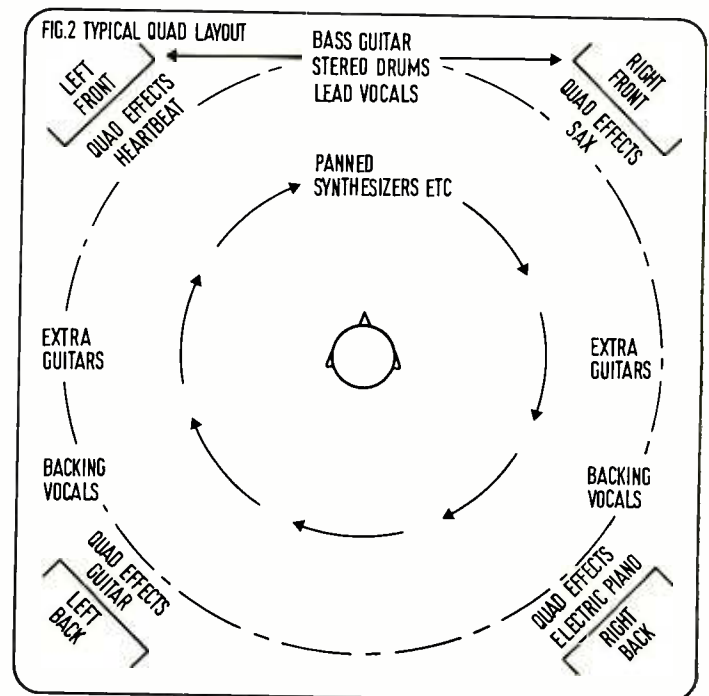
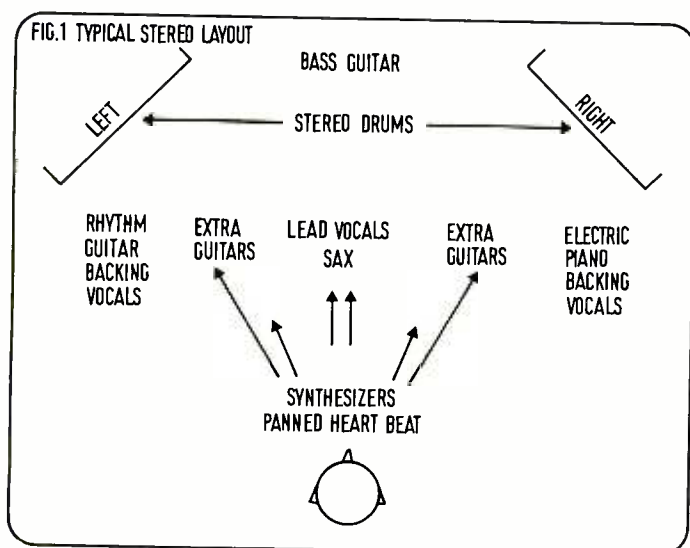
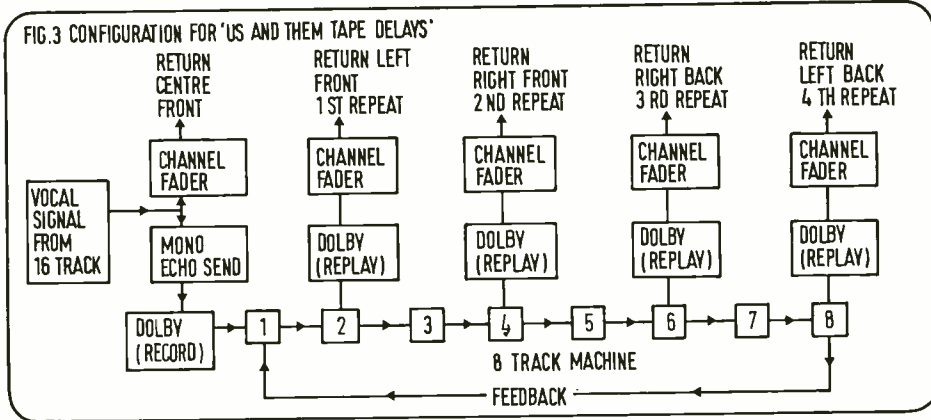

FIG. 3 CONFIGURATION FOR 'US AND THEM TAPE DELAYS'



cation of lineup procedures. It was eventually decided to work with one discrete four track tape and monitor it in such a way that assured a reasonable result for both systems, in other words bearing in mind the compromises in the subsequent two-channel processing. The quad remix room at EMI's Abbey Road Studios has the convenient facility to monitor a discrete tape passed through a back-to-back SQ encode/decode arrangement, and also the stereo result direct from the two matrix channels without decoding. Thus, we can monitor discrete, SQ and stereo from just one four track tape. An SQ master was to be prepared simply by making a copy of the final edited and crossfaded four track tape through the SQ encoder. This extra generation could be saved if it was felt necessary by direct transfer from an advance head four track machine to disc via an encoder, although normal practice is to prepare an intermediate two channel tape: azimuth and generation difficulties can be overcome by careful engineering. Having determined the manner in which the various systems could be handled for the reduction, the problem of quad positioning arose.

On the stereo version the basic instrument positions were arranged as in fig. 1. Additional sounds such as synthesizers, extra guitars and backing vocals were spread across the picture in various combinations for maximum filling out of the music stage. The stereo remix was by no means a simple one, many tracks having to be 'potted' for just a bar or two. The 16 track master itself was derived from an earlier 16 (down to nine or ten tracks on the second in some cases) in order to make spare tracks available for further overdubs. This did not make the quad picture 'design' any easier. For instance, the drums had been mixed to stereo on the second generation 16 track which, owing to SQ limitations, had to be spread from left to front right, leaving bass drum and snare centre front and tom toms spread in stereo across the front of the room. The bass guitar also had to remain centre front for the sake of the SQ, but this was no great problem as bass frequencies have little directional characteristics and the harmonics and attack of the instrument are not particularly strong here. Guitar was placed rear left and the electric piano rear right.

The reverberation system used throughout the quad reduction was two EMT reverb plates: one was spread across the front channels and one across the rear—both fed from the

same source. This gave a very full 'inside the chamber effect' and helped to minimise the 'hole in middle of the room' caused by the absence of direct sounds there.

The piano on *The Great Gig in the Sky* is a natural quad recording made in Abbey Road Studio One (while bass and drums were playing simultaneously in Two) using two distant mics for back channel reverberation. The four tracks were simply combined for the stereo version.

In *Time* the roto-toms (tom-toms tuned by rotating drums on a pivot to stretch the head) were spread across the back channels while most of the remaining instruments were distributed across the front. The recording technique and studio layout for the basic backing tracks were nothing especially unusual except that maximum possible separation was attempted. Poor separation for a quad remix of this type could prove very disturbing. This was no problem in most cases, as many instruments were overdubbed rather than laid down on the basic track. The Kepex system was used as a noise gate on all the 16 tracks for the reduction, and also in the earlier stages to improve separation between individual drums on the basic recording. Further use of Kepex enabled decay times of various tracks to be altered; the heartbeat on the introduction to the album was, in fact, a Kepexed bass drum.

The positioning for quad remix was effected by means of an external insertion unit containing sixteen dual-concentric pan pots (front to back and right to left). These were then fed into channel faders on the mixing console in the normal way. Any movement or panning was arranged by patching in external joystick panpots to the appropriate tracks and then again returned to channel faders.

Us and Them is probably the most involved piece of quad technique on the album. On the stereo version a vocal line is repeated by means of a very long tape echo which moves from the left towards the right on each successive repeat. In order to achieve an interesting effect in quad, each repeat was returned to a different channel which entailed using a different tape system for each repeat rather than recycling one signal back through the same system, as one would for a normal tape echo or digital loop. In order to do this a hook-up had to be arranged, with an eight track machine as in fig. 3.

AB Pearl Mikrofonlaboratorium.



DCT3.
48 volt, cardio.d.
Vocal hand microphone.

For further information on the complete range of Pearl microphones, contact:

Allotrope Limited

90 Wardour Street, London W1V 3LE.
Telephone: 01-437 1892. Telex: 21624

U.K. Representatives for:
AB Pearl Mikrofonlaboratorium - Sweden, Microphones & accessories.

HES Electronics - Brussels, TSV series telephone balancing units, and studio equipment.

Inovonics Incorporated - Campbell California U.S.A., Audio electronics.

Roland Zeissler Werk Für Elektro Mechanik - Cologne, Racks and instrument housings.

■ SIDES OF THE MOON

It will be noticed that each repeat involves two record-replay stages. This was necessary to attain the length of delay needed for the piece and in fact to increase the delay still further the tape speed of the machine was lowered. By the time the fourth repeat had arrived about four seconds after the original signal it had passed through eight stages of tape, so machine and Dolby line up were extremely critical. This caused troubles: originally, the record/replay eq was accurately set, as usual, but the relatively slight speed deviation meant that, at the changed speed, slight top lift occurred. After eight repetitions this became rather unusable. It will also be noticed that the repeat from track eight is fed back into the record stage of track one so that a further cycle takes place. Thus: fifth repeat returns left front, sixth right front and so on. The result is a round-and-round-the-room effect. The system is operated below unity gain however, and the sixth and seventh repeats are barely audible.

A similar type of delay is used in *Any colour you like* on synthesizers. Richard Wright, when overdubbing on to the section, heard the tape repeat in earphones, and played in such a way that the result was canonic.

Owing to the sheer complexity of some of the procedures involved in the recording of *Dark Side*, many of the sounds would be impossible to reproduce live, even with the most involved equipment. It is for this reason that Pink Floyd use a number of pre-recorded tapes, reproduced in quad on a Teac four track machine, for their concert programmes. The tape is operated at the mixing desk which is situated within the hall in the audience area. One unusual point about the quadraphonic layout for Floyd concerts can be seen in fig. 4. Rather than use a conventional double stereo set up, ie left front, right front, left back and right back, the whole system is rotated 45°. This has many advantages over a normal system.

The main stereo pa is extremely large and powerful (approx 8 kW). To set up an equally powerful system at the rear corners of a concert hall would be a mammoth task, and very impractical. Even with the layout shown, road crews have a hard time humping huge cabinets to the sides and back of the hall, especially when the auditorium is on several levels. This involves speaker stacks on every level together with their associated cables, which have to be kept out of the way of the audience.

It has been found very effective to have the quad output stacks on a level somewhat above that of the stage, especially since the system is used frequently to simulate movement.

This applies more especially to the stack behind the stage, of course, which in most cases would be drowned by the more powerful independent stereo stage pa. The stage quad stack also serves as an aural cue to the band, who might otherwise find it difficult to hear the other quad channels, which could literally be hundreds of feet away from the stage.

Any attempt to duplicate the quad picture from the recorded version would be disastrous. The delay from front to back in a large hall could be as much as half a second, and in tight rhythmic sections this would be very unpleasant to listen to, quite apart from the

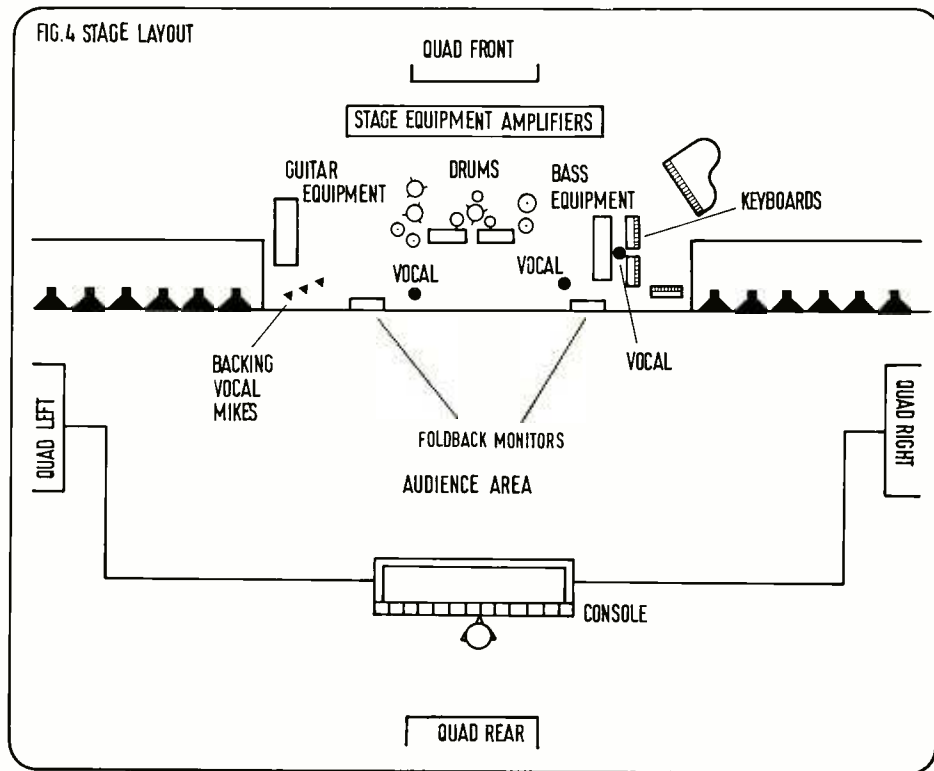

band finding time-keeping very difficult with their own sound coming back at them from all directions with various erratic degrees of delay.

Thus, the quad system for a live hall has to be used in a rather subtle manner, the aim being in this case to add impact at relevant points in the piece being performed. In the long introduction to *Dark Side*, the heart beat fades on slowly as the house lights dim and synthesizers and voices swirl round the hall. In one of the Floyd's old favourites the effect is slightly less subtle: in *Careful with that axe Eugene* the quad carries no sound at all until the famous horrific scream at which every amplifier and speaker is driven to its absolute maximum, accompanied by an explosion of flash powder behind the stage.

Any individual instrument carrying a microphone to the mixing console can be individually switched into the quad system. This is used to the most advantage on quiet passages where the main stereo pa can be virtually shut down and the maximum use made of quad pan pots for movement.

With domestic quadraphonic systems, seating position is very important. In a concert hall, however, this is not as critical owing to the greater distances involved between channels. It is an unfortunate fact, however, that some unlucky concert goers have to sit directly underneath a quad stack and get themselves deafened—which is as good a reason as any for not using the quad too much throughout the concert. In the film *Earthquake* the noise issues from huge cabinets at both ends of the theatre, and the author was unlucky enough to find himself sitting near one of the rear stacks at a showing in the West End.

Pink Floyd have recently used back projected film behind the stage with a 35 mm four channel

sound track. This has proved very successful but problems do arise with run-up-times of up to ten seconds when attempting to bring in a sound on a musical cue. Film and multichannel sound are now commonplace of course, as in the new Ken Russell picture of 'Tommy' and its use of a 'quintophonic' system—doubtless an indication of things to come.

AGONY COLUMN

■ The big name group was appearing at a certain big London gig, as was the small, enthusiastic band that was supporting them. The big time producer was around at the rehearsal which went very well for the superstars but even better for the support, who were sensational. 'You really mustn't do as well as that on the right, must you?' said the producer, 'otherwise we might get upset'. Or words to that effect. Support bands tend to be a bit green so they didn't really sort out all the possibilities. On the night, the superstars were pretty good, as befits a good, professional outfit; the support was even better... for the first few numbers. Then the vocalist found that he couldn't hear himself through the monitors, and the bass player's sound seemed to go wrong. The balance seemed to be a bit out. As a result, the set fell apart around them, and they finished in a shambles. Afterwards, they discovered that the pa balancer had been paid to ruin the sound. Oh well, so that's the way it goes. But the rub was when the band discovered that the price was £10; that hurt.

RAC

Custom-built mixers

Comprehensive range of audio modules suitable for the construction of mixers or incorporation in Public Address systems

Power Amplifiers 50w 100w

Catalogue sent on request

Trade and export enquiries welcome

APRS manufacturing members

RUGBY AUTOMATION CONSULTANTS

19 Freemantle Road, Rugby, Warks.

Telephone Rugby (0788) 81087

Magnetograph Recording Company Ltd

8 Harway Street London W11 0T 01-580 2156 or 01-323 0888
(Junction Oxford Street & Tottenham Court Road)

**AUDIO CASSETTE
DUPLICATION**

- Audio Cassette Duplication 10 - 100,000.
- Tape & Cassette Recorder Rentals.
- Video Tape Sales.
- Video Design and Installation Service.

* Dolby A361 for hire *

- REVOX A77 Mk III Recorders, standard and high speed model in stock. Sel-Sync model available.
- New REVOX A700 1372 and 1374 now available.
- NEAL 102 professional cassette deck from stock.
- All leading equipment at competitive prices including A.K.G., Beyer, Ferrograph, Teac A3340, Quad, Tannoy, Spondor, Uher 4000/4200/4400, Report IC, and CR210 cassette recorder with facility for chrome tape.

131 The Parade, High Street, Watford WDI 1NA
Tel. Watford 34644

BAILEYS

Penny & Giles Conductive Plastics Faders ... 1975 Design Council Award winner

The smoothest fader in the business, already chosen by the world's top studios - now endorsed by the UK Design Council.

The infinitely smooth, noiseless, fade achieved by the conductive plastics tracks, the unique Penny & Giles wiper arrangement and the touch-sensitive, positive, linear action impressed the judges.

So too did the designed-in reliability factor ensuring the faders keep right on specification for years and years without any routine maintenance problems.

And, of course, there is a range of Penny & Giles faders to suit all attenuation laws in mono, stereo and quadrophonic format.

Write, telex or phone for details to

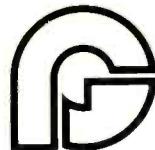

Penny & Giles Conductive Plastics Limited
Blackwood Gwent South Wales United Kingdom
Telephone Blackwood 3771 Telex 49135

The phase and consequent level relations implicit in the QS encoding system place certain restrictions on the balance engineer if he is to use it to best advantage. The ways in which different microphone arrays may be used constructively with and without electrical processing are also discussed in a practical manner. General principles are thus illustrated, particularly with this approach to ambience recording.

Recording techniques for QS four channel encoding

SUSUMU TAKAHASHI*

AS MONO RECORDS were replaced by stereo, we find it is now the time when the latter is being replaced by four channel records. This transition, however, seems to require very much more complex techniques than that of mono to stereo. The sooner these techniques are realised and put into practical use, the better the chance of experiencing the change.

Four Channel Recording

There are various difficulties in putting four channel signals into a single groove, but it is not the intention of this article to deal with these problems. Although most of these difficulties can be solved by using a matrix technique, if it is not used properly disastrous results may well arise. Therefore, I would like to describe how a matrix technique should be used. Before I go into the main subject, it must be remembered that four channel recording itself requires many new techniques: for example, we must consider what would be the best method of recording, in order to provide ambience only, in the back channel. It is a fact that microphones directed toward the back pick up mainly the direct sound of instruments, rather than the subtle ambience information which is required. This is one of the problems which arises in the recording of serious music. Another example: can the same timbre of an instrument be obtained when an instrument is reproduced by a single speaker and two, three or four speakers? With stereo, because the number of speakers is normally limited to two, the difference in the quality of sound between an instrument placed at the centre and the side is small. However, when the number of speakers is extended to four the difference will be much greater—in fact, the pitch of a bass instrument can be subjectively different when played back by a single or four speakers. How can this be equalised? Thus, it is quite clear that various new techniques are required when recording with four channels. However, problems such as these can be resolved by recording engineers and I do not wish to deal with them in this article.

QS Recording Techniques

I would like to elaborate on the techniques

FIG.1 CODED QS SIGNAL

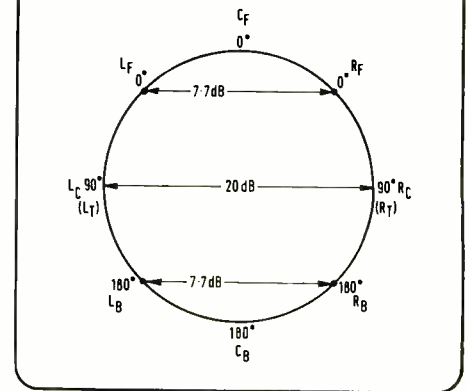

which are required to carry out successful QS recording. QS matrix encoding requires signals to be encoded as LT (left total) and RT (right total), based on the correct matrix theory. Signals which are obtained using a QS encoder may not always provide encoded signals to satisfy this theory and yet it is possible to obtain them even without using an encoder. It is not my intention to describe the technical background of the QS system here, but I would like to mention how the encoded signals, LT and RT, should appear when the QS encoding is applied correctly. Fig. 1 exemplifies properly encoded signals based on this theory.

An L_F signal is obtained when R_T is -7.7 dB against L_T with L_T - R_T phase relationship more closely in phase.

An R_F signal is of opposite amplitude relationship to L_F with the same L_T - R_T phase relationship more closely in phase.

An L_B signal is obtained when R_T is -7.7 dB against L_T but with their phase relationship more completely reverse phased.

An R_B signal is of opposite amplitude relationship to the L_B with the same L_T - R_T relationship more completely reverse phased.

A C_F signal is obtained when L_T and R_T are of equal amplitude and more closely in phase.

FIG.2 INCORRECT CARDIOID POSITION

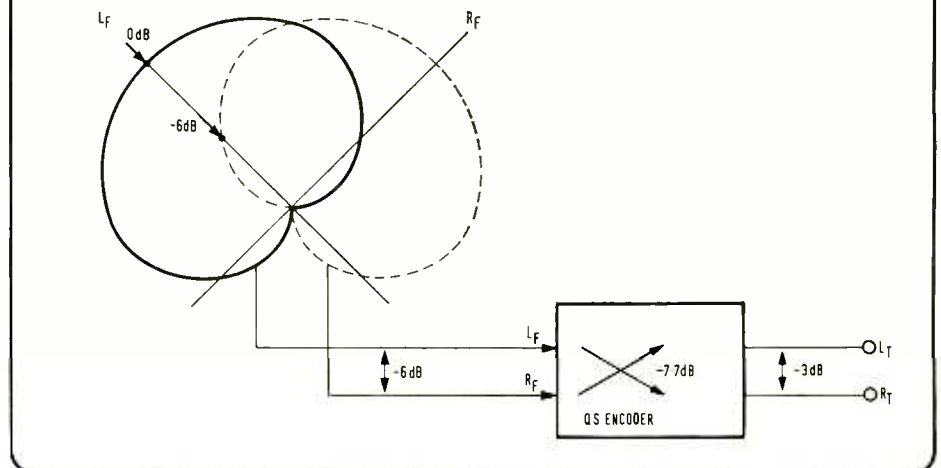

*Sansui Electric Co Ltd, Tokyo

A CB signal is obtained when LT and RT are of equal amplitude, but more completely reverse phased.

An LC signal is obtained mostly by LT and it is desirable that its crosstalk has 90° phase difference with RT.

An RC signal is obtained mostly by RT and it is desirable that its cross-talk has 90° phase difference with LT.

Having explained the basic QS encoded signals, let us now review some examples of incorrect QS encoding. If two cardioid microphones are directed to the LF and RF and their outputs are fed to the LF and RF inputs of an encoder, can the signals between the LF and RF be encoded properly (fig. 2)?

The signal from the LF direction is fed at 0 dB to the LF encoder input and also to the RF input at -6 dB. There is -7.7 dB blend between the LF and RF inside the encoder. In other words, the LF signal of 0 dB is blended -6 dB and again in the encoder -7.7 dB. Therefore, it is blended twice and leaves only about -3 dB difference between the LT and RT. This is not a proper way of QS encoding. Naturally, in this case, the LF-RF picture is encoded very narrowly and when this is decoded, even by a vario matrix decoder, the result is poor LF-RF separation. This is an example of an incorrect encoding for the front side but the same applies to the back. What then are the solutions for the pairwise coincident cardioid microphone arrangement?

First solution: As shown in fig. 3, when the microphones are widened to 180°; signals in the LF direction are fed to the LF and RF encoder inputs with sufficient separation of 14 dB, so that even with the -7.7 dB blend in the encoder, signals can still be regarded as good QS encoded ones. Thus wide sound image can be obtained at the decoding stage.

Second solution: As shown in fig. 4, the output of the coincident cardioid microphones placed at 90° can already be regarded as QS encoded signals without using the encoder. The blend amount of -6 dB between the microphones is similar to the amount required for the QS encoding. Therefore, signals obtained this way can be regarded as QS encoded and, of course, they can be properly decoded by the vario matrix decoder.

So far, I have explained mistakes in feeding stereo coincident cardioid microphones to the two encoder inputs (LF and RF). Then what happens when all four encoder inputs (LF, RF, LB and RB) are fed with cardioid signals?

As shown in fig. 5, a signal from the LF direction is fed not only to the RF but also to the LB at -6 dB. When fed to the encoder this double blended signal is again blended and the results are even worse than those in the first case. It is a bad mistake and against the theory to feed four outputs of a coincident cardioid microphone array to the encoder as they are. No decoder can offer sufficient separation and restore the original, directional information from signals obtained this way. What then are the solutions to obtain properly QS encoded signals from the four channel coincident cardioid microphone arrangement? There are various methods but the following diagram (fig. 6) shows one of the examples.

No encoder is used in this diagram, but the LT and RT obtained are based on the QS

FIG. 3 IMPROVED CARDIOID POSITION

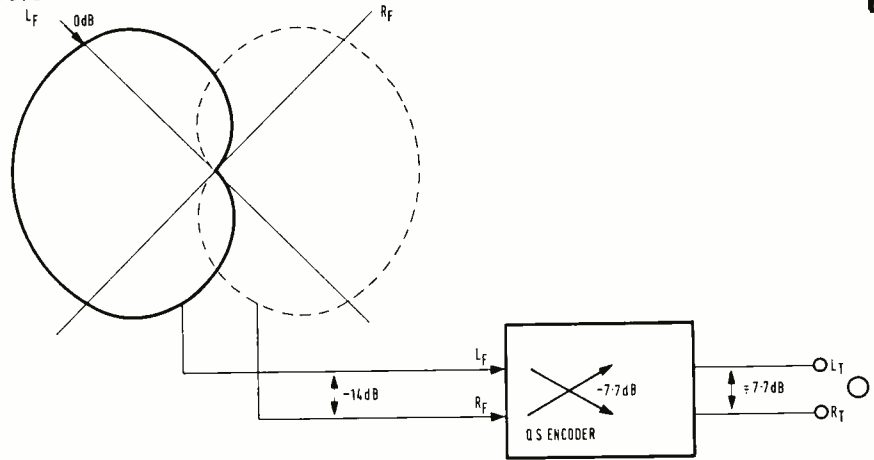

FIG. 4 CARDIOID-QS ENCODING WITHOUT PROCESSING

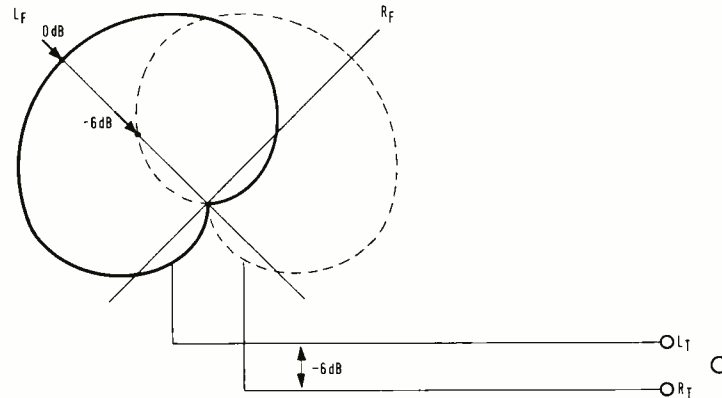
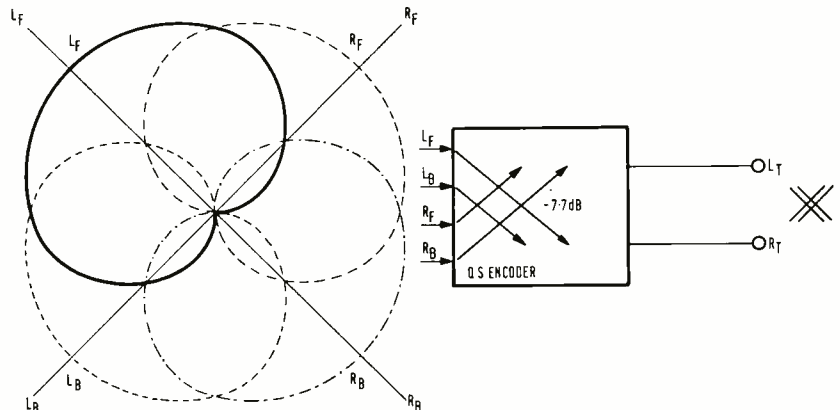

FIG. 5 INCORRECT COINCIDENT CARDIOID-QS ENCODING



RECORDING TECHNIQUES

matrix theory, and therefore can be treated as properly encoded QS signals. Because the details in fig. 6 are complex, I do not wish to go into the technicalities of it here, but there

are various other ways to obtain properly encoded signals.

I hope that you now appreciate what I said at the beginning of this article, ie QS encoding is to have signals as exemplified in fig. 1, yet even without using an electrical encoder, correct QS encoding can be made, while the

use of an encoder does not always guarantee correct encoding. In other words, it is very important when using the QS system to avoid double, triple or quadruple blending. Of course, this does not apply to the mixing of individually recorded signals, by means of the conventional sin/cos panpot as in the case of normal multichannel recording (fig. 7).

Special effects can be obtained by deliberate double, triple or quadruple blending, but this again is outside the scope of this article. With the coincident cardioid microphone arrangement, it is important to avoid multiple blending. Bearing this in mind, correct usage of the coincident cardioid microphones, can give better results than the multi microphone technique, as we have already learned from previous experience in stereo recording. Also, mixtures of the multichannel and coincident cardioid microphones, or mixtures of QS encoded signals obtained through the encoder and direct microphone outputs as previously explained, can be done without any problems. These are some of the points which have to be borne in mind when the QS matrix system is used, and which are different from discrete recording techniques. But this does not mean that the QS system is inferior to discrete. On the contrary, there are various advantages to be gained over the discrete system.

Next, let me explain one of the microphone

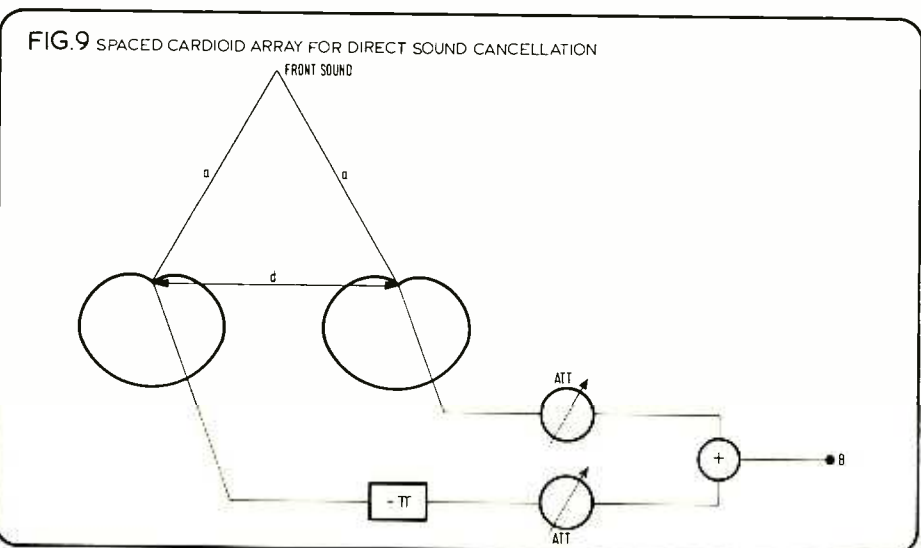
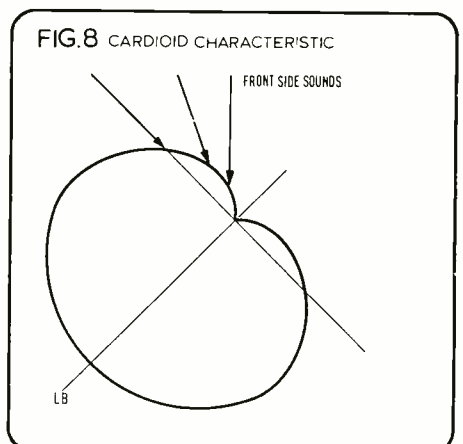
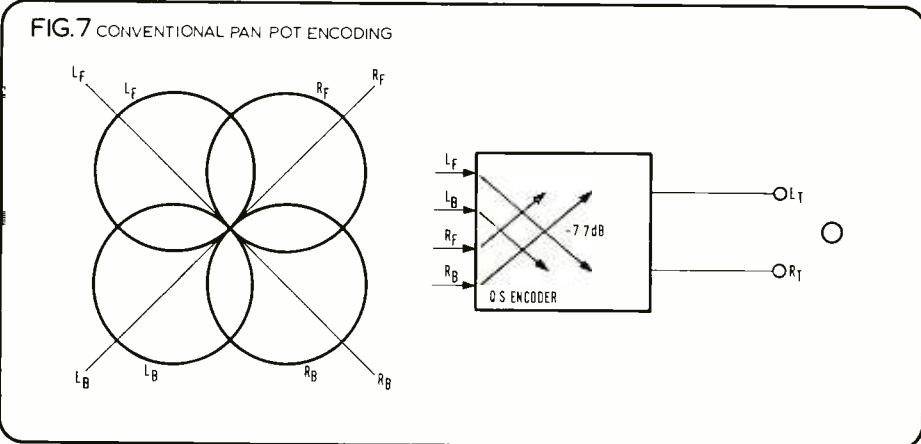
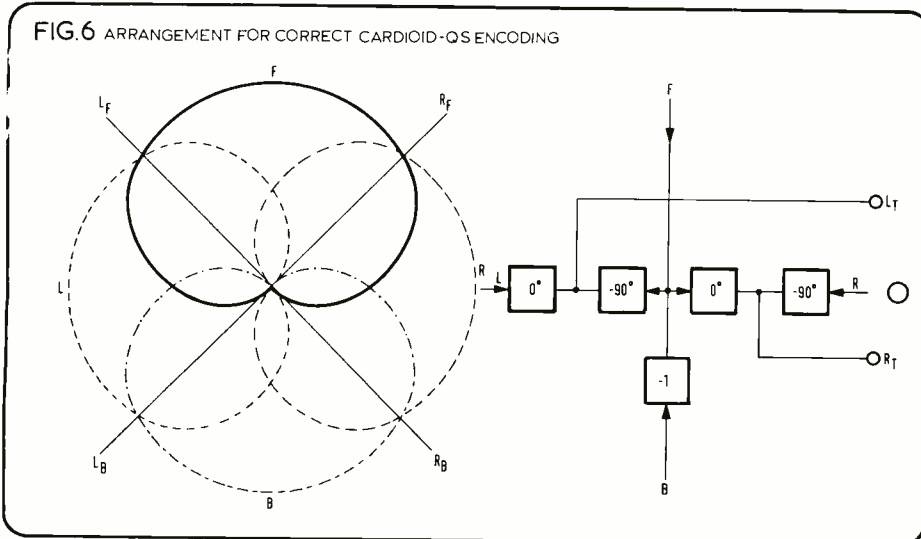

techniques which makes use of matrixing when recording ambience information only in the back channels. As I mentioned earlier it is not easy to record ambience only. For instance, a cardioid microphone directed to the L_B to record ambience also picks up direct sound from the front and fails to satisfy the objective (fig. 8). However, if a matrix technique is used employing two spaced microphones as in fig. 9, by mixing one in phase and one reverse phase it is possible to cancel direct sound images from the front.

When the microphones are installed equidistant from the front sound source, they are driven in phase and, therefore, by applying an electrical out of phase signal, the unwanted direct sound can be eliminated. However, information from sides is not cancelled because the two microphones are not of equal distance and the detected signals thus have inherent phase differences. This makes recording of

Within 2 years, 4-channel sound will be the rule. Sansui QS system puts you 2 years ahead.

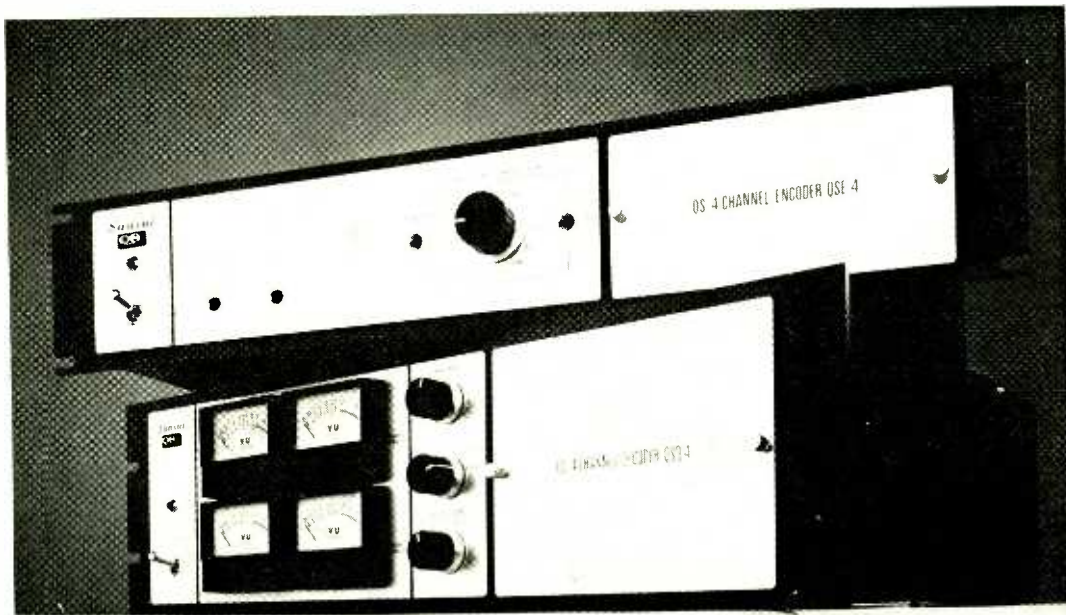

Now your listeners can enjoy the extra depth of 4-channel sound with the minimum of 2-channel conversion costs on your behalf.

Thanks to the Sansui QS Regular Matrix System. Now available for the first time in the United Kingdom.

Keep your equipment.

The Sansui QS 4-channel system is used with all current stereo transmitters/receivers, cutting equipment and hardware. So there's no need to upgrade. The listener only requires a 4-channel receiver and 4 speakers to obtain astounding quadraphonic effects.

Excellent separation.

Both encoding and decoding matrices are symmetrical. Together with the new QS Vario-Matrix in the decoder, an inter-channel separation of 20dB or more is no problem.

Maintains present hi-fi standards.

High standards are maintained. Because of a unique phase shift technique, the quality as well as the quantity of input information is

preserved. In fact it gives better stereo perspective than conventional 2-channel sources.

Proven performance.

In both Japan and the United States where 4-channel sound is becoming the rule rather than the exception, QS type matrixing is standard.

Listen to this remarkable equipment at the London showroom of Sansui.

It's right next to the GPO tower. Our technical experts are ready and willing to give advice on specifications and prices. Or send in this coupon for full information.



To: Sansui London Showroom,
39/41 Maple Street, London W1P 51-U Telephone: 01-580 5353

Please forward all technical and price details on the new QS 4-channel encoder and decoder.

My name:

My address:

Postal code:



Sansui equipment is distributed in the United Kingdom by Vemtron Ltd., Thornhill, Southampton.

Vemtron Ltd., Thornhill Southampton SO9 QF England
Sansui Audio Europe S.A., Diacem Building, Vestingstraat 53/55 - 2000 Antwerp Belgium
Sansui Electronics Corporation 55-11 Queens Boulevard, Woodside, N.Y. 11377, U.S.A.,
Sansui Electric CO., Ltd. 14-1, 2-chome, Izumi, Suginamiku, Tokyo 168, Japan

RECORDING TECHNIQUES

ambience only possible. When the space between the microphones is small, low frequency components of the ambience are lost, because of the small phase difference. In this instance, replacement of the phase inverter by a phase shifter or by increasing the space between the microphones should help to recover it. The writer is still in the process of further assessment and it is possible that there may be other solutions to this problem. However, it is quite clear that the application of a matrix technique assures better ambience when recording.

Stereo Compatibility

When the outputs of the coincident cardioid microphones are placed at 90° to each other, as explained in fig. 4, they provide good stereo signals and at the same time can be regarded as good QS encoded signals. Therefore, it goes without saying that QS encoded signals are compatible with stereo playback, and even wider left-right separation can be obtained than that of the coincident cardioid microphones. When equal signals are fed to the LF and LB inputs of the QS encoder, it becomes an LC signal with LT-RT separation of about 20 dB which is sufficient as a stereo separation (fig. 1). And, of course, by pan potting the LF signal toward the LB, separation can be altered between 7.7 dB and 20 dB. The QS system has the same signal composition as stereo for the front half circle and for the back half, while the LT-RT is of out-of-phase relationship. In stereo playback this enables signals to be located outside the stereo speakers and thus gives a wider stereo perspective than the ordinary stereo mix. Fig. 10 indicates stereo reproduction of the QS encoded signals.

In stereo, the encoded LF-RF offers 7.7 dB separation, which is slightly better than that of the 6 dB obtained with the coincident cardioid microphone arrangement (fig. 4). The encoded LC and RC provide about 20 dB separation in stereo reproduction and can be located in the left and right speakers respectively.

There is an opinion that stereo separation of the QS system is not sufficient. However, if mixing is done with the understanding that in the QS system, stereo left and right are equivalent to the encoded LC and RC, virtually the same results as conventional stereo can be obtained.

One may think that the LF and RF should be

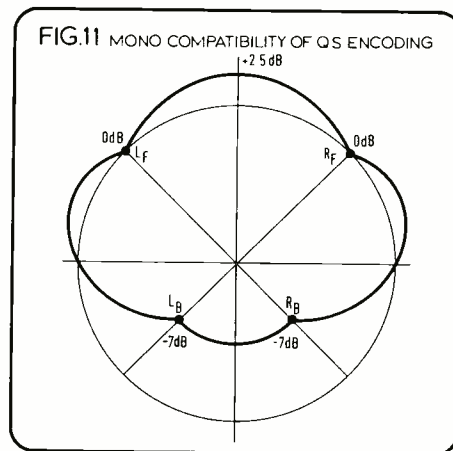
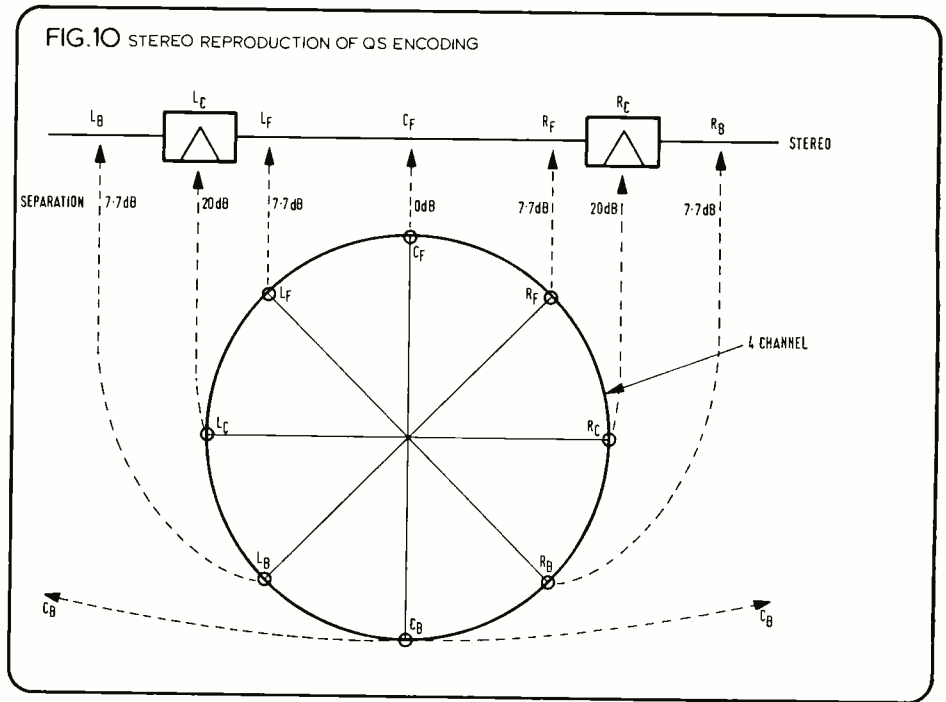

equivalent to stereo left and right, but this idea totally disregards the matrix theory, and above all is a mistake mathematically. Without going

into mathematical details, it is quite possible to explain why the LC and RC rather than the LF and RF have to be equivalent to stereo left and right. A matrix four channel system is a technique to transmit a sound field with only two transmission channels. Therefore, one can appreciate that unless a sound field is symmetrical to the basic stereo left and right, it cannot be regarded as a correct matrixing. In the QS matrix system the LC and RC are stereo left and right and thus give maximum left-right separation. And the encoded LF and RF are equivalent to stereo signals obtained by the coincident cardioid microphone technique.

Mono Compatibility

Since the front sound images are encoded more closely in phase, QS encoded signals are compatible with mono. As the back sound images are encoded more in antiphase, then the mono playback level decreases. However, the latest QS encoder assures that the phase and level relationships of the encoded signals are precisely adjusted so that a maximum level loss of -7 dB is maintained throughout the whole back quadrant (fig. 11). This offers good mono compatibility and, in practice, the 7 dB decrease in level for the back quadrant often gives better results than a discrete mono mix.

Conclusion

During this article I have outlined some of the precautions to be taken into consideration when QS encoding. For the commonly used multi-channel microphone recording technique, the QS encoder satisfies the requirements of engineers. When using the coincident cardioid microphone technique, one can assume the stereo signals are equivalent to the front side of the QS encoded signal, and that the back is composed out of phase. Thus conventional stereo mixing techniques may continue to be applied to QS encoding.

Mains powered self contained units

10 OUTLET DISTRIBUTION AMP

GENERAL STUDIO WORK ★ FEEDING MULTIPLE SLAVE PA AMPLIFIERS ★ DRIVING FOLDBACK HEADPHONES

Excellent distortion and LF performance with specially designed massive output transformer having separate secondaries for each 600 ohm balanced output, giving complete dc and ac isolation £94. Also available —kit of all electronics, excluding case and XLR connectors £55.

STEREO DISC AMPLIFIER

BROADCASTING ★ DISC MONITORING AND TRANSFER

Magnetic cartridge to balanced lines with HF and LF filtering. TO IBA SPECIFICATION £95

Ring for leaflets.

SURREY ELECTRONICS

The Forge, Lucks Green, Cranleigh, Surrey GU6 7BG
STD 04866 5997



naim audio
the power amplifier

BE FAIR TO YOUR MUSIC

Reproduction of sound and its acceptability is dependent on a combination of physical parameters not yet fully explored. We believe that only a compatible combination of specifications will enable a system to

reproduce music. We have taken care that the NAC 12 and NAP 160 pre and power amplifier will do so faithfully, while accepting the output of any pick-up cartridge and driving any loudspeaker.



Naim Audio Ltd. 11 Salt Lane, Salisbury, Wilts. Tel: (0722) 3746

AUDIO DEVELOPMENTS

PORTABLE MIXERS

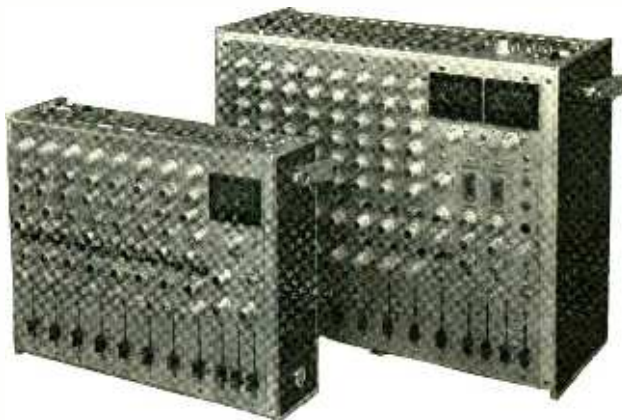

AD 031 and AD 007

The Portable Mixers with the professional qualities and the professional performance.

Both have 8 inputs that drive into 4 or 2 groups.

All inputs and outputs balanced using XLR connectors throughout.

Peak Programme Meter to BS 4297/1968 specification. (V.U. meter optional).

Auxiliary for use on either echo or foldback.

Stereo linkable compressors on the AD 007.

Extender Units that can incorporate 10 extra input modules.

Size: 540 x 480 x 225 mm AD 007
420 x 335 x 127 mm AD 031

Weight: 22.7 Kg AD 007, 10 Kg AD 031

Modular construction to promote serviceability.

Hire facilities of both types are available.

There are agents in Belgium, Canada, France, Holland, Norway and Sweden to date.



Hall Lane
Walsall Wood
Walsall
WS9 9AU
Brownhill 5351/3



Servicers to the music industry and studio maintenance and design

Specialists in all models of Revox tape decks, sales, service, repair, advice and any modification to suit your personal application.

Collection and delivery. Also hire facilities available.

Now in stock - THE NEW TEAC 4 CHANNEL A3340S

105 High Street, Eton, Bucks, SL4 6AF.
Telephone WINDSOR 51403

MOBILE MOST

RAK RECORDS, the label owned by Micky Most, has recently acquired a 24 track mobile for in-house and client use. The facility concerned is the erstwhile **TEAM** (see page 33, December **STUDIO SOUND**), latterly owned and run by Doug Hopkins. Doug remains in charge under its new masters. The transmutation came about after **TEAM** hit some financial trouble due to lack of work. At the time, Micky Most was hunting around for a mobile with the right facilities to do a Rak job, eventually coming across **TEAM**. He heard about the money problems and decided to make an offer that was, in the event, not refused.

The transaction outlined above is nothing out of the ordinary; the interesting facts arise from the intended use by Most. He plans to location record in the normal manner but also advocates doing the resulting mixdown in the truck. To this end, he has equipped it with phasers and adt for reduction, the only notable features missing on the original. To get a better idea of what the final mix will sound like, he now uses a pair of small speakers mounted on top of the 32 track API desk. He claims this arrangement produces a mix with a well balanced sound without any 'booming', as might be expected. To make the point, he played a couple of tracks produced in this manner. The balance was fair and

would have seemed a lot better if it hadn't been subjectively bristling with inter-mod distortion from causes unknown.

The former pop star's (between 1958 and '62 he had 11 hits in South Africa) stated reasons for using the mobile in this manner appear to be for convenience. When Doug Hopkins was asked, he said he didn't really know and it would be better to have a word with the man himself. Micky, whose world-wide interests don't, at present, include a land-based studio, claimed it was to 'mix in my front garden'. Some front garden.

At the time of writing, the mobile is working at Shepperton Studios recording the musical sequences for the latest Ken Russell film *Liszt*, and has other bookings right through the summer with RCA to record some classical works in London. The future seems assured. How come the swift recovery? Micky says: 'it was losing money and now it's making money through the better contacts available'. But it still depends on the person behind the controls. The man does most of the in-house work himself. Does this make him a recording engineer? 'No, I'm a producer.' So, what's the difference between a producer and a recording engineer? 'About £50 000 a year.'

Which is . . . 1500 sq ft in area, acoustically isolated by flexible couplings, providing room for up to 60 musicians. Just like the Albert Hall; even down to the inverted acoustic mushrooms suspended from the ceiling. Everyone agreed that the new colour scheme of gentle autumnal olive and golds was a great improvement on the 'dingy blue' so described by one anonymous employee. Drummers haven't been left out; there are two isolation booths, each with its very own adjustable mushroom to vary the acoustic conditions.

Regarding hardware, the studio boasts a 32/24 Quad Eight desk featuring a quad configuration, full panning, full eq and voltage controlled faders enabling channels to be subgrouped while retaining the original routing for either a stereo or quad arrangement. Vertical led meters offer a choice of ppm or vu metering with the actual recording done on an MCI 24 or Scully 16 track.

Total cost of the conversion is about £200 000—which goes some way to explain the £43 an hour charge for the new multitrack studio.

NAME GAME

DO IT AGAIN. *Blood on the tracks* and fuzz on the master. Whatever the problem is, Bob Dylan recut five tracks on the new lp, almost on top of its release date. The retake, done at Sound 80, Minneapolis, has resulted in an album claimed by some critics to be the best thing he's ever done . . .

Meanwhile, home on the range, Marquee continue their freaky feminist feature with Polly Brown doing a long playing record for release on GTO with the help of producer Jerry Shury and engineer Geoff Calver. Geno Washington and producer Kaplan Kaye are using the same man and facilities to record a new single scheduled for release on the DJM label.

It must be some record since the work is shared with John Eden at DJM's own studio. John also reports an attack of vulgarity from John Wells. William Rushton et al during the recent work on the tasteful give-away *Private Eye* record. Other stars in attendance include Alan Blakley—founder-member/producer of the Tremeloes, Denny Laine and Graham Layden.

Frank Ogden



Above: The Most mobile

Below: Advision Studio One



SLURPO SLURPO

EVERYONE WAS AT the party. The man with the dark suit, gold tie-pin and expensive looking gut thinking about his casting couch; the young producer with the Ginger Group haircut, kojaks, made to order shoes and sylph-like admirers. Even a few tired superstars being very boring about Rick Wakeman. Right at the bottom, among the beer-soaked cigarette ends and dried-out Bacardis were the journalists, ad-men and assorted freeloaders. Why?

Advision have finished the work of updating their Gosfield Street recording complex. The first section to be completed was the 24 track Studio 2 mixdown suite, centred around the Quad Eight Compumix desk described in detail earlier (Feb 75, p12). Roger Cameron, Advision supremo, says that the facility has enjoyed full-time patronage since its commission at the beginning of the year and has similar expectations for the completely revamped studio 1.

before...

you buy another mixer, consider our new product range.

Illustrated below is the new MOD 2 modular. 15 x 8 with 16-track monitoring, and all the most up-to-date operational features. We also have a new P.A. desk, a repackaged minimixer system with 4-track capability, and intercom system ...

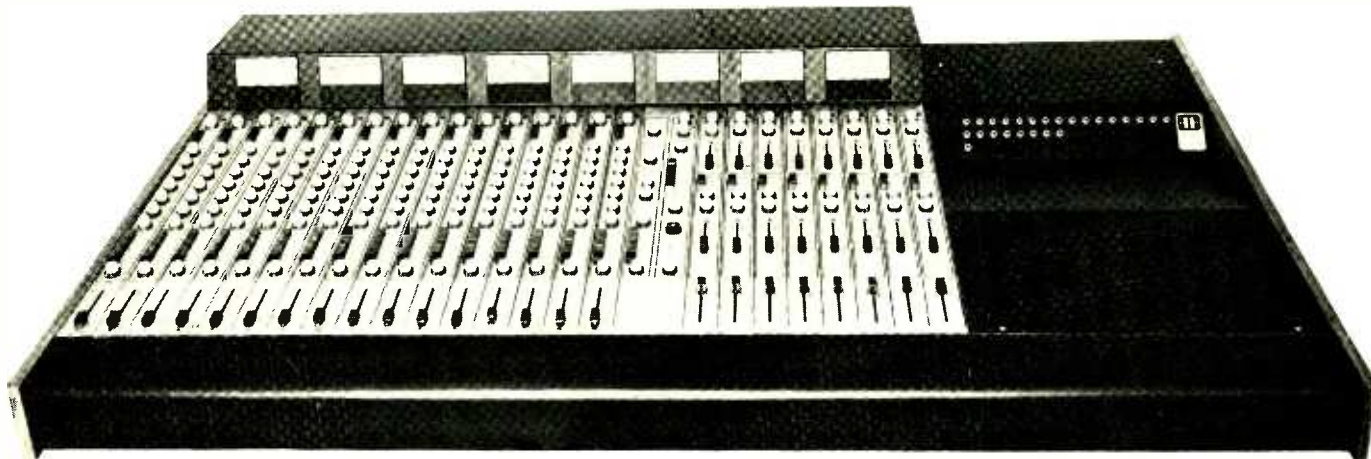

ALLEN & HEATH Ltd., Pembroke House, Campsbourne Rd., Hornsey, LONDON N.8. Tel : 01-340 3291 (10 lines)

STUDIO ACCESSORIES

WE SUPPLY HEADPHONE BOXES, MIC. BOXES, WALL BOXES, LEADS, SWITCHING BOXES, OR ANY SMALL CUSTOM BUILT BOXES TO ORDER.

WE SPECIALIZE IN SUPPLYING, SERVICING AND MODIFYING REVOXES.

We also supply mic. cable in 10 colours (ex-stock), and all other studio equipment. Including: Spondor, Neal, Alice, Quad AKG, Beyer and recording tape, Equipment hire.

RADIO RECORDINGS 01-586-0064

ONE INCH SCOTCH 206

(Ex master once used)

10½" NAB £9.50

QUARTER INCH SCOTCH 206

(Ex master once used)

10½" NAB £3.00

P & P 10p

AUDIO TRANSCRIPTIONS

177 Torridon Road, London SE6

01 697 0079



Great Sound...

The 4 kHz Horn is designed for use with the Vitavox acoustic damping compound, finished in hammer black paint, and with a heavy duty mounting bracket for wide dispersion of the upper audio frequencies. Mounted in the vertical position it gives a wide sound distribution in the horizontal plane. Made from heavy gauge steel, treated with

acoustic damping compound, finished in hammer black paint, and with a heavy duty mounting bracket to support the pressure unit weight—the 4 kHz Horn is geared throughout to meet the needs of BIG SOUND.

Please send me further information on your product range:

Name

Company

Address

V/IM/I

The 4 KHZ HORN



VITAVOX

Limited

Westmoreland Road

London NW9 9RJ

Telephone: 01-204 4234

Professional Studio Tape Recorders.

AEG-Telefunken

Second to none.

The rapidly rising cost of magnetic tape is inducing professional tape recordists to consider recording music at 7 1/2 i.p.s. instead of 15. For this purpose Telefunken Model M.12 is ideal because of its exceptionally good skew performance at 7 1/2 i.p.s., thereby offering excellent mono-stereo compatibility. Typical performance

figures for phase displacement between tracks are: $\pm 10^\circ$ at 10 kHz (speed 7 1/2 i.p.s.) *

Other notable features of this completely new tape recorder are:

Wow and flutter so low as to be almost unmeasurable, typically 0.015 % at 7 1/2 i.p.s.*

Very flat frequency response (typically

± 1 dB 20 Hz, to 20 kHz at 7 1/2 i.p.s. *).

Wear resistant tape guides of sintered ceramics. Ferrite heads of extreme density. Interchangeable plug-in electronic sub-assemblies accessible from the front.

Accurate timing counter resulting from tape tension control on both sides of capstan.

* As quoted in Studio Sound Product Review.

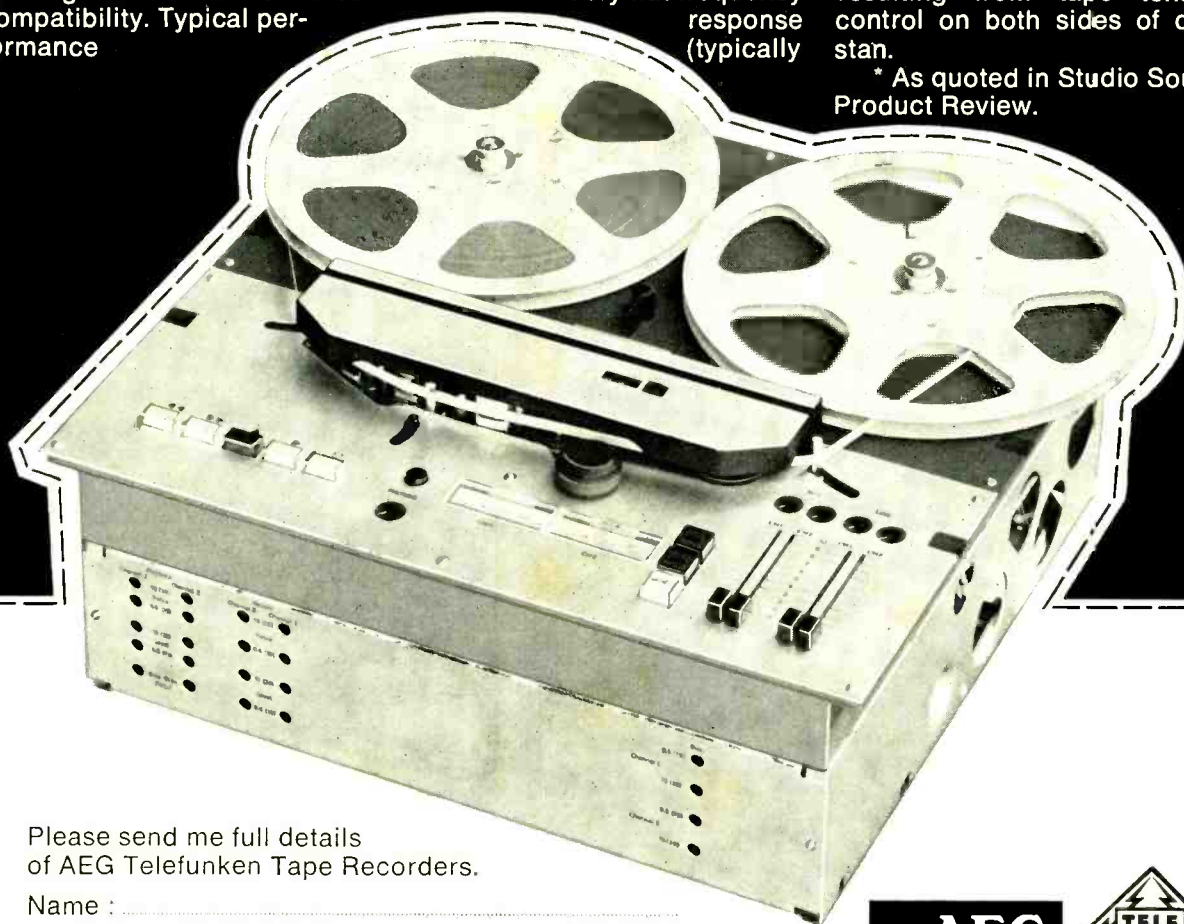

Please send me full details of AEG Telefunken Tape Recorders.

Name :

Address :

ST2



Hayden Laboratories Ltd., Hayden House, 17 Chesham Road
Amersham, Bucks, HP6 5AG - Telephone : (02403) 5511 - Telex : 83251

Young & Rubicam H.A.S

AMCRON AMPLIFIERS

STAND 6/7
APRS EXHIBITION
JUNE 19th/20th



0.60 the 100 watt amplifier

Two channel extra-compact power amp. In stereo—40 watts per channel at clip point into 8 ohms; 62 into 4 ohms; in mono, 100 watts into 8 ohms. At 30 watts per channel into 8 ohms power response is ± 1 dB from 5 to 30,000 Hz, THD is below 0.05% and hum and noise 106 dB below. Built-in protection against misuse. Input sensitivity 0.75V into 25 K ohms. Size 17in x 8 $\frac{1}{2}$ in x 1 $\frac{3}{4}$ in high.

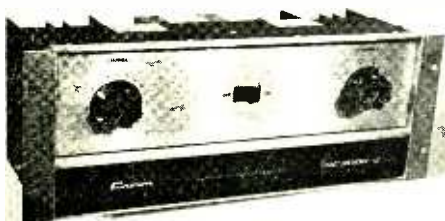

DC.300A the 1,000 watt amplifier

Power at clip point (per channel) 200 watts into 8 ohms: 350 watts into 4 ohms: 500 watts into 2.5 ohms. Used mono—greater than 650 watts into 8 or 4 ohms. This new unit will operate into loads as low as 1 ohm and no longer requires protection fuses as did its predecessor the DC 300. Power response ± 1 dB from zero to 20,000 Hz at 150 watts per channel into 8 ohms. Total harmonic distortion 0.02% at 300 watts per channel into 4 ohms. Hum and noise below 110 dB at 150 watts per channel into 8 ohms. IM distortion 0.05% from 0.01 watt to 150 watts per channel into 8 ohms. Input sensitivity 1.75V for 150 watts out per channel into 8 ohms. Size, with front panel, 19in x 7in x 9 $\frac{3}{4}$ in (suitable for standard rack mounting).

Amcron amplifiers carry a three years' warranty on materials and labour. Full descriptive leaflets gladly sent on application.



MAGINNES LABORATORIES LTD.

**MACINNES HOUSE, CARLTON PARK INDUSTRIAL ESTATE,
SAXMUNDHAM, SUFFOLK IP17 2NL
TEL: (0728) 2262 2615**

EXPOSURE
HI-FI

**RICHARDSON ROAD
HOVE BN3 8RB
SUSSEX Phone: 0273 777912**

PHASE LINEAR

AMP PEOPLE

Agents for **KLARK TEKNIK — MIDAS — QUAD**

IMPORT PRICES — TRADE — RETAIL — REPAIRS

Rycote

make
WINDSHIELDS
almost indestructible

for
Sennheiser 815, 415, 435. AKG 451-CK1, CK8, CK9

also shock mounts, swivels, pistol grips and covers

**RYCOTE, POOLHEAD LANE, TANWORTH-IN-ARDEN
WARWICKSHIRE B94 5EH Tel: EARLSWOOD 2339**

**KEEP IN TOUCH
WITH STUDIO SOUND**

25p

Place a regular order with your
Newsagent or take advantage of a
POST FREE Annual Subscription

Classified Advertisements

Advertisements for this section must be pre-paid. The rate is 10p per word, minimum 1.20p. Box Nos. 25p extra. Semi-display rates on application. Copy and remittance for advertisements in JULY 1975 issue must reach these offices by 15th MAY 1975 addressed to: The Advertisement Manager, Studio Sound, Link House, Dingwall Avenue, Croydon CR9 2TA.

NOTE: Advertisement copy must be clearly printed in block capitals or typewritten. Replies to Box Nos. should be addressed to the Advertisement Manager, Studio Sound, Link House, Dingwall Avenue, Croydon CR9 2TA, and the Box No. quoted on the outside of the envelope. The district after Box No. indicates its locality.

STUDIO FACILITIES

★**Fanfare Records.** Tape - disc pressings, demo's, masters, any quantity. Studio/mobile Neumann disc cutter. S.A.E. brochure. 1 Broomfield Close, Rydes Hill, Guildford. Tel. 0483 61684.

★**County recording service** stereo and mono masters and lacquer discs from your tapes. Telephone Bracknell 4935. London Road, Binfield, Bracknell, Berks.

★**J & B Recordings.** Tape to disc. 12in. L.P. £3.60. 7in. 45 rpm £1.50. E.P. £1.65. Pressings—stereo/mono. Tape Copying, 14 Willows Avenue, Morden, Surrey. 01-648 9952.

★**Anglia Pressing Company.** 7in. and 12in. pressings from your tapes, also Stereo/Mono masters and demo-discs. Neumann lathe. 112 Beach Road, Scratby, Great Yarmouth, Norfolk. Telephone 0493 730136.

★**Revox A77,** quad amps, AKG BX20 echo, mics, stands, etc., for hire. Radio recordings, 01-586 0064.

★**Sound News Productions.** Britain's oldest full-time Tape/Disc/Cassette transfer service. Direct transfers, pressings for private and for the trade. Fund-raising advisory service for societies, choirs, bands. 18 Blenheim Road, London W4. Tel. 995 1149.

★**For hire Revox A77 (HS+LS, NAB+CCIR, Vari-Pitch, Vari-Speed etc).** AKG. BX20 Quad 303, Revox A78, Spondor speakers, Teac four channel, mic stands, etc. Radio Recordings 01-586 0064.

Reel to reel
master copying.

PTO
54-58 Wardour Street
London W1
01-734 8765

RECORDS MADE TO ORDER

DEMO DISCS
MASTERS FOR
RECORD COMPANIES

VINYLLITE
PRESSINGS

Single discs, 1-20. Mono or Stereo, delivery 4 days from your tapes. Quantity runs 25 to 1,000 records PRESSED IN VINYLLITE IN OUR OWN PLANT. Delivery 3-4 weeks. Sleeves/Labels. Finest quality NEUMANN STEREO/Mono Lathes. We cut for many Studios UK/OVERSEAS. SAE list.

DEROY RECORDS
PO Box 3, Hawk Street, Carnforth, Lancs.
Tel. 2273

LOW BUDGET VIDEO SERVICES

Colour or Monochrome, Videocassette or reel/reel Videorecording/playback (in our studio or yours, or on location), copying, electronic editing, teletext transfers, etc. We also hire out and service equipment.

THE VIDEO UNIT
Studio 3, 3 Bridge Lane, London NW11
Tel: 01-435 0314

PEAK PROGRAM METERS TO BS4297

also 200KHz version for high speed copying:
Drive circuit, 35 x 80mm, for 1 ma L.H. zero meters to BBC ED 1477. Gold 8-way edge con supplied.
Complete kit £12. Built and aligned £17.
ERNEST TURNER PPM meters. Below scalings stocked
Type 642, 71 x 56mm £12.60; 643, 102 x 79mm £15.00
TWIN MOVEMENT, scale 86 x 54mm £37.00.



PUBLIC ADDRESS : SOUND REINFORCEMENT
In any public address system where the microphones and loudspeakers are in the same vicinity acoustic feedback (howl-round) occurs if the amplification exceeds a critical value. By shifting the audio spectrum fed to the speakers by a few Hertz the tendency to howling at room resonance frequencies is destroyed and an increase in gain of 6-8dB is possible before the onset of feedback.
SHIFTERS IN BOXES with overload LED, shift/bypass switch, BS4491 mains connector and housed in strong diecast boxes finished in attractive durable blue acrylic. Jack or XLR audio connectors.

Type	A	B	C
Input impedance	200Kohm	200Kohm	10Kohm Balanced
Output impedance	2Kohm	200r600ohm	20 or 600ohm BAL
PRICE	£58	£68	£84

SHIFTER CIRCUIT BOARDS FOR WW July 1973 article
Complete kit and board £24 Including p.s.u. and
Board built and aligned £31 mains transformer
DESIGNER APPROVED

SURREY ELECTRONICS

The Forge, Lucks Green, Cranleigh, Surrey GU6 7BG
(STD 04866) 5997
CASH WITH ORDER less 5% U.K. post free, add VAT

★**For Sound Communication** use our open reel and mono/stereo cassette copying service. A prospectus describing our other services is available on request. Sound Communication (Publishers) Ltd., Field House, Wellington Road, Dewsbury, West Yorkshire WF13 1HF. Tel. 0924 469436.

FOR SALE—TRADE

★**Nagra III and IV and SN models** available. Immediate delivery. Write or phone J. J. Francis (Wood Green) Ltd., Manwood House, Matching Green, Harlow, Essex. Tel. Matching 476.

★**Nagra Stereo IV's** £900; Nagra SLP £70; Nagra SLO £250; Nagra DH unit £70; Jensen 205s synchronizer £180; 2 Altec 686A Lavalier Mics £35; 2 RCA BK12A £60; 2 RCA BK6 £40; Beyer M100 £45; Beyer M130 £50; Beyer M110 £10; AKG D24 £30; AKG D25 £35; AKG C24 (stereo) £150; Electro Voice 10,001 £90; Electro Voice 624 £45; Levers Rich portable Model C (Professional) £55; Stereo Model Q £180. All goods subject to 8% V.A.T. J. J. Francis (W.G.) Ltd., Manwood House, Matching Green, Harlow, Essex CM17 0RS. Tel. Matching 476.

★**Audiofact No. 1!!** You can build 8 Cathedral Compliminters into your mixer for LESS than the cost of ONE medium competitor—and they perform. P.S. Ask about our Low Distortion Oscillator and Graphic Equaliser. S.a.e. details. Cathedral Sound, Fourways, Morris Lane, Halsall, Lancs L39 8SX. Tel. Halsall 840328.

SOWTER TRANSFORMERS

FOR SOUND RECORDING AND REPRODUCING EQUIPMENT
We are suppliers to many well-known companies, studios and broadcasting authorities and were established in 1941. Early deliveries. Competitive prices. Large or small quantities. Let us quote.
E. A. SOWTER LTD.
Transformer Manufacturers and Designers
7 Dedham Place, Fore Street, Ipswich IP4 1JP
Telephone 0473 52794

★**8 track mixer** with full E.Q., P.P.M.S. sync talkback foldback, 2 echo's, pre-fade mike line, three graphics, three power supplies, packfield oscillator, compressors, etc. £2000. Box No. 701.

OTARI MX 7000

1/4" Two Track Stereo Recorder in perfect condition.

OTARI MX 7000

1/4" Four Track Recorder both little used and in IMAC. condition. £1850.

Tel. 061-483 4684 or
FLEETWOOD 6095. Lancs.

RAC MIXERS

Custom-built mixers for groups, P.A., hospital broadcasting, recording, discos, etc. RAC plug-in audio modules for building your own mixers.

Sony, Akai, TEAC, Tandberg, Marantz, Lux, Nikko, Dual, Quad and Armstrong dealers. Shure, Calrec, AKG mikes and stands, etc. APRS Manufacturing members.

RUGBY AUTOMATION CONSULTANTS

19 Freemantle Road, Bilton, Rugby,
Warwickshire CV22 7HZ
Tel. 0788-810877 (Rugby)
Call, write or phone us

Audio Mixer Systems

SMALL or **BIG**
PARTRIDGE ELECTRONICS

21/25 Hart Road, Benfleet, Essex

FOR SALE—TRADE
(Continued)

Building Mixers?

zero88
AUDIO MODULES

offer high quality at competitive prices.
Contact Richard Brown at Zero 88
115 Hatfield Road, St. Albans, Herts.
AL1 4JS Tel: 63727

WANTED

★**Lee Electronics.** The Tape Recorder and Hi-Fi Specialists wish to purchase good quality Tape and Hi-Fi equipment for cash. 400 Edgware Road, W.2. Phone PAD 5521.

★**Owner** of small studio wishes to form partnership with a second person, preferably with good electronic knowledge and skill. Some capital required to expand into fully commercial studio. Box No. 699. (West Yorkshire).

★**BOARD** Canadian company in market for used 16in/4 sub/8 mon or 16in/8 out mixing console. Neve, Triad or other reputable equipment only. Contact Peter Alves, c/o Unison, 1310 Rue Lariviere, Montreal, Quebec, Canada. Phone area code 514, tel: 527 0559.

PROFESSIONAL STUDIO

requires Second-hand 2" 16 Track Tape Machine. All offers considered.

Phone 01-437 6255

DISC CUTTING AMPLIFIERS

WANTED
NEUMANN Type LV60

Valve Power Amplifiers with GV2a Feedback Amplifiers separately or in VG1 or VG2 rack or complete mono lathe.

Please reply to:

GERALD REYNOLDS

Hermes Development Company Ltd.,
38 Handsworth Wood Road,
Birmingham B20 2DS.
or phone 021-523 7307

PROFESSIONAL
RECORDING STUDIO

selling 8 Track and 4 Track machines with Desk Patch Bay and associated equipment at a very reasonable price.

Phone 01-437 6255

SITUATIONS WANTED

★**Chief Maintenance Engineer** with 24 track and automated mixdown experience, requires position in a progressive studio. Box No. 700.

SITUATIONS WANTED
(Continued)

★**Sound effects library** requires assistant librarian or trainee for small friendly company in W2 area. A.C.T.T. member preferred. Ring Peter Musgrave 01-727 9801.

FOR SALE—PRIVATE

★**Studio** plus business for sale, large area, good atmosphere. Just refitted **DOING** work. For full details Box No. 698.

SITUATIONS VACANT



PEIRIANNYDD RECORDIO

Gwahoddir ceisiadau am y swydd uchod, i fod i law erbyn Ebrill 23ain. Golyga'r swydd drafod peirianau mewn stiwdio 8-trac yn perthyn i Gwmni

Recordiau 'Sain', ger Caernarfon. Profiad mewn stiwdio recordio a gallu i gynnal a thrwsio'r offer yn fantais. Cyflog yn ôl profiad a chymwysterau. Ceisiadau, yn nodi oedran a chymwysterau, i:

SAIN (Recordiau)

Cyf., Ffordd Llanllyfni, Penygroes, Caernarfon, Gwynedd. (Penygroes
STD 028-618 732)

Dubbing
Engineer

Rediffusion Reditune Limited, the world's leading music service, requires a Dubbing Engineer with a minimum of 2 years' experience in the professional recording world.

He must be familiar with professional two and four track desks and machines, and have a working knowledge of compression and equalisation. Understanding of music would be useful.

He will need to fit in with a small group of people working in a busy dubbing studio complex at Orpington.

Salary negotiable around £2000 pa with usual holiday and sickness benefits. Holiday arrangements will be honoured.

For an interview, please write or telephone the Personnel Manager, Rediffusion Reditune Limited, Cray Avenue, Orpington, Kent, Telephone Orpington 32121.



REDIFFUSION
REDITUNE

CLASSIFIED ADVERTISEMENTS ORDER FORM

Please use this coupon for your private sales and wants. Rates 10p per word Box Nos. 25p extra.

To: Studio Sound, Classified Advertisements Dept., Link House, Dingwall Avenue, Croydon CR9 2TA. Please publish the advertisement indicated below below for insertion/s under the heading.....

Name
Address

Cheque/P.O. enclosed £
Is a Box No. required Yes/No. If no,
please include remittance to cover
name and address and/or Tel. No.
Please write in block capitals.

Link House Publications Ltd., Registered in England, No. 96948.
Registered Office: 10/12 South Crescent, Store Street, London WC1E 7BG.

GENERAL MANAGER (Marketing)

PROFESSIONAL PUBLIC ADDRESS (AUDIO RELAY SYSTEM)

A subsidiary of a major public company has recently diversified into the installation of custom designed Public Address Systems. Customers include factories, hotels, clubs and stores, etc.

Although current turnover is small the main board is ready to make considerable funds available to finance an aggressive growth programme.

The successful applicant must have had at least 5 years continuous experience in the industry with wide knowledge of the proposed equipment/supply and installation/marketing. This is an opportunity for a self starter with talent that matches ambition. A salary in excess of £5,000 p.a. is envisaged plus Company car.

Please apply in confidence quoting reference number. Should there be any company to whom you do not wish your application forwarded please advise in a separate letter.

pr

Pike Russell and Associates
Ref. CSD 367,
St. Vedast House, 150 Cheapside,
London EC3.

FOR SALE—PRIVATE (Continued)

★**Ten different colours** of 14/.0076 x 2 braided mic cable in stock. 45in. spring tensioned mic arm, 3/8in. thread for stand adaptors, designed for D202 etc. Heavier springs for Neumann mics. Radio Recordings 01-586 0064.

★**Exposure Hi-Fi** are selling their unique dual-driver Lockwood 'Majestic' monitors. Only pair, drive units are new H.P.D. Tannoys. Original Price over £1000 each. Will accept £600 pair.

★**Otari MX 7000** 1/2in. two track stereo recorder in perfect condition. Otari MX 7000 3/4in. four track recorder both little used and in immaculate condition. £1850. Tel. 061-483 4684 or Fleetwood 6095 Lincs.

EMI BTR2 RECORDER

Excellent condition. Recent new headblock.

Phone 0782-610679

★**EMI RE301C** 15/7 1/2 professional transportable stereo recorder. Exceptional wooden custom case. Spare heads and amplifiers. Other extras, £145. Offers considered. Tel. Melton Mowbray 822586.

★**STC 4038** ribbon microphones. Pair with stereo cradle, fittings and cases £95 complete. Offers considered. Tel. Melton Mowbray 822586.

★**STC 4033a** omni/cardioid/figure-of-eight adjustable microphone, £30. Tel. Melton Mowbray 822586.

★**Mordaunt-Short** loudspeakers, 4 x Model 737, ex-demonstration, £75 each, o.n.o. Tel. 0734 690177.

★**Mobile 12** into 4 desk brand new, custom built. All facilities and no expense spared in manufacture. Not in semi-prof. class. £1800. Genuine enquiries only to Box No. 697.

★**Revox HS77 1102** 19 and 38cm/s with Selsync, excellent condition, little used, £300. Tel. 0392 33577 after 6 p.m.

★**PR JBL L99** monitor speakers, 24in. x 14in. x 12in. £190 (cost £300 plus). Tel. 01-435 0532.

★**ITA 10** channel, 4 group mixer, current model used only once £495. Tel. Crewkerne 3993 day or South Petherton 40335 evening.

INDEX TO ADVERTISERS

Acoustical Manufacturing Co. Ltd. 15	Hayden Laboratories (Telefunken) 62	Raindirk Ltd. 10
Alice (Stancoil) Ltd. 8	Industrial Tape Applications 4, 5, 6, 7	Reynolds, Gerald 65
Allen & Heath 61	Icelectrics Ltd. 8	Revox 68
Allotrope Ltd. 51	Klark Teknik Ltd. 24	R.E.W. Audio Visual Ltd. 49
A.P.R.S. 9	K.L.H. Webland 37	Rycote 63
Audio Design Recording 14	Lee Engineering 10	Rugby Automation Consultants 53
Audio Developments 59	Lexicon 17	Sansui (Vernitron Ltd.) 57
Baileys 53	Macinnes Labs Ltd. 63	Scenic Sounds Equipment 6
B.A.S.F. 19	Magnegraph Rec. Co. 53	Sescom 12
Bauch, F. W. O., Ltd. 33	Midas Amplification 47	Shure Electronics Ltd. 29
Bias Electronics Ltd. 14	M.S.R. Electronics Ltd. 28	Sound Maintenance (Audio Transcriptions) 61
Cadac (London) Ltd. 2	Mustang Communications 47	Surrey Electronics 46, 58
Camel Recording 64	Naim Audio Ltd. 59	Tannoy 12
E.M.T.-Franz Vertriebsgesellschaft 13	Neve, Rupert, & Co. Ltd. 21	Taylor Hutchinson Ltd. 59
Exposure Hi-Fi 63	Ortofon 27	Trad 47
Feldon Audio Ltd. 7	Penny & Giles 53	Turner Electronic Industries Ltd. 12
Ferroglyph Prof. Rec. Co. 11	Radio Recordings 61	Tweed Audio Electronics 14
Future Film Developments 25		Vitavox Ltd. 61
Grampian Reproducers Ltd. 6		

A revolution in the recording industry

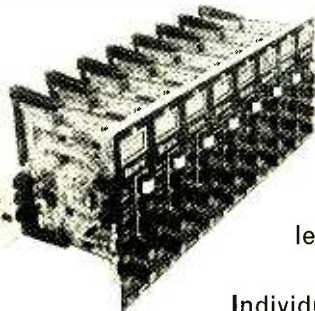

Fully modular electronics using plug-in PCB's throughout. Separate sync and replay amps give identical levels. Switchable VU's with slow decay.

Individual oscillator for each channel. Dolby A switching facility. Comprehensive facilities include sync on all

channels, servo controlled capstan, modular electronics, variable speed (optional), relay-solenoid operation.

Compact console presentation for easy portability.

£1790 + VAT. Full console optional extra.

Compatible 8-output Mixer available £1260 + VAT.



itam

Industrial Tape Applications, 5 Pratt Street, London NW1 0AE. Tel: 01-485 6162/7833. Telex: 21879.

IF YOU DO ANYTHING WITH 1/4" TAPE, YOU CAN DO IT BETTER WITH REVOX.

- Automated broadcast operations
- Scientific analysis
- On location mastering
- Tone or time changing
- Audio tape quality control
- Electronic music synthesis
- Noise analysis
- Film synchronization
- Radio telescoping
- Language laboratory
- Machine tool control
- Phonetic analysis
- Radio telemetry
- Industrial research
- Information retrieval
- Electrocardiography
- Making calibration tapes
- Tape mastering with SELFSYNC
- Data storage from digital computers

And that's a simple statement of fact.

From the moment it was introduced, the Revox A77 was hailed as a recording instrument of unique quality and outstanding performance. The magazines were unanimous in their praise. Stereo Review summed it all up by saying, "We have never seen a recorder that could match the performance of the Revox A77 in all respects, and very few that even come close."

So much for critical opinion.

Of equal significance, is the fact that the Revox A77 rapidly found its way into many professional recording studios.

But what really fascinates us, is that the A77 has been singled out to

perform some unusual and highly prestigious jobs in government and industry. The kinds of jobs that require a high order of accuracy and extreme reliability.

Take NATO (the North Atlantic Treaty Organization) for example. When they wanted a machine to standardize on, a machine that would lend itself to use in a wide variety of circumstances. And most importantly, a machine that was simple to use, the logical choice was the Revox A77.

Or take the governmental agency that wanted an unfailingly reliable tape machine to register and record satellite beeps. The choice? Revox.

Or the medical centers that use

specially adapted A77's for electrocardiographic recording.

We could go on and on (see accompanying list), but by now you probably get the point.

No other 1/4" tape machine combines the multi-functioned practicability, unfailing reliability, and outstanding performance of a Revox.

If you have a special recording problem that involves the use of 1/4" tape, write to us. We'll be happy to help you with it.

And if all you want is the best and most versatile recorder for home use, we'll be glad to tell you more about that too.



**REVOX
DELIVERS
WHAT ALL
THE REST
ONLY PROMISE.**

Revox at Lamb House, Church Street, Chiswick, London W4 2PB

Revox Corporation in USA: 155 Michael Drive, Syosset, NY 11791 and 3637 Cahuenga Boulevard West, Hollywood, California 90068

Revox Sales and Service in Canada.

For other countries: Revox International, Regensdorf 8105 ZH Althardstrasse 146, Switzerland