

September 1986

£1.50

STUDIO SOUND

AND BROADCAST ENGINEERING

A LINK HOUSE PUBLICATION



MIXING CONSOLES

Designed to give your studio an unfair advantage.



All top studios need an edge.
Like the revolutionary Saturn multitrack with
'Total Remote' control.

The most advanced multitrack of its kind
today, allying the new purity of analogue audio
to the precision of digital control.

Similarly, unrivalled ergonomics and sonic
transparency place the TS24 console in a class of
its own.

Both are designed to give the exceptional
operating flexibility that comes as standard from
Soundcraft.

Saturn. Total Remote. And the TS24. Classic
technology, created for music.

For further information, contact us today.

Soundcraft

STUDIO SERIES

Soundcraft Electronics Ltd, Unit 2, Borehamwood Ind. Park, Rowley Lane, Borehamwood, Herts
WD6 5PZ, England. Tel: 01 207 5050. Tlx: 21198 (SCRAFT G). Fax: 01 207 0194.

Soundcraft USA (818) 893 4351. Soundcraft Canada (514) 685 1610. Soundcraft Japan (03) 341 6201.

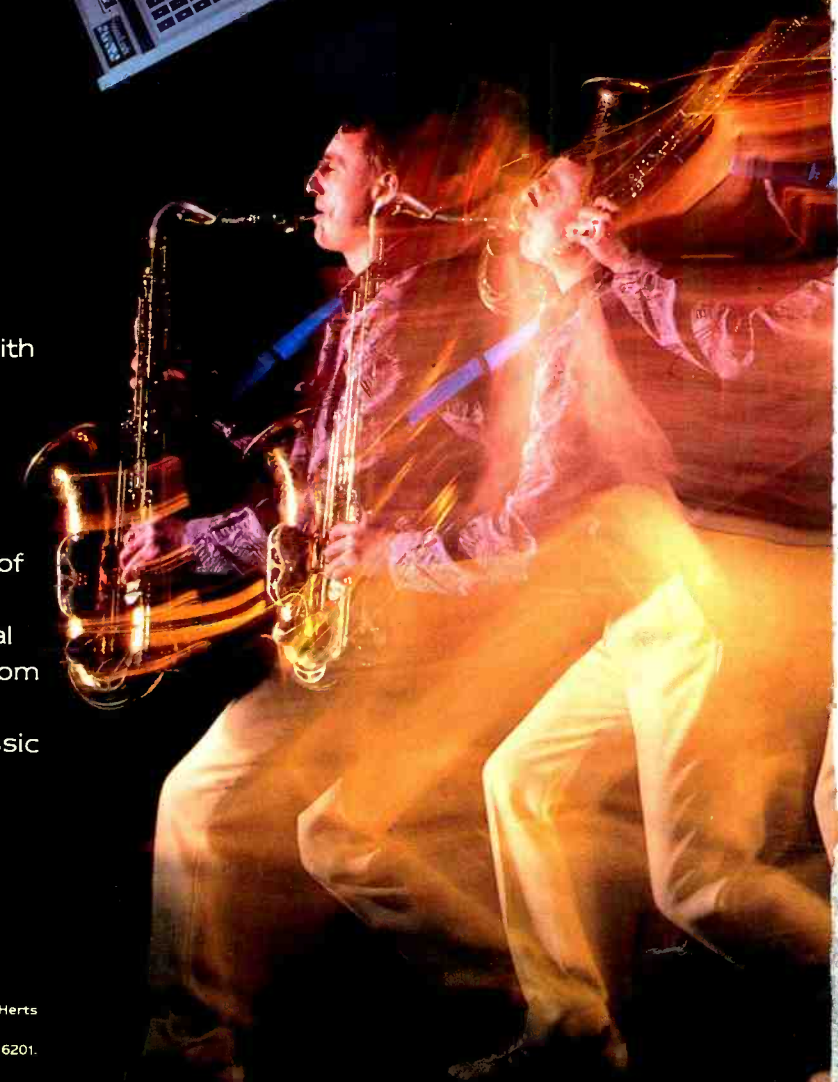

STUDIO SOUND

AND BROADCAST ENGINEERING

REGULARS

- 5** Editorial: Keith Spencer-Allen ponders the future of mixing console design



- 20** Diary: Digital Information Exchange—Akai acquires Linn—Corrections—Address changes—Agencies—Soundtracs goes public—People—Forthcoming events—Contracts—US Monitor Awards go international—Thames Madness
- 28** New products: Rebis RA701 noise gate—Fern EF8 digital filter—Merlin ME-318 VISA system—JBL monitor range—Invotron S256V switcher—Furman PL-Plus and RV-3 digital reverb—RCF 6000 nearfield monitor—In brief
- 32** Music page: Rosetti keyboard stands—Oberheim synthesiser—Roland JX-10. By Mark Jenkins
- 44** Studiofile: Trans/Audio, New York—Sound Studio Athens
- 68** Business: Copyright reform—CD pressing—Not so Live Aid? By Barry Fox

SPECIAL FEATURE

- 36** Mixing consoles: A summary of consoles introduced since our last round up

FEATURES

- 34** In perspective: US columnist Martin Polon on standardisation for digital audio
- 54** Noise reduction and directional microphones: Michael Gayford discusses mic techniques in live situations
- 62** It's only on the monitor: Peter Orr, producer for Argo specialists in the spoken word, recounts some of his experiences

REVIEWS

- 70** Citronic PPX 900: A technical power amplifier report by Hugh Ford

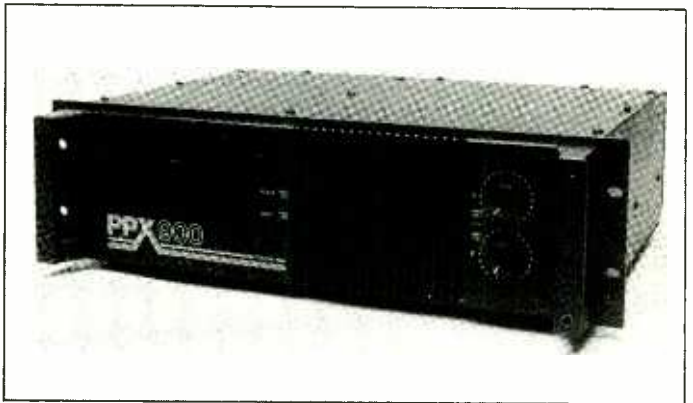

- 78** Akai S900: A disk driven sound sampling unit looked at by Mark Jenkins
- 80** Neotek Elite: A mixing console user report by Keith Spencer-Allen
- 84** Neve V series: A mixing console user report by Keith Spencer-Allen

EDITORIAL

Editor:
Keith Spencer-Allen
Deputy Editor:
Carl Anthony Snape
Production Editor:
Ann Horan
Production Assistant:
Beverley Hudec
Consultant:
Hugh Ford
US Commentator:
Martin Polon
Secretary:
Carrie Love

ADVERTISEMENTS

Sales Manager:
Mark Walsh
Secretary:
Kate Ross
Production Manager:
Jacky Thompson
Japan and Far East Agent:
Media Sales Japan Inc, Tamuracho
Bldg 3 3 14, Shimbashi Minato-Ku
Tokyo, Japan
USA Agent: Joe Statuto, Rt 1, Box
40A, Montague, TX 76251, USA.
Tel: (817) 894-6923.

COMMERCIAL MANAGER
Phil Guy

Cover: Harrison series 10



Editorial and advertising offices:
LINK HOUSE, DINGWALL
AVENUE, CROYDON CR9 2TA,
GREAT BRITAIN
Phone: 01-686 2599
International: +44 1 686 2599
Telex: 947709
E-mail: 78:DGS1071
IMC: STUDIOSOUND—UK
Fax: 01-760 0973
© Link House Publications
PLC 1986. All rights reserved.



A LINK HOUSE
PUBLICATION

Publisher and consultant to
APRS for Studio Sound's
Producer's Guide to APRS
Members 1984/85
September 1986 Number 9
Volume 28 ISSN 0133-5944

■
**If it's a demo
or a digital album**
■

**MUSIC
LAB HIRE**

Leading the way



76 EVERS HOLT STREET, LONDON NW1 1BY. TEL: 01-387 9356 24 HRS

EDITORIAL

EDITORIAL

This month's comment from Keith Spencer-Allen

Into the mystic

I make no apologies for returning to the subject of mixing consoles. The recent APRS exhibition (at the time of writing) highlighted the diversity of console types that are near available and further justified our conviction, stated in the December 1985 issue, that with console specifications becoming broadly equal, the major difference between console designs will be the philosophy of the manufacturer. Recent articles such as those on the Amek *APC 1000* and the Trident *DI-AN* have shown two very different approaches while forthcoming features will show many others. Whereas last year we were only able to say that in the near future you will have to choose a console that meets your own philosophy of working, that reality has now arrived.

Whatever feelings we may have about different console styles, there is one topic that is gradually becoming predominant and that is size. Some manufacturers such as Amek, SSL, SAJE and Neve, had addressed the problem within current products so that increasing channel quantities do not lead to unworkable large consoles. The catch is, however, that most of these 'compact' consoles were developed for areas outside straight music recording even if they are now or will be capable of multitrack usage. The non-recording studio user is far more ready to accept the compact console than his colleagues in the recording studio. If there is one instantly recognisable advantage in digital control of analogue or digital audio signal paths then it must be the ability to separate control surfaces from the audio components and therefore allow a vast reduction in size at the user interface in comparison to a fully analogue or non-assignable digital console.

There are, of course, certain practical reasons that have encouraged non-recording studio users to accept size reduction—often as a result of the lowly station that audio has occupied until recently in such areas as TV and theatre where the smallest room after the toilet was the audio control room. Also largely this type of facility does not have to sell time.

There is undeniably something very attractive about a large console. There are probably so many deep psychological reasons for studio personnel feeling happier

sitting behind a large console rather than a small one that I will leave such conjecture up to yourselves. There is also something very attractive about a large console even if it is assignable and doesn't have a million knobs. Large consoles undoubtedly sell studio time and this has to be an overriding factor. The lap top mixing console is not currently a commercial practicality for the recording studio even if most mixing console manufacturers will quite readily admit that this is the logical path for their products.

So following on from the current spread of console choice, the next development would seem to be a reduction in size. The manufacturers may hold this view but are equally aware that you cannot rush adoption of the necessary 'sacrifices' this would require of the engineer such as the loss of one fader per channel on a fixed basis. Almost all the manufacturers active in digital control have been heard to say that their consoles could be physically smaller but that there is no demand from the studios for such size reduction. Without a doubt operational changes will be necessary to realise the full potential of the 'next step'.

So what situation do we have? Firstly there is the inevitable technological size reduction capability which the manufacturers would all welcome although will only half implement until the studios accept the concept. The studios will not accept such a concept as it would change working practices such as 'many hands' operation and the sacrifice of the static desk facilities. And perhaps more importantly, it would be very much more difficult to sell an increased studio rate for a physically smaller console.

I believe though that most studios would welcome the facilities such a 'future' console could bring. So for the moment we just wait until the market is ready on all sides for a real change and perhaps by that time our colleagues in the non studio recording facilities will have debugged the future consoles for us. From the recording side the only disadvantage to such a scenario would be that equally they would therefore have more say in the console of the future. As our disciplines are somewhat different this may be detrimental to the recording studio. There is however, I feel, no alternative at this point in time until the studio industry has resolved its Catch 22.

STUDIO SOUND

AND BROADCAST ENGINEERING

STUDIO SOUND is published on the second Friday of the preceding month. The magazine is available

on a rigidly controlled requested basis only to qualified personnel (see back page for terms) or for an annual cost of £18.00 UK, \$40 US surface mail, \$75 US airmail, £24.50 overseas surface mail or £46.50 overseas airmail to non-qualifying readers or where more than two copies are required in a studio or small organisation. New subscription enquiries should be sent to the Croydon address on page 3. All other enquiries should

be made to **Studio Sound Subscriptions, Link House Magazines Ltd, Central House, 27 Park Street, Croydon CR0 1YD. Tel: 01-760 0054.**

US mailing agents: Postmaster please send address corrections to Studio Sound, c/o Expeditors of the Printed Word Ltd, 515 Madison Avenue, New York, NY 10022.

Total average net circulation of 14,240 per issue during 1985 UK: 6,335. Overseas: 7,905. (ABC audited).

Studio Sound and Broadcast Engineering incorporates Sound International and Beat Instrumental. Printed in England.





At Hilton Sound, we're ready to do battle with the roughest conditions to get the best in audio equipment to people who can appreciate service out of the ordinary.

Even to the hell of the French Riviera in July. The brave lads at Hilton didn't flinch when stout hearted volunteers were needed to truck a cargo of digital audio recording gear down to Jacques Loussier's Miraval Studios in le Val.

If Spandau Ballet want the best in audio equipment in the far wastes of the Côte d'Azur then who are we to complain? Must be downhill all the way to the South of France though,

because the lads seemed to take a lot longer getting back than they did going. Seriously though, the odd glass of Chateau Miraval beside the studio pool was well earned R & R after breaking our own records delivering and troubleshooting the installation.

That's the philosophy Hilton Sound's reputation is built on. Delivering the best service and equipment to our clients. Whenever,

whatever and whenever they want it. We could do the same for you. Ring Andy at Hilton Sound and find out how we can make your life easier, no matter where you want to send us

**HILTON
SOUND**

No. **1** for **Mitsubishi**

10 Steedman Street London SE17
Telephone: 01-708 0483.
EMAIL REF: HILTON-SOUND-UK.
DGS 1311. FAX NO. 01-703 0774.

BRAIN CHILD



Yes, the MA 6 is a conceptual breakthrough of magnanimous proportions. Yes, the MA 6 is eons ahead of any other amplifier configuration. And yes, when the brains at Rane came up with it they had to take the rest of the afternoon off to recuperate.

The MA 6 is the first and only dedicated 6-channel amplifier. And presents an entirely new way of looking at the system amplifier approach.

Those used to a two channel will find this degree of flexibility amazing. It can act as a monitor amp for up to six separate channels of stage monitor mixing. Or drive a stereo pair of two-way speaker

systems bi-amped with two bridged pairs of 300 watts for the low end, and two 100-watt channels for the high end, with limiter drive protection. Or run three bi-amped monitors at 100 watts each section. Or three passive monitors at 300 watts.

A single MA 6 does it with less size. With less weight.

**RIGHT
AS
RANE**

Once you see this baby, you'll want to start a family of your own. Rane Corporation, 6510 216th Southwest, Mountlake Terrace, WA 98043. 206/774-7309. **RANE**

UK Distributor:

Music Lab Sales, 72-74 Eversholt Street, London NW1 1BY. Tel: 01-388 5392 Telex 28159

HARDWARE HOUSE



As UK distributors for Nady radio systems and Countryman microphones, we brought together two products which between them can produce the high dynamic range and audio quality essential for live performance.

To find out more about these and our full range of technical and engineering services and equipment rental, phone us on:

01-986 6111

Hardware House (Sound) Limited
West Works, Chalgrove Road, Morning Lane, London E9 6PB



UK distributors for
Nady radio systems and Countryman microphones
Dealers for
AMEK/TAC (live performance), Amcron, Court, JBL



drake

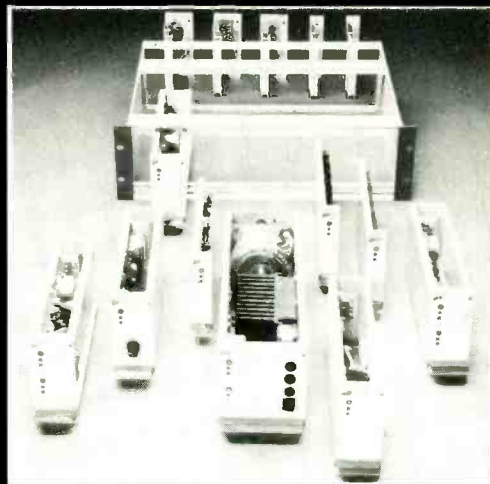

7000 Series Audio Models

- PD 7010 Variable Frequency Oscillator
- PD 7015 V.C. Distribution Amp.
- PD 7011 Dual-line Sending Amp.
- PD 7012 Dual Distribution Amp.
- PD 7061 8 x 1 Switcher
- PD 7017 Microphone Amp.
- PD 7024 1 x 10 Distribution Amp.
- PD 7060 6 into 1 Mixer Amp.
- PD 7032 50 Watt Power Amp.
- PD 7002 Power Supply

FFD FUTURE FILM DEVELOPMENTS

P.O. Box 3DG, 114 Wardour Street, London W1A 3DG, England.
Telephone: 01-434 3344 & 01-437 1892. Telex: 21624 ALOFFD G.
Cables: Allotrope-London W1.

NORTHERN AUDIO

PROFESSIONAL STUDIO EQUIPMENT SECONDHAND PRODUCTS

Neve 8128 48 frame fitted (new console available now)	P.O.A.	EMT 140 plate V/S model with remote	£1,500
Neve 8128 28-24-24 with 4 reverberation channels two years old in very good clean condition, available July '86	£47,500	JBL 4430 monitors, 6 months old in good order	£1,500
SSL 40 frame with 32 fitted, plus 2 stereo channels, this frame has total recall and computer with patchbay on the right	£93,500	JBL 4435 monitors, 2 years old in good order	£2,350
Neve V range 60 input frame, fitted the same, available Oct. '86	P.O.A.	Yamaha NS 10, in stock now	£204
Neve Necam 96 and software for the above console	P.O.A.	Yamaha NS 1000 monitors, 12 months old in good shape	£595
Helios 32-24-24 raparound console with VCA faders	£12,500	Tannoy DTM 8 monitors in stock	£275
Soundcraft TS 24 console, 15 months old in good condition	£23,500	Tannoy Stratfords, used	£95
MCI 636C 32-24-24 with JH50 automation	£23,500	Bose 301 monitors	£220
Otari MTR 90 Mk2 with Mk2 remote and autolocate	£15,500	Technics cassette decks, two off new	each £75
Otari MX 50-50 8-track Mk2 in good condition	£1,200	Psionics 4 way gate, as new	£275
Otari MTR 12 1/4 inch master, two years old	£3,450	20U high steel 19 in rack	£50
Studer A80 RC stereo master (NEW), ex demo	£7,500	BEL stereo noise reduction	£70
Soundcraft S20 1/4 inch master on stand, 1 year old	£3,500	Vestafire comp/lim, ex demo	£185
MCI JH116 24-track recorder with remote/autolocate	£10,500	Quad 405/2 power amp, ex demo	£185
Studer A800 Mk3 with autolocate and remote (NEW)	P.O.A.		
Studer A800 Mk1A 6/7 years old with new headblock remote/autolocator	£19,500	NEW PRODUCTS IN STOCK	
Trident TRS 24 24-track recorder, 3 years old	£9,500	Soundcraft consoles 200, 400, 500, 600 and the new 8000 series.	
AMS 1580 DDL in flight case, two years old	£2,750	Sennheiser, Shure, Beyer, Neumann and AKG, AMS Drawmer, Quad, Neve, BEL, Tannoy, Bose, Soundcraft AMPS.	
AMS RMX 16 reverb, ex demo	£4,000		
Eventide 949 harmonizer, 12 months old	£1,500		
Lexicon 224 with 4.4 seconds (no lark)	£4,995		
Lexicon 200 reverb, nice one	£1,950		
Fairchild comp/lim in packing case in mint condition	£2,500		

NOTICE

We also act for studios as selling agents, let us handle the hassle of getting rid of unwanted items, it does not matter where you are in the world, why not drop us a line listing your equipment or ring us on the numbers below for the best rates. We assure you of our best attention and service plus the utmost confidentiality of all times.

WANTED urgently SSL4040 consoles up to 2 years old with total recall. Customers waiting.

WE ARE CONSTANTLY ON THE LOOKOUT FOR USED EQUIPMENT. PLEASE GIVE US A RING.
RING TONY BAYLEY ON 061-483 9563/4299 *anytime* or WRITE TO US AT:
4 CHEVIOT ROAD, HAZEL GROVE, STOCKPORT, CHESHIRE SK7 5BH

Tel: 061-483 9563/4299

TELEX 666597 NAUDIOG

So you thought Shure only made vocal mics

SHURE 520D HARMONICA

The legendary 520D CONTROLLED MAGNETIC® "Green Bullet" microphone is world-renowned. It features a controlled low-end frequency response which reduces "bassiness" and delivers the "gritty" sound and response harmonica players want. Its size, weight and styling make it an exceptional choice

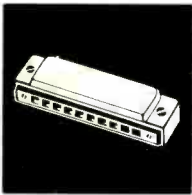

for performers who want freedom to move about the stage and still be heard.



SHURE SM98 DRUMS AND BRASS

The SM98 utilizes a high performance, low noise, low distortion preamp, allowing it to be used for close miking of drums, brass instruments, and other high SPL sources without danger of overload problems. Extremely smooth frequency response for accurate, faithful reproduction of acoustic instruments and near



perfect cardioid polar pattern at all frequencies for superior source isolation.



SHURE SM10A/12A/14A HEADSET

The hands-free operation drummers and keyboard players demand. The noise-reducing cartridge in the SM10A, SM12A and SM14A gives you high output for punch in live vocal situations, and a crisp, clean, balanced midrange. In addition, these microphones reject background noise and minimise leakage from other sound sources on stage. The microphone in each model is unidirectional and close talking.



SHURE SM94 GENERAL INSTRUMENTS

The SM94 is an excellent instrumentalist's microphone with performance that compares favourably to many more expensive studio units. Flat frequency response with no troublesome "spikes" or "icicles", very uniform cardioid pattern does not "collapse" at high frequencies for highly controlled off-axis performance,



internal battery takes over if Simplex power fails, low handling noise.



SHURE SM91 BOUNDARY EFFECTS

The SM91 is a surface-mounted permanently biased condenser microphone with a half-cardioid directional pattern. Because of this unidirectional pattern, the SM91 discriminates against sounds originating from the rear and permits the microphone to operate with much less reverberant pickup and muddiness

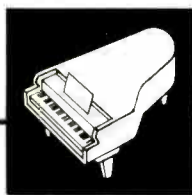

than omnidirectional models. Applications include piano, stage work and conferencing.

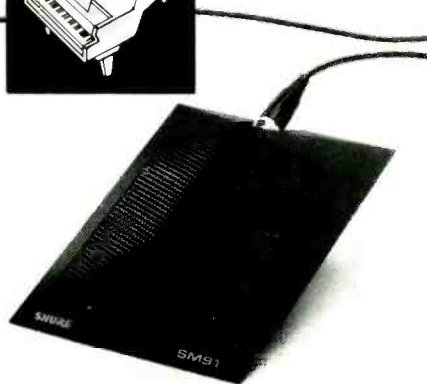

SHURE SM57 GENERAL INSTRUMENTS

Offering wide range reproduction of music and voice, this dynamic microphone features an exceptionally uniform and effective unidirectional pickup pattern. The performance characteristics and unique construction make it ideal for both studio and remote use. The SM57's mid-range presence peak and good low-frequency

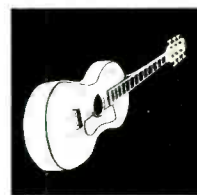

response make it an ideal microphone for use with a wide variety of instruments.



SHURE®

HW International, 3-5 Eden Grove, London N7 8EQ. Tel: 01-607 2717

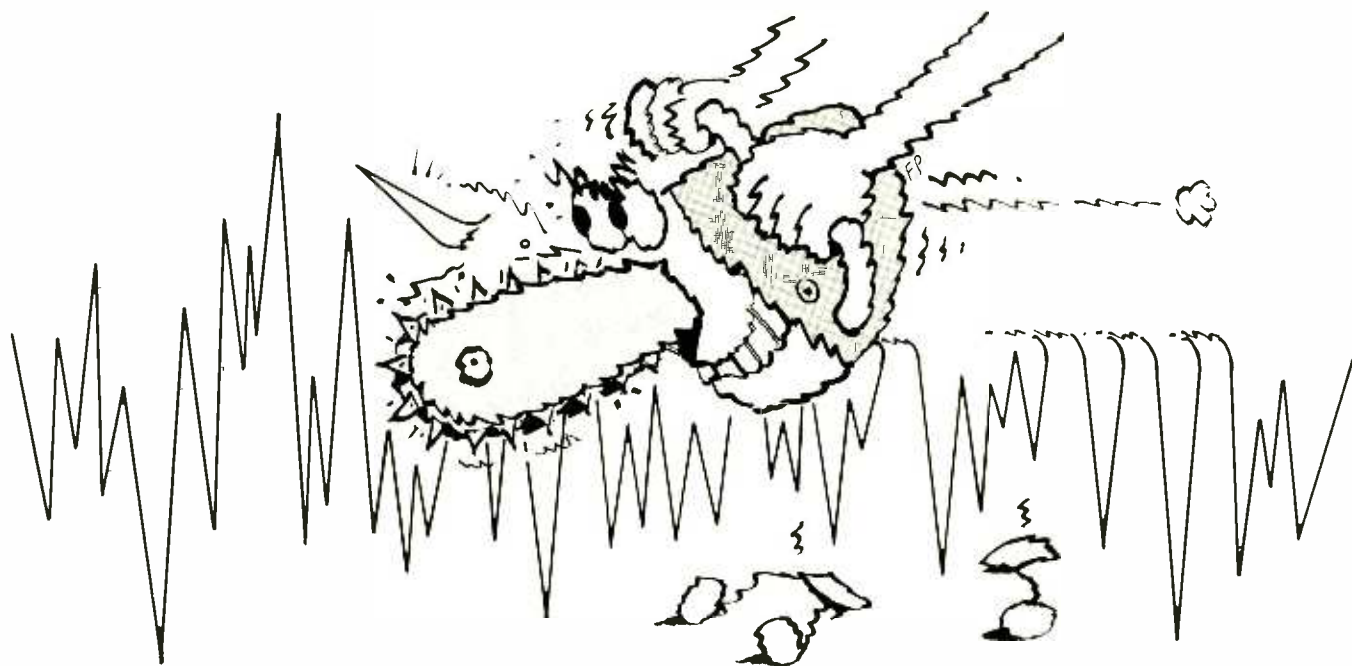

DOES YOUR LIMITER MASSACRE YOUR SOUND?

Most limiters are far from perfect...literally chopping up your sound. The new Aphex Dominator™ is the perfect solution.

Unlike dumb, over-threshold devices, the Dominator is an intelligent 3-band limiter with a proprietary circuit which varies the threshold for limiting. The result is an *absolute* peak ceiling while maintaining a transparent sound. Selectable crossover frequencies, plus high and low frequency drive controls allow creative flexibility.

You can run hotter levels to maximize signal-to-noise levels without fear of overloading your recording or transfer mediums.

The Dominator is ideal for *any* situation where clipping is a problem, such as digital audio, disc mastering, video post production and film. Stop massacring your sound. Ask your audio professional for a free trial of the Aphex Dominator. Once you've heard it, you'll never be satisfied with your old limiters.

- Provides Absolute Peak Ceiling.
- Total transparency below processing threshold.
- Increased loudness
- Freedom from spectral gain intermodulation
- Minimal loss of transient feel
- High density capability
- Flexible—easy to use
- Multiple applications
- Made in U.S.A.

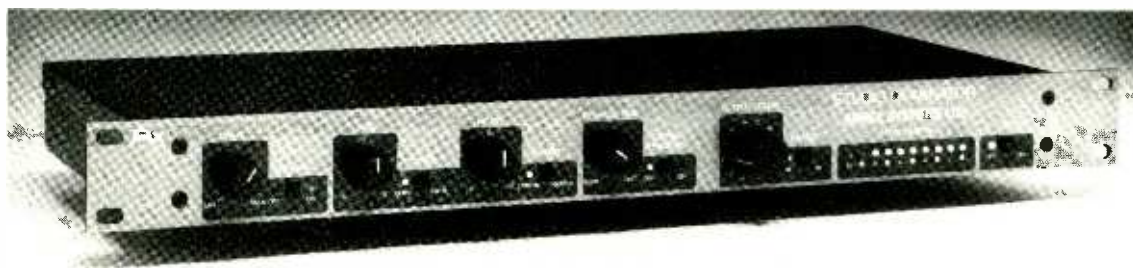

Aphex Systems Ltd.

13340 Saticoy Street • North Hollywood, Ca 91605 • (818) 765-2212 • TWX: 910-321-5762

Dominator is a trademark of Aphex Systems Ltd.

CLARITY BEYOND BELIEF

Sennheiser studio microphones have long stood for quality, being widely used by studios throughout the world. With the increase in digital recording the need for a microphone with extremely low inherent noise and capable of accepting high sound pressure levels with low distortion is required. The MKH 40 with its cardioid response has been designed to meet these requirements.



MKH 40 P 48

“ The clarity of this mic is astonishing . . . ”

Simon Croft *Sound, February 1986*



SENNHEISER

Hayden Laboratories Ltd, FREEPOST, Hayden House, Chiltern Hill,
Chalfont St Peter, Bucks SL9 9BS. Tel. (0753) 888447



Sennheiser manufactures an extensive range of audio products. Please tick the appropriate box if you would like information on the following.

Dynamic mics Electret condenser mics Tie clip mics
Studio condenser mics Radio mics Infra-red sound
transmission Headsets Headphones

Please send me further information on the Sennheiser range of Dynamic microphones.

NAME

ADDRESS

.....
.....

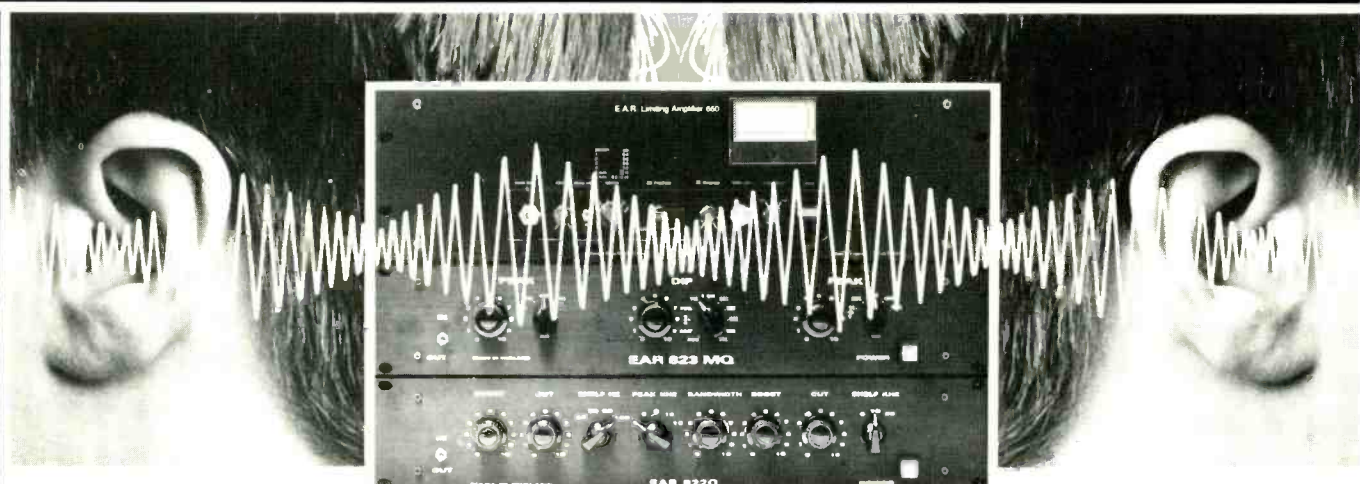

Treat your ears to ours...

E.A.R. 660 Lim/Comp.

Remember the Fairchild Lim/Comp? Well here is its modern equivalent. The all tube EAR 660. Keeps levelling under control without destroying the music. No more gritty clipping. Get your EARS on good buddy and do your ears a favour.

E.A.R. 823MQ Mid Eq. and E.A.R. 822Q.

Both models are vacuum tube no loss Passive equalizers that are balanced input and output to 600 ohm standards. The amplification circuits are all balanced push-pull with 3 tubes that are readily obtainable types and engineered to provide at least ten thousand hours before re-tubing. The dynamic qualities and headroom are highly appreciated.

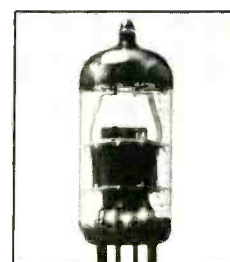

TRAD ELECTRONICS SALES LTD

149B ST. ALBANS ROAD · WATFORD · HERTS · WD2 5BB · ENGLAND
 TEL: WATFORD (0923) 47988/9 · TELEX: 262741 Answerback TRADEQ



Box clever!



MS 200

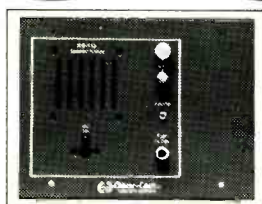

KB 112



SB 412

Clear-Com[®] intercom systems

Clear-Com is the industry's recognised leader in the manufacture of high quality, closed circuit intercom systems. Our "no-fail" system design, high output, wide band width, and wide variety of intercoms satisfy even the most demanding communications requirements, including theatre, studios, television and outside broadcast.

For more information or a demonstration of Clear-Com just phone or write to Zoumie Fallil at T.S.L. on 01-836-6902.

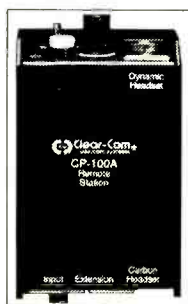

CP 100

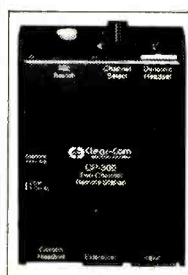

CP 300



Sole U.K. Distributors:

TSL

Theatre Sound & Lighting
 (Services) Limited.
 Showroom and Sales,
 67 Drury Lane,
 London WC2B 5JF.

AUDIO-DESIGN

THE PROFESSIONALS' CHOICE

MICROPHONES

CALREC Condenser Microphones.
1000 series – cost effective, fixed head, 48V range.
2000/2100 series – the studio standard, 7.5-56V. Comprehensive range of extensions, adaptors and accessories.
Sound Field Microphones – The most versatile and accurate microphone in the World.

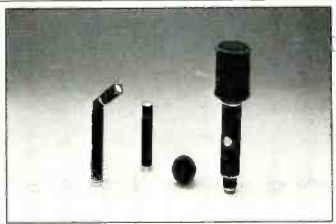

AMBISONICS

A + D Mastering Package for B-Format four channel and UHJ Surround Sound encoding and decoding.

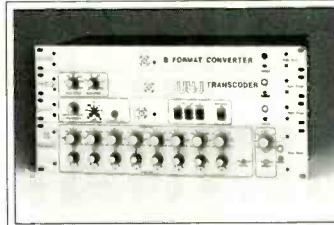

DIGITAL

A + D PCM701ES Professional.
AD-MIX Digital Mixing
1610/30-3324 Interfaces
DIGI-4 Four Channel Recording.



NOISE REDUCTION

New telecom c4.
Up to 118dB dynamic range
18 bit noise performance on analogue 24 track.
20 bit digital performance on 16 bit digital recordings.

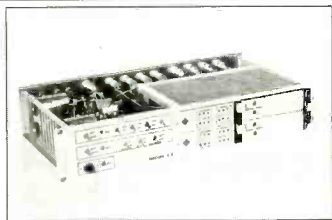

MINI MIXER

The **CALREC MiniMixer**, 8-16 channels in three frame sizes; 3 band EQ + filters; 4 auxiliaries; insert system; internal and external TB; built-in DA's. Meets BBC, IBA and ITCA specifications.

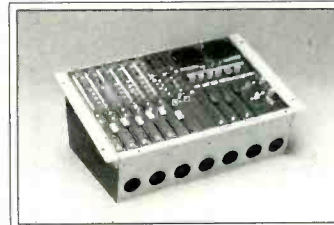

SIGNAL PROCESSING

A + D Rack Units:
Vocal Stresser, Complex, Superdynamic, Express, Easy Rider dynamic processors, and PANSCAN Autopanner.



SCAMP

A + D Modular Signal Processors:
Limiters, Compressors, Expanders, Gates, Equalisers, Distribution Amps, Special Effects.
FILMEX Noise Reduction.
Video Post-Production Processing.

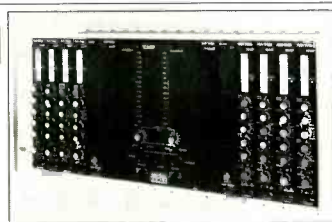

LITTLE BOXES

A + D PROPAP professional/domestic interface, plus CTC correction.
AMPAK, Di-Box, Time Code Reader.
TONEMASTER auto-generator.



UK AGENTS FOR RTW LIGHT METRES · ANT/telecom NOISE REDUCTION · EELA AUDIO PRODUCTS

WORLDWIDE
USA

Audio Design Ltd, Unit 3, Horseshoe Park, Pangbourne, Berks. Tel: (07357) 4545. Telex: 848722 ADR UK.
Audio Design, Inc., PO Box 786, Bremerton, WA 98310, USA. Tel: (206) 275 5009. Telex: 152426 ADR USA.

**SENNHEISER
MKH 416TU**



TECHNICS SL 1200



KLOTZ CABLE

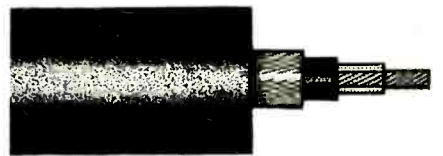

QUAD 306 Amplifier



TASCAM 34B Recorder

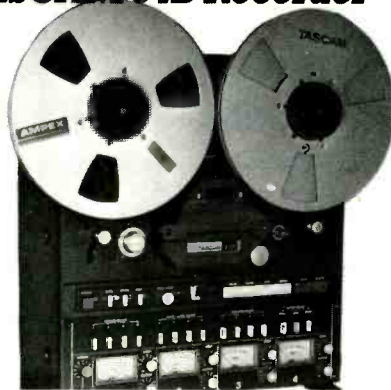

STUDIO SPARES

where everything is
IN STOCK
at last years prices

All orders processed
within the hour

Trade counter open
8am - 5pm



STUDIO SPARES

16 Stucley Place,
Hawley Crescent,
Camden Town,
London NW1 8NS
Tel: 01 485 4908
(Administration)
01 482 1692
(Orders only)

ACOUSTIC Tiles and Sheets

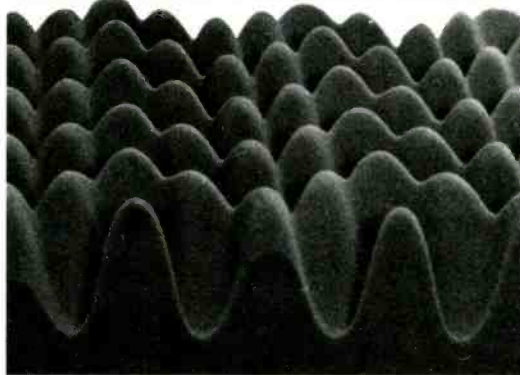

Motorbike for delivery today
SECURICOR for delivery tomorrow

SHURE SM57



**NEW
PRODUCTS**

A.K.G. D112 Microphone



AGFA PEM 469



BEYER Microphones



TASCAM 106 Mixer



SAJE DEALS THE WINNING HAND!



SAJE AUDIO CONSOLES

"Leaders of the Pack"

3 Rue Verte 95100 Argenteuil France. Telephone: (1) 39.61.15.62 Telex: 699672F SAJE.

**WOULD YOU BUY A CAR WITHOUT
A TEST DRIVE?
THEN WHY BUY A MIXER WITHOUT
A TEST DRIVE?**

Thinking about a new project — from a small Mixer to a large studio complex — come and talk over ideas with the people who offer manufacturing and user experience at our new premises:-

**Unit D, 318 High Road,
Benfleet, Essex SS7 5HB**

**TO TAKE THAT TEST DRIVE —
PHONE 0268-793381**

(Weekend visits welcome by prior arrangement)



**PARTRIDGE
ELECTRONICS**

A. C. PARTRIDGE LTD.

Head Office: 56 Fleet Road, Benfleet, Essex SS7 5JN
Telephone 0268-793256



**SONEX kills
background noise beautifully.**

Tom Hannaford, Dixieland
Productions, Atlanta, GA

SONEX is a special acoustic foam that absorbs noise four times better than acoustic tile or carpeting. It makes you sound like a pro — inexpensively — because your voice comes across clear, clean, and intelligible. Use SONEX for video, remote conferencing, voice-overs, radio communications, audio production, or anywhere else you need to sound crystal clear. Kill background noise beautifully — and save the true sound — with SONEX. Send for all the facts.

**Alpha
Audio**

SONEX is manufactured by Illbruck
and distributed exclusively to the pro
sound market by Alpha Audio.

2049 West Broad Street · Richmond, Virginia 23220 · (804) 358-3852
Acoustic Products for the Audio Industry

**Dynamic
Range
Control
at its best.**



Symetrix

SOUND TECHNOLOGY LTD
6 Letchworth Business Centre
Avenue One, Letchworth
Herts SG6 2HR
Telephone: 04626 75675

- 525 Dual Gated Compressor/Limiter**
Simultaneous compress/limit and expand/gate.
- CL150 Fast RMS™ Compressor/Limiter**
A highly cost-effective single channel automatic gain controller.
- 501 Peak-RMS Compressor/Limiter**
Simultaneous peak and RMS detection. An indispensable tool for PA.
- 522 Compressor/Limiter/Expander/Gate/Ducker**
Versatile multi-function processing for studio, stage, or production.
- 511 Noise Reduction System**
Removes noise from any source, pre-recorded or live, mono or stereo.

Symetrix products are sold and supported world-wide. When you specify Symetrix you specify quality, performance, and reliability.

Sigma

24

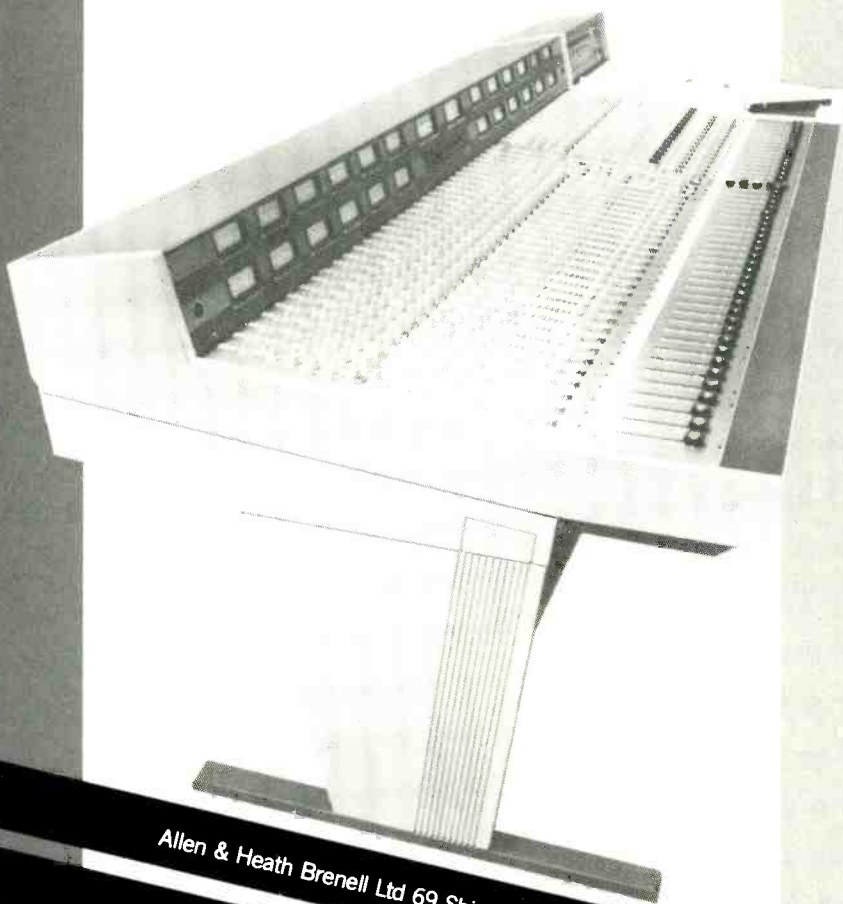

SIGMA 24

Total console system from AHB.
2 24-buss frame sizes, 44 and 32
positions (excluding masters).
All modules feature free positioning
and include mono mic/line input,
stereo line input, dual group output
and in-line tape/line input/output
module.
Extender frame 19" producer's desk
option.

SIGMA 24

MIDI controlled optional automute
sequencing system with 100 mute
patterns.
Control available for switching up to
16 external MIDI effects units.
Memory storage in interchangeable
RAM packs.
VCA fader option, providing 8 DC
groups.

SIGMA 24

Identical EQ and auxiliary send
facilities on all mono input and
output modules.
Fader reverse on all output groups.
2 independent foldback systems.
Stereo solo-in-place, PFL and AFL
featured on all inputs.
Hinged meterhood provides
connector and cable concealment
whilst easing accessibility.
Stereo and mono main outputs.
Dual tape machine operating levels.

SIGMA 24

Designed with high sonic quality as
prime objective. Ask for more
information.

Allen & Heath Brenell Ltd 69 Ship Street, Brighton BN1 1AE UK Tel: (0273) 24928 Telex: 878235 MB1 AHB G

Allen & Heath Brenell (USA) Ltd 5 Connair Road, Orange, Connecticut 06477 USA Tel: (0203) 795 3594

mbi/AHB

Mixing Art with Science

AHB



EUROPE'S NUMBER **1** DIGITAL HIRE · C9

FELDON AUDIO (HIRE) LIMITED · 126 GREAT PORTLAND STREET
LONDON W1N 5PH · TELEPHONE 01 580 4314 · TELEX 28668 ADDAX G

FLEXIBLE

System One offers FLEXIBLE audio test capability. Broadband and selective level and noise, thd + n, intermodulation distortion by SMPTE/DIN, CCIF, and DIM/TIM methods, quantization noise and distortion, frequency, and phase; wow and flutter soon. Measures common-mode rejection ratio without changing cable connections.

Four detectors, four high and four low frequency band limits, four sockets for optional filters.

Audio precision

P.O. Box 2209, Beaverton, Oregon 97075
503/297-4837, 1-800/231-7350
TELEX: 283957 AUDIO UR

Now, that's the way to test audio !



SCENIC SOUNDS EQUIPMENT LIMITED
Unit 2, 12 William Road, London NW1 3EN
Tel: 01-387 1262, 01-734 2812
Telex: 27939 SCENIC G

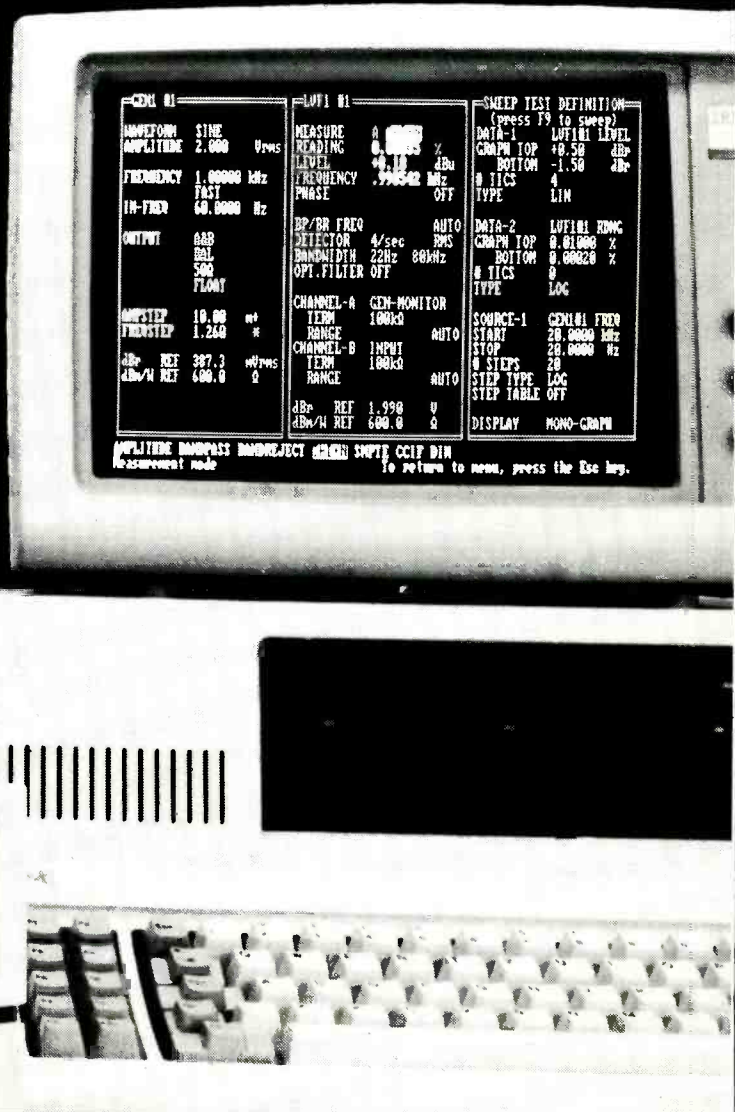

-CH1 H1		-LUT1 H1		-SWEPT TEST DEFINITION-	
WAVEFORM	SINE	MEASURE	A	(press F9 to sweep)	
AMPLITUDE	2.000 Vrms	READING	0.0000	DATA-1	LUT1 H1 LEVEL
FREQUENCY	1.00000 kHz	LEVEL	+0.10 dBu	GRAPH TOP	+9.50 dB
IN-FREQ	60.0000 Hz	FREQUENCY	0.00000 MHz	BOTTOM	-1.50 dB
OUTPUT	B&B	PHASE	OFF	# TICS	4
	B&L	BP/BR FREQ	AUTO	TYPE	LIN
	S&C	DETECTOR	4/sec RMS	DATA-2	LUT1 H1 EDWG
	FLWY	BANDWIDTH	22Hz 80kHz	GRAPH TOP	0.01000 %
AMPSTEP	10.00 mV	OPT.FILTER	OFF	BOTTOM	0.00020 %
FREQSTEP	1.240 #	CHANNEL-A	GEN-MONITOR	# TICS	0
dBc REF	387.3 mVrms	TERM	100kΩ	TYPE	LOG
dBu/N REF	600.0 Ω	RANGE	AUTO	SOURCE-1	GEN1 H1 FREQ
		CHANNEL-B	INPUT	START	20.0000 kHz
		TERM	100kΩ	STOP	20.0000 Hz
		RANGE	AUTO	# STEPS	20
				STEP TYPE	LOG
				STEP TABLE	OFF
				DISPLAY	MONO-GRAM

AMPLITUDE BANDPASS BANDREJECT SEARCH SWPTE CCIF DIN
Measurements made To return to menu, press the Esc key.

DIARY DIARY

People, events, services

Contracts

- West London Paradise Studios has added a Fairlight series III to its equipment list which includes the series II and several other keyboards.
- DDA has delivered a 28/8/2 D series console to Audio FX as part of their hire stock. Abbey Road will be the first to hire it for use on location. Abbey Road has also recently purchased a second, larger DDA console (24/8/2) for mobile digital recording. DDA has also supplied Dolby Labs with a 12/4/2 for use in their demonstration room and Sutton Sound with a 24/4/2 for use in their new installation in Bishopsgate Hall, EC2.
- Recent UK installations of the AMS *AudioFile* include Silk Sound, Rushes, Magmasters, the Film & Video Soundtrack Studio, Saunders & Gordon, ECO and BBC Manchester. Software updates have also been made at Trilion Video and BBC London.

French distributor High Fidelity Services has received two units, Studio Damiens being the first European customer for the system. Two systems have also been despatched to Harris Sound in Hollywood, California.

- Professional Audio has sold the first Renkus-Heinz *Smart* sound system to be shipped to the UK to Britannia Row Productions Ltd.

Professional Audio has also recently supplied RG Jones (Morden) Ltd with a Renkus-Heinz *Smart* PA system. The equipment can easily be divided to form two separate systems for promotional and/or video work.

- Industrial Tape Applications has supplied and installed all the equipment at The Tape Gallery's new Studio Four. The equipment included Otari *MTR90* and *MTR12* tape machines, 4-machine *Q.Lock* with *Eclipse*, custom Amek *Angela* console with *MasterMix*, dbx noise reduction

and a wide variety of ancillary audio and video equipment. Amek *Angela* consoles have also been installed at Red Shop Studios in North London and Sirocco Studios in Scotland. Joan Armatrading has recently installed an Otari *MTR90* 24-track machine in her private studio along with a TAC *Matchless* console, and Filmtrax, and producer/musician Martin Turner have also purchased *Matchless* consoles. Other Otari sales from ITA include *MTR90*s to The Power Plant, Beethoven Street Studios, VideoLondon and Battery Studios.

Multitrack Hire has purchased an 8-track Otari *MX70* along with two *MTR12* 4-track machines.

- Rental company Audio FX has taken delivery of a JVC *VP-900* series 2-track digital recording system and editor.

- Gravity Recording in Nogales, Arizona, has taken delivery of a 36-input Neve V series console. Neve has also

supplied The National Film Board of Canada with a second custom console.

The new 36-channel console features six subgroups, six main outputs and 6-track monitoring facilities in addition to *Necam 96* and VCA subgrouping. Bombay Broadcasting of New York City has taken delivery of an 8-input Neve *5432* desk and West German broadcasting network WDR has ordered a second *DSP* console. The new console will feature *Necam 96* automation.

Continuing their refurbishment of sound control rooms, London Weekend Television has placed a firm order for a second custom console. Based on the V series the 48-channel console will be used in Studio Two along with a new Neve grams mixer and an audience sub-mixer.

- Court Acoustics Sales has recently supplied Britannia Row with 12 *WBH 800* bass systems, John Henry

The REMARKABLE YAMAHA

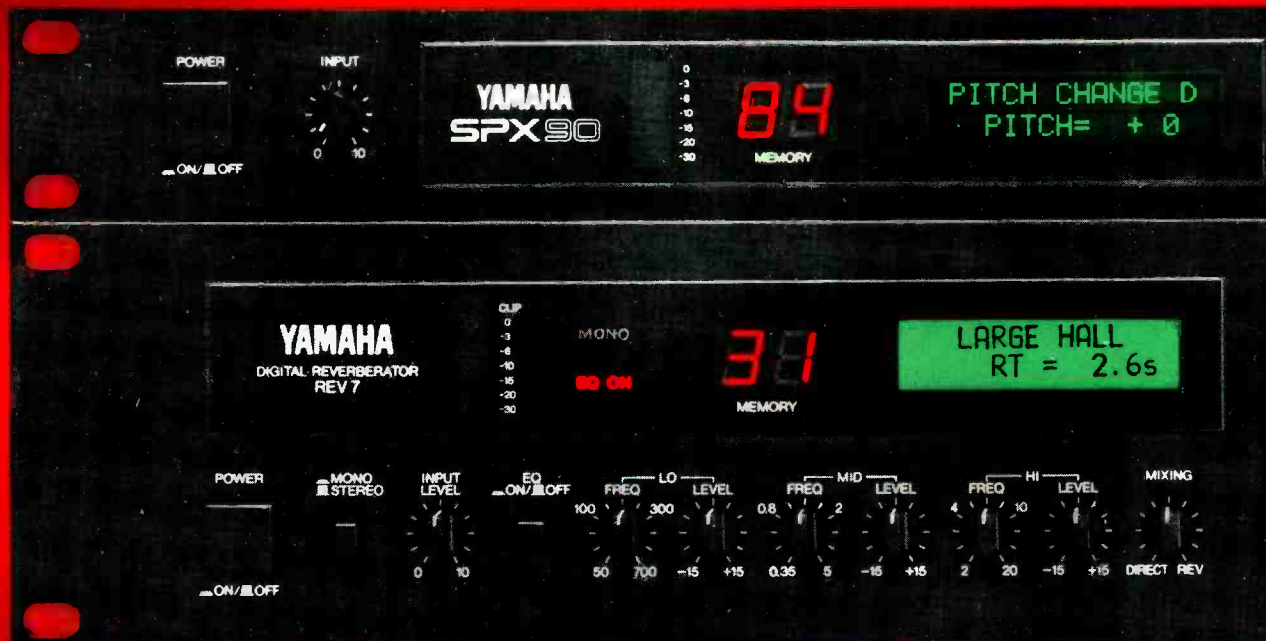

Alan Parsons • Swanyard Studios • Island Studios
Tyne Tees TV • Nik Kershaw • Manor Mobile • Genesis •
Power Plant Studios • Battery Studios • Howard Jones.

DIARY DIARY

People, events, services

Enterprises and The Touring Plant in Sydney with four Black Box systems and Clair Brothers with eight *GE-60*, 2-channel 30-band equalisers. Also taking delivery of Court equalisers is Hausmann Electronics; they have bought 16 *GE-60s* and 14 *GE-30s*.

- Philips Communications & Security has been appointed official supplier to the Commonwealth Games. The company will be supplying and installing public address systems in all areas, plus mobile systems for shooting in three locations. The Commonwealth Games is the world's fourth largest sporting event.

- Valley Audio in Nashville has announced the sale of the first Otari *DTR-900* 32-track digital multitrack machine in the USA. The new *DTR-900* will be interfaced with an SSL *4000E* in a new digital remix room at Masterfonics in Nashville. Valley Audio is also providing all the outboard

equipment for the new installation.

- Marmalade Studios in Wellington, New Zealand has recently completed rebuilding their 24-track control room. The new enlarged room features Quedest monitors, a 40-channel Soundcraft *TS24* console and an *EC-101* synchroniser card for the Otari *MTR90*.

- Elliott Bros has won a major contract to equip the new Opera Theatre at the Royal College of Music, London. Other projects include continuing work at the Barbican; installation of an AMS *AudioFile* in Studio Three at ECO, Cardiff and custom switching for the Services Sound & Vision Corporation.

- Britannia Row has announced the following sales of Westlake monitors since becoming the UK and European distributors: an update kit to Mike Oldfield for a *HR-1* system; installing and commissioning *HR-1* systems

in Townhouse Four; Genesis' Fisher Lane Farm; and Comforts Place studios. They have also supplied *BBSM* nearfield monitors to producers Mutt Lange, Andy Hill, Alan Tarney, Nick Mason and Derek Bramble, and Ultravox, Britannia Row and The Manor Mobile.

- Audio Kinetics has supplied

an *Eclipse* audio editor and *MasterMix* console automation to the Tape Gallery studios, London; an *Eclipse* audio editor to Advision Studios, London for use in conjunction with a *MasterMix* system; and to London based production studio Saunders & Gordon a pair of *MasterMix* systems, one for each of the Amek *Angelas*.

US Monitor Awards go international

Out of 650 finalists in 14 categories, four London based facilities houses have won Monitor Awards for Excellence. Rushes won 'Music Video Direction'; The Moving Picture Company 'Video Special Effects'; Limelight 'Music Video Production'; and, in audio, David Woolley of Trilion was awarded 'Best Audio Mixer—Music', for the television video *The Pointer Sisters in Paris*.

Instigated in 1979 the

awards are now under the auspices of the newly formed International Teleproduction Society (ITS) in New York, representing international awards in all areas of videotape production. ITS is the result of the amalgamation of the Video Production Association, New York, and the Videotape facilities Association, Los Angeles. This is the first year the awards have been competed for on a wider international basis.

SPX90 & REV 7.....

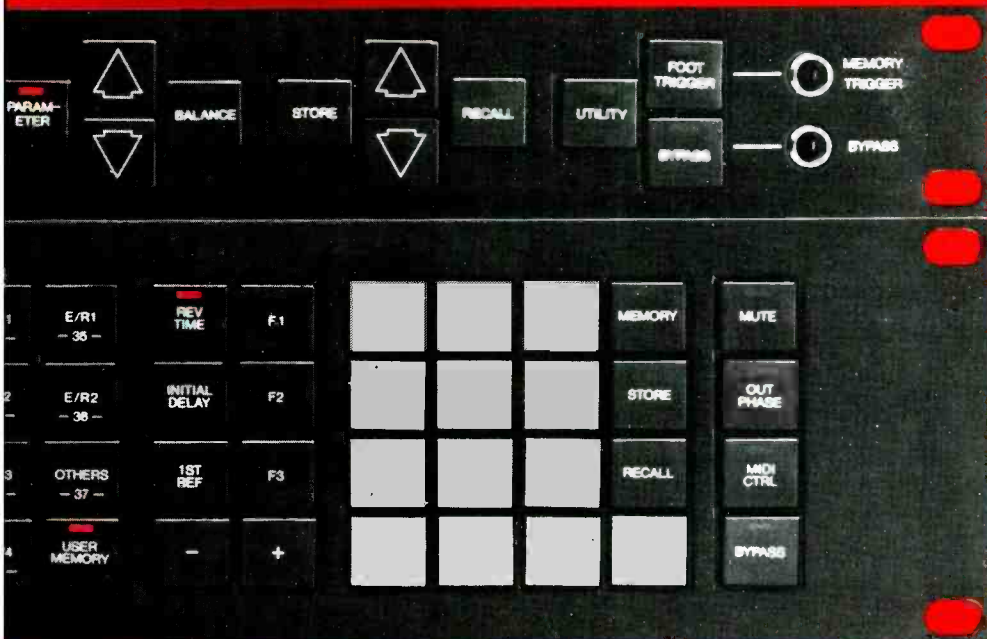

the
professionals
choice
for

WHAT
HAVE ALL
THESE GOT IN
COMMON?

Call HNB on
01961 3295
to find out!



HNB Hire & Sales, Unit F, New Crescent Works,
Nicoll Road, London NW10 9AX Tel. 019613295 Telex 923393

DIARY DIARY

People, events, services

Digital Information Exchange

This year's Digital Information Exchange will be held at the Private Member's Suite at London Zoo on November 25th, 26th and 27th. The seminar, which is sponsored jointly by Sony Broadcast and HHB Hire & Sales in association with *Studio Sound* and *Pro-Sound News* will cover a wide variety of digitally related topics including the all digital studio, R-DAT, digital VTR, new CD applications and the AMS hard disk recording system *AudioFile*.

Each of the three days will be specifically oriented towards various digital applications. Day one will deal mainly with digital audio in the broadcast environment with particular emphasis on the use of digital with video. Day two is dedicated to the recording engineers and record

company production managers with day three being set aside for digital audio applications in scientific research and data storage.

A wide variety of leading industry names have agreed to provide presentations, among them AMS Industries, EMI, Solid State Logic, Trilion, Philips Interactive Media Systems, Alan Parsons, Editel, HMV Shops, Audio FX, the Alvey Project, Silver Platter, Sony Broadcast and HHB Hire & Sales.

The cost of attending each daily session is £50 plus VAT. A reduced rate of £120 plus VAT is available for delegates wishing to attend all three days.

Further information from Peter Woodcock, Event Administrator, 12 Church Road, Bengoe, Hertford SG14 3DP, UK.

Address changes

• AMS has now completed the relocation of all the company's departments to new premises in Burnley. The new address is AMS Industries plc, AMS Industries Park, Billington Road, Burnley, Lancs BB11 5ES, UK. Tel: 0282 57011. Telex: 63108.

• Audio Technica Ltd has moved to Technica House, Lockwood Close, Leeds LS11 5UU, West Yorkshire, UK. The telephone and Fax numbers remain the same as before. Tel: 0532 771441. Fax: 0532 704836.

• Solid State Logic has now relocated to Begbroke (north-

west of Oxford on the A34). Their new address is Solid State Logic Ltd, Begbroke, Oxford OX5 1RU, UK. Tel: 08675 4353. Telex: 837400.

• Drawmer Distribution is now based at Charlotte Street Business Centre, Charlotte Street, Wakefield, West Yorkshire WF1 1UH, UK. Tel: 0924 378669. Telex: 556649.

• The Canadian Mitsubishi Pro Audio Group has a new address: Digital Entertainment Canada Inc, 260 The Esplanade, Toronto, Ontario M5A 1J2, Canada. Tel: (416) 365-3363. Telex: 06219839.

Agencies

• FWO Bauch has been appointed distributor for Magni Systems Inc, manufacturer of the *Magni 2015* PCATS (Personal Computer Aided Television Synthesiser).

• Vesta Fire USA Inc is the new exclusive marketing arm of Shiino Vesta Fire in the USA. Vesta Fire USA Inc, 10 McLaren, Building E, Irvine, CA 92718. Tel: (714) 380-7314.

• Court Acoustics has been appointed exclusive marketing agent for Milab microphones in the UK.

• Clear-Com has announced the appointment of Crow Broadcast Systems as UK agent for Clear-Com intercom and talkback systems to broadcast and production house customers.

• Stirling Audio Systems Ltd and Professional Audio Ltd have been appointed Westlake agents for the UK. Stage Theater en Studio Techniek is exclusive agent for the Benelux countries. Fading SA in Madrid remains Spanish exclusive agent. Westlake agents for other European countries will be announced in the near future.

• Soundcraft has appointed the Munich based company of AKG Acoustics as the exclusive distributor for West Germany for the entire range of Soundcraft products. AKG were first appointed dealers for the smaller Soundcraft products (up to the *800B*) at the end of 1984.

• Genelec OY has appointed three new sales agents worldwide. These are Redwood

Marketing, Nashville for the USA; EMM-Studio, Basel for Switzerland; and Power Source Development Ltd, Hong Kong for the Far East.

• PRECO is now distributing Strategic Sound products in the UK and Europe. Principally it will be handling the centre-tack timecode retrofit system for the Ampex *ATR100* series tape machine as covered in *Studio Sound* July.

• Audio Consultants Co Ltd has been appointed distributor by Mitsubishi Electric for digital tape recorders in Hong Kong and China.

• Martin Audio has announced the formation of a new company—Martin America. The new company will be run by Ted Telesky. Martin America, PO Box 5139, Chatsworth, CA 91313, USA. Tel: (818) 718-1031.

• Future Film Developments has signed an exclusive distribution agreement to market the complete range of Noriyuki timecode readers and generators. FFD has also completed agreements with Philip Drake to distribute its range of audio modules and FWO Bauch to distribute Tannoy loudspeakers and Neumann microphones.

• HHB Hire & Sales has reached an agreement with AMS to supply the *AudioFile*. The new arrangement makes HHB Hire & Sales the UK's only independent dealer for the AMS hard disk-based digital recording and editing system.

Akai acquires Linn

Akai has acquired the rights to future products under the Linn brand name. It is understood that Roger Linn is to work with Akai in a technical capacity and that Akai will be developing new products under the 'Akai

Professional by Roger Linn' banner. These products are to be marketed alongside the Akai professional range on a worldwide basis.

According to Akai (UK) Linn will be working with them on their new 12-bit product range.

Corrections

Our apologies to Dennis Smith of Sawmills Studio, Cornwall who was incorrectly mentioned in the June issue as Dennis Rigley and mistakenly corrected as Dave King in July.

An incorrect address for NEK Cables was given in the June cable survey. The correct address should be NEK Cables Ltd, Chepping House, Temple End, High Wycombe, Bucks HP13 5DR, UK. Tel: 0494 450371/2/3. We would also like to point out that NEK has a factory in Washington, Tyne & Wear producing cables for the broadcasting, computer and telecommunication industries.

In the same issue ('Interconnection' Page 72) we omitted to mention Canadian Instruments who are of course the major stocking representative for Switchcraft in the UK. Canadian Instruments & Electronics Ltd, Harris-Bass House, Station Road, Ilkeston, Derbyshire

DE7 5TX, UK. Tel: 0602 302331.

In the New Products section of the July issue we unfortunately attributed export sales of the Electrospace *'Pressor* to Musimex. This we understand is not the case and we apologise for any inconvenience and misunderstanding that may have been caused. The correct entry should have read: UK: Britannia Row, 35 Britannia Row, London N1 8QH. Tel: 01-226 3377. USA: Peak Marketing, PO Box 11712, Marina Del Ray, CA 90295. Germany: Electrospace KG, Wental Strasse 30, 7251 Wilmsheim, West Germany. Tel: 07044 42807.

Finally ROS Software inform us that they sent out a press release with a wrong zip code. The address printed on page 35 of the June issue ('New Products', In brief) should read NY 10116 and not 10117.

Low-cost digital audio comes of age.

The Sony PCM series has now been available for several years. In this time recording and broadcast organisations, government, educational and industrial establishments, as well as individual users have all acknowledged the unique value of these units, and made them a new standard. It is the superlative quality of Sony PCM digital, coupled with extremely low cost that has brought about this professional acceptance of the range. This is borne out by the number of new ancillary products from other manufacturers, that have further increased the flexibility and versatility of the range. Examples of these products are the 'CLUE' logging and editing system from HHB, as well as various interfaces which allow digital communication with the PCM 1610.

Sony has acknowledged that this acceptance by professional users necessitates a change of

policy towards these products. Accordingly they have upgraded them from the domestic catalogue, and, realising the need for professional support and all that that entails, have appointed HHB as specialist dealers to represent them in the pro-audio market.

We are proud to announce this appointment, and happy to assure our customers of continued availability of the PCM range. The re-instatement of the PCM production line has been very largely due to pressure from end-users, who are after all the motivating force in the audio world. So if you are involved with audio recording and are still unfamiliar with Sony digital, then you owe it to yourself to call HHB - the No. 1 name in Digital Audio.

SONY FROM 

HHB HIRE & SALES, UNIT F NEW CRESCENT WORKS, NICOLL ROAD, LONDON NW10 9AX TELEPHONE: 01-961 3295 TELEX: 923393.



THE SONY PCMF1 AND PCM701ES DIGITAL AUDIO PROCESSORS.

DIARY DIARY

People, events, services

Soundtracs goes public

Founded in 1972 as Soundout Laboratories, UK console manufacturer Soundtracs has placed 20% of its shares on the Unlisted Securities Market which values the company at £4 million. In June of this year Allied Provincial, instructed by United Trust & Credit plc placed 2 million new Ordinary shares at 40p each to raise £600,000 net. The new money will be used as working capital, to

accelerate expansion and fund new product development.

Soundtracs exports more than 80% of its production, the largest single market being the USA which accounts for 28% of sales. Future plans include further enhancement of existing products and the development of products for stereo AM radio, stereo TV and electronic sound application markets and commercial recording.

Forthcoming events

September 19 to 23

International Broadcasting Convention, Brighton, UK.

October 1 to 2 Sound Comm

86, New Century Hall, Corporation Street, Manchester, UK.

October 28 11th Sound

Broadcasting Equipment Show, Albany Hotel, Birmingham, UK.

November 6 to 9 Institute of

Acoustics 2nd Annual

Conference: Reproduced Sound, Hydro Hotel, Windermere, UK.

November 12 to 16 81st AES

Convention, Los Angeles, USA.

November 19 to 22 14th

Tonmeistertagung Munchen 86, Deutsche Museum, Munich, West Germany.

People

● Neve Electronics has appointed John Andrews as director of sales and marketing. John joins Neve from Alice (Stancoil Ltd) where he was joint MD.

● Bob Auger is European director of London audio and video facility Molinare. He will be based at Sun Film's offices in Paris.

● University of Sydney Senior Lecturer Dr Richard Small has left his post to take up the newly created position of head of research at UK loudspeaker manufacturer KEF Electronics.

● Martin Audio has appointed Bob Kelly as international sales manager. He will be responsible for all sales both in the UK and overseas.

● Mitsubishi Pro Audio Group has appointed Ralph Moss as eastern regional sales manager. Moss, a producer/engineer, has worked at several major US studios.

Also recently appointed at the New York office is Saul Walker, manager for broadcast marketing. Walker was previously with Datatronix, Straight Wire Audio and API. Joining the regional office in Nashville is Allen Rumbaugh. As regional sales manager he will be responsible for all sales in the southeast, parts of mid-America and Texas. Jerry Barnes, former vice-president of United Western Studios in Hollywood, and ex-president of SPARS is to assist the Group as an informal adviser. Barnes, who now runs a successful freelance recording business, will be advising the Mitsubishi marketing team and talking to potential users about Mitsubishi digital audio products.

● Bill Aitken the originator and developer of the *SynthAxe* has rejoined Solid State Logic, the company he left in 1982, to work on new projects.

ASONA for complete Cassette Production

ASONA offers a complete program of tape duplication and winding systems.

ASONA Type 301 recording slaves are designed to operate with ASONA Loop-bin master reproducer for optimum results in tape duplication.

Its sophisticated studio type transport mechanism with electronic torque-control at the supply reels provides accurate tape guidance and minimum of head wear.

Central bias generator in Loop-bin, bias switch for three different tape formulas.

Robust construction, with a minimum of moving parts.

Low maintenance requirements, low personal costs.



**We can tailor a cassette production system to your needs.
Write or call for a proposal.**

ASONA is manufactured in West Germany by AUVIS ASONA GmbH & Co. KG, Bahnhofstraße 60, D-7634 Kippenheim
Tel.: (0)7825 - 1068, Telex: 754325 auvis d



Covering the Monitoring Spectrum.

The Tannoy FSM studio monitor loudspeaker and the DTM-8 reference monitors cover the complete professional spectrum.

The new FSM inherits all the traditions of the widely-acclaimed SRM series. However, the crossover network is all 'hard-wired' and the frequency response adjustment in the crossover employs gold plated links between robust terminals. The result is increased reliability and superior aural properties when compared to wafer switches.

The unique 'LF Window' enables the high pass filter feeding the dual concentric unit to be bypassed. Both units then operate in parallel, with a 3dB subsequent increase in low frequency energy. This facility is of particular value in matching the FSM to

different room acoustics with difficult bass characteristics.

Compact desktop units

The new compact DTM-8 meets the need for phase-coherent point source desktop monitoring. It uses a state-of-the-art 8" dual concentric drive unit, which offers all the features of stable stereo images, axially aligned acoustic source, phase coherence, smooth frequency characteristics and low colouration.

For full details on both ends of the spectrum, just contact F.W.O. Bauch Limited.

TANNOY
The Name for Loudspeakers

F.W.O. Bauch Limited

49 Theobald Street, Boreham Wood, Hertfordshire WD6 4RZ
Telephone 01-953 0091, Telex 27502 Fax 01-2075970



DIARY DIARY

People, events, services

Capital Radio is the biggest commercial radio station in the UK and this was its most ambitious outside broadcast yet. For 40 min Capital Radio broadcast a Madness set from a moving riverboat on the River Thames and made a digital multitrack recording at the same time.

The idea came from Tony Hale, Capital's head of music. He asked the station's chief engineer, Peter Jackson, if it could be done. "It's one of those things that happens over a beer one evening," says Peter Jackson, "and it escalated. I, being a fool, agreed."

Thus, at 7.30 am one Sunday in June, a group of Capital and Solid State Logic engineers descended on the Cherry Garden Pier in London's east end to manhandle an *SL 4000 E* console on board the *Elizabethan*, a vessel which usually carries sightseers up and down the Thames. You may well have seen the actual desk used: it's the one SSL take to exhibitions. Later in the morning, a Sony 3324 on loan from Audio FX arrived, as did Madness' PA.

While the SSL team connected up the desk, Capital engineers set up the equipment needed for the live transmission which formed the first part of the Gary Crowley show. The stereo monitor mix from the SSL was used for this, fed into a Neve *PSM12* mixer. Whereas the SSL was used to mix the band, the Neve mixed in other sources necessary for the radio show including Gary Crowley's mic and a Sonifex *microHS* cartridge machine. The Neve also handled the off-air monitoring receiver feed and talkback on board the *Elizabethan*, except for radio talkback.

The stereo output of the Neve was fed into an Audio & Design *Gemini Easy Rider* acting as a peak limiter, then through telcom noise reduction and into a pair of Pye UHF radio link transmitters operating on roughly 400 MHz. We cannot reveal the exact frequencies because UK broadcasters have been the victims of a number of electronic hijacks on such links by pranksters: Capital Radio's traffic spotting

Thames Madness



Arrival at Westminster pier in front of County Hall



Above and below: Manoeuvring the console



Equipment chain inside the Elizabethan

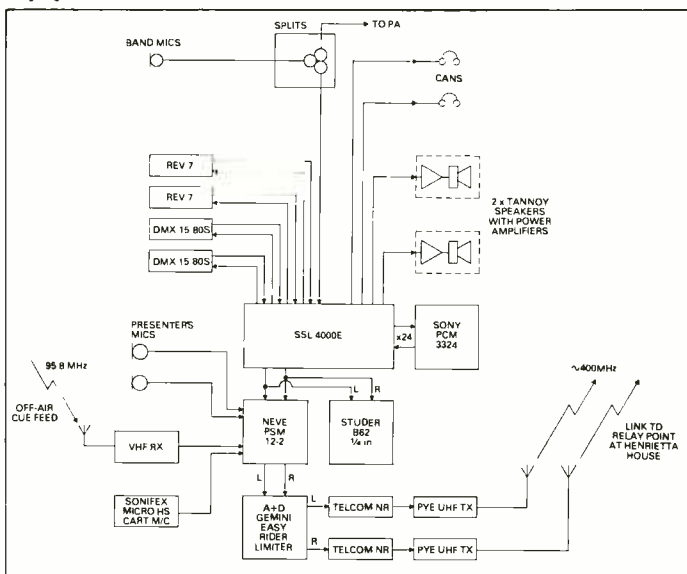

aircraft, the Flying Eye, once had its radio link hijacked by pirate broadcasters as an April Fools day stunt.

One of the UHF transmitters carried the left channel and the other the right. The two centre frequencies were 50 kHz apart—adjacent channels. FM stereo multiplex transmission is impossible in such a narrow RF assignment. The two links each gave an audio response flat to about 12 kHz. There are two further advantages to discrete transmission: multipath distortion and fading is less of a problem and should one of the links fail, the other one can continue in mono.

Each of the UHF transmitters was connected to a vertically-polarised 3-element Yagi mounted on a pole at the stern of the boat, pointing in the direction of a temporary link site on top of Henrietta House, a 10-storey building just north of Hammersmith Bridge. The broadcast was timed to happen when the boat was travelling south-east from Hammersmith Bridge down a relatively straight section of the river towards Putney Bridge: the UHF link was line-of-sight nearly all the way. An earlier link test from a launch had established that there was one point where the link would be doubtful, where the boat passed under an iron bridge, and this could be covered by taking a commercial brake.

The output of the receivers at Henrietta House fed a second pair of UHF link transmitters, operating about 20 MHz away, which relayed the signal to Capital's permanent receiver site at the Independent Broadcasting Authority's station near Croydon. From Croydon, the signal doubled back to London via a pair of British Telecom music lines.

Capital uses telcom noise reduction on its radio links; Peter Jackson says they have tried others. "Out of the three, we found the dbx suffered when a poor signal-to-noise ratio produced side effects. Dolby has the disadvantage of needing reasonably accurate level alignment. Telcom overcame that problem. We don't use it anywhere else, just on radio links."

Talkback between the

DIARY DIARY

People, events, services



UHF link transmitter antenna



The SSL 4000 E desk on board the Elizabethan

various points was provided by simplex VHF radio on three frequencies: one for a base station at the Barbican, another for a base station at the Croydon IBA site, and the third for local communication within an OB site.

On the boat, the SSL provided the music mix. Effects were limited to two AMS *DMX 15.80S* delays and two Yamaha *REV7* reverbs. Monitoring was on smallish Tannoys to start with but due to the high ambient noise

level producer/engineer Trevor White soon decided to mix on his own pair of Yamaha cans, which he knew well. "I was very pleased considering we had a 7 ft ceiling above the desk, with the band playing on top of it. Even so, the sound in

the cans was affected by the ambient sound above."

Would they do a similar thing again? Silly question, really. Capital, SSL and Audio FX are ready, they just need someone to supply the Jumbo Jet! **Richard Lamont**

The FX Series
by

 **NEUTRIK**

Sole Agent UK

Eardley Electronics Ltd.

Telephone: 01-221 0606

Telex: 23894

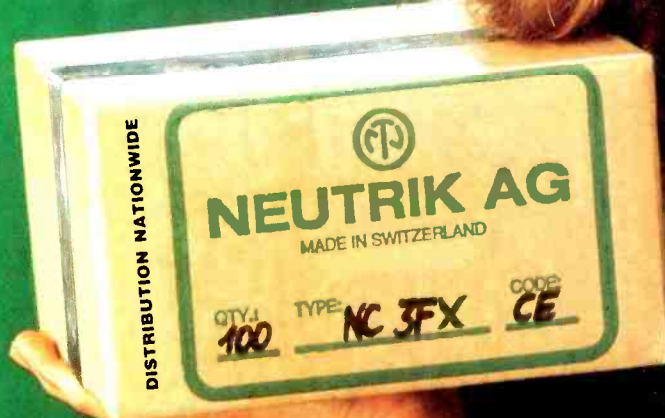

Photography Francis Loney
Smiles Studios at Eardley House

NEW PRODUCTS

NEW PRODUCTS

Equipment, modifications, options, software

Rebis RA701 noise gate

New from Rebis is a 19 in rack mounted MIDI noise gate. The RA701 claims to go some way to solving the problem of MIDI drum machines which will not trigger externally without special pads or interfaces. The unit's two channels provide note on/off, key number and velocity data via a single MIDI Out socket. It can be chained via a merge input and voices are normally selected using key number re-allocation on the receiving drum machine.

The RA701 has a 90 dB range, frequency conscious side

chain and 4-stage envelope. The hold and release can be switched to follow the attack regardless of signal length for fixed envelope shaping. Envelope delay (up to 2 s) can be used for slapback effects and trigger mask up to 4 s can be used to remove offbeats or change the accent level.

Also included on the unit are stereo and duck facilities, external key inputs and 5 V trigger outputs.

Rebis Audio Ltd, Kinver Street, Stourbridge, West Midlands DY8 5AB. UK. Tel: 0384 71865.



JBL monitor range

JBL Professional has released a new range of monitor loudspeakers that are claimed to offer greater accuracy and tighter response tolerance. The 4406 and 4408 are 2-way monitors and the 4410 and 4412 are 3-way. All the new units feature JBL's pure titanium diamond surround ribbed dome tweeter.

The 4406 has been designed primarily for console or nearfield listening and features a 170 mm (6½ in) polypropylene bass unit. The 4408 is for broadcast applications and uses a 200 mm (8 in) fibre cone bass driver.

The 3-way models include a 125 mm (5 in) mid range unit and laminate woofer, a 12 in version in the 4410 and 15 in in the 4412.

Special attention has been given to the crossover networks and all models incorporate low diffraction grille designs, cast aluminium frame transducers and continuously variable calibrated reference controls.

JBL Professional, 8500 Balboa Boulevard, Northridge, CA 91329, USA. Tel: (818) 893-8411.

UK: Harman Audio UK, Mill Street, Slough, Berks SL2 5DD. Tel: 0753 76911.

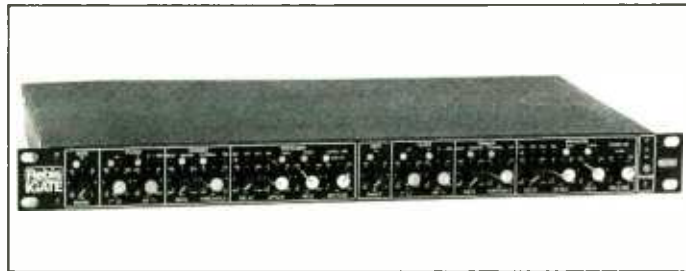

Fern EF8 digital filter

Formerly manufactured by Barr & Stroud, the EF8 is a universal digital filter system based on an original design created by the Medical Research Council—Institute of Hearing. The unit is claimed to offer near ideal filter responses, very high attenuation rates (typically 4,000 dB/octave), excellent stability, linear phase response and an operating bandwidth from DC to 30 kHz.

The EF8 can be supplied as a single or dual channel unit and the digital and analogue filter sections plus frequency synthesiser are all programmed via a General

Purpose Interface Bus (GPIB/IEEE 488). Various software application packs are available and an RS232 option is currently under consideration.

Construction is modular and there are currently eight options including an A/D and D/A converter (EF8-04); programmable anti-alias/post-process analogue low pass filter (EF8-05) and programmable 'sampling clock' frequency synthesiser and controller (EF8-07).

Fern Developments Ltd, 7 Springburn Place, College Milton North, East Kilbride, Glasgow G74 5NU, UK. Tel: 03552 29464.

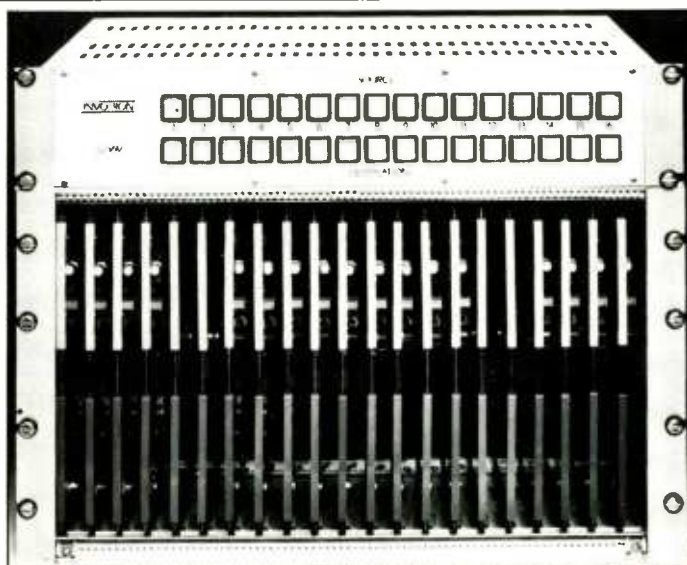

Invotron S256V switcher

Invotron Ltd has added a video switcher to its range of audio, timecode and data switching matrices. Control data can be either serial or parallel and the control panel includes Invotron's X/Y system incorporating Source Preview and Destination Monitoring. Custom built control panels are also available.

Options include multilevel

control (video, audio, timecode and data matrices) and pre-set switching configurations programmed from the control panel. The new systems, based on 16x2 modules are capable of providing 32 outputs per standard 6U frame.

Invotron Ltd, Brookfield Avenue, Blackrock, Co Dublin, Ireland. Tel: 01-884993/831938.

Merlin ME-318 VISA system

The full bandwidth (20 to 15 kHz) ME-318 VISA (Vertical Interval Stereo Audio) system from Merlin allows the insertion of stereo audio in NTSC or PAL television system vertical interval. The multipurpose unit can be used to upgrade all quad-type video recorders to stereo. The ME-318 features low distortion, excellent phase response and several layers of

error correction in its digitally formatted encoding and decoding system. This is claimed to make the unit immune to tape dropouts and video glitches.

Merlin Engineering Works, 2440 Embarcadero Way, Palo Alto, CA 94303, USA. Tel: (415) 856-0900.

UK: FWO Bauch Ltd, 49 Theobald Street, Borehamwood, Herts WD6 4RZ. Tel: 01-953 0091.

AMEK OTARI

ITA

THE WINNING COMBINATION

If you're putting together a new multitrack studio, or upgrading an existing one, the combination of an Otari multitrack and an Amek Angela has probably already occurred to you.

It's a combination that over the last two years has proved the most successful we've handled in our 14 years.



Otari MTR 90

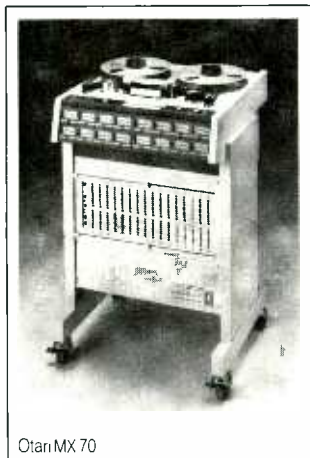

Otari MX 70

The MTR90, as the world's best-selling multitrack recorder, needs little introduction. Suffice to say the MTR90 is now the first choice of many of the world's leading producers and engineers.

The new Otari MX70 is a state-of-the-art 1" 8- or 16-track drawing on the advanced design ideas of the MTR90. The MX70 makes Otari performance and features available at a much lower price.

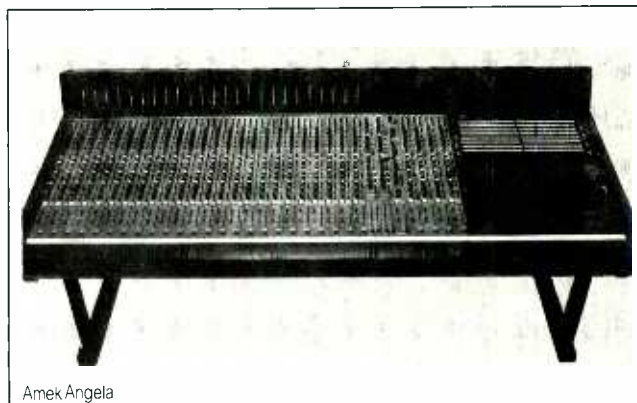

Amek Angela

The Amek Angela must be now nearly as well known as the MTR90. The attributes of the Angela are many and varied, but those most commonly-quoted are the highly musical eq section and general transparency of sound, the incredible flexibility of operation and the very high standard of mechanical construction.

ITA – UNIQUE EXPERIENCE OF OTARI AND AMEK

Only ITA can offer the experience of having already installed many Otari/Amek systems, for a variety of different applications, from private studios to video post-production facilities.

We don't stop with Otari and Amek; our product range is about the largest of any UK supplier, and the ITA service includes studio design and building as well as full installation and back-up.

ITA – the one source. Call Mick Boggis now for the full story.

INDUSTRIAL TAPE APPLICATIONS
PROFESSIONAL PRODUCTS DIVISION

ITA

1 Felgate Mews, Studland St, London W6 9JT. Tel: 01-748 9009 Telex: 21897

NEW PRODUCTS

NEW PRODUCTS

Equipment, modifications, options, software



PL-Plus power conditioner and light module

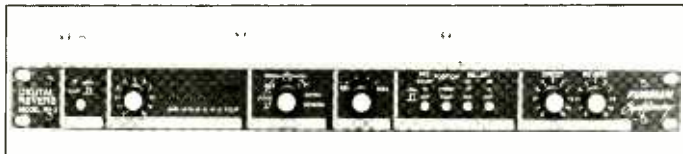

RV-3 digital reverb

Furman PL-Plus and RV-3 digital reverb

Furman Sound has introduced two new products, a new power conditioner and light module and a digital reverb unit. The *PL-Plus* is similar to Furman's other conditioner (the *PL-8*) and is designed to sit at the top of a 19 in rack of equipment. Eight switched AC outlets are provided with heavy duty spike and surge suppression and a pair of telescopically mounted light fixtures can be used to illuminate the equipment below.

Additional features of the *PL-Plus* include a multi stage *Pi* filter and an LED voltage monitor which continuously displays the line voltage. The *Plus* is also equipped with a circuit breaker and heavy duty 10 ft mains cable. Capacity is

rated at 15 A.

The *RV-3* digital reverb has been designed to make digital signal processing easier according to Furman. Two rotary controls give immediate and easy access to the major program types and decay times. Pushbuttons control pre-delay, room position and filtering. Rear panel features include line and instrument level switching, a footswitch jack for reverb bypass and a ground lift switch.

The *RV-3* is a mono in/stereo out device featuring a 79 dB dynamic range and a 14 kHz bandwidth.

Furman Sound Inc, 30 Rich Street, Greenbrae, CA 94904, USA. Tel: (415) 927-1225.

RCF 6000 nearfield monitor

RCF has introduced a nearfield monitor which features a single magnet MF/HF drive unit. According to RCF most studio monitors use separate mid and high frequency drive units which are typically spaced some 4 to 6 in between centres. RCF note that at the crossover point this prevents the acoustic output from appearing as a single source and results in poor source localisation and non-linearity due to phase delays.

The *6000* nearfield monitor addresses this problem by using a single magnet assembly incorporating in 2 in soft dome mid range unit and a high frequency dome together in one unit. The acoustic centres of the units is

2½ in which provides unaltered phase linearity and a clearer stereo image.

The 3-way system also includes a 12 in bass unit with a 3 in voice coil. The monitor will handle 200 W of continuous power, 400 W of programme (IEC-AES standards). Impedance is 8 Ω, sensitivity 90 dB (1 W/1 m) and frequency response, 44 Hz to 20 kHz ±3 dB. Mid range and high frequency attenuators (±2 dB) are provided.

Radio Cine Formiture sta Sede e Stabilimenti, 42029 San Murizuo, Via G Nottari I/A, Italy. Tel: 0522 551840. UK: Court Acoustics Sales Ltd, 29 Beethoven Street, London W10 4LG, UK. Tel: 01-960 8178.

In brief

French production company **Point 12** has just released *Sound Effects Volume 1*. Created by Yannick Chevalier the first volume includes 165 effects stored on two compact discs. The range includes cars, trains, planes, explosions, sirens, animals and synthesised effects. Point 12, 20 Rue Malher, 75004 Paris, France. Tel: 42 71 63 63... **ITT Cannon** (UK) has announced details of a new range of speaker connections—the *AXR-PDN* series. Designed for minimum power loss, the company claims improved performance when used with high quality audio cable. Male and female cord and wall mounting options are available. The connectors will accept cables up to 12 AWG, provide positive polarisation and have optional colour-coded boots for circuit identification. ITT Cannon (UK), Jays Close, Viabes Industrial Estate, Basingstoke RG22 4BW, UK. Tel: 0256 47317... **Electroustic** Ltd has introduced a range of solderless, high quality RF coaxial connectors. The range includes five single-pin connectors and one cable coupler. Electroustic Ltd, Hayward House, Northchapel, West Sussex GU28 9HL, UK. Tel: 042 878 611/2... **Daturr** is offering a range of transit cases under the name of *Transcase*. Designed to afford

protection under adverse conditions (military versions available). The general purpose range includes accessories such as foam inserts and additional tool wallets. Also available are two 19 in equipment cases for rack mounted equipment. Full protection against dust and water penetration to IP65 is standard. Daturr Ltd, Albany Park, Camberley, Surrey GU15 2PL, UK. Tel: 0276 681212/5... **First Order Effects** has introduced four programs for the Eventide *SP2016*. Small Room and Inverse Reverb are packaged together and are available on a single EPROM as are Moving Reverb and Sync'd Repeats. New programs are to be announced on a monthly basis. First Order Effects, 206 West 106th Street, Suite 27, New York, NY 10025, USA. Tel: (212) 864-5491... **Allen & Heath Brenell** has launched the MkII version of the *CMC* desk. Additional features include full cue, talkback and monitoring facilities; better noise performance; versatile sub-group facilities and optional high or low tape machine operating levels. A new dedicated remote controller, the *CMR*, has also been introduced which can synchronise events to MIDI and features interchangeable RAM cartridges with a 10 year memory. □

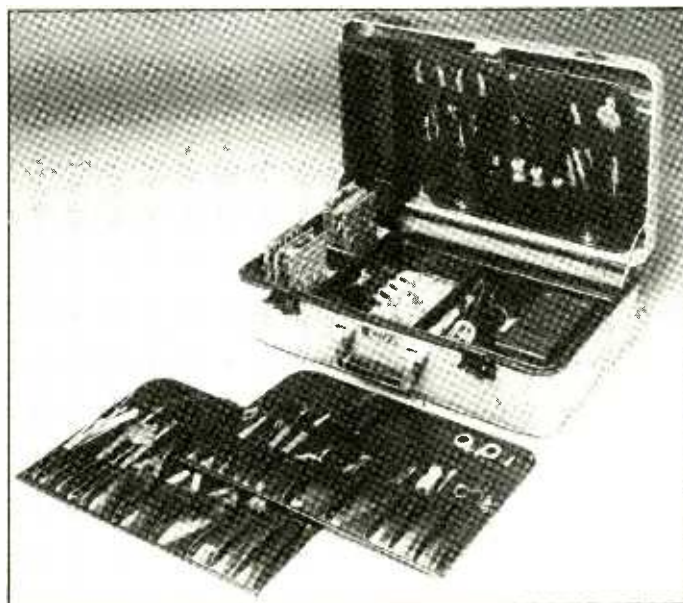

Tool case with PCB safety compartment from Daturr

Pick-n-Mix

MODULES FOR THE MXP-2000

The choice is yours

MXP-2000

FRAMES



MXP-2000

The MXP-2000 is unique. It is unique because you can choose and mix your own configuration of modules to suit your own personal requirements – in minutes. A customised console for a standard console price...

Sony Pro-Audio

Find out more about the MXP-2000 versatility by completing the coupon

Name _____
Company _____
Position _____
Address _____

SS/9/86



Sony Broadcast Ltd.
Belgrave House
Basing View, Basingstoke
Hampshire RG21 2LA
United Kingdom
Telephone (0256) 55 0 11
International +44 256 55 0 11
Telex 85 84 24
Fax G2/G3 (0256) 47 45 85

MUSIC PAGE

MUSIC PAGE

Mark Jenkins on synthesis for the studio

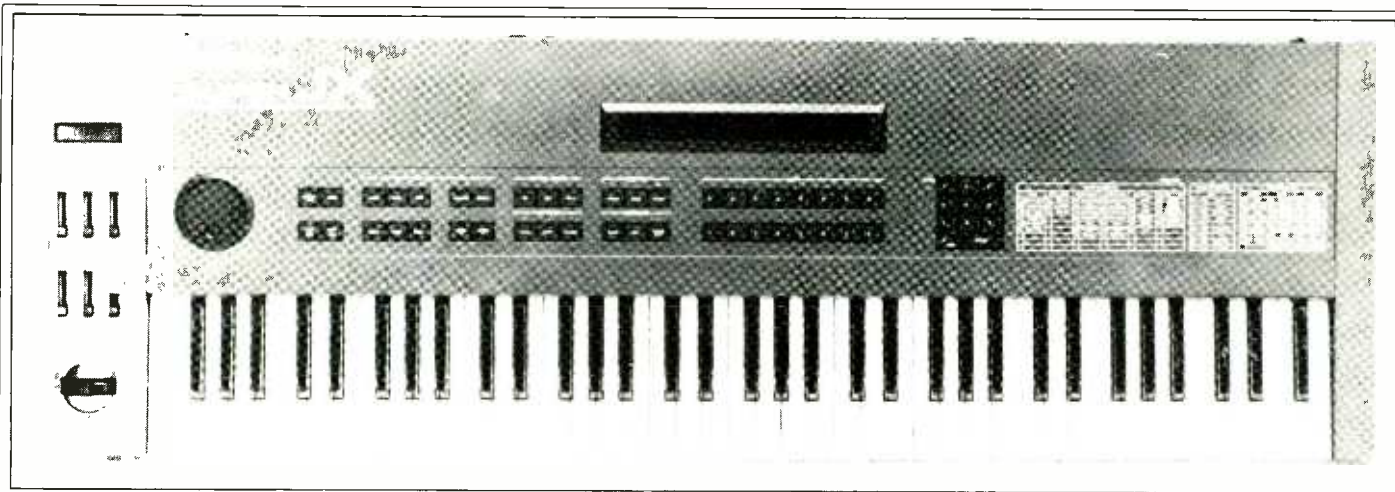

Roland JX-10 dual voice polyphonic synthesiser

Rosetti keyboard stands

Rosetti is now distributing a range of keyboard stands suitable for synthesisers, pianos, sequencers, drum machines and other accessories. The stands feature adjustable height and tilt on all levels, cross-supports on the top level for sequencers such as the Roland MSQ-700 or drum machines such as the Yamaha RX-15, and a braced leg design ensuring the minimum of movement.

Rosetti is selling a complete, range of stands in the UK which represent probably the best value on the market at the moment.

Rosetti, 138 Old Street, London EC1V 9BL, UK. Tel: 01-253 7294.

Oberheim synthesiser

Oberheim has announced *Matrix 6R*, the rack-mounting version of its *Matrix 6* analogue synthesiser. Like the *Matrix 6*, it offers six analogue voices, a simplified version of the Matrix Modulation method developed on the Oberheim *Xpander* and programmable keyboard split point. Also

announced is the *Prommer*, an EPROM programmer doubling as a MIDI-controlled sampler which can prepare new chips for the Oberheim, Linn, Sequential and Simmons drum machines. Sixteen sounds are held in the *Prommer's* memory and it can play multitimbrally, so a suitable sequencer can turn it on to a versatile drum machine.

Oberheim Electronics Inc, 2250 S Barrington Avenue, Los Angeles, CA 90064, USA. Tel: (213) 473-6574.

UK: Sound Technology, 6 Letchworth Business Park, Avenue One, Letchworth, Herts SG6 2BB. Tel: 0462 675675.

Roland JX-10

The *JX-10* is a 12-voice analogue synthesiser with programmable split and several unusual performance features. Its voice architecture is identical to the *JX-8P*, with two oscillators, two envelope generators and one filter per voice plus white noise. Two 6-note polyphonic sounds can be layered or played either side of a split point and four audio outputs allow both sounds, which can operate on different MIDI channels, to be recorded with stereo chorus. The 6½-octave semi-weighted velocity and

pressure sensitive keyboard makes the *JX-10* well suited as a master controller.

Volume and Brilliance can be velocity controlled as can Cross-Fade in Dual Mode. Sixty-four patch memories store one or two sounds, a split point, keyboard mode and all performance settings. There are 64 presets and 64 programmable sounds.

The Chase Play facility holds up to 32 notes for 10 ms to 3 s, repeating them with programmable Level, Dynamics Time Follow and Keyboard Mode (Lower, Upper or Upper/Lower Alternation). Using Chase Play, Dual Mode sounds can be echoed by the synthesiser with the same sound or a different sound to simulate a digital delay, parts can be doubled in a different voice with delay, and unusual cascading effects can be produced.

The *JX-10's* built-in real time sequencer has a storage capacity of 650 steps on the *M16C* RAM cartridge included with the machine. An optional *M64C* cartridge allows you to store 2,600 steps. Single and Loop Play functions, Overdub and Punch In are available via internal or external MIDI clock. The same *M64C* can store 128 patches and 150 sounds.

An Alpha Dial allows access to and editing of all parameters, while an optional *PG800* programmer allows more immediate access to all parameters.

An illuminated 32-character display allows program naming for non-preset sounds and shows the current keyboard mode and parameter values. An optional *DP-2* footswitch starts and stops the sequencer, shifts patches or switches Portamento and Hold on and off, and an optional *EV-5* pedal controls volume, portamento time and sequencer speed. A stereo headphone socket is also provided.

UK: Roland UK, 983 Great West Road, Brentford, Middx TW8 9DN. Tel: 01-568 4578.

USA: Roland Corp, 7200 Downsview Crescent, Los Angeles, CA 90040.

Tel: (213) 685-5141. □

PPM5

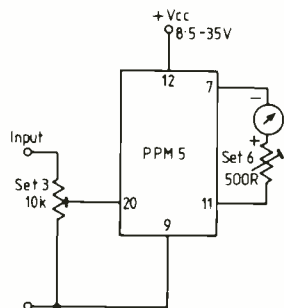
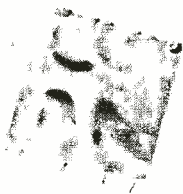

20 PIN DUAL IN LINE HYBRID

Consumption 3mA.
Fully meets BS5428-9

**SURREY ELECTRONICS LTD.
THE FORGE,
LUCKS GREEN,
CRANLEIGH,
SURREY GU6 7BG
Tel. 0483 275997**

MASTER OF SOUND

PETER HANDFORD M.B.E.

"Oscar" winner for best sound for

OUT OF AFRICA

Peter Handford M.B.E., Director of Transacord Ltd., Sound Recordists and Documentary Record Producers masters his location sound on **AGFA PER 368**.

"The choice of recording tape for use with stereo Nagra recorders, on a five month location in Kenya for the film 'OUT OF AFRICA' was particularly important because of the climatic conditions which had to be considered.

Fortunately I had previously used Agfa recording tape in extremely hot and humid conditions in Zimbabwe, when making recordings for one of the ASV Transacord 'Sounds of the Steam Age' records, so I had every confidence in choosing Agfa recording tape once more, for all the location recordings for 'OUT OF AFRICA'."



Agfa understands the requirements of the motion picture film and T.V. industry. Peter Handford demands the best – so should you.

AGFA PER 368 –
*It gives you what you want...
and more.*

AGFA AUDIO
professional

AGFA 

Agfa-Gevaert Ltd.
Professional Magnetic Products
27 Great West Road
Brentford Middx.
01 - 560 2131

Mr Handford accepts
no compensation for
his endorsement.

AGFA GEVAERT-SYSTEMS FOR PHOTOGRAPHY, MOTION PICTURES, TELEVISION, GRAPHIC ARTS, RADIOGRAPHY, VISUAL ARTS, REPROGRAPHY, MAGNETIC RECORDING.

IN PERSPECTIVE

IN PERSPECTIVE

Comment from Martin Polon, our US columnist

This column should serve to confirm the opinion of the most cynical audio professionals out there that this columnist has discovered other uses for tape head cleaner. Get out the suit of armour, Sancho Panza, we go to joust with the windmills of standardisation. Perish the thought—we joust with the most dreaded windmill of all: the concept of a standard for professional digital audio recording.

Everybody in the audio recording industry is aware by now of the two non-compatible systems currently being marketed for studio digital audio recording. A sort of professional audio equivalent of the Space Shuttle versus Ariane. Each of the current digital systems has significant virtues, stated so many times in so many places that we can forgo the experience here. Anyway, the question of any minor quantitative differences between the two systems that might exist is not what this column is about.

This is a difficult time for many recording studios. It seems to be a fact of life in the 1980s that some studios are making money but not showing adequate profits. Many studios have found their rates locked in a to-the-death competition

High finance

with the studio 'across the street' or 'across the city'. One not insignificant impact of the coming of compact disc has been the lessening of recording opportunities for professional studios. The record companies are trying desperately to build up a respectable catalogue of CD titles to offer record buyers some semblance of the historical catalogue of 75,000 LP performances. Catching up with the catalogue means fewer recording commitments relative to past album opportunities for studios. Added to that is the inability for marginal or speculative projects to obtain CD pressing commitments in this era of CD retail shortages. Add to this the presence of more new studios searching for the rumoured profits in the recording industry. Factor out the influence of many artist's home studios and/or synthesiser facilities. The bottom line is that cash flow is very limiting for many studios today when looking at major equipment acquisitions.

The studio operator is faced with two systems competing for the digital audio recording marketplace but in a

marketplace that will not tolerate a poor business decision. A recent survey of studio owners not yet equipped for digital recording found 42% citing the lack of standards and the incompatibility of competing systems as an important factor in their reticence to purchase. Another 32% cited the issue of the high acquisition costs for digital recording equipment.

Today, major studio equipment purchases must be gilt-edged, with virtually no possibility of any problems in returning the full investment promptly. One studio owner on the West Coast of the United States describes the current financial climate facing a studio trying to obtain a loan for the purchase of several capital equipment items including a digital audio recorder for his studio. "I make a living here. I feel like I am an important person in the business of making and recording music. But going to the bank was a sobering experience. My past officer at the bank had taken early retirement. His replacement made me more uncomfortable than I have ever been since the Army. I started to sweat when he asked about the useful life of the several units, the effect of industry

CLEAR REASON

For the music studio owner, no decision is more critical than choosing a console. Both financially and creatively, the success of your operation may well depend on the capabilities and quality of the system you select, and the company that supports it. Clear reason, we suggest, to consider the SL 4000 E Series Master Studio System from Solid State Logic. But certainly not the only reason.



plus switchable phantom power, patchfree audio subgrouping, AFL and PFL monitoring, fader start for external devices,

Consider, for instance, that only SSL has built-in track remotes on every channel, integrated with the industry's most versatile monitor fader and foldback facilities. Or that SSL alone provides pushbutton signal processor routing for each channel's noise gate and expander, compressor/limiter, high and low pass filters, and parametric equaliser —

and stereo modules with balance and Image Width controls.

Consider that SSL makes the industry's only comprehensive studio control system — with integral synchronisation of up to five audio/video machines,



concise English commands, tape location by timecode, foot/frames, cue numbers or key words, and complete session list management. And that SSL alone offers extensive fader, group and mute automation and mix manipulation plus optional parametric equalisation and panning, multi-repeatable Events Control, and Automatic Dialogue Replacement.



IN PERSPECTIVE

IN PERSPECTIVE

trends on artist equipment preferences, my ability to raise rates to cover the expense of the new recorder and electronics. But I could barely speak when he asked about the chance of the recorder or the electronics becoming obsolete before the loan was paid off. I couldn't answer and I couldn't get the loan—not at rates I could afford. I left the bank feeling like I did 30 years ago when I flubbed my first job interview."

Many factors shape the financial burdens of studio ownership today. Something as truly complicated as tax revision in the United States can shape the planning of studio purchases for years to come. The new tax law taking its shape from conferences between the US Senate and the House of Representatives has the potential to change most of the rules regarding tax incentives for equipment and lengthening the write off period. Some tax consultants are fearful that the most advantageous tax position for a studio owner will involve a studio's real estate and not its electronic equipment. A new tax law in the US could also take away incentives allowing deduction of expenses for recording sessions outside the US. Most important, the potential for

significantly lowered tax rates will reduce the write off value of all business expenses for the studio operator (and everyone else).

What is clear is that each of the competing systems for multitrack professional digital audio recording are propelled forcefully by the involvement of several large Japanese consumer/industrial conglomerates. It seems very likely that these multi-billion yen companies, whose names are so close to the tongues of so many of us, do not find professional digital audio recording equipment making a major contribution to their corporate bottom lines. Prestige may well be the real driving factor of professional digital audio recording and by inference, a valued commodity for the consumer market.

There can only be one answer to the conundrum of digital audio recording expansion: adopt an interim standard and do it now. The presence of a single standard 'now' can only mean more sales for all of the competitors in the marketplace. It could mean lower product costs with common VLSI chips developed for the standard system. It will also mean a guarantee of near-term standardisation for all products sold from

this point on. It would provide a common base for creating new digital standards with all those interested contributing technology.

If that cannot happen at this time, the professional audio industry has a financial obligation to co-ordinate new technologies entering the marketplace. The professional audio marketplace does not have the economic wherewithal to support competing standards for the same kind of product. The studios and other users cannot afford to pay for the Battle of the Titans. It seems to be time for the AES, the APRS, CCIR, the EBU, the EIA, the EIAJ, the IEE, the IEEE, the SMPTE, SPARS and any other appropriate group, to sit at the same table to establish standards for new professional audio technology. What is illuminating by contrast is the consumer audio industry which has had clearly defined standards for both digital disc playback (CD) and digital audio recording (R-DAT). In fact, the last time the consumer audio sector allowed competing standards to come to the marketplace was with Quad audio. And that was the closest I ever want to come to seeing the validity of the phrase 'not with a bang but a whimper'. □

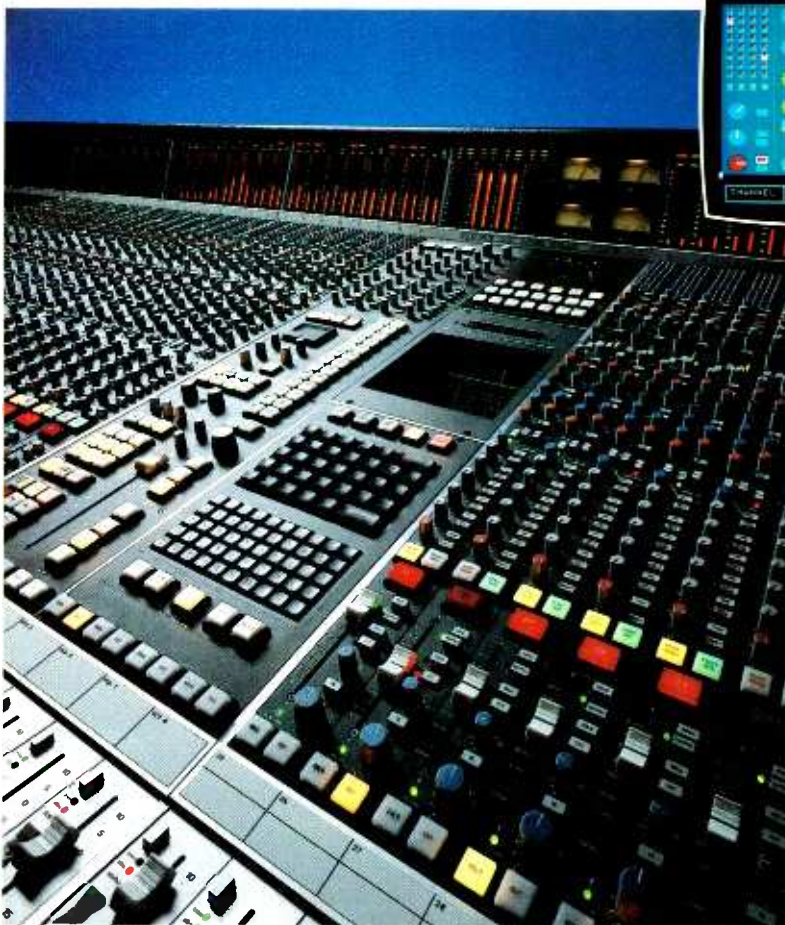

Then consider that SSL's Studio Computer alone goes beyond mixing automation to provide Total Recall™ — a unique system, completely independent of the audio path, which stores all I/O module settings after each session. The new TR AutoScan function makes

it faster than ever to recreate headphone and monitor mixes, equalisation, or entire console setups with quarter dB accuracy and rapid verification. And SSL alone offers data-compatibility with more than 300 installations — in over 80 cities around the world.

Finally, consider a company whose record of practical innovation, ongoing development and in-depth technical support has earned repeat orders from many of the world's toughest customers — a company that other manufacturers use as a standard for comparison. We join them in urging you to compare. Our 40 page colour brochure on the SL 4000 E Series is a good place to start. It's yours for the asking, and it just might make your difficult decision a whole lot easier. Clear reason, may we suggest, to write or call us today.

Solid State Logic

Begbroke, Oxford, England OX5 1RU • (08675) 4353
200 West 57th Street • New York, New York 10019 • (212) 315-1111
6255 Sunset Boulevard • Los Angeles, California 90028 • (213) 463-4444

MIXING CONSOLES

AHB: recently launched the *Sigma 24*, a 24-bus modular console system. It is available in two mainframe sizes with input channel facilities including 4-band swept EQ, six aux sends with fader reverse as do the group/monitor modules. There are two independent foldback systems with multisourcing. The console outputs can run at high and low operating levels for tape machine interfacing. There is an optional VCA fader system providing eight DC groups and auto-muting can be achieved by the use of the SSR control programmer. The SSR will also allow MIDI implementation of muting sequences against song pointers synchronised to other equipment, and up to 16 different MIDI controlled effects can be changed for each sequence event. Muting status can also be changed in real time via MIDI keyboards making the console

A summary of mixing consoles introduced since our last overview

ideal for MIDI based systems.

Other recent consoles introduced include the Mk3 version of the *System 8* which is cosmetically updated as well as having optional electronically balanced outputs, and increased mic gains and fader reverse on the eight output groups.

Akai: not a name that would normally be associated with mixing consoles but the *MPX820* is an 8-channel rack mounted programmable mixer with MIDI compatibility and timecode options. Up to 99 front panel settings can be stored internally or downloaded to tape or computer. Levels, fades, pans, 3-bank EQ, sends and returns, aux inputs and

effects loops can be called up either by button or through a MIDI sequence. Although the basic unit is only 8-channel we understand it is possible to slave units to provide up to 64 channels.

Alice: is now providing four groups (two stereo pairs) on their new portable mixer along with DC subgrouping, noise gate, 4-band parametric and five aux sends (two single, one stereo and a switchable 'clean feed') per channel. In addition to the wide dynamic range (106 dB according to the manufacturer) imaginative use of the VCA's allows adjacent channels to be linked. The new mixer features broadcast-style monitoring, fully balanced inputs and outputs and is designed for theatre, PA, broadcasting and digital recording.

Amek: has released preliminary details of the *Classic*, a general purpose console broadly based on the earlier *M1000* in terms of function, signal flow and controls. New features include optional dynamics on each channel and retrofit VCA faders. Available in 32-, 48-, 64- and 80-input frame sizes, the *Classic* forms part of the new generation of Amek consoles which includes the *APC1000* (see the article in the May 1986 issue) and *BC2*.

Also new is the *G2520* recording console which replaces the *M2500* in-line console which has been in production since 1979. The new console is a radical enhancement of the *M2500* and includes greatly increased signal handling and routing capabilities. Major features include dual I/O modules with improved signal flow; eight aux sends (four mono, two stereo) with extensive control switching; expanded master status and individual channel status indication; separate fader block for optional automation; plasma metering and improved monitor facilities. Two frame sizes will be available—40/24 and 56/48 (usable inputs double with dual input modules).

Audix: has recently introduced the Assignable Audio Mixing System, a series of consoles featuring comprehensive automation. Three standard configurations are currently

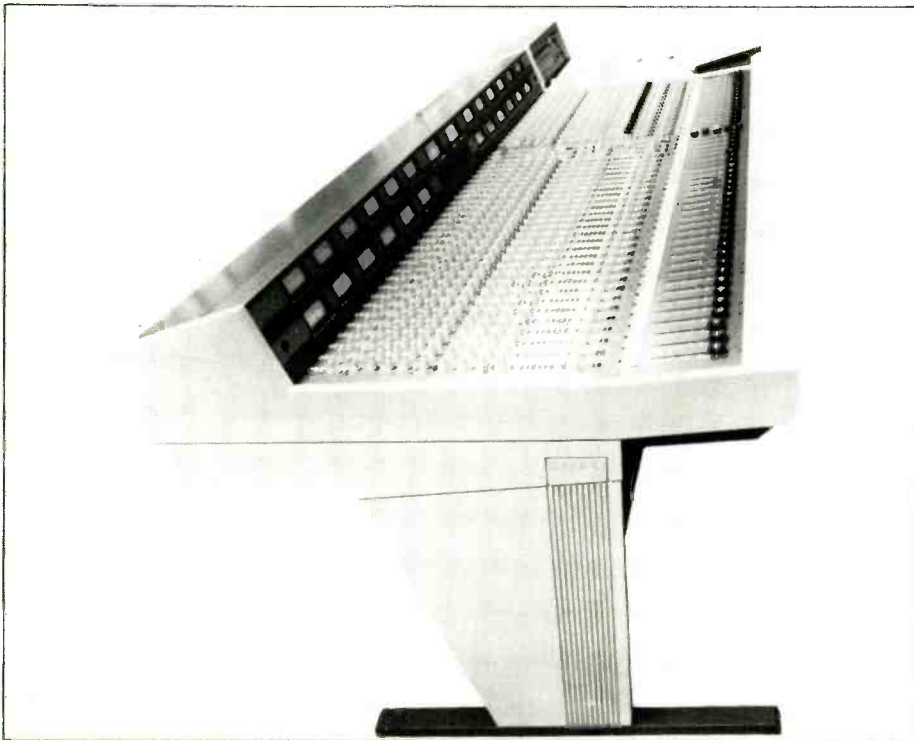

Allen & Heath Brenell's Sigma



New portable mixer from Alice

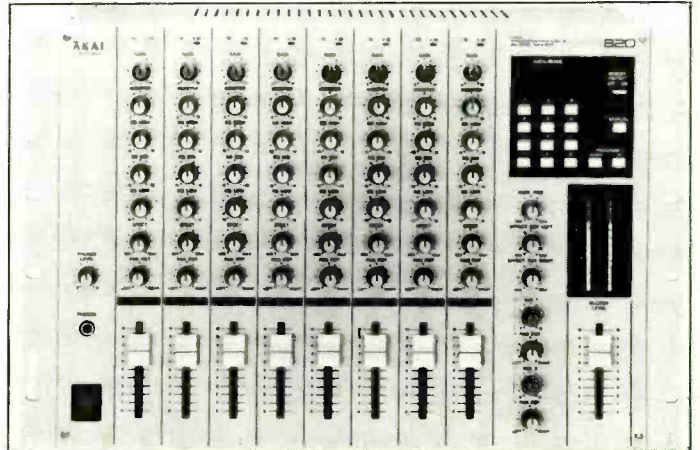

Akai MPX820



NEUMANN

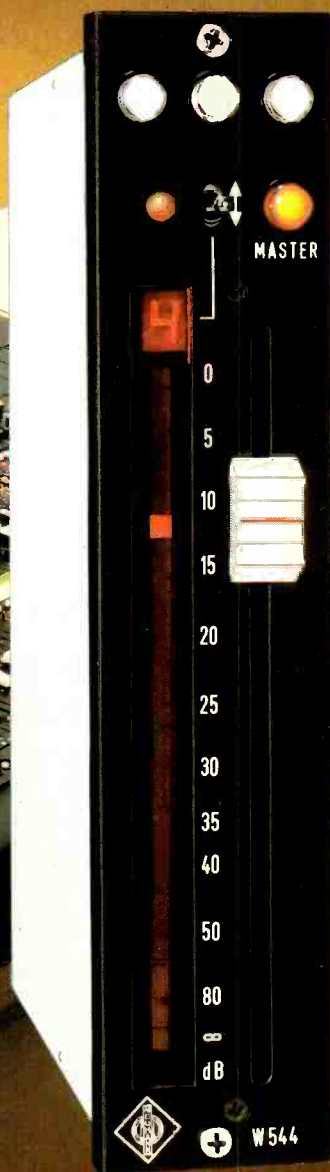

mixing consoles

for 20 years neumann has been building
n 40 standard mixing desks
for stationary applications
n 20 standard mixing desks
for transportable applications
control system of custom design
fader widths of 20 or 40 mm

console components

in standard broadcast cassettes of a1 or b1 size
extraordinary flexibility resulting
from free choice of layout
easy service exchange of modules
during operation
24 v supply voltage

a 500 microprocessor controlled system

ame 591 autonomous, microprocessor controlled
equalizer system central control, memory
storage, master/slave operation
amr 544 autonomous, microprocessor controlled
fader system, master/slave formation
without level jumps, max 10 groups
prepared for automatic mix-down

let us custom design a console for you

AUDIO EXPORT GEORG NEUMANN & CO GMBH

Badstraße 14 · Postfach 1180 · D-7100 Heilbronn · Tel. (0 71 31) 8 22 7 5
Telex 7-28 558 audex d · Cables Audioexport



741 Washington St., New York, NY 10014
(212) 741-7411
West Coast Sales Office
(213) 841-1111

MIXING CONSOLES

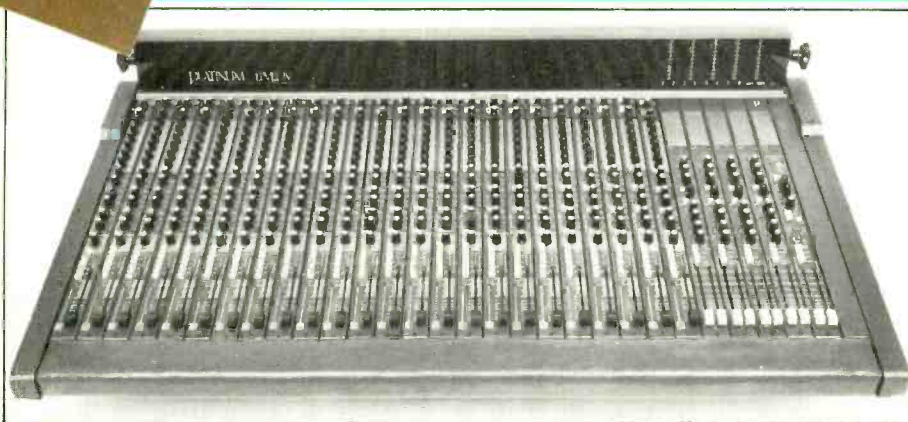

Platinum Level IV

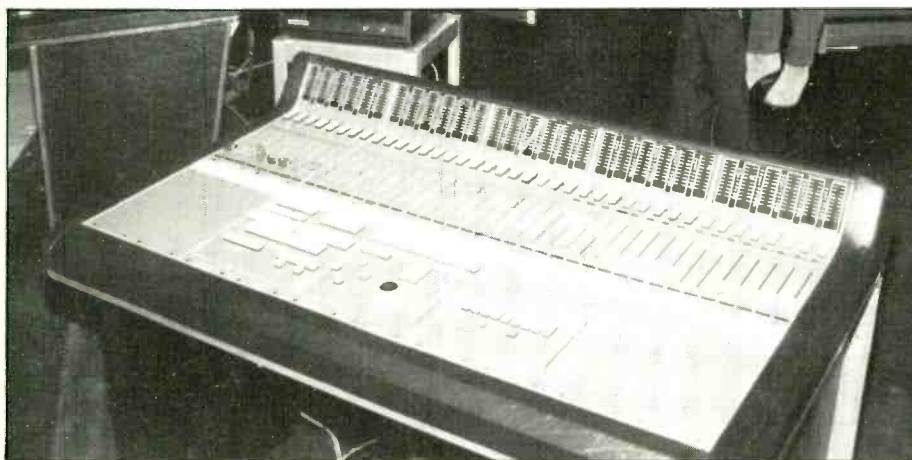

Saje Memory

available—the *AAM24*, *AAM32* and *AAM48*. Systems with up to 100 inputs, 36 groups and eight outputs can be made to special order. Key features of the *AAM* console include automation of all functions including optional fader automation, recall of up to 20 whole states, central control of all channel/group controls, and reduced console size enabling, for example, all controls on the 100-channel version to be within comfortable reach of the operator. This latter feature is achieved by mounting the analogue circuits in remote racks with coaxial links to the console. Channel parameters include phase reverse, low/high pass filters, 4-band EQ, pan, 4-group routing, and six aux sends.

DDA: has introduced a new version of the *S* series console, the *S* series PA with 4x4 output matrix, eight equalised sends and four equalised auxiliary aux/foldback returns. Introduced earlier this year was the Theatre Input module for the *D* series consoles. Featuring independent mic and line level controls the module has individual subgroup routing switches with the signal selectable direct or via the panpot and access to all eight aux buses simultaneously.

Harrison: the APRS exhibition saw the first public demonstration of the Harrison series *10* console with the fully operational hard disk automation system. All parameters of the console are capable of being reset by the *HDA-10* automation system without operator intervention.

There are three automation modes: *Save/Recall* which resets the console to a previous configuration in less than 3 s; *Snapshot* suitable for live TV and theatrical use where the program can be used to recall set-ups in less than one video frame; and the *Auto* program which provides for dynamic, sub-frame accurate, real time automation of all parameters including levels, muting, pans, equalisation, dynamics and signal routing. Four systems have been delivered so far with several more due by publication time.

Midas: has launched a new console series, the *XL* range. Available in 24-, 32- and 40-input formats the *XL* has in addition to 4-band EQ, full metering on all inputs and gold plated contacts on every switch, eight auto mute groups, eight aux sends/returns and transformer balanced inputs with electronically balanced outputs (electronically balanced inputs and/or transformer balanced outputs can be specified). All buses are accessible allowing easy console linking and a special 16-input stretch console is also available. Customers can also specify multiway connector systems if required.

Mitsubishi: is now in full production with the *Westar* console which is available in 20, 28, 36, 44 and 52 input/output options. The *Westar* uses eight input/output modular frames, modular meter and patchbay sections and features interchangeable plug-in equalisers, preamps, VCAs and faders. EQ options

include basic 4-band EQ, 4-band parametric and 10-band graphic. Four different fader systems are available with the *Westar*—conventional straight line fader, VCA with eight group masters, automated fader with tape automation system and IDF (Intelligent Digital Fader) with or without the *Compumix IV* 80 Mbyte hard disk automation system.

Neotek: the most important introduction is the *Elite* console which is reviewed within this issue. This is a console available in mainframe sizes from 28 to 56 channels based around the in-line type concept but with dual signal paths in the input modules and optional stereo line input/subgroups.

Neumann: continues to offer a custom design service in addition to their *n40* and *n20* (portable) range of consoles. Options include microprocessor controlled EQ system (*ame 591*) and automated fader system (*amr 544*).

Neve: has introduced two new analogue consoles this year. The *V* series is based on the Neve *51* range and developed from a number of custom consoles ordered over the past year. Using the latest technology the console is a full 48-bus multitrack design featuring individual channel dynamics (lim/com/gate) with external keying, a unique solo system and up to eight mono (four stereo) cue/reverb sends. The cue system has been designed to ease overdub or post sync recording. The *V* series is available in 36-, 40- and 60-channel frame sizes.

The *8232* is the latest console and is an in-line console providing 32 input channels and 24 mix buses. Neve's Formant Spectrum Equalisers are used in the EQ section and both filters and EQ can be independently assigned to either the channel or monitor path. One stereo and four mono aux outputs are provided and each can be programmed to receive either multitrack or mixdown signals. Input channels can also be programmed as effects returns and as an additional option two stereo effects return channels can be fitted. Instant reset of all track assignments is provided by the on board solid state memory. The *8232* can be supplied with manual faders, VCA faders or the *Necam 96* automation system.

Platinum: has a new range of modular consoles under the name *Level IV*. Frame sizes are designed for 22, 30 or 38 units, each unit being 1½ in wide and 26 in deep. Two input and two output modules are currently available and all modules are interchangeable. Mic/line inputs offer 4-band EQ, monitor EQ is 3-band.

Saje: continue to develop SARP their sound processing concept designed to control sound parameters from a centralised command position. The *Memory* is the first Saje console to feature SARP. Effectively the console is 'visualised' on a TV monitor. The *Memory* console includes 40 motorised linear faders, three keyboards for function switches, an alphanumeric ASCII type keyboard, high resolution monitor, floppy and hard disk drives, memory card reader and modem.

The *Memory* is available with 8 to 128 mic inputs (switchable A/B); 8 to 128 line inputs and from eight to 64 outputs which can be 'seen' by the internal

Neve. We never compromise.



With the coming of the digital age to music recording, there's a new, critical awareness of sound quality. A new era of no-compromise.

This has meant the need for an unusually high signal path quality and technical performance in sound mixing.

To help meet this demand, and after a careful research and development programme, Neve has introduced the V series consoles.

A recording system that employs sound engineering principles, state of the art technology and years of acquired expertise to advance analogue techniques to their outer limits

The facilities and flexibility of the

V Series, especially when combined with Neve's computer mixdown system Necam 96, allow all the normal track-laying, overdubbing and mixdown functions to be easily and expertly handled.

And we believe that the clean, musically sympathetic quality and ultimate performance of these consoles will never compromise the finest of your recordings.

If you would like to know some of the ways in which you need no longer compromise, why not give us a call?



 **Neve**

The Ultimate Performer

A SIEMENS COMPANY

NEVE ELECTRONICS INTERNATIONAL LIMITED, CAMBRIDGE HOUSE, MELBOURN, ROYSTON, HERTFORDS, HIRE, SG8 6AU, ENGLAND. TELEPHONE (0763) 60776. FACSIMILE (0763) 61886. TELEX 81381.
RUPERT NEVE INCORPORATED, BERKSHIRE INDUSTRIAL PARK, BETHEL, CONNECTICUT 06801, USA. TELEPHONE (203) 744-6230. FACSIMILE (203) 792-7863. TELEX 96 9638.
RUPERT NEVE INCORPORATED, PO BOX 40108, NASHVILLE, TN 37204, USA. TELEPHONE (615) 385-2727. TELEX 786569.
RUPERT NEVE INCORPORATED, 7533 SUNSET BOULEVARD, HOLLYWOOD, LOS ANGELES 90046, USA. TELEPHONE (213) 874-8124. FACSIMILE (203) 874-1406.

MIXING CONSOLES

software as aux sends, stereo subgroups or main outputs. Input modules feature two mic inputs (A or B), one line input, phase reverse, remote start/stop of effects and various routing options. EQ is 4-band parametric with low/high pass filtering and EQ on/off. Other features include PFL with 10-segment LED

metering (VU) and channel number, instant manual reset of motorised faders and storage of up to 8000 complete console settings.

Seck: has introduced two new mixers. The 242 is a 24-channel stereo mixer similar to the other 6- and 12-channel consoles within this range. The other

Sony digitally controlled MXP-5000 prototype



Soundtracs MC monitor console



console is the 1282 which is essentially a stripped down version of the established 1882 with a reduced number of channels and the omission of 16-track routing.

Sony: has developed a successor to the JH600 console. The MXP-3000 is designed for digital recording and although it is unavailable in Europe it can be ordered in the USA. The console is based on a 20- or 36-input frame and features a tape-based automation system with infra-red controller. A 10 Mbyte hard disk system (ADS-3000) is also available. The console features oxygen-free internal wiring, low noise hybrid amplifiers, gold contacts and connectors, a modular jackfield, and is claimed to have better than average noise figures.

Currently in use in Japan is the MXP-5000, a prototype 24-input digitally controlled console. As things stand it is doubtful if the 5000 will be sold outside Japan although no doubt it is providing a useful test bed for future console developments.

Soundcraft: has introduced a number of new consoles mainly in the form of developments from existing models. The recent APRS exhibition saw the introduction of the TS12 in-line console. This uses much of the technology of the established TS24 and will be available in 24- and 36-channel configurations with 12-group buses, and is configured for 24-track recording. The design allows separate subgrouping—six stereo subgroups for the mixdown without additions to the console. Channel facilities include 4-band EQ, six aux sends and two mute groups. Delivery will begin in the last quarter of this year.

Other new consoles include the series 200SR which is a dedicated sound reinforcement console available in 8-, 16-, 24- and 8-channel rack mounting configurations; and the series 8000 console developed for touring and fixed installation in the live sound market. This will be available in frame sizes of 24, 32 and 40 channels with full 4-band parametric EQ, eight aux sends and comprehensive talkback facilities. Also introduced has been a version of the series 600 with a patchbay. This addition has allowed the design to expand to cope with 24-track and even 32-track applications.

Soundtracs: has introduced three new products this year. The MC series is available in 32-10+2 and 24-10+2 formats and is primarily designed for monitoring applications. Recently released is a new range of 19 in rack mounted modular mixers. Applications include broadcast, stage monitoring, 4/8-track recording, sound reinforcement, keyboard mixing and video post production. The latest console, the CP6800, is a development of the CM4400. It uses the CM4400 modules and includes the CMS2 interface, computer and TV monitor in a completely integrated and cosmetically restyled package.

SSL: has recently introduced two new refinements that can be retrofitted to all E series consoles and will be part of the 5000 M series broadcast consoles. The first is a series of improvements to Total Recall—Advanced Total Recall with AutoScan will allow the storage of more than 10,000 controls to an accuracy of

better than 0.25 dB in less than 5 s. There will be more detailed graphics displays which are also generated more rapidly. *Total Recall* has also been extended to incorporate memory of control group assignments. The *AutoScan* feature allows the computer to detect any controls that differ from their previously stored configuration and displays them for matching. As the adjustment is made the system sequences to the next relevant display, *AutoScan* can then be used to check that all changes have been made.

The second introduction is liquid crystal bargraph metering. Similar in appearance to the established orange plasma bargraphs, brightness is continuously adjustable and may be balanced against ambient lighting. The system is microprocessor controlled and provides switchable input sensitivity with a +24 dB range at the top of the scale. The 80-segment displays are generated by selectively blanking the required number of segments in an LCD element letting incandescent backlights through. This metering is available for all *E* and *M* series consoles.

Studer: was showing a prototype version of the *970* console earlier this year. The console is based on the on-air frame format and can be configured in many standard versions with each base frame accommodating nine 40 mm modules. The modules themselves are expanded versions of the *961/962* series modules and the input modules have been enhanced with three low noise control buttons and a flexible internally programmable logic circuit. Three or four

base frames (including a producer/script area) are typically combined to form a complete console.

The *961/962* series was introduced earlier this year. Modular in construction the mixers are designed for use in video production, radio and remote recording. The *961* series uses 30 mm modules accepting up to 40; the *962* will accept up to 20. Both compact mixers offer stereo line level input modules either with or without 3-band EQ and master input modules featuring PDM (Pulse Duration Modulation) compressor/limiter. Other features include new faders with improved glide characteristics, click-free muting, FET switching and electronically balanced insert points.

Also shown earlier this year in prototype form was the *963* production console. Drawing on both the larger *900* and the compact *961/962* series, the *963* is designed for use where large frame capability is needed in a confined area. Based on the 30 mm system the console is available in high density configurations from 16 to 40 inputs. The 40-input version being just 6½ ft in length and providing four stereo subgroups and two stereo masters. Balanced inserts, video switcher interface, direct outputs and patchbay are all standard.

Studiomaster: has introduced the series *11* console with MIDI-controlled muting of aux returns and input channels. Up to 32 input channels can be used in the basic frame (using 8-channel expander sections) and the 16/8/2 and 16/16/2 can be expanded to monitor 16- and 24-track tape machines respectively

by means of a new retrofit addition. Other new features include pushbutton output level selection (+4 dBm/-10 dBV); tape remix function plus separate control room and studio cue mixes.

TAC: is due to release a sound reinforcement 'superconsole' later this year. The *SRS9000* as it will be known is intended to satisfy the needs of large touring hire companies and theatre installations. The console will feature extended subgrouping facilities including 16 mono audio subgroups and eight VCA DC subgroups; eight aux sends selectable across 16 aux buses; eight mute groups (with Mute Safe switching); 4-band EQ (parametric mid); matrix output (16×8) and onboard jackfield. The standard configuration will be 40 electronically balanced mic/line inputs, 16 mono subgroups and separate stereo bus.

Trident: principal development has been the introduction of the *DI-AN* console at the APRS. This is a digitally controlled analogue console that is fully assignable. For example the concept of the channel strip has been dispensed with and there are central panels for EQ and dynamics, etc. These panels are selected to individual channels by hitting the access button above the channel fader. The console has no knobs and can not only store complete console settings but also update settings against timecode from its onboard memory. Console information may be downloaded to floppy disk which is integral to the desk. We understand that orders have already been received for two consoles. For more detailed information please refer to the article in the June 1986 issue. □

PPX AMPLIFIERS

CITRONIC

**A SIGN
OF
QUALITY**



Technically superior and totally dependable high quality power amplifiers.
PPX, better performance.

The new Tr



As we hoped, it's creati

WHEN WE LAUNCHED our revolutionary new Di-An console at the APRS show in June, we expected to cause quite a stir:

But we were taken aback by the absolute surge of interest that took place at Olympia and which has continued ever since. Resulting in a flood of enquiries, and even firm orders sooner than we ever thought possible.

What has been responsible for this reaction?

Perhaps it is our complete rethink of console operation and ergonomics, which has produced a console far more compact than ordinary machines,



ident DI-AN.



ng a tremendous buzz.

with only a fraction of the switches.

Perhaps it is the Di-An's awesome control and storage power. Which simultaneously frees the operator from many time-consuming routine tasks and gives considerably greater creative scope.

Perhaps it is the supreme sound quality, made possible by having a conventional analogue signal controlled by a unique digital method and by routing the audio signal away from all the front-line controls.

We don't know. Presumably different people have been particularly impressed by different aspects of the Di-An.

But we do know that if you're thinking of getting involved with digital audio and haven't seen or heard the Di-An yet, you should call Trident on (0932) 224665 and find out what the buzz is all about.



TRIDENT AUDIO DEVELOPMENTS LTD
Trident House, Rodd Industrial Estate, Govett Avenue, Shepperton, Middx TW: 7 8AQ.
(0932) 224665 Telex 8813982 TRIMIN G
Trident USA Inc., 308 N Stanley Avenue, Los Angeles, 90036 USA
(213) 933 7555 Telex (255) 5106000019

STUDIO FILE

STUDIO FILE

Trans/Audio opened its new re-recording theatre, Studio C, in January. The new theatre is the centrepiece of the company's major expansion programme; when completed the complex will provide film and sound post-production services for television, documentary and feature film producers.

Until last year, Trans/Audio comprised five floors in an unassuming building on 254 West 54th Street (midtown on the west side of Manhattan). For the past 13 years, these floors have been home to 35 mm film editing rooms, several sound transfer rooms, edge numbering facilities, two recording theatres, an expanding sound effects library, maintenance shops and administrative offices required to keep the complex running smoothly. Owners, brothers Jack and Dick Vorisek and Mark Wortreich formed the company in 1973 after deciding that a better equipped post-production facility for film makers was needed in New York City. It was not a new venture for any of them.

Dick and Jack Vorisek started in the business in the late 1930s and early 1940s respectively as audio technicians for Reeves Sound Studios. By the time the two departed to form their own company Reeves had become one of the largest independent sound and video recording facilities in the world. The Voriseks have gained international reputations for themselves: Jack as an administrator and authority on recording, Dick as the 'dean' of American motion picture sound mixing. In the early 1970s, they decided to open their own recording facility, with plans to expand into complementary film production services. At this time the brothers met Mark Wortreich, who had started as a film technician in the early 1950s and gone on to form several film production companies. Wortreich was dissatisfied with the quality of sound for film and wanted to expand his services to include quality sound mixing.

"It seemed like the ideal marriage," commented Jack. Since opening, the facility has catered primarily for the

Trans/Audio, New York

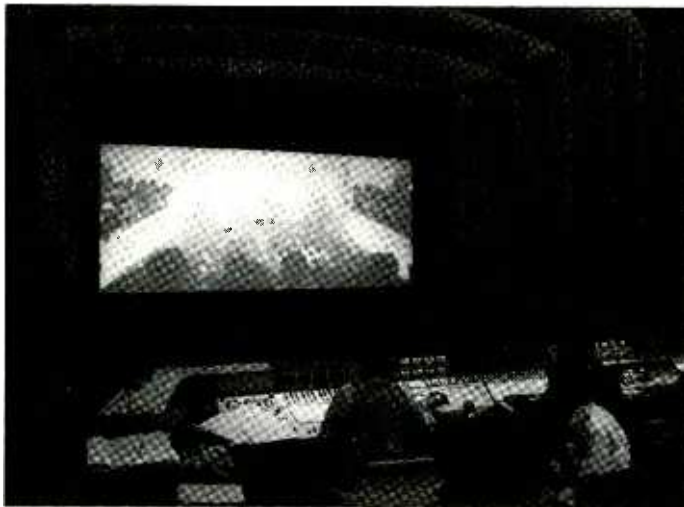

Post-production in Studio C

feature film, television and documentary film producer, though it welcomes commercial, industrial and educational film producers, as well. Clients include all the major film studios and television networks: the list of credits features recent films *Reds*, *All that Jazz* and *Arthur*.

The film industry has flourished in New York City in recent years, so Trans/Audio found itself needing larger premises and more sophisticated equipment. The first move was to lease the top two floors of a building across the way at 259 West 54th Street, doubling their space. Next they designed new facilities.

What the company wanted was a 'state-of-the-art' facility—no expense spared: \$4 million was spent completing the top floor; approximately another \$2 million was allocated to finish the lower floor.

Work started in July 1984. Jeff Cooper was hired as architect and designer; the company also worked closely with Max Siegel Associates, the architects of the building owner, thus heading off any potential difficulties with the landlord. Chief engineer Ernie Machanic worked on the layout, trying to incorporate everyone's suggestions and needs, and saw the project through to completion.

Earlier this year when we visited the top floor had

just been completed, the paint still drying in some places. Studio C is centred roughly in the middle of the floor and surrounded by hallways on three sides and a machine room on the fourth. Various offices, maintenance shops, sound transfer rooms and editing suites are to be found off the hallways, along with kitchen and toilet facilities. The lift opens on to a long window lined lobby. At the far end of the lobby, a hallway opens to the left which skirts the rear of the theatre.

Access to the theatre is via two entrance ramps at the rear, one on each side. Also at the rear of the room is a storage area and a producers' lounge. The latter is equipped with speakers and a viewing window. Above these rooms is the projection room. In front of this is a large comfortable lounge area. Down a level is the equipment rack (which is referred to as a 'jack bar') and console, 14 and 26 ft wide respectively. There is a parquet floor. In the theatre, another lounge area is situated in front of the console and from here the floor slopes down in gradations, like a cinema, to the screen. About 40 cinema-style seats fill this area.

The floors are carpeted with golden brown rugs and the walls are covered with floor-to-ceiling oak panels which hook into recessed ceiling panels. The theatre measures 70 ft by 40 ft, and the ceiling height

ranges from 19 ft at the rear to 24 ft at the screen end of the room. The screen itself measures 32 ft by 13½ ft. Visually, the room leaves a warm and calm impression; acoustically, it approximates a movie theatre—reverberation time is about 0.6 s.

Acoustic treatment is by low frequency slot (or slat) absorbers. The walls consist of panels that protrude into the room at 30° angles with roughly seven panels to a side. These panels are made of 4 in by ¾ in oak strips with 1 in spaces between strips; they are backed with membrane resonators of ½ in plywood. Each panel hooks into a recessed ceiling diffuser made of cloth and glass fibre. Wall and ceiling recesses are filled with lights creating pleasant, indirect lighting.

The room was carefully documented in each stage of construction. The designers took full advantage of the top floor location: the roof was raised to give the room its high ceiling. This removed all the structural pillars. The room is entirely floated: the walls are a sandwich of 12 in solid cement blocks, 4 in airspace, insulated steel stud walls, ¾ in plywood, ¾ in homosite and ¾ in sheetrock. The floors were cut up to lay in conduits and then cemented. Isolators with reinforcement crossbars were installed and 4 in of concrete was poured over the lot. The ceiling is similarly isolated. Air conditioning, central heating and electrical power systems are separate from the rest of the building.

The console was delivered in a 26 ft long crate, lifted by crane to the roof and lowered through a hole in the studio wall, wisely left unfinished for the occasion. The unit consisting of two pieces—jack bar and console—was custom built for Trans/Audio. Chief mixer Dick Vorisek and chief engineer Ernie Machanic collaborated with Quad Eight and the Mitsubishi Pro Audio Group on specifications. They needed a console that would operate efficiently in real time, which would also allow flexibility in reconfiguring for changing film formats and mixing. The console can handle all the standard film formats: 6-track 70 mm,



by **quad eight**
Designed and built in U.S.A.

“It outperforms that well-known console, for much less money.”

Compare features, specifications, sonic performance and dynamic automation options, and you'll agree. Key features: Fully parametric EQ on *all* 4 bands. *Eight* echo/cue sends. *Dual* stereo mix buses. 60 segment LED meters with *spectrum analyzer*. 24 track monitor, from 20 to 60 inputs. *Field expandable* frame. *Three* levels of automation options.

Typical performance: Transformerless +28 dB outputs. EIN at -129 dB. Output noise at -86 dB. IM distortion at 0.02% with VCAs. Crosstalk at -80 dB. Wide band frequency response. Excellent RF immunity.

With prices starting at less than £35,000, it all adds up to a professional studio console system offering an unequalled performance/price ratio. Call or write for our comprehensive brochure.

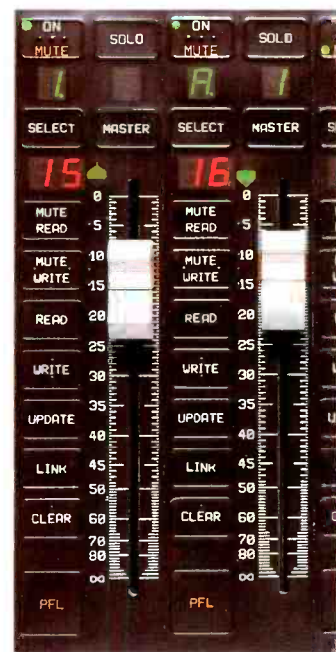

Optional IDF Faders

 **MITSUBISHI PRO AUDIO GROUP**

DIGITAL ENTERTAINMENT CORPORATION

Headquarters: 225 Parkside Drive, San Fernando, CA 91340 • Phone (818) 898-2341 • Telex 311786
New York: Suite 1530, 555 W. 57th Street, New York, NY 10019 • Phone (212) 713-1600 • Telex 703547
Nashville: 2200 Hillsboro Road, Nashville, TN 37212 • Phone (615) 298-6613
Canada: 363 Adelaide Street E., Toronto, ONT. M5A 1N3 • Phone (416) 865-1899
United Kingdom: 1 Fairway Drive, Greenford, MIDDY UB6 8PW • Phone (01) 578-0957 • Telex 923003

STUDIO FILE

STUDIO FILE

6-track Dolby (with or without split surrounds), 4-track normal or wide stereo, three-to-five stereo mode and combined mode; all selectable via a single mode switch.

The console has three separate mixing positions for dialogue, sound effects and music, running left to right. Each position has its own custom designed angled control 'turret' which presents all the controls in an easy position for the engineer. Designed specifically for 6-track stereo recording, the console has 48 inputs: 12 for dialogue, 21 for effects and 15 for music. Four dedicated 6-track mixer inputs allow predubs (bringing the total number of inputs to 72); each of these can be switched to take two 3-track machines or to give a mono six-in-one mix of input signals. As for outputs, each mixing position has its own set of outputs, with two buses available for cross-transfers among the positions. There's also separate composite outputs for each, a mono composite output, and separate 6-channel music and effects outputs.

Automation is (or soon will be) provided by a Quad Eight *Compumix IV* computer automation system, due to be installed this spring. The system was developed and funded by Trans/Audio along with three other film studios—Universal, MGM and Burbank. The first system was installed at Universal, where any problem will be dealt with.

Jack explained the advantages: "We can mix the sound here and then send it off to one of the other studios with a disk to program their

Trans/Audio, continued

computer to match ours—it allows interchangeable mixing among the studios, even though we all have slightly different equipment."

Behind the console is the jack bar which contains patchbays and a variety of signal processing equipment—reverbs, limiters, Dolby noise reduction and so on. A special trough was cut into the floor between jack bar and console, in which sits all the wiring that runs between the two.

Theatre speakers consist of the Lucasfilm *THX* system of five speakers installed behind the screen which use JBL components and the Lucasfilm crossover; they're biamped with Crown *PS400s*.

Additionally there are two JBL subwoofers underneath the screen and eight surround speakers, all Boston Acoustics *A150s*, three on each side in the walls and two on the back wall.

The projection booth has two

MagnaTech combination 16/35 mm machines and two Century 35/70 mm for continuous projection. The machine room borders one side of the theatre. This room houses a variety of MagnaTech high-speed machines: 40 reproducer track machines (or 'playback sprockets') with expansion room for 96 and four recorders, with room for eight more. Various racks hold MagnaTech interlock control units, Dolby units and some exquisitely wired patchbays. There are also patches to four studios and Studio C.

A quick look at the lower floor completed the visit. This floor is still a shell although it has been completely wired. Plans for this floor include two theatres: Studio D will be a smaller version of Studio C, and Studio E will be an ADR and Foley room. The rest of the floor will house offices, sound transfer rooms, the edge numbering department and

small audio sweetening for video studios.

During the visit, the first client was already in, busily mixing. Staff and owners are breathing a sigh of relief. "We had to push to be ready this week—Ron Howard had booked us to mix the sound for his new film, *Gung Ho*. I was in doing some last minute painting this weekend," said Jack. Staff for Trans/Audio is surprisingly small—a total of 28 full time staff, five of whom are maintenance engineers.

The facility operates Monday through Friday from 9 a.m. to 6 p.m., although they run weekends and nights when necessary. "This is the last stop in the production line for films. After we mix the sound and make a developed sound negative, it's sent off to be put together with the picture negative and composite prints are made and sent out to your local cinema. If there's been filming delays or whatever along the line, we tend to get squeezed," explained Jack.

Future plans include finishing the lower floor. Business is currently good. "We've been working with the same clients on picture after picture. With our new facilities, we hope that more producers who shoot here in New York will complete their films here too. And you know this business, we've got the best facility around for the next 15 minutes—until someone takes what we've got and adds to it."

Kathleen White

Trans/Audio, 254 West 54th Street, New York, NY 10019, USA. Tel: (212) 265-6225. □

Three separate mixing facilities on console

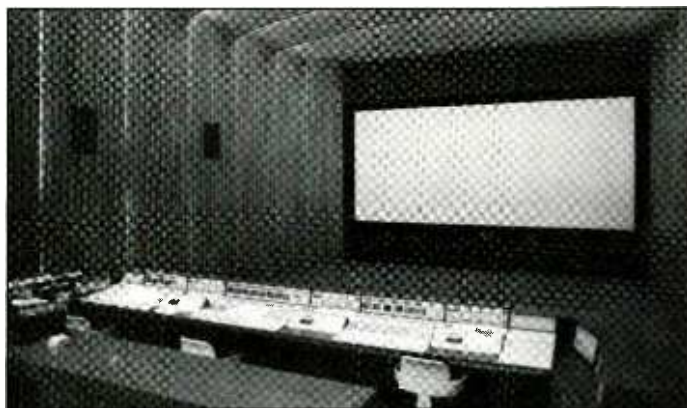

Greece is not renowned for her contribution to the European recording world, mainly because there are not many recording facilities. Those that exist are, for the main part, pretty small affairs dealing with a local market. It has come as rather a surprise therefore that George Tachiatis, an Austrian/Greek classical musician, has built an extraordinary complex in the middle of Athens where it stretches skywards in stark contrast with the more typical buildings on either side.

With typical Greek bravado George explains: "It is my first studio and it is the first

Sound Studio Athens, Athens

studio in Athens!" Not quite true but still. "Four years ago I stopped playing and I had this dream: to bring to Greece the best studio and I think I have done this."

The new studio is intended to fill several gaps they perceive in the market. Attempting to be all things to all men it is sizeable enough to cater for film music as well as rock and Greek music. Merely the first step on the road to success, future plans are to install audio/visual facilities to cater for cinema,

television and video productions; the building itself has been constructed with all this in mind.

"In Greece there are many small studios but they are not good, a problem for the musicians." It also means that they are, for the main part, ignored by non-native recording artists.

Building a facility such as this in Greece is a major undertaking, not least because of the horrendously high import taxes which are levied on recording industry-related

goods. Building techniques apparently can be doubtful, shall we say. The necessity for a solid structure to cope with the demands of isolated and insulated rooms is often outside the general experience of the average builder and a great deal of careful planning had to be carried out.

Difficulties apart, designer David Hawkins of Eastlake was faced with an unusual list of requirements: a studio for a musician who has ideas about the rooms to suit his own personal needs which should at the same time incorporate a lot of space for its film work

Are you making a sound investment?

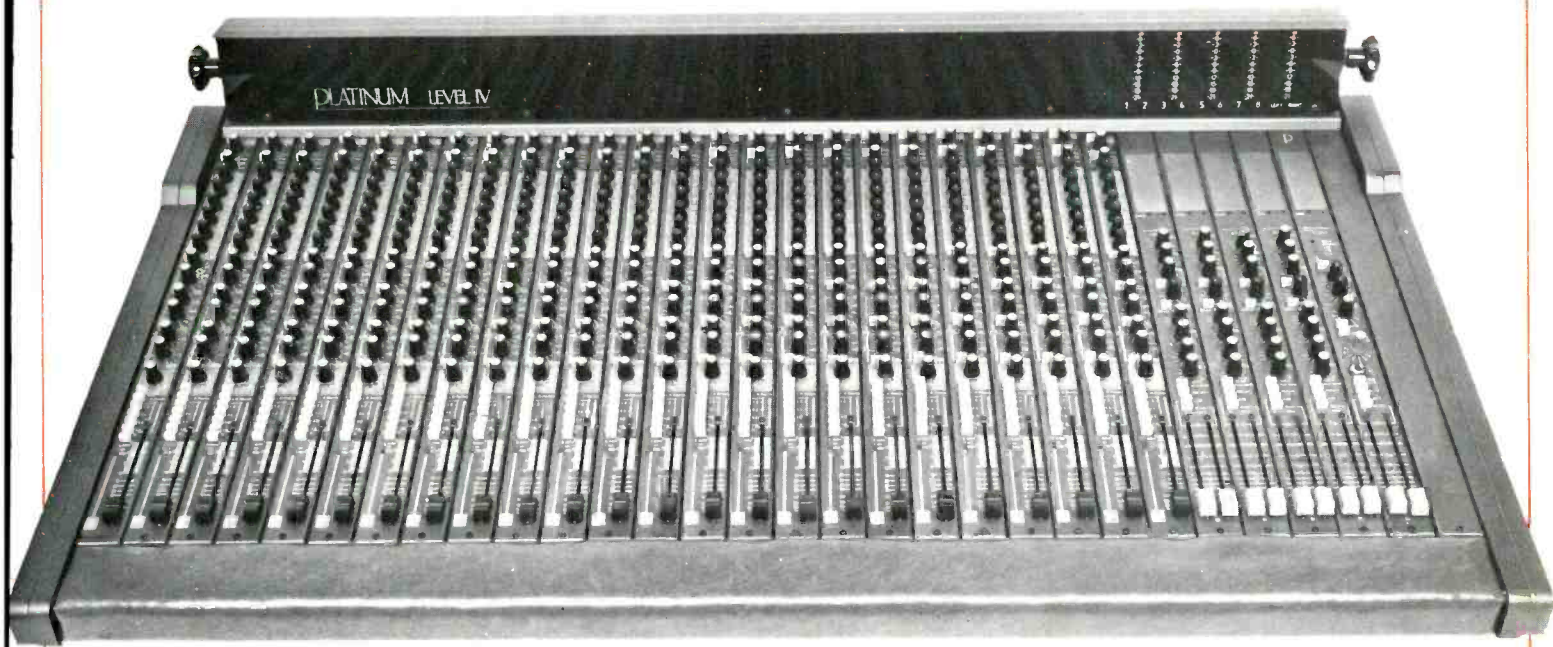

Platinum is a new name in the audio industry but it has a pedigree second to none.

Modular mixers come in all shapes and sizes but we at Platinum thought that it was about time that an 'In Line' based console should be available and affordable.

The unique module construction allows the modules to be made more economically and makes the frame construction more rigid. Modules can be changed in seconds and even serviced while still connected to the main frame.

Level IV is the first range to be produced and Levels III and V are on the drawing board. Level IV is basically configured as an 8 track desk although with split bussing it can be extended to 16 tracks.

Main frames come in three basic sizes (A, B, C,) to allow for 16, 24, 32 inputs + Mastermodules + 1 spare. Stabilized power supply units are external 19" rack mounting.

Meter bridges are available for all models and have bar graph displays for each channel or masters in any configuration.

If you require further information please don't hesitate to contact us.

PLATINUM

159 PARK ROAD,
KINGSTON UPON THAMES
SURREY, KT2 6DQ, ENGLAND.
TEL: 01 - 549 9130
TLX: 889294 MIXER G.

STUDIO FILE

STUDIO FILE

requirement. One of George's particular personal requirements was for a totally enclosed drum cage. A drummer himself, a lot of time was spent deciding exactly what form this should take. Little things are catered for so ash trays are fitted and the air conditioning must be adequate.

The reason for choosing Eastlake is apparent immediately: "I have seen many studios in America—I have a house in Oklahoma—and for me the best studios are Eastlake, for atmosphere and for rooms. This is the second Eastlake studio in Greece; the other one has been here for eight years and that is where I got my engineer from!"

George feels that a studio facility from a musician's point of view, should not be somewhere you just go and play your bit and then leave. Rather the atmosphere should encourage you to feel comfortable and be able to stay even when not particularly required to play. Initially they accept that their market must be essentially local although they have no intention of stopping there.

Once the building was complete, Eastlake moved in to install the studios in its bowels (I mean this in the nicest possible way!). Taking into consideration the film aspect, the 13×11.5 m studio area is divided into two distinct zones—one very live for acoustic work and one more tailored for rhythm

Sound Studio, continued

work. Because it is economically viable in Greece to do so, Eastlake made a feature of locally available marble to cover the floor in the live area, as well as specific points around the walls.

The impression of space is further enhanced by extensive use of mirrors. The entire back wall and one side is mirrored with additional mirrored surfaces to improve visual communication with the control room which, at certain points in the room, seems to be quite some distance away. The rear wall is angled to throw sound up rather than out as well as hindering echoes from bouncing around, and has a pair of JBL 4435s set into it.

Overhead in the live area the ceiling is finished in a laminate which is very reflective and achieves a 15° offset with the floor. Ceiling height is some 4.5 m (extending above the treatment a further 1.5 m). Coming down the room the angled side walls are treated variously to create different sounding areas, eg the Steinway concert grand piano sits in a trapped recess and going round the room wall finishes include grooved pine, cork tree bark and various rocks.

The rhythm area is carpeted and the room is still fairly bright. David Hawkins: "Because the drummer is

totally isolated from the rhythm area it has been possible to make it brighter than we could have, had the drummer had to play in the open in this section."

Funnily enough the rock and cork which almost became a trademark of Eastlake in days of yore, more recently has not featured, the company along with most studio designers having incorporated a much wider variety of materials to suit each client. It was, therefore, at George's specific request that these traditional finishes were incorporated.

The ceiling over the rhythm area houses broadband absorbers and throughout the room is fitted with a galaxy of incandescent downlighting which creates a very pleasant peaceful atmosphere whilst actually being quite bright.

The drum room occupies some 3.1 sq m with the corner chopped off and, as David explained, is fairly unusual in that the client wanted it totally enclosed. This is normally avoided (a) because the room is usually so tiny it would by its very nature be very claustrophobic and (b) because the drummer needs to be very much involved with whatever else is going on.

This room has visual communication with the control room by means of CCTV as well as via the mirror finishes on the studio wall areas. Having achieved 37 dB isolation between drum

cage and studio, the room was clad in grooved pine with additional curtains which may be opened or closed as required.

Amongst the equipment in the drum cage was a headset equipped with microphone which the studio has found useful for communication between drummer and conductor.

The studio itself was fairly littered with a large number of instruments including Kawai electric grand, Yamaha DX7, KX88, two Oberheim DMX drum machines, Simmons kit and Ludwig and Oberheim drum kits and so on which benefit from additional lighting from spotlights mounted in the nearby wall areas.

The 8.2×6.6 m control room size was dictated by the structure of the building. Since it is unlikely that there will be any classical recording here the standard TM32 monitors with TAD drive units and powered by VMOSFETS for low and high frequency (800 W low side and 200 W high) were chosen, the amp rack console power supply and computer all being housed in a separate room keeping the noise factor down. Everything else is in the room. Communication with the studio is via sliding glass doors between the monitors. There are additional windows beneath the monitors, the left hand one gives a view of the mirrored studio wall reflecting the drum cage on the opposite wall! Wood finishes in the control room are again a very

Eastlake control room



Custom Neve console



▶ You're looking at the most exciting developments in sound reinforcement in the world:

The Turbosound TSE and TMS Series.

Products with a proven pedigree from live sound users like Kool and the Gang, King, Grover Washington, George Benson and David Bowie to permanent installations in prestige concert halls and venues around the world.

They're so versatile that, by combining models from the two ranges, they're as perfect in small clubs and discotheques as they are at massive outdoor festivals.

The choice: The TSE Integrated

Turbosound. Nothing in the world comes close.

Series, or the TMS Full-range Series. Both are a system installer's dream – singly, in multiple arrays, fixed or free standing, in installations or for touring.

The incredibly compact enclosures with their unique TurboMid™ and TurboBass™ devices* create a sound that's radically different from ordinary loudspeakers.

Crystal clear highs, a seamless midrange and a tight, punchy bass combine to convey the 'feel' of music like nothing you've heard before.

Even at an SPL of 141dB, they produce the dynamics and clarity of a top-level hi-fi system – without the need for compensating electronics.

Who else can say that?

Richard Symons (Disco International) said: "They have a remarkably even response... extremely well-designed... an impressive clean sound. The excitement is there but no fatigue... superb quality."

Dan Valberg, chief technician of Borsen – Stockholm's top nightclub – was asked what, if money was no object, he'd do to improve his Turbosound system.

His answer? "Nothing."

In fact, nothing else even comes close.

Now the choice of the world's leading venues and performers is available to you.



Call Tim Chapman or David Bearman to arrange a personal audition at our London demo room.

And take a listen to the best in the world. ▶

Turbosound
A member of the Turbosound Group of Companies, London, New York

Turbosound Sales Ltd, 202-208 New North Road, London N1 7BL

Tel: (01) 226 0099 Telex 265612

Turbosound, Inc. 611 Broadway #841 New York, New York 10012

Tel: (212) 460-9940 Telex 230199

TSE INTEGRATED SERIES: TSE-111 Mid/High Pack (150W RMS, 250Hz – 18kHz), TSE-118 Bass Unit (300W RMS, 45Hz – 350Hz), TSE-218 Bass Unit (600W RMS, 40Hz – 350Hz) TMS FULL-RANGE SERIES: TMS-1 (250W RMS, 90Hz – 17kHz), TMS-2A (400W RMS, 65Hz – 17kHz), TMS-3 (775W RMS, 55Hz – 17kHz), TMS-4 (450W RMS, 45Hz – 17kHz), SUB BASS: TSW-124 (300W RMS, 27Hz – 300Hz)

*The TurboBass™ and TurboMid™ devices are covered worldwide by Principle Patents, and not simple design patents. The concepts embodied in their design, are, therefore, entirely unique. (See brochures for further information)

Worldwide distributors: Australia: Creative Audio Pty Ltd Melbourne (03) 354-3987 Austria: Audiosales Moedling (2236) 888145 Canada: Beisile Acoustique Inc Quebec (514) 691-2584 China: Wo Kee Engineering Ltd Hong Kong (5) 249073-5 Denmark: Per Meistrup Productions Karlslunde (02) 151300 France: Regiscene Paris (01) 4374 5836 Greece: Alpha Sound Athens (01) 651-31300 Holland: Ampco Holland b.v. Utrecht (30) 433134 Hong Kong: Tom Lee Music Co Ltd Hong Kong (3) 722-1098 Indonesia: PT Auvindo Merien Prima Jakarta (01) 323029-320704 Israel: Barkal Ltd Ramat-Gan (03) 735178/732044 Italy: Audio Link Parma (0521) 598723/4 Milan (02) 285-0334 Japan: Matsuda Trading Co Tokyo (03) 295-4731 Korea: Bando Pro-Audio Inc Seoul (02) 546-5491 Malaysia: Atlas Hi-Fi Sdn Bhd Kuala Lumpur (03) 432104/432077 Norway: Nordtek Equipment a.s Oslo (02) 231590 Singapore: Atlas Sound (Pte) Ltd Singapore 220-4484 Spain: Lexon s.a. Barcelona (03) 203-4804 Sweden: Inter Music a.b. Skovde (500) 85260 Switzerland: Sinec Schonenwerd (64) 413-747 Thailand: Bangkok Cine/Graphic Center Bangkok (2) 311-3570 UK: Turbosound Sales Ltd London (01) 226-0099 USA: Turbosound Inc New York (212) 460-9940 West Germany: Adam Hall GmbH Usingen (6081) 16031

STUDIO FILE

STUDIO FILE

straight-grained pitch pine. David explained that it is very unusual for him to employ soft wood and they did so because it was a readily available timber. "Because of the trading laws in Greece some of the materials we used came from very funny places, for instance we used a soft wood which came from Poland.

"During a number of visits we identified local sources of supply; we found someone to make the doors; we got someone to glaze the control room window frames which we sent out from England."

Cinnamon/orange carpet covers the control room. Tape machines are recessed in the traditional fashion with trapping at the back of the room covered in curtains which tone in. The front section of the side walls are clad in a selection of different rocks and the monitor wall and front section of ceiling are clad in wood, the rear section being trapped.

Central to the room is, of course, the 48-channel custom Neve console, which is a forerunner of the AES forerunner of the AES launched V series, featuring *Necam 96*. Customisations specifically for Sound Studio included additional talkback facilities and special mono output with independent level control. The trapped, carpet-clad machine recesses house two Otari *MTR90* 24-track machines and two *MTR12* stereo machines. Noise reduction is by *Dolby PS2*. The ancillary equipment is housed in a custom-built effects console which sits at right angles to the desk and includes *Lexicon Super Prime Time, Larc, Apex Compellor* and *Aural Exciter*. Reverb is provided by *EMT Gold Foil*, and the machines are synchronised with *Q.Lock*. The microphone collection is large and includes *Beyer MPC50* dynamic boundary mic for voice, *C-Ducers*, *Neumann U89*, *AKG D224, D202*, *Neumann KM84*, *AKG C452*.

One drawback to setting up a studio in Greece is the enormous taxes the government imposes; the situation appears to be somewhat unstable and unpredictable. As George explained, "We paid six million Drachmas in tax on import. We had a small

Sound Studio, continued



Main studio with live acoustic area

discount for example to buy the tape machine from Japan we should pay 120%; they charged us 55%. That is the situation today. I don't know what will happen tomorrow—everything changes every day."

So it is an expensive business. "We must be crazy to spend so much money on a studio but we hope something must happen here—look at Italy, Spain. It is not difficult to make music but we must make not just Greek music but for people from around the world. We have built a very good studio, now someone must do a very good production to get us established. There are many Greek people who have made it big but now they live outside of Greece; here we have nothing."

The rest of the building is extremely comfortable with bar and kitchen facilities as well as a sitting room with television etc, all designed to a high standard. George beams as he explains from here down is David Hawkins, from here up is me. And they are obviously very proud of their Eastlake facility as they have put up a brass plaque announcing its origins!

Sound Studio Athens is managed by Nic Despotides who is also the chief engineer. His background is in Greek and international film production and he played a large role in the studio build, co-ordinating the work of local architect, local contractors and studio designer and

constructor Eastlake. He explained the method employed by film directors filming on location in Greece: "In America they have three, four maybe five engineers to make a film, doing the location recording, dubbing, mixing, sweetening etc. In Greece one person makes the whole film." He has worked in this way on many English, American, French and German films including *Oedipus the King* with Christopher and Lilian Palmer and Orson Wells. Sound Studio's other staff are assistant engineer Dimitrius Mikolaou and Phillip Courides who looks after bookings.

How did Sound Studio Athens get its name? George: "I wrote to David from Sound Studio SA, and he wrote back Sound Studio Athens SA. He was right of course."

So why would anyone want to go and work in Greece? "Don't be silly," smiled film soundtrack producer Simon Heyworth of the English FilmTrax. "It's a great place to go. We went out because we were doing a Greek film for which I was co-ordinating the music; it was called *The Girl from Mani*, a lovely old town in Southern Greece, and was a fairly typical love story type of thing."

"The composer was Theodore Antonio who as well as writing film music is a lecturer at Boston University. It was major orchestral stuff with lots of Greek bouzouki. Authenticity was called for and the studio rates and hotel

accommodation were an incredibly good deal compared with what you would have to pay here.

"I'm definitely going back; you also have the use of two speed boats and a yacht!" No that's not what we are trying to discuss! Simon was not only impressed with the studio but also the calibre of orchestral player that he encountered. "The technical standard of the studio is great; well up to that of somewhere like Abbey Road. I took my own U-matic over; that's not a problem, you just get a carnet for any equipment you want to take with you.

"The room was good; it is not hugely live—it's a good sound; not as big as Abbey Road or CBS but then it's not as physically big; a nice smooth sound, no problems with it at all.

"I'm lucky enough to travel all over the place with my work and one thing about Athens was an enthusiastic response from the people because it is so new and they think you know everything! If you are an English engineer people always think you are wonderful!

"In England we are to all intents and purposes 10 years ahead of the Athens recording industry but they have got the money and the talent and I think it is interesting. Why record in the UK when you can go to Athens and do it? For a \$1 m electronic soundtrack American picture I could afford to spend two weeks/10 days just working in the evenings and having a nice time."

What about recording bouzouki? "No problems there, just record it live, no overdubs. The interesting thing was learning about all the different musical forms in Greek music, the history and how it has all evolved; you learn to respect it a bit more, because what I knew of Greek music before was a bit dire! I was really knocked out with the way it all went I must say. They had lots of good microphones and all in all it was a very good experience."

Janet Angus

Sound Studio Athens SA,
184 Messogion Street,
Holargos, 155 61 Athens,
Greece. Tel: (01) 6510055 —
6533536. □

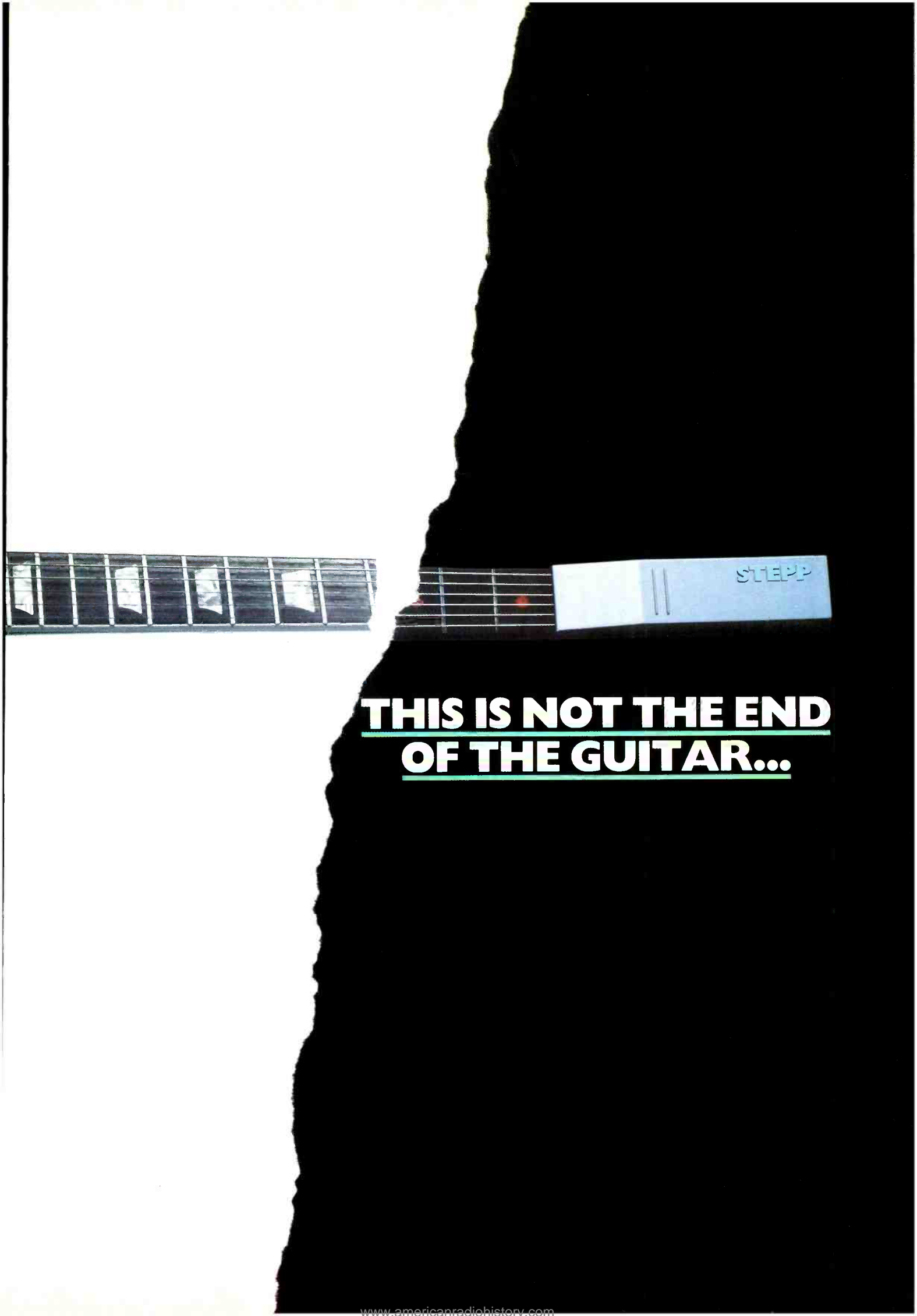

STEPP

THIS IS NOT THE END
OF THE GUITAR...

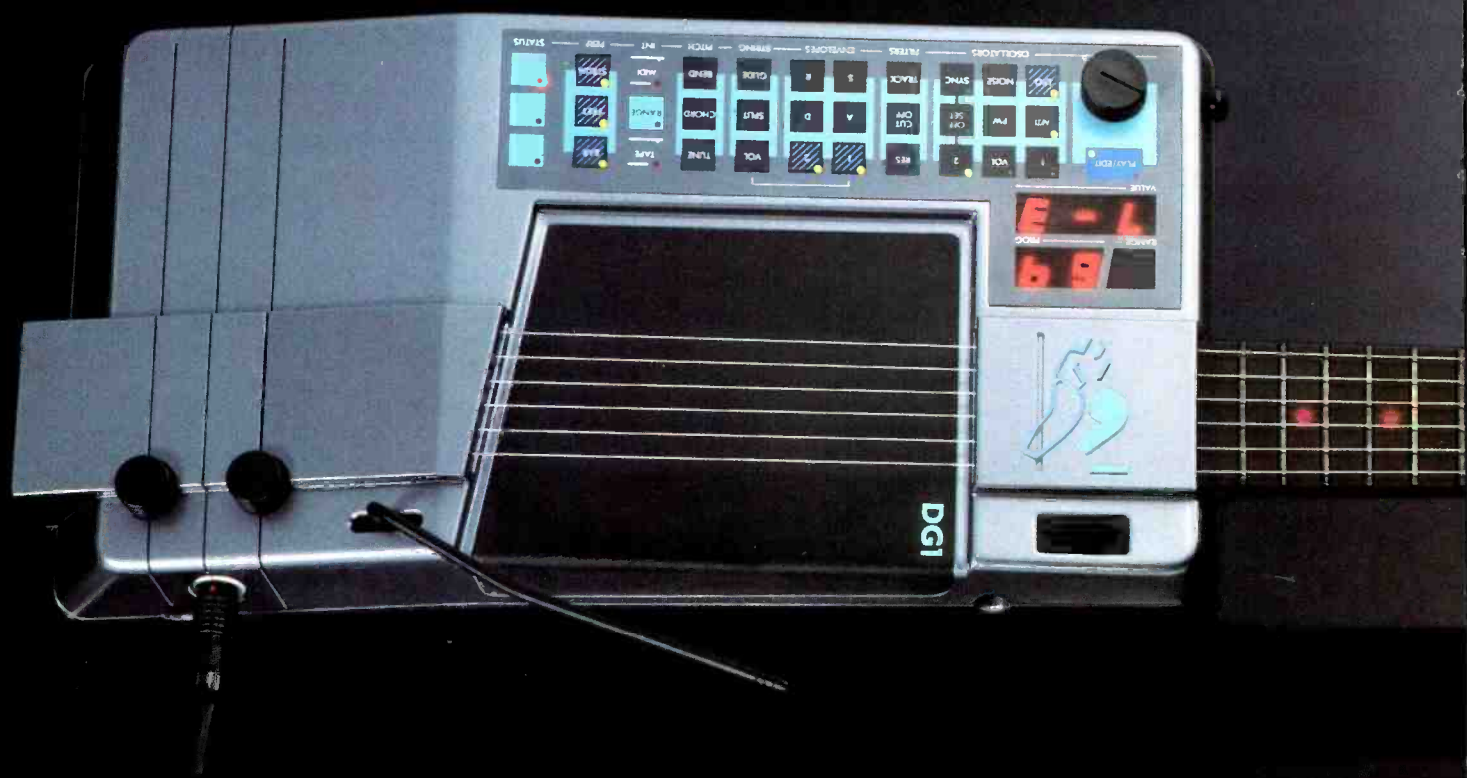

The electric guitar hasn't changed much since the 50's. Music has.

Synthesizers and digital technology have revolutionized popular music with the result that guitarists have to some extent been left behind. Quite a few have taken to the keyboard synthesizer only to sound like every other guitarist turned synth player.

Guitar synthesizers have been around for a while but they have been shunned by guitarists because they are basically keyboard

synthesizers you can plug a guitar into.

No one has built a guitar-dedicated system.

Until now.

The STEPP DGI is the first digital guitar designed totally and solely for the guitarist – the only other thing you need to plug into is your amp or mixing desk. It comes as a complete unit, giving you the control essential for dramatic guitar performance.

And it speaks your language.

Previously so called guitar synthesizers and MIDI guitars failed because they were locked into a keyboard language far too limiting for the enormous range of expression and subtlety of the guitar.

The DGI is capable of instantly analysing every chord, solo or strum, and via its dedicated synthesizer section can translate every nuance into a whole new palette of sounds. These can be stored in 100 memory locations on the guitar itself.



THIS IS JUST THE BEGINNING

In addition every new guitar sound can be modelled in performance by the way you play.

STEPP'S unique open architecture and active performance software (APS) allows parameters to be routed to 'real-time' controls such as the wang bar, frets or strum area.

To take one example you can wang volume, bend resonance and strum filter cut-off, or just stick to the traditional parameters such as bending pitch.

In short it's the most expressive guitar ever developed.

And with MIDI-IN you can use a sequencer to record and playback your last solo or play bass while playing rhythm and drums.

All on one guitar.

The STEPP DGI is a very sophisticated instrument

harnessing the very latest in 16 bit microprocessor technology.

But happily it is technology that doesn't herald the end of the guitar.

Just a new beginning.

Call or write for a brochure:

STEPP Ltd, 3 Primrose Mews, Sharpleshall Street,
LONDON NW1 8YL. Telex: 267002 STEPP G.
Telephone: 01-722 5448 (24hr)



THE STEPP DGI

YOU'RE A GUITARIST – SO PLAY THE GUITAR

REDUCTION DIRECTIONAL MICROPHONES

Michael Gayford discusses mic technique and design

In almost any sound collecting set-up there will be some amount of undesired sound present. It may be external, machine, traffic or audience noise, excessive reverberation, echoes, etc. In a live situation where the listener is present, the effect is greatly reduced because normally the full binaural hearing facility is used. The listener faces towards the sound source and psychological as well as physical rejection of the unwanted sounds occurs. When replayed in another place, however, much of one's natural ability to focus on the wanted sound is lost, even with the best modern stereo reproduction.

We are handicapped further by the fact that the fundamental laws of acoustics mean that microphones cannot be sharply focused or zoomed-in like a camera although various types of directional and noise reducing microphones are available today. With further development, and hopefully new inventions, it is to be hoped that more precise directional microphones will make the task of satisfactory sound pick up in adverse situations more akin to the optical pick up. At present many promising programmes are unfortunately degraded or even ruined by the unsuitability or wrong application of the microphones used. It may be helpful to review in some detail the use and the characteristics of the types of microphones which may now be used in adverse acoustic situations.

The desired sound source should be reproduced in a forward manner in a correct acoustic perspective as regards the whole sound picture. Most of the sound pick up situations concerned will be monophonic but the single mic used for voices or the other discrete sounds featured may be mixed in with other tracks or processed in various ways which can affect the forwardness or dominance of the voice concerned. Obviously, a basically poor initial result cannot be compensated later. It means that the correct type of

microphone must be chosen for any particular job and that it must be properly applied as far as the prevailing situation allows.

Normal conversational speech at about 1 m in unobstructed conditions will produce approximately 70 dB SPL. Many average busy office areas or outdoor street scenes, to say nothing of sports arenas will often greatly exceed this noise level. An omni mic will have to be quite closely addressed. This is often done in interviews where an omni stick mic is moved from mouth to mouth by the interviewer. It is difficult to maintain a constant close speaking distance and the result may be distracting visually and psychologically. There is some risk of handling noise on mic and cable. Low noise cable with conductive lining to shielding braid can reduce static noise induced by movement of the cable. Nevertheless, in fixed positions an omni mic, possibly equipped with a small windshield to minimise breath noises and 'blasting' from high levels, is often a good solution when the background is not too high or too obtrusive.

Noise reducing microphones as a separate category are those which are acoustically gradient-operated or which achieve directionality by means of a spaced array, multiple openings along a front tube, etc. Some units may combine both these principles¹.

Gradient microphones are

characterised by separate sound openings to the front and the rear of the diaphragm. First order gradient mics such as the basic ribbon mic, are bidirectional with equal back and front lobes and a marked null at right angles. Adding acoustic networks or delay systems between the rear openings and the diaphragm can produce unidirectional responses in the various shapes of the cardioid family². All gradient mics to a greater or lesser degree exhibit proximity-effect gain with respect to a relatively close small source; a well-known property of a spherically expanding wave. This means that low, and to some extent mid, frequencies can be cut in the response whilst maintaining a substantial level response for a close voice. Most background noise encountered has a substantial low and middle frequency spectrum, with less energy in the highest frequencies. This is rather similar to an average voice spectrum so it is seen that proximity discrimination, as described, is in the nature of a noise discriminating bonus! Otherwise, one must rely on the inherent discrimination of a microphone with a reasonably narrow lobe in the forward direction. The nominal directivity is given by the fraction of a sphere represented by the solid angle containing the lobe. An ideal microphone of this kind should have a single frontal lobe of, say, 30° ($\text{Cos}^3\theta$), any unwanted side or rear lobes being negligibly small.

Most practical directional microphones produced so far do not fully meet the ideal in that the main lobe tends to broaden considerably at low frequencies where the wavelength of sound is comparable to the length of the microphone line. A central difficulty encountered in all full range electroacoustic

devices is that we have to deal with a frequency and wavelength ratio of over 1000:1. Although a microphone may be small compared to the wavelength at very low frequencies, it is large relative to the wavelength at high frequencies thus involving obstacle effects—diffraction, standing waves, etc. This greatly complicates most design calculations and measurements. A line microphone or a microphone array depending on its size to obtain low frequency directivity, thus becomes unwieldy and the high frequency response is likely to be erratic and difficult to control accurately. The effective size of a microphone array and hence its effective low frequency directivity can be artificially increased by introducing an artificial delay between the pick up points in the array. Olson's tubular line mic inventions in the 1930s introduced kinks or loops in the tubes at right angles to the main axis inserting an acoustic delay between the open ends of the tubes, which were effectively pressure sensing elements (Fig 1). It follows that the same effect can be obtained by introducing electrical delay in a combining network or preamplifier used with the microphone concerned. Systems have been

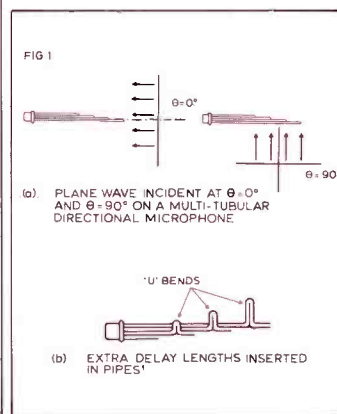

TABLE 1 Properties of directional microphones

Type of microphone	Approximate size	Mode of operation	Directivity factor at frequencies indicated					
			200 Hz	500 Hz	1 kHz	2 kHz	4 kHz	8 kHz
Parabolic reflector type with omni mic	3 ft dia 1 ft deep Wt=25 lb	Focal concentration of axial sound	4	20	47	125	—	—
Multi-tubular type. Staggered tube lengths	5 ft long 3 in dia Wt=5 lb	Phase interference from staggered openings	3.5	8	12	25	25	40
Single tube with a damped slit	3 ft 6 in long 1 to 2 in dia Wt=4 lb	Phase interference from different parts of slit entry	5.4	13	28	55	100	—
Single tube with discrete filter entries	3 ft 6 in long Wt=4 lb	Phase interference from discrete entries along tube	6	15	30	50	45	60
Normal cosine or cardioid gradient mic	Typically 1½ in dia x 4 in long Wt=1 to 2 lb	Pressure gradient operation	3	3	3	3	3	4

proposed broadly along these lines to produce zoom microphones of widely variable directivity¹.

Even more esoteric systems have been reported, in which the Doppler principle is exploited to provide an array which can be programmed externally to provide accurately defined frontal lobes of any desired shape, which do not vary with frequency. The sound pick up point is effectively vibrated at a supersonic frequency along the line of sound incidence. Filters and a demodulation process are shown to be capable of producing a bidirectional polar response proportional to $\cos^n\theta$, without any side lobes, where n can be set by suitably choosing the demodulation frequency. Mechanical vibration of even a small pressure mic at such a high speed may be difficult so

electronic switching of the outputs of a small line array of miniature microphone units with substantially uniform phase characteristics could be used instead⁷. Presumably, the rear lobe can be suppressed by using unidirectional microphones as the pick up elements.

It is apparent that sophisticated systems of this kind might eventually be realised in an economical and compact form by the use of digital ICs, LSI, etc. So much for the possible future!

For the present we can review the types of directional noise reducing microphones which are available using current technology (Table 1).

Personal microphones

These include microphones attached to the person, mainly for speech purposes, in the form of neck cord mics, tie or shirt mics, lapel mics, headset boom mics, etc.

The first point to note is that when a mic is used well off the mouth axis there is a substantial loss of higher frequencies, particularly below chin level. If a gradient mic is used, it may be necessary to allow for proximity effect gain at low frequencies as well as any pop noise from close speech, though this is less troublesome well off the mouth axis and below chin level. The microphone should also be well insulated from clothing rustle on its case and cable. For high quality speech it is often worth doing a test run and optimising the speech by some external equalisation. For regular users, the results can be preset or memorised. High quality radio mic systems are often made to work with particular mics and allow for some preset equalisation. Moving coil mics, piezo, electret condenser mics and ribbon mics have been used. It is probably worth buying a

microphone which is specifically designed for the purpose^{1,6}.

The response of a specialised neck cord moving coil microphone is shown in Fig 3. As well as the increase in high frequencies above 2 kHz, the mid-low frequency region is reduced in level with the object of offsetting excessive chest tones around 700 Hz which are relatively closely coupled to the microphone. This should be borne in mind when applying a mic chosen for personal use. This type of response is partly achieved in many small mics due to reduced case volume, slight overdamping of the system and a damped high frequency front cavity resonance, however, the result will probably not be as good as those from a mic which has been specially designed for the purpose and carefully equalised over the whole speech band. The Shure SM 83 is an example of an equalised microphone with a dip at 730 Hz.

One of the earliest lapel microphones was developed by Olson in the 1930s as a small ribbon mic with its main axis angled towards the mouth and the dead axis directed to the chest. Recently Beyer have introduced a miniature ribbon microphone mounted on a headset boom with the provision of orientation to allow for the main lobes to pick up the vocal and also an instrument such as a drum the wearer is playing, the off-axis drop in level allowing adjustment of the balance.

Because of the great convenience of freedom of movement without a trailing cable and the inconspicuous nature of a small personal mic, their use in conjunction with a small high quality radio mic link will undoubtedly continue to increase and it is likely that more of these specialised mics and systems will be developed in the future. RCA, Beyer, Shure, Knowles and Sony have developed small personal mics.

Communication boom mics, mask mics, etc

These cover a wide range of mics designed for basic communication sets designed to transmit intelligible speech under conditions of very high background noise in vehicles, aircraft, etc. They usually have a restricted bandwidth with a severe upward slope on the response, restricting the bass and boosting the top up

to about 3 kHz, giving a very hard speech quality. They are often gradient mics. Where noise is not so severe, there is often a demand for good natural speech quality, for example in commentaries, airline cabin address, etc. Here good quality specialised small moving coil or electret cardioid mics are used. Placement slightly off the mouth axis helps minimise any pop noise. The development of specialised commentator's mics has emphasised the need for scientifically designed breath shields and also the reproduction of sounds from the nose in proper amounts. A lack of these gives a somewhat 'cold in the nose' effect.

Small dynamic, piezo and electret mics are used on booms. Headset boom microphones must be relatively small and light, as well as being adjustable on the boom to give a good talking position. The breath shields must also eliminate wind noise and help to combat the build-up of condensed moisture. Siliconised finely woven metal screens can minimise this trouble. Foam windshields are convenient as they can be readily slipped over a microphone but they must be made of high grade foam of the correct porosity so that the response of the microphone does not deteriorate. It is also necessary to check at intervals that the windshield is not sodden with moisture as this will cut the mic output. The testing and measurement of the response curves of close talking mics is not an easy matter and will be touched on later. The effect of clothes covering or near to the mic must be checked.

Apart from the effects of background noise, speech levels are often quite high because a speaker in some conditions will tend to shout. Earlier boom microphones were often not capable of handling high sound pressures without nonlinearity, tending to degrade speech quality and intelligibility.

Commentator's mics

Many broadcast events and films, videos, announcements, etc, require close range speech fully up to broadcasting standards. The use of a high quality microphone specially developed for the purpose is recommended. General purpose broadcasting microphones all too often produce unsatisfactory results due to varying talking distance, insufficient noise exclusion,

FIG. 2 SECTIONAL VIEW OF A COLES MOVING COIL MICROPHONE

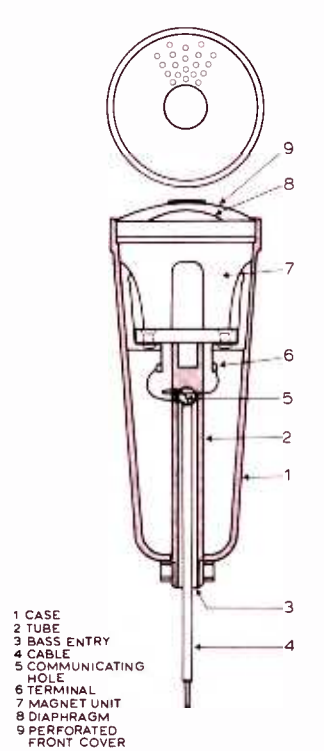
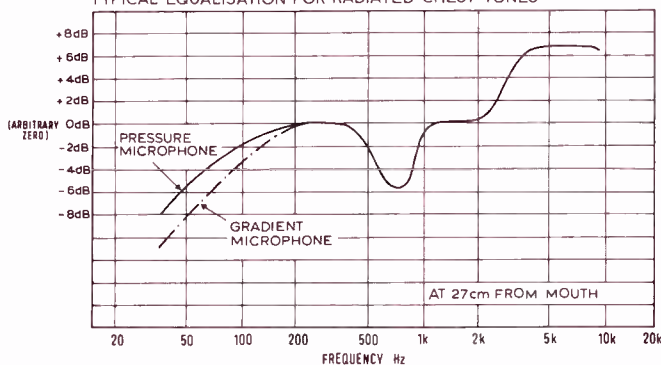

FIG. 3 OVERALL RESPONSE OF A LAVALIER MIC SHOWING TYPICAL EQUALISATION FOR RADIATED CHEST TONES³



NOISE REDUCTION

DIRECTIONAL MICROPHONES

poor wind and noise exclusion, deterioration due to general lack of ability to resist deterioration due to the effects of weather and the rough and tumble of outside use.

One example of a broadcast quality commentator's microphone is shown in Fig 4. This is the ribbon unit designed as a result of extensive research by the BBC over a period of some years which was described briefly in the September and October 1985 issues of *Studio Sound*². A first order ribbon gradient unit has a number of advantages in that with careful design it is capable of giving a wide frequency response with good linearity. It lends itself to noise reduction by exploiting proximity effect and directional polar response and is a simple and robust microphone of low impedance.

With modern magnetic materials a light flat magnet and pole piece structure can be designed, which is readily housed in a damped sound permeable case mounted on a

handle which can take a small shielded line matching transformer or a transistorised head amplifier and battery if it is desired to raise the output to full line level where needed. The system can be hum-neutralised and, if necessary, made with a balanced transformerless output.

A few points are worth bearing in mind regarding high quality reproduction of speech from a microphone close to the mouth.

- The sensitivity and the output linearity must accommodate speech levels from a whisper up to loud shouting.
- The response of a gradient microphone designed for close talking varies considerably with small variations in the distance from the mouth. This may be accurately controlled by means of a light distancing bar designed to touch the upper lip. Correct choice of materials will allow comfortable contact and, with the rest of the microphone, should be capable of being



FIG 4: Commentator's ribbon mic with distance bar

cleaned and disinfected at intervals.

- Speech very close to the mouth has abnormal frequency characteristics as compared to speech at the usual range and it is also affected by nasal

sound contributions.

• Considerable wind and breath levels may be encountered in addition to the plosive speech sounds. The ribbon must be damped and protected against damaging surges which could cause over-stressing.

All these factors, together with the development of a special artificial voice with balanced nose and mouth sources were investigated and researched in considerable detail by the BBC research engineers, as reported by H D Harwood^{1,2}.

The work culminated in the design of an improved 'lip mic' in the early 1950s. STC and Coles Ltd have devoted continuous development to these concepts over the intervening years, using these BBC results and patents by agreement with the BBC.

Fig 5 shows typical responses illustrating some of the above effects exemplified by these microphones. The effective point source of the voice is found to be further back behind the lips at lower frequencies where the main voice formants occur, the sibilants and fricative sounds coming forward to the teeth and lip positions.

It is possible to compare the speech response of a talker on

STUDIO POLYgone

TOULOUSE/FRANCE

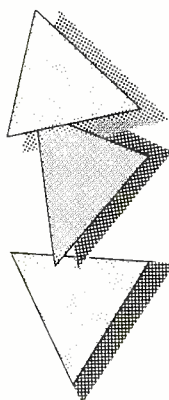

48 TRACKS

2 x STUDER A 800

SSL 48 CHANNEL
TOTAL RECALL

6, rue des Saules 31400 TOULOUSE

Tél. 61.53.86.65 - Télex 530171/code 650

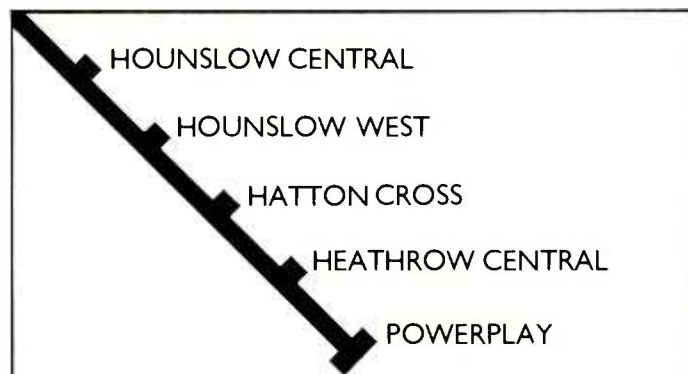

NEXT STOP ON THE PICCADILLY

At least that's the way we, and many of our English clients, think of Powerplay Studios.

15 Minutes from Zurich Airport - 90 minutes from London - you will find our two studio facility, complete with SSL 4000E and Total Recall, Studer A800, a mouth-watering choice of outboard equipment and just about everything else you would expect in a top London Studio - except the hassle.

We hardly dare mention our residential facilities, leisure area, lake views, ski-ing, and the very special advantages of working in Switzerland, irresistible? We hope so. To find out more contact Silvia Hagen at Powerplay.

POWERPLAY
RECORDING STUDIOS AG

CH 8124, MAUR ZURICH, SWITZERLAND Telephone 01-980 1521/22

911. DRIVE THE HIGH PERFORMER

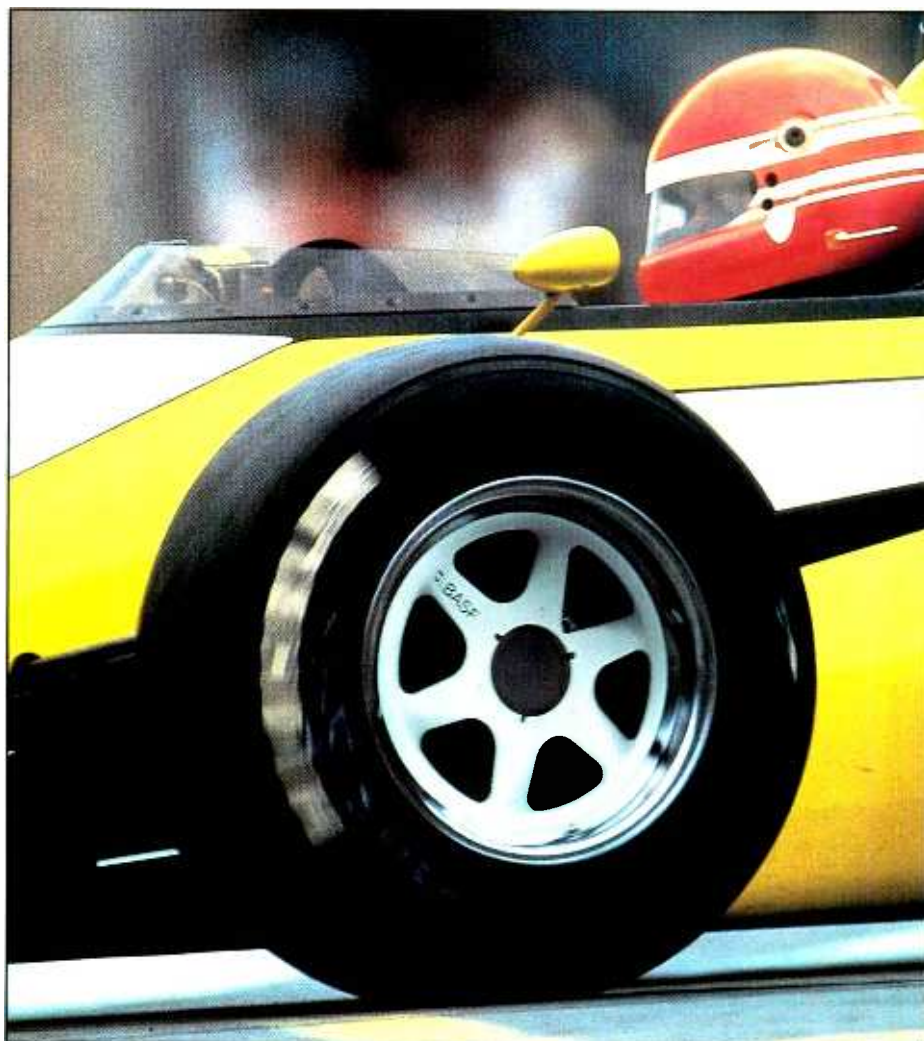

BASF Studio Master 911. The new professional analogue tape designed to meet the extreme demands of tomorrow's multi-track technology.

911 is a significant design achievement – outstanding audio performance matched with excellent mechanical properties.

- ☐ High dynamic range at all frequencies (74.5dB at 1kHz)
- ☐ Very low modulation noise (DC ratio 54.5 dB)
- ☐ Excellent winding characteristics
- ☐ Low print-through (signal to print at 1kHz 56.5dB)

BASF United Kingdom Ltd.,
151 Wembley Park Drive,
Wembley, Middlesex HA9 8JG.
01-908 3188

BASF Aktiengesellschaft Gottlieb-Daimler-Str.10
D-6800 Mannheim 1
Tel: 06 21/40 08-1 Telex: 4 62 621 basf d

MORE SOUND. LESS NOISE.

Information systems

Audio · Video





AT LAST ALBERT HAD FOUND THE SOUND HE WANTED AND HAD ONLY LOST 2 ENGINEERS.

Britannia Row offers a total Audio Hire service from a complete customised 24 track recording package through the range of our extensive analogue and digital recorders to any individual studio effect you may require.

The equipment is cased and delivered by our professional and efficient staff to anywhere in the U.K. or overseas.

Our technical engineers will fully install the equipment and leave you assured of a smooth recording session with 24 hour back-up guaranteed . . . Even Albert will be happy.

We can supply all your U.K. audio hire needs from a noise gate to a complete multitrack recording pack. Our full range of equipment is also available in Europe, contact our new German office at the address below.

Contact: MATTHEW PEAVERS ELECTROSPACE GERMANY, WENTAL STRASSE 30, 7251 WILMSHEIM WEST GERMANY. TEL: 07044-42807

35 BRITANNIA ROW LONDON N1 8QH

**BRITANNIA
ROW** 01 226 3377

COMPLETE SERVICE AUDIO HIRE

TEL: DAY 01-226 3377 NIGHT 01-223 1901 BLACK 281

TELEX: 268279 BRITRO G

NOISE REDUCTION DIRECTIONAL MICROPHONES

FIG. 5
RESPONSES OF COLES 4104 MIC

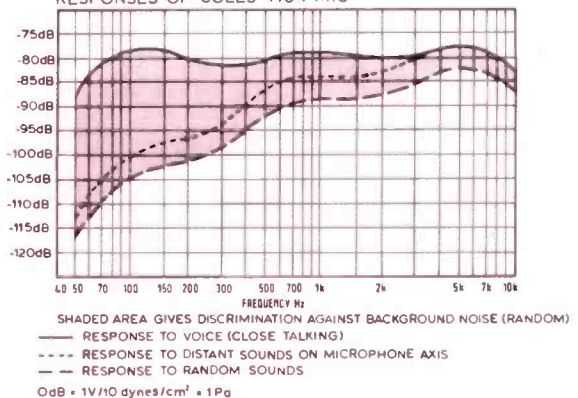

a close talking mic with the speech from the same talker on a flat mic at 1 m under anechoic conditions using an analyser. The effective response of the close talking mic is then derived. The response may be optimised over the lower frequencies by adjusting the ribbon damping. Higher frequencies may be raised slightly by exploiting a broad polepiece resonance. Angling the unit slightly to move the dead axis slightly off the nose axis adjusts the balance of the nose response.

The responses of a ribbon commentator's microphone are illustrated in Fig 5 which shows the Coles 4104 unit. This is made in various versions to meet different requirements. The optimum response is obtained when the ribbon is about 50 mm (2 in) from the lips, as determined by the light lip guard bar. The ribbon is 25 mm (1 in) long by 3 mm (1/8 in) wide and is of similar form and material as in the 4038 studio ribbon microphone described in *Studio Sound*². It is made from 0.6 micron beaten aluminium foil stretched between chamfered flat polepieces. Older units use U magnets at the rear. More compact layouts with modern magnets may lead to a flatter and more compact system. A hum-neutralising wiring system around the ribbon connects to a shielded line transformer and/or a small preamplifier in the handle. A thin flexible cable connects to a line feed or to a radio transmitter on the person.

The advantages of this type of microphone are considerable and account for the continued worldwide use of this product. The controlled talking distance and exploitation of proximity effect and first order

directionality, as well as studio quality speech are able to go a long way to assure producers that the ultimate quality of a programme will be good in all respects. It is quite easy for an interviewer to pass the mic to other persons, who will find it easy to hold the mic at the correct talking distance. Commentators immersed in crowds at ringsides etc are able to maintain a clear unforced speech quality.

It is said that the original BBC demonstration of their ultimate development of the microphone was to have a commentator walk through a brass band playing fortissimo and to reproduce clear natural speech quality with the music in a correct background perspective.

Wave microphones

These at present achieve directionality by using a sound collecting system which is large or at least comparable to the wavelength of the sounds which it is desired to reproduce.

Earlier types used an omnidirectional microphone in the centre of a baffle or parabolic reflector which excludes sound from the rear primarily because of obstacle effect and focuses sound picked up in the frontal hemisphere because of the geometrical configuration of the surface and diffraction effects from the edges. A recent study has extended the theory of these mics⁵.

Later inventions used tubular line extensions fitted in front of the microphone. WE and RCA proposals used a bundle of tubes open at the far end and graded in length. The method of operation is shown

*Just when you thought the future
couldn't shock you any more.*

Introducing the Lexicon PCM 70, our extraordinary new digital effects processor with dynamic MIDI. Designed, creatively speaking, to thrust you into the future.

To begin with, the PCM 70 gives you access to the same astonishing Lexicon digital effects used by the world's top artists and studios. With complete, variable parameter control, and registers that let you create and store your own programs.

Now, about dynamic MIDI. With this pioneering Lexicon development, you can vary any PCM 70 parameter through a MIDI keyboard while you're actually playing. Just imagine being able to vary the wet-dry mix, for example, through finger pressure on the keys. Or by your choice of other controls, like the modulation wheel. Or even by a computer.

There's more. The Lexicon PCM 70 digital effects processor is also a full-fledged digital reverb, with a complete selection of Lexicon reverb programs. And the price? Shockingly reasonable.



You'll want our detailed PCM 70 brochure. At your Lexicon dealer, or contact us. Lexicon Inc., 60 Turner Street, Waltham, MA 02154, USA. (617) 891-6790. Telex: 923468. Lexicon International, P.O. Box 122, 8105 Regensdorf, Switzerland. Telex: 59222.

Come to the future.



SCENIC SOUNDS EQUIPMENT LIMITED
Unit 2, 12 William Road, London NW1 3EN.
Tel: 01-387 1262, 01-734 2812
Telex: 27939 SCENIC G



AUDIO EXPORT,
Badstr 14, 7100 Heilbronn,
Germany,
Tel: 07131 82275

lexicon

NOISE REDUCTION

DIRECTIONAL MICROPHONES

in Fig 1. It is seen that plane sound waves incident at or near to 0° will be propagated in the tubes at substantially free air velocity, the system then being, to a first order, transparent to sound; wavefronts being propagated inside and outside the tubes in the same phase relationship. All contributions arrive in-phase in the frontal cavity before the microphone diaphragm. For plane waves incident at 90° (approx) to the axis, a series of wave contributions will be launched simultaneously down the tubes of various lengths. At higher frequencies the relative phase displacements of the contributions arriving in the frontal cavity differ in relative phase angles by amounts sufficient to cause a substantial degree of phase cancellation in the microphone cavity. At lower frequencies, there will be less difference in phase due to the differing tube lengths and the directional discrimination will be reduced. Fig 1 shows the operation and also shows the RCA 'U' delay kinks.

Sounds incident at intermediate angles between the axis and 90° can be considered as the resultant of components resolved in the orthogonal directions 0° and 90°, the final output being the vector sum of the contributions in the microphone cavity, as a result of propagation down the tube.

A different approach was followed in Germany after the war where single tube

microphones were developed. The first types used omnidirectional extension tubes fitted to a moving coil microphone unit housed in the base of a floor stand. The acoustic impedance of the microphone and the frontal cavity were designed as far as possible to terminate the tube with its characteristic impedance so as to minimise ripples on the response curve.

A later invention proposed a line of holes or a slit down the side of a frontal tube to give a directional response. The present line microphones have been developed from this concept (Fig 6).

Tubular line directional microphones are now made by several makers including AKG, Beyer, EV, Sennheiser, Sony, RCA, etc. The units range in length from about 260 mm (10 in) to 700 mm (28 in). The microphone used at the tube end is either a small dynamic or a miniature cardioid condenser mic. Foam or mesh type overall wind shields are available which can give the microphones a fair degree of protection against wind and weather. The main forward response lobe tends to vary with frequency, being fairly sharp at higher frequencies and tending to a cardioid at low frequencies. Minor unwanted side and back lobes have been fairly well suppressed by careful design but may still not be entirely negligible. The shorter line mics are often used on booms or as hand mics in audience participation shows etc. The

broadening of the polar pick up at lower frequencies can be combatted by using a bass cut filter below about 200 Hz. The on axis response is generally fairly flat, due to carefully arranged damping in the tube. Fig 7 shows some typical curves.

We may summarise the present position by noting that

there is a quite wide range of units available in the various categories described above. The strengths and limitations of each category are apparent. A careful choice of microphone for any particular application will generally bring dividends in that the best sound can be obtained under the particular circumstances which prevail. □

FIG. 7 RESPONSE AND POLAR CURVES FOR SONY MIC

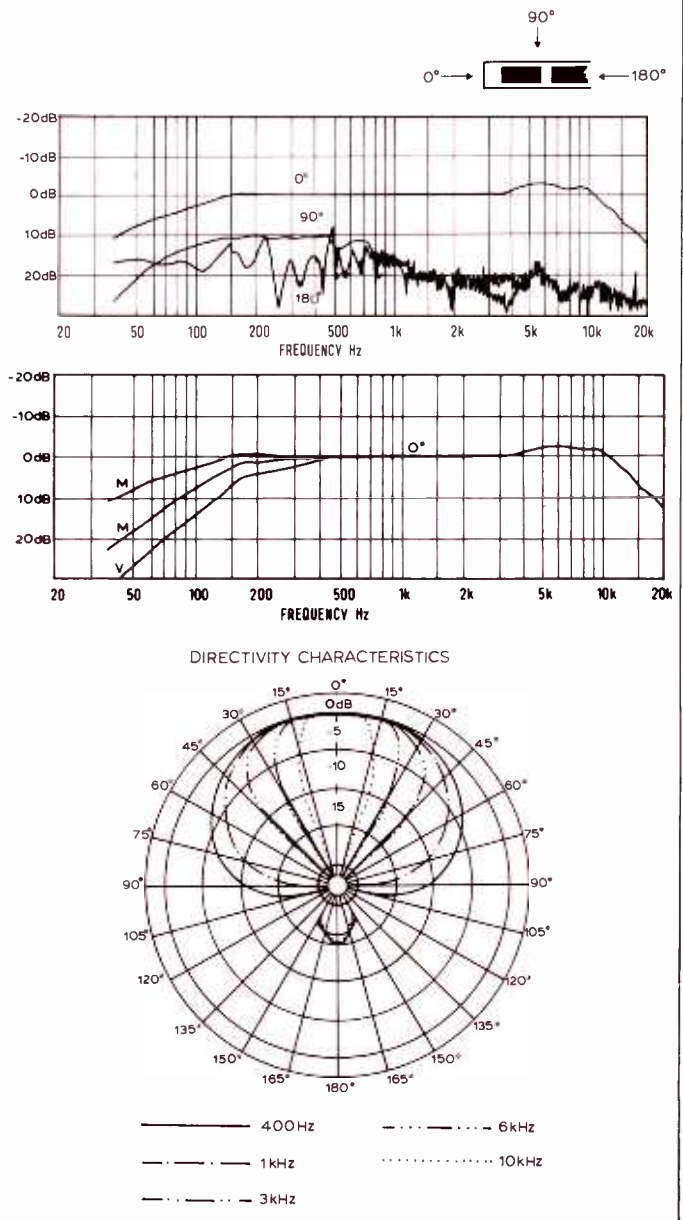

FIG 6: Modern line mics with cardioid condenser

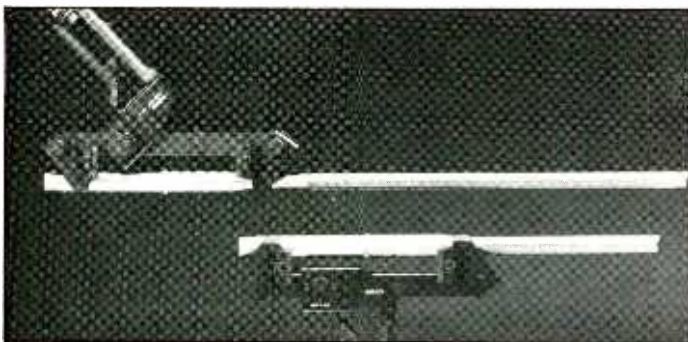
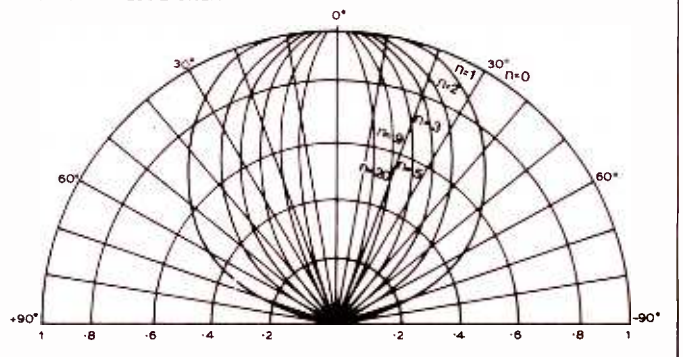

FIG. 8 IDEAL THEORETICAL CURVES FOR DIRECTIONAL MICS $\cos^n(\theta)$ PLOT (FRONTAL LOBE ONLY)



References

- 1 *Jnl Audio Eng Soc*, 1985 July/August. Jon R Sank. 'Microphones'. A comprehensive review. Also a bibliography on mics. Richard Knoppow.
- 2 *Studio Sound*, September & October 1985, 'Ribbon microphones', M L Gayford.
- 3 *Electroacoustics*. Microphones M L Gayford. Newnes Butterworth.
- 4 *Jnl Audio Eng Soc*, 1985, December, Letters on zoom mics. p.969.
- 5 *Jnl Audio Eng Soc*, 1985, June, 'Parabolic reflectors', S Wahlston.
- 6 Lavalier microphones. D L Shorter. Proc. 3rd Int. Congress on Acoustics. Stuttgart 1959.
- 7 Doppler variable directional microphone. Hikaru Date. Proc. 5th Int. Congress on Acoustics. Liège. 1965.

AKG

ACOUSTICS

THE NEW AKG DIGITAL REVERB & EFFECTS PROCESSOR ADR 68K

A powerful computer capable of translating creative impulses for reverb, sampled sounds, audio effects, and more, from idea to finished product completely and easily.

The ADR 68K is a state of the art audio processing system using at its center the 68000 microprocessor. Several AKG engineering advancements in methods of low cost, high quality ADA conversion ensure full bandwidth performance and natural sound.



All functions of the ADR 68K are available on the remote control.

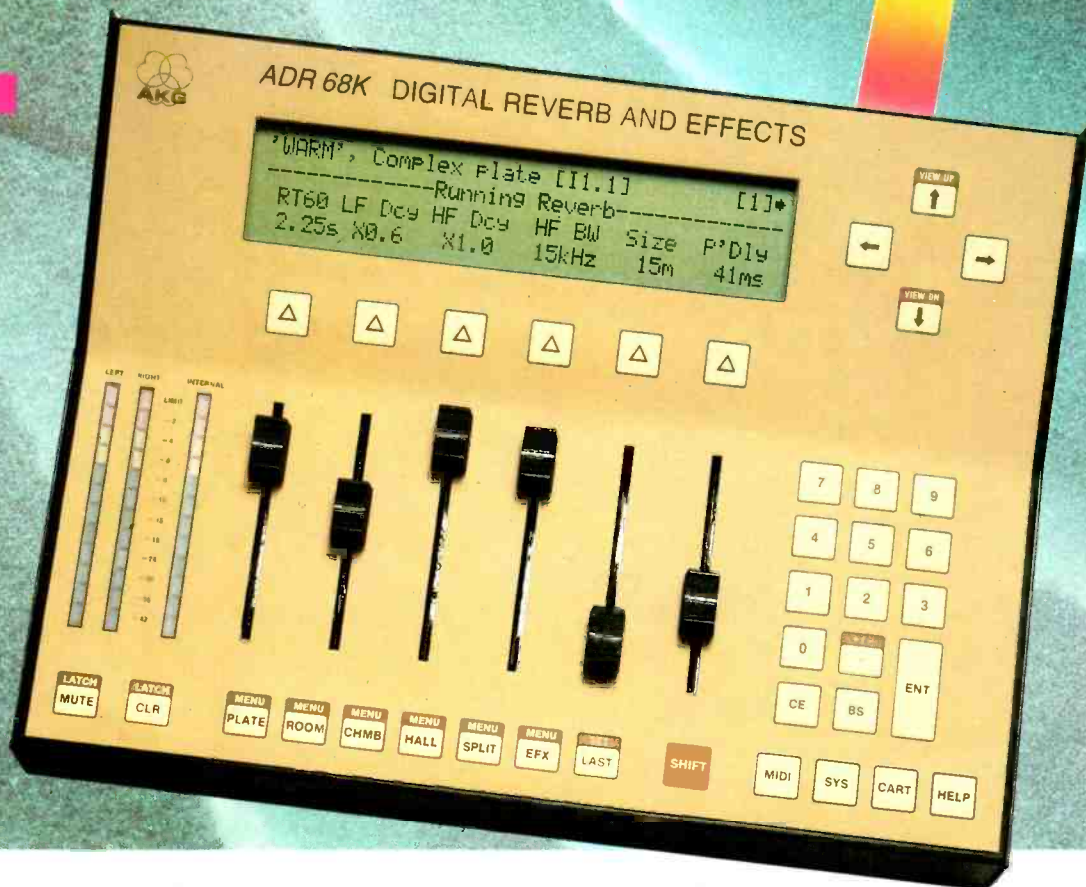

For more information about programs, program storage, and future programs write or call



AKG AKUSTISCHE U. KINO-GERÄTE GESELLSCHAFT M.B.H.
Brunhildengasse 1, A-1150 Wien
Tel.: (43222) 95 65 17-0*, Telex: (47) 131839 akgoao, Telefax: (43222) 92 34 58
AKUSTISCHE U. KINO-GERÄTE GESELLSCHAFT M.B.H.
Bodenseestraße 226-230, D-8000 München 60, BRD
Tel.: (4989) 87 16-0*, Telex: (41) 523 626

AKG ACOUSTICS LTD.
Catteshall Wharf, Catteshall Lane, Godalming, Surrey GU7 1JG, GREAT BRITAIN
Tel.: (44 48) 6825702, Telex: (51) 859013 akgmicg, Telefax: 04868 28967

AKG OF JAPAN SERVICE CO. LTD.
401-3, Daichi-Kanoh-Bldg, 2-12-1 Kita-Orsuka, TOSHIMA-KU, 170 Tokyo, JAPAN
Tel.: (813) 949 2905, Telefax: (813) 57 62 265

AKG ACOUSTICS INC.
77 Selleck Street, Stamford, Connecticut 06902, USA
Tel.: (1-203) 348 2121, Telex: (23) 285481, Telefax: (1-203) 3241942

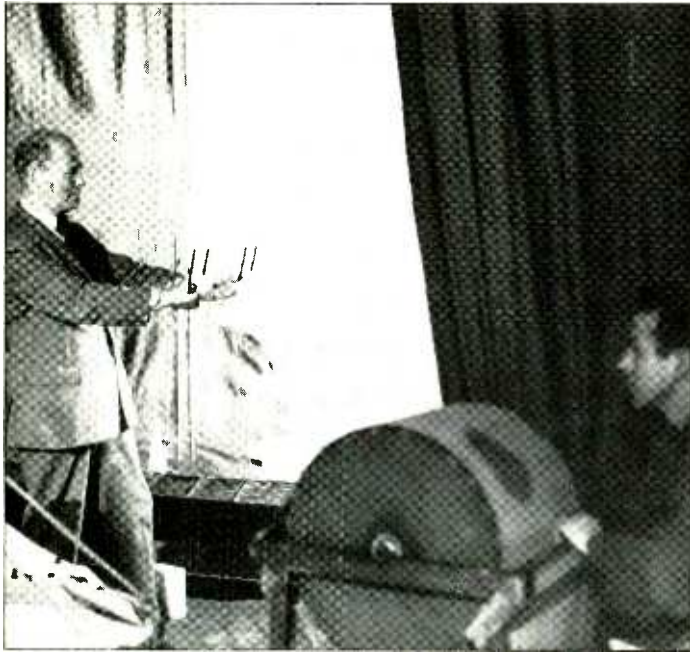

George Rylands directs the wind and rain from the thunder sheet for recordings of Shakespeare at the ADC Theatre, Cambridge in 1960



Peter Orr and Sir John Gielgud discuss the recording of *Brideshead Revisited*

IT'S ONLY ON THE MONITOR

I cannot now recall exactly the circumstances in which I first heard the words which make up the title of this article but I believe it was in my early days as a producer, some 30 years ago, with Radio Jamaica. When I went to work at the little broadcasting station in Kingston, some recordings were still made on 16 in acetate discs and tape was still quite a novelty. There were, I remember, some rather cumbersome machines, bearing the brand-name *Presto*. It was when we were playing back a programme I had recorded for transmission the next day, that I became increasingly alarmed by a persistent hum which made itself heard at a fairly high level. "It's all right," said the studio engineer reassuringly. He then used those unforgettable words: "It's only on the monitor."

"Ah, good!" I said, feigning an understanding which, in those fledgling days, I was still far from possessing. The next day's broadcast revealed, to my shame and consternation, that it was certainly *not* 'only on the monitor', and wherever I have worked since, in the West Indies, America and Britain, that ominous phrase has continued to haunt me.

The spoken word

Spoken word producers do, I believe, sometimes think of themselves rather as Cinderellas of the recording

The recording of plays and stories often requires considerable ingenuity in the area of sound effects. Spoken Word producer Peter Orr recounts some of his experiences

industry. To begin with, there are not very many of us. Then, when our colleagues in the classical and pop departments of the big companies are off to the ball—or, to put it another way, attending banquets at large hotels and receiving awards for their achievements, or are jetting away to produce recordings in places like Vienna, Rome, Sydney or San Francisco—we of the spoken word fraternity are following our calling in more obscure locations; in my own case, small studios in Bradford, Newcastle, Rayners Lane or Shepherds Bush.

Yet the recording of plays, autobiographies, poetry, novels, etc, can be as challenging, as rewarding and, on occasions, as frustrating as any other job in the industry. A few years ago, I had the pleasure of producing for Argo, in association with Radio 210 at Reading, a dramatised version of Bram Stoker's *Dracula*, with a cast which not only included such luminaries of stage, screen, radio and television as Dame Wendy Hiller, Paul Scofield, Robert Hardy, Wendy Craig, Timothy West and Nigel Hawthorne but also pressed into service of

the spoken word, the talents of a number of distinguished musicians including Vladimir Ashkenazy, Gerald Moore and Antal Dorati.

It was a production which demanded a number of sound effects, some of them quite bizarre and, by virtue of the ingenuity and determination of two young programme assistants and a patient recording engineer, we managed to make all of them ourselves, on the spot—which I always think preferable to relying on pre-recorded effects from the library. *Dracula*, as everyone knows, calls for such things as noisy blood-sucking (Spanish blood-oranges), the sound of a stake driven through the heart (a good, firm cabbage, a tent-peg and a mallet), chiming of a distant church clock (fire extinguisher struck with hammer, replayed at double speed), creaking coffin lids (easy), flapping of bats' wings (more difficult), and breaking of glass (I had just had three windows replaced at home and had kept the old panes).

Paradoxically, it often happens that a manufactured sound effect is more convincing than the real thing.

When Argo was engaged on recording the complete works of Shakespeare, there arose a need for a pack of baying hounds in *Titus Andronicus*. Several dogs were auditioned for the purpose but none sounded convincing. In the end, by multitracking, we were able to provide just the right thing by using human beings! It is with some pride that I am able to reveal here that those canine creatures were played by myself and a former Decca studio engineer, Jack Clegg. In fact, Jack took the whole thing very seriously and refused to begin barking until I had told him what breed of dog he was supposed to be!

Perils and pitfalls

It is by no means easy to find suitable locations for recording the spoken word. Too small a studio can produce a 'boxy' effect, which the listener quickly finds unpleasant. On the other hand, an over-resonant acoustic can be very tiring on the ear. Of course, the choice and placing of microphones can make a world of difference, and these days there is quite an alarming range of choice. In its time, the old and trusty STC/BBC ribbon microphone proved admirable for spoken word recordings. And now, the most expensive and elaborate equipment is of little use unless it is used with proper skills. For more than a quarter of a century, I have had the good fortune as a

*Affordable
Quality*

FMX SERIES MIXERS

SOUNDTRACS

A British company dedicated to the design and manufacture of one of the broadest ranges of mixing consoles in the World. We offer ten individual models in over fifty versions to suit your specific requirements.

The choice is yours.

Soundtracs plc. 91 Ewell Road, Surbiton, Surrey,
KT6 6AH, England Telephone: 01-399 3392
Telex 8951073/STRACS/G Fax: 01-399 6821
U.K.: Studio Equipment Distribution (0582) 452495



Applications: Sound Reinforcement;
Video Post Production;
4&8 Track Recording;
Broadcast "On Air"; Stage Monitoring.

IT'S ONLY ON THE MONITOR

producer to have enjoyed the support of successive generations of Decca engineers, headed by the almost-legendary Kenneth Wilkinson, now enjoying well-merited retirement.

Perhaps the biggest problem for any recording engineer and his producer, is the nightmare of 'noises off'. They can be heard in so many forms and spoken word recording is notoriously vulnerable. Years ago, I was assigned to produce a recording of the Royal Shakespeare Company's *Murder in the Cathedral*, to be made in Kingsway Hall, London. Nobody had told me in advance about the underground trains which run regularly and audibly beneath the hall. All very well, if you happen to be taping a heavily-scored orchestral piece with a few Wagner tubas to drown the subterranean rumbles. But a verse play is a different proposition altogether and in those circumstances it became necessary to work with short takes in between trains. How we all prayed for a strike on London Transport!

When *Brideshead Revisited* was enjoying such success as a

television serial, we decided to record an abridged version of the book, with Sir John Gielgud, at a comfortable little studio somewhere in London's north-western suburbs. I had been given warning that every afternoon, at around 4.00pm it would be necessary to suspend operations for 20 minutes or so, while the pizza parlour next door turned on a machine that mixed the daily quota of dough. I thought an extended tea break would be the simplest way around that problem, while waiting for the dough-making to run its appointed course. Perhaps they were expecting a large party for dinner, as it seemed to go on for a very long time; but Sir John was the very soul of patience, eventually the din subsided and we returned to the studio. Just as we were settling down for a fresh take, there came from the direction of the pizza-making establishment what sounded like loud hammering. Another adjournment while enquiries were made as to the origin, nature and probable duration of this new noise. After a few minutes we were informed that what we had been

hearing was nothing more than the chopping of mushrooms. I had not previously realised that the manufacture of pizzas was quite such a rowdy operation!

It was in a studio just outside Newcastle one autumn day that Derek Jacobi's splendid reading of *I, Claudius* was suddenly and rudely interrupted by unfamiliar voices on the speakers. It turned out to be a transmission from a local taxi firm conveyed by some freakish set of circumstances into the studio's circuitry. On that occasion, the engineer ventured the opinion: "I think it may be only on the monitor." He seemed quite taken aback by my reaction.

The isle is full of noises

Those words of Caliban, from *The Tempest* have often struck me as singularly appropriate to some of the situations in which I have found myself: two most undesirable features of Argo's old studio in the Fulham Road were the presence of some massive

coffee-grinders used by the shop next door on one side, and on the other the motor for a lift serving the adjacent block of flats.

In former times Decca's No 1 Studio in West Hampstead, once host to the Moody Blues, was frequently invaded by the metallic voice of the intercom announcing, "Mr Haddy, there's a continental call for you."

The variety of sounds that can somehow make their way into supposedly soundproof chambers is quite astonishing: they come from aeroplanes, trains, cars, lorries, motorcycles, water-pipes, radiators cooling off or heating up, fluorescent lights humming to themselves, electrical clicks, creaking floorboards, mice in the wainscoting, bats in the belfry... the list is never ending. Then there are what one might politely term 'artists' noises': coughs, hiccoughs, sneezes, noisy wrist-watches (Daniel Massey insisted that he did not know how to stop his from bleeping every hour on the hour and interrupting the reading of *A Christmas Carol*), rumbling stomachs (an effective way of forcing an early lunch break), page turning and I don't know what else. One very charming

When your business is sound, Klark-Tek

The advertisement features a grid of 20 television monitors, each displaying a different scene or product related to audio and video production. The scenes include:

- SPECTRUM ANALYSERS:** A monitor showing a red bar graph with the text "SPECTRUM ANALYSERS" below it.
- Satellite:** A monitor showing a satellite in space with the text "SATELLITE" below it.
- Piano:** A monitor showing a person playing a piano.
- Microphone:** A monitor showing a person holding a microphone.
- NEWS AT TEN:** A monitor showing a news anchor with the text "NEWS AT TEN" and "Sandy Gall" below it.
- Drum Set:** A monitor showing a drum set.
- Desk:** A monitor showing a person sitting at a desk with a microphone.
- DIGITAL DELAY:** A monitor showing a digital delay unit with the text "DIGITAL DELAY" below it.
- NEWS AT TEN:** A monitor showing a news anchor with the text "NEWS AT TEN" and "Sandy Gall" below it.
- Trophy:** A monitor showing a trophy.
- MASTERMIND:** A monitor showing a person at a desk with the text "MASTERMIND" and "with Magnus Magnusson" below it.
- Microphone:** A monitor showing a person holding a microphone.
- GRAPHIC EQUALISERS:** A monitor showing a graphic equaliser with the text "GRAPHIC EQUALISERS" below it.

actress explained that her elbow occasionally gave out a loud crack, because of her advancing years. And then there is the popping 'p' which perennially plagues the producer...

Of course, it is possible to circumvent some of these obstacles by subsequent editing and it is not uncommon to find upwards of a hundred joins in a single reel of edited master tape. Not only the extraneous noises have to be removed: there are the fluffs, the stumbles and misreadings which almost inevitably punctuate the progress of any recorded reading. I have collected some rather fine examples of these, including such delights as Britt Ekland, reading from her autobiography and giving an account of her day out 'with Prince Philip and the Queen, when we went shooting peasants'. Twenty years ago, in a recording I produced for BBC Radio Enterprises, Sir Michael Redgrave had to make no fewer than 18 attempts to say the word 'protestantism'. For some time, Robert Hardy (who has recorded quite a number of Sherlock Holmes stories for Argo) and I have continued—in studios and by correspondence—a running battle over the pronunciation

of the word 'lichen'. At the last encounter, I was leading narrowly on points!

From past years, I recall long hours of toil and the blunting of many razor-blades while attempting to cope with the curious threading pattern of a TR-90. And, near the end of a long day, joining the wrong pieces of tape together to find that Act One, Scene One, of a Shakespeare play suddenly and inexplicably gives way to Act Five, Scene three—backwards! But I rather dread the day when spoken word will be recorded and edited digitally.

A cautionary tale

Not so very long ago, I had to record a set of those well-known fairy tales by the brothers Grimm with an eminent actor and his actress wife. I spied the opportunity for a pleasant rural outing since the eminent actor and his actress wife, very sensibly, live in the country and it seemed like a good idea to investigate the possibility of recording facilities in their area rather than bring them all the way into London. The Yellow Pages delivered up some promising leads and telephone enquiries produced earnest assurances that all my

stated requirements, including my insistence on a really quiet location, could very easily be met. Thus encouraged, I set out to make a reconnaissance.

My first call was at a large house set back a little way from a very busy trunk road. The owner, an entirely amiable but rather vague gentleman, greeted me and led me into the garage. I should add that it was a double garage.

"Well, here it is," he announced confidently. "This is the studio, and that—" (he motioned towards a flimsy partition standing precariously at the far end) "that is the control room." I was conscious of a sinking feeling; it was not a promising beginning.

"May I see inside the control room?" I asked, raising my voice in order to be heard over the thunder of a passing lorry. My host seemed not to be aware of the traffic noise. Perhaps he is deaf, I thought. Certainly, on the basis of our telephone conversation I had not expected him to be quite so elderly and frail in appearance.

We looked round the partition and into the so-called control room. There was a simple workbench, a small, rather grubby window offering a dim view of the garage

(sorry—studio!), an ancient-looking tape recorder on the floor and beside it a mysterious object which I took to be the remains of an early wireless set. Of other equipment, there was no sign.

My host picked up the mysterious object and dusted it off. "This—" he proclaimed with every appearance of seriousness, "this is the mixer."

"Ah... yes," I said; I could not think of anything else. We looked at it for a little while in a kind of reverent silence, and then he began to rotate the knobs, obviously anxious to convince me that the mixer was in good working order. One of the knobs fell to the floor. He picked it up and tried to push it on again.

"This one is for the bass," he announced.

"For the bass?" I echoed "Ah... yes."

There was another silence while we both contemplated this product of modern technology. He turned it round in his hands to afford me a better view; I thought he was going to drop it. Eventually, I attempted a question: "At what frequency does it roll off?" Not a very elegant way of putting it but I thought it would do. He considered the question carefully and then

Technology is in your interest.



Although artificial reverberation is often used as a special effect in the recording process it is naturally all around us. We associate it with realism and it allows us to define space. It is therefore an essential ingredient in the making of soundtracks.

The Klark-Teknik Digital Reverberation System brings to your working environment an extremely versatile reverberation processor which gives you instant access to Hall, Chamber, Room and Plate reverb simulations of outstanding audio quality.

There is that rich reverberation sound that makes musical instruments sound transparent and alive, and gives sonic stature to vocals, brilliant percussive plate sound, highly convincing reverberant room ambience and a selection of super-effective Non-Lin and Reverse gated sounds frequently used in contemporary music production.

As a bonus, there are a number of useful digital versions of special effects devices, and a fully functional remote control included at no extra cost.

The Klark-Teknik Reverberation System is based upon a high speed Digital Signal Processor and is claimed to be one of the leading digital systems currently available. Moreover, with the additional benefits of progressive hardware architecture and comprehensive world-wide software update service, it represents unsurpassed value for money when it comes to competitive price/performance ratio.



DN780 Features

- 16 bit linear conversion system with 32 bit arithmetic processing essential for state of the art reverb.
- 28 factory loaded, program library inclusive of the "Alive"™ super-enhancement program.
- Exclusive from Klark-Teknik.
- 50 user memories with optional tape re-load facility.



- Instant program access and sequencing.
 - Full function remote control.
 - Mono compatible.
 - Transformer balanced outputs.
 - Can be operated from SMPTE reader.
- Computer/midi interfacing hardware available.

KLARK TEKNIK

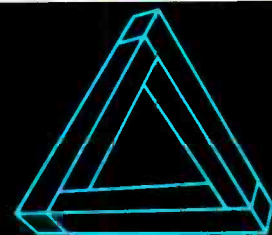

DIGITAL REVERB

Klark-Teknik Plc
Klark Industrial Park, Walter Nash Road,
Kidderminster, Worcestershire DY11 7HJ, England.
Telephone: (0562) 741515 Telex: 339821 Fax: (0562) 745371

IT'S ONLY ON THE MONITOR



The old control room of Decca's No 3 studio

asked me to repeat it. I tried a different formula: "At what frequency does attenuation start with that control?" I asked, pointing to the wobbly knob. Another silence. "Or even boosting, perhaps?" I added hopefully.

"Well, now," he said, looking rather hurt, "I think you're getting a bit too technical for me."

Over a mug of tea in the house (we had exhausted the possibilities of the garage/studio) I explained as kindly as I could that his premises were really not suited to my particular needs. "There are certain noise problems," and I pointed towards the road just a few yards away.

"Oh, really," he said, disbelievingly. Clearly, he was deeply disappointed by my lack of enthusiasm. After a pause, he tried another tack.

"Well, look, I have a friend who has a caravan in the middle of a field, miles away from anywhere. I could take my equipment over, and we could do the recording there if you like."

"Where exactly is this field?" I asked. I have to confess I was not really interested in the answer. So far as I was able to gather, it appeared that the field was not far away, and quite close to a major airport. Very probably in line with the main runway, I thought. I thanked the amiable gentleman rather too profusely as he saw me to the door and he began to propose other and equally

unlikely schemes for the recording. I explained that I found myself in something of a hurry.

It was with a sense of real relief that I found myself, half an hour later and 10 miles or so from my first unfortunate port of call, in what was unmistakably a genuine working studio with all the familiar clutter of microphones, booms, jack leads, headsets and miscellaneous musical instruments, and run by someone who obviously knew what he was talking about.

"Yes, dead quiet it is here," he said. "Absolutely soundproof." We listened approvingly to the silence that reigned there. It really was quiet. A pair of Studers and a bank of Dolby units, glowing red and green, were a reassuring sight after what I had just been through. Clearly, this was the place; and their hourly rates were far lower than I could hope to find in central London. Accordingly, I made a booking for a Saturday morning session some weeks ahead and departed, confident that my mission had been successful.

When I got home, there was a message on the answering machine from my amiable gentleman with the double garage, saying that he had just been speaking to another friend of his, who owned a farm. where there was a disused cowshed and that his friend would be happy to let us have the run of the place for the recording. I was unable

to find the courage to return his call.

All's well that ends well?

You would think that there ought, in all justice, to be a happy ending to this story. Well, here is what actually happened. On the Saturday morning appointed, I met the eminent actor and his actress wife at the quiet studio aforementioned. While I went into the control room to check that everything had been set up according to my instructions, I remember noticing the eminent actor settle down to the *Times* crossword; I think his wife had brought a magazine with her. They did not realise then just how wise they had been!

My acquaintance of the previous visit was, I was given to understand, away on a gig somewhere but Martin (or Charlie, or George—I forget the name) would see to all my requirements. He presented himself. I thought he looked rather young but then so do many policemen these days. The 'dead quiet' studio was, all of a sudden, shaken by an enormous roaring noise, accompanied by quite violent vibration. "What on earth is that?" I asked, more than a little shaken.

"Oh, that'll be the 10.15 to London. It'll soon be gone. Station's just behind the studio, you know."

I did not know. Looking around the control room, I

thought there was something missing. "Now, what about the talkback?" I asked. A furtive look appeared to cross the young man's face.

"I'm not the regular bloke here," he announced. "I'm just filling in—temporary you see."

"Yes, but what about the talkback?" I persisted. "I do need to be able to talk to my actors in the studio."

"Couldn't you just give them signals through the glass panel?" he suggested hopefully.

With all that sophisticated equipment lying around, I did not feel it was necessary to resort to semaphore. "I must have a proper talkback," I insisted. Eventually, after some rooting around, and the soldering of a few connections, a speaker was set up in the studio, a microphone for me in the control room and somewhere between them, an amplifier. While all this was going on the eminent actor was deep in his crossword. I decided not to disturb him until I had made a brief test recording. A few minutes

later, I was listening to the playback. A very loud hum came out of the speakers. "Where is that ***** hum coming from?" I demanded.

The young man looked at me—and then he said: "It's only on the monitor."

"How can you be sure?" I responded. The dialogue seemed oddly familiar.

"Well," he said, "this monitor always has a hum."

In a room next to the studio, I had noticed a tape deck, connected through an amplifier to a pair of wall-mounted speakers. "All right, then," I said, "what we'll do is take the tape off this machine, and play it on the equipment in the next room." Which is exactly what we did. And—yes, dear reader, if you have stayed with me thus far, then you have surely guessed it—the hum was still there.

"Oh," said the young man.

"Yes," said I, grimly. The eminent actor was still absorbed by his crossword puzzle, his wife had not yet reached the end of her magazine. It was evident that we were in real trouble.

There is not space here to relate the tedious processes by which we were at length able to complete our task successfully. At this point, I shall merely make grateful acknowledgement to the those inventors of highly efficient filters, originally designed I feel sure to remove the things which are found only on the monitor. Now have I, I wonder, heard those words for the last time? □

OTARI MX-70



IT MAKES TAPE MORE FLEXIBLE

Otari would like to draw your attention to a remarkable new recorder. The MX70.

The MX70's microprocessor-controlled tape transport, closed-loop tension control and real-time tape counters give you instant, accurate tape control. And that gives you more time to do a better job.

The MX70 is designed for ease of use with machine controllers and synchronisers, meeting a variety of standards, including SMPTE. This makes it as valuable in video

post-production and broadcast studios as it is in audio recording.

Features like these, and many others, make the MX70 one of the most flexible tools any growing studio could wish for.

But there's one area where Otari's MX70 really does offer the kind of flexibility that no other machine can match. In formats.

The MX70's option list lets you choose between 1" 8-track and 1" 16-track formats. Convert to 1/2" 8-track. Or even switch between all three options on the same machine.

But while the MX70 sets new standards for flexibility, the men at Otari have stuck rigidly to tradition.

They haven't budged an inch on quality.



OTARI®

For more information on the MX70 or other Otari products, contact
Industrial Tape Applications, 1 Felgate Mews, Studland Street, London W6 9JT. Telephone: 01-748 9009
Stirling Audio Systems Ltd., 1 Canfield Place, London NW6 3BT. Telephone: 01-625 4515

Otari Corporation
2 Davis Drive,
Belmont, California 94002
Telephone: (415) 592-8311
Telefax: (415) 591-3377
Telex: 910-376-4890 OTARICORP BI MT

Otari Electric Co. Ltd.
4-29-18 Minami-Ogikubo,
Suginami-ku,
Tokyo 167
Telephone: (03) 333-9631
Telefax: (03) 331-5802
Telex: J26604 OTRDENKI

Otari Singapore Pte Ltd.,
625 Aljunied Road,
07-05 Aljunied Ind.,
Complex Singapore 1438
Telephone: 743-7711
Telefax: (743) 6430
Telex: RS36935 OTARI

Otari Electric Deutschland GmbH
Gielen Strasse 9,
4040 Neuss 1
Telephone: 02101-274011
Telefax: (02101) 222478
Telex: 8517691 OTEL D

BUSINESS BUSINESS



Barry Fox investigates the facts behind the industry news

Copyright reform

British copyright law is such a mess that even lawyers in the entertainment industry cannot properly understand it. They have now lost patience. Seven organisations which represent music copyright owners have banded together to form the Music Copyright Reform Group and get Whitehall moving. Electronics have long since overtaken the 1956 Copyright Act which a judge, Mr Justice Whitford, described even 10 years ago as a nightmare to those who have to try to understand it. The MCRG reckons that the Government's previous attempts at amending the act to cope with new technology, have made matters even more confused.

The MCRG includes the Mechanical Copyright Protection Society, the Music Publishers Association and Performing Rights Society. Significantly the British Phonographic Industry, which represents the record companies, was not invited to join the MCRG. Although the two groups both want a levy on blank tape they cannot agree on tactics. The split is now public. The BPI blames home taping for poor record sales and claims a levy as compensation. The MCRG wants a levy as a matter of legal principle, regardless of whether copying causes financial loss.

Bob Montgomery of the MCPS acknowledges that this will create "an element of rough justice" for people who use tape for interviews and their own computer data. When quizzed, the MCRG reluctantly admits that its argument on blank tape means it may have to support a call by magazine and book publishers for a levy on blank paper used for photocopying!

There are some quaint anomalies in the current law which the MCRG wants straightening out, for instance, the "compulsory recording licence" and term of copyright. Together these two create an unmanageable situation.

Under current British law, and nowhere else in the EEC except Ireland, a composer cannot stop anyone making a recording of a musical work once permission has been given for one recording. The exception is when a musician changes the arrangement. Imogen Holst stopped RCA releasing a record of *The Planets* performed on an electronic synthesiser by Japanese artist Tomita. When I was with a party of journalists in Japan five years ago we bought every copy in Tokyo for friends back home. The record shops wondered what the crazy roundeys were up to.

Tomita's recording is now available in Britain because copyright ran out a year ago, 50 years after the death of Gustav Holst. In Germany copyright runs for 70 years after death and in several European countries it runs for an extra period of years and days which exactly matches the duration of their last war. Only a judge can decide whether a

musical performance is an acceptable rehash of an original performance or a new version which needs special permission.

In 1984 the Government amended the copyright law with the Cable and Broadcasting Act which only succeeded in making matters worse. Even industry lawyers find it hard to know exactly what is meant. They think it means that when entertainment programmes are beamed up to a high power direct broadcasting satellite, for reception by anyone with a home dish, responsibility for copyright payment rests with whoever is sending the signal out into space. On the other hand if the signal sent into space is intended to be received by cable stations for relay to subscribers, copyright responsibility rests with the ground stations. Unfortunately by the time the act became law, Britain's plans for DBS had been shelved. Then, last year, the Government authorised individuals to receive cable station programmes on backyard dishes as if they were DBS signals. Now the IBA is talking about DBS again. The obvious thing, says the MCRG, is to have every uplink transmitter bound by copyright. The Government never thought of something as simple as that.

Bob Montgomery of the MCPS speaks for MCRG. "The further you go from the quill pen—the more murky it gets," he says of new technology.

Mr Justice Whitford, the man who said the copyright Act was a nightmare, enlarged on his theme in a legal report.

"A man of reasonable intelligence faced for the first time with the German Copyright Act would in the space of a few hours be able at least to understand it, even if he did not agree with it. The same can scarcely be said of the 1956 act. It is to be hoped that it may be said of any new act."

The MCRG fear the worst.

CD pressing

Nice idea by the APRS to have a reception at Olympia on opening day, invite all the firms involved in pressing compact discs in Britain and give them a chance to talk with the press. Four firms were invited, Nimbus (with one factory up and running in Wales and another on the way), Thorn-EMI (with the VHD videodisc pressing plant at Swindon now producing compact discs), Discet (the Phil Race operation which he has said will be producing discs by the end of the year), and Musitech (the Roy Matthews operation about which only secondhand news exists).

Nice idea. But a pity that only Jim Drennan of Nimbus turned up. If there was anyone from Swindon, I didn't see them. But I have seen the Swindon presses producing discs with my own eyes. Particularly interesting was the absence of Discet and Musitech. It would have been a golden opportunity

for the press to get some first hand, hard fact answers to burning questions like, 'How is it going?' Perhaps that's why they didn't turn up.

Incidentally, there are some interesting differences between the Thorn-EMI plant at Swindon, the Nimbus plants in Wales and the PolyGram plant in Germany. Nimbus and PolyGram use German and Swiss-made presses and evaporation chambers; Thorn-EMI bought from Toshiba in Japan. In fact Swindon even buys its raw polycarbonate plastics from Teijin in Japan, rather than Bayer in Europe. But Thorn bought its laser mastering suite from Philips. Nimbus, though built its own laser mastering lathes. Three are already running and a fourth is under construction.

Meanwhile there is interesting news from the classified advert columns. One un-named firm was offering £60,000 and upwards for someone to run a new CD pressing plant. No-one would say who was offering. But we now know the plant was planned for Northern Ireland. The high salary is danger money.

Philips has been quietly test pressing compact discs at its Laservision plant in Blackburn, Lancashire for at least a year. The factory, now jointly owned with Dupont of America, is currently spending £4 million on equipment to press CDs on a commercial scale. How do we know? Philips told all in some adverts asking for engineers to run the plant.

Not so Live Aid?

Well Bob Geldof got his gong. And some editing work has already been done on those Live Aid master tapes, remember how the beginning of Paul McCartney's *Let It Be* solo was spoilt when he started to sing before the faders were up. His voice was lost but not for ever. When BBC Radio 1 and TV now put out clips from the Live Aid concert tapes, you will hear McCartney's voice on *Let It Be* back where it belongs.

McCartney heard that the BBC wanted to broadcast the clip, asked to borrow the multitrack tape and took it up to Air Studios where he re-layed the vocal track. But he did it without video, just listening to the piano as a guide track. This didn't matter on radio but when the BBC first tried to broadcast the same clip on television, there were sync problems. McCartney's new voice didn't match his original lip movements.

Beeb engineers did sterling work, pulling voice and pictures together but they couldn't get it spot on. So there's a lot of added echo to blur the lines.

Needless to say no-one is talking too much about this. But it looks as if other sequences have been repaired as well. Clips of the final sing-song which suffered from lost radio mic channels, now seem to sound far better than the original. □



The Studer Standard.

The Studer A820 has created a new audio standard by which all other tape machines are to be judged. Studer's new generation of phase compensated audio electronics takes the A820 far ahead of tape recorders made just a few years ago. With its transformerless inputs and outputs, recordings on the 1/2" stereo A820 have been favourably compared to the best digital recordings heard to date.

The A820 also sets new standards in ease of control – it is designed to meet the demands of tomorrow's computer controlled audio production facilities. Multiple on-board microprocessors control all operating sub systems including capstan drive, spooling motors and audio parameter settings.

- Other features include:
- 14" spool capacity.
 - Soft keys can be programmed to suit operational requirements (40+ function internal library).
 - Storage of audio line up information for different tape types.
 - Automatic adjustment of audio parameters between 1/4" and 1/2".
 - Shuttle control cue for fine control of tape position.

Just write or phone for full technical details.

STUDER

STUDER REVOX S A R L Paris
CH-8105 Regensdorf Telephone (01) 840 29 60



STUDER REVOX AMERICA INC Nashville Telephone (615) 329-9576
STUDER REVOX S A R L Paris Telephone 533 5858
STUDER REVOX CANADA LTD Toronto Telephone (416) 423-2831

F.W.O. Bauch Limited

49 Theobald Street, Boreham Wood, Hertfordshire WD6 4RZ
Telephone 01-953 0091, Telex 27502 Fax 01-2075970

REVIEW REVIEW

Hugh Ford reviews a power amplifier

CITRONIC PPX 900

The *PPX 900* is one of several models available from Citronic, the *PPX 450* is identical but lighter as it offers half the power. Both are complementary MOSFET professional power amplifiers designed with reliability in mind, and are made to a very high standard of construction with many sensible features.

The amplifiers are suitable for rack mounting at 3U high. Thermostat controlled forced air cooling draws air in at the front when the heatsink temperature rises above 60°C. The cold air is passed over the output device heatsinks and ejected at the rear of the unit. No air filtering is provided but in my opinion filters are a mixed blessing because they rarely get cleaned.

In use the fan cut in and out quite frequently but it was unusually quiet and unlikely to be a nuisance. The front panel is made from 6 mm thick alloy plate to which is bolted the 1.5 mm thick steel 'U' section which forms the rear and sides. Top and bottom covers, again of 1.5 mm steel, secure to this and to an intermediate vertical steel section which forms a screen within the amplifier between the power supplies and the audio sections where a further screen exists between the two channels.

Substantial carrying handles front and rear provide physical protection for the controls and connectors—important for mobile use.

To the front left a substantial rocker switch applies power with a power on LED at the centre where a second LED shows if the amplifier has been set to the bridge mode of operation.

To the left in vertical array are the two gain controls in the form of detented potentiometers with arbitrary calibrations. The detents represented approximately 2 dB steps down to -30 dB with intermediate positions being usable. Adjacent to each control is a clip warning LED.

At the rear, power is fed via a fixed 3-core lead which is properly secured. The power fuse and the 110/120/240 V transformer tap changing are internal, the latter at a screwed terminal block. Whilst the chassis is grounded via the mains lead the electronics may be lifted from ground by means of a rear panel slide switch. A further recessed pushbutton switch selects the twin-channel or bridge mode of operation.

The electronically balanced audio inputs are available at 3-pin *XLR* sockets in parallel and twin 3-pole ¼ in jack sockets for each channel allow a rack-mounted amplifier to be daisy chained.

Similarly the outputs are fitted with terminals/banana sockets on the standard ¼ in spacing in parallel with 3-pin *XLR* plugs—I don't like to see voltage available at unprotected pins but if sockets had been used they could be confused with the inputs.

Within the amplifier the power supplies, including a large toroidal transformer, are in a separate compartment to the left with the transformer mounted at the front to move the centre of gravity towards the front panel. To the right each amplifier channel is mounted on a single printed circuit board which includes the front panel features and the input connectors thus virtually eliminating any hand wiring, and increasing reliability. The boards are of excellent quality with a clear layout and proper component

MANUFACTURER'S SPECIFICATION

Input signal: 0 dB=775 mV, 0 dBm. 20 kΩ unbalanced, 40 kΩ balanced.
Input connection: jack socket, ¼ in, balanced (TIP +VE) and *XLR*-type connector.
Output power: (Measured with both channels driven, sine wave drive, resistive load, continuous rating with mains at 100%, at visible onset of clipping.) 8 Ω bridge mono—900 W; 4 Ω (per channel)—450 W; 8 Ω (per channel)—280 W.
Voltage gain: at full gain ×52 (34 dB) 0 dB ref *O/P*=40 VRMS.
Output connection: terminal posts 4 mm on ¼ in spacing and *XLR*-type connector.
***XLR* wiring:** to BS 5428/IEC 268 (Pin 2 hot).
Load impedance: stereo—8 or 4 Ω per channel; bridge—8 Ω minimum.
Bridge mode: channel A driven in-phase (+ output); channel B driven out of phase (- output).
Damping factor: >300 ref 8 Ω, 100 Hz.
Frequency response: <10 Hz to >100 kHz at 1 W.
Power bandwidth: <10 Hz to 100 kHz.
S/N ratio: 100 dB, 10 Hz to 20 kHz.
Slew rate: ±45 V/μs (10 kHz square wave at +10 dB).
Rise time: <4 μs 10% to 90% with 8 Ω resistive load.
Harmonic distortion: typically 0.005% at 1 kHz; <0.03% 10 Hz to 10 kHz; <0.06% 10 kHz to 20 kHz. Measured at 0 dB output into 8 Ω.
Intermodulation distortion: <0.03% SMPTE. 60 Hz:7 kHz 4:1.
Power connection: 3-core captive cable—brown core Live (phase); blue core Neutral; green/yellow core Earth (ground).
Dimensions: (whd) 483×133×337 mm/19×5¼×13¼ in.
Weight: 22 kg.
Manufacturer: Citronic Ltd, Halifax Road, Bowerhill, Melksham, Wiltshire SN12 6UB, UK.

identifications including transistor lead functions and the pinout diagram of the input RC 4558 integrated circuit which is socketed. The latter may be for good reason as the inputs are DC coupled and completely unprotected against over voltage. The integrated circuit is rated at a maximum input voltage of 15 V to earth.

Protection is by the 1¼ in mains fuse (which should be identified in value) and six 20 mm fuses in each channel, each protecting a single output MOSFET. This is a very good idea as it simplifies fault finding if an output device fails. Further protection is provided by a 125°C thermostat mounted within the mains transformer which is disconnected from the mains if over-temperature occurs. In addition to the fan thermostats each heatsink has a second thermostat operating at 100°C which disconnects the output (but not the power) if excessive heating occurs.

Loudspeaker protection is effected by a FET clamp which removes the drive to the output stages at switch-on, giving a ramped increase in gain. In addition protection against DC at the outputs is provided by a crowbar circuit which fires a triac across the output if excessive DC occurs. This, or shorting the outputs by other means, leads to current limiting rather than any failure mode.

Inputs and outputs

In the unbalanced mode the input impedance for each leg was 21.6 kΩ and 19.6 kΩ leading to an input impedance of 41.2 kΩ in the balanced mode. Both channels were closely matched and the input impedance was constant with gain setting.

The inputs are DC coupled and unprotected such that they take exception to the application of DC with the input stages locking-up under some DC conditions. The maximum input that may be used (corresponding to 0.1% total harmonic distortion at 1 kHz) was 4.35/4.53 VRMS (about +15 dB.7V) which is on the low side for some applications.

The two channels were accurately matched in gain to the outputs at 34.33 dB/34.31 dB which in round figures makes an input of 0.7746 VRMS (0 dB.7V) correspond to an output of 200 W into 8 Ω.

Common mode rejection for the two channels was identical as shown in Fig 1 where it is 48 dB at 1 kHz falling to 20 dB at 200 kHz.

At the output the DC offset was found to be 42/14 mV with the only pre-set controls in the amplifier setting the output device bias current. Fig 2 shows the modulus of the output impedance versus frequency which unlike some amplifiers was the same at all output currents. The impedance of 8 mΩ at 1 kHz leads to a damping factor of 1,000 relative to 8 Ω.

TAC

TOTAL AUDIO CONCEPTS



MATCHLESS

The world's most cost-effective and best-sounding

24 buss multitrack/production console

MATCHLESS IN EVERY WAY

Sales and Factory:

TOTAL AUDIO CONCEPTS LTD

Unit 12, Bar Lane Industrial Park, Bar Lane,
Basford, Nottingham NG6 0HU.

tel: 0602 701002-783306 telex: 37329 AMEK NTG

In the USA

AMEK CONSOLES LTD

10815 Burbank Blvd, North Hollywood,
Ca 91601. Tel: (818) 508 9788

telex: 662526 AMEK USA

REVIEW REVIEW

Frequency response and noise

The frequency response from 10 Hz to 20 kHz was found to be virtually independent of power output below clipping; within ± 0.5 dB reference 1 kHz for the worst channel. Fig 3 shows the frequency response for both channels in five 2 dB increments below the onset

of clipping where the response is within ± 0.5 dB at any level up to 40 kHz.

Noise performance was measured relative to an output of 200 W into 8 Ω as opposed to the apparent rated power output of 280 W quoted as output power in the manufacturer's specification. Closer inspection of the latter shows that 280 W is the specified output at clipping whilst 200 W is the power used for specifying sensitivity and distortion.

200 W output is a realistic power output capability.

Noise in both outputs was measured at minimum and maximum gain settings with the noise at maximum gain being the worst case gain setting unlike some amplifiers where mid-point gains give the worst noise. Table 1 shows a good performance with consistent results between the channels, also power line hum was insignificant in the outputs.

TABLE 1
Measurement method

	Noise referred to 200 W into 8 Ω	
	Minimum gain	Maximum gain
22 Hz to 22 kHz RMS	-110.8/-113.9 dB	-101.9/-103.4 dB
A-weighted RMS	-118.4/-118.0 dB	-104.4/-105.0 dB
CCIR-weighted quasi-peak	-104.4/-106.9 dB	-97.8/-98.5 dB
CCIR/ARM ref 2 kHz	-119.6/-119.8 dB	-103.6/-103.8 dB

TABLE 2

Load	Maximum power output		Clipping output Single channels
	Both channels	Single channels	
8 Ω	284/284 W	294/296 W	306/306 W
4 Ω	463/470 W	490/490 W	536/544 W
2 Ω	—	—	729/756 W

FIG. 1 PPX 900
COMMON MODE REJECTION BOTH CHANNELS

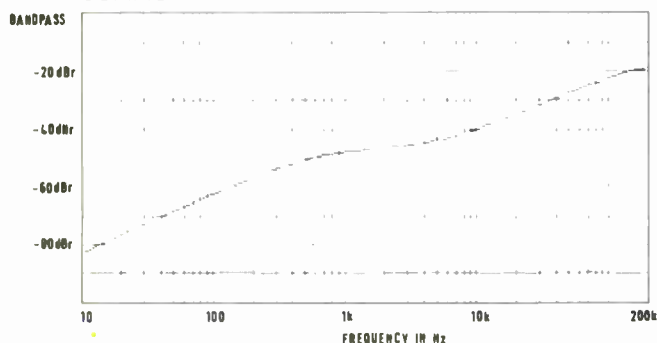

FIG. 2 PPX 900
OUTPUT IMPEDANCE AT 1A CURRENT
SAME AT 100 mA AND 10 mA

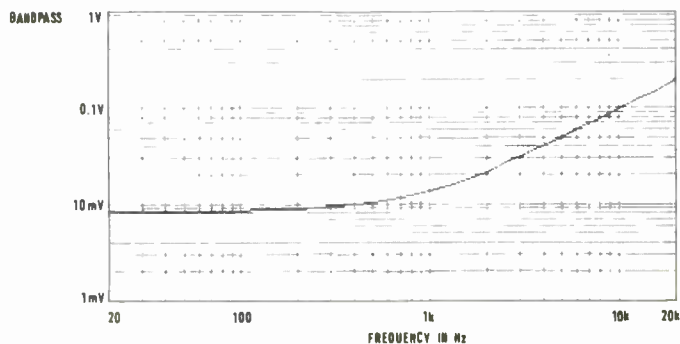

FIG. 3 PPX 900
FREQUENCY RESPONSE IN 2dB STEPS BELOW
RATED OUTPUT OF 280W INTO 8 Ω

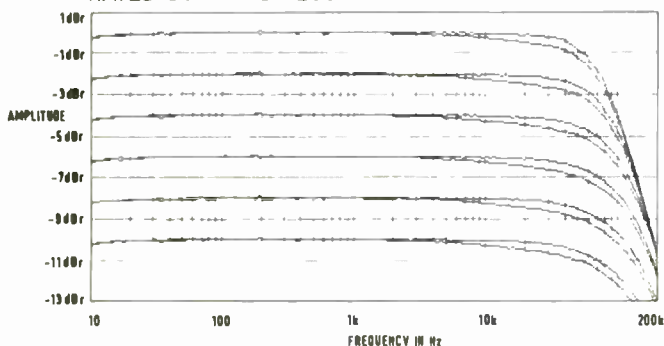

FIG. 4 PPX 900
THD+N AND POWER OUTPUT VERSUS INPUT VOLTAGE
BOTH CHANNELS INTO 4 Ω AT 1kHz

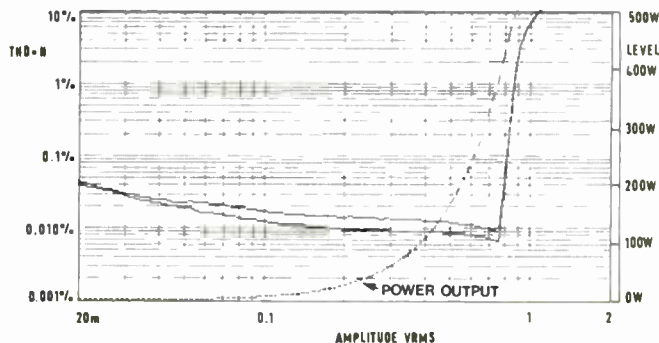

FIG. 5 PPX 900
THD+N AND POWER OUTPUT VERSUS INPUT VOLTAGE
BOTH CHANNELS INTO 8 Ω AT 1kHz

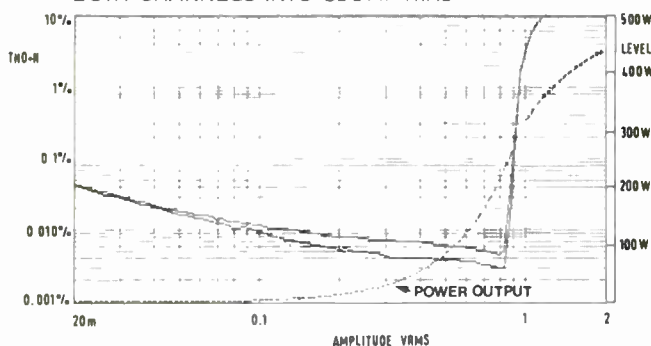
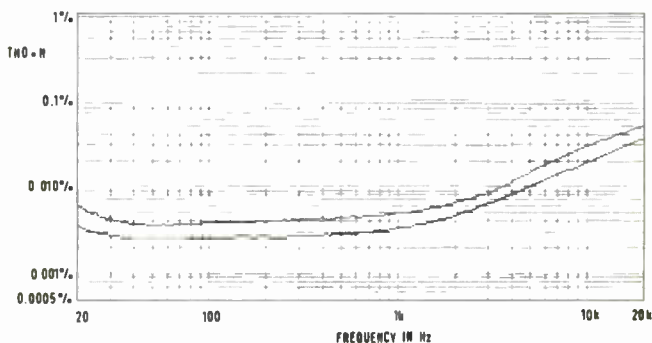
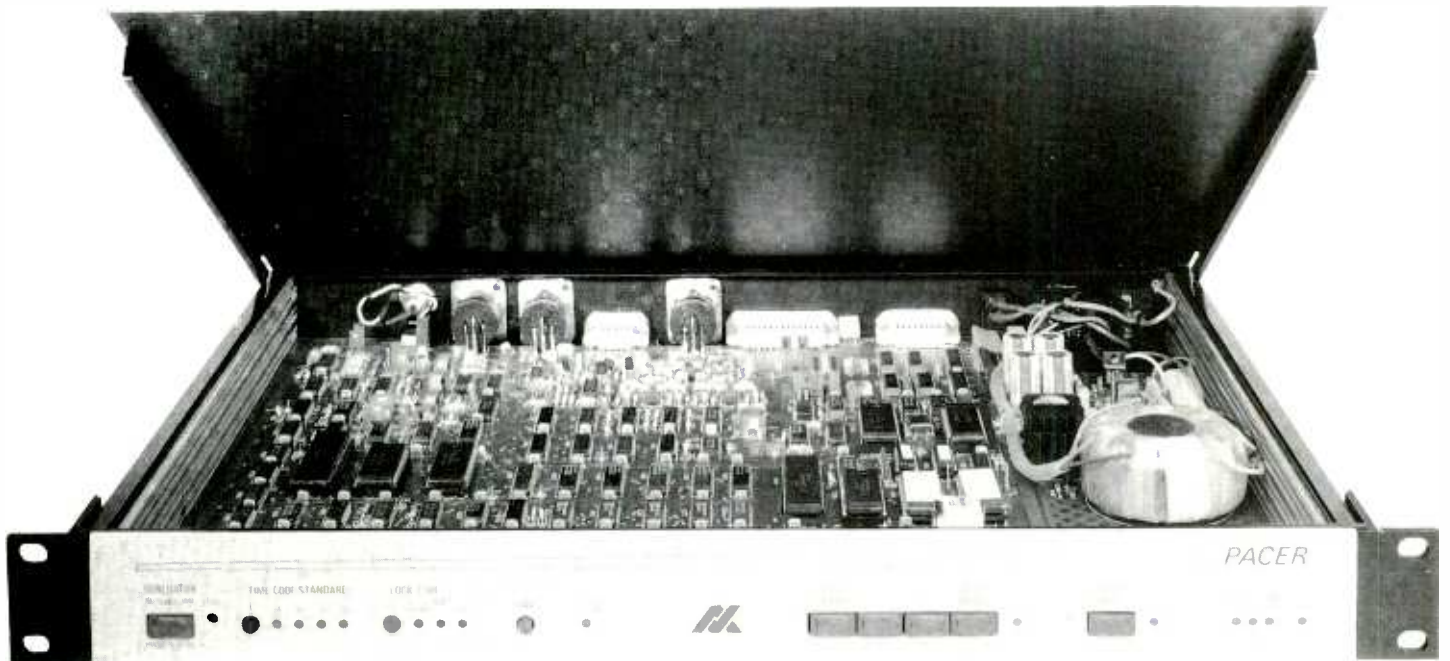

FIG. 6 PPX 900
THD v FREQUENCY AT 200W INTO 8 Ω
BOTH CHANNELS SHOWN OVER 10Hz TO
30kHz BANDWIDTH RMS



TAKE THE LID OFF OUR NEW SYNCHRONISER...



... YOU'LL FIND EVERYTHING YOU NEED.

PACER - A SYNCHRONISER/GENERATOR/RESOLVER

Most other Synchronisers seem to offer you a complete unit, but when you look into it deeper, you find you need a timecode generator as well, or an optional high speed reader, or even TWO complete units.

PACER is different. Just one module, only 1.75 inches high (1U), fitting into a 19" Rack, and containing everything you'll need. It's extremely easy to use, and software interfacing is included for most popular machines. Whether your application is simple multitrack to multitrack locking, Video/Audio Synchronisation, or adding audio machines to a VT Editor, PACER fits the bill.

PACER contains, as standard:

- A Multistandard Time Code Generator
- A Two Machine Synchroniser
- Twin High Speed Time Code Readers
- Tach & Direction Circuitry for Master & Slave
- Full Slave Interface
- A Resolver Facility (Synchronise to Ext. Ref)
- A Serial Interface for External Computer Control
- Automatic Slave Calibration with Battery Backed Memory

Take a look at PACER today. Call or write for the name of your nearest dealer.



AUDIO KINETICS LIMITED

Kinetic Centre, Theobald Street, Borehamwood, Herts. WD6 4PJ, England. Tel: 01-953 8118 Telex: 299951 Fax: 01-953 1118

AUDIO KINETICS INC

1650 Highway 35, Suite 5, Middletown, New Jersey 07748, U.S.A. 201-671 8668 Fax: 201 671 6902
4721 Laurel Canyon Blvd, Suite 209, No. Hollywood, Cal 91607, U.S.A 818-980-5717 Fax: 818 761 3916



REVIEW REVIEW

Power output and distortion

Initial attention was directed at the maximum power that could be delivered at 1 kHz with 1% total harmonic distortion into loads of 4 Ω and 8 Ω using accurate load resistors with the input voltage stabilised at 240 V \pm 0.5% which were also used for other high power measurements; voltages were measured with a highly accurate digital voltmeter.

The amplifier was then driven with 10 ms bursts of 1 kHz tone every 100 ms and the power output at the onset of clipping determined by far less accurate methods.

Table 2 shows clearly there is little

difference between the two channels both of which can deliver a substantial power into 2 Ω and cope with the impedance variations of 4 Ω loudspeakers which can fall well below the rated impedance.

Figs 4 and 5 are plots of power output and total harmonic distortion and noise against the input level in volts on the horizontal axis for 4 Ω and 8 Ω loads, both channels being shown in each figure. In both cases noise and distortion reaches a minimum as the input is increased and then exhibits a very rapid rise. Whilst slight differences exist between the two channels the point of rapid rise is well defined and corresponds to 230 W into 8 Ω or 370 W into 4 Ω . The minimum total harmonic distortion plus noise was 0.002% into 4 Ω .

Generally the distortion was mainly crossover type products which varied little with level such that Figs 6 and 7 represent typical results for both channels into 8 Ω and 4 Ω .

Intermodulation distortion was measured to the CCIF twin tone method using tones separated by 80 Hz at 200 W peak equivalent sine wave output. The results were fairly similar for both channels from 5 kHz to 200 kHz as shown in Fig 8 where the distortion rises rapidly above 30 kHz.

Using similar tones the relation between CCIF intermodulation distortion and input level is shown in Fig 9 when working into 8 Ω with similar good results being obtained when working into 4 Ω .

FIG. 7 PPX 900
THD v FREQUENCY AT 400W INTO 4 Ω
BOTH CHANNELS SHOWN OVER 10Hz TO
30kHz BANDWIDTH RMS

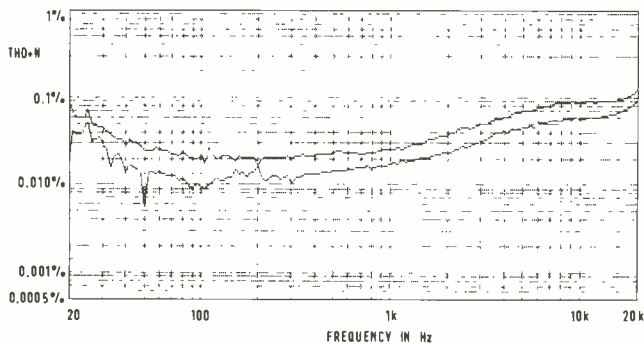

FIG. 8 PPX 900
CCIF IM DISTORTION WITH 80 Hz DIFFERENCE
TONE AT 200W PEAK EQUIVALENT
INTO 8 Ω SINGLE CHANNELS

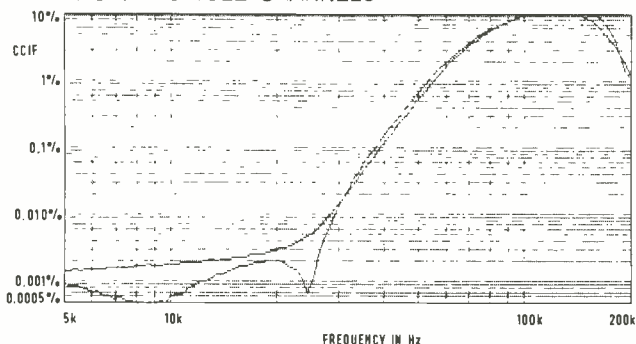

FIG. 9 PPX 900
CCIF IM DISTORTION WITH 80Hz DIFFERENCE
TONE VERSUS INPUT LEVEL AT 15kHz
INTO 8 Ω SINGLE CHANNELS

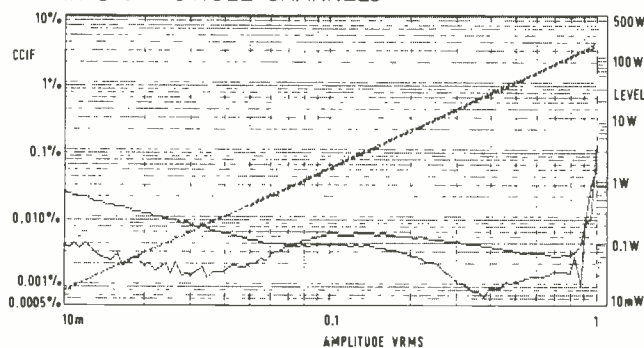

FIG. 10 PPX 900
DIM30 DISTORTION WITH 15 kHz PROBE
TONE VERSUS INPUT VOLTAGE
INTO 8 Ω SINGLE CHANNELS

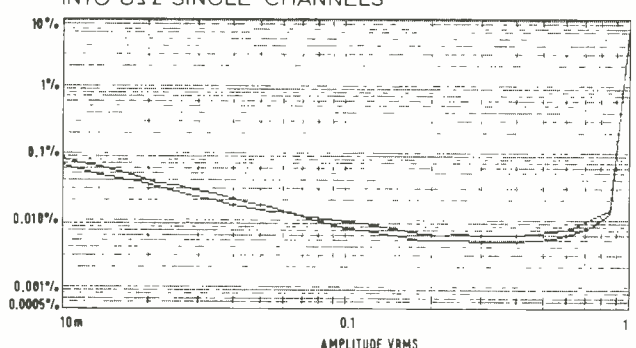

FIG. 11 PPX 900
PHASE RESPONSE WORKING INTO 8 Ω

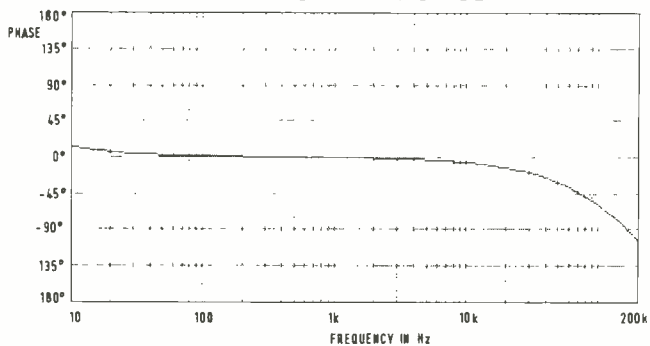
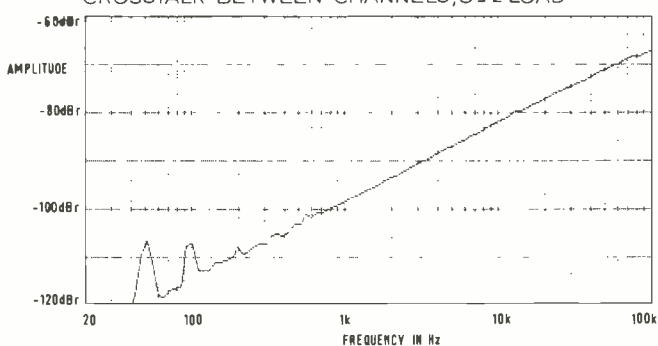

FIG. 12 PPX 900
CROSSTALK BETWEEN CHANNELS, 8 Ω LOAD



By-pass Spaghetti Junction



The **MG1212 Recorder/Mixer** – the complete recording system from Akai – offers unparalleled flexibility for all your recording needs. So compact, it's as much at home in your front room, when you're putting songs together or trying out an arrangement, as it is in the studio, when you're working on masters.

Whatever your application, the Akai MG1212 Recorder/Mixer's got the edge over the competition. If you were limited by 8-track before, now look at this: the MG1212 has 12 audio tracks plus a special sync track – ideal for synchronising your MIDI sequencer to tape for overdubs with a small instrument set-up. If you hated the hassle of wiring between machine and mixer – finding enough leads that worked every time you wanted to put down an idea – the MG1212 has the answer to that too: it's a combined mixer and recorder, and both sections of the MG1212 have the flexibility, versatility and professional quality

you expect from a company like Akai. At a price you can afford.

The mixer section features XLR inputs, insert points, LED bargraph metering, and a full 3-band sweep EQ. A centralised routing matrix deals simply and quickly with the task of getting the right sounds to the right tracks.

Akai's unique 1/2" cassette system is at the heart of a recorder section that's crammed with the features you need: an autolocator with pinpoint accuracy; dbx noise reduction; and much more. It's as simple to use as a home video recorder.

And talking of video, the MG1212 has all the facilities you need for synchronising a video recorder with SMPTE time code.

What you won't find is a load of gimmicks that slow you down. The Akai MG1212 is designed to get top-quality results. Quickly. Easily. The way you want.

AKAI
professional

REVIEW REVIEW

FIG 13

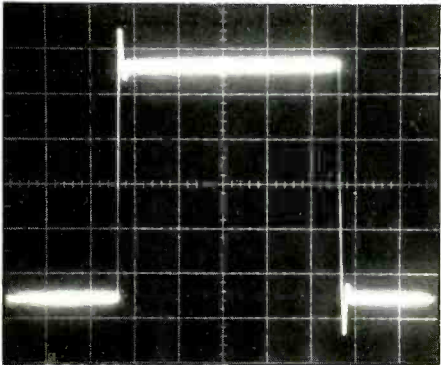
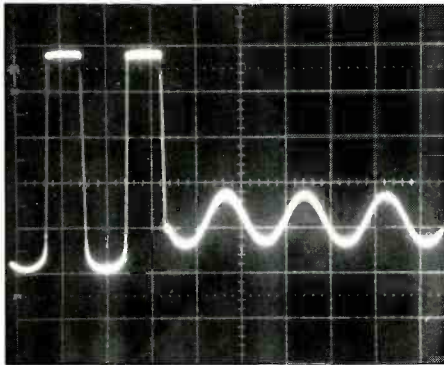

FIG 14



Transparent

Series 4000 professional microphones



Brüel & Kjær 
 Bruel & Kjaer (UK) Ltd

Harrow Weald Lodge · 92 Uxbridge Road · Harrow · Middlesex · HA3 6SZ
 Telephone: 01 954 2366 Telex 934150 Fax: 01 954 9504
 Contact Ralph Dunlop or Jon Ridel at turnkey for further information Telephone: 01 202 4366

86-270

Dynamic intermodulation distortion (DIM) was measured using a 3.15 kHz square wave band limited to 30 kHz with a 15 kHz sine wave superimposed in a peak amplitude ratio of 4:1 whilst measuring the fifth and sixth order intermodulation products. The results of this test for both channels working into 8 Ω whilst varying the input level from 10 mV to 1 V are shown in Fig 10 where the amplifier offers a good performance up to 850 mV peak equivalent sine wave input. Similar results were obtained into 4 Ω loads.

Other matters

Fig 11 shows the minimal phase shift up to 20 kHz and Fig 12 the excellent crosstalk performance confirming the very low level of mains frequency components in the output.

The rise and fall times of the amplifier were similar at 2.65 μs and 2.74 μs with the maximum slew rate of 28 V/μs. The effect of working into a load of 8 Ω in parallel with 2 μF is shown in Fig 13 for a 1 kHz square wave with little overshoot.

Recovery from overload was instantaneous even when the amplifier was driven into 10 dB of asymmetrical clipping. Such an effect is shown in Fig 14 where a 1 kHz low level sine wave has been applied continuously and an asymmetrical burst of 1 kHz tone superimposed to drive the amplifier into 10 dB of clipping.

The clipping indicators worked on voltage or current overload and were set to a point of less than 0.02% total harmonic distortion into 8 Ω or 4 Ω. A period of 8 ms of overload was needed to illuminate the indicators.

Summary

This is a very well made amplifier with an excellent standard of construction in terms of both the mechanics and the electronics.

As a result of the good screening, crosstalk and power line components in the outputs are at a very low level. Both harmonic and intermodulation distortion performance was to a good standard.

All measurements made agreed within sensible limits with the manufacturer's test results provided with the amplifier and I do not have any quarrel with the manufacturer's specification. It is, however, rather unusual to specify the output power capability at the onset of clipping.

The only reservations I have relate to the lack of protection at the inputs and the fact that they are DC coupled, also the maximum input signal handling capability will cause problems in some applications—ie many digital audio systems can deliver peaks in excess of +15 dB reference 0.7746 VRMS. □

These condenser microphones are designed expressly for digital audio recording.

They deliver an entirely natural, uncoloured sound. Their distortion figures are insignificant, and their phase response is, to all intents and purposes, perfect.

They are perhaps the finest of their kind in the world.

And in the rarefied quality of CD, they can make the vital difference.

THE SANKEN CU-41.

Developed jointly by Sanken and NHK Research, the CU-41 is the culmination of 58 years of Japanese microphone design.

Two condenser capsules are incorporated, each with a one-micron titanium diaphragm, the most stable material available.

Just as in a full range loud-speaker, one handles the high frequencies; the other, the lows.

The overall response is flat – within 1dB – from 20Hz to 20kHz, and at the maximum SPL of 134dB, T.H.D. is just 0.5%.

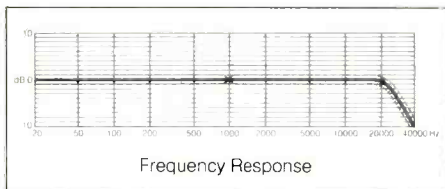

(Each microphone is accompanied by an individual frequency response trace, a unique guarantee of quality).

The Sanken CU-41's perfectly phase-complementary design exceeds the performance of any other microphone in the world.

THE SANKEN CMS-2.

Our unique MS Stereo microphone is the smallest and lightest in the world – just 180 grams of leading-edge technology.

Again, it's in an acoustic class of its own. A very flat response, inaudible self-noise (below 16dB) and a startling 129dB dynamic range add up to extremely low colouration and a near-perfect stereo image.

They are features that make it the perfect choice for broadcast/compact disc recording.



How to make a perfect microphone.

THE SANKEN CONNECTION.

As users of a world-class product, our clients receive excellent before and after-sales back-up.

Ask your distributor (see list) to arrange a demonstration for you, in your studio.

And, of course, they'll provide you with a service that's as good as the microphones themselves – perfect.



Pan Communications Inc., Azabu Heights, Suite 607,
1-5-10 Roppongi, Minato-ku, Tokyo 106, JAPAN.
Tel. 03 503 5463. Tlx. 2423934 KNMPCM J



SANKEN DEALERS WORLDWIDE

Australia: SYNTEC INTERNATIONAL PTY LTD New South Wales Tel: (02) 406-4700 Belgium: RADELCO Antwerp Tel: (03) 233-7800 Canada: GOULD MARKETING INC Montreal Quebec Tel: (514) 342-441 Denmark: SLT STUDIE AND IYDTEK NIK APS Vanlose Denmark Telex: 22924 SIT DK England: STIRLING AUDIO SYSTEMS LTD London Tel: (01) 625-4515 Telex: 946240 Ref. no: 19014280 Fax: 01-372 6370 Finland: MS-AUDIOTRON KY Laitilantie 10 00420 Helsinki Finland Tel: (9) 0 566 4644 Telex: 125778 MSA SF France: 3M FRANCE Cergy Pontoise Cedex Tel: (03) 031-6423 Hong Kong: ADVANCE COMMUNICATION EQUIPMENT (INTERNATIONAL) CO., LTD. Wing Ming Industrial Centre, 1/F, 15 Cheung Yue Street Cheung Sha Wan, Kowloon Hong Kong Telex: 40442 ACECO HX Fax: 3-7452776 Italy: GRISBY MUSIC PROFESSIONAL S.R.L. Via Delle Industrie, 4 60022 Castelfidardo (Ancona) Italy Tel: (071) 781714 Fax: (071) 7819048 Los Angeles, USA: AUDIO IN 1032 North Sycamore Avenue Los Angeles California, 90038 USA Tel: (213) 469-4773 Telex: 315254 AID LSA US Netherlands: STAGE THEATER EN STUDIO TOEGEHORIG: CHNIEK Nieuwegein Tel: 03402 45780 Norway: SIV. ING. BENUM A/S Oslo Tel: (02) 14 54 60 S. Africa: ELTRON Johannesburg Tel: (011) 29 3066 Sweden: T.M. AND TON ELEKTRONIK AB Goteborg Tel: (031) 80 36 20 Switzerland: TECNAD SA Lausanne Tel: (021) 35 35 01-02 U.S.A.: MARTIN AUDIO VIDEO CORP New York Tel: (212) 541 5900 STUDIO SUPPLY COMPANY INC. Nashville Tennessee.

REVIEW REVIEW

A user report by Mark Jenkins

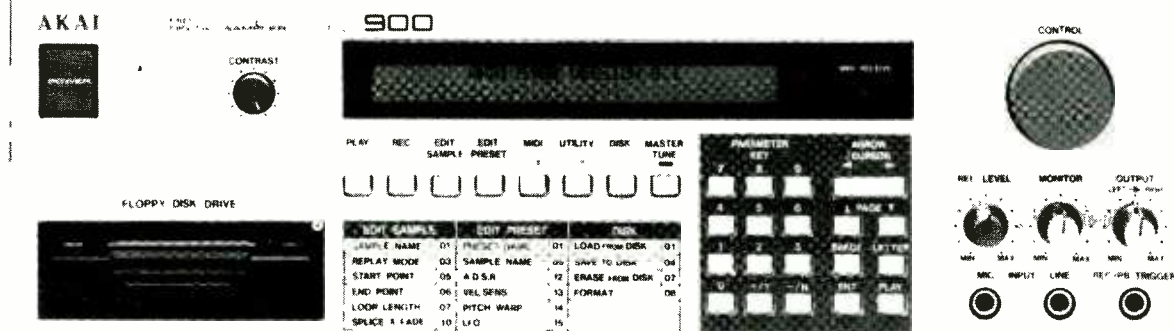

AKAI S900

The Akai S900 sampler is an expanded and improved model based on the successful S612 unit but having an integral disk drive using 3½ in disks rather than the less easily available Sharp Quick Discs. The sampling time, frequency response and disk capacity are all improved as compared to the S612, and the S900 is multi-timbral with eight independent voices.

The S900 has a 3U 19 in rack mounting format and loading time for a full 1 Mbyte disk is around 40 s; the exact number of sounds available on a disk depends on the length and arrangement of the sounds. Thirty-two sounds can be held in memory at once and the S900 has 12-bit operation with 16 kHz maximum frequency response for 12 s of sampling (48 s at 4 kHz), 6-octave range and velocity response over MIDI. The unit also responds to pitch bend and modulation information and has built-in envelope generators, LFO's and static filters. Advanced sampling functions include Sample Merge, Velocity and Positional Crossfade, Looping and Alternating Looping.

Eight front panel buttons select the S900's main modes, which are Play, Record, Edit Sample, Edit Preset, MIDI, Utility, Disk and Master Tune. Data is entered either from a numeric keypad or from a continuously rotating Control wheel.

Thirty-two 'Key Groups' (comprising one sound, or a pair of sounds distinguished by their response to Loud or Soft keyboard playing) can be

assembled into a 'Program', and eight programs can be held in memory or on a disk. Outputs are unbalanced line individual jack outputs and mix output, plus a 13-pin multiway socket (as used on the S612) which interfaces with the AX73 synthesiser or VX90 expander. Either of these units can add dynamic filter envelope and chorus treatment to the S900's sounds.

Sampling inputs are front panel Mic and Line jack sockets; a Rec/Play trigger socket allows several different sampling techniques to be used. A large LCD display demands a sound name when entering Record Mode; letters are entered by hitting the Letter button and dialling them up on the Control wheel, and numbers by typing on the keypad.

Subsequent 'pages' on the Record Mode display are selected with the Page Up and Page Down buttons. The 'Monitor' page allows an existing sample to be called up for use as a tuning reference while sampling, and 'Sample Type' allows the optional Normal, Loud or Soft to be entered for single or dual-sound keygroups.

'Audio Bandwidth/Sample Time' has a maximum setting of 16 kHz but defaults at 10 kHz, giving 19.005 s of sampling. Sampling times may be set to the ms using the keypad, or samples can be edited retrospectively.

'Pitch' is expressed as a MIDI Note Number or as a musical note (for example C#5) and can be tuned using Coarse or Fine parameters, the Coarse pitch being entered either from the Control dial or from a MIDI keyboard. A front panel Play button triggers the

sample for checking if no keyboard is available.

The 'Sample Start Option' page offers MIDI Key Down, Footswitch, or Audio Trigger options, while the 'Sampling' display simulates a VU meter with 0 dB and adjustable trigger threshold markings. A line of arrows crosses the top of the display to show time remaining during the sampling process.

A sample can be stored to disk or edited in Edit Sample mode. The sample name can be changed, the volume and pitch altered and One Shot/Looping/Alternating selected. The Looping and Alternating options set an auto loop locate routine in action which generally locates an acceptable zero crossing point on the third or fourth attempt. Start and end points of the sample may be altered, with the total length being shown in arbitrary units.

Sounds may be re-sampled at half bandwidth, if it is vital save memory or disk space, and any two samples may be joined using the Splice and Crossfade options. The Crossfade time factor is variable from 0 to 32,000 arbitrary units.

Once several satisfactory samples have been prepared, Edit Prog mode allows you to create a program on disk, again beginning with a request for a file name. 'Key Loudness' allows you to balance up the levels of sounds which are to be used together, while 'Positional Crossfade' allows you to decide how rapidly one sound turns into another if they overlap on the key assignment page.

It is then possible to decide how many key groups to use in a program and to allocate their key ranges. Each key

REVIEW REVIEW

group can work on a different MIDI channel, be assigned to the left or right stereo outputs, and have a common or an independent envelope. Conventional ADSR settings are available with default values allowing most sounds to be played immediately; a 'Warp' factor for Velocity/Pitch offset can be programmed to simulate the bending of a guitar string if the key is hit harder.

The LFO page has settings for Depth, Rate, Delay, Modulation Wheel Depth, After-Touch Depth, and De-Sync (so that individual key groups can have independent LFO treatment). The Filter can be set to follow the keyboard position so that high pitched sounds have greater frequency response than low pitched sounds, and Constant Pitch can be selected to make the sample's pitch independent of the keyboard not struck.

The MIDI mode allows Omni Mode to be switched off, selects the basic channel for multi-timbral playing, and tests all MIDI functions (this last routine was not present on the review prototype). The MIDI Monitor page displays the note value, channel and velocity of any key played into the *S900*, and Pitch Wheel range over MIDI can be set from zero to seven semitones.

RS232 control is also available via a rear-panel socket—this is probably with future computer-aided sample editing in mind. Disk operations are straightforward; eight programs can be stored on each disk, the disk catalogue being loaded on power-up; the Control Dial scrolls the LCD display's contents sideways to show all the samples on a disk and it is possible to load individual sounds or an entire disk, erase individual programs or samples, clear disks and format a new disk in approximately 40 s.

The Tune command sends a MIDI Master Tune command to all connected MIDI units, primarily for tuning synthesisers with analogue oscillators.

The rear panel of the *S900* features MIDI In, Out and Thru sockets, the RS232 interface and a blank panel intended for a future update for individual trigger input sockets for percussion pads. *Harmonic Synthesis* software, a *Long Duration Looping Recorder* package and a sample waveform editing package are also forthcoming.

Four disks are supplied with the unit—*Pianos* (which demand some editing work), *Bass Guitars*, a 'Welcome' disk with a selection of musical examples and a blank disk. Akai and MIDI Services amongst other companies, will be making a sound library available.

Assessment

The Akai *S900* falls mid-way in price between the similar Ensoniq *Multi-Sampler* and Prophet *2002* units. Frequency response also falls between

that of the other units but its sampling time is the longest of the three (unless a memory expansion is fitted to the *2002*). Many synthesiser-type treatments such as dynamic filter effects are missing from the *S900* (they can be added with the synthesiser units mentioned) as are the arpeggiator of the Prophet *2002* or the real time sequencer of the Ensoniq *Multi-Sampler* but facilities such as sample merge, velocity crossfade, positional crossfade and static filter effects are present which can be used rapidly and to good effect.

The large LCD display of the *S900* is invaluable and carefully chosen default values mean that the speed of use of the

simpler *S612* model is not entirely lost. Complex multi-split samples may be created, stored and recalled quite rapidly, and sound quality is more than sufficient for most purposes. Akai market the *MX73* master keyboard which is the perfect accompaniment for the *S900* in the absence of another MIDI keyboard such as the Yamaha *DX7* or Roland *JX-8P*.

UK: Akai (UK) Ltd, 12 Silver Jubilee Way, Haslemere Heathrow Estate, The Parkway, Hounslow, Middx TW4 6NF. Tel: 01-897 6388.

USA: Akai Professional Products, PO Box 2344, Fort Worth, TX 76113. Tel: (817) 336-5114. □

the 'mix' consoles

multimix	19" rack mount 16:2:1 12:4:2:1 and 16:4:2:1 * 3 band eq. * 2 aux sends * 48V p.p. * line inputs * RIAA inputs * direct outs * 100mm faders * 12 way LED displays * peak LEDs
stagemix	19" rack mount 12:6 rack mount monitor console * inputs: mic split, trans balanced, 3 band eq., peak LEDs * outputs: trans balanced, 4 band eq., 12 way LED displays
SOUNDMIX	24:4:2:1 and 16:4:2:1
RAKMIX	19" rack mount 8:4:2:1 * 4 band eq. * 4 aux sends * 4 aux returns * 48V p.p. * patch points * direct outs * +4dBm or -10dBu outputs * pil metering * 12 way LED displays on groups and outputs



Total Audio Transparency



Hill Audio Ltd., Hollingbourne House, Hollingbourne, Kent ME17 1QJ England
(062 780) 555 Tlx 966641 HILL
Hill Audio Inc., 5002B N. Royal Atlanta Dr. Tucker, GA 30084 USA (404) 934-1851 Tlx 293827 HLAD

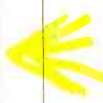

REVIEW REVIEW

A user report by Keith Spencer-Allen



NEOTEK ELITE

The Neotek Corporation is a Chicago-based manufacturer of mixing consoles. They have always taken a somewhat different attitude to the design of their consoles with very heavy emphasis on the audio quality in the signal path, rather than opt for any facilities which might have a negative effect on the audio path. This has led to ranges of fairly simple consoles which have gained a reputation for audio quality. To achieve this end Neotek completely removed all transformers in the signal path many years ago and have concentrated on optimised noise, distortion and bandwidth figures. The *Elite* is their top of the range console for multitrack recording and is their first console to achieve wider marketing. Although Neotek have been manufacturing for nearly 12 years there has only been very limited European distribution so far. With the recent appointment of a UK agent, Neotek have indicated their aim to become a fully international name.

The *Elite* is available in a wide range of frame sizes from 28 to 56 input channels although custom formats are quite readily available. I am informed that the manufacturing and design structure of the company and products allows for quite significant modifications in both console sizes together with customisation of the modules. However, the 40-channel *Elite* I looked at for the purpose of this report was a standard unit comprising 32 standard input modules, eight stereo line/submaster modules, a master control section split over four modules and an integral patchfield.

On this console the basic layout (from left to right) was patchfield with producers area below it, 26 input

modules, master section, a further six input modules, and the eight stereo line/submaster modules. Metering is LED bargraph types for each bus plus stereo outputs with a pair of standard VU meters for selectable functions that will be covered later.

The console itself is fully modular and uses a lightweight construction that does away with any form of solid metal frame. This allows easy customisation of frame size and it does not appear to have any detrimental effect on the rigidity across the width of the console—at least no more than other similar consoles. The console uses a lot of wood, in this case a very dark (almost black) timber with the end panels being an integral part of the frame. There is also an option for metal end panels. At the rear of the console there are no connectors or connections visible—all cables, etc, enter the console at either end behind a wooden panel that masks all connectors. Visually the console is very attractive from all angles and the combination of subtle greys and blacks should match most décor.

Input channel

The input channel is a single module with a separate fader section. The module is angled gently away from the user so the rear of the module is approximately 5 in higher than the front of the module. The channel layout allows easy viewing from the operating position with only a couple of switches not being in completely open view.

The *Elite* input channel is really two signal paths—fader and monitor although they need not necessarily be used as such. This, in fact, typifies the console as a whole as there are many functions quite easily adaptable for other purposes. Each of the signal paths have separate

input sections and output assignments while sharing a high pass filter, insert point and the equaliser which can be individually switched into either or both signal paths thereby creating some interesting splitting and summing possibilities within the channel.

The channel starts furthest from the operator with two rows of latching pushbuttons of seven and eight buttons each. These are the bus assignment selectors arranged in pairs of groups, ie 1 and 2, 3 and 4, etc. There are 26 assignment output buses which, of course, uses 13 of the buttons. The remaining two buttons are a track mute which removes the output of that channel from the output buses regardless of what has been selected; and the button labelled 'Sub to 1-16' separates that channel from the mix buses and allows free routing independent of the main signal path. Within this section of the desk there is also a bus trim control and a pan control for panning between the odd and even outputs of the selected bus outputs.

The next section down the module contains the independent mic and line level trim controls together with mic pad and 48 V phantom power on/off.

The *Elite* has six aux sends arranged as one stereo pair and four mono sends. They can be switched in pairs as pre- and post-fader or feed from fader or monitor paths. All levels are independently adjustable while levels on the stereo send are controlled by a stereo pot together with a pan control. Also within the same button bank is the assignment to the three mute groups. This is done by the use of two buttons giving mute groups A or B with C being selected by pressing both buttons at the same time. This, of course, means that 'overlapping' mute groups, ie those with common



Now an audio analyzer for the way you test audio.

Audio Technology has become High Technology. And there is increasing pressure on the way you handle audio problems.

The RE201 makes it easy to test audio the way you want to test audio. In only minutes you can run complete test procedures with the capability to store and recall up to 100 test setups. Testing which used to take hours can now be done in minutes with even more consistency than before.

A major advance in meeting audio test applications

The need for top quality audio in a wider range of areas has left most audio analyzers unequal to the task. The RE201 replaces an entire configuration of audio test instruments.

Some of our customers chose the RE201 for transmission link testing because it is immune to radiated interference, and functions without a tangle of cables or an external controller. Broadcasters use the RE201 as a fast, repeatable testing base for calibration and for measuring a variety of different parameters on multi-track recorders, mixing consoles, tapes as well as amplifiers. It's a real time saver. In manufacturing of audio components such as car radios, hearing aids or CD players, you can also use the RE Memory bus or IEEE488 bus to integrate the RE201 with other RE signal sources into a fully automated production line test system.

The RE201 measures:

- Level: True RMS (selective bandwidth), Peak, Quasi-peak, Average, DC
- S/N: Weighted and unweighted
- Harmonic distortion
- SINAD
- Difference Frequency distortion (DIN std.)
- Intermodulation distortion
- Transient Intermodulation distortion
- Frequency and Drift
- Phase and Phase Drift
- Separation and Crosstalk
- Rumble
- Wow and Flutter

If it all sounds too good to be true, call us for a demonstration. Find out more about audio testing to fit your application before further advances in audio technology put you behind.

**A Complete
Audio Test System
in One Instrument**

RE INSTRUMENTS Ltd.

Sherwood House, High Street, Crowthorne, Berkshire RG 11 7AT
United Kingdom (0344) 77 23 69

RE INSTRUMENTS Corp.
RE INSTRUMENTS ASB
RE INSTRUMENTS GmbH
saRE INSTRUMENTS

31029 Center Ridge Road, Westlake, Ohio, 44145, USA (216) 871-7617
Emdrupvej 26, DK-2100 Copenhagen O, Denmark +45 118 44 22
Dürener Strasse 17, D-5170 Jülich, West Germany +49 02461/4147
140 Avenue Pablo Picasso, 92000 Nanterre, France +33 1 47 78 74 92

re

Licensed agents in more than 30 countries throughout the world.

REVIEW

REVIEW

channels, are not possible.

Next in line comes the high pass filter in the form of a fixed slope continuously variable pot with a calibrated range of 20 Hz to 375 Hz. The knob on this control has been rotated through 180° so that the selected cut frequency is visible all the time from the operating position. We now come to some of the clever bits on the console. There are six buttons arranged in three pairs as Filter In, Insert In and EQ In. This allows each of these functions to be selected for either the monitor or fader signal path or both. Should you be operating the console in an in-line type mode then having inserted effects easily switchable between channels makes life easier as does the EQ and filter. These controls can be used to sum and split signals within the channel which I will return to later.

The equaliser is a 4-band parametric system arranged around four concentric pairs of knobs. The centre knob is the amplitude control for that knob offering a graduated ± 12 dB. The outer knob selects the frequency and this has also been rotated through 180° so there is an easy view of the selected frequency from the operator's position without standing up. The four frequency bands range over 20 Hz to 400 Hz, 50 Hz to 1.2 kHz, 400 Hz to 8 kHz and 1 kHz to 20 kHz. The heavily overlapping bands in the LF region allow real control over this area of the spectrum. If the centre (amplitude) knob is pulled on the high and low bands then those bands become shelving type EQ while on the other two the Q of the frequency increases in width. Neither the amplitude or frequency graduations are very precise so repeatability of settings may be a problem or rather the recording of settings accurately will. I have only one other minor reservation about the EQ and that is that the centre detent on the amplitude knob is quite fierce and I found it annoying to use. This may of course ease with use.

Below the equaliser is the small fader and the 'master' channel controls. These are divided into buttons for the monitor/small fader and the main signal path. These include solo, phase reverse for both paths together with mic/line and bus selection switches for both. When the console is powered up and with no buttons selected the 'natural state' would be for all monitor signal paths to be looking at the line inputs while the main signal paths would be fed by mic amps. This is why the small fader path has a mic select and the main fader path a line select. The remaining switch in this bank is the fader reverse that flips the two faders.

The remaining channel controls are pan control for the mix bus, a latching solo button with yellow LED, and a mute button with red LED which indicates mute mode which is the opposite of what I would naturally expect. The mute button itself, however, meets with my

full approval: it has a quick action, is lightweight, easily accessible and of a reasonable size. If you are running without automation or any form of programmed muting then these are important points.

Below the module is a numbered scribble strip followed by the fader. These faders are Alps and are quite acceptable. As the faders are in a self-contained section of the desk it would be relatively easy to fit a fader automation package such as *MasterMix* or GML both of which are available as factory-installed options.

The modules are a mid-grey colour with all legends in white. All the knobs are a light grey except for the HPF, EQ and line trim which have blue knob caps and the mic trim which has a red cap. The outer knobs of the concentric EQ controls are black. This straightforward colour scheme is practical and workable under any lighting conditions.

Stereo line/subgroup module

As mentioned before, the review console was equipped with eight stereo line/subgroup modules. These can be used for several different applications having two separate signal paths for stereo operation and the ability to act as a stereo line input channel or a stereo subgroup for bus assignment.

The module features are similar in many ways to the input channel beginning with the routing switching to any of the 26 output assignment buses together with the main stereo bus. The aux facilities and mute groups are identical to the input channels but, of course, as the module is stereo there is no pan facility on the stereo aux send. The other module facilities include independent left and right level trims, phase reverse, mono/stereo operation select, subgroup status selection, a fixed turnover frequency 4-band equaliser with turnovers at 150, 600 Hz, 3 kHz and a shelving 8 kHz, a subgroup effect return in mono stereo with both level and pan controls, solo and mute.

Master section

The master controls are on four separate modules and largely self-explanatory.

Effects return module: has four returns on the same module each of which comprise a level and pan control with an on and solo select, phase reverse and two cue sends for feeding the return into the cue systems.

Cue/Aux master: consists of the four mono aux sends with level and solo functions together with a peak level LED indicator. The additional stereo aux send is treated as independent outputs with identical facilities to the mono sends. At the top of this module there is a selection bank of switches for the cue

sends (foldback). Above the cue level sends and the solo function buttons there is a row of latching buttons that allows selection from any or all of the six aux sends, the main stereo bus left or right and anything from the patch point on the patchfield.

Stereo master module: is again straightforward. The section of the module just above the fader contains the master mute group controls together with a master mute all facility. Above this lies the master solo section with solo lockout which prevents the effects of using a solo button, and the in-place mutes select for the three mute groups which means that selected mute groups are the mute channels when the solo button is pushed. This module also contains mix level trims for left and right channels together with a row of buttons to select the metering subject for the two free VU meters as well as peak or VU characteristics for all meters.

Monitor/communications module: contains the oscillator section; *XLR* socket for talkback mic, talkback level select to studio, slate stereo aux and the cue sends. Below this comes the studio and control room monitor levels and speaker selects, selection of monitoring sources, slate select and talkback button. There is an additional talkback button by the producer's area.

Construction and maintenance

The desk is externally finished to a high standard and cannot really be faulted. As mentioned earlier the construction technique is fairly lightweight with no flexing problems across the console width. The small degree of flex along the length of the module does not place any strain on the boards as the design of the module PCBs are mainly in two sections.

The modules are all interconnected with ribbon cables and eight screened individual cables all of which are on sockets and can be removed from the board. From the maintenance aspect modules do not need to be disconnected for servicing as all connecting cables are long enough to pull the module clear of the console. Supplied with the console are a pair of aluminium supports that clip through the screw holes in the module and rest in the screw-retaining bus on the console frame. This leaves the module surface about 6 in above the normal level of the console with all the PCB fully exposed for work.

The internal construction is very neat with fully identified component legends and good, wide PCB tracks. Most components appear to be accessible.

In operation

The operational nature of this review is slightly restricted by the amount of time available for full assessment of the

REVIEW REVIEW

facilities, however, I feel that the basic aspects of the desk became clear.

While I hesitate to make subjective comments on equalisers particularly when there is no way of comparison I consider the *Elite* equaliser to be very good. The widely overlapping bands give a feeling of being able to mould the signal in critical areas particularly in the low frequencies. A general descriptive judgement on the EQ could be 'smooth and effective'.

Once you acquire an understanding of the way the two signal paths work (for this you may need the console schematic to hand as there is not a full manual as yet) you realise how you can use the console to suit your own foibles of working. Most of the assessment was in the mixdown mode and I found a number of applications of the signal path facilities which would be quite difficult to achieve on some other desks. For example by selecting the insert point on the input module to both the fader and monitor signal paths with the line input selected on the main signal path, you are effectively splitting the input signal. If the EQ is then inserted in just one of the signal paths then within the same channel you have effectively two 'different signals' and then these can be panned independently into the mix bus left and right using little outside of the single channel. Should you then take the same arrangement, phase reverse one of the signal paths, pan both signals to the same place in the stereo bus, then altering the levels of the two signal paths against each other causes a series of phase cancellations—a kind of static phasing if you like. This is probably of little use but it does show some of the versatility within the channel itself.

It is of course possible that the opposite could be done and signals could be summed in the channel with mix levels being controlled in either path.

There are a number of other facilities that the console can offer but during the evaluation time it was not really possible to check fully the practicality of the system. For instance during mixdown it is possible to use the multitrack buses as additional effects buses using either the bus assignment panpot or the monitor fader as level controls. It is also possible to use the cue mix selection switches to produce unusual combinations of aux, tape, and other sends that might require complex patching within other consoles. Further the 'extra' output buses 25 and 26 would make useful additional mix buses perhaps for producing slightly different mixes—mix plus or minuses.

Summary

In the limited time available for the full evaluation of this console I feel I may not have done it full justice. The architecture and the ideas employed in such a console really only become fully

apparent with heavy duty use which was not possible. There are, however, several conclusions that can be drawn straight away.

Firstly the console is very straightforward. This is a word that kept recurring throughout the evaluation. It takes a few minutes to grasp the concept of the dual channel and then the possibilities of this design gradually unfold. The console can be used in ways that would make both users of split and in-line consoles feel quite at home.

As the console stands in the review format it would make an excellent tracking console or one for mixdown of

electronic musical instruments. With the addition of one of the automation packages it would make a useful mixing system as well. There is certainly nothing in the technical performance of the console which would suggest that it should be used with anything other than high performance peripheral equipment—a high performance straightforward console with a host of possibilities that need investigation. □

Neotek Corporation, 1154 West Belmont Avenue, Chicago, IL 60657, USA. Tel: (312) 929-6699.

UK: Syco Systems Ltd, 20 Conduit Place, London W2. Tel: 01-724 2451.



Our new software installed in your DR1 offers you the most extensive MIDI implementation of any reverb made and includes Performance MIDI!

You now have real time control, in addition to full computer control, preset dump and reload, and master/slave operations allowing you to link two DR1s. Other features standard in ART's new Version 1.2 software include a Flanger/Chorus Room, a Preset Sequences feature and 10 additional new Factory Presets.

For those who demand performance, check out these specifications for our DR1 with Performance MIDI:

PRESETS	40 FACTORY 100 USER PROGRAMMABLE!
D/A BANDWIDTH	16 BIT LINEAR - 14KHz RESPONSE!
UPDATEABLE	YES! AND WE DELIVER VERSION 1.2 NOW AVAILABLE!
REMOTE CONTROL	YES! FULL CONTROL OF ALL REVERB AND PERFORMANCE MIDI FUNCTIONS!
MIDI	YES! THE MOST MIDI CONTROLLED REVERB AVAILABLE!
SPECIAL EFFECTS	YES! UPDATEABLE AND EXPANDABLE!
DECAY TIME	0.1 TO 25 SECONDS AND DYNAMIC DECAY TIME CAPABILITIES!
PREDELAY	0.0 TO 200ms IN 1.0ms INCREMENTS!
OTHER CONTROLS	H.F. DAMPING, POSITION AND DIFFUSION!

Simply, if you want the best sounding reverb with the fullest M/DI implementation available including the best sounding PLATES, ROOMS AND HALLS, contact us. We'll continue to impress you with unique products that deliver superior performance!

Call or write today, for more information!

- Digital Reverberation Systems
- Digital Delay Systems
- Full Line of Equalizers
- Pitch Transposer Packages
- Software Update Packages



Applied Research & Technology Inc.
215 Tremont Street
Rochester, New York 14608
(716) 436-2720

**PRO-AUDIO NEVER
SOUNDED SO GOOD!**

REVIEW REVIEW

A user report by Keith Spencer-Allen

The V series console was first shown under that name at the AES Convention in Montreux, Switzerland last March although it had been marketed for some months before as a custom console in the same and slightly differing forms. There are already quite a number of these consoles up and running—at the time of writing Neve provided a figure of 24 installations throughout the world.

The line of development of the V series comes not from the 8128 series as might be expected but from a demand for customised consoles using modules from the 51 series particularly the equaliser. This console range was originally intended for radio, TV and film programme production with facilities that include full multitrack use.

The console upon which this report is based was a 36-channel *Necam 96* equipped system with four optional reverb sends in Neve Electronics' demonstration studio at Melbourn, Nr Cambridge. This room has been acoustically treated and has a good complement of equipment including Tannoy *FSM* monitors, Otari 24-track *MTR-90*, A+D modified *PCM 701*, Sony *VO-5850P* U-matic and processing units including A+D *PanScan*, Yamaha *SPX90*, Bel *BD-80* and a pair of *REV7s*. Although it was not possible to evaluate the desk from the operational recording aspect, the environment was a pretty true studio situation.

Basic background

The console comes in three channel frame sizes: 36, 48 and 60. The input channels sections are made up in 12-module widths with 8-channel wide monitor unit facilitating conversion to a larger frame size. The console is basically an in-line type design, however, there are provisions within the design that allow the splitting of the console into two separate sections so other methods of working are possible under certain operational conditions, ie that you have enough channels on the console for your purpose. The reviewed unit also had an integral patchbay although it is possible to select an external unit. The desk can be supplied with standard faders, *Necam* faders or *VCA* faders which give you six *VCA* subgroup facilities, or apparently without faders at all for customer retrofitting.

Input channel

The console has provision for 48-track routing in the form of 24 white latching pushbuttons and associated LEDs labelled 1/25, 2/26 and so on. The output buses are arranged 1 to 24 and 25 to 48 with button assignment to either set of buses or both, eg 1 or 25 or both. This allows the running of a backup or slave

NEVE V SERIES

machine with just selection of routing buttons. Selection of operative sets of buses is decided by further latching pushbuttons below the routing buttons. Additionally the desk has two 2-track output buses—not the vestiges of some quad ideas but two separate stereo pairs. There are separate select buttons for 1-2 and 3-4. Panning between these buses is by a pan control just below the routing. There is no detent position on the pot—this is a Neve policy as they say it is not possible to determine the accuracy of the pot at the detent position. Instead a centre position is selected by bus selection without pan being selected.

The only control remaining in this immediate section is the Bounce button which is used for track bouncing and functions by connecting that output of the multitrack machine corresponding to that channel via the small fader of the channel to the multitrack assignment buttons. The mic channel and 2-track routing are automatically muted and the other channel functions are not in the signal path.

Below the bus section is the input section which is fairly self explanatory providing mic/line switching (which is also available on a master console basis), individual stepped mic and line level switched resistive controls for accuracy of setting, a fine mic level trim pot, a phase reverse button operating on both mic and line inputs, an LED that indicates when the channel is switched in an opposite mode to the master input status, and a group select button. This provides a patch-free audio subgrouping facility so that for example selecting group on channel 18 will insert the fader and all the channel facilities on channel 18 into the output bus 18 overriding mic/line switching. This group can then be routed via the output bus matrix or direct to the corresponding multitrack channel by using the direct button lower down the channel. Immediately below the input section are high and low pass filters which are switched in circuit by pulling the pot, with an LED that indicates that one or both of the filters are operative. The ranges are 31.5 Hz to 315 Hz and 12.5 kHz to 4 kHz respectively for the high and low pass filters.

Each channel has a full dynamic section with limiter, compressor and signal/noise gate. This is quite a comprehensive section and because of this, it took some time to grasp its full operation with a high density of knobs and switches. The Gate button selects the noise gate into circuit with the threshold being set by a control immediately below whose range is extended by 30 dB to 70 dB when pulled out. There is LED indication of the increased range. The release time of the gate and the compressor limiter is set on another control with the range being 0.05 to 3 s. Pulling the release pot provides individual release time setting on the gate while the compressor/limiter switches to auto-release. *L/C* selects the limiter/compressor into circuit with the threshold and compression ratios being selected by two pots. Pulling the threshold control increases the range by 20 dB. Other functions available within this section includes EQ/D which selects the EQ output of the channel to the dynamics side chain for various applications such as de-ess, etc; the Key button which selects an external patch input for triggering of the gate; an Invert button which inverts the trigger from the patch input for ducking use; signal presence/overload LED indication and a tri-coloured LED gain reduction. Finally there is a button that allows linking of the control voltages of the next channel along (to right) for the limiter/compressor section allowing multichannel ganging.

The equaliser is a 4-band parametric type that is of Neve's *Formant Spectrum Equaliser* design. Each band has ± 18 dB gain control with the frequency controls being continuously variable—the high and low bands being switchable to shelving type. The band ranges are 31.5 Hz to 315 Hz, 200 Hz to 2 kHz, 800 Hz to 8 kHz and 1.6 kHz to 16 kHz. There is an EQ in button together with LED indication. There is no zero detent position on the gain control. Just above the equaliser is an insert select button together with another button to select insertion pre- or post-EQ.

There are eight individual aux sends or they can be configured as four stereo sends or any combination. In the stereo mode one of the level sends becomes the pan control while the other remains the level. All sends have an on/off switch with pre/post selection being made in pairs of sends.

The small fader section begins with the direct output select button that assigns that channel direct to the same multitrack input with a level control pot beside it. This has a centre detent position beyond which you are into gain with 10 dB available. The operation of the module in many ways is controlled from two buttons by the top of the small fader. Either of the faders can be in the monitor or signal paths. In the normal

WE ARE RATHER GOOD AT ASSEMBLING PACKAGES



We think the Soundtracs CM4400 with the CMS2 SMPTE Automation and Soundcraft SCM762 24 track machine represents unbeatable value.

The Soundtracs CM4400 with CMS2 gives you automated routing, channel and group muting, pre-programming of effects, sends and returns, programmable record drop in via events recorder, control of eight external devices and 30 different mixing combinations all under SMPTE timecode control.

The Soundcraft SCM762 Mk III recorder comes complete with remote control, varispeed, zero locate

and cycle functions. It will run at 15 or 30 ips and is widely used by many professionals in master recording and video post-production work.

Package consists of:

Soundtracs CM4400 – 32 input mixing console.

Soundtracs CMS2 – automation system.

Soundcraft SCM762 Mk III 24 track recorder.

Commodore PC and disk drive.

Video monitor.

Set of interconnecting cables.

Please ring for a full demonstration.

STUDIOMASTER

SERIES II

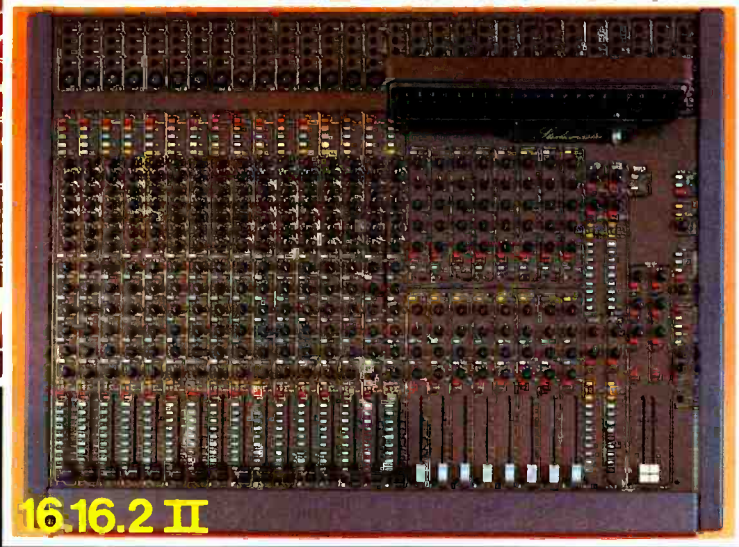

16.16.2 II

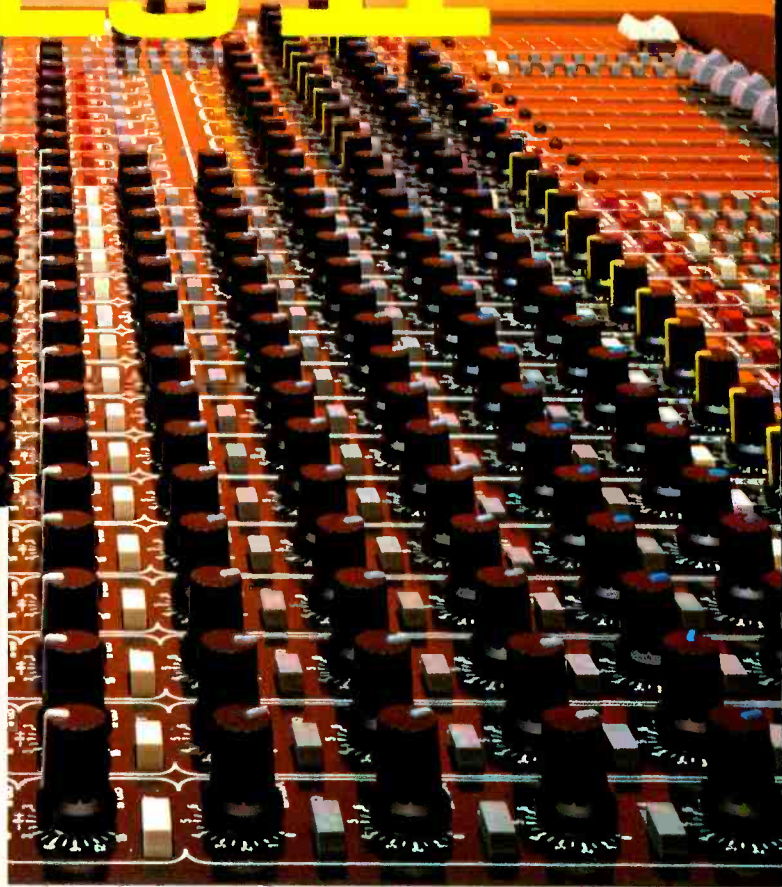

SPECIFICATIONS

FREQUENCY RESPONSE: 14Hz to 19kHz + 1dB T.H.D.: < 0.02% @ 1kHz C.M.R.R.: -79dB @ 1kHz EQUIVALENT INPUT NOISE: -128dB CROSSTALK: -62dB channel to channel @ 10kHz MAXIMUM VOLTAGE GAIN: 82dB DIMENSIONS (L x H x D): 1016 x 245 x 718 mm (16.8.2 & 16.16.2) 888 x 245 x 718 mm (16.4.2) Input expander 268 x 140 x 718 mm Tape monitor expander 76 x 140 x 718 mm ACCESSORIES: ALL SERIES II mixers are supplied with an external power supply as standard. Flight cases are available for any SERIES II at extra cost.

THE STUDIOMASTER SERIES II MIXING CONSOLES

For many years now, Studiomaster have been producing high quality mixing consoles which with each phase of development have brought improved standards of mixing within the reach of more people.

The SERIES II mixers are lighter and more compact than ever before, so you can quickly set up a recording environment wherever it need be. The logical control layout means that despite the extra functions, the mixer is still easy to understand and they are built ruggedly to withstand the knocks of live work.

Six auxiliary busses with push-button return routing and a wide range of insert points cater to the growing demand for effects. 4-band input equalisation offers supreme sound control. Other useful features new to this mixer range include push-button output level selection (+4dBm/-10dBv), tape remix function, separate control room and studio cue mixes.

Perhaps the most outstanding feature of the SERIES II is the MIDI controlled muting of auxiliary returns and input channels. "Patches" are set up on a computer screen, then during mixdown or remix, sets of channels and auxiliaries are sequentially muted or switched on leaving you free to adjust fader levels and effects etc. while the computer actually performs the mixdown.

At Studiomaster we perfected the audio aspect of the mixer to give superb sound control and flexibility, THEN added the computer assistance in a clever way which adds very little cost to the desk, and leaves the desk fully operational when the MIDI is not required. All too often, mixers are built with "gimmick" computer features which are in practical terms useless as they create extra work, or their inclusion means sacrificing audio facilities.

The specification of these mixing consoles is superb, which means you can be sure that the mixer quality matches your multi-track machine for first class recordings that can go on to be mastered perfectly.

As always with Studiomaster, your mixer will grow with your demands, after purchasing your mixer and acquainting yourself with it, you can explore the MIDI capability, you can expand your input channels up to 32 (with 8-channel expanders that require NO soldering) and even expand your multi-track tape monitoring up to 16- or 24-track (on the 16.8.2 and 16.16.2 respectively) with an all new retro-fit add-on.

If you think all this is out of your price range, then you will be pleasantly surprised: state-of-the-art design means that no-compromise performance is within your reach.

For further details:

STUDIOMASTER

STUDIOMASTER, Chaul End Lane, Leagrave, Luton, Beds LU4 8EZ
☎ 0582 570370 TELEX: 825612 STUDIO G FAX: 0582 570242

REVIEW

REVIEW

recording mode, the larger faders would control the input signal via the assignment buses to the multitrack while the return monitor signal would pass through the small fader and be routed through the monitor 4-track assignment bus and pan pot allowing monitoring. The Swap button transposes the faders with their respective solo and mute buttons and there is also a master control for a global change across the console. The C/O (changeover) button is an individual routing flip that will reverse the assignment and send the monitor path to the multitrack routing and the channel path to the 2-channel routing allowing the console to be individually configured for recording or mix mode overriding the master controls. This means that it is possible to select a large number of channels to this mode and effectively use them as a separate monitor mixer like a split console or to produce a separate stereo mix at the same time as the multitrack recording.

Additionally in this section of the desk there is a bank of seven switches that allows assignment of dynamics, insert, EQ and the aux sends (in pairs) into the monitor path. LED indicators make it fairly clear what is assigned to where and I think that in practice this design will not cause confusion. Remaining in this section is the Solo button. This is a triple function button that depends on the master selection and record status allowing assignment to this button of solo cut, positional AFL or PFL. With the tape machine in record the solo safe mode will automatically be set and solo monitoring will be via the AFL and PFL buses.

Remaining on the channel we have the main assignment for the two 2-track buses, pan pot and pan select switch, large solo and mute switches with selection of A and B mute groups, a Ret button that stops that channel being muted when another track is solo'd. This means that any channel can be used as an effects return and the effect will still be audible under solo conditions. There is easily visible LED indication of this status so potential errors are unlikely.

The only remaining channel button is the OD (Overdub) button. This allows the artist to hear the already recorded track being played back in addition to his own line in signal until the point of recording whereupon the level of the signal across the channel is dropped by 3 dB to compensate for the gain increase. This is only effective on the foldback send.

Only remaining on the module is a black scribble strip and the fader which is separate from the channel module.

Master section

At the top of the master section there is provision for control of monitors in the studio area including level, cut, external input and a follow control room monitors

mode. Below this are the solo button master controls. The three master buttons are Latch, I/L and Reset. With none selected all the solo buttons on the desk become momentary solo cut functions—an actual physical cut as far as the output of the desk is concerned. In the latch mode all solos will build up when selected; in the I/L mode the solos are interlocking and selection of a new solo cancels the previous selection.

The master mode selection is divided into three banks of three buttons labelled Mic, Fader Sweep and Mixdown. Pressing the centre button on any of the banks assigns that mode to the complete console with the buttons on either side of this only assigning that side of the console to that mode. This enables split console operation. Next comes the master solo functions as described under the channel module section.

The Mixed Cue and Cues Post EQ buttons allow additional functions to channels with the OD button selected. Mixed Cue switches a mix of tape in tape out to the sends with OD selected. Cues Post EQ sends a backing track mix with EQ and dynamics as the main monitor to those tracks without OD selected—a follow monitor condition.

There is full provision for stereo bus monitoring and multitrack metering output or playback; master mute group mutes; a comprehensive talkback selection with talk to slate, all buses, cues, etc, with the mic being flush console mounted. There is also full monitor select with independent left and right cut, independent level preset controls for three monitoring systems within the control room, an AFL/PFL level control and full provision for monitoring just about every output bus on the console individually except the multitrack buses.

The console additionally has oscillator functions, signal LED threshold, full aux master send levels, and on this console optional reverb returns which are stereo modules with on/off, level, feeds to cue sends, and a basic EQ section on each return. The Cue sends are the feeds to the studio foldback system. They have the same basic EQ as the Rev returns and also high pass filters. The input to the cue sends are taken from a matrix which allows selection from any of the aux sends, the monitor, an insert patch or the stereo buses.

Construction

The console follows the Neve tradition of being 'tank' like in construction. The modules have heavy duty mechanical guides that mate with runners on the chassis to locate themselves within the frame so there is no need to take the module out and try to reinsert it to make it locate. All construction and circuit boards, etc, are up to the normal high Neve standard.

Comments

The console is a well thought out design as one would expect from a manufacturer with as much experience as Neve. They have obviously taken a great deal of care on the master functions of this console to be as comprehensive as possible and I think that they have come down the positive side of overkill. There are a number of functions that take some sitting down and considering to understand their full implications but the general channel functions are very clear particularly the EQ and aux. I have some reservations about the layout of the dynamics section as this is so densely packed together with the dual function of the release control leads to some possible confusion until the operator becomes fully familiar. As mentioned earlier though this is a price one has to pay for those facilities in such a small space. On other sections of the desk layout is clear with sensible use of LEDs to aid rather than confuse.

On specifics there are a number of very good points such as in the dynamics section—the ability to switch in the gate and compressor/limiter separately is convenient as it means that you only have to concern yourself with the dynamic control that you are using—you don't have to normal the non used control. The ability to split the console into two halves makes a great deal of sense particularly on installations with large numbers of channels and perhaps permanently wired synths etc so that sections of the desk can be switched to match studio functions.

In terms of performance there is little to say other than it appears to be up to normal Neve levels of specification together with an equaliser that has a proven history of industry acceptance.

Conclusion

As mentioned elsewhere in this issue, potential purchasers of mixing consoles have to study manufacturer's design philosophy to see if the manufacturer understands their particular needs. In the case of the V series we have a console that has been developed from user demand and incorporates what are now some 'industry standard' facilities that have been requested of Neve. This redresses the balance slightly for those Neve developments which were copied by other designers in the past. In the V series we have a few frills comprehensive console design capable of handling a wide range of specific studio applications and environments. With *Necam 96* it makes a useful addition to the choices at the top end of the console market. □

**Neve Electronics International Ltd,
Cambridge House, Melbourn,
Royston SG8 6AU, UK.**

**USA: Rupert Neve Inc, Berkshire
Industrial Park, Bethel, CT 06801.**

TUBE•TRAPS

CONTROL BASS ACOUSTICS

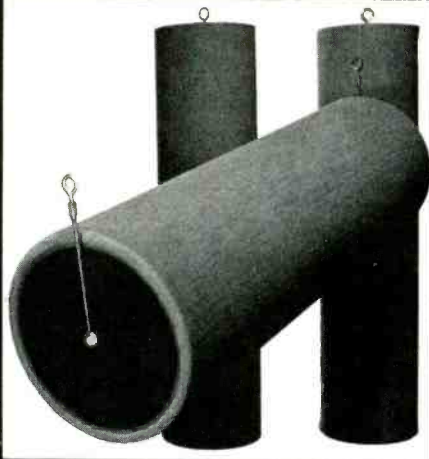

THE ONLY ACOUSTICAL TREATMENT SYSTEM

- Broadband, Effective 400 Hz, Thru 40 Hz
- Corrects Low End Phase Distortion
- Damps Standing Wave Room Resonances
- Reduces Room Resonance "Q" Response By 4
- EQ's Low End RT-60 Decay Constants
- Packs 15 Sabines Absorption Into Each 3' Tube
- Midrange, Adjustable Diffusion
- Light Weight, Sturdy and Very Portable
- Versatile, Pressure Zone Bass Trap or GOBO

1-800-ASC-TUBE

ASC ACOUSTIC SCIENCES CORPORATION

P.O. BOX 11156 EUGENE, OREGON 97440

1-503-343-9727 TELEX 910 4592027

STRAMP

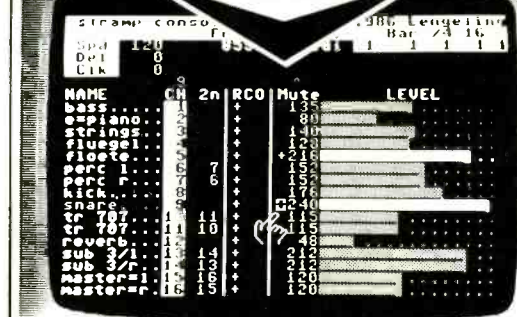

mixdown automation

- * without console modification
- * 8-64 channels (modular)
- * synchronized via SMPTE/EBU TC
- * affordable for **every** studio

AUDIO VERTRIEB
Peter Strueven GmbH

Am Mühlberg 26, 2085 Quickborn
West Germany ☎ 04106/69999
TX 2180 633 STAM D

please contact

GRAFF Today's sound buy

For the transfer of music,
speech, computer
software and
audio visual
formats.

The all British Graff series 11
has no peers among High Speed
Cassette Duplicators.

- Fast precise cassette copying - both sides simultaneously - at 16 times normal speed
- Highest quality recordings in stereo or mono
- Advanced technology built into proven design
- Modular system to meet specific requirements
- Excellent sales and after sales service



GRAFF the sophisticated aristocrat of sound copying

Graff Electronic Machines Limited, Collingham, Newark, Notts. NG23 7NR Telephone 0636 893036 Telex 377119



WHEN YOU HIRE AUDIO EQUIPMENT REMEMBER TO LOOK BEHIND IT



Almost anyone can go out, buy equipment, rent it out and call themselves a rental company.

Almost anyone can offer you great 'deals' on the rental.

Almost **no-one** can provide the degree of skill and expertise that Audio FX can.

With our team of technical engineers, our clients have access to their knowledge of digital recording, signal processing and keyboards 24 hours a day.

With the security of knowing that if you're in the studio you can call on us to provide not only the widest range of equipment but also the people and experience to back it up.

That's what's behind our equipment — and that's what's behind our success!



Our reputation's built on success

15 Elizabeth Mews, London NW3 4UH
Telephone 01-586 9592 (24 hours)



Studio Technology of world wide fame

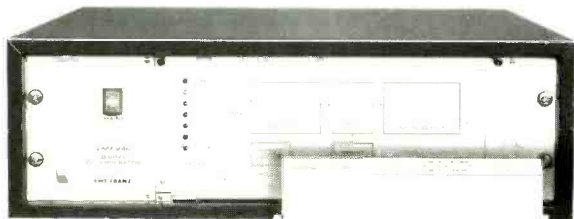

THE EMT 246 DIGITAL REVERBERATOR

expands the boundaries: New reverberation programs with optimized eigentone distribution allow reverb times from 0.25 to 20 seconds. The "sound" of the reverberation is freely adaptable due to the adjustments in bandwidth, pre-delay, level of early reflections, as well as frequency content of the reverberation. In spite of the abundance of parameters, operation of the unit is quite simple, even if things should become hectic. And, if need be, one of the 190 (!) program memories may be of assistance.

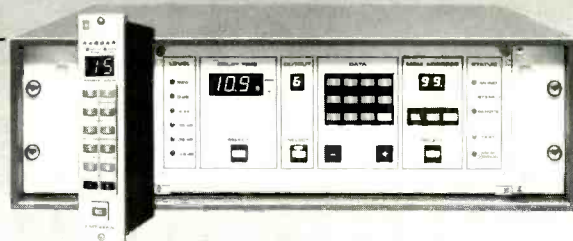

THE EMT 445 DIGITAL AUDIO DELAY UNIT combines separate entities: picture with sound, when transmitting via satellite and cable or in combination with video standards conversion or framestores; sound with sound, when transmitting via wire and air. The high-resolution delay will help you with these tasks. Even stereophonic signals may be delayed with absolute phase coherence: ideally suited for analog disk cutting.

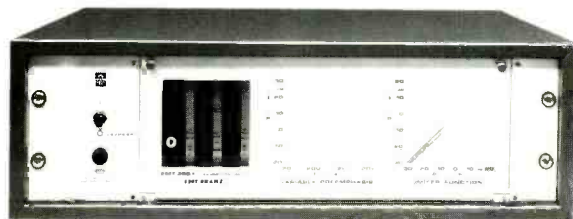

THE EMT 266 X TRANSIENT LIMITER solves your worries: because (with adaptive pre-emphasis) you will never exceed the maximum frequency deviation for FM transmissions, but, moreover, are able to process maximum levels at the input of the limiter; because transients are limited in a click-free manner with digital recording or in tape duplication applications. It's all made possible by the principle of transient limiting.



POSTFACH 1520, D-7630 LAHR
TEL. 07825-1011, TELEX 754319
FEDERAL REPUBLIC OF GERMANY

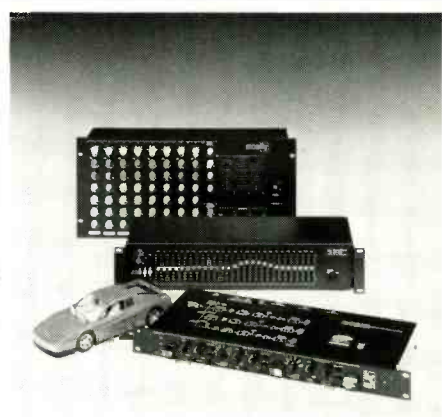
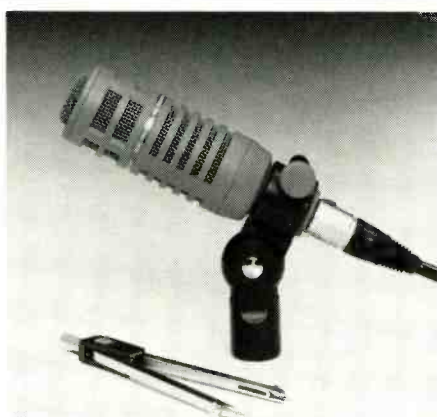

1930: Amy Johnson flew to Australia and back; Bentley won Le Mans for the fourth consecutive year; Ray Charles was born in Albany, Georgia; England lost the Ashes and Electro-Voice was incorporated in Buchanan, Michigan on July 1st.

Dedicated to the highest quality of audio excellence Electro-

Voice have continued to manufacture products directed at the professional audio industry for more than 50 years.

Further information, of what happened in 1930 and in the year of your birth, is available if you return the coupon below. We'll even include a catalogue of Electro-Voice products.

EV Electro-Voice®

SHUTTLESOUND

SOUND THINKING ABOUT SOUND PRODUCTS

Unit 15, Osiers Estate, Osiers Road, London SW18 1EJ
Tel: 01-871 0966 Telex: 27670 SHUTSO G

NAME

ADDRESS

TEL. NO.

YEAR OF BIRTH

SS/9/86

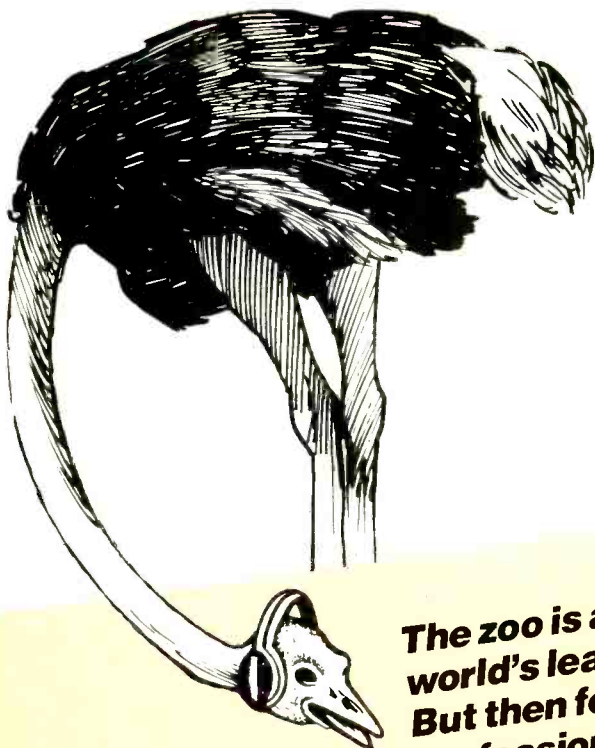

IF YOU DON'T WANT TO BE AN OSTRICH, COME TO THE ZOO THIS NOVEMBER...

The zoo is a strange place to find a selection of the world's leading authorities on digital audio technology. But then few industries are as full of surprises as the professional audio business. After all, with R/DAT on the horizon and hard disc recording and editing a reality, the science of studio engineering is moving very fast indeed. People who don't want to bury their heads in yesterdays technology should book a place at London Zoo with Digital Information Exchange '86

On November 25, 26 & 27 1986, the most important, seminar series in the pro-audio calendar is taking place in the Private Member's Suite at London Zoo. A must for any professional in the broadcast or recording industry keen to know the latest opportunities in the digital audio revolution.

Places are strictly limited and the cost, thanks to the sponsorship of Sony Broadcast and HHB Hire & Sales is very low, especially as it includes lunch and refreshments: £50 + VAT for each day or £120 + VAT for all three days.

DAY 1 Tuesday 25 November DIGITAL TECHNOLOGY IN BROADCASTING & VIDEO

- Audiofile: Digital Audio Recording & Editing on Hard Disk
- Broadcast Applications of Two-Track Digital Audio Tape (R/DAT)
- The Digital VTR
- Digital & Satellite Transmission
- Digital Audio & Video in Post Production
- Digital in the USA

THE PROGRAMME DAY 2 Wednesday 26 November DIGITAL RECORDING & COMPACT DISC

- The Opportunities & Implications of R/DAT
- Audiofile: Music Recording & Editing with Hard Disk
- Digital Reverbs
- The All-Digital Studio
- Compact Disc Market Update
- User's Guide to DASH Multi-Track
- Record Company Analysis of Digital Masters

DAY 3 Thursday 27 November DIGITAL IN SCIENTIFIC RESEARCH – THE NEW OPPORTUNITIES

- R/DAT: the potential and limitations of the technology
- CD ROM & CD I
- The Alvey Project: Voice Recognition & Speech Synthesis
- Data Storage & Data-base Preparation in CD ROM
- Interfacing half-inch digital with VAX/MICRO VAX and IBM PC's

Speakers and participants include senior technical and management personnel from Sony Broadcast, HHB Hire & Sales, AMS Industries, EMI, Solid State Logic, Trillion, Alan Parsons Productions, Philips Interactive Media Systems, Silver Platter, Oros, Editel, Audio FX, Hilton Sound, HMV Shops and the Alvey Project.

Sponsored by



AND

SONY Broadcast



IN ASSOCIATION WITH

STUDIO SOUND

AND Pro Sound News

Please post to Peter Woodcock, PO Box 43 Hertford SG14 3TP enclosing a cheque or P.O. State clearly which days you wish to attend. A detailed programme and entry ticket will be forwarded in late September.

Block capitals please ▶

NAME
 POSITION
 COMPANY
 ADDRESS
 TEL NO DAY 1 DAY 2 DAY 3

AUDIO JACKFIELDS & JACK SOCKETS

Mosses & Mitchell are the largest manufacturer of Audio Jacks and Jackfields in the UK. We are approved suppliers to the BBC, British Telecom, Pye Telecommunications and many other major telecommunication companies throughout the world. We manufacture a complete range of Audio Jacks and Jackfields and offer a design and manufacturing service geared to meet your specific requirements. For further information and technical data on our products contact:

MOSSES & MITCHELL

Mosses & Mitchell Limited
Weydon Lane Farnham Surrey GU9 8QL Telephone: Farnham (0252) 721236 Telex: 858820

**CLEAN
JACKFIELDS
NO DOWN
TIME**



VERTIGO BURNISHERS AND INJECTORS RESTORE ORIGINAL PERFORMANCE TO YOUR JACKFIELDS

VERTIGO GPO/TRS 1/4" AND TT/BANTAM BURNISHERS: Each used to eliminate noise caused by contamination of main contacts in normal patching situations

VERTIGO GPO/TRS 1/4" AND TT/BANTAM INJECTORS: Each allows injection of cleaning solvent into breaking contacts (normals), to eliminate intermittency that occurs when patch cord has been removed.

ONLY \$29.95 EACH Plus Shipping. Please write for additional information and order form today. Used by Professionals Worldwide. Patents Pending.

VERTIGO RECORDING SERVICES 12115 Magnolia Blvd. #116
No. Hollywood, CA 91607 USA. Telephone: (818) 769-5232 Telex: 5106006748 VERTIGO RECRD

Your Guarantee

**NO GUESSES
NO GIMMICKRY**

The circulation of this publication is independently audited to the professional standards administered by the Audit Bureau of Circulations



The Hallmark of Audited Circulation

FLEXIBLE PRECISION. . .

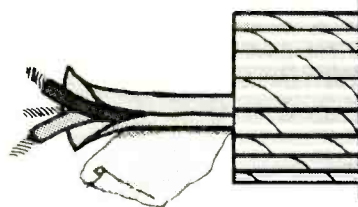

Connectro

CONNECTRONICS LIMITED
20 Victoria Road New Barnet Hertfordshire EN4 9PF England
Telephone: 01-449 3663/ 9942
Telex: 8955127 SGAL G

YOU CAN BUY A DELAY LINE WHICH ISN'T A DMX15-80S BUT IT WON'T BE HALF AS GOOD



OR WILL IT?

Economy-priced audio processors do not guarantee value for money. Consider instead, the DMX15-80S. Nothing comes half as close to offering you similar features and functions. So when an AMS unit represents such a modest proportion of your studio spend, surely it makes sound sense to buy the DMX 15-80S.

A keyboard controllable, dual channel/stereo digital pitch changer with two channels of sampling ... and much, much more. Remember, choosing AMS means never doing things by halves.

DMX15-80S



Advanced Music Systems.

The Queen's Award for Export Achievement to Edendeck Ltd. In July 1985 Edendeck Ltd. became AMS Industries plc.



For full details on the DMX15-80S contact us today.

AMS Industries plc, AMS Industries Park,
Burnley, Lancs. BB11 5ES. England.
Tel: (0282) 57011 Telex: 63108 AMS-G

Harris Sound Inc. (Los Angeles)
For nationwide sales, rental or
service Tel: (800) 233 1580

NEW

A4 size STUDIO SOUND binders are now available (each holds 12 copies). Keep your copies of STUDIO SOUND in smart black binders with the title in gold block letters on the spine.

At only **£3.50** each including inland and overseas postage and packing. Send your order with cheque or postal order to: Modern Bookbinders Ltd., Chadwick Street, Blackburn, Lancs BB2 4AG (state clearly your name and address and the relevant magazine title).

OVERSEAS READERS MUST SEND INTERNATIONAL MONEY ORDER



(Limited number of old size binders available).



LINK HOUSE GROUP

PA-VS 01-540 2164

Express studio equipment rental service

DIGITAL RECORDERS
SYNCHRONISERS
DRUM COMPUTERS
KEYBOARDS

DIGITAL DELAY
DIGITAL REVERB
ANALOGUE EFFECTS
VIDEO EQUIPMENT

SALES AND TECHNICAL SERVICES

PA-VS offers a range of new and used studio equipment for sale at competitive prices plus a comprehensive studio and studio equipment design and installation service. Repairs and modifications carried out on most makes of equipment.

Palmer A-V Systems Ltd. 67 Mostyn Road, London SW19 3LL.

Electronics Cable

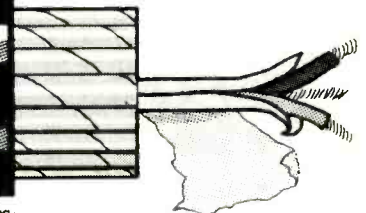

UK STOCKISTS:

STUDIO SPARES 01 482 1692 - SHUTTLE SOUND 01 871 0966

the know-how, the back-up and the goods

AVCOM

SPECIALISTS IN CASSETTE DUPLICATORS
SUPPLIERS OF

TELEX

HIGH SPEED DUPLICATORS

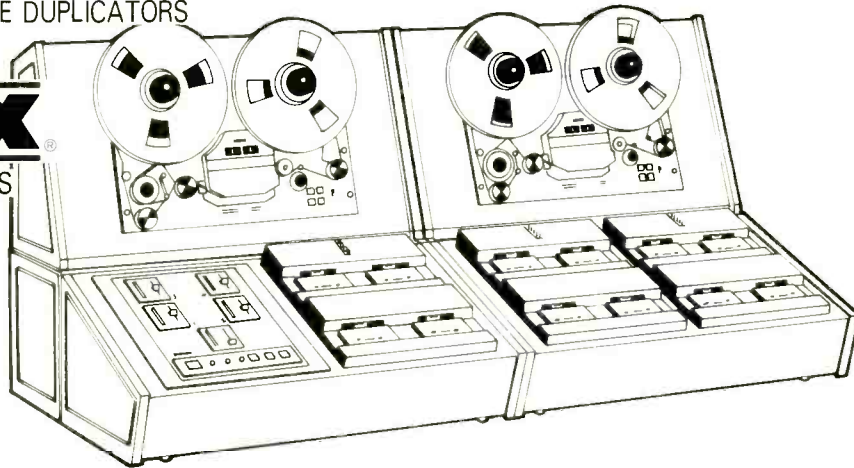

The TELEX 6120—just one of a wide range of cassette duplicators for the production of audio and data cassettes. Efficient and durable. TELEX equipment is backed up by 15 years of AVCOM experience and reliability.

Tony Martin, AVCOM SYSTEMS LTD, Stanlake Mews, London W12 7HS Tel no 01-740 0051 Telex 892513



SMASHING WINDOWS!

DIGITAL SAMPLING & DELAY UNITS BDE SERIES

The BEL BDE Series lets you set up, sequence and edit up to 99 windows.

BDE3200 gives you 32 seconds @ 15kHz bandwidth

BDE2400 gives you 24 seconds @ 18kHz bandwidth

Delay times may be doubled at reduced bandwidth

- Reverse Play
- Samples can be stored to disk
- MIDI keyboard compatible
- Manual/auto deglitch
- Options: twin floppy disk drive, Remote control



29 Guildford Street, Luton,
Beds. LU1 2NQ.

Tel. Luton (0582) 452495.

Studio Equipment Distribution

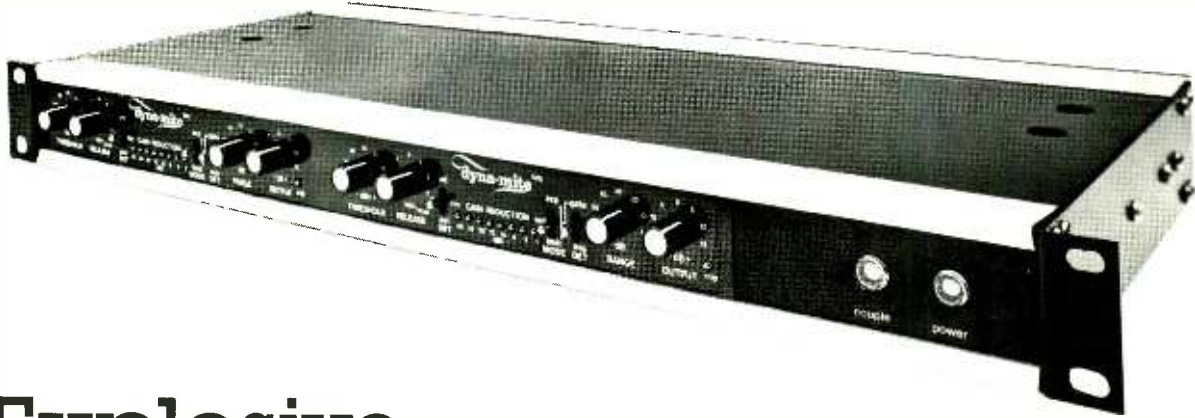

Explosive Results

The ultimate sound tool of the 80's is at your fingertips today. It's the Valley Dyna-Mite ... an extremely versatile multi-function signal processor.

Dyna-Mite delivers 18 operating modes offering a variety of choices for limiting, gating, ducking, and keying functions. And, when you consider that Dyna-Mite may be operated as either a two-channel or stereo-coupled device, it's easy to see why your problem-solving capabilities become practically limitless.

As you would expect, our Dyna-Mite comes in a small package. It's a rugged steel and aluminium, 1 3/4" x 19" rack-mount enclosure.

To discover why the Dyna-Mite is the hottest multi-function processor available, call your local Valley dealer.

VALLEY PEOPLE, INC. · P.O. Box 40306 · 2817 Erica Place · Nashville, TN 37204 · (615) 383-4737 · TELEX 3785899 · NASH AUDIO

VALLEY PEOPLE INTERNATIONAL · C/O Gotham AG, Regensdorf Switzerland · Telex 59222 gothm.ch, Tele 0041-1-840-0144

Stirling
AUDIO SYSTEMS LTD

1 Canfield Place London NW6 3BT ☎ 01-625 4515
Telex 946240 CWEASY G Ref No. 190 14280

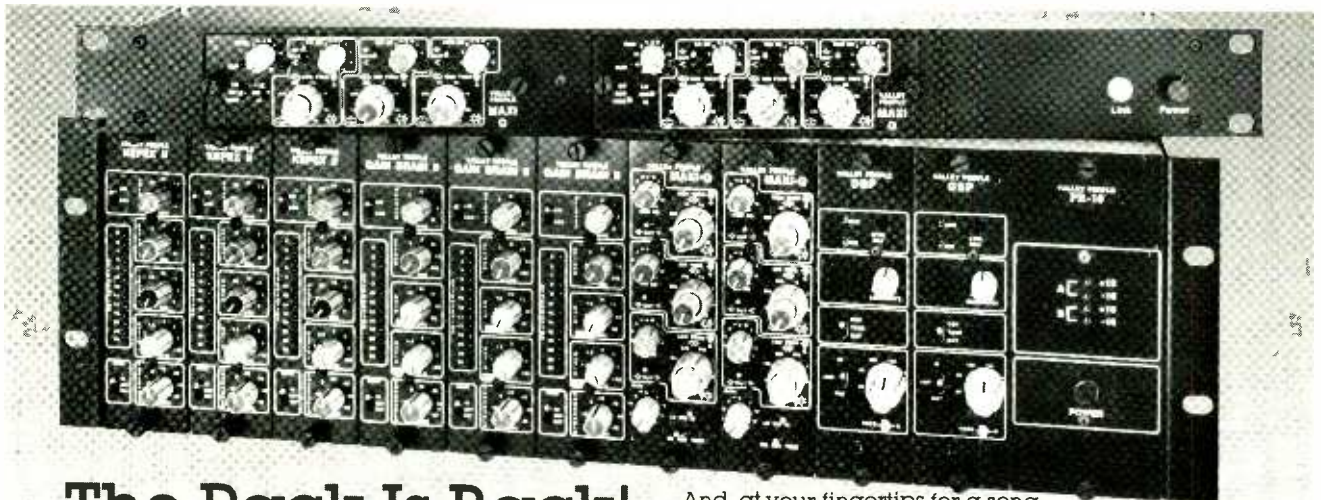

The Rack Is Back!

... And, at your fingertips for a song. Valley gives you the flexibility of modular signal processing without the expense, thanks to our new rack systems. Previously, the only way you could go modular was to purchase an expensive multiple unit rack that might not fit your budget. Valley has changed all that!

We've eliminated the heavy expense, while retaining the signal processing versatility. The new PR-10 is built with cost effectiveness in mind, yet it has a beefier power supply and is more road-worthy than any other rack system on the market today.

And, now Valley gives you even more flexibility with the only two module rack. The PR-2 is for those jobs requiring one or two modules of your choice. With the PR-2, just pop in the selected modules and you're ready to go. You can even link identical modules via the front panel link switch.

The rack is back, and it's better than ever. Valley's got 'em and the price is right. Go modular at your nearest Valley dealer, or write for free literature.

VALLEY PEOPLE, INC. · P.O. Box 40306 · 2817 Erica Place · Nashville, TN 37204 · (615) 383-4737 · TELEX 3785899 · NASH AUDIO

VALLEY PEOPLE INTERNATIONAL · C/O Gotham AG, Regensdorf Switzerland · Telex 59222 gothm.ch, Tele 0041-1-840-0144

Stirling
AUDIO SYSTEMS LTD

1 Canfield Place London NW6 3BT ☎ 01-625 4515
Telex 946240 CWEASY G Ref No. 190 14280

ScotchCart™

NAB HEAD
PENETRATION AND
CENTRING MARKS

NATURALLY
LUBRICATED
CONCAVE GUIDES

PLAYBACK
HEAD
SHIELD

WINDOW FOR VISUAL
SPLICE
IDENTIFICATION

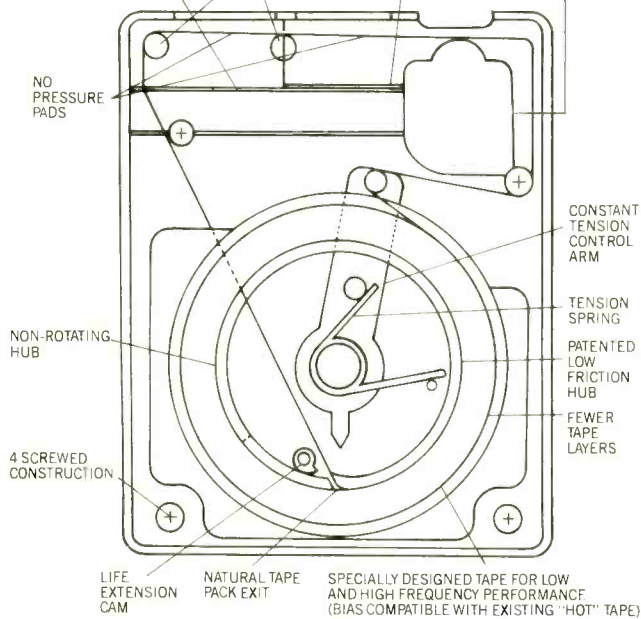

the cartridge revolution

The ScotchCart from 3M brings a revolutionary new design and a new tape quality to broadcast cartridges. This double breakthrough means you can now equal the frequency response of professional reel-to-reel performance with a cartridge that lasts up to five times longer than conventional designs.

Cartridge design has no pressure pads and incorporates a non-rotating hub. This improves troublesome tape guidance, tape wear, modulation noise and eliminates hub rattle. It also minimises wow and flutter and over-shoot of stop cues.

The new lubricated studio quality tape offers high output and low noise for recording at high levels without performance loss.

For the full story, just contact F.W.O. Bauch Limited.

3M

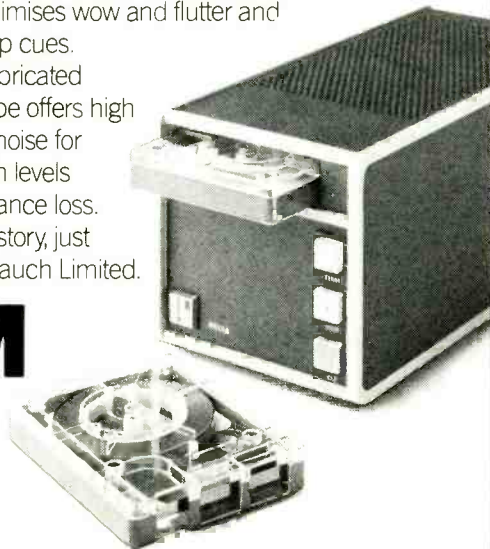

F.W.O. Bauch Limited

49 Theobald Street, Boreham Wood, Hertfordshire WD6 4RZ
Telephone 01-953 0091, Telex 27502 Fax 01-2075970

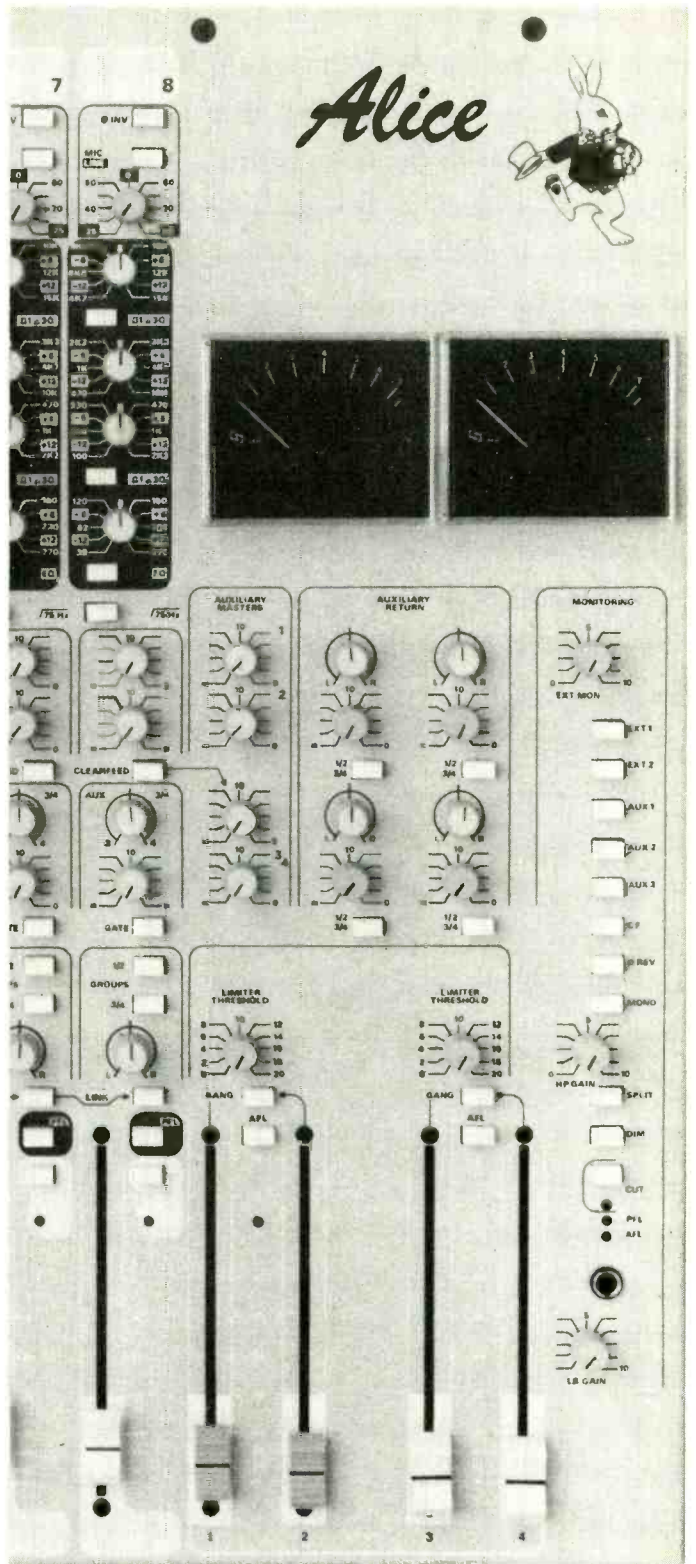

**FOUR BAND PARAMETRIC EQ
NOISE GATES AND SUBGROUPING
106dB DYNAMIC RANGE**

THE NEW *Alice*

WINDSOR (0753) 851056 Tx AEGIS G 849323

CLASSIFIEDS

Advertisements for this section must be pre-paid. The rate is 55p per word, minimum £13.75. Box Nos. £3.50 extra. Semi-display rates on application. Copy and remittance for advertisements in **NOVEMBER** issue must reach these offices by **10th SEPTEMBER** addressed to: The Advertisement Manager, **Studio Sound**, Link House, Dingwall Avenue, Croydon CR9 2TA. Cheques made payable to Link House Publications (Croydon) Ltd. **Note:** Advertisement copy must be clearly printed in block capitals or typewritten.

Replies to Box Nos. should be addressed to the Advertisement Manager, Studio Sound, Link House, Dingwall Avenue, Croydon CR9 2TA, and the Box No. quoted on the outside of the envelope. The district after Box No. indicates its locality. **SEX DISCRIMINATION ACT 1975:** No job advertisement which indicates or can reasonably be understood as indicating an intention to discriminate on grounds of sex (e.g. by inviting applications only from males or only from females) may be accepted, unless (1) the job is for the purpose of a private householder or (2) it is in a business employing less than six persons or (3) it is otherwise excepted from the requirements of the Sex Discrimination Act. A statement must be made at the time the advertisement is placed saying which of the exceptions in the Act is considered to apply.

The attention of advertisers is drawn to "The Business Advertisements (Disclosure) Order 1977", which requires that, from 1st January 1978, all advertisements by persons who seek to sell goods in the course of business must make that fact clear. From the above date consumers therefore should know whether an advertisement relates to a sale by a trader or a private seller.

SERVICES

CASSETTE DUPLICATING USING screwed shells. Ferric or chrome tape. Label and inlay printing. Shrink wrapping. Audicord, 59 Mayfield Way, Barwell, Leicester LE9 8BL. Tel: 0455 47398. (M)

TORQUAY, DEVON, ONE INCH eight-track high speed cassette duplication. Radio Jingle's musical director Ed Welch, South Western Studios, Castle Chambers, Union Street. 0803 28288. (J)

QUALITY HIGH-SPEED and real-time audio and video cassette copying and processing. Any quantity. While you wait. 24-hour, 7-days-a-week service. Central London W2. GWBB Audiovision. Tel: 01-723 1583/5190. (X)

THE COMPLETE SERVICE. Disc cutting, pressings, duplicated cassettes and blanks. Bin Masters. Location Recording. Free Brochure. Tam Studio, 13a Hamilton Way, London N3 IAN. Tel: 01-346 0033. (X)

WHO SAYS YOU DON'T NOTICE THESE SMALL ADS! For as little as £13.75+VAT you too could be getting your service message across. For more details contact Adrian Tippin at STUDIO SOUND. Tel: 01-686 2599.

DECIBEL AUDIO
Sound Services
P. A. Hire - any size - anywhere
We also manufacture:-
SPEAKER CABINETS & FLIGHT CASES
Sales of all makes of audio equipment
SOUND SYSTEM INSTALLATIONS
01-311 3099
Satisfaction Guaranteed

100 C-60 cassettes beautifully copied in stereo from **£59.50** (plus VAT)
We can copy from 100 to 5,000 high quality cassettes on our high speed loop-bin system, load them precisely into top-class shells. Price includes library case and all production work from your 1/4" in edited master. Any length C-5 to C-90. Ring for price check.
STUDIO REPUBLIC
47 High Street, Pinner 01-868 5555 01-866 5555

CASSETTE DUPLICATORS
SALES SERVICE MAINTENANCE
High speed cassette duplicators throughout the United Kingdom and export.
GRAFF WOLLENSAK SONY
Sound Cassette Services Ltd.
P.O. Box 2, Chard, Somerset
0460 67237
LONDON SERVICING FACILITIES

Check It Out...

DIRECT FROM OUR MODERN U.K. PRESSING PLANT
• CUTTING · PRESSING
• TEST PRESSING
• LABELS · SLEEVES
• CASSETTES
• ARTWORK
• COMPETITIVE PRICES
MARKET LEADERS
SRT
01-446 3218

WEST 5 Tapes Ltd.
Rapid supply of high quality blank bulk cassettes C1-C120
Example C60 31p
5-screw C-Zero - no minimum or maximum order
Phone Dave West 01-502 2447
West 5 Tapes Ltd, Unit 34, Oakwood Hill
Industrial Estate, Loughton, Essex

the records
MUSIC-SPEECH-COMPUTER
REAL-TIME or (Slow) HIGH-SPEED Quality Cassette Duplication and Blanks from 1 to 1000+. Computer printed Cassette Labels. Speech and 1/4" reel-to-reel recording/editing. Fast Security Delivery service.
the records - a division of FILTERBOND LTD.
19 Sadlers Way, Hertford SG14 2DZ. 0992-551188.

COACH HOUSE

RECORDS & TAPES
For real time & high speed cassette duplication, Prewound blank cassettes, and all aspects of record manufacture, call 0322 71712 for comprehensive quote.

CASSETTE DUPLICATING:
GAUSS Loop-Bin / TELEX In-Cassette
High Quality Blanks / Label Printing
OPEN REEL DUPLICATING
(ANY SPEED - ALSO TO BROADCAST SPEC.)
SPEECH RECORDING
(VOICE-OVERS; LANGUAGES; AUDIO-VISUALS)
SPEECH-PLUS RECORDINGS LTD.
UNIT 32, NO. 19, PAGES WALK, LONDON SE1 4SB. TEL: 01-231 0961

SERVICES

HIGH QUALITY CASSETTE DUPLICATION AND SPECIALISED LENGTH BLANK CASSETTES

ICM C-O's

Leeholme Audio AGFA/BASF TAPES

Leeholme Audio Services Ltd., 350-4 Leabridge Road, Leyton, London, E10 Telephone 01-556 4748

Revox & Uher Sales & Service
 16mm sound 35mm slide projectors, open reel and cassette recorders, amplifiers, etc., serviced and repaired.
 Bell & Howell, Elf, Ferrograph, Revox, Tandberg, Uher approved service agents. Maintenance contracts available.
 Visit our Amateur Radio Showroom at:-
 58 High Street, Newport Pagnell. Tel: 0908 610625.

Photo Acoustics Ltd

TAPE DUPLICATION

CASSETTE: * Hi-speed * Real-time * Quality shells *
 * Quality tape * Short runs welcomed *
OPEN REEL: * Real-time * Double-time * Broadcast spec *
 * Rapid copy service for ILR network *
 * Post production *

APRS Member
GRIFFITHS HANSEN (RECORDINGS) LTD.
 Park Mews, Parkhall Road, London SE21 8EX
 Contact: Tony O'Leary Tel: 01-761 0055

TAPE & FILM HEADS

WE MAKE WE STOCK
 WE RE-PROFILE

BRANCH & APPLEBY LTD
 STONEFIELD WAY, RUISLIP
 MIDDLESEX HA4 0YL
 01-864 1577

WHY PAY LONDON RATES?

Professional Disc Mastering operation offering top quality with over 20 years experience. Contact Brian East, "Suncliffe", 43 Sandgate Hill, Folkestone, Kent.

SPECTRUM SOUND
 0303 38752

SELECTA PHONE FOR
 NEW PRICE LIST
 04024 53424



SOUND WHERE THE CHOICE IS YOURS

THE SOUND & VISION WORKSHOP LIMITED

3M
 SPARES
 SERVICE

SOLE U.K. AGENTS
 COMPETITIVE 3M HEAD PRICES
 EXCHANGE MOTORS AND
 BOARDS. ALL SPARES IN STOCK.
 EXPORT ENQUIRIES WELCOME

SERVICE FOR ALL MULTITRACK RECORDERS
 SPARES · REBUILDS · PROFESSIONAL AUDIO
 ELECTRONICS · SALES · EQUIPMENT

153A Victoria Street,
 St. Albans, Herts. AL1 3TA
 Tel: (0727) 58977 24hr.

REAL TIME CASSETTE DUPLICATION

Onto exact length Ferric / Chrome tape.

CUSTOM WOUND BLANK CASSETTES
 ICM C-O's BASF Tape

TEL: Cardiff (0222) 790040

Backyard Recording Studios Ltd.
 60 Orchard Park St. Mellons Cardiff.

backyard
 STUDIO

EMULATOR II

PLUS FULL SOUND LIBRARY

ALSO: LINN DRUM, SIMMONS KIT, KEYBOARDS ETC.

STUDIO SUPPLY SERVICE
 061 928 5037

THE MANCHESTER BASED HIRE COMPANY

REAL TIME CASSETTE COPYING

All work carried out on Nakamichi machines to the highest standard. Normal or chrome tape available.

We also supply blank cassettes wound to length.
 AGFA and BASF chrome tape available

GATEWAY CASSETTE SERVICES
 1 GAUDEN ROAD, LONDON SW4 6LR
 TEL: 01-627 4758

ACCURATE SOUND LIMITED

Quality Cassette Duplication, High-Speed (Loop Bin) and Real Time, Overwrapping, Exact Length Blank Cassettes, Labels and Inlays
 Tel: Leicester (0533) 602064

QUENIBOROUGH (Ind. Est.) MELTON ROAD
 QUENIBOROUGH, LEICESTER LE7 8FP

SPEEDY REVOX SERVICE

Plus TEAC/TASCAM, FOSTEX, UHER, most Mixers, Amplifiers, Effects. Priority Bookings taken. Collection/Delivery arranged. A personal service by experienced engineers.

34 Danbury Street, London N1 8JU
 Telephone 01-359 9342/3030

RAPER & WAYMAN

Let Saki expertise relap your tape heads in London

Factory-approved laboratory and training guarantees finish to original performance specification

ALL MAKES RELAPPED

Tapetek, 44A Brighton Road, London N16 8EG
 Tel: 01-254 5203 or 0836 215900 (mobile)

Replacement Saki heads from:

Tape Marketing, 13 Elm Road
 Faringdon, Oxon SN7 7EJ 0367 20262

SAKI

051-430-9001

HIGH SPEED DUPLICATION
 MASTERING, DUBBING, EDITING
 INLAY CARD & SIDE LABEL DESIGN
 & PRINTING

THE COMPLETE SERVICE

AMPEX & BASF DISTRIBUTORS
 STUDIO ACCESSORIES

RAINHILL TAPE SPECIALISTS
 31 ECCLESTON STREET
 PRESCOT, MERSEYSIDE L34-5QA

DATAGENK

CUSTOM LENGTH BLANK CASSETTES
 MONO & DATA DUPLICATING
 LABEL PRINTING · SHRINKWRAPPING
 READING 0734-302600

THE COMPLETE SERVICE

includes:

BLANK CASSETTES (C1 - C100 incl.) Chrome
 HIGH-SPEED LOOP-BIN CASSETTE COPYING
 OPEN-REEL COPYING
 CASSETTE LABELS & INLAY CARDS
 EMPTY TAPE SPOOLS & TAPE BOXES
 LEADER TAPE & SPLICING TAPE
 AMPEX MAGNETIC TAPE

and is available from -
 MEDIATAPE LIMITED

The Courtyard, 152-154 Ewell Road,
 Surbiton, Surrey KT6 6HE England

01-399
 2476 7

AUDIO LEADS

ALRIGHT JACKS

FREE INFO
 YOUR WISH IS OUR COMMAND!

Patch leads—Multicore systems—Multitrack looms
 Stage/Studio boxes—Wire mesh cable support grips
 Neutrik connectors—all cable assemblies guaranteed
 RUB YOUR LAMP AND SPEAK TO THE GENIE...

Ask for Geoff Lowther
 TEL: SLOUGH (0753) 821812

MUSICABLE

CLASSIFIEDS

FOR SALE—PRIVATE

DOLBY A361—two available at £250 each. Flight cased TAC 28-8-2 desk £1,595. Hill K Series 20/16 in line desk, needs attention—offers? Bristol 773804.

1X TEAC A 3340s 4 TRACK REEL TO reel also 2X Amcron D 60 power amplifiers. Offers please to Greg Shannon—01-741 8922 (office hours).

TEST GEAR FOR SALE—Analysers—Sound Technology 1700A Distortion Measurement System. Crown (Techron) IMA SMPTE Intermodulation Distortion Analyser. Rank Kalee Model 1740 Wow & Flutter Meter. OSCILLATORS—Bruel & Kjaer Model 1013 Beat Frequency Oscillator (200 Hz—200 kHz). Heathkit model 1G18 Sine/Square decade oscillator (1 Hz—100 kHz). VOLTMETERS—Sennheiser Model UPM 550 Universal Level Meter 30 uV to 300 V. RMS, quasi-peak. CCIR or A weighted etc. Sennheiser Model RV 55 level Meter 1 mV RMS, quasi-peak. Sennheiser Model FO 2 DIN weighting for RV 55. OTHER—Bruel & Kjaer Model 440 Response Test Unit. Fluke Model 8110A Digital Multimeter. ACV, DCV & Ωs. SE Laboratories Model SM 202 150 MHz Timer/Counter + BCD interface. Commodore Pet 3032 Computer with twin Computhink disk drives, Wordcraft word processing program etc. Textronix Model 31 Programmable Calculator + interfaces + twin DMM's + X/Y Plotter etc. GEC Model RC-460 Communications Receiver (10 kHz—30 MHz). Bell & Howell 5-127 UV Recorder + drive amplifiers. Offers invited to Hugh Ford, 24A, Trinity Road, Richmond, Surrey. 01-948 5669.

EVENTIDE HARMONISER H910. Fine adjustment octave pitch shift, short digital delay effects, etc. Two outputs. £750. Clive: 01-230 4504 (work); 01-579 4518 (home).

AMPEX MM.1100, c.w. 16 trk Head Block & 2x1" 8 trk. Extensive spares kit, varispeed, search to cue remote extension. £2,250 o.n.o. Tel: 031-557 0181.

TANNOY LITTLE RED Studio monitors, 8 months old, little used, immaculate condition—£750 (o.v.n.o.). Tel: Clive—0787 78634.

E.M.T. 140. VALUE. MONO. Electrics O.K. but needs mechanical attention. Offers? Tel: Aberdeen (0224) 310152.

FAIRCHILD MODEL 670 stereo valve compressor limiter £2,300—phone 01-991 0699 after 7 p.m.

DUAL SPEED REEL six cassettes duplicator Otari DP4050CF £575 o.n.o. good condition. AKAI 1410W Stereo reel tape recorder £65. Acorn Atom Home Computer £199 o.n.o. 101c Honor Oak Park, London, SE23 3LB.

LEXICON 224 £3,200 o.n.o. Levers Proline 1000 15/30 IPS o.n.o. Rebis—various modules from £50. Revox A77, SLF-1, more items. Tel: 060885 360/269.

24 TRACK TAPE RECORDER and 32 input inline desk, internal patchbay, designed by ACES UK. One year old excellent condition, private studio £9,500. Tel: (0273) 561900.

USED MICS BOUGHT & sold: Calrec Soundfield Mic hire: DIY mic pre-amps/mixers etc: SAE details: Mike Skeet, Whitetower Records, 44 Challacombe, Furzton, Milton Keynes MK4 1DP (0908) 502836.

UREI 813B studio monitors less than 1 year old, v.g.c. £3,500 o.n.o. EMT PDM 156. Stereo Compressor Limiter. Ideal for disc cutting. £2,000 o.n.o. Please contact Roy or Callie: 01-451 3727.

USED STUDIO EQUIPMENT FOR SALE? Advertise it now in STUDIO SOUND CLASSIFIEDS for as little as £13.75 + VAT. For more details call Adrian Tippin at STUDIO SOUND. Tel: 01-686 2599.

FOR HIRE

SAM THERAPY
The first Hire Company
to offer the
FAIRLIGHT III
Tel: 01-229 0225/960 1336



MAC
sound hire
nationwide

Telephone **061-969 8311** for brochure
1 & 2 Attenburys Park, Park Road,
Altrincham, Cheshire, WA14 5QE.

HIRE & SALES INSTALLATIONS
ONE NIGHT WITH US CAN
LEAD TO ANOTHER
THE PA COMPANY LIMITED
01 607 0087
SPECIALIST SERVICE AND ADVICE
ON ALL SOUND PRESENTATION

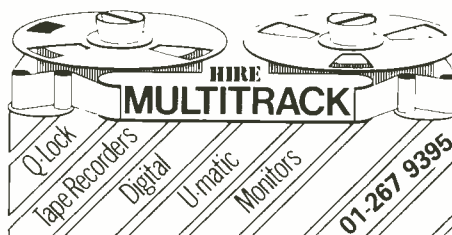

TEAC 244/34/38 discounts and HP and leasing. Erricks VCD, Brighthouse 722121 (Bob) (X)

SURPLUS mono & stereo amplifiers, speakers, turntables etc; bought & sold at reasonable prices. Midland Radio Supplies, Maypole Lane, Birmingham B14 4PE. Tel: 021-430 7817. (J)

DISC CUTTING EQUIPMENT and systems bought, sold, installed and manufactured (under licence from ORTOFON). TAM/ENGLAND, 13a Hamilton Way, London N3 1AN. Telephone 01-346 0033. (X)

TAPEMATIC CASSETTE BOXING machine, reconditioned and guaranteed 6 months £5,000 plus VAT. Save over £3,000 on new. Tapematic Services Ltd, 0367 20262.

DYNAMIC DUOS	
18719-87581 09728-67581 TEL	2" MT24-HS 24 track with autolocator ML24-24 in-line console ACES PACKAGE DEAL £13,700 +VAT
	2" MT24 standard 24 track with autolocator ML24-24 in-line console ACES PACKAGE DEAL £12,475 +VAT
	2" MT16 A-HS 16 track with autolocator B1816 mixing console ACES PACKAGE DEAL £8,350 +VAT
	SML 1216 1/2" 16 track with Aces B1816 console (6 aux, 5 band Eq, 2 sweeps) ACES PACKAGE DEAL £3,950 +VAT

Prices include all wiring and installation.
M.S. Audio are suppliers of all home and studio equipment. Part exchange welcome.

PHONE NOW FOR QUOTES ON OTHER PACKAGES

M.S. AUDIO

FOR SALE—TRADE

AGFA PROFESSIONAL PER 368, 1/4" tape. 5" LP reels only £1.50 + VAT ea. 25 reels—10%. Post £2/order. C.W.O. to Solent Records, 6 Mountbatten Drive, Ryde, Isle of Wight.

FOR SALE SOUNDTRACS 16:8:16 Desk. Straight out of our Demo-room at £995 + VAT, i.e. HALF LIST PRICE SCENIC SOUNDS—01-387 1262.

USED NEVE CONSOLES FROM DON LARKING AUDIO SALES

NEVE 8108 32-input mixing console with NECAM II **£57,000**
NEVE 8068 **£50,000**
NEVE 8048 with NECAM II **£50,000**

Call us now on (0582) 450066 for more information

Don Larking
audio sales

Luton: 29 Guildford Street, Luton, Beds.
Telephone: Luton (0582) 450066. Telex: 825488 DONLAR G

CLASSIFIEDS

FOR SALE—TRADE

THE HHB SILLY SUMMER SALE

Sony CCDV8 Video 8 Camcorder, ex-demo, £795
 Sony CCDM8 Handycam Video 8 camera, ex-demo, £595
 Sony Compact 75 Hi-Fi system, £375
 Sony C35P Condenser Mic, £119
 Sony EBP 9LC D50 power supply, £35
 Sony ECM929T Stereo electret condenser mic, £35
 Sony EVC8 Portable Video 8 VCR, £395
 Sony EVA 300 Video 8 VCR, £350
 Sony EVS700 Video 8/PCM VCR, £550
 Sony PCMEV10 Digital processor for EVA300, £139
 Sony SLC9P Printer VCR, £295
 Sony PCM1610 (S/hand) digital audio processor, £11,000
 Sennheiser MD421 mics, £99
 Gauss 3588 Coaxial loudspeakers, £275
 Electrospace spanner stereo panner, £425
 Clue (Computer, logging unit+ editor), ex demo, £1,995
 12" Green screen VDU, £59
 BSS FDS320 Crossover, £275
 BSS AR116 ex demo DI boxes, £39
 Lexicon PCM60 digital reverb, £1,095
 Allen & Heath System 8, 1616 MkII mixer, £1,275
 Allen & Heath CMC168 mixer, £1,325
 Allen & Heath CMC 32, 32 into 24 mixer, £2,750
 Roland SRV 2,000 Digital reverb, £795
All prices exclude VAT



HHB HIRE & SALES

Unit F, New Crescent Works
 Nicoll Road, London NW10 9AX

Telephone: 01-961 3295 ★ Telex No: 923393



24-TRACK STUDIO AND EQUIPMENT FOR SALE

JACKSON MUSIC GROUP
 The Studios, Rickmansworth,
 Hertfordshire, England WD3 2XD

APRS Member

TEL: 0923 772351

TELEX: 262284 REF 1728G



Your Northern appointed agent for:

NEUMANN	J.B.L	LEXICON	SOUNDCRAFT
SENNHEISER	TANNÖY	DRAWMER	STUDIOMASTER
SHURE	REVOX	D.B.X.	B.E.L.
BEYER	TASCAM	YAMAHA	APHEX
UREI	QUAD	AMPEX	APPLIED
TRIDENT	ROLAND	AKG	MICROSYSTEMS

18-42 Charlotte Street, WAKEFIELD, W. Yorks WF1 1UH
 Tel: (0924) 371766

WANTED

WANTED TO BUY RECORDING EQUIPMENT of all ages and varieties, recording consoles, microphones, outboard gear, etc. Write or call Dan Alexander Audio, PO Box 9830, Berkeley, CA 94708, U.S.A. Tel: (415) 527 1411. (J)

NEUMANN VALVE MIC. CAN YOU HELP?
 I need power supplies. Model NKMA and NKMH any condition, not working or parts. So look in your audio graveyard please. Tel: Mick 0582 412331.

WANTED DEAD OR ALIVE

Neumann valve mics
 Types U47, U48, U67
Tel: 01-387 9356



The first 2 editions of **ONE TO ONE** (as shown) proved to be extremely well received by readers and advertisers alike.

ONE TO ONE seems to have filled a gap in a market hungry for information.

News and commentary are the mainstay of the magazine keeping the professional in the many areas of mastering, pressing and duplicating up-to-date on developments and techniques throughout the world. In addition to this there are articles covering the use of equipment, profiles, overviews on the international industry plus the interface between producers and the record industry as a whole and much more.

Circulated to over 70 countries and published by the same world renowned team who produce **STUDIO SOUND** magazine, the third edition of **ONE TO ONE** will be published in October.

To coincide with the Los Angeles AES (12th to 16th November) and the Japanese International Broadcast Equipment Exhibition (19th to 21st November) **ONE TO ONE** will be available free of charge during these two important events.

To ensure that your message is seen contact Carl Anthony Snape, Editor; Phil Guy, Commercial Manager or Adrian Tiffin, Advertisement Sales by the final dates to be included in this important new magazine.

COPY DEADLINES

Editorial copy date: 20th August latest.
 Advertising copy date: 8th September.

Further information on advertising rates are available from

ONE TO ONE, Link House Magazines Ltd., Link House, Dingwall Avenue, Croydon CR9 2TA, U.K. Tel: 01-686 2599. Telex: 947709. Fax: 760 0973.



CLASSIFIEDS

SITUATIONS VACANT

Soundcraft

UK SALES ENGINEER

Due to continuing expansion Soundcraft Electronics Ltd, one of the leading names in Professional Audio requires a professional Sales Engineer to assist our UK Sales Manager.

A proven track record with professional mixing consoles and multitrack recorders is essential, as is an ability to negotiate sales successfully.

The job includes existing customer support as well as developing new business throughout the UK.

The successful candidate can expect an excellent remuneration package including company car.

Applications in writing to:
HELEN THOMAS Personnel Officer
 SOUNDCRAFT ELECTRONICS LTD
 Unit 2, Borehamwood Industrial Park, Rowley Lane
 Borehamwood, Herts WD6 5PZ

FREELANCE RECORDING ENGINEER required for a new 16-track facility in West London. Please reply and send c.v. to Box No. 937.

24-TRACK STUDIO IN Maida Vale requires freelance engineer with good knowledge of MIDI, SMPTE, sequencing, sampling, mic placement and contemporary music. 286 0642 daytime.

FREELANCE MAINTENANCE ENGINEER required for 24 track (Trident Otari) studio in Maida Vale. 286 0642/289 9224 office hours.(J)

STUDIO DESIGNERS AND CONSULTANTS

TIME DELAY SPECTROMETRY
 Discover why your studio sounds the way it does . . . or should
MUNRO ASSOCIATES. 01-480 7121

STUDIO SOUND

AND BROADCAST ENGINEERING

CLASSIFIED ADVERTISEMENTS ORDER FORM

Please use this coupon for all your sales and wants.
 Rates: 55p per word. Min £13.75. Box Nos. £3.50 extra

PLEASE PRINT IN BLOCK CAPITALS

To: STUDIO SOUND, please publish the above advertisement for insertions under the heading Cheque/P.O. to be made payable to LINK HOUSE PUBLICATIONS LTD, LINK HOUSE, DINGWALL AVENUE, CROYDON CR9 2TA. Is a Box No. required Yes/No. If no, please include remittance to cover name and address and/or tel. no.
 Name Address

CLASSIFIEDS

AUDIO SERVICES

SUMMER SALE

Professional Audio & Audio for Video Equipment
Phone and ask for our latest list - more bargains are coming in daily!

NEW EQUIPMENT

Tascam MS16 16-track inc. Autolocator, dbx, console	£7 750
Lyrec TR532 24-track inc Locator	£22,500
TAC Scorpion in Stock - on demo	POA
TAC Matchless - to order	POA
Tascam ATR-60 8 Track Professional	from £4 375
Tascam 48 OB	£3 295
Soundtracs MR Series 24.8	£5 000
Fostex B-16 (Package Deals)	P.O.A.
Fostex M-80 (Package Deals)	P.O.A.
Fostex 450 Mixer	£695
Tascam 38	£1 795
Tascam 32	£1 995
Tascam M-520 20:8:16	£2 850
Tascam M-312 12:4:2 + 8TK	£1 335
AHB System 8 24:16	£2 200
AHB System 8 16:8	£1 485
AHB CMC 24	£2 335
AHB CMC 32	£3 250
Seck 1882	£950
Tascam M216 (16:4:2)	£725
Tascam M208 (8:4:2)	£525
RSD Studiomaster Series II 16 8:2 (Package Discount)	£2500
RSD Studiomaster Series II 16 16:2 on demo (Package Discount)	£2975
RSD Studiomaster 16 8:2	£1 150
RSD Studiomaster 16:16:2	£1 425
Ram RM10	£495
Ram Mega 18	£1 640
Tascam ATR60 1/2" Prof. 15/30 ips	£4 400
Tascam ATR60 1/2" Prof Centre Time Code	£3 500
Fostex M-20 1/2" Stereo + Time Code	£799
Tascam M106 6.4	£345
Tascam 42 NB	£1 595
Tascam 22-2	£450
Revox B-77 Mk II	£840
Revox PR-99 Mk II	£1 275
Tascam 34B	£1 180
Tascam 388 inc Remote Control	£2 169
Alesis Midiverb - loads in stock	£345
Yamaha SPX-90 - loads in stock	£520
Lexicon PCM 70 in stock	P.O.A.
UREI, JBL, Tannoy and RCF monitors, A/B for comparison	P.O.A.
Lexicon PCM60 - one only - new, in box	£1000
Tascam 58 OB - New ex-demo	£3,950
Tascam 44 OB - New	£1,595
Tascam 52 NB - Ex-exhibition	£2,100
Tascam 42 NB - Ex-exhibition	£1,595

SECOND-HAND BARGAINS & EX-DEMO EQUIPMENT

Allen & Heath syncon A 32:24 inc Patchbay & Producers Desk	offers around £6 000
MCI JH1624 MK II c/w Autolocate	offers around £6 000
Teac 3440 - Two available	from £595
Cassette Duplicating Package, comprising Otari DP4050 OCF, Dolby 330, Teac X-1000	
Approx 3 years old, very little used	£4 500
JBL 4435 Studio Monitors ex-showroom	pair £2,950
AMS DMX-1580 370ms + 370ms	£795
Bel BD-80 (4 Secs) Retrigger etc. - 'Mint'	£595
Neumann M269 Valve (U87 Predecessor) inc PSU - 'Mint'	£800
Neumann SM69 Valve inc. Original Dual Polarity PSU	
Cradle & Windshield	£1 100
Loads of Second Hand Neumann Mics U47, Cradle & Windshield	£595
Bei 8 Chan Noise Reduction Unit	£295
Quad Eight CPR-16 Digital Reverbator - good condition	£495
Studer Penthouse for B67 - new	£300
JBL 5234A X-over with Cards	£450
Tascam 38 - six months old - perfect	£1 450
AHB System 8 16:8 - second hand - 'Mint'	£1 295
Seck 16:8:2 - good condition	£695
Teac M2A + MB20 Meterbridge second hand	£295
Master Room MR-3	£295
AKG BX-20E - just reduced	£495
Promark MX-3 - 'Mint' - 2 available	each £295
Yamaha MT1X - in stock - new	£430
Tascam 122 - 3 available	each £395
Tascam 58 with 8 chans - dbx in console. As new	£3 950
UREI 809 Monitors - Ex-demonstration	pair £1 595
Ram Mega Custom 421/P, 8 out 24TK Monitor	£2 300
Ampex MM1000 1" 8T, autolocate/noise reduction, spare HB - lovely	£2 000
Soundcraft SCM762 III, autolocate/remote - only 10 months old	£12 000
Soundcraft TS24, 28 in 32 frame - 10 months old	£21 000

NEW PACKAGE DEALS

Tascam MS-16 inc DBX Autolocator stand with Tascam M520 console	£10 400
Tascam ATR60-8 inc. DBX inc. stand with M312 console	£5 180
Fostex B-16 with AHB CMC 24 Console	£5 235
Fostex B-16 with AHB 24/16 System 8 Console	£1 090
Fostex B-16 with Ram RM18 Console	£1 840
Fostex B-16 with Soundtracs 16/8/16 Console	£5 025
Fostex B-16 with Seck 18/8 Console	£4 055
Tascam 38 with Tascam 312 Console	£3 120
Tascam 38 with AHB 16/8 Console	£1 075
Tascam 38 with RSD 16/8 Console	£2 845
Fostex Model 80 with Ram RM16 Console	£2 034
Fostex Model 80 with Ram RM10 Console	£1 866
Fostex Model 80 with Model 450 Console	£1 956
Special Introductory Offer! Two Fostex B-16 Recorders, One Synchronous Technologies SMP1 synchroniser inc. interfaces and T.V. Monitor - 30 Track Recording. For Only	£7 850
Loads more equipment in stock - we have gear coming in all the time.	

STUDIO HOUSE Please note: the prices above do not include VAT
High Lane Village, All major credit cards accepted, 4 Wellington Road,
Stockport SK6 8AA, St. John's Wood,
Tel: 06632 4244, Telex 665721 London NW8 Tel: 01-586 3167
Normal opening hours are 9.30 am to 6.00 pm Monday to Friday; 10.00 am to 2.00 pm Saturdays
If you intend to call at either of our premises we recommend you make an appointment first

INDEX TO ADVERTISERS

Acoustic Sciences Corporation	88
AMS Industries PLC	93
Agfa Gevaert	33
Akai	75
AKG	61
Allen & Heath	17
Alpha Audio	16
AMEK Ltd	71
Ampex (UK)	IBC
Aphex Systems	10
Applied Research & Technology	83
Asona	24
Audio Design Calrec	13
Audio FX	89
Audio Kinetics	73
Audio Precision	19
Audio Service Co	102
Avcom Systems Ltd	94
BASF AG	57
Britannia Row Equipment	58
Bruel+Kjaer	76
Citronic Ltd	41
Connectronics Ltd	92, 93
Digital Info Exchange	91
Don Larking Audio	85
Eardley Electronics	27
EMT-Franz	90
Feldon	18
Future Film Developments Ltd	8
FWO Bauch Ltd	25, 69, 96, OBC
Graff Electronic Machines Ltd	88
H W International (Shure)	9
Hardware House	8
Hayden Laboratories Ltd	11
HHB Hire and Sales	20, 21, 23
Hill Audio Ltd	79
Hilton Sound	6
ITA	29
Klark Teknik Research Ltd	64, 65
Lexicon	59
Mitsubishi Pro Audio Group	45
Mosses & Mitchell Ltd	92
Music Labs Group Ltd	4
Neumann	37
Neve	39
Northern Audio	8
Otari	67
Palmer Av Systems	93
Partridge Electronics	16
Peter Struven GMBH	88
Powerplay Recording Studios	56
RE Instruments	81
Rane Corporation	7
Regent Port Ltd	47
SED	94
SAJE	15
Sanken	77
Scenic Sounds	19, 59
Scotchcart	96
Shuttlesound	90
Solid State Logic	34, 35
Sony Broadcast Ltd	31
Soundcraft Electronics Ltd	IFC
Soundout Labs	63
Stancoil	96
Stapp Ltd	51, 52, 53
Studer	69, OBC
Studiomaster	86
Studio Polygone	56
Studio Spares	14
Surrey Electronics	32
Symetrix	16
Tannoy	25
Theatre Sound & Lighting	12
Trad Sales & Services	12
Trident	42, 43
Turbosound	49
Valley People	95
Vertigo	92

Studio Sound is available without charge to qualified readers; these are directors, managers, executives and key personnel actively engaged in sound recording in any part of the world. The Publisher reserves the right to refuse applications considered inappropriate and restrict the number of free copies sent to any one company or organisation. Non-qualifying readers can buy Studio Sound at an annual subscription of £18.00. All enquiries to: Subscription Department, Link House Magazines, Central House, 27 Park Street, Croydon CR0 1YD. Tel: 01-760 0054. Published by the proprietors Link House Magazines Limited, Link House, Dingwall Avenue, Croydon CR9 2TA and printed by Lawrence-Allen Ltd., Gloucester Street, Weston-super-Mare, Avon BS23 1TB.



THE EVOLUTION OF SUCCESS

To stay number one, you've got to make the best even better. Which is why for ten years Ampex has continued advancing the performance of mastering tape. Through a decade of increased performance and reliability, Grand Master® 456 remains the tape behind the sound of success. Which is why more top albums are recorded on Ampex tape than any other tape in the world. For Grand Master 456, the beat goes on.

AMPEX

Ampex International, Magnetic Tape Division, Acre Road, Reading RG2 0QR, England, (44) 734-875200 Ampex Corporation • One of The Signal Companies

AND THE BEAT GOES ON



Studer 961/962 Small Wonder

It's a wonder how a console so small can do so much... and sound so good!

The Swiss have a special talent for making great things small. A case in point: the new 961/962 Series mixers from Studer. In video editing suites, EFP vans, remote recording, and radio production, these compact Studers are setting higher standards for quality audio.

Sonic performance is impeccable throughout, with noise and distortion figures well under what you'd need for state-of-the-art digital recording. By refining and miniaturising circuits developed for our 900 Series production consoles, Studer engineers have squeezed a world-class performance into suitcase size.

The 961/962 Series is fully modular, so you can mix-and-match modules to meet your requirements. The 961/962 features

stereo line level input modules with or without 3-band EQ, plus mono mic/line inputs and master module with compressor/limiter. Other choices include a variety of monitor, talkback, auxiliary, and communication functions. The 961 frame holds up to 14 modules, the 962 accepts up to 20.

Other new features in the 961/962 Series include improved extruded guide faders, balanced insert points, FET switching, electronic muting, Littlite® socket, and multi-frequency oscillator.

Thanks to its light weight, DC converter option, and sturdy transport cover, you can

put a 961/962 mixer on the job anywhere. And, with Studer ruggedness and reliability, you can be sure the job will get done when you get there.

Packed with performance and features, 961/962 consoles will surely make a big splash in audio production circles. Small wonder. Call your nearest Studer representative for more details.

© 1988 Studer AG, Switzerland

STUDER

IMPORTED BY F.W.O. BAUCH LTD
CH-8105 Regensdorf Telephone (01) 840 29 60



STUDER REVOX AMERICA INC Nashville Telephone (615) 329-9576
STUDER REVOX S A R L Paris Telephone 533 5858
STUDER REVOX CANADA LTD Toronto Telephone (416) 423-2831

F.W.O. Bauch Limited

49 Theobald Street, Boreham Wood, Hertfordshire WD6 4RZ
Telephone 01-953 0091, Telex 27502 Fax 01-2075970

www.americanradiohistory.com