

# how to build radio receivers

Lowell Kendrick  
4800 Lubbock Ave.  
Fort Worth, Texas 76115

ERNSBACK LIBRARY

NO. 38

50 cents

# How to Build . . .

## ***battery sets***

Twinplex 1-Tube Portable—by Robert Marks . . . . .	3
2-Tube Short-Wave DX-ER—by L. F. Rodgers . . . . .	6
3-Tube Ocean Hopper—by Harry D. Hooton . . . . .	9
Radio Hearing Aid—by Dr. Angelo Montani . . . . .	12
Battery-4 Portable—by Allan Stuart . . . . .	15
Miniport 5-Tube Superhet—by Ricardo Muniz and S. M. Decker	18
32-Volt D.C. Receiver—by Lyle Treakle . . . . .	22

## ***a.c.-d.c. sets***

Easy-Built 2—by H. L. Davidson . . . . .	25
All-Wave Explorer—by Bob White . . . . .	28
5-Tube 2-Band Set—by John Crouch . . . . .	33
Midget 3-Tuber—by H. L. Davidson . . . . .	37
Portable Phono-Radio—by John F. Millar . . . . .	39

## ***a.c. sets***

A Receiver for the Den—by Chas. R. Leutz . . . . .	41
Compact 5-Tube Set—by R. W. Baetz . . . . .	45
Short-Wave Superhet 5—by H. H. Arnold . . . . .	48
Wide-Band Broadcast Tuner—by J. C. Hoadley . . . . .	52

## ***v.h.f. sets***

144-Mc Receiver—by I. Queen . . . . .	56
V.H.F. Receiver—by R. L. Parmenter . . . . .	60

Copyright 1946 by H. Gernsback  
2nd printing—Apr. 1947  
3rd printing—Dec. 1947  
4th printing—Sept. 1948  
5th Printing—June 1950

# Twinplex 1-Tube Portable

A LOW-COST efficient, all-wave portable receiver is ideal for use in the car to listen to ham transmitters, for field use, or for the home. On all bands with a short antenna, even an auto pole type antenna, it provides loud headphone reception. It weighs about five pounds. For the radio experimenter it is a very practical outfit.

In building this portable, the first consideration was what circuit to use.

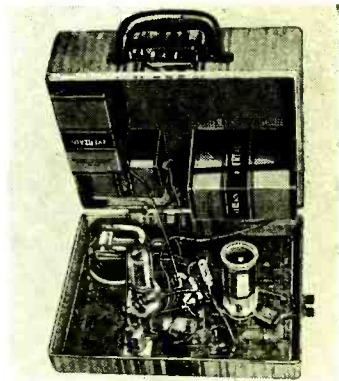
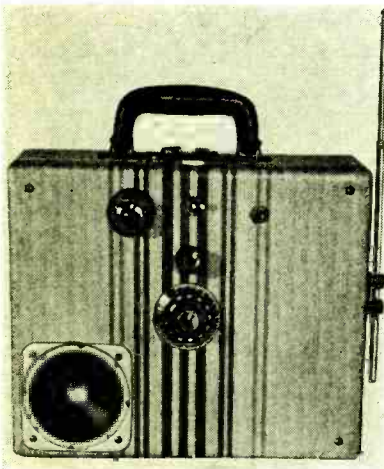

Above—Interior of all-wave portable.

Left—Portable battery set works loudspeaker.

Naturally, in trying to keep the cost low, we had to use a circuit using few tubes and batteries. After much reading and thought and finally a lot of testing, we chose the popular *Twinplex* circuit, using the 1G6G double triode tube. In our final receiver we made just a few changes; we added a 20  $\mu\mu\text{f}$  bandsread condenser, connected in parallel with the main tuning condenser; we used commercial 4-prong short-wave and broadcast coils instead of home-made coils; and we used 90 volts on the plates of the 1G6G.

Having chosen the receiver circuit, the next step was to find a suitable

case. We were not trying to break all records for compactness, nor did we wish to crowd the parts and thus impair reception. What we wanted was a carrying case that was not too large and was attractive looking. Finally, after a good deal of window shopping, we picked out a woman's vanity case, size  $11\frac{1}{2}'' \times 9\frac{1}{2}'' \times 4\frac{1}{2}''$ , which can be bought in novelty or department stores. This case we knew would hold the set and three batteries easily.

Our next step was to fit the batteries and receiver neatly into this case. We did this by cutting a cardboard piece the same size as the lid of the case. Then we mounted the receiver parts on that cardboard piece, i.e., coil socket, condensers, tube socket, jack and switch. Then, by placing this temporary panel inside the lid, we could see where to place the batteries and how everything would fit. After some manipulation we placed all parts in the position shown in the photographs. Looking at the case closed and with the handle up, the parts on the outside of the panel are as follows: In the center, the main tuning dial, above that the band-spread dial, above that the switch which turns the 90 volts on and off. To the left and above is the regeneration control dial. And to the

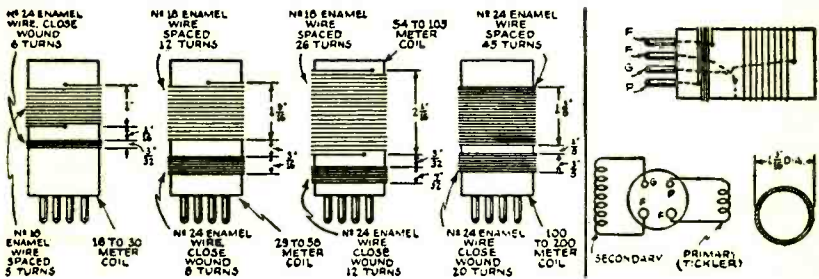

Fig. 1—Coil winding data for Twinplex.

right and above is the phone jack. The loudspeaker, of course, is in the lower left-hand corner. The hole for the speaker was cut out of the tin plate with shears and out of the case with a razor blade. Having seen how everything would fit we used the cardboard piece as a pattern and placed it over a panel made of tin plate cut to fit inside the lid of the case. Then, having drilled the panel and mounted the parts on it, we bolted it to the lid of the case with four corner bolts. Once bolted in position, it was easy to drill the rest of the way through the lid of the case itself. We were surprised to find that the lid drilled very well with practically no frayed edges.

The next job, after the receiver was mounted to the lid, was to bolt in the three batteries so that they would stay put, so the receiver could be placed or played in any position. After some shopping around, we decided to use two small 45 volt B batteries, and one 1.4 (1.5 v actually) volt A battery. These batteries are small, long-lived, and pack a good wallop. In order to strap them into place in the position



shown in the photographs, we used metal straps that are used in packing boxes. As we did not want the bolts to show, we held the straps in place with wood screws. The wires from the batteries are long and flexible so that the portable may be opened and closed without disconnecting any wires. The wires are soldered to the prongs of battery clips which are then placed permanently in the battery holes. By using just

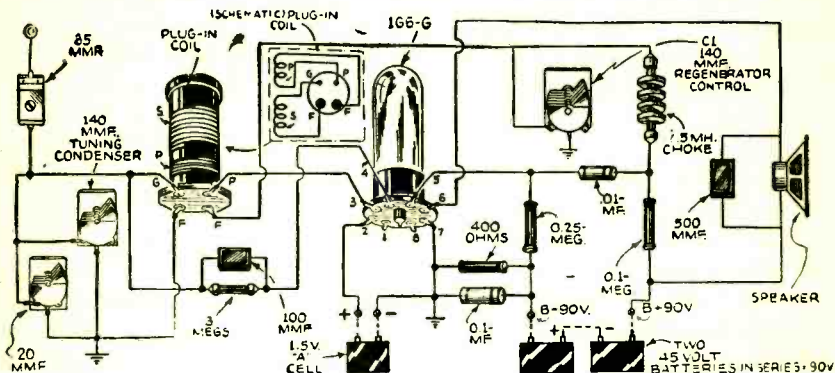

Fig. 2—Diagram of one-tube receiver.

the prongs of the clips, a good connection is made without taking up any space. (The batteries fit very closely together.)

The antenna and ground posts are mounted on the edge of the lid of the case, so that they will be out of the way and allow a very direct line from the antenna to the coil and tuning condenser. The speaker is a 3 inch magnetic type, which is very satisfactory. If space is at a premium, a 2 inch speaker may be used.

You cannot go wrong on this circuit or the portable construction and for the experimenter it will prove not only interesting and fun to build, but an excellent portable outfit.

### List of Parts

- |   |                                       |
|---|---------------------------------------|
| 2—Variable condensers, 140 $\mu\text{f}$            | 1—Condenser, 100 $\mu\text{f}$        |
| 1—Antenna condenser, 35 $\mu\text{f}$               | 1—Pair 2,000 ohm headphones (if used) |
| 1—20 $\mu\text{f}$ variable condenser (band-spread) | 1—1G6-G tube                          |
| 1—Octal Isolantite socket                           | 1—No. 6, 1.5 volt drycell (A battery) |
| 1—4-prong Isolantite socket                         | 2—45 volt B batteries                 |
| 1—Set all-band plug-in coils                        | 1—3-inch magnetic speaker             |
| 1—Grid-leak resistor, 2 meg                         | 1—Antenna stand-off insulator         |
| 1—Resistor, 400 ohms, $\frac{1}{2}$ watt            | 1—R.f choke, 5 mh                     |
| 1—Resistor, 0.1 meg, $\frac{1}{2}$ watt             | 1—Ground binding post                 |
| 1—Resistor, 0.25 meg, $\frac{1}{2}$ watt            | 1—Twin headphone binding post         |
| 1—Condenser, 0.01 $\mu\text{f}$ , 200 v             | 1—3-inch tuning dial                  |
| 1—Condenser, 0.1 $\mu\text{f}$ , 200 v              | 1—Tuning knob                         |
|   | Chassis, miscellaneous hardware, etc. |

# 2-Tube Short-Wave DX-ER

**T**HIS LITTLE 2-tuber was designed to be a *personal* set. A 1T4 r.f. pentode is used as a regenerative screen grid detector and a 1S4 as a power output pentode. This arrangement affords quite a healthy wallop in the earphones. Extreme compactness of the receiver is made possible by the small dimensions of these tubes. They are less than  $\frac{3}{4}$

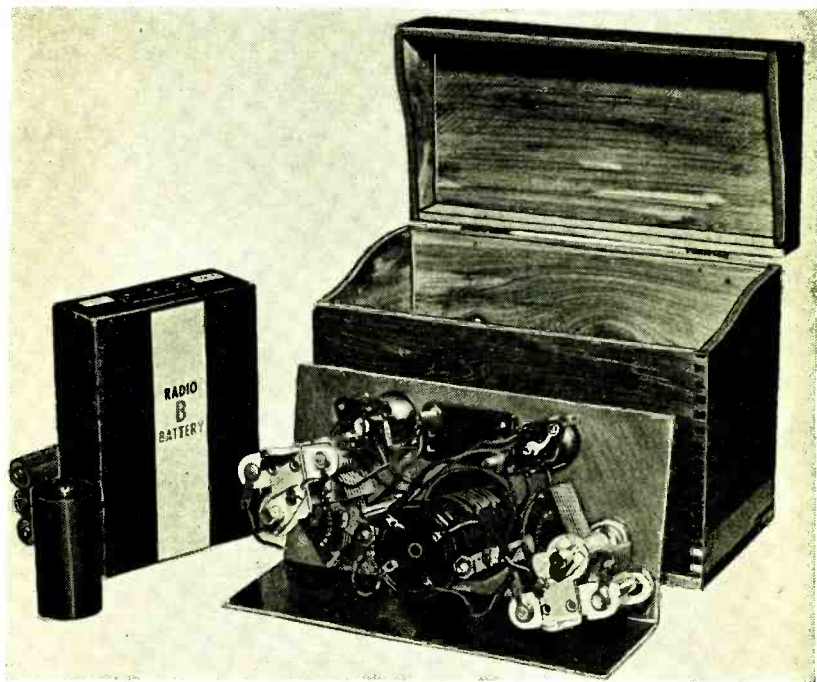

Overseas short-wave stations can be heard on this set.

inch diameter with an overall bulb length of only  $1\frac{3}{4}$  inches. The entire chassis including all components are so compactly arranged that they fit snugly into a standard 4" x 6" card filing case. The batteries consisting of one 45 v B block and a single 1.5 v flashlight cell fit into the bottom of the case.

As the schematic diagram Fig. 1 shows, regeneration is obtained by means of the usual tickler coil in the plate circuit of the 1T4 and is controlled by a 140  $\mu\mu\text{f}$  variable condenser which is identical with the tuning

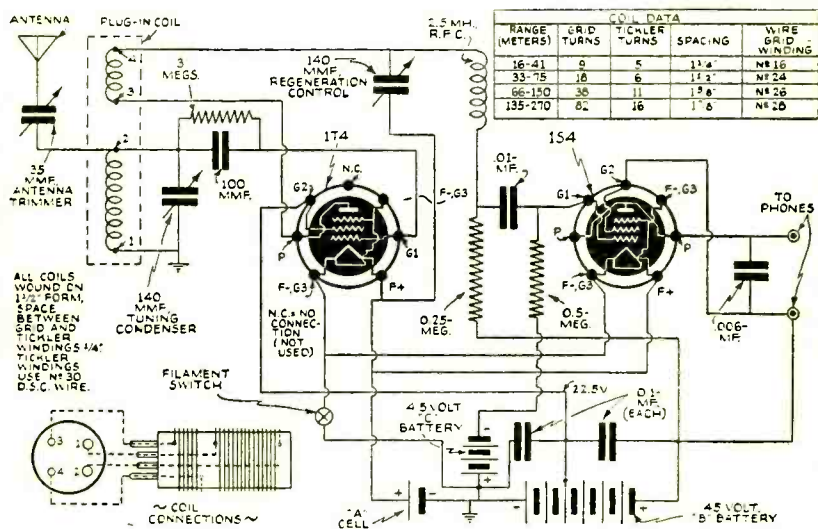

Fig. 1—Circuit for 2-tube all-wave receiver.

condenser. No screen grid resistor is used inasmuch as the B battery has a  $22\frac{1}{2}$  v tap. The antenna is coupled to the grid circuit of the detector through the usual trimmer condenser, 35  $\mu\mu\text{f}$ . Four plug-in coils are used to cover the range of 16 to 270 meters without skipping. An additional coil may be used to cover the rest of the broadcast band. Three 1.5 volt pen flashlight batteries, in series connection, supply 4.5 volts for grid bias of the power pentode.

The entire chassis is made of one piece of aluminum 6" x 5" and  $1/16$ " thick. This sheet is bent at angle of 90 degrees to form a top panel 6" x 3" and a 2" x 6" shoulder. All components are mounted on the panel except the tube and coil sockets. These are suspended from the top panel in such a manner that only  $3/4$ " of each tube protrudes through the panel. This goes for the plug-in coil too. The tuning condenser is mounted on the right-hand side of the panel and the regeneration is mounted on the left-hand side forming a symmetrical arrangement. The antenna condenser is mounted between the two tubes and is controlled by a knob instead of the usual slotted nut. The antenna and ground leads enter the box through

a small hole in the back. The filament on-off switch is also located on the back of the cabinet.

It is suggested that the constructor follow this layout as closely as possible inasmuch as the components have been mounted in such a manner as to be not only symmetrical but also to afford shortest possible connections between them. No dial plates are used. Two scales are marked in India ink on the aluminum front panel for the tuning and the regeneration controls. These are arbitrarily calibrated from 0-100 in a 180 degree arc.

When all wiring has been completed and checked, connect the A and B batteries to their respective leads. Plug the 16 to 32 meter plug-in coil into its socket, attach antenna and ground leads and plug in the headphones. Now, flip on the filament switch. Turn the regeneration control condenser either clockwise or counter-clockwise until the familiar rushing sound of regeneration is heard. Then tighten or loosen the antenna trimmer condenser knob until oscillation over the entire 16 to 32 meter range is obtained. This procedure will have to be followed every time a new plug-in coil is inserted. However once the best position for the antenna trimmer is obtained it need not be altered unless the plug-in coil is changed. If the above instructions are carefully followed you have a set which you will use frequently and with great pleasure.



Complete receiver with headphones.

### List of Parts

- 2—140  $\mu\mu\text{f}$  variable condensers
- 1—2.5 mh r.f. choke
- 1—35  $\mu\mu\text{f}$  antenna trimmer condenser
- 1—0.006  $\mu\text{f}$  fixed paper condenser
- 1—0.001  $\mu\text{f}$  mica condenser
- 1—0.01  $\mu\text{f}$  coupling condenser
- 2—0.1  $\mu\text{f}$  fixed paper condenser
- 1—3 meg grid-leak resistor,  $\frac{1}{4}$  w
- 1—0.25 meg,  $\frac{1}{4}$  w resistor
- 1—0.5 meg,  $\frac{1}{4}$  w resistor
- 1—Type 1T4 tube (r.f. pentode)
- 1—Type 1S4 tube (power pentode)
- 2—Wafer-type 7-pin sockets for tubes
- 1—45 v B battery with  $2\frac{1}{2}$  v tap, portable type
- 1—Flashlight cell, standard type
- 1—4-prong coil socket
- 1—Set of plug-in coils, home-made as per coil data
- 1—Sheet of  $\frac{1}{16}$ " aluminum, 5" x 6"
- 1—4" x 6" card file case, obtainable from 10c store
- 1—Filament "on-off" toggle switch
- 3—Pen flashlight cells from 10c store
- Miscellaneous hardware, wire, tip jacks, etc.



# 3-TUBE OCEAN HOPPER

**T**HIS LITTLE three-tube "midget" battery-operated short-wave receiver was designed especially for use with miniature 1.4 volt battery tubes.

The tubes in the midget receiver are 1T4 untuned r.f. amplifier, 1T4 regenerative detector and a 1S4 a.f. amplifier. Although the tubes are not recommended for operation at plate or screen voltages other than 45 volts, which would seem to prohibit the use of resistance coupling; by using  $67\frac{1}{2}$  volts on the detector plate, a plate resistor of 100,000 ohms may be used with satisfactory results. It is sometimes easier to use a slightly larger B battery than to incorporate impedance coupling into the set. However, if the lower voltage must be used, an audio frequency

Rear view of 3-tube  
battery receiver.

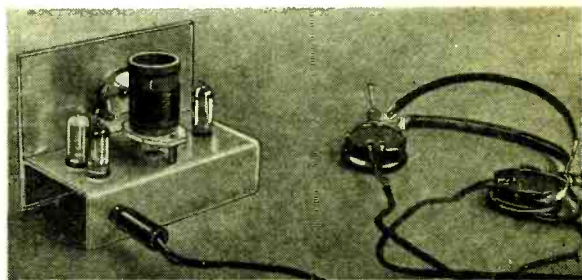

choke of at least 100 henries should be used instead of the resistor R. The plate voltage of the detector should, if possible, be kept close to the value of the actual potential of the screen.

Stick to the layout as shown as this will permit very short wiring in all parts of the circuit. The various paper and mica fixed condensers and fixed resistors are mounted directly on their respective parts terminals.

The coils may be of the manufactured type, if desired, or may be wound by the experimenter himself. A coil data chart giving the exact number of turns required for all-band operation will be found at the

end of this article. The *band-setting* condenser, C4, is of the midget air-tuned type and is placed *inside* of the coil form itself. A separate condenser is used in each coil, the setting being adjusted to spread the various bands completely over the tuning dial scale, and thereafter left alone. The bandspreading obtained varies from 180 degrees on the 80

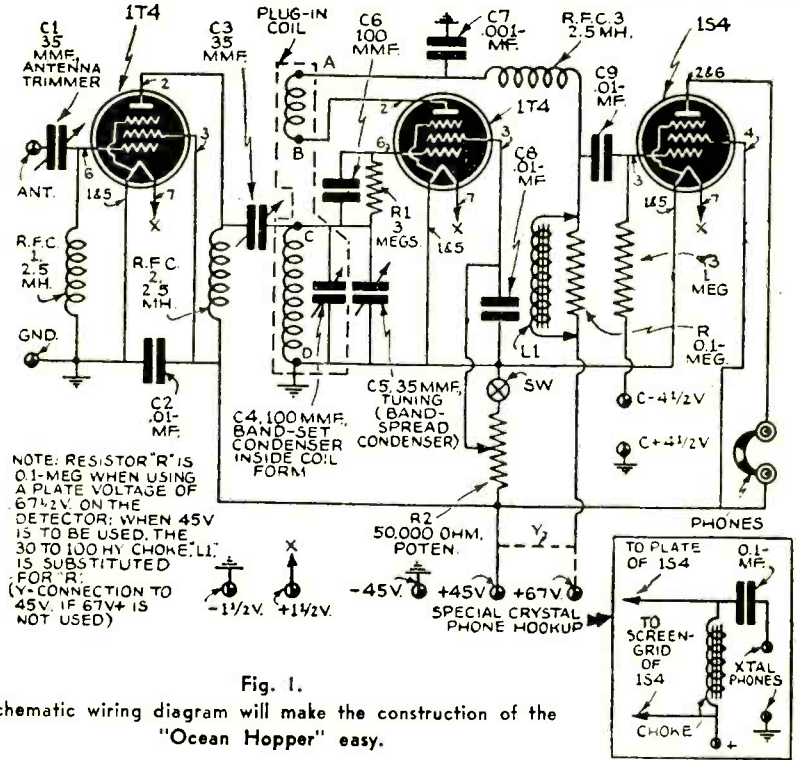

meter amateur band to about 75 degrees on 20 meters. The receiver will operate on 10 meters but the sensitivity is not great enough to receive the weaker stations, especially if there is considerable local noise. A number of *strong local* 10 meter stations have been received very well, however.

It will be necessary to use the ordinary magnetic headphones, unless some provision for coupling crystal phones to the 1S4 plate circuit is made. A small midget coupling choke of about 30 henries and 20 milliamperes rating and a .1  $\mu$ f condenser may be used as shown in the dotted lines of Fig. 1. A small resistor in place of the 30 h choke cannot be used with satisfactory results, as it drags the plate voltage down below that of the screen, causing poor quality and low amplification.

Almost any antenna or none at all may be used with this receiver. *The designer has listened to European and South American stations on several occasions using only a small three- or four-foot piece of insulated wire*

thrown on the floor or hanging over the edge of a table or chair. Like all short wave sets, however, better results will be obtained with a good outside antenna. The stronger stations usually can be received with good headphone volume *without any antenna whatever!*

### Coil Data

Band	Grid Turns	Wire Size	Spaced	Tickler Turns	Wire Size
200-500 met.	126	28 enam.	close	28	34 d.s.c.
135-270 met.	82	28 "	17/8"	16	30 "
66-150 met	38	26 "	15/8"	11	30 "
33-75 met.	18	24 "	1 1/2"	6	30 "
17-41 met.	9	16 "	1 1/4"	5	30 "
9-20 met.	3 1/2	14 "	1"	3	30 "

All forms are 1 1/2" in diameter and may be either 4- or 6-prong type. Spacing is the distance between the grid and filament ends of the coil, not the space between turns. Wind ticklers in the same direction as grid coils and on the grid ends of the form. Data is for 35  $\mu\text{f}$  tuning condenser, with a 100  $\mu\text{f}$  midget padder or band-setting condenser *inside* the coils. Spacing between tickler and grid coils is 1/4".

### List of Parts

- 5—Four or five-prong low-loss coil forms, 1 1/2" diameter
- 1—Five-prong isolantite socket (for coils)
- 1—Tuning dial
- 2—35  $\mu\text{f}$  isolantite base midget trimmer.
- 3—Midget r.f. chokes, 2.5 millihenries
- 1—35  $\mu\text{f}$  midget tuning condenser
- 5—100  $\mu\text{f}$  midget padding condensers, air-tuned for use inside coil forms
- 2—Type 1T4 battery tubes
- 1—Type 1S4 battery tube
- 3—.01  $\mu\text{f}$  paper dielectric condensers, tubular, 400 volts
- 1—.001  $\mu\text{f}$  midget mica condenser.
- 1—100  $\mu\text{f}$  midget mica condenser
- 3—Miniature 7-prong sockets
- 1—Resistor, 3 megohms, 1/2 w
- 1—Metallized resistor, 1 megohm, 1/2 w
- 1—Metallized resistor, 100,000 ohms, 1 w
- 1—Volume control, 50,000 ohms, with d.p.s.t. switch
- 1—Aluminum panel and chassis (Fig 2)
- 1—Knob

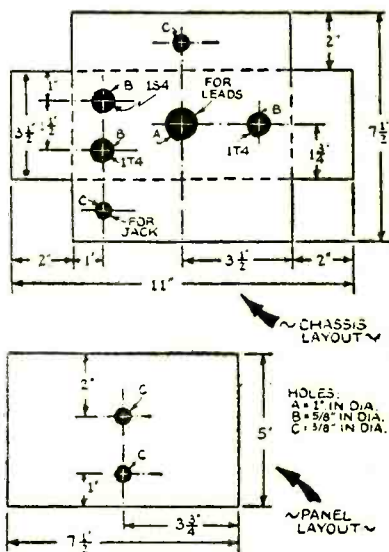
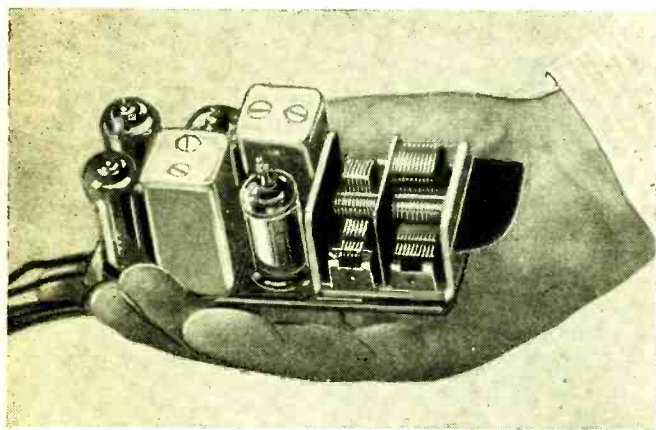

Fig. 2.  
Chassis and panel details.

# RADIO HEARING AID

**T**HE VACUUM-TUBE hearing-aid is essentially an audio-frequency amplifier where a compromise has been reached between the performance, the physical size and the weight of the component parts. Frequency distortion is purposely introduced to compensate for the uneven pitch sensitivity of the ear of the wearer.

Commercial hearing aids use two-stage, or more generally three-stage amplifiers. This inspired the idea of utilizing the same tubes and component parts for radio reception. After some experiment, the circuit shown was adopted, and gives good results in both capacities.



A midget pocket radio and hearing aid — just a handful.

The positioning of a switch transforms the set from a hearing-aid to a radio receiver embodying the audio-frequency characteristics of the hearing aid. A third switch position where the instrument performs simultaneously as hearing-aid and radio-receiver is also mandatory. This enables the wearer to hear conversation while listening to the radio.



For the best performance, the circuit has to be individually "fitted" in so far as audio-frequency is required; damping that portion of the range where the defective ear is most sensitive. The superheterodyne circuit, Fig. 1, has been chosen, incorporating necessary modifications to amplify simultaneously at i.f. and a.f. "Slug" or permeability tuning instead of variable condenser may be preferred because of compactness and reduction of weight. The apparatus is not exceptionally compact or lightweight because it was assembled with parts available on the radio market at the time. To reduce the dimensions every component part should be redesigned.

The body of the wearer acts as a capacity-coupled antenna. A loop of wire stretched inside the belt of the carrying case forms one element of the input condenser.

Several constructional difficulties were encountered with the wiring. Feedback from the audio-frequency grid leads is the most troublesome. The a.v.c. is also a source of trouble and although represented in the schematic for sake of completeness, was eliminated in the model shown in

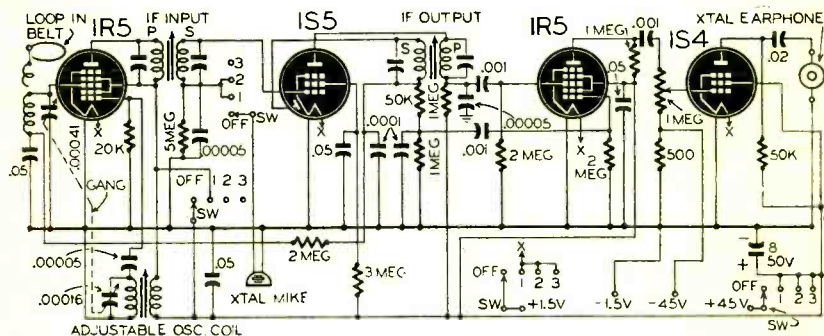

Fig. 1—Four tubes are used in this set. I. f. is 455kc.

the photos. The a.v.c. voltage may be applied to the converter only since the 1S5 amplifies both at i.f. and a.f. Besides the 1S5 is not a variable mu tube.

The positions of the switch are: Off; 1—Hearing-aid; 2—Radio-Hearing-Aid; 3—Radio. Since it was impossible to procure a very tiny switch, plug-in contacts were used.

The important switch decks are the ones located between the first 1R5 and the 1S5. When they are in position 1, the plate section of the oscillator coil is short-circuited and therefore the first 1R5 does not convert any frequency or produce any i.f. The 1S5 therefore amplifies at a.f. only. The amplified a.f. appears across the 1-meg resistor located after the primary of the i.f. coil and is applied through an .001  $\mu$ f condenser to the third grid of the second 1R5. The second 1R5 is used as an audio-frequency mixer.

The fact that the secondary of the first coil is in the input circuit of

the 1S5 and that the primary of the second i.f. coil is in the output of the same tube does not impair the performance at a.f. The reactance and mutual inductance of the i.f. coils is infinitesimal at low frequencies. *In position 1* the apparatus works as a hearing aid where the 1S5, the second 1R5 and 1S4 all amplify at a.f.

*In position 2*, the oscillator coil works. The i.f. is applied to the input of the 1S5. In the output, the second i.f. coil applies the i.f. to the diode section of the same tube. The output is fed to the first grid of the second 1R5. The two 50- $\mu$ f condensers in the input and output of the 1S5 close the i.f. path to ground. The microphone is still connected and its output is amplified as when switch is in position 1. In this case the 1S5 amplifies at i.f. (radio) and a.f. (microphone). The i.f. signals are also demodulated by the diode section of the 1S5. In this position the apparatus works as radio *and* hearing aid.

*In position 3*, the microphone is disconnected. The 1S5 amplifies only i.f. (and demodulates). This is the "radio only" position.

The second 1R5 is an audio-frequency *mixer*. The a.f. rectified by the diode is applied to grid 1, a.f. amplified by the 1S5 to grid 3. In the

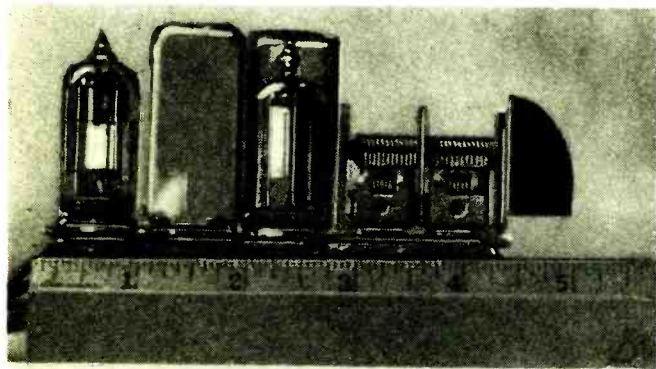

Chassis of the receiver — less than  $4\frac{1}{2}$  inches long.

plate circuit of the second 1R5 we find both signals in amplified form when grids 1 and 3 are both operating. We find only one signal when either grid 1 or grid 3 is working alone.

No definite assembly sketch can be given since the location of the component parts depends too much on their physical shape.

The sensitivity of the radio receiver is better than 400 microvolts r.f. input (Broadcast band) for 50 milliwatts a.f. output.

# BATTERY-4 PORTABLE

**Y**OU'VE HEARD so much about battery portables. Here then is your opportunity to *build* one.

You will note in the schematic diagram that the circuit is that of a 4-tube superheterodyne utilizing a type 1A7G tube as the oscillator pentagrid converter; a 1N5G as the i.f. amplifier; a 1H5G as second detector, automatic volume control and first a.f. stage; and, finally, a 1C5G as the power output tube. These are all 1.5 volt tubes, each consuming only 50 milliamperes—a trifling amount.

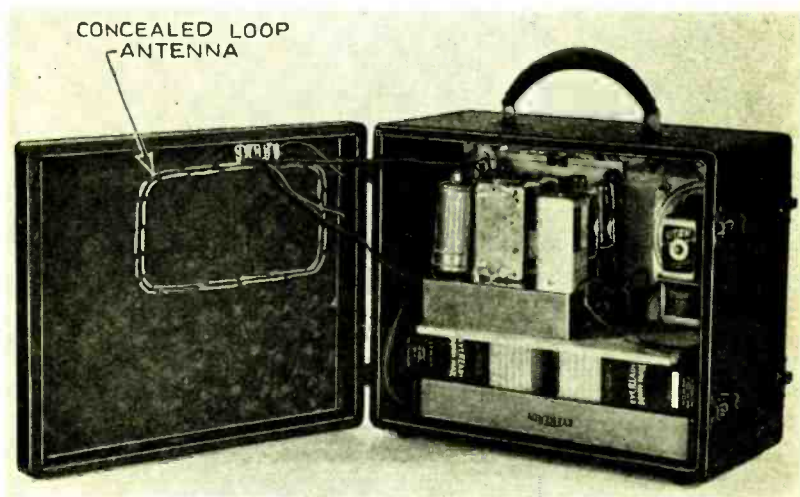

Rear view, with lid open, showing batteries.

For those readers preferring a "3-way" portable—that is, a receiver which will operate from self-contained batteries as well as from the 110-volt a.c. or d.c. power line—an optional schematic diagram is given.

The first step is to collect all the parts shown in the list at the end of the article. It is best to obtain the loop antenna, oscillator coil, and the tuning dial from the same manufacturer in order to be assured that they are perfectly matched to each other.

The question of chassis size remains for the individual to decide. If

you like to work on a large chassis without danger of burning your fingers when soldering or bruising them when replacing batteries, then use a larger chassis. If you are a "midget-ite", then get the smallest chassis possible commensurate with the parts of the receiver. The chassis used by the author measures 5½" long x 4½" wide x 1½" high. Mount the two i.f. transformers, tuning condenser and tuning dial on top of the chassis, as shown in the illustrations. All other parts mount underneath

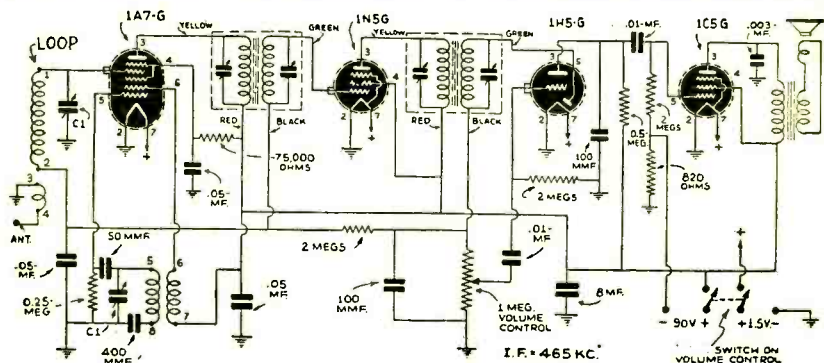

Fig. 1—Set wired for battery operation.

the chassis. The volume control shaft should line up with the tuning shaft—being directly below it.

Follow the schematic circuit very carefully in wiring. Pay particular attention to the wiring of the oscillator coil, since the reversal of any of these connections may result in non-oscillation. The loop antenna has an extra single turn wound around it (terminals Nos. 3 and 4) terminating in *antenna* and *ground* binding posts. These are for use with an outside antenna when using the receiver at any great distance for broadcast stations or when DX reception is desired.

When all wiring has been completed and thoroughly checked, proceed to align the i.f. transformers as follows. Feed a 465 kc signal from a

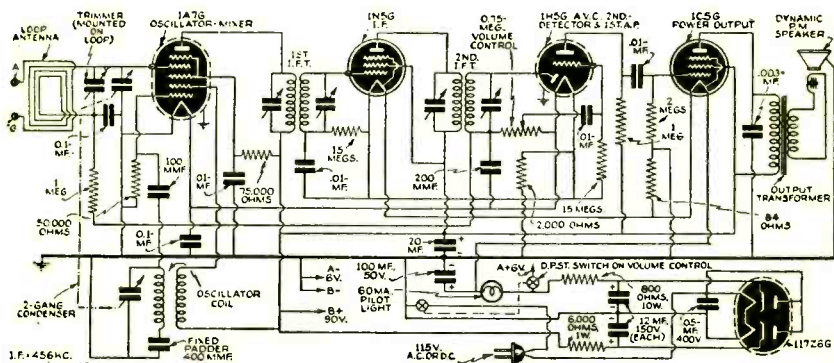

Fig. 2—Optional circuit for 110 volts A.C.-D.C.



test oscillator to the grid of the 1N5G through a .002  $\mu$ f condenser and adjust both trimmers of the second i.f. transformer for maximum response in the loud speaker. Follow the same procedure for the trimmers of the first i.f. transformer, feeding the signal into the grid of the r.f. section of the 1A7G tube. For final alignment of the i.f. channel, short the rotor and stator plates of the oscillator section of the 2-gang condenser with a jumper wire, and feed a 465 kc signal from the test oscillator into the loop antenna inductively; that is, connect two turns of any size wire to the output terminals of the oscillator and bring them within close proximity of the receiver loop. Carefully readjust all i.f. trimmers for maximum response.

To adjust the oscillator parallel trimmer, set the dial pointer to 1400 kc. Remove the jumper wire from the oscillator tuning condenser, and switch the signal generator output to 1400 kc. (The generator remains inductively coupled to the receiver loop during this operation). Adjust the oscillator trimmer (on top of the oscillator section of the 2-gang condenser) for maximum response. The set does not employ a variable series padder trimmer, hence the set cannot be aligned at 600 kc. However, since all tuning components are *matched*, this operation is not necessary. The set should now "perk" beautifully if all wiring has been correctly done and all the alignment procedure carefully followed.

### List of Parts

- 1—8  $\mu$ f electrolytic, 250 volts condenser
- 1—4" PM dynamic speaker and output transformer with 9,000 ohm impedance primary
- 2—45v B—batteries
- 1—1½v A-battery
- 1—Any suitable carrying case (approx. 7½" x 12" x 10" inside measurements)
- 1—2-gang 365  $\mu$ f variable tuning condenser (C1)
- 2—465 kc i.f. transformers
- 1—Oscillator coil to match C1 (for 465 kc i.f.)
- 1—.0004  $\mu$ f mica padding condenser
- 1—B'cast band Loop Antenna
- 1—Drilled chassis
- 4—Octal wafer sockets
- 1—Tuning dial
- 1—75,000 ohms ½ w resistor
- 1—250,000 ohms ½ w resistor
- 3—2 meg ½ w resistor
- 1—½ meg, ½ w resistor
- 1—820 ohms ½ w resistor
- 1—Volume control, 1 meg, with d.p.s.t. switch
- 1—1A7-G tube



Panel of 4-tube broadcast band portable.

- 1—1N5-G tube
- 1—1115-G tube
- 1—1C5-G tube
- 2—.05  $\mu$ f tubular condenser
- 1—.0005  $\mu$ f mica condenser
- 1—.0001  $\mu$ f tubular condenser
- 1—.0001  $\mu$ f mica condenser
- 2—.01  $\mu$ f tubular condenser
- 1—.003  $\mu$ f tubular condenser

# Miniport 5-Tube Superhet

**T**HIS SET IS a really good 5-tube superheterodyne, complete with batteries, speaker and antenna, in a box with inside dimensions  $3\frac{3}{4}$  by 4 by 6 inches.

The superheterodyne circuit was chosen because of its well known superior sensitivity. The tube line up is as follows: 1R5 pentagrid converter; 1T4 intermediate frequency amplifier; 1S5 detector, a.v.c., 1st a.f.; two 1S4's in parallel output audio power stage. The set uses two dual purpose tubes to cut down size. The 1R5 acts as oscillator and first detector in the superheterodyne: a dual function. The 1S5 acts as 2nd detector with automatic volume control and also as the first stage of audio frequency amplification, another tube with dual function. The tubes selected are small in size and have a low filament drain. The 1R5, 1T4 and 1S5 each draw .05 amp.; the 1S4's draw 0.1 amp. each.

## **Circuit design features**

One of the failings of the commercial "mini" sets has been the low audio power output. The result has been low volume operation. By using two 1S4's in parallel the power output has been practically doubled. The proper output transformer has been specified in the parts list to "match" the output impedance of these two 1S4's.

In order to obviate danger of "blowing" the filaments if B+ is inadvertently shorted to filament, an 800 ohm resistor has been connected in series with the B supply to limit possible current flow to a value too low to blow out filaments.

It will be noted that the loop antenna acts as both signal pickup and as the antenna coil. It is tuned by the first condenser in the two-gang variable tuning condenser. The trimmer on this condenser is adjusted for maximum volume of reception.

The B supply is one of the miniature 67.5 volt batteries which weighs about one pound. The choice of this powerful miniature battery is an important contributing factor to the small size and loud volume of the receiver.

A sub-midget volume control is used. This control, however, does not come with a switch and a separate switch is used to turn on the filaments.

It was decided to make the loop antenna to fit the size box to be used as it is difficult to purchase one of suitable dimensions. 40 turns

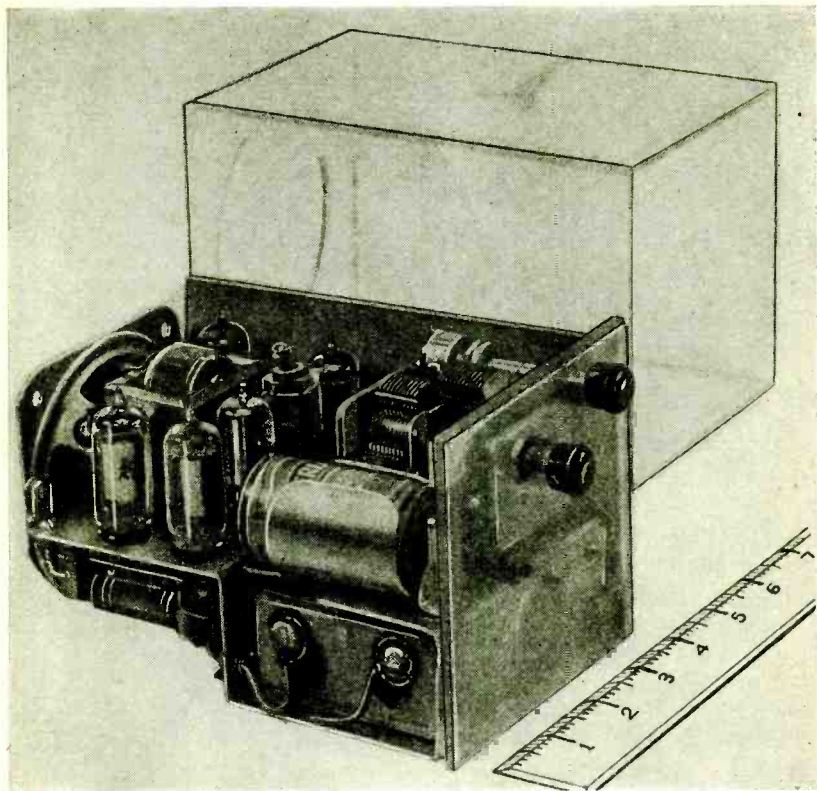

The "Miniport"—a 5-tube battery portable.

of No. 20 cotton and enamel insulated wire was found suitable. The winding dimensions are given in the drawings.

The chassis is made of 1/16 inch aluminum and is bent in such form as to "clamp" the B battery in place. The A battery is held by a clip of the same material which is mounted on the main chassis. The speaker and chassis form a complete unit which will stand up by itself. Refer to drawings for details and dimensions. The chassis has a cut-out which accommodates the speaker. The tube sockets are mounted around this cut-out as close together as their mounting rings permit. The i.f. transformers are also mounted around the cut-out.

The volume control is mounted on the baffle plate at the middle of the condenser; this economizes space. The tuning condenser itself is

mounted on the part of the chassis which is acting as a B battery clip. The speaker and controls are mounted on opposite ends of the chassis, which permits it to be easily slipped into the cabinet, the *control end* of which is removable. This also makes possible much more compact construction with the parts available. The mounting flanges of the transformer and one of the mounting flanges of the speaker having been previously clipped off, the output transformer is soldered directly onto one of the mounting flanges provided on the speaker. Thus one side of the transformer case is soldered to the remaining speaker transformer-mounting flange.

Right-angle wiring was used throughout, with all parts at right-angles under the chassis to give neat appearance. This is especially important since a transparent polystyrene cabinet is used.

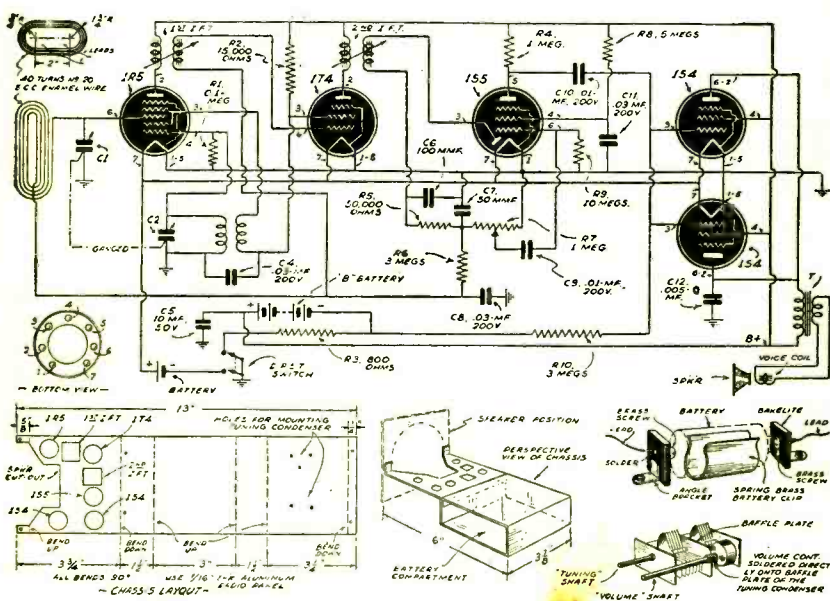

Diagram of the superhet

After all the parts have been assembled and all the wiring completed, it is well to check it very carefully yourself before applying power. This may save you a set of batteries or tubes.

The set will probably play right away when it is turned on and tuned. (Remember that the inside of a steel building is pretty well shielded and a very poor place to test a loop-operated receiver, "mini" or not.) Reception will be improved by aligning the set. While a signal generator is preferable it may be aligned on a weak station. Tune in the *weakest* station you can pick up; adjust the antenna condenser trimmer for maximum volume, with the volume control all the way up. If you are



not concerned about the station positions on the dial (and you can after all calibrate your own dial) you can proceed to adjust the i.f. trimmers. Use a *weak* station and have the volume turned up all the way.

If you want good calibration on the tuning dial you had best use a signal generator and peak the i.f.'s at 456 kc with the signal generator connected from prong 6 of the 1R5 (control grid) and chassis. Ground prong 4 (oscillator grid) temporarily. Next adjust the oscillator trimmer to maximum response with circuit restored to normal and tuning condenser set at 1500 kc and feeding 1500 kc in from the signal generator. (Coupling it to the loop by means of a loop of wire connected to the terminals of the generator and brought near). Adjust the oscillator trimmer. Also adjust the antenna trimmer. Since a cut plate condenser is used, no adjustment is needed at the *low frequency end* of the dial. When adjusted in this manner (which is only a very brief description of standard superheterodyne alignment procedure) the various stations will always come in at the same place on the dial, even if at a later time you find it desirable to realign. It will therefore be a convenience in that you need make a calibrated dial only once. If the constructor is not familiar with alignment procedure, he is referred to any of the radio handbooks for detailed information.

### List of Parts

- |                                |   |
|--------------------------------|---|
| 1—10 meg resistor, R9          | 1—Miniature 2-gang b-c tuning condenser, with cut plate osc. section for 456 kc i.f. C1, C2 |
| 1—5 meg resistor, R8           | 1—Miniature oscillator coil to match C2   |
| 2—3 meg resistors, R6, R10     | 2—Miniature 456 kc i.f. transformers  |
| 1—1 meg resistor, R4           |   |
| 1—100,000 ohm resistor, R1     |   |
| 1—50,000 ohm resistor, R5      |   |
| 1—15,000 ohm resistor, R2      |   |
| 1—800 ohm resistor, R3         |   |
| 1—1meg potentiometer, R7       |   |
| 1—Type 1R5 tube                |   |
| 1—Type 1T4 tube                |   |
| 1—Type 1S5 tube                |   |
| 2—Type 1S4 tubes               |   |
| 2—Knobs                        |   |
| 5—Miniature tube sockets       |   |
| 1—Sheet plastic (for cabinet)  |   |
| 1—Bottle cement (for cabinet)  |   |
| 1—Bottle thinner (for cabinet) |   |

### CONDENSERS

- 1—.00005  $\mu$ f, C7
- 1—.0001  $\mu$ f, C6
- 1—.005  $\mu$ f, C12
- 3—.03  $\mu$ f, C4, C8, C11
- 2—.01  $\mu$ f, C9, C10
- 1—10  $\mu$ f, 50 v, C5
- 1—3" loudspeaker with 2500-ohm output transformer
- 1—1.5 v A cell
- 1—67.5 v B battery

# 32-Volt D. C. Receiver

**A**LL VOLTAGES—heater, plate and screen—of the receiver shown in Fig. 1 are obtained directly from the 32-volt d.c. line.

Surprising as it may seem, the 6-volt series of tubes work much better than the 1.4- or 2-volt battery type, as determined by actual comparison. 25L6 output tubes were found most satisfactory after trying many types.

The radio-frequency stage was included to keep hiss from the mixer to a minimum. The hiss was strong enough to be annoying before this stage was added. It also reduces image interference to the vanishing point.



Appearance of the 32-volt receiver resembles commercial receivers.

Gain added by the r.f. stage is valuable, as the radio must be used for distance. More straight gain could of course have been obtained by adding an i.f. instead of an r.f. stage, but the other advantages more than offset any sacrifice of gain made by using it in preference to an i.f. stage.

Automatic bias control is applied to the r.f. and i.f. stages. This is the only bias used, the low plate voltages rendering cathode bias unnecessary and undesirable. Hi-Q iron-core coils are used in all the r.f. and i.f. circuits, to keep efficiency of the tuned stages at a maximum.

The oscillator-converter is a 6A8, as tests showed it to be the most satisfactory type for the low electrode voltages used. The oscillator is

extremely strong. Plate voltage can be dropped to 20 before it goes out of oscillation. Several types were tried before the 6A8 was finally adopted. (Battery tubes were the poorest, unless filament voltages were raised to an unsafe value.) To operate the 6A8 with best results at 32 volts, it is necessary to raise the grid condenser and resistor values over those conventionally used. No trouble with parasitics is encountered in this circuit.

The oscillator coil is of the adjustable-iron type commonly used for replacements. These take a little time to adjust, but are a great improvement on the non-adjustable type, as the oscillator can be made to track at three points on the dial instead of only two. Adjusted at 600 (padder) 1000 (coil) and 1400 (trimmer) kilocycles, tracking is excellent all over the band. No a.v.c. voltage is used on the 6A8.

One intermediate-frequency stage is sufficient when hi-Q i.f. transformers are used. On the first model two stages with ordinary coils were tried. It gave only slightly more gain than the one-stage model with

An under-chassis view — the wiring is simple.

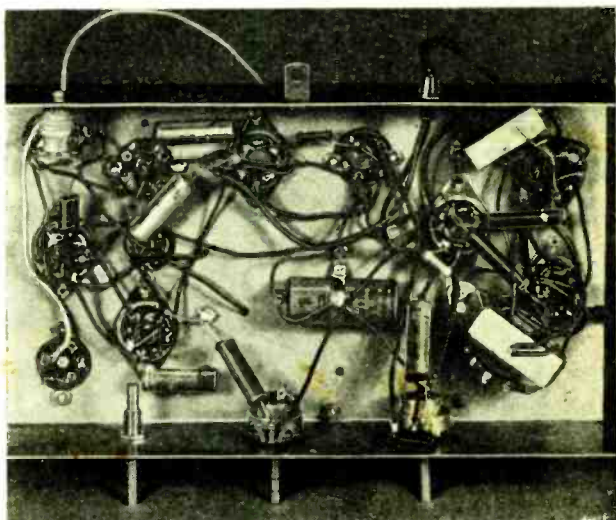

iron-core high-gain coils. As with the r.f. stage, no grid bias other than the a.v.c. is applied to the single 6K7 i.f. tube.

The diode section of the 6R7 acts as a conventional detector, and supplies a.v.c. The volume control—a 1-megohm unit—acts as the diode load resistor. An r.f. choke is used to filter out radio frequencies instead of the resistor more commonly used. The loss of audio voltage through this (normally 50,000 ohm) resistor is not objectionable in a regular a.c. receiver, but was eliminated here to keep gain at a maximum.

The 6R7, transformer coupled, was found best for the amplifier tube, as the combination of medium-mu and transformer coupling proved better than a high-mu tube with resistance coupling at the low voltage

available. The 6R7 is normally diode-biased, but in this circuit a 1.5 v bias cell was found necessary. One Mallory bias cell is used. It must not be shorted or it will lose its voltage. Moist fingers affect it, and it must not be checked, except with a vacuum-tube voltmeter.

The power output stage consists of two 25L6 tubes in pushpull. These are biased by a 50-ohm resistor in the cathode circuit. No cathode by-pass condenser is necessary as no signal voltage should be present. Tone quality of the output stage is satisfactory so long as the supply voltage does not fall below 29 volts. A noticeable dropping off in quality starts at that point, and becomes very serious if the voltage falls much further.

Some experimenting was done with fixed bias, but more undistorted output was obtained with the system shown.

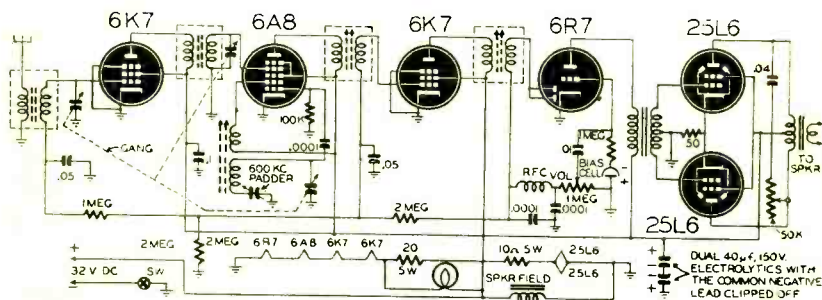

Fig. 1—Schematic diagram of the 32-volt receiver. I. f. is 455 kc.

The output transformer is of the universal type. Various taps were tried till the combination which sounded best to the ear was found. A tone control consisting of a 50,000-ohm potentiometer and an .04  $\mu$ f condenser is across the plates of the power stages.

The four 6.3-volt tubes are connected in series with a 20-ohm resistor—across which is placed a No. 47 pilot light—and put across the line. The 25L6's connected in parallel and in series with a 10-ohm, 5-watt resistor form another branch across the line, as shown in the diagram.

A PM speaker was tried instead of the electrodynamic type shown, the idea being to save current. The electrodynamic speaker gave better results than any of the PM's tried and as the drain was only 70 ma, it was adopted.

The filter consist simply of a dual 40- $\mu$ f electrolytic condenser. The common negative lead is cut off and the condenser connected as indicated in the schematic. The unit now has no polarity. This is important because the radio may be plugged into the d.c. line backward. This would ruin a polarized condenser, but has no effect on this circuit other than to render the receiver inoperative till the plug is reversed. The power factor of the dual condenser is rather high, and a 0.1- $\mu$ f paper condenser is shunted across it to by-pass the r.f. currents.



# EASY-BUILT 2

**F**OR THE beginner, a regenerative short-wave set is most likely his first goal. Inexpensiveness and good reception are required. This two-tube circuit has given good results and the cost is small.

**DETECTOR:** A commonly used tube for detection, which works on a.c. power, is the 6J7, a pentode detector. The supply voltage required for these tubes is taken from a 360 ohm line cord, with the current at .3 amp. The tube leads are twisted close to the chassis and the 6C8G's terminal No. 7 is grounded to the chassis or buss wire and it is found the hum is very small.

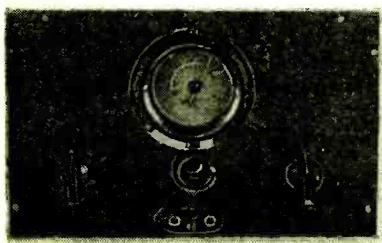

Above—Front panel of the 2-tube set.



Right—Rear view of the receiver.

Using a 50,000 ohm potentiometer as the regeneration control, connected in series with a 50,000 ohm  $\frac{1}{2}$  watt resistor, and a bypass condenser of .1  $\mu$ f, ground to the buss, gives smooth operation.

**AUDIO AMPLIFIER AND RECTIFIER:** A twin-triode is used for first audio and low-power rectifier. For this purpose a 6C8G tube with separate triodes, one the rectifier and the other the audio amplifier is installed. Terminals 5 and 6 are tied together on one side of the line and terminal 8, the cathode, filtered with dual 16  $\mu$ f condensers, and a 1,000 ohm, one watt resistor. The other triode unit with terminals 3, 4, and grid cap is used for audio amplification.

**CONSTRUCTION:** This short-wave receiver was built on a chassis 5 x 9 inches. A chassis of masonite will do the trick, but using buss wire for all ground connections.

**OPERATION:** The 50,000 ohm regeneration potentiometer (with switch) is turned until a plop is heard; then rotate the tuning condenser until a

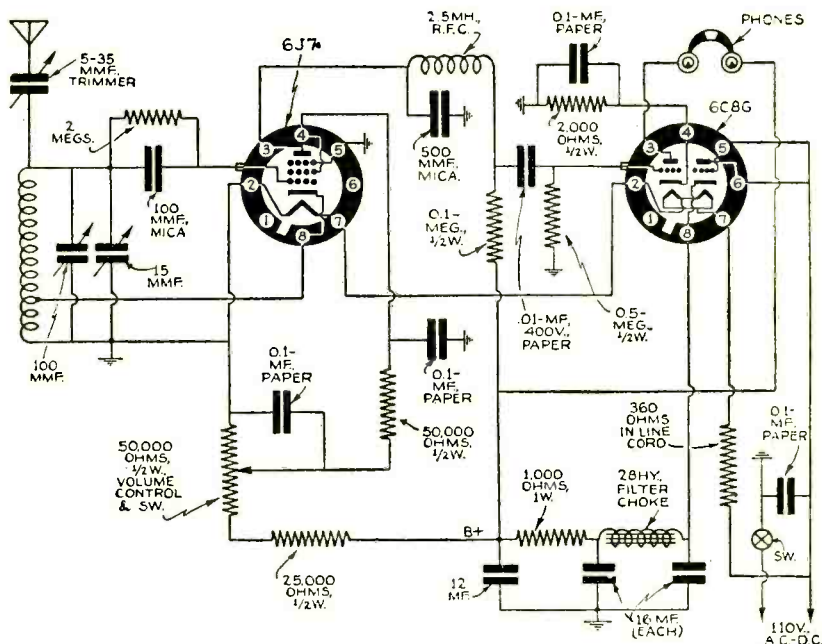

Fig. 1—Circuit of 2-tube beginner's receiver.

squeal is heard. Slowly back up the regeneration control until signal is clear.

By experimenting with the cathode tap, one may find a better signal. Upon changing coils, the 15  $\mu\text{f}$ , and 5-35  $\mu\text{f}$  trimmer condensers should be adjusted.

Be sure to use an outdoor antenna at least 30 feet long and elevated as high as possible. A good antenna will aid in bringing in weak stations which cannot be heard otherwise.

### Coil Data

(All coils wound on 1 1/2" dia. forms)

- |   |   |
|---|---|
| 130-270 met—60t, No. 25 enamel, tap 2 turns from ground end*    | 33-64 met—20t, No. 22 d.s.c., S.W. to 1 1/2t from tap, tap 1 1/2t from ground |
| 65-130 met—40t, No. 25 enamel, tap 1 1/2 turns from ground end* | 17-33 met—10t, No. 22 d.s.c., S.W. to 1 1/2t tap, tap 1t from ground          |

\*Close-wound.

NOTE: S.W.—Space-wound.

Under-chassis view of the receiver, showing wiring and location of parts.

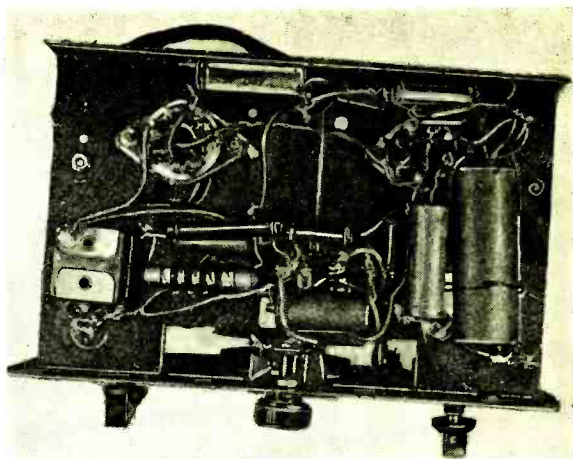

### List of Parts

#### CONDENSERS

Variable—

100  $\mu\text{f}$

15  $\mu\text{f}$

5—35  $\mu\text{f}$  (trimmer)

Fixed—

.0001  $\mu\text{f}$  mica

.0005  $\mu\text{f}$  mica

3—.1  $\mu\text{f}$  paper

.01  $\mu\text{f}$ , paper, 400 volt

1—Dual 16  $\mu\text{f}$ , elec,

1—12  $\mu\text{f}$ , elec., single

#### RESISTORS

1000 ohm, 1 watt

50,000 ohm,  $\frac{1}{2}$  watt

25,000 ohm,  $\frac{1}{2}$  watt

500,000 ohm,  $\frac{1}{2}$  watt

3 meg,  $\frac{1}{2}$  watt

50,000 ohm pot (with sw)

#### SOCKETS and TUBES

1—Octal, 8 prong, bakelite

1—4 prong, steatite socket

1—Octal, 8 prong, steatite

1—6J7 metal tube

1—6C8G glass tube

28 henry filter choke

### Frequency Bands Have Names

During World War II the United Nations adopted a standard system of names for the various frequencies used in radio communication. The system has become commonly accepted in the U.S.A.

Frequency	Designation	Abbreviation
10 to 30 kc	very low frequencies	v.l.f.
30 to 300 kc	low frequencies	l.f.
300 to 3000 kc	medium frequencies	m.f.
3 to 30 mc	high frequencies	h.f.
30 to 300 mc	very high frequencies	v.h.f.
300 to 3000 mc	ultra high frequencies	u.h.f.
3000 to 30,000 mc	super high frequencies	s.h.f.

# ALL-WAVE EXPLORER

**T**HIS 3-TUBE receiver has a tuning range from  $4\frac{1}{2}$  to 665 meters. It consists of a two-stage audio amplifier, which provides loud-speaker volume on all signals, and which also operates as a code practice oscillator; a regenerative triode detector of the grid leak type; an untuned r.f. amplifier; and a half-wave rectifier. The set has good selectivity, and is a real-distance getter on both short-wave and broadcast bands.

The receiver was built on a chassis which measures 9 x 6 x 2 inches. The front panel can be made of wood if it is lacquered and shielded. The pictures clearly show how the parts are mounted. The volume control (R3), the regeneration control (R6) and the vernier tuning dial (C11 and C12) are operated from the front panel. The r.f. gain control (R9),

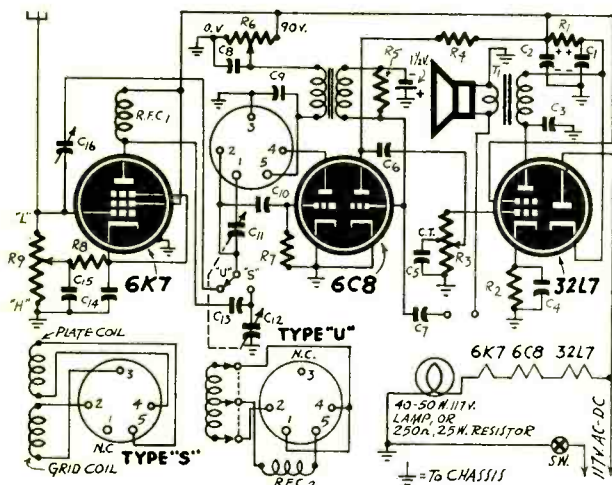

Fig. 1 — Schematic shows switching and plug-in combined.

the trimmer condenser (C16), and the "U"-S" switch, which are adjusted only when a plug-in coil is changed, are accessible from the back.

The audio amplifier of the receiver will also operate as a code oscillator. The volume control is connected in such a way that it will act as a pitch control when the oscillator is in use. The pitch of the oscillator depends upon the value of the condenser C7. A .1  $\mu$ f condenser should be used if bass tones are desired, or a .01  $\mu$ f condenser if treble tones are preferred. The volume control does not reduce the strength of an incom-



ing signal to a very great extent until it is almost off; therefore, it is possible to make it operate as a tone control also. This is done through the use of a fixed tap and condenser C5.

The primary of the audio transformer and the chassis are connected to three Fahnestock clips. This attachment makes it possible to connect sup-

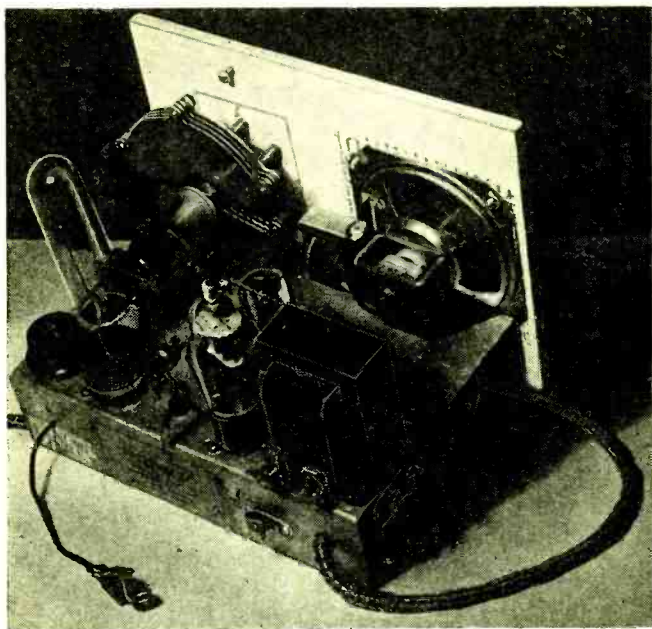

Neat arrangement of parts on sub-panel makes assembly an easy matter.

plementary detectors or other external experimental devices to the audio amplified and to also use the B supply in external circuits. When such devices are connected to the amplifier or B supply, the plug-in coil should be removed from its socket. Care should be taken to see that the device is not grounded or directly connected to the power line.

The plate and grid leads of the detector should be made as short as possible. The grid leak resistor is of a low value so that the detector will not overload on strong signals. The "U"- "S" switch can be a s.p.d.t. switch or an insulated single jack with two cord tips. The special two-gang tuning condenser was made from two old condensers. They are both operated by the band-spread vernier dial on the front panel. The large condenser (C12) is insulated from the v.h.f. tuning condenser (C11) by a plastic drawer knob. They are insulated from the chassis by plastic supports.

The plug-in coils are classified as type "S" and "U". The "S" coils tune 665 to 10 meters using the r.f. amplifier. The "U" coils tune 10 to 41½ meters with the r.f. amplifier disconnected. The coils are assigned a second letter to indicate the style of winding used, and also a numeral to reveal the "U" or "S" band covered by the coil.

## Plug-In Coil Data Table

All windings wound in same direction.  
All "S" series coils on 1½-inch forms.

COIL	PLATE WINDING	GRID WINDING	"S"- "U" switch position	Approximate Wavelength
S-D-7	60 turns close No. 28 wire	250 turns close No. 28 wire	"S"	665-425 meters (451-700 kc)
S-C-6	40 turns close No. 28 wire	140 turns close No. 28 wire	"S"	500-275 meters (600-1100 kc)
S-B-5	6 turns close No. 28 wire	60 turns close No. 28 wire	"S"	300-140 meters (1000-2200 kc)
S-A-4	10 turns close No. 28 wire	29 turns close No. 26 wire	"S"	150-80 meters
S-A-3	8¾ turns close No. 26 wire	13 turns close No. 26 wire	"S"	80-40 meters
S-A-2	3¾ turns close No. 28 wire	6¼ turns spaced No. 26 wire	"S"	45-19 meters
S-A-1	4¾ turns close No. 28 wire	2¼ turns spaced No. 26 wire	"S"	20-10 meters
U-U-8	10 turns, ½ inch inside diam. Self-supporting coil, center tapped.		"U"	8 meters
U-V-6	2½ turns, 1½ inch diam. Self-supporting coil, center tapped.		"U"	6 meters
U-V-5	¾ turn, 2 inches tall. Self-supporting wire, center tapped.		"U"	5 meters
U-V-4½	½ turn, 1¼ inch tall. Self-supporting wire, center tapped.		"U"	4½ meters

The grid coil of S-D-7 is wound with four layers of wire. After the first layer has been wound on the coil form, it is doped and covered by a paper strip which is wrapped tightly in place. The next layer is wound on this paper so that it ends directly over the place where the preceding layer starts. The third and fourth layers are wound similarly. It is important to have an insulating paper between each layer. The plate coil is wound in the same manner at the other end of the coil form, but has only three layers. Plug-in coil S-C-6 is wound in the same manner. The grid coil and plate have two layers each.

The grid coil of S-B-5 consists of a single layer of wire. The plate coil is wound upon an insulating paper that is wrapped tightly around the grid coil.

The four coils S-A-4 through S-A-1 are ordinary single-layer wound coils. S-A-1 and S-A-2 can be wound on a 5-prong tube bases.

The "U" coils listed in the Plug-in Coil Data Table will not have a con-

Under the chassis,  
showing location of  
many parts.

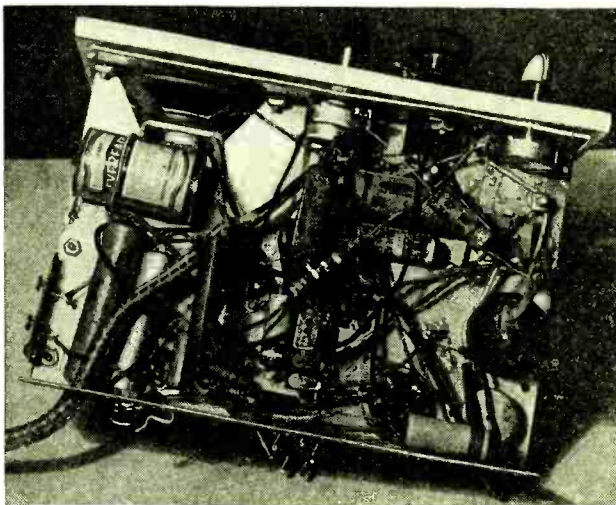

tinuous range from  $4\frac{1}{2}$  to 10 meters; but the additional coils required can easily be constructed. The coils are connected to the receiver by means of a three-terminal strip mounted on an adapter unit which is plugged into the coil socket. The r.f. choke, mounted in the adapter base, consists of about 20 turns of number 28 d.s.c. wire wound upon a  $\frac{1}{4}$ -inch wooden dowel. The coil and dowel should be carefully doped.

The data given in the Coil Table is only approximate; minor adjustments may have to be made with some coils. The plate winding should have just enough turns to cause the detector to oscillate over the entire dial. If too many turns are used, the detector will not be sensitive. "U" type coils should be tested with the tap at several different turns so as to insure best results.

The controls which are operated from the front panel will be found to respond similarly for every coil if the "U"-S switch, the r.f. gain control, and the trimmer condenser are set so that the proper conditions for the coil being used are created. The volume control should be turned all the way up to receive distant stations. The regeneration control is advanced clockwise from zero until the detector goes into oscillation. When a station is tuned in, a beat frequency squeal or whistle will be heard. The detector is left in oscillation for reception of code signals; but when modulated phone stations are heard, the control should be reduced so that the sensitive point, just before the detector starts to oscillate, is reached.

When coils S-D-7 through S-A-4 are used, the r.f. gain control is adjusted so that the sliding contact arm is near the terminal marked "L" on the diagram. This reduces the r.f. gain sufficiently to bring in local and distant stations with good tone quality and high selectivity. Broadcast stations several hundred miles distant can be received with a long aerial.

When coils S-A-3 through S-A-1 are used, the r.f. gain control is set so that the arm touches terminal "H". This allows the amplifier to operate normally. Although coil S-A-1 may not oscillate over the entire dial, it should tune from about 10 to 20 meters. Stations from all over the world can be received regularly.

The trimmer condenser (C16) couples the aerial to the v.h.f. type "U" coils. The r.f. gain control should be set to "H" position while the trimmer is being adjusted. If the trimmer is adjusted too tightly, the detector will become unstable or refuse to regenerate. Minor adjustments can be made with the r.f. control. Although the range of this regenerative v.h.f. detector is limited to local reception, police, FM, television sound, and many other interesting stations can be tuned-in.

### List of Parts

#### CONDENSERS

- C1, C2—20-20  $\mu$ f 150 v electrolytic
- C3—.05  $\mu$ f tubular condenser
- C4—5  $\mu$ f 35 v condenser
- C5—.005  $\mu$ f tubular condenser
- C6—.02  $\mu$ f tubular condenser
- C7—.01  $\mu$ f tubular condenser
- C8—.5  $\mu$ f 200 v condenser
- C9, C13—.0001  $\mu$ f mica condenser
- C10—.00025  $\mu$ f mica condenser
- C11—V.h.f. tuning condenser (15  $\mu$ f)
- C12—140  $\mu$ f tuning condenser
- C14, C15—.06  $\mu$ f tubular condenser
- C16—3-30  $\mu$ f trimmer condenser

#### RESISTORS

- 1—40 or 50 watt 120 v cylindrical light bulb, or one 250 ohm 25 watt power resistor
- R1—3000 ohm 10 watt resistor
- R2—200 ohm carbon resistor
- R3—500,000 ohm potentiometer with fixed center tap and switch
- R4—200,000 ohm carbon resistor
- R5—15,000 ohm carbon resistor
- R6—50,000 ohm potentiometer
- R7—250,000 ohm carbon resistor
- R8—400 ohm carbon resistor
- R9—20,000 ohm potentiometer

#### TUBES

- 1—32L7-GT
- 1—6C8-G
- 1—6K7

#### MISCELLANEOUS ITEMS

- T1—4 or 5 inch PM speaker with output transformer; primary should be 2,600 ohms
- T2—3:1 good quality audio transformer
- 1—Large size flashlight battery (1½ volts)
- 1—2 post terminal for key leads
- 1—3 post terminal
- 2—Tie point strips
- 1—S.p.d.t. switch or one single jack and two cord tips
- 3—Octal "MIP" sockets
- 1—5 prong "MIP" socket
- 1—Lamp socket for light bulb
- R.F.C.1—2.5 mh r.f. choke
- R.F.C.2—V.h.f. choke (see text)
- 8—5 prong coil forms
- 1—Vernier dial
- 3—Pointer knobs
- 1—Chassis (9 x 6 x 2 inches) with front panel
- 1—Power cord with plug
- Nuts and screws, wire, grid caps, etc.



# 5-TUBE 2-BAND SET

**R**EQUIRED: A set which was easily transportable for vacationing, and yet did not sacrifice any of the efficiency of *high gain* tubes available for use in electrically-operated sets.

The result: An a.c.-d.c. job using 12 and 35 volt heater tubes of the efficient single-ended metal type, together with 2 bantam type glass tubes. The receiver is a two-band-job covering the broadcast band and short waves from 18.5 to about 6 mc. On the broadcast band reception is by

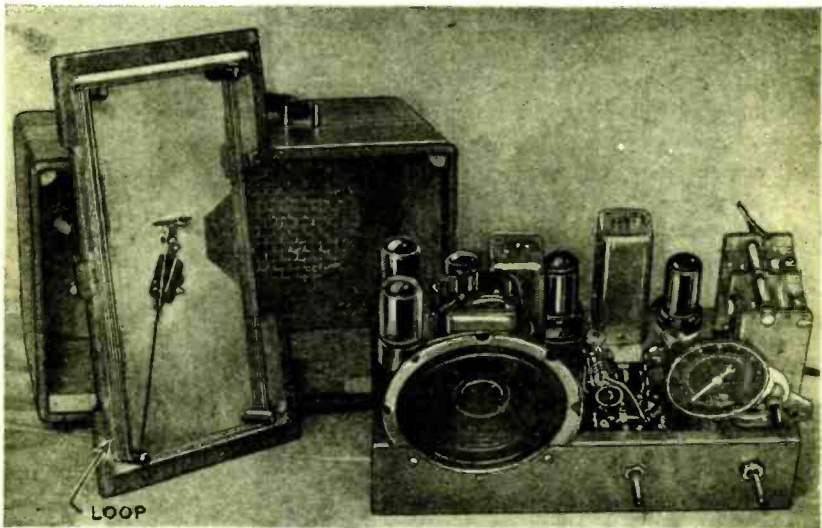

Chassis, loop aerial and cabinet.

means of a self-contained loop. On the short waves an aerial is necessary. It was originally intended to use the loop on short waves, too, but tests showed that while pick-up with a loop on the short waves was fair it was impossible to get the antenna and oscillator tuning condensers (which are ganged) to track together. If the builder is prepared to sacrifice single dial tuning he can experiment with a loop on the short waves. One or two turns of No. 18 wire on the same frame as the broadcast band loop will do the trick.

A novel feature of the set is the use of a 1N34 as second detector. This

is a germanium crystal half-wave diode made especially for use as a diode detector.

Another feature is the use of inverse feedback over the two audio stages. This reduces distortion considerably at the expense of some loss of audio gain. However, the audio system was purposely made with extra gain to take care of this. When the wave change switch is in the S-W position the feedback is automatically cut out, leaving full audio gain available as it is more apt to be needed on the short waves. The feedback is from the output transformer to the cathode of the 12SJ7 tube.

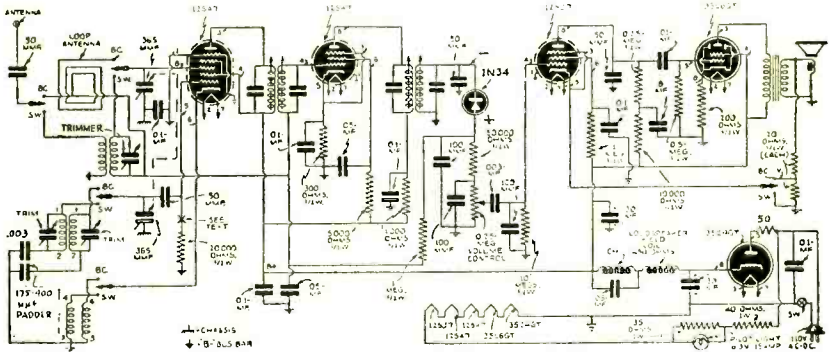

Fig. 1—"Hook-up" for the "carry-around" A.C.-D.C. receiver.

The mixer stage is a 12SA7. Reference to the circuit shows that the oscillator feedback coil is in series with the cathode.

The single i.f. stage uses a 12SK7 single-ended metal tube. The first a.f. is a 12SJ7. The output tube is a 35L6GT. The rectifier is a 35Z4GT.

The permanence of alignment of the i.f. stage is assured by the use of iron core transformers, provided with adjustable cores instead of adjustable trimmer condensers. This type of transformer is also very compact. The i.f. employed is 456 kc.

There are no special points about the assembly of the set. Mount the sockets and i.f. transformers first and complete the wiring of the heater circuits as far as possible at once. Note particularly that the chassis is *not* connected to the circuit, except through a .1  $\mu$ f condenser and to the rotor of the tuning condenser. The oscillator coils are mounted on the wave-change switch so that they are *above* the deck of the chassis. The s.w. antenna coil is mounted on the switch so that it is *below* the chassis deck level. It is necessary to alter the two oscillator coils. This is done after the receiver has been assembled and checked. A 0.1 ma milliammeter is connected in series with grid No. 1 of the 12SA7 at point X on the diagram. The number of turns on the tickler or feedback winding of the oscillator coil (The winding in the cathode circuit of the 12SA7) will have to be adjusted as follows: On the *broadcast* band turns should be removed, one by one, until the meter shows a reading of 0.5 ma with the tuning conden-

This 5-tube receiver works on A.C.  
or D.C.

ser at mid-scale. On the s.w. coil the tickler should be adjusted so that with the tuning condenser *fully closed*, the current reading is from 0.2 to 0.25 ma. With this coil it may be necessary to rewind the tickler with No. 28 d.c.c. wire as the number of turns already on it may be insufficient. However, first

try removing turns, one by one, until the proper current reading is obtained. Generally  $1\frac{1}{2}$  to  $2\frac{1}{2}$  turns are proper for the s.w. coil. One last point—if no current reading at all is obtained at the start, make sure that the tickler is connected properly. Try *reversing* connections to it.

The loop antenna used on the broadcast band is wound around four wooden dowels mounted on the inside of the back cover of the carrying case. The dowels are spaced to form a rectangle 10 x 5 inches. These are the loop's dimensions. The loop consists of about 21 turns of No. 28 d.c.c. wire wound so that the ground end of the winding (end nearest the antenna tap at  $1\frac{1}{2}$  turns) is close to the surface of the back cover of the case.

In aligning the set the i.f. transformers should be aligned first, preferably with the aid of an oscillator. Next adjust halfway out the trimmer mounted on the broadcast oscillator coil. Then the antenna trimmer condenser should be tightened as far as it will go and then backed off one turn. With the set on the *broadcast* band the oscillator trimmer on the gang condenser should be adjusted so that with the tuning dial set 10 degrees away from minimum capacity, 1500 kc will be tuned in. Similarly the series oscillator padder mounted on the chassis should be adjusted so that the set will tune to 530 kc with the tuning condenser set at maximum capacity. When this has been ascertained, the set should be tuned to a station near 600 kc and the antenna trimmer condenser adjusted for maximum signal.



Bottom view of chassis,  
showing location of  
parts. 1N34 is right of  
center.

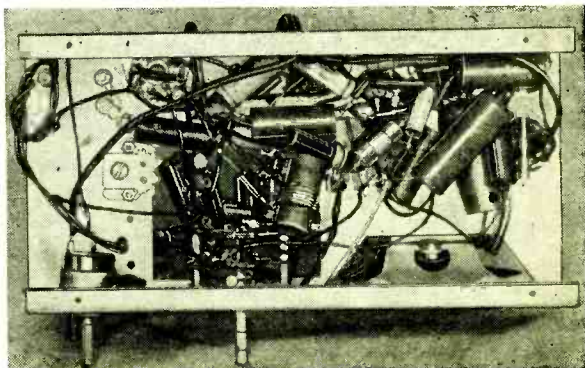

During these adjustments the loop should be placed in the *exact position* with respect to the chassis that it will occupy when the set and loop are mounted in the cabinet.

Adjustment of the s.w. trimmers should be exclusively on the trimmers mounted on the s.w. antenna and oscillator coils. Generally it is only necessary to check the s.w. tracking at the high-frequency end of the band (where the tuning condenser is nearly wide open).

### List of Parts

#### CONDENSERS

- 5—.1  $\mu$ f paper
- 3—.05  $\mu$ f paper
- 1—.01  $\mu$ f paper
- 1—.003  $\mu$ f mica (s.w. osc. paddler)
- 1—175-400  $\mu$ mf mica type, variable (bc osc. paddler)
- 1—.003  $\mu$ f paper
- 4—50  $\mu$ mf mica
- 3—100  $\mu$ mf mica

- 2—30  $\mu$ f 150 v electrolytic
- 1—8  $\mu$ f 150 v electrolytic
- 1—2 gang 365  $\mu$ mf variable condenser

#### RESISTORS

- 1—250,000 ohm pot with sw
- 1/2 watt
- 1—20,000 ohms
- 1—300 ohms
- 1—5000 ohms
- 2—1 meg
- 1—1000 ohms
- 1—50,000 ohms
- 1—10,000 ohms
- 1—10 meg
- 1—250,000 ohms
- 1—500,000 ohms
- 1—200 ohms
- 2—20 ohms
- 1 watt
- 1—35 ohms
- 1—40 ohms
- 1—50 ohms

#### COILS and I.F. TRANSFORMERS

- 1—456 kc input
- 1—5.8-18 mc ant. coil with trimmer (Meissner 14-7674)
- 1—5.8-18-mc band osc. coil for 456 kc i.f. (Meissner 14-7670)
- 1—Bc. band osc. coil for 456 kc i.f. (Meissner 14-7682)

#### SOCKETS

- 4—Octal
- 1—Octal steatite

#### WAVE CHANGE SW.

- 1—6 circuit, 3 position

#### TUBES

- 1—12SA7
- 1—12SK7
- 1—12SJ7
- 1—35L6GT
- 1—35Z4GT
- 1—1N34 crystal

#### MISCELLANEOUS

- 1—Special chassis per drawing
- 1—Cabinet (see drawing)
- 1—2-10 henry midget filter choke, resistance as low as possible
- 1—Insulated pilot light bracket
- 1—Aerial terminal strip
- 1—5" speaker with universal output transformer and 450 ohm field.
- 1—Dial for 3/8 inch shaft

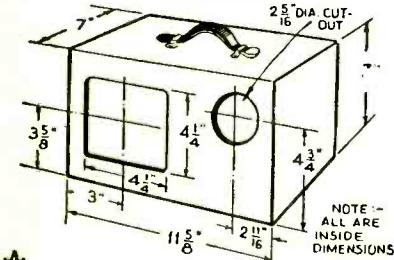

A.

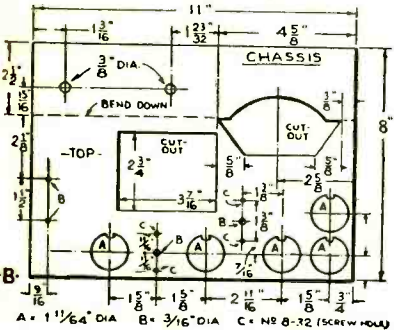

B.

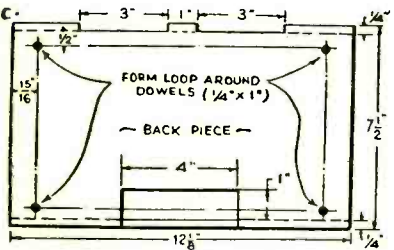

Dimensions of cabinet, chassis and back panel.



# MIDGET 3-TUBER

**T**HIS SET is ideal for the beginner and can be used for "silent listening" on the *broadcast* band. The set uses three tubes, 6J7 as detector, 6J5 as a.f. amplifier, and 6C5 as a low-powered rectifier. Filaments of the 6.3 volt tubes are connected in series with a 330 ohm resistor in the line cord.

The little set has a novel idea in that an ordinary receptacle outlet plate, used in every home and which can be purchased at any dime store, is used for the front panel. The two holes in the receptacle are used for dials of the tuning condenser and regeneration control. A piece of cardboard was used as the dial itself, and was marked out with pen and ink mounted between panel and receptacle plate.

A small chassis is employed about 2½ inches wide by 4¼ inches long. All three tubes are mounted in a line and condensers and resistors are

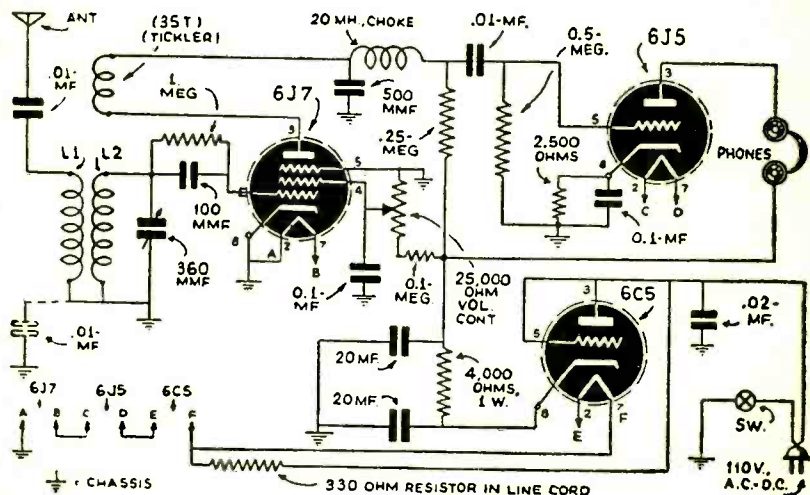

Wiring diagram of the "Midget 3-Tuber".

mounted beneath the chassis. The entire receiver measures  $4\frac{5}{8}$  inches wide by 5 inches long.

The coil is an antenna coil, of the type now used in commercial midget receivers in which 35 turns of 28 d.c.c. are wound over the secondary coil. In testing the set, turn on switch and a click is heard in the headphones. By feeling the line cord, you can tell by its warmth if the tubes are heating up. Turn up the regeneration control and a plop will occur. If no plop is heard and the set will not regenerate (rushing sound in headset) reverse the leads to the tickler coil winding. Then rotate tuning condenser. Every squeal heard will indicate a station. Readjust the regeneration control until the whistling noise has stopped and the station can be tuned in without a squeal.

The set itself can be wired in a few hours. Because the receptacle plate was ivory, the cabinet was also painted ivory to match. The top panel was cut with tube holes in it, and the tubes project slightly above the panel.

The receiver has sufficient pick-up so that an ordinary short aerial strung around the picture molding, or laid on the floor behind furniture or under a rug, will bring in local stations with sufficient volume. The stronger stations will operate a sensitive loudspeaker, but it is presumed that the average builder of this set will probably want to use it with a pair of headphones.

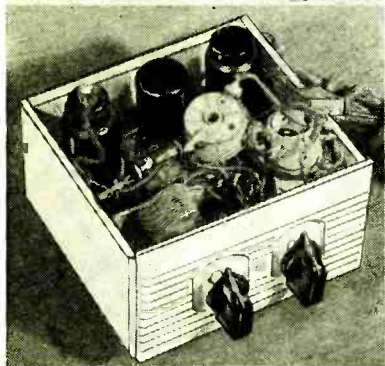
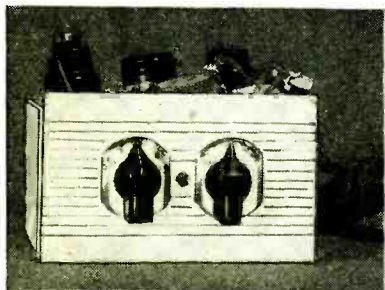

Two views of the midget 3-tube "BC" receiver.

## List of Parts

### CONDENSERS

- 1—.0001  $\mu$ f
- 1—.0005  $\mu$ f
- 2—.01  $\mu$ f
- 1—.02  $\mu$ f
- 2—.1  $\mu$ f
- 1—Dual type elec. 20-20  $\mu$ f
- 1—Variable 360  $\mu$ f

### RESISTORS

- 1—1 megohm
- 1—100,000 ohm  $\frac{1}{2}$  watt
- 1—.25 meg,  $\frac{1}{4}$  watt
- 1—500,000 ohm,  $\frac{1}{4}$  watt
- 1—4000 ohm, 1 watt
- 1—Volume control 25,000 ohms, (midget potentiometer) with switch
- 1—2,500 ohm,  $\frac{1}{4}$  watt
- 1—330 ohm resistor cord

### MISCELLANEOUS

- Tubes—6J7, 6J5, 6C5; sockets, screws, bolts, wire etc.

# PORTABLE PHONO-RADIO

AN OLD portable phonograph can be converted into a phono-radio combination with a little careful planning and circuit design.

The first step was the removal of the spring motor and substitution of

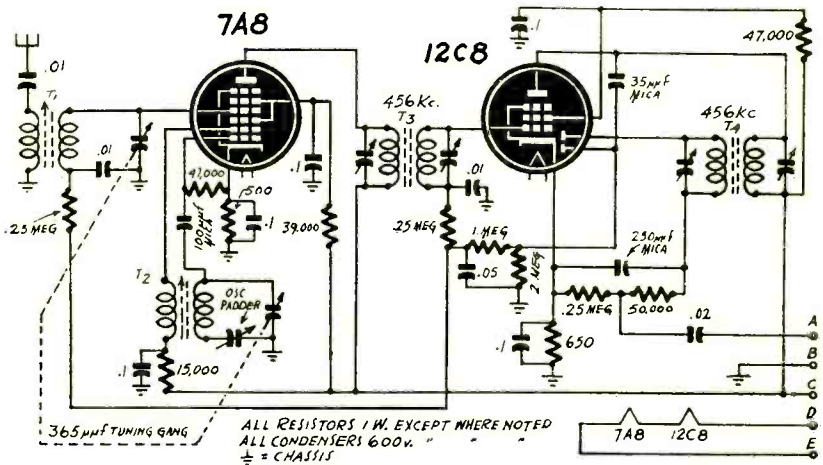

Schematic. The connections between the two sections of the diagram are keyed A-A, B-B, etc. Consider these solid connections when tracing circuits from one section to the other.

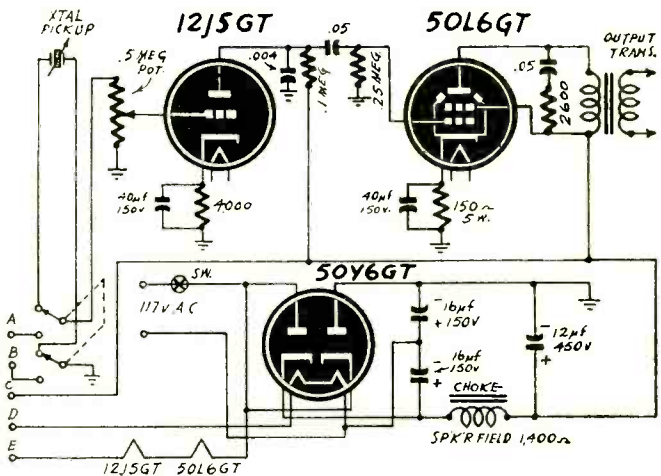

an inexpensive rim-drive phono motor. Then the mechanical reproducer was discarded and replaced by a crystal pickup. The next problem was to design an efficient amplifier small enough to fit the limited space and still leave room for a speaker. The minimum requirement appeared to be a two stage unit with a transformerless power supply and on consulting the tube manual we decided the most suitable lineup of available tubes to be a 12J5GT driving a 50L6GT, with a 50Y6GT rectifier.

Our first thought was to use a simple half wave rectifier circuit for power supply, but on considering the current requirement—approximately 65 mils—and the unavoidable voltage drop of a small filter choke, we found the voltage output would be too low. The answer here was obviously a voltage-doubling circuit, but now the voltage would be far in excess of the rating on a 50L6GT. Eventually we made a compromise which involved a full wave voltage doubler and the 1400-ohm field coil of a 6-inch speaker. This solved the filter choke problem and at the same time served as a dropping resistor to reduce the plate voltage of the 50L6GT to 135 under operating conditions.

The remainder of the amplifier circuit is conventional, though the following point may be of interest: The combination of a 0.1  $\mu$ f condenser and a 2600-ohm resistor across the output acts as a corrective filter to improve the frequency characteristic of the output stage, while the large cathode by-pass condensers assure good low frequency response. The .004  $\mu$ f condenser from first amplifier plate to ground was found necessary to prevent oscillation

### **Adding a small tuner**

The results obtained thus far were highly satisfactory, as the amplifier had excellent tone and plenty of gain for the average crystal pickup. Some months later we considered the possibility of adding a tuner to make a complete portable combination. For best possible efficiency a superhet seemed in order and again the tube manual was put to work. The most suitable tubes were a 7A8 and a 12C8 for the circuit we had in mind, which was a converter followed by a combined i.f., detector and a.v.c stage. We used Meissner adjustable antenna and oscillator coils for easy tracking adjustment and iron core i.f. transformers for high gain. The final circuit is straightforward though some details call for discussion.

The use of separate diodes for detector and a.v.c. has several advantages, the most important being to reduce the loading on the secondary of the output i.f. transformer. This is accomplished by coupling the a.v.c. diode to the plate circuit of the i.f. stage. Another advantage is the reduction of the shunting effect of the a.v.c. circuit on audio output which occurs with the use of a single diode for both functions. A third advantage is the delayed a.v.c. obtained.

For an antenna we used a few loops of wire tacked inside the case with provision for an external antenna to be connected through the .01  $\mu$ f antenna condenser. No external ground connection should be used.



# A RECEIVER FOR THE DEN

**F**OR THE listener who stays up late at night, operation of a large receiver may disturb other members of the family and a small set exclusively for short wave operation and headphone reception is in order.

The complete receiver is shown in Fig. 1 and a separate view of the

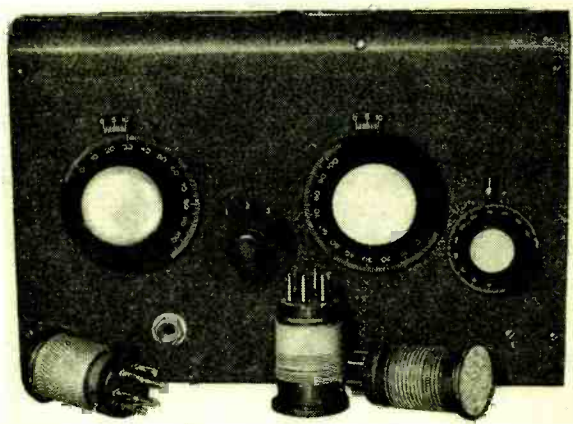

Fig. 1.—Front view of the Den receiver. Set is fitted with red and white dial knobs, which enhance its appearance. Set uses doublet single-wire antenna.

chassis-panel assembly illustrated in Fig. 2. From the schematic wiring diagram shown in Fig. 3, it will be noted that the circuit consists of a regenerative detector (using either a 6SK7 or 6SJ7), a first audio stage (resistance coupled), and a second audio stage. The first and second audio circuits are handled by the 6C8G *twin triode* which is equivalent to two separate high-gain triodes; a 5W4 rectifier tube is used in the full wave midget power supply.

Regeneration in the detector is controlled by varying the detector screen grid voltage through the 50,000 ohm potentiometer control (R1).

Fig. 4 gives the drilling dimensions of the front panel and also shows the drilling and cut out dimensions of the chassis. The standard cabinet and chassis suggested are made of soft steel and easily drilled and cut as required.

The assembly and wiring are relatively simple. On the chassis, the transformer, filter choke, sockets, filter condenser, antenna terminal socket, tuning condenser and fuse extractor post are mounted in place. The phone jack is left loose as it is finally fastened by a front panel nut. The 50,000 ohm potentiometer and stage switch are mounted on small brackets to line up with the front panel holes indicated. The wiring can now proceed, first taking care of the filament leads and carefully twisting these wires. Keep filament wires away from grid or plate leads subsequently added. The r.f. leads shown in the diagram with a sup-



Fig. 2—Rear view of  
the receiver.

plementary dotted line are covered with low loss Amphenol 912 beads. Instead of using an inductive r.f. choke in the detector plate circuit, a filter is substituted, consisting of a 5000 ohm resistor and the two 250  $\mu\text{mf}$  mica condensers shown. The performance of the detector circuit is substantially improved by using a 500 henry, 5 ma iron core choke in parallel to the plate coupling resistor (R6).

The first audio grid lead, which is to the cap of the 6C8G, is covered with a small piece of copper braid, which is *grounded*. The multi-stage switch permits connecting the phones to the detector output, first audio output or second audio output.

Care must be taken to connect the coil socket leads exactly as shown. Coil winding data is given at the beginning of the parts list. Extra coils can be wound for shorter wavelengths, following the design of the standard coils, but of course with fewer turns. The cathode tap in each case should be approximately at 1/3 the total grid-to-ground or secondary

turns. The antenna coupling coil can have about the same number of turns as the ground-to-cathode tap.

In completing the wiring, simplification can be obtained by mounting one end of component parts (such as condensers or resistors) directly to the socket contact or other terminal involved, as shown in the diagram. The by-pass condenser ordinarily across the first audio cathode resistor, R10, has been purposely omitted to reduce hum.

Upon completing wiring, the chassis assembly can be tested prior to final panel and cabinet mounting. Plate, screen grid and bias values can be checked and will be approximately the same as recommended for these tubes in the standard tube manuals.

After satisfactory tests have been secured, the front panel can be mounted to the chassis, using the two holding screws and spacers. The

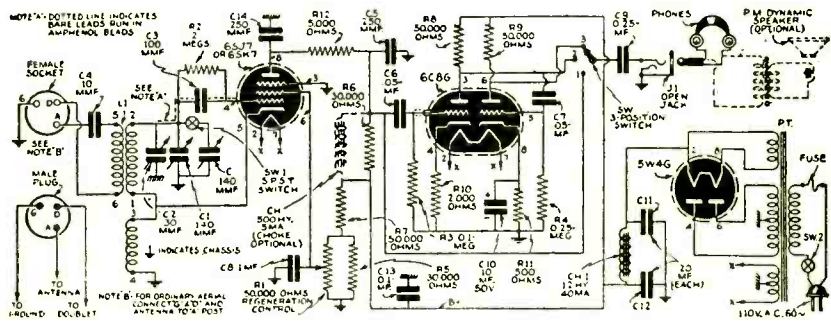

Fig. 3—Short-wave receiver with built-in rectifier. Phones or speaker may be used.

jack is then permanently installed. The large dials are for the main tuning condenser (C1) and *band-spread* or fine adjustment condenser (C2). The small dial is for the *regeneration control* and the single knob for the “stage” switch.

In tuning, ordinarily only one section of the two-gang condenser (C1) is used and this spreads the stations well out over the dial. However, a wider frequency range per coil can be secured by connecting both sections of the two-gang condenser in parallel by closing the switch (SW1).

## Coil Data

Coils wound on 1¼ inch diameter 6-pin forms, with single-silk covered copper wire.

Met.	Prim.	Sec.	Tick.
10-20	4t No. 32	5t No. 26	5t No. 32
20-40	8t No. 32	11t No. 26	7t No. 32
40-80	15t No. 32	23t No. 26	8t No. 30
80-200	31t No. 32	50t No. 30	16t No. 30

## List of Parts

- 1—Cabinet 7¼" x 10½" x 6"
- 1—Chassis 5½" x 9½" x 1½"
- 1—Power transformer 6.3v, 2 amp.; 5v, 2 amp; 300v, c.t. at 50 ma.
- 1—Filter choke, 12 h, 40 ma
- 1—Plate impedance (CH) 500 h, 5 ma
- 1—6SJ7 or 6SK7 detector
- 1—6C8G twin amplifier
- 1—5W4 rectifier

- 1—2 gang tuning condenser, 140  $\mu\mu\text{f}$  each section (C1)
- 1—Single condenser 30  $\mu\mu\text{f}$  (C2) stock 140  $\mu\mu\text{f}$  condenser altered to one rotor plate
- 1—Pair headphones
- 1—Steatite octal socket
- 1—Steatite coil socket

- 1—Phone plug
- 1—1  $\mu\text{f}$  400 volt paper condenser (C8)
- 1—10  $\mu\text{f}$  50 volt dry electrolytic condenser (C10)
- 1—.25  $\mu\text{f}$  400 volt paper condenser (C9)
- 1—.1  $\mu\text{f}$  400 volt paper condenser (C13)
- 1—Dial and knob
- 1—Knob

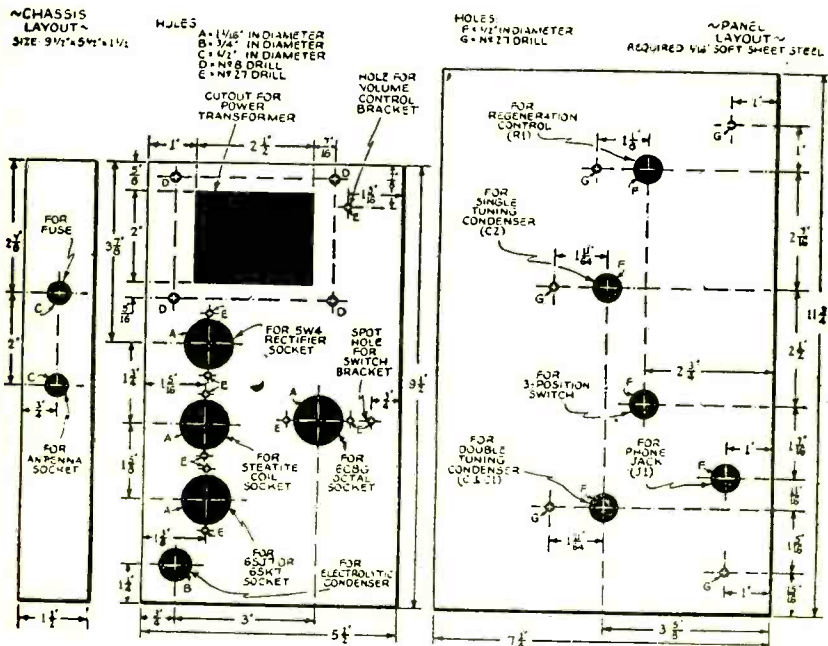

Fig. 4—Layout details for panel and chassis.

- 2—Octal sockets, rectifier and amplifier
- 25—Amphenol 912B beads
- 1—3 contact socket and 1—3 contact plug
- 1—5" PM dynamic speaker (optional)
- 1—2 circuit 3 position rotor switch (S1)
- 1—50,000 ohm volume control and sw (R1)
- 1—20-20  $\mu\text{f}$  450 v condenser (C11, C12)
- 1—.0001  $\mu\text{f}$  mica condenser (C3)
- 1—.00001  $\mu\text{f}$  mica condenser (C4)
- 2—.00025  $\mu\text{f}$  mica condensers (C5, C14)
- 1—Open circuit jack (J1)
- 2—.05  $\mu\text{f}$  400 v paper condensers (C6, C7)

- 1—Fuse extractor post and 1 ampere fuse (F1)
- 1—2 meg, 1/2 watt resistor (R2)
- 1—100,000 ohm, 1/2 watt resistor (R3)
- 1—250,000 ohm, 1/2 watt resistor (R4)
- 2—30,000 ohm, 1/2 watt resistor (R5, R6)
- 3—50,000 ohm, 1/2 watt resistor (R7, R8, R9)
- 1—2,000 ohm, 1/2 watt resistor (R10)
- 1—500 ohm, 1/2 watt resistor (R11)
- 1—5,000 ohm, 1/2 watt resistor (R12)
- 1—50,000 ohm potentiometer with switch (R1, S2)
- 1—Unmounted single pole single throw switch (S1)



# COMPACT 5-TUBE SET

**H**ERE IS A simple 5-tube receiver that is economical to build and will be a welcome addition to the *shack*.

A 6K8 was chosen as the mixer-oscillator tube of this compact receiver followed by a 6K7 i.f., 6C8G second detector-b.f.o., 6V6GT output feeding the 5 inch PM speaker, and a 5W4 rectifier.

The parts are substantially mounted on the standard 7x13 inch black crackle chassis. A glance at the accompanying chassis photo will clearly show the location of all above-chassis parts. Directly behind the ganged tuning condenser is the 6K8 and midway between the two edge-mounted i.f. transformers is the 6K7 followed by the 6C8G to the right of the b.f.o. transformer. The 6V6GT is mounted in front of the b.f.o. transformer and the 5W4 rectifier is directly in front of the power trans-

Rear view of 5-tube  
line-operated  
superheterodyne.

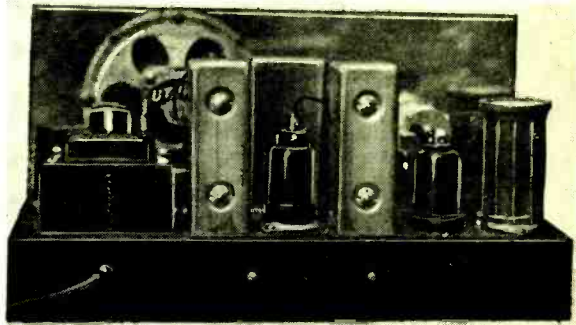

former. It was necessary to mount one of the small filter chokes above the chassis and at an angle to make room for the small speaker.

The two 100  $\mu\text{f}$  tuning condensers are ganged by means of a flexible coupling and the front section is mounted directly to the front panel while the rear is mounted on a piece of mycalex, simply because this was on hand.

A glance at the photo of the front panel will readily show location of parts. Just below the speaker is the a.c. switch-volume control, next in line is the b.f.o. toggle switch. The small trimmer is next, just below the tuning dial and finally the feed-through insulator to the left of the tuning dial.

The receiver was primarily built for *overseas* reception and therefore no effort was made to get a broad band-spread. The coils, located on the extreme left of the chassis cover from about 9.4 to 13.8 mc. No additional coils were wound for other bands as most European reception comes through in this frequency range.

For best results it is suggested that the i.f. transformers be lined up in the conventional manner—that is by the use of a signal generator set at 465 kc. The i.f. transformers are the permeability tuned, iron core

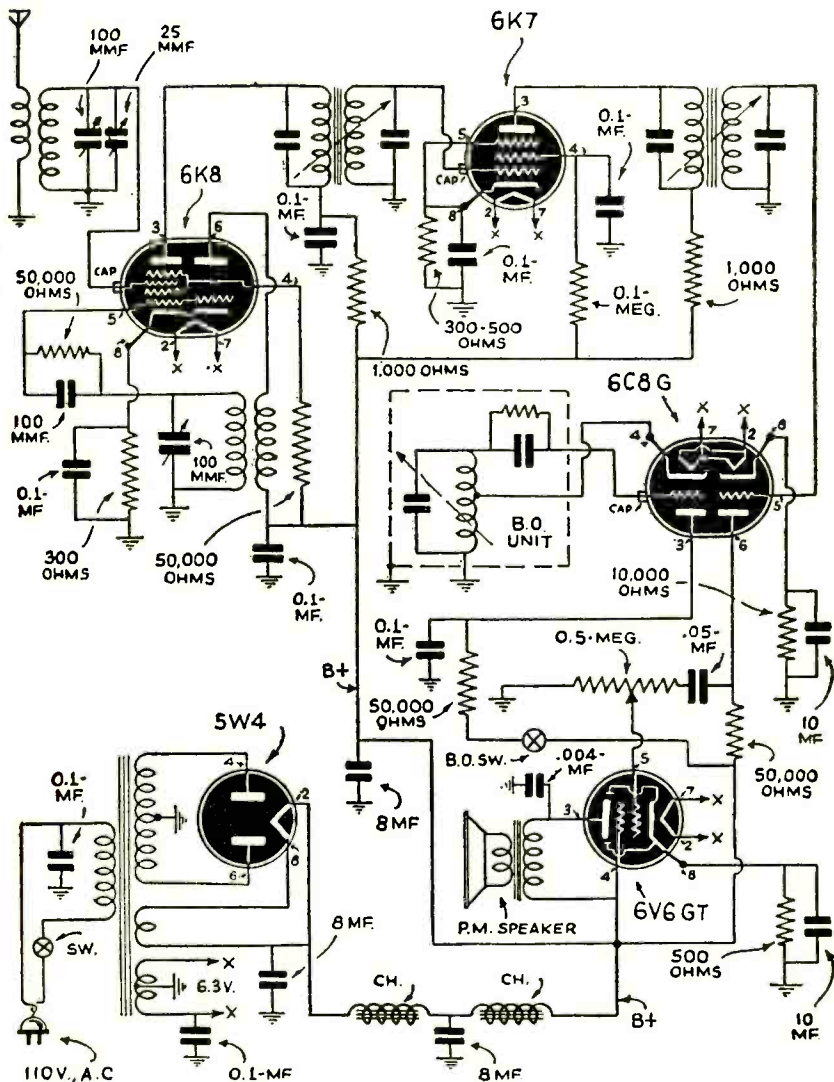

Fig. 1—The 5-tube superhet circuit is simple and easily followed.

type and once set to the proper frequency they will keep their original settings for long periods of time despite severe changes in temperature.

In order to properly align the i.f. stage, a signal generator must be used. The procedure is simple but care should be taken to get the setting right on the nose.

The detector and oscillator coils are plugged in so as to prevent oper grid oscillation during the lining up. The signal generator is set at 465 kilocycles and the modulated-unmodulated switch is thrown to the modulated position. The ground lead of the generator is clipped to the chassis

### Coil Data

All coils are wound on 4 prong ribbed,  $1\frac{1}{4}$ " diameter forms.

Detector—8 turns #22 enamelled for grid  
4 turns #34 d.s.c. for antenna winding

Oscillator—8 turns #22 enamelled for grid  
5 turns #34 d.s.c. for tickler

The coils cover the range from about 9.4 to 18.8 mc.

To cover the band from 4.7 to 9.4 mc, double the number of turns on the grid windings and increase the antenna winding to 6 turns and the tickler winding to 6 or 7 turns.

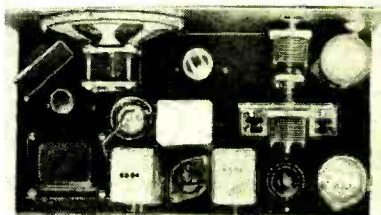
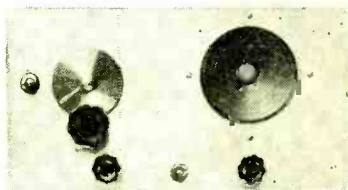

Front and top views—dial at left, speaker at right on panel view.

of the receiver and the r.f. lead is clipped to the grid of the 6K7. An output meter is hooked up in conventional manner in the output of the 6V6GT and the actual alignment can now be started.

Both receiver and generator are turned on and the trimmers on the last transformer are adjusted until a modulated signal is heard on the speaker and is finally peaked as indicated by a maximum voltage reading on the output meter. As the circuits come into line and as the signal increases in intensity, the attenuator on the signal generator is backed off.

The r.f. lead is then taken off the 6K7 and clipped to the grid of the 6K8. The trimmers on the first transformer are then adjusted and when peaked the last transformer is given a going over again. This is done several times to make certain the circuits are in resonance.

After the set has been turned on and has warmed up for about a minute, advance the volume control and rotate the small detector condenser until a definite hiss is heard in the speaker. The tuning dial is then turned until the desired signal is heard. Turn the dial slowly as the set has no real band-spread and the stations are fairly close together.

The setting of the detector trimmer will vary with the setting of the tuning dial and so will have to be changed slightly when tuning over a large portion of the dial.

# SHORT-WAVE SUPERHET 5

**T**HIS SET'S only claim to a place on your operating table is its compactness and efficient application of well known principles. The parts complement has been kept low and standard; easily obtainable parts have been adhered to. The cost of the parts should not be found exorbitant, but nowhere has quality been sacrificed for cost.

Front view of the set. A beat frequency oscillator is included.

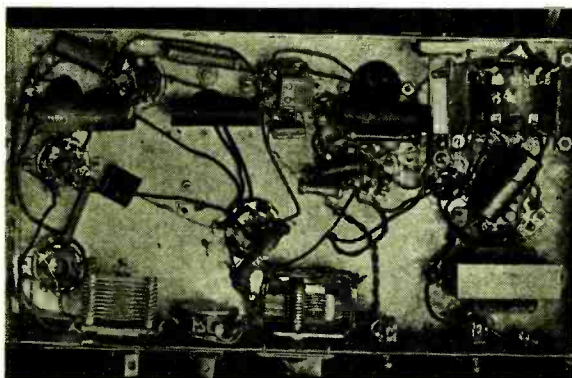
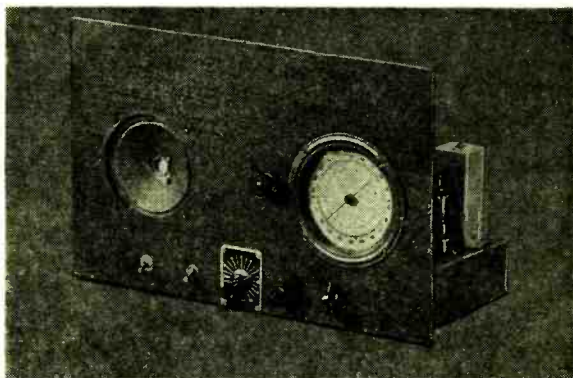

Bottom view of short-wave superhet receiver. Wiring and parts are not crowded.



The low cost of the parts is rather due to the use of double-purpose tubes, and to the design of the circuits around tubes which require a minimum of circuit components.

To begin with, the beat frequency oscillator, which usually requires a separate tube, has been combined into the detector circuit through the use of a double triode, the 6C8G. This idea saved an extra tube.

It also saved the annoying necessity of external coupling into the second detector circuit, as the inter-electrode capacity of the two triode sections serves admirably as the coupling "condenser." Another example

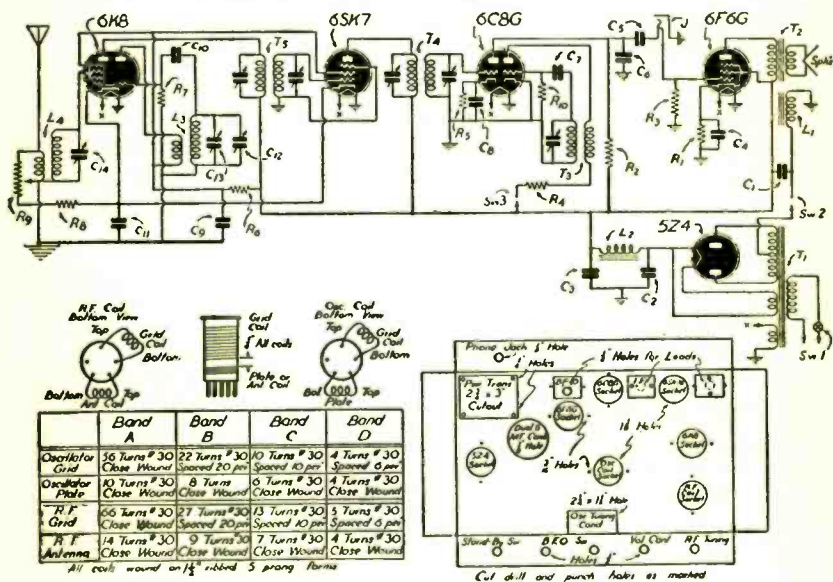

Fig. 1—Short-wave coil data is given at left of diagram above.

of a similar saving is the choice of the 6K8 as oscillator-converter tube. The use of the internally connected "injection" grid in this tube eliminates an external oscillator coupling condenser, and at the same time cuts down on losses by doing away with the external wiring of this circuit. The one extravagance the designer allowed himself was the use of 1500 kc i.f. transformers of the iron core variety, rather than the cheaper air core type. It was found a wise choice, too, since the gain of this type of transformer is inherently much higher than the air-core type. The choice of 1500 kc rather than a more conventional lower frequency type was, of course, made necessary by the lack of an r.f. or preselector stage. The image rejection ratio was thus kept high enough to be unobjectionable.

### Space for Expansion

The second detector is wired in a conventional power or grid-bias detector circuit. This was found desirable over a diode circuit as it

introduced enough gain into the audio circuit so that a 2-stage audio system was not necessary. Sufficient space has been reserved on the chassis for the addition of another tube, however, thus allowing the constructor to add a diode detector and making automatic volume control possible, at some later date. Panel space is also reserved for an "R" meter, if automatic volume control should be added. A point which should appeal to the beginner is the fact that separate oscillator and r.f. variable condensers are used, thus doing away with the difficult and patience-trying problem of tracking the sections of the gang condenser in more conventional circuits. A 140  $\mu\mu\text{f}$  condenser tunes the r.f. section, a 150  $\mu\mu\text{f}$  "bathtub" type tunes the oscillator and a 30  $\mu\mu\text{f}$  midget is used for *spreading* the amateur or foreign bands over the whole tuning dial.

A dynamic loudspeaker is used, and its field together with three 8  $\mu\text{f}$  condensers and a 30 h choke, provide excellent power supply filtering. The phone plug is connected into the *grid* circuit of the 6F6G, doing away with d.c. in the phones, and also making it possible to use high-impedance crystal phones if desired, without external blocking condensers.

## Construction of the Receiver

So much for the *design*. Now for the *construction*. The set is constructed on an electrical or galvanized chassis base, 7" x 12" x 2". The panel is 15" x 9". The band-spread in the original is a 4" *airplane* type dial, mounted so that the knob extends to the left of the dial, and even with the center. To mount it in this way, the dial must be revamped slightly. The small metal tabs that hold the glass in place are bent up carefully, and the glass removed, as well as the gasket below it. The hand is next taken off, and the celluloid dial scale will then fall free. Remove the scale, and turn it 90° to the right, so that the scale will be in position for reading properly when the dial is mounted on its side. Cut a notch in the dial scale in the right position to engage the pin which serves to hold it in position. Then carefully reassemble the entire mechanism. Some means must be devised for supporting the dial in this position, and just what this will be depends on the type of dial you have chosen. In the model being described, a simple right-angle bracket mounted on the base of the oscillator tuning condenser, which, incidentally, extends through a cutout in the chassis top, was sufficient, together with the support given the dial by the connection to the tuning condenser shaft. The 30  $\mu\mu\text{f}$  tuning condenser must also be mounted on a right-angle bracket. No particular data is given for this part of the construction, as all measurements, etc., will depend entirely on the parts used.

After the chassis and panel have been prepared, mount all of the larger parts—that is, the power transformer, tuning condensers, speaker, volume control, switches, b.f.o. transformer, i.f. transformers, choke, can type

electrolytic condenser, dial, and tube sockets. Also the dial plate which is to serve as a band-set marker on the large oscillator tuning condenser can be mounted now more conveniently than after the wiring is completed. If the holes have been drilled and punched as given in the specifications, very little trouble should be experienced with this phase of the work. The panel is held to the chassis by the mounting bushings for the two switches, volume control, and r.f. tuning condenser. The speaker is fastened to the panel with four  $\frac{1}{8}$ " stove bolts and the dial escutcheon is held in place with the four small machine screws provided.

## Alignment Procedure

Alignment of the set is simple, as the band-spread condenser permits a certain amount of misalignment in the coils to be compensated for. Best results with the band-spread, however, can be obtained only if the coils are so trimmed as to give perfect tracking, and it is suggested that this condenser be set on center position and L4 coils adjusted to give loudest signals. This may be done at a point where the "bathtub" condenser is about two-thirds in. Needless to say, the i.f. section must be perfectly aligned before any attempt is made to regulate the r.f. end of the receiver.

## List of Parts

- |   |  |
|---|--|
| 1—8 $\mu\text{f}$ , 450 v tubular condenser, C1                     | 1—300 ohm, $\frac{1}{2}$ -w resistor, R8                       |
| 2—Dual 8 $\mu\text{f}$ , 450 v upright can elect. condenser, C2, C3 | 1—10,000 ohm variable resistor, R9                             |
| 2—10 $\mu\text{f}$ , 35 v elect. condenser, C4, C8                  | 1—Power transformer, T1 6.3 v @1.2a, 5-v @2a, 600-v c.t.       |
| 1—.01 $\mu\text{f}$ , 600 v condenser, C5                           | 1—b.f.o. transformer, T3                                       |
| 2—.00025 $\mu\text{f}$ mica condenser, C6, C7                       | 1—1500 kc iron core i.f. transformer, T4                       |
| 1—.0001 $\mu\text{f}$ mica condenser, C10                           | 1—1500 kc iron core i.f. transformer, T5                       |
| 2—.1 $\mu\text{f}$ , 200 v condenser, C9, C11                       | 1—30 h choke, L2   |
| 1—30 $\mu\mu\text{f}$ variable condenser, C12                       | 1—Osc. plug-in coil, L3  |
| 1—150 $\mu\mu\text{f}$ variable condenser, C13                      | 1—r.f. plug-in coil, L4  |
| 1—140 $\mu\mu\text{f}$ variable condenser, C14                      | 1—s.p.s.t. on volume control, Sw1                              |
| 1—800 ohm, 1-w resistor, R1   | 1—s.p.s.t. toggle, Sw2   |
| 2—70,000 ohm, $\frac{1}{2}$ -w resistors, R2, R10                   | 1—s.p.s.t. toggle, Sw3   |
| 1—250,000 ohm, $\frac{1}{2}$ -w resistor, R3                        | 1— $4\frac{1}{2}$ -inch dynamic speaker with 450 ohm field, L1 |
| 2—50,000 ohm, $\frac{1}{2}$ -w resistors, R4, R7                    | 1—Circuit-opening jack, J1                                     |
| 1—100,000 ohm, $\frac{1}{2}$ -w resistor, R5                        |  |
| 1—10,000 ohm, 10-w resistor, R6                                     |  |

# Wide-Band Broadcast Tuner

**F**OR PERSONS who live within forty miles or so of a broadcasting station a t.r.f. tuner is entirely adequate and has some advantages, particularly in large metropolitan areas where there are more than three stations. For high-fidelity reception, it is essential that our tuner not cut sidebands, or, that is, not have too high selectivity. As the standard AM broadcast stations generally operate so as to limit their band width to 10 to 20 kilocycles, it is necessary to provide a tuner with a response characteristic which has a flat top 15 or 20 kilocycles wide. This can be done well with a superheterodyne, but requires special intermediate frequency transformers and a complex circuit. A simple three-tube tuned radio frequency receiver can be built with a reasonably flat 15 to 20 kilocycle band width for a small fraction of the cost of the super. The t.r.f. tuner will have a lower noise level, as it contains less tubes. It is

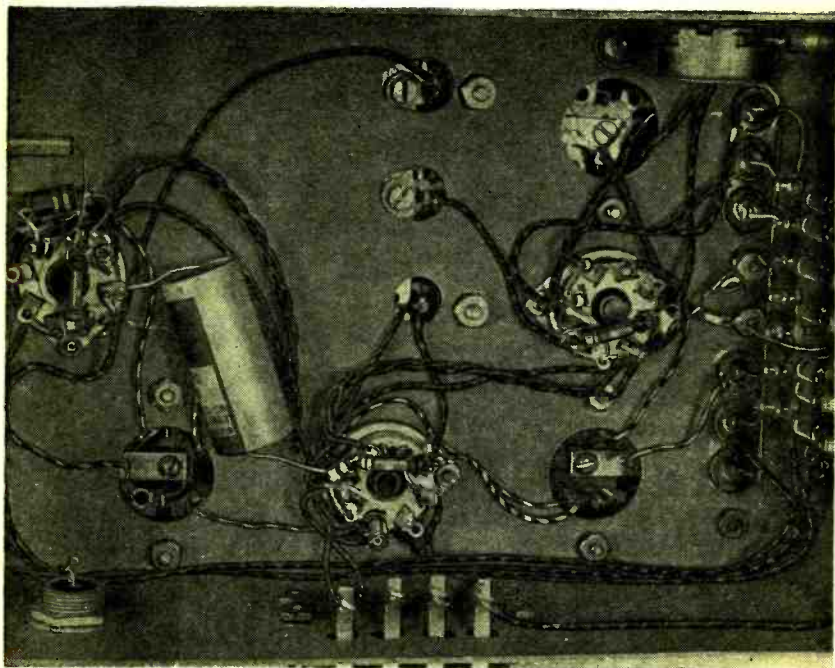

Fig. 1—Under-chassis wiring is simple and appearance improved by resistor board.



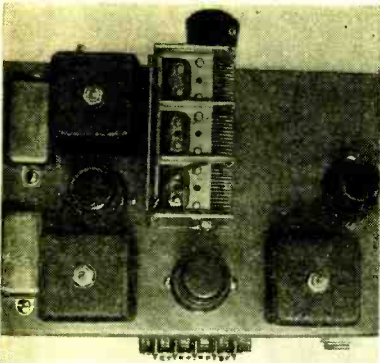

Fig. 2—Top view of high-fidelity tuner.

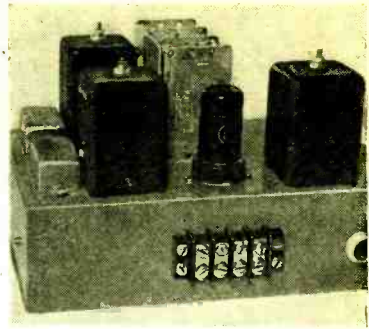

Fig. 3—Rear view of broadcast tuner, showing aerial connection (right) and terminal block for power and output.

also much easier to align. All that is necessary is to have a screwdriver and a station. The heart of this tuner is the coils. They should be of the shielded type.

Iron-core coils have the advantage of being tunable, so that the inductance of the coil may be varied to suit the variable that you have.

The condenser is a three-gang unit, and should have trimmer condensers mounted on it. If not, three auxiliary compression-type condensers that have a capacity of about 70  $\mu\text{mf}$  should be provided. All else we need are three octal tube sockets, a few resistors and condensers and a chassis. The chassis may be bent from steel or aluminum.

The layout shown in Figs. 1 and 2 worked out very well. However, it can be changed somewhat if the shape of your chassis is different. The important thing is to keep the grid leads from the tube to the condenser and coil, short, and as far away from the other grid leads as possible, or oscillation will result. These leads should also be kept close to the chassis, to keep down stray coupling. The parts are mounted on a resistor board, which makes for a very neat arrangement.

A simple resistor board can be made of a piece of bakelite, cut in an oblong shape as in Fig. 4. Holes are drilled and soldering lugs are bolted to the bakelite. Resistors are soldered between the lugs. Of course, the resistors can be hung on the tube socket pins if a resistor board is not used. A terminal strip is provided on the back for connection to a power source. It is assumed that any standard amplifier will stand the additional current drain, which is very light, being in the order of 25 milliamperes. If the amplifier does not have a 6.3-volt filament supply, or if it is heavily loaded, a 1½-ampere 6.3-volt transformer may be mounted on the tuner. Note that the output is taken from a microphone connector and should be run through shielded mike cable to the amplifier.

The circuit diagram is shown in Fig. 5. An audio volume control was not included as it is assumed that the builder's amplifier will have one. If one is used it would be connected as in Fig. 6. It will be noted that

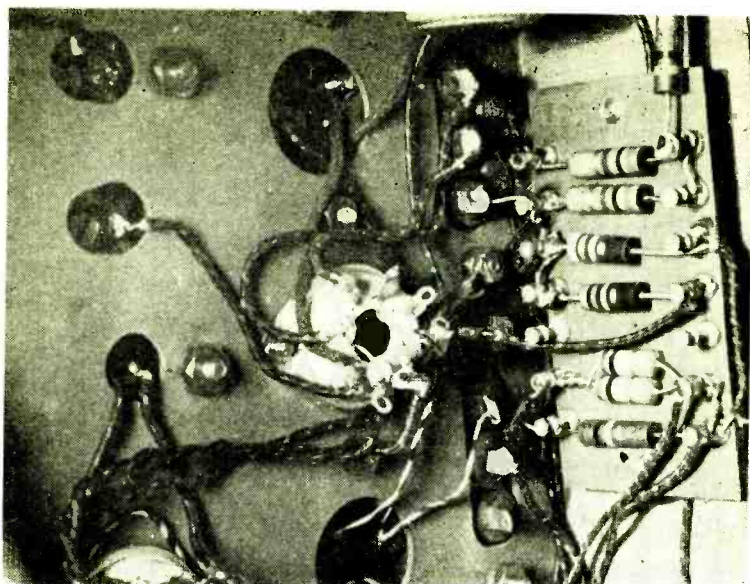

Fig. 4—How resistor strip looks in a close-up.

resistors are connected across the coils. This is to increase the band width by reducing the  $Q$  of the coils and making their tuning broader. An r.f. gain control is provided as a sensitivity control. It has several functions. First, it allows the tuner sensitivity to be reduced when receiving a powerful local signal, which might overload the first tube's grid and cause serious distortion. Second, it may be advanced almost to the point of oscillation to provide high sensitivity and greater selectivity so that two adjacent powerful stations may be separated.

The detector is of the so-called infinite-impedance type, which has many advantages. It has very low distortion, which makes it particularly adaptable for high fidelity reception. Its low output impedance is not affected by shunt wiring capacities, so the high audio frequencies are not attenuated.

The output is taken from the cathode through a coupling condenser to keep the d.c. drop across the cathode resistor from biasing the first grid in the amplifier.

The wiring is straightforward, the heaters being wired first and then the grid and plate leads, care being taken to keep them short and well apart.

When the unit is finished it should be connected by means of the terminal strip shown in Fig. 3 to 6.3 volts at  $1\frac{1}{2}$  amperes and 250 volts at 25 milliamperes. An amplifier should be connected to its output and turned on. The unit should have an outside antenna if it is to be used at some distance from a station. In the city you may use 20 feet of wire run under the rug, though an outside aerial will more than pay for itself by improving the signal to noise ratio.

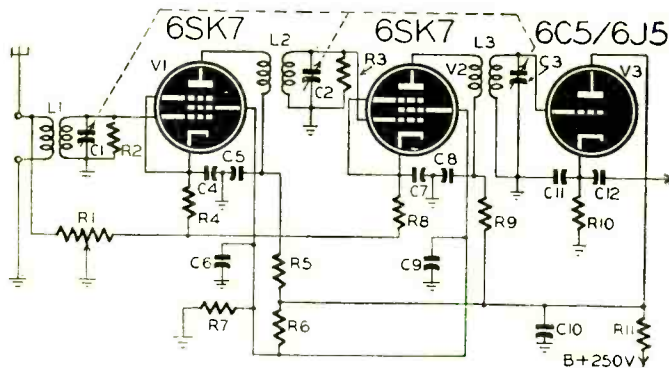

Fig. 5—Tuner is a 3-tube t.r.f. with infinite-impedance detector.

Turn the dial until a station is received. If no station is heard, then adjust the trimmers, listening to the noise level with the sensitivity control advanced full. When a station is heard, adjust the trimmers until it is at its maximum loudness. Start with the detector trimmer and work toward the one on the first r.f. stage. That done, turn the condenser all the way out to see if you can tune to a high enough frequency. If a station is heard with the condenser all the way out, turn all the adjustable slugs in the coils clockwise several turns to reduce their inductance. Then readjust trimmer for maximum volume. Turn the condenser to the low frequency end (plates engaged) and readjust slightly. If the position of the trimmers is very different at this end of the condenser, bend the end condenser plates until the trimmer adjustment holds over the whole dial.

A dial of the slide-rule or airplane type would be desirable, but a plain knob and pointer may be used with a Bristol board scale. The frequencies may be penned in with India ink.

### List of Parts

- R1—10,000 ohms potentiometer
- R2, R3—100,000 ohms
- R4—400 ohms
- R5—10,000 ohms
- R6—50,000 ohms
- R7—60,000 ohms
- R8—400 ohms
- R9—10,000 ohms
- R10—60,000 ohms
- R11—5,000 ohms, 10 watts (optional if power supply is well filtered)
- C1, C2, C3—gang condenser, .00036  $\mu$ f
- C4, C5, C6, C7, C8, C9—.1  $\mu$ f

- C10—8  $\mu$ f, 450 volt electrolytic
- C11—.0001  $\mu$ f mica
- C12—.1  $\mu$ f, 600 volt, tubular
- L1—Iron core shielded ant. coil
- L2, L3—Iron core shielded r.f. coils

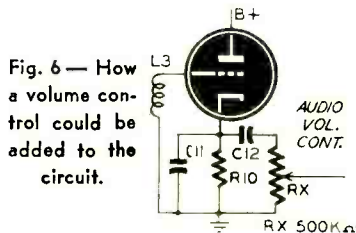

Fig. 6—How a volume control could be added to the circuit.

# 144-Mc RECEIVER

FOR THOSE interested in listening to amateur phone stations in the 144-148 mc "ham" band and for those planning to become licensed amateur operators in this band, this receiver is ideal for a starter.

In general, the v.h.f. of about 100 mc and higher are limited to line-of-sight distance. This means that greater distances are covered by higher antenna systems. Fig. 1 illustrates approximate line-of-sight distance vs antenna height. To find the distance which can be covered between two stations, add together the distances which correspond to each antenna height.

The v.h.f. permit very compact and simple sets and components. Mobile stations (such as in cars or boats), can be conveniently outfitted by amateurs. Such sets can be operated from storage battery and vibrator supplies.

Many ordinary tubes cannot be used at very high frequencies because of capacitance and leakage paths. Among efficient types are the 7A4, 6C4, 9002, 1201 and 955. The latter two are somewhat similar and are effective even at 700 mc. Because of its compactness and effectiveness, the 955 is used in many "ham" shacks.

A simple circuit using the 955 acorn tube in a superregenerative stage is shown in Fig. 2. It has been used as shown, but a two-stage amplifier



Fig. 1—Antenna height for given radio range.

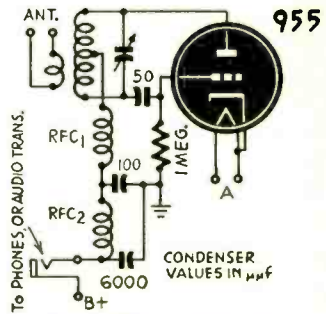
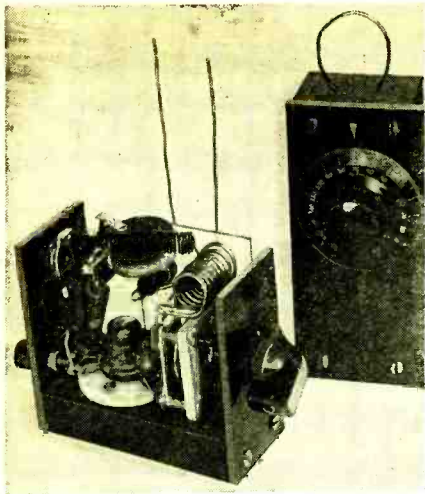
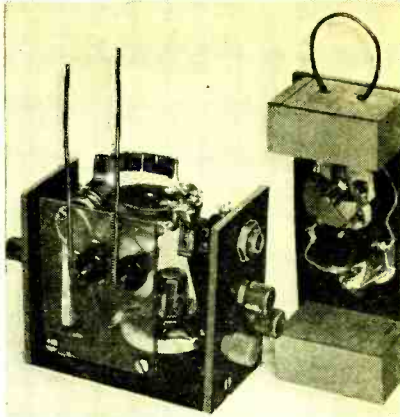

Fig. 2—The receiver is a superregenerator.





Front view of 955 receiver and wavemeter.



Above—Rear view of receiver and wavemeter. The receiver employs a 955 acorn tube connected in a superregenerative circuit. This set is ideal for mobile use with batteries.

can be added for speaker response. It is adaptable to mobile use since it can work with a low plate voltage (less than 35 volts).

The tank coil is wound on a  $\frac{1}{2}$ -inch form with  $61\frac{1}{2}$  turns of No. 14 bare copper wire, and is spaced to take up a total length of  $\frac{3}{4}$ -inch. The band is correctly centered on the dial by spreading the coil turns apart or squeezing them together. The antenna coil is a single turn, ending in tip jacks for external connection. The tuning condenser is a two-plate Cardwell with a range of 0.2 to 2.8  $\mu\text{f}$ . The entire amateur band covers about half the total condenser rotation allowing ample room for the "marker" stations as well.

Some amateurs use two variable condensers in parallel, a large one to locate the band and the other to tune, as in Fig. 3. It is easy, however, to lose the band through accidental rotation of the larger condenser. Besides, a much lower Q exists with the large capacitance. We find that the use of a single small condenser gives better results although it is much more difficult to find the band originally. The radio-frequency choke RFC1 is wound with No. 26 wire on a  $\frac{1}{4}$ -inch form with 30 turns. The total length is about  $1\frac{1}{4}$  in. RFC is an 8-mh r.f. choke which prevents loss of energy in the output circuit. A one-megohm resistor provided superregeneration. Some circuits may require experimentation with this component. Improper value may result in audible squeal or absence of hiss entirely.

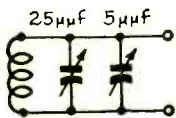
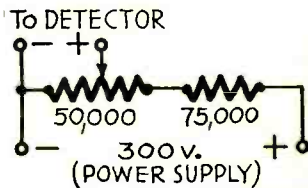

Fig. 3 — (Left) Band-spread tuning arrangement.

Fig. 4 — (Right) Voltage adjustment is in power-supply.



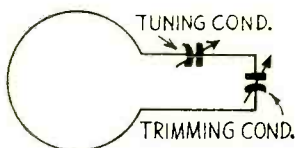

Fig. 5—Absorption wavemeter circuit.

For optimum results the following procedure can be followed to determine the tank “center” tap. Connect RFC1 to some point near the middle of the coil, then reduce the plate voltage (as by means of

the potentiometer in Fig. 4) until the set just goes out of superregeneration (hiss disappears). Now move RFC1 to a nearby point on the coil and try to find a point where superregeneration still occurs, and so on.

The voltage node corresponds to the point where operation results with the lowest voltage. This is the correct position for the RFC1 connection. If the choke is held by its far end during the adjustment, there will be no need for soldering until the final point is located.

The rear panel contains a phone jack and three binding posts for connection to A and B supply. Since the acorn tube works well with a minimum of 25 volts, it is ideal for mobile work with batteries.

For convenience a dipole antenna is used. Good results have been obtained with a single feeder tapped 7 inches from the center of the vertical  $\frac{1}{4}$ -inch brass tubing dipole. Antenna length is 40 inches.

## Lecher wires for Calibration

Calibration by harmonics of lower frequencies is not very useful with “rush-boxes” since unmodulated signals are heard only as a reduction of noise. The most accurate method of frequency finding is the use of Lecher wires. We use a Lecher wire system constructed on a 7-foot length of 1x2-inch white pine. Bare wires, one inch apart, are stretched the length of the baseboard.

At one end the wires are insulated by stand-offs and at the other end small turnbuckles (the ten-cent variety) are used to maintain tension (Fig. 6). No insulation is needed at the latter end. A loop of wire made up of a total length of about 18 inches is connected to the insulated end for coupling to the receiver antenna.

Now the Lecher wires are coupled to the receiver antenna through the 18-inch loop.

A runner made of 1x2-inch wood with a metal shorting strip slides along the base board (Fig. 7). As this portable shorting bar is moved along the wires a resonant point is reached where the detector will go out of oscillation; at this point the rushing sound in the headphones will be greatly reduced. This point is noted. The shorting bar is now moved out to the next resonant point. The distance between these two points determines the operating frequency (Fig. 8).

For convenience we have marked off the wooden base in foot lengths. Then it is only necessary to measure from a resonant point to the nearest mark and subtract or add as called for. The Lecher wire board may be screwed down to a table at each end while it is being used.

Fig. 6—Turn-buckle arrangement for tightening Lecher wires.

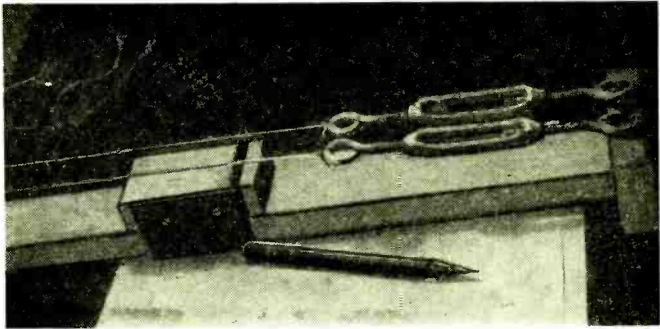

The use of an absorption meter is ideal if the band is once located or if it is desired to duplicate the frequency of another receiver or transmitter. It consists of a tuned circuit with means for calibrating. Fig. 5 shows such a circuit. One turn of No. 14 wire ( $\frac{3}{4}$ -inch radius) is used with a  $35\text{-}\mu\mu\text{f}$  tuning condenser and a trimmer condenser to set the band. (See photos.)

When the loop is brought near a superregenerating receiver the latter will go out of superregeneration into ordinary oscillation when both circuits are in tune. In this condition, only carrier whistles will be heard, most of them probably receiver re-radiation. It is advisable that the band be calibrated on the absorption meter before "improvements" are contemplated on the receiver since it is an easy matter to lose the band and difficult to relocate it.

Much interference on the v.h.f. is due to the use of "rush boxes" by both amateurs and v.h.f. listeners. These circuits are periodically interrupted oscillators which may radiate over a broad band with favorable radiators. They constitute, in fact miniature transmitters when used with high voltages. Even a 955 can put approximately  $\frac{1}{2}$  watt into an antenna.

It is recommended that only low plate voltages be used with superregenerators. No appreciable signal increase has been found to result from high voltages. It is also recommended that inductive rather than direct coupling be used. A single turn loosely coupled is satisfactory.

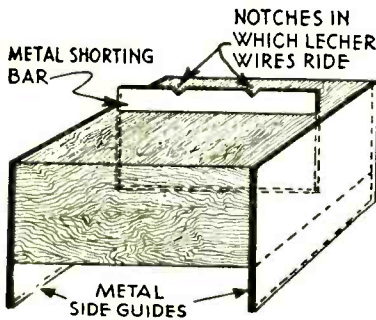

Fig. 7—Sliding block used to short Lecher wires.

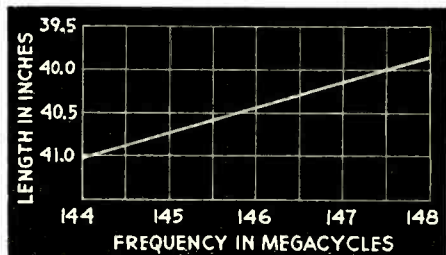

Fig. 8—This chart shows the frequency for a given distance between nodes on the Lecher wire system.

# V. H. F. RECEIVER

**I**NTEREST IN very high frequencies has resulted in a demand for a good, modern receiver for the very short waves. Some of this demand has been supplied by modified war surplus gear. The v.h.f. war surplus receivers are a bargain to the experienced radio man who can alter them to suit his purposes. For the beginner and probably for the average experimenter and ham the superregenerative receiver would still seem to be the best bet.

The circuit is the self-quenched superregenerator. A 9002 tube is used for the detector. It mounts in a "button" type miniature socket whose contacts are very secure as compared to some types of sockets. A base connection plan is shown on the circuit diagram (Fig. 1).

A relatively new tuning system—the butterfly tuning capacitor—is used. This provides practically linear tuning and completely eliminates the noise from the moving rotor. A manufactured type would have been used but none were available at the time. Cardwell has introduced two units, one having a range of 11 to 14  $\mu\mu\text{f}$  and the other of 6 to 11  $\mu\mu\text{f}$ . If the reader prefers a ready-made part we recommend the smaller size. It will provide better Q at the frequencies desired.

A 6SF5 is used in the first audio stage. Greater gain is thus realized even if the plate voltage supply is low. A 6K6 is used in the output

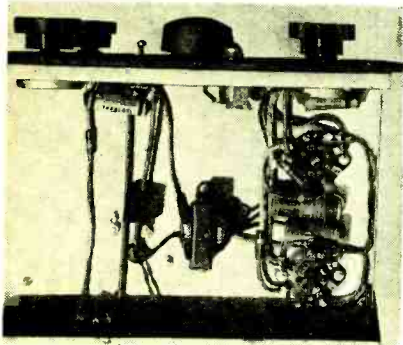

Little apparatus appears below the chassis.

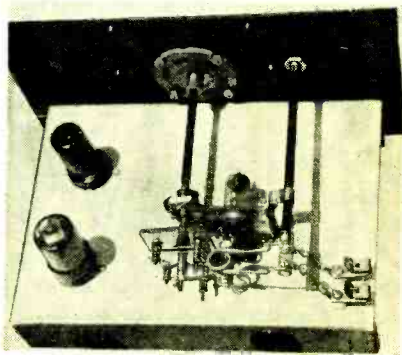

Parts layout is clearly visible in this rear view.



section. Plate and screen connections are brought out to two banana jacks on the rear of the chassis for speaker connection. The switch (SW) is for standby.

Construction of this receiver is not difficult. A 7 x 10 inch chassis is used. This allows plenty of room to add an r.f. stage later if desired.

The panel is a piece of masonite 6 inches high by 11 inches long. Holes for regeneration control, the standby switch, pilot light and the volume control, are drilled in a row along the bottom of the panel one inch up from the lower edge. These should be placed symmetrically to maintain a good front-panel appearance. The holes for two 10-32 oval-head screws that secure the panel to the chassis should be drilled along the same line, one inch in from either side.

A hole 2 inches in diameter is then cut in the panel. This should be centered and 2-7/16 inches from the top edge. The mechanism from an old National Velvet Vernier dial with the dial removed is then installed in this 2-inch hole and secured with four 3/8-inch, 6-32 flat head machine screws. This allows the movable part of the dial to come out flush. A lucite pointer may be attached to this part with the three original screws. The panel then may be given two coats of flat black enamel allowing ample time for drying between coats. An escutcheon plate similar to the one used should now be made of thin sheet brass stock and also given a coat or two of flat black. The dial card (of draftsman's Bristol Board or a good quality index card) should be made of ample size to allow for the swing of the pointer and to match the escutcheon plate. The card we used when trimmed measured 2 1/2 x 4 3/8 inches and the escutcheon was made to match this size. Two or three half-circles may now be drawn on the card for calibration purposes. If carefully handled this home-made dial will present an appearance that will match that of a commercially-made unit and should be presentable in the most finished station.

The chassis should now be prepared by making the socket holes for the two audio tubes on the top and that for the five prong socket on the rear. Two 5/16-inch holes are drilled for two banana jacks on the rear

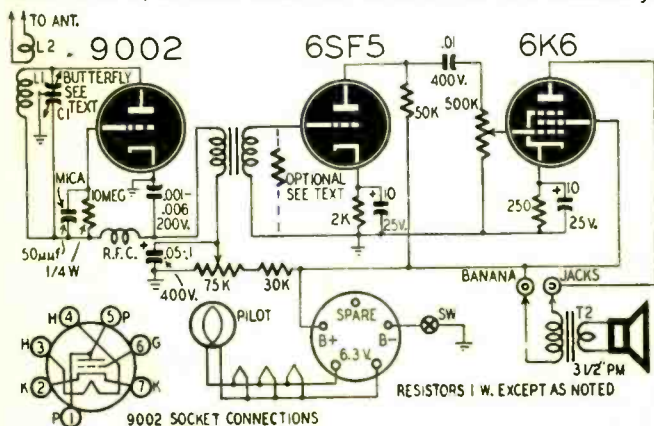

Fig. 1 — Except for the butterfly-tuned super-regenerative detector, circuit is a straight-forward 3-tube v.h.f. receiver.

of the chassis near the 6K6 socket, for speaker connections. The detector section construction may well be started by the dismantling of a Cardwell tuning condenser, type ZR15AS. This is a midget, single bearing rotor type and lends itself well to revision since it is assembled with machine screws and nuts. The original steatite base may be used as a template for drilling a piece of polystyrene for a new base. This material is preferable due to its low loss characteristics at very high frequencies but the steatite might be used if polystyrene is not available. Details of the modification are pretty clearly shown in the photograph. Fig. 2 and Fig. 3 give drilling details and provide a full size pattern for both rotor and stator plates. As shown in Fig. 2, new stator plates were cut out of thin sheet aluminum to get the maximum capacity possible, since we weren't sure how much would be necessary for the coverage desired. This accounts for the difference in the shape of the stator plates in the photograph and the originals. Either may be used.

Using a set of two stator plates and one rotor plate with single spacing, satisfactory bandspread was achieved in our receiver. This combination with the coils as constructed gave ample spread for the two meter band. If the builder plans to use the 1¼ meter band he may prefer to double-space the capacitor and make the coil somewhat larger to get greater bandspread.

The photos and Fig. 2 show how the coils are mounted across the stator plates for short connections. The tube socket is directly behind the coil, mounted on a small aluminum bracket. The antenna coupling assembly is two Fahnestock clips mounted on two small stand-off insulators. Flexible leads connect to the movable shaft which holds the two-turn coupling loop. This coupling loop is mounted on a small piece of polystyrene tubing with two small machine screws, and this in turn is mounted on the end of the movable shaft which is a 5⅜-inch length of ¼-inch bakelite rod. In similar fashion the tuning capacitor is coupled to the dial using a 2¾-inch length of the same rod and a Millen flexible coupling made of steatite. By having the tuning assembly at the rear of

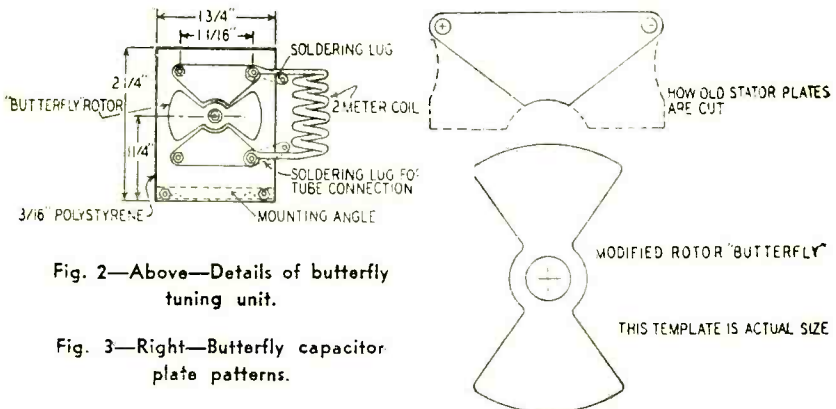
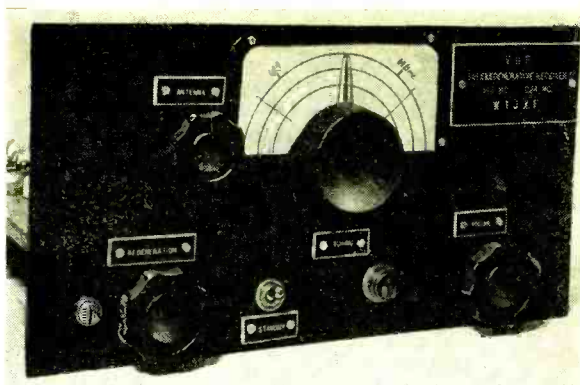

Fig. 2—Above—Details of butterfly tuning unit.

Fig. 3—Right—Butterfly capacitor plate patterns.

Front view — note  
the boundaries of  
the 144-148 mc band.



the chassis body capacity effects are eliminated. The r.f. choke is home-made and is shown in the photo, below the tuning coil. It is made by winding 16 turns of No. 24 enameled wire on a  $\frac{1}{4}$ -inch form and removing the form afterward. Tin the ends of the wire and solder it directly to the soldering lug on the grid stator plate.

In wiring it is excellent practice to connect up all heaters first, then the cathodes and then the rest of the audio components. When wiring the detector section, keep in mind that short leads are imperative in very-high-frequency circuits, since only a fraction of an inch here and there will add up to sizeable values of inductance and capacity when the whole circuit is considered. For instance, the plate of the tube is connected to the stator by a  $\frac{1}{4}$ -inch wire and the grid is tied to its stator by direct connection to the capacitor and its grid leak.

The coil for the two-meter band is made by winding 6 turns of No. 20 tinned copper wire on a  $\frac{3}{8}$ -inch form and then removing the form. The turns are then spread to occupy about  $\frac{5}{8}$ -inch in length. The  $1\frac{1}{4}$ -meter coil is made with three turns and spread to approximately  $\frac{3}{8}$ -inch. These will undoubtedly need adjustment when the receiver is calibrated.

The five-prong socket at the rear of the chassis is for the power connections and should be wired as marked in Fig. 1. A spare prong will be noted. Its purpose is for the use of a power supply with a built-in voltage divider. If one of these (or batteries) should be used the detector voltage may be adjusted to approximately 50 at the 75,000-ohm regeneration control, and the 30,000-ohm dropping resistor eliminated. The external power supply should be a low power unit capable of delivering 200 to 250 volts at 40 to 50 milliamperes. The speaker used should have an output transformer to match the pentode output tube. An inexpensive  $3\frac{1}{2}$ -inch PM unit gives ample volume.

### Testing the Set

The power supply may be turned on with the standby switch (SW) in the off position to note if the heaters are correctly wired. The speaker must be plugged into the banana jacks before the high voltage is applied

to avoid ruining the screen of the 6K6. When switch (SW) is snapped to the ON position the superregenerative hiss characteristic of this type of receiver should occur at some point as the regeneration control is advanced. If the set will not regenerate smoothly, some experimentation

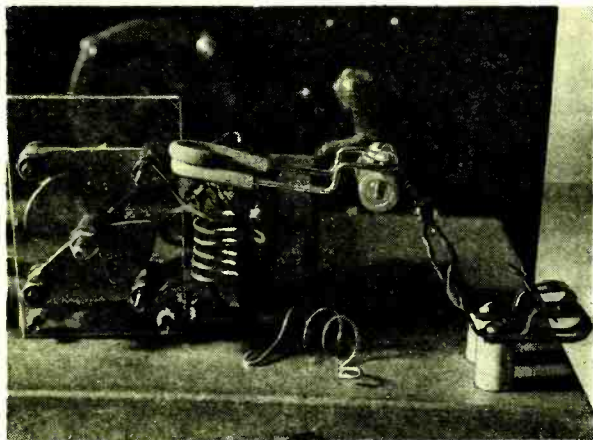

Rear view of receiver, showing antenna-coupling link.

will be necessary. The radio frequency by-pass capacitor, marked “.001 to .006” in the diagram, should be changed until best performance is noted.

In our particular case a  $0.002 \mu\text{f}$  condenser was best but values from  $0.001$  to  $0.006 \mu\text{f}$  should be tried. The by-pass capacitor may or may not be necessary. Values from  $.05$  up to  $1$  or  $2 \mu\text{f}$  might be used to eliminate the noise from the potentiometer rotor. If audio howl is present the resistor shunting the secondary of the a.f. transformer and marked “optional” in Fig. 1 will have to be used. Use the largest possible value since smaller values reduce the volume appreciably. Values from  $1$  megohm down to  $50,000$  ohms may be tried.

When the receiver “soups” satisfactorily, the band to be used will have to be located. With the proper coil connected across the condenser the frequency may be checked by the use of a homemade wavemeter which has been previously calibrated by another receiver already located in the band. Usually some neighboring ham or experimenter will have one of these which he will lend you. This wavemeter should be coupled to the detector coil by bringing them close together. Then tune the wavemeter. When the receiver blocks (goes out of oscillation) the receiver frequency is that of the wavemeter and the reading on the wavemeter dial may be marked on the receiver dial. If the wavemeter is deemed accurate enough the megacycle and half-megacycle points can be marked in.

If no wavemeter is available, the receiver may be roughly calibrated by using Lecher wires to locate the bands and then more closely lined up by listening for marker stations. Data on the construction and use of Lecher wires is given in the article “144-Mc Receiver” on page 58. We used a matched impedance type antenna erected at a height of  $40$  feet above the ground, which has given very satisfactory results.





*The Constantly expanding*  
**GERNSBACK LIBRARY**

**29—HANDY KINKS AND SHORT CUTS.** A compilation of practical methods of overcoming difficulties encountered by every radio man. Here are kinks on antennas, servicing, the shop, power supplies, etc. — arranged by sections for easy reference, and illustrated. 64 pages. 50¢.

**31—RADIO QUESTIONS AND ANSWERS.** Here are answers to questions most frequently asked the titors by radiomen. The material selected is well diversified and chosen for practical application to workaday problems. Many diagrams. 64 pages. 50¢.

**32—ADVANCED SERVICE TECHNIQUE.** An up-to-date collection of information on specialized phases of servicing, appealing to the advanced serviceman. The book is a diversified library of ideas, methods, and procedures not found in other books for professional servicemen. 64 pages. 50¢

**33—AMPLIFIER BUILDER'S GUIDE.** A valuable book for the designer and constructor of sound equipment. Theory and construction of audio amplifiers are treated. It contains a wide range of technical data on amplifier design, followed by constructional details for a variety of amplifiers. 64 pages. 50¢

**34—RADIO-ELECTRONIC CIRCUITS.** Here is an extensive collection of circuit diagrams with a brief description of each, to serve as a source of inspiration to the experimenter bent on developing new circuits. Constructional data is purposely limited to allow space for a maximum number of circuits. 64 pages. 50¢

**35—AMATEUR RADIO BUILDER'S GUIDE.** Here is a book for the "ham" who builds his own. Practical and down-to-earth, it is divided into sections on receivers, transmitters, and accessories (antennas, converters, and other equipment). The book is packed with information. 64 pages. 50¢

**36—RADIO TEST INSTRUMENTS.** Every radio man can use this new book on building test equipment. Among the instruments described are signal tracers, capacity meters, portable and bench multicheckers, signal generators, tube checkers, and electronic voltmeters. 64 pages. 50¢

**37—ELEMENTARY RADIO SERVICING.** How to get started and keep going. A wide range of essentials is covered: Planning and Equipping the Shop, Systematic Circuit Checks, Signal Tracing Methods, Servicing Midget Receivers, and other fundamental servicing topics. 64 pages. 50¢.

**39—PRACTICAL DISC RECORDING.** This invaluable book is the last word on making good recordings. Technique as well as underlying principles are fully covered. Each important recording component is given a full chapter, explaining its purpose and what features to look for when buying. 96 pages. 75¢

**40—THE CATHODE-RAY OSCILLOSCOPE.** This up-to-the-minute book explains how the scope works and its use for servicing and amateur operation. Television, FM and AM receiver alignment is described in progressive stages; also checking modulation percentage, a.c. hum, and general trouble shooting. 112 pages. 75¢

**41—PUBLIC-ADDRESS GUIDE.** A brand new easy-to-read book that opens a new source of income for service technicians in installing, operating and servicing P.A. systems. Also discusses outlay and income and gives complete construction details for a system that handles 90% of all P.A. requirements. 80 pages. 75¢

**42—HIGH-FIDELITY TECHNIQUES.** Brand new! A common-sense guide to high-fidelity audio design by James R. Langham, Radio-Electronics' popular audio writer. Not a slice-rule and laboratory treatise, but an unusual book that will help every hi-fi man get top performance from his equipment. 112 pages. \$1.00.

**WATCH FOR NEW TITLES NOT LISTED HERE**