

radio and tv

# TEST INSTRUMENTS



No 49

GERNSBACK LIBRARY

\$1.50

*BK - 906*

# **RADIO and TV TEST INSTRUMENTS**



Gernsback Library No. 49

**PUBLISHED BY**  
**GERNSBACK LIBRARY, INC.**  
New York, N. Y.

COPYRIGHT, 1953

BY HUGO GERNSBACK

All Rights Reserved

First Printing—July, 1953

Second Printing—June, 1955

Third Printing—May, 1957

# RADIO and TV TEST INSTRUMENTS

Chapter 1	Television Grid Dip and Absorption Meter . . . . .	<i>H. L. Bumbaugh</i> . . . . .	7
Chapter 2	Picture Tube Circuit Analyzer . . . . .	<i>H. L. Matsinger</i> . . . . .	16
Chapter 3	Picture Tube Tester . . . . .	<i>General Electric Company .. Tube Dept. Electronics Div.</i>	21
Chapter 4	The TV Service Aid . . . . .	<i>Charles G. Buscombe</i> . . . . .	28
Chapter 5	Television Intercom . . . . .	<i>Milton Lowens</i> . . . . .	33
Chapter 6	Three-Inch Oscilloscope . . . . .	<i>Robert C. Sanford</i> . . . . .	37
Chapter 7	Oscilloscope Calibrator . . . . .	<i>Robert F. Scott</i> . . . . .	46
Chapter 8	Omnitester . . . . .	<i>Wesley Neelands</i> . . . . .	52
Chapter 9	Portable Signal Generator . . . . .	<i>J. C. Anderson</i> . . . . .	57
Chapter 10	Signal Launcher . . . . .	<i>Robert E. Altomare</i> . . . . .	61
Chapter 11	Dynamic Signal Tracer. . . . .	<i>W. Carl Marsh</i> . . . . .	67

Chapter 12	Practical VTVM .....	<i>Julian P. Freret</i> .....	73
Chapter 13	Multi-Purpose Tester .....	<i>A. Iwaniewsky</i> .....	79
Chapter 14	Volt-Ohm-Milliammeter ....	<i>William C. Stoecker</i> .....	85
Chapter 15	Sensitive R.F. Voltmeter....	<i>A. Stratmoen</i> .....	91
Chapter 16	Resistance and Capacitance Bridge .....	<i>J. W. Korte</i> .....	95
Chapter 17	Power Tester .....	<i>Rufus P. Turner</i> .....	101
Chapter 18	Loudspeaker Test Unit ....	<i>Samuel P. West</i> .....	103
Chapter 19	Television Marker Generator .....	<i>Bruce Morrissette</i> .....	106
Chapter 20	Carrying Case for Home Service .....	<i>Andrew E. Jackson</i> .....	113
Chapter 21	Work Bench for Radio and TV .....	<i>C. R. Askey</i> .....	120
Chapter 22	Miscellaneous Test Equipment .....	<i>William E. Wadsworth and George Kelly</i> .....	125

# Introduction

**T**HERE is such an excellent variety of radio and TV test instruments available both in complete and "you build it yourself" form, that it may be somewhat surprising to learn that many service technicians still prefer to design and construct their own.

In a sense, construction of test equipment is really a measure of a technician's mechanical and electronic ingenuity. For those who wish to get the maximum amount of test equipment with the least expenditure of time and money, following the circuits and mechanical layouts shown in each chapter is perhaps the wisest procedure. Constructors having a good mechanical flair and those having a substantial electronic background should have no hesitancy in making changes to suit their own personal ideas or requirements.

The prime motive for home construction of test instruments is not always based on the economic factor—the desire to save money, or the inability to make the necessary financial outlay. Quite often test equipment is built to meet a particular servicing need. Constructing your own has the added advantage that "if you make it, you're not afraid to fix it."

Fear of obsolescence is another factor. Home constructors feel that advances in radio and television introduce some element of risk in the purchase of commercial test apparatus and for that reason may prefer to build equipment which they will have no hesitancy in modifying.

The test equipment described in these pages covers almost all of the test units used in modern day radio and television servicing. Perhaps for the first time in a book of this type there is

included a chapter on the construction of a carrying case for home service and also a chapter on building a service bench for radio and TV. The carrying case and service bench have become such a definite part of servicing that these units should be designed to "work together" with test instruments.

Every one of the test instruments described in this book has been built, tested, and used by practicing service technicians. Originally appearing in RADIO-ELECTRONICS Magazine, they have been combined here as a service for the man who still likes to build his own. Grateful acknowledgment is made to the many contributors who helped make this book possible. The names of these authors are listed in the Table of Contents. The Television Picture Tube Tester described in Chapter 3 originally appeared in the copyrighted publication Techni-talk, and is reprinted here through the courtesy of General Electric Co., Tube Department, Electronics Division.

# Chapter 1

## Television Grid Dip and Absorption Meter

**R**ADIO technicians do not often have access to such laboratory instruments as inductance and capacitance bridges and must first energize circuits to check their operating frequency and characteristics, instead of being able to assemble combinations of capacitors and inductors and predetermine their behavior when they are placed in a circuit. This test instrument helps overcome these difficulties.

This meter is an r.f. oscillator with a milliammeter in the grid circuit. Plug-in coils are used to vary the inductance, and a calibrated variable capacitor extends the frequency range for any one coil. The milliammeter reads rectified grid current, and this current is a measure of the energy in the oscillatory circuit—the greater the energy the greater the current.

This type of meter is called a grid dip meter and its operation is based on the interaction of coupled circuits. An example will best explain its operation.

Assume we have a coil and fixed capacitor hooked up in parallel and we wish to find the resonant frequency and  $Q$  of this circuit. This circuit could very well be in the i.f. section of a TV receiver. The L-C combination will absorb energy from an external or exciting source when its resonant frequency is the same as that of the source. Since our L-C combination is fixed, we must vary the frequency of the source to the correct resonant frequency. In this case the source will be a grid dip oscillator, or, as some prefer to call it, a grid dip meter.

First, select a coil for the meter whose range is likely to include the resonant frequency of the L-C combination. Then place the meter coil alongside the coil of the L-C circuit and tune the



meter through its range and watch the milliammeter for any change in reading. Initially the meter will read well up on the scale, but as you turn the capacitor dial it will make a sudden dip and then return to its high reading. Tune the meter for its greatest dip and refer to the tuning capacitor dial which is calibrated in frequency for each inductance coil. This frequency is the resonant frequency of the L-C combination, and the sharpness of tuning and depth of the dip gives a good idea of its Q.

When the energized circuit of the grid dip meter has the same frequency as the resonant frequency of your L-C combination, a transfer of energy takes place between the energized and the un-energized circuits. The energy lost from the meter circuit causes the feed-back in the oscillator circuit to decrease, and there is less

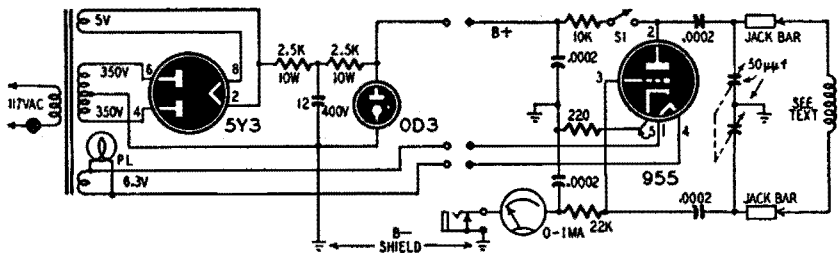

Fig. 101. The grid dip meter and its power supply. The units are connected by a 3-wire cable.

rectified grid current. The milliammeter which measures this grid current dips to its lowest value at the frequency where the energy absorption is greatest, and this is the resonant frequency of the circuit under test. A resonant circuit to be tested does not necessarily have an actual physical capacitor shunted across the coil. The distributed capacitance of the coil often forms part of the L-C combination.

Fig. 101 shows the circuit of the meter. It is one long used for grid dip meters and is easy to construct.

Fig. 102 is the additional circuit which is built into the meter case. It is an absorption meter for making TV antenna field strength measurements in locations where it is inconvenient to use line or batteries. When using the circuit a short antenna may be attached to the antenna binding post. Absorption meter coil data given in Table 1 covers only the lower frequency channels. Some experimentation will be necessary to cover the FM and high-frequency TV channels. A single-turn coil for the secondary and a two-turn coil for the primary should be correct.

## Construction details

The instrument is built into a 3 x 3 x 12-inch case made of Dural with the two sides and one end piece made of  $\frac{1}{4}$ -inch thick pieces and the top and bottom of  $\frac{1}{8}$ -inch pieces. The side pieces are drilled and tapped to hold the top and bottom in place with 6-32 screws.

One end of the case is made of lucite which is drilled to accommodate the two jack bars in which the coils are plugged. Details of the jack bars are shown in Fig. 103.

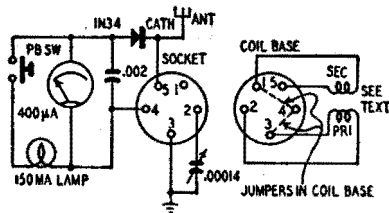

Fig. 102. The absorption meter circuit.

Two brackets, also shown in Fig. 103, must be made to hold the jack bars which are peened to these brackets in hole A which is drilled and countersunk to provide anchorage. To mount the brackets on the tuning capacitor, in this case a National STD 50, first take the capacitor apart and reassemble it with the brackets bolted to the stator assembly. When this is done, the jack bars will stick out from the stator plates with their center-to-center

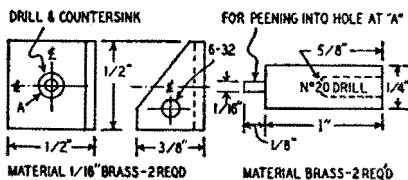

Fig. 103. Construction of capacitor brackets and jack bars.

distance about  $1\frac{1}{2}$  inches. Now the lucite end piece can be drilled to take the jack bars. One of the photos, Fig. 104, shows the capacitor assembly.

The jack bars should extend through the lucite end piece about  $\frac{1}{8}$  inch. A little Vinylite cement around the jack bars on both sides of the window will help keep them in place. The only other fastening is a sleeve of copper tubing around the jack bars between

the lucite and the bracket on the capacitor. This sleeve takes up the thrust when the coils are inserted.

Another bracket, made of aluminum, is mounted on the back to take the 5-pin coil socket for the absorption meter coils. Use ceramic sockets for the coil and the 955 tube. This socket is mounted about 4 inches from the Dural end of the case, and

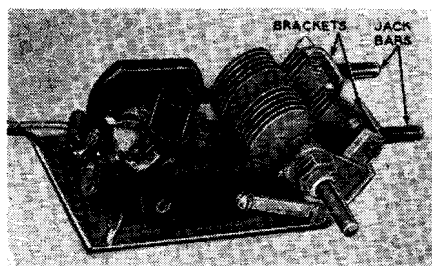

Fig. 104. Oscillator circuit sub-assembly.

a hole must be cut in the Dural bottom piece to fit over this socket. The rear view photo, Fig. 105, shows this bracket in place. The 140- $\mu\text{f}$  capacitor of the absorption meter is mounted directly below this bracket with its shaft extending through the top piece between the two meters.

Range (mc)	Secondary		Tuned primary		
	Turns	Wire Size	Turns	Wire Size	Winding Length (in)
1.75-6	11	30	38	24	1-5/8
4.5-16.3	6	30	18	20	1-1/2
10.4-28	4	30	9	16	1-1/4
25.3-80	2	30	3	16	1

Secondary turns all close-wound, 1½-inch diameter, spaced ¼-inch from primary. Use enameled wire for all windings.

The rest of the circuit can be assembled in any way. The only requirement is that the mechanical construction be very rigid, because this is a frequency measuring circuit.

### Coil data

Two sets of coils are needed for the instrument. One set is for the absorption meter and the other for the grid dip meter.

Fig. 105. This is a rear view of the grid dip and absorption meter. The front view of this instrument is shown to the right in the photograph, Fig. 107 on page 13. The 5-pin coil socket is mounted between the meters on a metal strip fitted across the back. The 5-pin socket does not have a keyway since there is only one possible way in which the coil can be inserted into the socket. All parts must be securely mounted or supported since vibration of components can spoil the accuracy of the instrument. The top end of the case is made of lucite. Each jack bar is connected to the stator of the two-gang 50-uuf variable capacitor. Since the jack bars are mounted securely on the variable capacitor, it is only necessary to drill clearance holes through the lucite to allow the jack bars to go through. The two-terminal grid dip meter coils will be plugged into these jack bars. The plate to cover the back can be held in position with self-tapping screws. Holes to accommodate these screws are shown along the sides and bottom of the case. A cut out must be made in the back plate to clear the 5-prong socket shown above the bottom meter. Although wiring of this instrument is simple, make sure wires are supported in some manner, or tied down, to keep them from moving around.

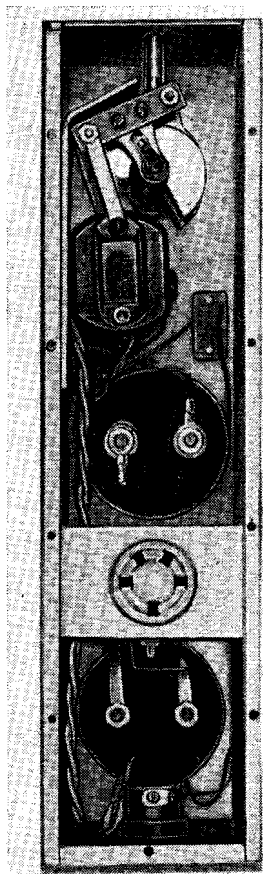

The absorption meter coils are wound on standard 5-pin, 1½-inch diameter coil forms. Fig. 102 shows how the coils are connected to the base, and Table 1 gives the winding data.

The grid dip meter coils are wound on special forms which must be made up. These forms are mounted on a polystyrene or lucite base which is fitted with banana plugs that plug into the jacks on the lucite end piece of the meter case. Dimensions for the coil form and base are shown in Fig. 106. Dimensions A and B depend on the number of turns on the coil and are given in the winding data of Table 2. Coil 5 in Table 2 can be used for alignment of most TV i.f. stages.

Two 1/16 x 1/16-inch slots are milled in the coil form. One

extends from hole X to the base, and the other from hole Y to the base. Start the coil winding by passing the wire through hole Y, run it through the longest slot and solder it to the lug on the banana plug on the base. Now start the winding from the top

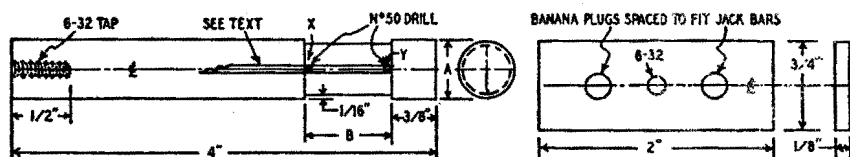

Fig. 106. The details and dimensions of the coil forms for the grid dip meter.

of the winding space. When the correct number of turns is wound, pass the wire through hole X from the side opposite the shorter slot, run it through this slot to the base, and solder it to the banana plug on that side. When the coils are finished, they are fitted with a protective sleeve of polystyrene or lucite which is  $\frac{3}{4}$  inch longer than dimension B. A front view photo of the grid dip and absorption meter is shown in Fig. 107.

## Calibration

The meter may be calibrated for frequency coverage with a good communications receiver, with the coils of an accurately aligned TV receiver, the coils of an accurately calibrated signal

Coil No.	Range (mc)	A (in)	B (in)	Wire Size	Turns
1	2.9-5.4	$\frac{3}{4}$	1-1/8	30	108
2	4.5-8.3	$\frac{1}{2}$	1-1/4	30	100
3	6.5-11.9	$\frac{1}{2}$	$\frac{3}{4}$	30	57
4	10.2-18	$\frac{1}{2}$	1-3/16	24	45
5	17.5-31	$\frac{1}{2}$	1-1/8	20	24

Coil No. 5 spaced over 1 inch, all others close-wound. Use enameled wire for all windings.

generator, or better yet, compared with a good frequency meter. The value of the grid dip and absorption meter depends on how carefully and precisely you calibrate it.

When using a communications receiver, allow it to warm up thoroughly, then beat the meter oscillator frequency against the b.f.o. of the receiver. The frequencies for various zero-beat points

can then be marked on the meter tuning dial. Each coil has a separate scale on the meter dial.

A good check of the calibration is to make a zero-beat setting between meter and receiver at some frequency. Then move the

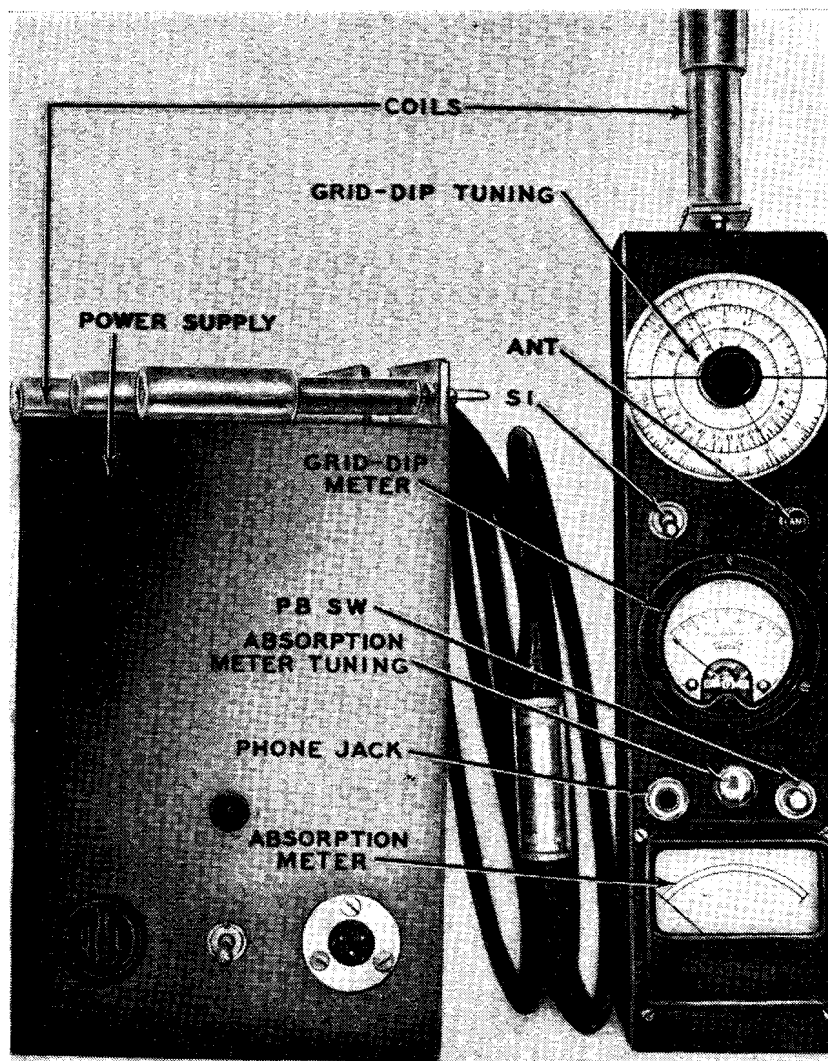

Fig. 107. Photo of the grid dip and absorption meter together with the power supply. The absorption meter uses no power, is entirely independent of the dip meter.

meter setting to what should be the second harmonic of the frequency. Leave the meter set and retune the receiver to the second

harmonic on its own scale. If the meter calibration is good, the new setting should also be close to zero-beat.

### **Uses for the meter**

The grid dip meter can be used as an absorption type frequency meter by removing the plate voltage from the 955 tube with switch S1. In this case, resonance is indicated by upward readings on the milliammeter.

### **Measuring inductance**

Inductance can be measured with the meter by hooking it up in parallel with a known value of capacitance and finding the resonant frequency of this combination. The value of the inductance is then given by:

$$L = \frac{1,000,000}{4 \pi^2 f^2 C}$$

where L is in henrys, f is in cycles, and C is in microfarads. The inductance of peaking coils (not wound on loading resistors) can be found in this manner.

### **Measuring capacitance**

In the same way a capacitor can be measured with a known value of inductance. In this case the value is given by:

$$C = \frac{1,000,000}{4 \pi^2 f^2 L}$$

and the answer comes out in microfarads.

### **Measuring Q**

Being an r.f. oscillator, the grid dip meter naturally will serve as a signal generator. It can be used for receiver alignment, as well as to measure the Q of a tuned circuit. To find Q, connect a v.t.v.m. across the tuned circuit and measure the voltage as the grid dip oscillator is tuned to the resonant frequency of the tuned circuit. Then back the meter off resonance (both above and below) to the point where the v.t.v.m. reads 70.7% of the voltage at resonance. The Q is then found by applying the formula:

$$Q = \frac{f}{f_1 - f_2}$$

In this case  $f$  is the resonant frequency, and  $f_1$  and  $f_2$  are the off-resonance frequencies at the 70.7% points.

### Checking antennas

Antennas also can be checked with the meter. In this case it is necessary to get near a point of high current in the antenna because coupling to the meter coil is inductive. In TV antennas, this is the point at which the transmission line is connected to the antenna. If such a point cannot be reached, turn the meter pickup coil so its axis is parallel with the antenna to get capacitive pickup. Normally this pickup is rather weak.

### Standing waves and parasitics

Standing waves on a transmitter transmission line can be detected by energizing the line and sliding the meter pickup coil

---

#### Materials for Grid Dip Meter

**Resistors:** 1—220, 1—10,000, 1—22,000-ohm, ½-watt.

**Capacitors:** 4—200- $\mu$ f, mica; 1—50- $\mu$ f, 2-gang, variable.

**Miscellaneous:** 1—type 955 tube and ceramic socket; 1—0-1-ma meter; 1—closed circuit phone jack; jack bars, coil forms and coils (see text); 1—s.p.s.t. switch; hookup wire and assorted hardware.

#### Materials for Absorption Meter

**Capacitors:** 1—.002- $\mu$ f, mica; 1—140- $\mu$ f variable.

**Miscellaneous:** 1—0-400- $\mu$ a meter; 1—150-ma lamp; 1—push-button switch; 1—IN34 crystal; 5-pin, 1½-inch diameter coil forms and sockets; hookup wire, and assorted hardware.

#### Materials for Power Supply

**Resistors:** 2—2,500-ohm, 10-watt.

**Capacitors:** 1—12- $\mu$ f, 400-volt, electrolytic.

**Miscellaneous:** 1—350-0-350-volt a.c. power transformer with 6.3 and 5-volt windings; 1—5Y3-GT, 1—0D3, tubes and sockets; 1—pilot lamp; 3-wire shielded cable; hookup wire and assorted hardware.

---

along the line while watching for a reading. For this check, use the meter as an absorption meter and watch the milliammeter for a reading. Neutralization can be checked in the same way.

Parasitics in transmitters are located by plugging headphones into the closed-circuit phone jack provided for them on the front panel and using the instrument as a grid dip meter. Be careful not to come in contact with the power circuits of the transmitter. Using the meter as a grid dip meter, tune it through its range until you find the parasitic beat note. Leave the meter setting unchanged and explore the transmitter until the dip of the milliammeter indicates that the offending resonant circuit is nearby.



# Chapter 2

## Picture Tube Circuit Analyzer

OF all the circuit checks involved in testing a modern TV receiver, few can match the picture tube from the standpoint of annoyance and sheer aggravation. Although the wires are right in front of you, there is no way to get at them with your test prods. Of course, you can always remove the socket, but this will not give you readings under load, nor will it show whether or not the picture-tube filament is good. These voltages must be checked, especially when the trouble is one of those no-picture, no-raster deals.

Years ago, when you could count the number of tube types on your fingers, most analyzers came complete with adapter plugs. A plug was inserted in the tube socket of the set, the tube was placed in the adapter, and socket voltages were checked while the tube was functioning. This caused distortion and detuning in some circuits, but at least the set was operating and supply voltages were not affected.

Here is a new twist for the old pretzel—a quick, cheap, and efficient means of checking picture-tube voltages under operating conditions. This little device, as simple or as elaborate as you care to make it, will tell at a glance if the filament is O.K., will measure filament, cathode, first-anode, and grid voltages (bias and signal), as well as focus-anode voltage of electrostatic-focus tubes. This picture tube circuit analyzer will test your picture tube circuit voltages as they should be checked—with the picture tube in the set and all voltages applied. It does not interfere with normal operation of the picture tube. This convenience can be yours for an outlay of as little as five dollars.

For the basic instrument you will need a duodecal socket, a five- or six-pin duodecal base from a defunct picture tube, about four feet of 8-conductor cable, a 2-pole, 5-position switch such as a Mallory 173C, two pin jacks, a 2-contact automotive-type lamp socket, and a 2-candlepower automotive-type bulb. The bulb will show filament continuity and is far cheaper than a 0-1 a.c. ammeter.

### Adapter plug and analyzer

A quick glance at Fig. 201 should give you a good idea of what we are trying to do. If you don't have a base from an electrostatic focus tube, you will have to insert pin 6 in a standard 5-pin

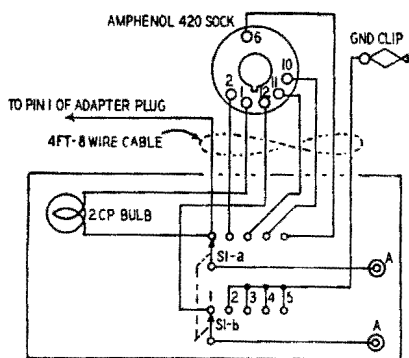

Fig. 201. Socket and selector schematic.

base. This is not much of a task. Drill a hole in the base of the pin 6 position, and cement in the extra pin.

Strip back the outer sheath at one end of the 8-conductor cable for a distance of about 8 inches. Then cut *all but one* of the exposed wires to a length of 2 inches. When you have done this you will have a cable about 4 feet long covered with an outer sheath or fabric. Coming out of the cable will be 7 wires extending 2 inches out of the sheath and one wire extending 8 inches out of the sheath. The long wire is used for a ground, and is fitted with a small alligator clip. Next, strip back the insulation on the seven remaining leads for about  $\frac{1}{2}$  inch, and tin them carefully. Now cut five pieces of No. 16 bus about 2 inches in length. If the cement in the base is dry and hard, cut off the tubular part with a hack-saw, leaving only the pin wafer and key, and make certain that the pins are not blocked by cement or solder.

## Wiring the socket

Next take the duodecal socket, and solder a length of bus and one wire of the cable to terminals 2, 6, 10, 11, and 12. This should leave two unused wires. Solder one of these wires to the No. 1 pin of the socket. Nest all soldered wires in the channels of the socket, and align the bus leads from the socket with the corresponding pins of the plug. Insert the remaining free wire in the No. 1 pin of the plug and put each bus lead in its proper pin. Work the plug over the leads gently until it meets the socket firmly; then lock it in place temporarily by crimping over the No. 6 and No. 12 bus wires. Apply polystyrene dope generously around the base and socket. When dry, solder the bus and wire leads to the ends of the plug pins and trim off any excess.

Mount the 2-pole, 5-position switch (S1) on a panel, and wire it up as shown in Fig. 201. The automotive-lamp socket should be mounted on the panel near the switch. The panel may be  $\frac{1}{8}$ - or  $\frac{1}{4}$ -inch tempered Masonite. If the whole business is mounted in a small box made of  $\frac{1}{4}$ -inch plywood, you will have a neat looking job. Use pin jacks for terminals A-A.

## Using the analyzer

Insert the adapter between the receiver socket and the base of the picture tube, and connect the voltmeter to pin jacks A-A. With the analyzer switch in position 1, the bulb should light and the meter should show about 6 volts a.c. if the picture-tube filament is good. Positions 2 and 3 of S1 (grid and cathode, picture tube pins 2 and 11, respectively) may show d.c. voltages anywhere from  $\pm 1$  to  $\pm 150$ , depending on the method used to feed the video signal to the picture tube and on the circuit location of the brightness control. Before checking voltages in these positions refer to the receiver schematic and voltage charts. The important factor is the voltage relation *between position 2 and position 3*. Position 2 (grid) should always be negative to position 3 (cathode), and the difference should *increase* smoothly as the brightness control is turned toward *minimum* brightness.

When a signal is present there should also be a fairly high a.c. voltage on the pin receiving the video input, (this can be either the control grid, pin 2, or cathode, pin 11, of the picture tube) which can be varied with the fine-tuning control or by changing the position of the antenna. This makes it possible to use the voltmeter for orienting antennas. With enough 2-

conductor cable the meter can be taken to the roof and the antenna system can be adjusted for maximum signal (a.c.) voltage.

Some measure of the effectiveness of the a.g.c. can be determined by rotating the front end selector from channel to channel. During this test, the setting of the contrast control should not be touched, although the fine tuning control should be set for maximum signal for each channel. The meter should not show too great a variation of peak a.c. signal strength when going from one channel to the next.

Position 4 of S1 (the first anode or accelerator grid) should show between 200 and about 475 volts d.c., depending on the

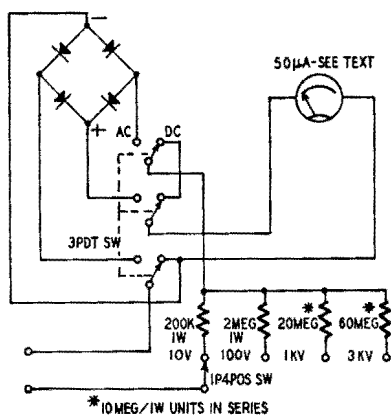

Fig. 202. Circuit of companion voltmeter.

circuit and the size of the picture tube. Position 5 is used only with electrostatic-focus tubes. Low-voltage-focus types will read 0 to 500 volts, while high-voltage-focus types may have as much as 3,000 volts. With either type, the voltage should vary smoothly as the focus control is adjusted.

**Note:** High-voltage-focus types are generally supplied from the flyback circuit through a separate rectifier and very-high-resistance voltage divider. Your voltmeter must have higher input resistance than the divider to avoid loading the circuit and reducing the voltage. Only a v.t.v.m. or a 20,000-ohms-per-volt meter with a suitable high-voltage range should be used.

## Voltmeter unit

In the event that you decide to build a voltmeter to go with the analyzer, use the circuit shown in Fig. 202. By housing the

meter in a separate case, and making connections to the switch box with banana plugs, you can take the meter to the roof for orienting the antenna. The photo, Fig. 203, shows two models of the analyzer-voltmeter.

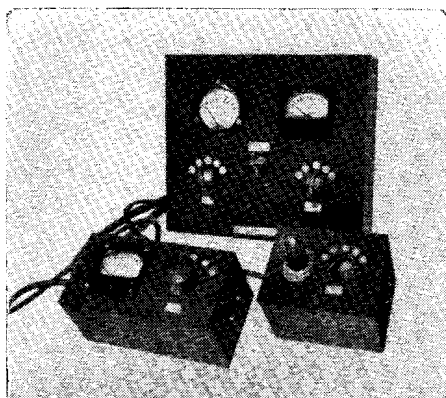

Fig. 203. Two models of the analyzer-voltmeter. Large unit has filament a.c. ammeter.

The multiplier resistors should have the highest possible accuracy. The rectifier is a standard full-wave-bridge instrument type obtainable from most supply houses.

However elaborate or simple you decide to build your analyzer you will find it of great value in speeding your trouble-shooting, and you will probably find even more uses for it than described here.

---

#### **Materials for Analyzer**

**Miscellaneous:** 1—duodecal socket; 1—2-pole, 5-position switch (Mallory type 173C or equivalent); 1—2-contact automotive type lamp socket; 1—2-candle-power automotive type lamp; 2 pin jacks; 4 feet of 8-conductor cable; panel; cabinet; bus bar; alligator clip; hardware; solder.

#### **Materials for Voltmeter**

**Resistors:** 1—200,000 ohms, 1—2 megohms; 8—10 megohms, 1 watt,  $\pm 1\%$ .  
**Miscellaneous:** 1—0-50 d.c. microammeter; 1 full-wave-bridge instrument rectifier to match microammeter; 1—3-pole, 2-position switch; 1—single-pole, 4-position switch; panel; cabinet; hardware; wire; solder.

---

# Chapter 3

## Picture Tube Tester

THE testing of a picture tube has always been somewhat of a mystery to most service technicians. The unit described in this chapter has been designed to provide the technician with a dependable low-cost picture tube tester. This unit incorporates a test for "shorts" which is practically identical to that used in the General Electric picture tube factory.

In the manufacture of picture tubes, a great many tests are made to ensure good picture quality and long life. If we exclude tests for screen defects such as blemishes, color, etc., it is a fairly simple matter to determine whether a picture tube is good. The necessary tests are:

1. Check for shorted elements.
2. Check for open connections.
3. Check for leakage between elements.
4. Check for cathode emission.
5. Check for condition of cathode.
6. Check for gassy tube.
7. Check for air leaks.

The first four tests can be performed on the tester to be described. The condition of the cathode (test No. 5) can be checked by removing the yoke and focus coil assembly from the neck of the tube (without disconnecting these units) and by observing the condition of the spot of light on the face of the picture tube. If the picture tube uses an ion trap, make sure that it is on the neck of the tube and is properly adjusted. The last two tests for gassy tubes or air leaks can be performed with a commercial "sparker" unit.

## Picture tube tester

The unit shown in the photograph, Fig. 301, can be assembled and wired in a few hours time. The parts required will in most localities cost about \$27.00 if all the parts have to be purchased. However, you will probably find that a number of these parts can be found in your "junk" box. This tester will save you many hours time substituting picture tubes to determine whether the tube or the circuit is defective. The circuit for this unit is shown in Fig. 302.

## Construction

The parts are mounted in a 7 in. x 12 in. x 3 in. Metal Utility box, but any similar type box can be used. A view of the completed assembled unit is shown in Fig. 303. The only problem

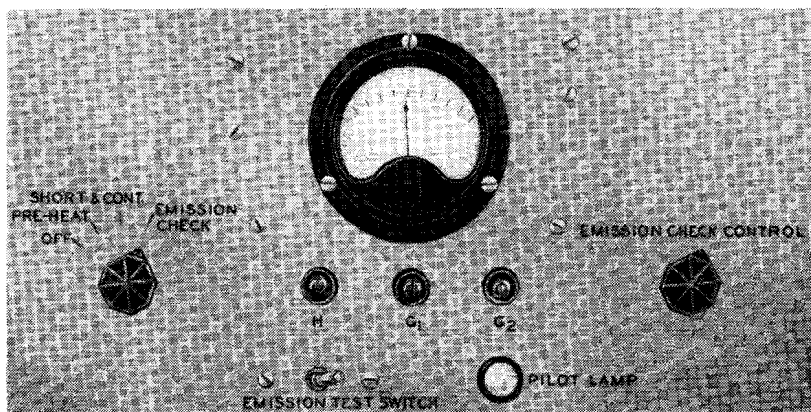

Fig. 301. Front view of the picture tube tester. The indicating neon bulbs are located beneath the meter. Mount the neon bulbs so that the neon bulb elements are in a vertical position.

that you may have will be in drilling the metal panel for the meter and neon lamps. Since the flange of the meter case usually covers at least  $\frac{1}{2}$  inch all around the hole, it can be cut out with a drill and a metal cutting saw.

Keep in mind when wiring the rotary switch that when looking at it from the rear, the terminal next to the rotor terminal is not used. Then come terminals No. 1, 2, 3 and 4 going counterclockwise. You will notice that the switch specified has 5 positions when only 4 positions are required. This type switch normally has a stop-set washer which should be set to limit the number of

positions to 4. Since the rotary switch is a six-pole type, one of the front sections which would have been difficult to solder was left unused.

### Short-Open-Leakage test

When the unit is completely assembled and wired, it is ready to be used. The picture tube socket should be placed on the picture tube which may be either separate or in a receiver. If the

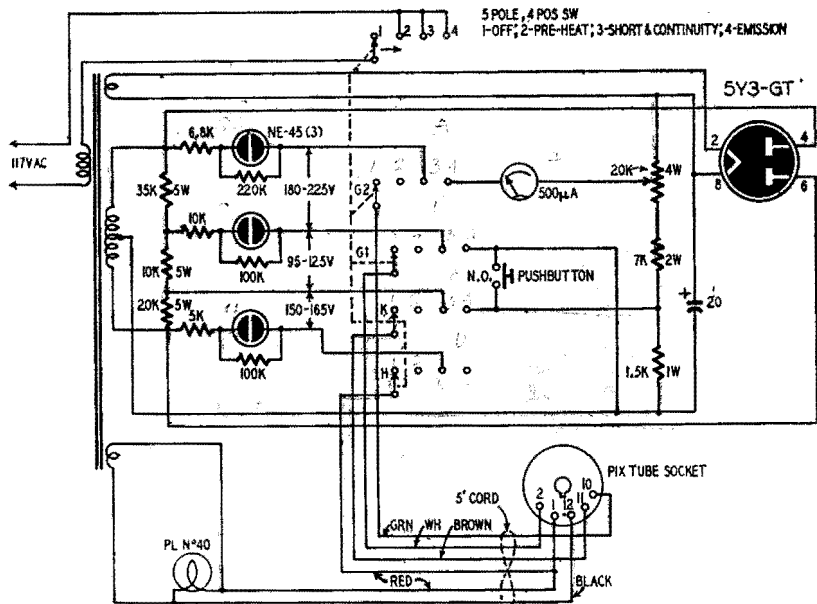

Fig. 302. Circuit diagram of the complete picture tube tester.

picture tube is in a receiver, be sure that the receiver is turned "off" to eliminate any possibility of the voltage on the HV anode arcing over to one of the other elements inside the tube.

The rotary switch should be turned from the "off" position to the "preheat" position, and left there for three minutes. The switch should then be turned to the "short and continuity" position. If the tube is good, one-half of the  $G_1$  and  $G_2$  neon bulbs will glow as shown at the top of Fig. 304. You will probably find that the lighted half of the  $G_1$  and  $G_2$  neon bulbs are not in the position shown in Fig. 304. In some instances, the bulbs can be correctly positioned by turning them one way or the other. In



other cases, it may be necessary to build up the center contact on the bulb base with solder. The neon bulb on the left marked "H" can be in any position since both sides glow when some element is shorted to the heater.

While the tube is on this test, the neck should be tapped on the glass area near the tube base to show up any intermittent shorts. A tapper can be made in accordance with the drawing shown in Fig. 305. This is very simple to make since a pencil can be used as the dowel and a No. 15 cork can be obtained at most

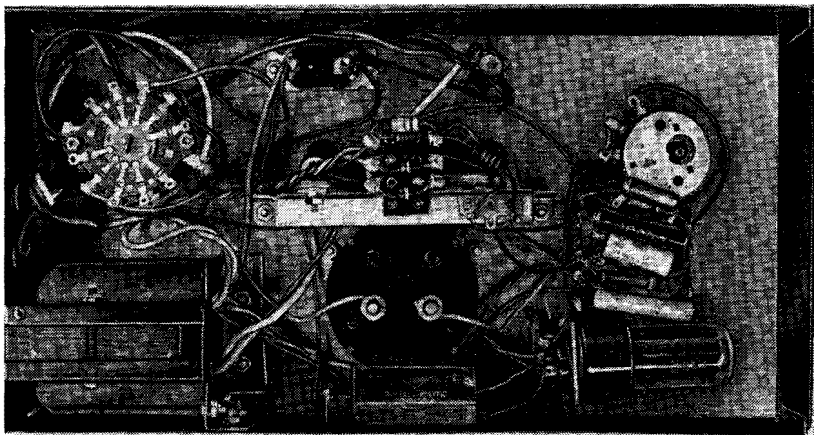

*Fig. 303. Under chassis view of the picture tube tester showing placement of parts. The complete power supply, consisting of the power transformer, rectifier, and filter capacitor are shown along the bottom of the photograph. The rectifier can be mounted horizontally, as illustrated. Wiring is not critical.*

hardware stores. A hole should be drilled in the cork and the dowel or pencil cemented in place. The tapper should be held between the thumb and forefinger and used with a wrist action only. Tap the tube several times at different points going around the neck.

The short and continuity test will indicate either an "open" or a "short" and in addition, points out the tube elements which are defective. Resoldering the base pins should always be tried whenever an "open" is indicated. If the neon lamps indicate that  $G_1$  is "open," resolder pin No. 2. If  $G_2$  is "open," resolder pin 10 and if the cathode is "open," resolder pin 11. An "open" in the heater does not show on the indicator lamps since this defect can be detected by looking at the gun inside the picture tube.

If a short or leakage is indicated on the tester, try using a "sparker" to burn off the material causing this defect.

A somewhat different method should be used when a "hot"  $G_1$ -cathode short occurs. This type of short occurs *only* after the tube has been in operation for a period of time, and is indicated by the complete loss of control over brightness. A short of this

### REJECTION CRITERION

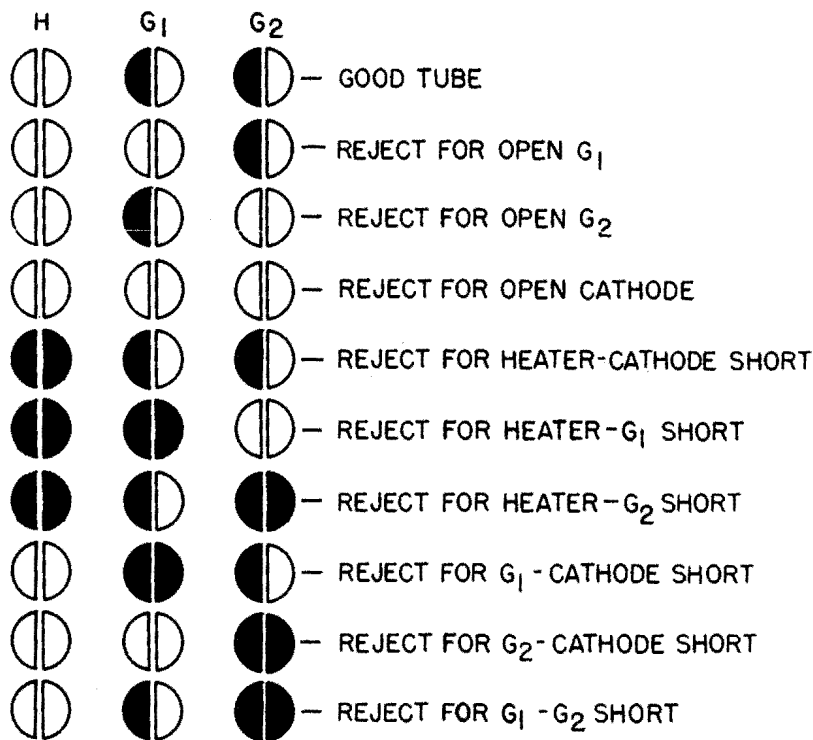

Fig. 304. The circles in this illustration represent the three neon bulbs on the front panel. Condition of the picture tube can be determined from the way in which these bulbs light.

type can sometimes be eliminated by the application of about 150 volts d.c. between  $G_1$  and the cathode while the tube is hot. This voltage should be applied with the negative side connected to  $G_1$  and with a 500-ohm resistor placed in series with one of the leads.

## **Emission test**

If the short and continuity test indicates that the tube is good, turn the rotary switch to the "emission check" position. Then turn the right hand knob to the point where the meter reads 10 microamperes. This current reading is important and requires careful adjustment particularly if an 0-1 milliammeter is used. The 10 microampere point on the meter would be midway between 0 and the first mark on the scale. The  $10\mu\text{a}$  point would be much easier to locate on a 0-500 microammeter and it is for this reason that a 0-500 microammeter is preferred. After the meter is set at the correct point, press the push-button switch. The meter should read between 350 and 550 microamperes if the emission is normal. If the emission reads between 250 and 350 microamperes, it is questionable and below 250 it should be replaced. In most cases, it will be found that tubes below the 300 microampere reading will have large dead areas on the cathode surface.

The limits indicated here are based on a line voltage of 115 v a.c. If the line voltage is low, the limits should be decreased by  $10\mu\text{a}$  for each volt below 115 v. If the line voltage is high, the limits should be increased by  $10\mu\text{a}$  for each volt above 115 v. These readings are, like *all* tube tester readings, subject to exceptions due to tolerance variables and "cut-off" characteristics. It will, however, provide the service technician with a reasonably accurate and reliable indication of the condition of a picture tube.

## **Gassy tubes and air leaks**

Another defect which develops in a picture tube is that it becomes "gassy." The sparker previously mentioned can be used to detect gas by placing its tip on the glass near the base of the picture tube. If the tube is gassy, the area near and in the electron gun will have a pink glow. A similar condition will be noticed if the tube is an "air leaker" except that sparks may jump through the glass to the gun and between the elements in the gun. Another indication is the milky appearance of the getter on the neck of the picture tube. This milky area will appear on the clear glass window sometimes left in the inside graphite coating near the position of the getter bar and shield. There is nothing the technician can do to correct either a gassy tube or an air leaker except to replace the picture tube.

It might be well to point out here that when using the picture tube tester, a tube very low in emission may show as an open cathode. This is to be expected because it is the current flow between the cathode and the  $G_1$  and  $G_2$  elements in the picture tube which causes the neon bulbs to glow. If the cathode is not emitting a sufficient number of electrons, these two lamps may not light up.

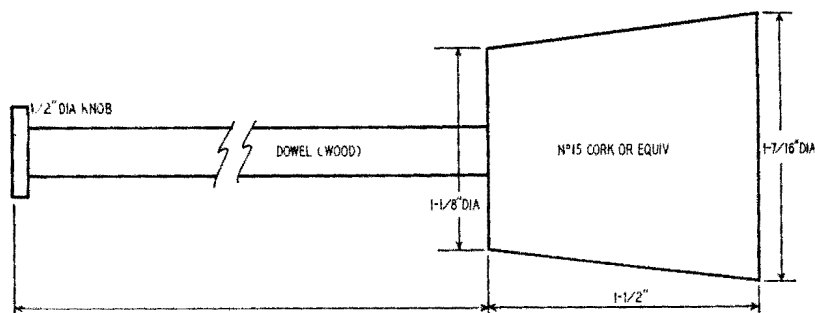

Fig. 305. This taper can be used to show up intermittent shorts.

This tester will not check electrostatic deflection type picture tubes or those with triode guns. It may be used, however, to indicate a "short" or "open" in tubes with triode guns. Obviously the  $G_2$  bulb will not operate on tubes of this type.

### Materials for Picture Tube Tester

**Resistors:** 1—35,000-ohm, 5-watt (1—20K and 1—15K used); 1—10,000-ohm, 5-watt; 1—20,000-ohm, 5-watt (2—10K used); 1—7,000-ohm, 2-watt; 1—1,500, 1—5,000, 1—6,800, 1—10,000, 2—100,000, 1—220,000-ohm, 1-watt. 1—20,000-ohm, 4-watt potentiometer.

**Miscellaneous:** 1-power transformer, 275v-0-275v at 50 ma, 5v at 2 amp, 6.3v at 2.5 amp (Thordarson T22R01 or equivalent); 1—3 gang, 6-pole, 5-position rotary switch (Mallory 1335L or equivalent); 1—0—500

microammeter (preferred) or 0—1 milliammeter (3-in. or 3½-in. case); 2—1¼-in. pointer type bar knobs; 1-octal base tube socket; 1-General Electric 5Y3-GT tube; 1—20-mf 450-volt capacitor; 1-normally open SPST push-button switch; 3-General Electric type NE-45 neon bulbs; 3-adjustable slide, candelabra base, pilot light sockets; 1-no. 40 pilot light; 1-adjustable slide, miniature screw, pilot light assembly with ½-in. jewel; 1-picture tube socket with 5-ft cable (picture tube extension cable can be used); 1-metal chassis, 7-in. deep x 12-in. wide x 3-in. high; 1—8-ft a.c. line cord.

The picture tube tester described in this chapter can be used effectively to increase your picture tube business. A good practice would be to test the picture tube on every receiver serviced. A notation could be written on the customer's bill as well as the job record. In this way the customer is aware of the condition of the picture tube and the job of selling a new tube either at the present time or some time in the near future should be easier.

# Chapter 4

## The TV Service Aid

THESE is no disputing the value of accurate test equipment such as the sweep and marker generator, oscilloscope, tube checker and vacuum-tube voltmeter for fast, efficient, complete TV receiver servicing, but there are times when the technician is called upon to service a set without any of these instruments. The amount of apparatus that can be carried into a customer's home is strictly limited, to give one example. When regulation type test instruments are not readily available, the *skilled* technician can do nicely with nothing more than a kit of replacement tubes, an R-C decade box or an assortment of resistors and capacitors, plus the usual hand tools. His greatest asset in such work is a plentiful supply of down-to-earth "know-how" and a good knowledge of circuit theory.

To supplement the above, this chapter describes and tells you how to construct a simple *Service Aid*. It is cheaper and more rugged than the standard v.t.v.m. or multitester, and because it is specifically designed for television set testing, may be even more useful. With this instrument and the intelligent use of suitable techniques, it is possible to locate close to 90% of the troubles encountered in any section of the TV receiver.

The TV Service Aid is a tubeless, meterless instrument of vest-pocket size, that will enable a capable technician to perform all the tests normally performed in a customer's home with reasonable accuracy and speed.

It was originally constructed experimentally and put to use with some reservations as to its ultimate value, considering its utter simplicity. But over a period of several months it has more than lived up to expectations.

Such a Service Aid can be of great value to the busy technician on house calls, or even in the shop when regular equipment is tied up on other jobs. It can be used:

**For measuring plate and screen voltages** and taking other readings in low-voltage supplies. The hot lead is connected to terminal B (See circuit diagram, Fig. 401) with black ground lead clipped to chassis. The 5 meg control potentiometer is then slowly varied until the neon bulb just barely fires. Voltage is read directly from the calibrated scale, which is graduated from 80 to 1,000 volts. (It was found after considerable experiment that the average neon lamp could not be made to fire at less than about 70 volts. This of course prevents it being used for bias

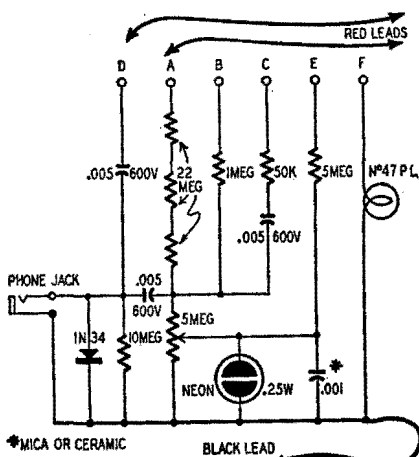

Fig. 401. The circuit of the TV Service Aid is quite simple.

tests.) Its reliability over the calibrated range is extremely good, as proven by continued accuracy over several months of use.

**For measuring output of high voltage power supplies.** Use terminal A and ground lead. Readings are taken as for low voltages. *Be careful not to touch bared ends of hot leads because of the shock hazard.* The scale should be calibrated from 1 to 50 kv. Negligible loading is imposed on the circuit under test since the multiplier totals over 70 megohms and firing current of bulb is only a few microamps. Make sure the test lead is insulated for the highest voltage you expect to measure.

**Audio signal generator,** using conventional relaxation-type oscillator circuit. Terminal B is connected to a convenient B-plus point in the set under test. Audio signal of approximately 1,000

cycles is taken from terminal C. It can be used for signal tracing in both audio and video amplifier circuits. Control is varied until desired tone at proper level is obtained. The setting will vary according to the amount of B-voltage used.

**Signal tracing** of all stages (front end, pix i.f., video, sound i.f., a.f., sync and sweep circuits). Uses a 1N34 crystal diode.

Probe lead is taken from terminal C and applied to circuit under test. Signals can be monitored by plugging phones into the jack or—what is usually more convenient—making use of the audio amplifier in the set. This is done by connecting terminal D to the volume control or to the first a.f. grid. To prevent possible overload to crystal when tracing high amplitude signals, probe should be connected to terminal E, using potentiometer as an attenuator.

For tracing inaudible horizontal sync and sawtooth voltages, use a lead to jump test pulses to the a.f. amplifier input. Then use the neon voltage tester for visual indication by connecting C to the a.f. output plate. A little practice will enable the user to recognize the control setting which indicates approximately correct pulse levels. The setting at which the neon tube fires will of course vary somewhat with different amplifiers.

**Control voltage for a.g.c. and sync stabilization.** To obtain a small amount of negative voltage to stabilize a.g.c. during alignment, connect A or B to some negative voltage point in set, with black lead to chassis. Stabilizing voltage is taken from terminal E, and varied with control.

To determine if horizontal or vertical sweep oscillators are free-running too fast or too slow, and to make necessary frequency correction, thus providing a temporary sync or hold control: Connect E direct to sweep oscillator grid. (If oscillator frequency is too high a negative voltage is required, and if too low, connect A or B to B-plus of set).

**To find why high-voltage fuse blows:** Connect dial light across fuse (terminal F and black lead). The brightness of the bulb will give a relative idea as to overload conditions. Pulling tubes which may be responsible may then locate the trouble.

The dial light is also a handy continuity tester in all circuits where normal current should light it within its normal brilliancy range.

**Capacitor testing and continuity checks:** With connections as for low-voltage measurements, connect capacitor in series with

hot lead and B-plus, and adjust for glow on neon bulb. Its brilliance and/or flicker rate is the indication. A good capacitor will cause the neon bulb to flicker just once. If the capacitor is open, the neon bulb will not flicker at all. If the capacitor is leaky, the neon bulb will continue to flicker, the rate of flicker being determined by the amount of capacitor leakage. This test is not suitable for electrolytics. Continuity tests on high resistance components are made in the same manner.

### Constructing the testaide

The original unit was built into a plastic box of the type used as container for small parts and hardware, as sold by most parts

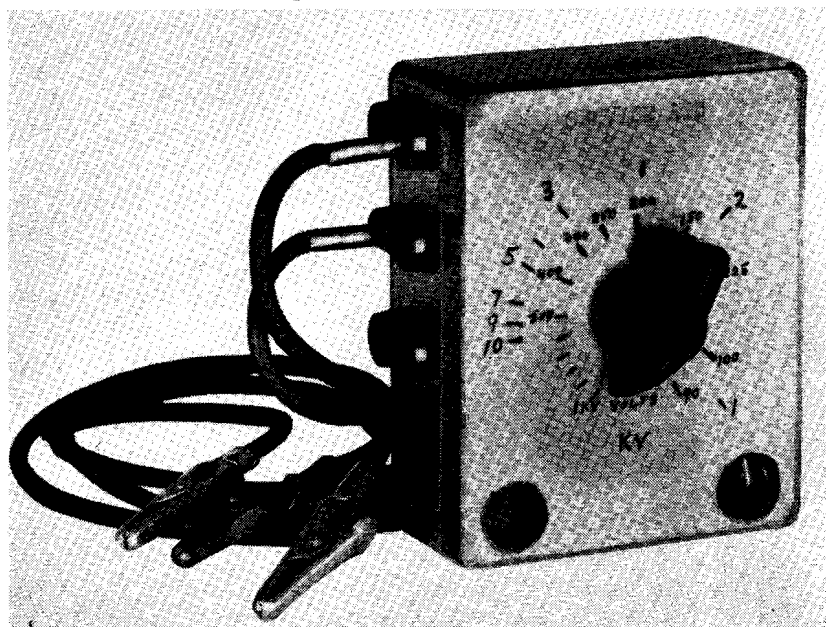

Fig. 402. Front view of the TV Service Aid. Dial numbers can be placed on a card cemented to the front plate.

stores. It was chosen for its insulating properties and because of its small size ( $3\text{-}3/8 \times 2\text{-}3/4 \times 1\text{-}3/8$  inches). Cover has a  $3/8$ -inch hole at its center for mounting the control pot. On right side is another  $3/8$ -inch hole for phone jack and a  $1/8$ -inch hole to accommodate the black ground lead. Left side has six  $1/4$ -inch holes for pin jacks and two  $1/8$ -inch holes for the two red "hot" leads, which must be good quality heavy rubber covered test lead wire. All three leads are fitted with alligator clips, and the red leads only have pin tips for inserting in the jacks. Although not



shown in the photo, Fig. 402, it would be advisable to cover the alligator clips with rubber shields.

To keep the two red leads in place, four holes were made in the case as shown in the photograph, and the leads were threaded through them. This prevents pulling the leads out of the jacks, while in no way making it less convenient to insert them. Some constructors may not wish to have the leads permanently connected to the instrument, in which case these holes will not be needed, and another jack should be provided for the negative lead.

To avoid cracking the thin plastic, the holes were not drilled. Instead, they were burned through with heated rods of the correct sizes.

Needless to say, all components and connections must be well spaced. Particularly keep the three 22-meg high-voltage multipliers clear of other parts. Because of the small size, sub-assembly techniques were employed, first mounting as many components as possible on the control pot, crystal and jacks. This leaves only a few connections to solder as the two sections of box are brought together. Don't touch the plastic with the hot iron!

The neon bulb is soldered to a small bracket that uses the same mounting hole as the control. A small dab of paint on one side of the glass makes it possible to identify polarity of any d.c. voltage (a.c. of course causes both plates to glow).

For easy replacement of dial light when necessary, its socket is soldered to tip jack F. It is necessary only to raise cover slightly and turn or twist the socket and jack a little more to one side, making bulb easily accessible.

The Service Aid was simply calibrated against a Simpson 303. A card was fastened to the front cover and the voltage and kilo-voltage calibrations made. Then it was cemented to the inside of the cover, forming the "meter scale." Another card with the necessary terminal identifications and circuit diagram was cemented inside the rear of the box. The two half-inch windows in the front card are for observing the neon and dial-light bulbs.

---

---

### **Materials for Service Aid**

**Resistors:** 1—50,000 ohms, 1—1 meg, 1—5 meg; 1—10 meg, 3—22 meg, ½-watt, 1—5-meg potentiometer.

**Capacitors:** 1—.001- $\mu$ f mica or ceramic; 3—.005- $\mu$ f, 600-volt type (C-D Tinychief or

equivalent).

**Miscellaneous:** 1 open circuit phone jack; 1 crystal diode, 1N34; 1 No. 47 dial light with bayonet socket; 1¼-watt neon bulb and neon bulb socket, 6 red tip jacks, plugs to match, wire, leads, etc.

---

---

# Chapter 5

## Television Intercom

THIS TV intercom is a very simple and inexpensive communication arrangement which can be used by TV antenna installation teams. The essential component, which practically all service technicians already have, is a pair of headphones. Connect two phones together through any reasonable length of wire as shown in Fig. 501 and you have a sound-powered telephone system: no batteries, microphones, transformers, or amplifiers are required.

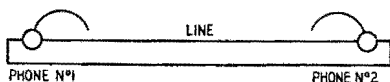

Fig. 501. *Simple sound-powered phone.*

No wire is required either—the antenna down-lead serves the purpose.

The phone is one of the simplest radio devices and its normal operation is well known. Send audio current into its electromagnet and the resulting variations in pull will cause the steel diaphragm to vibrate, producing sound. Not so readily remembered is the fact that the operation is reversible; make the diaphragm vibrate—by speaking into the phone—and a small audio voltage will appear across the coil terminals. As the steel diaphragm in the phone changes its distance from the pole pieces of the permanent magnet upon which the coil is always wound, the strength of the magnetic field varies because of the changing reluctance of the magnetic circuit. Going back to fundamentals: whenever the strength of a magnetic field around a coil changes, a voltage is induced. Thus the headphone is really a dynamic microphone. Although its output—like all dynamic mikes—is

rather low, it is great enough to operate another phone to produce a "readable" signal. Since two identical units are used at both ends of the line, the impedance match is good and power transfer is optimum.

### Putting it into practice

The usual TV antenna installation team consists of two men; one at the set, the other on the roof. If each clips his phones to

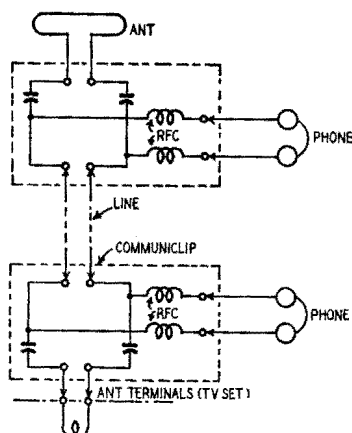

Fig. 502. The intercommunicator circuit.

the two wires of the TV transmission line (lead-in), communication theoretically is possible. Actually there are a number of problems to be overcome before the system is practical:

1. If a folded dipole antenna is used, the phones would be shorted.
2. The antenna coil in the TV set will in most cases also short-circuit the phones.
3. Even if the above were corrected, attaching phones directly to the line could interfere with antenna performance and make adjustments difficult.

The solution to the problem is shown in Fig. 502. The capacitors prevent short-circuiting the low-frequency audio by low-resistance antenna and set components without interfering with TV signal frequency transmission. The chokes (RFC) isolate the phones for r.f. without interfering with audio currents. Values of the capacitors and r.f. chokes are not critical: about 500  $\mu\text{f}$  for each of the capacitors and 6 turns of No. 22 insulated wire on a  $3/8$ -inch dowel for the coils will do nicely.

## The communiclip

While almost any arrangement of parts will work, the assembly should be rugged so as to be trouble-free despite the hard use it is likely to get, especially on the roof. The design shown in Fig. 503 is suggested. It is built around a plastic clothespin, of the type that sells for about two for 5 cents in most hardware stores. Fig. 503 shows only half the clip—the other half is identical.

In use, the clip is left attached to the phone tips, using the proper Fahnestock terminals. The man at the set attaches the ends of the lead-in to the center terminals, and clips the whole

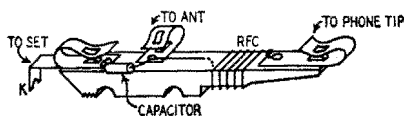

Fig. 503. Drawing of one half of the clip.

“clothespin” onto the teletset’s antenna terminals by means of the ears (K in Fig. 503) improvised from a piece of light metal. At the antenna, the lead-in is cut at a convenient point and its ends

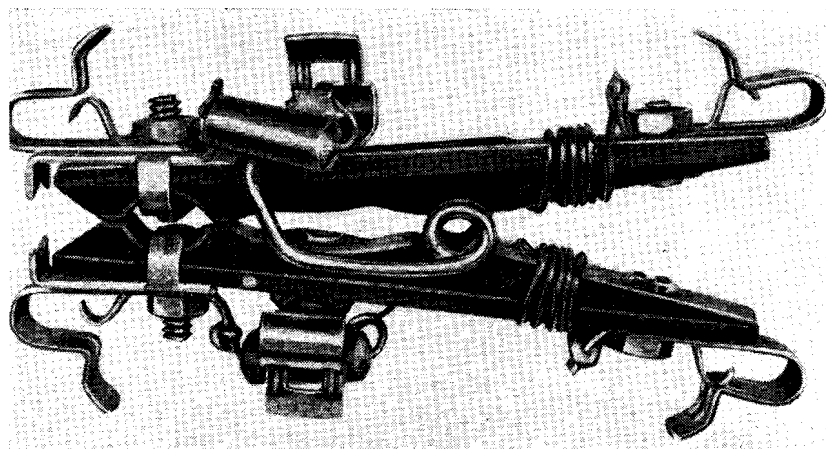

Fig. 504. The entire communicclip is built on a plastic clothespin.

are clipped to the proper terminals. Communication is then established. The man at the set, whose hands are free, does most of the talking. His partner on the roof wears his phones, leaving his hands free for shifting or turning the antenna as directed by

the man at the set. Whenever he wishes, however, the man on the roof may speak to the other by talking into one of the phones.

A few final precautions: Any kind of phones may be used as long as both pairs are electrically similar. *They must be in good condition*; weak magnets will not produce sufficient output. Single phones at each end are somewhat more effective than pairs because when one phone is used as a mike, the generated energy must drive *three* other receivers when pairs are used. However, the received signal is quite adequate even with pairs, and a pair of phones is more comfortable. The complete communiclip is shown in the photo, Fig. 504.

# Chapter 6

## Three-Inch Oscilloscope

**W**HY not make a try at constructing your own oscilloscope. Too expensive? Not so—if you do all the work yourself, and cut a few corners.

A scope for AM and most FM work needs only ordinary amplifier and sweep circuits. These are fairly simple for the average constructor. The circuit for such an instrument is shown in Fig. 601.

Each section of the scope should be considered separately. They are:

1. The C-R tube and high-voltage power supply.
2. The low-voltage power supply.
3. The amplifiers.
4. The sweep circuits.
5. The synchronization circuits.

### Power supplies

The high-voltage power supply depends on the C-R tube used. Many service scopes use a 3-inch tube which needs 1,000 volts d.c. to operate. This poses the problems of power transformer, rectifier, and input filter capacitor. The average small power transformer has a secondary of 350-0-350 volts, which will give 700 volts across the entire secondary. The peak value of this is 1.414 times 700, or approximately 1,000 volts. This will provide enough d.c. voltage for the tube as the current drain through the cathode-ray tube is negligible.

Using a half-wave rectifier and the entire secondary, the output with no load will be this peak value. Since the C-R tube draws



This power supply operates with a positive ground, and the elements of the C-R tube that are hot are the filament, cathode, grid, and, to a lesser degree, the focusing anode. When checking voltages, remember this, and save yourself a nasty shock. The load

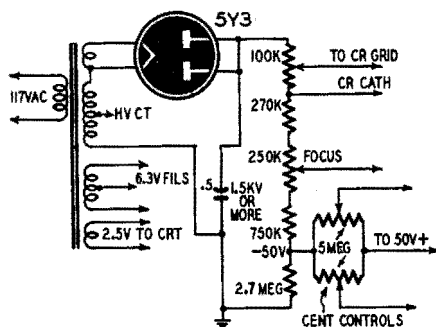

Fig. 602. The high-voltage rectifier circuit supplies a negative 1,000 volts.

is a voltage divider, providing adjustable voltages for the grid and focus, and the negative centering voltage. This is shown in Fig. 602. The centering controls go from a negative 50 volts on the high-voltage supply, to a positive 50 volts which is obtained from the low-voltage supply.

The low-voltage supply shown in Fig. 603, is half-wave, using the center-tap of the power transformer. This gives a 300-volt

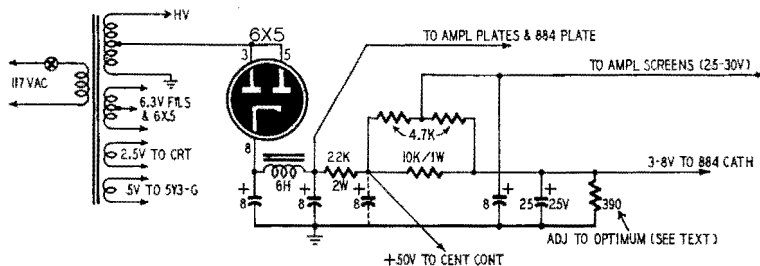

Fig. 603. The low-voltage rectifier connects to the transformer's center tap.

d.c. output, with the negative side grounded. The load is a voltage divider giving the screen voltage for the amplifiers, 50 volts for the centering controls, and a low voltage (3 to 8 volts), for the bias on the gas tube sweep oscillator.

Greater control of centering is possible, if desired, by making the two centering voltages greater than 50 volts. This value was chosen for the 3-inch tube because it has a deflection sensitivity



of 75 volts per inch. This means that 75 volts gives a deflection of 1 inch on the screen. Halfway to each side of the screen from the center is  $\frac{3}{4}$  inch, or about 50 volts. Certain types of traces, such as audio oscillators swept through the range for audio response curves, may need further control of centering to get half the picture only on the screen.

Since both power supplies are half-wave, the filtering must be better than usual. The ripple frequency is 60 cycles, instead of 120. Poor filtering in the low-voltage supply is noticeable as a 60-cycle pattern on the screen. Poor filtering in the high-voltage supply is not normally noticeable, as it causes no deflection. Any hum voltage is applied to the elements of the C-R tube, and will

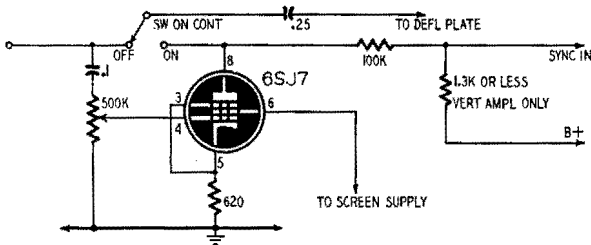

Fig. 604. This circuit is used for both the vertical and horizontal amplifiers.

intensity-modulate the spot. If a Z-axis is included, the filtering must be good enough to eliminate this modulation.

## Amplifiers

The amplifier response should be as nearly flat as possible over as much of the range as is to be examined. Television uses pedestals for synchronizing pulses, which are similar to square waves of short duration, or high frequency. If a square wave is shown on the screen, and the amplifiers have poor low-frequency response, the front edges of the wave will be rounded. If there is poor high response, the trailing edges will be rounded, or slanted.

Low-frequency response is improved by using large, low-voltage electrolytics across bias resistors, large screen bypasses, large coupling capacitors, and large electrolytic capacitors across plate-filter resistors, if any. High-frequency response is improved by using pentodes, low values of plate resistors, and keeping wiring capacitance low. The amplifier circuit is shown in Fig. 604.

Most scopes have provision for switching the input to the deflection plates directly, or through the amplifiers. Two panel controls are eliminated if you put s.p.d.t. switches on the amplifier gain controls. When the controls are thrown to zero gain, the switch throw connects the plates direct to the input.

### Time base circuits

The picture on a scope screen is a graphical representation of a voltage waveform. The signal goes positive or negative (up or down on the screen) while time passes. Time is represented by a steady movement from left to right across the screen, and the voltage that produces this steady, linear movement, is called a sweep. The perfect sweep would be one that sweeps the trace

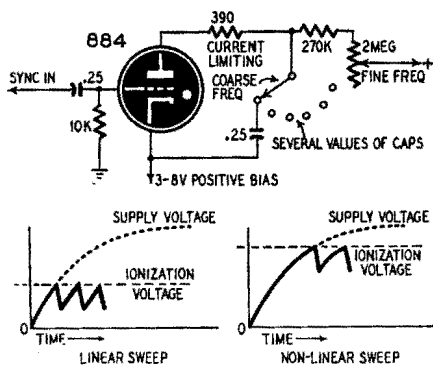

Fig. 605. The sawtooth generator hook-up with linear and nonlinear waveforms.

across the screen at a constant rate, and then flips it back to the beginning instantly, to start another sweep.

A voltage that will accomplish this slow movement and then a fast retrace is in the form of a sawtooth, as in Fig. 605. The slow build-up of the sawtooth is the gradual movement across the screen, and the sharp drop at the end is the quick retrace. This voltage may be produced in several ways, but usually is from a gas tube such as the 884 or 885. These tubes ionize at a high plate voltage, producing a low-resistance path from cathode to plate, then de-ionize at a low plate voltage. The grid is supplied from a low-voltage negative bias supply, and controls the ionization voltage. More negative bias means high ionization voltage, and less negative voltage means lower ionization voltage. Bias (3 to 8 volts) for the 884 is obtained from the 390-ohm resistor in the

low voltage supply. This bias voltage (plus) is applied to the cathode of the 884.

The plate of the tube is fed by a resistor, and is bypassed to ground or cathode by a capacitor. When the switch is thrown, the capacitor starts charging to the supply voltage. The larger the capacitor or resistor, the longer this charging takes. When the voltage across the capacitor (plate voltage) reaches the tube's ionization voltage, the tube fires and discharges the capacitor. When the voltage across the capacitor drops to the de-ionization voltage of the gas tube, the tube stops conducting, the capacitor starts charging, and the process repeats.

The voltage across the capacitor is the output sawtooth voltage. If the tube fires before the capacitor gets very far along on its

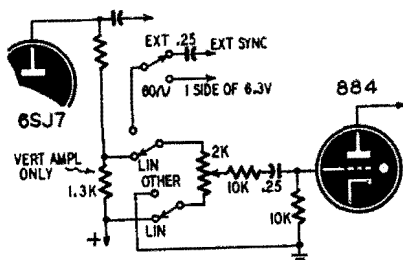

Fig. 606. A circuit for applying a sync signal to the gas-tube sweep generator.

charging curve, the output sawtooth voltage is practically linear. If the bias on the gas tube is too low, the ionization voltage will be too high, and the sawtooth will have a curve on the charge portion instead of a straight line. The bias should be adjusted for maximum output, while keeping the sawtooth linear. The frequency of the sweep oscillator is set by the value of the charge-discharge capacitor in the plate circuit of the 884. The plate resistor is made variable for fine frequency control.

The linearity of the sweep oscillator can be checked approximately by feeding a known waveform, such as a sine wave (from the secondary of a filament transformer), to the vertical input. If the waveform crowds up at one end of the sweep, the linearity needs adjustment. A more accurate way is to feed sharp pulses (obtained by differentiating a square wave) to the vertical input. The pulses will be equally spaced if the sweep is linear.

The upper limit of frequency for gas-tube oscillators is 15,000 to 20,000 cycles per second, due to the time necessary for the tube to de-ionize during each cycle. Vacuum-tube oscillators, such as

multivibrators, will give higher frequencies, but are not necessary for most scope work. The sweep amplitude should be high enough, so that when used with the amplifiers, it will spread the pattern several times wider than the screen. If the amplifiers do not have a fairly wide range, the sawtooth sweep will be distorted and will result in distorted patterns on the screen.

## Synchronization

You can now adjust your pattern on the screen, till it shows what you are after, but you will find that it drifts slowly across the screen, no matter how carefully you adjust it. The synchronization (SYNC) control, allows a small portion of sync signal to be fed into the grid of the gas-tube oscillator, which causes it to lock-in or synchronize with the pattern being studied, and makes

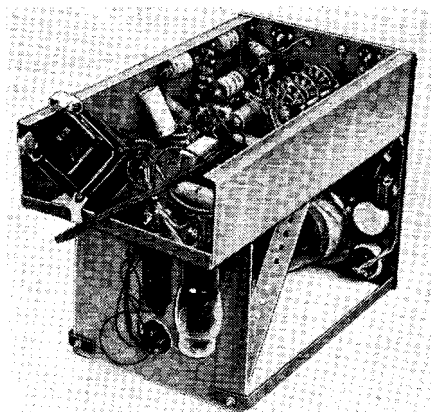

*Fig. 607. Underside of the scope. Transformer is mounted sideways to reduce hum.*

it stationary. This voltage causes the gas tube to fire slightly earlier or later than normal, to effect the lock-in.

Sync signals are usually a small part of the output of the vertical amplifier, but provision is generally made for internal 60-cycle sync, and connection to some external source. Commercial scopes isolate the sync signal from the gas-tube grid through a 1-to-1 transformer, but it is simpler and cheaper to tie it in through a coupling capacitor as shown in Fig. 606. If you do this, you may find that it over-synchronizes at times. This can be checked by running an r.f. signal into the vertical amplifier, and observing the pattern. Over-sync shows up as a slanting of one end of the pattern from the vertical, and if the low voltage

filtering is insufficient, the slanted end will take the form of an ellipse, due to 60-cycle hum in the vertical amplifier plate circuit.

For most work, this effect is not serious, and may be reduced by reducing the value of the series plate resistor used to feed the sync signal into the gas tube. Over-sync is the bugaboo of all who first operate a scope. The less sync you can use, the better your pattern.

### Construction hints

**Always remember that the high-voltage supply is dangerous and that the elements of the C-R tube that should be safe are hot. This 1,000 volts probably won't kill you, but it may make you wish it had. A good safety measure is to break open the wire connected between pin 6 of the 5Y3-GT and the 0.5- $\mu$ f, high-voltage filter capacitor, and insert a 1-megohm, 1-watt resistor.**

The centering controls go to positive and negative voltages that are supposed to be equal. If they are not, some of the bleeder

---

### Materials for Oscilloscope

**Resistors:** 2—390, 2—620, 1—1,200, 2—4,700, 2—100,000, 1—270,000, 1—750,000-ohm, 2—1, 1—2.5 megohm,  $\frac{1}{2}$ -watt; 1—10,000-ohm, 1-watt; 1—22,000-ohm, 2-watts; 1—2,000, 1—100,000, 1—250,000, 4—500,000-ohm 1—2 megohm potentiometers.

**Capacitors:** 1—600- $\mu$ f, mica; 1—.0025, 1—.01, 1—.05, 2—0.1, 6—0.25- $\mu$ f, 400-volt, paper; 1—0.5- $\mu$ f, 1,500-volt, oil filled pa-

per; 4—8- $\mu$ f, 450-volt, 1—25- $\mu$ f, 25-volt, electrolytics.

**Miscellaneous:** 1—350-0-350 volt power transformer with 6.3-, 5-, and 2.5-volt windings; 1—6-h, 300-ohm choke; 1—5Y3-GT, 1—6X5, 1—884, 1—3AP1, 2—6SJ7 tubes and sockets; 1—s.p.d.t. switch on vert, gain control; 1—s.p.d.t. switch on horizontal gain control, 1—s.p.d.t., 1—d.p.d.t., 1—3-pole, 11-position, switches, chassis, hookup wire, assorted hardware.

---

resistors may burn up, due to current flowing from one power supply to the other. It may be necessary to move the -50-volt tap up or down on the high-voltage bleeder until you get equal and opposite polarity voltages at the outside terminals of the horizontal and vertical centering controls. Treat the amplifiers as you would any other high-gain amplifiers, and keep the leads short and direct, with plate and grid circuits well separated. Keep the sweep circuits away from other circuits, and, if possible, shield them from the rest of the scope. They may produce r.f. hash under certain conditions.

Isolate all incoming signal circuits with at least a 0.25- $\mu$ f capacitor rated at 600 volts, and be careful when working on a.c.-d.c. equipment. A capacitor in the ground lead is the best bet. If at all possible, get a power transformer designed for scopes, as it will

be magnetically shielded. The simple replacement transformer shown in the photo of the underside of the scope, Fig. 607, had to be mounted askew under the chassis to avoid magnetic deflection. Check filament windings on the power transformer, and see that all the windings are separate.

If magnetic deflections bother you, whether from the power transformer or external fields, a piece of 3-inch iron pipe will stop them; just place it around the C-R tube. Electrostatic pick-up may be reduced by enclosing the scope in a complete cover of sheet iron. Use shielded mike cable for leads and phone

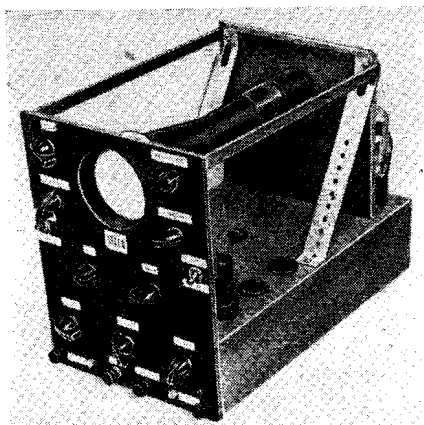

*Fig. 608. This view shows technique used in mounting the cathode-ray tube.*

plugs and jacks for connectors. Power supplies built on a separate chassis, and kept away from the scope, comprise one way of minimizing deflection difficulties.

This scope uses a 3AP1 C-R tube, which has a 2.5-volt filament. The 6.3-volt equivalent is the 3BP1.

No layout has been given, for everyone has his own ideas. Mount the power transformer directly behind the C-R tube if possible, even though you have to build a bracket to support it. See Fig. 608. Use a ring-type socket for the C-R tube, and cut the ring so that it doesn't quite complete a circle. This will give a loose mounting, and allow the C-R tube to be rotated to get correct positioning.



It is easy to observe the waveforms on a scope, but measuring peak-to-peak voltages is another story. You cannot get accurate readings on conventional v.t.v.m.'s or a.c. volt-meters because they are not designed or calibrated to measure pulses, square waves, or other nonsinusoidal voltages.

The peak-to-peak voltage calibrator whose circuit appears in Fig. 701 provides known square-wave voltages which are fed into the scope and compared with the positive and negative tips of the signal under test. A front panel view is shown in Fig. 702.

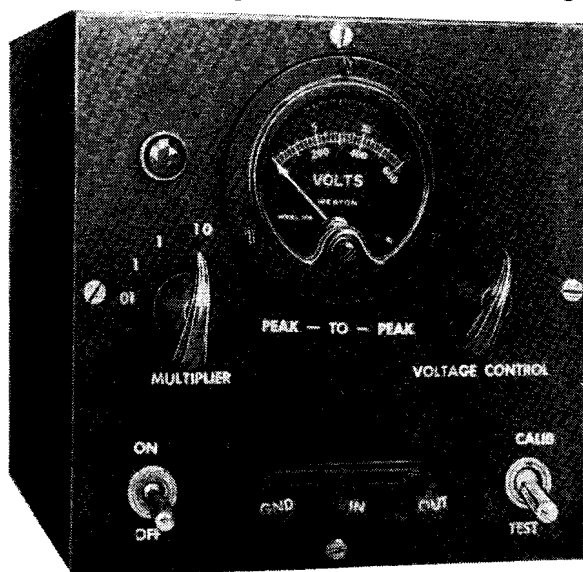

Fig. 702. Front panel photo of the peak-to-peak voltage calibrator. The meter can have a full-scale deflection of 1.5 ma or less.

The constant voltage used for calibrating is not affected by normal line voltage fluctuations because the two diodes connected back-to-back act as clipper-limiters. Diode D1 of the 6AL5 has its cathode biased positive at 150 volts. Approximately 300 volts a.c. is applied to its plate. This diode does not conduct until the positive half-cycle of the alternating voltage exceeds 150 volts. D2 is connected in reverse with its plate biased 150 volts negative and a.c. applied to its cathode. It does not begin to conduct until the negative peak of the sine wave is above the bias voltage.

If the diode load—the VOLTAGE CONTROL and multiplier in parallel—is very large and R1 is comparatively small, the voltage across



the load will be a square wave because of excessive drop across R1 during periods of conduction in the diodes.

The resistors in the multiplier are the only critical components in the calibrator. The capacitor in series with R1 may be as low as .005  $\mu$ f. The values of R1 and the VOLTAGE CONTROL, and also the multiplier resistor may vary widely from those shown on the diagram. These can be determined experimentally as will be shown later. The diode load should not be too low. If it is, the a.c. will be bypassed around the diodes. Furthermore, the rise time of the square wave increases as the load decreases. If R1 is

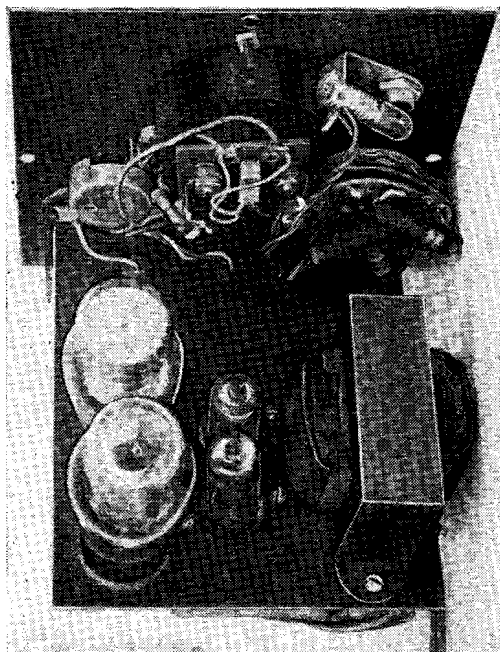

*Fig. 703. Top-chassis view of the voltage calibrator.*

too high or too low, the diodes do not limit the peaks during conduction. You can select a value for this resistor by substituting a 250,000-ohm variable resistor and varying it through its range while observing the waveform on the scope. Measure the resistance in the circuit at points where the peaks start to round off.

Select a fixed resistor somewhere around the center of this range.

The diode load (VOLTAGE CONTROL) may be as low as 50,000 ohms if the values of the coupling capacitor and R1 are selected to produce a good square wave.

For parts placement see the top-chassis photo in Fig. 703, and also the bottom view shown in Fig. 704.

## Calibration

Before deciding on values for the VOLTAGE CONTROL and multiplier resistors, connect a variable resistor and high-resistance voltmeter between the a.c. line and vertical input of the scope as shown in Fig. 705. Adjust the horizontal gain for convenient deflection—2 and 4 inches for 3- and 5-inch scopes. Leave the

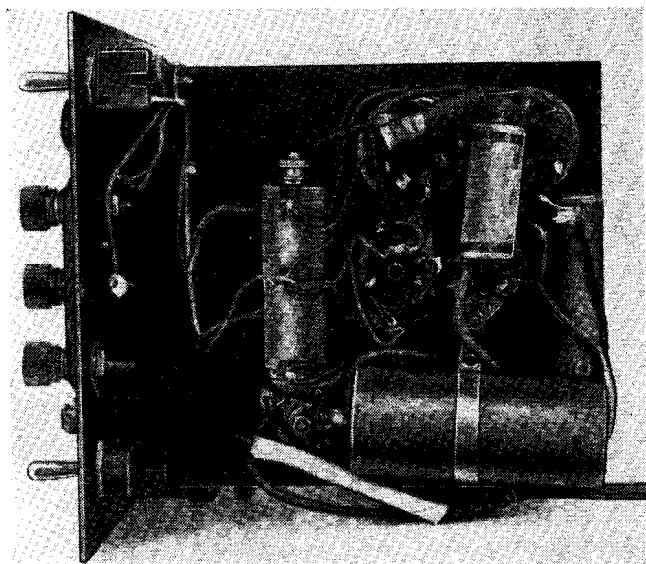

Fig. 704. Under-chassis view of the completed voltage calibrator.

gain control set—do not move it. Disconnect the meter and variable resistor. Connect leads across the diode load resistor (VOLTAGE CONTROL) and note the deflection and wave shape on the scope. Adjust the load resistor and R1 for 100 volts or more peak-to-peak. Replace the load resistor with a potentiometer having approximately twice its value. Make up the multiplier from resistors having a total value approximately equal to twice the value of the original load resistor.

The meter has a basic movement of 1.5 ma or less. A 0-1 ma movement, readily available, can be used. Ours is a surplus 500- $\mu$ a instrument having 15- and 600-volt scales. We selected the 15-volt scale and jockeyed values in the calibrator for a 150-volt peak-to-peak square wave.

Connect the calibrator to the scope, set the multiplier to MULTIPLY BY 10, and adjust the VOLTAGE CONTROL to 100 volts peak-to-peak deflection on the scope. Make R2 a variable resistor of 150,000 ohms or more and vary it until your meter reads

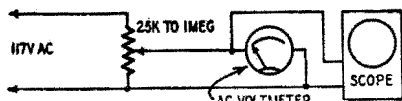

Fig. 705. Hookup for meter calibration.

exactly 100 volts. Turn off the calibrator and measure the resistance remaining in the circuit. Replace this with fixed resistors hand-picked to make the meter read correctly.

If the calibrator delivers more than the full-scale voltage of the meter, insert resistor R3 and vary its value until the meter is at exactly full scale when the voltage control is set for maximum voltage. If you use care in selecting resistors for the multiplier, the output voltage can be reduced in four steps—each being one-tenth the one above it.

The multiplier values in Fig. 701 are nominal values only. The calibration will be exact if each resistor is one-tenth the value of the one above it in the multiplier string. The precision of the

### Materials for Calibrator

**Resistors:** 1—470, 1—4,700, 1—470,000-ohm, ½-watt (selected for multiplier); 1—75,000-ohm, ½-watt; 1—2,000, 2—25,000-ohm, 10-watt. 1—500,000-ohm potentiometer. R2 and R3 depend on meter used.

**Capacitors:** 1—0.1- $\mu$ f, 600-volt, paper; 1—20- $\mu$ f, 450-volt, electrolytic.

**Miscellaneous:** 1—power transformer, 300-0-300-v. a.c. at 50-ma; 1—6X4, 1—6AL5, 2—0D3 tubes and sockets; 1—meter, 1.5-ma. or less; 1—meter rectifier; switches, hookup wire and assorted hardware.

multiplier will depend on the precision with which these resistors are selected.

The frequency of the calibrator output is 60 cycles (or the same as the line frequency). The instrument therefore calibrates the oscilloscope for that frequency. If the calibration is to be accurate for other frequencies, the response of the vertical amplifier must be flat to 60 cycles.

### Operating instructions

Connect your probe or test leads to the IN terminal of the calibrator and connect the output (OUT) terminal to the scope.

The GND terminal is a common return for the scope and equipment under test. In the TEST position, the signal feeds from the receiver directly to the scope. Adjust the vertical gain control for a convenient deflection. Set the vertical positioning control so the signal under observation is centered on the screen. Throw the function switch to the calibrate (CALIB) position and adjust the multiplier and voltage control for the same peak-to-peak deflection. Multiply the meter reading by the setting of the multiplier.

If the voltage being observed is symmetrical, the operation may be speeded up by flipping the function switch rapidly while

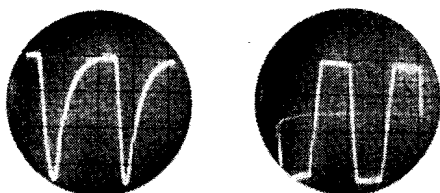

*Fig. 706. The waveform at left is from a TV sweep oscillator. The one at the right is the calibrator output set at the same peak-to-peak deflection.*

adjusting the voltage control until the peaks of the signal and standard voltage are equal. An enterprising constructor could work out a combination of a calibrator and electronic switch so the standard and unknown voltages can be superimposed. The photos in Fig. 706 are waveforms produced by a TV sweep oscillator and the voltage waveforms produced by the calibrator.

When you have completed the calibrator, you will find it worth while to check the tubes in your scope and record the deflection for at least one setting of the vertical and horizontal gain controls. By making periodic checks with the calibrator, it will be easy to detect changes in the performance of the scope. Weak or gassy amplifier tubes will produce less deflection for a given input voltage and setting of the gain controls. A weak high-voltage rectifier will show up in the form of greater deflection and less brightness for a given voltage input.

# Chapter 8

## Omnitester

MANY service technicians prefer having a test instrument that performs the maximum number of functions. Consisting of a signal tracer, capacitor tester, signal generator and tuner on one panel, this compact unit tests practically everything. Fig. 801 shows the complete circuit.

### Tuner

The tuning unit is exceedingly simple. It brings in local stations with good volume and is very dependable and useful for providing music in the work shop; for checking the output of the signal generator (with a dead radio on the bench one sometimes wonders if the generator *is* operating); and for checking distortion.

The tuning unit will pick up the output of the signal generator. The r.f. or i.f. signal is heard in the speaker and can be adjusted for modulation and pitch. Distortion is checked by feeding a good voice or music program to the tuning unit and applying the output of the tuning unit to the first audio stage of the signal tracer. The output of the signal tracer then provides an audio signal to use for distortion checks.

### Capacitor tester

The capacitor tester provides a test for all capacitors commonly used. Insert the capacitor between the neon bulb and B-plus. One flash when contact is made and another (on the opposite neon element) when the capacitor is grounded indicates a good unit. No flash shows an open, and a steady glow a shorted or leaky capacitor. For low voltage capacitors, use a voltage divider inserted between B-plus and ground.

## Signal tracer

The signal tracer is a simple audio amplifier that needs little explanation. The combination of a 6SQ7 and a 6V6 gives very good sensitivity for a triode-pentode combination, having a high- $\mu$  triode and a beam-power output. Use shielding as indicated, short leads in plate and grid circuits, no crowding, and adequate filtering in the B-supply. The result is a quiet, stable amplifier.

## Audio probe

Two probes, shown in Fig. 802, are required. One is a simple shielded probe with an alligator clip for picking up audio signals.

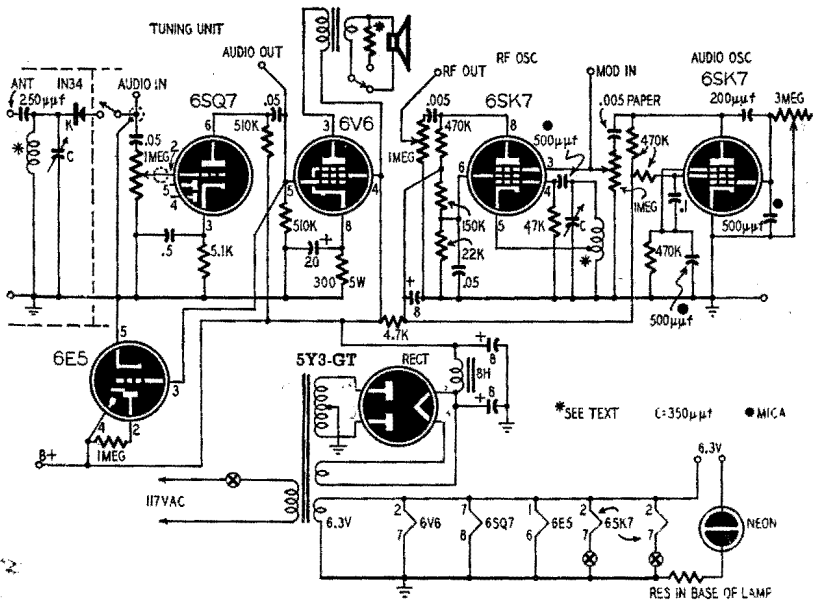

Fig. 801. Circuit of the tester. Pin jacks permit many tests and supply various voltages.

For example, it can be clipped to one side of the voice coil with the other side of the voice coil grounded. The tracer then acts as an output meter.

## R.F. probe

The other probe contains a 1N34 germanium crystal. With it, signals can be traced from the antenna to the detector stage. No

provision is made in this probe for a return r.f. path and the circuit itself must provide a path or a more elaborate probe is required. The speaker can be switched off to avoid confusion between the output of the test speaker and that of the radio under test. A short circuit switch for the output transformer is needed when the speaker is out or enough signal will leak across the switch to be troublesome.

The 6E5 eye is valuable for alignment, output tests, and comparison of gain from stage to stage. For the latter, it is helpful to



Fig. 802. The r.f. and a.f. signal probes.

set up a chart using different types of good radios that come to your shop. The point on the tester volume control at which the eye closes should be noted as the tracer is put on each test point. The simplified diagram shown in Fig. 803 may be used and the test positions, as numbered, incorporated into the chart.

### Signal generator

The signal generator has no plug-in coils and no coil switching. The complete audio range, from a few cycles per second to the inaudible frequencies, is available at the turn of a knob. The r.f. and i.f. range covered is from 456 to about 1450 kc. The r.f. can

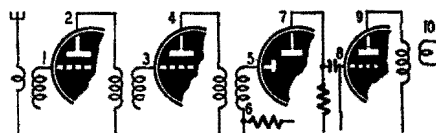

Fig. 803. Rough signal tracing procedure.

be modulated with any desired audio note at any desired percentage of modulation. The r.f. or i.f. can be modulated by the output of the 6SQ7 or from an outside source. When this is done, the filament of the audio generator is switched off and the a.f. output jack becomes the modulation input jack.

One fault with this generator is that the audio signal from this type of oscillator is a sawtooth wave and is difficult to interpret on an oscilloscope. For all other purposes it is just as good as a sine wave. The stability and range of the audio wave are affected

by the values of the plate to grid capacitor, the screen resistor, and the screen to suppressor capacitor. The values given should prove satisfactory.

To cover the required i.f. and r.f. frequencies, it is possible to wind a coil that covers from just below the required i.f. of 456 kc. to almost the top of the broadcast band. Thus all the commonly

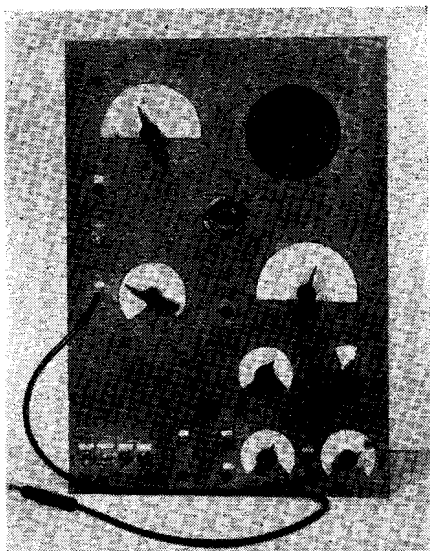

Fig. 804. Front view of the instrument. Pointers are used with hand-calibrated scales.

required frequencies are available with one twist of the wrist. The tuning coil is 85 turns of d.c.c. copper wire wound to nearly 2 inches on a 2-inch form, and the oscillator coil has 104 turns of

### Materials for Omnitester

**Resistors:** 1—4,700, 1—5,100, 1—22,000, 1—47,000, 1—150,000, 4—470,000, 2—510,000, 1—1 megohm, ½-watt; 2—300-ohm, 2-watt; 3—1 megohm potentiometers; 1—3 megohm potentiometer.

**Capacitors:** 1—.0002  $\mu\text{f}$  mica; 2—.0005  $\mu\text{f}$  mica; 1—.0005, 2—.005, 3—.05, 1—.5  $\mu\text{f}$ ; 2—350  $\mu\text{mf}$  variable; 3—8  $\mu\text{f}$  electrolytic;

1—20  $\mu\text{f}$  electrolytic.

**Tubes:** 1—6SQ7; 1—6V6; 2—6SK7; 1—6E5; 1—5Y3-GT, 1—neon bulb.

**Miscellaneous:** 5—tube sockets; 7—pointer knobs; 1—power transformer; 1—audio output transformer; 1—loudspeaker; 1—8-henry filter choke; 4—toggle switches; shielded wire; 1—chassis; 1—panel; 7—pointer knobs; 1—alligator clip; 2—1N34 crystals; shielded probe cable.

d.c.c. wire occupying 2½ inches on a 2-inch form with the cathode tap at 38 turns above ground. No. 26 d.c.c. wire is roughly correct without noticeable spacing.

The large, heavy aluminum panel shown in Fig. 804 effectively



shields a radio from signals radiated directly from the coil, but, with a probe inserted, a strong signal is radiated. If used close to other radios, it might cause interference. The circuit of the r.f. generator is the familiar Hartley electron-coupled oscillator. Too large a grid leak may cause instability. That is, the oscillator may squeal at certain settings because of grid blocking. The screen voltage must be kept at a moderate figure.

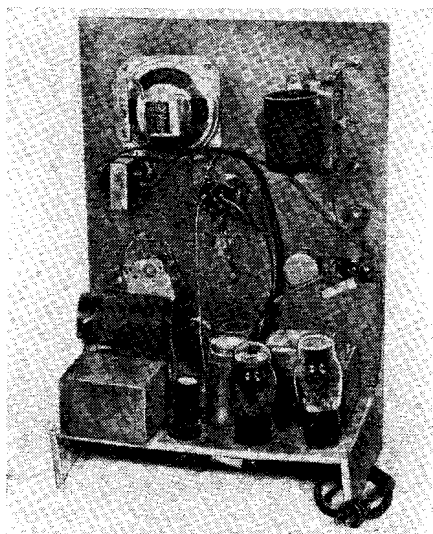

*Fig. 805. Rear view showing positioning of parts.*

It may pay to experiment with the location of the tap on the coil. Do not be satisfied until you have a signal which is inaudible until modulation is added or the signal beats against some other r.f. signal. In either case the signal should be quite loud.

Most of the layout can be seen from the rear-view photograph of the panel, Fig. 805. Coils are mounted on the backs of the capacitors and the output transformer is on the speaker. The chassis is 11 x 7 x 2½ inches, allowing plenty of room for the power transformer, tubes, can-type filters, and the filter choke. The panel is 12 x 17 inches. A 5Y3-GT is now being used as the rectifier.

# Chapter 9

## Portable Signal Generator

**I**DEAL for the rural service technician and experimenter, this battery-powered, portable, all-wave signal generator tunes from 130

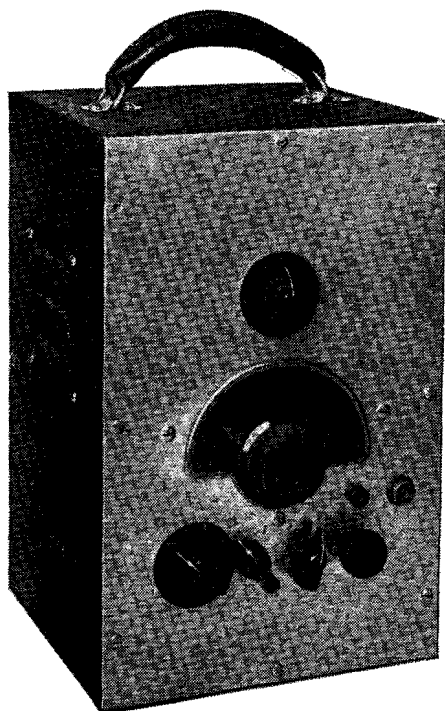

*Fig. 901. The complete and compact generator.*

kc to 16 mc in 5 ranges. It has a 1N5-GT r.f. oscillator and a 1G4-GT a.f. oscillator that can be used alone or as a modulator

for the r.f. generator. Power is supplied by a 1½-volt A-battery and a 45-volt B-battery. Most of the parts can be found in the junkbox or salvaged from old receivers.

The r.f. generator is a standard Hartley oscillator with the 1N5-GT connected as a triode. The grid is returned to the midpoint of two 100,000-ohm resistors across the filament supply. This tube is plate-modulated by the 1G4-GT when a modulated signal is desired. The range switch is in the center of the panel above the tuning control as shown in the photo, Fig. 901. The other controls

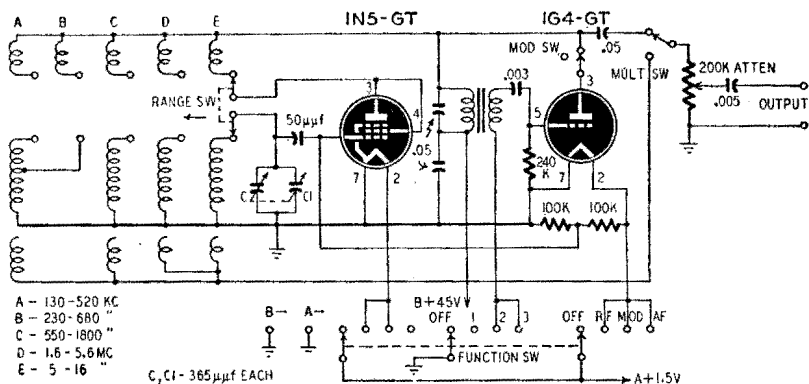

Fig. 902. Each range coil has three parts—oscillator tuning, tickler, and output coupling.

are in a row across the bottom. From left to right these are the function switch, modulator switch, multiplier, and attenuator.

The complete circuit appears in Fig. 902. When the function switch is in position 1, the filaments of both tubes are lighted and the 1N5 generates a signal whose frequency is determined by the setting of the range switch and the tuning control. An unmodulated signal is obtained when the modulator switch is open. When it is closed, the signal is modulated at about 1,000 cycles. Moving the function switch to position 2 grounds one end of the transformer secondary, and the signal is modulated at about 400 cycles. The 400-cycle a.f. signal is available at the output terminals when the function switch is turned to the No. 3 position. The modulation frequencies are determined by the size of the capacitor across the plate side of the audio transformer.

Two r.f. output levels are available, selected with the multiplier switch. The low-level voltage is taken from the plate circuit of the 1N5-GT through a .05- $\mu\text{f}$  blocking capacitor. When the signal

is taken from the pickup loops, it is about 10 times stronger than the low-level signal. The attenuator controls the strength of the signal at the output terminals.

If only a single output level is sufficient, remove the .05- $\mu$ f capacitor from across the plate winding of the audio transformer. This will raise the level available directly from the r.f. plate coils almost to that obtained from the small pickup coils, which may

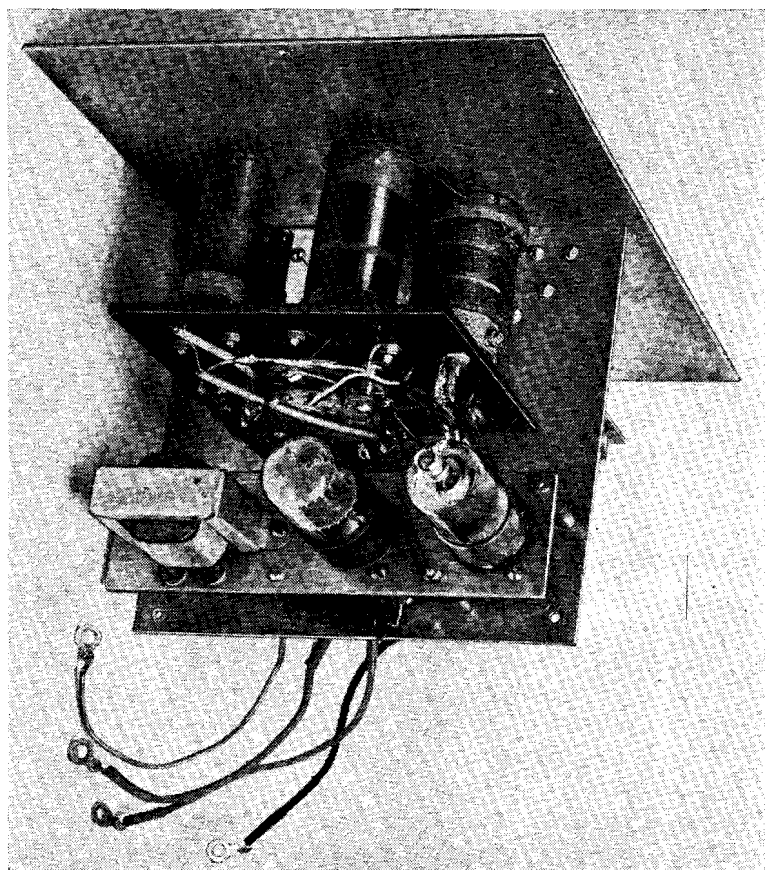

Fig. 903. Sub-assembly construction showing placement of components. Use of sub-chassis increases mounting space.

then be omitted. There will also be some change in the audio modulation frequency. Fig. 903 shows parts layout.

The oscillator tuning capacitor is a standard two-section broadcast tuning capacitor with its sections connected in parallel. The low-frequency coil used in the 138-520-kc range is a three-pie coil

salvaged from an old European receiver. We isolated one pie and used it as the tickler. A tap was made at the connection between the remaining pies and connected to the range switch. The low-frequency coil can be made from an i.f. transformer or r.f. choke.

When this switch is in position A, both pies are used and the tuning range extends from 130 to 520 kc. When the switch is in position B, a single pie is used and the tuning range is 230 to 680 kc. Use an old broadcast oscillator coil to cover the 550-1800-kc range.

The two high-frequency coils are wound on 1-inch forms. The grid coil of the 1600-5600-kc coil has 36 turns of No. 24 s.c.c. wire, and its tickler has 23 turns of No. 28 s.c.c. The two coils are spaced  $\frac{3}{16}$  inch apart. The 5000 to 16000-kc coil has seven turns of No. 18 wire on the grid winding and nine turns of No. 28 s.c.c. on the tickler.

The pickup coils for the two low-frequency coils are four turns each. Pickup coils for the 1600-5500-kc and 5000-16000-kc coils have one turn and one-half turn, respectively. The ticklers are on one end of the coil forms, and the pickup coils on the other.

The broadcast and shortwave coils may be standard three-band antenna, r.f., or oscillator coils.

The simple circuit of this signal generator can be constructed by almost anyone who can follow a schematic diagram.

## **Construction**

As shown in the photograph, Fig. 901, the signal generator is built into a standard metal carrying case (often known as a "utility box") obtainable in radio parts stores. A standard chassis was impractical because of the shape of the case, so several strips of aluminum were cut up to support the components.

There are not many parts in the instrument but nevertheless the constructor should be very careful to lay out the "chassis" in such a way that the batteries have plenty of room. The main point is to get the assembly as high in the cabinet as possible.

The batteries may be clamped to the removable rear panel with metal straps or angle brackets can be used to make brackets for them. They should be fastened down solidly so they don't rattle around.

# Chapter 10

## Signal Launcher

**S**PEED is an essential characteristic of the modern servicing technique. To attain speed, the radio service technician must have a thorough knowledge of fundamental electronic theory and circuits. He must also have suitable test equipment and know its limitations and use.

One common trouble-shooting method is signal substitution (or signal injection). This requires a signal generator. Starting from the speaker end, a signal is applied to each stage or group of stages, and, progressively, the result is noted in some manner in the output. A limitation is that the signal generator and the receiver tuning dial must usually be preset. For rapid trouble-shooting, a *universal-frequency signal source* is desirable, since no dial-twiddling will then be necessary. Such a signal source can be had from any extremely distorted low-frequency generator. Most often a square wave having a fundamental frequency approximating 1,000 cycles is used. Multivibrators have been used in the past to obtain this.

Such a signal source is useful since a distorted wave has not only fundamental frequency energy but harmonic energy as well. Any complex wave can be broken up into a Fourier series representing a series of sine waves harmonically related. The number of harmonics and their amplitude is a function of the original wave-shape. When the output of the distorted wave is applied to a circuit, the circuit will choose and pass only those frequencies it can handle.

Thus, an i.f. amplifier will pass essentially the intermediate frequency. Only audio-frequency components will pass through an

a.f. amplifier. This principle can be used to simplify trouble shooting.

### **A suitable instrument**

A test instrument of the universal-frequency type which can be used for trouble shooting and alignment too is described in this chapter. A multivibrator circuit having a fundamental frequency of approximately 1,120 cycles is used. The output waveform provides strong signal energy over a wide frequency range.

The Signal Launcher unit is compact and self-contained, being

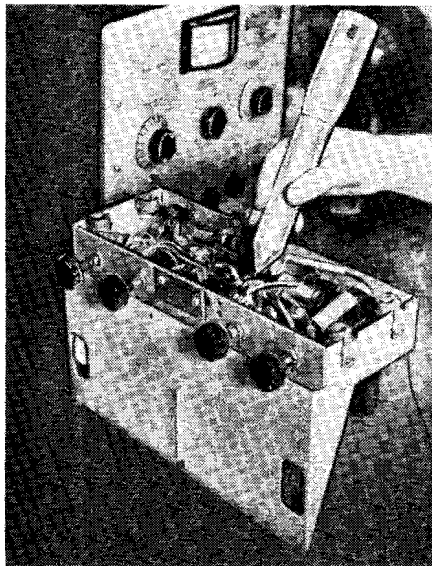

*Fig. 1001. Unit is injecting a signal; note ease of handling*

mounted in a probe-projectile type housing. It is light, small enough (see photo in Fig. 1001) to be held in one's hand, and battery operated, necessitating no dragging wires or cable. The life of each battery is practically equal to its shelf life. One of these units has been in operation for three years and the original batteries are still used. The unit might be kept in operation by using discarded batteries from battery portable receivers.

At the fundamental frequency, the r.m.s. output is 2.4 volts and less, of course for high harmonics. Most bands of an all-wave receiver and the i.f. stages of FM receivers are covered.

Fig. 1002 shows the schematic circuit. A type 3A5 7-pin miniature battery tube is employed. A No. 1 flashlight cell provides

filament voltage. Note that the series filament connection is used although only 1.5 volts is applied. The B-supply is 22.5 volts, and can be one section of an Eveready type 467 (or 457) Minimax 67.5-v battery. Since first building this instrument, smaller batteries are being marketed. These provide more output, since they furnish 30 volts (Eveready 413, Burgess U20E). All resistors are  $\frac{1}{8}$  watt, although larger sizes are easier to obtain. The two blocking (coupling) capacitors are mica, postage-stamp size. The output is taken through a .001- $\mu$ f ceramic capacitor.

The output waveform is shown in Fig. 1003. This wave-shape was selected to provide optimum output over a wide frequency range. The output signal is applied to the circuit under test in a single-ended manner; i.e., only the probe tip is used. No return connection is necessary.

### Making the case

The housing may be any handy shape or design. Thus, a square could be used.

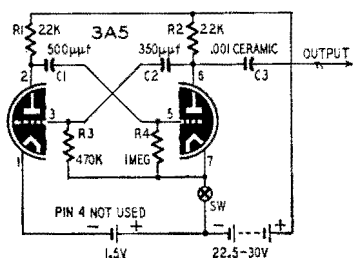

Fig. 1002. Signal Launcher is a multivibrator.



Fig. 1003. Complex square wave.

The container shown was made from 1/16-inch sheet aluminum in two sections. Fig. 1004 shows the physical layout and dimensions of both sections before forming. The sawtooth edges are formed by cutting out with a hack-saw or tinsnips and finishing with a file. Part A is formed to have an inside diameter of approximately 1 inch by rolling around a 1-inch dowel or pipe, hammering lightly if necessary. Part B is formed around a 1½-inch dowel. A section is cut out to provide space for mounting a slide switch. This can be riveted in place.

Aluminum soldering or welding of the outside seam of each piece preferably should be done with the forming dowel in place. Solder only along edges Y-Z and Y'-Z'. Aluminum soldering generally is difficult, but excellent results can be obtained by using



aluminum solder and a small torch. Stearic acid is useful as flux. The dowel forms now may be removed and the inside seam also soldered but only at the ends. The most difficult task follows. This is gently bending the triangular edges of section A between X and Y to a point, rounding at the same time. If a lathe is handy, the

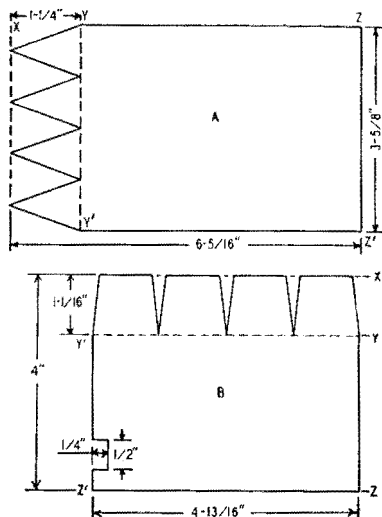

Fig. 1004. The case dimensions; note cutout for switch.

wooden dowel previously used may be turned to have approximately the same taper as the desired finished product. By properly inserting the dowel, the aluminum may be formed nicely by hammering. The four new seams should now be soldered.

#### Materials for Signal Launcher

**Resistors:** 2—22,000, 1—470,000-ohms, 1—megohm, 1/2-watt.

**Capacitors:** 1—350  $\mu\text{mf}$ , 1—500  $\mu\text{mf}$ , mica;

1—.001  $\mu\text{f}$ , ceramic.

**Miscellaneous:** 1—3A5; 1—battery (1.5-volts); 1—22.5—30-volt B-battery; 1—slide switch; aluminum tubing; 1—miniature 7-pin socket.

If the unit appears rough at this point, sandpaper and a bit of elbow grease will miraculously transform it into a smooth, professional job.

Point X is longitudinally filed toward point Y until a hole is large enough to admit the lead from C3, insulated except at the very tip by means of a length of spaghetti.

The portion of section B between X and Y is now similarly formed except that the trapezoidal edges form a tapered cylinder which fits snugly around the pipe end of section A. This completes

the housing except that a cap or plug, as desired, may be fitted over the end of "B." Some constructors may prefer to use standard thin-walled brass tubing. The cylinder-forming process will then be unnecessary. Other alternate schemes such as the one depicted in Fig. 1005 are possible. Here an 8-inch length of 1½-inch

*Fig. 1005. Alternative generator housing. This can be a length of tubing with a lucite head shaped as shown in the illustration. This is an easy and practical form of construction.*

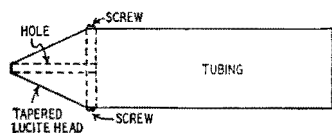

tubing is used. A small hole is drilled through the center of a short length of 1½-inch lucite, plexiglas, or polystyrene rod. The rod is tapered as shown.

### Wiring procedure

The entire unit (see photo, Fig. 1006), may be easily inserted

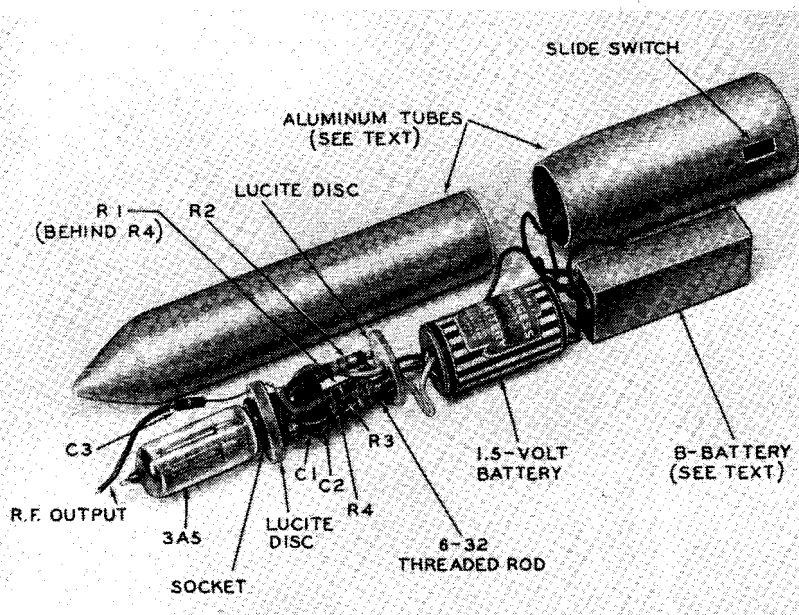

*Fig. 1006. An exploded view of the Signal Launcher showing the location of parts.*

in—or removed from—the housing. Fig. 1006 shows a 7-pin button type socket mounted in a lucite ring of 1-inch diameter. C1 and C2 are arranged as shown and wired to the socket, their leads furnishing all the support needed. Now R1, R2, R3 and R4 are wired. Another lucite disk, having a ⅜-inch center hole, is now arranged.

Three leads thread through the center hole and connect to the battery and small slide switch mounted in the cutout provided. This is all there is to the wiring. A 2-inch 6-32 headless screw should be arranged as shown to increase the rigidity of the unit.

### **Using the probe**

If no wiring errors have been made the tube and support can be inserted in the housing and the unit should be ready to operate. Check the unit by touching its output to the input of an audio amplifier. A loud clear note should be heard from the speaker.

To become familiar with the operation of the Signal Launcher try it out on a receiver in operating condition. Touch the probe to the plate of the power amplifier. Note the sound and then move progressively toward the front end of the receiver by touching the power-amplifier grid, driver plate, etc., until the antenna is reached.

Having become familiar with the general operation, the final test can be made on an inoperative receiver. The unit cannot be used to check FM and TV front ends, however. Proceed as above until a point is reached where a very weak or no signal is heard. The trouble will usually be found between the last two points touched.

# Chapter 11

## Dynamic Signal Tracer

SERVICE technicians have been offered many signal tracers which claim to trace the signal "from the antenna to the speaker," but they neglect to tell you that *you* have to furnish that signal, either from a strong local station or a signal generator.

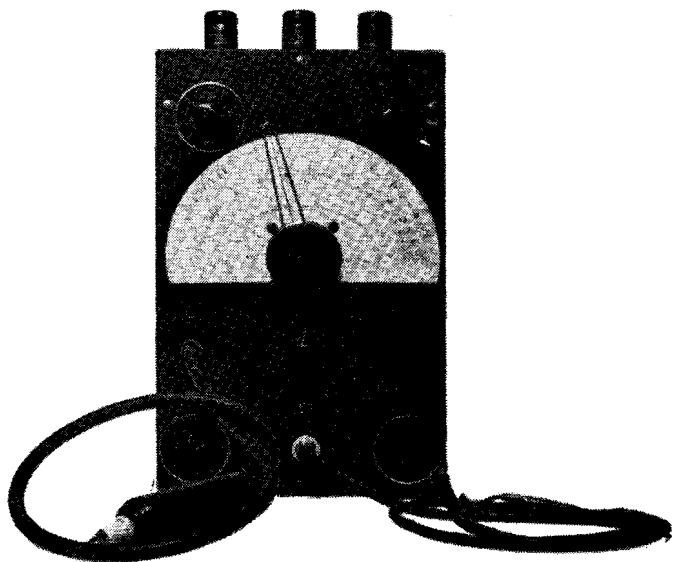

*Fig. 1101. The complete tracer. Its housing may be enlarged to accommodate the power supply and speaker.*

In many locations the nearest stations are many miles away, so a signal tracer that will follow a signal from antenna to speaker has to be a sensitive one. With this in mind here is a practical

and extremely flexible signal tracer, used in a shop for approximately twelve months and invaluable in saving time and eliminating some tough jobs of hunting with voltmeter and soldering iron. As proof of its sensitivity you can place the contact point of the prod against the insulation of an antenna lead-in and tune in half a dozen stations in an area over 75 miles from the nearest stations.

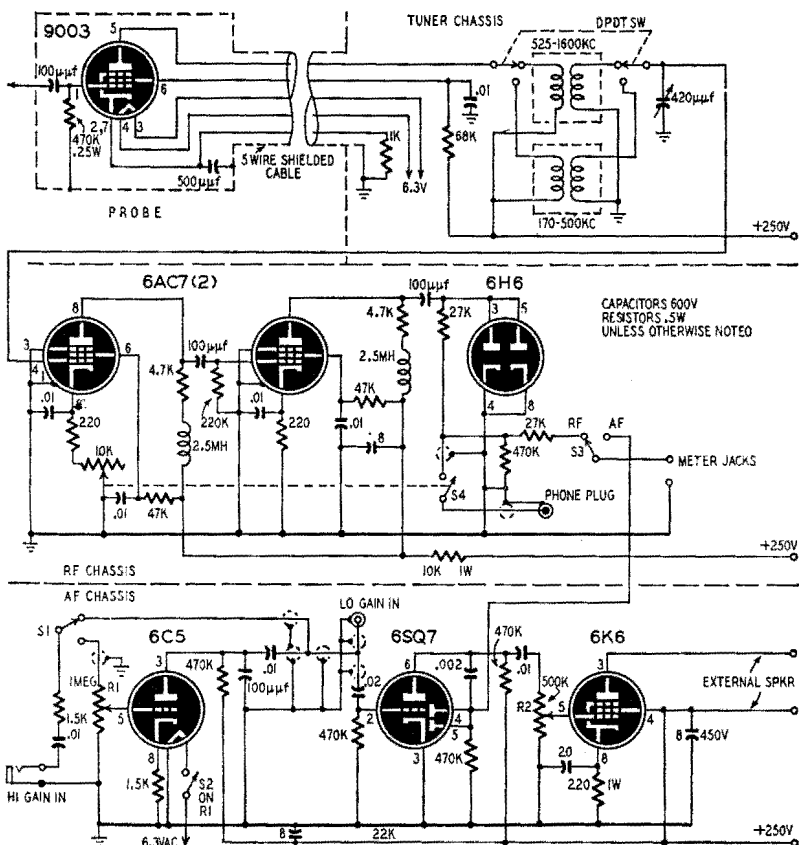

Fig. 1102. Signal circuits of the tracer. Probe and tuner sections are at the top; the r.f. amplifier-detector unit is in the center; the audio amplifier is at the bottom.

The signal tracer shown in Fig. 1101 is built in a steel cabinet 7½ x 12 x 7 inches. The schematic is shown in Fig. 1102. Power supply and speaker are not included. Any power supply delivering 6.3 volts a.c. at 2.5 amps and 250 volts d.c. at 100 ma will do.

### Audio amplifier

The audio section is a straightforward 3-stage high-gain ampli-

fier. Metal tubes should be used in the first two stages for maximum stability. Be sure to connect the No. 1 pin of the 6C5 and the 6SQ7 (and all other metal tubes) to the chassis. The main volume control (R2) is in the grid circuit of the 6K6 (you can substitute a 6V6 if you wish) with an auxiliary control (R1) at the input to the first amplifier. Where extremely high gain is not required switch S1 can be used to bypass the input stage. S2 is ganged with R1 and opens the 6C5 heater circuit when this stage is not used. A low-gain input connection is also provided for direct connection to the second stage.

A portion of the audio signal is rectified by the diode plates of the 6SQ7, and fed to one terminal of S3 for signal voltage measurements. A v.t.v.m. can be placed across the meter jacks for audio voltage measurements. Be sure to take proper precautions

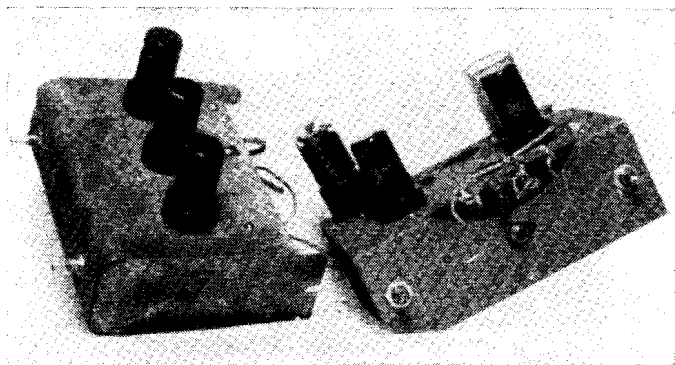

Fig. 1103. *Audio-frequency and radio-frequency amplifier sub-chassis.*

to eliminate feedback by liberal shielding and separation of grid and plate leads. The audio section is placed in the bottom of the signal tracer cabinet.

### **R.F. amplifier**

The r.f.-i.f. section uses two untuned 6AC7 amplifiers and a diode detector. The control in the cathode of the first 6AC7 is a sensitivity control. The 6AC7's are impedance coupled. Because of the high plate impedance of the 6AC7, 2.5-mh chokes are used as part of the plate load. At frequencies below 300 kc, most of the signal voltage is developed across the 4,700-ohm load resistor. Above 300 kc the increased inductive reactance of the choke coil causes most of the signal to appear across the coil. Switch S4 disconnects the output of the r.f. unit when only the audio section is

being used, to prevent spurious sounds issuing from the speaker.

Each stage of this unit is completely isolated from the next by interstage shields. The interstage coupling-capacitor leads run through small holes in the shields. Be sure to use a bottom shield as well to eliminate the possibility of pickup from the audio amplifier. The r.f.-i.f. amplifier is placed in the upper part of the cabinet with the tubes projecting through holes in the top.

After this unit has been completed and connected to the audio amplifier it can be tested by connecting an antenna, through a 100- $\mu$ f mica capacitor, to the input. Temporarily connect a

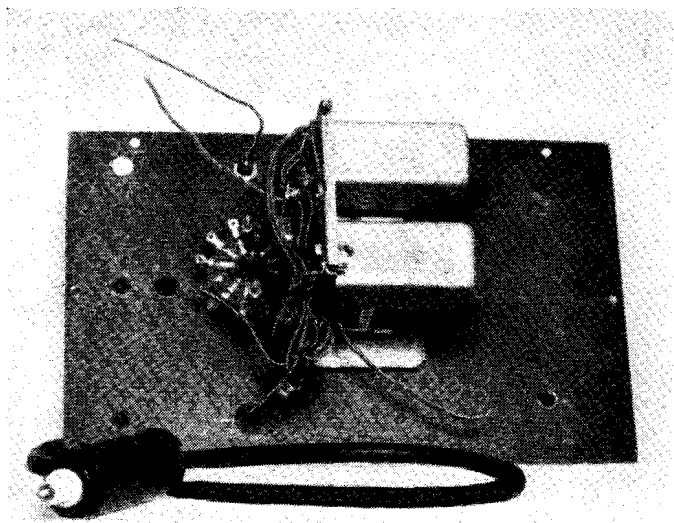

*Fig. 1104. The r.f.-i.f. selector unit sub-assembly, shown mounted to the tracer panel, and the completed r.f. probe unit.*

10,000-ohm resistor from the grid of the first 6AC7 to ground. As there is no selectivity in this unit several stations should be heard simultaneously.

The coils for the tuner are made from i.f. transformers with enough turns removed to bring the frequency up to the proper range and the primaries wound over the secondary. The tuning capacitor has a capacitance of 420  $\mu$ f, but any coil and capacitor combination that will cover the desired frequency ranges can be used. The ranges of this tracer are 170–500 kc on the i.f. band and 525–1600 kc on the r.f. band. Fig. 1103 shows the a.f. and r.f.-amplifier unit sub-chassis and in Fig. 1104 we have the r.f.-i.f.

selector unit subassembly, shown mounted to the tracer panel. Note the completed r.f. probe unit in this illustration.

### Probe unit

The probe assembly is shown in Fig. 1105. The housing is made from the shell of an old MG type 6F6 tube. The crimps holding the shell to the base were pried out and the inside glass tube removed from the base. The guide pin was broken off and the hole enlarged to pass a 5-wire shielded cable. The base of another tube was also used as an insulating washer by grinding it down until it fit inside the shell. The cable was passed through the holes in the base piece and washer and connected to a 7-pin miniature socket for the 9003 pickup tube. A hole was made in the closed end of the shell to take a small feedthrough insulator. A long bolt through this insulator serves as the probe tip and connects to the 100  $\mu\text{f}$  mica isolating capacitor. Be sure to ground the shielding on the cable to the shell of the probe and connect an external ground lead and clip.

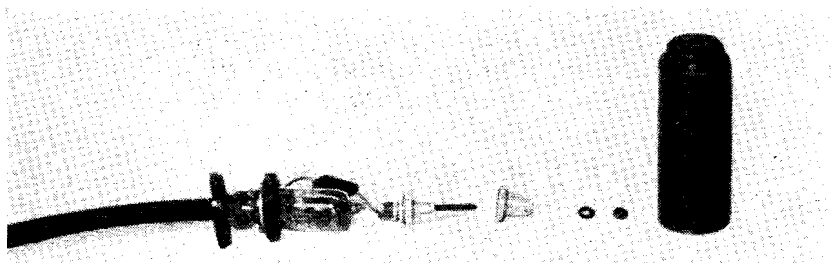

Fig. 1105. Exploded view of the r.f. probe unit assembly, showing components.

The tuner was calibrated with a signal generator. Broadcast stations can be used for the 525–1600 kc range if enough are available.

After calibration you are ready to use one of the handiest test instruments you will ever own. The possible uses are limited only by the ingenuity of the operator.

Due to the high sensitivity of this tracer it is not necessary to make actual contact with the circuits being tested. Thus there is no detuning of critical circuits.

### Testing with the tracer

To check a receiver oscillator, turn S3 to the RF position and connect a v.t.v.m. set to the 10- or 15-volt range to the meter ter-



minals. Tune the receiver to the low end of the dial and add the i.f. to the dial reading. Tune the signal tracer to this frequency and hold the probe tip near the oscillator coil or tuning capacitor. If the oscillator is operating on or near the correct frequency, the meter needle will kick strongly as the tracer is tuned back and forth across this frequency.

To locate trouble in a dead receiver where supply voltages are normal, simply tune the receiver to the frequency of a strong station and trace the signal from grid to plate through each stage. Use the correct tuning range of the signal tracer for the r.f. and i.f. sections of the receiver. Only the audio section of the tracer is needed when you have passed the detector.

For testing phono pickups and microphones, simply feed the output into the proper stage of the audio amplifier. For crystal pickups use the low-gain input and volume control R2. If the crystal is good you will be able to hear the output with plenty of volume. With a standard test record and a good crystal pickup you can calibrate the v.t.v.m. for comparison checks. The high-gain input should be used for dynamic or variable-reluctance pickups, and microphones.

If proper precautions and good workmanship are used in constructing this signal tracer, you will have an instrument that you will depend on more and more as time goes by. Many new uses will suggest themselves as you become more accustomed to handling your tracer.

---

---

### **Materials for the Signal Tracer**

**Resistors:** 2—220 ohms, ½ watt; 1—220 ohms, 1 watt; 1—1,000, 2—1,500, 2—4,700 ohms, ½ watt; 1—10,000 ohms, 1 watt; 2—27,000, 2—47,000, 1—68,000 ohms, ½ watt; 1—220,000, 6—470,000 ohms, ½ watt; Potentiometers: 1—10,000 ohms; 1—500,000 ohms; 1—1 Megohm, with s.p.s.t. switch.

**Capacitors:** (Mica) 4—100, 1—500  $\mu\text{mf}$ ; (Paper) 1—0.002, 8—0.01, 1—0.02  $\mu\text{f}$ , 600 volts; (Electrolytic) 2—8  $\mu\text{f}$ , 450 volts; 1—20  $\mu\text{f}$ , 25 volts. (Variable) 1—420  $\mu\text{mf}$  (max).  
**Miscellaneous:** Tubes: 1—6H6, 2—6AC7, 1—6C5, 1—6SQ7, 1—6K6-GT, 1—9003. Tube sockets. Coils (see text). Switches: (Wafer) 2—s.p.d.f.: 1—d.p.d.f. Cabinet. Chassis. Connectors. Hardware. Wire. Solder.

---

---

# Chapter 12

## Practical VTVM

THE 20,000 ohms-per-volt multimeter has become the basic item of test equipment for shop and laboratory. The popularity of the vacuum-tube voltmeter has also increased substantially during the past few years. With greater complexity in FM and TV receiving equipment, the v.t.v.m. has become a necessity for many jobs which require high-impedance measurements.

The home constructor and small shop owner is confronted with the dilemma of either buying a ready-made instrument, assembling a kit, or making up a meter from scrap and surplus components lying around in the extra parts department. The technician who has learned to make full use of his 20,000 ohms-per-volt meter may not feel like spending the \$50 to \$200 required for a factory job, nor even making up one of the several kits on the market ranging from \$20 upward. A home-built job may fill the bill insofar as basic measurements and ranges are concerned, and at the same time dent the pocketbook only slightly, depending, of course, upon the number of spare parts that can be gathered from the junk box.

A glance at the back issues of radio construction periodicals and at the various v.t.v.m.'s made up by acquaintances reveals that they fall into two classes: the super-duper jobs including ohms scales reading to thousands of megohms, supplied with 1% resistors, 4-inch meters and voltage-regulator tubes (and incidentally priced out of the average shop operator's budget) and the "look-it's-no-larger-than-a-match-box!" type (accompanied by a photo showing that it is, in fact, no larger than the box of safety matches posed beside it).

The v.t.v.m. shown in the photograph, Fig. 1201, was made up as a happy compromise between the extremes of high cost and

tiny impracticability. Except for resistance measurements, it will perform most of the functions of the larger models at a considerable saving in original cost. Resistance measurements were omitted, as it is seldom necessary to obtain readings in excess of 20 megohms, and all values below that may be obtained with the usual high-resistance multimeter. Too, a measuring device of high input impedance for determining resistance is of limited value to the average repairman or experimenter. The additional switch and switch bank, resistances, voltage cell, and recalibrated

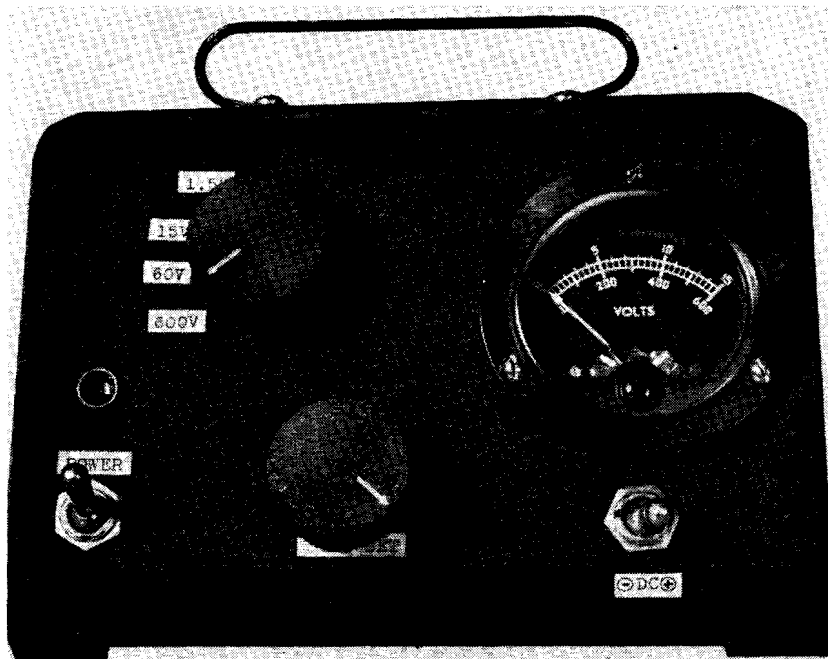

Fig. 1201. Front view of the v.t.v.m. The sloping panel makes it easy to read the meter.

meter-movement scale necessary for resistance measurements not only would increase the cost of complexity of the instrument but might also result in expanding its size or severely overcrowding the interior of the cabinet.

### Construction details

The meter was constructed in a small sloping-front sheet-steel box more or less as a novelty, as horizontal face meters always seem to necessitate leaning over to observe small changes in readings, while the vertical models on a bench or work table usually

require stooping for careful scrutiny. Dimensions of the cabinet are 4 by 4-1/2 by 7 inches long, a standard size readily obtainable from supply houses. It was adequate to house the parts without undue crowding. A miniature tube was decided against, on the basis of availability, lower replacement cost and greater ruggedness of the 6SN7-GT. A miniature-type 12AU7 might be substituted for the octal tube, with a saving of space, but the 6SN7-GT has furnished satisfactory service since the instrument was completed, and the decision against a miniature tube was apparently a wise one.

Details of construction are shown in Fig. 1202. The power

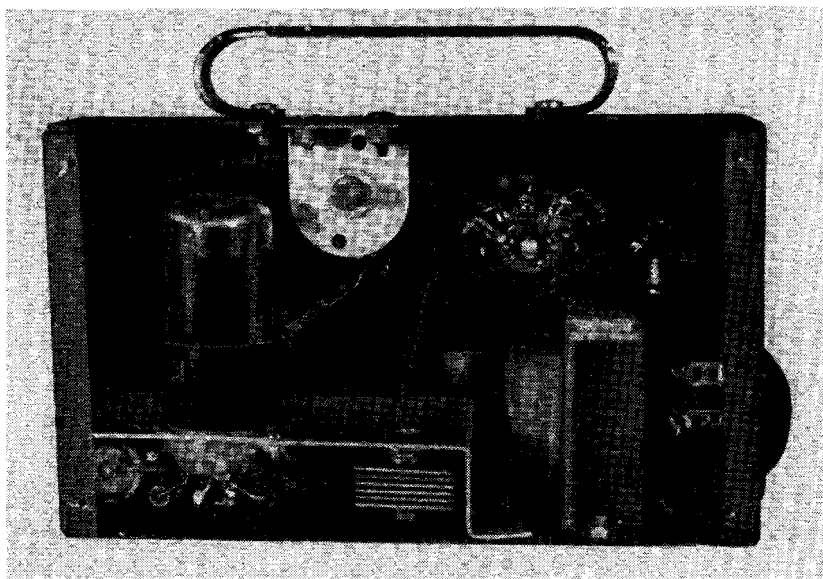

*Fig. 1202. Rear view of the v.t.u.m. Note the mounting of the selenium rectifier.*

transformer is mounted directly on the floor of the sloping-face cabinet, and the switches and controls are held to the front panel by their retaining nuts. The rest of the parts are mounted on a small aluminum chassis bent out of a 3 x 4-inch piece of scrap cut down to size and drilled for the socket and various mounting lugs. The chassis is provided with sheet-metal screws to the bottom and side of the cabinet to retain it in place. The scrap pile also furnished another piece of thin aluminum, which was used for a cabinet back. The back was carefully drilled near the tube to provide ventilation and prevent overheating, which might cause inaccurate readings.

The tube filament is heated by a transformer secondary winding rather than by a dropping resistor. (See Fig. 1203.) This precaution was incorporated so that the 117-volt a.c. supply would be divorced completely from the meter circuit, since much work involves a.c.-d.c. sets, and a direct 117-volt line in either the plate or filament power supplies is likely to produce fireworks and misfortune. The high-voltage secondary of the power transformer

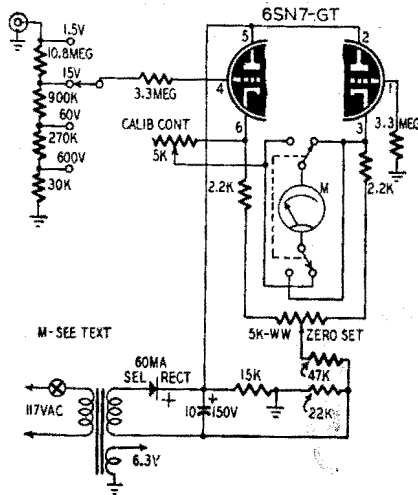

Fig. 1203. Schematic diagram of the v.t.v.m.

furnishes 117 volts, which, when used with the selenium rectifier, produces a low and stable plate supply for the tube.

### The Meter Movement

A word about the meter movement. The one shown has a 500-microampere movement with 0-15 and 0-60 volt scales. These scales lend themselves to easy multiplication and the finished instrument was designed for a.c. and d.c. ranges of 0-1.5- 0-15-, 0-60, and 0-600-volt full-scale measurements, which have proved the most handy around the shop. Any other low-current movement that may be available can be pressed into service. Remember that the lower the basic movement the better. A 0-50 microampere movement, for example, will permit operation over a smaller portion of the tube's characteristic curve, and consequently allow greater linearity and accuracy than a 0-1 milliamperer meter. Of course, since the price of meters is generally directly proportional to their sensitivity, the limiting factor will be the expense.

unless a spare meter of high sensitivity is lying around the extra-parts bin.

Resistors for the "resistance stick" are of the inexpensive half-watt variety, but were chosen with care to assure values as close as possible to 30,000, 270,000, 900,000 and 10.8 megohms. Since the basic accuracy of the meter depends directly on the tolerance of these resistors, selections were made from the stocks of a tolerant retailer after many measurements with an accurate ohmmeter. Precision or semiprecision resistors could have been substituted but, again, the cost was the limiting factor and the more accurate and expensive units were decided against.

In the front-view photo, controls, from left to right, are: on-off

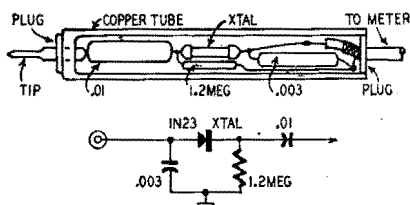

Fig. 1204. Schematic and construction details of the test probe.

switch in the power line, with pilot-bulb indicator above it, range-selector switch, balance-control potentiometer, polarity-reversing switch, and (at the right side) the connectors for input leads. At the rear, as shown by the photo, Fig. 1202, the calibration control is mounted behind the meter movement and once adjusted need not be moved unless the tube is changed or the resistance stick changes markedly in value.

### Circuit operation

The circuit is of the balanced type. The balance control makes the two halves of the dual triode draw such current that both plates are at the same potential. A change in the grid voltage of one will upset the balance and cause the meter movement to register according to the impressed voltage. The 6SN7-GT was found to have sufficiently straight characteristic curves to make readings linear over the instrument's basic operating range, which is from  $-1.5$  volts to  $+1.5$  volts for full-scale movement.

The a.c. probe (Fig. 1204) contains a 1.2-megohm isolating resistor which results in reduced capacitive loading of the circuit under test. Most a.c. measurements are made at higher frequencies, so it was decided that no rectifier be built into the cabinet.

Instead, a probe with crystal and coupling capacitor was assembled from the junk box. It has been more than adequate for general shop and home construction work. The probe was constructed in a short section of 1/2-inch diameter thin-walled copper water pipe such as is used in ordinary house plumbing. Formica plugs for the ends were cut to general shape with a coping saw and turned down to size in the chuck of an electric drill. The tip consists of a screw-type earphone tip threaded into one plug. Shielded cable connects both the d.c. and a.c. plugs to the connector fitting at the side of the meter, reducing hand capacity to a negligible amount. The scale readings for a.c. measurements with the probe are a trifle higher than the actual values of potential. Since the difference is slight (about 10%) it can be ignored

---

---

#### **Bill of Materials for Meter**

**Resistors:** 2—2,200, 1—15,000, 1—30,000, 1—47,000, 1—270,000, 1—900,000 ohms ½ watt; 1—1.2, 2—3.3, 1—10.8 megohms, ½ watt; 1—22,000 ohms, 1 watt; 2—5,000-ohm wirewound potentiometers.

**Capacitors:** 1—.003, 1—.01  $\mu$ f, paper; 1—10  $\mu$ f electrolytic, 150 volts.

**Switches:** 1-single-pole, 5-positions; 1 s.p.s.t., 1-d.p.d.t.

**Miscellaneous:** 1 60-ma selenium rectifier, 1-1N23 crystal; 1-half-wave power transformer, 117-120 volts, 40 ma or more, 6.3 volts, 1 amp or more; 1 meter, as per text, 1 6SN7-GT tube and socket for same, jack, plug material, hardware, wiring, etc.

---

---

in favor of comparative measurements, or may be compensated for with a correction factor on the meter scale, if desired.

The v.t.v.m. shown has been in service for many months now. Though it lacks hairline accuracy and large-instrument versatility, it has provided creditable results for all service and the usual home-experimental type of work. An aluminum strap handle completes the job, and makes the instrument readily portable for service calls or movement about the house and shop. At a total outlay in the neighborhood of \$5 plus parts salvaged from the average spare-parts bin, it will represent an asset of far greater value to the average radioman and experimenter.

### **Calibration**

Calibration is no problem if your meter is identical to the one used in this instrument. Feed in a known voltage which has been measured on an accurate multimeter or v.t.v.m, and adjust the CALIBRATION CONTROL for a correct reading. If you use a different type of 500- $\mu$ a meter, you will probably have to prepare a new dial scale or calibration chart. Use variable-voltage a.c. and d.c. supplies and an accurate meter to supply calibration points.

# Chapter 13

## Multi-Purpose Tester

THIS device combines five highly useful electronic instruments in a single compact unit. It will handle practically any measurements required in routine servicing, and in addition pro-

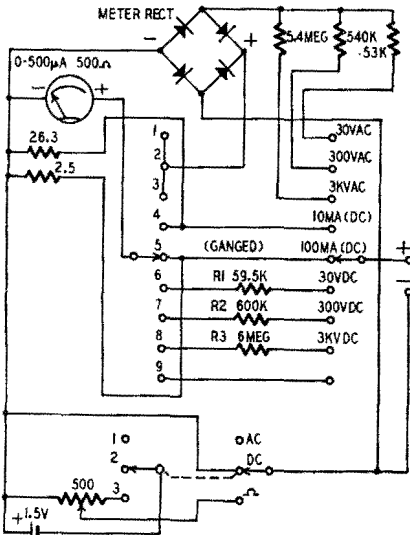

Fig. 1301. Schematic of the volt-ohm-milliammeter section.

vides facilities for capacitance, inductance, and high-resistance measurements.

The five functions of the instrument are as follows:

- Straight volt-ohm-milliammeter (2,000 ohms per volt).
- Audio output meter.
- V.t.v.m.
- Capacitance and inductance grid-dip meter.
- High-resistance and capacitance bridge.



## Volt-ohm-milliammeter

The schematic of this section is shown in Fig. 1301. The meter is a 0-500  $\mu$ amp movement with an internal resistance of 500 ohms. The rectifier is a full-wave-bridge instrument type available from several manufacturers. Voltage ranges of 30, 300, and 3,000 (a.c. or d.c.) are provided, although these can be changed or extended by substituting suitable values for R1, R2, and R3. The values shown for these resistors should be obtained by combining suitable units in series or parallel. This is somewhat less

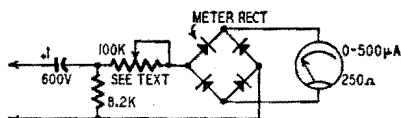

Fig. 1302. The audio output voltmeter.

expensive than purchasing precision resistors. The current ranges are 10 ma and 100 ma. These too can be changed by the use of different shunts. A single resistance range is included, with a mid-scale value of 500 ohms. The voltage multiplier resistors for the a.c. and d.c. scales and the meter shunts can be conveniently mounted on a terminal board. The ohmmeter portion uses a 1.5-volt dry cell.

## Audio output meter

For maximum sensitivity, this section is designed to operate from the primary side of the receiver output transformer. (See Fig. 1302.) The meter and instrument rectifier are identical to

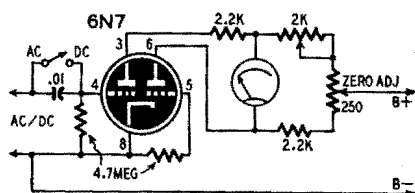

Fig. 1303. Vacuum-tube voltmeter circuit.

those used for volt-ohm-milliammeter measurements. Any meter of the same sensitivity may be used provided its internal resistance is at least 250 ohms. The adjustable series resistor is for calibrating the meter. The receiver under test must get its signal from a constant-voltage source such as a signal generator. Using a broadcast station as the signal source will cause severe fluctuations in the audio output voltmeter.

## V.t.v.m. section

The circuit shown in Fig. 1303 is used for grid-bias and signal

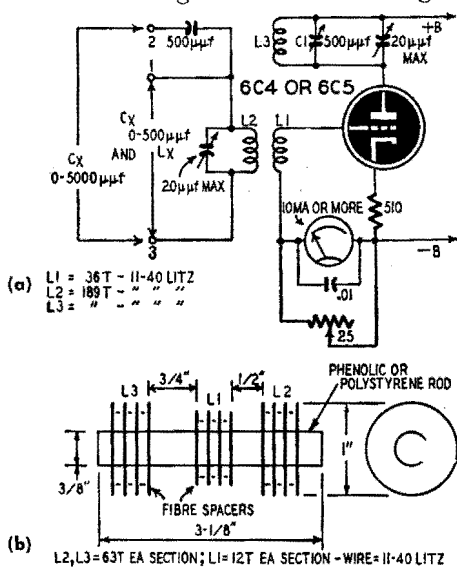

Fig. 1304-a, b. Grid-dip oscillator and coil data.

voltage measurements in low-level audio stages and oscillator circuits. Its full-scale sensitivity is 3 volts a.c. or d.c. The 2,000-

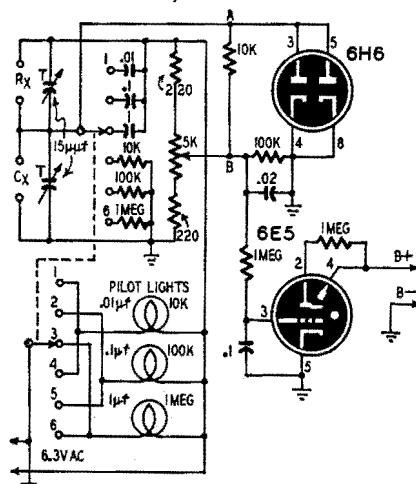

Fig. 1305. Bridge for R-C measurements.

ohm potentiometer is a calibrating control. Zero adjustment is provided by the 250-ohm control.

## Capacitance and inductance tests

A grid-dip oscillator (Fig. 1304-a) is used for these measurements. Capacitance values up to 500  $\mu\text{mf}$  are measured by connecting the unknown capacitor directly across L2 (terminals 1

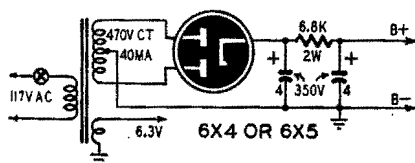

Fig. 1306. Power supply for the tester.

and 3). This forms a resonant circuit. The oscillator is then tuned to the same frequency by varying C1. Resonance is indicated by minimum grid current. Higher values (up to 5,000  $\mu\text{mf}$ )

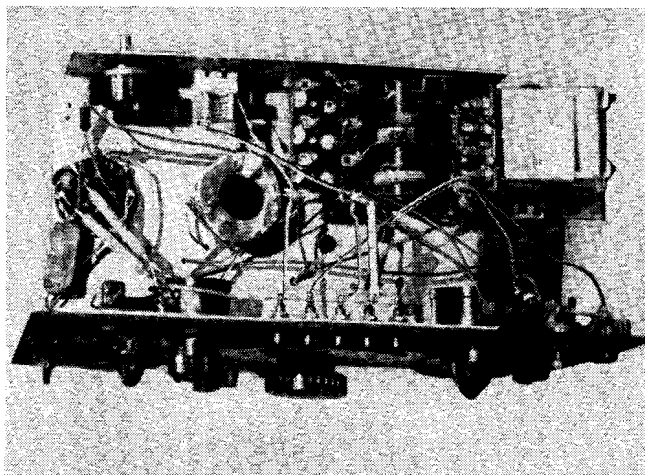

Fig. 1307. Under-chassis view of the combined measuring set.

are measured by connecting the unknown capacitor across terminals 2 and 3. The C1 tuning dial is calibrated by connecting various standard capacitors across the test terminals. Coil details are given in Fig. 1304-a and Fig. 1304-b.

Small inductance values may be checked in the same way. R.f. chokes and TV peaking coils can be used for calibrating the inductance ranges of the instrument.

The meter should have a minimum full-scale reading of 10 ma. A standard 1 ma meter can be used if properly shunted. Its sen-

sitivity is controlled by the 25-ohm rheostat. The trimmer capacitors across L2 and L3 are used to balance out stray capacitances. Coils and capacitors should be connected directly to the terminals.

### Resistance-capacitance bridge

Higher values of resistance and capacitance are measured by the circuit shown in Fig. 1305. A low a.c. voltage from the heater circuit is applied through standard resistors or capacitors to the

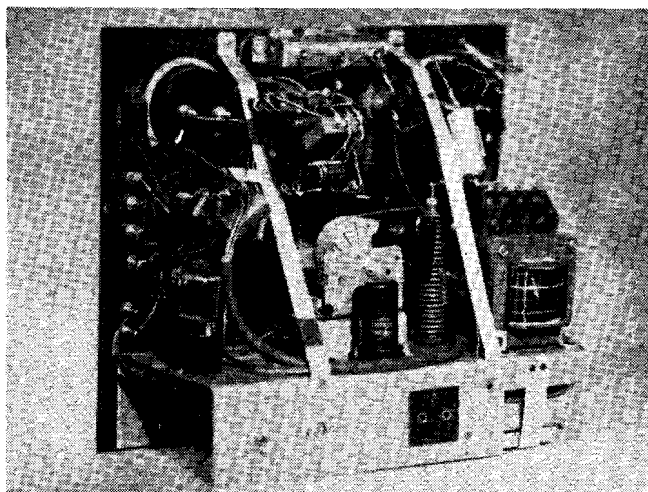

*Fig. 1308. Behind the panel. The multi-plate metallic rectifier mounted next to the power transformer has been changed to a 6X4.*

6H6 diode rectifier. The output of the 6H6 is fed to the 5,000-ohm potentiometer which controls the shadow area of the 6E5 electron-ray indicator. This control is adjusted for maximum shadow area with the test terminals open.

Any impedance (resistance or capacitive reactance) inserted in the a.c. supply reduces the current through the 6H6 and narrows the shadow. The potentiometer is then adjusted to restore the shadow to its original size, and the unknown value is then read from the dial, which may be calibrated with standard resistors and capacitors.

Three 6.3-volt pilot lamps wired to an extra section on the selector switch, show which range is in use.

### Power supply

A standard rectifier circuit (Fig. 1306) using a small power transformer and 6X4 supplies all operating voltages.

Although individual meters are used in each of the first four circuits, a single 0-500- $\mu$ a movement can be used by providing pin jacks at the meter terminals in each section. This will also require a number of different scales for the meter. An under-chassis view is shown in Fig. 1307 and a behind-the-panel view appears in Fig. 1308.

Obviously, any one of the sections described may be built as a separate unit. For that reason, separate parts lists for each section are given.

---

---

### Materials for Measuring Set

#### Volt-ohm-milliammeter

**Resistors:** 1—6 megohms, 1—600,000 ohms, 1—60,000 ohms,  $\frac{1}{2}$  watt (see text); 1—5.4 megohms, 1—540,000, 1—54,000 ohms,  $\frac{1}{2}$  watt; 1—26.3 ohms, 1—2.5 ohms,  $\frac{1}{2}$  watt (see text); 1—500-ohm potentiometer.

**Miscellaneous:** 1—2-pole, 9-position selector switch; 1—1-pole, 3 position selector switch; 1—0-500 microammeter, internal resistance 500 ohms; 1—full-wave-bridge instrument rectifier (Conant 160B, Electroxx AA-4, or equivalent); 1—1.5-volt dry cell; wire, hardware.

#### Audio Output meter

**Resistors:** 1—8,200 ohms,  $\frac{1}{2}$  watt, 1—100,000-ohm potentiometer.

**Capacitor:** 1—0.1  $\mu$ f, 600 volts, paper.

**Miscellaneous:** 1—0-500 microammeter; 1—full-wave-bridge instrument rectifier (Conant 160B, Electroxx AA-4, or equivalent); wire, hardware.

#### V.t.v.m.

**Resistors:** 2—4.7 megohms, 2—2,200 ohms,  $\frac{1}{2}$  watt; 1—2,000-ohms, 1—250-ohms, potentiometers.

**Capacitor:** 1—0.01- $\mu$ f, 600 volts, paper.

**Miscellaneous:** 1—0-500 microammeter; 1—6N7 tube; 1—s.p.s.t. toggle switch; wire, hardware.

#### L-C grid-dip meter

**Resistors:** 1—510 ohms,  $\frac{1}{2}$  watt; 1—25-ohm rheostat.

**Capacitors:** (Paper) 1—0.01  $\mu$ f, 600 volts, (Ceramic or mica) 1—500  $\mu$ f. (Air variable) 1—500  $\mu$ f. max. (Trimmers) 2—20  $\mu$ f max.

**Miscellaneous:** 1—oscillator coil (see text); 1—6C5 or 6C4 tube; 1—octal socket; wire, hardware.

#### R-C bridge

**Resistors:** 3—1 megohm, 2—100,000 ohms, 2—10,000 ohms, 2—220 ohms,  $\frac{1}{2}$  watt; 1—5,000 ohms potentiometer.

**Capacitors:** (Paper) 1—1.0  $\mu$ f, 2—0.1  $\mu$ f, 1—.02  $\mu$ f, 1—.01  $\mu$ f, 600 volts; (Variable), mica trimmers 2—20  $\mu$ f.

**Miscellaneous:** 1—6H6 tube, 1—6E5 tube; 2—tube sockets; 1—2-gang 6-position wafer switch; 3—6.3-V pilot lamps; 3—pilot-lamp sockets, wire, terminals, hardware.

#### Power Supply

1—power transformer (470 volts center-tapped, at 40 ma; 6.3 volts at 1.5 amp) 1—6X4 or 6X5 tube; 2—4- $\mu$ f, 350-volt electrolytic capacitors, 1—6,800-ohm, 2-watt resistor; 1—tube socket; 1—s.p.s.t. toggle switch; 1—line cord and plug; wire, hardware.

---

---

# Chapter 14

## Volt-Ohm-Milliammeter

CONSTRUCTION of a volt-ohm-milliamperere meter is feasible and can be an economical project. Furthermore, the experience to be gained from making such a unit is not to be underestimated.

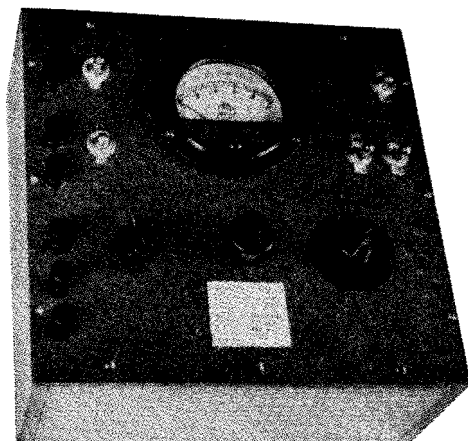

*Fig. 1401. Front view showing neat arrangement of tester controls.*

This multitester employs a 0-1 milliamperere meter and is a reliable and convenient instrument for many general testing purposes. A meter with a 1,000 ohms-per-volt sensitivity can be inexpensive and fairly rugged, and may be used with wire-wound resistors at a cost much lower than would be possible with a meter of higher sensitivity. The only calibration required is a check with another a.c. voltmeter at a few points. Some voltage measurements, of course, require higher sensitivity, but those are commonly made with a vacuum-tube voltmeter. This instrument is

built around an ordinary 0–1 ma meter having an accuracy rating of 2% at full scale and an internal resistance of approximately 45 ohms. The tester provides 8 d.c. voltage ranges, 7 a.c. voltage ranges, 4 d.c. milliamperage ranges, and 2 ohmmeter ranges.

No attempt was made to mark scales on the meter directly. D.c. voltage and d.c. milliamperage ranges use simple multipliers and shunts. Ohms and a.c. volts are read from the meter scale with the aid of tables. For accuracy wire-wound 1% precision resistors were used as multipliers and shunts. D.c. measurements on any range are nearly as accurate as the meter itself at the particular part of the scale where the reading falls. The limiting factor for accuracy in resistance measurement is the linearity of the scale.

### **Construction details**

The general layout of the front panel is indicated by the photo in Fig. 1401. All parts except the internal batteries are mounted on the 3/16-inch Masonite panel. The usual milliammeter is not shielded, and accuracy will be affected if ferro-magnetic material is mounted close to it. Therefore a clearance of approximately 1 inch should be provided between the meter and parts. The voltage multipliers are mounted on the rear section of the rotary switch; the front section is used as the ohmmeter range selector. The rectifier and fuse holder are mounted on small pieces of Masonite, providing insulation for these items. Heavy-duty toggle switches (3 amperes) are used in the milliamperage section, since contact resistances must be kept low. This section should be wired with No. 18 wire, or heavier, and the shunt leads should be kept as short as possible.

The assembly is mounted in a sturdy oak box the bottom of which is a piece of 1/8-inch Masonite with rubber feet attached to its corners. The overall dimensions of the box with panel and bottom attached are 8-3/4 x 8-3/4 x 3-3/4 inches. This plan of construction facilitates assembly and wiring, and allows space for adjustments and replacements. The arrangement of parts is not critical and any desired layout can be used according to the preference of the constructor. Fig. 1402 shows the circuit.

### **Voltmeter section**

The required resistance for each d.c. range was calculated from

Ohm's law, assuming a current of 1 milliampere for full-scale deflection. On selector point 1, for example, a 950-ohm resistance (theoretically 955) was added to the meter resistance to provide a circuit resistance of 1,000 ohms, and on point 2 an additional 4,000 ohms brought the circuit resistance to 5,000 ohms. Since a 950-ohm precision resistor was not available, a 900-ohm and a 50-ohm resistor were connected in series.

On a.c. voltage measurement the scale is not linear, but shows a certain amount of crowding near zero. This is because rectifier efficiency, which is the ratio of forward to inverse rectifier current, decreases at low currents. This is true of all ranges. An effect noticeable on low voltage ranges is the increase in rectifier resistance with decreasing rectifier current. If this resistance

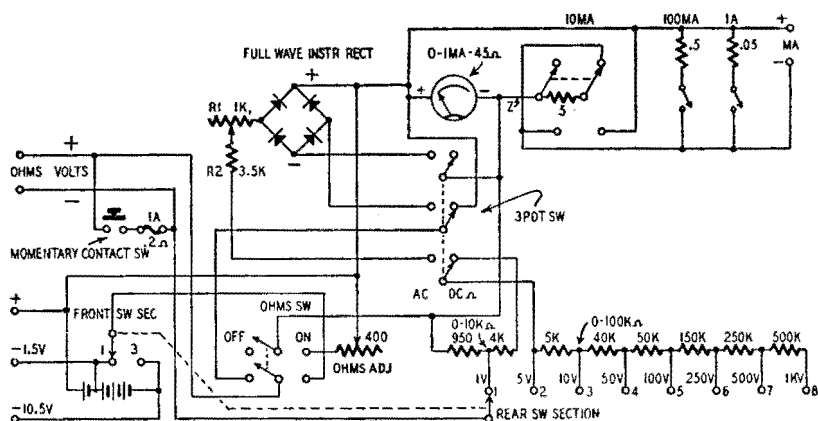

Fig. 1402. Diagram of the tester. Positions 1 and 3 are the two ohmmeter ranges.

change is not negligible in comparison with the total resistance in the multiplier circuit, an additional distortion will result. For this reason, the 1-volt scale is not used for a.c. voltage measurement. A chart supplied with the rectifier showed the comparison of an a.c. scale with a linear d.c. scale. By accurate interpolation from it, values were obtained giving the comparison for 100 points on the d.c. scale.

A compensator consisting of R1 and R2 is connected in series with the rectifier input to provide an adjustable correction for rectifier resistance. R1 and R2 are mounted on a brass angle behind the panel. If the readings on all a.c. ranges are to be made proportional to the d.c. multipliers it is necessary to adjust the effective resistance of each multiplier resistance 10% below



the nominal value for d.c. Since rectifier characteristics vary, it will be necessary to determine R2 by experiment. Starting with a 3,900- or 3,300-ohm carbon resistor, one should be found which will permit adjustment for correct reading on the lowest ranges by varying R1.

Prepare an a.c. voltmeter table from the scale conversion chart supplied for the particular rectifier used. With a borrowed a.c. voltmeter locate a series of points. Adjust R1, and if necessary R2, for correct readings on the 5- and 10-volts ranges. Revise your table or chart to fit the other ranges, if necessary.

Since each voltage multiplier resistance for a.c. would be 10% lower (depending on rectifier efficiency) than the d.c. units, it would be more accurate to use separate precision resistors for a.c. ranges. We found the chart more convenient. It is possible, of course, *for use with 60-cycle a.c. voltages*, to connect proper value paper capacitors across each multiplier resistance such as to lower the a.c. impedance (correcting the a.c. reading) without affecting the d.c. ranges. The voltage rating for the higher resistance multiplier shunt capacitors should be 600 volts or better.

### Ohmmeter section

The tester measures resistances from 0 to over 10,000 ohms on the low range (980 mid-scale), and from 0 to well over 100,000 ohms on the high range (10,000 mid-scale). An internal battery supplies 1.5 volts for the low range and 10.5 volts for the high range. The rotary range-selector switch selects the proper battery voltage and circuit resistance for the two ohmmeter positions, points 1 and 3, and a d.p.d.t. toggle switch connects the battery and ohms-adjust shunt. Battery terminals are connected to three binding posts on the panel for external battery use. A momentary contact switch shorting the ohmmeter terminals has proved to be a great convenience in making the full-scale zero ohms adjustment.

In measuring an unknown resistance the instrument is first set for ohms on the proper range and then adjusted for full-scale deflection of the meter. With an unknown resistance connected to the terminals, the meter will read some value less than full scale,  $I$  milliamperes. If  $R_c$  is the total circuit resistance of the instrument, the unknown resistance  $R$  is given by

$$R = \frac{R_c}{I} R_c$$

$R_c$  was calculated at 980 ohms for the low scale and 10,000 ohms for the high scale, taking into account the resistance of the meter and the effect of its adjustable shunt. The resistance of a battery in good condition may be neglected. For each range a table was prepared containing 100 calculated resistance values, one for each half-division on the scale. The tables have proved to be rapid and convenient in use; the small effort involved in calculating a value for each half-division has been well justified.

### Milliammeter section

Milliamperes are measured on four current ranges, 0-1, 0-10, 0-100, and 0-1,000. The meter itself covers the 0-1 ma range, and for each of the other ranges it is shunted by a resistor.

---

#### Materials for Volt-Ohm-Milliammeter

**Resistors:** 1—.05 (parallel two 0.1-ohm units), 1-0.5, 1-5.0, 1-950 (parallel units as required), 1-4,000, 1-5,000, 1-40,000, 1-50,000, 1-150,000, 1-250,000, 1-500,000 ohm resistors. See text for value of R2 (10% tolerance, or better).

**Miscellaneous:** 1-rotary switch, 2 circuits, 8 positions, 2 wafers; 1-rotary switch, 3 poles, 2 positions; 2-toggle switches, s.p.s.t.; 2-toggle switches, d.p.d.t.; 1-toggle switch, s.p.d.t., momentary type; 1-meter, 0-1 ma, 45-ohms internal resistance; 1-full-wave instrument rectifier, 1 ma; 1-instrument fuse, 1 amp.; 7-binding posts, insulated (colored as desired).

---

For a meter having an internal resistance  $R_m$ , the required shunt resistance  $R_s$  for any scale multiplier  $n$  is found by the formula,

$$R_s = R_m / (n - 1)$$

The meter used has an internal resistance of almost exactly 45 ohms, therefore a shunt of 5 ohms resistance was required for the 0 to 10 ma range. The 5-ohm shunt was arranged so that it could be switched in series with the meter for the two higher ranges, making the effective meter circuit resistance 50 ohms. Note that connecting a resistor in series with the meter in the manner shown in the circuit diagram is equivalent to substituting a meter having an internal resistance which is greater by the amount of resistance added. However, this does not mean that the sensitivity of the meter is increased thereby. Using this arrangement, shunts of 0.505 and 0.05005 ohms resistance were calculated for scale multipliers of 100 and 1,000 respectively. Even-value resistors of 0.5 and 0.05 ohms were used, the latter being secured by connecting two 0.1-ohm resistors in parallel.

There would, of course, be no point in using the series-shunt switch in cases where the meter resistance is not nine-tenths of a convenient round number, as (in this case) 45 or 27 or 90. Compensation can be made readily for a lower (or slightly higher)

resistance by inserting additional resistance at point Z on the diagram to make up the difference between it and 50 ohms. For meters far from 50 ohms, it would be better to calculate the shunts. Remember that the  $n - 1$  of the formula means that to multiply 10 times, you have to use a shunt  $1/9$  the resistance of the meter; for 100 times, use a shunt  $1/99$  the meter resistance.

Before setting up the milliamper section, the internal resistance of the meter must be accurately determined. The following method is satisfactory, and does not require costly equipment: Connect the meter to a good 9-volt battery *in series* with a resistor of approximately 10,000 ohms and note the deflection. (Use two 4.5-volt batteries in series.) Now shunt the meter with a 50-ohm

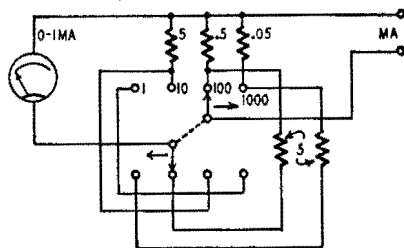

Fig. 1403. A modified milliammeter circuit.

precision resistor or any resistor of approximately that value which has been accurately calibrated, and again note the deflection. Calculate the meter resistance by substituting in the shunt formula previously given, using for the value of  $n$  the first deflection divided by the second. (By a process similar to this, it is possible to use the tester for measurement of very low resistance.)

It must be emphasized that should any of the switches in the milliammeter section become defective or dirty, all the current being measured would flow through the meter, and probably destroy it. While there has been no trouble with this particular instrument, an improved method of switching the current shunts into the meter circuit is indicated in Fig. 1403. As will be noted, the three toggle switches are replaced by one 1-pole 4-position rotary switch (which may be a section of the main range-selector switch used). With this circuit any imperfect or dirty contacts will take the meter out of the circuit and eliminate any possibility of excess, unshunted current from flowing through the meter and injuring it. The two extra 5-ohm resistors should be the same type as the 10-ma, 5-ohm shunt. They serve to maintain an effective meter resistance of 50 ohms for the 100- and 1,000-ma ranges.

# Chapter 15

## Sensitive R.F. Voltmeter

THE r.f. voltmeter illustrated in Fig. 1501 can be constructed for about ten dollars and can be designed to cover many ranges by increasing the case size and multiplier resistance. It is ready

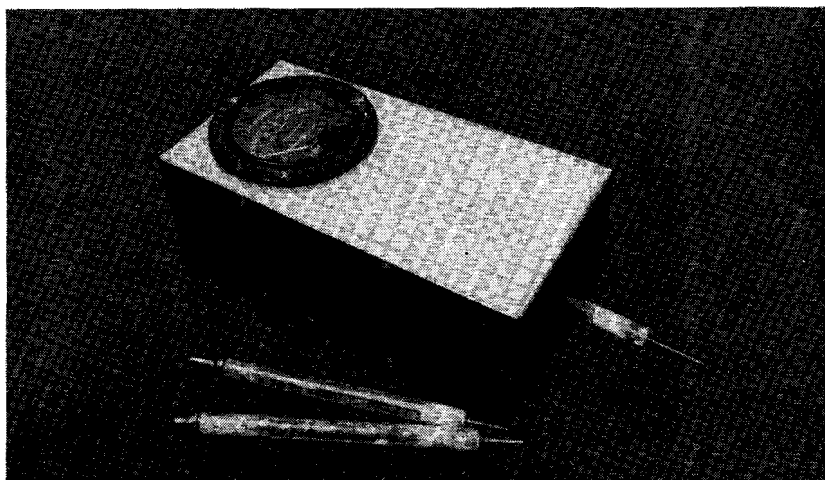

*Fig. 1501. Photo of the trim-looking unit and the associated plug-in multiplier probes. Connection to the power line is not needed.*

to operate instantly and requires no connection to the power line. It isn't even necessary to have a ground connection as body capacitance is enough to provide a return path. But for safety's sake it is best to ground it, especially if there is high-voltage d.c. around. Where d.c. is present in the circuit an external blocking capacitor is necessary.

## Uses for voltmeter

Originally built for amateur use, this circuit can be used to measure *relative* values of the voltage (with a more sensitive meter and a higher voltage multiplier) at the plate of horizontal output tubes or high voltage rectifiers in TV sets. The meter should present about the same load as the picture tube and the filter capacitor.

The popular germanium diode probe used for measuring r.f. voltage is usually limited to 30 volts maximum, as more than this might exceed the back voltage rating of the crystal, especially if the waveform is not a sine wave. Some crystal diode rectifiers can be used up to 150 volts, and with a capacitance-type multiplier will safely read almost any voltage.

The unit described in this chapter has been used for quantitative tests on transmitters and open-wire feeder lines to antennas.

---

### Materials for Voltmeter

One 0-1 ma meter, one .01- $\mu$ f mica capacitor, one 1N35 dual germanium crystal, some 1/4-inch polystyrene rods, several lengths of 3/8-inch polystyrene tubing 5 1/2 inches long, several pieces of brass welding

rod, several banana plugs, a jack with insulating washers, three matched 1-watt 5% tolerance resistors (see text), for multiplier-probe, and solder. Several .025-gauge 52S1/2H aluminum sheets, binding posts, hardware, etc.

---

The illustration, Fig. 1502, shows that the case is used as a three-section shield—two sections around the probe which is also the multiplier, and one around the meter and rectifier assembly. The shield around the probe must have a low capacitance to the resistors or some of the current will pass directly to ground without registering on the meter. The multiplier must be shielded to prevent the sensitive low-voltage end of the multiplier from picking up r.f. both from the source and from the high-voltage end through distributed capacitance. The two-section box shield does this without introducing too much capacitance to ground. The capacitive effect is minimized further by using a fairly large meter current. A 0-1 ma meter is used but the overall sensitivity is about 450 ohms per volt. This does load the circuit somewhat but for transmitting work this is not undesirable. The circuit is shown in Fig. 1503.

### Construction

The case is constructed of 52S1/2H aluminum sheet. This alloy combines stiffness and workability. For an 8 x 4 x 3-inch case,

sheeting of .025 gauge is about right. The sides, however, could be heavier since it isn't necessary to bend them. One side is riveted permanently and the other one is fastened with self-tapping screws. Two partitions reinforce the sides, shield the multiplier, and divide the case into three sections. The construction of the inner shields and banana jack support should be completed before assembling the case.

The multiplier resistance for each range may be determined by using an audio-frequency voltage and an accurate a.c. voltmeter. Start with about 450 ohms per volt. The multipliers would be accurate only for sine waves as most voltmeters read

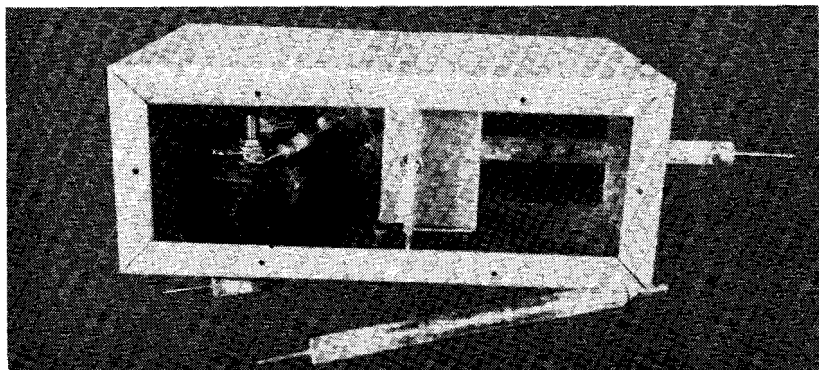

*Fig. 1502. View of the inner construction, showing the resistor shielding and the components.*

r.m.s. values. The multiplier should have at least three resistors, especially for the higher ranges. On the 1,500-volt range the resistors may dissipate a little over 3 watts so the total wattage should be adequate. It is preferable to have the resistors in a multiplier as nearly identical as possible in wattage and ohmage.

The probe-multipliers are made of Amphenol polystyrene tubing and rods. 1/4-inch rods just fit into 3/8-inch tubing, so these sizes are used. A 1/2-inch length of rod is drilled axially and tapped for the 6-32 thread of standard banana plugs. It is difficult to drill this straight unless the rod is placed in the drill chuck and the drill bit clamped in a vise. This rod is then cemented in the end of a piece of tubing with polystyrene cement and allowed to harden. Then a 1/16-inch hole is drilled alongside the threads for the resistor lead. After the resistor string is made up use a length of 1/16-inch brass welding rod at one end for the probe tip. The resistors should be so spaced that about half of the last

one will be inside the inner shield when the probe is plugged in. After making a final check of the multiplier for accuracy, seal the probe end with a section of rod drilled to fit the welding rod, and cement it in place.

The meter uses four probes to give 0-3, 30, 300, and 1,500-volt

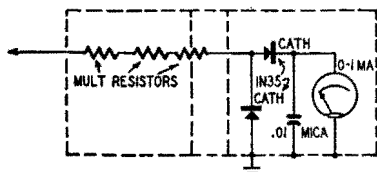

Fig. 1503. Diagram of the diode-type voltmeter.

ranges. The circuit was selected because it gives linear readings on all but the 3-volt scale, allowing d.c. meter scales to be used. A 1N35 dual crystal (having matched characteristics) is used in preference to the 1N34 types.

# Chapter 16

## Resistance and Capacitance Bridge

EVERY service technician and hobbyist needs equipment to measure wide ranges of capacitance and resistance. The best instruments for this purpose use bridge circuits. This tester, whose panel view appears in Fig. 1601, includes test features

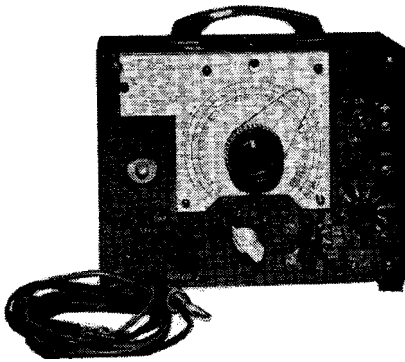

Fig. 1601. A panel view of the bridge.

found in higher-priced resistance-capacitance bridges and capacitor leakage testers. Its total cost, about \$25, may be greatly reduced by using components already on hand.

The tester measures capacitance from 10  $\mu\text{f}$  to 700  $\mu\text{f}$  in four ranges; makes leakage tests of oil, paper, and mica capacitors by the relaxation oscillator method and of electrolytics by three ranges of leakage current; measures resistance from 10 ohms to 700 megohms in four ranges; supplies a polarization voltage for testing electrolytic capacitors; and indicates power factor.



The basic circuit is shown in Fig. 1602. When the detector indicates a null, the voltage between points 1 and 2 is zero. The voltage across arms A and C are equal, and the voltages across B and D are equal. This can be expressed by the equation:

$$A/B = C/D.$$

A, B, C, and D may be expressed in terms of voltage; or, if A

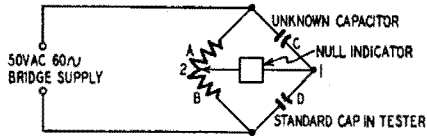

Fig. 1602. The capacitance tester is built around this conventional bridge circuit.

and B are in terms of resistance, C and D may be in terms of capacitive reactance. As capacitance is inversely proportional to reactance, C and D may be expressed in terms of capacitance. The equation can then be used for calibrating the dial.

### Dial calibration

The potentiometer used is a 10,000-ohm wire-wound, linear-taper unit with 279° of electrical rotation and is not hard to find in radio parts stores. The dial scale in Fig. 1603 is used with the

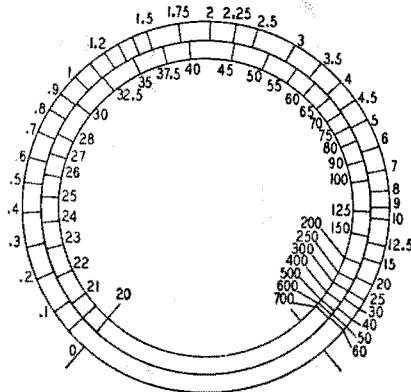

Fig. 1603. Dial scale gives readings for all four ranges.

potentiometer to give all the necessary readings. If a potentiometer with a different rotation or taper is used, the builder may calibrate his own dial.

Any point on the dial may be found by using the bridge equation given. Assume that the capacitor at D is 2  $\mu\text{f}$  and the capacitor to be tested at C is 0.5  $\mu\text{f}$ . If the potentiometer is 10,000 ohms,



factor control) is much easier to calibrate. It indicates deterioration of the dielectric of a capacitor and shows when an electrolytic is nearing the end of its useful life. Usually a capacitor is rejected if its power-factor reading is greater than 5%. (This actually indicates a 5% drop from a power factor of 1.)

If the power-factor reading is greater than zero, the dielectric absorbs some of the charge on the capacitor and the current flow through it has somewhat of a time lag compared with a perfect capacitor. This effect can be simulated by putting a resistance in series with the capacitor. The power-factor control R2 will balance out the dielectric absorption of the capacitor under test. The percentage power factor is indicated when this resistor is adjusted for maximum opening of the eye. Table 1 gives the resistance of this potentiometer for different values of power factor.

The power supply is a conventional halfwave rectifier. A 300-0-300-volt transformer with centertap unused supplies about 800 volts d.c. If voltages other than those shown in Fig. 1604 are used, the bleeder resistance should be tapped to supply about 200

% Power factor	Resistance of R2 in ohms
0	0
5	66.3
10	133
20	201
30	417
38.3	550
40	578
41.2	600
50	776

volts to the electron-ray tube. Two 4- $\mu$ f capacitors in series may be used for C4, but C1 should be an oil-filled or paper type.

### Testing leakage

Leakage tests with this checker are conventional except that additional ranges are used. The neon bulb used as a current indicator for electrolytic capacitors extinguishes on ranges 3 and 4 with leakages of less than 1.4 and 2.5 ma, respectively, and on range 2 it changes from a flash to a glow when the current decreases to 0.2 ma. When electrolytics have been unused for a long time, about 5 minutes should be allowed for the capacitor to form under full test voltage before it is rejected for excess leakage. When used to check oil, paper, and mica capacitors, the relaxation oscillator flashes more slowly for smaller leakages.

Range switch S1 is a five-pole, four-position wafer switch with poles, 1, 2, and 4 used for resistance, capacitance, and leakage ranges, respectively, while pole 3 is used to switch R3 in the one resistance arm for extended range 4. Pole 5 applies polarizing voltage only on ranges 3 and 4. The three-pole, three-position wafer switch S2 places standard values of resistance and capacitance in the bridge arms and applies polarizing voltages on the capacitance ranges only. S3 is a single-pole, nine-position wafer switch used for the d.c. voltage steps. Table 2 shows the ranges of S1 for the three settings of S2.

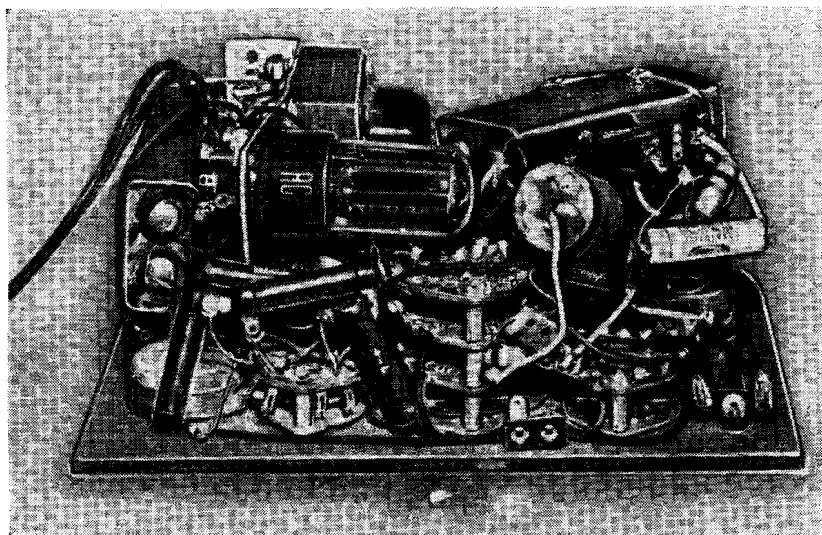

*Fig. 1605. A back-of-the-panel photo. Many of the components are mounted on the switches.*

The construction of this tester is neither critical nor complicated. The wiring should be point-to-point to keep stray capacitance as small as possible.

You can use a 6 x 9-inch Masonite panel with a wooden box 5 inches deep. Metal cabinets of similar size are generally available; but if a metal cabinet is used, be careful to keep stray capacitance at a minimum. A back-of-the-panel photo appears in Fig. 1605.

High-quality parts with 1% tolerance should be used for C1, C2, C3, R3, R4, R5, and R6. Standard tolerance parts may be used if they are selected with a bridge.

## To test a capacitor

1. Turn switch S2 to the leakage position; S1 to the range required, S3 to the d.c. voltage rating of the capacitor.

2. Connect the capacitor and note the neon tube indication. If the indication is O.K. according to Table 2, proceed with the test.

S1 Setting	1	2	3	4
Res	Rx100 10-5K	Rx-10K 1K-500K	Rx1 meg .1-50 meg	Rx 1 meg 20-500 meg
Cap	Cx.0001 10-5,000 $\mu\text{mf}$	Cx.01 .001-0.5 $\mu\text{f}$	Cx1 0.1-50 $\mu\text{f}$	Cx1 20-700 $\mu\text{f}$
Leak	paper under 0.1 15 sec flash OK	paper over 0.1 6 sec flash OK	dry elec. ext. at 1.4 ma OK	Wet elec. ext. at 2.5 ma OK

3. Set switch S2 to the capacitance position; S1 to the range required, and, when testing oil, paper, or mica capacitors, S3 to zero voltage. Adjust the main and power-factor controls for maximum opening of the eye tube. If the maximum opening is near the zero end of the dial, switch S1 to the next lower capacitance range; and to the next higher if the reading is near the high end.

*CAUTION: D.c. voltages on the test terminals may be high! Always turn S3 to zero volts before handling the capacitor under test.*

## To test a resistor

1. Set S2 to the resistance position and S1 to the range required.

2. Connect the resistor and adjust the main control for a maximum opening of the eye tube. If the eye opens near the zero end of the dial, switch to the next lower range; if it opens near the high end, use the next higher range.

---

### Materials for Capacitance Bridge

**Resistors:** 1—1 megohm,  $\frac{1}{2}$  watt; 1—100,000, 1—270,000 ohm, 1 watt; 1—1,000, 3—6,000, 1—9,000, 1—10,000, 1—11,000, 1—12,5000, 1—60,000 ohm, 5 watt; 1—30,000 ohm, 10 watt; 1—20,000 ohm, 1—2 megohm,  $\frac{1}{2}$  watt, 1%; 1—200, 1—100,000 ohm, 1 watt, 1%; 1—1,000 ohm, 1—10,000-ohm, wire-wound linear-taper potentiometers.

**Capacitors:** 1—0.0002- $\mu\text{f}$  mica; 1—.02 $\mu\text{f}$ , 100 volt, 1—.02- $\mu\text{f}$ , 600-volt, 1—.02- $\mu\text{f}$ , 800-volt paper; 1—0.5- $\mu\text{f}$ , 200-volt paper; 2—2- $\mu\text{f}$ , 800-volt oil.

**Transformers:** 1—300-0-300 volt; 5 volt, and 2.5 or 6.3 volt; 1—audio interstage, 2:1 ratio.

**Miscellaneous:** Tubes, sockets, neon bulb NE48, switches, chassis, hookup wire.

---

# Chapter 17

## Power Tester

WITH the simple adapter shown in Fig. 1701 the radio technician can use his regular a.c.-d.c. voltmeter to measure quickly the watts drawn from the power line by a radio, toaster, or other electrical appliance.

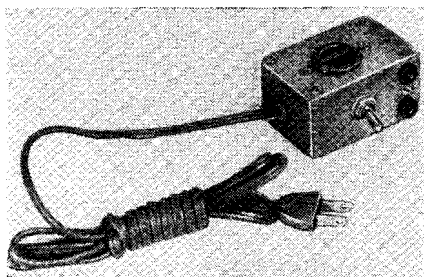

Fig. 1701. The watts adapter is a compact unit.

The adapter measuring only 3 inches long, 2 inches wide, and 1-1/2 inch deep, has a line plug, an outlet receptacle, and a pair of jacks for the voltmeter leads. In use, the plug is inserted into a nearby power outlet, the appliance under test is plugged into the outlet receptacle of the adapter, and the voltmeter plugged into the meter jacks. A toggle-type changeover switch in the adapter allows voltage readings to be taken at two points in the circuit, and the wattage is determined from these readings.

Fig. 1702 is the complete circuit schematic. Current  $I$  drawn from the power line by the appliance under test must flow through resistor  $R$ . This current flow sets up a voltage drop  $E_1$  equal to  $I \times R$  across the resistor, and this drop is directly proportional to the current. If the voltage drop is measured with

a voltmeter, the current through R may be determined by dividing  $E_1$  (in volts) by R (in ohms). If the line voltage  $E_2$  also is measured with the voltmeter, the power drawn by the radio or appliance under test may be determined by multiplying  $E_2$  by I.

These calculations can be eliminated entirely on the job by working out beforehand the wattage corresponding to the voltage drop across R. This has been done and appears in the table for a line voltage of 115 volts, and can be calculated for line voltages from 90 to 120 volts. The figures in Table 1 are easy to derive. Assume that with switch S in the "2" position, you

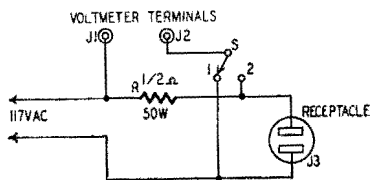

Fig. 1702. Schematic of the watts adapter.

measure 0.1 volt. Since R is  $1/2$  ohm,  $I = E/R$ , and the current through the resistor is  $0.1/0.5$  or 0.2 ampere. Throwing switch S to the "1" position will give you the line voltage, assumed in this case to be 115 volts. The product of the line voltage and the current will give the power used by the electrical device being tested ( $W = E \times I$ ). In this example, the current drawn by the device is 0.2 ampere and the power used is 23 watts. Since power used is proportional to the current, note that successive values in the WATTS column are all multiples of 23. Thus, if the current drawn is 0.5 ampere, the power used is 115 watts ( $5 \times 23$ ).

VOLTS	WATTS	VOLTS	WATTS
0	0	1.6	373
0.1	23	1.7	396
0.2	46	1.8	425
0.3	69	1.9	444
0.4	92	2.0	468
0.5	115	2.1	491
0.6	138	2.2	515
0.7	162	2.3	539
0.8	185	2.4	563
0.9	208	2.5	587
1.0	232	3.0	708
1.1	255	3.5	829
1.2	278	4.0	952
1.3	302	4.5	1080
1.4	325	5.0	1200
1.5	349		

WATTS DRAIN VALUES (115-VOLT LINE)





The features included in this unit are:

1. A test speaker with universal transformer connections for impedance matching.
2. Field coil connections for resistances from 400 to 1,800 ohms in 200-ohm steps.
3. An 0-75 and 0-250 d.c. milliammeter in the field coil circuit.
4. An output meter with five ranges of sensitivity.
5. Pin jacks for direct connection to the voice coil, primary of the output transformer, and the field coil.

The unit consist of a PM speaker, a universal output transformer, and a 400-ohm filter choke and series resistors which substitute for the speaker field in some sets. Three s.p.s.t. toggle

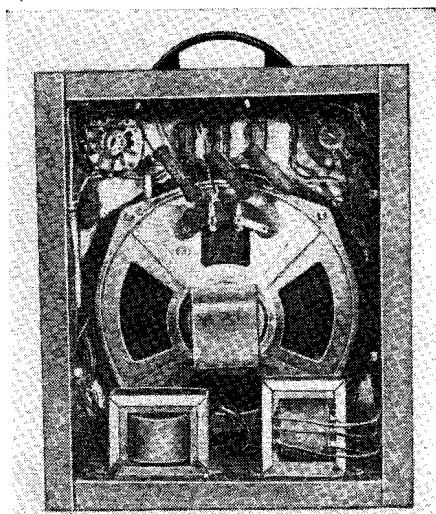

*Fig. 1802. Rear view of the loudspeaker test unit.*

switches are used to add resistance to the field-coil circuit. A d.c. milliammeter having 75- and 250-ma scales may be used to measure the current drain on the B-supply. Shorted bypass or output filter capacitors will be detected immediately because of excessive current through the meter.

The meter, basically a 0-1 ma type, and a 1N34 diode can be switched in series across the secondary of the output transformer to serve as a sensitive output meter. S1 and S2 enable the operator to connect the internal speaker to jacks on the front of the case so it can be used with sets which have the output transformer on the chassis. The primary of the output transformer is con-

nected to three color-coded jacks. Blue is used for the plate terminals and red for the center tap. A rear view of the loudspeaker test unit is shown in Fig. 1802.

Many sets have standard 5- or 6-prong sockets for speaker connections. A 5- and a 6-prong socket are mounted on the side of the case so the test speaker can be connected to these sets through cables fitted with 5- and 6-prong male plugs at each end. This cable can be used with sets having 5- or 6-prong speaker sockets. Just be sure that the voice-coil and field coil connections follow the standard wiring system. If you don't, you may end up with the primary of the output transformer in series with the B-plus line.

The meter used is a 3-inch 1-ma movement with 0-75- and 0-250-volt scales. It was connected across a 35-ohm resistor in the field coil circuit for the 75 ma scale and by switching a 15-ohm resistor across this the meter then reads on the 250-ma scale. Any other available meter might be used by matching the shunt resistors to the meter scales. The meter reversing switch completes the circuit. To save space on the front panel, the meter is mounted coaxially with the speaker just as tweeters often are.

## Using the speaker

In practically all cases the speaker in the sets can be quickly checked to determine if repairs are needed. A PM speaker can be checked with a pocket ohmmeter. If it is O.K., a clear click will be heard and a reading will show on the meter when the test leads are touched to the primary leads of the output transformer. Field coils can also be checked with an ohmmeter or the plug can be loosened and voltage readings taken from each side of the field to ground. The field resistance can be marked on the set chassis for future use in connecting the test speaker.

---

### Materials for Loudspeaker Test Unit

**Resistors:** 1-15, 1-35, 1-200, 1-400, 1-800 ohms, all 10 w.

**Miscellaneous:** 1-PM speaker, 1-universal output transformer, 1-15 henry, 400-ohm, 75 ma filter choke, 1-1N34 crystal,

1-d.c. millammeter, 0-1 ma, 7-pin jacks, colored as desired, 1-carrying case with handle, 1-5 prong socket, 1-6 prong socket, 2-5 prong male connectors, 2-6 prong male connectors, 3-s.p.s.t. toggle switches, 1-s.p.d.t. toggle switch, 1-single pole, 5-position rotary switch, 1-single pole, 7-position rotary switch.

---

# Chapter 19

## Television Marker Generator

**S**WEEP generators for aligning wide-band i.f. amplifiers in television and FM sets usually need highly accurate marker signals or pips for identifying frequency points along the response curve. Accurate markers are especially important for peaking individual coils and setting sound and adjacent-channel traps. Inter-carrier receivers also require an accurate 4.5-mc unmodulated signal for aligning sound-take-off windings and discriminators.

The two most common sources of marker signals for sweep alignment are the *built-in* marker (either a calibrated tunable oscillator, or a passive, absorption-type network), and the *external* marker oscillator or signal generator. The absorption-type marker is useful for locating points along the response curve but cannot serve as a single-frequency r.f. source for aligning individual stages. A variable marker oscillator, internal or external, not only will mark points on the curve but may be used to tune individual coils and traps.

Both types leave much to be desired with respect to accuracy of calibration. Most modern television i.f. systems are stagger-tuned at various fractional frequencies like 25.3 mc, 23.1 mc, and 21.7 mc. Even the best tunable marker oscillators and signal generators may be off calibration by as much as 0.5 mc, making it practically impossible to align a set exactly at the specified frequencies. A few of the more expensive TV generators are equipped with crystal calibrators which give accurate marker pips every 2.5 mc or 5 mc along the curve.

The low-cost, easy-to-construct unit described in this chapter not only gives accurate markers at 0.5-mc intervals, but provides

a 4.5-mc, crystal-controlled, pure r.f. signal for intercarrier alignment. The wide range of marker pips is adequate for almost any servicing or design need, and all have the high accuracy and stability associated with a well-designed crystal oscillator.

Although this marker oscillator-mixer was constructed to fit a *Heathkit* model TS-2 sweep generator, it can be installed in almost any other make or model, or built as an independent unit. The choice of crystal frequencies and the use of either separate or mixed outputs gives the unit unusual versatility. It consists of separate 4.5-mc and 5-mc crystal oscillators. Either crystal or both may be disabled by switching off the B supply to the appropriate oscillator, and each section has its own output-control potentiometer. A mixer-amplitude control adjusts the combined outputs of the two crystals to any desired level, and a simple mixing network

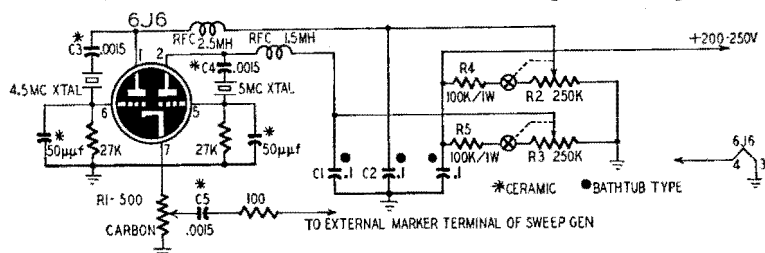

Fig. 1901. Schematic of the dual-frequency calibrator. Operating power may be obtained from the sweep generator or from the power supply in Fig. 1902.

added to the sweep-generator combines the sweep signal and the crystal-marker frequencies at the sweep output terminals.

### Circuit details

Fig. 1901 is the schematic diagram of the dual-marker unit. Each section of the 6J6 is connected as a Pierce crystal oscillator. Using r.f. chokes rather than resistors in the plate circuits increases the output on the higher harmonics essential in this application. Amplitude of oscillation is controlled by individual potentiometers which vary the B plus voltage to each plate. Switches on these controls turn the individual oscillators off and on, by opening or closing the B plus line. With a single crystal switched on, the cathode potentiometer (R1) functions as the load resistor of a conventional cathode follower, providing the correct low-impedance match for connecting the marker in parallel with the output of the sweep generator.

When both crystals are operating, the 6J6 functions as a mixer, since the two triodes have a common cathode resistor. The out-

put contains the frequency difference between the two crystals (0.5 mc) and harmonics of 0.5 mc extending to 50 mc and even higher. Sum frequencies also appear in the combined output (9.5 mc and its harmonics), but they are superimposed on 0.5-mc pips. The 0.5-mc pips are given uniform amplitude by adjusting the relative outputs of the two crystal oscillators with potentiometers R2 and R3.

The height of the pips on the alignment curve itself is controlled by cathode-potentiometer R1. (Like all marker signals, they should be kept at the lowest possible level to avoid distorting the response curve. About one-eighth to one-quarter inch is right for the average pattern on a 3-inch or 5-inch oscilloscope.)

The 50- $\mu$ f ceramic capacitors across the grid resistors give added reliability of operation in the Pierce circuit. Plate-supply

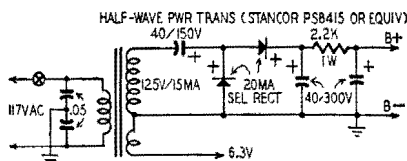

Fig. 1902. Power-supply schematic.

decoupling is accomplished by resistors R4 and R5 and capacitors C1 and C2. Capacitors C3 and C4 isolate the crystals from the d.c. on the oscillator plates. C5 couples the output from R1 through a 100-ohm isolating resistor, which reduces interaction between the marker circuit and the sweep generator. The supply voltages for the marker unit are taken from the sweep generator, or the small power supply shown in Fig. 1902 may be added. The total drain with both crystals functioning is less than 5 ma.

## Construction

The two photographs (Fig. 1903 and Fig. 1904) illustrate the unit during and after construction. The small aluminum chassis (1-3/4 x 3-1/8 x 1 inch) is a standard commercial type and is supported firmly by the shaft bushing of control potentiometer R1. An aluminum bracket may be added if desired.

The photos show the layout of the tube socket, crystal holders, "outboard" tie-points for the r.f. chokes, and the triple-0.1- $\mu$ f bathtub capacitor. Potentiometers R2 and R3 shown unmounted in photographs can be placed on your sweep-generator front panel. The parts values in the *output circuit* should be followed closely, since they were chosen to reduce interaction between the

crystal markers and the sweep generator to a minimum. The only moderately expensive items are the crystals.

### Using the marker unit

Testing and using the complete unit involves straightforward procedures. It is assumed that the reader is already familiar with the technique of applying the sweep generator to the mixer or first i.f. grid; with connecting the oscilloscope across the video-detector load resistor (preferably through an isolating resistor of

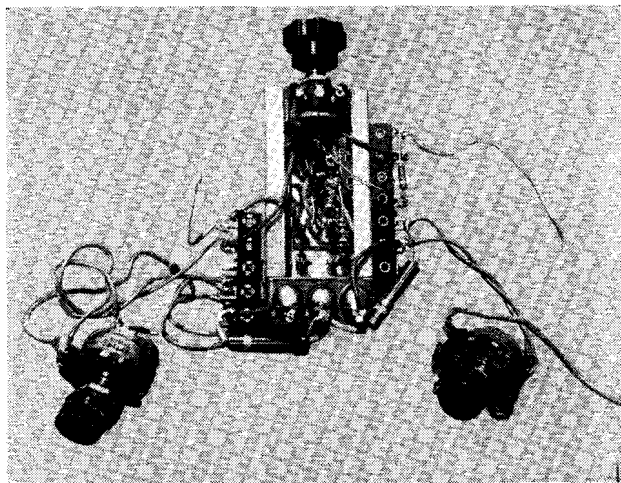

*Fig. 1903. The calibrator as it appears during construction.*

about 25,000 ohms); and with supplying the scope sweep with synchronized horizontal input from the sweep generator.

First, connect the sweep generator with the built-in marker unit to a television or other wide-band-i.f. amplifier known to be approximately in alignment, or at least capable of passing the i.f. signal. Phase the sweep response curve on the scope screen or throw the blanking control—if one is provided—to the ON position for single-trace operation.

Adjust the curve to normal height with the sweep-generator attenuator, and switch on the 5-mc crystal. With cathode control R1 well advanced, rotate output control R3 until a 5-mc harmonic pip in the pass band of the i.f. strip appears on the curve. Most television-i.f. amplifiers include 25 mc somewhere near the flat top of the curve (see Fig. 1905). Keep the pip amplitude at a minimum; too much signal from the marker will distort the curve.

Now turn off the 5-mc crystal and switch on the 4.5-mc section.

The same amplitude-regulating procedure (this time with R2) will give a pip at any harmonic of 4.5 mc which lies in the i.f. pass band. In ordinary TV receivers, the 22.5-mc pip will be prominent on the curve. Well-designed wide-band i.f. amplifiers will also show the next harmonic pip at 27 mc (see Fig. 1906).

If both harmonic pips of the 4.5-mc crystal are visible, the bandwidth characteristics of the amplifier can be seen at a glance, since the separation of the two markers is the 4.5-mc difference

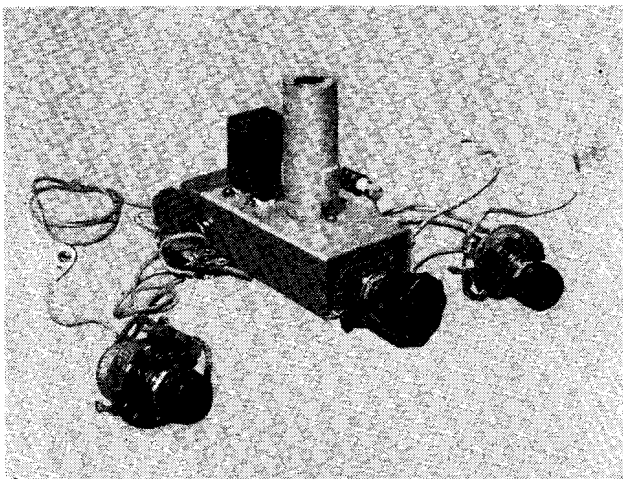

Fig. 1904. View of the completed unit. Miniature capacitors and tube reduce the overall dimensions.

that separates video and sound carriers, and which is fundamental to the design of ideal i.f. circuits.

When each crystal is oscillating satisfactorily, as indicated by its harmonic pips, switch them *both on*. Adjust controls R2 and R3, and the cathode control R1, to produce a line of uniform markers of convenient height, each of which is separated from the next by the crystal difference frequency of exactly 0.5 mc. The response pattern should then have the appearance of Fig. 1907. Output control R1 should be used to adjust the amplitude of the 0.5 mc pips with respect to the alignment curve.

The 0.5-mc pips may be identified by noting the nearest reference pip from *either* the 5-mc or the 4.5-mc crystal, and counting the order of the 0.5-mc pip in question from that point. For example, the first pip *above* 25 mc would be 25.5 mc, the second, 26 mc; the first pip *below* 25 mc is 24.5 mc, the second, 24 mc, and so on.

Some of the newer i.f. systems will need a 45-mc pip as a reference point. Since any television-i.f. response curve must have a bandwidth of about 4.5 mc, there will always be a 4.5- or 5-mc reference point on the curve.

In testing or aligning an i.f. amplifier, turn on the 0.5-mc pip

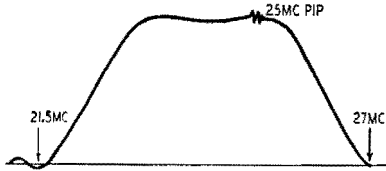

Fig. 1905. Typical i.f. response curve with 25-mc marker pip from crystal calibrator.

series as soon as the response curve appears. Bandwidth between any two critical points can be determined almost instantly. The point at which the picture-carrier should appear, as shown in the service information for the set, is located by counting pips or running the tunable marker along the pips. If the picture carrier is not at its proper position (usually exactly halfway up on one

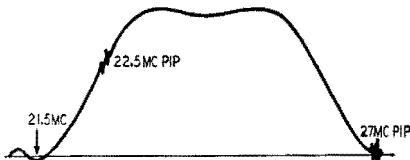

Fig. 1906. Two marker pips from the 4.5-mc crystal show i.f.-amplifier bandwidth.

side of the response curve) the i.f. stages must be adjusted to correct the misalignment. The vestigial-side-band transmission employed in television requires that modulating frequencies extending approximately 1 mc above and below the video carrier be amplified by the same amount as the higher-frequency video components for which only one side band is transmitted.

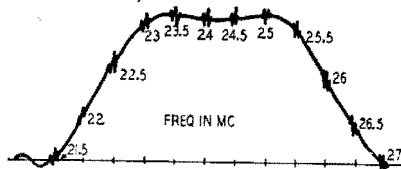

Fig. 1907. With both crystals in operation the over-all response curve shows accurate marker pips every half-mega-cycle.

The sound i.f. carrier point, on the other hand, must be almost



at the bottom at the opposite end of the curve to avoid sound interference in the picture, and to minimize 60-cycle sync buzz in intercarrier receivers. Many of the better intercarrier sets have a "sound shelf" or flat portion near the bottom of the curve for the sound i.f. carrier. Ordinary marker systems cannot be relied on to identify this point without significant error.

With the sweep generator on standby, the output of the 4.5-mc crystal can be used for intercarrier sound alignment. (The 5-mc crystal is turned off during this operation.) Service manuals explain the manner in which the sound-take-off coil and the FM-detector-transformer primary and secondary are to be peaked with the 4.5-mc signal. The precision required in this operation is shown in the following statement from an Admiral service manual (19A1): "Before proceeding, be sure to check the signal generator used in alignment against a *crystal calibrator* or other frequency standard for absolute frequency calibration at the 4.5-mc point. *Accuracy required within one kilocycle.*" The 4.5-mc signal from this dual-crystal unit has the required accuracy (.02% of 4.5 mc =  $.0002 \times 4,500,000 = 0.9$  kc) and eliminates all need for additional equipment.

### Finding fractional frequencies

For extreme precision in tuning individual i.f. coils and traps, or in experimental design work with wideband television- or radar-i.f. amplifiers, this unit allows the technician or experimenter to set an ordinary tunable marker generator to hair-line fractional-megacycle values. Suppose a certain i.f. stage must be peaked at exactly 22.3 mc. An ordinary signal generator set at this frequency may be putting out a signal anywhere between 22 and 23 mc. But if the output of this external generator is applied to the circuit under test along with the sweep and the 0.5-mc pips from the crystal oscillator-mixer, the *tunable marker pip* may be set visually at a point between the 22.0- and the 22.5-mc crystal pips corresponding in frequency to 22.3 mc. This can generally be done with very great accuracy.

---

#### Materials for Television Marker Generator

**Resistors:** 1—2,200-ohm, 1-watt; 2—100,000-ohm, 1-watt; 1—100, 2—27,000-ohm, ½-watt; 2—250,000-ohm potentiometers, with switches; 1—500-ohm potentiometer.  
**Capacitors:** 3—.0015- $\mu$ f ceramic; 2—50- $\mu$ f ceramic; 2—.05- $\mu$ f paper; 3—.1- $\mu$ f bathtub

type; 1—40- $\mu$ f, 150v, 2—40- $\mu$ f, 300 v electrolytic.

**Miscellaneous:** 1—power transformer, 125v 15 ma (Stancor PS8415 or equiv.); 2—20 ma selenium rectifiers; 1—toggle switch; 1—line cord; 1—4.5 mc crystal; 1—5 mc crystal; 1—6J6, 1—miniature 7-contact socket; 1—2.5 mh, 1—1.5 mh r.f. chokes.

---

# Chapter 20

## Carrying Case for Home Service

HOME servicing—unpopular in the past—is increasingly becoming necessary because of television. The technician can do many jobs in one trip with a representative selection of radio parts and tools, which can be carried in the case described in this chapter. If the model number of the set is known (from previous servicing

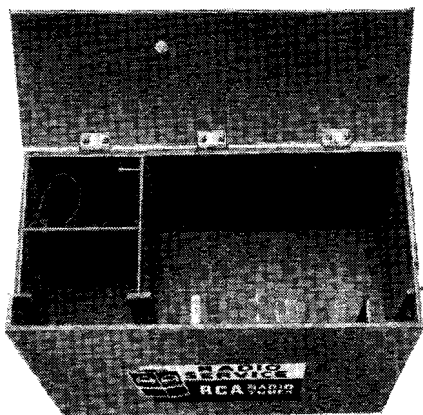

Fig. 2001. Top-side view of the case.

records or from inquiry to the owner) practically all service needs may be anticipated. Service data can be carried in the book rack. Home servicing becomes more efficient and profitable.

The carrying case is 20-1/2 inches wide, 19-1/4 inches high, and 10 inches deep. It will hold a volt-ohm-milliammeter, signal generator, signal tracer, substitution tester, soldering iron, tools, books, 40 GT or metal tubes, and most of the other parts needed for radio and TV servicing. Dimensions of the case can be modi-

fied to carry some of the smaller pieces of test equipment described in this book. Weight is only 15 pounds empty. Cost is about five dollars. The design is extremely flexible so that, while primarily for the service technician, the case makes a complete workshop for the amateur or experimenter.

Fig. 2001 shows the various compartments in the case. The signal-generator compartment will hold most of the smaller size AM or FM models. (It also makes an excellent place to carry demonstration receivers.) The drawer serves as a holder for all small parts and will hold 20 additional tubes, if desired. A large, heavy cloth upon which to lay parts and tools also may be carried. Fig. 2002 is the inside of the door. A hacksaw is mounted on

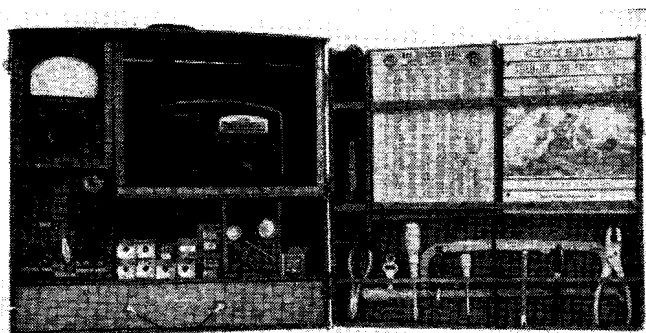

*Fig. 2002. The carrying case and its contents are ready for a job.*

right-angle hooks behind the tool rack, which is removable. The signal-tracer compartment is made for a tracer probe of the crystal-diode type which can be used with a pair of headphones. The headphones are mounted in the test-lead compartment which is behind the volt-ohm-milliammeter compartment. The parts, test unit panels, books, etc., are accessible by opening the door which covers the front of the case. Test equipment, test leads, and headphones may be removed by opening the top lid.

The case is made of quarter-inch plywood because it is inexpensive, requires a minimum of tools, and has much more strength for its weight than regular wood. Saw crossgrain cuts slowly and carefully to avoid chipping the wood.

Assemble the parts of the case as shown in Figs. 2003 and 2004 according to the general rules given below. Check with the photos. All joints of the construction are glued, and are rein-

forced with nails wherever possible. Parts should be fitted together temporarily to determine where glue and nails go. When nails are used, space them evenly, driving them from the side opposite that from which glue will be applied and until their points are seen on the surface which will be glued. Then apply glue, fit the glued surfaces together, and drive the nails all the way in.

Figs. 2003 and 2004 show inside dimensions of compartments. The double solid lines on these figures should be drawn on the

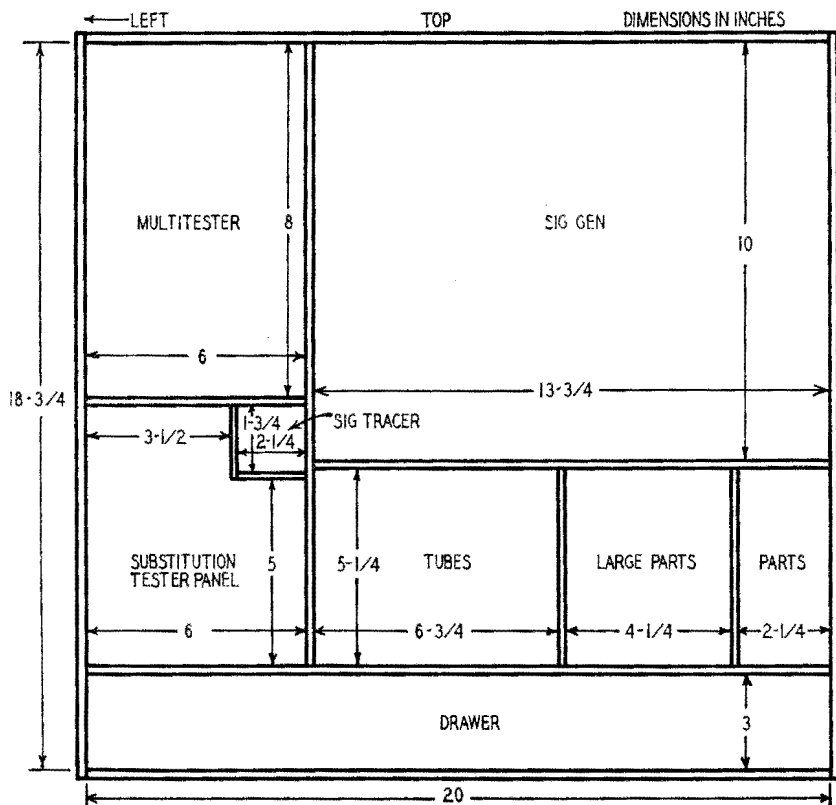

Fig. 2003. This diagram shows the inside dimensions of the compartments.

inside of the back and door front respectively as a guide for spreading glue. Draw light pencil lines, as a guide for driving nails, on the outside of the back so that they fall between double lines (given dimensions plus 1/8 inch).

Start construction by fastening the ends to the end edges of the bottom so that the pieces are perpendicular to each other. The

back then may be secured to the unit just made. Now the pencil lines previously drawn on the back may be extended to the sides to aid in assembling the shelf and the bottoms of the test-equipment compartments. Drive nails into the sides of the shelf first to hold it in place while driving nails into the back.

Draw parallel pencil lines 8 and 8-1/4 inches down on the multimeter side of the partition to aid in gluing the partition to the multimeter compartment bottom. Where the partition joins the bottom of the signal-generator compartment use a 1-1/2 x 1-1/2-inch right-angle bracket for reinforcement. Drill 3/16-inch holes for the bracket in the partition and the compartment bottom 1-1/4 inches from their front edges. Insert bolts with their heads inside the signal-generator compartment. Place the bracket *outside* the compartment. Another bracket holds the partition to the back of the case. Bolt it on the volt-ohm-milliammeter side of the partition with the bolt nuts facing in.

The back of the multimeter compartment is the front of the test-lead compartment. Draw two parallel lines for glue, as before, placing the first one back from the front of the case the thickness of the instrument which will occupy the space plus a quarter of an inch. Finish the multimeter and signal-generator compartments by installing facing strips to the outer quarter inch of their sides and bottoms. Install the lower strips first. Corrugated cardboard, if placed around the multimeter and signal generator, will cushion these instruments against damage.

Draw the proper parallel lines on the shelf to aid in gluing its partitions in place.

Fasten the side of the signal-tracer compartment perpendicularly to the outside edge of its bottom. Then fasten this unit to the rest of the case.

The door sides and bottom are assembled to the front just as was done for the main part of the case. Space and drive nails very carefully into the front to avoid denting the wood. Fasten the tool rack holders to the door sides and screw the right-angle hooks for the hacksaw into the door front slightly less than a quarter of an inch. Then the tool rack, after being drilled with various sized holes for tools (use two 1/2-inch holes 1 inch apart for pliers), is set on its supports so as to be easily removable when the hacksaw is needed. If necessary, brace the tool rack with a 3-1/4 x 1-inch plywood piece to prevent sagging. Use glue only in fastening the bottoms of the book rack and soldering iron compartment and

their partition to the door front. Secure the fronts of the soldering iron compartment and the book rack flush with the front edges of the door sides and partition to complete the door.

Begin constructing the drawer by fastening its front and back outside its bottom as was done for the sides and bottom of the case proper. Make the front and back extend  $\frac{1}{4}$  inch farther to the right (front view) than the bottom and the end to allow space for door bolts, making cutouts in the drawer front where

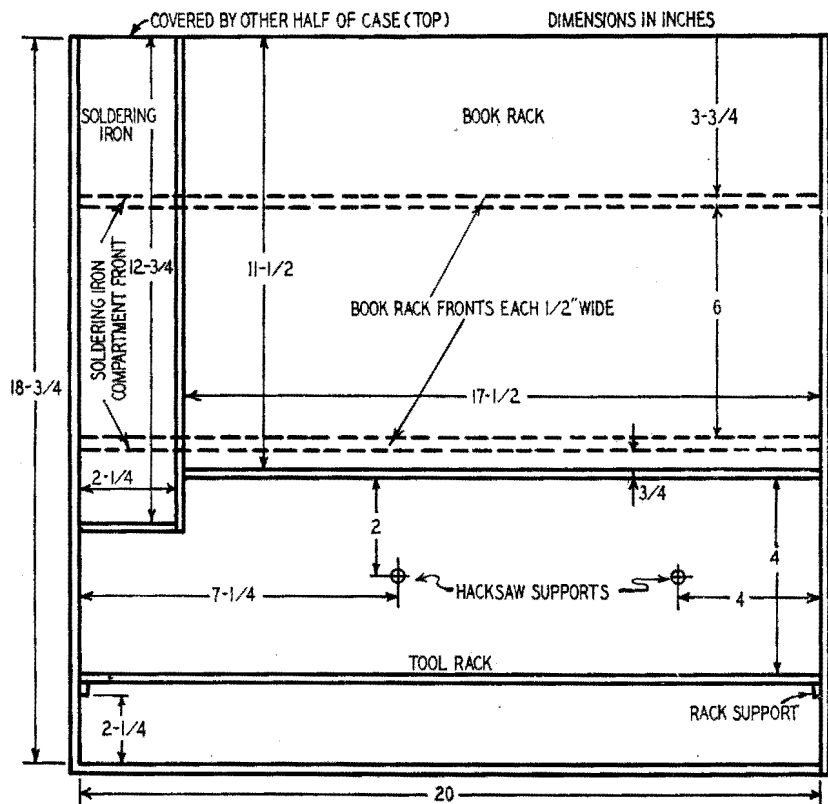

Fig. 2004. Diagram of the inside of the front cover panel showing book and tool placement.

necessary to pass them. Space drawer partitions as desired. After the glue has dried, rub the sides and bottom of the drawer with beeswax or soap to make it slide easily. A drawer pull may be made by screwing  $\frac{3}{8}$ -inch screw-eyes into the drawer front  $1\frac{1}{2}$  inch from the drawer bottom and 7 inches from each end. Connect the screw-eyes with hookup wire.

In fastening the top to the case, drill 3/16-inch holes in the top 3/8 inch from its back edge and 3-1/2, 4-1/2 and 9-3/4 inches from each end. Drill holes in the back 3/8 inch from its top edge and the same distances from each end. The 3/8-inch dimension will vary—check your hinges. Bolt one-half of each of the three hinges to the outside of the back with the bolt heads and hinge pins facing outside the case. The other halves of the hinges are bolted to the inside of the lid. Bolt heads and washers for these go outside the top as shown in the top view photo.

### Bill of Materials

Quarter-inch plywood (Dimensions in inches)

- 2—20½ x 19, front and back
- 1—20½ x 10, top
- 2—19 x 1½ for door sides
- 2—19 x 8, left and right ends
- 2—17½ x ½, book compartment fronts
- 2—1½ x ½, tool rack holders
- 1—20 x 1½, door bottom
- 1—20 x 8, bottom
- 2—20 x 2¾, front and back of drawer
- 1—20 x 7¾, shelf
- 1—20 x 1, tool rack
- 1—14 x 8, sig. gen. compartment bottom
- 1—6 x 8, v-o-m compartment bottom
- 1—17½ x 1½, book rack bottom
- 1—2¼ x 1½, soldering iron compartment bottom
- 1—19¾ x 7¼, drawer bottom
- 7—2¾ x 7¼, drawer sides and divisions
- 1—½ x 6, v-o-m compartment lower facing strip
- 2—½ x 2¼, soldering iron compartment fronts
- 1—10 x 8, partition between v-o-in and sig. gen. compartments

- 1—8 x 6, v-o-m compartment back
- 1—7 x 6, substitution tester panel
- 3—5¼ x 7, divisions of shelf
- 1—2 x 7, sig. tracer compartment side
- 1—7 x 2¼, sig. tracer compartment bottom
- 1—13 x 1½, partition between soldering iron compartment and book rack
- 2—9½ x ½, sig. gen. compartment side facings
- 1—14 x ½, sig. gen. compartment bottom facing strip
- 2—9½ x ½, sig. gen. compartment side facings

### Hardware and miscellaneous

- 6—1½ x 1½ butt hinges; 3—hasps about 1" wide by 3½" long; 30—½" x 6/32" bolts with nuts; 1—handle for top; 24—¾" x 5 flat-headed wood screws; 3—metal washers ¾" diameter; 6—metal washers, ¾" in diameter; 3—right-angle screw hooks ¾" longest way; 2—¾" over-all eye bolts with a ¾"-in-diameter eye; 1—service decal; ½ pt.—clear varnish; small box ¾-inch No. 17 flat-head wire nails; ¼ pt.—good quality liquid glue.

Drill 3/16-inch holes for the door hinges in the right side of the case and the right door side (front views) 1/2 inch from their front edges (again depending on the hinges) and 2-1/2, 3-1/2, 9 and 16-1/2 inches from the top edge of the case. Places where holes are not drilled because of interference with shelves may be filled with screws. Place hinges and bolt heads outside the case.

The hasp on the left side of the door and its associated eye on the left side of the case should hold the door tightly to the case proper. Fasten the hasp to the outside of the case with screws. The hasps fastening the top to the sides of the case are placed 2-1/4 inches from the front with the hinge on the top and the eye on the

side of the case. Notch the eyes of the hasps with a file so that they will hold their hinges without a padlock.

A special feature of the case is the right-angle bracket and eye fastener on the door and top. This combination holds much of the case's weight and acts as a safety feature because the top can't be opened unless the door is open. When the door is closed the bracket on it slides into the slightly flattened eye-bolts on the lid. Fasten the bracket to the inside of the door 9-1/8 inches from the right outer edge (inside view) and even with the top of the door. Locate the eyes 9-1/8 inches from the left edge of the top and 1/2 and 1-1/4 inches from the front edge.

Bolt the handle to the center of the top and reinforce with washers on the under side. Give the case two or three coats of clear varnish, wax and polish. You now have a very useful carrying case for service calls. The substitution tester in the lower left compartment is one of the most important features of the equipment. However, every service technician has his own pet "substitutionalyzer" or other personal test instrument. Put it in that compartment to complete your equipment!



# Chapter 21

## Work Bench for Radio and TV

THE plans for this work bench were drawn after a careful study of the good and bad features of service benches. One of the undesirable features noted in all benches was the lack of provision for holding the schematic diagram of the set under repair. Usually it is placed on top of the bench (taking up valuable working space) or spread out on another bench somewhere in the shop, or even held in the technician's lap. A pull-shelf has been built into this bench for diagrams or service manuals. It is located over the top left-hand drawer; it is 17 inches wide, and will pull out a full 30 inches. The pull-shelf is shown in operation in the photo, Fig. 2101.

Servicing an individual test instrument when several are built into a single panel is inconvenient, and the whole bench is tied up until the repairs have been completed. Individual panels are provided for all built-in instruments on this bench. This system of mounting test equipment eliminates the expense and time of installing a complete new panel if instruments of different dimensions are later used instead of the original ones. It also facilitates modifying or replacing test equipment in the event of obsolescence.

Oscilloscopes usually take up a large part of the bench's working area, as the shelves of the instrument panel are seldom deep enough to hold the average scope. By building the top shelf 18 inches deep, plenty of room is provided for most oscilloscopes. The lower shelf and sides of the instrument panel are only 15 inches deep, giving the bench top three additional inches of depth. Most service benches are short on a.c. outlets. It is often necessary to disconnect some piece of test equipment—or even the soldering iron—to plug in a set to be checked. All foreseeable future requirements in this respect have been taken care of by providing 20 a.c. outlets behind the instrument panel, plus one duplex outlet each from the Variac and isolation transformer, and

five duplex outlets for plugging in sets, the soldering gun, and portable test equipment. One additional duplex outlet with its separate on-off switch is mounted under the bench for the tank-type vacuum cleaner. This adds up to a grand total of 36 outlets. Some technicians might consider this excessive—but so far no one using this bench has griped about not having enough a.c. outlets!



*Fig. 2101. The completed radio and TV workbench. All test instruments are readily available.*

Fig. 2102 shows the outlet wiring diagram. Make sure the wire used in connecting the outlets is heavy enough to carry the maximum current drain of any sets or equipment plugged into the outlets.

The vacuum cleaner is mounted out of the way under the bench, with the hose in an easily reached position. The bench top, which is covered with 1-8/16-inch tempered Masonite, measures 42 x 72 inches, leaving a 27 x 72 inches clear working surface, after allowing for the instrument panel. This gives ample room for TV work, while leaving the instruments within easy reach.

Two cabinets are located under the bench, each containing

two 5 x 17 x 30-inch drawers, plus a 17 x 17 x 30-inch storage bin. See Fig. 2103 for construction details.

The legs and instrument panel are fastened to the top of the bench with wood screws. The drawer cabinets are likewise

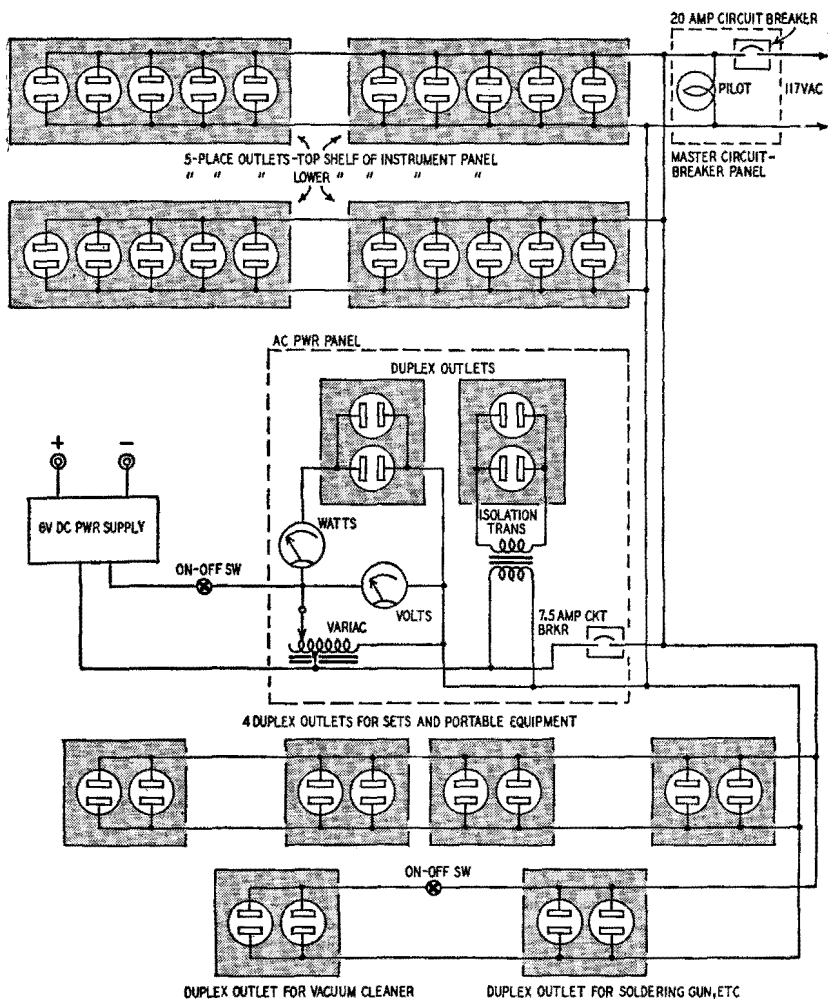

Fig. 2102. Outlet and wiring diagram. Unusual feature is the power panel shown enclosed in dashed lines.

secured to the legs, which allows the entire unit to be disassembled in a few minutes if it must be moved through a narrow doorway.

A duplicate set of tools similar to the ones shown mounted in the tool box cover are available in the top righthand drawer. The

tool box and portable meter are used on outside calls.

The top shelf of the instrument panel contains the following: capacitor checker, TV alignment generator, oscilloscope, v.t.v.m. audio sine and square wave generator, and cross-bar TV generator. The lower shelf contains a combination TV marker and

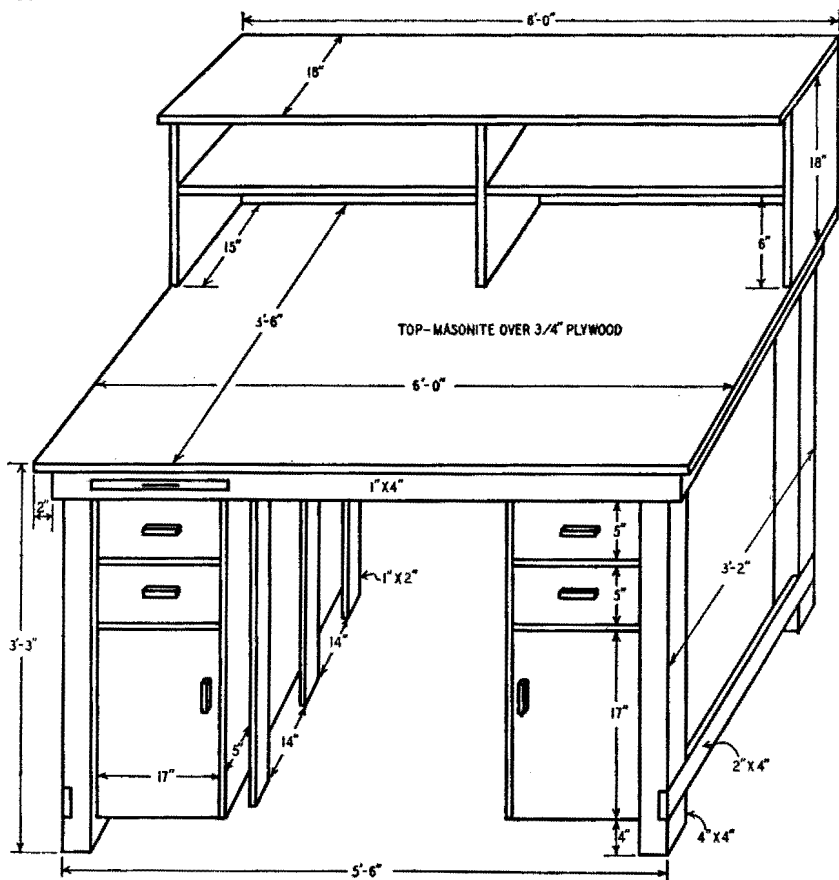

Fig. 2103. This projection will make it easier for the constructor to visualize the bench. Slide-out pull shelf located over top-left drawer is for diagrams or service manuals.

standard signal generator, signal tracer, 6-volt d.c. power supply, a.c. power panel, r-c substitution panel, 7- and 9-pin miniature tube pin straighteners, a tube tester, crystal-controlled signal generator, and a master circuit-breaker panel.

The master circuit-breaker panel contains a 1-inch pilot light assembly and a 20-ampere switch-type circuit breaker which also serves as an on-off switch for the entire bench.

The a.c. power panel contains a 7.5-ampere switch-type circuit

breaker, a 7.5-ampere Variac, a 5-ampere isolation transformer, a 0-500 a.c. wattmeter, a 0-150 a.c. voltmeter, and two duplex a.c. outlets. The Variac feeds one duplex outlet and also the 6-volt d.c. power supply. The isolation transformer feeds the other duplex outlet.

The resistor-capacitor substitution panel contains 10-, 100-, 1,000-, 10,000-, 100,000-ohm, and 1-megohm, 2-watt resistors, and .05-, 0.5-, 8-, 16-, 30-, and 80- $\mu$ f, 600-volt capacitors.

The oscilloscope was modified by adding two additional vertical amplifier stages (giving a vertical sensitivity of 0.01 v/inch), a vertical sweep circuit, and a Z amplifier. By applying a video signal to the Z input terminals, and sync voltages to the appropriate inputs, a picture may be viewed on the 'scope tube.

The signal generator was selected with the intention of converting it to serve also as a TV marker generator. The large amount of dial travel makes it ideal for this purpose. An additional band covering 20 to 30 mc was added to the original circuit. It spreads completely across the dial. Another oscillator with a 20-position fixed-frequency selector switch was added, providing fixed frequencies of all the present TV video carriers, plus i.f. frequencies of 4.5, 25.75, 26.1, 26.25, 26.4, and 26.75 mc. Two spare positions are available for future needs. The outputs of the two oscillators may be used together or individually.

Before purchasing the materials for the bench, it is advisable to plan the finished bench around the equipment which you have on hand or plan to purchase in the near future. Arrange and rearrange your equipment to determine which layout is most convenient to use. After settling on the layout, check its dimensions and compare them with those of the bench. Don't forget to leave space for service manuals if you like to have them on the bench where you can get at them without moving. After determining the space you need, it is a simple matter to add a foot or two to the length of the bench. The materials are sufficiently heavy to permit this without complicating the construction. The extra area under the center can be used for storing record changer racks and other bulky items of this type. If the shop is well lighted a single goose-neck lamp may suffice on the bench. However, if the area is fairly dark, it is advisable to install tubular lighting fixtures over those instruments whose dials are often obscured. Since fluorescent fixtures can be noise producers, use vacuum-type lights.

# Chapter 22

## Miscellaneous Test Equipment

### Capacitance and leakage resistance tester

This tester and a 20,000-ohm-per-volt 1-kv voltmeter as shown in Fig. 2201 are used to measure leakage resistance of a paper capacitor and to compare its capacitance with a standard. The instrument consists of a 450-volt, voltage tripler transformerless power supply and a circuit-reversing switch.

To measure leakage resistance, short the test leads and read the

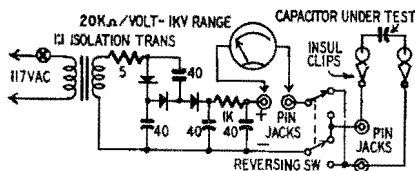

Fig. 2201. Complete circuit of the tester.

supply voltage on the 1-kv scale of the meter. Record this voltage as E1. Connect the capacitor to the test leads and allow it to become fully charged—the needle comes to rest. Read the new voltage on the meter as E2. Because the meter resistance is 20 megohms on the 1-kv range, the leakage resistance is equal to:

$$20,000,000 \times \frac{E1 - E2}{E1}$$

To measure capacitance, allow the capacitor to charge, then press the reversing switch. The meter will kick to nearly twice the supply of voltage E1. Compare the kick with that delivered by a standard capacitor.

The isolation transformer is necessary in this circuit. It insures that the user will not be caught between ground and the hot side

of the a.c. line. It also prevents fireworks which would otherwise occur if the tester were used to check capacitors in the a.c.-d.c. equipment by unsoldering one lead, as is common practice with all skilled radio technicians.

### Quick capacitor checker

Speed is one of the first essentials in profitable servicing. Here is a pocket-sized checker that not only speeds your work but makes many tests that cannot be made with an ordinary meter. It shows open, shorted, or intermittent capacitors, leaky electrolytics, and circuit continuity. In addition it indicates whether voltage in a circuit is a.c. or d.c.

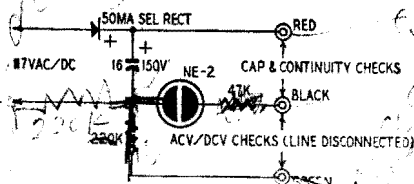

Fig. 2202. Circuit of the capacitor checker.

Fig. 2202 shows the extremely simple circuit. The checker can be built breadboard style, or can be fitted into a plastic cigarette case (as in the photograph, Fig. 2203). If the case has a metal top the pin jacks can be mounted as shown, with the insulating shoulder washers usually supplied. If you like, a plastic top may be substituted. Mount the rectifier, capacitor, and tie lug on a small piece of bakelite or plastic, then wire in the neon lamp, resistors, and line cord. Make a small notch in the side of the case to pass the line cord.

The circuit can be checked after wiring by connecting a jumper between the *red* and *black* pin jacks, and plugging the unit into the line. The neon lamp should glow brightly. Slip the unit into the case and it is ready for use. Make two suitable test leads with *insulated* phone tips for the checker pin jacks at one end, and alligator clips at the other.

### Using the checker

To check paper, mica, or ceramic capacitors, disconnect one side of the capacitor completely from the circuit, connect the test leads to the *red* and *black* pin jacks, and plug the checker into the line. Good capacitors will show a single flash on the initial

charge. (With small capacitance values the flash will be faint.) Intermittent or repeated flashing indicates leakage. If the neon lamp glows steadily the capacitor is shorted. There will be no flash or glow at all if the capacitor is open.

The output of the power supply is approximately 155 volts d.c. with 117-volt a.c. input. Do not use the checker on any capacitor rated at less than 150 volts or on any equipment that is grounded or connected to the power line.

When checking electrolytic capacitors, polarity as well as working voltage must be observed. The red jack is connected to the *positive* side of the capacitor. The bulb will glow brightly at first, and as the capacitor charges this glow will grow dimmer

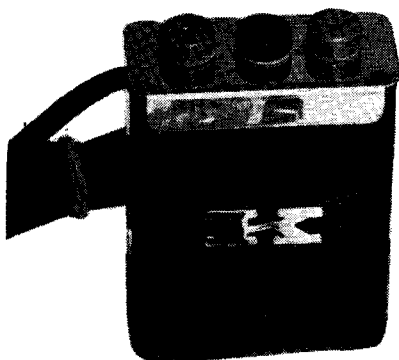

Fig. 2203. The capacitor checker in its case.

until the bulb goes out. If the lamp flashes more than once per second, the electrolytic is too leaky to trust in a circuit. Flashes at the rate of one per second or longer are normal, as all electrolytics have a small leakage current.

This unit can indicate a leakage of over 300 megohms, and can be used for many types of continuity checks where an accurate resistance measurement is not required.

When using the instrument for continuity checks on resistors, appliances, or ignition systems, the lamp should show a steady glow. The glow will be less bright with high credit resistances. This provides an excellent test for the quality of the capacitor in auto ignition systems.

The checker also will test the electrical continuity of photoflash bulbs without discharging them. This will often save good flash bulbs which did not fire because of low battery voltage or defects



in the flash-gun or shutter switch. A good flash bulb produces a steady glow.

The green and black pin are used for voltage checks. *The unit should not be plugged into the line for these checks.* When the glow surrounds both electrodes in the neon bulb, the circuit voltage is a.c. The lamp will ignite on 65 volts and operate up to 500 volts. Only one electrode glows on d.c., igniting at 90 volts and operating up to 500 volts.

The unit also will indicate the presence of r.f. voltage around a

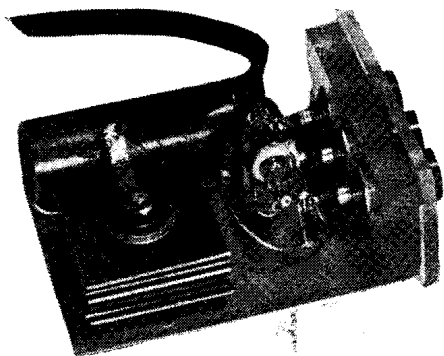

Fig. 2204. Inside view of the capacitor checker.

transmitter circuit by merely bringing a single lead near the circuit while holding the other lead in the hand. *Caution:* Do not make an actual connection to the circuit or to the a.c. line in this case.

Some handy modifications can be worked out. One change is to add a compact d.p.d.t. slide switch with one section in series with the a.c. line, and the other section across the red and black output terminals. With the line switch open, the other section shorts the output terminals and discharges both the internal filter capacitor and the capacitor being tested. This eliminates the danger of a shock from the test leads even with the line disconnected, since the electrolytic filter capacitor will retain its charge of 150 volts or more for a considerable time.

Another refinement is the addition of a detachable line cord. A standard television "cheater" receptacle fits neatly in the side of the case, and allows the cord to do double duty.

Follow Fig. 2204 for layout of parts.