



THE OSCILLOSCOPE

by

GEORGE ZWICK, B.E.E.

Television Instructor, Delehanty Institute, New York, N. Y.



Gernsback Library No. 52

PUBLISHED BY

Gernsback Publications, Inc.

25 West Broadway

New York 7, N. Y.

COPYRIGHT, 1954
GERNSBACK PUBLICATIONS, INC.
All Rights Reserved

Library of Congress Catalog Card Number: 54-10599

Foreword

THE primary aim of this book is that of an instruction manual. As such, it has some similarity to the usual operating instructions supplied by almost every manufacturer of test equipment. However, while this book fulfills the basic functions of a manual of operation, it does much more. Unlike the multimeter, the tube tester and even the signal generator, the scope, because of its extremely diversified applications, must be *understood* much more thoroughly if its benefits are to be fully realized. As such, THE OSCILLOSCOPE is intended to supplement, not supplant, the operating instructions supplied with the instrument.

Of all the test instruments used by the service technician, the scope is the most indispensable as well as the most recent of electronic working tools. The average service technician seldom if ever used this instrument in pre-television days. Even in the early post-war television years, many a service technician who acquired a scope as an essential tool for TV work, would shy away from it, the instruction book notwithstanding. While the operating manual was usually explicit enough for many simple uses of the instrument, it could not, to be practical, detail and explain the myriad of possibilities and indications of this most essential piece of equipment. The difficulty lay not so much in the inherent complexity of the instrument itself as in its vulnerability to misinterpretation in the hands of the average user. The scope, unlike the multitester or signal generator, is so much more at the mercy of the operator, often giving indications just as much, if not more, due to the manner of use as to the circuit being tested. For example, an i.f. response curve can be made to look much better than it actually is, simply by improper manipulation of the scope controls. Likewise, a perfect square wave may be obtained where one does not exist, by "proper" overloading of the vertical amplifiers. It is the aim of this book to help the user to avoid these and many other pitfalls associated with servicing with the scope.

While the book logically begins "at the beginning" and progresses through intricate troubleshooting of TV defects, it is not

expected that the user first digest the whole book before approaching the scope. On the contrary, it is intended to be used on the service bench, alongside the manufacturer's instructions, the defective set and the service data and wave shapes supplied by the maker of the TV set. It is to be hoped, however, that in due time the book will have been sufficiently assimilated to enable the service technician to have a mental picture of normal conditions in a circuit as well as possible causes of deviation from such normal conditions. Only then will he be able to judge from abnormal indications on the scope the causes and locations of the defects.

In making use of this book, no cut-and-dried plan of study can be given, neither would this be desirable. It is advisable that the first four chapters of the book be covered fairly completely, to give the user confidence and familiarity with the scope. Having acquired this basic knowledge, he will have no difficulty understanding other versions of the same circuits and methods. The simple experiments in the final chapter are ideally suited for the less informed on the subject, since the behavior of the instrument is then observed minus the pressure attendant on an actual repair job. Later, when the acquired skill is applied to actual service conditions, the instrument proper will no longer be the center of attention. Similarly, when an alignment procedure is studied in the book, even if the same conditions should never be encountered in the field (due to such factors as differences in i.f. center frequencies used by different manufacturers, variations in stagger frequencies, coupling methods, etc.), the service technician will have acquired a familiarity with the basic procedure, so that subsequent actual jobs will take on the form of "old stuff".

A few words about the illustrative circuits used in the book. While all of the partial or complete circuit diagrams used in the text are "real", that is actual circuits in use by one manufacturer or another, it is best for the student to view them as examples of the functions described. Later, when the user encounters other circuits, not necessarily identical in structure, but performing the same function, he will not be confused by minor circuit differences, but will instead observe the functional similarity or identity.

The author wishes to acknowledge with thanks the cooperation of the Radio Corporation of America Manufacturing Company and the Allen B. Du Mont Laboratories for the photographs and diagrams supplied by them for use in this work.

GEORGE ZWICK

The Oscilloscope

FOREWORD	5
CHAPTER 1...WAVEFORMS	7
Direct current. Alternating current. The alternating-current cycle. Peak and root-mean-square values of a wave. The sine wave. The sawtooth. The square wave. Use of square waves. Trapezoidal wave. Comparison between trapezoid and sine waveforms.	
CHAPTER 2...THE CATHODE-RAY TUBE	15
Structure of the cathode-ray tube. The electron gun. Heater, cathode, and control grid of scope tube. First, or focusing, anode. Second, or accelerating, anode. The intensifier anode. Crossover point. Virtual cathode. The deflection system. Structure and behavior of horizontal and vertical-deflection plates. How the electron beam is deflected. Linear deflection. Application of sweep and signal voltages to the deflection plates. The time base. Linear and nonlinear sweep. The fluorescent screen. The phosphor.	
CHAPTER 3...SWEEP SYSTEMS	29
Retrace time or flyback time. Horizontal deflection voltage. Sawtooth generators. Techniques for production of a sawtooth waveform. The relaxation oscillator. Ionization potential or firing voltage. Gas-tube sawtooth generator. Factors influencing capacitor charge and discharge in gas-tube circuits. Sawtooth frequency. Single sweeps. Thyatron circuit. The multivibrator. Plate-coupled and cathode-coupled multivibrators. Frequency control. Synchronization. Types of sync pulses. Number of waves displayed on scope screen. The electronic switch. Intensity modulation. Marker signals. Retrace blanking. Aural indicator.	
CHAPTER 4...TYPICAL OSCILLOSCOPES	52
Du Mont 208B. The vertical amplifier. The horizontal amplifier. The power supply. The sweep system. Negative low-voltage and negative high-voltage supplies. Deflection sensitivity. Operating controls. Focus. H-position. V-position. H-gain and V-gain. V-signal attenuator. Coarse and fine-frequency controls. Sync signal selector and sync signal amplitude. Use of test signal. RCA WO-56A. Horizontal and vertical amplifiers. Sweep generator system. Phasing control.	
CHAPTER 5...ALIGNMENT	76
Meaning of bandpass. Alignment of peak-tuned i.f. system. Band-pass or broad-band alignment. The FM discriminator. Discriminator response curve. Types of FM detectors. Sweep alignment of discriminator. AM generator method of discriminator alignment. The ratio detector. Ratio-detector alignment. FM	

i.f. alignment. Video i.f. channels. Effect of a.g.c. on alignment. I.f. alignment procedure. Bifilar i.f. systems. Quick alignment check. Intercarrier i.f. system. Alignment of intercarrier i.f. TV sound i.f. channels. Sweep alignment of 4.5-mc sound i.f. 4.5-mc trap in the video circuit. Split-sound i.f. Front-end alignment. Oscillator alignment using stations. Video output response.

CHAPTER 6 . . . OSCILLOSCOPE TECHNIQUES110
 Matching pad balanced to ground. Scope probes. The r.f. probe. Isolation of instrument from equipment under test. Coupling to the front end. Measuring low input voltages. A.g.c. bias substitute. Calibrating the scope as a voltmeter. Calibration of horizontal sweep. Horizontal deflection and phasing for sweep alignment. Deflection polarity. Calibrating the sweep in micro-seconds. Plotting curves. Scope precautions.

CHAPTER 7 . . . TESTS AND MEASUREMENTS133
 Audio-gain measurements. Power output calculations. Audio response. Phase shift. Hum. B plus supply hum. Hum in the video signal. Video flutter. Regeneration of i.f. amplifiers. Measurement of current waveshapes. Checking synchronization pulses. Auto radio vibrator supplies. Vibrator power-supply defects. Selenium rectifiers. Checking filter operation. Measuring ripple.

CHAPTER 8 . . . EXPERIMENTS USING THE OSCILLOSCOPE156
 Adjustment of oscilloscope controls. Relation between signal and horizontal sweep frequencies. Effect of sync selector and sync amplitude controls. Comparison of direct and amplified signals. Lissajous figures. Audio distortion due to overload. Effect of marker pip amplitude on response curve. Modulation envelope — under-and overmodulation. Square-wave response. Square-wave testing. Relation between r.m.s. and peak values of symmetrical waves. Experimental effect of meter behavior on pulse voltages. Capacitor leakage measurements.

INDEX188

Chapter

1

Waveforms

THE cathode-ray tube is one of the most versatile electronic devices in use today. Its applications in the field of radio are extremely wide and important. This book explains in simple terms the uses of the cathode-ray tube in the oscilloscope as employed in the television, radio, and closely allied fields.

The most important uses of the cathode-ray oscilloscope are in the measurement and study of alternating-current waveshapes of frequencies from a small number of cycles per second, such as common power frequencies and very low audio frequencies, up to many megacycles, as found in radio, video, and similar applications. For d.c. measurements, simple meters of the D'Arsonval type (permanent-magnet, moving-coil type), or the vacuum-tube voltmeter, are quite adequate and often are preferable because of their simplicity and ease of operation. However, these simple meters become quite useless in the case of variable or pulsating d.c. voltages consisting of superimposed a.c. and d.c. components. Such components or waveshapes are quite common in radio, television, and allied electronics. The relative values of the a.c. and d.c. components of a combined wave, often referred to as the "d.c. level" of a wave, play an extremely important role in the operation and trouble-shooting of television circuits.

Circuits such as d.c. restorers, sync separators and clippers, FM limiters, horizontal a.f.c., and many others, depend very largely on the level of the d.c. upon which the a.c. waveshape is imposed.

To fully understand the advantages of the oscilloscope for

a.c. measurements, let us briefly review the elements of both a.c. and d.c., particularly the differences between these two types of voltages or currents.

Direct current, as its name implies, flows in one direction only. Its amplitude may vary from time to time, but its polarity is always the same. A source of d.c., such as a dry cell, a storage battery, a d.c. generator, or a B+ supply in a receiver, is capable of supplying different amounts of current, depending on the energy capacity of the source and the resistance of the path (the load) connected across such source. Should the value of the resistance increase, or, should the source voltage decrease (due to changes, aging, deterioration, etc.), the current level also will decrease. The direction of the current, however, will remain the same, from the negative to the positive terminal of the circuit,

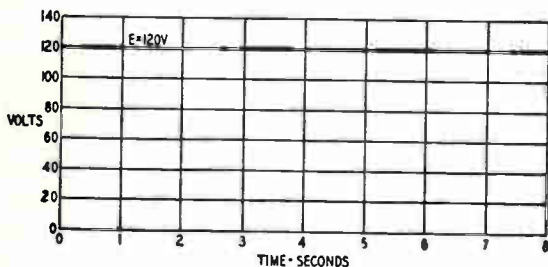

Fig. 101 Graph of a steady d.c. potential.

regardless of changes in the amount of current flowing or the time elapsed. Thus, for example, a source of constant voltage, such as a generator or a battery, measuring 120 volts, would be shown graphically as in Fig. 101. Similarly, a steady current of 40 milliamperes would be as in Fig. 102. In both cases, it is sufficient to measure the value of voltage or current only once in order to be able to accurately state their values, not only at the time of measurement, but all the time, until a change is made either in the circuit connected to the source or in the source itself.

With a.c., however, the situation is completely different. While the same two characteristics, namely, amplitude and polarity (or direction), are still used to positively and unmistakably identify an alternating voltage or current, these characteristics cannot, as was the case in d.c., be stated only once, because in a.c. these characteristics vary all the time. The first and the simpler of the two is the regular, periodic reversal of polarity. Thus, a 60-

cycle current would increase from zero to maximum in the positive direction, decrease back to zero, continue to a maximum negative value, and return to zero, 60 times each second. If we were to use a zero-center a.c. voltmeter, the pointer would start

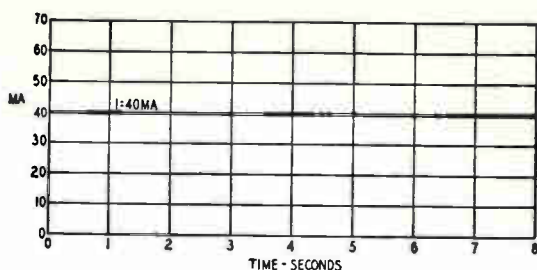

Fig. 102. Graph of a non-varying direct current.

from center, swing to the right and back to zero during the first half-cycle, to the left and back to zero during the next half-cycle, again to the right, etc., as indicated in Fig. 103. However, no pointer could swing back and forth fast enough, even at the comparatively low frequency of 60-cycles per second, to keep up with these polarity reversals. And the human eye could not follow such quick movements, even if the pointer were capable of making them.

The second outstanding characteristic of a.c. is the continuous variation in the magnitude of the voltage or current. The value

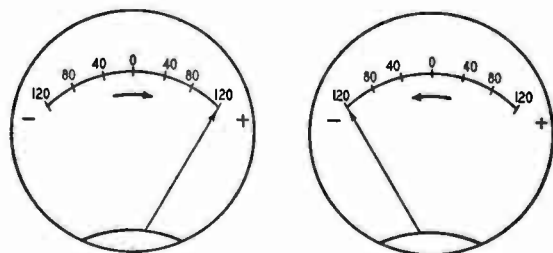

Fig. 103. Change is characteristic of an alternating voltage.

is never the same from one instant to the next, although the values can repeat periodically. For example, an a.c. voltage having a maximum value of 120 volts starts at zero, rises to +120, decreases to zero, reverses polarity, rises to -120, decreases to zero, and so on, over and over.

Fig. 104 shows the a.c. cycle, or the completed repetition of the variation, as it really occurs in time. On the graph, the line

0-0'''' represents the elapsed time from the moment the circuit was closed. Point 0 indicates the moment the switch was turned on. As time passes from 0 to 0', the voltage rises from zero to a maximum at point A, then falls back to zero at point 0'. Next the voltage rises again, but in the opposite direction, until it reaches maximum at point B, and again decreases to zero at point 0''. This completes one cycle. From point 0'' to 0'''' the cycle repeats itself, duplicating the original variation from 0 to 0'. While it is quite simple to represent a.c. voltages or currents on paper, it is impossible to have a meter whose pointer could follow these variations. We must find another way to observe a variable voltage.

A few words about a.c. meters. These do not measure the voltage at any one instant (so called "instantaneous values"). Some

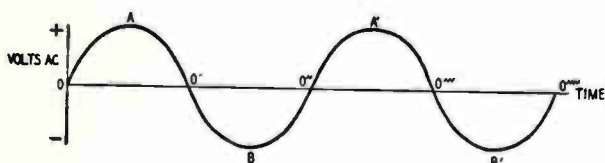

Fig. 104. Several complete sine-wave type alternating voltage cycles.

are calibrated in peak voltage, or peak-to-peak (so called "peak voltmeters"), while others are calibrated to read some value averaged over the cycle. The most common of these indicate a value which is called the r.m.s. (root mean square) which is approximately 70.7% of the maximum value. Thus, for an a.c. voltage of 120 volts, the meter would only read 70.7% of 120, or approximately 84.8 volts. While this r.m.s. value is important, being the value used for all calculations of power (the 117-volt a.c. line in our homes is such an r.m.s. value, its peak being approximately 165 volts), it is nevertheless an arbitrary value, and does not tell much about the nature of the variation of the a.c. It remains for the oscilloscope to *show* the a.c. as it changes at any and every instant of its variation throughout the cycle.

Complete a.c. variations or cycles such as shown in Fig. 104 are often called waves because they resemble waves on graphs as well as on a cathode-ray screen. When studying the oscilloscope, a brief description of the most common of the different types of a.c. variations, or waves, occurring in radio and television is helpful.

The sine wave

First and most important as well as the most common of the a.c. waveforms, is the sine wave. It appears approximately as in Fig. 104, and is typical of the output of all our commercial a.c. as well as most a.f. and r.f. signal generators.

The first important fact to remember is that the value measured by most a.c. voltmeters is approximately 70.7% of the maximum or peak of this wave. Another way of expressing this is to say that the peak value of the sine wave is $\sqrt{2}$ (1/0.707 or 1.414) times the r.m.s. value indicated by the ordinary a.c. voltmeter. The importance of this is quite obvious when we consider that any electrical or radio apparatus which operates on a certain a.c. line voltage, say 117 volts, must be able to withstand 1.414 times

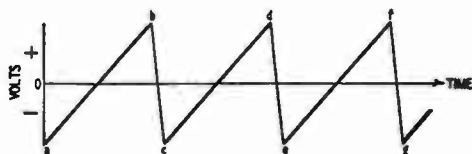

Fig. 105. An alternating voltage can also have a sawtooth waveform.

117 volts, or approximately 165 volts peak. Thus, a capacitor designed to withstand up to 150 volts is still likely to fail on a commercial 117-volt line. The second important thing to remember is the fact that the sine wave has generally been accepted as the standard by which other waveshapes are judged. As a matter of fact, other waves, often called "complex waves," are studied and analyzed as combinations of sine waves. Thus, sawtooth waves, square waves, and others, are each considered to be a combination of a number of sine waves of different frequencies and amplitudes. In the great majority of cases, specifications for equipment will be given in terms of sine-wave a.c.

The sawtooth

The second type of variation in the order of importance is the sawtooth a.c. wave, which gets its name from its appearance (see Fig. 105). It is widely used in oscilloscopes, radar equipment, television circuits, and in many types of measuring apparatus. The ideal sawtooth wave has a straight-line (usually called linear) rise, as shown by the lines a-b, c-d, e-f in Fig. 105, and a quick, abrupt decline along vertical lines in the same figure (lines b-c, d-e, f-g). In practice, a sawtooth wave may not look quite as linear as shown here, but only the most linear portion of the

rise of the wave is used. You will find the sawtooth waveform as the sweep voltage in oscilloscopes, as a deflection voltage in TV sets, and in modified forms in many other applications.

The square wave

The third type of a.c. wave of interest to us is the square wave. It is shown in its ideal form in Fig. 106 and derives its name from its square-sided appearance. In reality, it is a rectangular wave, but the word "square" is commonly used. Notice the two important characteristics of this wave. The first is the abrupt and steep rise and fall. In this drawing these are actually instantaneous. In practical cases, the sides are not quite vertical, looking more like Fig. 107, but are still very steep. The second feature of this type of waveform is the flatness of the top of the wave.

The structure of the square wave, despite its rather simple appearance, is extremely complex and quite difficult to analyze.

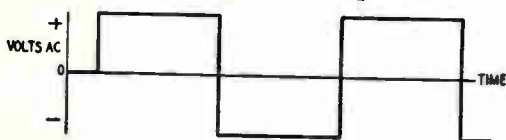

Fig. 106. Another type of alternating voltage—the square wave.

Theoretically, the square wave consists of a large number of sine waves of different frequencies, magnitudes, and phases combined into one. The square wave has many applications in radio and television. In audio and video amplifiers, the square wave is used as a test signal for linearity (flatness of response) and distortionless amplification. The electronic switch, a valuable laboratory instrument enabling the viewing of two separate signals on a scope, is essentially a square-wave generator. The multivibrator, commonly used in horizontal and vertical sweep circuits in television, is basically a square-wave generator. The synchronizing pulses, both horizontal and vertical in television receivers, are practically square waves.

Trapezoidal wave

A fourth type often encountered by service technicians is the trapezoidal wave. It is most often found in electromagnetic sweep circuits and is used to produce sawtooth current waves in the deflection yoke. The trapezoidal wave is a combination of a square and sawtooth wave, and is usually found in r-c discharge

circuits (outputs of horizontal and vertical oscillators). A typical trapezoidal waveshape compared with a sine wave is shown in Fig. 108. Effective (r.m.s.) voltages can be applied accurately only to the measurement of symmetrical sine waves. The amplitudes of trapezoids, pulses, and other irregular waveforms are generally expressed in terms of peak-to-peak, positive-peak, or negative-peak voltages, which can be read on a scope.

Mention should be made of differentiated and integrated

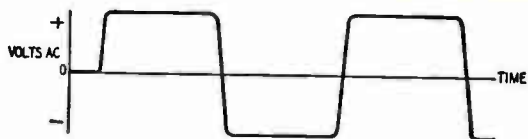

Fig. 107. Most square waves have rounded edges, sides are not truly vertical.

pulses, so important in TV sync circuits. Although these are not basic types, but derivatives of square waves, their prominence in television work makes them important. The *differentiated* wave is actually the charging current (or voltage developed by such current flowing through a resistor) of a capacitor to which a square wave such as a sync pulse has been applied. It is a short-duration, almost instantaneous, voltage. The *integrated* wave is

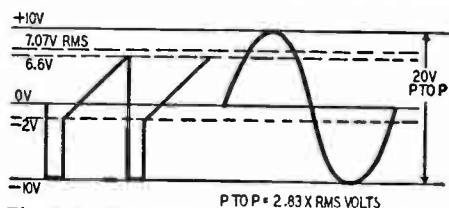

Fig. 108. Comparison between trapezoid and sine waveforms.

the voltage which a capacitor builds up as a result of the application of a square wave and the current flowing into the capacitor. This wave is a comparatively long-duration phenomenon, being the accumulation of a number of pulses over a period of time.

From the foregoing examples it is apparent that alternating voltages and currents cannot be identified by either their magnitudes or their averages alone. While the average values of a given square wave and a given sawtooth wave may be the same, their instantaneous values and their shapes differ greatly. Yet, an a.c. meter would read the same voltage in both cases! And since we are concerned with the differences in appearance and behavior of these different waveshapes, a meter would be of little use. The

practical importance of the appearance of a particular wave of a.c. voltage may be seen from a typical audio-amplifier test. If, for example, a 400-cycle sine wave is applied to the input of an audio amplifier for the measurement of gain and power output, the output at the plate of any of the amplifier stages, or at the loudspeaker, should be a greatly magnified sine wave. In other words, the amplifier should act as a faithful, distortionless magnifier. Should distortion take place, however, the output may (and usually will) still be magnified, but the shape will no longer be the pure sine wave applied to the input. Instead, the output will be a combination of the original plus other sine-wave components generated by the nonlinearity of the circuit and combined with the original to produce the final, distorted waveshape. This behavior of the amplifier may be compared to a photographic enlarger, which, due to some internal defect distorts the features of a person in the negative although the enlargement may well be of the desired size. The only satisfactory way of examining the output of an amplifier for possible distortion is through the use of a visual indicator such as an oscilloscope.

To summarize briefly, the cathode-ray tube is a screen on which a point of light traces the various patterns which are to be studied. It is only necessary to have that point of light follow the variations in the voltage or current we wish to examine in order to produce a picture of that variation on the cathode-ray screen. However, since we are studying voltage and current waves, not light variations, it is necessary to convert the voltage or current into light. This is accomplished through the use of the fluorescent screen. This mineral-metallic coating on the inner surface of the cathode-ray screen has the property of producing a glow whenever electrons strike it at sufficient velocity. To enable the eye to see the glow on the screen, the trace must persist a reasonable length of time. Although the voltage or current variations in themselves are too fast for this requirement, it is possible, partly with the aid of the persistence of the glow on the screen, and mainly through the use of sweep circuits, to give the illusion of slowness or even to stop motion altogether for the purpose of measurement or photography. Thus, although there may be wide variations in the frequency of the a.c. being observed, it is possible by means of a suitable sweep circuit adjustment to produce a motionless trace or picture on the screen by superimposing identical traces one upon the other, many times per second.

Chapter

2

The Cathode-Ray Tube

WE have already stated that the purpose of the cathode-ray oscilloscope is to permit visual observation of the behavior of alternating voltages and currents. This requires a conversion of electric current, or electrons in motion, into light. To accomplish this, a cathode-ray tube is used. Figure 201 illustrates such a tube.

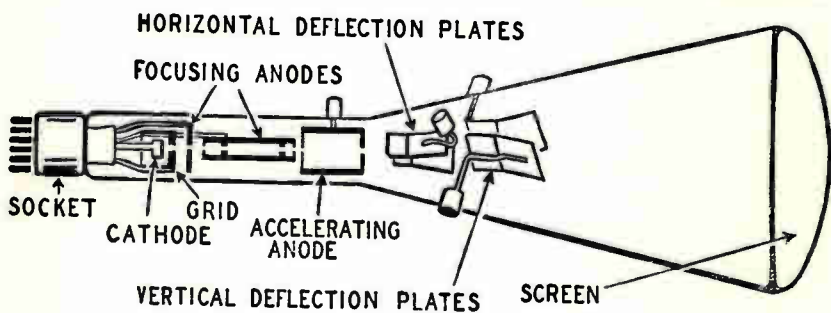

Fig. 201. Typical cathode-ray tube showing location of gun, deflection system, and fluorescent screen.

The cathode-ray tube may be divided into three major units: The electron gun; the deflection system; and the fluorescent screen.

The electron gun

This is the structure and arrangement of elements or electrodes in the cathode-ray tube which produces a sharp beam of electrons

moving at high velocity in the direction of the screen. The elements of the electron gun are:

Heater

This resembles, both in structure and function, the heater of the familiar vacuum tube. Its job is to bring the cathode to normal operating temperature. Most cathode-ray tube heaters are designed to operate on 6.3 volts, a.c.

Cathode

The purpose of the cathode, as in any vacuum tube, is to emit electrons. However, the *physical* structure of the cathode is not the same as that in an ordinary vacuum tube because of

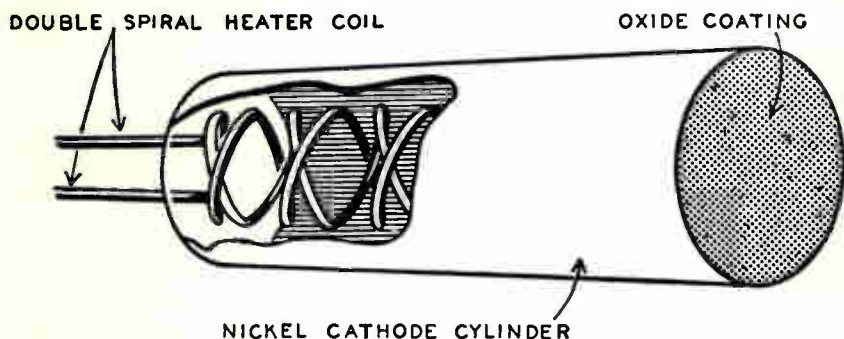

Fig. 202. The cathode is a nickel cylinder, surrounds the spiral-wound filament. Oxide coating is electron source.

the difference in requirements. In most vacuum tubes the plate is in the form of a cylinder around the cathode (the various grids, located between the cathode and the plate, are also cylindrical in shape), and the electrons flow to the plate in the pattern of spokes from the hub to the rim of a wheel. In the cathode-ray tube, however, the electrons do not go to such a "plate." Instead, they form a narrow stream which travels straight ahead, somewhat like a thread pulled through a hollow tube or pipe. The cathode is therefore constructed like a pill-box or cylinder, covering the heater, and having a small circular area of oxide-coated electron-emitting material on the surface facing the screen of the tube. Thus, the stream of electrons from this cathode is almost entirely forward. An enlarged view of the filament and cathode structure is shown in Fig. 202.

Control grid

The grid functions in a manner similar to the ordinary vacuum-tube grid, but is modified in structure to meet the par-

ticular requirements of the cathode-ray tube. The grid is almost always negative, and controls the intensity (brightness or brilliance) of the electron beam. In some oscilloscopes, and in almost all television receivers, the control varying the grid bias is called *brightness* control, because the effect of varying the bias on the grid actually varies the brightness of the trace on the cathode-ray screen. In most cathode-ray tubes, the bias voltage varies between 0 and -100 volts.

Since the electrons are to move in a narrow stream, the grid consists of a metal sleeve or cylinder open at the cathode end, and closed, except for a very small, almost pin-point aperture, on the end facing the screen. Fig. 203 shows the cathode and the control grid. Visualize these elements as a small cylinder

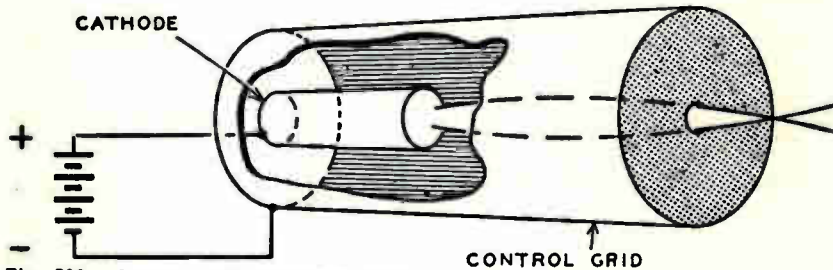

Fig. 203. Control grid regulates electron emission and helps focus the beam.

enclosed by a larger one. It is in the cathode and grid structure that we have the beginning of the formation of the cathode-ray beam. Electrons emitted by the heated oxide-coating on the cathode can escape only by moving through the small hole in the center of the grid cylinder. The entire grid cylinder is negative with respect to the cathode. This means that any electrons directed toward hitting the inside wall of the grid cylinder will be repelled. The motion of these electrons is such that they rejoin the main electron stream.

The control grid has a triple job. By controlling the amount of emission from the cathode it determines the brightness of the spot on the screen. It acts as a lens, concentrating the electrons into the shape of a beam. Finally, the grid can be modulated (intensity modulation).

First, or focusing anode

This element (in conjunction with the second anode) has as its function the concentrating, or focusing of the electron stream so that it ends in a fine point at the surface of the

screen. The narrowing, or focusing, of the electron beam is first accomplished by the control grid. Since this focusing action by the control grid is rather weak, the electrons will come to a point (point of focus) at only a short distance after the grid, beyond which the electrons will diverge or spread out.

The focusing anode, located forward of the control grid, is also shaped like a cylinder, but with small openings at both ends. It is operated at a positive potential with respect to the cathode with focusing being accomplished by varying this potential. The actual voltage varies with the type and diameter of the tube, being as low as 250 volts in the case of a 3-inch tube, and increasing to thousands of volts for tubes of large-screen diameters.

At first, it might seem that the focusing anode, being positive, would merely attract electrons in a manner similar to the plate of an ordinary tube. However, since the anode is cylindrical and exerts an equal pull all around, the net effect is to force the beam as close to the center line, or axis, as possible.

Second, or accelerating, anode

The principal function of the second anode is to impart a high velocity to the electron beam. In addition, this anode combines with the focusing anode to determine the focusing characteristics of the cathode-ray tube. The second anode is located closer to the screen than the focusing anode, and is generally similar to it, except that it is larger. It is operated at a fixed positive potential, usually three to four times higher than the focusing-anode potential. In addition to the actual cylinder, there is a conductive coating called *aquadag* on the inner surface of the glass, that extends almost all the way to the screen; it is internally connected to the second-anode terminal and serves as part of the accelerating anode.

Intensifier anode

This element, although not strictly a part of the electron-gun structure, performs a function similar to the second anode and the aquadag. The element is found on many (but not all) cathode-ray tubes for oscilloscopes and radar applications. It consists of a metallic ring located on the inner surface of the glass, just behind the screen. It is operated at the highest positive potential, and serves to further accelerate the beam after deflection has taken place.

Figure 204 illustrates the manner in which the electron gun

produces a sharp, or focused spot on the cathode-ray screen. For the sake of clearness, the deflection plates have been omitted. The electrons leave the cathode in a rather wide stream. Since the aperture of the control grid is very small, and since the potential on the grid produces a negative charge all around the aperture, the electrons begin to converge, or bunch, and actually come together in a small area near the focusing anode. This area is commonly referred to as the *crossover point*. Sometimes this point is considered as the *virtual cathode* (as distinguished from the physical cathode) since the electrons are concentrated at this point and continue forward as from a cathode. As a matter of fact, this point acts as the electron source except that the area is much smaller than the original cathode surface.

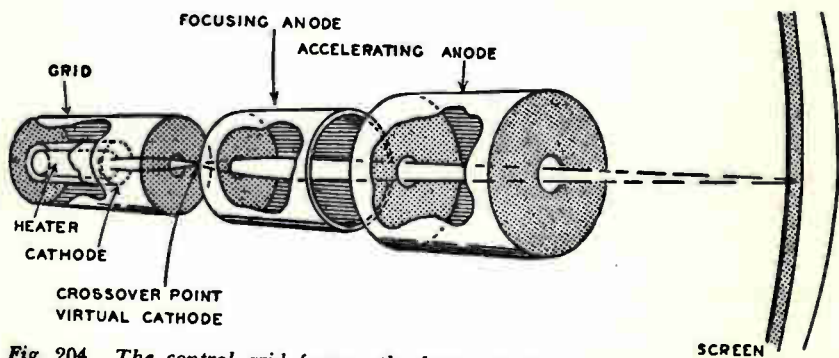

Fig. 204. The control grid focuses the beam on the crossover point. The beam then diverges, but is pin-pointed on the screen by the focusing anode.

Continuing past the crossover point, the electrons begin to spread apart just as light rays would in passing through a small opening. Now both the first and second anodes combine to accomplish the focusing. While the detailed discussion of the nature of the electric field produced by the two anodes is beyond the scope of this book, a simplified statement of the functioning of this portion of the gun can easily be understood. Since both the first and second anodes are positive with respect to the cathode and cylindrical in shape, they will exert a uniform pull on the electron beam. But, because of the structural and potential differences between the two anodes, the electrostatic (or charge) field within the region of the first and second anodes is such that the farther away from the center line (or axis) of the tube, an electron is, the greater the force on the electron toward the axis. The strength of the field along the axis is greatest in the vicinity between the first and second anodes, and therefore it is here that

most of the bending of the beam toward the axis takes place. Farther on, the beam is less and less affected, hence it travels generally in the forward direction, under the influence of the high accelerating potential.

As shown in Fig. 204, the beam converges rather gradually as it leaves the region of the focusing anode, the amount of convergence being just enough to make the beam come to a point at the surface of the cathode-ray screen. Too high a focusing potential would make the convergence so great that the beam would come to a point before reaching the screen, then start spreading out again, and be out of focus when finally reaching the screen. Conversely, too weak a bending force, because of too low a focusing potential, would allow the beam to reach the screen before it had time to converge to a point. If allowed to continue past the cathode-ray screen, the beam would focus somewhere beyond the front surface of the screen. Fig. 205 illustrates the effects of too little or too great a focusing potential. The exact function of the focusing control should now be clear. The first, or focusing anode is made sufficiently positive so that the bending of the electron beam toward the axis is just enough to make the electrons reach the axis at the screen.

The deflection system

The electron gun is designed to produce a sharp spot on the cathode-ray screen. In order for this spot to trace various patterns of voltage or current, it is necessary to move the spot to any required point on the screen. This is the function of the deflection system.

There are two main systems of beam deflection in use today. These are (1) the *electrostatic* system, used almost exclusively in oscilloscopes, radar sets, spectrum analyzers and similar commercial applications, and (2) the *electromagnetic* system, found in television receivers.

The electrostatic deflection method is based on the law of magnetic poles: like charges repel each other and unlike charges attract each other. A simple illustration of this is the behavior of a capacitor. In its simplest form, a capacitor consists of two metallic surfaces or plates, insulated from each other and separated by a dielectric. When a capacitor is in a neutral or uncharged state, both plates have the same number of electrons. No force exists between the plates. However, when a charge is placed on the capacitor, one plate has more electrons than the other

plate. In other words, one plate is negative with respect to the other. Note that this is only a relative polarity, since both plates may be negative with respect to a common point, such as a chassis, or ground. Relative to each other, one plate is called positive, the other negative. In such a charged capacitor, a force of attraction exists between the plates. Not only does this force tend to pull the plates toward each other, but it also acts on any electron between the plates, in the dielectric. This effect of a charged capacitor on the electrons in the dielectric is utilized in electrostatic deflection.

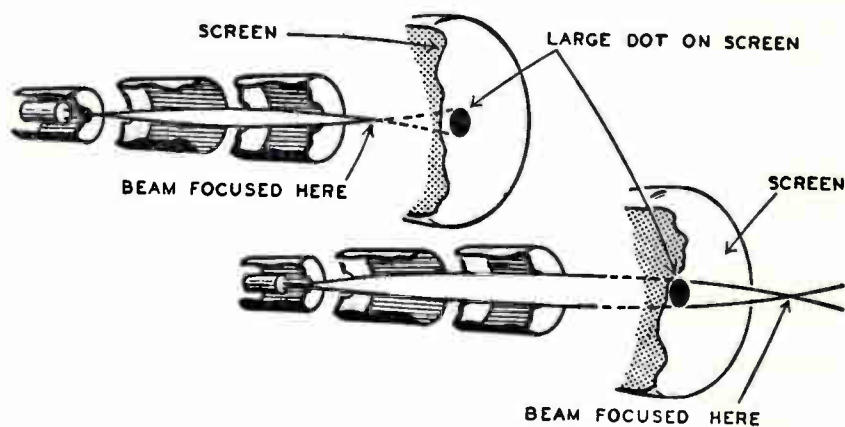

Fig. 205. Improper focusing of the beam results in a large dot on the screen.

There are two such pairs of plates or capacitors in the electrostatic cathode-ray tube shown in Fig. 201. One pair is called the horizontal plates, the other the vertical plates. The horizontal deflection plates are positioned like two opposite walls of a room; the vertical deflection plates resemble the position of the ceiling and the floor. As shown in Fig. 201, the plates of each pair are not quite parallel, but diverge or flare somewhat toward the front of the tube. The first pair of plates is capable of deflecting the electron beam to the left or right, hence the name *horizontal plates*, although physically they are in a vertical position. The second pair, actually in horizontal position, are called the *vertical plates*, because they deflect the beam up or down. In addition, the deflection plates are used to center the beam, or, for that matter, position it anywhere on the screen.

To illustrate the functions of the deflection plates, let us begin by examining Fig. 206. This illustration shows one set of plates

with no potential between them, hence with no force on the traveling electron beam. Theoretically, the electron beam will strike along the center line of the screen. Fig. 207, showing both sets of plates, assumes a high d.c. potential from each of the plates to ground, but, and this is important, there is no difference of potential *between* the plates. The net force on the direction of the electron beam is still zero, hence the beam will continue undeflected. In other words, the beam will be centered. Therefore we may state that centering the beam involves adjusting the potentials on the deflection plates so that the beam remains undeflected and proceeds on course. In actual circuits, this does not

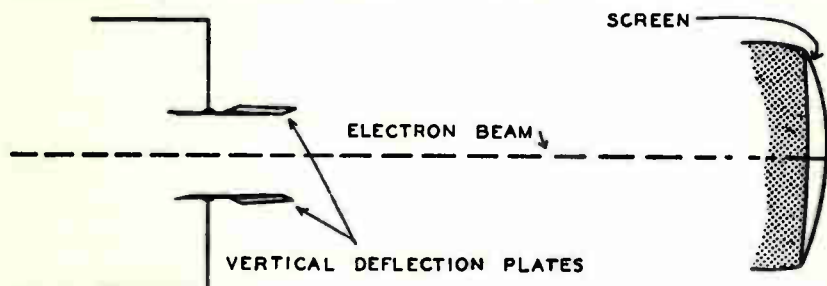

Fig. 206. With zero potential difference between the vertical deflection plates, the beam is unaffected.

necessarily mean that the voltage between the plates is exactly zero. Quite often, due to minor structural and circuit variations, the beam would originally be off-center, and a certain amount of force on the beam is required to bring it to the central axis. Furthermore, in many applications it may be desirable to have the beam at some point other than the exact center. In such cases, a definite force across the horizontal, or vertical, or across both sets of plates, may be required. In addition to the need for centering, it is necessary for purposes of acceleration to have a high potential on the deflection plates, regardless of the desired initial position of the beam. For either purpose, centering or deflection, an adjustment of the potential across the two pairs of deflecting plates is required. For initial positioning, whether exactly on center or at any other point on the screen, a d.c. potential, adjustable at will, is required. In cathode-ray oscilloscopes these adjustments are made by potentiometers in the high-voltage system, varying the difference between each of the plates to the extent of a few hundred volts while at the same time maintaining the deflection plates at a potential high enough to allow acceleration of the beam.

Fig. 208 shows the effects of a difference of potential between a pair of plates. In Fig. 208-a the upper plate is positive with respect to the lower. The electron beam, being negative, is attracted toward the upper, more positive plate. Since the voltage

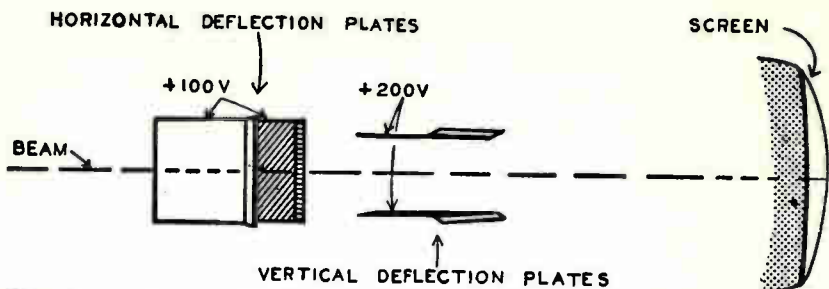

Fig. 207. It takes a voltage difference between the vertical deflection plates or between the horizontal deflection plates to get the beam to deflect.

on the upper plate also acts to pull the beam forward, the net result is that the beam strikes the screen above the mid-point. In Fig. 208-b the polarity is reversed, causing the beam to strike the screen below the mid-point. The same situation applies to the

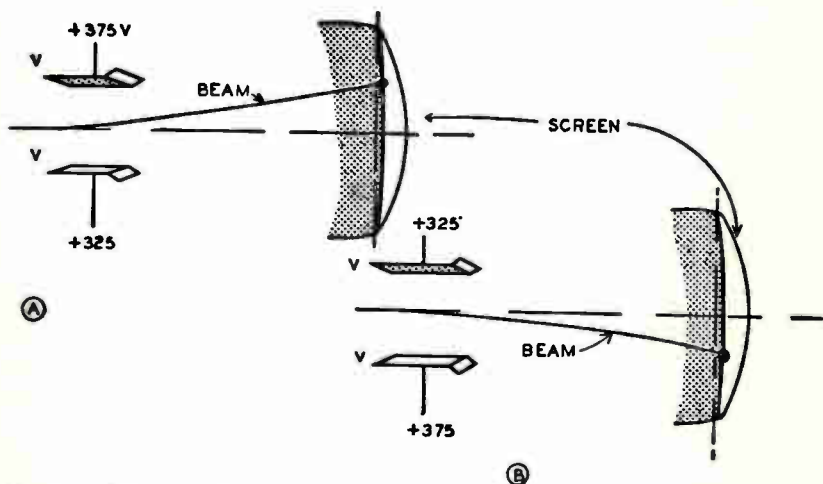

Fig. 208. The beam always moves in the direction of that plate having the higher positive voltage.

horizontal deflection plates. If the left plate is made negative with respect to the right plate, the beam will move to the right, and vice versa.

Linear deflection

In addition to the general direction of deflection of the beam, the amount of deflection, in distance on the screen, also should be considered. Thus, if a 50-volt difference between a pair of plates will deflect the beam one inch from center, it should follow that 100 volts will deflect the beam two inches, and so on. This is known as *linear deflection*. Fig. 208-a shows the position of the spot on the screen under the force of a hypothetical 50-volt difference in potential across the plates.

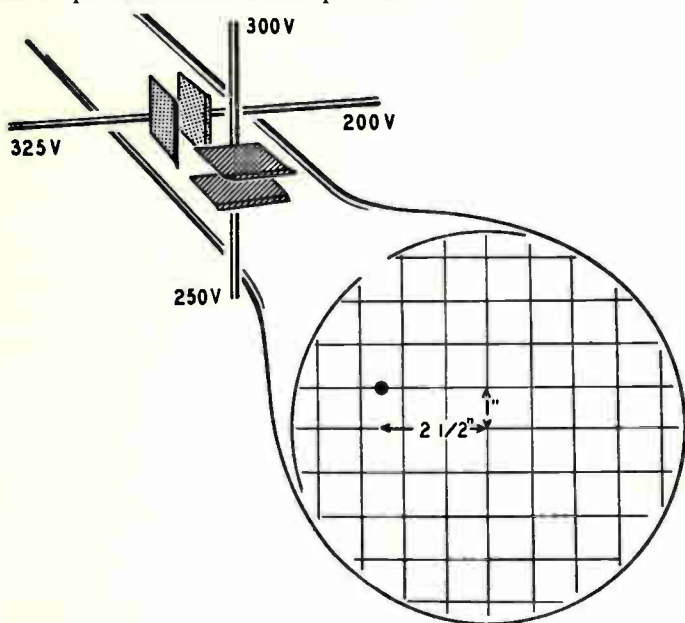

Fig. 209. There is a potential difference on both sets of deflection plates. Beam moves vertically and horizontally.

An example of the effect of deflecting potentials on *both* sets of plates is shown in Fig. 209. Here, a potential difference of 50 volts exists across the vertical plates, and 125 volts across the horizontal plates. As shown, the spot deflects in each direction in proportion to the particular force in that direction—two and a half inches to the left of center, and one inch above the center line.

Up to now, examples of deflection under fixed potentials have been considered. If, instead, a gradually varying potential is applied to one set of plates, while the other set has a d.c. potential, not fixed, but increasing at a uniform rate, the spot, while moving across the screen at an even speed due to the d.c. potential just

mentioned, would also move up and down, in step with the varying potential on the other sets of plates. Fig. 210 illustrates such a case. A sine wave (a.c.) is applied to the vertical plates, while a d.c. voltage, starting with a high negative value and gradually and uniformly (linearly) decreasing to zero and continuing to increase in the positive direction, is applied to the horizontal plates. As the spot is moved at an even pace from left to right across the screen, by the horizontal voltage, the sine wave applied

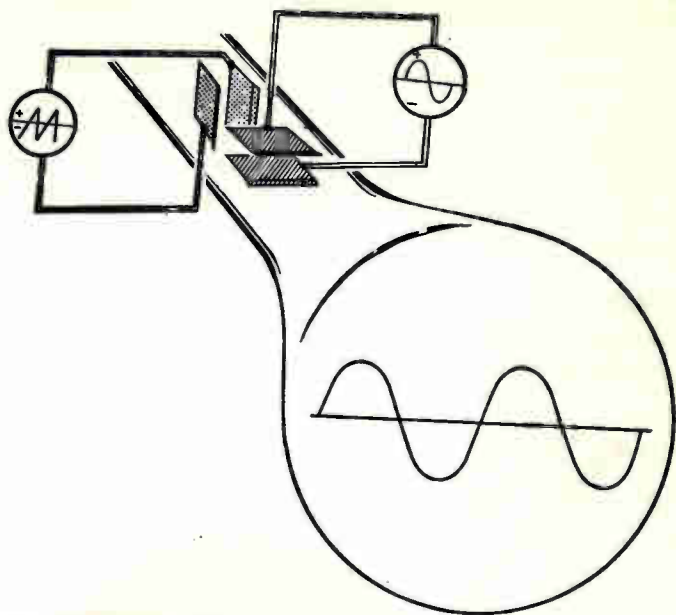

Fig. 210. Sweep voltage is applied to the horizontal deflection plates. Vertical deflection plates receive signal to be tested.

to the vertical plates is also moving the spot, but in an up-and-down direction, in step with the changes of the voltage of the sine wave. Thus, an actual waveshape of a signal is traced on the screen.

Normally, before a signal is applied to the scope, the spot rests in the center of the screen. However, since deflection takes place across the whole screen, not just from center to right, the beam has to be brought to the extreme left to start the cycle. For example, the beam will deflect to the left (looking toward, or facing the screen) when the left-hand horizontal plate is more positive than the right-hand plate by a certain fixed potential. The horizontal deflection (or *sweep*) voltage, as discussed in the next chap-

ter, is such a potential. As far as the horizontal deflection plates are concerned, this potential starts at a maximum *negative* value on the right-hand plate. The beam, repelled by the negative voltage, will be at the extreme left side of the screen. The voltage on the right-hand plate gradually and uniformly becomes zero, at which time the beam is again in the center. The voltage then continues to rise in the positive direction to the same numerical maximum value. Since the right-hand plate is now positive, the beam will continue, after passing the center, to move uniformly toward the extreme right edge of the screen. While this type of potential may be considered as a type of a.c., this in no way contradicts the explanation given earlier. If, for example, the beam were originally located at the extreme left, the potential on the horizontal plates would actually be d.c., starting from zero and increasing linearly to a maximum value, with the right-hand plate always being positive.

Time base

It was stated earlier, that in most oscillographic applications it is important to have the beam move across the screen at a uni-

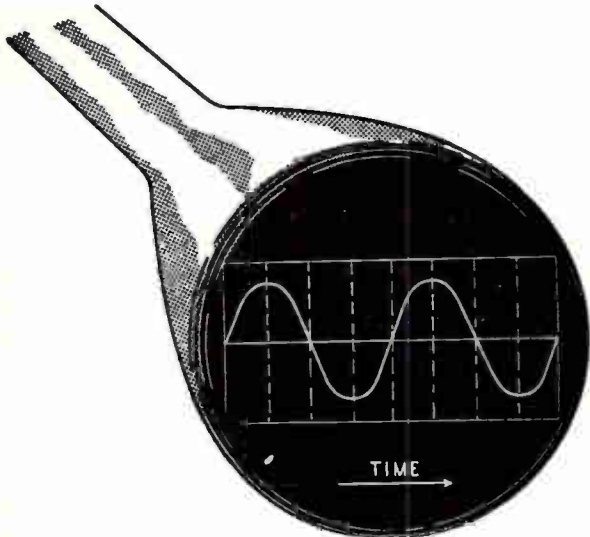

Fig. 211. Effect of linear sweep on sine waveform.

form rate. In considering any voltage or current wave (a sine wave for example) it should be remembered that successive points on the wave are actually values of voltage or current following

each other in time—they happen one after the other. Also, except in rare cases, waves following each other in series actually are identical. When such a wave is shown on the oscilloscope, the succeeding points are displaced in space, from left to right. Thus, the horizontal sweep of the scope is really a time scale. As a matter of fact, this sweep is very often called *the time-base*—a linear time-base, to be exact.

Fig. 211 shows two sine waves divided into quarter-waves by

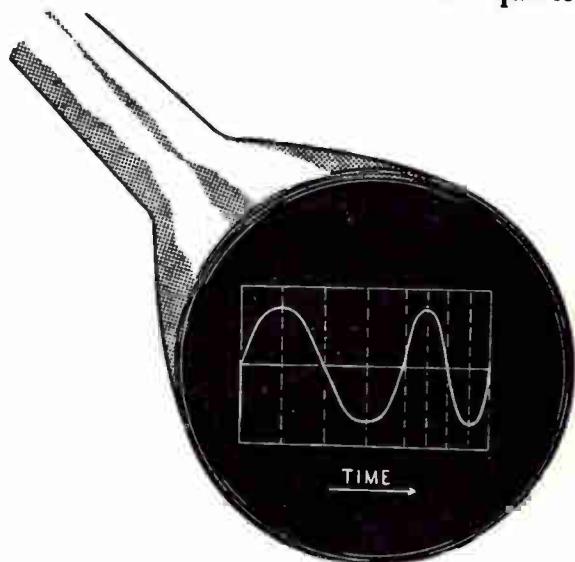

Fig. 212. Example of nonlinear sweep on signal being studied.

vertical lines. Every quarter-wave is shown to occupy an equal distance as well as an equal amount of time on the horizontal time-base. This is a true representation of the a.c. wave being studied, since, as stated before, these waves are all alike. Each quarter-wave, as assumed in this example, takes $1/10$ of a second. It is shown occupying equal spaces on the screen because the beam travels across the screen at a uniform rate. The sweep is said to be linear.

The results of a nonlinear time-base, or sweep, are illustrated in Fig. 212. Two cycles are shown, separated into quarter-cycles by vertical lines. However, while the first quarter-cycle is of the same width as that in Fig. 211, successive quarter-cycles are progressively narrower. This is an indication of a nonlinear sweep; specifically, a gradual slowing down of the speed with which the

beam moves across the screen. A sweep of this kind could give misleading information to the observer, particularly if he is not familiar with the characteristics of the particular oscilloscope. Unless one knows that the oscilloscope sweep is not linear, the piece of equipment under test might be suspected of being defective.

From these illustrations it is evident that in order for an oscilloscope to give a true picture of the voltage or current being examined, the horizontal deflection voltage, or the *sweep voltage* must be linear, as far as practically possible. The next chapter concerns itself with the types, methods, and details of such linear-sweep systems.

The fluorescent screen

The conversion of electron energy into light is accomplished by impact of the electron beam on the fluorescent screen. This screen, or rather the coating on the inner surface of the face-plate of the cathode-ray tube, has two important characteristics. The first of these is luminescence (the property of converting the kinetic energy of the electron beam into light energy at relatively low temperatures). The second characteristic is that of phosphorescence. This is the property of continuing to glow after the actual impact of the high-speed electron beam. This persistence varies with the type of chemical coating, and with the application for which the cathode-ray tube was intended. The coatings, or phosphors, as they are commonly called, may be zinc silicates for many normal oscillographic applications, or various zinc sulfides in the case of television picture tubes. The persistence, too, varies with requirements, and is identified by the letter *P* followed by a numeral. Thus, P1 is a medium-short persistence designation, commonly found in scope tubes. Television tubes have a medium persistence, and are identified by a P4 in their designation, while P7 is an example of a very long persistence, found in radar and similar applications, where it may be necessary to see the trace, or its slow motion on the screen, for quite a while after the first instant of observation.

Chapter

3

Sweep Systems

THE time-base or sweep-voltage generator is an important part of the cathode-ray oscilloscope. The signal to be investigated usually must be plotted as some function of time. This is done by feeding the signal to one pair of deflecting plates, while a second voltage, proportional to time, is fed to the other pair. The circuit that generates this latter voltage is called a sawtooth time-base generator.

The requirements of the sweep voltage for moving the beam across the cathode-ray tube screen may be briefly stated as follows:

1. A deflecting voltage is required to move the electron beam across the screen, the magnitude of such voltage depending on the diameter of the cathode-ray tube.
2. For faithful tracing of the pattern, a uniform speed of motion is required. The deflection voltage must rise from its minimum to its maximum value at an even rate.
3. Since the electron beam traces the same pattern over and over again, each time overlapping the preceding trace, it is necessary for the beam to return to its starting point as quickly as possible. The deflection voltage therefore must decrease from its maximum value to its initial value in the shortest possible time. This time is commonly referred to as *retrace time* or *flyback time*.

The deflection voltage placed on the horizontal deflection plates is known as a *sawtooth voltage*, due to its graphical similarity in shape to the teeth of a saw. A sawtooth waveform meets the three requirements (listed earlier) for a horizontal deflection voltage.

Sawtooth generators

The three most common types of sawtooth generators are: The gas-discharge, or relaxation oscillator, the multivibrator, and the blocking oscillator, the latter two being vacuum-tube types, while the first, as its name implies, is a gaseous-tube type. Regardless of the type of circuit used for this purpose, the generation of a sawtooth voltage is based on the same principle—the charging of a capacitor from a steady d.c. source in series with a resistor. To fully understand the functioning of the various sawtooth generating circuits, we must first examine the nature of a sawtooth charging and discharging cycle.

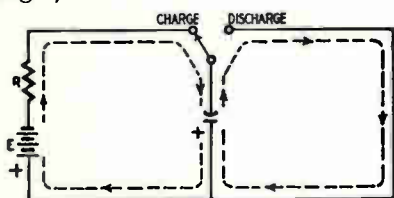

Fig. 301. Path of charge and discharge of a capacitor.

Fig. 301 shows a simple setup for demonstrating the charging and discharging of a capacitor. With the switch in the charge position, the capacitor is connected in series with the resistor R across the fixed battery voltage. At the instant of closing the switch, the potential across the capacitor is still zero. The electrons begin flowing into the capacitor from the negative battery terminal, at the maximum rate, limited only by the series resistor, to the upper capacitor plate and to the positive battery terminal from the lower plate. The upper capacitor plate becomes, relatively speaking, excessively negative and the lower plate (due to the loss of electrons) becomes excessively positive. This is equivalent to saying that a potential difference, or voltage, exists between the two plates, this voltage increasing as the excess of electrons on the upper plates increases. Another way of stating this is to say that current is flowing into the capacitor and building up a charge. The polarity of this voltage, as shown, is negative on top, positive on the bottom. This makes the capacitor voltage in parallel with

the battery voltage. During the initial instant, when there was no voltage across the capacitor, the current flow was a maximum. But, as the capacitor voltage builds up in opposition to the battery, the current flow, or charging rate, gradually decreases, until finally, when the capacitor has built up a potential equal to the battery voltage, current flow has decreased to zero. The capacitor is now said to be fully charged.

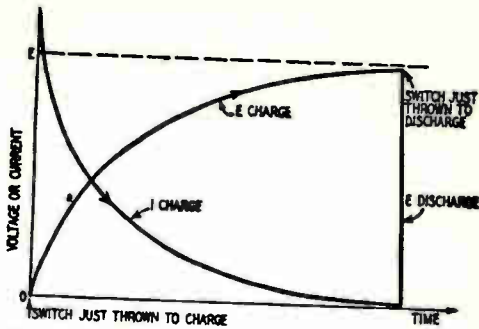

Fig. 302. Charge and discharge curve of a capacitor.

Fig. 302 illustrates graphically the charging cycle just described. As can be seen, the voltage across the capacitor rises very sharply and very uniformly during the early portion of the cycle. As the voltage increases, the curve of the voltage rise becomes less and less linear. On the voltage curve of Fig. 302, the voltage rise from zero to point *a* is assumed to be linear. This portion could be utilized as the *forward* or rising portion of a sawtooth.

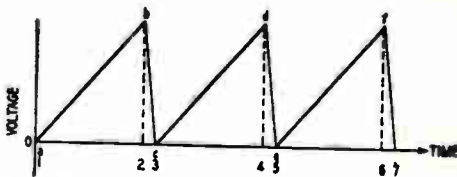

Fig. 303. Part of the capacitor-charge curve resembles a sawtooth.

The switch of Fig. 301 is now thrown to the discharge position. The capacitor is now disconnected from the battery circuit and placed across a short-circuit. Since the resistance in series with the capacitor is now practically zero, the capacitor will discharge almost instantly. The discharge portion of the cycle, as shown in Fig. 302, will be almost vertical, indicating that the discharge time is practically zero. This cycle can be repeated as many times

as desired, simply by throwing the switch to the charge position, leaving it there until the voltage rise begins to curve, then throwing the switch to the discharge position, and then repeating these steps. Fig. 303 shows the result. A number of sawtooth waves have been produced. It is important to realize that only a small portion of the total capacitor charge time has been used. The capacitor is allowed to charge until the voltage across the capacitor reaches the amplitude indicated by point *a* in Fig. 302. The capacitor is then discharged. From the graph we can also see that capacitor-charging current is maximum at the instant the switch is closed, and decreases as the charge across the capacitor builds up.

There are two important characteristics to observe in Fig. 303. First, each charging portion of the cycle, such as a-b, c-d, e-f, etc., is uniform and gradual, taking up a major part of the total sawtooth cycle time. This time (known as trace or sweep time) is indicated on the scale by the distances 1-2, 3-4, 5-6. Second, the discharge portion of each cycle is almost instantaneous, shown by the letters b-c, and d-e. Notice that the discharge time (also called flyback or retrace time), shown by the spans 2-3, 4-5, 6-7, is extremely short compared to the charging time.

In connection with this description, it might be helpful to explain the reason for the quick discharge time requirement. Any a.c. wave, with the exception of some pulses occurring at irregular intervals, continues without interruption, one cycle after the other. If this a.c. wave is to be displayed on the cathode-ray screen, any interruption in the scanning or display of such a wave will result in missing portions. Thus, when the horizontal sweep of the oscilloscope reaches the right-hand end of the screen (facing the screen from the outside), it must return to the extreme left-hand in order to continue scanning the wave. However, during the time that the sweep returns, or retraces, to the left side, the a.c. wave being observed continues to move, without waiting for the beam to return. A small fraction of the wave being displayed is therefore going to be lost. Because of this, the fastest retrace time possible is always desirable. In practice, two or three waves are shown on the screen, so that while the extreme left and right of the pattern may be somewhat distorted the cycle or cycles in between are never affected.

Relaxation oscillator

One of the simplest and most easily understood sawtooth-gen-

erator circuits is the relaxation oscillator. In its simplest form it looks as in Fig. 304. The tube is a triode containing a small amount of inert gas. Under the effect of a sufficiently high potential, the gas ionizes and becomes conducting. When the gas is not ionized, the plate-to-cathode resistance of the tube is extremely high, and practically no current flows. However, when fully ionized by the application of a sufficiently high voltage (known as the *ionization potential*, or *firing voltage*), the gas becomes so highly conductive that the tube acts almost like a short-circuit from plate to cathode.

The gas triode has three important characteristics which have to be dealt with in order to obtain satisfactory performance in a circuit such as the sawtooth generator. They are: the ionization potential, the extinction potential, and the effect of the control grid. The ionization potential is the voltage at which the gas

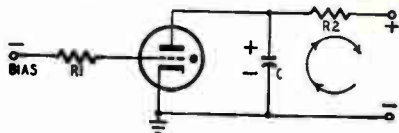

Fig. 304. Gas-tube sawtooth generator.

becomes ionized and conducts heavily. For any voltage below this value, the tube does not respond at all. The required ionization potential or voltage is determined by a number of factors, such as the type of gas used, the grid voltage, the temperature of the gas, and, to a certain degree, the gas pressure. The extinction potential is the value of voltage at which the tube stops conducting. This value is always lower than the ionization voltage, but it, too, varies in different gases. The third characteristic, the effect of the grid on the operating characteristics of the tube, is particularly important. Within certain limits, the value of grid voltage controls the firing point of the tube. However, after the firing point has been reached, the grid loses control and the tube conducts at a maximum rate. It is this behavior of the grid that is utilized in timing or synchronizing the sawtooth being generated. If, for example, during the charging portion of the cycle, a sudden change in the grid voltage were to take place, making the grid less negative (or more positive), the tube would instantly ionize, and the sawtooth would suddenly collapse to zero. A positive sync pulse, not unlike the sync pulses encountered in television receivers, applied to the gas-triode grid would act to control the frequency of the sawtooth being generated.

Here is the sequence of operation of the gas-tube relaxation oscillator of Fig. 304. When the circuit is closed, capacitor C begins to charge from the B+ supply through the resistor, R2. While the B+ supply is more than adequate to ionize the gas, the voltage at the plate of the tube is below the ionization point because of the IR drop across R2. In fact, the capacitor charging current is so high, that the voltage drop across R2 reduces the plate voltage to almost zero. As shown, the direction of electrons into the capacitor is such that the upper plate will be positive, the lower plate negative. Since the capacitor is connected from plate to cathode, the capacitor voltage is actually the plate voltage of the tube. As the charging proceeds, the capacitor voltage builds up, exactly as in Fig. 302. When the capacitor charges up to the ionization potential of the tube, as determined by the setting of the grid bias voltage (applied through R1) the tube effectively ionizes or conducts, short-circuiting the capacitor, and

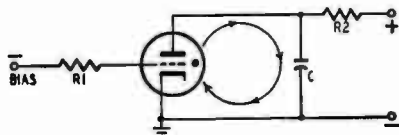

Fig. 305. The capacitor discharges through the gas tube.

causing it to discharge quickly in the direction shown in Fig. 305. As the capacitor voltage, and hence the tube plate voltage, falls below the extinction potential of the tube, the gas again becomes non-conducting, the capacitor cannot discharge any further, and the charging cycle begins again. It should be noted that during the ionization of the gas and the discharging of the capacitor, the B+ supply is not being short-circuited. The series resistance, R2, is usually so high that an only negligible current is drawn from the B+ system, the heavy short-circuit current coming entirely from the discharging capacitor.

Fig. 306 shows the sequence of operation over a number of cycles. Notice that there is but one level of extinction potential, this being very little affected by circuit adjustments. However, two levels of ionization potential are shown, corresponding to two different values of grid bias. With the more negative bias, the ionization potential is higher, as shown by line 2-2. Since the time required for the capacitor to reach this higher potential is longer, the frequency is correspondingly lower. Line 1-1 shows a lower ionization potential due to a less negative bias than in the

first case. The capacitor builds up to this voltage sooner, then discharges through the tube, and is ready to begin the next cycle. Notice that four cycles have been produced in about the same time interval that produced three cycles in the case of the higher

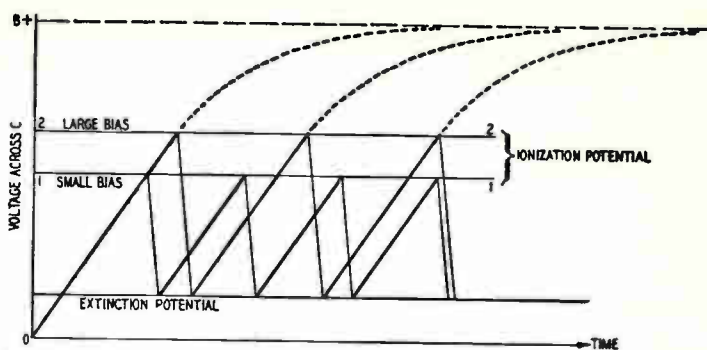

Fig. 306. Factors influencing capacitor charge and discharge in gas-tube circuit.

ionization potential. Thus, a change in the grid bias of the gas triode can produce a change in the frequency of the generated sawtooth wave. Incidentally, Fig. 306 also shows a difference in the amplitudes of the two waves. However, this is not of major importance, since amplifiers almost always follow such oscillators, providing more than adequate gain from even a very low oscillator output.

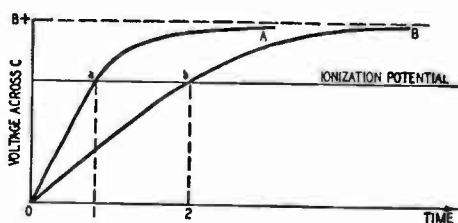

Fig. 307. Sawtooth frequency depends upon speed of capacitor charge and discharge.

While the grid bias affects the frequency of the sawtooth output, the usual method of changing the frequency in oscilloscope sweep circuits is to vary the resistor-capacitor combination in the plate circuit. Since the capacitor charges in series with the resistor in the plate circuit, any change in the value of the resistor will affect the charging cycle. A larger resistor will slow down the charging, requiring a longer time for the capacitor to reach the

ionization potential. Similarly, for any given resistor, a small capacitor will reach the ionization potential sooner than a large one. Fig. 307 shows two charging curves, O-a-A and O-b-B. Notice that while the first curve reaches the ionization level in time interval 0-1, the second curve does not build up to this voltage until sometime later, shown by point 2. Obviously, the first sawtooth will be of a higher frequency than the second. Looking again at the two charging curves, it can be seen that the first is much steeper, or, it may be said that it rises much faster. One may conclude that, in the first case, either the charging resistor or the capacitor, or both, were smaller than in the second case. Therefore the variation of either the series resistor or the charging capacitor produces variations in frequency. This method is actually used in practical circuits for changing frequency.

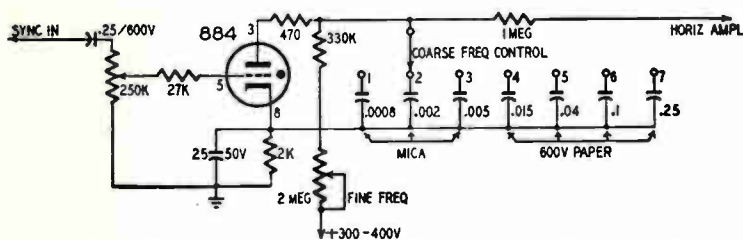

Fig. 308. Typical gas-triode sawtooth generator, showing values.

Fig. 308 shows the values used in a typical gas-triode sawtooth generator, with r-c frequency control in the plate circuit. Switching in different values of charging capacitors (1, 2, 3, etc.) allows large changes in frequency to be made. This is often called a COARSE-FREQUENCY control, and it acts in the manner of a band-switch, switching in different ranges of frequency. The 2-megohm potentiometer is in series with the B+ supply and acts as a vernier, or FINE-FREQUENCY control, varying the frequency within the limits of the band chosen by the switch. The approximate ranges covered by the FINE-FREQUENCY control when the COARSE control is in positions 1 through 7 are: 3,500-11,500, 1,500-5,000, 700-2,200, 300-900, 100-350, 40-150, and 20-60 cycles respectively. The maximum frequency corresponds to the minimum resistance setting of the FINE-FREQUENCY control.

The grid circuit, while no longer a direct-frequency control, still has a frequency-controlling effect. When the sawtooth oscillator is to be synchronized with any outside standard, the sync pulse, in the form of some positive *pip*, is fed to the grid. The

frequency is first adjusted to slightly below the exact desired value, using the FINE-FREQUENCY control. When the positive sync pulse is applied to the grid, the ionization potential requirement is made lower and the tube conducts instantly when the grid is pulsed, thus ending the cycle sooner than it would have ended without the pulse. This is equivalent to increasing the frequency, since the duration of each cycle is made shorter, allowing the subsequent cycles to follow sooner.

Single sweeps

In some cases the signal to be observed exists only for a short time and then disappears. This is called a transient. If the ordinary sawtooth sweep is employed for such a signal, the electron

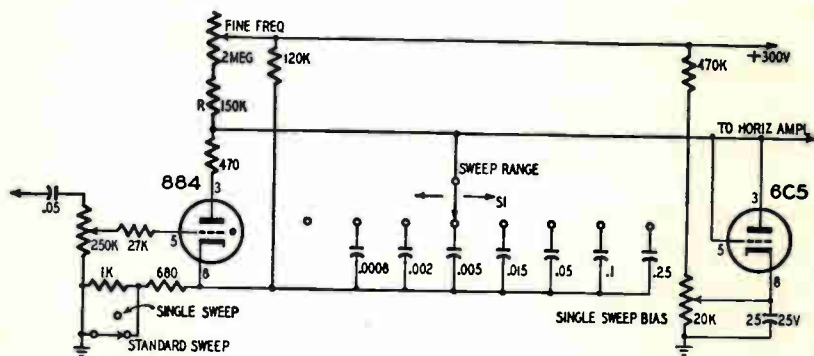

Fig. 309. Thyatron sweep circuit used in connection with study of transients

beam moving across the face of the cathode-ray tube is independent of the beginning of the transient and there is no way to determine when it occurs. This problem is solved by using a single-stroke sweep generator that generates a time base only when the transient occurs. The sweep is started by the transient itself or by some identical signal voltage applied to the sync input terminals.

An ordinary thyatron sweep circuit can be used for this purpose without much change.

In the circuit of Fig. 309, the plate of a diode-connected 6C5 is connected to the plate of the 884 thyatron through a small resistor. The cathode of the diode being biased with a positive voltage that is just below the plate voltage, this tube normally conducts, but the voltage drop across it is less than the firing voltage of the 884. When a positive sync signal is applied to the grid of the 884, its firing point is lowered and it conducts. The capacitor

selected by S1 discharges through the thyratron until the extinction voltage is reached. The capacitor then begins to charge again until it reaches the voltage at which the diode begins to conduct, and only one sweep is produced until another sync signal is applied to the circuit.

While the gas triode is still used in many oscilloscope and similar applications, it has some objectionable features. In high-gain circuits, the inherent noise of a gas tube (sometimes called *hash*, similar to the noise caused by gas rectifiers in auto-radio receivers) may become too objectionable, requiring careful shielding and filtering. In addition, there are limitations imposed by the fundamental characteristics of the gas itself, as well as the limited range of frequency in which the gas tube operates satisfactorily. A more popular type of sawtooth generator circuit is the multivibrator. Being strictly a vacuum tube circuit, it is free of the gas noise inherent in the gas triode type. In addition, its excellent behavior at the higher frequencies encountered in modern oscilloscopes and television receivers makes the multivibrator the favorite type of sweep oscillator in use today.

The multivibrator

In its simplest form, the multivibrator looks like a two-stage resistance-coupled amplifier, to which has been added a feedback capacitor from the plate of the second tube to the grid of the first. Fig. 310 shows such a circuit. The basic function of this circuit is that of a square-wave generator. Capacitor C3 across the output of the second tube (V2) charges from the square-wave output voltage of this tube, developing a sawtooth voltage very much in the manner described in the case of the gas tube. In both cases, a steady d.c. voltage is applied to the capacitor in series with a resistance. The main difference lies in the method of discharging the capacitor. In the case of the gas tube, the sudden ionization of the gas produces a short-circuit across the capacitor, discharging it and initiating the next cycle, while in the case of the multivibrator, the two tubes, V1 and V2, alternate in short-circuiting each other.

As shown in Fig. 310, the circuit is perfectly balanced as far as circuit and components are concerned. Also, notice that the cathodes connect directly to ground, resulting in zero initial bias on both tubes. Under this condition, both tubes draw maximum current. Their plate voltages, being the difference between the B+ supply and the large IR drop across R2 and R4, the plate-

load resistors, would be a minimum, perhaps near zero. These conditions would hold only as long as steady state, or absolute equilibrium, existed. However, since such absolute stability is practically impossible, any change anywhere in the circuit would immediately start the multivibrator functioning. Such a change might be the rise in plate current (as the circuit is first put on) somewhat more in one tube than in the other. A minor difference in the IR drops in the plate circuits, or, in fact, any unbalance at all, would be sufficient to begin the cycle.

Assuming a rise in the plate current of V1, the plate voltage of this tube would drop, due to the increased IR drop in its plate circuit. C2, the coupling capacitor, would then discharge down R3, making the grid of V2 more negative. This, in turn, would

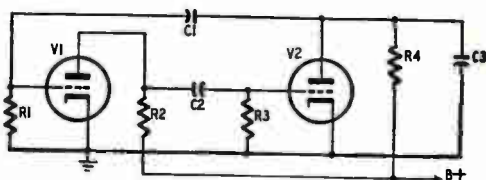

Fig. 310. Plate-coupled multivibrator resembles r-c audio amplifier.

lower the plate current and raise the plate voltage of V2. C1, the feedback capacitor, would now charge up to the value of the B+ supply. But, as C2 continues discharging, at a progressively slower rate, the bias on V2 becomes less negative. While the initial discharge pulse drove V2 to beyond cutoff, the bias now gradually gets lower and V2 begins to conduct again. This lowers the plate voltage on V2, and C1 now discharges down R1, making the grid of V1 more negative (actually driving it beyond cutoff). The plate voltage of V1 now rises, causing C2 to charge. Thus, a complete cycle has been produced. From now on, the two tubes will alternately cut off, with a rise in plate voltage to maximum, will then conduct very heavily, lowering the plate voltage to nearly zero. Or, considering any one tube of the pair, it will alternately have a period of maximum plate voltage, followed by a period of minimum voltage. For a circuit such as the one shown in Fig. 310, where $R1 = R3$, and $C1 = C2$, the on and off intervals would be of the same duration, and the multivibrator would be called a "balanced" multivibrator, sometimes called a symmetrical square-wave generator.

The charge and discharge of C3 depends upon the behavior of V2. During the time that V2 is being driven to cutoff, its plate

voltage rises, and since C3 is in parallel with this tube its charge will increase. When V2 conducts heavily, it acts like a short-circuit across C3, discharging the capacitor. This charge and discharge action produces a sawtooth waveform across C3, this capacitor representing the output of the circuit. What we are doing is using a square-wave generator (multivibrator) to charge and discharge a capacitor, giving us the sawtooth voltage we need for sweep voltage in the oscilloscope. The circuit is more elaborate than the relaxation oscillator, but the results are the same.

Cathode-coupled multivibrator

One of the most common types of multivibrators used in oscilloscope and television circuits is the cathode-coupled multivibrator. As can be seen from Fig. 311, the cathode-coupled type omits the feedback capacitor shown in Fig. 310. Instead, feedback takes place through a common, unbypassed cathode resistor, R5. While cathode coupling does not necessarily produce unbalance, the circuit is most often operated to produce this condition. Notice that the cathode resistor develops a common bias voltage for both tubes. However, the r-c circuit in the grid of V2 is an additional source of grid voltage for V2 only. In operation, V1 conducts heavily for a long portion of the cycle. A large IR drop appears across R2. This reduces the plate voltage of this tube, causing C1 to discharge through R3. V2 is therefore cut off during the time of discharge, such time being adjustable by varying the grid-circuit resistance of V2. The plate voltage of V2 during this time is a maximum, enabling the sawtooth capacitor, C2, to charge. Near the end of the discharge cycle of C2, V2 begins conducting, raising the cathode bias and reducing the current through V1. At the same time, the plate voltage of V1 rises, causing C1 to charge, and further increase the current in V2. While the cathode bias is applied to both tubes, nevertheless, V1 current decreases rapidly due to the rise in cathode voltage, while V2 is still conducting heavily, due to the charging of C1. However, as the charging diminishes, V2 current falls, reducing the bias on V1 (toward zero), and the cycle is completed, as V1 current rises again. The values of C2 and R4 help determine the frequency and amplitude of the sawtooth waveform.

In television and oscilloscope circuits, a synchronizing pulse is applied to the control grid of V1. In Fig. 311, this pulse would be placed across R1. The pulse, in the form of a sharp negative-going pip is applied to the grid of V1 at the time the sawtooth is

intended to end, driving V1 bias sharply negative and V2 plate current up. This is the beginning of the discharge of the sawtooth capacitor, corresponding to the retrace, or flyback, on the cathode-ray tube screen.

Frequency control

Frequency variation, or tuning, is a characteristic common to and necessary in all types of sweep generators. At audio frequencies, such as in oscilloscope and television sweep systems, the r-c network takes the place of the coil-capacitor combination of r.f. circuits. The time-constant in an r-c network is the product of

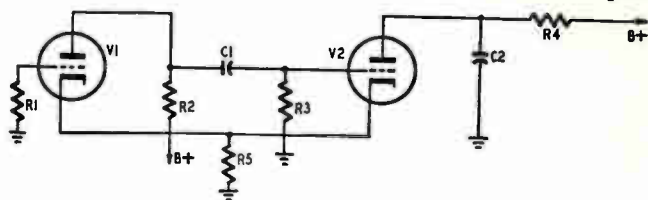

Fig. 311. Cathode-coupled multivibrator. Note use of common cathode resistor.

the resistance in megohms and the capacitance in microfarads, and is expressed in seconds. Thus,

$$T = R \times C$$

expresses the time required for one cycle of sweep, for instance. In the formula, T is the time in seconds if R and C are in the units stated. The frequency, or the number of such cycles in one second, is obtained by dividing 1 by the time. Therefore,

$$f = \frac{1}{T}, \text{ or } f = \frac{1}{R \times C}$$

It should be apparent from the last formula given, that in order to increase the frequency, either R or C or both should be decreased, and vice versa for a desired decrease in frequency. This is the basis for tuning r-c circuits.

In television applications, where a single frequency is desired, the circuit can be designed for approximately the correct frequency, with a minor variation provided through a variable resistor in the r-c network. These are the HOLD controls in vertical and horizontal sweep circuits. In oscilloscopes, however, or in r-c audio oscillators, a wide range of frequencies is required. A potentiometer alone would not be adequate. In such cases, both R and C are variable. In the oscilloscope, for example, there is both a COARSE and a vernier, or FINE-FREQUENCY control. The

COARSE control operates in the manner of a bandswitch in multi-band receivers. Each position of the switch connects a different capacitance into the r-c circuit. The potentiometer, functioning as the FINE control, can now vary the frequency over a considerable portion of the total range. With proper choice of capacitors, a continuous range from as low as a few cycles to over 100,000 cycles is practical, and is often found in commercial equipment.

Nonlinear sweeps

Up to now, we have considered linear sweeps—deflection voltages intended to move the electron beam across the cathode-ray tube screen at a uniform pace. While the linear sweep is the one most often used in oscillography, and always in television deflection systems, nonlinear sweeps are finding many uses in television service and other applications of the oscilloscope. Two of the most common applications of interest to the service technician are the Lissajous figures and the use of sweep generators for alignment of wide-band r.f., i.f., and video circuits in television, and i.f. circuits of FM receivers. Lissajous figures are useful in frequency calibration and in determining the exact frequency of a voltage. The unknown frequency is applied to the VERTICAL input of the scope and the standard frequency to the HORIZONTAL input. The resultant pattern on the screen is an accurate indication of the unknown frequency, in multiples, or submultiples, of the standard frequency.

The use of nonlinear sweeps in alignment is even more important to the service technician. Since the advent of FM and television, sweep generator alignment of bandpass circuits is almost a must. Since all sweep generators today use 60-cycle sine wave a.c. as the repetition frequency, a 60-cycle (or 30, in some cases) horizontal sweep for the oscilloscope is required for best display of the bandpass characteristics. While at first this might seem to result in distortion of the waveshape being studied, further consideration will show that the contrary is true. A linear sweep, such as the sawtooth, would display a distorted version of the sine-wave-swept input signal, while the sine-wave sweep would show the response in its proper value. While the INTERNAL sweep of the oscilloscope could be used, the sine wave is much more correct for this application. We shall discuss the matter of sweep generator use in Chapter 5, in connection with alignment of television and FM circuits.

Synchronization

In the discussion of sawtooth generators, it was stated that frequency was primarily determined by the r-c network. While this is quite true, there are other factors affecting the frequency of an oscillator. Variations in B+ and temperature drift contribute to frequency instability. Even the r-c circuit itself is subject to variation from the set value, unless extremely elaborate precautions are taken. Thus, it cannot be said with any degree of certainty that the same setting of the dial will produce exactly the same frequency every time. Under these conditions, the oscillator is said to be free-running. Both the frequency of the sawteeth as well as their magnitude may vary somewhat from cycle to cycle. On the other hand, the requirements of sweep circuits, both in oscilloscopes and in television receivers, are such that exact frequencies are a necessity. In the case of the scope, even a minor variation in the frequency of the sweep will cause the wave under study to drift across the screen, making observation difficult and photographing impossible. In television receivers, picture rolling will result from any drift of the vertical oscillator, while a change in the horizontal frequency will result in tearing. It therefore becomes obvious that for proper operation a method of controlling the frequency is essential. Such control is called synchronization. Simply stated, the frequency of the sweep oscillator is controlled by a source outside its own circuit. Thus, if an accurately maintained frequency is applied to the input of a sweep generator, this standard frequency will time the local oscillator at the same point in each cycle, making all the cycles equal in size and duration. In other words, the correct frequency will be maintained.

One might wonder at this point whether the synchronizing signal or pulse is itself absolutely reliable. The answer is quite simple. It is not very important that the synchronizing pulse frequency be exact from the viewpoint of absolute standards. The important point is that the local oscillator, such as the television sweep generator, follow the sync pulse, or the control frequency, as closely as possible. Thus, if the horizontal sweep frequency of a television transmitter should vary somewhat from the standard value, no apparent effect on the receiver picture will be noticed as long as the receiver sweep varies exactly the same way as the transmitter frequency. In other words, as long as the local frequency is locked with that of the incoming pulse, the reproduced

picture will not be affected. The same is true also in the case of the oscilloscope.

Types of sync pulses

There are a large variety of synchronizing voltages, the most commonly known being the sine wave, widely used in oscilloscopes, and the sharp pulse, or pip, as exemplified by the differentiated and integrated pulses in television receivers. Fig. 312 illustrates the effect of a sine-wave synchronizing voltage, applied to the grid of sawtooth generator, on the grid bias, sawtooth frequency, and, indirectly, on the sawtooth amplitude. From point 1 to point 2, the oscillator is free running, and the sawtooth charging cycle ends at the moment the grid bias reaches cutoff in the positive direction. At point 2, a negative-going sine wave a.c. signal has been applied to the grid. The net bias voltage is now the combined value of the feedback capacitor discharge and the applied sine wave. As a result, cutoff bias is reached sooner, at point 3' instead of 3, as would have been the case had the oscillator continued to be free running. The sawtooth, too, ends sooner, at point b' instead of b, the free-running position. Thus, the amplitude of the sawtooth has decreased somewhat, since the charging was stopped sooner, and the frequency has increased, the time for each cycle having been shortened by the arrival of the sync pulse. In Fig. 312, the solid lines are the actual waveshapes, both before and after synchronization, while the dashed lines indicate what the waveshapes would have been without the synchronizing effect.

The cathode-ray oscilloscope embodies a good example of sine-wave synchronization. When the SYNC selector of a scope is set for LINE, a sine-wave a.c. voltage, taken from a point in the power supply, is fed to the input of the sweep-frequency generator for synchronization. Also, whenever a sine-wave a.c. is applied to the vertical amplifier for study, sine-wave sync is utilized, with the selector in the INT position.

The effect of the sync voltage on the amplitude of the sawtooth is of no great significance. In most cathode-ray measurements, as well as in television receivers, amplifiers are provided, which, in conjunction with a gain control (usually marked WIDTH in television receivers and H-GAIN in scopes), enables amplification of the sweep voltage to more than enough for full-screen sweeping. Since an inadequate voltage will not move the beam all the way across the screen, while too large a sweep voltage will deflect the

beam beyond the diameter of the screen, as if wrapping part of the waveshape being studied around the sides of the c-r tube, a WIDTH or H-GAIN control is necessary.

Number of waves displayed

It was stated earlier that in order to study the waveshape of a voltage or current more than one wave on the screen is desirable, since the beginning of the first wave as well as the end of the last wave displayed on the c-r screen may often be somewhat distorted. If, for example, three waves are shown, the middle one is certain to be unaffected by any nonlinearity of the sweep. To obtain a desired number of cycles on the screen, the relation between the signal frequency and that of the cathode-ray oscilloscope sweep must be known.

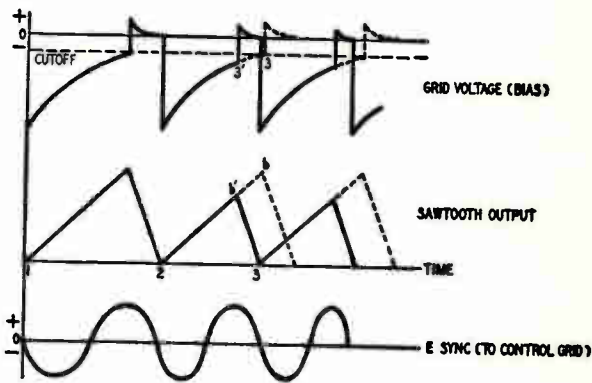

Fig. 312. The frequency of the sawtooth generator can be controlled, within limits, by a synchronizing voltage. The most common form of synchronizing voltage, in oscilloscopes, is the sine wave. The solid lines shown in the illustration above are waveshapes before and after synchronization. The dashed lines indicate waveshapes as they would be without synchronization.

Let us assume that a 600-cycle signal is to be studied. If the beam moves across the screen in the same time that one cycle of the test voltage is generated, one signal cycle will be on the screen. During the time the signal voltage varies from zero to positive maximum, back to zero, down to negative maximum, and finally back to zero, the sweep voltage has traveled from the extreme left to the extreme right, across the screen. Fig. 313 shows the time relation between the signal and the sweep voltages. Should the

beam move across the screen faster, it would reach the right-hand edge before the sine wave is completed. As a result, less than a full cycle would be displayed. Conversely, a slower moving beam would allow more than one cycle to be generated during the horizontal sweep across the screen. The principle has thus been established. To view more than one cycle, the sweep has to be slower than the signal. As a corollary to this, it is correct to say that as many cycles will be displayed on the screen as the number of times the signal frequency is higher than the sweep frequency. In case of the 600-cycle example, one cycle will be shown when the sweep frequency is also 600 cycles. To see three cycles, the sweep

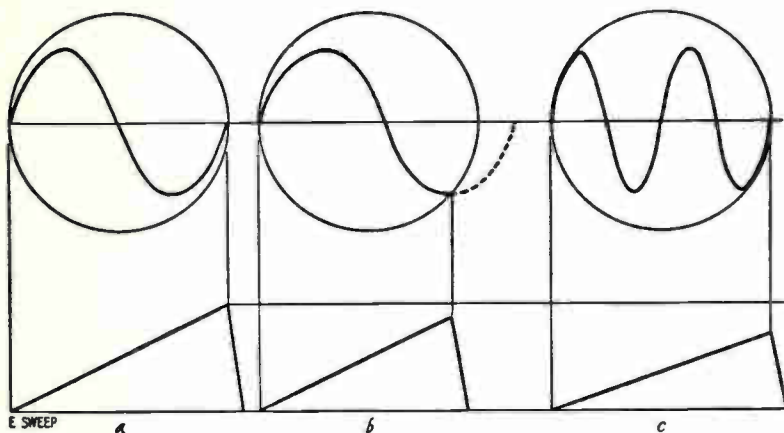

Fig. 313. Time relationship between the sweep and signal voltages.

should be set to $600/3$, or 200 cycles. While the sweep controls on the oscilloscope are seldom accurately calibrated, it is enough to set the COARSE adjustment to the range which includes, say, 200 cycles, then rotate the FINE control slowly until three waves appear. While it is desirable to view few waves on the screen in order to be able to observe small portions of a wave, sometimes it is necessary to have a higher number shown, due to the limitations of the sweep range. If the maximum sweep frequency of an oscilloscope is, for example, 75 kilocycles, and the signal frequency is 375 kilocycles, no less than 5 cycles can be displayed. Generally, however, the 75-kc range is adequate for all purposes.

There are various devices, in connection with the use of the oscilloscope, which the experienced technician can use. In the case of apparently inadequately high sweep frequency, it is possible to view a small portion of a cycle by simply increasing the hori-

zontal gain beyond the width of the screen, in cases where such gain is available. In this manner, it is possible to view a small portion of a single horizontal line of a television sweep, whose duration may be only two or three microseconds. While you may not be able to lock the pattern on the screen under these conditions, observation is still possible.

While the main use of the multivibrator in oscilloscopes and television receivers is to produce a linear time-base voltage, or sawtooth, there are many other applications in which the multivibrator plays an important part. Most interesting to the service technician is the electronic switch.

Electronic switch

The electronic switch is basically a balanced multivibrator, in which each tube plate circuit alternately connects to the input of

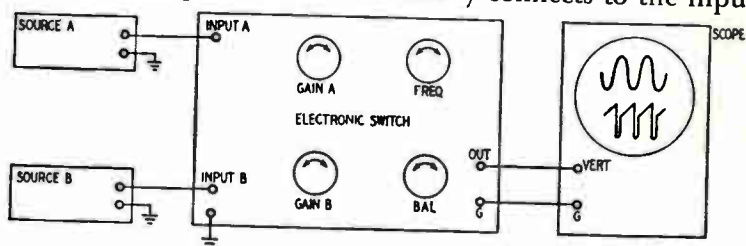

Fig. 314. The electronic switch can be used for viewing two waveforms on the c-r screen.

an oscilloscope. Since, in the balanced multivibrator, each plate conducts, or is *on*, during alternate half-cycles, then any signal applied to each tube would be displayed on the c-r screen on alternate half-cycles only. This feature makes it possible to view two signals at the same time, for comparison purposes. Such phenomena as amplifier gain, phase shift, relations between E and I in reactive circuits, and many others, can be viewed simultaneously through the use of the electronic switch.

Fig. 314 gives a block diagram of a setup for viewing two wave-shapes on the c-r screen. The two signals to be studied or compared are fed, respectively, to INPUT A and INPUT B. The common OUTPUT terminal connects to the v-INPUT of the scope. The FREQUENCY and BALANCE controls are adjusted for the desired relative positioning of the two signals, while the amplitudes of the two test signals are adjustable with the GAIN A and GAIN B controls. Actually, only one signal is displayed on the screen at a time. However, due to the repetition frequency of the sweep

and the persistence of the c-r screen, both signals appear simultaneously.

Intensity modulation

The brightness of the trace on the c-r screen can be varied by adjusting the grid voltage, or bias. If, for any reason, during the tracing of the pattern of the signal, the voltage on the grid should vary, the intensity of the pattern will change, but otherwise the waveshape will be unaffected. As an illustration, examine Fig. 315. The top sine wave is a continuous, unbroken line, indicating that the grid bias was held constant. The lower wave is dashed, consisting of twelve short strokes with blank spaces in

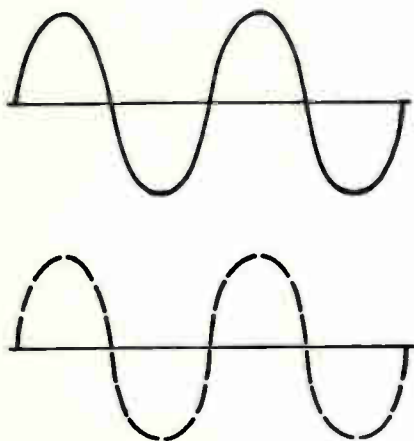

Fig. 315. Intensity modulation produces interrupted pattern on the screen.

between. The electron beam was in this case interrupted twelve times during each cycle of the signal. Since the spaces between the dashes correspond to a dark screen, or no beam, it is evident that cutoff bias, applied to the c-r tube grid produces this effect. This is done by feeding a square wave to the grid circuit. The square wave has a frequency twelve times higher than the signal and an amplitude sufficient to bias the tube to cutoff on the negative half-cycle of the square wave. In some oscilloscopes, a terminal is provided for this purpose, and is marked INTENSITY MODULATION. In more versatile instruments, a video amplifier is provided, with the input terminal marked Z-AXIS AMPLIFIER. Provided with a gain control, the amplifier enables the use of fairly small signals for intensity modulation.

A scope can be modified for Z-axis input if it does not already

have this feature. The schematic in Fig. 316 shows the connections to be made. The 1-megohm isolating resistor R1 must be connected between the No. 1 grid of the oscilloscope (intensity electrode) and the intensity (brilliance) control, if R1 is not already in the regular circuit. The Z-axis input circuit consists of coupling-capacitor C, resistor R2, and the insulated binding post or pin jack. The Z-axis lead must be covered with grounded shield braid throughout its length. The binding post must be installed in the rear of the oscilloscope case as close as possible to the oscilloscope tube socket.

A signal applied to the Z-axis input while another signal is being observed on the scope screen will modulate the intensity of the pattern on the screen. If the Z-axis input consists of sharp positive pulses, bright dots will be spaced along the trace of the pattern. If the pulses are negative, blanked-out spots or spaces

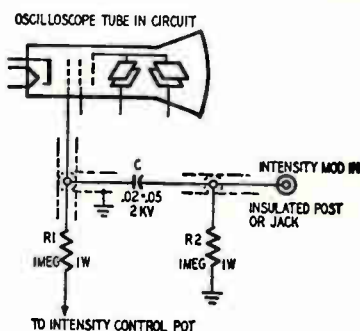

Fig. 316. Circuit for modifying scope to incorporate intensity modulation.

will be present instead of dots. If the frequency of the Z-axis input is known, these dots or blanks may be used for timing purposes. When a positive-going half of a sine or square wave is applied to the Z-axis input, the pattern will be broken up into a series of bright lines along the trace, their number and length depending upon the frequency of the Z-axis signal. All negative-going Z-axis signals blank out portions of the trace. Intensity modulation is very useful in the establishment of "dot wheel" patterns for a.f. comparisons.

Marker signals

Although the interruption of the trace serves as a sort of marker, the system used in television sweep alignment is somewhat different. A signal of the correct frequency and adjustable

amplitude is fed to the VERTICAL input of the scope and appears superimposed on the response curve of the circuit being aligned. Such a marker, or pip, as it is referred to in television and FM sweep generators, consists of an r.f. pulse of adjustable amplitude and frequency. By varying the frequency of the marker, its physical position atop the response curve of the i.f. or video circuit being aligned can be moved from one extreme position to the other. Since the marker frequency is usually accurately calibrated, the frequency of any point on the response curve can be obtained simply by moving the pip into position and reading the frequency on the marker generator dial.

Retrace blanking

In all sweep circuits both the charge and the discharge of the sawtooth capacitor will appear on the screen. Many oscilloscopes have blanking circuits that cut off the electron beam during the discharge or retrace period. To accomplish this, either a negative pulse is applied to the cathode-ray tube grid or a positive

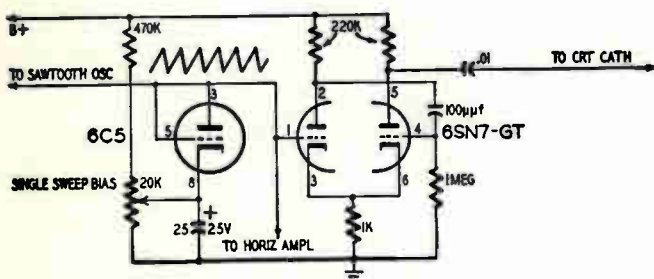

Fig. 317. Circuit to supply intensity modulation or for blanking.

pulse is applied to the cathode during the retrace to cut off the tube. The circuit of Fig. 317 shown above can be used for intensity modulation when using the single sweep or can be switched to the c-r tube cathode for blanking when the sawtooth sweep is used. If the oscilloscope has a Z-axis amplifier, this additional tube is not needed for blanking.

Aural indicator

When working with the oscilloscope in conjunction with a radio receiver or audio amplifier, it is often difficult to interpret the patterns because it is the ear rather than the eye that is accustomed to the signals which they represent. When using an actual signal for servicing, it is often difficult to tell whether the observed waveforms are normal or not. The obvious solution

is to connect a headphone jack somewhere in the vertical deflection circuit of the oscilloscope, enabling the waveform to be heard as well as seen. However, such a direct connection is useful only for audio-frequency signals. The circuit shown in Fig. 318 is capable of making audible audio-frequency signals, and the modulation on r.f. signals.

Its operation is simple. Throwing the switch to the AF position connects the tube as a cathode follower, while the RF position connects the tube as an infinite-impedance detector. The input is connected through the .001- μ f capacitor to the vertical deflection

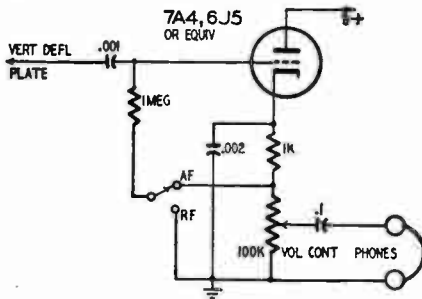

Fig. 318. Your scope can be modified to include this aural indicator.

plate or the output of the vertical amplifier, thus getting plenty of signal. The output is controlled by the potentiometer which also acts as the tube load resistor. The oscilloscope circuit should be checked carefully to make sure that the signal take-off point is not at a dangerously high potential. In any event, the .001- μ f coupling capacitor must have a voltage rating high enough to withstand the peak potential at the point of signal takeoff.

Although it requires a little work to add this circuit to an oscilloscope, it can make a great improvement in the instrument's usefulness. It makes it possible to use the ears to detect troubles such as distortion, noise, or hum, which are difficult to detect from scope patterns, especially when they are slight. Then, a close examination of the waveform of the defective signal can be used to determine the electronic nature of the defect.

Chapter

4

Typical Oscilloscopes

THE two oscilloscopes described in this chapter are good examples of commercial practice. The first, a Du Mont type 208B, although not of recent design, is an excellent instrument having high quality and performance. Many modern scopes have incorporated some of the outstanding features of the 208B. The second is the RCA type WO-56A, a modern instrument designed prima-

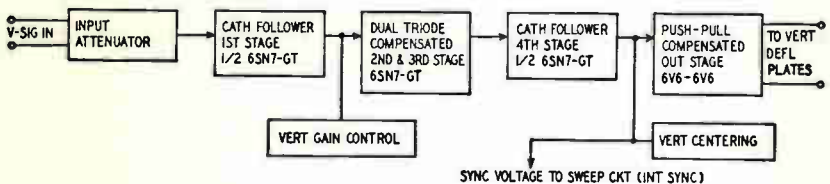

Fig. 401. Block diagram of vertical amplifier section of 208B scope.

rily for television service work, and using a 7-inch cathode-ray tube. Most other commercial oscilloscopes, except those designed for special laboratory applications, follow the general layout and characteristics of the two scopes just mentioned.

Du Mont 208B

For clarification, the diagram of the Du Mont type 208B has been divided into four major units. These are (1) the vertical amplifier; (2) the horizontal amplifier; (3) the sweep system; (4) the power supply.

The vertical amplifier

Fig. 401 shows the block diagram of the vertical amplifier section. The schematic of the same section is shown in Fig. 402. The input attenuator is a high-low input switching system. For input signals below 25 volts r.m.s., the signal is fed, without attenuation, directly to the grid of the first stage. C1 is an isolating capacitor for blocking any d.c. from reaching the grid of the first stage, V1.

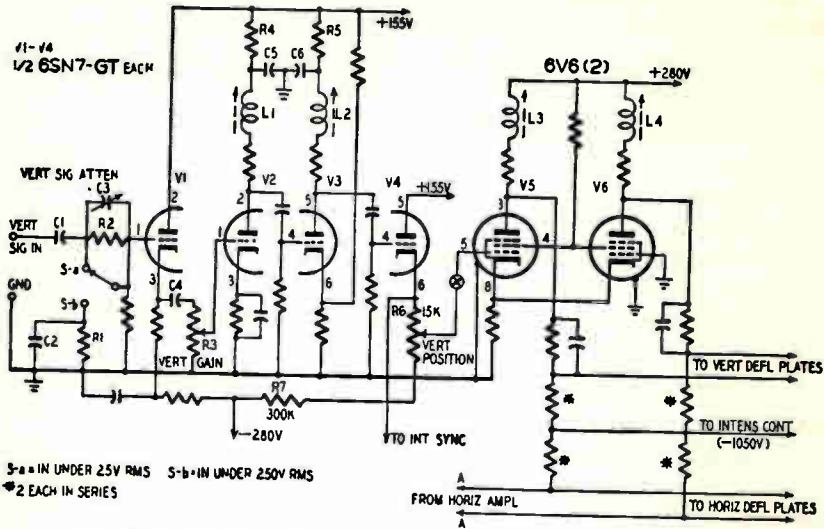

Fig. 402. Schematic diagram of vertical amplifier section of scope.

In the high position, for signals up to 250 volts r.m.s., a combination series-shunt r-c network (R1, R2, C2, C3) is switched across the grid circuit. This network acts as a frequency-compensated voltage-divider system, preventing both overloading and frequency distortion.

The first vertical amplifier stage, V1, using one-half of a 6SN7-GT dual triode, is connected for cathode output (cathode follower), with the plate going directly to B+. The advantage of this type of amplifier lies in high input impedance and low output impedance, providing good frequency response and minimum loading. Since the input to the scope may often consist of circuits sensitive to loading and distortion, a cathode-follower input stage is desirable. As in the case of the input attenuator, a series capacitor, C4, is used as a d.c. block. Potentiometer R3 acts as the v-gain control, varying the output amplitude of the complete vertical system. The next two stages, V2 and V3, using a dual triode,

are frequency-compensated amplifiers, having both high (L1 and L2) and low (R4, C5 and R5, C6) frequency compensation. Unlike the first stage, in which there is a signal loss, these two stages are voltage amplifiers, providing a major portion of the amplifier gain. The frequency-compensating circuits are for the purpose of insuring flat response over the operating range of the vertical amplifier.

The vertical amplifier may be called upon to handle frequencies at least a few times higher than the horizontal, or sweep, frequency. Assuming a 75-kc maximum for the sweep frequency, the vertical amplifier would be expected to accept up to about 300 kc, and down to a few cycles. The ordinary resistance-coupled amplifier, by comparison, may have a flat response of only about 15 or 20 kc, at most. Since the scope is expected to act as a measuring device, it is important that all frequencies measured be amplified equally. If either the very low or the very high frequencies get a lesser amount of amplification, the scope would give a false indication of poor response in the equipment being tested.

Poor response in wide-band amplifiers is largely due to two main causes. First, there is a loss at low frequencies due to the increasing series reactance, accompanied by phase shift, of the coupling capacitors between stages. Second, attenuation of the higher frequencies increases due to the shunting of the circuit by tube capacitances, whose reactance decreases with increase in frequency. Added to this is the effect of wiring capacitances, as well as that of placing components which are part of the signal path near the chassis. A brief review of elementary capacitor characteristics will help make this clear.

From fundamental a.c. theory, we know that the reactance of a capacitor varies inversely with the frequency. Expressed mathematically,

$$X_c = \frac{1}{2 \pi f C} \cdot$$

A 0.25- μ f coupling capacitor has a reactance of approximately 640 ohms at 1,000 cycles. At 10 cycles, the same capacitor has a reactance of almost 64,000 ohms! Similarly, a 25- μ f capacitor, which at 1,000 cycles has a reactance of almost 6.4 megohms, is reduced to about 64,000 ohms at 100 kilocycles. With these facts in mind, we are in a position to understand the problem of poor frequency response at the extremes of a wideband amplifier.

Figure 403 shows a simplified version of an r-c amplifier. The 0.25- μf coupling capacitor in series with the 0.25-megohm grid resistor form a voltage divider across the input to the tube, with only the resistance portion appearing across the grid-cathode circuit, representing the actual input to the tube. Using our earlier figures it is seen that at 1,000 cycles, when the reactance of the capacitor is relatively negligible, almost 100% of the signal input appears across the actual tube input. At 10 cycles, however, the 64,000-ohm reactance of the capacitor is a much larger portion of the total voltage divider. Since only that part of the signal developing across the resistor appears across the tube, a large portion of the total signal—the part dropped across the capacitor—is lost as far as the tube is concerned. While this is not quite a linear proportion, because the two component voltages are not in phase, the

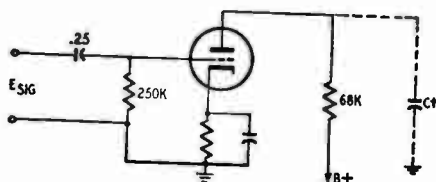

Fig. 403. Simplified form of r-c amplifier.

loss across the capacitor is nevertheless considerable. This loss accounts for the falling off of the response as the frequency decreases. While direct coupling (omission of the coupling capacitor with a corresponding complication in the power-supply requirements) can avoid this problem, such coupling is not always feasible. When applied to more than one stage, the power-supply requirements begin to mount, since direct coupling requires the equivalent of separate power supplies connected in series. Low-frequency compensation is therefore required to make an r-c amplifier perform satisfactorily at the very low-frequency end of the bandpass range.

Looking at the circuit of Fig. 403 again, the plate load consists of a 68,000-ohm resistor. In parallel with this (actually shunting it to ground) is a capacitor C_t , representing the combined effects of tube input- and output- capacitances and the stray wiring capacitance of the circuit. This total capacitance is further increased due to a phenomenon called the Miller effect. Simply stated, a tube with an a.c. signal applied to the grid circuit appears to have an additional shunt capacitance to ground, the amount depending

on the gain of the tube. Assuming a total shunting capacitance to ground of only 25 μf (often it is much more than that), the effect is totally negligible at 1,000 cycles, when the capacitor acts like 6.4 megohms. However, at 100,000 cycles, which is not unusual in oscilloscope vertical amplifiers, the shunting effect is that of 64,000 ohms across the 68,000-ohm load. This is practically equivalent to a bypass capacitor. This is why high-frequency compensation, or *peaking*, is required in wideband high-frequency amplifiers.

To better understand the operation of the frequency-compensating circuits, let us examine one of the stages incorporating such compensation. Fig. 404 shows the circuit of such a stage. The plate-load impedance consists of three distinct components, all in series. They are an 8,000-ohm resistor, a 1-to-3-millihenry adjustable inductance (peaking coil), and a 25,000-ohm resistor in parallel with a 30- μf capacitor. Of these components only the resistors are fixed, remaining at the same value at all frequencies. On the basis of the explanation of the effect of frequency on the capacitive reactance, it is obvious that the 25,000-ohm portion of the load is little affected at the lowest frequencies, while at the higher ones it is progressively reduced due to the increasing shunting effect of the parallel 30- μf capacitor. As far as the peaking coil is concerned, it may be simply explained by considering that inductive reactance of a coil varies directly with frequency, according to the formula

$$X_L = 2 \pi f L.$$

At low audio frequencies, say 1,000 cycles, the reactance of a 3-millihenry coil is approximately 20 ohms, certainly a negligible amount in comparison to 8,000 ohms in series with 25,000 ohms. At 100 kilocycles, however, the same coil has a reactance of 2,000 ohms. With these facts in mind, the effects of compensating circuits can be easily understood. At the middle frequencies, the plate load consists essentially of the 8,000-ohm resistor only, since the peaking coil still has negligible reactance, while the 30- μf capacitor effectively bypasses the 25,000-ohm resistor. At the low frequencies, the coil effect is totally absent, but the shunting effect of the capacitor is now less, due to its increased reactance. Thus, as the frequency decreases and the output tends to lessen, the 25,000-ohm resistor is gradually added to the plate load, and the output is kept constant. At the high frequencies, where the tube and stray capacitances shunt the plate load and tend to reduce the

output, the reactance of the peaking coil rises, increasing the plate-load impedance and making up for the loss. In order to obtain the desired amount of peaking over the required portion of the bandpass, the coil is adjustable, using a tuning core, or slug. The over-all effect is to produce a substantially flat response over the entire range of frequencies for which the amplifier was designed.

Returning to Fig. 402, we see that in addition to the two stages which use frequency compensation, the push-pull stages of the horizontal and vertical output amplifiers use high-frequency peaking coils (L3 and L4). However, there is no low-frequency compensation here, since both of these stages are direct-coupled (no series coupling capacitors) from cathode followers.

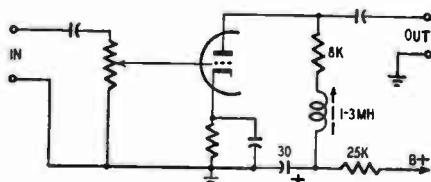

Fig. 404. Circuit using frequency compensation.

The fourth stage of the vertical amplifier, V4, is a cathode follower, feeding the push-pull output stage directly. The potentiometer V-POSITION (R6) in the cathode circuit of this tube acts as a very effective vertical-centering control, providing instantaneous centering, as contrasted with the sluggish response of the usual capacitor-bypassed centering control found in some oscilloscopes.

The cathode load impedance of V4 consists of two resistors in series—the 15,000-ohm potentiometer, R6, and a 300,000-ohm fixed resistor, R7. As a result of this, any change in the setting of the 15,000-ohm centering control will have no noticeable effect on the signal input to the push-pull stage. However, since the setting of this control can change the bias on V5 by approximately ± 7 volts, centering is conveniently achieved.

The second tube of the push-pull stage, V6, is a grounded-grid, cathode-coupled circuit, with the unbypassed cathode resistor acting as the input source for V6, while at the same time being a part of the load for V5. Since the signal across the cathode resistor is in phase with the input to V5, and since this signal is fed to the cathode of V6 instead of to the grid (as is usually the case), the grid of V6 sees an input signal 180 degrees out of phase

with the V5 grid, thus satisfying the requirements for push-pull operation, namely, that the grids, and consequently the plates of a push-pull stage, be 180 degrees out of time with each other.

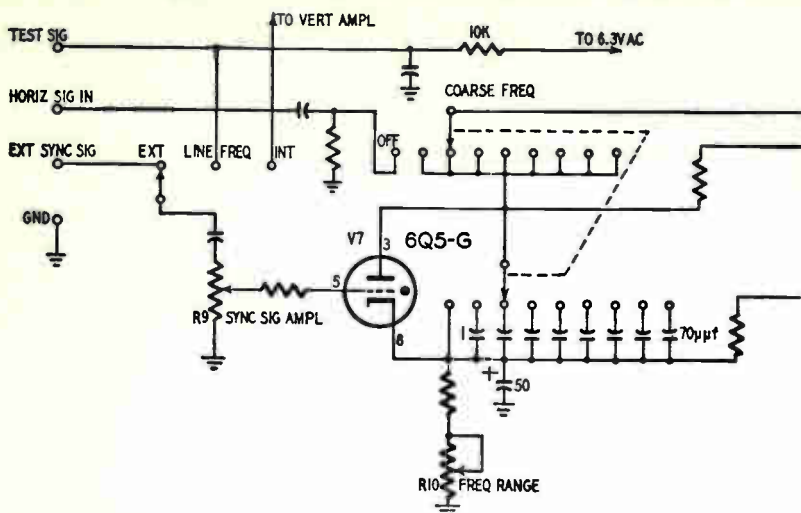
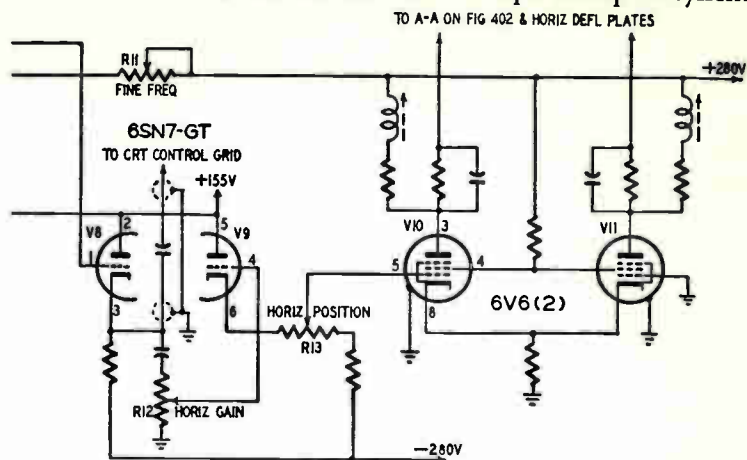

Fig. 405. Schematic diagram of the horizontal amplifier and the sweep section. Sweep frequency is controlled by means of a switch (coarse) and a potentiometer (fine). Note the inclusion of frequency-compensating circuits in the amplifier. The

The plates of the push-pull vertical output amplifier connect to the vertical deflection plates of the cathode-ray tube. For centering, the v-POSITION potentiometer, R6, is used. When this vertical-centering potentiometer is moved clockwise (toward the cathode), the plate current of V5 rises, while its plate voltage falls, making the plate *less positive*. At the same time, the voltage drop across the common cathode resistor rises, thus making the grid of V6 more negative. This, in turn, reduces the plate current and makes the plate of V6 *more positive*. Since the anodes of V5 and V6 connect to the deflection plates of the cathode-ray tube, a clockwise rotation of the v-POSITION potentiometer makes the upper deflection plate more positive and the lower plate less positive. The electron beam traveling between these plates will therefore deflect upward. Moving the potentiometer in the opposite direction will reverse the relative polarities of the deflection plates, causing the beam to move downward. Thus, centering is accomplished. Furthermore, since the centering control acts as a bias adjustment on the push-pull stage, changes in the plate potentials are instantaneous, hence beam centering is also instantaneous.

Besides the main job of the vertical amplifier, that of strengthening the test signal and feeding it to the push-pull amplifier, there is another function—that of supplying a sync pulse to the sweep generator. In the majority of applications, internal synchronization is used, that is, the oscilloscope sweep is synchron-



amplifier has two cathode-followers, followed by a push-pull output stage. Centering technique is same as in vertical amplifier circuit.

ized with the incoming test signal. In the vertical amplifier the output of the cathode-follower stage, V4, connects to the INTERNAL position of the SYNC SIGNAL SELECTOR switch. A potentiometer, in the grid circuit of the sawtooth generator, adjusts the amount of sync voltage to be applied to the relaxation oscillator used in this scope.

The horizontal amplifier

The horizontal amplifier and sweep is shown schematically in Fig. 405. The horizontal amplifier (see block diagram, Fig. 406) is much simpler than the vertical amplifier. Both the gain and the frequency compensation are simplified here. The reasons are easy to understand. First, it should be remembered that the horizontal system of a scope does not handle the signal itself, but merely enables such a signal to be displayed on the screen. While the test signal applied to the vertical plates may be as low as a few millivolts before amplification, the sweep voltage is usually quite large, especially when internal sweep is used. The output of almost any sweep generator, whether gas or multivibrator type, is

seldom less than a few volts. High-gain horizontal amplifiers are therefore unnecessary. Second, regarding the frequency response, the requirements here are much less exacting than in the vertical amplifier. Since two or more cycles are usually displayed on the screen, the horizontal frequency therefore can be two or more times slower than the vertical-input frequency. Another factor is the nature of the sweep waveshape. Although any type of wave may theoretically be used as the sweep voltage, the sawtooth is by far the most common type, with sine waves having some limited use, as in television alignment with an r.f. sweep generator. The relative simplicity of these waveshapes in comparison with the very complex shapes encountered in video circuits, sync systems, and various other types of signals the vertical amplifier may be called upon to handle, makes the requirements of the horizontal amplifier much less stringent.

The horizontal amplifier consists of two cathode-follower stages, V8 and V9, followed by a push-pull output stage, V10 and V11. The input to the first cathode-coupled stage is either from the local sawtooth generator, or from an external source, through the front panel binding posts marked H SIGNAL INPUT. The horizontal gain control, marked H-GAIN, is located in the grid of the second cathode-follower stage, V9. The output of this stage feeds the push-pull output amplifier, direct-coupled. The horizontal centering control, H-POSITION, is located in the input grid circuit of the push-pull stage. Centering is accomplished in exactly the same manner as in the vertical system. The horizontal output stage, except for some minor deviations, is identical with the vertical output stage.

The sweep system

The sweep generator as shown in Fig. 405 consists of a single tube, a type 6Q5-G gas triode. It operates essentially as the gas-tube sawtooth generator described in Chapter 2. A double-deck switch serves as a COARSE frequency bandswitch, connecting capacitors of different values across the plate circuit of the gas tube. A potentiometer, R11, in series with the plate circuit of the tube (V7), hence in the capacitor charging path, acts as the FINE-FREQUENCY vernier in each of the bands selected by the switch. At the extreme clockwise position of the COARSE FREQUENCY switch, the first horizontal amplifier is connected to the H SIGNAL INPUT binding posts, for external sweep use.

The grid circuit of the sweep generator contains the sync selection and amplitude circuits. The SYNC SIGNAL AMPLITUDE CONTROL (R9) operates in the same manner as any gain control at the input to an amplifier, adjusting the amount of sync voltage to the sawtooth generator grid. A free-running sawtooth generator, whatever the type, tends to be unstable, varying somewhat above and below the intended frequency. Since exact timing is required for pattern stability, a synchronizing or timing pulse is applied to the input of the sweep oscillator, this sync pulse setting off or timing each cycle generated.

The SYNC SIGNAL SELECTOR is, as its name implies, a selector of three different types of synchronizing signals to be fed to the

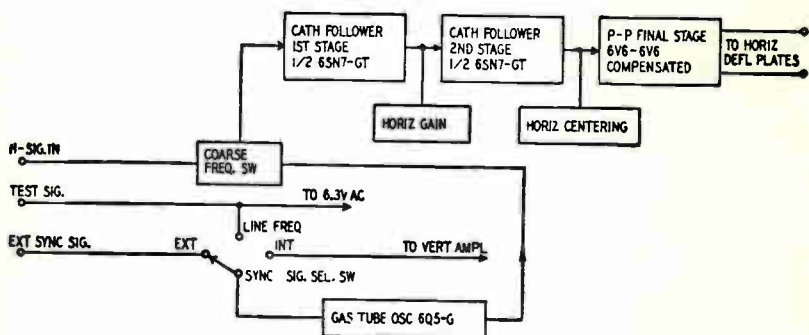

Fig. 406. Block diagram of horizontal amplifier and sync signal selector.

sweep oscillator—INTERNAL, taken from the input signal in the vertical amplifier system; EXTERNAL, which may be any waveshape or pulse from an outside source, and connected through a binding post; or LINE. The latter is a 60-cycle source, being therefore usable in limited cases, at 60 cycles and some of its multiples. However, because of the very high frequency accuracy of the commercial 60-cycle supply, it finds use in such applications as checking the vertical oscillator frequency in television receivers, or, through the use of Lissajous figures, of multiples or submultiples of 60 cycles.

The power supply

The power-supply system of the 208B (Fig. 407) is rather elaborate, more so than in most scopes. In addition to supplying the B+ voltages for the amplifiers and the high potentials for the cathode-ray tube, this supply has automatic voltage regulation for

the more critical circuits. In addition, there is a negative supply for use in the returns of the direct-coupled stages, and in the cathode returns of the push-pull stages, for proper functioning of the centering controls.

The main B+ supply starts off as a conventional full-wave rectifier, V16 followed by a 2-section filter, consisting of C7, C8, C9, L5 and L6. The well-filtered B+ 280-volt output is used for the push-pull horizontal and vertical amplifiers, the sweep generator, and the intensifier anode of the 5LP1 cathode-ray tube. The preamplifier and cathode follower stages are fed from this power supply, but after a voltage-regulating system.

As seen in the diagram, V13, a type 6V6 tube, is triode-connected (plate and screen tied together), with the plate going to the unregulated B+ 280 supply, while the cathode acts as the output, or regulated voltage, supplying 155 volts to the cathode followers, preamplifiers, and the push-pull stage return circuits. The 6V6, being connected in series with the power-supply output, is often called a pass or control tube, since it passes a controlled voltage to the circuits. The control grid of this pass tube is connected to the plate of a 6SJ7 d.c. amplifier, V14. Potentiometer R16 is part of a voltage divider across the B+ output, and connects to the grid of the 6SJ7. The cathode of the 6SJ7 is always kept at a fixed potential, due to the neon tube regulator, V12. Should the B+ output rise, perhaps due to line-voltage increase, the grid voltage of the 6SJ7 also would rise, making the tube draw more plate current, and its plate voltage would become less positive, since the increased plate current causes a higher IR drop across the plate resistor, R14. Since this plate connects to the grid of the pass tube, the grid would become more negative (with respect to its own cathode) than before, increasing the plate resistance and lowering the output voltage. Conversely, for a decrease in the B+ output, the reverse would be true. The 6SJ7 grid would be more negative, plate current would decrease, and the plate voltage, which is the 6V6 grid bias, would become more positive. The pass-tube resistance would decrease, allowing a higher voltage to pass. The grid-bias potentiometer is so adjusted that with normal line voltage and load current the voltage drop across the pass tube is just correct to make the regulated output voltage +155 volts.

In this discussion, the terms "more positive" and "less negative" have been used interchangeably. This may bear a short ex-

planation. While both the grid and cathode of a tube may be positive, the grid may still be negative with respect to its own cathode. Consider the 6SJ7 in this circuit, for example. Both the grid and cathode are positive with respect to ground. However, the cathode is kept at a fixed value of +55 volts (held constant by the regulating action of the neon bulb which acts like a VR tube), thus maintaining a constant voltage drop in spite of the variation of the current in the cathode circuit. The grid potential, on the

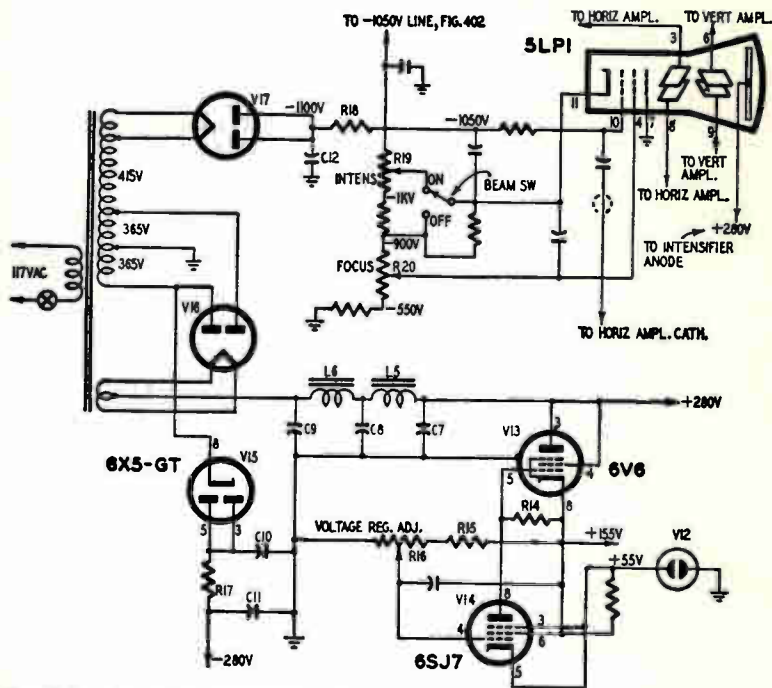

Fig. 407. Low- and high-voltage power supplies used in the Du Mont scope.

other hand, is variable by means of the voltage regulator adjustment, R16. This potentiometer, in series with a fixed 0.5-megohm resistor, R15, is across the regulated output (+155 volts), acting as a voltage divider with a maximum of 77.5 volts across the potentiometer. Thus, it is always possible to adjust the grid bias to a value anywhere between zero and 77.5 volts. Since the cathode of V14 is always at +55 volts, the grid may be positive to ground, yet be negative by as much as 22.5 volts with respect to the cathode. The same reasoning, except for numerical values, is true for the 6V6 pass tube.

Negative low-voltage supply

There actually are two negative power supplies in the 208B, as shown in Fig. 407. One of these is the very high voltage system for the cathode-ray tube, the other is the return, or bias system for the preamplifiers and cathode followers. In the latter power supply half-wave rectification is used since the current drain is small. The rectifier tube is a 6X5-GT (V15), with the plates paralleled, and the input, one-half of the transformer secondary, going to the cathode. As a result the tube conducts only when the cathode is made negative. An r-c filter is used, consisting of C10, C11 and R17. The -280-volts output connects to the return circuits of the push-pull grids in both the horizontal and vertical amplifiers, as well as to the first amplifier in both channels. This method of voltage distribution and grid returns makes possible the instantaneous positioning of the beam described earlier, since this system enables the grids of the first of the push-pull tubes to vary both above and below ground, and at the same time maintains correct bias for the tubes.

Negative high-voltage supply

This section of the power-supply system feeds the cathode-ray tube with a maximum potential of about 1,350 volts. Essentially, this is a half-wave rectifier system connected series-aiding with the low voltage B+ of about 280 volts. One half of the low-voltage secondary, approximately 365 volts, is in series with an additional 415-volt winding on the transformer. The filament winding of the high-voltage rectifier, V17 is connected to the far end of the 415-volt winding. The total secondary voltage is therefore 780 volts r.m.s. However, since this supply has to deliver a very small current (less than 1 milliampere), the filtered d.c. output is approximately the peak value of the applied r.m.s. Multiplying 780×1.41 gives approximately 1,100 volts, which is the value prior to connecting this in series with the main B+ supply.

The control grid of the cathode-ray tube, pin 10, goes to the most negative point in the whole system, -1,050 volts, immediately after the 50,000-ohm resistor, R18, which acts with C12 as a simple r-c filter network. The cathode, through switch SW and the slider of intensity potentiometer R19, goes to a less negative point, being adjustable to any value between -1,050 and -1,000 volts, giving a 50-volt bias for the cathode-ray tube. In addition, with the switch in the BEAM OFF position, the cathode voltage rises to -900 volts, biasing the cathode-ray tube beyond cutoff

with -150 volts. The cathode of any tube is the correct *zero level* to which all other element voltages are referred.

The first, or focusing anode, pin 4, connects through the slider of the focusing potentiometer R20, to a potential of between -900 and -550 volts. Since the cathode is at approximately -1,025 volts (with the slider in mid-position), the focusing anode will vary between 125 and 475 volts positive, with respect to the cathode. The second, or accelerating anode, pin 7, connects to ground. Unusual as this may seem at first, it is nevertheless quite logical, since the cathode is about 1,025 volts below ground, making the second anode positive by the same amount.

Deflection sensitivity

In the 5LP1 there is an additional element, the intensifier anode. This element, in the shape of a ring on the glass just behind the screen, has the highest positive potential applied to it through a tube-cap type of connector. This element serves to intensify the trace on the screen by accelerating the beam after it has passed between the deflection plates. The major advantage of this method is the greater deflection sensitivity, with undiminished brightness. The result is that a smaller signal voltage is adequate for full deflection on the screen.

The deflection of the electron beam is a result of two forces, the forward motion due to the accelerating potential and the side-wise motion due to the deflecting potential. Since the deflecting force may be considered as tending to push the beam "off course," the faster the beam moves forward the more difficult it is to deflect it, hence more force is required for the same amount of deflection. Conversely, the slower the forward motion, as when the accelerating potential is decreased, the less force will be needed for a given amount of deflection. Since any acceleration of the beam forward of the deflection plates no longer affects the deflection sensitivity, a system of lowered acceleration before deflection with increased pull beyond the deflection plates will accomplish the the desired effect. The intensifier anode type of tube makes this possible.

Deflection sensitivity, expressed in volts per kilovolt per inch, is the number of volts applied to the deflecting plates, for every 1,000 volts on the second anode, to move the beam one inch on the screen. The lower this voltage, the higher the sensitivity.

This in turn means that the signal amplifiers may have lower gain for the same size tube, or, preferably, that a smaller available sig-

nal at the input to the amplifier will be adequate. In modern high-gain scopes, a vertical deflection sensitivity of as little as 10 millivolts per inch is not unusual.

As shown in Fig. 407, the second anode is grounded. Its potential in this circuit, however, is roughly 1,025 volts positive with respect to the cathode of the scope tube. The vertical and horizontal plates are only slightly above this potential since they connect to the plates of the push-pull amplifiers, which are only about 75 volts above ground. The intensifier anode connects to B+280, making it almost 1,350 volts above the highly negative cathode. This produces the added acceleration for high-beam intensity.

The vertical and horizontal deflection plates are included in the voltage distribution system. In addition to serving as signal plates, they also center the beam. And while the centering potential across a pair of plates need not be very high, often as low as 50 volts, their potential to ground must be as high as that of the second anode, if the beam passing between these plates is not to slow down, or be prevented from reaching the screen.

Looking at Fig. 408, the plates of the push-pull amplifiers (vertical and horizontal) are connected through a high-resistance network to the -1,050-volt point on the negative high-voltage system. With no input signal, these plates are at a potential of +85 volts, giving a total of 1,050 +85, or 1,135 volts across a total resistance of 10.75 megohms. Since the deflection plates are tapped on this resistor network at a point 750,000 ohms from the plates of the push-pull amplifiers, the potential to ground of both the horizontal and vertical deflection plates is approximately zero or ground potential, the same as that of the second anode. In some popular scopes, the deflection plates are actually at ground, one of each pair being connected to chassis, while the other can vary above and below ground to effect centering. In the 208B the deflection plates receive their signals from the plates of the output amplifiers. Since the latter are obviously above ground, the deflection plates, too, must be above ground. The high-resistance network of two 5-megohm resistors in series with a 750,000-ohm resistor, accomplishes both purposes—the deflection plates are properly coupled to their respective amplifiers, at the same time having the correct d.c. potentials with respect to the cathode of the cathode-ray tube.

Operating controls

The operating controls of the 208B are similar to those of other scopes, hence this will also serve as a set of general operating instructions.

POWER, ON. This is the main power switch. The only point to be made about this control is that it should be switched on a few minutes before actual use, to allow the instrument to reach a stable operating temperature.

BEAM ON. This is a stand-by switch. During a test, whether trouble-shooting a TV receiver, measuring frequency response, or any other work requiring a scope, it is usually necessary to

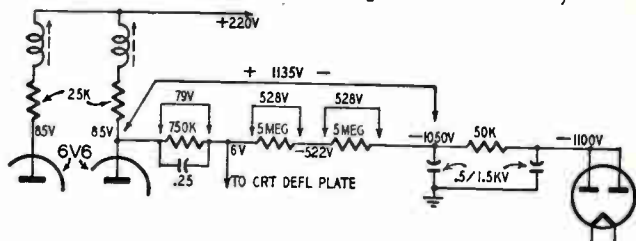

Fig. 408. Voltage-distribution system for vertical and horizontal amplifiers in Du Mont scope.

perform various steps other than with the actual use of the instrument. While doing such things as replacement of parts, soldering, etc., it is desirable to keep the scope warmed up and ready for use. However, leaving stationary patterns, especially points, on the screen for prolonged periods of time, unduly wears or burns the fluorescent coating. With the BEAM SWITCH in the OFF position, the beam on the screen is extinguished, while the instrument is still kept in "ready-to-operate" condition. Referring to Fig. 407 it can be seen that the BEAM SWITCH (SW) in the ON position connects the cathode of the cathode-ray tube to the slider of the INTENSITY CONTROL, R19. In this position, the trace is adjustable to the required brightness. Without disturbing this adjustment, the trace can be extinguished by throwing the switch downward. This connects the cathode to the -900 volt point on the high-voltage supply, making the grid negative with respect to the cathode by 150 volts (1,050 - 900). This bias is more than enough to cut off the cathode-ray tube, extinguishing the beam. When the pattern is to be viewed again, the switch is put back in the BEAM ON position, and the trace reappears at the same intensity as previously adjusted.

INTENSITY. This is simply a grid-bias adjustment, like the

brightness control in a television receiver. The intensity potentiometer, (see Fig. 407) varies the cathode potential of the c-r tube from $-1,050$ to $-1,000$ volts, while the grid is kept fixed at $-1,050$ volts. The grid bias variation in this case is from practically zero to -50 volts, which is more than adequate for cutoff.

FOCUS. This is controlled by a potentiometer (R20) which varies the positive potential on the first or focusing anode, allowing the beam to converge in a fine spot on the screen.

H-POSITION. This is adjusted by a horizontal centering control, R13. (Refer to Fig. 405.) It provides instantaneous centering of the spot, or displacement of it, left or right, by simultaneously making one deflection plate more positive and the other plate more negative. Its function is not only to center the beam, but, as may be convenient, to move the trace to any desired position, other than the middle, across the cathode-ray tube.

V-POSITION. The vertical centering control, R6 (see Fig. 402) functions exactly in the same manner as the H-POSITION, except that it moves the beam upward or downward.

A few words of explanation of the names of the last two controls are in order. Many scopes use the terms HORIZONTAL CENTERING and VERTICAL CENTERING. However, the terms X and Y are also quite common and logical, if one thinks of the cathode-ray screen as a graph, which it really is. On such a graph, the horizontal line or scale across the screen is called the "X-axis," while the vertical line or height scale is known as the "Y-axis."

H-GAIN. This control (R12 in Fig. 405) is the usual gain control found in the circuit of an amplifier. It is used to vary the width or spread of the trace on the screen. It is located in the second stage (V9) of the horizontal amplifier and will vary the input signal from either the local sweep generator, or from any source applied to the H-signal input terminal.

V-GAIN. The function of this control (R3 in Fig. 402) is to vary the height of the trace. It operates exactly as the H-GAIN control.

V-SIGNAL ATTENUATOR and 25-v or 250-v SWITCH. In addition to gradual variation of the signal with the V-GAIN control, this switch is used to adjust the input circuit to the vertical amplifier for either a small or large test-signal source. In the INPUT UNDER 25V R.M.S. the signal is applied directly to first stage. The ultimate sensitivity of the vertical amplifier is now at a maximum. When a comparatively large signal is being observed, the switch is

thrown to the INPUT UNDER 250 v R.M.S. This cuts in a compensated series-shunt attenuator, reducing the signal about ninety percent. In operation, the high-gain position should be used only when the 250-v position results in too small a trace on the screen. (See Fig. 402.)

COARSE FREQUENCY. This bandswitch as shown in Fig. 405 is in the discharge circuit of the gas-triode sawtooth generator, switching in different capacitances for different frequency ranges. For any one position of this switch, the sawtooth frequency may be varied, using the FINE FREQUENCY control (R11), over specified limits. If, for example, the COARSE switch is in the 8-40 position, the FINE control is adjustable to any frequency between 8 and 40 cycles.

FINE FREQUENCY. This potentiometer, R11, is in series with the B+ supply to the sawtooth-generator plate. (See Fig. 405.) Varying this potentiometer will change the time-constant of the charging circuit and consequently will change the frequency. The charging capacitor in series with R11 is across the +280-volt B-supply. Actually, the cathode of the gas tube, which is the low side of the sawtooth capacitor is not physically at B- or ground potential. However, the cathode bypass capacitor of V7 is so large (50 μ f), that the cathode potential is absolutely constant. This means that the sawtooth capacitor will always discharge to this constant value, and the cathode r-c network is not effectively involved in the charge-discharge cycle. The highest voltage across the sawtooth capacitor is also fixed (sawtooth maximum), since the gas-tube ionization potential is also practically constant, and the charging cycle always stops (capacitor discharge) when ionization potential is reached. This leaves but two factors affecting the sawtooth frequency. The first of these is the size of the sawtooth capacitor. Since the maximum voltage across the capacitor is constant, the time required to reach this voltage will depend on the size of the capacitor—the larger the capacitance, the more electrons are required to build up the same voltage, the more time per cycle, hence a lower frequency. The other factor is the series-charging resistance. After choosing a particular size of capacitor, the time can be increased or decreased (the frequency lowered or raised) by varying the series resistance, with an increased resistance lowering the frequency. On the schematic diagram of the sweep oscillator, Fig. 405, the arrow on the FINE FREQUENCY control (R11) requires clockwise rotation for de-

creased frequency. It also moves in the direction of increased resistance. Also, the values of the sawtooth capacitors are such that a 1.0- μf capacitor is used for the lowest frequency range (2 cycles and lower), while capacitors in the higher frequency positions of the range switch are progressively smaller. At the highest (50 kc) frequency position, the capacitance of the smallest capacitor in use is only 0.00007 μf .

SYNC SIGNAL SELECTOR. This switch shown in Fig. 405 allows three different types of synchronizing signals to be applied to the sawtooth generator. In the **EXT** position, the switch connects to the panel binding post marked **EXTERNAL SYNC SIGNAL**. The synchronizing pulse is fed through a coupling capacitor and potentiometer R9 to the sawtooth-generator grid. The second position, **LINE FREQ**, uses 60-cycle a.c. for synchronization. This voltage is obtained through an isolating resistor from the 6.3-volt heater system of the scope. The isolating resistor safeguards against overloading or shorting of the heater voltage without affecting the open-circuit voltage required for sync purposes. The third position marked **INT** takes the sync voltage from the signal applied to the vertical-amplifier system. This switch position connects to the output of the vertical amplifier, V4. Incidentally, this is the most common method of synchronization, the test signal itself providing the locking pulse for the sweep. Regardless of the position of the sync selector switch, potentiometer R9 is always in the circuit.

SYNC SIGNAL AMPLITUDE. This is a very important control (R9 in Fig. 405) and its proper adjustment is essential for correct operation. Its function is to vary the magnitude of the sync pulse fed to the sweep generator. Since the sync pulse is intended to correctly time the sweep frequency, it is apparent that the closer the generator frequency is to the exact frequency desired, the less correction is needed, hence a smaller sync pulse will be required. If the **FINE FREQUENCY** is misadjusted, it may still be possible to stop the motion of the trace on the screen by adding a larger sync pulse. This, however, leads to possible distortion of the pattern, accompanied by a reduction of width on the screen. While the latter fault may apparently be corrected by increasing the horizontal gain, signal distortion may still remain, hence this method should be avoided. Use the smallest sync signal possible.

TEST SIGNAL. Although not an operating control, this terminal serves a very useful purpose in the calibration and operation of

the oscilloscope. As can be seen from Fig. 405, this binding post connects, through a 10,000-ohm resistor, to the 6.3-volt heater supply. This voltage may be used as a quick check on the operation of the horizontal or vertical amplifier, by connecting a lead from TEST-SIGNAL post to the amplifier input (high side). In the case of the vertical amplifier, a vertical deflection on the screen is an indication that the amplifier is functioning. In the case of the horizontal amplifier, two different tests are possible. If, in connecting the test signal to the H-SIGNAL INPUT, with the COARSE FREQUENCY in the OFF position, a deflection is obtained across the screen, then the horizontal amplifier is operating. If, after this, the COARSE FREQUENCY control is set to any other position, and no horizontal deflection is obtained, the sweep oscillator is at fault. If no deflection is obtained in either case, it is most likely that the horizontal amplifier is inoperative.

Some other applications of the TEST SIGNAL are: Horizontal sweeping at 60 cycles, calibrating or determining unknown frequencies in multiples or submultiples of 60 cycles, and calibrating the vertical amplifier for peak-to-peak voltage measurements.

D1, D2, D3, D4, GND. This is a terminal board on the rear of the oscilloscope. There are, in addition to the GND terminal, four pairs of screw terminals, each pair normally connected by a jumper. The terminals connect directly to the horizontal and vertical deflection plates of the cathode-ray tube. These connections are intended for feeding a test signal directly to the cathode-ray tube without the use of the deflection amplifiers. Although the horizontal and vertical amplifiers are frequency-compensated, their bandpass is nevertheless limited. In some applications, even the wide-band response of the vertical amplifier is inadequate. In such cases, and if the signal voltage amplitude is high enough, direct connection to the deflection plates is used.

RCA WO-56A

The Du Mont 208B is an excellent example of high quality and performance. It is a general purpose instrument, and was designed some time ago. The RCA scope is of more recent date and is primarily a television service instrument. Having discussed the principles of operation of the individual circuits of the Du Mont scope, it will be unnecessary to repeat these. Instead, the major characteristics and differences in methods of achieving the various functions will be outlined.

Horizontal and vertical amplifiers

All stages of both the horizontal and vertical amplifiers are connected in push-pull. The first stage in the vertical and in the horizontal amplifier uses miniature high-gain pentodes. Since the tubes are connected in push-pull, the shunting capacitances are effectively in series, reducing the net capacitances of the input and output circuits to approximately half, or roughly about 2.5 μf each. Incidentally, the pentode stages are responsible for converting the single-ended input circuit to push-pull. In the vertical amplifier (the horizontal operates in identical manner), the input signal is fed to the control grid through a calibrated input attenuator.

The second and third vertical and horizontal amplifier stages are triodes, having substantially lower input and output capacitances than the first stage (only about 1.5 μf each). Here again, the individual tube capacitances are in series, resulting in an extremely low shunting effect across the signal circuit. However, since triodes have relatively large plate-to-grid capacitances, precautions must be taken to avoid undesirable feedback. Neutralizing capacitors are connected from each plate to the opposite grid, for balancing out the feedback capacitances.

The use of low-capacitance tubes in push-pull obviates the necessity for high-frequency peaking, as was used in the Du Mont scope, since the primary purpose of peaking coils and circuits was to compensate for excessive shunting, at the high frequencies, by the tube input and output capacitances.

The second major difference in the amplifiers is the omission of low-frequency r-c compensation. This is made possible by direct coupling throughout the system. Direct coupling is superior to low-frequency compensation, since the former makes possible a linear response close to zero cycles. Starting with the first vertical amplifier (the same holds true in the horizontal system), direct coupling is used through each succeeding stage, up to and including the deflection plates of the cathode-ray tube, a type 7JP1. The voltage system of this instrument is such that all tubes are properly biased with respect to their own cathodes. Thus, as shown in Fig. 409, V1 and V2 push-pull vertical amplifier cathodes are at +1.5 volts, while their grids are at zero (ground) potential, resulting in a grid bias of -1.5 volts. V3 (dual triode, second push-pull vertical amplifier) has a grid potential of +47 volts, the same as the plates of V1 and V2. However, since the cathodes

are returned to +48 volts, the grids are effectively biased at -1 volt. Similarly, the grids of V4 (push-pull vertical output), connected to the plates of V3, are at +98 volts. But, since the cathodes are operated at +104 volts, the grids are automatically biased by -6 volts. This system requires that a series power supply be used for all tubes.

A third difference between the two scopes is the gain-control arrangement. In the RCA scope, the gain control, in both the horizontal and the vertical amplifiers, consists of a bias adjustment in the cathode circuit of the pentode stage. Increasing the bias reduces the transconductance of the tube and lowers the gain.

The input attenuators are another feature worth mentioning. Both the vertical and horizontal attenuators have four steps, or

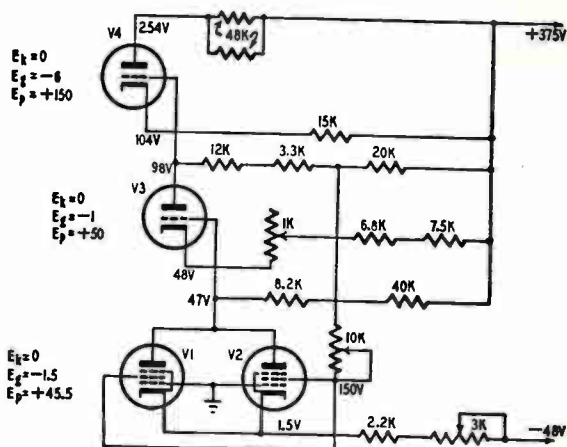

Fig. 409. Voltage-distribution system in RCA scope. V3 and V4 are simplified versions of push-pull stages.

ranges, with a total attenuation of 1,000 times, in steps of ten times each. Both the V-GAIN and H-GAIN controls are dual types, the center knob being the gain-control potentiometer, while the outer knob operates a switch in the attenuator circuit. The first position has no attenuation in series with the input signal. The next position attenuates the signal 10:1. The third position further attenuates the signal 10 times, for a total of 100:1. Finally, the last position attenuates an additional 10 times, for a total attenuation of 1,000:1. This system has the desirable characteristic of enabling numerical comparisons of input signal amplitudes, stage gain estimates, etc.

In addition to these major features, both horizontal and vertical amplifiers incorporate balance adjustments. Although these

are not operating controls, the adjustments are used, when required, to prevent interaction between gain and centering settings. The centering controls are located in the input to the first triode stage. These controls adjust the relative cathode return of each triode, so that the d.c. (no signal) deflection voltage is just right for centering the beam. However, since the two triodes may not have identical dynamic characteristics, a deflection due to a signal may at the same time cause a shifting of the initial position of the spot. This amounts to a shift in the zero line on the screen. The balance adjustments are intended to correct this by slightly varying the signal input to each triode. However, once adjusted, these settings need not be changed over long periods of time.

Sweep generator system

The time-base generator of the RCA WO-56A scope (unlike the Du Mont 208B) utilizes a dual-triode vacuum tube in a cathode-coupled multivibrator. This avoids some of the inherent weaknesses of the gas-tube sawtooth generator, and provides more stable operation, excellent linearity, and fast retrace time at the higher sweep frequencies. The COARSE and FINE FREQUENCY control circuits, although somewhat different in structure, perform the same basic functions as in any other oscilloscope. Dual controls are employed, switching both the discharge and time-constant capacitors; there is a twin potentiometer for FINE FREQUENCY control, one in the time-constant (grid) circuit, the other in the plate circuit.

A somewhat unusual and very convenient feature of this sweep system is the TV-H-V switching positions. Since this scope is primarily intended for television servicing, two fixed sweep frequencies have been provided. The TV-H position provides a sweep frequency of 7,875 kc, this being exactly half the horizontal sweep frequency in television receivers. Since it is most convenient to view two cycles of the waveshape being studied, the 7,875 sweep frequency in the scope will display two horizontal lines on the cathode-ray tube. In the TV-V position, two fields will be shown, since the vertical television frequency is 60 cycles, while the fixed scope sweep is now at 30 cycles. In trouble-shooting, quick change from vertical to horizontal viewing is very desirable, especially if the FINE-FREQUENCY control on the scope does not have to be readjusted. Furthermore, these two fixed frequencies are quite accurately preset, whereas the vernier dial on the scope, at best,

is only approximate, requiring searching to stop the trace on the screen.

Phasing control

In sweep-generator alignment, as used for television r.f., i.f., and video circuits, a 60-cycle sweep source properly phased with respect to the generator repetition rate is required. Some sweep generators actually supply the horizontal deflection voltage and phasing control for the scope. Other generators do not have this convenience. In the WO-56A scope, one of the heater windings, in conjunction with a phasing control circuit, provides properly phased sweep for displaying a single response curve of the television circuit being aligned.

The remaining features of the RCA scope are quite conventional. The discussion of the Du Mont scope earlier in the chapter adequately covers all these details.

While there are many different makes of oscilloscopes for the service technician to select from, few, if any, have any radical differences from the two types we have discussed. Of course, the specific operating instructions with any instrument help save time and aid in the most efficient use of the instrument. Nevertheless, the understanding of the basic functions and purposes of the oscilloscope and its component circuits is a prime requisite for efficient use of any scope, regardless of make or its accompanying specific operating instructions.

Chapter

5

Alignment

UNTIL the advent of television, visual alignment of tuned circuits was almost unknown to the service technician. Broadcast and short-wave receivers, even so-called *high-fidelity* types, concerned themselves little with r.f. or i.f. bandwidth response, although bandpass receivers were to be found here and there. Their claim to high fidelity was based mainly on improved audio channels, increased audio power output, complex speakers, etc. There was no great need for visual alignment, since the i.f. response was generally limited to ± 5 kc. Peak alignment, often by ear, sometimes with an output meter, was the usual procedure.

But even before FM broadcasts began, a few manufacturers saw the need for an i.f. system better than the conventional peaked type, and designed their receivers accordingly. Some incorporated a third tuned circuit in the i.f. coils—a tertiary winding, whose function it was to provide *flat-topping* of the response curve for better fidelity. Others used loading resistors across the tuned circuits for flattening the i.f. peaks. But even in these cases the bandwidth was so narrow that ordinary peak alignment was a fair substitute.

FM broadcast reception, with an extension of the modulation frequencies to 15,000 cycles, and the i.f. bandwidth to ± 75 kc, made aural and output meter alignment useless. Moreover, TV receivers, having r.f. bandwidths up to 6 mc (600 times as wide as the broadcast i.f. of 10 kc), and having a number of critical points on the i.f. response curve, in addition to the required band-

pass and shape, brought about the general use of the sweep generator and the scope for visual alignment. These instruments can also be conveniently used for alignment of the relatively narrow-band broadcast receivers, with a net gain in performance and with little added expenditure of time and effort.

Meaning of bandpass

When a modulated signal is transmitted, it contains, in addition to the carrier, a number of sideband frequencies above and below the carrier. Thus, a station transmitting on 740 kc, modulating with an audio range of up to 5 kc, transmits a band of frequencies from 735 to 745 kc. Since the band of frequencies alongside

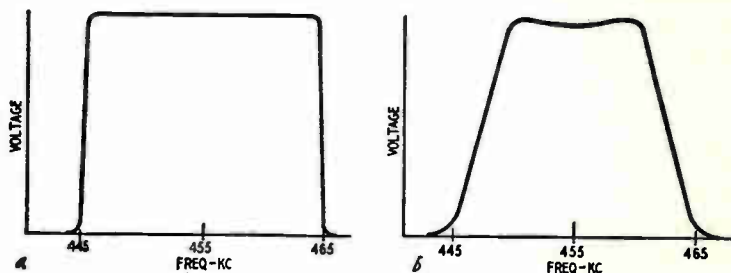

Fig. 501-a, -b. Ideal form (left) and usual form (right) of 20 kc bandpass.

the carrier (the sidebands) contains the audio modulation, faithful sideband reproduction is necessary. In FM and TV, these sidebands are similar to the example given, except for the width. FM and TV sidebands extend much further than in the case of ordinary AM signals. In all cases, however, for undistorted output, it is desirable to have the receiver respond evenly to all the transmitted frequencies. It is the function of bandpass circuits to ensure such even response.

A bandpass circuit, as its name implies, should pass, without discrimination, all the frequencies within the limits of the band. Theoretically, this would require a response curve such as shown in Fig. 501-a. The band is 20 kc wide and is flat-topped. Actually, such response curves are difficult to produce, and are seldom used in tuned r.f. circuits. Instead, the usual tuned-circuit response curves are designed to give as flat a response as practicable. Such a practical curve is shown in Fig. 501-b. Notice that the response is never actually flat, but the change in amplitude from one frequency to the next is rather small.

The arbitrary standard of bandwidth is the width of the curve

at the half-power points, or more commonly referred to as the 70% points—those points on the response curve, on the opposite sides of the peak, which have approximately 70% ($1/\sqrt{2}$, to be exact) of the center frequency amplitude, assuming a symmetrical response curve. The half-power points are so called, because they would be at half the amplitude of the center, or maximum component, on a mathematically squared curve. This curve is obtained by taking the amplitudes of the various component frequencies of the original curve, squaring them, and plotting a new curve. On the latter curve, the amplitude of the center frequency is taken as *unity*, or 1, and all others are related to it. Since the square values of the voltages were used, this curve is called a *power curve*. In alignment, whether r.f., i.f., or video circuits, the response curve is shaped so that these points are of the correct frequency and amplitude, while the frequencies between these points and the carrier are allowed to have somewhat higher amplitudes.

It is now obvious that if the response rises sharply from the half-power point to the center frequency, excessive variation will result, and fidelity will be reduced. Visual alignment of these circuits is the most practical way to obtain proper adjustment for best response. Since in visual alignment we wish to observe a band of frequencies, not just a single frequency peak, a new type of signal generator is required—one that will, as far as the scope and the eye can detect, generate all frequencies simultaneously—a sweep-frequency generator.

Alignment of peak-tuned i.f. system

This type of i.f. circuit is found in most broadcast receivers, from simple portables and a.c.-d.c. types to most of the large console radio-phonograph combinations, with the possible exception of some so-called high fidelity receivers, which often employ bandpass type circuits. Although sweep-generator alignment of these ordinary receivers is not impossible, good alignment can be obtained without the sweep generator, using an audio-modulated (400 cycles) signal generator and the oscilloscope. The technique is based on aligning for maximum audio amplitude on the scope with the scope connected to the output of the detector or to an audio stage.

The detailed procedure for alignment of a peak-tuned i.f. system is as follows:

1. Allow receiver, scope, and signal generator to warm up for at least 10 minutes.
2. Disconnect the antenna and connect output of the signal generator to the input of the mixer tube (between mixer signal grid and ground).
3. Disable the receiver oscillator, by grounding the stator of the oscillator tuning capacitor. If the oscillator tube is separate from the mixer, and the heaters are not in series, as in a.c.-d.c. sets, remove the oscillator tube from its socket.
4. Short-circuit the a.v.c. voltage by grounding the a.v.c. bus.
5. Connect the VERTICAL INPUT terminals of the scope across the detector load resistor. See Fig. 502 for typical setup.
6. Set signal generator to the receiver i.f. (usually 456 kc in

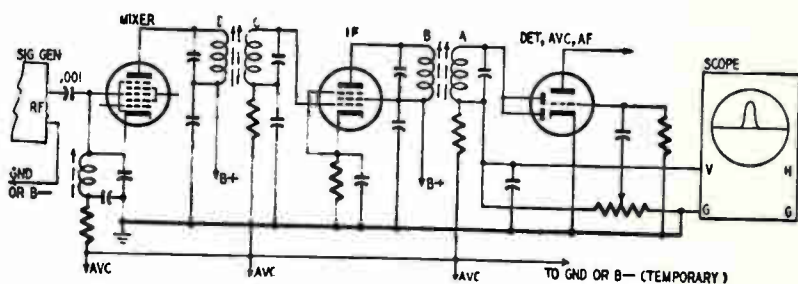

Fig. 502. Connections to scope for alignment of peak-tuned i.f.

7. Adjust scope controls for proper pattern display. Since 400-cycle audio is to be observed, the sweep should be set to approximately 130 cycles, to view three cycles. The INTENSITY, FOCUS, H-GAIN and V-GAIN are adjusted for normal operation. The FINE frequency control and the SYNC AMPLITUDE are now set to obtain a clear, locked pattern on the screen, using a *minimum* of sync voltage.
8. Align trimmers or slugs in the order shown in Fig. 502 (A, B, C, D) for maximum amplitude on the screen.
9. Remove oscillator and a.v.c. shorts from the receiver. The i.f. alignment is now complete.

This type of alignment permits you to see the output waveform, an obvious advantage. If you are not interested in the waveform shape but just want to align for maximum output, set the scope for a straight, vertical line pattern. Rotate the frequency controls, (COARSE and FINE) and the HORIZONTAL GAIN counterclockwise to zero. Set SYNC control to EXT. Adjust INTENSITY and

focus until you get a sharp dot on screen. Connect generator and scope in the manner described earlier. Disable receiver a.v.c. and oscillator. Adjust generator gain control until you get a small vertical line on scope screen. Align A, B, C, D, until you have maximum vertical line on screen. Be sure signal generator is not overloading the receiver. Feed in signal until pattern on scope shows definite signs of overloading, then back off generator output until overloading disappears.

In most a.c.-d.c. receivers, direct connection of the signal generator to the set may result in undue hum. In such cases, a series capacitor (.001- μ f or larger) should be connected in series with the high side of the signal generator, while the low side is connected to the B- of the set, instead of the chassis. A slight hum is not objectionable, particularly when a scope is used. It would be objectionable by ear, or even with an output meter.

Band-pass or broad-band alignment

In this category fall some of the highest-priced console AM receivers and all FM sets. The procedure here is more elaborate and exacting, although not more difficult. Alignment is very much the same in broad-band AM and FM sets, except for the difference in the connections to the receiver. Considering the AM set first, and assuming the usual two stages of i.f.:

1. Allow equipment to warm up and stabilize.
2. Short the antenna circuit, and disable the oscillator and a.v.c. circuits.
3. Connect the VERTICAL INPUT of the scope across the detector load resistor (volume control), terminals V and G in Fig. 503.
4. Set scope controls for proper pattern display, as explained earlier.
5. Set scope sweep control to EXT, and connect a 60-cycle sweep voltage from the generator to the H-INPUT terminals. Since almost all sweep generators on the market today use a 60-cycle sine-wave sweep, the sawtooth sweep of the oscilloscope is not suitable.
6. Connect the sweep generator to the input of the mixer or converter stage. Set the i.f. of the generator to the center or nominal i.f. of the receiver being aligned. Set the sweep width to about 30 kc.
7. Align the last i.f. circuit first, working back to the mixer output circuit. In each case, an attempt should be made to

obtain a curve as much like a square wave as possible. The sides, although not actually vertical, should be as symmetrical as possible, with the top as flat as you can get it.

Many sweep generators have a built-in horizontal deflection, or sweep voltage for the scope. In such a case, this voltage is connected to the H-INPUT terminals of the scope. Some scopes have self-contained 60-cycle sine-wave sweep, with phasing control. In this case, no external connections are required.

While this procedure is correct to follow as a general rule, it must be remembered that specific instructions for individual receivers always yield best results. In a receiver in which the bandpass response is obtained by loading the i.f. primaries and secondaries with resistors, (thus reducing the Q of the coils and widening the response), the alignment outlined here is quite satisfactory as long as symmetrical response is obtained. In other sets, tertiary

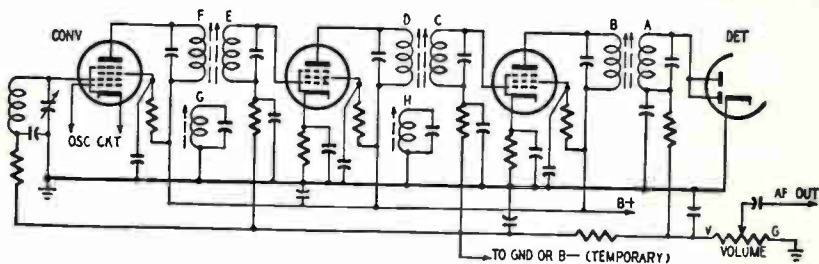

Fig. 503. Representative i.f. system in better grade AM and FM receivers.

windings (as shown in Fig. 503) are used to obtain the required bandpass. A slightly different alignment procedure is called for, since both bandwidth and symmetry are determined by the setting of the tuned circuits. Follow the procedure previously outlined above (except step 7) for the resistor-loaded circuit, and then continue as follows:

7. Align the secondary and primary, in this order, of the last i.f., for maximum output.
8. Reduce the signal generator output and proceed to align the next-to-the-last i.f. in the same manner. Continue up to the mixer output (first i.f. transformer). The sequence is marked A, B, C, D, E, F, on Fig. 503.
9. Without resetting the signal generator, tune the tertiary windings, G and H, in that order, for maximum bandpass or flatness, consistent with symmetry.

In well-designed commercial circuits of this type, the position of the tertiary winding is such that the coupling is just right for

flat-topping. Thus, when tuning the tertiary closer to the i.f. center, the peak of the response curve will be lowered and the response will widen. Too close coupling will produce a dip in the center of the response curve. Obviously, this is undesirable, and should be avoided.

So far we have discussed visual alignment in those cases where the scope is either helpful (as in the case of ordinary peak-tuned i.f. circuits of a.c.-d.c. sets), or fairly essential (as in the case of bandpass AM console receivers). The visual scope method in these cases is a time-saver where the best obtainable results are desired. However, alignment without the scope would not have been impossible.

The most common examples requiring alignment with the sweep generator and the scope are: FM discriminators, FM i.f. channels, video r.f. channels, video i.f. channels, and video i.f. traps. Distortion, oscillation, sideband cutting, and poor picture quality in the case of TV receivers are almost certain to result from attempts to align by ear or output meter only.

The FM discriminator

The discriminator is an audio detector performing in an FM receiver the same function as the second detector in the AM set. Both AM and FM systems produce sideband frequencies as a result of modulation. In AM, these sidebands extend on each side of the carrier by a span equal to the span of the original audio-modulating frequencies. In FM, the audio range extends up to 15,000 cycles. The sidebands would seem to be ± 15 kc, resulting in a total bandwidth of 30 kc. However, this is not quite the case. In the AM system, variation in audio amplitude (loudness) produces corresponding variations in sideband amplitudes, without producing any changes in the sideband frequencies. This is implied in the term AM—amplitude variation in the r.f. sidebands due to amplitude variations in the original audio. By contrast, in FM, variation in audio amplitude, or loudness, produces variations in r.f. sideband width, resulting in multiples of sidebands. Thus, a 600-cycle audio note may produce a number of lower sidebands, the first being 600 cycles from the carrier, the second would be 1,200 cycles away, the third would be 1,800 cycles off, and so on. In addition, there would be the corresponding upper sidebands for each of these. Considering now an audio range of 15,000 cycles, the sidebands would extend, on the basis of current FM modulation standards, up to five times the audio

span on each side of the carrier, or a total of 150 kc. Since each sideband is 75 kc wide and the original audio range was 15 kc, the ratio between the two, obtained by dividing the sideband span by the audio, is 5. This figure is known as the *deviation ratio* and is the standard modulation extent in the 88–108 megacycle FM band. In the audio portion of television receivers, however, although the modulating system is still FM, the sidebands extend only ± 25 kc. Despite this comparatively narrow bandwidth, the FM i.f. channel and the discriminator in almost all television receivers is seldom less than 200 kc wide, and in some cases is as wide as 400 kc.

Discriminator response curve

In an FM system the width of the response curve, both in the i.f. stages and the discriminator, varies with the intensity (or amplitude) of modulation. With no modulation the

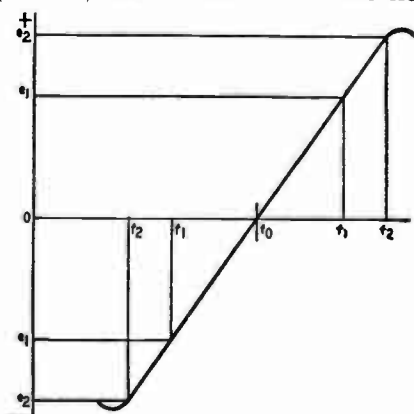

Fig. 504. Ideal form of discriminator S-curve.

bandwidth is almost zero (carrier only), increasing above and below the carrier as the modulation amplitude increases. The shapes of the response curves, however, differ radically between the i.f. system and the discriminator. In the i.f. stages, a flat response is desired, since in this portion of the circuit variations in modulation amplitudes are intended to produce changes in frequency or bandwidth. By contrast, in the discriminator, amplitude variations are produced, thereby recreating the original audio amplitude changes.

Fig. 504 illustrates the behavior of the discriminator. The response curve is the usual discriminator S-curve, and is linear except for the extremes. The curve crosses the zero voltage point

at the center frequency of the band, corresponding to the carrier. Since there is no modulation at this frequency, the audio output is also zero. An increase in the audio modulation level will shift the center frequency both above and below the f_0 point, by a value, say f_1 . At these points the output voltage is $\pm e_1$. As the audio amplitude further increases, the frequency shifts further away from f_0 , resulting in larger outputs, $\pm e_2$ at the deviation f_2 . Thus the discriminator converts frequency variations into amplitude changes.

Types of FM detectors

There are two main types of FM detectors in general use. They differ principally in circuit details and somewhat in alignment methods, but are alike in performing the function of FM demodulation. Although both are discriminators, one is best known by the name *ratio detector*, while the other is called a *discriminator*. Most of the recent TV receivers use the ratio-detector, while FM sets as well as many of the earlier TV sets, use the discriminator.

Fig. 505 shows a schematic of a discriminator. Both the primary and secondary of the input transformer are tunable, either by trimmer capacitors or by iron cores, the latter method being more popular. In viewing the response of a discriminator circuit on the scope, the familiar S-curve consists basically of response curves of opposite polarity, or phase, such that two major requirements are fulfilled. First, the curve is substantially linear between the extremes. Second, the curve intersects the axis at the center frequency of the i.f. Since this curve represents the detector output, zero amplitude at the center frequency means that there is no audio output when there is no FM deviation. The linearity of the curve assures that the audio output at all times will faithfully follow the frequency deviation. Thus, a frequency deviation of 100 kc produces twice as much output voltage as does a 50-kc deviation.

One point should be made in connection with actual alignment instructions. Both primary and secondary of the discriminator must be aligned for maximum output, that is, at the exact i.f. center. The fact that discriminator alignment instructions state that the secondary should be aligned for zero output in no way contradicts this requirement. The primary is aligned for maximum output for just this purpose—to get maximum signal input to the discriminator. However, since linearity is a prime requisite, the primary is aligned for the greatest linear range of the S-curve.

The secondary in turn is aligned to fulfill the second major requirement, zero amplitude at the center frequency.

In aligning the discriminator, it is very helpful to have a graduated scale on the face of the cathode-ray tube. A plastic shield, ruled vertically and horizontally in 1/10-inch spaces enables quick adjustment of the zero center and balanced S-curve conditions.

Sweep alignment of discriminator

1. Allow receiver, sweep generator and scope to warm up for a few minutes.
2. Disable receiver oscillator and a.v.c.
3. Using the INTERNAL SWEEP of the scope, adjust for a straight line on the center of the graduated shield. This can be done by first establishing a horizontal line, adjusting the VERTICAL CENTERING until the line is midway between top and bottom

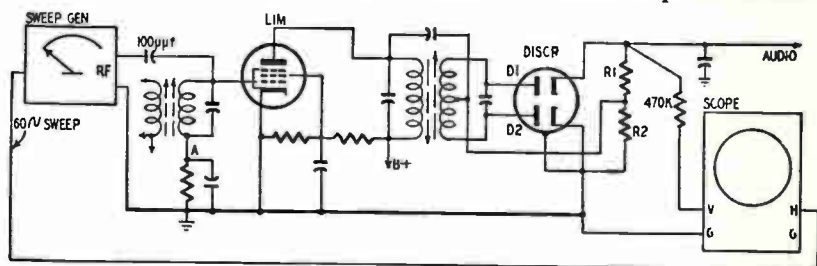

Fig. 505. Connections to scope for alignment of FM discriminator.

of the screen, then reducing the HORIZONTAL GAIN until the line shrinks almost to a point. With the HORIZONTAL CENTERING control, the point can now be brought to the center of the screen.

4. Switch off the INTERNAL SWEEP and connect a sweep voltage to the HORIZONTAL INPUT of the scope. If the r.f. sweep generator or the scope contains such a source, it can be conveniently used.
5. Connect the VERTICAL INPUT terminals of the scope to the output of the discriminator, using a 470,000-ohm decoupling resistor. See Fig. 505.
6. Set the sweep generator center frequency to the i.f. of the receiver being aligned. Set the sweep width to about 300 to 400 kc. Keep sweep generator marker in OFF position.
7. Couple the output of sweep generator to the last i.f. or limiter tube, through a small capacitor (100 μf to 250 μf is adequate).

8. Increase output of sweep generator until a good-sized pattern is obtained on the screen. Use as low a generator signal as practicable, using the V-GAIN control of the scope for obtaining good size. Adjust sweep-generator phasing control to produce a single pattern on the screen.
9. Adjust primary of the discriminator until the S-curve is most linear over the longest part of the curve obtainable.
10. Adjust the discriminator secondary until the zero point (obtained in step 3) divides the S-curve into equal halves in the upper and lower portions of the screen.
11. Readjust primary, and then secondary, if necessary, until the curve is as linear and as centered as possible.
12. Turn on sweep-generator marker. Increase marker output until marker pip appears on scope pattern. The marker signal amplitude should be large enough to be seen, yet should not distort the S-curve. Use the minimum amount of marker signal possible. By means of the marker, check the center and end frequencies of the S-curve.
13. Restore receiver to normal, reversing the procedure of step 2.

With most commercial discriminator circuits, it should be possible to obtain a linear span at least 200 kc wide. In high-grade FM receivers a span up to 400 kc is not unusual. In the sound i.f. section of TV receivers, a lesser bandwidth is quite satisfactory, although many of these have a response over 200 kc.

In every type of bandpass alignment it is helpful to know the exact frequency of one or more points on a response curve. Markers are superimposed on the curve as a type of amplitude modulation. With the aid of a calibrated scale over the face of the cathode-ray tube it is not generally necessary to have markers at the extremes of the S-curve. A quick check at the extremes, however, will give you a quick idea of the bandpass. The marker should be used to locate the center frequency at the intersection of the S-curve with the X-axis.

Most modern sweep generators contain a marker generator. It is unmodulated, or CW, and has an accurately calibrated dial. The sweep-generator dial, by contrast, is only roughly calibrated, since it is monitored during alignment by the marker generator. There are two main types of marker generators. One is an actual signal generator whose output is coupled to and mixed with, the sweep generator. In operation, the sweep generator is tuned until the desired response curve appears on the scope. This is

done almost without regard for the dial reading, except in an approximate manner. The marker generator is then tuned until a pip appears on the pattern. With the marker dial, the pip is moved to the extremes of the response curve, and the dial is read for the frequency limits of the curve. In using such a marker, it is important to keep the marker pip at a minimum, otherwise distortion of the response curve will result.

The absorption marker generator is the second type. This is simply a sharply tuned circuit, coupled to the main signal generator. When tuned to a frequency within the response curve, the marker tuned circuit absorbs some energy, causing a dip in the response curve. While the absorption marker is usually less sharp than the superimposed type, good results can be obtained if the marker is kept to a minimum.

AM generator method

While the sweep generator method is the only sure way of obtaining correct discriminator alignment, it is possible to obtain fair results using an ordinary AM generator, with modulation. However, this is not generally recommended. When using the AM generator for this purpose, keep two facts in mind. First, it is assumed that the discriminator is normal in every way, except for being off frequency. This means that it could be correctly aligned with a sweep generator. Second, (and this is the basis for alignment without a sweep generator) both primary and secondary must always be tuned to the center frequency. On this basis, the discriminator is temporarily converted to an AM detector, and the alignment is then made for maximum output. The procedure is as follows:

1. Set the signal generator to the center frequency of the i.f., with MODULATION ON.
2. Open the center-tap on the discriminator coil.
3. Ground the bottom end (going to the plate of D2) of the secondary. See Fig. 505.
4. Disable receiver as in the sweep generator method previously outlined.
5. Connect input of AM generator to the last i.f. or limiter stage, as in sweep alignment.
6. Connect the VERTICAL INPUT terminals of the oscilloscope across the discriminator load, R1 and R2.
7. Adjust the scope sweep so that 3 cycles of the waveform will appear on the screen. Since most AM generators are

modulated by 400 cycles, the sweep setting should be in the vicinity of 133 cycles.

8. Tune primary and secondary of the discriminator for maximum amplitude of the 400-cycle trace on the scope. The generator output should be kept low and further reduced as alignment progresses.
9. Restore the circuit to normal by reversing the steps of items 2 and 4.

In case of insufficient generator output and/or low vertical gain in the scope, the latter may be connected across the grid circuit of the final audio stage. This is possible, because this is an alignment for maximum a.f. output.

Since this method assumes that the discriminator is correctly balanced, it may be necessary to make a small final readjustment with a radio station signal. A station is tuned in and the audio quality is observed. Should the audio sound off-station, or detuned, a slight readjustment of the discriminator secondary is made, until the quality sounds normal. If this does not help, the alignment was not correct, and should be done over again. The only other cause for distortion would be a defect in the circuit.

The ratio detector

This is the most popular of FM detectors in TV receivers today. (See Fig. 506). Theoretically, an FM signal is of constant r.f. amplitude, with frequency variations corresponding to audio modulation levels. Thus, a perfect FM signal would be said to contain no amplitude modulation whatever. This cannot be realized in practice. A certain amount of AM invariably appears on the signal, partly incidental to the frequency modulation in the transmitter, partly due to noise, receiver nonlinearities, etc. The effect of noise on the signal is mainly amplitude variation, obviously undesirable. This is the main reason for using FM — to get higher fidelity through extended high-frequency audio response, combined with the absence of noise (AM). Any system that would restrict or limit the signal amplitude would remove all amplitude variations without affecting the FM. Such limiting is effected in high-quality receivers by limiter stages.

In the more conservatively designed FM receivers, two limiter stages are employed. More often, and in less elaborate receivers, only one stage of limiting is used. In either case, these modified i.f. stages are in addition to the usual i.f. amplifier stages, resulting in increased cost and complexity.

The situation is somewhat different in TV. First, the deviation, or bandwidth, is much less than in FM receivers, being only ± 25 kc as compared with ± 75 kc in FM. Second, the general tendency toward simplification and economy in design, coupled with the fact that video is the major factor makes the use of limiter stages in television receivers unpopular. The ratio detector solves the problem by combining the functions of FM detecting and AM limiting without the use of additional tubes or circuit components. Briefly, the ratio detector is insensitive to AM, responding only to a ratio of two voltages, this ratio in turn corresponding to the original audio variations.

Ratio-detector alignment

The procedure for aligning the ratio detector is similar to discriminator alignment. However, because this detector also eliminates AM noise (without the usual limiters) it is more im-

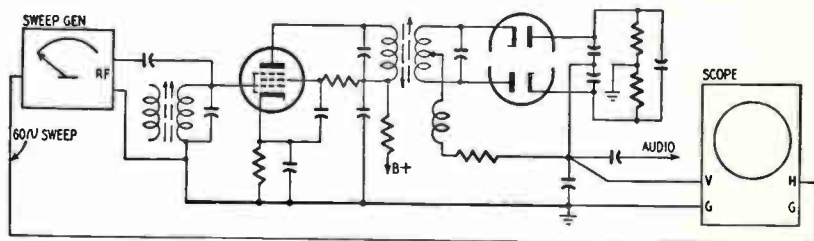

Fig. 506. Circuit illustrates procedure to follow for ratio-detector alignment.

portant than usual to carefully balance the secondary. The general procedure is to align the primary for maximum voltage output, then balance the secondary for zero output at the center frequency. The step-by-step alignment is:

1. Allow the equipment to warm up, as usual.
2. Connect sweep voltage to the HORIZONTAL INPUT of the oscilloscope. See Fig. 506.
3. With a calibrated shield over the face of the cathode-ray tube, adjust the beam to center on the screen.
4. Set the sweep generator to the nominal i.f. of the receiver. In the case of intercarrier type of i.f. in television receivers, the center frequency is always 4.5 megacycles.
5. Set the FM sweep to at least 100 kc in the case of TV receivers and no less than 200 kc for FM broadcast receivers.
6. Detune the secondary of the ratio-detector transformer by opening the trimmer capacitor or turning the slug fairly well out.
7. Connect the VERTICAL INPUT of the scope as shown.

8. Connect the signal generator to the grid circuit of the last i.f. stage, using a small series capacitor.
9. Align the primary of the ratio detector transformer for maximum linear span of the S-curve.
10. Align the secondary for correct balance on both sides of the center point, remembering that zero output at the center frequency is even more important than exact balance between the two halves of the curve. Use the marker generator to get the correct center point.
11. Restore the circuit to normal operating condition.

In connection with this procedure, keep in mind that while correct alignment will result from following these steps, it is nevertheless to the advantage of the service technician to follow the specific recommendations of the manufacturer whenever alignment information is available. Minor differences in circuits, different output take-offs, etc., often require series networks with the signal generator, points of signal input, or points of scope connection. Where no specific instructions are given, following the steps listed will produce satisfactory results.

FM i.f. alignment

The bandwidth of the FM i.f. extends much further than the best AM type. Even in television sound where the bandwidth is only ± 25 kc, appearance of the response curve is important for faithful audio reproduction. In FM broadcasts, the band extends ± 75 kc, and here careful visual alignment is imperative.

Most modern FM i.f. channels are center-tuned, i.e., each circuit is tuned to the center frequency of the i.f., with bandwidth obtained through circuit design, such as resistive loading, circuit Q, etc. However, since the tuned circuits are not sharply peaked, it is not possible to tune for maximum output and let it go at that. A tuned circuit having a flat top cannot be tuned exactly by looking for maximum output, since the same output will be obtained over all of the flat portion. Since there are a number of circuits tuned to the same frequency, correct tuning is essential to obtain the desired over-all flatness and symmetry. A sweep-generator-marker combination is the only sure way of accomplishing this purpose.

The alignment procedure for broadcast FM i.f. circuits is substantially the same as for TV sound i.f. channels. In the case of the former, and where limiters are used, a convenient output point is across the limiter grid-leak resistor. Since this stage operates on signal-developed bias, the amount of such bias is a good

indication of the magnitude of the i.f. signal. In the case of non-limiter type circuits (where ratio detectors are used), the output indicator, the scope in this instance, is placed across the ratio-detector transformer output, assuming that the transformer has been previously aligned.

The step-by-step procedure for i.f. alignment is very much the same as for the bandpass i.f. described earlier, with these exceptions:

1. The VERTICAL INPUT of the scope is connected across the last limiter grid-leak resistor. This is point A in Fig. 505.
2. The sweep width is set for the same amount as for the discriminator in the set being aligned—50 kc minimum for television sound i.f., 200 kc minimum for broadcast FM.
3. A calibrated shield is used on the face of the cathode-ray tube; the center frequency is located and the individual i.f.'s are tuned, beginning with the one nearest the detector and going back toward the mixer until the band is as symmetrical as possible, consistent with normal gain.
4. Where tertiary windings are used for flat-topping, the primary and secondary circuits are tuned for maximum amplitude, and then the tertiary trimmers or slugs are adjusted for best bandwidth.

The subject of gain is very important in bandpass alignment. In almost any circuit of this type, it is possible to obtain very good bandwidth at the expense of gain, simply by peaking the circuits farther apart from each other. This is particularly so in the case of stagger-tuned i.f.'s in video circuits. Conversely, apparently high gain can be obtained at the expense of bandwidth, by bringing the individual i.f. peaks closer together. The most reliable guide in such cases is the manufacturer's recommendations for signal input and the expected output. A calibrated peak-reading voltage scale on the plastic screen is most helpful in this instance. If, for instance, the manufacturer claims that a 200- μ v signal at the input should produce a 1-volt output at the detector, a gain of 5,000 is indicated, and the service technician can guide himself accordingly. Ordinarily, it may be adequate to follow the recommendations for the bandwidth and align for maximum gain consistent with such bandwidth and symmetry.

Video i.f. channels

The video i.f. channels of modern TV receivers require even more careful alignment than high-fidelity FM circuits. There are a number of reasons for this. First, the video i.f. is seldom less

than 3 mc wide, more often, it is approximately 4 mc, and, in the case of the almost universal intercarrier system in use today, it must be a full 4.5 mc. Second, the video response curve is usually nonsymmetrical, necessitated by the multiple duties of the system. Third, the presence of two carriers in at least part of the i.f. chain, often in every stage up to the detector, with the relative position of such carriers fixed by official standards, makes the location of the edges of the response curve critical. Finally, the fact that in almost all TV receivers today the final i.f. response is the result of a number of response curves, each one at a specified frequency and with a fixed relation to the other curves, makes video i.f. alignment more elaborate and more exacting.

Almost all video i.f. circuits in use today are of the stagger-tuned type. A number of circuits, each capable of passing all the required frequencies but tuned to peak at one frequency only, combine to produce an over-all response curve. Fig. 507 illustrates the structure of such a response curve. The design of the individual circuits, although generally responsible for producing the final over-all response, is by no means foolproof assurance that the curve will be obtained. In the early days of television some manufacturers specified peak alignment of the individual circuits, using only an AM generator and an output meter with the expectation that the correct peaking of the individual circuits would, by virtue of design, produce the correct final curve. This is no longer the usual case. Any well-designed circuit can be hopelessly misaligned if nothing more than an AM generator and output meter are used.

Although stagger-tuned circuits are almost always used, there are two main types of such circuits in common use. The first, generally found in earlier sets, is the impedance-coupled type. It consists of a single winding per stage, almost always slug-tuned, and located either as the plate load of an i.f. amplifier or in the grid circuit of the following stage. In every stage the coupling to the next tube is of the r-c type. Peaking of each circuit at a particular frequency, together with the other staggered peaked circuits, results in the over-all bandpass characteristics of the i.f. system. The resistor of the r-c network together with the shunting of the input and output capacitances of the two tubes, as well as the stray circuit capacitance, effectively load the tuned circuit, reducing the peak and widening the response curve, as required for the proper over-all response bandwidth.

The second type of stagger-tuned i.f. system found in recent

TV receivers, is the bifilar type. A double winding, very tightly coupled and tuned by a single core, acts as a loaded transformer, providing loading for correct bandwidth and coupling between stages. The difference between the two types of i.f. coupling methods is primarily in performance. Better noise immunity makes the bifilar system preferable. As far as alignment is concerned, the circuits are treated alike.

In aligning the video i.f. system either stage-by-stage tuning or an over-all alignment procedure may be followed. The peak frequency of each stage is usually given either on the schematic diagram or in the alignment instructions. Since the circuits are

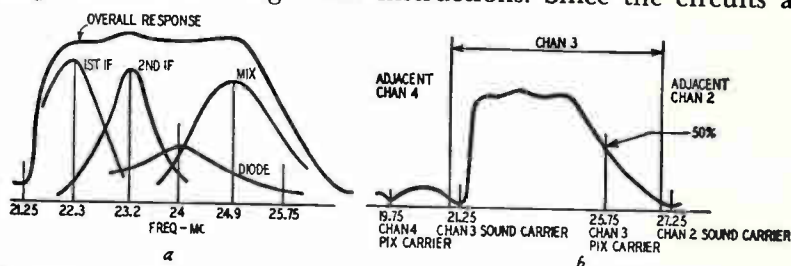

Fig. 507-a, -b. Response curve of stagger-tuned i.f. (left) and frequency relationship of sound and picture signals in the i.f. (right).

designed for proper individual gain and bandpass characteristics, tuning of the individual stages together with visual observation of the final response shape will produce the desired response. As to the merit of over-all alignment versus stage-by-stage alignment, the former is simpler and perhaps less time-consuming, though the latter may be more precise but involves a more elaborate procedure.

Effect of a.g.c. on alignment

Most TV receivers use a.g.c. on one or more of the video i.f. stages to reduce the need for manual contrast adjustment and to maintain a fairly constant input to the video detector. Since the effect of the a.g.c. is to counteract variations in the output of the amplifier, this would hamper alignment of the i.f. system. Any increase of the output would, to a certain degree, be nullified by the reduced gain of the stages under control. Thus, as the output tends to increase due to alignment, the a.g.c. effect would counteract the increase. For this reason it is necessary to fix the gain of the system by providing a constant bias. A d.c. voltage, preferably with a shunt potentiometer, conveniently provides the necessary bias. The bias should be adjustable to any value between maximum and zero volts, with about 3 volts being a

good value for most cases. Often the manufacturer's alignment instructions will specify a suitable bias setting for such a substitute grid voltage.

I.F. alignment procedure

1. Switch on all equipment and allow to warm up. Remove receiver oscillator tube or switch to unused channel. See Fig. 508.
2. Connect substitute bias system. The exact bias will vary, depending upon whether the receiver is used in a fringe area or a strong signal location.
3. Set sweep generator to the approximate center of the video i.f. band. A rough setting is adequate since the exact points will be determined by the marker generator dial. For a 21.25–25.75 mc i.f. system, a setting of 24 megacycles is used. For sets using higher i.f.'s set the sweep generator to the approximate center of the i.f. and follow the same general procedure outlined here.
4. Set sweep width to approximately 10 megacycles.
5. Connect a 60-cycle sweep to the HORIZONTAL INPUT of the scope, either from a separate source or from the sweep generator itself. Set scope sweep control to OFF position.
6. Couple the sweep generator as loosely as possible to the input of the first i.f. stage. Sometimes it is feasible to couple a small series capacitor of less than 10 μf to the grid. In other cases, merely placing the hot lead of the signal generator near the first i.f. stage is sufficient coupling for adequate output. In many cases, an effective coupling device consists of one or two turns of wire wrapped around the glass of the mixer tube, after the shield has been removed, connecting one end of this wire to the hot side of the sweep generator. A strip of tape may be used to hold the wire to the glass for constant coupling. In any case, excessive coupling should be avoided, to prevent overloading of the first stage.
7. Connect VERTICAL INPUT of scope across the video detector output load resistor. Set receiver contrast control to mid-position, unless otherwise specified by the manufacturer.
8. Adjust scope controls for best trace. Adjust PHASING control for overlapping of the forward and return traces.
9. Peak the i.f. circuits for best response similar to Fig. 507-a. It will be seen that coil L1 in Fig. 508 will affect the high-frequency (video) end of the curve; L2 will mostly affect

the low side (sound) of the curve; L4 will change mostly the middle portion of the curve.

10. Set the marker generator to 21.25 mc and align the sound take-off for minimum output at the marker position. This adjustment assures minimum sound i.f. component remaining in the video response, and maximum being absorbed by the input circuit to the sound i.f.
11. Move the marker to 19.75 mc and peak the cathode trap for minimum or a dip in the response curve of the adjacent upper channel video carrier.
12. Reset marker to 27.25 mc and adjust trap for minimum lower adjacent channel sound carrier.

The picture i.f. response for a representative channel (channel 3) is shown in Fig. 507-b. Note that the picture carrier is set at about 50% of the maximum amplitude of the flat part of the curve. This is necessary because one of the sidebands in television transmission is partially suppressed (vestigial sideband transmission). If, during alignment, you force the picture carrier too high up on the slope of the curve, the low-frequency portion of the signal will be emphasized and picture quality will be poor.

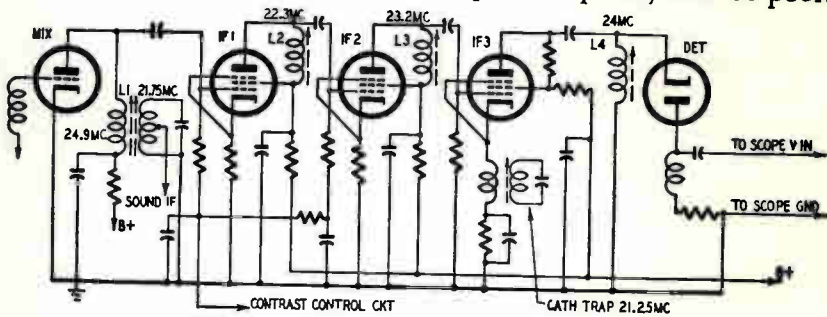

Fig. 508. Typical stagger-tuned i.f. system in television receiver.

If the carrier is moved below the 50% point, there will be a loss of low- and high-frequency response, giving poor picture definition. If carried to an extreme, sync and blanking pulses will be attenuated, or completely lost, resulting in picture rolling and tearing.

In this i.f. response curve, as in many split-sound arrangements, there can be at least three different trap-circuit adjustments. The first and most important of these is the sound take-off circuit. This accomplishes the requirement stated in step 10, which is a basic requirement in all split-sound systems. Other trap adjustments are to eliminate possible interference from nearby carriers

of the neighboring channels. The final response curve should agree with manufacturer's published response curve.

Bifilar i.f. systems

In the development of the modern i.f. system in TV receivers, the slug-tuned, r-c coupled, stagger-peaked type of i.f. was used for split-sound as well as for more recent intercarrier types of receivers. The bifilar type of coupling did not become popular until after the intercarrier method was in general use. It is worth noting that, although singly-tuned bifilar coupling is found almost exclusively in intercarrier systems, there is no basic reason for this other than the accidental adoption of bifilar i.f.'s after split-sound went out of vogue. As far as alignment is concerned, the methods are almost exactly the same, the differences being only those between split-sound and intercarrier, regardless of the type of coupling used. Thus, any alignment procedure holds equally for r-c and bifilar coupling, since in the bifilar types a single core or slug tunes both the primary and secondary simultaneously. The advantage, incidentally, of the bifilar type is the fixed loading, or flat-topping provided by the tight coupling between the primary and secondary, as well as the omission of the coupling capacitor and grid resistor, the latter being a potential source of noise.

Quick alignment check

For your own satisfaction as well as for the customer's benefit, you should check the alignment of every TV set you repair. Do this after you have fixed the other troubles and the set is in operating condition. If you do not want to take the time required by the procedures discussed earlier, try this quick alignment technique.

- 1—Hook up the sweep generator and scope, and check the i.f. response as before. If realignment is necessary, turn the sweep-width or deviation control on the sweep generator to *zero*; throw the sweep center-frequency dial or band-selector switch out of the i.f. band.
- 2—Turn on 400-cycle modulation in the marker generator (modulated r.f.).
- 3—Using the height of the 400-cycle waves on scope screen as an indicator, tune traps for *minimum* output, and i.f. windings for *maximum* output, at specified marker frequencies, as before.
- 4—To check the over-all response merely reset the sweep-width or deviation control to its original setting, and put the sweep center frequency back in the i.f. pass-band.

The same method can be used for aligning the TV sound section or any FM receiver.

Intercarrier i.f. system

Up to now the video i.f. circuits discussed were of the split-sound type, i.e., the video and sound were separated before reaching the video detector. In early receivers, splitting of the two channels took place at the output of the mixer stage. In other cases, sound take-off was at the output of one of the video i.f. stages, sometimes as late as the third. However, as long as only the video i.f. reached the detector, the system was of the split-sound type. From the viewpoint of alignment this meant that sometime before the video detector the sound-trap adjustment had to be made such that a minimum output existed at the sound i.f. marker point in the over-all response curve. In addition, the low-frequency side of the video-response curve had to be relatively steep, in contrast to the sloping high-frequency or video side of the curve. Last, the sound i.f. center frequency, although always 4.5 megacycles below the video carrier, would differ from manufacturer to manufacturer and even from set to set of one manufacturer. In the intercarrier system, this is no longer true.

The intercarrier i.f. system may be considered as a double superheterodyne in which two i.f. carriers are amplified in the common i.f. stages. The video detector now has a double job—the old one of an AM detector of video modulation and the function of a superheterodyne mixer. The video carrier acts as the oscillator in the familiar converter stage, while the sound carrier has the role of the incoming signal. The result is an i.f. whose center frequency is the difference between the oscillator and incoming frequencies. Since in every TV channel the two carriers are spaced 4.5 megacycles apart, the i.f. output of the video detector is always 4.5 megacycles. However, since the video i.f. carrier acting as the oscillator, is amplitude modulated, the resultant 4.5 megacycle i.f. will have, in addition to its original FM, some AM. Either limiting action or a ratio detector will be required to remove the AM from the sound i.f.

The first difference between an ordinary video i.f. and the intercarrier type is the bandwidth. While any bandwidth up to 4 megacycles and as low as 2.5 megacycles might be adequate for split-channel receivers, depending on the quality desired, the intercarrier i.f. must have a bandwidth of 4.5 mc since this is the spacing between the two carriers. While the amplitude of the response curve at the sound carrier must not be of the same level

as the rest of the curve, it is nevertheless an absolute necessity that the response curve extend to and beyond both carriers on opposite extremes of the bandpass. The second important characteristic of an intercarrier response is the relative level of the two carriers. Since the amplitude-modulated video i.f. carrier acts as the oscillator for the second superheterodyne, the 4.5 megacycle sound i.f. will have some of the AM characteristics of the video. These characteristics will be most evident when the two signals are of comparable amplitudes, and least noticeable when the FM carrier is much smaller in relation to the video carrier. It is therefore important to make the FM carrier as small as practicable in the common i.f. channel. From the service technician's viewpoint, the most obvious effect of amplitude modulation of the FM carrier is *intercarrier buzz*. This is the result of the 60-cycle vertical sync pulses appearing in the 4.5 mc sound i.f., due primarily to improper alignment of the video i.f. and resulting in too high a relative FM carrier. While a well-designed, exactly aligned and balanced ratio detector should be able to remove most of the AM components of intermodulation, balancing of the detector transformer is critical and the over-all results

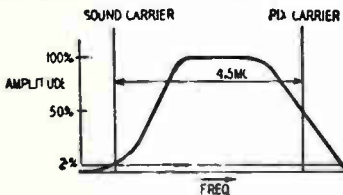

Fig. 509. Intercarrier i.f. system must have a bandpass of 4.5 mc. Sound carrier should be less than 5% of video amplitude. Amplitude modulation of the FM carrier results in intercarrier buzz.

are not always 100% satisfactory. The simplest method of avoiding this source of interference is to maintain the FM carrier level so low that the amplitude modulation effects are negligible. In practice, the FM carrier level in the common i.f. response is kept down to between 2% and 5% of the maximum video carrier amplitude.

In setting the response level of the sound carrier on the video response curve, there are two major considerations which are in conflict. (1) The amount of sound i.f. amplification at 4.5 mc (i.e., after the video detector) depends largely on the shape of the common i.f. response curve. If the sound carrier is high up on the curve, less gain (and fewer stages) will be required later. This may have two potential drawbacks. First, the relatively high level of the sound carrier in the common i.f. may give rise to sound components in the video signal. In addition, the video i.f. response has to be wider, up to a full 4.5 megacycles, resulting

either in lowered gain (less peaking, or more staggering), or in an additional i.f. stage. (2) A high sound-carrier level in the common i.f. is almost certain to produce intercarrier buzz. This is a good example of the necessity of visual observation and alignment with a sweep generator and a scope.

Fig. 509 shows a typical intercarrier i.f. response with the video and sound carriers at proper relative amplitudes. Notice that the sound carrier amplitude is judged not from the maximum response level but from the video carrier amplitude, which itself is 50% down. The 2% figure for the sound carrier is not always easily realizable, particularly when the response curve slopes gradually. Many commercial i.f. circuits are so staggered that a *shelf* exists 4.5 mc from the video carrier. In such cases, the appropriate stagger circuit, as given by the manufacturer, should be aligned, with the aid of the sound i.f. marker, until the shelf is at the correct frequency and amplitude.

In connection with the problem of interference, the effect of the FM carrier on the video cannot be neglected. A fine weave

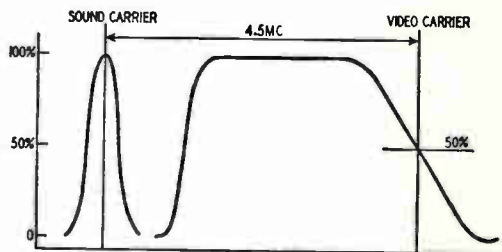

Fig. 510. Video response of typical split-sound receiver. Careful adjustment of the fine-tuning control is always necessary in such receivers.

pattern on the picture tube screen is evidence of 4.5 mc interference. This is due to the audio carrier directly, as the 4.5 mc sound traps cannot completely remove the remnants of the carrier from the video-amplifier circuits. Another source of trouble from improperly shaped response curves in intercarrier sets is audio interference, known as *sound bars*. This is actually the fault of FM detection in the video detector stage, or in the video amplifier, by a method known as *slope detection*. This is a crude type of FM demodulation based on the fact that the FM carrier shifts in frequency with audio modulation. If such a carrier at its nominal frequency were to occur partly up on the slope of a response curve, subsequent shifts in the carrier would make it effectively ride up and down on the response curve, resulting in variations in the amplitude of the output in step with the carrier shift—hence FM detection. While slope detection in this

case is accidental and unintended, it is nevertheless likely to occur in many receivers, and will produce sound bars unless the FM carrier is kept low enough in the common i.f. stages.

A third intercarrier characteristic is the behavior of the fine-tuning control. Specifically, the control is less critical and less important than in the split-sound system. A simple sketch will illustrate this. Fig. 510 shows the video i.f. response of a typical split-sound receiver, alongside of which is also shown the sound i.f. response. The latter has a bandpass of approximately 200 kc, with

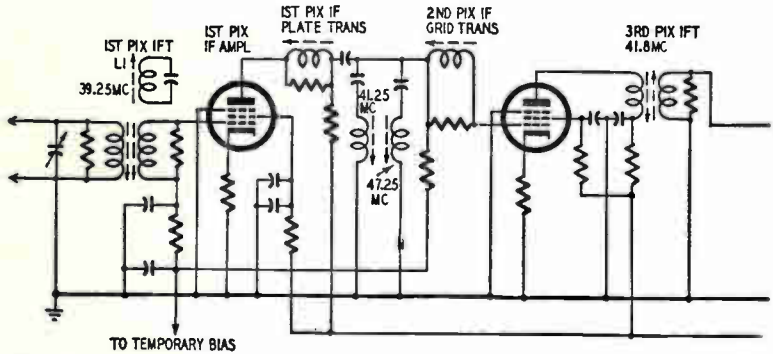
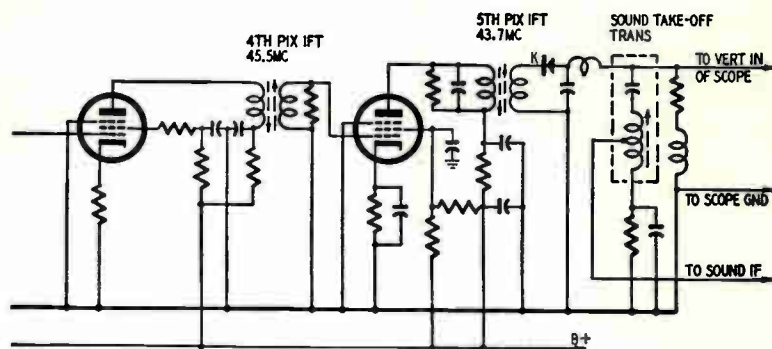

Fig. 511. Typical circuit of the i.f. system of an intercarrier-type television receiver. The bandpass must be wide enough to accommodate both picture and sound signals. Sound take-off can be anywhere between the video detector and

the carrier shown at the mid-point of the bandwidth. The video carrier, 4.5 megacycles higher, falls midway up on the high-frequency slope of the video i.f. response. If the oscillator frequency should now change, both carriers would move by an amount equal to such change, in one or the other direction. A readjustment of the fine-tuning control would now be required. Another way of stating this is to say that the fine tuning control must be adjusted accurately enough so that the FM carrier always falls midway in the FM response curve. Since this is a comparatively narrow band, careful setting of the fine-tuning control is always necessary. In the intercarrier system, however, such critical tuning is not necessary. Fig. 509 shows the response of the intercarrier i.f. Here the oscillator frequency could wander almost all the way up and down the slope of the response curve without losing the sound carrier. As long as the 4.5-mc point below the video carrier falls within the over-all response curve, a 4.5-mc output of the video detector is assured. In fact, the complete omission of a fine-tuning control, in some cases, is not impractical.

Alignment of intercarrier i.f.

Intermediate frequencies in TV receivers range from a low median value of approximately 25 mc up to 45 mc. Earlier in this chapter the alignment of a low i.f. split-channel receiver was described. When higher i.f.'s are used, the same alignment technique is followed, except that it is important to keep the signal generator test leads as short as practicable. With higher i.f.'s, realignment may be necessary even if only a tube is replaced.



input to the picture tube. For alignment of the i.f., scope is connected across the picture detector diode load.

1. Set sweep generator to approximately the 40-50 mc span. See Fig. 511.

2. Adjust sweep to a minimum of 6 mc, preferably to about 10 mc.

3. Connect vertical input of scope across video-detector load.

4. Adjust all scope and generator controls for a suitable deflection on the scope. Turn off scope sweep and feed 60-cycle sine-wave sweep from generator to H-INPUT of scope. Adjust phasing control when necessary, to eliminate retrace.

5. Substitute a fixed bias for the normally developed a.g.c. voltage by connecting a voltage of about 3 volts between the a.g.c. point and the chassis, with the positive end going to chassis.

6. Allow normal warmup time for equipment and set.

7. Adjust i.f. transformers, using frequencies shown in Fig. 511 until the overall appearance of the response curve is as nearly as possible like the response curve shown in Fig. 512.

8. Set the marker generator to 39.25 mc and adjust L1 for a minimum at the marker pip on the response curve.

9. Use the marker generator to check the response at the points shown on the curve, Fig. 512.

In this procedure, as in any other general alignment procedure, individual differences between circuits and manufacturers' methods are necessarily omitted. It is advisable that specific directions of manufacturers, whenever available, be followed with regard to manner and exact point of signal-generator coupling, output-indicator connection, circuit isolation, etc. Where a response curve is given, it is the best guide in achieving the ideal response for the particular circuit.

TV sound i.f. channels

There are two main types of sound i.f. channels in television receivers. The first and perhaps the most popular is the 4.5 mc

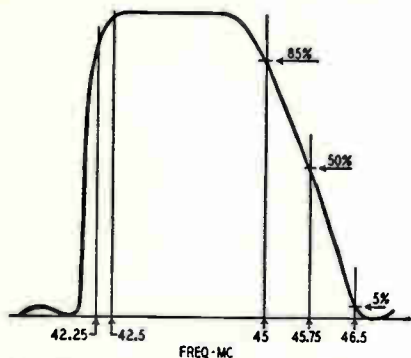

Fig. 512. Marker points are used to check the response curve.

sound i.f., resulting from the intercarrier system. The center frequency is always 4.5 mc in all intercarrier sets.

Another unmistakable identification is the takeoff point, almost always placed after the video detector, and often after the video amplifier. A third, although less positive identification, is the FM detector following the 4.5 mc i.f. In most cases there is but one i.f. stage, followed by a ratio detector.

In alignment of the sound i.f. channel, whether intercarrier or split-sound type, it is imperative that the discriminator or ratio detector be aligned first. Once this is done, the alignment of the i.f. proper is quite simple, and may often be done with only an AM oscillator and oscilloscope. However, the sweep-generator method is preferred.

Sweep alignment of 4.5-mc sound i.f.

Fig. 513 shows the pertinent portion of an intercarrier i.f. sys-

tem in which the sound take-off point is the plate of the video amplifier and a ratio detector is used.

1. Turn on the receiver, sweep generator, and scope; allow the usual warmup time for stabilization.

2. Switch receiver to an unused channel to avoid interference from the oscillator.

3. Set sweep generator to exactly 4.5 megacycles and the sweep to about 500 kc.

4. Turn off the INTERNAL SWEEP of the scope and connect the synchronized 60-cycle sweep from the generator, an external source (or from the scope, if available) to the HORIZONTAL INPUT terminals of the scope. If the scope contains such a sweep, connection to the H-TERMINALS is unnecessary.

5. Connect the VERTICAL INPUT terminals of the scope to the output of the ratio detector.

6. Connect the output of the sweep generator across the video-detector load circuit.

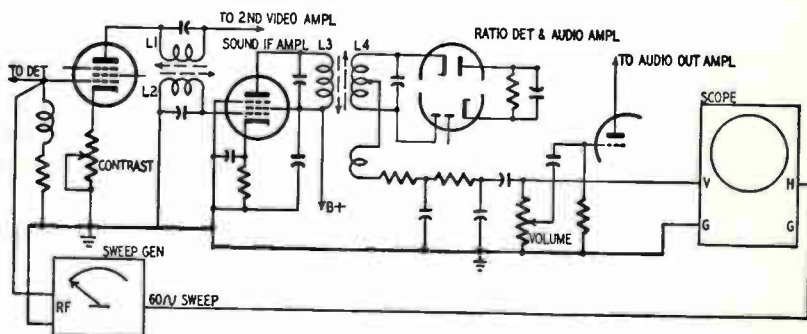

Fig. 513. Sound i.f. section of intercarrier receiver showing scope connections for alignment.

7. Adjust scope controls for an adequate S curve.

8. Tune L1, L2, L3 and L4 until maximum amplitude of the curve is consistent with best linearity and symmetry of the curve. L1 and L2 will primarily affect amplitude, while L3 and particularly L4 will affect the shape of the curve.

9. Use markers at 4.5 mc for the center of the response curve, and at 4.45 mc and 4.55 mc for the extremes of the linear portion of the curve. The 4.5 mc marker will diminish and tend to completely disappear as the best adjustment of L4 is reached, since the marker is a AM component, while correct alignment of the transformer secondary means zero output at the center frequency of the i.f.

4.5-mc trap in the video circuit

In addition to the usual 4.5-mc sound take-off trap found in intercarrier TV sets, there is often found, even in split-sound receivers, a 4.5-mc trap in series with the video lead to the picture tube. This is often necessary to eliminate either *sound bars* or a fine *weave* in the picture. The reason for this lies in a characteristic known as slope detection, mentioned earlier in this chapter.

Slope detection is a crude method of FM detection without the usual discriminator or ratio detector. It utilizes one side of a response curve for the equivalent of the S-curve in normal FM detectors. Fig. 514 shows a typical response of a tuned circuit, with the sides sloping, as usual. When an FM carrier is placed midway up one side of such a curve, amplitude variations will occur as the carrier shifts or deviates, due to modulation. Thus, as the carrier shifts from f_c to f_1 , a higher frequency, the output amplitude will increase since the signal now falls higher up on the curve. The reverse is true when the modulation shifts the carrier to f_2 , a lower value. Therefore it is apparent that FM detection can take place even without the conventional FM detector.

The effect of the slope detection phenomenon on the picture can be understood by considering the response characteristics of the video amplifier. Since this stage is usually about 4 megacycles wide, the upper frequency slope of such a response curve may sometimes act as a slope detector for any FM carrier that remains in the video circuit. In addition, the 4.5-mc carrier itself, aside from the audio modulation it contains, may cause a fine high-frequency weave on the screen. A parallel 4.5-mc trap placed in series with the video signal to the picture tube will effectively trap such interference. To adjust such a trap for maximum effectiveness:

1. Set up the equipment as for the sound i.f. alignment procedure outlined before.
2. Set the signal generator to 4.5 mc, but with amplitude modulation (approx. 30%).
3. Connect the VERTICAL INPUT of the scope, using an a.c. probe, across the input of the picture tube, grid to ground or cathode to ground, depending on which element is the high side for the video input signal.
4. Increase the output of the signal generator until the audio frequency (400 cycles in most signal generators) is shown on the scope, with the HORIZONTAL SWEEP of the scope properly adjusted.

5. Adjust slug of the 4.5-mc trap until the signal is reduced to a minimum.

Split-sound i.f.

Alignments of sound i.f. channels of television receivers are very much alike regardless of receiver type. However, some differences do exist.

The center frequency of the sound i.f. channel is entirely at the discretion of the manufacturer, and generally varies even from year to year, the tendency being for higher i.f.'s. The input point for the signal generator depends on the take-off point in the particular set. Where the sound take-off trap is in the plate circuit of the mixer, as was the case in the earliest receivers, the sweep generator is fed to the grid of the mixer, or, in some cases, to the sound trap in the plate circuit. In those receivers where the sound take-off is in one of the video i.f. stages, the signal is fed to that stage input or to the trap in the output circuit. Where the i.f. response alone is to be viewed, this must be done ahead of the discriminator.

Front-end alignment

TV alignment can be no better than the accuracy of the marker generator. Not too serious at broadcast-band intermediate frequencies, the problem is aggravated as we go up in frequency.

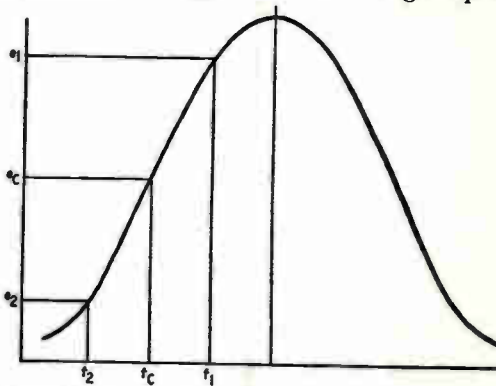

Fig. 514. Generalized response curve of a tuned circuit.

Containing both sound and picture signals, and also working at much higher frequencies, TV i.f. alignment requires more care, and equipment having a higher order of stability and accuracy

Since TV front-ends handle the signal prior to conversion, the service technician is confronted with the problem of aligning the r.f. amplifier, oscillator and mixer to produce a pass band

of 6 mc starting at frequencies of 50 mc and higher. Before attempting alignment, get full instructions from the manufacturer, or from organizations selling servicing and alignment information.

The over-all bandwidth of a TV channel is approximately 6 mc, including 4.5 mc between carriers and 1.25 mc of vestigial sideband at the low-frequency end of the channel. While it is possible to get a fair picture with a bandwidth of little over 4.5 mc (including the two carriers and most of the video sideband), this is usually inadequate for any but fringe-area reception, since the low-frequency video modulation response is seriously reduced. At the output of the mixer the response narrows, in practice, to only about 4 or 4.5 mc.

There are two major requirements in front-end tuner alignment. First, the r.f. and mixer stages must be aligned for the full 6 mc, since in these stages the signal is handled as is. Second, the high-frequency oscillator must be aligned to the correct frequency to produce the video and sound i.f. components at the center frequencies of the particular i.f. channels.

Although there are many front-end tuners in use today, most of them are variations of two basic types. The first, used primarily in earlier sets, is the series-type tuner in which the coils for the individual channels are part of quarter-wave resonant line, with additional sections switched in series as the tuner is switched from channel 13 down to channel 2. This type requires adjustment of the highest channel first, progressing down to the lowest.

The second and more popular today, is the turret type. Here individual coils are switched in for each channel, with the adjustments being independent of one another, and therefore capable of being aligned at any random sequence. A major advantage of this tuner is that a defect in any one channel does not affect any of the others. Replacement of a defective coil is simple and inexpensive. As far as alignment is concerned, there is not too great a difference between them, except for accessibility.

Oscillator alignment using stations

You can get good results by aligning the oscillator of a series-type tuner with the antenna connected to the receiver and the picture appearing on the screen. The oscillator slugs are tuned, starting with channel 13, until the audio of the particular station is a maximum. When a test pattern is on the air, the scope may be put across the voice coil of the speaker for visual alignment. However, when music or speech is on, simply listen for the best sound.

A word of caution is in order. The oscillator must be tuned for the best audio, not the strongest picture, otherwise poor frequency response of the video will result when the tuner is operated in the usual manner. It may even be possible to lose the sound completely when maximum video is obtained in adjusting the oscillator.

The procedure for oscillator alignment of a turret tuner is the same as that described for the series-type. However, since individual coils are used for each station, no sequence need be followed in the tuning.

In connection with oscillator adjustments, remember that in intercarrier receivers the fine tuning is not nearly as critical as in the case of split-sound sets. Because of this, it is not necessary to tune for best sound. Often the sound loudness and quality will be little affected by the setting of the fine tuning control. In such cases, the best oscillator position is that giving the most satisfactory picture.

Video output response

While the video output stages of a TV receiver are not subject to alignment, the analysis of the response of this amplifier requires equipment and procedures similar to i.f. sweep alignment.

Fig. 515 shows a typical video amplifier. Notice the similarity

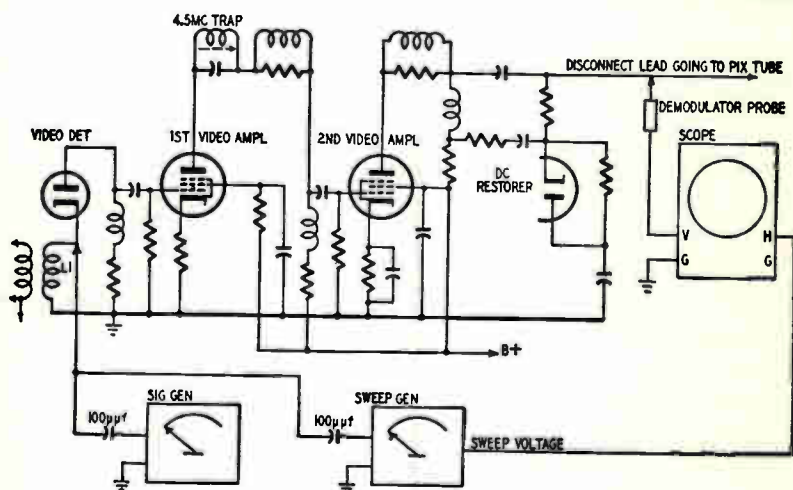

Fig. 515. Video amplifier and setup for observation of frequency response.

to the vertical amplifiers of the scope. Although different in detail, the method of obtaining flat response over a 4-megacycle

band is quite similar. Direct-coupling is sometimes used for best low-frequency response, while loaded and unloaded peaking circuits, both series and shunt, are used for high-frequency compensation. In many cases r-c coupling is used (as shown in Fig. 515) with the accompanying problem of low-frequency response. Screen and cathode-bias resistors introduce further low-frequency problems. Since the video amplifier must have a flat response down to perhaps 10 cycles, the reactance of the cathode bypass capacitor must be negligibly low compared to the bias resistance at this frequency. For a cathode resistance of 680 ohms, for example, the reactance of the bypass capacitor should be, according to good practice, no more than 10% of this, or 68 ohms. At 10 cycles this means a capacitor of about 250 μ f. A similar problem exists in the screen circuit, although here a much smaller capacitor is adequate because of the higher resistance of the screen circuit. Deterioration of low-frequency response will result from a change in the circuit, as in aging of the capacitors, increase in leakage resistance, etc. Since signal currents flow in both of these circuits, any variation, such as that due to poor bypassing will result in degeneration and decreased output at these frequencies.

In the case of high-frequency compensation circuits, both the series and shunt-peaking methods rely on the circuit and stray capacitances to resonate with the peaking coils, thus raising the output at the higher frequencies. In addition, the series-peaking circuit serves to isolate the shunting capacitances of the two tubes, reducing the loading. Should either of these peaking circuits fail, as when a peaking coil has shorted turns or even an open-circuit break, low- and high-frequency response will suffer.

In trouble-shooting video stages for defects in response, it may be possible to locate defects with nothing more than an ohmmeter. However, visual observation of the effect of replacement of each suspected component is the only reliable method. When the video response is below normal, the service technician must not only know the effect of each of the frequency-sensitive components but he must observe the response on the scope and judge the effects of any corrective measures, taken one at a time.

In displaying the video response on the scope, it is easiest to make a setup resembling a symmetrically modulated AM signal fed into a point before the video detector. Assuming the video i.f. to be approximately 26 mc, an r.f. signal of 26 mc, without modulation is fed into the video-detector input circuit. This signal serves as the carrier. A frequency-modulated sweep generator,

with the center frequency the same as the r.f. generator, or 26 mc, and a sweep of ± 5 mc, is also coupled to the same point, using isolating capacitors in series with each generator high side. The output of the video amplifier is fed, through a demodulator probe, to the VERTICAL INPUT of the scope. Using the proper horizontal sweep for the scope, either from the sweep generator or from the scope, or from a separate source, a double-sideband response with a marker-like notch in the center, will appear. Since this is a double response, the scope can now be adjusted to show only one-half of this response. The position of the notch is the low-frequency end of the response curve. The effect of individual changes in the video circuit can now be seen on the scope.

1. Connect an r.f. signal generator, without modulation, in series with a 100- μ f capacitor to video-detector input. Connect the low side to chassis. See Fig. 515.
2. Connect a sweep generator in the same manner to the same points.
3. Set both generators to the video i.f., or, if specified, to the stagger frequency of the detector input circuit (if tuned).
4. Set the bandwidth of the sweep generator to 5 mc.
5. Connect the VERTICAL INPUT of the scope through a demodulator probe, to the video output stage, or to the input of the cathode-ray tube, whichever is more convenient.
6. Connect a horizontal sweep voltage to the HORIZONTAL terminals of the scope, and adjust the appropriate scope controls.
7. Shunt L1 with a resistor (between 200 and 300 ohms) since the coil is frequency responsive. Disconnect lead going to picture tube.
8. Allow all equipment to warm up for a few minutes.
9. Observe the response on the cathode-ray tube and adjust, if necessary, the r.f. oscillator for a minimum notch in the center of the curve.
10. Readjust the sweep generator and scope until only one-half of the original response curve is visible. This is the actual response of the video amplifier, with the position of the notch indicating the low-frequency end.
11. Substitute, one at a time, for the suspected capacitors in the video bypass circuits, noting the effect each time. In the case of a leaky capacitor, it will not help to parallel a good one with it.

Chapter

6

Oscilloscope Techniques

UP to the advent of television, the service technician was concerned with comparatively low frequencies—one or two megacycles in the r.f. portions of receivers, and only about 10 kilocycles in the audio sections. Ordinary voltmeters, signal generators, etc., were quite adequate. Even mismatching or some loading by the test equipment did not seriously affect the test procedure or the repair involved. Since the coming of television and high-frequency FM, the situation has completely changed.

The first problem in TV servicing is the matching of the signal generator, which is the antenna substitute, to the receiver input circuit. In most modern TV receivers the input circuit has an impedance of 300 ohms, balanced to ground, while most signal generators have an output impedance of approximately 50 ohms, unbalanced (shielded coaxial). As in the case of a mismatch between antenna and receiver, a mismatch between the generator and the receiver can lead to various difficulties in the appearance of the input signal, bandwidth, etc.

Briefly stated, the term matching refers to a method of interconnecting two pieces of equipment so that each faces, or *sees*, an impedance equal to its own. As to the reason for matching, it is simply to insure that the energy flows from the source to the load and not vice versa. When a generator and a load are matched, the energy is fed from the generator to the load and is absorbed by the latter. In contrast, when a mismatch exists, some of the energy reaching the load is reflected in the direction of the gener-

ator, combining with the energy traveling toward the load, such combined energy causing standing waves, losses, phase shifts, etc.

Fig. 601 shows a typical interconnection between a 50-ohm generator having a shielded coaxial output and the usual TV receiver with a balanced 300-ohm input. The resistance network,

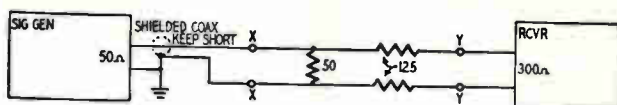

Fig. 601. Impedance matching between 50-ohm output and 300-ohm input.

although causing some signal loss, provides a good match between the two units. The loss is insignificant in the case of alignment with the signal generator, since usually there is more than enough output from the generator. However in the case of an antenna and a receiver, the loss might be serious. Remember, each unit should feed into an impedance equal to its own. Looking at Fig. 601, points X-X are the terminals of the receiver input circuit, as far as the signal generator is concerned, since the generator actually connects to these two points. Looking at Fig. 602-a, the

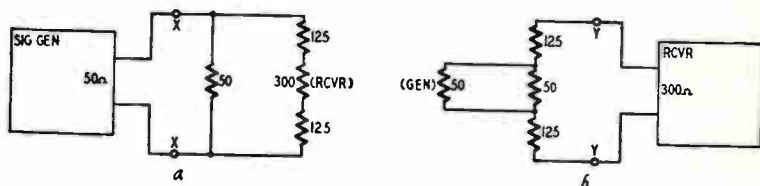

Fig. 602-a, -b. Circuit (a) shows impedances across a generator output. Circuit (b) shows impedances across receiver input.

network (simplified) across which the 50-ohm generator connects consists of 50 ohms shunted by an approximate impedance of 550 ohms, for a net value of 46 ohms.

The impedance across X-X can be calculated in this way:

$$\begin{aligned}
 R_{xx} &= \frac{50 (125 + 300 + 125)}{50 + 125 + 300 + 125} \\
 &= \frac{50 \times 550}{600}
 \end{aligned}$$

$$R_{xx} = 46 \text{ ohms.}$$

This is close enough to match the generator output impedance.

Going back to Fig. 601, terminals Y-Y are the actual points to which the 300-ohm receiver connects, and therefore the impedance here should be approximately 300 ohms. As shown in the simplified version in Fig. 602-b, the receiver connects to a circuit consisting of 125 ohms, two 50-ohm units in parallel for a net value of 25 ohms, and another 125-ohm element.

The impedance across Y-Y can be calculated as follows:

$$\begin{aligned} R_{YY} &= 125 + \frac{50 \times 50}{50 + 50} + 125 \\ &= 125 + 25 + 125 \end{aligned}$$

$$R_{YY} = 275 \text{ ohms.}$$

The total, 275 ohms, is quite a good match for the receiver primary.

While the matching network described is for a 50-ohm generator, it is simple to determine the required resistance values for

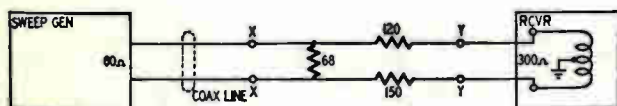

Fig. 603. Generator-to-receiver matching pad.

other impedances, using the following rule: Each series element should be half the receiver input impedance minus half the generator output impedance. Using a 300-ohm receiver and a 60-ohm generator, the series resistance should be

$$300/2 - 60/2, \text{ or } 150 - 30 = 120 \text{ ohms.}$$

The shunt element should in each case be the same as the output impedance of the generator. In this example it is 60 ohms.

Matching pad balanced to ground

A slightly different version of a generator-to-receiver matching pad is shown in Fig. 603. While not radically different from the matching network described earlier, this one has some advantage in that it does not disturb the balance to ground of the receiver primary. One series element has a resistance exactly equal to one-half the receiver input impedance, or 150 ohms. The other series element is less than one-half the input impedance by one-half of the generator impedance, or 150 - 30.

The impedance seen by the signal generator is:

$$\begin{aligned}R_{xx} &= \frac{68(120 + 300 + 150)}{68 + 120 + 300 + 150} \\ &= \frac{68 \times 570}{638}\end{aligned}$$

$$R_{xx} = 61 \text{ ohms.}$$

The impedance seen by the receiver is:

$$R_{yy} = 120 + \frac{68 \times 60}{68 + 60} + 150$$

$$= 120 + 32 + 150$$

$$R_{yy} = 302 \text{ ohms.}$$

The impedance matching is at least as good as before, while the added advantage is that both ends of the receiver antenna terminals have the same resistance to ground, i.e., 150 ohms.

In every case where attenuation or matching is desired, it is important to use noninductive resistors. Wire-wound resistors, even the so-called noninductive types, may react on the circuit, causing possible reflections or otherwise changing circuit conditions. Commonly available molded composition resistors are most suitable.

Scope probe

In most video checking, a shielded lead to the vertical input of the scope is absolutely essential to avoid stray pickup. This shielded lead has the disadvantage of adding considerable capacitance across the signal circuit being examined, in addition to the input capacitance of the vertical input circuit. Not only in video, but even in horizontal sweep circuits, this capacitance, amounting at times to as much as 50 or 75 μf , is sufficient to produce severe distortion of pulses and other waveshapes. The low capacitance probe is the solution.

Fig. 604 shows a sketch of a simple, but effective low-capacitance probe for the scope. Electrically, it consists of a 1-megohm resistor shunted by a small ceramic capacitor of 10 μf . Since this network is in series with the signal it will cause a considerable reduction in signal input to the scope. However, this is not of too great importance since most good scopes have more than sufficient vertical gain to compensate for this. The great advantage of the

probe is the fact that the shunting capacitance across the signal is reduced to about 10 μmf , usually a negligible value. Some commercial probes have an adjustable capacitor of approximately the same capacitance. This enables adjustment of the series capacitor for the best value, using a standard audio-frequency square-wave generator and adjusting the capacitor for an undistorted square wave on the scope screen.

R.f. probe for scope

Another problem often encountered in television testing is the observation or measurement of signals in r.f. or i.f. circuits, i.e., before the detector stage. This may sometimes take the form of signal tracing; on other occasions it may be for the purpose of stage gain or sensitivity measurements. Obviously, an ordinary

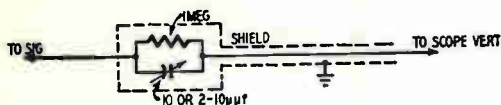

Fig. 604. Low-capacitance probe for scope.

low-frequency scope will show incorrect waveshapes, if any at all. A suitable r.f. probe makes the instrument a high-frequency device that can give a reasonably exact picture of the signal at the particular point. The probe must have two major characteristics suitable for use in high-frequency circuits: a suitable low capacitance in order not to detune or load the circuit being measured, and a detector or demodulator for converting the high-frequency signal either to video or audio in the case of a modulated signal or to d.c. in the case of pure r.f. such as a carrier or generator signal. A crystal detector of the germanium or silicon type is most often used, because of its compactness, because it has no heater power requirements, and because of its good behavior at low-signal levels. As to the low capacitance of the probe, the construction must be such that the leads are as short as possible and the shielded cable is of sufficient diameter to reduce shunting.

Fig. 605 shows a circuit of a typical probe. The input blocking capacitor and the output isolating resistor serve to keep the circuit under test as undisturbed as possible. With such a probe, signal measurements may be made almost anywhere in an r.f. or i.f. circuit. A suitable signal generator is coupled to the grid circuit and the demodulator probe is connected across the output, or, preferably, across the input circuit to the next stage. Of course, overall gain of a complete i.f. or video amplifier may be determined in a similar manner. However, the main use of the probe

is in a circuit where an ordinary meter will not indicate correct values. Fig. 606 shows one setup for measuring stage gain in an i.f. amplifier.

In connection with the application of the demodulator probe, some caution is in order. Often the point being measured may of necessity have a small capacitance in series with the signal. If

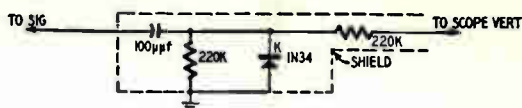

Fig. 605. Demodulator probe using crystal detector.

the probe must go in series with such a capacitance to the signal point, a reduction in measured signal will result because of the voltage-divider action taking place between the series capacitor in the circuit and the probe itself. When such circuit capacitance is 100 μf or more, the reduction is negligible. Where small capacitances are encountered, the user will have to allow for such reduction in estimating or evaluating the results.

Isolation of instrument from equipment under test

One of the simplest and most commonly suggested devices for use in oscilloscopic analyses of television circuits is an isolating

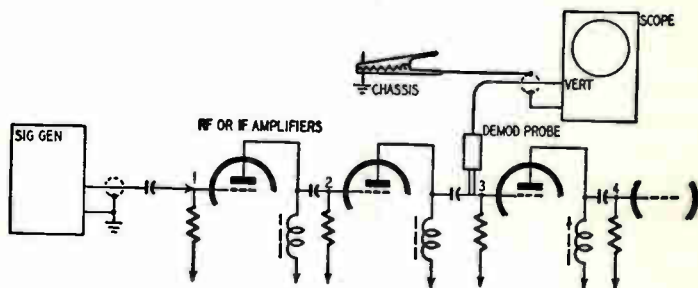

Fig. 606. A scope and a demodulator probe make an excellent team for testing r.f. and i.f. amplifiers.

resistor. Such isolation is not required when a low capacitance or demodulator probe is used. In other cases, however, where the scope normally seems to give a good indication, a 1-megohm resistor in series with the *high* side of the scope lead to the vertical input will help maintain the circuit being tested in normal condition. In other words, the input circuit of the scope vertical amplifier will not be shunting the circuit under test.

Another simple precaution for the same general purpose is an isolating capacitor. The main purpose of this capacitor is d.c. iso-

lation, and it is usually large enough for the lowest frequency expected. The series capacitor suggested for external connection should be no larger than required for the particular test in progress. For instance, when a signal generator is coupled to a mixer or an i.f. grid of a 25-mc amplifier, a capacitance of as little as $5\ \mu\text{f}$ to $10\ \mu\text{f}$ is often sufficient. If the signal frequency is in the general vicinity of 100 mc, such as for front-end TV alignment, mere placement of the hot generator lead near the antenna terminals of the receiver provides sufficient coupling.

A further aid in circuit isolation, particularly in tuned circuit alignment, is the judicious placement of the signal generator. Wherever avoidable, the generator should not be placed across the actual circuit being aligned. This is quite easily done in the non-stagger type of i.f. stages, such as broadcast, FM, and sound

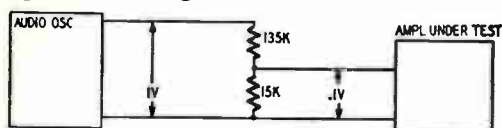

Fig. 607. Simple voltage divider enables measurement of small voltages.

i.f.'s of TV receivers. Thus, for aligning the first i.f. stage of a series, the signal should be fed to the mixer grid. When aligning the third stage, the generator is best coupled to the grid of the second stage. Even in stagger-tuned stages, this can be done by detuning the stage to which the generator connects, preferably by opening the capacitor all the way, or turning the slug as far out as practical. The signal will pass through the untuned stage, and alignment will then be possible.

Coupling to the front end

In many modern TV tuners, the mixer grid of the front end is necessarily inaccessible, due to the thorough shielding required. A simple and effective method of coupling consists of making a coupling capacitor out of the mixer-tube shield. The shield is lifted off its base just enough to break the continuity. Next a loop of wire is wrapped around the ungrounded shield and the high side of the generator is connected to one side of the loop of wire. Depending on the amount of input signal required, it is often feasible to simply fasten the high end of the generator cable with adhesive tape to the shield. The capacitance of the ungrounded shield to the tube elements provides the coupling needed.

Measuring low input voltages

When a signal generator contains an accurately calibrated at-

tenuator, it is simple to find out the signal voltage fed to the circuit. However, such an attenuator is rather expensive, and is not too commonly found on service equipment. The following network, illustrated in Fig. 607, provides a simple means of measuring voltages as low as 50 millivolts with fair accuracy, assuming that the available meter can measure accurately a value as low as 1 volt. If, for example, a signal of 0.1 volt is to be used out of an audio oscillator, the voltage-divider ratio is made 9:1, so that an output of 1 volt from the generator will feed 1/10 of the total into the test circuit. The meter is connected across the total voltage divider and the circuit under test is made across the small resistor at the ground end of the total network. To avoid reactive effects, the resistors should be noninductive. Molded carbon resistors are quite suitable, although noninductive wire-wound resistors may be used.

A.g.c. bias substitute

It is necessary to disconnect the a.g.c. bias circuit from the i.f.

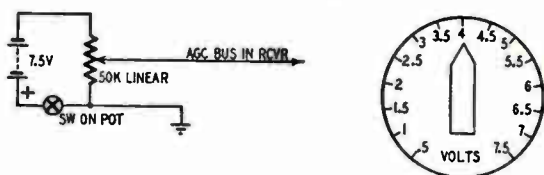

Fig. 608. This easy hookup can be used to supply bias voltage during alignment of receivers.

system during alignment, since the a.g.c. tends to counteract any decrease in signal, including that due to misalignment, and may give a false indication of higher amplitude and broader response. However, since most modern i.f. systems operate with very small initial bias, it is necessary, in addition to disabling the a.g.c. to substitute a temporary bias source. A fixed voltage such as a battery is most suitable because it also acts as a clamp to prevent the a.g.c. action from changing the chosen bias value.

Fig. 608 shows a simple device suitable for use with almost any TV receiver. Since different manufacturers specify different values of bias to be used during alignment, an adjustable source is desirable. The battery is a small 7.5-volt unit, adjustable by means of the shunting potentiometer to any value from zero to 7.5 volts. The potentiometer is linear, enabling calibration on a uniform scale. The dial is divided into 15 evenly spaced divisions, each division being a 0.5-volt interval. It may be desirable to calibrate the device after long intervals, but this is not essential.

In application, the positive terminal is connected to the chassis or common B— in some sets, while the negative terminal is connected to the a.g.c. bus, or to the point specified by the manufacturer. If no specified value of bias is given by the manufacturer, the alignment may be made using a value of -3 volts, this being a very common value on medium signals. In the case of the r.f. stage in the tuner, a value of as low as -1 volt may be sufficient.

While the majority of television receivers today employ some kind of automatic gain control, there still are many sets of earlier design without it. Usually, these sets employ a manual bias adjustment for r.f. and i.f. gain control. In these cases manual adjustment of the bias is necessary. If the manufacturer does not specify a bias level for use during alignment, a good value is about -3 to -4 volts. A vacuum-tube voltmeter or a 100,000-ohms-per-volt meter is preferable to use, but a 20,000 ohms-per-volt meter may be used, preferably on the highest range possible. Due to the loading of this type of meter, the actual bias will be somewhat higher than the meter indicates and allowance should be made for this.

Calibrating the scope as a voltmeter

One of the most useful applications of the scope other than

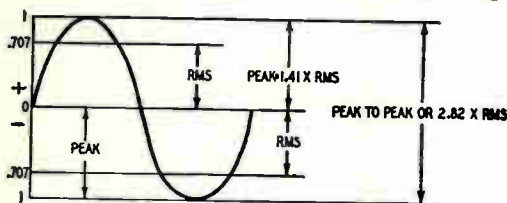

Fig. 609. Relationship of r.m.s. (effective), peak, and peak-to-peak voltages.

actual waveshape observation is the measurement of voltages unsuitable for v.t.v.m. or multimeter measurements. This applies to almost any voltage other than d.c., sine wave, square wave, and perhaps one or two other regular waveshape voltages. The sweep and sync voltages in television are invariable examples. Many of these pulses are of short duration, unsuitable for average measurements. Furthermore, the proper operation of such circuits as horizontal drive, differentiator and integrator circuits, retrace blanking as taken from the vertical amplifier circuit, and many others, depends on adequate peak values at the appropriate points. The vertical amplifier of the scope, especially if it has good high-frequency response, will accurately measure any of these pulses, provided it has been carefully calibrated. A plastic shield,

ruled 10 lines to the inch and placed on the face of the scope, is the only accessory required in addition to the calibrating voltmeter and the voltage source.

The basis for calibrating the scope for peak-to-peak voltage measurements is the sine wave. Fig. 609 shows one cycle of sine voltage, on which two points are marked on each half-cycle. These points are the r.m.s. (root mean square) values, and are the usual voltages read by meters. The maximum value of a sine wave is $\sqrt{2}$ times the r.m.s. Usually the figure given is 1.41, which means that the peak value of a sine wave may be obtained

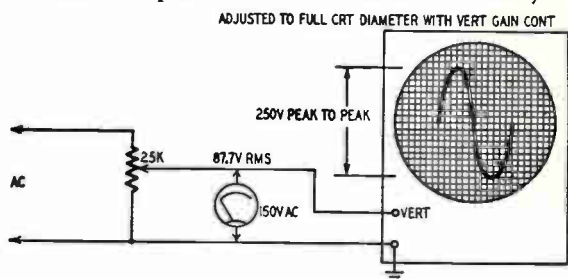

Fig. 610. Technique for calibration of the scope.

by multiplying the r.m.s. value by 1.41. The peak-to-peak value of a wave, as shown in Fig. 609, is the total amplitude, from the positive maximum to the negative maximum. Thus, the peak-to-peak value of 1 volt r.m.s. is 1×2.82 , or 2.82 volts. Similarly, the common 6.3 heater voltage has a peak-to-peak value of 17.76 volts, while the nominal 120-volt line is 338.4 volts peak-to-peak. Once the scope has been calibrated for peak-to-peak reading using a sine wave, any other waveshape may be measured with equal accuracy.

In calibrating the scope, three different ranges will usually cover all requirements. They are 1 volt, 25 volts, and 250 volts. Should any other range ever be required, it can be easily calibrated in a similar manner. The accessories required are:

1. An accurate voltmeter—either v.t.v.m. or multimeter is satisfactory.
2. A source of a.c.—the usual heater and line voltages of any receiver will do.
3. A potentiometer—1,000 ohms for the low ranges and 25,000 ohms for the high scale.

To determine the amount of r.m.s. voltage required for each scale, each peak-to-peak value desired is divided by 2.82, the answer being in r.m.s. Thus, for a 1-volt peak-to-peak range, the

r.m.s. voltage needed is $1/2.82$, or approximately 0.355. Similarly, the 25-volt peak-to-peak range will need 8.87 volts r.m.s. for calibration, while the 250-volt scale will require 87.7 volts r.m.s.

Fig. 610 shows the setup for 250-volt calibration.

1. Connect the 25,000-ohm potentiometer across the line.
2. Connect the a.c. voltmeter across the VERTICAL INPUT terminals of the scope.
3. Connect a lead from the low side of the line (usually grounded) to the ground terminal of the scope.
4. Connect a lead from the center terminal of the potentiometer to the VERTICAL INPUT terminal of the scope.
5. Adjust the potentiometer until the meter reads 87.7 volts.
6. Adjust the VERTICAL GAIN of the oscilloscope for full-scale deflection. This will cover 50 divisions on the graduated scale placed over the scope screen.
7. Remove the line-potentiometer circuit. The peak-to-peak range of the oscilloscope is now 250 volts, or 5 volts per division. Do not touch the VERTICAL GAIN of the scope as long as this calibration is desired.

For the other ranges, a similar procedure is used. In Fig. 611 a known a.c. voltage (from a filament transformer in this case) is applied to the VERTICAL-INPUT terminals of the scope, and the VERTICAL-GAIN control is adjusted until the signal occupies the desired number of vertical divisions on the graph screen. With the gain control left in this position, the deflection obtained with any other signal indicates the peak (or peak-to-peak) voltage exactly.

As an example, the peak-to-peak value of a 6.3-volt (r.m.s.) signal is 18 volts. If a 6.3-volt signal is applied to the scope input, and the VERTICAL-GAIN control is adjusted until the trace occupies 18 vertical divisions, each square represents 1 volt. Thus, if another signal is observed without changing the position of the gain control, and a deflection of two squares is obtained, the new signal has a peak-to-peak value of 2×1 , or 2 volts.

It is not advisable to calibrate the scope for future use, since line voltage, tube age, and other factors will make the gain different at different times. For rough approximations, however, such calibration is permissible.

Calibration of horizontal sweep

In many uses of the scope for the display of waveshapes to be studied, the exact frequency need not be known. The sweep con-

controls are usually adjusted until two or three cycles of the unknown voltage appear on the screen. Sometimes, however, as in the case of oscillator adjustments in TV receivers, the exact frequency is required. Since the sweep controls are seldom calibrated, individual calibration is required in each case. This is conveniently done by either of two methods: (1) substitution; (2) use of Lissajous figures.

The substitution method, as its name implies, relies on the substitution of a standard known frequency in place of the unknown. In this procedure, the unknown is first displayed on the scope in the usual manner, showing 2 or 3 cycles. Next, the unknown is disconnected from the vertical terminals of the scope,

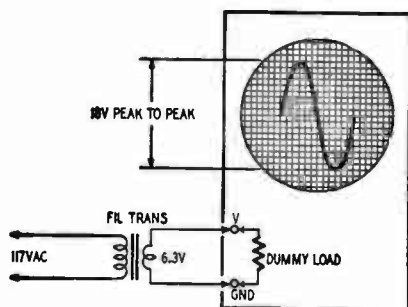

Fig. 611. The scope can be calibrated by using a filament transformer.

and the standard, such as a signal generator, is connected into the vertical input. The sweep controls, including the sync amplitude adjustment, are left intact. The dial of the standard generator is now rotated until the same number of cycles as before appears on the screen. The frequency of the unknown signal is now read on the dial of the standard generator.

In calibrating a particular frequency on the horizontal sweep of the scope, a slightly different version of the same method is employed. Assume that it is desired to set the horizontal sweep to 30 cycles for the purpose of viewing 60-cycle waveshapes of the vertical circuits of a TV receiver. (This will produce 2 cycles of the vertical). A standard frequency signal (in this instance it might be the a.c. line or the heater voltage of the receiver) is connected to the vertical input of the scope. Next the sweep is adjusted until 2 cycles appear on the screen. The internal sweep is now set to exactly 30 cycles. Should the test involve the adjustment of the vertical frequency of the set, merely connect the scope to the output of the receiver vertical oscillator and adjust

the appropriate control until 2 cycles, regardless of their shape, appear on the screen.

The Lissajous figures method is somewhat different. It is based on the ratio of vertical-to-horizontal input frequencies to the scope and the resultant patterns. As explained in connection with the study of deflection, a single cycle appears on the screen when the horizontal or sweep frequency is the same as the vertical, or signal, frequency. Should the vertical frequency be twice as high, 2 cycles will be displayed, and so on. Conversely, when the horizontal frequency is twice the signal frequency, the equivalent of one-half cycle will be shown. More correctly, the two halves of the signal cycle will be swept in sequence, each across the whole screen. This is most clearly illustrated using sine waves for both sweep and signal voltages. Fig. 612 illustrates some of the types

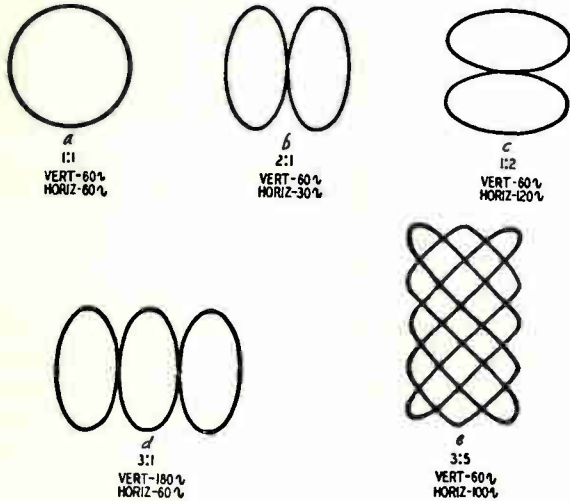

Fig. 612-a, -b, -c, -d, -e. Lissajous figures show the relationship of vertical input to horizontal sweep frequencies.

of Lissajous figures commonly encountered. In Fig. 612-a, both frequencies are the same and a circle results. The case of a 2:1 ratio, with the vertical higher in frequency, is shown in Fig. 612-b, while a 1:2 ratio is shown in Fig. 612-c. Various other combinations are possible, although it becomes progressively more difficult as the ratios take on large numbers. Because the 60-cycle line frequency is highly accurate and readily available, it is often used for Lissajous figures comparisons. A 180-cycle voltage will produce a 3:1 pattern with 60 cycles, while a 60-cycle test frequency will result in a 3:5 pattern with a horizontal frequency of

100 cycles. See Fig. 612-d, -e. Ratios of more than 6:1 or 8:1 become too difficult to count, hence are no longer reliable.

To calculate frequency ratios, count the number of loops along the vertical edge of the pattern. Next, count the number of loops along the horizontal edge, or across the screen. Since the loops up and down the screen are produced by the sweep voltage, while the loops across the screen are due to the signal applied to the vertical input of the scope, the ratio of these two numbers is the ratio between the signal and sweep frequencies. Thus, in Fig. 613-e, having 3 horizontal and 5 vertical loops, the ratio is 3:5. Since the sweep voltage was assumed to be 100 cycles, the vertical or signal frequency is $3/5$ of 100, or 60 cycles.



Fig. 613. Lissajous figures can be used to calibrate an audio oscillator.

Lissajous figures can be used for the calibration of audio oscillators. The technique for doing this is shown in Figure 613. The output of the audio oscillator is fed to the VERTICAL INPUT of the scope, while 60-cycle line voltage is injected into the HORIZONTAL INPUT through an isolating transformer. This can be a 6.3-volt filament transformer with the primary connected to the power line. This will enable calibration of the audio oscillator up to about 500 cycles. Calibration accuracy depends on the stability of the line frequency. Calibrate when line frequency is stable, preferably during normal daytime working hours. If the line frequency is actually 59.5 or 60.5 instead of 60 cycles, the calibration accuracy can still be held within 1%, which is good enough for most purposes. But if the frequency swings between these two extremes while you are calibrating, the results can be very confusing. If the supply frequency fluctuates, it will be difficult to keep the patterns steady enough to recognize them. For audio-oscillator calibration at higher frequencies, use a 1,000-cycle input to the HORIZONTAL INPUT terminals of the scope.

Horizontal deflection and phasing circuit for sweep alignment

A sinusoidal voltage of 60 cycles is commonly used as the FM sweep frequency. Also, in alignment procedures using sweep generators, a phasing control or adjustment is required to obtain a single pattern of the response curve on the screen. The simple device described here is a useful source of such phasable sweep

voltage for the scope when neither the generator nor the scope contain such a voltage.

While it is generally assumed and often stated that cathode-ray tubes in scopes and TV receivers are swept from left to right, this is not quite accurate. Actually, all sweeps (except for some rare special cases) start from center and sweep to the right, after which the beam returns to the extreme left and continues to sweep toward the center. At this point on the screen the next sweep cycle really begins. As proof of this, one need but recall that before any deflection voltage is applied, the beam is at the center of the screen. Generally, it is not too important which viewpoint the scope user may have. For the purpose of this explanation, however, it is necessary to consider the center as the starting point.

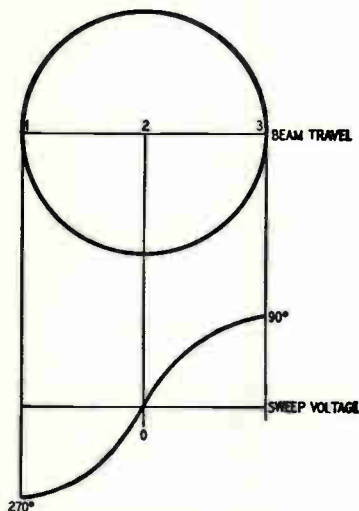

Fig. 614. Effect of sine-wave sweep voltage on beam travel.

Fig. 614 shows the effect of a sinusoidal sweep voltage on the beam of the scope. Since the beam normally rests at the center, i.e., with zero deflection voltage applied, it is obvious that there are three points on the sweep-voltage cycle during which this is possible. These points are: the beginning (0 degrees), the midpoint (180 degrees), and the end (360 degrees), of the sine wave. As the sine wave moves from zero to the positive maximum at 90 degrees, the beam, under the influence of an increasing deflection voltage, will move from center to the extreme right. Incidentally, this 90-degree point is the only one at which the beam will be located at the extreme right. As the cycle continues from max-

imum back to zero, at 180 degrees, the beam will gradually return to its initial position at the center of the screen. From 180 to 270 degrees the sweep voltage again increases—this time, however, in the negative direction, moving the beam in the opposite direction, from center to the extreme left. Finally, as the sine-wave voltage varies from maximum negative back to zero, from 270 to 360 degrees, the beam again returns to the center, or zero deflection position.

The effect of this type of sweep voltage on a response curve display can now be understood. Fig. 615 shows a response curve on

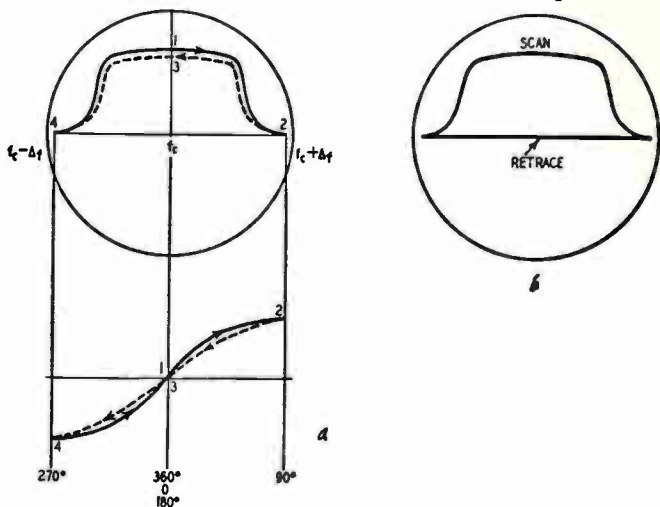

Fig. 615-a, -b. Response curve showing upper and lower frequency limits (a) and waveform as seen on the scope (b).

which are indicated the center frequency and the extremes of the lower and upper sidebands, f_c , $+\Delta f$ and $-\Delta f$ respectively. Recalling that the sidebands increase as the sine wave sweep voltage increases, it becomes apparent that the center frequency corresponds to the 180-degree position of sine wave, the $+\Delta f$ position on the extreme right occurs at the 90-degree point of the cycle and the $-\Delta f$ position corresponds to the 270-degree point of the cycle. Since we naturally wish the response curve to appear on the screen as in Fig. 615-b, i.e., with the left-hand slope at the left of the screen, the scope sweep voltage must at that time be at its 270-degree peak, or 90 degrees (one-quarter cycle) from the start of the cycle.

There are two main reasons why a phase-shifting correction is required. First, the energizing coil of the sweep unit, correspond-

ing to the voice coil of the speaker, has both a resistive and reactive component, causing a phase shift in the sweep current supplied to it. Second, the mechanical displacement of the modified speaker cone, acting as the sweep capacitor, causes additional

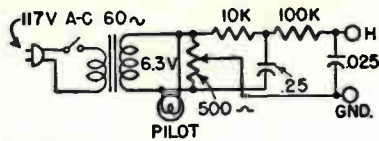

Fig. 616-a. Adjustable phase sweep circuit.

phase delay, or shift. Since both the energizing current and the resulting mechanical motion vary with the amount of sweep desired, different amounts of phase correction are required at different times. The variable phasing control is the answer.

Fig. 616-a gives the schematic of the adjustable phase sweep voltage for the scope. The source is the secondary of a 6.3-volt filament transformer. Shunting this secondary is a series r-c network, with a potentiometer acting as the resistive component. From elementary a.c. theory we know that the current in a resistor is in

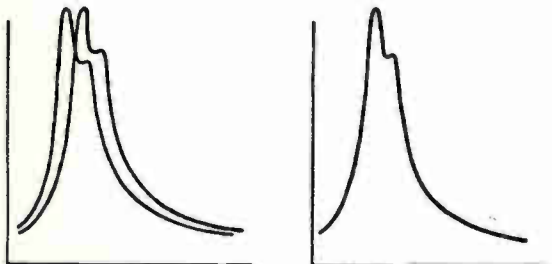

Fig. 616-b. Illustration at left shows need for phasing correction. Picture at right shows overlap of forward and return sweeps.

phase with its voltage, while in a capacitor the current is 90 degrees out of phase (leading). In a combined r-c circuit, the current still is out of phase, but by less than 90 degrees, due to the resistive component. The lower the resistance value, the nearer the circuit comes to being purely capacitive and vice versa. Thus, the potentiometer serves as a convenient means of phase-angle adjustment. As the voltage for the scope sweep is taken from the junction of the potentiometer and the capacitor, this voltage, too, will be phase-shifted. The exact setting of the potentiometer is that at which the forward and return patterns of the response curve overlap as completely as possible. See Fig. 616-b.

When using this device for scope sweep, it is customary to have the low-frequency side of the response curve on the left side of the scope screen. Should the reverse appear, as evidenced by moving the marker pip over the pattern, it is necessary only to reverse the a.c. plug of the sweeper-phaser to correct this minor defect.

Deflection polarity

It is often important to know whether the upper half-cycle of a signal seen on a scope is the positive or negative half-cycle in the original. Referring to Fig. 617, if the upper half-cycle of the sine wave (a) is the positive half of the original signal, then the wave shapes shown in Figs. 617-b and -c indicate different causes of distortion. Fig. 617-b may be caused by excessive bias on an amplifier stage, so that the tube is driven beyond cutoff on negative half-cycles. Fig. 617-c may be caused by inadequate bias or too low plate voltage.

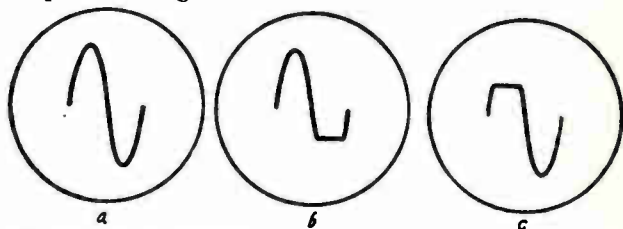

Fig. 617-a, -b, -c. Undistorted sine wave is shown in a, while clipping at bottom and top appears in b and c.

On the other hand, if the upper half-cycle seen on the scope is the *negative* half-cycle of the original wave, the causes for conditions 617-b and 617-c are reversed.

Thus, when using a scope, it is important to know whether

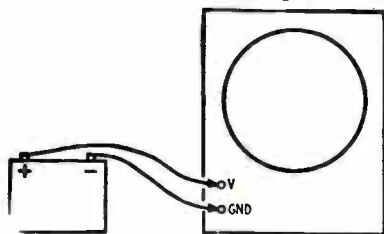

Fig. 618. Means for determining deflection polarity of scope.

a positive signal deflects the spot upward or downward. Either situation may exist, depending on the number of amplifier stages in the scope and exactly how the vertical-deflection plates are connected to the amplifier.

The simple technique illustrated in Fig. 618 may be used to

determine the deflection polarity of any scope. Any ordinary dry cell or B battery can be used. Connect the negative terminal of the battery to the GND terminal of the scope, turn on the scope sweep, turn up the vertical-gain control, and center the trace. Next, touch the positive battery terminal to the VERTICAL-INPUT terminal, watching the scope face closely. The line will be deflected *momentarily* either up or down, then will return to center.

If the deflection is upward, then the positive half-cycle of any observed signal will appear on the upper part of the scope screen, and vice versa.

Keep your eyes on the screen when making this test, since the deflection occurs only at the instant the battery terminal is touched to the input.

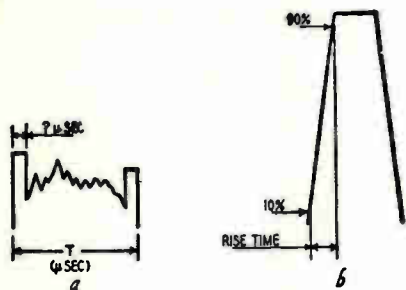

Fig. 619-a, -b. Typical pulse appears in composite video signal (a). Rise time of pulse is shown in illustration (b).

Calibrating the sweep in microseconds

In studying complex waveforms, it is often desirable to know the duration of a pulse, or even of a complete complex cycle, as shown in Fig. 619-a. In some types of analysis, the rise time of a sharp pulse (Fig. 619-b) must be known accurately.

Some expensive scopes have provision for making such measurements in the form of a sweep calibrated directly in microseconds per inch-deflection. However, even ordinary scopes can easily be calibrated for specific applications by using the technique shown in Fig. 620.

Connect an ordinary signal generator to the VERTICAL-INPUT terminals of the scope, set the frequency to the desired value, and adjust the scope sweep until one cycle occupies a fixed number of squares on the scope scale. When adjusting the scope sweep, use the smallest possible amount of sync, and obtain the single cycle by careful adjustment of the FINE-FREQUENCY control. This insures that the scope sweep is accurately on frequency. If too

much sync gain is used, the signal to be checked may give a false indication by saturating the sync circuit. This will cause a change in the scope sweep frequency.

As an example, if the scope sweep is adjusted until 1 cycle of a 100-kc signal occupies 10 horizontal spaces on the screen, then each space represents 1 microsecond. If a sharp pulse is then observed (signal generator disconnected), and it rises from 10% to 90% of its peak value in the space of one-half a square, its rise time is 0.5 microsecond.

The relationship between the frequency of the calibrating signal and the time duration of 1 cycle in microseconds is:

$$T = \frac{1,000,000}{f \text{ (c.p.s.)}}$$

If the scope is to be calibrated so that 10 spaces represent 1 microsecond, a single cycle of 1-mc signal is made to occupy that much space by adjusting the internal sweep. See Table 1.

TABLE 1

Time for 1 Cycle	Sweep Frequency
10,000 microseconds	100 cps
1,000 microseconds	1,000 cps
100 microseconds	10,000 cps
10 microseconds	100,000 cps
1 microsecond	1 megacycle
0.1 microsecond	10 megacycles

Most older scopes, and many of the less expensive scopes of today, use thyratron sweep circuits. These have an upper sweep limit of about 30 kc, so that a single cycle at 100 kc or 1 mc cannot be observed. However, a satisfactory calibration may still be obtained by adjusting the sweep till several cycles are observed, then expanding the trace with the HORIZONTAL-GAIN control until one cycle occupies the desired number of squares on the scope graph screen.

Plotting curves

The scope may be used to plot any curve showing the relationship between two varying electrical quantities, or between any two related quantities that can be converted into proportional voltages. As an example, the setup shown in Fig. 621 may be used for obtaining a B-H or hysteresis-characteristic curve of a transformer core made of iron or other magnetic materials.

The voltage across R1 is proportional to the current in L1, hence is proportional to the magnetomotive force. The voltage

induced in L2 is proportional to the derivative of the magnetic flux . . . that is, to the number of flux lines produced. An integrating network consisting of R2 and C1 is used to obtain a voltage proportional to the lines of flux, and this is applied to the vertical input of the scope.

Thus, since the horizontal deflection of the spot on the c-r tube is proportional to magnetomotive force (input current), and the vertical deflection is proportional to the number of flux lines produced, a conventional B-H curve is traced on the scope screen.

In an actual setup, the input voltage to the transformer is controlled by a *Variac* or a large wire-wound potentiometer (about 600 ohms at 50 watts). R1 should be kept as small as practicable—about 50 to 200 ohms generally being used. If preferred, a 75-watt lamp may be used in place of R1. R2 may have a value of 10,000 ohms, and C1 should be a 4- μ f paper unit.

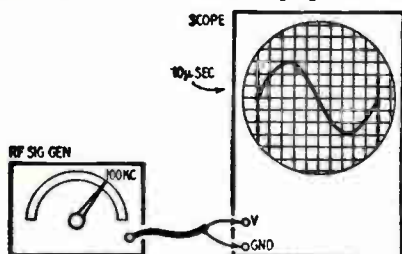

Fig. 620. Technique for calibrating scope sweep in microseconds.

Satisfactory curves can still be obtained if the integrating network R2-C1 is replaced simply by a load resistor R3. This load is necessary to prevent core saturation with low exciting current in the primary. Without a load (or integrating network), the flux density will be driven beyond saturation on peaks, and a distorted hysteresis loop will result. The exact load value can be determined experimentally for the transformer but 10,000 ohms is usually satisfactory for a start.

Scope precautions

Unless the scope is properly used, the pattern you get will be either inaccurate or misleading. Although some of these suggestions may seem obvious, ignoring them means trouble.

1. It is sometimes helpful if all test equipment together with the receiver under test is placed on a metal-top bench.* The ground connections for each piece of equipment should then be
- * This is not required for ALL makes of test equipment.

tied to the bench top with short lengths of 1/2-inch braided-copper ribbon. If a metal bench top is not available, the equipment must be bonded together with short lengths of braided-copper ribbon. The effectiveness of this bonding can be checked during alignment by placing the hand on the metal chassis being aligned and on the metal cases of the various pieces of test equipment. If the response pattern changes, the grounding must be improved before the circuits are aligned.

2. Use shielded leads between the sweep generator, scope, and receiver. You can use a strong signal from the generator when first starting alignment in order to force the signal through, but as alignment progresses, keep reducing the input signal. Too strong a signal will give a misleading response curve. An overloaded scope amplifier can also clip the signal. Don't go to the

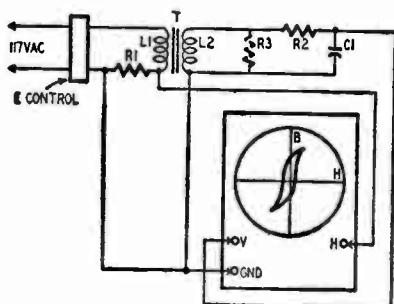

Fig. 621. Hysteresis characteristic as shown on the scope.

other extreme by pushing the test signal down to zero. The ideal input signal is one which approximates the actual value that the signal itself would have at the point of signal injection.

3. To prevent interference with the response curve when aligning picture i.f.'s, always remove the local oscillator tube or set the front end to a higher channel. If you align stage by stage, always disable preceding stage with a capacitor (.01 μf) from control grid to chassis.

4. When aligning a receiver, whether AM, FM, or TV, the receiver controls should be placed approximately in the positions they have during normal operation.

5. An isolating resistor in series with the hot side of the scope (V input) when connecting the scope across a high-impedance point will minimize high-frequency bypassing due to the input shunt capacitance of the scope. Resistance is not critical; it will vary from scope to scope. Typical values range from a low of 10,-

000 ohms to as high as 470,000. Some scopes have the resistor built in as part of the scope.

6. The bias to be used in place of a.g.c. during alignment is usually specified by the manufacturer of the receiver. The ideal bias to use is that value of bias which the receiver develops under normal operating conditions. Amount of bias depends on receiving location. In weak-signal areas we want the receiver to operate with maximum sensitivity, hence bias is low. Bias is more in strong-signal areas for the same receiver.

7. When injecting a signal into the secondary of an over-coupled i.f. transformer, disable the primary by shunting it with a capacitor, approximately 0.0001 μ f. If this is not done, the primary will act as an absorption trap, putting a dip into the response curve.

8. From the viewpoint of frequency, your sweep generator is not accurate. It doesn't have to be. Accuracy is of the utmost importance in your marker generator. The marker generator should be checked against a crystal-controlled oscillator.

9. The marker generator can distort the response curve, so keep the marker output as low as you can. If marker signal persists in distorting sweep curve, bring marker lead close to sweep generator lead, but do not connect. If marker is part of sweep generator, keep marker turned off except when necessary to check a frequency point. As soon as you can see the marker pip on the screen, mark the screen with a marking crayon or pen, then turn off the marker generator.

10. Don't try alignment until test equipment and receiver have been allowed to warm up for about 10 minutes.

Chapter

7

Tests and Measurements

IN this chapter we shall concern ourselves with general applications of the scope. Some of the tests and measurements will be for the establishment of normal conditions of operation, as well as comparison between these and abnormal cases.

Audio-gain measurements

This phase of radio has achieved tremendous significance in recent years. Maintenance of this equipment requires more than the services of an ordinary technician, since audio repair calls for audio knowledge, first-rate equipment, and experience.

Gain is a relative quantity. Amplifier gain is a comparison between available input to required output. An amplifier with a rated output of 6 watts may require a 9-volt input to the final stage for full rated output. The gain of this amplifier will then depend on the available output of the microphone, phono cartridge, or detector, whichever is used. Assuming a high-fidelity cartridge with an output of 10 millivolts, the over-all gain required is:

$$\frac{E \text{ output}}{E \text{ input}} = \frac{9}{0.01} = 900$$

In the measurement of amplifier gain, it may be most convenient to use the scope as a calibrated voltmeter. The scope is

placed across the plate circuit of the output stage and the generator signal is increased until the output waveform begins to show some distortion and then is backed off until the distortion disappears. The generator frequency for this test should be the standard test frequency of 1,000 cycles. Both amplifier output and generator input should be measured with the calibrated scope. The gain is calculated and then converted to decibels.

In making gain measurements it is important to know the absolute value of input voltage, since the signal from the input device may cause distortion due to overloading. Thus, an amplifier capable of high undistorted output from a 0.2-volt source may distort badly on larger input signals. If, during a gain test, it is found that an amplifier intended to work from high signal input distorts on a signal lower than that of the input device, the first (and sometimes also the second) stage should be analyzed for abnormal operation, low B plus potentials, leaky coupling capacitors, wrong bias, etc.

Power output calculations

When sine wave a.c. is used for this measurement, it is simple to calculate the undistorted power output of the amplifier, knowing the voice-coil impedance. The setup is the same as for gain measurement, except that the calibrated scope is now transferred to the voice-coil winding of the output transformer. Since the scope is most likely to be calibrated from an r.m.s. meter, the scope reading in r.m.s. volts is therefore used "as is" in the formula: $P = E^2/R$. E is the voice-coil voltage and R is the voice-coil impedance. Assuming a voice-coil voltage of 6, and an impedance of 8 ohms, the power output is: $P = 6^2/8 = 36/8 = 4.5$ watts.

Audio response measurement

The response curve of an amplifier is intended to indicate the behavior of the system at various frequencies. While all audio frequencies must be checked, it is not necessary to actually apply them all to get an over-all indication of amplifier linearity. Furthermore, it is not usually necessary to make this test at the maximum output of the amplifier. In some cases, the response is given at some nominal output level below the maximum and the response at the maximum output may be indicated as being within a number of decibels of the given response curve. This is prac-

tical, since it is not often desired to have as flat a response at the peak output as at some normally used, moderate power level.

One of the methods for judging frequency response with the scope involves the use of a square-wave generator. Instead of testing at all frequencies, square-wave testing at but two or three selected frequencies is quite adequate. The basis for this is the nature of the square wave. Although simple in appearance, the square wave actually consists of a great number of sine-wave components, superimposed so as to produce the final square waveform. Since the component sine waves are of both low and very high frequencies, faithful reproduction of a square wave by the amplifier is a reliable indication of over-all good frequency response. Specifically, the steeply rising sides of the wave are indicative of good high-frequency response, while the undistorted flat tops are

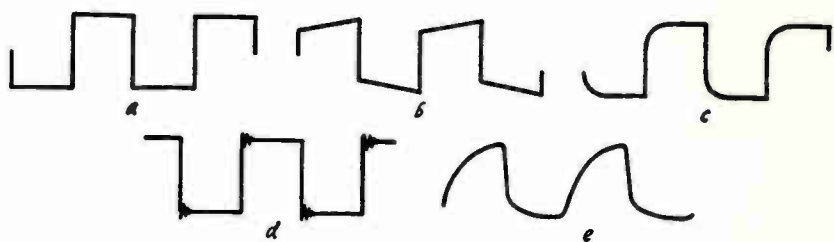

Fig. 701. *Ideal square wave and effects produced by improper amplifier design.*

evidence of linear operation at the very lowest frequencies. The tests are made at three frequencies, as, for example, 50 cycles, 500 cycles, and 5,000 cycles. Various resultant scope waveshapes are shown in Fig. 701. In Fig. 701-a the original, perfect square wave is illustrated for comparison. Since the linearity test is affected by the quality of the input waveshape, it is necessary to have good waveform at the generator output. In most generators, the higher frequencies are somewhat poorer in shape, hence it is important during a test to observe any imperfections (such as rounding of the corners, tilting of the sides, sloping of the flat top) in the original signal by means of the scope, before amplifier performance is judged. In a high-quality amplifier, the output waveshape at low frequencies should very closely approach the shape shown in Fig. 701-a. Poor low-frequency response, such as might be caused by insufficient bypassing, too small or leaky coupling capacitors, improper low-frequency compensation, poor audio transformers, etc., is shown in Fig. 701-b. Fig. 701-c shows the square wave with

rounded corners. This is an indication of poor high-frequency performance, possibly due to excessive distributed capacitance of a transformer, high-gain triode input and output capacitance, etc. Aside from the most obvious response characteristics of the square wave, there are some other defects which can be identified. Fig. 701-d shows the effect of some transient oscillations, or stray resonance, in the amplifier. R-c decoupling circuits, shielding in high gain, low-level stages, and B plus circuit isolation between plates and screens—any or all of these, if not functioning properly, might be responsible for this condition. Another fairly common defect, phase shift (or rather, variation of phase shift with frequency) may be identified from the sloping sides of the distorted square wave of Fig. 701-e.

In case of trouble, individual stage analysis will locate the offending stage, or stages. Oscillation is likely to start in an early, high-gain stage. If the scope is placed at the output of that stage, the remainder of the amplifier is automatically eliminated, if oscillation is found. Similarly, hum pickup is more likely to occur in the first stage, due to low signal level and high gain. Another example is that of poor low-frequency response. Since many high-quality amplifiers incorporate low-frequency compensating stages (so-called "bass boost"), it is not always feasible to check the over-all amplifier low-frequency response without first ascertaining whether the circuit up to and including the boost circuit is normal. Assuming a good square-wave input, the boost circuit should be set for *flat* response, or zero rise in response. Then the subsequent stages can be checked for any deterioration of the low frequencies. The same holds true for the usual *treble boost* since oscillation may actually be caused in some cases by excessive rise in treble response. Preliminary checking of the frequency-compensating circuits will therefore help localize the faulty stage.

Phase shift

The term *phase shift* as used in evaluating the performance of audio amplifiers does not refer to the absolute phase shift of the signal in going through one or more stages, but rather to the difference in phase shift at different frequencies. While this may be considered as another method of determining the quality of response of an amplifier, it is largely a check on low-frequency performance, since it is here that phase shift is likely to be greatest.

The basis of phase-shift analysis of amplifier response is the fact that an amplifier, which theoretically shifts an input signal by an exact number of multiples of 180 degrees (once for each triode or pentode stage, none for a cathode follower), actually may cause a net shift of a few degrees more or less, depending on design, quality of components, linearity of characteristic curves, etc. Furthermore, the slight variations of the different stages may sometimes be cumulative, resulting in an appreciable over-all amplifier shift from an exact 180-degree multiple. Were it possible to insure that all frequencies would be shifted by an equal amount, the net effect would be that of no noticeable shift at all. However, since this phenomenon is a frequency-variable quantity, the result is distortion. As a matter of fact, phase shift curves are often plotted against frequency, with the significant factor being not the number of degrees of shift, but the variation in shift at different frequencies. A *flat* curve is an indication of good amplifier performance.

In analyzing the phase-shift characteristics of an amplifier, use

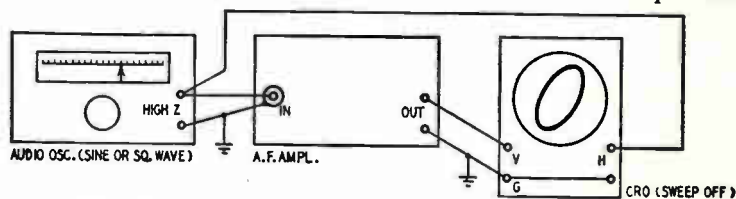

Fig. 702. Technique for measuring the phase shift of an amplifier.

is made of the Lissajous figures. However, in this case, the frequency ratio is kept constant at 1:1, i.e., the input to the vertical and horizontal terminals of the scope are at the same frequency. Fig. 702 shows, in block diagram form, the setup for measuring the phase shift of an amplifier. The audio oscillator is fed to the input circuit of the amplifier, with the input level kept below that which would produce distortion. The same oscillator also connects to the HORIZONTAL INPUT of the scope, with the INTERNAL SWEEP disconnected. The output of the amplifier connects to the VERTICAL scope input, and both VERTICAL and HORIZONTAL GAIN controls are adjusted to give a reasonable size of pattern on the CRT. Fig. 703 shows a number of examples of phase-shift patterns obtainable. The 0- or 180-degree shift is ideal, but seldom realizable. In practice, a shift of 10 to 15 degrees is barely noticeable. When making quantitative phase shift measurements, a graduated scale placed over the scope screen helps compare the

shift at different frequencies. For a good evaluation of amplifier performance, take measurements at regular (logarithmic) frequency intervals over the whole range of the amplifier, with particular emphasis at lowest frequencies. Since the highest frequencies will show the least shift, it is desirable to start the measurement at the high end and observe the increase in the shift (opening of the ellipse) as the frequency is reduced. In connection with this test, remember that the vertical and horizontal amplifiers of the scope are also involved in the signal path. Unless the scope is known to have a negligible phase shift of its own, or

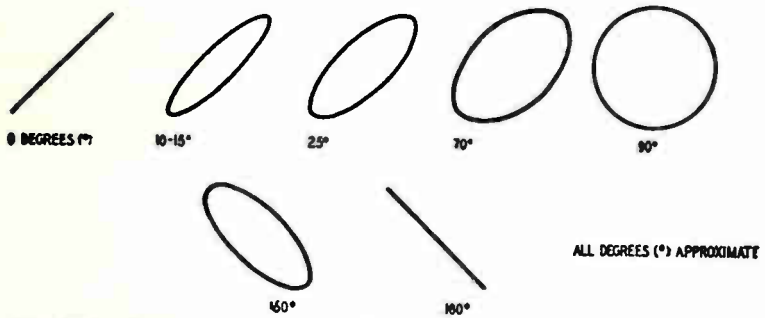

Fig. 708. Representative phase-shift patterns. Use a graduated scale over face of scope when making such tests.

at least the amount of shift is definitely known, the accuracy of the measurement will be seriously impaired.

Here is a specific procedure for measurement of amplifier phase shift:

1. Allow equipment to warm up. Turn scope sweep to off position.
2. Set the scope controls so that the spot is in the middle of the screen.
3. Connect the output of the audio oscillator simultaneously to the HORIZONTAL INPUT of the scope and the amplifier under test. See Fig. 702. Connect the output of the amplifier to the V-INPUT terminals of the scope. Adjust the V-gain for a convenient height of the trace, one-half of the CRT diameter being a good size. This is best done with the HORIZONTAL GAIN set at zero, resulting in a straight vertical line on the screen. Note the height of the line, using a graduated scale screen.
4. Reduce the VERTICAL GAIN setting to zero and adjust the HORIZONTAL GAIN for the same length of line as in step 3.
5. Restore the VERTICAL GAIN setting to the value used in step

3. This will give equal vertical and horizontal deflections, resulting in a perfect circle for 90- and 270-degree shifts, and making it easy to judge the amount of shift at intermediate angles.

6. Vary the frequency of the audio oscillator over the range claimed for the amplifier. Generally, it is more important to watch the lowest frequencies, hence a minimum frequency of 30 cycles is suggested.

7. Observe the width of the ellipse at the various frequencies tested and compare with the typical examples shown in Fig .703. For a more accurate determination of the angle of shift in degrees, the following method is suggested:

8. Plot a phase-shift characteristic curve, using the number of degrees of shift as an ordinate (vertical scale) and the frequency as the abscissa (horizontal scale). The "zero" line corresponds to no-shift condition (180 or 0 degrees).

Hum

In curing hum problems, the source must be clearly identified before remedial measures can be taken. There are two very common sources of hum in radio and TV receivers, and they require different treatment. These are hum pickup from a.c. leads and hum residue from inadequately filtered B plus supplies. Since the hum from a.c. leads, such as heater wiring, cannot be killed, the remedy lies in placement of components, lead dress, and routing of wires. Assuming that there is a normally designed circuit, such as in commercial TV sets, the presence of hum is evidence of some local failure.

1. *Heater-cathode leakage.* This is a very common trouble. In normal tubes, the heater-to-cathode insulation is more than adequate for circuit requirements, unless the maximum heater-to-cathode potential specified by the tube manufacturer is exceeded. With aging, however, the insulation resistance between the two elements often goes down to the point of allowing sufficient a.c. to reach the cathode and the signal circuits. While a specific tube in a local circuit is most likely to cause the defect, it is not at all uncommon for a defective tube anywhere in the receiver to be the offender. In case of difficulty, every tube in the signal circuit, up to and including the tuner, should be checked. A good tube tester will usually suffice, although sometimes nothing will work out short of substitution with a tube known to be good.

2. *Grid circuits.* Hum pickup in this portion of a tube circuit is most likely because of the high sensitivity of the circuit. Being usually of high impedance, the grid circuit is naturally more susceptible. For example, a grid circuit may appear to function normally as far as the signal is concerned, but is almost certain to pick up hum from a nearby heater lead, or its own heater circuit. Here, too, dressing of leads and placement of components is extremely important. The best procedure is to duplicate as far as possible the manufacturer's original placement, otherwise experimentation must be used.

3. *Screen bypass and B+ decoupling circuits.* These are grouped together since both involve bypass capacitors operating at relatively high voltages. Leakage due to age or excessive ambient temperatures, while not sufficient to produce a marked change in circuit operation, is sufficient to cause hum pickup. In many circuits, filtering of the B plus actually consists of both the filter network at the rectifier output and the local r-c filtering at each individual tube or element.

4. *Critical lead dress.* This refers particularly to those components which, because of their function in the circuit, are more susceptible than others. Leads from i.f. coils to tube grids, video circuit peaking coils, r.f. chokes, etc., fall into this category. Unlike such passive components as resistors, these reactive components are naturally more responsive, because of their tunable characteristics (Q, etc.). Exact duplication of original positions after repair or replacement is the best method of avoiding trouble. Only general suggestions for curing such difficulties can be given, since positioning of components necessarily differs in various receivers. In general, r.f. leads should be kept as high as possible, as short as possible, and as clear of other components (especially those carrying a.c.), as local conditions will permit. The manufacturer's specific lead-dress instructions, where available, are always preferred.

In all of these examples, analysis of the point or points involved, using the scope at or near its maximum VERTICAL GAIN setting, will almost always produce good results. However, since at some of these points, particularly grid circuits, very small amplitudes are encountered, the trouble-shooter must be certain of his scope. In high-grade scopes there should be no trace of hum on the screen with the VERTICAL GAIN all the way up. If there is some waviness in the horizontal line at a high gain setting, the user must be care-

ful not to mistake this for a fault in the receiver being analyzed. This is particularly important, since both the scope hum and that of the receiver under test are likely to be of the same frequency and the same order of magnitude. Thorough familiarization with the characteristics of the vertical amplifier of his own scope will enable the user to distinguish between defects in a receiver and shortcomings of a piece of equipment.

B plus supply hum

Insufficient filtering of the B plus, such as that due to a leaky or open capacitor, may be due to failure either in the basic filter network at the rectifier output or the local r-c filtering at each

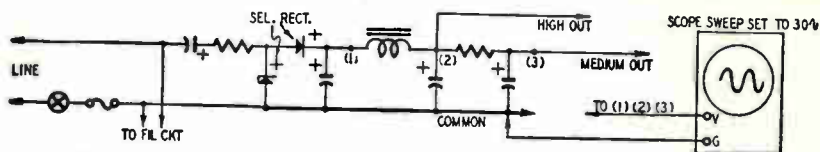

Fig. 704. Method for checking hum voltage of transformerless supply.

tube. Fig. 704 shows the diagram of a transformerless power supply and the method of measuring the hum at the points indicated. In using the scope, it should be calibrated for a peak-to-peak deflection of 1 or 2 volts. Be careful. Transformerless supplies can be dangerous! Common of supply should connect to grounded side of power line.

Hum in the video signal

There are two main sources of hum that may appear in the video signal. First there is the 60- or 120-cycle hum from the power supply. This can be seen either on the TV screen, or on the scope. The 60-cycle hum can be identified by single dark and light bars across the picture screen, each taking up approximately half the picture height and blending into each other, due to the gradual sinusoidal variation. The 120-cycle hum has two bars, dark and light, alternating with each other. On the scope the same defect can be identified by the sinusoidal outline. Actually, the whole signal is "snaking" sine-wave fashion.

As a preliminary check, the contrast control is turned down. If the hum disappears with the signal, leaving a normal raster, the hum origin is most likely in the video circuits. Short-circuiting the video detector (or the plate of the final i.f. stage, using a capacitor) will definitely indicate whether the hum originates before the detector (tuner, i.f. stages, a.g.c. circuit, etc.) or in the

video amplifier. After that, signal tracing with the scope by moving back one stage at a time will locate the origin of the hum. Since, in addition to the signal circuits, the hum may stem from the a.g.c. or brightness control circuits, analysis of these with the scope is necessary. In either case, placing the VERTICAL INPUT of the scope across the main a.g.c. bus and turning the scope VERTICAL GAIN to maximum will reveal any a.c. modulation on this line. The same holds true for the brightness circuit. Fig. 705 shows a brightness control circuit with the scope connection for hum tracing illustrated. It is possible to observe some vestige of hum, especially if the scope VERTICAL GAIN is extremely high. However, it should not be difficult to ascertain the difference between minor hum, and a major component of hum, perhaps a large fraction of a volt, by calibrating the scope for a full-scale deflection

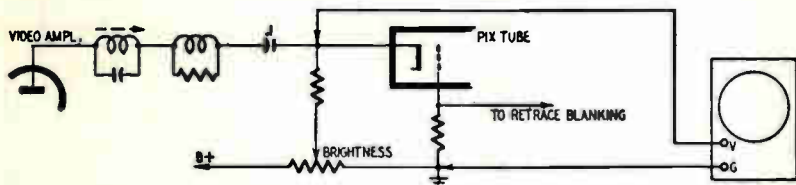

Fig. 705. Procedure for tracing hum in TV brightness circuit.

of 1 volt peak-to-peak and then measuring the unknown hum component on this scale. Should this test prove negative, heater-to-cathode leakage in the video circuits should be looked for. In cases where a component has been replaced in the video circuit (anywhere beyond the video detector), lead dress must be checked, since careless placement of a grid lead near a source of a.c. may well be responsible for hum pickup.

Video flutter

In connection with the examination of a.g.c. voltage for possible source of hum, there is another useful test that can be made with the scope, by observing the stability, or lack thereof, of the a.g.c. voltage. Normally, the a.g.c. is intended to vary the r.f. and i.f. gain of a TV set to compensate for relatively long-term fluctuations of signal input at the antenna. The r-c time constant of the a.g.c. circuit is therefore relatively long, to correspond with the slow rate of input signal variations. Fig. 706 shows a typical a.g.c. network with normal filter components. If a filter capacitor should open up, the result would be a very unstable a.g.c. voltage, resulting in a fading in and out of the signal on the screen. With

the scope set up as for hum tracing, the horizontal line across the scope can be watched for periodic, regular rise and fall, indicating voltage fluctuations. It may be helpful to also have a v.t.v.m. placed in parallel with the scope, as well as to watch the picture on the TV screen simultaneously. A falling of the a.g.c. in step with fading of the picture is conclusive proof of the failure of the a.g.c. circuit. In making this test, the service technician should first ascertain whether or not the signal circuits before the video detector are operating normally. Misalignment of the i.f., faulty screen and plate circuit bypassing, excessive peaking of the i.f. and r.f. circuits, as is sometimes done for the purpose of enhancing fringe area reception, all these will contribute to general circuit

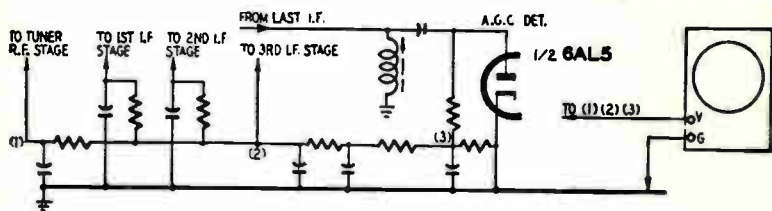

Fig. 706. The a.g.c. network can be tested with the scope.

instability. If misalignment is at fault, make your correction as closely as possible in accordance with the specific recommendations of the manufacturer, since such factors as gain, bandwidth, and peak frequencies of stagger-tuned circuits vary greatly among different receivers.

Regeneration of i.f. amplifiers

Open bypass capacitors, poor grounding, defective or inadequate shielding, and overcoupling produce regeneration. In picture i.f. stages even mild regeneration is sufficient to ruin the picture.

To check for i.f. distortion, set up the equipment as for i.f. alignment, stage by stage. That means that the last i.f. stage is checked first, then the preceding one, and so on all the way back to the mixer. With the equipment so set up:

1. Feed a signal to the grid circuit of the stage.
2. Observe the pattern of the scope. If the sides of the response curve are fuzzy or jagged (see Fig. 707-b), either regeneration or oscillation is present, depending on the degree of departure from the smooth curve of Fig. 707-a.
3. Move the input signal back toward the mixer one stage at a time and repeat this observation in each case.

NOTE: In receivers having the contrast control in the i.f. circuit, such as a cathode bias or a.g.c. voltage adjustment, this control should be set nearly all the way up, in order to determine whether regeneration exists at high gain (weak signal) operation. However, a slight trace of regeneration at this setting is permissible, since any signal of acceptable strength will seldom require

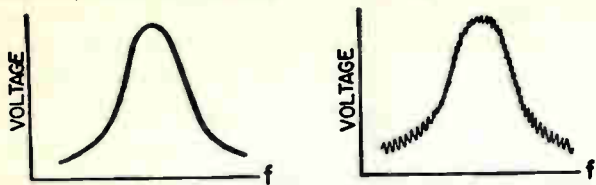

Fig. 707. Regeneration or oscillation in i.f. amplifier stages produces a fuzzy or jagged curve. Smooth curve at left should exist practically up to maximum contrast-control setting.

such a high setting of the contrast control. Conversely, any signal so weak as to require maximum gain setting is likely to be too poor for acceptable performance.

Measurement of current waveshapes

In most oscillographic observations, particularly in television and radio circuits, voltage waves are observed. When the component across which the voltage appears is a simple unit, such as a resistor or a high-grade capacitor, the test is simple, since only one electrical quantity is involved—resistance only in the case of the former and almost 100% pure capacitance in a high-grade capacitor. Thus, although the voltage waveshape is observed, the current waveform is accurately known. In the resistance, the voltage and current shapes are identical, while in the perfect capacitor the relation between voltage and current is also known. There are cases, however, in which the current waveshape is important, such as in the deflection yoke of a TV receiver. Since the scope is almost universally an electrostatic device, with the input terminals being the grid circuit of an amplifier, only voltages can be applied and observed. The simple device described will enable observation of current waveshapes with almost perfect accuracy. The method is based on the fact that the current in a resistor is in phase with its voltage across it, hence observation of the voltage is equivalent to viewing the current waveshape.

Fig. 708 shows a partial diagram of the vertical deflection output circuit of a TV receiver. Since the yoke is an r-l device, con-

taining, in addition to the necessary inductance, a certain amount of unavoidable resistance, and since for linear deflection a sawtooth current is required in the yoke, the voltage across the r-l yoke is a trapezoid, which combines the characteristics of a square and sawtooth voltage waveshape, in such proportions that the resultant current is a sawtooth. However, placing the scope across the yoke will show the composite voltage waveshape of the trapezoid, hence will not show conclusively the current waveform.

Referring again to Fig. 708, a small resistor is placed in series with the yoke, the value of the resistance being such as not to materially affect the over-all yoke characteristics. A 5- or 10-ohm, 5-watt resistor is quite adequate. Since the resistor is in series, the

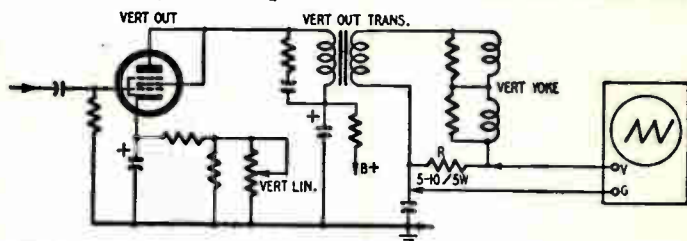

Fig. 708. Voltage across the yoke is a trapezoid. Current through the yoke should be a sawtooth.

current in it is the same as that in the yoke. Furthermore, since in the resistor the voltage waveshape is the same as the current producing it, observation of the voltage across the resistor is tantamount to viewing the current shape in the yoke. The scope is therefore placed across the resistor, and if necessary the vertical linearity control is adjusted until as linear a sawtooth as possible is obtained. The same procedure applies to the horizontal circuit, enabling adjustment of horizontal drive and linearity controls for best sawtooth waveform across the yoke.

Checking synchronization pulses

Another check which *must be done with the scope* is the observation of synchronizing pulses and the pulse-clipping action in the television receiver. *Improper* clipping may result in poor holding (picture drift). The synchronizing pulses, instead of the video signal, are clipped, leaving little or no sync pulses at the input to the sweep generating circuits.

Fig. 709 shows the various types of video-sync signals. In Fig. 709-a, the combined video and sync signal is shown. In Fig. 709-b we see the signal after *correct* clipping—the sync pulse without

the video. Wrong clipping, in which the synchronizing pulse has been removed and the video left, is shown in Fig. 709-d.

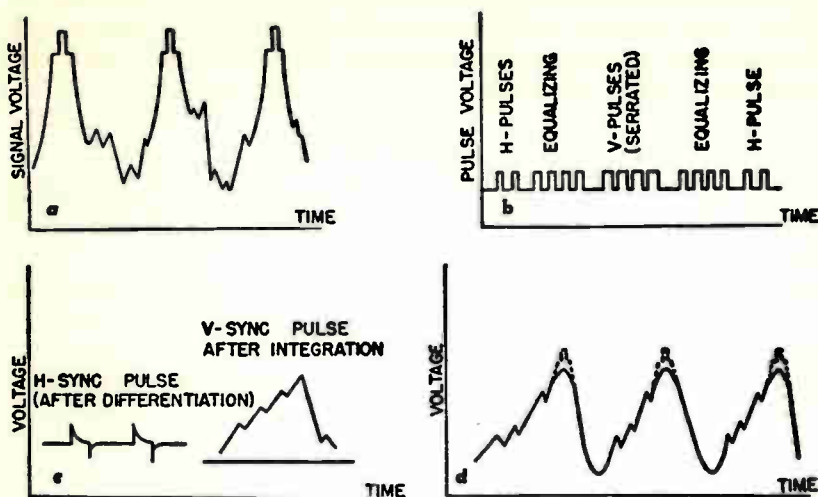

Fig. 709. Sync pulses in a TV receiver can be examined with the scope.

To check these phenomena with the scope, view the pulses at the following points by applying the VERTICAL INPUT terminals to:

1. Output of the video amplifier—this should show the combined signal. (Fig. 709-a)
2. Output of the sync amplifier—clipping takes place here, hence the video should be substantially removed. (Fig. 709-b)
3. Output of sync separator—both pulses (H and V) appear here *without* the video.
4. Input to the horizontal oscillator—only the horizontal pulse should appear. (Fig. 709-c)
5. Input to the vertical oscillator—this will show the vertical sync pulse only. (Fig. 709-c)

Remember, that individual variations in manufacturers' designs may call for somewhat different techniques. The best advice in addition to the information in this book is: Follow manufacturers' procedures as far as possible. They save time and trouble.

Auto radio vibrator supplies

One of the more important applications of the scope is the checking and correction of faults in auto radio vibrator systems. In spite of the fact that it is almost impossible without a scope

to service properly this most common job in the shop, too few service technicians have ever taken advantage of this instrument. Difficulties such as chronic rectifier failures, short-lived vibrators, low output voltages, and noisy receivers are almost beyond the ability of the multimeter to diagnose. Yet the scope will locate these faults with little expenditure of time or effort.

Vibrator power-supply defects

The vibrator power supply, whether in auto-radios, self-charging portables, or similar equipment, depends for its operation on the conversion of steady d.c. to pulsating or interrupted d.c. While the resultant voltage is not quite sinusoidal, approximating more closely a square wave, the characteristics of the waveform are very important. In normal sine-wave a.c. the variations in amplitude are always gradual, resulting from the sinusoidal rise and fall of the voltage. The square wave, by contrast, is quite different. The rise from zero to maximum is quite fast and sudden, while the maximum level is steady throughout its duration, like d.c. Such a steady voltage or current contributes little to the operation of the step-up transformer. In applying a square wave to the transformer primary, a certain amount of rounding off of the wave is produced by the characteristics of the transformer, due to its reactance, flywheel effect, and the r-l characteristics of the windings. Nevertheless, due to the steepness of the nearly square-wave output of the interrupter, surge voltages are likely to occur, which not only cause difficulty in filtering and bypassing but very often cause tremendous secondary peaks, sometimes in the order of a few thousand volts. In practical vibrator power supplies, damper resistors and buffer capacitors are used to counteract this tendency toward surges. Unlike many other applications where a larger capacitor is often "just as good," if not better, the value of a buffer capacitor is rather critical, too small a size being inadequate to reduce surges to a safe value, while too large a size may cause rounding off of the input waveshape to the extent of seriously reducing the output voltage, causing excessive heating, etc. Of no less importance is the behavior of the vibrator contacts. Erratic or pitted contacts can be responsible for low output, noise, fluctuations in receiver volume, and many other objectionable operating characteristics. A defective buffer capacitor can cause low voltage output, bad arcing, and damage to the vibrator, rectifier tube, and even the power transformer. Similarly,

improperly adjusted vibrator contacts can cause most of these, in addition to noise in the receiver.

Fig. 710 shows a portion of the vibrator supply system. With the circuit in normal operating condition, and the vertical input to the scope across points A and B or A and C (not to ground!), the voltage pattern should look like Fig. 711-a. The SCOPE SWEEP frequency for this test should be about 40 or 50 cycles, giving

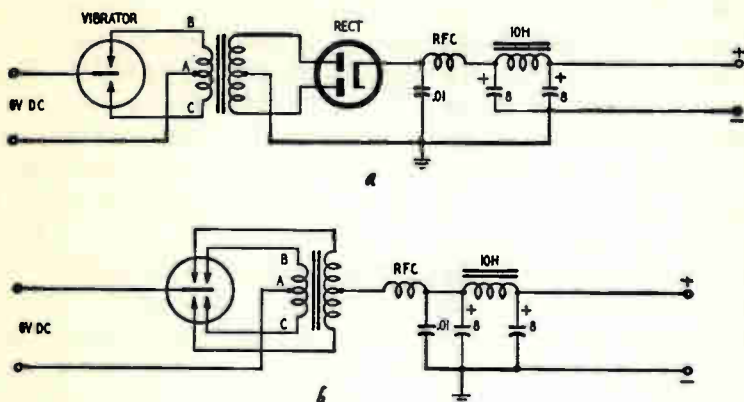

Fig. 710. Test points in non-synchronous and synchronous vibrator power supplies.

about 3 or 4 cycles on the screen. Note that the wave is substantially square, with no steep peaks or rounded corners. This indicates a correct value of buffer capacitor and proper contact spacing.

Fig. 711-b indicates either too small a buffer or a complete lack of buffering. This will usually be accompanied by low output voltages. If an exact duplicate replacement cannot be made, the substitute chosen should bring the wave shape as closely as possible to that shown in Fig. 711-a.

Fig. 711-c shows the effect of too large a buffer capacitor. The lagging edge of the wave is rounded off. A very common defect in old vibrators is poor contact due to pitted contacts and chattering. The resultant wave looks somewhat like Fig. 711-d. Careful dressing and readjustment of the spacing of the contacts will remedy most of this difficulty, although it may be more convenient as well as more economical to replace such a vibrator with a new one. However, where replacement cannot be made

for any reason, this procedure will make the old unit serviceable for quite a while longer.

Fig. 711-e shows the wave form for a normal vibrator of the *synchronous* (self-rectifying) type. The sharp pips in this case are no indication of a defect as was the case in Fig. 711-b. They are due to the opening of the secondary, or rectifying, contacts in synchronism with the primary breaker points.

When adjusting vibrators, slightly different vibrator frequencies in different receivers require variations in contact spacing as well as buffer capacitances. Since manufacturers do not encourage vibrator repairing, it is difficult to outline precise adjustment

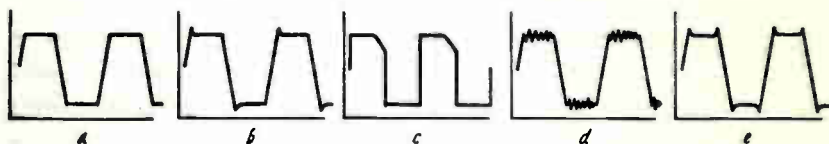

Fig. 711. Improper operation of vibrator power supply can be quickly checked through waveform analysis.

procedures. However, these directions and sample patterns are typical of most common practices, as well as of good design and operating conditions. Where a repair has to be made and no other specific instructions are available, the outline given will prove sufficiently helpful to achieve satisfactory results.

Selenium rectifiers

The condition of a selenium rectifier also may be checked with the scope, and impending troubles anticipated. Remove the normal load and substitute a load resistor as indicated in Fig. 712. The selenium unit should be loaded just under its maximum rating with suitable resistors as indicated in Table 2. Connect the vertical deflection plates of the cathode-ray tube directly across the unit as shown.

TABLE 2

Rectifier Rating (ma)	Load Resistor (ohms)
75	2,000-3,000
100	1,200-1,800
125	960-1,200
150	800-950
200	600-800
300	400-600

The selenium rectifier is composed of a number of metal plates which have one side coated with selenium and a low-temperature alloy. As the selenium unit begins to "show its age," or, when

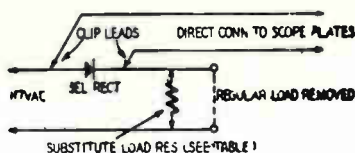

Fig. 712. Setup for checking selenium rectifiers.

minute arcs develop from excessive moisture on the plates, the conduction in the *undesired* direction increases and rectifier action is impaired. Typical traces on the scope with the setup of Fig. 712 are illustrated in Figs. 713-a, 713-b, and 713-c. A good unit will give the pattern shown in *a*. A deteriorating selenium unit will produce a trace like the one in *b* when operated near its

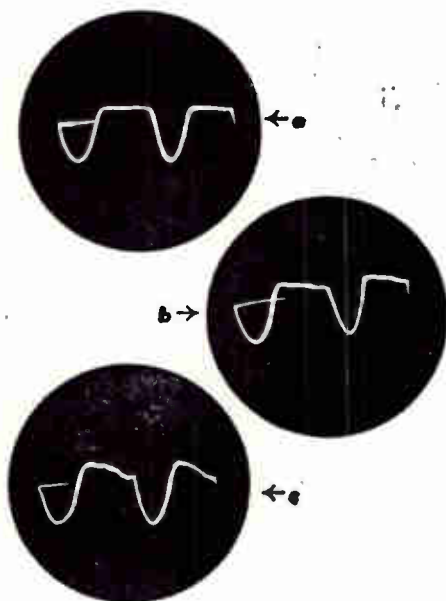

Fig. 713. Typical waveforms produced when checking selenium rectifiers with the scope.

maximum load. (It should be noted that some hump will appear normally if the rectifier is not loaded properly.) Fig. 713-c is the trace produced by an unsatisfactory unit.

Checking filter operation

A number of conditions may be observed with the connection shown in Fig. 714. The VERTICAL INPUT terminals of the scope are connected directly across the filter choke. The amplitude of the trace at this point is usually great enough to allow the signal

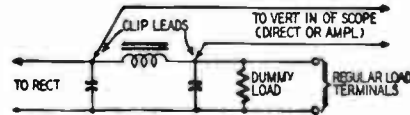

Fig. 714. Scope connections for checking filter operation.

to be fed directly to the vertical deflecting plates, although the vertical amplifier may be used if desired. (Caution: Practically every general-purpose scope has one terminal of each input circuit grounded to the case. The hookup shown in Fig. 714 puts the full output voltage of the power supply directly on the scope case. This is a highly dangerous situation. Do not attempt to make

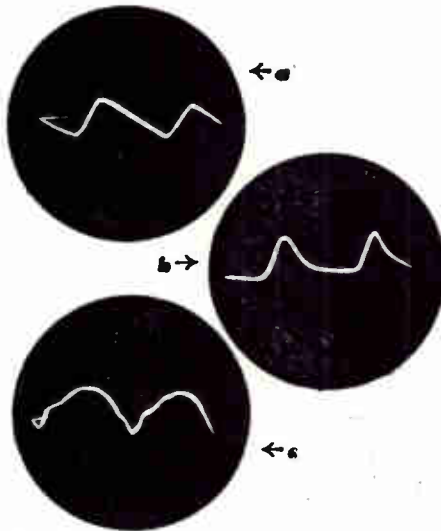

Fig. 715. Representative waveforms obtained when checking power-supply filter.

measurements of this type without taking every possible precaution to avoid a fatal shock from contact with any part of the scope).

The scope sweep should be adjusted to show two or three alternations on the screen. The normal power-supply load may be removed and a suitable dummy-load resistor substituted across the filter output.

A normal pattern obtained from this connection with good input and output capacitors and normal load current is shown in Fig. 715-a. The slope of the discharge trace depends on the resistance of the load. The higher the resistance, the slower the rate of discharge will be. If the power supply is in good operating condition, the discharge trace will be straight and smooth.

If the output capacitor is open or partially open, the waveform will look like Fig. 715-b. The effect of the choke inductance is readily apparent and the rate of discharge is no longer linear. A completely open output filter capacitor can usually be recognized by excessive hum or motorboating, but a partially open capacitor may go undetected until a customer has used his set a few days after a service job. Thus any test that will anticipate possible future trouble is well worth the time consumed.

A completely open *input* filter capacitor shows up in low-voltage output and may also introduce excessive hum. Again, however, this condition can sometimes be anticipated with the scope, as illustrated by Fig. 715-c. This pattern across the choke reveals an open or partially open input capacitor. The height of the hump will depend on the amount of input capacitance left in the circuit. (The same is generally true of Fig. 715-b, where the steepness of the discharge curve just after the charge peak will depend on the effective output capacitance for a normal load current.)

In general the input filter capacitance affects voltage output and ripple (hum) content, and the output filter capacitance controls the amount of ripple in the d.c. delivered to the load. Another factor relating to adequate output filter capacitance should be borne in mind by the reader concerned with high-fidelity audio amplifiers or transmitters. The reactance of the output filter capacitor must be negligible at the lowest audio frequency to be amplified efficiently.

Measuring ripple

The simplest way to determine the amount of ripple in the output of the power supply is to compare the a.c. component of the output with the output of a voltage calibrator. (Before proceeding with these ripple measurements check whether the d.c. output of the power supply is higher than the maximum-signal-input rating of the scope. If it is, you will have to make up a simple resistance voltage divider as shown in Fig. 716.)

Feed the output of the calibrator to the scope VERTICAL INPUT (through the voltage divider, if required) and adjust the over-all height of the trace with the scope VERTICAL GAIN control to fill the required number of calibration lines. For example, if the calibrator output is 50 volts peak-to-peak, it should fill 25 or 50

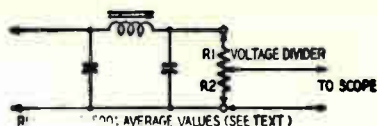

Fig. 716. Simple voltage divider protects scope.

horizontal lines. It is not necessary to balance the trace uniformly on either side of the center line.

Then—without changing any of the scope adjustments—disconnect the calibrator and hook the VERTICAL INPUT leads of the scope (or the voltage-divider leads) across the power-supply output terminals. The blocking capacitor in the scope input circuit

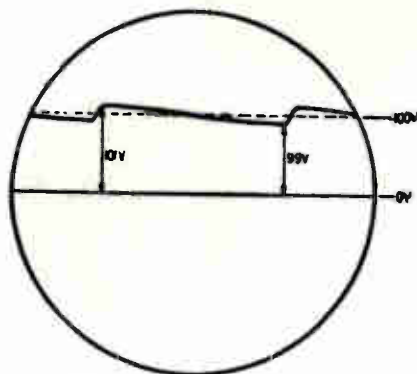

Fig. 717. Method for measuring ripple voltage.

will pass only the a.c. component of the power-supply output voltage. The peak-to-peak ripple voltage can then be read simply by counting the total number of horizontal calibration lines occupied by the trace.

To find the ripple percentage, measure the d.c. voltage at the scope input terminals and apply the following formula:

$$\text{Ripple } \% = \frac{35 \times E_{pp}}{E_{dc}}$$

where E_{pp} is the peak-to-peak ripple voltage and E_{dc} is the measured d.c. voltage.

If no voltage calibrator is available, the ripple can be computed by observing the actual variation in d.c. output voltage on the scope. To do this, first lock the scope sweep at the *line frequency*, so that *two complete ripple cycles* will appear on the screen with a full-wave rectifier. Short out the VERTICAL INPUT terminals and adjust the position of the sweep trace so that it coincides perfectly with one of the horizontal calibration lines near the bottom of the calibrating screen.

Next, apply an accurately known d.c. voltage (a 100-volt B battery, for example) directly across the vertical deflecting plates of the scope. This will shift the trace vertically, but it should still remain perfectly horizontal. Now switch the scope input to

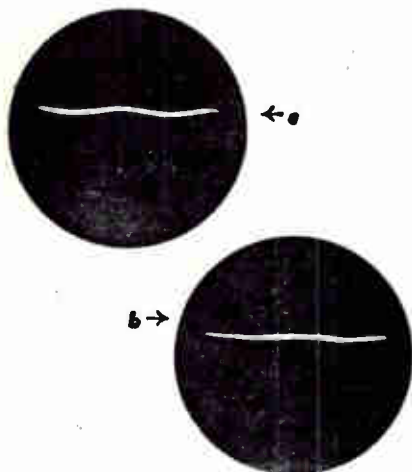

Fig. 718. Photo of filter output hum traces.

the voltage divider across the power supply. Adjust the divider output for the same vertical displacement obtained with the battery, and center *one* of the ripple cycles exactly on the horizontal calibration line.

The peak-to-peak a.c. component (ripple) can now be found by counting the number of horizontal lines between the left and right ends of the cycle.

This method of measurement is illustrated in Fig. 717. The test is most accurate when a screen containing a sufficient number of fine lines is used. Assume, for example, that the trace is as shown in Fig. 717, with the left end of the trace showing 101

volts and the right end showing 99 volts. In the example given, the actual ripple is 1 volt (varies 1 volt above and below d.c. level), and the percentage ripple is therefore $100 \times 1/100$, or 1%. This amount may be considered satisfactory for many receivers and PA systems, but the maximum allowable for high-fidelity equipment is 0.5%. This amount is hardly calculable on the scope and will appear as a perfectly straight line.

Figs 718-a and 718-b illustrate filter output traces under two typical conditions for a typical full-wave rectifier system. Fig. 718-a illustrates the trace without an *output* capacitor, and Fig. 718-b shows the same system without an *input* capacitor. Note that hum is greater without the output capacitor than without the input capacitor. The voltage output is lower, and the performance of the amplifier might be poorer.

Chapter

8

Experiments Using the Oscilloscope

THE following experiments are intended to acquaint the user not only with the particular instrument he has purchased, for more efficient utilization of its capabilities, but also to learn the various functions and interpretations of the waveshapes displayed on the scope. Learning the intricacies of an instrument such as a scope while attempting to make use of it in actual trouble-shooting of a TV receiver is at best only a poor substitute for an orderly study of the device.

Most of the experiments are based on the type of equipment the average service technician usually has. While the square-wave generator is not too widely used, it is becoming more popular, especially in audio-amplifier servicing. Even here, the lack of the square-wave generator will not prevent the service technician from performing some of the tests, as suggestions are given for improvising and simulating certain conditions.

Adjustment of Oscilloscope Controls

EXPERIMENT I

Purpose: To become familiar with the various operating controls of the scope.

Equipment: Cathode-ray oscilloscope, test leads.

Theory: See Chapters 1 and 2.

Procedure

1. Plug instrument into power source and turn switch ON. Allow a few minutes for warmup.
2. Advance INTENSITY control until beam or spot is visible.
3. Turn COARSE sweep control to any of the mid-positions, and advance H-GAIN, or X-AMPLITUDE, control until a line appears on the screen.
4. Rotate FOCUS control slowly through its range, observing the effect on the sharpness and thickness of the line. Leave control at the sharpest position of the line.
5. Advance INTENSITY control gradually to its maximum setting and notice the effect on the sharpness of the line on the screen.
6. Readjust FOCUS control until the line is again as sharp as possible.
7. Reduce INTENSITY setting to approximately halfway position and observe effect on focusing of the line.
8. Reduce intensity to the minimum satisfactory brightness and refocus. Observe quality (fineness) of line.
9. Turn V-GAIN or Y-AXIS AMPLITUDE control to its minimum (extreme counterclockwise) position.
10. Place finger on metallic part of V-INPUT binding post and gradually advance V-GAIN control with other hand. Observe height of trace.
11. With pattern as in 10 above, touch metal cabinet of scope with free hand and observe effect on height of trace.
12. With setup as in 10 above, adjust COARSE and FINE (or VERNIER, or FINE FREQUENCY) control until two or three waves appear on the screen.
13. Connect a lead between TEST POINT or "60 cycles" on the scope and the V-INPUT terminal. Readjust FINE control until two or three waves are almost stationary on the screen.
14. Vary the H-GAIN control over its entire range and observe the effect on the pattern. Leave control in position so that pattern nearly covers the screen.
15. Switch the SWEEP-AMPL control to AMPL position. Observe effect on horizontal deflection.
16. With switch left as in 15, place finger on H-INPUT post. Notice the effect on the trace.
17. Turn SYNC SIGNAL SELECTOR to LINE.

18. Gradually advance SYNC AMPLITUDE control and observe effect on nearly-stationary pattern on the screen. Leave control in position at which trace stops moving.

19. Detune the FINE frequency control until trace starts moving and readjust SYNC control until trace stops again. Compare settings of SYNC with previous case. Continue advancing this control and observe effect on trace. Back off control until trace again begins to drift, then increase until trace stops moving.

20. Turn SYNC SELECTOR to EXTERNAL. Observe effect on trace. Switch back to INT.

21. Rotate V-POSITION or V-CENTERING control through its range. Observe effect on trace. If effect is not instantaneous, wait a few moments after each portion of rotation until trace stops moving.

22. Reset V-POSITION control until trace is midway up on the screen. Using the H-POSITION control, repeat step 21.

Relation Between Signal and Horizontal Sweep Frequencies EXPERIMENT II

Purpose: To study the effect of sweep frequency on the number of cycles displayed. To identify signal frequencies from known sweeps.

Equipment: Oscilloscope, audio oscillator, test leads.

Theory: The detailed theoretical discussion of Chapter 2 need not be repeated here. A brief statement of the principle, however, will serve as a reminder. When the signal frequency is equal to the sweep, one cycle of the signal will appear. In general, the number of signal cycles appearing on the screen is the number the signal frequency is higher than the sweep frequency. On the other hand, when the sweep frequency is higher, less than one cycle will be displayed. The pattern is then rather broken up, consisting of two or more parts of one cycle, partly superimposed on one another, since the sweep goes across the screen and then retraces a number of times while one signal cycle is generated. Such viewing of unknown signals is generally of little use, except in the case of Lissajous figures, where the broken parts of the cycle are linked together.

When the test frequency is so high that a large number of cycles is displayed on the screen, details of an individual cycle can still be observed through the use of the HORIZONTAL GAIN CONTROL.

This control is advanced sufficiently so that only two cycles are on the screen, the remainder being "wrapped around" the edges of the tube face. Thus, signal frequencies as high as 1 megacycle can be viewed with the ordinary scope having a sweep range no higher than about 50 kc. Special-purpose scopes have sweep frequencies much higher than 50 kc, but these are of but little use to the service technician.

Procedure

1. Allow instruments to warm up and adjust scope controls for normal brightness, correct focus, centering, etc.
2. Connect output of audio oscillator to the VERTICAL INPUT of the scope. Set oscillator frequency to 50 cycles.
3. Set COARSE control of the scope sweep to the position which includes 50 cycles (this might be 30-110 on one scope, 25-80 on another, etc.).
4. With SYNC AMPLITUDE control at minimum setting and SYNC SELECTOR ON INT, adjust FINE or VERNIER frequency control until two or three cycles appear on the screen and are almost stationary.
5. Slowly rotate FINE control in the direction of increasing frequency (clockwise) and observe effect on pattern. Repeat in the opposite direction. Restore sweep to original position (wave almost stationary).
6. Advance SYNC AMPLITUDE control until pattern on screen just stops moving.
7. Gradually advance frequency dial of the audio oscillator, observing the effect on the screen. Continue until three cycles appear on the screen. Read frequencies on oscillator dial.
8. Continue rotating oscillator dial until four cycles appear. Read frequency dial. Repeat the above until five cycles appear. Read oscillator dial.
9. Slowly increase FINE and if necessary, COARSE dials of the scope sweep until only four cycles are shown on the screen, with the audio oscillator dial unchanged. Estimate the approximate frequency of the scope sweep setting. Repeat above procedure until three, then two cycles appear on the screen. Each time estimate the setting of the sweep frequency.
10. Vary either the oscillator or the sweep frequency controls until only one cycle appears on the screen. Estimate the sweep frequency and read the oscillator dial.

11. Set the **COARSE** and the **FINE** sweep controls to maximum. Gradually advance the audio oscillator frequency until a few cycles are shown. If the cycles on the screen are too crowded, advance the **HORIZONTAL GAIN** until sufficient spread is obtained on the screen to see two cycles clearly. Record the oscillator frequency and the estimated sweep frequency.

NOTE: If the maximum audio oscillator frequency is not high enough (not over 20 kc) substitute an r.f. signal generator with the modulation **OFF** and proceed with step 11, until the highest observable frequency is determined, using the maximum scope settings outlined in step 11.

12. Advance the oscillator frequency until no individual cycle can be observed on the screen. Observe the pattern of the signal under this condition. This is the appearance of an unmodulated carrier. The zero line, although invisible, is midway down the band, as can be seen by reducing the vertical gain control to zero.

Effect of Sync Selector and Sync Amplitude Controls

EXPERIMENT III

Purpose: To observe the purpose and behavior of the synchronizing circuits.

Equipment: Scope, audio oscillator, test leads.

Theory: In practical terms, synchronization means stopping the motion or drift of the pattern on the screen after the sweep frequency has been adjusted to as nearly an integral submultiple of the signal frequency as possible. The common term for this is *locking*, implying that the sweep has been locked to some exact point on the signal voltage cycle. When the sweep frequency is somewhat faster than an exact submultiple of the signal frequency, the trace drifts to the left, while too slow a sweep makes a drift to the right. A more exact analysis of this phenomenon may be given as follows: Consider a signal frequency of say, 120 cycles, and a sweep frequency of approximately 40 cycles, resulting in three cycles being displayed. Bearing in mind that the signal is continuous while the sweep is regularly interrupted by the retrace time, it is apparent that a small portion of the trace, namely the end of each third cycle on the right-hand edge of the screen, will be invisible. Fig. 801 shows this in graphic

form. The dashed portion of each third cycle occurs during retrace time, hence is missing from the trace. Since the retrace time of any sweep is determined by the circuit constants, an equal portion of each third cycle (at any particular frequency) will be missing. If the same portion is missing each time, say from 330 to 360 degrees, the left-hand edge of the trace will always begin at the same point, hence the traces will overlap and the pattern will stand still. However, if due to drift or any other difference in individual sweep

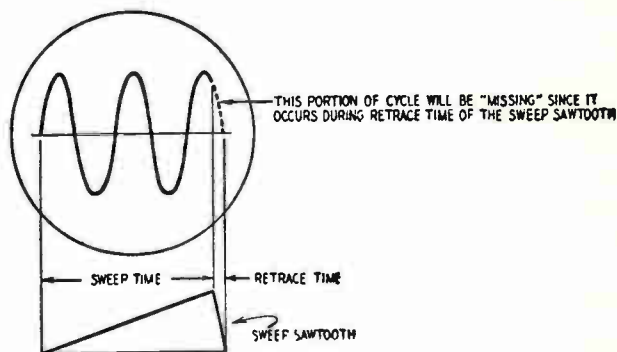

Fig. 801. Waveform shown on scope is affected by retrace time of sweep sawtooth.

cycles, such as too fast or slow a sweep, a different 30-degree section of the trace is missing, perhaps from 327 to 357, or from 335 to 365 degrees, the visible portion of the trace on the right side will begin a bit sooner or later, resulting in what is commonly called *drift*. The remedy for this effect is called *synchronization*. Briefly, synchronization means timing the end of each sweep cycle so that the beginning of the next cycle is always at the same degree point on the signal wave being displayed.

There are usually three sources of sync voltage in ordinary scopes, the INTERNAL, the LINE, and the EXTERNAL. The most common of these, the INTERNAL, is actually the signal voltage itself. It is by far the most useful source of sync voltage, since it is virtually infallible and always keeps pace with the signal. This may be compared to synchronization in television receivers. Regardless of any possible drift in the sweep frequencies from the nominal values, synchronization is not affected, since the sync pulse always keeps step with the signal.

The second type of sync source, the **LINE**, is used mainly because of its relative stability. Naturally, it has limited application, in case of 60 cycles and its multiples. Lastly, the **EXTERNAL** sync position is mainly for special applications, not too often used in radio and TV service. It has wide applications, in laboratory and other commercial work, where timing and similar measurements are involved. The external sync source is fed to the appropriate input terminal and the amount is adjusted by the same amplitude control used for **INTERNAL** or **LINE SYNC**.

Procedure

1. Allow the equipment to warm up and adjust the scope controls for proper viewing.
2. Turn **SYNC SELECTOR** to **EXTERNAL**, and **SYNC AMPLITUDE** to minimum.
3. Connect the 60-CYCLE test point to the **VERTICAL INPUT** of the scope and adjust the sweep for two cycles, as nearly stationary as possible.
4. Rotate **SYNC AMPLITUDE** control as far as possible and observe the effect. Return this control to minimum.
5. Switch the **SYNC SELECTOR** to **LINE** and gradually increase **AMPLITUDE** control setting until trace locks. Observe setting of this control, leaving it in this position.
6. Return **SYNC SELECTOR** to **EXTERNAL** and observe effect on trace. Switch **SELECTOR** to **INT**. Observe effect on trace. Rotate **AMPLITUDE** control slightly below and above its setting and observe position at which pattern locks. Return **SELECTOR** to **EXTERNAL** and return **AMPLITUDE** to minimum.
7. Connect the output of the audio oscillator to the **EXT. SYNC** input terminal of the scope and adjust the gain control of the oscillator for about 6.3 volts r.m.s.
8. Gradually advance **AMPLITUDE** control until pattern again locks. Observe setting of this control. Return **SYNC SELECTOR** switch to **INT**.
9. Disconnect 60-CYCLE test signal from **VERTICAL INPUT** and substitute the audio oscillator in its place. With the **AMPLITUDE** control set to minimum, obtain 4 cycles on the screen, using a 500-cycle signal from the audio oscillator.
10. Gradually advance the **AMPLITUDE** control until the pattern locks. Observe setting.
11. Continue advancing the **AMPLITUDE** control while observ-

ing the pattern. Advance until three cycles, then two cycles appear on the screen. Observe setting of AMPLITUDE control for three and two cycles. Restore scope controls to positions giving four cycles, as in step 9, but with AMPLITUDE control at zero.

12. Adjust FINE frequency sweep until pattern drifts noticeably. Advance AMPLITUDE control until trace again locks. Observe setting of AMPLITUDE control at locking.

13. Detune FINE sweep control and simultaneously advance sync amplitude until locking results. Continue until sync amplitude setting is at maximum and the trace can barely be locked. Observe effects on pattern in each step.

Comparison of Direct and Amplified Signals

EXPERIMENT IV

Purpose: To become familiar with and distinguish between direct and amplified signals. To learn the characteristics of the scope amplifiers.

Equipment: Scope, i.f. sweep generator, TV receiver of known response, or i.f. system capable of being aligned for at least 4 megacycles bandwidth.

Theory: The signal amplifiers of the scope, particularly the vertical amplifier, are expected to handle frequencies from nearly d.c. up to four megacycles, as found in television receiver video output stages. Since the ordinary r-c amplifier is seldom linear over such a wide range, various methods are used to extend the response of the vertical amplifier system of the scope. The horizontal amplifier, too, must at times amplify a wide band of frequencies, although not nearly as wide or as often as the vertical. Through peaking, direct coupling or low-frequency compensating circuits, the response of these circuits is brought up to a nominal 3- or 4 megacycles. However, absolutely flat response over the entire range is not always obtained. It is therefore necessary, where signal amplitudes are large enough, to bypass the vertical amplifiers of the scope and feed the signal directly to the deflection plates. When the input signal is not adequate to permit this, the amplifier must be used, of course. It is desirable under these conditions to know the relative performance of the vertical amplifier, by comparing the response of a given signal as affected by the amplifier with that applied directly to the deflection plates. If the attenuation of the amplifier is known

relative to the direct-input method, the quality of the response can be judged and proper allowance made. Of course, this comparison holds only for the particular scope tested. It is the purpose of this experiment to enable the user to become familiar with the response characteristics of his vertical scope amplifier.

Procedure

1. Set up equipment as for a video i.f. alignment.
2. Make a preliminary i.f. alignment, using the vertical amplifier of the scope, and feeding a maximum possible signal to the receiver without overloading. An a.g.c. battery substitute voltage should be used and set so that the i.f. grids are not driven positive.
3. Using the graduated plastic scale on the scope screen, strive for the best response possible. Carefully observe and record the height, width and sloping of the curve on the gradual scale.
4. Change the scope input circuit to direct input. The amplifier will now be out of the circuit, the signal going directly to the deflection plates. Observe width and slope of response curve and compare with the amplified response previously obtained.
5. Change back to amplified input and adjust VERTICAL GAIN so that response is now approximately the same amplitude as that obtained with direct input in step 4.
6. Compare bandwidth of the two response curves, at 100% amplitude, at 70%, and at 50%. Also notice whether the high- or low-frequency end of the response is more attenuated in the amplified signal.
7. Realign the i.f. amplifier to a bandwidth of about 2.5 or 3 megacycles. Repeat steps 4, 5, and 6 and observe difference between direct and amplified responses.

Lissajous Figures

EXPERIMENT V

Purpose: To become acquainted with the Lissajous Figures method of identifying unknown frequencies by comparison with a known frequency.

Equipment: Scope, audio oscillator, test leads.

Theory: As discussed in the text and illustrated in Experiment II, the number of cycles displayed on the CRT screen de-

depends on the ratio between the signal and the sweep frequencies. Thus, if one of these frequencies is known, the number of cycles on the screen enables determination of the second signal frequency. This is the basis of the Lissajous figures system of frequency determination. There is a major difference between the usual scope (built-in) sweep and the sinusoidal sweep used in Lissajous figures. The internal sawtooth sweep of the scope is practically linear, with but a small portion of the total cycle time given to retrace. As stated earlier, during the retrace time a portion of the signal waveshape is lost, either because the beam is extinguished ("blacked out") or simply because the time is so short and

Fig. 802. The internal sweep of a scope is a sawtooth waveform. With internal sweep in the off position and controls set for external sweep, a sine-wave voltage can be applied to the horizontal-deflection plates for sweeping the electron beam. Sine-wave sweep has no retrace portion, as is the case with sawtooth sweep, hence no part of the displayed waveform will be missing. Sine-wave sweep produces nonlinear scanning.

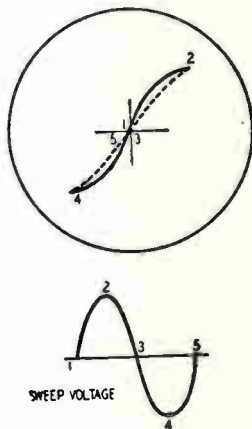

the path of the beam is in the opposite direction, so that the small part of the cycle generated during this time is spread out across the whole screen, in addition to being much dimmer than the forward trace or scan. By contrast, consider a sine-wave voltage applied to the horizontal deflection plates for beam sweeping. The scan is no longer linear, but sinusoidal, causing the beam to travel at different speeds over different portions of the screen. Furthermore, since the rate of change of this scanning voltage never changes abruptly, none of the signal cycle will be omitted.

Fig. 802 shows the result of one cycle of sine-wave a.c. sweeping another sine-wave cycle. Starting with the zero degree position of the sweep cycle, the beam is deflected to the right during the first 90 degrees of the sweep, whereupon the voltage increases to a maximum positive value. As the sweep voltage progresses from

90 to 180 degrees, the amplitude decreases from maximum positive back to zero, retracing and repeating the values of the first quarter cycle. The beam will therefore return from its final position back to its origin. As the sweep cycle continues from 180 to 270 degrees, its amplitude now increases, as during the first quarter cycle, but in the opposite direction. The beam will now be deflected from its original position in the left-hand direction, at the same rate as during the first 90 degrees of sweep. The final portion of the sweep, from 270 degrees to 360, will retrace the path of the third quarter-cycle, bringing the beam back to its starting point. Notice that throughout this sweep cycle the beam was always visible, thus forming a continuous trace.

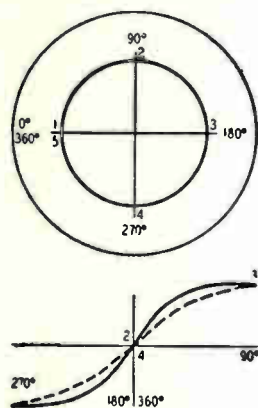

Fig. 803. With sine-wave input to the vertical-deflection section of the scope, and using sine-wave horizontal sweep, a circle will be displayed on the scope screen if the signal and sweep voltages are 90 degrees out of phase with each other. For lesser degrees of phase shift the circle becomes an ellipse. Where the phase difference between signal and sweep voltages is 0 or 180 degrees, pattern is a straight line.

Consider now the situation in Fig. 803. The signal and sweep sine waves are now 90 degrees out of phase with each other. At the extreme left edge of the screen, the signal voltage is at its 0-degree position, while the sweep is at its 270-degree point. As the sweep returns to the 360-degree point (or zero deflection voltage), the signal rises to its maximum value while returning to the center of the screen (the normal undeflected position). During the next quarter cycle of sweep the beam is pulled to the right edge of the screen while the signal amplitude gradually decreases to zero. Without going into elaborate mathematical proofs, it is sufficient to say that due to the fact that both the signal and the sweep are sinusoidal, a semicircle will have been traced on the screen. Next the sweep voltage decreases back to zero while the signal sine wave increases in the negative direction to its maximum. The beam is now at the bottom center of the screen, having traced three-quarters of a circle. During the last quarter-

cycle sweep, when its voltage increases to its maximum negative value, the signal or beam is pulled to the extreme left while the amplitude decreases back to zero. A complete circle has thus been scanned.

This example is the simplest of the Lissajous figures, representing a 1:1 ratio. Should the sweep cycle be twice as fast (double the frequency) as the signal, only one-half of the signal cycle will have been traced. However, since the trace is still a closed figure, there will be two loops along the vertical and one along the horizontal axis (resembling a figure 8). The vertical-to-horizontal ratio is now 1:2. Similarly, a 300-cycle signal swept by a 60-cycle deflection voltage will have 5 horizontal loops and 1 vertical loop (ratio 5:1), while a 100-cycle signal swept by the same 60 cycles will have a ratio of 5:3, resulting in 5 loops along the horizontal axis, and 3 along the vertical.

In displaying these ratios on the c-r tube screen, take care not to skip over some of these ratios as the signal frequency is changed. Thus, in moving from a simple 1:1 to a 2:1 ratio, it is possible to stop at a 5:3, 3:2, and other combinations. However, it is best at first to become familiar with the simple ratios before attempting to identify the more complex ones. In adjusting the audio oscillator for a stationary trace, make sure that all the loops are shown on the screen. If this is not done, erroneous ratios may be obtained when right-to-left loops overlap those traced from left to right. There will be twice as many loops when no overlapping takes place, hence counting of the loops should be done in this position.

Procedure

1. Allow equipment to warm up, as usual.
2. Disconnect the INTERNAL SWEEP of the scope, using the SWEEP-AMPL switch.
3. Connect the 60-CYCLE TEST signal from the terminal on the scope to the HORIZONTAL INPUT posts. The sweep frequency will now be 60 cycles.
4. Connect the audio oscillator to the VERTICAL INPUT of the scope. Adjust V-GAIN.
5. Set the oscillator dial to slightly below 60 cycles and gradually move dial to increase frequency. Adjust dial until a stationary circle appears on screen. Read oscillator dial.
6. Continue rotating dial in the same direction until a fig-

ure-8, lying on its side, appears. See Fig. 804-a. Again read the oscillator dial.

7. Rotate dial in the opposite direction, past the "circle" (1:1) frequency, until a figure-8 again appears, but this time in an upright position. See Fig. 804-b. Read dial again.

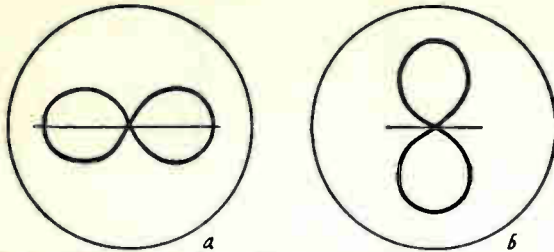

Fig. 804-a, -b. Lissajous figures in the form of a number 8.

8. Set dial to approximately 90 cycles and adjust carefully until a stationary figure appears. See Fig. 805-a. Repeat at approximately 180 and 240 cycles. See Figs. 805-b, -c. Read dial each time. Compare traces obtained with those shown in Fig. 805.

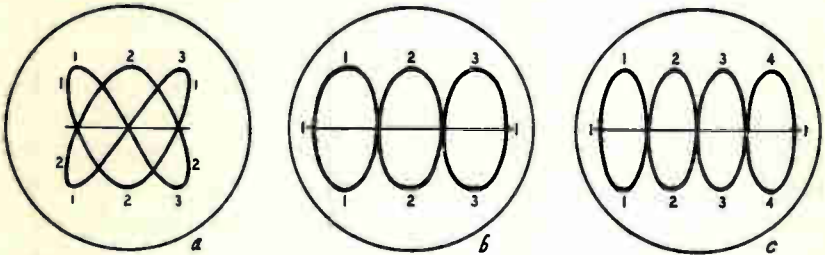

Fig. 805-a, -b, -c. Use of Lissajous figures for determination of an unknown frequency.

9. Reset dial to approximately 100 cycles. Carefully adjust until a stationary figure like Fig. 806 appears. Repeat procedure at 150 cycles, and read dial when trace like Fig. 807 appears.

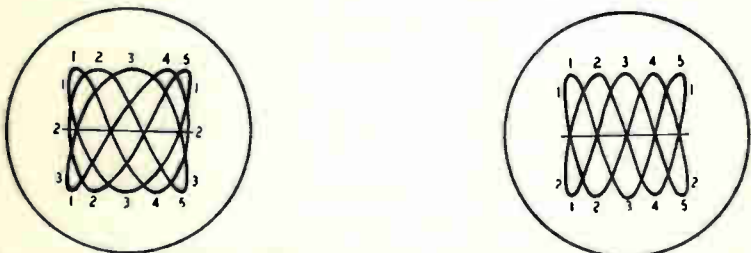

Fig. 806 and Fig. 807. In the illustration at the left (Fig. 806) we have a 5:3 ratio. Fig. 807 at the right shows a 5:2 ratio.

Audio Distortion Due to Overload

EXPERIMENT VI

Purpose: To become familiar with the appearance of the wave-shape of an overloaded audio amplifier.

Equipment: Scope, audio oscillator, audio amplifier, test leads.

Theory: While overloading is not the only type of audio distortion encountered in amplifiers, it is most interesting from the viewpoint of the television service technician. In aligning video i.f. amplifiers, the object is to obtain as flat a response as possible. It is possible, however, to obtain an erroneous flatness of response, due to overloading of the i.f. stages, wrong bias, etc. The object of this experiment is to recognize the appearance of a flat-topped curve due to such overloading. Since the input signal in this case is a sine wave, there is no possibility of mistaking the flatness of the trace for a normal signal.

Audio distortion due to overloading may be caused by one or both of the following two factors. First, the operating bias of an audio amplifier (in most cases, except for Class B) is usually such that the maximum input signal will not quite drive the tube to cutoff. Thus, for a bias of -8 volts, the peak value of the signal should be less than 8, so that at the maximum negative excursion of the grid-voltage plate current still flows along the linear curve. The wave-shape of the signal will then be faithfully reproduced. Should the signal be increased to a peak value of, say, 10 volts, cutoff will be reached when the signal is 2 volts below peak. The same situation in a video i.f. stage would produce a perfectly flat top on the response curve, although actually there is almost always considerable variation in that portion of the response.

The second factor producing overload distortion is plate-current saturation. Although less frequent, except in limiter or clipper stages, a sufficiently high input signal will drive the plate current, on the positive signal swing, into the more-or-less flat part of the characteristic curve, where plate current rise no longer follows grid swing. Should this happen in an i.f. response alignment, the curve will again look much better than it really is.

In observing the distorted waveshapes in this experiment, distinction must be made between overload in the amplifier before the signal reaches the scope and overloading of the scope vertical amplifier. In some scopes it is quite easy to drive the vertical

amplifiers sufficiently to obtain squaring or clipping. To avoid this, the maximum input to the vertical amplifier before clipping must be ascertained.

Procedure

1. Allow all equipment to warm up.
2. Connect the audio oscillator to the VERTICAL INPUT terminals on the scope.
3. Set the audio oscillator to 1,000 cycles and increase generator output while observing output waveshape. Keep increasing generator output up to maximum. If distortion appears, measure the input voltage to the scope, using a v.t.v.m. (If no distortion is obtainable, no measurement is required.) At all times, the input to the scope should be kept below this value.
4. Switch the audio oscillator to the input of the amplifier and connect the output of the amplifier to the VERTICAL INPUT of the scope. If the output transformer in the amplifier is for a speaker voice coil, the scope is almost certain not to be overloaded, and no measurement of the scope input signal will be required.
5. Advance audio oscillator output control to the point where the wave just begins to distort. Reduce slightly and measure generator output.
6. Increase signal input further until a definite flattening of one peak of the sine wave appears. Readjust VERTICAL GAIN control on scope, if necessary. Measure the output of the generator at this setting.
7. Continue increasing the signal input until the opposite peak of the sine wave also begins to distort. In addition to decreasing the scope VERTICAL GAIN, it may be necessary to use the VERTICAL CENTERING control, moving the trace up or down, until the extreme of the signal is visible. Record the voltage at which distortion begins on the second peak.
8. Continue increasing the signal input beyond the value at which the first peak became flattened, and observe the effect on the trace. Observe both the width of the flat top as well as the change in steepness of the sides, compared to a normal sine wave.

Effect of Marker Pip Amplitude on Response Curve

EXPERIMENT VII

Purpose: To learn the proper setting of the marker amplitude for correct appearance of the response curve during alignment.

Equipment: TV receiver, scope, sweep generator with marker, test leads.

Theory: The frequency marker, or pip, is a necessary adjunct to alignment of TV and other bandpass circuits. Its function is twofold: To measure the over-all bandwidth of a response curve or the width between two definite points on such a curve, and, second, to locate the absolute frequencies (such as locations of carriers) involved in alignment. For bandwidth determination, the marker is placed first on one side, then on the other, of the response curve. The difference in megacycle reading between the two markers is the bandwidth of the response. In absolute determination of frequency, the marker is moved to the desired point on the curve and the frequency is read on the marker dial.

Fig. 808. As shown in the illustration at the right, the marker signal amplitude modulates the sweep waveform. Marker signal strength should be kept to a minimum value. Bandpass can be determined by reading the frequencies shown on the marker dial.

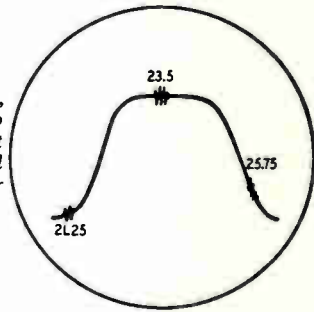

There are two main types of markers in use today: The superimposed type and the absorption type. The superimposed marker consists of a c.w. oscillator tunable over the desired range, coupled to, or mixed with, the sweep generator r.f. input to the circuit being aligned. The marker amplitude is separately adjustable. When placed on the swept response curve, the marker appears as a jagged oscillation on a small portion of the response curve, with the center of the jagged portion being the marker frequency at that point. Fig. 808 shows a response curve with superimposed marker, with the appropriate frequencies indicated.

The second type of frequency marker is the absorption type. Basically, it consists of a high-Q tuned circuit coupled to the main sweep generator r.f. circuit. In operation, the absorption marker functions like an i.f. trap in a TV receiver. When tuned to a particular frequency within the sweep range, the marker circuit absorbs some energy at that frequency, leaving a dip in the response curve. As shown in Fig. 809, the absorption marker leaves a dent in the response curve, with the deepest point indicating the marker frequency. Although the absorption type marker is simpler, it is less desirable, since it is likely to excessively distort the response curve, especially when the marker circuit Q is not high enough. However, excessive marker amplitude of either type has a detrimental effect on the curve, tending to reduce the amplitude and flatness of the curve. The absorption marker has a further disadvantage in that a relatively large marker amplitude is required on the slopes of a response curve before good identification is possible. Distortion under these circumstances is rather severe.

Procedure

1. Set up equipment as for video i.f. alignment.
2. Obtain a good response curve, leaving the marker switch in the OFF position.
3. Switch the marker ON and advance the marker amplitude control until the pip is barely seen on the curve. Use the marker tuning dial to bring the pip to the appropriate frequency.
4. Place the marker first on the flat portion of the response curve (somewhere near the middle of the curve) and observe the effect on the response compared to the original no-marker condition.
5. Without changing the marker amplitude, move it until it falls on either of the slopes of the curve. Observe the effect on the slope.
6. Advance the amplitude control until the marker is now just as prominent as on the middle of the response in step 5.
7. Retune the marker dial until the marker again falls on the middle of the response. Without readjusting the amplitude, observe the depth of the dip and the effect on the curve, as compared with the original no-marker appearance. This can be done by simply throwing the marker switch to OFF. Return switch to ON position.

8. Increase marker amplitude until a severe dip or jaggging of the response occurs. Observe amplitude and shape of response curve. Compare with the no-marker position.

9. Repeat step 7 on the slope of the response, then on the

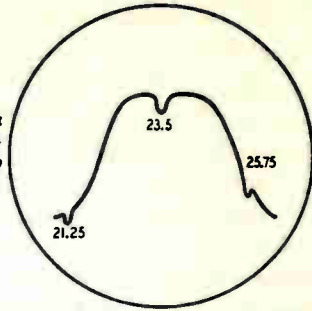

Fig. 809. An absorption-type marker will show a dip in the sweep waveform as indicated in the illustration. Operation here is similar to that of a trap in the television receiver.

lowest portion of that slope. In each case, observe the relative distortion of the response curve.

Modulation Envelope — Under and Overmodulation

EXPERIMENT VIII

Purpose: To observe the appearance of symmetrically modulated r.f. wave as well as modulation envelopes of less than 100% and over 100% modulation.

Equipment: R.f. generator with adjustable amplitude modulation, scope.

Theory: One type of distortion in AM signals is due to overmodulation of the carrier. In commercial broadcasts, modulation percentage is constantly monitored, with the average modulation level being well below 100%, except on extreme peaks. In amateur phone communication, such monitoring is not very common. Overmodulation is objectionable for various reasons, both legal and practical. Overmodulation gives rise to distortion, waste of power, overloading of class C stages, arc-overs, sideband shifting (FM components) and even carrier shift. Under conditions of speech (or music) modulation, it is difficult to observe the normal and excessive modulation levels. However, any test made with a known modulation signal, such as sine-wave a.c., applies to actual operating conditions as well. Thus, modulation level adjustment can be made using a standard signal with the assurance that the same conditions will prevail when speech is

substituted for the test signal. When modulating a c.w. signal with an audio type sine wave, the modulation envelope is displayed on the scope by adjusting the INTERNAL SWEEP to a submultiple of the modulation frequency. Thus, if the modulation frequency is 400 cycles, the INTERNAL SWEEP is set to approximately 133 cycles to give three modulation cycles on the screen. The r.f., being much higher (1,000 kc, for instance), will appear as a continuous band with no single cycle detail being discernible. Thus the characteristics of modulation are observable against the background of a constant carrier.

Another important characteristic of modulation is the symmetry about the zero axis. The ideal condition is symmetrical modulation, i.e., the positive and negative peaks should be equal. In this experiment, symmetry can be observed by using the graduated plastic scale over the c-r tube screen and setting the VERTICAL CENTERING control so that when the VERTICAL GAIN control is reduced sufficiently, the thin line falls on a graduated line, henceforth called the "zero line." When the VERTICAL GAIN is now advanced, positive and negative excursions are measured from this zero line and compared against each other. Any appreciable discrepancies between the positive and negative peaks is an indication of improper operation of the modulator or the stage being modulated.

Procedure

1. Connect the output of the signal generator to the VERTICAL INPUT of the scope. Set the generator frequency to 1,000 kc and the modulation to OFF.
2. Set the scope SWEEP frequency to approximately 150 cycles and adjust the various scope controls until a rectangular band, about half the screen height, is shown.
3. Switch the modulation to ON and advance the modulation amplitude until amplitude variations appear on the c.w. band on the screen. Adjust the SWEEP and SYNC controls to lock the pattern. Three cycles should appear on the screen. Advance the modulation control until the upper or lower half of the c.w. band decreases cyclically to the predetermined zero line. Observe the amplitude on the corresponding opposite side of the carrier. If not at zero, determine the approximate amplitude, using the graduated plastic scale. Also measure the maximum amplitude of the sine wave peaks.

4. Continue increasing the modulation amplitude until a considerable *zero amplitude* space appears on the screen between cycles.

5. Measure the positive and negative peak amplitudes under the conditions established in step 4.

6. Reduce the modulation until the minimum amplitude on the screen is approximately half the unmodulated carrier amplitude. Measure the positive and negative peaks.

7. Gradually increase the HORIZONTAL GAIN and, if necessary, the SWEEP frequency until the uniform c.w. band (with the modulation) expands until individual cycles can be seen. Observe the peak outline of the pattern on the scope.

Square-Wave Response

EXPERIMENT IX

Purpose: To observe the effect of amplifier characteristics on the square-wave input signal. To learn to identify high- or low-frequency attenuation from the appearance of the amplified square wave.

Equipment: Square-wave generator (or sine-wave generator followed by a clipper amplifier), audio amplifier, test leads.

Theory: The square wave has dual significance to the radio and TV service technician. The square wave has the characteristics of both low and high frequencies. As such, it is suitable for quick testing of frequency response of amplifiers, without the tedious work of running a response curve over the whole frequency range of the amplifier. From this viewpoint, familiarization with the effects on the square wave makes for easy identification of possible causes of poor response of the amplifier.

Of perhaps greater and more immediate concern to the TV service technician is the characteristic of the square wave, as it commonly appears in TV receivers, namely the sync pulse. Many a difficulty in sync and blanking circuits can be traced to a rounding-off of the sync pulse square wave, due to improper supply voltage or to component failure. Furthermore, since the square wave in sync circuits is but a signal used for shaping purposes in the differentiator and integrator circuits, knowledge of the importance of the steepness of the sides (rise time) and the flatness of the top, is of considerable help in analysis of improperly

functioning circuits at the input to the vertical and horizontal oscillator circuits.

To briefly review the characteristic indications of response by the square-wave distortion, two main observations are required. Any change in steepness and/or rounding of the sharp corners indicates high-frequency deficiency. Poor low-frequency response is evident from the slanting, either upward or downward, of the flat top of the wave, with more or less curving (concave) of this portion of the wave at the same time. Figure 701 on page 135 shows typical examples of these characteristics.

In testing a wide-band amplifier, it is usually preferable to check at two or three different square-wave frequencies. In sync circuits, however, only a single frequency is involved, hence a one-frequency test is adequate. A 30-kc signal is most desirable, since it is the approximate frequency (or repetition rate) of the sync pulses during the vertical retrace time.

Procedure

1. Connect the signal generator to the VERTICAL INPUT of the scope. Set the generator frequency to 1,000 cycles, and adjust all controls for a good pattern of about 3 cycles. Using plastic scale on screen, observe quality of the square wave.
2. Transfer generator to input of the amplifier and scope VERTICAL INPUT to output of the amplifier. Readjust generator output until approximately the same amplitude is obtained on the scope as in step 1. Observe quality of output wave shape.
3. Retune generator to 100 cycles. Shift scope to input of the amplifier, adjust sweep for 3 cycles, and adjust gain controls for a proper amplitude on the scope.
4. Move the scope to the output of the amplifier and readjust gain controls. Using the calibrated screen on the c-r tube, observe the variation from the waveshape obtained at the input to the amplifier in step 3. Notice particularly the effect on the flat portion of the square wave. If the output square wave looks nearly as good as the input, retune the generator to a lower frequency and repeat steps 3 and 4, until a marked deterioration at the output of the amplifier is observed.
5. Repeat steps 3 and 4, but with the generator set first to 5,000 cycles, then to 10,000 cycles. Continue at one higher frequency until the output waveshape has both sloping sides and rounded corners, beginning to resemble a sine wave. Also observe

the apparent reduction of the original flat portion of the square wave.

Square-Wave Testing

EXPERIMENT X

Purpose: To learn the effect of r-c networks on square waves. To observe the types of pulses developed by r-c networks when either R or C or both are changed.

Equipment: Square-wave generator, scope, various resistors and capacitors.

Theory: In connection with pulse shaping in TV sync circuits, the shape of the wave depends on the absolute and relative magnitudes of the R and C components. This experiment is intended to show some results of varying one or the other of these components and how the output pulse or *pip* may be shaped in width and amplitude to suit different requirements. The basic components for these tests are a square-wave-input voltage and a series r-c network load. A capacitor charging in series with a resistor from a square wave (or d.c.) source will accumulate or *integrate* a voltage over a period of time due to the current flowing into it, the time depending on the size of the capacitor and the magnitude of the series resistance. Furthermore, the initial accumulation is greatest, since the current flow is largest then. By contrast, the current in the series resistor is maximum at the start of the cycle, and decreases thereafter at a slower or faster rate, depending on the same factors mentioned. However, since the voltage developed across the resistor due to the charging current is in phase with the current, hence instantaneous, a voltage pulse, called a differentiated pulse, is developed across the resistor. Another observation worth repeating is the fact that the voltage across the capacitor develops during, and depends on, the flat portion of the square wave, while the voltage across the resistor is due primarily to the leading edge, or rise, of the same square wave.

An important point to make here is the fact that the absolute values of R and C are much less important (except for specific use) than the relative magnitudes of R and X_c . For example: A .001- μ f capacitor will charge up quickly in series with a 0.5-megohm resistor (500 microseconds). By contrast, a 0.25- μ f capacitor, charging to the same voltage, will require a much longer

time (125,000 μ s), saying, in effect, that the resistance is much too high. Thus it is possible to obtain similar waveshapes from different values of capacitors if the resistance in each case is appropriately changed.

As shown in Fig. 810, a differentiated pulse is a sharp *spike* having extremely short time duration at its peak. As such, it is very suitable for triggering or synchronizing, just as a sharp point can distinguish between two adjacent points very close to each other. In differentiating a square wave, the spike can be made steeper or wider depending on the size of the capacitor, hence the amount of charging current required. Another factor of

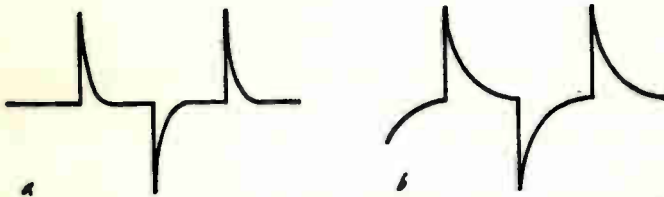

Fig. 810-a, -b. The shape of the pulse waveform can be altered by modifying the time constant of the r-c network.

importance in TV sync circuits is the *off time* of the square wave. If successive pulses are to be distinct from each other, leaving no charge accumulation from one cycle to the next, the zero-amplitude of the square wave must be long enough to allow complete dissipation of the energy of the previous pulse. This is the case in differentiation of the horizontal sync pulses having an *on* time of about 5 μ s and an *off* time of almost 57 μ s. The serrated vertical pulses, by contrast, are on for roughly 25 μ s and off only about 6 μ s. Because of this, and, as a matter of fact, intentionally so, the vertical pulses *integrate* — energy accumulates from pulse to pulse, with but a small loss during the *off* time.

In this experiment, the series r-c network will serve as both a differentiating and integrating circuit, depending on which of the two components is considered the output circuit. Furthermore, as the frequency is varied, the degree of differentiation and integration will change, as X_c varies with the frequency while R remains constant.

Procedure

1. Connect a 100 μ f capacitor in series with a 10,000-ohm resistor across the output of the audio oscillator. Set oscillator

frequency to 1,000 cycles. Adjust INTERNAL SWEEP of scope to get three pulses on the screen.

2. Place VERTICAL INPUT terminals of the scope across the generator output terminals and observe the quality of the square wave as well as its amplitude. Repeat at 10 kc.

3. Switch scope leads across the resistor only. Observe (and preferably record) amplitude and steepness of pulse. Note relative *off-time* space between pulses.

4. Switch test leads to capacitor and record pulse obtained alongside the pulse obtained in step 3. Compare the two pulses for the characteristics stated in step 3.

5. Reset generator frequency to 10,000 cycles and repeat steps 3 and 4. Record the R and C waveshapes along the R and C pulses of steps 3 and 4.

6. Change r-c network to 100,000 ohms and .001 μ f respectively and repeat steps 3 and 4 at 10,000 cycles. Record pulse shapes as previously.

7. Reset generator to 1,000 cycles and repeat steps 3 and 4, recording the pulses, and arranging the R and C pulses as previously.

8. Change the r-c network to a .01- μ f capacitor and a 100,000-ohm resistor and repeat steps 3 and 4 at 1,000 and 10,000 cycles. Record the pulse shapes and amplitudes.

Relation between R.M.S. and Peak Values of Symmetrical Waves

EXPERIMENT XI

Purpose: To compare and observe the effects of an alternating voltage on the scope and on a meter; to learn the relationship between root mean square and peak values of a voltage or signal.

Equipment: Multimeter, scope, test leads, d.c. source.

Theory: As explained in Chapter 1, and illustrated in Fig. 101, a d.c. voltage is of constant value, showing no amplitude variations with time. A single measurement of such a volt-

age with a meter is, therefore, a complete and exact description. Although not generally referred to as such, it is desirable, for the purpose of this experiment, to state that such a measurement indicates the "peak" value of the voltage. This is quite correct if we add the fact that a d.c. voltage is always at the "peak" level. As a practical example in evidence of this statement one need but recall that a capacitor breakdown voltage is usually given in both r.m.s. and d.c. If the peak voltage is calculated from the given r.m.s. value, the result will be the d.c. value in volts. (In practice, the manufacturer usually specifies the voltages in round figures, but a few calculations will convince the reader that this relation checks quite closely.)

While the instantaneous value of grid voltage is important in all signal circuits, it is particularly significant in TV. Sync clippers, a.f.c. noise gates and similar functions are based on both the instantaneous and the peak values of the applied signal or pulse. It is for this reason that meter measurements at these points are inadequate, while peak indications by the scope tell the true conditions of operation. However, if the relations between the meter readings and the actual instantaneous voltages (as would be shown on the scope) are understood, the meter readings can be intelligently interpreted in cases where it is not convenient to use the scope.

A simple example of a symmetrical wave is the sine wave. This wave is said to be symmetrical because a line drawn vertically through the peak (90 or 270 degrees) divides the half cycle into exactly identical quarter cycles. Similarly, the horizontal line or the zero voltage axis has identical half cycles above and below.

If we now compare a sine and a square wave, with both having the same width and peak values, it becomes apparent that the square wave (over any particular half cycle) has constant amplitude equal to the peak value of the sine. Another way of illustrating the difference is in terms of area under the half cycle. The sine area is much smaller because it is at peak value for only one instant (90 or 270 degrees), while the square wave is always at peak, as stated for d.c. Since the usual meter reading corresponds to the area under the curve, it becomes apparent that a sine wave having a peak of 100 volts, will not read as high on the meter as a 100-volt battery. But, knowing the relation between the two

types of voltage, one can state that the sine peak will be 100 volts if the meter reads approximately 70.7 volts.

There is one other difference between meter and scope indications that is of great importance, namely the r.m.s. versus peak-to-peak value. A signal voltage, whether a sine wave, a trapezoid, or other waveform, "swings" the grid of a tube not by the r.m.s. value, but from one extreme to the other—in other words, from peak to peak. Should either peak swing the grid beyond the intended range of operation, distortion will result. It is therefore necessary for the user to understand the relationship between a meter voltage reading and the peak-to-peak voltage such reading represents. Even in the case of the symmetrical (sine) wave the ratio between r.m.s. and peak-to-peak is almost 3:1; it may be much higher in the case of non-symmetrical signals such as sync pulses.

In the experiment to follow, comparisons are made between a d.c. voltage and an a.c. having the same peak value as the d.c. Once this is understood, the scope may be calibrated for peak-to-peak readings using sine waves, not only because they are readily available, but because they are absolutely symmetrical and their relationships (r.m.s. vs. peak or peak-to-peak) are always the same. The accuracy of calibration will then depend only on the accuracy of the meter used to measure the a.c. and the care with which the measurements and scope observations are made. A further obvious advantage is the fact that calibrations need not be permanent and subject to effects of tube aging and other changes in the scope from time to time. Since the calibrating a.c. is measured each time, the scope reading (in volts-per-inch) is of equal accuracy every time, regardless of vertical amplifier gain, etc.

Procedure

1. Switch on the scope and allow it to warm up. Adjust all controls to give a sharp spot near the bottom of the screen, midway between left and right.

2. Connect the d.c. voltage to the vertical deflection plate. A terminal board is generally placed at the back of the scope for making such direct connections. The pairs of terminals marked V and H near the center of the diagram, Fig. 811, are for use when neither horizontal nor vertical amplification is desired. Normally, they are bridged by a wire jumper, as shown. When direct

signal connection to the deflection plates is desired, the jumpers are removed, and the signal (or d.c. voltage, in this case) is connected between the lower of the two posts and ground. Fig. 811 shows these connections as viewed from the outside. If necessary, consult the schematic diagram of the scope. A 45- or 90-volt battery is convenient, although any d.c. supply may be used. If the

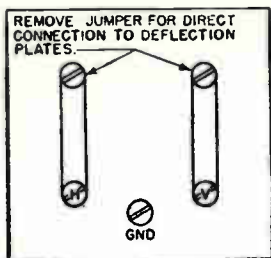

Fig. 811. Typical terminal strip for direct connection to deflection plates. These are high-voltage terminals and should not be touched when scope is on.

spot moves downward and disappears from the screen, reverse the polarity of the d.c. voltage. Use sufficient voltage to move the spot at least 1 inch.

3. Measure the d.c. used and the distance in inches the spot has moved.

4. Substitute a sine wave a.c. voltage for the d.c. If possible, adjust this voltage until the spot deflects the same distance as previously. If such adjustment is not convenient, use a smaller voltage and measure the deflection in inches. The spot will deflect in both directions. Measure the deflection only in the same direction obtained previously. Measure the a.c. voltage, using an a.c. voltmeter.

5. Reduce the a.c. voltage, and if necessary, adjust the centering control of the scope until all of the trace is on the screen. If the a.c. voltage is adjustable, set the value so that the same deflection is obtained as with the d.c. Again measure the applied voltage with the a.c. voltmeter.

6. Calculate the equivalent a.c. voltages in this way: If the a.c. was adjusted for the same deflection as with d.c., divide the d.c. value by the a.c. value. For example, if the measured d.c. was 60 volts and the measured a.c. voltage was 42, dividing 60 by

42 will give approximately 1.41 which is the relation between r.m.s. and peak for a sine wave. This proves that a 42-volt r.m.s. sine wave has a peak value of 60 and deflects the beam as much as the 60 volts d.c. Similarly, if the a.c. voltage in step 5, which gave a *complete* trace of the same height as 60 volts d.c., measures 21 volts on the meter, dividing 60 by 21 gives a ratio of approximately 2.82, this being the relation between r.m.s. and peak-to-peak.

7. If the a.c. voltages used were not adjusted, but the deflection was measured in each case, the calculation is somewhat different. Assume that the d.c. voltage gave a deflection of 1.5 inches for 60 volts, while the a.c. voltage in step 4 gave a deflection of 1 inch and (if the experiment was done correctly) the meter reading was approximately 28.5 volts. It logically follows that increasing this voltage by 50%, to 42, would also increase the deflection by 50%, to 1.5 inches. A similar calculation in the case of step 5 will prove the case for the peak-to-peak condition.

NOTE: In this above experiment it was assumed that the service technician has the usual type of service scope, with r-c coupling (blocking capacitors to the grids) between stages. Such instruments will not respond to d.c. input voltages to the amplifiers. Consequently, connection had to be made directly to the deflection plates. In those cases where the scope has provision for d.c. input signals, this experiment is greatly simplified, since the input is made to the VERTICAL INPUT terminals and the amount of deflection can be adjusted to suit with the V-GAIN control.

Effect of Meter Behavior on Pulse Voltages

EXPERIMENT XII

Purpose: To observe the effect of the multimeter on the shape of the pulse; to compare the sine wave and a sharp pulse under similar conditions of measurements.

Equipment: Scope, a.c. meter, television receiver in operating condition.

Theory: In experiment XI it was shown that the voltage indicated by the usual meter depended on the shape of the wave, and particularly on the area under the curve. It follows, therefore, that a pulse such as the sharp pip used for horizontal sync in TV receivers, would produce even less of an indication on the meter, since the pulse width or duration, hence

the area under it, is much less than that of the sine wave of the same peak value. There are other reasons why a sharp pulse is unsuitable for measurement with the ordinary meter. Two of the most important ones are the great variety of pulses, each with a different shape, width and degree of dissymmetry, and the great susceptibility of pulses to loading.

The sine wave is one of the few types of a.c. suitable for measurement with the ordinary meter, because of absolute uniformity and symmetry (other examples are the triangular and square waves). One might justly say that there is but one sine wave. Such is not the case with pulse voltages. These may be of any width, they may vary in shape during the rise and fall, the positive and negative parts of the "cycle" are seldom identical, etc. While you could calculate the relationship between a meter reading (r.m.s.) and the peak value of any one type of pulse, this would not hold for any other kind. Furthermore, since no assurance can be given, as in case of sine waves, that the pulse will be identical under varying conditions and in different circuits, such a calculation would be of little use. Another factor against the use of the meter is the difficulty of determining peak-to-peak values, a most important characteristic of pulses, because the positive and negative peaks are seldom equal in amplitude.

The loading effect of the meter on the pulse source is due to the steepness or narrowness of the pulse and the nature of the pulse circuit. As an example, the horizontal sync pulse in TV is almost vertical in shape and of very short time constant. Any loading, such as produced by a meter, is sufficient to reduce the pulse amplitude as well as change its shape sufficiently to make the pulse nearly useless. Even the ordinary input amplifier in a scope has a slight effect on the pulse amplitude. It is obvious from this that measurement of such pulses with a meter is practically useless.

Procedure

1. Allow receiver and scope to warm up.
2. Connect VERTICAL INPUT of scope across a source of a horizontal sync pulse. This may be the output of the differentiator circuit, the input to the horizontal a.f.c., etc.
3. Set INTERNAL SWEEP of the scope to approximately 15,750 cycles and adjust the FINE FREQUENCY CONTROL until a single horizontal pulse appears. Tune the receiver and also adjust its con-

trast control until the pulse covers most of the CRT screen. Use the scope VERTICAL GAIN control as needed.

4. Measure the deflection in inches.

5. Without changing the setting of the VERTICAL GAIN, disconnect the sync pulse and apply a sine voltage of known value to the scope VERTICAL INPUT, calibrating the screen in peak-to-peak volts as described on page 118.

6. From these measurements, calculate the peak-to-peak value of the pulse.

7. Remove the a.c. and reconnect the sync pulse, as originally.

8. Connect the a.c. meter across the V-INPUT to the scope, using a meter scale on the basis of the calculations of step 6. Observe the effect of connecting the meter on the height and shape of the pulse on the CRT screen. Read the meter voltage and the deflection in inches on the screen with the meter connected.

9. Divide the meter reading into the value obtained from the calculation of step 6. The result obtained will vary from case to case, but will seldom be as low as in the case of the sine wave, namely 2.82.

10. Substitute a vacuum-tube voltmeter for the multimeter used and repeat steps 8 and 9. Compare the results and the loading effects of the two meters.

11. Compare the original height of deflection on the screen with that obtained in case of loading with the multimeter. Repeat for the case of the v.t.v.m.

12. Remove the meter and observe the total deflection on the screen once more. With a crayon or strip of tape, mark the positions of the positive and negative peaks of the pulse. The VERTICAL GAIN control may be readjusted so that the negative peak is of noticeable size.

13. Reduce the VERTICAL GAIN control until the pulse amplitude is zero. Notice the position of the trace on the screen.

14. Measure the distance from the zero position just obtained to each of the peak positions previously marked. Compare the positive and negative amplitudes. This will illustrate the fact that in pulse voltages it is incorrect to measure "the peak" voltage and multiply by two to obtain the peak-to-peak value.

NOTE: In many cases the sync pulse obtained may have little or no visible negative swing, all of the pulse being on one side of

zero only. In such case, steps 12 through 14 may be done using a trapezoidal sweep voltage, such as the output of the vertical oscillator of the TV receiver. In either case, the dissymmetry between the positive and negative portions of the signal will be demonstrated.

Capacitor Leakage Measurements

EXPERIMENT XIII

Purpose: To test the leakage or power factor of capacitors.

Equipment: Scope, miscellaneous capacitors, audio oscillator.

Theory: One of the most useful applications of the scope beyond the common observations of waveforms is the measurement of the leakage or power factor of capacitors. This is particularly so in case of small coupling, bypass and pulse shaping capacitors. While large filter capacitances may also be checked, this is not nearly as useful, since electrolytic capacitors are easily substituted with units known to be good, or checked with a high range ohmmeter. In the case of small capacitors, up to perhaps a few thousand μf , the scope is far superior, the ohmmeter being of little value. TV service technicians are well aware of the fact that while an electrolytic capacitor measuring as low as 1 megohm or even less may be perfectly good, a coupling capacitor of the same resistance value is all but short-circuited. Unfortunately, few capacitance checkers have any accurate leakage indicators for such units.

The measurement of capacitor leakage is based on the fact that a perfect capacitor is a purely reactive device, consuming no power whatsoever, regardless of the voltage across it or the current in it. The usual statement is that "the power factor of a perfect capacitor is zero." Another way is to say that the d.c. resistance is infinite. A defective capacitor, however, consumes some power, its power factor being some value between zero and 1, while its d.c. resistance, although still relatively high, is not infinite. It is this resistance that consumes some power. In the measurement of capacitor leakage with the scope, comparison is made between the suspected capacitor and a standard unit, known to be perfect.

Procedure

1. Connect the suspected capacitor in series with the one known to be good across the output of an audio oscillator. Set the fre-

quency to any convenient value, a few hundred cycles being preferred. The frequency may have to be adjusted to get an adequate deflection pattern, in the case of some extreme capacitance values.

2. Connect the junction of the two capacitors to the GND terminal of the scope. Connect the other end of the test capacitor to the V-INPUT of the scope, and the free end of the standard capacitor to the H-INPUT.

3. Switch the INTERNAL SWEEP off and adjust the various controls, including the output of the audio oscillator, for a sizable pattern on the CRT screen.

4. Observe the pattern on the screen. If the suspected capacitor is perfect, the voltage and current of the entire network will be exactly 90 degrees apart. If, however, some leakage exists, the suspected capacitor will then act as an r-c network, and the phase angle will be less than 90 degrees.

5. Compare the pattern obtained with those of Fig. 703 on page 138 showing amplifier phase shift. A perfect capacitor will have a straight-line pattern similar to one having a zero degrees phase shift, while leakage will show up as an opening up of the ellipse, the amount of opening increasing with the leakage.

Index...

Absorption Marker Generator	87	Band-Pass:	
A. C.	8	Alignment	80
A.C. and D.C., Characteristics of	8	Meaning of	77
A.C. Meters	10	Vertical Amplifier	54
Accelerating Anode	18	Bandwidth, I.F.	97
Adjustment of Oscilloscope		Bandwidth vs. Gain	91
Controls	67, 156	Bars, Sound	99
Adjustments, Trap-Circuit	95	Base, Time	26, 29
A.G.C.	93	Battery Bias	117
A.G.C. Bias Substitute	117	Beam:	
Alignment:		Brightness	17
Band-Pass	76	Centering of	22
Broad-Band	80	Convergence	20
Discriminator	85	On Switch	67
Discriminator, with AM Generator	87	B-H Curve	129
Effect of A.G.C. on	93	Bias:	
F.M. I.F.	90	Battery	117
Front-End	105	Cathode-Ray Tube	17
I.F.	94	Substitute, A.G.C.	117
Intercarrier I.F.	101	Temporary	117
Peak-Tuned I.F. System	78	Bifilar I.F. System	93, 96
Ratio-Detector	89	Blanking Retrace	50
Sweep, of Sound I.F.	102	B Plus Supply Hum	141
Alternating Current	8	Brightness Control	17
AM Generator Alignment of		Broad-Band Alignment	80
Discriminator	87	Burn, Fluorescent	67
AM I.F. System	81	Buzz, Intercarrier	98
Amplified and Direct Signals, Comparison of	163	Calibrating the Scope as a	
Amplifier:		Voltmeter	118
R-C	55	Calibrating the Sweep in	
Video	107	Microseconds	128
Z-Axis	48	Calibration:	
Amplifiers:		Audio Oscillator	123
Horizontal	58, 59, 72	Horizontal Sweep	120
Vertical	53, 72	Scope	119
Amplitude, Sync Signal	70	Scope as a Voltmeter	118
Anode:		Sweep, in Microseconds	128
Acceleration	18	Capacitance, Shunting	56
First	17	Capacitor:	
Focusing	17	Charge and Discharge	30
Intensifier	18, 65	Isolating	115
Second	18	Leakage Measurements	186
Aquadag	18	Cathode:	
Attenuator	117	-Coupled Multivibrator	40
Attenuator, V-Signal	68	of Cathode-Ray Tube	16
Audio:		Physical Structure of	16
Distortion due to Overload	169	-Ray Tube	14, 15
Gain Measurements	133	-Ray Tube Bias	17
Oscillator Calibration	123	-Ray Tube Filament	16
Response Measurement	134	Virtual	19
Aural Indicator	50	Centering:	
Auto Radio Vibrator Supplies	146, 147	Beam	22
Balance Control	47	Horizontal	68
Balanced Multivibrator	39	Vertical	68

Characteristics of A.C. and D.C.	8	Filament of Cathode-Ray Tube	16
Circuit:		Filter Operation, Checking	151
Intercarrier I.F.	100	Fine Frequency	69, 74
Sweep	58	Fine-Frequency Control	36, 41
Clipping	127	Firing Voltage	33
Coarse Frequency	69, 74	First Anode	17
Coarse-Frequency Control	36, 41	Fixed Loading	96
Coating on the Screen	14	Flat Response	54
Compensation, Frequency	54, 55, 56, 57	Flat Topping	76, 96
Control:		Fluorescent Burn	67
Coarse Frequency	36	Fluorescent Screen	14, 28
Fine-Frequency	36	Flutter, Video	142
Frequency	41	Flyback Time	29
Grid of Cathode-Ray Tube	16	FM:	
Intensity	67	Carrier Level in Intercarrier Sets	98
Phasing	75	Detectors, Types of	84
Vertical-Gain	53	Discriminator	82
Controls, Operating	67	I.F. Alignment	90
Convergence of Beam	20	I.F. System	81
Coupling, Direct	72	Focus	68
Coupling to the Front End	140	Focusing	21
Crossover Point	19	Focusing Anode	17
Crystal-Detector Probe	115	Frequency:	
Current Waveshapes, Measurement of	144	Coarse	69, 74
Curve:		Compensation	54, 57
B-H	129	Control	41
Discriminator Response	83	Line	69, 70, 74
Hysteresis-Characteristic	129	Sawtooth	35
I. F. Response	93	Sweep	74
Power	78	Front-End Alignment	105
Response	77	Front End, Coupling to the	116
Curves, Plotting	129	Front Ends	106
CW	86	Gain:	
D.C.	8	Measurements	132
D.C. and A.C., Characteristics of	8	vs. Bandwidth	91
Decoupling	140	Gas:	
Deflection:		-Discharge Generator	30
Electromagnetic	20	-Triode Sawtooth Generator	36
Electrostatic	20	-Tube Noise	38
Linear	24	-Tube Oscillator	84
Plates, Direct Connections to	71	Generation of Sawtooth	31
Polarity	127	Generator:	
Sensitivity	65	Absorption Marker	87
System	20	Gas-Triode Sawtooth	36
Demodulator Probe	115	Marker	86
Detection, Slope	99	Sawtooth	29, 30
Detector:		Time-Base	74
Ratio	84, 88	-to-Receiver Matching Pad	112
Ratio, Alignment of	89	Generators, Types of Marker	86
Detectors, Types of FM	84	Graphs	10
Differentiated Wave	13	Grid Circuits	140
Direct and Amplified Signals, Comparison of	163	Half-Power Points	78
Direct Connections to Deflection Plates	71	Hash	38
Direct Coupling	72	Heater of Cathode-Ray Tube	16
Direct Current	8	Heater-to-Cathode Leakage	139
Discriminator	82, 84	H-Gain	44
Alignment Using AM Generator	87	High-Frequency Compensation	56
Response Curve	83	High-Voltage Supply, Negative	64
Sweep Alignment of	85	Horizontal:	
Distortion due to Overload, Audio	169	Amplifier	58, 59, 72
Distribution of Voltages in RCA Scope	73	Centering	68
Divider, Voltage	116	Deflection for Sweep Alignment	123
Double Superheterodyne	97	Deflection Plates	21
Du Mont 208B	52	Gain	44
Effect of A.G.C. on Alignment	93	Sweep	25
Effect of Sine-Wave Sweep Voltage on Beam Travel	124	Sweep, Calibration of	120
Effective Voltage	118	H-Position	68
Electromagnetic Deflection	20	Hum	80, 139, 141
Electron Beam	16	Hum in the Video Signal	141
Electron Gun	15	Hysteresis Characteristic Curve	129
Electronic Switch	12, 47	I.F.:	
Electrostatic Deflection	20	Amplifiers, Regeneration of	143
Experiments Using the Oscilloscope	156	Bandwidth	97
External Sync Signal	70	Bifilar	93, 96
Extinction Potential	88	Channels, TV Sound	102
		Channels, Video	91
		Impedance-Coupled	92
		Response Curve	93

Response, Intercarrier	98	Multivibrator:	12, 30, 38
Response, Split-Sound	99	Cathode-Coupled	40
Stagger-Tuned	92, 95	Plate-Coupled	39
I.F. Alignment:		Negative High-Voltage Supply	64
FM	90	Negative Low-Voltage Supply	64
Intercarrier	101	Noise	38
Procedure	94	Noise, Gas-Tube	38
I.F. System:		Noninductive Resistors	113
Alignment of Peak-Tuned	78	Nonlinear Sweep	27, 42
AM	81	Nonlinear Time Base	27
FM	81	Operating Controls	67
Intercarrier	97	Oscillator Alignment Using Stations	106
Impedance-Coupled I.F.	92	Oscillator, Relaxation	30, 32
Impedance Matching	111	Oscilloscope:	
Indicator, Aural	50	Adjustment of Controls	156
Integrated Wave	13	Audio Distortion Due to Overload	169
Intensifier Anode	18, 65	Calibration of	119
Intensity	17	Capacitor-Leakage Measurements	186
Intensity Control	67	Comparison of Direct and	
Intensity Modulation	17, 48	Amplified Signals	163
Intercarrier:		Effect of Marker Pip Amplitude	
Buzz	98	on Response Curve	171
I. F. Alignment	101	Effect of Sync Selector and Sync	
I. F. Circuit	100	Amplitude Controls	160
I. F. Response	98	Experiments Using the	156
I. F. System	97	Lissajous Figures	164
Interference, Sound	99	Meter Behavior on Pulse Voltages	183
Interrupted Pattern	48	Modulation Envelope	173
Ionization Potential	33	Precautions	130
Isolating Capacitor	115	Probe	113
Isolating Resistor	70, 115	Relation Between R.M.S. and Peak	
Isolation of Instrument from		Values of Symmetrical Waves	179
Equipment under Test	115	Relation Between Signal and Horizontal Sweep Frequencies	158
Lead Dress, Critical	140	Square-Wave Response	175
Leakage, Heater-to-Cathode	139	Square-Wave Testing	177
Lens System	17	Techniques	110
Level, Zero	65	Typical	52
Limiters	88	Output Calculations, Power	134
Line	44	Pattern, Interrupted	48
Line Frequency	70	Peak:	
Linear Deflection	24	and R.M.S. Values of Symmetrical	
Lissajous Figures	121, 122, 123, 164	Waves, Relation Between	179
Loading, Fixed	96	-Tuned I.F. System, Alignment of	13, 118
Loading Resistors	76	Voltage	10, 118
Locking Pulse, Sweep	70	Peaking	56
Low-Capacitance Probe	113	Persistence of Screen	28
Low-Frequency Compensation	55	Phase Shift	136
Low Input Voltages, Measuring	116	Phase-Shifting Correction	125
Low-Voltage Supply, Negative	64	Phasing Circuit for Sweep Alignment	123
Luminescence	28	Phasing Control	75
Main Power Switch	67	Phosphorescence	28
Marker:		Phosphors	28
Absorption	87	Physical Structure of Cathode	16
Generator	86	Pip	36
Generators, Types of	86	Plate-Coupled Multivibrator	39
Pip Amplitude	171	Plates, Horizontal Deflection	21
Points	102	Plates, Vertical Deflection	21
Signals	49	Plotting Curves	129
Superimposed	86	Polarity, Deflection	127
Matching	110	Poor Response in Wide-Band	
Matching Pad, Balanced to Ground	112	Amplifiers	54
Matching Pad, Generator to Receiver	112	Potential, Extinction	33
Meaning of Bandpass	77	Potential, Ionization	38
Measurements:		Power:	
Audio Gain	133	Curve	78
Audio Response	134	Output Calculations	134
Current Waveshape	144	Supply	61
Small Voltage	116	Switch	67
Measurements and Tests	133	Precautions, Scope	130
Measuring Low Input Voltage	116	Probe:	
Measuring Ripple	152	Crystal-Detector	115
Meter Behavior on Pulse Voltages	183	Demodulator	115
Meters, A. C.	10	Low-Capacitance	113
Microseconds, Calibrating the		R. F.	114
Sweep in	128	Scope	113
Miller Effect	55		
Modulation Envelope	173		
Modulation, Intensity	17, 48		

Pulse:	
Duration	128
Rise Time	128
Voltage, Meter Behavior on	133
Pulses, Checking Synchronization	145
Ratio Detector	84, 88
Ratio-Detector Alignment	89
R-C Amplifier	55
RCA WO-56A	71
Rectangular Wave	12
Rectifiers, Selenium	149
Regeneration of I. F. Amplifiers	143
Relaxation Oscillator	30, 32
Resistance-Coupled Amplifier	55
Resistor, Isolating	70, 115
Resistors, Loading	76
Resistors, Noninductive	113
Response:	
Curve	77
Curve, Discriminator	83
Curve, Effect of Marker Pip Amplitude on	171
Curve, I. F.	93
Curve of Tuned Circuit	105
Curve Width	83
Flat	54
Video Output	107
Retrace Blanking	50
Retrace Time	29
R. F. Probe	114
Ripple, Measuring	152
Rise Time, Pulse	128
R.M.S.	10, 13, 118
R.M.S. and Peak Values of Symmetrical Waves, Relation Between	179
Root-Mean-Square	10, 13, 118
Sawtooth:	
Frequency	35
Generation of	31
Generator	29, 30
Waveform	11
S-Curve	83
Screen:	
Bypass	140
Coating	14
Fluorescent	28
Persistence	28
Phosphors	28
Second Anode	18
Selector, Sync	44, 70
Selenium Rectifiers	149
Sensitivity, Deflection	65
Sensitivity, Vertical Amplifier	68
Series-Type Tuner	106
Shelf	98
Shift, Phase	136
Shunting Capacitance	56
Sideband Suppression	95
Sidebands	77, 82
Signal:	
and Horizontal Sweep Frequencies, Relation Between	158
External Sync	70
Marker Sync	49
Test	70
Sine Wave	10, 11, 13
Sine-Wave Synchronization	44
Single Sweeps	37
Sinusoidal Sweep	124
Slope Detection	99, 104
Sound:	
Bars	99, 104
I. F. Channels, TV	102
I. F., Sweep Alignment of 4.5-mc	102
Interference	99
Split	95, 99, 105
Take-Off Circuit	95
Split Sound	95, 99, 105

Square Wave:	13, 13
Response	175
Testing	177
Square Waves, Use of	12
Stagger-Tuned I. F.	92, 95
Stand-By Switch	67
Substitution Method	121
Superimposed Marker	86
Supply, Power	61
Suppression of Sideband	95
Sweep:	
Alignment of Discriminator	85
Alignment of 4.5 mc Sound I. F.	102
Alignment, Phasing Circuit for	123
Calibration of Horizontal	120
Circuit	58
Frequency	74
Generator System	74
Horizontal	25
Locking Pulse	70
Nonlinear	27, 42
Sinusoidal	124
Systems	29
Thyratron	37
Voltage	25, 29
Sweeps, Single	37
Switch:	
Beam-On	67
Electronic	47
Main Power	67
Stand-By	67
Symmetrical Square-Wave Generator	39
Sync:	
Amplitude and Sync Selector	
Controls	160
Pulses, Types of	44
Selector	44
Selector and Sync Amplitude	
Controls	160
Signal Amplitude	70
Signal Selector	70
Voltage	44
Synchronization of Sine-Waves	44
Synchronization Pulses, Checking	145
Systems, Sweep	29
Take-Off Circuit, Sound	95
Temporary Bias	117
Tertiary Winding	81
Test Signal	70
Tests and Measurements	133
Thyratron Sweep	37
Time:	
Base	26, 29
Base Generator	74
Base, Nonlinear	27
Constant	41
Duration of Pulse	128
Flyback	29
Retrace	29
Transients	37
Trap-Circuit Adjustments	95
Trap in the Video Circuit, 4.5-mc	104
Trapezoid	18
Trapezoidal Wave	12
Tuned Circuit Response Curve	105
Tuners	106
Turret Tuner	106
TV Sound I.F. Channels	102
TV Stagger-Tuned I.F.	95
Types:	
of FM Detectors	84
of Marker Generators	86
of Sync Pulses	44
Typical Oscilloscopes	52
Use of Scope	7
Use of Square Waves	13

V-Gain Control	53	Voltage:	
V-Position	68	Distribution in the RCA Scope ..	73
V-Signal Attenuator	68	Divider	116
Vertical:		Firing	33
Amplifier	53, 72	Measurement of Small	116
Amplifier Bandpass	54	Sweep	25, 29
Amplifier Sensitivity	68	Sync	44
Centering	68	Voltmeter, Calibrating the Scope	
Deflection Plates	21, 22	as a	118
Gain Control	53	Waveforms	7
Sync in Sound I.F.	98	Waveshapes, Measurement of	
Vibrator Power-Supplies, Auto-		Current	144
Radio	146, 147	Weave	104
Vibrator Power-Supply Defects ..	147	Weave Pattern	99
Video:		Width, Response Curve	83
Amplifier	107	X-Axis	68
Circuit, 4.5-mc Trap in the ..	104	Y-Axis	68
Flutter	142	Z-Axis Amplifier	48
I.F. Channels	91	Zero Level	65
Output Response	107, 108		
Signal, Hum in the	141		
Virtual Cathode	19		