



**the**  
**V.T.V.M.**

- **how it works**
- **how to use it**

**by RHYS SAMUEL**

published by gernsback library, inc.  
25 west broadway, new york 7, new york

**GERNSBACK LIBRARY BOOK NO. 57**



© 1956 Gernsback Library, Inc.  
All rights reserved under Universal,  
International, and Pan-American  
Copyright Conventions.

Library of Congress Catalog Card No. 55-11946  
cover design by muneef alwan

# contents

chapter

page

1

## Instrument characteristics

Low circuit loading in voltage measurements. Input capacitance and a.c. resistance of the v.t.v.m. Wide-range frequency response on a.c. measurements. High sensitivity. Burnout-resistant meter circuit. Resistance readings over wide ranges. Accuracy.

7

2

## How the v.t.v.m. works

The bridge circuit. Cathode-metered bridge circuit operation. D.c. voltage-divider network. Resistance-measurement network. A.c. voltage measurements. Frequency response. A.c. voltage measurements and contact potential. Direct-current measurements.

15

3

## Meter scales

Typical meter scales. Multiplication factor. Scale divisions. Scale subdivisions. Scale units. How to read scales. Linear and nonlinear scales. Scale compression. Zero-center scales. Types of zero-center scales. Decibel scales.

37

4

## Probes and cables

Advantages of probes and cables. Probe construction. Direct probes and cables. Isolating probes. Rectifying probes. Types of rectifying probes. Vacuum tube and crystal probes. Peak-to-peak probes. Multiplier probes. Grounding the probe. Limitations of the v.t.v.m.

45

5

## Using the v.t.v.m.

Front-panel controls. FUNCTION and RANGE controls. ZERO ADJUST and OHMS ADJUST. Scales and multipliers. How to take measurements. Measuring d.c. voltage, a.c. voltage, ohms. Direct-current measurements. Null indications. Measurement tips.

65

6

## TV troubleshooting

Analyzing TV receivers. Tube troubles. A.g.c. circuit troubles. Troubleshooting components, tuners, picture and sound i.f. amplifiers. Intermittents. Plotting a bandpass curve. Trap alignment. Troubleshooting in the video amplifier. Checking picture tubes, sync and deflection circuits.

79

7

**AM-FM alignment and repair**

AM broadcast receivers. Tube failures. Component failures. Signal tracing. Voltage measurements. Checking power supplies. Hum. Intermittents. R.f. and i.f. alignment. The test setup. FM receivers. Discriminator detectors. Ratio detectors.

103

8

**Servicing audio amplifiers**

Troubleshooting and signal tracing. Making amplifier adjustments. Eliminating hum. Frequency-response measurements. Preliminary considerations. Frequency-response checks. Frequency test records. Checking phonograph equalizers. Determining input and output impedances.

123

9

**The v.t.v.m. in the ham shack**

The amateur transmitter. Checking oscillator, amplifier, and multiplier stages. Measurement of screen voltages. Checking grid bias. Adjustment of high-power amplifiers. Measuring high voltage. The v.t.v.m. as a neutralizing indicator and field-strength meter.

141

10

**Miscellaneous applications**

Calibrating generator and oscillator output. Power-supply measurements. Checking battery voltages, bias cells, transformers, tubes, potentiometers. Scope calibration. Null indications. Checking selenium-rectifier circuits, TV antennas, transmission lines, reactance, impedance. Q and inductance measurements. Direct db readings. Checking r.f.-amplifier gain. V.t.v.m. preamplifier.

157

11

**Troubleshooting the v.t.v.m.**

Preventive maintenance. Ohms battery. General troubleshooting. Switches. Replacement parts. Tube replacement. Measurement accuracy. Mechanical zero setting of the meter. Analyzing and localizing trouble. Description and analysis of two commercial v.t.v.m.'s.

195

Index

219

# introduction

**T**his is a working man's book because the vacuum-tube voltmeter is a working man's instrument. Of the many types of instruments designed to make the electronic worker's job easier, none is so valuable or more used than the vacuum-tube voltmeter. This highly versatile instrument has long been a familiar device on hundreds of factory production lines, in thousands of service shops, and on experimenters' and engineers' work benches all over the world. The popularity of this relatively inexpensive instrument is well earned because the vacuum-tube voltmeter is a trustworthy and highly versatile measuring instrument, capable of use in hundreds of known and yet-to-be-discovered applications.

Successful servicing with the v.t.v.m. requires both a good instrument and proper techniques. A service procedure consisting of 90 percent instrument and 10 percent technique is not nearly as effective as the procedure which uses a 90 percent technique and 10 percent instrument. Expert service technique comes from knowing the capabilities and limitations of the test instrument. Knowing *how* the instrument functions is important to knowing *where* and *when* to use it.

Such important measurement considerations as circuit impedance, frequency response, and loading factor are often overlooked, resulting in misleading measurement indications. Without an adequate knowledge of the equipment under test and without familiarity of the capabilities and limitations of the v.t.v.m., speedy and reliable test results cannot be obtained by the technician.

It is the purpose of this book to describe how the v.t.v.m. works and how to use it. Because the v.t.v.m. is basically simple in design, it should present no special problems in either application or repair. With a good understanding of the few basic features of the v.t.v.m., the technician should be able to use it without hesitation or error in nearly all his service applications.

With the practical nature of the subject in mind, discussion of circuit theory and instrument design has been restricted to material which helps explain directly the types and functions of conventional v.t.v.m. circuits. Representative basic circuits employed in different service-type v.t.v.m.'s are discussed and examined in relation to measurement applications. Analysis of design theory and laboratory-type instruments has been omitted. Emphasis is placed on how, when, and where to use the v.t.v.m., which is of primary importance to the service technician.

Many manufacturers, engineers and technicians have been especially helpful in providing technical data and suggestions: Electronic Instrument Co., Inc.; Forrest H. Frantz, Sr.; Hector E. French; Heath Co.; Hickok Electrical Instrument Corp.; Jackson Electrical Instrument Co.; Robert G. Middleton; Precision Apparatus Co., Inc.; QST; Radio City Products Co.; Radio Corporation of America; Simpson Electric Co.; Sylvania Electric Products Co., Inc.; and Triplett Electric Instrument Co. Special thanks is due Mort Bernstein, Saul Koren, and John Meagher of the Tube Division, Radio Corporation of America, for their expert assistance in offering suggestions and editorial comment.

**RHYS SAMUEL**

# instrument characteristics

**S**ervice technicians use a wide variety of test instruments to check the operation of antennas, lead-ins, front ends, i.f. amplifiers, video amplifiers, sync circuits, sweep circuits, high-voltage circuits, AM and FM receivers, and over-all receiver performance. The minimum requirements of a one-man shop include a v.t.v.m., signal generator, oscilloscope, and sweep generator; most technicians also have a tube tester. Many shops regard as essential additional instruments — audio oscillators, square-wave generators, frequency meters, field-strength meters, pattern generators, grid-dip meters, capacitor checkers, sensitivity checkers, etc. Nevertheless, the v.t.v.m. is the key instrument in the layout.

Vacuum-tube voltmeters have undergone considerable development during the past several years. Copper-oxide rectifiers which are applicable only at low frequencies in low-impedance circuits, and which can measure only r.m.s. values, have given way to diode peak-to-peak indicating arrangements. D.c. scale ranges now extend from 1 to 30,000 volts, full scale.

In a sense, the term v.t.v.m. is a misnomer because it indicates only one of the functions of the instrument. The service type v.t.v.m., which is the subject of this book, may be used to measure resistance as well as a.c. and d.c. voltages, while some others may also be used to measure direct current and capacitance. The design engineer, production worker, service technician and experimenter, all must make voltage and resistance measurements in their daily work. The v.t.v.m. has become, in fact, as important to the modern electronics worker as the soldering iron.



Troubleshooting of any defective electronic equipment consists mainly of isolating the defective section of the unit and determining exactly the stage or circuit in which the trouble exists. Because a faulty circuit is usually revealed by improper voltage or abnormal resistance readings, the troubleshooting process itself may consist almost exclusively of voltage measurements, followed by resistance measurements or a combination of both.

The v.t.v.m. is able to make such measurements with speed, accuracy and convenience. The vacuum-tube type of voltmeter is also able to make these measurements better than nonelectronic meters for a number of reasons. (In many types of industrial electronic equipment as well as in TV and audio units, the v.t.v.m. is the only instrument which can make these checks accurately.) The following features of the v.t.v.m. show why:

1. Low circuit loading in voltage measurements.
2. Wide-range frequency response on a.c. measurements.
3. High sensitivity.
4. Burnout-resistant meter circuit.
5. Resistance readings over wide ranges.
6. Accuracy.
7. Dependability.

### **Low circuit loading in voltage measurements**

Circuit loading is one of the most critical factors in electrical measurements. All commercial types of measuring instruments, when connected to a test circuit, must draw some power to make their measurements. Some circuits, however, are more susceptible to circuit loading than others. Circuits which are characterized by very high d.c. resistance (the kinescope supply in a TV receiver), high a.c. impedance (an r.f. or i.f. amplifier) or low-current characteristics (automatic gain-control circuits) can be seriously disrupted in operation if any substantial load is placed on them. These considerations have an important and direct effect upon the usefulness of the voltage reading.

In both a.c. and d.c. voltage measurements, the voltmeter is connected in parallel across the resistance or impedance of the voltage source. The loading effect, then, is simply a matter of Ohm's or Kirchhoff's law. The loading effect of an ordinary 20,000-ohms-per-volt instrument is demonstrated in Fig. 101. On the 100-volt range, the meter has a total resistance of 2 megohms (2,000,000 ohms). When the voltmeter is placed across one of the 1-megohm resistors in the voltage divider network of the circuit shown,

the combined resistance of the voltmeter and half the bleeder resistance is 666,666 ohms. This causes the voltage to change from 100 at the center of the divider to 80, a change of 20%. Thus, when a voltmeter is connected across a source of d.c. voltage, the voltage which will be read by the voltmeter will not be the original operating voltage but a lower value, depending upon the resistance of the voltmeter and the regulation and current characteristics of the circuit.

The higher the resistance of the voltmeter, the less will be the loading effect on the test circuit. An accurately calibrated voltmeter can be depended upon to indicate the voltage across which it is connected. In the example, shown in Fig. 101, 80 volts is the

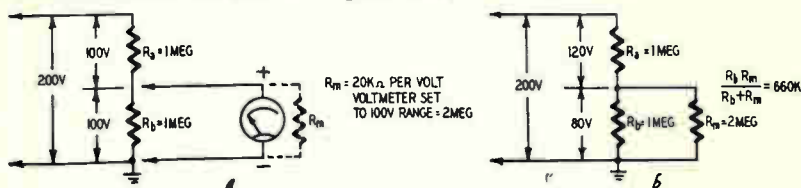

Fig. 101-a, -b. In the illustration at the left (a) the loading effect of the meter is such that it reduces the voltage across the lower resistor from 100 to 80. The equivalent circuit at the right (b) shows that the low impedance of the meter upsets the voltage distribution in the network.

voltage which actually appears at the center point of the network when the low-resistance voltmeter is connected. The voltage will rise, however, as soon as the shunt resistance of the voltmeter is removed. A high input resistance is desirable in a d.c. voltmeter, therefore, to minimize loading effects and provide a more accurate indication of circuit operating voltages. The d.c. input resistances of service type vacuum-tube voltmeters range from approximately 10 megohms to as high as 50 megohms.

When d.c. voltage measurements are made in circuits containing a.c., such as in the plate circuit of an amplifier stage, capacitance loading may cause serious disruption of circuit operation unless the input capacitance of the voltmeter is kept low. Reduced a.c. loading in d.c. voltage measurements is achieved in most vacuum-tube voltmeters by use of an isolating resistor in the d.c. voltage probe. This resistor acts to reduce the effective input capacitance of the instrument to a few micromicrofarads (see Chapter 4). Low input capacitance and high resistance, which increase the overall a.c. input impedance of the voltmeter, are desirable to prevent excessive loading and detuning of high-impedance circuits and to insure dependable a.c. voltage measurements. Commercial vacuum-tube voltmeters using a vacuum-tube

signal rectifier usually have an input capacitance of less than 50  $\mu\text{f}$  and an a.c. resistance of approximately 1 megohm or higher.

There are some vacuum-tube voltmeters, however, which employ a copper-oxide or selenium type signal rectifier, have much lower input impedance characteristics. Consequently, their a.c. loading effect is much higher and their frequency response is usually limited to power-line frequencies or a few kilocycles at best.

The majority of vacuum-tube voltmeters contain voltage divider networks and bridge circuits which make possible input resistances of several megohms on d.c. voltage scales and generally high input impedances on a.c. measurements. Because circuit loading is greatly reduced, more accurate indications of actual circuit operating voltages are possible.

### **Wide-range frequency response in a.c. measurements**

The same characteristics which govern a.c. circuit loading have an effect upon the frequency response characteristics of the instrument. With the exception of metallic rectifier types, commercial vacuum-tube voltmeters employ tubes, usually single or twin diodes, as either half-wave or full-wave a.c. signal rectifiers. With proper circuit design, the high-impedance characteristics of the vacuum tube can be utilized to extend the frequency response of the v.t.v.m. well into the megacycle region.

High-frequency response is achieved in different ways, depending upon the type of v.t.v.m. Special crystal and diode type probes are available for use with many instruments and can extend the working range to 200 mc and beyond. Important, also, is response at lower frequencies. A v.t.v.m. should be able to measure a.c. voltages accurately at 60 c.p.s. and it is desirable that the instrument indicate accurately down to 30 c.p.s., a useful feature in checking low-frequency performance of high-quality audio equipment. High-frequency response is desirable in such applications as television signal tracing, running frequency response curves on wide-range audio amplifiers and checking r.f. and i.f. amplifiers. In TV troubleshooting, good high-frequency response is a major requirement for an a.c. voltmeter. And the only voltmeter which has this feature is the v.t.v.m.

### **High sensitivity**

The v.t.v.m. is a high-sensitivity instrument primarily because it employs vacuum tubes, which are highly sensitive amplifiers.

The signal voltage obtained from the circuit under test is applied, in part, to one grid of a triode bridge circuit. Because of the amplifying action in the vacuum tube, this relatively small voltage can control a large amount of plate-current flow.

The sensitivity of a properly designed vacuum-tube bridge circuit can be made so high that an indicating meter of relatively low sensitivity may be used. This high sensitivity permits use of a more economical and more rugged meter movement which is better able to stand the rigors of daily service work. Meters having a basic sensitivity of  $200 \mu\text{a}$  to  $1 \text{ ma}$  are ordinarily used in v.t.v.m. circuits.

### **Burnout-resistant meter circuit**

The meter movement of the v.t.v.m. is connected across a sensitive bridge circuit. (Bridge circuits are described in the next chapter.) When voltage or resistance measurements are made, the input signal is first of all applied to a resistance voltage divider which, in turn, applies only part of the input signal to the balanced bridge circuit. With this type of design, to be described fully in Chapter 2, it is impossible for the input signal to be applied directly to the meter movement. Because of the limiting action of the vacuum tubes and associated circuitry in the bridge circuit, the amount of current which can flow through the meter is restricted, regardless of the amount of signal voltage applied to the input of the v.t.v.m. Consequently, ordinary overloads do not seriously endanger the meter movement.

This highly desirable feature does not mean, however, that the v.t.v.m. may be used without some precautions. Although excessive and repeated overloads may not result in burnout of the meter coil, the delicate meter pointer may be bent or the movement damaged to the extent that accuracy is seriously impaired. Also, excessive input signal may result in a change in value of the precision resistors in the divider networks or cause burnout of low-value resistors.

While meter resistance to burnout is not a guarantee that voltage overloads, improper settings of controls and use of incorrect probes and cables can be ignored, the v.t.v.m. provides a more than adequate margin of safety against routine and understandable mistakes which could cause serious trouble in other types of meters.

Protection against meter burnout is not always present, however. Many types of vacuum-tube voltmeters which can be used to

measure direct current employ only the meter movement and special shunt resistances; the vacuum-tube bridge is not used. In these instruments, the current in the circuit under test flows directly through the input circuits of the instrument, and only part of the current is shunted around the meter by the shunting resistors. In instruments of this type, protection against overload is *not* assured for current measurements.

### **Resistance readings over wide ranges**

Nearly all commercial vacuum-tube voltmeters are capable of resistance measurements up to 1,000 megohms. Few nonelectronic meters are capable of resistance measurements above 50 megohms. The v.t.v.m. usually requires only one or two small flashlight cells ( $1\frac{1}{2}$  volts each) for all values of resistance measurements. Conventional nonelectronic meters may employ as many as four or five batteries, with voltages up to 90, to enable them to make resistance measurements of these high values. Use of low battery voltages in the v.t.v.m. is made possible, in part, by the high sensitivity of the instrument.

Most vacuum-tube voltmeters are factory-checked for accuracy of resistance measurements at the center-scale points. This method is convenient because of the difficulty which would be present in attempting to check accuracy at the full-scale point, which is the infinity mark, or at the zero-resistance point, a short circuit. On these instruments, then, greatest accuracy on resistance measurements will be obtained at the center-scale points. Therefore, the highest resistance which can be measured with maximum assurance of accuracy is the resistance shown at center scale on the highest resistance range. With the v.t.v.m., this center point is usually the 10-megohm mark. Because few nonelectronic meters are capable of measurements above 50 megohms, this center-scale point may be as low as 1 megohm or less.

An ohmmeter which is limited to measurement of low values of resistance can be a handicap when it comes to general troubleshooting and checking capacitors for leakage. Television receivers and many other types of electronic equipment, for example, contain resistors having a value of several megohms. A leakage resistance of a few hundred megohms can make some capacitors useless. The wide range of resistance measurements offered by the v.t.v.m. makes these checks much easier. A method for using the v.t.v.m. to measure resistances higher than 1,000 megohms is described on p. 90.

## Accuracy

The v.t.v.m. can be designed to give readings of very high accuracy. Its construction also permits use of indicating meters having expanded scales which can be subdivided into relatively small units of voltage, current and resistance. These are primarily mechanical features but they make it possible to read the meter indications with greater precision. Internal calibrating adjustments are also provided for voltage and current scales to allow compensation for any slight shifts in calibration which might occur over periods of time. Aging of tubes and components, climate and other factors can effect slight electrical changes in precision circuitry. When internal calibrating controls are provided, it is a relatively simple matter to correct for deviations.

## Dependability

The v.t.v.m. is a dependable instrument principally because it is a simple instrument. Its principles of operation, circuit design and construction are straightforward, requiring only that the user be familiar with the circuitry he is testing and that he know a few fundamentals important to electrical measurements. When properly used, the v.t.v.m. can be expected to give long, trouble-free operation. Design of these instruments is usually conservative. Operating voltages on bridge tubes and power rectifiers are usually well below maximum ratings, which greatly extends the life expectancy of tubes, components and the instrument in general.

The v.t.v.m. also has some miscellaneous features which help make it a good all-around instrument. These include the ability to measure a.c. voltages in d.c. circuits and the ability to measure the d.c. component of a.c. signals; a wide range of voltage measurements from approximately 0.1 to 1,000 or 1,500 volts both a.c. and d.c.; resistance measurements from a few tenths of an ohm to 1,000 megohms; good stability over a range of line-voltage conditions; light weight and portability and adaptability to numerous other measurements through the use of external accessories. For example, high-voltage probes are available for extending the d.c. voltage measurement ranges of the v.t.v.m. up to 30,000 volts and higher. These relatively inexpensive probes contain a special precision resistor which drops the high voltage to a value which can be measured with the v.t.v.m. Well insulated, the probes can be attached directly to the d.c. voltage input connector of the v.t.v.m. No modification of the v.t.v.m. is required. High-fre-

quency probes which either slip on or connect to the probes supplied with the v.t.v.m. (or which attach to the front-panel connector of the instrument) can be used to extend the high-frequency measurement range of the v.t.v.m. well into the megacycle region. These accessories and their principles of operation are discussed in Chapter 4.

These, then, are the major features and advantages of the v.t.v.m. Altogether, they make the v.t.v.m. one of the most versatile and reliable of all measuring instruments. When it is realized that a single instrument incorporating all of these features is within the price range of nearly everyone engaged in servicing, experimenting or electronic construction, the v.t.v.m. has an even greater attraction.

# how the v.t.v.m. works

One of the best reasons for understanding how the v.t.v.m. operates is that a good working knowledge of the instrument and its accessories can eliminate many servicing errors and simplify many problems. Some typical questions are: Where is the best point in the circuit to make the measurement? What cable and probe should be used? Is the reading on the meter dependable?

Because of the great variety of electronic equipment, it is impossible to anticipate all the measurement problems which can arise. If the technician knows how his instrument works, he will know more about its capabilities and limitations. Consequently, he will be able to solve his own measurement problems without trouble. An adequate knowledge of the instrument is also important when it comes to troubleshooting the v.t.v.m. And, a knowledge of v.t.v.m. circuits and principles of operation can be applied to many other types of equipment using circuits which function on similar principles.

Basically, the v.t.v.m. is a simple instrument. It uses standard circuits, familiar components and conventional vacuum tubes. To technicians familiar with the much more complicated circuitry of a television receiver, the most involved part of the v.t.v.m. is the switching arrangement. And even the switching networks can be easily understood if a schematic diagram is available.

When stripped of its switches, the v.t.v.m. consists simply of



a vacuum-tube bridge circuit, a.c. signal rectifier, voltage divider networks, power supply and, on some instruments, a compensating section for contact potential in the a.c. signal detector, a special problem discussed further on in this chapter. A v.t.v.m. (the RCA WV-77A Junior VoltOhmyst) may employ as few as two tubes or as many as five (the Sylvania 221Z and 134A), including the rectifier in the diode probe. The tubes are often dual-section types, however, and may be used to perform more than one function. In the case of the Junior VoltOhmyst, four-tube per-

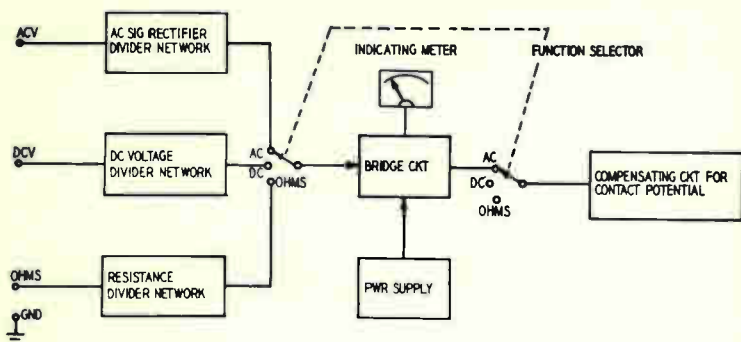

Fig. 201. Block diagram of the circuits found in a typical v.t.v.m. Some v.t.v.m.'s include a current-measuring section.

formance is achieved with two tubes, effecting economy of design without sacrificing accuracy or versatility.

The service type v.t.v.m., with which we are exclusively concerned here, employs one or two tubes in the bridge circuit, one tube in the power supply and one in the a.c. signal-detector section. The Sylvania instruments employ an additional twin triode, which functions as a cathode-coupled amplifier stage, ahead of the bridge circuit. Battery-operated units, however, such as the G-E AA-2 and RCA WV-65A VoltOhmyst, do not employ a vacuum-tube signal detector or vacuum-tube power rectifier, but use a metallic type signal detector.

If we borrow a little from each of the current types of instruments, a typical block diagram of the v.t.v.m. will look like that shown in Fig. 201. There are exceptions, of course, but the exceptions do not alter our basic description. A check of the schematic diagram for individual instruments will quickly show any deviations.

The v.t.v.m. is built around the vacuum-tube bridge circuit and indicating meter. The functions of the a.c. signal rectifier and the divider networks for a.c. and d.c. volts and ohms are to supply

a fixed proportion of the a.c. or d.c. input signal to the bridge circuit. In operation, a d.c. voltage is fed to the bridge from one of these three sections. On resistance measurements, the resistance divider network in series with an internal battery furnishes a value of d.c. voltage which depends upon the value of the unknown shunt resistance placed across the network. On d.c. voltage checks, the voltage under measurement is applied across the d.c. voltage divider network which, in turn, apply a proportionate part of the test voltage to the bridge.

In a.c. voltage tests, however, the signal is rectified first and the resultant d.c. voltage is then applied to the bridge circuit. The

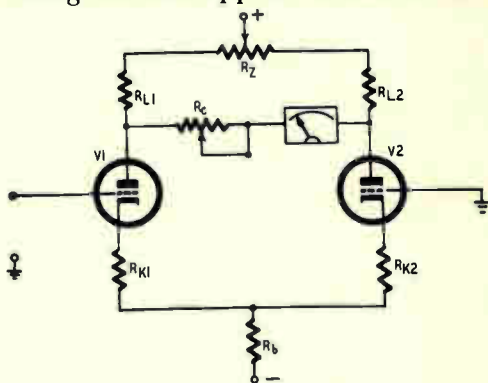

*Fig. 202. Bridge circuit used in a modern v.t.v.m. Although separate tubes are shown here, twin triodes (with independent cathodes) are generally used.*

input divider networks for the three functions are designed so that only a small part of the input voltage (1.5 to 3 volts maximum) reaches the bridge circuit.

The power supply provides the heater and plate voltages for the bridge tube and heater voltages for the a.c. signal rectifier and contact-potential bucking tube, if one is used. Voltage for ohms measurements is obtained from an internal low-voltage dry cell. The compensating circuit for contact potential is used when the v.t.v.m. is switched to a.c. measurements. An explanation of this circuit will be given later.

### The bridge circuit

The majority of vacuum-tube voltmeters now being manufactured or currently in use have a great deal in common. The bridge circuits, especially, are similar in operation. In fact, two basic bridge circuits with only slight modifications can be used to

demonstrate the operation of these circuits in almost all service type vacuum-tube voltmeters.

The first of these bridge circuits is shown in Fig. 202. This is a push-pull circuit in which the indicating meter is connected between the plates of the two triodes. The tubes employed may also be pentodes, although the use of pentodes increases power-supply problems and requires additional components. For these reasons, plus the fact that pentodes have no great advantages over triodes in a v.t.v.m. bridge circuit, pentodes are seldom employed. The practice is to use twin-section triodes having separate cathodes.

The circuit shown in Fig. 202 is degenerative, an important feature in increasing general stability and immunity from effects of line-voltage variations. Degeneration (negative or inverse feedback) also aids in increasing the overall linearity of the circuit. In this circuit cathode resistors  $R_{k1}$  and  $R_{k2}$  are connected to a common resistor  $R_b$ .  $R_{L1}$  and  $R_{L2}$  are the plate load resistors. Total current for both tubes must flow through  $R_b$ ,  $R_{k1}$  and  $R_{k2}$ , which affect bridge-circuit sensitivity, are usually made relatively small in value with respect to  $R_b$ .

If a positive voltage is applied to the grid of V1, the current flowing through the left side of the bridge is increased, causing the voltage at the plate of this section to decrease. This current also flows through the common cathode resistor  $R_b$ , causing an increase in the voltage drop across it. The cathodes of both V1 and V2 will appear more positive. Because the grid of V2 is grounded, however, the bias is increased and current flow through V2 is less than that through V1, the voltage drop across  $R_{L2}$  is decreased and the voltage at the plate of V2 is increased. The resulting difference in potential between the plates causes current to flow through the meter from the plate of V1 to the plate of V2. The meter may be calibrated in units of voltage or resistance. The ratios between the values of the plate-load resistors and the resistors in the cathode circuit are important because they determine the operating characteristics of the bridge circuit. In the Hickok model 215, for example,  $R_{L1}$  and  $R_{L2}$  are 39,000 and 36,000 ohms, respectively.  $R_{k1}$  and  $R_{k2}$  are 1,800 ohms and  $R_b$  is 47,000 ohms. A 12AU7 is used as the bridge tube. These values are representative of those used in other instruments which employ this circuit.

Perfect electrical balance between the two halves of the bridge is an ideal condition which, however, is difficult if not impossible

to achieve in practice. Such an ideal condition would require two tubes which are electrically identical and resistors matched to perfection. Also, tube and component aging would have to be of such a nature that circuit equilibrium would be unaffected over long periods of time. Such a condition is impractical to achieve, of course, and unnecessary if means are provided for compensating for slight electrical differences between tubes and components. Under static conditions, the bridge is adjusted by means of  $R_z$  so the indicating meter reads zero and the currents flowing through both sides of the bridge are apparently equal.

In the circuit of Fig. 202, a fair degree of static circuit balance may be achieved by use of tubes with similar characteristics and

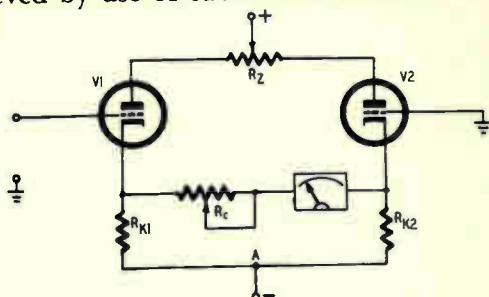

Fig. 203. This bridge is similar to that of Fig. 202. Note that in this case, however, the indicating meter is in the cathode circuit.

components having approximately equal values.  $R_z$  permits precise overall adjustment of the bridge. Calibration of the v.t.v.m. bridge is accomplished by adjustment of  $R_c$ , the calibrating potentiometer. With no input voltage applied, the bridge is first adjusted for zero reading on the meter by means of  $R_z$ , the ZERO-ADJUST control. A positive voltage of exact known value is then applied to the input terminals and  $R_c$  is adjusted until the meter pointer reads this exact value on the meter scale. The calibrating voltage is usually the value of the full-scale point on a lower voltage range. Once the v.t.v.m. has been calibrated on the required D.C. VOLTAGE range, the instrument should maintain its accuracy on the remaining D.C. VOLTAGE ranges. A separate calibrating control is usually provided for each function of the instrument. The RCA WV-87A Master VoltOhmyst, for example, has a separate calibrating potentiometer for +D.C. VOLTS, -D.C. VOLTS, DIRECT CURRENT and RESISTANCE. On other instruments, however, one control may serve for both +D.C. and -D.C. VOLTS. The resistance adjustment on service type vacuum-tube

voltmeters is the familiar OHMS control, located on the front panel. This control usually requires adjustment whenever the instrument is used. Other calibrating controls, however, are located inside the instrument case and are adjusted at the factory.

### **Cathode-metered bridge circuit operation**

Another commonly used bridge circuit of slightly different design is shown in Fig. 203. This cathode-metered bridge is used widely and with considerable variations in component values and arrangement. (In Eico, Heath, Triplett and Simpson instruments, for example, the ZERO-ADJUST control is located at the junction of  $R_{k1}$  and  $R_{k2}$ , with the arm of the control connected to the negative side of the voltage supply.)

If a positive voltage is applied to the grid of V1, current flow is increased and the positive voltage appearing at the cathode of V1 is increased. Part of the increased voltage at the cathode of V1 is also applied to the cathode of V2 through the relatively low resistance of the meter and calibrating resistor  $R_c$  and through  $R_{k1}$  and  $R_{k2}$ . Because the voltage at the cathode of V2 is raised and the grid of V2 is grounded, the bias on V2 becomes more negative. The current flow through V2, then, is decreased with a resultant decrease in potential at the cathode of V2. Since the cathode of V1 is more positive than the cathode of V2, current flows through the meter from the cathode of V2 to the cathode of V1. Note that the direction of current flow is opposite to that in the push-pull type bridge circuit.

### **D.c. voltage-divider network**

The purpose of the d.c. voltage divider network is to provide a resistance path to ground across which the voltage to be measured can be developed and applied in a small, fixed proportion to the bridge circuit. The network is tapped at various points, depending upon the number and ranges of d.c. voltage scales on the v.t.v.m.

The network shown in Fig. 204 is typical of those used in service type vacuum-tube voltmeters. The values and taps shown are those used in the divider network of the RCA WV-97A Senior VoltOhmyst. Other units may employ a different number of ranges and different values of resistances in their networks, but the principle of operation is the same.

The external d.c. voltage is applied across the full resistance

network, whether the instrument is to measure 1,500 or 1.5 volts. On the WV-97A, approximately 1.35 volts is required at the grid of the bridge input tube for full-scale meter deflection on all ranges and functions. The d.c. voltage divider and other divider networks are designed accordingly. It can be seen from Fig. 204 that as the voltage range increases, a smaller amount of the applied voltage is tapped off for application to the bridge tube. With 1,500 volts applied to the instrument, only about .09% or

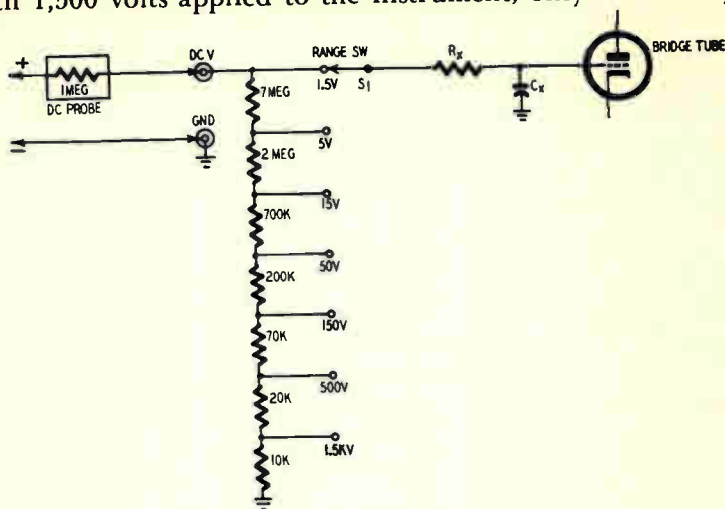

Fig. 204. Voltage-divider network at the d.c. input to a v.t.v.m. The input resistance, including the resistance of the external probe, is 11 megohms. Some v.t.v.m.'s have an input rated at 25 megohms.

1.35 volts of the input voltage will be tapped off. The relationship of the individual resistances which make up the series network is such that when the maximum rated voltage for any particular range is applied, the voltage developed between the corresponding range tap and ground is always approximately 1.35. Generally, commercial vacuum-tube voltmeters require between 1 and 3 volts at the grid of the input bridge tube for full-scale deflection.

The input resistance of a v.t.v.m. on d.c.-voltage measurements is calculated simply by adding the values of all the resistors in series from the d.c. voltage input terminal to ground, plus the value of the isolating resistor in the d.c. probe. The input resistance is constant for all d.c. voltage ranges. The purpose of the isolating resistor (one megohm d.c. probe) is described in Chapter 4.

The values shown in Fig. 204 total 11 megohms (including 1

megohm in the probe) which is the input resistance and resistance-loading factor of the Senior VoltOhmyst. Current drain from the circuit under test is about  $100\ \mu\text{a}$  on the 1,500-volt range and only  $0.14\ \mu\text{a}$  on the 1.5-volt range! Circuit loading, therefore, is not a serious problem.

The d.c. input resistance can be made higher, of course, by employing a divider network made up of higher resistances. This is not usually done, however, for two reasons. The first is that a very high input resistance creates problems of stability. Leakage resistance of switch wafers, wiring insulation and probes and cables, all of which are affected by temperature, humidity and dust, act to shunt the high-resistance divider network and change its effective resistance. The second reason involves bridge circuit design and vacuum-tube characteristics. It is highly desirable and necessary to keep grid current as close to zero as possible. A direct current as small as  $1\ \mu\text{a}$  flowing through a grid-to-ground resistance of 1 megohm can generate 1-volt d.c. Such a voltage is more than enough to cause serious trouble in bridge-circuit action. If a d.c. input resistance of 30 or 40 megohms is employed, extreme care must be taken to restrict leakage resistance and to keep grid current at a very low level. These measures require the most careful circuit design and the use of especially high-quality components. However, these are expensive measures which experience has shown are unnecessary in a service type v.t.v.m.

In Fig. 204,  $R_x$  and  $C_x$  comprise a simple filter network designed to keep any high-frequency a.c. voltage picked up in the grid circuit from being rectified by the input bridge tube and thereby affecting meter indications.  $R_x$  also acts as a limiting resistor to prevent overload voltages from driving the grid of the tube too far in a positive direction. This filter network is part of the grid circuit of the input bridge tube and is, therefore, in operation on all functions. Similar networks are used on all commercial vacuum-tube voltmeters.

The precision of the resistors used in the d.c. divider network have a great influence on the accuracy of the voltage reading. Wirewound or deposited carbon-film resistors having a tolerance of  $\pm 1\%$  or better are generally used since a change in value of any resistor in the network can affect the accuracy of the voltage reading on all ranges. Consequently, the resistance divider network is one of the first circuits to check when the v.t.v.m. starts to give haywire d.c. voltage readings.

An important feature provided in most vacuum-tube voltmeters

is polarity switching on d.c. voltage measurements. The function switch, which has positions marked +D.C. and -D.C., provides a means of reversing connections of the meter terminals between the two bridge tubes. By merely resetting the front-panel switch, upscale deflection can be obtained on either positive or negative d.c. voltage measurements. This convenient feature eliminates the necessity of reversing test leads when changing the polarity of measurement.

### Resistance-measurement network

Two types of arrangements are used in the "ohms" measurement section of the v.t.v.m. Both work on the same principle: the value of the unknown resistance is compared with the value of a precision standard resistor in the v.t.v.m. The answer is read directly in

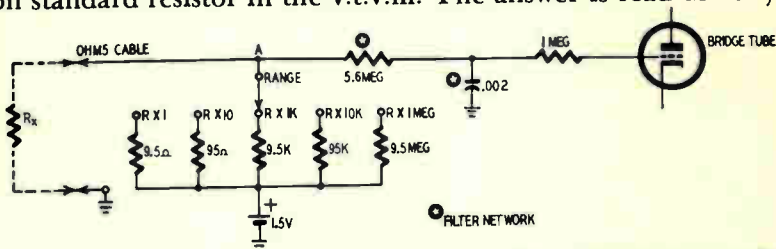

Fig. 205. Resistance measuring circuit of a v.t.v.m. Some v.t.v.m.'s use 1.5 volts as the voltage source for resistance tests; others use 3 volts (see Fig. 206).

ohms from a v.t.v.m. scale specially calibrated in units of resistance.

The comparison works on a principle in which the external resistance is connected in series, by means of the ohms probe and cable and the ground cable, with the standard resistor and the internal battery. The most common arrangement is shown in Fig. 205. The circuit is that used in the Eico model 214, which has five resistance ranges for measuring values up to 1,000 megohms.

A 1.5-volt battery is used as the voltage source. When the range switch is set to any of the five positions, one of the standard resistors is connected in series with the battery and the ohms probe. If no external resistance is connected across the circuit, no direct-current path will exist in the battery circuit, no current will be drawn from the battery and a maximum amount of voltage will be present at point A. This will cause the tube to conduct and, in turn, cause the meter pointer to swing to the full-scale point. The full-scale point, then, indicates an infinite amount of resistance.



When an external resistance, shown as  $R_x$ , is connected across the circuit, the d.c. path from the positive terminal of the battery is completed through the standard resistor,  $R_x$ , the ohms probe and cable and the ground cable. Current will flow, producing a voltage drop across both resistors. The ratio between the values of the two resistances will determine the voltage available at point A. This voltage will always be less than the full battery voltage, causing a corresponding reduction in the voltage reaching the grid and a smaller excursion of the meter pointer.

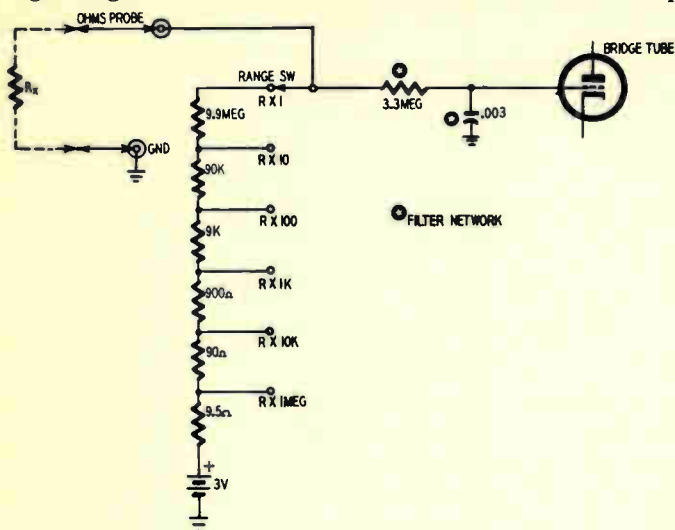

Fig. 206. Fundamentally this circuit is identical with that of Fig. 205. Note, however, that here all the resistors connected to the range switch are in series.

Because the amount of pointer deflection depends directly on the value of the external resistance, the scale may be marked in units of resistance.

If an external resistance equal to the normal resistance of the grid circuit is connected, the ratio between the two resistances and the divided voltages will be 1 to 1; only half the battery voltage will appear at point A, and the pointer will deflect to half scale. This point, which is basically determined by a voltage value, is also the point which corresponds to the value of the standard resistor. In practice, the mid-scale point is 10 ohms or a multiple of 10. External resistances larger than the resistance of the grid circuit will cause deflection in the top half of the ohms scale; smaller resistances will cause the pointer to indicate in the lower half of the scale. Positions of all other points on the ohms scale

may be determined easily. (Typical ohms scales are shown in Chapter 3.)

The circuit arrangement shown in Fig. 206 works in the same manner as that shown in Fig. 205 except that, as the resistance range is increased, the effective value of the standard resistor is made up of two or more resistances connected in series. The differences in the merits of each arrangement are of no great importance and both systems are used with good results in many vacuum-tube voltmeters.

Most commercial units employ a single 1.5-volt flashlight cell as the voltage source for ohms measurements. Some vacuum-tube voltmeters, however, employ two batteries in series to give 3 volts.

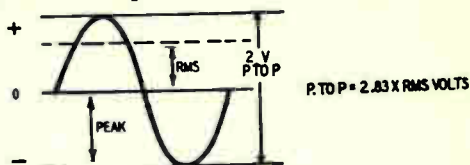

Fig. 207. This drawing indicates the relationship between the values of a sine wave. If the peak is 1 volt, then the peak-to-peak is 2 volts, and r.m.s. is 0.707 volt.

The battery voltage required for full-scale deflection depends on design of the bridge circuit and its operating characteristics. A low battery voltage has the advantage of permitting measurements in very low-resistance low-wattage circuits which might be damaged by application of a higher voltage. Resistances of thermocouples, battery-tube filaments and other low-power devices should be measured only after making sure the ohms-measurement voltage of the v.t.v.m. will not cause burnout of the resistance being measured.

### A.c. voltage measurements

The a.c. voltage measurement too often is a problem, especially in TV servicing where much confusion could be avoided by a better understanding of how the v.t.v.m. works, what waveforms it is designed to measure and what type reading (r.m.s., peak, or peak-to-peak) is provided by the meter. If the technician has this knowledge firmly in mind, he should be able to use his v.t.v.m. without hesitation. He will know exactly the reliability of the reading and whether he is attempting to measure a waveform or trying to obtain a type of reading which his instrument was not designed to handle.

Reliable a.c. voltage measurements can be assured if the technician is aware of these basic facts:

1. All vacuum-tube voltmeters are designed to provide a specific type of a.c. voltage reading—either r.m.s., peak, or peak-to-peak.

2. The shape and repetition rate of the waveform being measured have a direct effect on the accuracy of the meter indication.

3. The v.t.v.m. is designed to measure a.c. signals over a frequency range defined by the manufacturer. The frequency response of the v.t.v.m. is not unlimited.

Service type vacuum-tube voltmeters are designed to indicate directly either r.m.s. or peak-to-peak values of a.c. voltages. The a.c. signal rectifier used in most r.m.s. indicating instruments is a half-wave peak rectifier; the meter scales, however, are calibrated

**TABLE 1**

CONVERSION TABLE FOR SINE WAVES ONLY			
MULTIPLY			TO GET:
R.M.S. BY	PEAK BY	P - P BY	
—	0.707	0.353	R.M.S.
1.414	—	0.5	PEAK
2.83	2.0	—	PEAK-TO-PEAK

in r.m.s. values (0.707 of the peak value) of the rectified voltage.

The relationships between r.m.s., peak and peak-to-peak portions of a sine wave are shown in Fig. 207. The portion of the waveform rectified by the v.t.v.m. depends on the type of a.c. signal rectifier used. Half-wave diode rectifiers are used in peak rectifying instruments; a full-wave voltage doubler circuit, similar to the rectifier circuits employed in many a.c.-d.c. radio receivers, is used in peak-to-peak reading instruments.

In measurement of pure sine waves, a fixed mathematical relationship exists between these three portions of the waveform. It is important to remember that these values, which are shown in Table 1, hold only for sine waves. They cannot be applied to any other waveshape. If this point is ignored, trouble may result. Each type of waveform has its own mathematical relationships. The r.m.s. value of the pulse shown in Fig. 208 may be only 10 or 20% of its peak value, depending upon the width of the pulse, the repetition rate and the reference level. If we try to measure

the r.m.s. value of the pulse on a v.t.v.m. designed to indicate the r.m.s. value of a sine wave, the large error will make the reading meaningless.

If we restrict our a.c. voltage measurements to pure sine waves, it is possible to calibrate the meter scales to indicate the r.m.s., peak and peak-to-peak values simultaneously, because all sine waves, regardless of their voltage value, have a fixed relationship between these portions. Some commercial vacuum-tube voltmeters are calibrated to indicate simultaneously the r.m.s. and peak-to-peak values of sine waves. Other instruments are designed to indicate directly, not only the r.m.s. and peak-to-peak values of

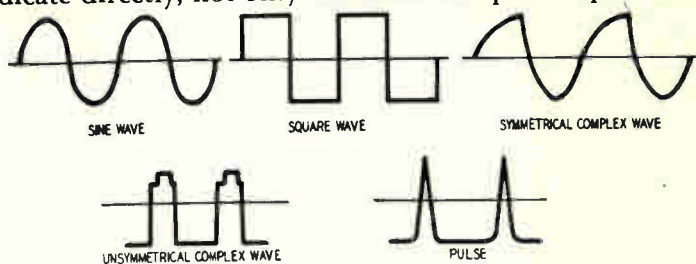

Fig. 208. Types of waveforms that you will encounter in radio and TV servicing. Many v.t.v.m.'s are designed for sine-wave measurements only.

sine waves, but the values of complex wave shapes as well. These instruments employ special rectifier circuits however.

It is necessary, therefore, that the technician understand exactly the types of waveforms his v.t.v.m. is designed to measure. This information should be provided by the manufacturer in his published specifications for the instrument. In cases where no information is given regarding waveshape, it is safer to assume that on a.c. the instrument is designed to measure sine waves only.

### Frequency response

The frequency response, or the range of frequencies over which the v.t.v.m. will provide accurate a.c. voltage readings, depends upon the a.c. circuit and input characteristics of the instrument. Mainly, the input resistance and capacitance are the governing factors. These characteristics may be uniform throughout all the voltage ranges of the instrument or they may vary from range to range. All vacuum-tube voltmeters are limited to a certain range of frequencies; the range may run from a few cycles per second to several megacycles. Special high-frequency probes are often available for extending the response into higher frequencies.

The input capacitance should be kept low and the resistance made as high as possible to enable the v.t.v.m. to work at the higher frequencies. The shunting capacitance may have a relatively high reactance at audio frequencies, but at radio frequencies the reactance may be low enough to attenuate the input signal seriously. The meter reading, then, will be lower than the normal value of the source voltage. The v.t.v.m. should be used only for frequencies within its response range.

Fig. 209 shows a half-wave rectifier circuit which is similar in

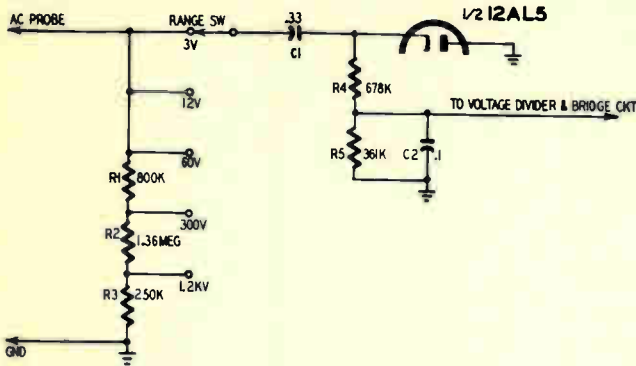

Fig. 209. A.c. measuring circuit of a v.t.v.m. Unless otherwise indicated, the v.t.v.m. will read the r.m.s. value of the input a.c. waveform.

operation to those used in other r.m.s. indicating units. This circuit, part of the RCA WV-77A Junior VoltOhmyst, employs a single diode section of a 12AL5 miniature twin-diode. The other diode section is the a.c. power rectifier. Circuit operation is as follows:

When an a.c. signal is applied between the a.c. probe and ground, the negative half of the cycle charges capacitor C1 through the diode to the negative peak value of the input voltage. When the voltage starts to swing in the positive direction, the diode becomes nonconductive and C1 can discharge only through resistors R4 and R5. The time constant of C1, R4 and R5 is relatively long, however, and the voltage charge on C1 and the voltage across R4 and R5 remain at essentially the peak value. Any charge which may leak off capacitor C1 will be replenished during each succeeding cycle of the a.c. input voltage. Resistors R4 and R5 form a precision voltage divider to supply the voltage divider network and vacuum-tube bridge with a d.c. voltage proportional to the peak value of the wave being measured. Meter scales are calibrated in r.m.s. values.

Because at low voltage levels the 12AL5 goes into nonlinear operation, correction is necessary to insure accurate voltage readings. Correction is made by providing a separate scale for the 3-volt a.c. range. This scale should always be used for measurement of a.c. voltages up to 3 volts.

Note that a.c. attenuation is provided for in two sections of this circuit. A.c. voltages up to 60 are fed directly to the diode rectifier, and attenuation occurs in a voltage divider network

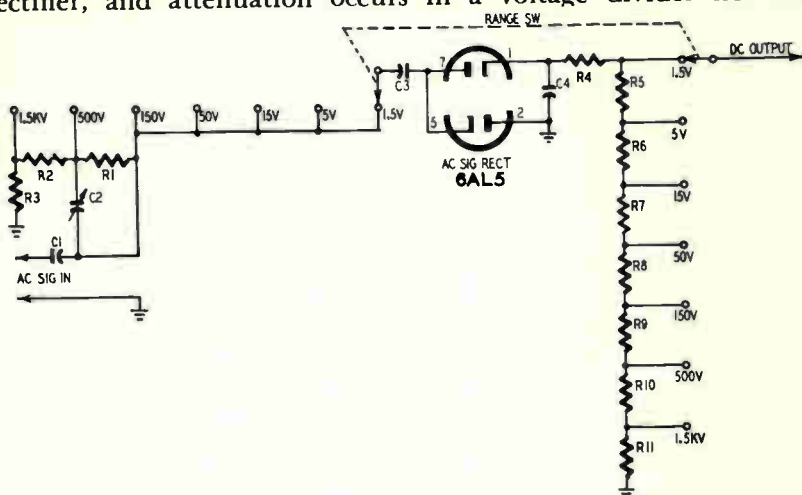

Fig. 210. A.c. measuring circuit of a peak-to-peak type of v.t.v.m. This circuit enables the instrument to measure the peak-to-peak values of complex waveforms.

beyond R4, R5. On the 300- and 1,200-volt ranges, however, attenuation occurs in the network made up of R1, R2 and R3 before the voltage reaches the rectifier. This arrangement prevents the inverse peak voltage rating of the tube from being exceeded. Another advantage of this circuit arrangement is that a common voltage divider network may be used on some a.c. and d.c. voltage measurements.

A peak-to-peak rectifier circuit is shown in Fig. 210. This circuit, which is used in the RCA WV-97A Senior VoltOhmyst, is capable of rectifying sine waves and a variety of pulses and other nonsymmetrical complex waves. The d.c. output voltage is proportional to the peak-to-peak value of the waveform.

Seven voltage ranges are provided. Measurement of peak-to-peak values of waveforms other than sine waves is made possible by the use of component values which give the rectifier circuit a long time constant. When the applied a.c. signal swings negative, C3 is charged through the bottom diode section to the negative

peak value of the applied voltage. As the voltage starts to swing in a positive direction, this diode section becomes nonconducting and the charge on C3 is prevented from discharging.

As the a.c. signal swings positive, the positive peak is added in series with the charge on C3 and is applied to the plate of the other diode section. C4 is then charged to a value equal to the sum of the positive and negative peaks. Because of the relatively long time constant of the circuit, the voltage across C4 will be maintained at the peak-to-peak value of the applied a.c. voltage. This charge is then applied as a d.c. voltage to the a.c. voltage divider and the bridge tube.

R1, R2 and R3 are a voltage divider which limits the voltage applied to the 6AL5 and prevents damage on the high-voltage ranges. C1 is a blocking capacitor which prevents any d.c. voltage in the test circuit from reaching the divider networks and diodes. C2 is a frequency-compensating capacitor which is adjusted at the factory to maintain a frequency response essentially flat up to 3 mc on all ranges up to and including the 500-volt range. Response may be extended to 250 mc when an accessory crystal rectifying probe is used. The crystal probe, however, does not provide for peak-to-peak readings, and meter indications are in r.m.s. values.

### **A.c. voltage measurements and contact potential**

When a vacuum-tube diode is used as an a.c. signal rectifier in a v.t.v.m., special allowance must be made for the effect of contact potential. Contact potential is a d.c. voltage generated within the tube itself, even when no external voltage is applied to the plate. Basically, contact potential is caused by (1) the difference in characteristics of the metals used within the tube envelope and (2) the velocity with which electrons leave the cathode. If the cathode is hot enough to emit electrons, a few electrons will be propelled to the plate due to thermal energy, even with no applied plate voltage. In most receiving tubes, contact potential increases as the temperature difference increases between the tube metals. In the simple diode circuit shown in Fig. 211, for example, the contact potential which exists between the cathode and plate will cause a small amount of current to flow in the external circuit. This current may be extremely small, less than 1 microampere.

Suppose R in Fig. 211 is 10 megohms, which corresponds in value to the resistance of a typical v.t.v.m. voltage divider. If the diode contact potential causes a current of only 0.1 microampere

to flow, the external voltage developed will be 1 volt. All or part of this voltage will then appear at the grid of the bridge input tube, depending on the setting of the RANGE switch, and cause the meter pointer to deflect off zero, the direction of deflection being dependent on how the diode is connected in the circuit. The ZERO-ADJUST control must then be readjusted to bring the meter pointer back to zero. As the RANGE switch is changed to different taps along the network (see Fig. 210), a different fraction of the voltage will be tapped off and the meter pointer will shift accordingly. The pointer will also shift off zero when the v.t.v.m is switched from A.C. to D.C. or vice versa.

If the meter pointer is not set to zero once again, the voltage reading will probably be inaccurate. If the pointer has to be

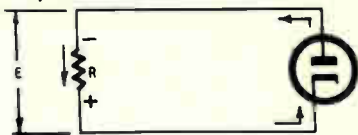

Fig. 211. Contact potential, produced by a minute current flowing through  $R$ , is serious when measuring small voltages.

returned to zero whenever the range is changed, the practice becomes a nuisance.

This operating inconvenience can be overcome in the design of the instrument by incorporating a circuit which will either provide a counteracting or balancing-out voltage of opposite polarity to buck out the contact potential or which will automatically balance the bridge circuit when the v.t.v.m. is switched to A.C. When the bucking or compensating circuit is properly adjusted, the range switch may be set to any position without materially affecting the zero setting of the pointer.

Three types of circuits are commonly used to overcome the effects of contact potential. The first circuit, shown in Fig. 212, uses a small voltage tapped from the power supply to buck out the contact-potential voltage. The figure shows a v.t.v.m. which employs a half-wave signal rectifier,  $V1$ . The detector circuit is connected to the bridge only when the FUNCTION switch is set to A.C. Compensation is not required on other functions.

On A.C., contact potential in the diode  $V1$  will cause a positive voltage to appear at the cathode of the diode and also at the grid of the input bridge tube. This positive voltage, which will produce off-zero deflection of the meter pointer, is neutralized by tapping a corresponding voltage of negative polarity off the power



supply voltage divider. R is a variable resistor, usually a potentiometer, which is set correctly at the factory. In some instruments, the diode detector may be connected differently, causing a negative voltage to be applied to the bridge. In these cases, a positive bucking voltage is tapped from the power supply. The method described in Fig. 212 is employed in the RCA WV-77A Junior VoltOhmyst.

Another circuit arrangement is shown in Fig. 213. This a.c. circuit is a full-wave peak-to-peak rectifier. The diode V2 is used

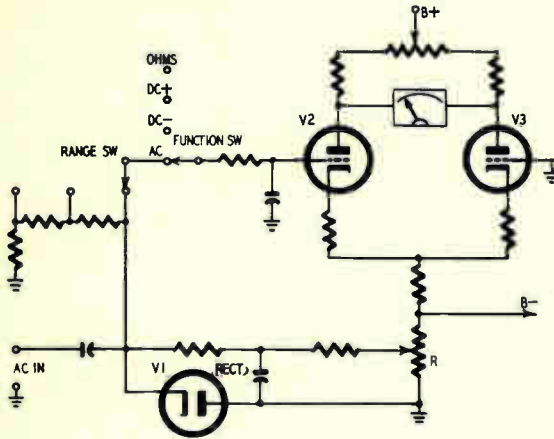

Fig. 212. Contact potential will cause the meter needle to swing off scale when the range switch is set to read low voltages. Potentiometer R can be properly positioned to counteract contact potential and to provide a zero reading on the scale before making low-voltage measurements.

to generate a contact-potential voltage which is applied to the grid of V4 to offset the effect of the negative voltage applied to the grid of V3 due to contact potential in V1. R1 is adjusted to give the correct amount of counterbalancing voltage. As the range switch is changed, a voltage which is proportional to the amount of contact potential voltage appearing at the grid of V3 is tapped off the network R2, R3 and R4 to keep the bridge in balance. This method is used in the RCA WV-87A and WV-97A Volt-Ohmysts and several other commercial vacuum-tube voltmeters.

A third method of counteracting contact potential is shown in the simplified diagram in Fig. 214. The functioning of this circuit is similar to that of a bridge. The a.c.-balance potentiometer R is adjusted for zero output with no signal applied to the input terminals. V1 is the signal rectifier and V2 acts to balance out the contact potential of V1.

## Direct-current measurements

Not all commercial vacuum-tube voltmeters provide current-measurement facilities because there is little need for current measurements in radio and TV servicing. This feature is useful,

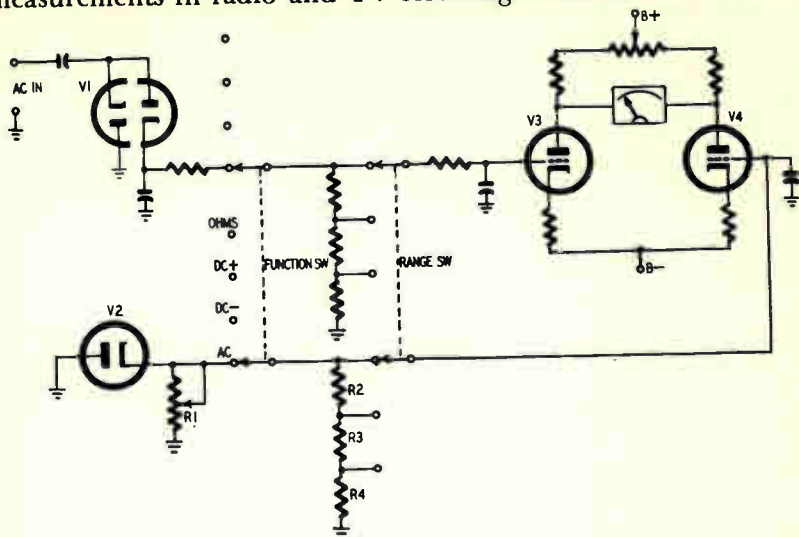

Fig. 213. Circuit of a full-wave, peak-to-peak rectifier. Diode V2 produces a bucking potential to counteract the contact potential of V1. Zero adjustment on the low-voltage scale is obtained by proper setting of R1.

however, in checking current drain of auto radios, d.c. balance of push-pull amplifiers and general measurements in amplifiers and other d.c. devices. The circuit shown in Fig. 215 is typical of

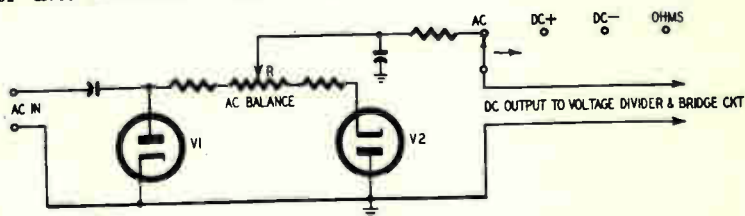

Fig. 214. In this circuit V2 produces a voltage in opposition to contact potential. Potentiometer R is adjusted until the meter needle is at the zero point.

those employed in commercial instruments. This circuit, used in the Sylvania 221Z, 301 and 302 Polymeters, will measure direct current from 3 ma to 10 amperes (full-scale values). The circuit consists simply of a d.c. meter movement (1-ma full-scale deflection), a series dropping and calibrating resistor  $R_c$  and seven current-shunting resistors.

Shunt-resistor values and taps are arranged so that, with correct

use, current flow through the meter is restricted to a maximum of approximately 1 ma. The switch is connected in series with the meter rather than in shunt so that the contact resistance will not change the accuracy of the meter reading. The meter shunt circuit is never broken so that no overload current surges will occur when ranges are changed. The series resistance increases on the higher current ranges and gives the meter some degree of protection against current surges.

Instruments which use this type of circuit do not utilize the bridge circuit and vacuum-tube functions of the instrument and

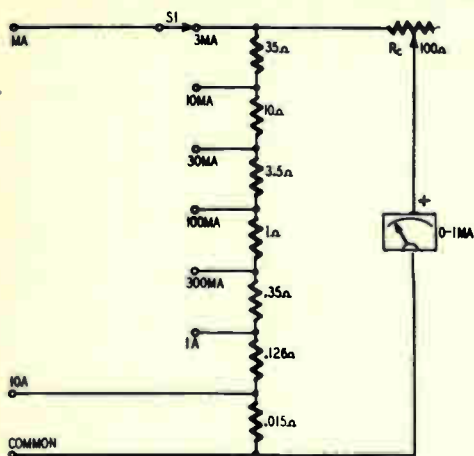

Fig. 215. Current measuring circuit used in some v.t.v.m.s.

do not require connection to the power line. The instrument is connected directly in series with the circuit in which current is to be measured. Note that current will flow directly through the shunting resistors and the meter; no vacuum-tube protection is provided against meter burnout on this function.

For currents up to 1 ampere, the terminals marked MA and COMMON are used. The range switch is set to the range setting which will include the current to be measured. For currents between 1 and 10 amperes, the positive current cable is moved from the MA terminal and inserted in the 10 AMP terminal.

As the current range and the series resistance of the meter are increased, a larger amount of current will flow through the shunting network. On the 10-ampere range, only the .015-ohm resistor is in shunt, permitting nearly all of the total current to bypass the meter. When the instrument is used properly, no more

than 1 ma will flow through the meter movement itself. Operation of this circuit is similar to that of the Hickok models 125, 209 and 209A, Jackson model 645 and RCA model, WV-65A and WV-87A VoltOhmysts.

## Power supply

The power supply for the v.t.v.m. is about as simple as can be devised, as reference to Fig. 216 will show. This power supply, which is representative of those used in other vacuum-tube volt-

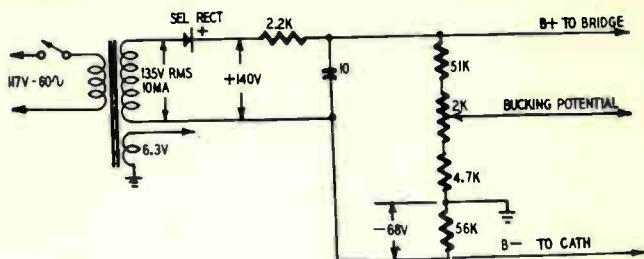

Fig. 216. Power supply for the v.t.v.m. is small, uses selenium rectifier and simple R-C filter. A vacuum-tube rectifier is sometimes used in place of the selenium unit.

meters as well, is employed in the Hickok model 215. This supply uses a resistance-capacitance filter section. The supply provides a B plus voltage for the bridge tubes, a B minus voltage for the cathode circuit of the bridge and a small bucking voltage to nullify effects of contact potential in the a.c. signal rectifier when the instrument is switched to a.c. voltage measurements. The 6.3-volt winding furnishes heater voltage for a 12AU7\* bridge tube and a 6AL5 a.c. signal rectifier. The selenium power rectifier does not require any heater voltage.

V.t.v.m. power supplies employ a half-wave rectifier; either a vacuum tube or selenium type. A small power transformer, one or two filter capacitors, a filter resistor, and a resistance divider network complete the supply. In many instruments a twin diode, such as a 6AL5 or a 12AL5, is employed. One of the diode sections of the tube is used as the power rectifier and the other diode section works as the a.c.-signal rectifier (when the v.t.v.m. is set up for a.c.-voltage measurements). In some peak-to-peak reading v.t.v.m.'s, one diode section may be used as the line voltage power rectifier while the other section is employed in a contact-potential

\*The filament of the 12AU7 can be connected for either 6.3- or 12.6-volt operation.

correcting circuit. Most power supplies are required to furnish only the B+ and filament voltages. A resistance divider network is used where it is necessary to furnish bias voltages or a contact-potential bucking voltage.

Commercial vacuum-tube voltmeters have simple power requirements; both the tube-heater and B-supply demands are extremely small. Because the bridge circuit and a.c. signal rectifier are required to furnish little power, B plus current drain is usually limited to a few milliamperes. To minimize grid current flow in the bridge tubes, a critical factor which was discussed on page 22, some of the heaters are run at reduced voltages, often as low as 5.8 for heaters which would normally be operated at 6.3 volts. Total power consumption of the v.t.v.m. is in the order of 5 to 10 watts.

# meter scales

**M**eter scales used on different makes of service type vacuum-tube voltmeters are very much alike in design, and the methods of reading them are essentially the same. If a few simple

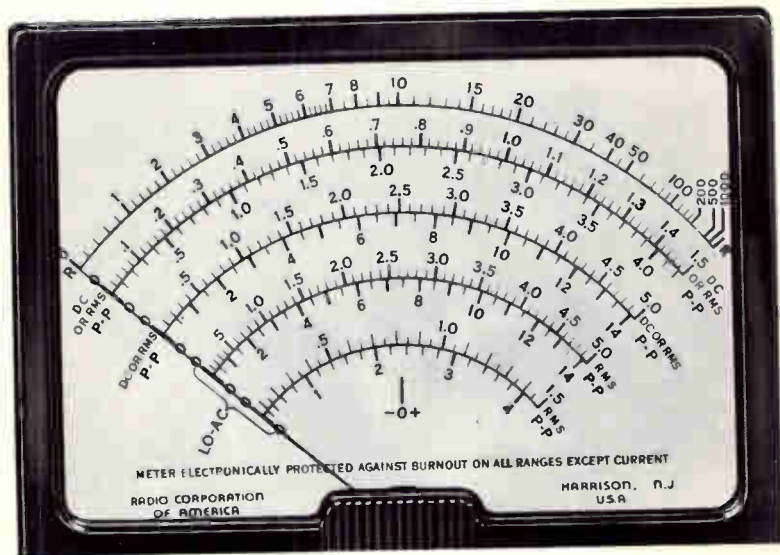

Fig. 301. In this illustration we have the dial scales of a modern v.t.v.m. The use of a number of scales having various ranges gives the instrument considerable versatility, extends its usefulness.

facts are understood, it is possible to read the scales of any commercial v.t.v.m. without hesitation or error.

Fig. 301 shows the dial scales which appear on the face of a typical service type v.t.v.m., the RCA Master VoltOhmyst. Because of the number of different functions (volts, ohms and current) provided on this instrument and the different ranges (0-1.5, 0-5,  $R \times 1$ ,  $R \times 10$ , etc.) for each function, the VoltOhmyst will provide measurements over 37 different ranges. The scales are provided for resistance, positive and negative d.c. voltages, r.m.s. and peak-to-peak a.c. voltages and direct current. It is possible, however, for one scale to serve for the measurement of several different functions. For example, a single scale on the meter may be used to measure a.c. or d.c. voltages up to 5 volts or direct current up to 5 milliamperes. By the use of such combinations, the total number of scales required on the Master VoltOhmyst was reduced to nine. In addition, two scales may be plotted on the same base line as shown in Fig. 302 (see Figs. 302-d, e) by the use of different calibrations above and below the base line. The doubling up of scales in this manner makes it possible to print all the required meter scales on only five base lines.

Scale sharing is conventional practice on all vacuum-tube voltmeters. Upon initial examination, such an arrangement might appear complex. But, try to picture a meter having 37 separate scales! This simplified arrangement is made possible in large part by the multiplication factors of the range-switch circuits which are discussed in Chapter 5.

Each meter scale has a distinct purpose, and the scale to be used for a particular measurement depends upon three factors:

1. The type of measurement (a.c. or d.c. volts, current or resistance) being made. The scale used for each of these measurements is determined by the setting of the **FUNCTION SELECTOR** on the instrument.

2. The quantity to be measured; that is, the estimated voltage, resistance or current.

3. The setting of the **RANGE SWITCH**. This is especially important because it is frequently overlooked and results in incorrect readings.

Factors 2 and 3 are specified separately because it is often possible to use two different scales for the same measurement.

When the v.t.v.m. has been set up correctly, the reading is made by noting the exact setting of the meter pointer on the appropriate scale and multiplying the setting by the multiplier factor indicated on the **RANGE SWITCH**. The multiplier factor is usually 10 or a multiple of 10. This procedure is simple but requires that the user

be able to read the meter scales correctly and know how to apply the multiplier factors of the range switch.

### Scale divisions

Examples of the methods used to subdivide scales are shown in Fig. 302. The simplified scale shown in Fig. 302-a has 10 major divisions. Because no minor divisions are used, the operator must mentally subdivide the scale. Fortunately, high precision is not

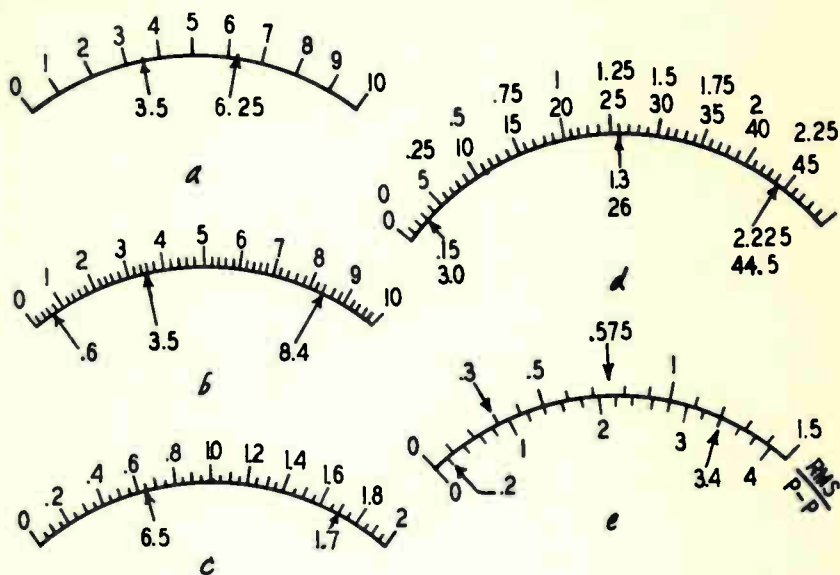

Fig. 302-a to e. Scales can be subdivided in a number of different ways. The technique in reading a scale is the same as that used in reading a ruler.

required in most service measurements. The scale provides adequate spacing between divisions, however, and can be read without difficulty to a half and a quarter of a division.

The division of meter scales may be compared to the methods used to divide an ordinary ruler. As shown in Figs. 301 and 302, scales are divided into major and minor divisions. The scales of a v.t.v.m. are calibrated from left to right, with the full-scale points on the right-hand end. On some units, however, the "ohms" scale is reversed, with the zero or short-circuit point at the right. This practice is conventional on many non-electronic ohmmeters.

The scale shown in Fig. 302-b includes subdivision marks. Note that these subdivision marks are shorter than the major division



marks and divide the major sections into five equal parts. Each subdivision, therefore, represents one-fifth or 0.2 of a major division. For example, the third subdivision mark to the right of zero would represent  $3 \times 0.2$ , or 0.6. The second subdivision mark to the right of 8 represents the setting for 8.4. Because it is convenient to subdivide the scale mentally even further, it is possible to read an indication between subdivisions. For example, 3.5 is located between the second and third subdivision marks to the right of 3.

The scales on different makes of vacuum-tube voltmeters are not always marked in the same units. Some scales have major divisions marked off in units of 10. Others may be calibrated with decimal fractions or combinations of odd and even whole numbers and decimal fractions. The subdivisions may be based on units of one, tenths, quarters or other convenient fractional units. In all cases, it is possible to determine easily the exact value of each subdivision. This is done simply by dividing the quantity represented by a major unit by the number of subdivisions between major division points. For example, the scale shown in Fig. 302-c has three types of division marks. Each major division mark represents a step of 0.2. Because there are four subdivisions (formed by *three* subdivision marks) between each numbered point, the subdivisions represent steps of .05 ( $0.2 \div 4 = .05$ ). The 1.7 point, for example, is half-way distant between 1.6 and 1.8; the 0.65 point is denoted by the first .05 mark to the right of 0.6.

Frequently, one scale base serves for two different types of scale calibration. Examples of this type scale base are shown in Fig. 302-d and Fig. 302-e. In Fig. 302-d, one scale base serves for the 0 to 2.5 scale, with subdivision marks representing units of .05 ( $0.25 \div 5 = .05$ ). The other scale is calibrated from 0 to 50, with minor division marks representing steps of 1. The scale in use is determined by the setting of the RANGE switch. When the 2.5 scale is used, the third subdivision mark to the right of zero represents  $3 \times .05$ , or 0.15. This same point represents 3 on the 50 scale. Points equally distant between subdivision marks would represent steps of .025 on the 2.5 scale, and steps of 0.5 on the 50 scale.

Another method of sharing a scale base is shown in Fig. 302-e. This type of scale is often found on units which read both the r.m.s. and peak-to-peak value of a.c. waveforms. Because the peak-to-peak value of a sine wave is always equal to 2.83 times the r.m.s. value, it is possible to calibrate the same scale base in both r.m.s. and peak-to-peak units so that both types of readings may be had

simultaneously. The scales are usually distinguished by different colors.

### Linear and nonlinear scales

All the scales shown in Fig. 302 have a common feature: the calibration points are evenly spaced throughout the scale. These are *linear type* scales. It is often necessary, however, to calibrate a

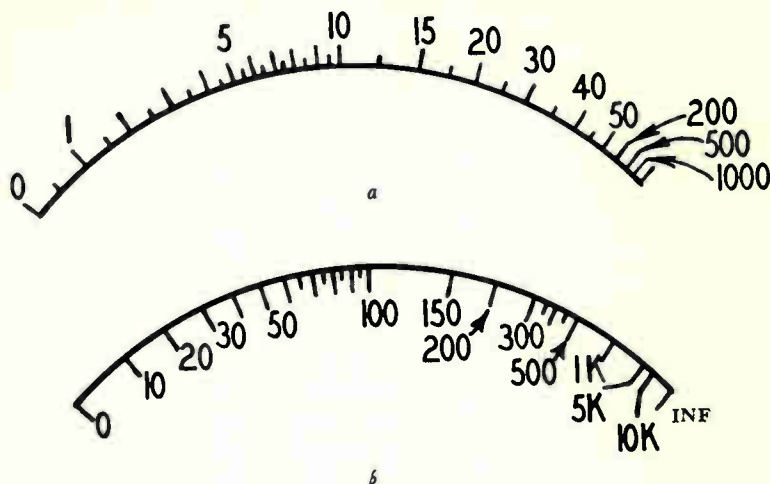

Fig. 303-a, -b. Typical resistance scales shown above are nonlinear. The right-hand end of such scales is so crowded that it is often difficult to read. It is easier to make an error reading these than when reading voltage or current scales.

scale in units which have nonuniform spacing between them. These are called *nonlinear* scales. The ohms scale is always nonlinear. Two representative ohms scales are shown in Fig. 303. The calibration of the scale in Fig. 303-a, which is from the Sylvania model 301 Polymeter, is representative of those used on the majority of vacuum-tube voltmeters. The scale shown in Fig. 303-b is patterned after that used on the Hickok model 209A.

The most notable feature of these scales is the compression at the high end. For example, in the scale in Fig. 303-a, the interval between major division points becomes narrower as the scale progresses. From 10 to 1,000 the scale intervals narrow down so much that different calibration units must be used. From 0 to 10, the major calibration unit is 1 with subdivisions at 0.5 intervals. From 10 to 20, the major unit is 5, with subdivisions representing steps of 2.5. As the scale continues toward the full-scale point, the intervals become so narrow that all remaining major divisions are

marked off in progressively larger units of 50, 200, 500 and 1,000. Subdivision marks in this upper region of the scale also represent larger steps.

Although the scale shown in Fig. 303-b is calibrated differently from that in Fig. 302-a, the nonlinear spacing between units can be seen. On both these scales it is important to remember that subdivision marks between major calibration points represent different quantities at different points along the scale. Therefore, it is important that each subdivision mark be understood if correct readings are to be obtained.

The last mark on the scale does not have a number. This is the

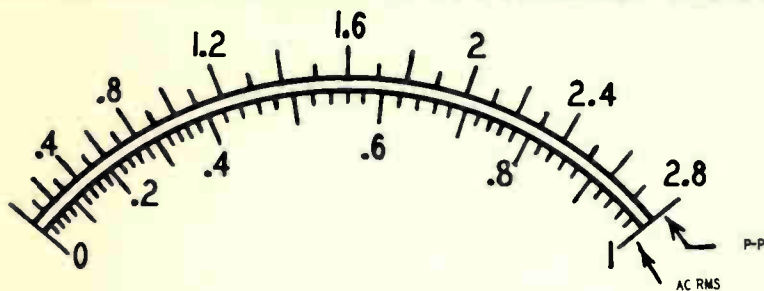

Fig. 304. Some low a.c. voltage scales are also nonlinear, a situation caused by the nonlinearity characteristic of the rectifying diode (used in the v.t.v.m.) at low a.c. signal levels.

point of infinite resistance and is usually labeled INF or " $\infty$ ," the mathematical symbol for infinity. When the meter is properly adjusted, the meter pointer will normally deflect to the infinity mark when the ohms probes are not connected to a circuit because of the infinite resistance across an open circuit. The letters K and M which appear on some ohms scales signify  $\times 1,000$  and  $\times 1,000,000$  respectively.

Nonlinear calibration is sometimes found on low a.c. voltage scales. Two scales of this type are shown in Fig. 304. Note that the divisions on the top of the base line are linear above the 0.8 mark. Below 0.8, however, the scale intervals narrow. This scale, which is representative of the low a.c. voltage scale used on the Triplet model 650, should be used only for measurement of voltages up to 2.8 volts peak-to-peak (equivalent to 1 volt r.m.s.). On many instruments, this scale is labeled LOW A.C. and should not be used for any other measurement because of the possibility of error.

The nonlinearity at the bottom end of the low-voltage a.c. scales is due to the operating characteristics of the vacuum-tube diodes used in the a.c. signal rectifiers of vacuum-tube voltmeters.

At extremely low signal levels, the diodes operate on the nonlinear portion of their plate-current curves and special scale compensation must be made for this factor.

### Zero-center scales

In many cases, the ZERO-ADJUST control of a v.t.v.m. has sufficient range to permit setting the meter pointer in the center of the scale. When this is possible, the v.t.v.m. can be used as a null indicator for making alignment checks on FM discriminators and

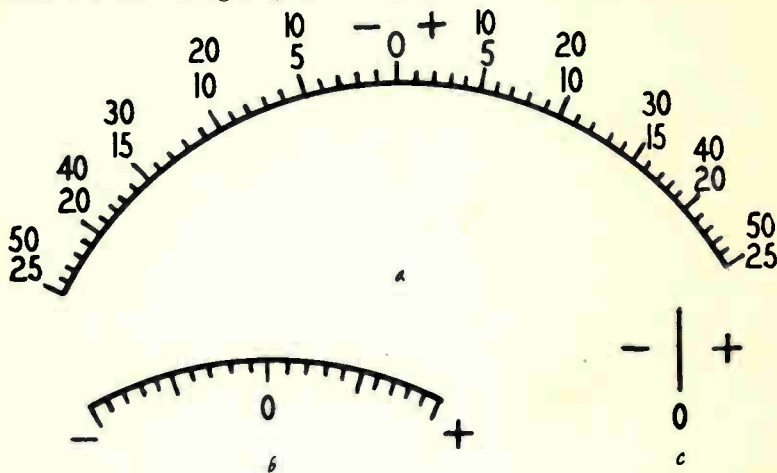

Fig. 305-a, -b, -c. Typical zero-center scales used in some v.t.v.m.'s. Some scales are calibrated, others simply have a center marker and a plus-minus indication. Calibrated scales are helpful in the alignment of circuits such as FM detectors.

indicating circuit balance in bridge measurements. Many instruments have separate zero-center scales. These scales may be calibrated directly in volts or be provided with reference markers to indicate the degree of positive or negative unbalance in the circuit. Applications which use the zero-center feature are discussed in Chapter 7.

Some representative zero-center scales are shown in Fig. 305. The scales shown in Fig. 305-a are used on the Jackson model 709 Tele-Volter. For the use of these scales, the v.t.v.m. must be set up for +DC voltage measurements. The meter pointer is set to the center 0 by means of the ZERO-ADJUST control. The d.c. voltage range used should cover the overall voltage swing, from maximum positive to minimum negative. For example, a circuit which can be adjusted to provide a voltage ranging from -25 to +25 would

require that the 50-volt range be used. In most null-indicating applications, however, voltages are low, often in the order of 2 or 3, and a low-voltage d.c. range is employed. Two scales employ the same base on this instrument.

An example of a zero-center scale which employs uncalibrated reference marks is shown in Fig. 305-b. The scale shown in Fig. 305-c indicates only the polarity of the unbalance. In ordinary applications, these types of scales are used where only a null indication is required.

### Decibel scales

A few commercial v.t.v.m.'s are equipped with special scales for use in audio troubleshooting and measurement. These scales may be calibrated in units of db, dbm, or VU, depending upon the type of load with which the v.t.v.m. is used. In some v.t.v.m.'s, this load may be built into the instrument; in others it must be set up externally. Because load characteristics are important in

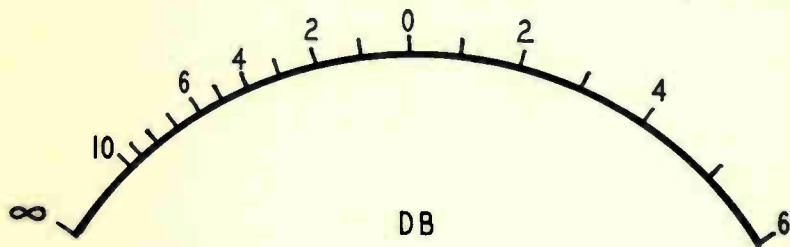

Fig. 306. Decibel scale, shown above, is nonlinear.

interpreting the scale readings, application of the v.t.v.m. in these measurements is discussed in Chapter 8.

A representative db scale is shown in Fig. 306. It should be noted that the zero point is centered on the scale, providing for direct reading of units above or below the reference level. The nonlinear calibration of this scale is due to the fact that the decibel system employs a logarithmic progression and conventional v.t.v.m.'s are designed for linear operation.

If the technician desires, he may add his own db or dbm scale to the v.t.v.m. This modification is discussed in detail in Chapter 10. A description of decibel measurements is also given on page 136.

# probes and cables

**A** v.t.v.m. is often called upon to make measurements of d.c. voltages from less than 1 to as high as 25,000 volts; to measure resistances from less than 1 ohm to several thousand megohms; to measure r.f. and i.f. voltages from a fraction of a volt to 25 or 30 volts; to measure the peak-to-peak voltages of complex video, sync, and sweep waveforms; and to measure direct current throughout the milliamperere range. To meet this wide range of requirements, the v.t.v.m. is used with various external probes.

Familiarity with the functions and applications of various types of probes and cables is essential for the most effective use of the v.t.v.m. Fortunately, these accessories are relatively simple devices, and it is not difficult to learn to use them properly. The design and operation of probes is discussed in this section; application is described in later chapters.

Modern probes and cables provide the v.t.v.m. with four worthwhile advantages:

1. Probes and cables increase the usefulness of the v.t.v.m. For example, high-voltage probes permit the measurement of voltages much higher than those for which the v.t.v.m. was designed. Other types of probes make possible a.c. voltage measurements over a wider frequency range than is possible with the v.t.v.m. itself.

2. Problems often arise in servicing where a v.t.v.m. cannot be applied directly to the circuit under test because of high frequencies, high voltages or loading difficulties. Correctly designed probes and cables, however, provide an efficient, practical means for connecting the v.t.v.m. into the circuit.

3. Probes and cables simplify the basic design of the v.t.v.m. "Slip-on" type probes, for example, reduce the number of cables required. High-frequency probes limit the complexity of circuits used in the v.t.v.m.

4. Efficient probes and cables speed troubleshooting by giving the v.t.v.m. increased flexibility. For the service technician, especially, this is a profitable advantage.

The basic purpose of probes and cables is to transfer the required electrical information from the test circuit in a form that can be utilized most efficiently by the v.t.v.m. At the same time, it is necessary that connection of equipment to the test circuit

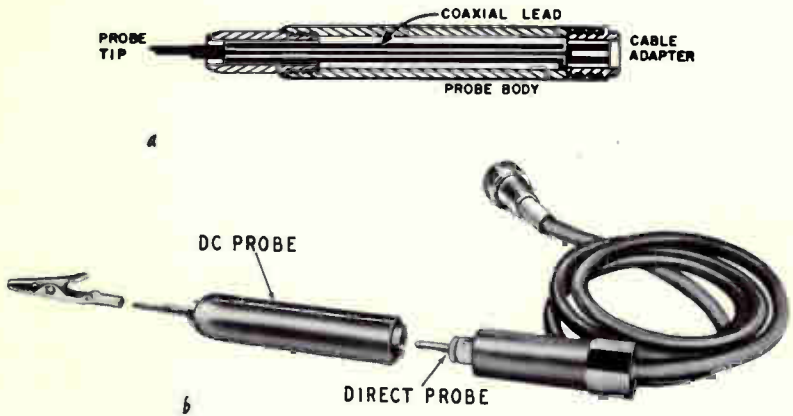

Fig. 401-a, -b. Direct probe (a) shields the test lead almost up to the probe tip. The lower illustration (b) shows slide-on type probes.

cause a minimum of disturbance to circuit operation. This requirement is met by means of different types of probes and cables, which can be classified in this manner:

1. Direct probes and cables
2. Isolating probes
3. Rectifying probes
4. Multiplier (divider) probes

### Direct probes and cables

Direct probes and cables are the simplest accessories used with the v.t.v.m. The direct probe and cable consists primarily of a length of flexible wire lead terminated in a probe, prod or tip. The probe is an insulated plastic handle which does not contain any electrical components. The purpose of the direct type is to

transfer electrical information from the test circuit directly to the v.t.v.m. without attenuation or modification.

On most instruments, the direct probe and cable is used for measurements of resistance, and low-frequency a.c. voltage. Some vacuum-tube voltmeters also employ a direct probe and cable for d.c. voltage measurements. On these instruments, the components normally housed in the isolating probe or a.c. probe are placed inside the instrument.

Fig. 401 shows two types of direct probes which are representative of those used on all vacuum-tube voltmeters. That in Fig. 401-a is an insulated wire lead which has a needle point on the probe end. The connector at the meter end of the cable may be a phone tip, pin plug, spade lug or bare wire, depending on the



Fig. 402-a, -b. Cutaway view of isolating probe (a) and its equivalent circuit (b).

v.t.v.m. The probe in Fig. 401-b is equipped with a length of coaxial cable and a microphone type connector on the meter end. The probe is designed to accommodate additional "slip-on" type probes, such as a d.c. isolating probe, a switch probe, or a high-frequency probe. The principal advantages of this type are the shielding of the inner conductor from the probe tip to the connector and the fact that it is not necessary to change cables when using different types of probes.

### Isolating probes

Isolating probes are used for the measurement of d.c. voltages. For example, d.c. voltage measurements from 0 to 1,000 are made with a shielded cable terminated with an isolating resistor, as shown in Fig. 402-a. The shielded cable eliminates the pickup of any stray magnetic fields about the test bench, which might otherwise result in an inaccurate indication by the vacuum-tube voltmeter. The isolating probe resistance prevents the shielded cable from acting as a capacitive shunt across tuned and high-impedance circuits, such as the local-oscillator in a receiver. If it were not for the isolating effect of the resistance, connection of the v.t.v.m. test leads might detune the test circuit so greatly that circuit operation might cease altogether.



The equivalent circuit in Fig. 402-b shows that the cable capacitance  $C$  is isolated from the probe tip by the 1-megohm resistor, which cuts down the effective value of  $C$  to approximately 1 or 2  $\mu\text{mf}$ . This is a large reduction, as compared with the approximately 75  $\mu\text{mf}$  of cable capacitance. Hence, the d.c. probe can be applied across a local-oscillator circuit to measure the self-bias on the oscillator grid without disturbing circuit operation.

The equivalent circuit is also a low-pass filter. This is an essential feature, since d.c. voltages at the grids and plates of tubes often must be measured in the presence of large a.c. voltages. If the a.c. signal is passed along to the bridge circuit, it might be rectified and cause an erroneous d.c. reading. Most v.t.v.m.'s include an-

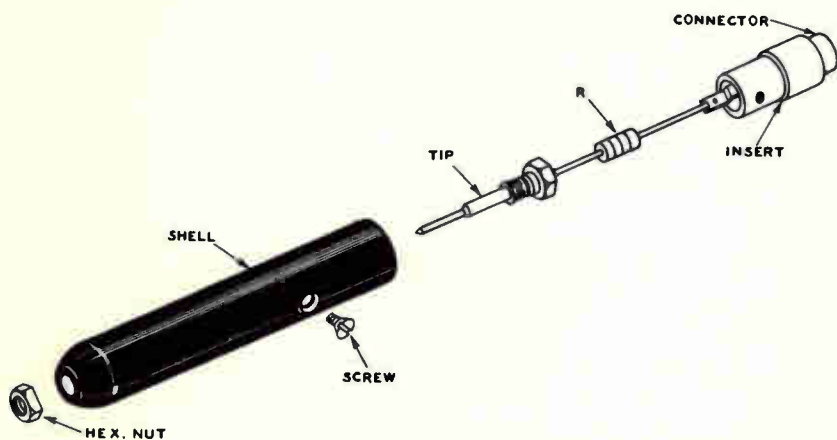

Fig. 403. Exploded view of a d.c. (or isolating) probe. The resistor,  $R$ , most often has a value of one megohm. The probe, held together by a single screw and hex nut, can easily be taken apart when repairs are needed.

other low-pass filter at the grid of the v.t.v.m. tube to make certain that no a.c. voltage reaches the grid.

These probes consist of plastic housings containing the isolating resistor in series with the probe tip and the output end of the probe. While the value of the resistor used depends upon the d.c. input resistance of the v.t.v.m., a 1-megohm resistor having a  $\frac{1}{2}$ - or 1-watt rating is most generally employed. An exploded-view drawing of a d.c. probe is shown in Fig. 403.

The d.c. isolating probe should always be used for measurements of d.c. voltages because d.c. voltage scales are calibrated on the basis of the d.c. input resistance. The isolating resistor in the probe is in series with the voltage divider networks in the v.t.v.m. and is part of the d.c. input resistance of the instrument. If the

isolating probe is not used, a considerable degree of error might result.

The switch type probe, which combines the functions of direct and isolating probes, is finding increased popularity among v.t.v.m. manufacturers. An exploded-view drawing of one of these probes is shown in Fig. 404. When set to the forward or DIRECT position, the sliding switch shorts the 1-megohm resistor so that the probe can be used for ohms and a.c. measurements. When set to the rear or D.C. position, the short is removed and the resistor is placed in series with the test lead. This switch probe is similar in operation

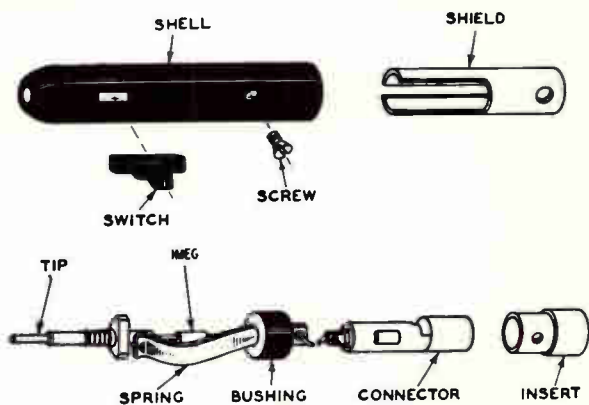

Fig. 404. Exploded view of a direct and isolating probe. This has the advantage of combining two probes into one.

to those used on several makes of commercial vacuum-tube volt-meters.

A switch probe of slightly different construction is shown in Fig. 405. This probe has a rotating-sleeve switch at the pointed end. The rotating sleeve is set to DCV for d.c. voltage measurements or rotated to the OHMS position for resistance measurements. A separate probe is provided for a.c. voltage measurements.

Switch probes of these types avoid the necessity of changing to different probes and cables when various types of measurements are made. This is an especially convenient feature on a cluttered workbench where time is often lost in looking for misplaced accessories.

### Rectifying probes

Rectifying probes include probes which have several different names, such as a.c., crystal-diode, demodulator, detector, high-frequency, r.f. and vacuum-tube probes. Because there is no pre-

scribed standard of classification, probes which are almost identical in electrical design and application may have different names. All have a common purpose and that is to detect and rectify the a.c. voltage at its source in the test circuit and to provide the v.t.v.m. with a proportional d.c. voltage. All these probes contain diode type rectifiers and filter circuits.

Although many rectifying probes employ similar designs, they are not generally interchangeable. A rectifying probe is usually designed for a specific v.t.v.m. by the instrument manufacturer. Probe design depends upon a number of factors, including the type of voltage reading required (peak, peak-to-peak or r.m.s.), the frequency range over which measurements are to be made, the



Fig. 405. Another type of combined probe. Similar to that of Fig. 404, it differs only in switch construction.

voltage ranges on the v.t.v.m. and the input circuit characteristics of the instrument.

Some rectifying probes are designed to handle all the a.c. measurements of the v.t.v.m. Probes of this type contain all the electrical components required to detect and filter a.c. signals over the entire specified frequency range of the instrument. Other types are designed to supplement the a.c. circuits built into the v.t.v.m. and serve primarily to extend the frequency measurement range of the instrument.

Rectifying probes are valuable accessories because they permit the critical part of the v.t.v.m. measurement circuit to be placed right at the test point. This consideration is important because it lessens the loading effect of the test instrument, helps to preserve circuit stability, minimizes tendencies toward regeneration and greatly reduces hum, noise pickup, and radiation from the probe or its connecting cable; effects which can create serious measurement difficulties. These considerations are not usually serious at audio and very low radio frequencies, but they become increasingly important as the frequency increases. With properly designed rectifying probes, for example, it is possible to make a.c. measurements directly in sensitive circuits, such as i.f. amplifiers. Most i.f. amplifiers would cease operation if loaded down by lengthy test cables and low-impedance measurement circuits. However, sufficient voltage must be present at the test point to give an indication on the meter.

The rectifiers used in these probes may be either vacuum-tube diodes or crystal diodes. Vacuum-tube diodes have an outstanding advantage: they can handle much higher a.c. voltages than can be applied to crystal diodes. This advantage, however, is slowly being overcome by the progress in semi-conductor development. At present, the vacuum-tube is also a more reliable rectifier over extended periods of operation because it is more stable under conditions of changing temperature. With vacuum-tube rectifiers, it is also possible to design probe circuits with higher overall input impedances.

The vacuum-tube probe has several noticeable drawbacks, however. It is comparatively large and bulky, even when miniature

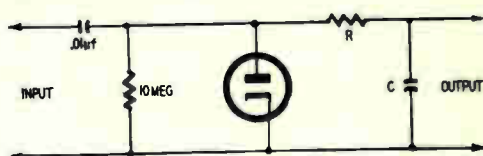

Fig. 406. Circuit of a vacuum-tube rectifying probe.

tubes are used. The vacuum-tube probe also requires heater power, which increases the complexity of cables and circuitry. Transit time (the time it takes electrons to travel from the cathode to the plate) and lead length, both in the tube and in the circuits, impose limits on the high-frequency range of vacuum-tube probes. Of even greater importance is the difficulty created by contact potential within the diode. The additional components required to counteract this effect increase the complexity of the circuit and add to the bulkiness of the probe.

Fig. 406 shows a tube type rectifier probe, which will handle moderately high voltages, and provide negative-peak voltage indication. The  $0.01\text{-}\mu\text{f}$  capacitor charges up to the negative-peak value of the applied a.c. waveform. R is an isolating and calibrating resistor; in its absence the cable capacitance would shunt the diode and bypass the a.c. signal. The value of R must be properly selected to provide the desired scale indication—usually to indicate the r.m.s. voltage of a sine wave. The 10-megohm resistor is a bleeder, and is used to avoid undue lag in return of the meter pointer to zero. If very low frequencies are to be accommodated, the value of the  $.01\text{-}\mu\text{f}$  capacitor must be increased correspondingly.

A crystal-diode type of v.t.v.m. rectifier probe is illustrated in Fig 407; such a probe is commonly rated to approximately 20 volts,

and provides peak indication. The input impedance may not always be sufficiently high to avoid throwing i.f. stages into oscillation. However, various expedients can often be used in case of difficulty.

It might be supposed that a rectifier probe and a v.t.v.m. could be used to signal-trace the i.f. circuits of a TV receiver, but the low signal level in the early stages limits this. The full gain of a 3-stage i.f. amplifier is about 5,000; so with a 2 volt peak-to-peak input to the video detector, the corresponding input to the first i.f. grid will be 0.0004 volts peak-to-peak. Since a v.t.v.m. does not satisfactorily indicate voltages below approximately 0.1, a serious signal-tracing limitation is imposed. To overcome this, see page 177.

Crystal diodes, such as the 1N34-A, have the advantage of ex-

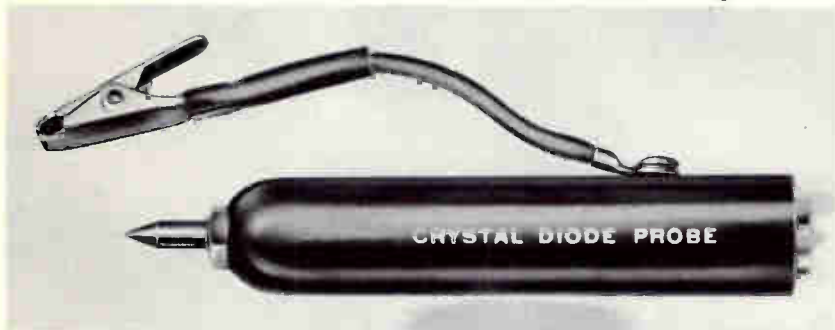

Fig. 407. Crystal-diode probe. The ground clip should be fastened as close to the test point as possible.

tremely small size (permitting compact probe design) and very short lead lengths. Consequently, crystal diodes are especially well suited to measurements above 50 mc. Contact-potential difficulties do not exist in these devices; probe cables and circuitry are simplified because no heater voltage is required. Crystal diodes have very low input capacitances (which is desirable) but, conversely, have a lower shunt resistance than vacuum-tube diodes, a factor which lowers their overall input impedance.

Two different vacuum-tube rectifying probes are shown in Fig. 408. Note the metal enclosure which shields the tube and components. Because lead length is critical at high radio frequencies, grounds must be made as near as possible to the test point. One probe is equipped with an alligator type ground clip welded directly to the metal probe housing. A short extension lead with an attached alligator clip can be screwed onto the front end of the probe for use in applications at lower frequencies.

R.f. voltages up to 300 can be measured in circuits containing

up to 500 volts d.c. with this probe. Because the output from this probe is the rectified input signal, readings are indicated on the d.c. voltage scales. For r.f. voltages from 0 to 3, however, a special r.f. scale is provided because of the nonlinearity in tube perform-

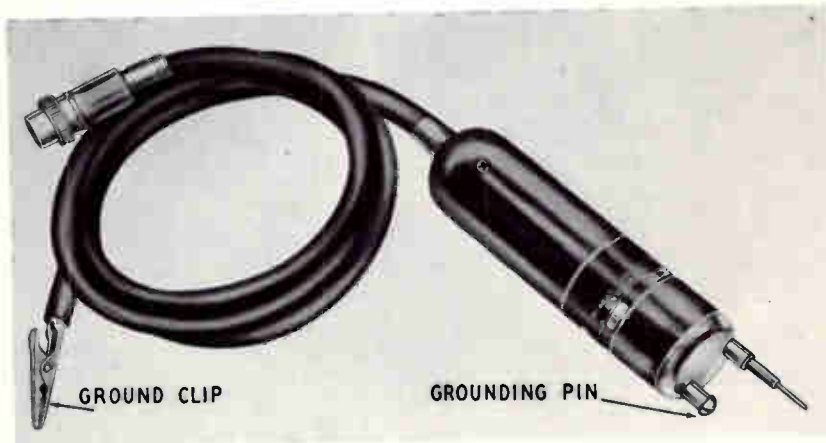
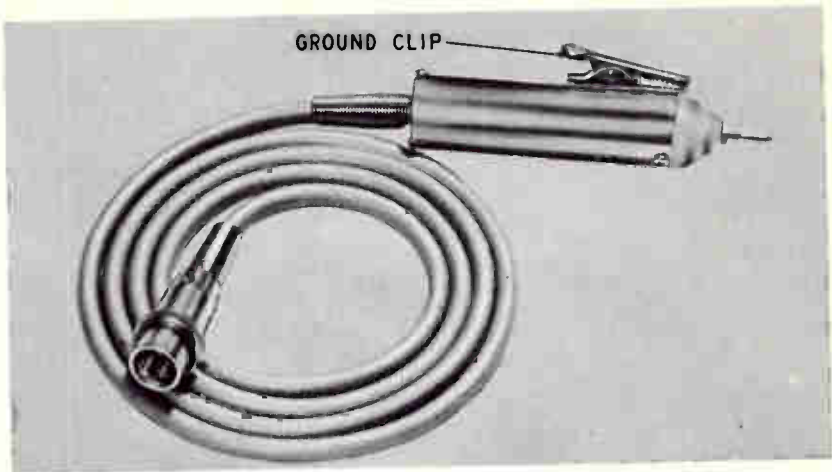

Fig. 408-a, b. The vacuum-tube probe shown at the top uses a ground clip fastened to the probe housing. The probe at the bottom uses a grounding pin.

ance at low signal voltages. The probe has an input resistance of 2.3 megohms and an input capacitance of only 3  $\mu\text{f}$ . A special subminiature tube, type 1247, is used as the rectifier.

Of particular interest is the vacuum-tube probe shown in Fig. 408-b. This is similar in application to that shown in Fig. 408-a but has these important differences: The former is a peak-reading probe which provides a d.c. output voltage substantially equal to

the positive peak value of the applied a.c. voltage. The polarity of the output voltage from this probe, however, is negative. Because the rectified peak voltage can be maintained at full value only across an infinitely high d.c. input resistance, the output voltage is slightly less than the peak value. The instruments for which this probe is designed have a d.c. input resistance of 13.5 megohms on all d.c. voltage ranges. While this input resistance is sufficiently high to prevent excessive circuit loading, it presents a load to the rectifying probe and causes a slight drop in the peak output voltage. This voltage drop is small enough, however, to permit calibration on the basis of the true peak voltage. For almost all conven-

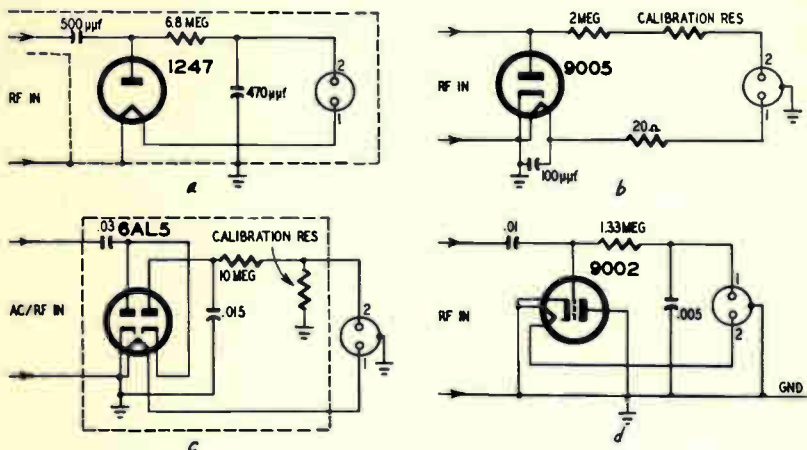

Fig. 409-a to d. Four different types of vacuum-tube probes. Those shown in a and b are single diodes. The probe at the lower left (c) is a peak-to-peak (voltage doubler) type. Although the probe shown at the bottom right (d) uses a triode, it is actually worked as a diode with the plate grounded and the control grid operating as the anode.

tional service applications, the readings are adequate. In the few applications which may require a high degree of accuracy, a correction chart is provided.

When the probe is connected to the v.t.v.m., contact potential causes a slight deflection of the meter pointer. The contact potential is counteracted on the low a.c. ranges by setting the ZERO-ADJUST control to zero the meter pointer. Little or no adjustment is required to counteract the contact potential on ranges above 12 volts.

Schematic diagrams of four vacuum-tube probes are shown in Fig. 409-a, -b, -c, -d.

Construction of a typical crystal-diode type probe, together with the schematic diagram, is shown in Fig. 410. This probe can be

used for measurement of r.f. voltages from 50 kc to 250 mc. The probe requires no heater voltage, is compact and slips onto the front end of the direct probe and cable shown in Fig. 401-b. Note how the resistors are soldered in close to the terminals and how the 1N34-A crystal is provided with a special clip type holder. These features make for short lead lengths, especially important above 30 mc. A ground clip is attached directly to the probe to provide a short r.f. return path to the test circuit.

The design and construction of other makes of crystal-diode probes are similar. Most of these probes are equipped with a

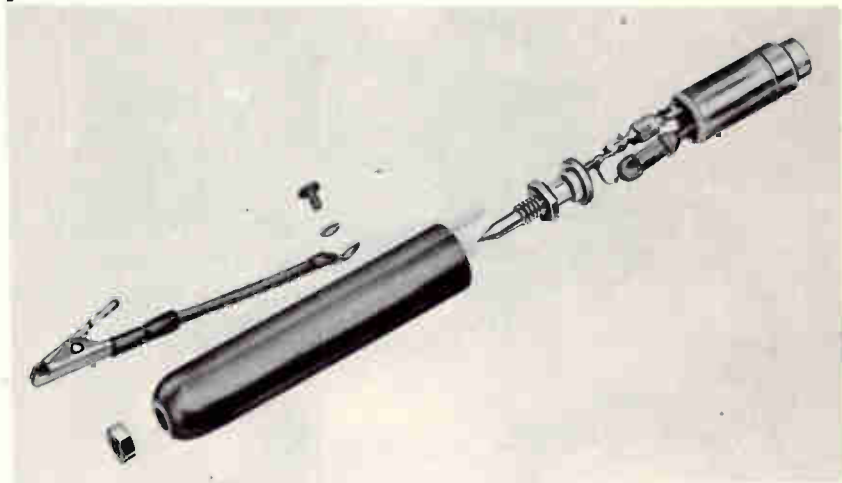

Fig. 410. *Internal construction of a crystal rectifier probe. The ground lead is an important part of the crystal probe circuit.*

special ground lead which should be used in conjunction with the regular ground lead provided with the instrument.

Although probes of this type are peak rectifiers, design of the R-C filter circuits and the v.t.v.m. input circuits result in a d.c. output voltage equal to the r.m.s. value of a sine wave. The peak value of the r.f. signal may be obtained by multiplying the meter reading by 1.41.

### **Peak-to-peak probes**

The peak-to-peak type of probe used to measure peak-to-peak voltages of complex a.c. waveforms, is shown in Fig. 411. Tubes and crystal diodes are used commercially, with the same general considerations as have been noted for the half-wave type of probe. The tube will withstand much higher voltages than the crystal diode.



In some cases, the peak-to-peak indicating arrangement is built into the v.t.v.m. This raises the input capacitance, but also provides a much greater voltage-handling capability, since a compensated multiplier then precedes the rectifying tubes, and will usually raise the top range of peak-to-peak voltage measurement to 1,000. Such a range will accommodate the majority of complex a.c. waveforms encountered in a TV chassis.

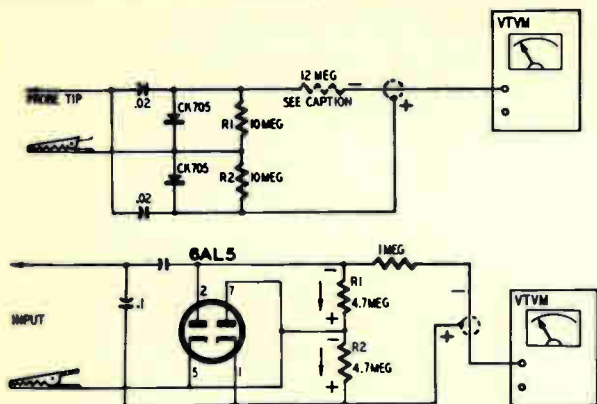

Fig. 411. Crystal and vacuum-tube diode types of voltage doubler probes. The 12-megohm resistor (upper illustration) is shorted for v.t.v.m.'s with an 11-megohm input. R1 and R2 (lower illustration) are the diode load. The arrows indicate direction of rectified current flow.

## Multiplier probes

Multiplier probes are designed to extend the d.c. voltage ranges of the v.t.v.m. to 30,000–50,000 volts. These probes are especially useful in the measurement of high voltages in television receivers, X-ray equipment, transmitters and similar electronic equipment. The probes make possible such measurements with complete safety for the operator.

Multiplier probes are also known as *high-voltage* probes and *divider* probes. Although the terms “multiply” and “divide” have opposite meanings, it is possible to justify the differences in description if the functions of the probes are understood. Because the majority of manufacturers prefer to call these accessories high-voltage probes, this terminology will be used here. The ways in which these probes “divide” and “multiply” are explained further on.

Several high-voltage probes, designed for use with service type vacuum-tube voltmeters are shown in Fig. 412. All these probes

are basically similar; they provide a well-insulated housing for a multiplier resistor which serves as a series voltage divider.

One typical example of this type has a molded polystyrene body, a tapered and rounded probe point to reduce corona and a series of five anti-arc baffles which serve to increase the length of the insulated path along the body of the probe. The heavy molded flange on the front of the handle is equipped with a metal ground

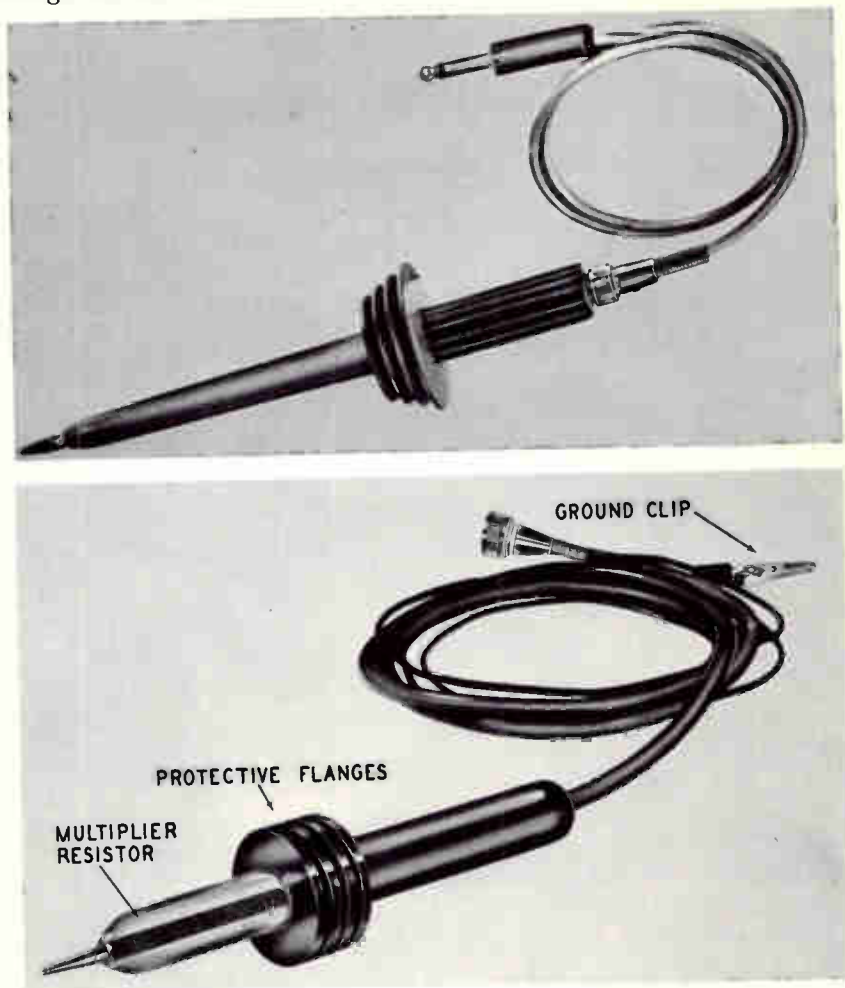

Fig. 412. Two types of high-voltage probes. These are used to extend the d.c. range of the v.t.v.m., should not be used for the measurement of a.c. voltages.

ring on the probe side to provide a protective barrier between the point of voltage contact and the handle. The multiplier resistor is completely enclosed and is suspended within the probe by its

ends only. Note that the probe is equipped with a separate ground lead. The ground lead is connected to the outer shield of the high-voltage cable and provides additional safety in event of a short circuit in the cable.

The divider resistors used in high-voltage probes are of special construction to reduce the possibility of voltage breakdown. They are usually spiral-wound of metallic or carbon-film ribbon and encased in a plastic having a high dielectric. Because these resistors may have values of several hundred megohms, they must be carefully constructed to resist the effects of temperature and humidity changes. Resistors for typical high-voltage probes are shown in Fig. 413.

The method by which the probe “multiplies” or “divides” can be seen in Fig. 414. All measurements are made with the v.t.v.m. set to one of the positive d.c. ranges. As shown on the simplified

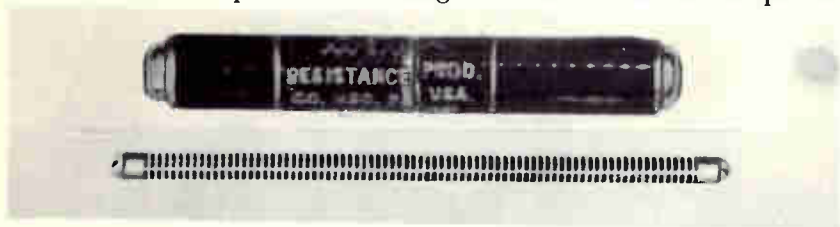

Fig. 413. Multiplier resistors used in high-voltage probes.

schematic diagram, the resistance of the high-voltage probe  $R_{HV}$  is in series with the d.c. voltage divider network. The high voltage is applied across the combined resistance of the probe and the network. Because the probe resistance is 100 times the resistance of the divider network, the ratio of the voltage drop across the probe and the network will be 99 to 1. If 10,000 volts are applied across the input to the instrument, 9,900 volts will be dropped across the probe resistance and 100 volts across the divider network. If the values of the probe and divider-network resistances are chosen carefully, measurements at very high voltages can be made with a considerable degree of accuracy. Thus the high-voltage probe serves to multiply the voltage range of the v.t.v.m. and also acts as an additional voltage *divider*. Hence we have the terms “multiplier” probe and “divider” probe.

As previously stated, 100 volts will be dropped across the voltage divider network of the v.t.v.m. The amount of voltage applied to the meter depends upon the setting of the RANGE switch. Because the input to the divider network will be 100 volts, only the 300-volt and 1,200-volt ranges should be used. To obtain the high-

voltage measurement, multiply the voltage reading on the v.t.v.m. by the ratio, or *multiplier factor*, of the probe resistance. On either the 300- or 1,200-volt range, the meter will indicate 100 volts. Thus,  $100 \times 100 = 10,000$  volts.

Multiplier probes may be used with almost any type of voltmeter to measure very high voltages. The value of the high-voltage multiplier resistor required is computed as follows:

$$R_{HV} = M(R_{IN}) - (R_{IN} - R_C) \quad (1)$$

where  $R_{HV}$  is the resistance in ohms of the multiplier resistor of the high-voltage probe,  $M$  is the scale factor described in formula (2),  $R_{IN}$  is the input resistance in ohms of the v.t.v.m. (this in-

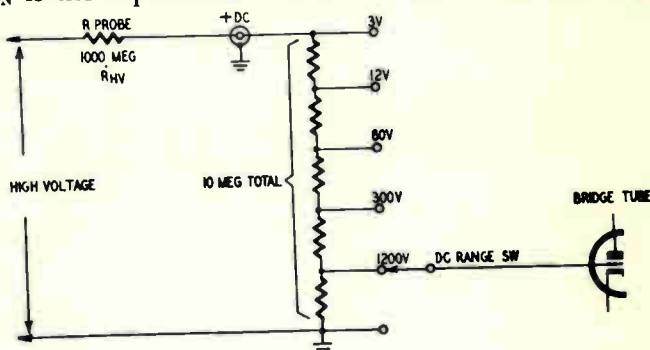

Fig. 414. The resistor in the high-voltage probe is in series with the voltage-divider network in the v.t.v.m. Most of the high voltage is dropped across the probe resistor, thus reducing the v.t.v.m. voltage input to a safe value.

cludes the value of the resistor used in the d.c.-isolating probe),  $R_C$  is the value in ohms of the isolating resistor used in the d.c. isolating probe.

For example, assume that a high-voltage probe is needed to extend the d.c. voltage ranges of a v.t.v.m. which has an input resistance of 11 megohms, including the 1-megohm isolating resistor. A scale factor of 100 times is desired to enable the instrument to read 30,000 volts on the 300-volt scale. Using formula (1) and substituting values, we get

$$\begin{aligned} R_{HV} &= 100(11,000,000) - (11,000,000 - 1,000,000) \\ &= 1,090 \text{ megohms} \end{aligned}$$

On some vacuum-tube voltmeters, solution of the formula will show that the multiplier resistor has an odd value of resistance not readily obtainable. Here, it will be necessary to use a resistor which has a different value. In these cases, a new *scale factor*

(multiplier M) must be computed on the basis of the input resistance of the meter and the resistance value of the multiplier resistor. A new scale factor is computed as follows:

$$M = \frac{R_{in} - R_c + R_{hv}}{R_{in}} \quad (2)$$

For example, assume that a v.t.v.m. has an input resistance of 16 megohms, including the 1-megohm d.c. isolating resistor, and is to be used with a multiplier-probe resistor of 500 megohms. The new scale factor, computed by substituting values in (2), is:

$$\frac{16,000,000 - 1,000,000 + 500,000,000}{16,000,000} = \frac{515,000,000}{16,000,000} = 32 \text{ (approx.)}$$

When this combination of probe and v.t.v.m. is used, all voltage readings taken with the high-voltage probe are multiplied by 32 to obtain the correct high-voltage reading. Although numbers which are not multiples of 10 do not lend themselves to quick multiplication, they can still be used to obtain accurate readings.

The measurement of high d.c. voltages, such as the second anode voltage of a picture tube, with a v.t.v.m. and high-voltage d.c. probe are rather well understood. Less understood is the measurement of relatively low d.c. voltages in the presence of high a.c. pulse voltages, such as are found at the plate of the horizontal-output tube. Receiver manufacturers commonly insert a technical note in their service data, warning against attempts to measure the d.c. plate voltage of the horizontal output tube. This is because the approximately 350 volts d.c. is accompanied by an approximately 6,000 volt kickback pulse. If this high-voltage a.c. pulse is applied to the precision input circuit of the v.t.v.m., serious damage to the v.t.v.m. can result.

Because the high-voltage d.c. probe provides a high degree of lowpass filter action, it is possible to use the v.t.v.m. in conjunction with the high-voltage probe for measurements in these circuits. For example, the v.t.v.m. can be set to its 6-volt range, and when used with a high-voltage d.c. probe having a 100-to-1 attenuation factor will indicate the 350 volts d.c. at approximately half-scale of the v.t.v.m.; at the same time, the low-pass filter action of the high-voltage d.c. probe effectively protects the v.t.v.m. against the 6,000 volt a.c. pulse.

### Grounding the probe

Technicians sometimes overlook the fact that the ground lead

or ground connection on a probe is part of the measuring circuit, and an important part at that. The significance of a ground connection depends upon just what it is you are measuring. When measuring d.c. volts in a low-impedance circuit, the ground connection is not critical. When measuring voltage at a high-frequency point, not only does the ground connection become important, but the length of the ground lead itself must be considered. To keep the ground lead short, some probes have a grounding button or clip right near the tip end of the probe.

### **Limitations of the v.t.v.m.**

Although the v.t.v.m. is one of the most reliable of all testing instruments, it has definite limitations. Some measurement restrictions can be overcome through the use of the accessory probes described in this chapter. Other limitations may be avoided by auxiliary measurements in different parts of the test circuit. When difficulty is encountered in making a voltage or resistance check, the technician should re-examine his measurement technique to determine whether the v.t.v.m. is being used properly.

Here are listed some of the general limitations and capabilities of the v.t.v.m. Some specific applications which require special consideration are given in Table 2.

#### **D.c. voltage measurements**

1. D.c. voltage too low to read on lowest v.t.v.m. range.
2. Circuit impedance is too high; d.c. probe introduces too much loading.
3. Circuit contains high amount of circulating r.f. signal. Signal cannot be kept out of v.t.v.m. on d.c. measurements and causes erratic operation.
4. Circuit resistance is very high; v.t.v.m. causes d.c. loading, even with high input resistance.

#### **A.c. voltage measurements**

1. Frequency of a.c. signal is too high or too low to be measured by v.t.v.m.
2. V.t.v.m. is loading down circuit. Note: Even with a vacuum-tube signal rectifier, the v.t.v.m. has an input resistance in the order of 1 megohm shunted by approximately 50 to 75  $\mu\text{f}$  capacitance on a.c. measurements.
3. Waveshape of a.c. signal is different than that which the

**TABLE 2—V.T.V.M. APPLICATIONS AND LIMITATIONS**

Feature	Applications	Misapplications
<p>D.c. voltage measurement, with high input impedance, even on the low-voltage ranges. (Measurements made using shielded cable terminated with 1-megohm isolating resistor.)</p>	<p>Checking values of plate, screen, and grid voltages; tracing progress of signal by measurement of self-bias (only in circuits using overdrive grid bias); checking local-oscillator operation by measurement of self-bias; checking for amplifier distortion in terms of shift of operating point with applied a.c. signal; measurement of voltage in high resistance circuits such as a.g.c. systems, etc.</p>	<p>Attempted measurement of plate voltage of horizontal-output tube; high-voltage a.c. pulse damages v.t.v.m. Attempted measurement of grid bias in vertical blocking oscillator circuit when grid leak has very high resistance; v.t.v.m. will load circuit seriously. Attempted measurement of pulsating d.c. voltage values; v.t.v.m. indicates only the average value.</p>
<p>A.c. voltage measurement, in peak-to-peak values, using built in peak-to-peak indicating circuit and low-capacitance a.c. test cable.*</p>	<p>Checking peak-to-peak voltages of most of the complex a.c. waveforms found in the sync and sweep sections of the TV chassis. Also, checking line voltage and power-transformer voltages, being certain to convert from peak-to-peak to r.m.s. values of sine waves. Checking most a.f. voltages.</p>	<p>Attempted signal tracing in tuned circuits; relatively high input capacitance of v.t.v.m. seriously disturbs circuit operation, and voltages less than 0.1 volt cannot be measured with certainty. Attempted conclusions concerning waveshapes or frequency components of complex a.c. waveforms, no information of this sort is provided by a peak-to-peak v.t.v.m.</p>
<p>A.c. voltage measurements, in r.m.s. values, with instruments using built-in copper-oxide contact rectifier. Frequency limitations are same as v.o.m. with similar rectifier.</p>	<p>Checking line voltages and power-transformer voltages, and checking the lower audio-frequency voltages in relatively low-impedance circuits. Checking heater voltages.</p>	<p>Attempted checking of complex waveform voltages in sync and sweep circuits with v.t.v.m. which will measure sine waveforms only. Attempted signal tracing in tuned circuits; no indication obtained.</p>
<p>*Note: The high-voltage d.c. probe which is usually available for use with service v.t.v.m.'s, is unsuitable for use on the a.c. voltage ranges of the v.t.v.m. Attempted use of the probe to measure high a.c. voltage values, such as the pulse voltage at the plate of the horizontal output tube results only in failure.</p>		

Feature	Applications	Misapplications
A.c. voltage measurements, in peak values, using external diode probe.	Checking peak voltages of some oscillator circuits. Checking sine-wave audio-frequency voltages. Checking line voltages, power-transformer, and heater voltages, being certain to convert from peak to r.m.s. values of sine waves.	Attempted checking of complex waveform voltages in sync and sweep circuits with v.t.v.m. which will measure sine waveforms only. Attempted measurement of voltage values exceeding input rating of probe. Attempted r.f. or i.f. signal tracing.
A.c. voltage measurements, in peak-to-peak values, using external peak-to-peak diode probe. (Provides higher input impedance than built-in peak-to-peak indicating circuit, but input voltage rating is usually less.)	Checking of peak-to-peak values of many of the complex a.c. waveforms encountered in the sync and sweep sections of the TV chassis. Checking a.f. voltages. Checking line voltages, power-transformer, and heater voltages, being certain to convert from peak-to-peak to r.m.s. values.	Attempted measurement of a.c. voltage values exceeding input rating of probe. Attempted measurements in high-impedance circuits, such as ratio-detector circuits. Attempted signal tracing of r.f. and i.f. tuned circuits.
Resistance measurements, when internal ohmmeter battery voltage is other than 1.5. (Some ohmmeters provide a low driving voltage on the low-resistance ranges, and a high driving voltage on the high-resistance ranges.)	Measurement of forward and back resistance, and front-to-back ratios of all crystal diodes, including u.h.f. mixer crystals. Measurement of most resistance values encountered in TV chassis.	Attempted measurement of high resistance values, such as the leakage resistance of paper or mica capacitors (unless high driving voltage is provided on the high-resistance ranges). Attempted measurement of resistance values in hot circuits, or in circuits with capacitors retaining residual charge.
Resistance measurements, when internal ohmmeter battery voltage is higher than 1.5 (on low ranges).	Measurement of forward and back resistance of picture-detector crystals, but not of u.h.f. crystals (except on higher ranges, to limit terminal voltage to 1.5). Measurement of all resistances found in TV chassis, with exception of leakage resistance of small capacitors.	Attempted measurement of the filament resistance of small battery-operated tubes. Attempted measurement of the internal resistance of meter movements. Attempted measurement of resistance values in hot circuits, or in circuits with capacitors retaining residual charge.



v.t.v.m. was designed to measure. Unless manufacturer has specified the type of waveshapes which can be measured with the v.t.v.m., it should be assumed that the instrument can be used only to measure sine waves.

4. On low a.c. measurements, questionable readings can be obtained if the special "low a.c." scale is not used.

5. A.c. voltage is too low to be read on v.t.v.m. This situation is especially common in signal-tracing work in low-level r.f. and i.f. amplifiers.

### **Resistance measurements**

1. Measurement of same resistance on two different scales gives two readings of considerable difference. Use resistance scale which gives reading nearest the center-scale point.

2. Highly erratic action of meter pointer on resistance measurements. Be sure to remove power from circuit under test or to discharge all capacitors before making ohms measurements.

3. Ohms measurement of components installed in circuit does not give satisfactory indications. Shunting resistances of other resistors and capacitors can be causing misleading reading. Disconnect one or both ends of component from circuit.

# using the v. t. v. m.

**F**ront-panel controls on nearly all service-type v.t.v.m.'s are the same in purpose. They may differ only in design, number of switch positions, and placement on the panel. The four controls found on all v.t.v.m.'s are: (1) **FUNCTION SELECTOR**, (2) **RANGE**, (3) **ZERO ADJUST** and (4) **OHMS ADJUST**. The connectors and terminals used will depend upon the number and types of probes and cables employed.

## Front-panel controls

The **FUNCTION** control is the front-panel switch used to select the type of measurement to be made. Although this control is labeled **SELECTOR** and **CIRCUIT** on some instruments, the purpose is the same. The **RANGE** control is the front-panel switch used to select the voltage, current or resistance range on which the measurement is to be made. On some instruments a single switch which has a large number of positions combines the duties of both the **FUNCTION** and **RANGE** controls.

The **ZERO-ADJUST** control is used to set the meter pointer at the left-hand zero mark on all functions after power is applied to the instrument. The **OHMS-ADJUST** control is used to set the meter pointer to the infinity mark on the ohms scale after the **SELECTOR** is set to the ohms position.

These four basic controls — **RANGE**, **SELECTOR**, **ZERO ADJ** and **OHMS ADJ** — are provided on the RCA WV-87A Master Volt-Ohmyst. Because operation of this v.t.v.m. is straightforward and similar to other commercial units, it is an excellent example for

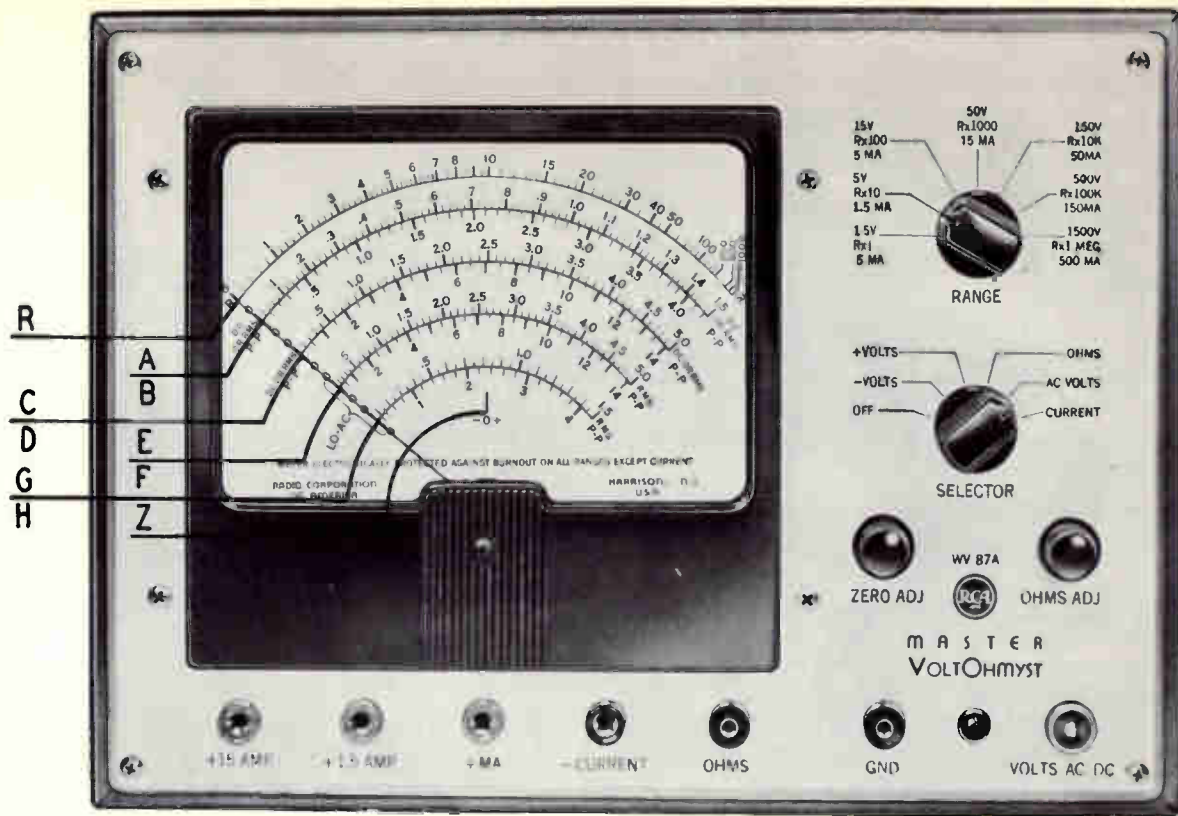

Fig. 501. The modern v.t.v.m. is one of the most useful and versatile test instruments in the service shop.

demonstration. The operating techniques and precautions for this instrument apply, in general, to all vacuum-tube voltmeters.

The v.t.v.m. is equipped with a switch type probe and cable for a.c. and d.c. voltage measurements, an ohms probe and cable, a ground cable and two test leads for direct-current measurements. A slip-on type switch probe is also provided for use with the direct probe and cable to permit a.c. and d.c. voltage measurements with a single probe and cable. The ground cable is used for all voltage and resistance measurements.

The first two positions on the SELECTOR switch are for negative and positive d.c. volts. When the switch is set to  $-$ VOLTS, a negative d.c. voltage applied to the d.c. probe tip will produce upscale deflection of the meter pointer. When the switch is set to  $+$ VOLTS, the pointer will deflect upscale when a positive voltage is applied to the d.c. probe. This polarity-reversal feature avoids the necessity for reversing the ground lead and d.c. probe when changing the polarity of d.c. voltage measurements.

The v.t.v.m. will measure both negative and positive voltages to 1,500, a.c. voltages to 1,500 r.m.s. or 4,200 peak-to-peak, resistance to 1,000 megohms and direct current to 15 amperes.

## Scales and multipliers

The number markings on the different positions of the range switch indicate which meter scale is used for a particular measurement. These numbers always correspond to the maximum limit or full-scale value of the range selected.

Fig. 501 shows that the lowest range for all types of measurements is the extreme left-hand position on the range switch. The range positions increase in value as the switch is rotated clockwise. The lowest position, marked  $1.5 \text{ v-R} \times 1-.5 \text{ MA}$  indicates that the full-scale value of the scale used is 1.5 volts for a.c. or d.c. voltages, that a multiplier of 1 is used on the ohms scale and the full-scale value for direct current is 0.5 ma.

Table 3 is helpful in showing the use of multipliers and the selection of scales. For demonstration, let's use the instrument for a series of d.c. voltage measurements. Suppose we wish to measure the cathode bias developed in a TV i.f. amplifier stage. This voltage is estimated to be  $+1.4$ . After setting up the instrument (as described in the next section of this chapter) and adjusting the FUNCTION selector to  $+$ VOLTS, the RANGE switch is set to 1.5 v because this range includes the estimated value of the voltage to be measured and also is the range which will give a reading nearest to the full-

**TABLE 3**

Function	Quantity To be Measured	Range-Switch Setting	Meter Scale To Use	Meter-Scale Multiplier
D.C. VOLTS (use d.c. direct probe; set switch to D.C.)	0 - 1.5 v	1.5 v	A	1
	1.5 - 5 "	5 "	C	1
	5 - 15 "	15 "	A	10
	15 - 50 "	50 "	C	10
	50 - 150 "	150 "	A	100
	150 - 500 "	500 "	C	100
	500 - 1,500 "	1,500 "	A	1,000
OHMS (use ohms probe and cable)	0 - 30	R× 1	R	1
	30 - 300	R× 10	R	10
	300 - 3,000	R× 100	R	100
	3,000 - 30,000	R× 1,000	R	1,000
	30,000 - 300,000	R× 10,000	R	10,000
	300,000 - 3 Meg	R× 100,000	R	100,000
	3 Meg - 1,000 Meg	R× 1 Meg	R	1,000,000
A.C. VOLTS: R.M.S. (use d.c. direct probe; set switch to DI- RECT and read on black scales)	0 - 1.5 v	1.5 v	G	1
	1.5 - 5 "	5 "	E	1
	5 - 15 "	15 "	A	10
	15 - 50 "	50 "	C	10
	50 - 150 "	150 "	A	100
	150 - 500 "	500 "	C	100
	500 - 1,500 "	1,500 "	A	1,000
A.C. VOLTS: PEAK-TO-PEAK (use d.c. direct probe; set switch to DI- RECT and read on red scales)	0 - 4 v	1.5 v	H	1
	4 - 14 "	5 "	F	1
	14 - 42 "	15 "	B	10
	42 - 140 "	50 "	D	10
	140 - 420 "	150 "	B	100
	420 - 1,400 "	500 "	D	100
	1,400 - 4,200 "	1,500 "	B	1,000
DIRECT CURRENT (use special red and black current cables)	0 - 0.5 ma	0.5 ma	C	0.1
	.5 - 1.5 "	1.5 "	A	1
	1.5 - 5 "	5 "	C	10
	5 - 15 "	15 "	A	10
	15 - 50 "	50 "	C	100
	50 - 150 "	150 "	A	1
	.15 - 1.5 a	*	A	10
1.5 - 15 a	*	A		
NULL INDICA- TIONS; D.C. VOLTS (use d.c. direct probe; set switch to D.C.)	- .75 - + .75 v	1.5 v	Z	
	- 2.5 - + 2.5 "	5 "	Z	
	- 7.5 - + 7.5 "	15 "	Z	
	- 25 - + 25 "	50 "	Z	
	- 75 - + 75 "	150 "	Z	
	- 250 - + 250 "	500 "	Z	
	- 750 - + 750 "	1,500 "	Z	

scale point where accuracy is greatest. Referring to Table 3, we see that meter scale A (Fig. 501) is the scale on which the reading should be made. When the probe is connected to the cathode pin of the amplifier tube, the meter pointer should swing up to the 1.4 mark on scale A if our voltage is correct.

Suppose we wish next to check the operation of the horizontal oscillator stage. A reliable indication of whether the stage is oscillating properly may be had by checking the developed grid bias voltage. In our particular receiver, this voltage should be approximately  $-9$ . The FUNCTION switch, therefore, should be set to  $-VOLTS$ . Table 3 shows that scale A is used for this measurement also, but the RANGE switch should be set to the 15 v position to provide for a reading of 9 volts. (Remember that the 1.5 mark now corresponds to 15, and all readings on this scale must be multiplied by 10 to obtain a correct reading.) This same procedure applies to other scales and ranges. If the RANGE switch is set to 150 v, for example, and 130 volts are applied to the test probes, the meter pointer will rest at 1.3 on the 1.5 scale. The scale reading should be multiplied by 100, therefore, to obtain the correct value.

The use of multipliers on the 5 v scale is the same. If, for example, the RANGE switch is set to 500 v and a B+ voltage of 240 is measured, the meter pointer will rest at the first division mark to the left of 2.5 on scale C (Fig. 501). A multiplier factor of 100 must be used to obtain a correct reading.

The scales marked LO-A.C. (shown as scales E, F, G and H in Fig. 501) are used only for a.c. voltage measurements. Scale G is used only for a.c. voltages (r.m.s.) from 0.1 to 1.5; scale E only for a.c. voltages (r.m.s.) between 0.1 and 5. On this v.t.v.m., scales B, D, F and H are printed in red and are used only for peak-to-peak a.c. voltage readings. These scales are used simultaneously with the black scales immediately above them. For example, an r.m.s. voltage of 1.4 is read on the black scale G; the corresponding peak-to-peak voltage of approximately 3.9 is indicated simultaneously on scale H. An r.m.s. voltage of 14 is read on scale A; the corresponding peak-to-peak voltage of approximately 39 is read on scale B.

This same procedure applies to direct current and resistance measurements. The use of multipliers is simple if it is remembered the full-scale marking of the scale in use corresponds to the number indicated on the range switch. A chart similar to that in Table 3 can be made up easily for other types of v.t.v.m.'s and may be extremely helpful in acquainting the technician with a new instrument.

## How to take measurements

In this section, the procedures for making different types of measurements with the v.t.v.m. are described. Important points, which are helpful in obtaining more accurate and faster readings, are also included.

### D.c. voltage

1. Connect the power cord to an a.c. outlet which supplies from 105 to 125 volts, 50 to 60 c.p.s.

2. Turn the selector switch clockwise from the OFF position to the +VOLTS position. Allow a minute or two for the operating voltages to stabilize.

3. Connect the ground cable to the GND jack and connect the direct probe and cable (Fig. 401-b) to the VOLTS A.C.—D.C. connector. Slip the d.c. direct probe (switch probe shown in Fig. 403) onto the front end of the direct probe. Set the sliding switch in the probe to the D.C. position.

4. Rotate the ZERO ADJ control, if necessary, to bring the meter pointer into exact alignment with the zero points on the left-hand end of the meter scales.

5. Estimate the value of the d.c. voltage to be measured. Set the RANGE switch to the position which includes the estimated voltage. (See Table 3 for the correct range settings.)

6. Connect the clip of the ground cable to the chassis of the equipment under test. (If transformerless or a.c.—d.c. equipment is to be tested, refer to the listing of special precautions under "Measurement Tips.") Apply power to the equipment that is to be checked.

7. Connect the tip of the d.c. probe to the positive test point. Do not touch the metal part of the tip with the fingers. The meter pointer should deflect to the right but should not go past the last calibration mark on the scale. If the pointer swings off scale, the RANGE switch should be set to a higher scale which will provide an on-scale reading.

8. Read the d.c. voltage from the scale indicated in Table 3.

9. If a negative polarity d.c. voltage is to be measured, this same procedure is valid (steps 1–8) with the exception that the SELECTOR switch must be set to —VOLTS. This will allow the meter needle to read directly, moving up from left to right. If polarity settings of the selector switch are disregarded, possible damage to the meter needle can result.

## Ohms

Here is the procedure for making ohms measurements:

1. Connect the ohms probe and cable to the OHMS jack on the front panel. The ground cable should be connected to the GND jack.
2. Estimate the value of the resistance to be measured and set the RANGE switch to the setting which includes this value. (See Table 3 for the correct range setting.)
3. Turn the selector switch to OHMS. The meter pointer should deflect fully to the right. This is the normal setting for the pointer when the v.t.v.m. is set up for ohms measurements and no load is connected across the ohms probes. If the pointer does not rest exactly at the full-scale infinity mark, set the OHMS ADJ control for the proper setting.
4. Short the ohms probe and the ground cable together. The meter pointer should swing over to the left-hand zero point (zero resistance). Adjust the ZERO ADJ control, if necessary, to bring the pointer into exact alignment with the zero mark. Unshort the probes and recheck the infinity setting of the pointer. Reset the OHMS ADJ control, if necessary.
5. Connect the ground clip to one side of the unknown resistance and the ohms probe to the other side. If the resistance is connected into a circuit, it may be necessary to disconnect one end from the circuit to prevent shunt resistances from affecting the meter reading. *CAUTION: Never attempt to make resistance measurements in circuits which have power applied. Failure to observe this precaution may result in burnout of the precision resistors in the ohms-measurement network of the v.t.v.m.*
6. Read the resistance from the top scale of the v.t.v.m.

## A.c. voltage

1. With the power cord connected to an a.c. outlet, turn the selector control to the A.C. VOLTS position.
2. All a.c. voltage measurements are made with the ground cable and the direct probe and cable. If the switch probe is used, the sliding switch should be set to the DIRECT position. Connect these probes and cables, if necessary.
3. Estimate the value of the a.c. voltage to be measured and set the RANGE switch to the position which includes this value. Table 3 lists the correct range settings. (If transformerless or a.c.-d.c. equipment is involved, refer to the listing of special precautions under "Measurement Tips.") Make sure the frequency



and waveshape of the a.c. signal to be measured are within the measurement capabilities of the v.t.v.m.

4. Short the ground cable and direct probe together and zero the meter pointer with the ZERO ADJ control, if necessary. The probe switch should be set to DIRECT.

5. Connect the clip of the ground cable to the chassis or ground bus of the equipment under test. Connect the direct probe tip to the test point. Do not touch the metal part of the tip with the fingers.

6. Read the *r.m.s.* value of the a.c. voltage from the black scale (indicated in Table 3). Read the *peak-to-peak* value from the red scale.

### Direct-current measurements

Current measurements\* require several precautions not usually necessary for other measurements. These precautions are recommended to protect the meter from burnout and to protect the technician from electrical shock. They may be summarized briefly as follows:

- A. Take special care in setting up the instrument and the test circuit because the meter is *not* protected against burnout on current measurements.
- B. Do not attempt to measure current in circuits containing more than 1,500 volts d.c. Do not attempt to measure alternating current.
- C. Always remove power from equipment under test before connecting test leads. Discharge all capacitors in the test circuit.

Current measurements are made as follows:

1. Turn the selector switch to the CURRENT position. (It is not necessary that the instrument be connected to the power line for direct current measurements.)

2. Connect the "negative" current cable (black) to the —CURRENT jack. Connect the "positive" current cable (red) to one of the three +CURRENT jacks. The jack used depends upon the estimated value of the current to be measured. *To protect the meter against possible damage, the range selected for the initial measurement should be able to handle a current of at least twice the value of the estimated current.* The RANGE switch is connected in the

---

\*Most v.t.v.m.'s measure resistance and voltage only, and do not have provisions for measuring current.

circuit only when currents of 500 ma or less are measured. When the +1.5 AMP and +15 AMP jacks are used, the setting of the RANGE switch may be ignored.

3. Remove power from the equipment under test. Short all filter capacitors to prevent accidental shock.

4. Break the circuit wiring at the desired measurement point and connect the two current cables in series with the circuit. The black cable should be connected to the negative lead or terminal of the opened circuit or to the point of lower potential, and the red cable should be connected to the positive lead or terminal.

5. Apply power to the equipment and observe the meter reading. If necessary, readjust the RANGE control or change connection of the red cable at the v.t.v.m. to give a reading on a scale which is nearest to full-scale deflection of the meter pointer (see Table 3).

6. Remove power from equipment and short the filter capacitors before disconnecting the cables.

#### **Null indications:**

The test procedure used in making null measurements varies with the application. Null indications in bridge circuits, for example, may require that probes and cables be connected differently than in other applications, such as FM discriminator tests. For correct connection of probes and cables, the technician should refer to the manufacturer's service notes or equipment instructions. In general, the procedure is as follows:

1. Connect the power cord to an a.c. outlet and set the SELECTOR control to +VOLTS.

2. Connect the ground cable to the GND jack and connect the direct probe and cable, with the d.c. direct probe attached, to the VOLTS A.C.-D.C. connector. Set the sliding switch on the probe to the D.C. position.

3. Rotate the ZERO ADJ control to position the meter pointer exactly at center scale, as indicated by scale Z in Fig. 501.

4. Estimate the maximum voltage swing in the null-indicating circuit. The maximum swing is measured by adding the maximum negative voltage to the maximum positive voltage. For the correct range setting, see Table 3.

5. Remove power from the circuit under test. The ground cable and d.c. probe should be connected as recommended by the manufacturer of the equipment under test. Usually, the probe tip is connected to a point which is positive with respect to the point to which the ground cable is connected. If the meter pointer

swings off scale in either direction, switch the RANGE control to a higher range which gives on-scale deflection. Make circuit adjustments as required to center the pointer on the center-scale zero mark.

6. Remove power from the test circuit and disconnect the test leads.

## Measurement tips

Here are some practical suggestions that will help you get the most out of your v.t.v.m.

### Ohms measurements

Because accuracy is the first consideration in any measurement, keep the following suggestions in mind when resistance measurements are made.

As pointed out previously, nearly all ohmmeters are designed to provide most accurate readings at the center-scale point. This factor should be remembered when measurements are taken. Most manufacturers, while specifying accuracy percentages for the a.c. and d.c. voltage functions of their instruments, do not specify an accuracy figure for resistance measurements. While this practice may seem questionable, remember that resistance measurements of high accuracy are not required in general service work. The tolerance of most resistors used in conventional TV and radio receivers is in the order of  $\pm 10$  and  $\pm 20\%$ . If the receiver can tolerate deviations of these magnitudes, it is not necessary to read the values to a close tolerance. Resistance measurements at very tight tolerances should be made with calibrated resistance bridges designed especially for such applications.

The value of the battery voltage used in the ohms section of the v.t.v.m. should be known and remembered by the technician. Some sensitive devices, such as low-voltage low-wattage tube filaments, meter multipliers and thermocouples may be burned out if too high an ohms test voltage is applied.

When resistance measurements are made in electronic circuits, the shunt resistance may be very difficult to estimate. In these cases, it is usually best to unsolder individual components or to break up a complicated circuit by disconnecting major leads and buses and checking resistances of parts and simple circuits individually. Some manufacturers provide resistance measurement tables in addition to voltage tables in their service notes. Usually, however, the technician has to work without this assistance.

In some circuits, especially those which contain large value capacitors, several seconds may be required for the meter pointer to reach its maximum position. This slow pointer swing is usually most apparent on the high-resistance scales and is more pronounced in test circuits which contain both a large capacitance and high resistance. This effect, caused by the charging of the capacitor by the battery voltage in the v.t.v.m., is due to the fact that the current must flow through the v.t.v.m. resistance in series with the battery. This resistance is highest on the highest ohms range and the charging time of the test-circuit capacitance, therefore, is increased. Charging time may often be greatly reduced by setting the RANGE switch to the lowest ohms setting, where the series resistance is least, and then switching up to the desired range.

V.t.v.m. ohms circuits are designed to provide extremely long battery life. Aside from a minute leakage current, no battery current is drawn when the ohms probes or leads are disconnected. If the v.t.v.m. is used over an extended operating period, the ohms test leads should not be left connected in a shorted position.

A weak ohms battery is usually indicated when the meter pointer will not deflect to the infinity mark on the ohms scale. Batteries in this condition should never be left in the instrument. The chemical action in an exhausted battery produces a highly corrosive residue which quickly attacks such critical metal parts as the switch contacts and solder joints. A badly corroded switch section may require complete replacement of the switch and associated components. Units which require flashlight type batteries should use steel-encased batteries to reduce effects of corrosion.

#### **Voltage measurements:**

A few tips on safety are of first importance in taking both a.c. and d.c. voltage measurements. It is always best to work with one hand in a pocket when a *hot* circuit is being worked on. The ground cable of the v.t.v.m. should be connected first. If the probe is connected first and the technician picks up the ground clip, he is in series with the v.t.v.m., the voltage source and ground.

Special care should be taken when working with a.c.-d.c. or transformerless equipment because the chassis, ground or B-buses are usually tied to one side of the power line. If the ground cable of the v.t.v.m. is connected to any of these points, the metal case of the instrument will be at the same potential as the common point in the test circuit. In some applications, the v.t.v.m. case will be hot to the full value of the line voltage.

A situation of this type is shown in simplified form in Fig. 502.

When the line cords are connected to the outlets, one chassis will be hot. Because the chassis are connected to different sides of the line, a dead short across the line would result if the chassis should touch or if they should be tied together through the ground circuit of the v.t.v.m. Such a condition is, obviously, an extreme shock hazard as well as a possible source of damage to expensive test equipment. This common danger can be eliminated by use of an isolation transformer which provides isolation from the power line for a.c.-d.c. receivers.

When working with equipment carrying high B+ voltages, a shorting lead or screwdriver should be used to discharge capacitors after power has been removed. Large electrolytic capacitors may store a charge for several minutes after power is shut off. Mica capacitors, used in TV high-voltage supplies, may store a charge for many hours.

One of the most common d.c. voltage measurement problems arises in high-resistance high-impedance circuits which are sensitive to resistive and capacitive loading. The high input resistance of the v.t.v.m. helps greatly in overcoming the d.c. loading effects. The isolating resistor in the d.c. probe aids in reducing the capacitive loading. This probe should always be used for d.c. voltage measurements.

Greatest accuracy on both a.c. and d.c. voltage measurements is usually obtained in the upper third of each scale. Overall v.t.v.m. accuracy depends primarily upon two factors: (1) the accuracy rating of the meter movement used and (2) the accuracy of the resistors used in the voltage divider networks of the v.t.v.m. In the case of the RCA Master VoltOhmyst, for example, the meter movement is designed to provide a reading at the full-scale points of within  $\pm 2\%$  of the true voltage. The precision carbon-film resistors used in the voltage divider networks have a tolerance of  $\pm 1\%$ . The maximum combined reading error possible, therefore, is  $\pm 3\%$ . If a high-voltage multiplying probe is used, the possible error is increased by the percentage tolerance of the high-voltage multiplier resistor. Since the error is cumulative, with a high-voltage probe having a resistance tolerance of  $\pm 2\%$ , a maximum error of  $\pm 5\%$  is possible.

When measurements are made on scale points below full scale, "tracking" error may be introduced. While a meter may be designed to have a high degree of accuracy at the full-scale point, the amount of error may increase as readings are made elsewhere on the scale. This effect is most noticeable in the lower quarter of

the scale. Vacuum-tube and meter movement nonlinearity and meter-bearing friction often make readings in very low sections of the scale untrustworthy. The degree of tracking error is seldom specified by the v.t.v.m. manufacturer.

Probably the greatest source of error in a.c. signal measurements is due to application of the v.t.v.m. The a.c. loading characteristics of these instruments often are not as good as could be desired, although they are vastly better than the a.c. loading characteristics of nonelectronic meters. In TV signal circuits, for example, it is often desirable to measure the a.c. signal drive supplied to the grid circuit of a stage. Signal circuits are usually characterized by a resistance of 1 megohm or better and usually have relatively low shunt capacitance. Input characteristics of most vacuum-tube voltmeters are in the order of 0.75 to 1 megohm with from 50- to 100- $\mu$ mf capacitance. The effect of this added load upon the test

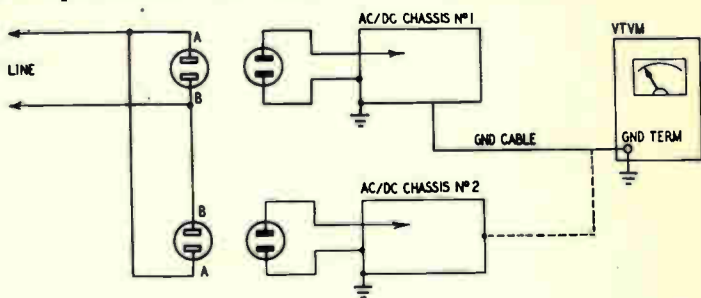

Fig. 502. If both a.c.-d.c. chassis are plugged into the power line, as shown, a connecting link between the two chassis (or if the two are tied together through the v.t.v.m.) would result in a short circuit.

signal depends upon the impedance of the test circuit, the frequency and type of a.c. waveshape and the voltage value of the signal. A good check of the loading effect of the v.t.v.m. may be had by setting up a TV receiver in good operating condition and tuning in a picture and accompanying sound signal. The a.c. probe can be applied to different stages in the receiver and the effect on picture and sound performance noted.

The discussion in Chapter 2 of the a.c. signal rectifiers used in commercial vacuum-tube voltmeters demonstrates the importance of frequency and waveshape upon the reading obtained with the v.t.v.m. If measurements are made in TV circuits where special types of waveforms are encountered, the meter should be able to respond to the peak-to-peak value of the a.c. signal. Waveforms which are narrow in shape and have a low repetition rate usually cannot be measured accurately. Attempts to measure a.c. signals

which have higher frequencies than those the v.t.v.m. was designed to handle may also lead to erroneous readings. The instrument manufacturer usually states the frequency limits of his v.t.v.m. and often specifies the type of waveform the instrument will measure.

Poorly shielded instruments and cables may often lead to some weird effects, especially when the instrument is used in a strong a.c. field. Hum, noise and stray-field pickup may cause the meter pointer to deflect regardless of how probes are connected. In high-frequency circuits, especially where the v.t.v.m. is used on a low-voltage range, good shielding and grounding are essential. When r.f. circuits are involved, the ground cable should be connected as closely as possible to the voltage test point. Probes and cables should be shielded throughout to prevent the test leads from picking up stray energy and feeding it to the meter circuit.

Most units which can be used for current measurement do not require connection to the power line. The meter, together with its associated shunting and dropping resistances, is inserted directly in series with the test circuit. Three precautions are necessary in these current-measurement applications. They are: (1) Use a range setting considerably higher than the estimated value of the current to be measured to avoid the possibility of meter burnout. (2) Take extreme care if the meter case is connected to the minus side of the current circuit because the case will then be at the same voltage potential as the test circuit. (3) Be careful to connect the current cables to the points of correct polarity in the circuit. Because the meter must be connected in series with the test circuit, all power should be removed and capacitors discharged before the meter is connected.

The considerations discussed here apply in general to v.t.v.m. applications. The next few chapters, which deal with specific applications, will point out some additional tips and considerations which can be used to advantage.

# tv troubleshooting

In no service application can the v.t.v.m. be put to greater use than in the troubleshooting of television receivers. Voltage and resistance measurements are still two of the best ways of locating a faulty stage and finding a defective component quickly. The high d.c. input resistance and wide resistance measurement ranges of the v.t.v.m. are well suited to the circuits found in TV receivers. Because of these basic advantages, the v.t.v.m. will find even greater use in servicing color sets.

## Analyzing the defective tv receiver

In any type of servicing, remember that a test instrument is not a substitute for expert technique. It is merely a servicing aid which helps make the job quicker and easier. Intelligent analysis of receiver performance is a necessary first step in determining which section of the receiver is defective. Unless you make a careful examination of the symptoms, hours or even days can be wasted in checking voltages, resistances and components which have nothing to do with the defective section of the circuit.

When a defective receiver is first approached by the service technician, it is important that the operation of all controls be checked and noted. Careful examination of the picture raster and sound performance must be made as the first step in determining what the defects are. Too often a hurried check results in the technician's overlooking an important symptom which indicates that the trouble exists in an unsuspected section. In intercarrier type re-



ceivers, for example, lack of both picture and sound may indicate trouble in the tuner or picture i.f. amplifier, although a.g.c. circuit defects may sometimes also affect both picture and sound. A helpful check in locating sync troubles is to note whether the sync bars have the proper blackness level as the picture is rolled vertically or tilted horizontally. The effects obtained by varying the brightness and contrast controls, the hold, fine-tuning and a.g.c. controls should always be noted carefully. A few extra minutes spent at this stage of the job can save hours of fruitless hunting later on. Illustrated servicing booklets, which show the effects of circuit faults on the picture, are helpful in demonstrating methods of checking and analyzing symptoms of defective receivers.

### **Tube troubles**

After the technician has checked operation and symptoms, he should have a good indication of what section of the receiver is defective. Tube failure, the most common difficulty, may be checked easily by substituting new tubes in the appropriate sockets of the suspected section. Tubes should be substituted one at a time. If it is necessary to remove several tubes of the same type, they should be marked in some way so they can be replaced in their original sockets. This is often important in the tuner section where interchanging of the oscillator tube with the mixer tube may require resetting of the oscillator channel adjustments.

Series-string receivers, which are rapidly gaining in popularity, present a special problem because a single tube with an open heater can remove power from all tubes in the string. Finding the open tube can be time-consuming. The v.t.v.m. is an excellent instrument for checking heater continuity. The "ohms" section of the v.t.v.m. is used and the ohms probe and ground cable are connected to the heater pins of individual tubes.

Often the technician will discover a set which has repeated failure of one particular tube. While it may be a temptation simply to install another tube, the careful technician will check further for trouble. Persistent failures can usually be traced to a defective component. For example, a common cause of repeated failure of amplifier tubes may be traced to a leaky coupling capacitor, which causes the tube to draw an excessive amount of current.

The change in value of this capacitor may not be immediately apparent in receiver performance but the tube may be considerably overloaded as a result. Similarly, changed-value resistors may cause tube failure. Operation of the receiver may or may not be

seriously affected. Troubles of this type may be discovered quickly by means of resistance measurements.

Surprisingly, repeated tube failures may sometimes be traced to improper receiver design, although the technician should be extremely careful in his diagnosis and troubleshooting before he reaches this conclusion. Excessive line voltage, a condition which can be checked quickly with the v.t.v.m., can cause circuit voltages to exceed their proper values. Faulty oscillator operation and component breakdown may result from too low or too high a line voltage. In such cases, the remedy may be an adjustable line-voltage transformer which can step up or step down the line voltage applied to the receiver. In a few cases, it is possible to substitute tubes having higher ratings, although the technician should be cautious in making any changes not specifically recommended by the receiver manufacturer.

If tube substitution fails to correct the difficulty, the chassis must be removed for troubleshooting. Always disconnect the a.c. power cord and short the high-voltage output terminal to the chassis *before* pulling the set. Modern receivers may store a high-voltage charge for several days. While this charge may not be lethal, a shock may result in dropping of the chassis or cuts and bruises. A flexible wire, 18 inches long, equipped with alligator clips on both ends is a good shorting device. *Always clip the wire to the chassis before clipping it to the high-voltage terminal.*

If the suspected component cannot be located immediately, a voltage check should be made. Whenever possible, the chassis should be operated with the picture tube, yoke and focus coil connected. Receivers which have the tube and deflecting components mounted on the chassis usually present no special problem because the complete chassis can be removed and placed on its side on the workbench. Other sets, however, have the picture tube and necessary components mounted in the cabinet separate from the chassis. On many of these sets, the leads connecting to the chassis are equipped with plugs which permit quick disconnection. Because these leads are usually short, the technician requires a set of extension leads or a "harness" to permit complete operation of the receiver with the chassis removed. Pin connections for different kinescopes are similar. Connection for the yoke, focus coil, high-voltage lead and speaker vary with different manufacturers, and a separate harness is required for each make. Ready-made harnesses for Du Mont, Philco, RCA and others can be purchased from most parts distributors or made up by the technician.

The correct circuit operating voltages are usually shown on the

manufacturer's schematic design. In some service notes, a separate voltage chart is provided which shows the correct d.c. voltage at each tube pin in the set. These voltages are usually obtained at a working line voltage of 117. A variation of  $\pm 20\%$  from the manufacturer's voltage specifications is acceptable. A v.t.v.m. is almost always used in making these tests because of its high input resistance. Before measurements are made, the antenna should be disconnected and a shorting wire connected across the tuner input terminals to prevent any incoming signal from making voltage changes in the receiver. On some receivers, the manufacturer will specify that certain controls, such as brightness, contrast or a.g.c., be turned to a certain position.

Most d.c. voltages are measured with respect to the receiver chassis, which serves as a common ground, and when this is the case the ground cable of the v.t.v.m. should be clipped to the chassis. Bias voltages and other negative d.c. voltages are also ordinarily measured with respect to ground; it is necessary only to set the FUNCTION switch to —VOLTS to switch polarity on the v.t.v.m. probes. *CAUTION: Remember that the chassis of transformerless or a.c.-d.c. type receivers may be hot.* In some receivers, the chassis is tied directly to one side of the a.c. line. In other sets, the chassis may be connected to one side of the line through a resistor. If the v.t.v.m. ground cable is clipped to the chassis, the case of the v.t.v.m. will also be hot and there is danger of a severe shock or short circuit. It is always best to use an isolation transformer on receivers of this type.

With receiver cables properly connected and if the test precautions just described are complied with, the technician is ready to take voltage measurements. The B plus voltage at the output from the power supply should be checked first. This voltage will range from about 120 to approximately 300, depending upon the type of power supply. If B plus is considerably lower than it should be, rectifiers and filter circuits should be checked for faulty operation. If B plus voltage is excessively high, a bleeder resistor may be open or a defective component elsewhere in the receiver may have reduced the load on the power supply and caused a corresponding increase in the supply voltage available.

Because of the complexity of TV receiver circuitry, several B plus voltage buses may be used. The highest voltages are used in the sweep and audio circuits; the lowest voltages in the tuner and i.f. amplifier sections. D.c. operating voltages throughout the receiver will generally vary with the value of the B plus voltage. If a serious defect exists, it can cause radical changes in plate,

screen, grid and cathode voltages on most tubes in the receiver. Because of this, voltage measurements throughout a defective receiver may show that operating voltages are out of tolerance in several stages which appear to have no direct relationship with each other. A problem set of this type is best handled by breaking up the B plus buses and checking them one at a time.

After the B plus supply voltage is checked, the operating voltages in the suspect section or stage of the receiver should be measured. In most defective receivers, these measurements should bring the technician very close to the source of trouble. Low voltage in a section or stage may indicate a leaky or shorted capacitor. Too high a voltage can point to an open resistor or defective tube. There are many possible causes, of course, but these are the most common.

### **Troubleshooting defective components**

After the technician has analyzed the defective receiver and substituted new tubes in the suspect section without success, he can conclude that one or more components are defective. The capacitors, resistors, coils or other components may be checked in different ways. This section will point out the best ways of checking components. The principles discussed here apply also to these same components when they are used in radio receivers, amplifiers and other types of electronic equipment.

#### **Capacitors**

Faulty capacitors are a common source of trouble. Sometimes, as in the case of a sync circuit, the faulty capacitor may be relatively easy to locate. Often, however, considerable unsoldering and checking may be necessary. The v.t.v.m is extremely helpful in this type of troubleshooting.

Capacitor troubles can be divided into three categories: (1) shorted, (2) leaky and (3) open. The technician is often at a disadvantage because the defective capacitor usually shows no outward sign of being faulty. Shorted and leaky capacitors can usually be detected easily by resistance measurements. An open capacitor is usually best discovered by substitution of a new capacitor in place of, or across, the suspected part.

Shorted capacitors are usually the easiest to detect. A short may reduce the internal resistance to zero or to a few hundred or a few thousand ohms at most. Where a short is suspected, the v.t.v.m. may be connected directly into the circuit without requiring dis-

connection of the capacitor from other parts of the circuit. A leaky capacitor requires disconnection from the circuit before a positive indication may be had. Disconnection is usually necessary because other capacitors and resistors in the same circuit provide shunt resistance around the capacitor being measured. A positive check can be made by disconnecting one or both ends and measuring the resistance across the capacitor.

The shorted capacitor can be detected by voltage measurements in the associated section of the receiver. In any plate, screen, cathode or grid-return circuit that uses a bypass capacitor, there is normally some voltage across the capacitor. If there is not or if the voltage is considerably lower than normal, the capacitor should be disconnected from the circuit and its resistance checked. Also, if

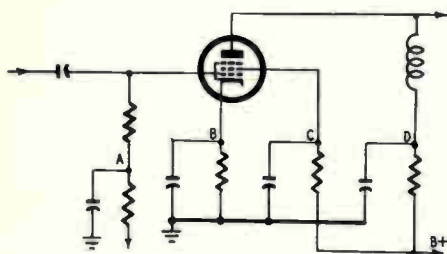

Fig. 601. The v.t.v.m. can be used to test for shorted bypass capacitors.

the circuit voltage returns to normal after the capacitor has been disconnected, a short in the component is indicated. Fig. 601 is useful in demonstrating the effect of a faulty capacitor in a typical amplifier stage. If any of the bypass capacitors are shorted, the voltage at the circuit end of the capacitor will be zero. A leaky capacitor will cause the circuit voltage to be lower than normal. The letters A, B, C and D are typical test points.

When a plate or screen circuit capacitor becomes shorted, it usually causes excessive current flow through any resistor connected in series between it and the voltage source. Consequently, the resistor may change value considerably or become open. Therefore, whenever a shorted capacitor is discovered, it is always wise to check out adjacent components with the v.t.v.m.

A shorted or leaky coupling capacitor can be detected by d.c. voltage measurements. For example, a leaky coupling capacitor will usually result in an abnormal voltage on the grid of the stage being fed. The voltage may be higher or lower than normal. In these cases, a new capacitor should be substituted in place of the old one.

In some cases, a shorted or leaky capacitor may be extremely difficult to detect because the short or leak may not show up until after the full circuit voltage is applied across it. For example, a plate or screen bypass capacitor may show infinite resistance when checked with a v.t.v.m. which applies only 1.5 or 3 volts on the ohms test. But, the capacitor may break down quickly when 200 or 300 volts are applied. Defects of this type are best discovered by monitoring the d.c. voltage across the suspected capacitor with the v.t.v.m. When the short or leak develops, the voltage read on the v.t.v.m. should drop noticeably.

No prescribed resistance limits have been established by which

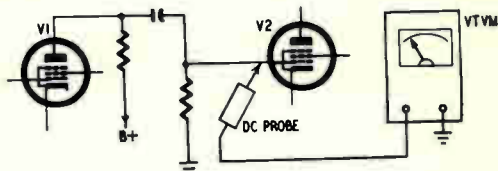

Fig. 602. Quick check for a leaky coupling capacitor. Remove V2 from its socket, and test with a d.c. probe, as shown. A d.c. voltage reading indicates a defective capacitor.

capacitors may be classified as *leaky* because the permissible leakage depends upon the type of capacitor used and the circuit in which it is installed. For example, high leakage in a capacitor connected across a cathode-bias resistor may have very little effect on circuit operation. If the resistor has a nominal value of 100 ohms and the bypass capacitor has a leakage resistance as low as 1,000 ohms, operation may be virtually unaffected. This same amount of leakage in a coupling capacitor or plate or screen bypass capacitor may have serious results.

A leakage resistance of 1 megohm in a plate or cathode bypass capacitor will probably have a negligible effect on circuit operation; but the same amount of leakage in a plate-to-grid coupling capacitor may be equivalent, in effect, to a short circuit. If the grid circuit has a high value of resistance to ground or cathode, a coupling capacitor having a leakage as high as 1,000 megohms may noticeably affect operation.

The best method of detecting a leaky coupling capacitor is by measuring the d.c. voltage drop across it while the capacitor is connected in the circuit and the receiver is in operation. The check may also be made by connecting the d.c. probe of the v.t.v.m. to the grid pin of the driven stage. See Fig. 602. The driven tube should be removed from its socket to prevent any grid cur-

rent or contact-potential current from developing a voltage at the measurement point.

Open capacitors are best detected by temporarily connecting a good capacitor across each of the suspected capacitors while the receiver is in operation and noting the effect on receiver operation (Fig. 603). The substituted capacitor should have the same value

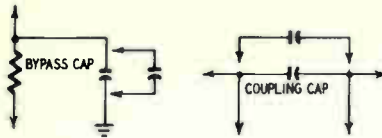

Fig. 603. Technique for checking for open bypass or coupling capacitors.

as the suspected unit. If connection of the new capacitor restores the receiver to normal operation, it may be assumed that the original capacitor is open.

Capacitor substitution is also a good method for discovering open, shorted or leaky capacitors when the suspected unit is disconnected. Some applications in which this method is useful are shown in Fig. 604. The "high" end of the capacitor is disconnected from the circuit.

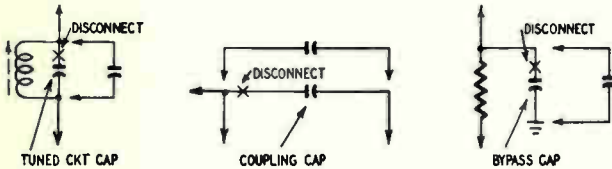

Fig. 604. When making a capacitor substitution test, one end of the suspected capacitor must be disconnected from the circuit.

Electrolytic capacitors are polarized and require that the ohms probe of the v.t.v.m. be connected to the positive terminal and the ground cable to the metal can or common negative lead. The polarity of paper, mica and ceramic capacitors is not important. Electrolytic capacitors will generally show a considerable degree of leakage. Because these capacitors require a relatively larger forming voltage than that supplied by the ohms circuit of the v.t.v.m., the leakage resistance should not be considered significant unless it is in the order of a few thousand ohms or less.

While no set resistance limits can be prescribed for electrolytics on ohms measurements, some experience in measuring these components may be helpful in acquainting the technician with their resistance characteristics. The tabulations in Table 4 may be of

use to the technician in estimating the general condition of various kinds of capacitors. Charging time depends upon the size of the capacitor being tested and the input resistance of the v.t.v.m. on the resistance range in use. The data given under the heading of "Charging Time" is based on the use of a v.t.v.m. having an input resistance of approximately 10 megohms on the  $R \times 1$  megohm resistance measurement range.

## Resistors

In addition to faulty tubes and capacitors, defective resistors are common causes of faulty receiver operation. Fixed composition resistors frequently change value because of excessive current loads or aging. These factors usually cause the resistor to increase in

**TABLE 4**

CAPACITANCE ( $\mu\text{f}$ )	INSULATION	VOLTAGE RATING	RESISTANCE* (Meg-ohms)	SCALE	CHARGING TIME*	SCALE
.001	paper	600	>1,000	$R \times 1$ Meg.	$\frac{1}{2}$ Scale Flick	$R \times 1$ Meg.
.002	mica	600	>1,000	"	$\frac{1}{2}$ " "	"
.006	paper	600	1,000	"	$\frac{1}{2}$ " "	"
.01	"	600	1,000	"	$\frac{1}{2}$ " "	"
.04	"	600	>1,000	"	3 secs.	"
.05	"	600	>1,000	"	4 "	"
0.1	"	600	1,000	"	8 "	"
0.25	"	400	200	"	20 "	"
1.0	"	600	500	"	60 "	"
1.0	"	600	500	"	6 "	$R \times 100\text{K}$
4.0	electrolytic	450	20	"	25 "	$R \times 10\text{K}$
4.0	"	450	20	"	5 "	"
10	"	450	40	"	10 "	"
20	"	150	35	"	20 "	"
20	"	25	50	"	20 "	"
25	"	450	10	"	20 "	"
40	"	50	8	"	30 "	"
100	"	50	15	"	60 "	"
100	"	12	15	"	10 "	$R \times 1\text{K}$
1000	"	—	3	$R \times 100\text{K}$	15 "	$R \times 100$

\*The values given for resistance and charging time are only typical values for the guidance of the experimenter. They should not be considered as limits or quality end points. The symbol > in the resistance column means "more than."

—Courtesy of QST

value, sometimes to many times its original value. A resistor may change value or become open without showing any outward indication, such as discoloration or swelling. Therefore, normal appearance of the resistor should never be taken as an indication that the component is satisfactory. The v.t.v.m. should be used to measure its actual value after one end of the resistor is first disconnected from the circuit to prevent shunt resistances from upsetting the value of the reading.

Intermittent resistors are often encountered and may be difficult to locate. In these cases, the v.t.v.m. may be used to monitor the voltage in the circuit, as shown in Fig. 605. The circuit shown here is a power supply voltage divider network similar to those found in



many TV receivers. R1, R2 and R3 are wirewound high-wattage resistors which provide the required voltages on different buses in the receiver. If circuit voltages show a marked increase or decrease during receiver operation, the trouble may be traced to a resistor which is changing value or opening up as it becomes heated. The v.t.v.m. is set up for d.c. voltage measurements and the d.c. probe is clipped to the desired point in the divider network. If all the resistors are functioning correctly, the voltages should be as indicated. If R1 opens, no voltage would be indicated

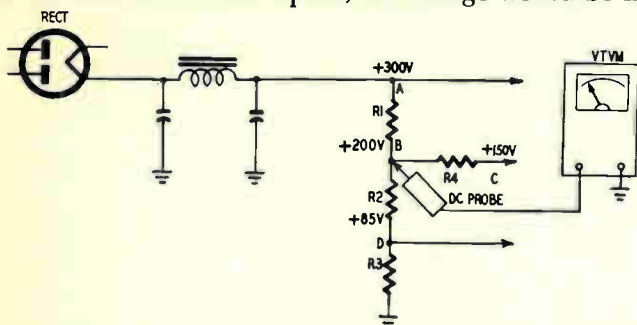

Fig. 605. The v.t.v.m. and a d.c. probe can be used to test a power supply. The d.c. voltage should increase as you move the probe back toward the filament of the rectifier.

on the v.t.v.m. If R3 should open up, the voltages at points B, C and D should increase noticeably. Any change which would cause a marked difference in operating voltages is very likely to be accompanied by a definite change in receiver sound or picture performance. When operation performance is affected, the technician can check the reading on the v.t.v.m. to ascertain whether the trouble lies in the power supply section or elsewhere in the receiver.

The v.t.v.m. can, of course, be used to monitor d.c. supply and signal voltages in all sections of the receiver. The monitor method of checking intermittent resistors as well as capacitors has the advantage of allowing the technician to work on another job while waiting for trouble to show up.

Series voltage-dropping resistors which become defective should not be replaced until the technician is satisfied that no other defective components have caused the trouble. In Fig. 601, for example, a shorted screen or plate bypass capacitor might cause an excessive amount of current to flow through the screen and plate dropping resistors. If one of these is faulty, the capacitors should be checked for shorts or leakage.

Vertical and horizontal sweep and sync difficulties may often be

traced to a defective resistor in the oscillator stages. In multivibrator stages, for example, a changed value resistor may result in inability to sync the picture.

### Coils and transformers

Troubles with these components are: (1) open windings, (2) shorted turns and (3) shorts and leakage between windings or to the shell or ground. Unless the trouble is intermittent, open windings are perhaps the easiest to discover. A permanently open coil or transformer may be found easily by resistance and voltage measurements. Often, trouble caused by an apparently open winding may actually be caused by a broken or loose connection at a

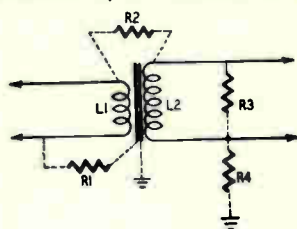

Fig. 606. Possible leakage paths in a transformer.

terminal on the part which can be repaired easily. Internal opens, however require replacement of the unit.

A partial or severe short in these components may be detected by resistance measurements, provided the normal resistance of the winding is known. Resistance checks with the v.t.v.m. are valuable in revealing open windings, shorted coils and shorts across about 20% or more of the turns. In less severe cases, however, it may be necessary to employ voltage measurement methods or to replace the suspected part with a new unit.

Shorted turns in a coil or transformer may or may not be difficult to detect, depending upon the normal resistance of the windings and the function of the part in the circuit. A single shorted turn in an r.f. or i.f. tuned coil, which may make it impossible to peak the circuit at the desired frequency, usually cannot be detected by resistance measurements. A shorted turn in a video peaking coil may have no noticeable effect on receiver operation.

Fig 606 shows the possible leakage paths in a transformer. R1 represents the leakage path to the core; R2 the leakage path from one winding to another; R3 the leakage across a winding and R4 leakage from a winding to ground.

Shorts and leakage between windings and the core, shell or ground (chassis) are best discovered by resistance measurements. The v.t.v.m. is especially useful in these applications because of its ability to read very high resistances. In many cases of leakage, the resistance may be several hundred megohms or more. The suspected component should be disconnected from the circuit and readings taken from each winding to the case, core, chassis and also to other windings to detect leakage. In cases where suspected leakage cannot be detected with the v.t.v.m., a higher test voltage may be used, as shown in Fig. 607, to break down the leakage resistance. Where there is reason to suspect leakage or breakdown from the winding to the core, shell or chassis, a check can also be made by temporarily insulating the unit from the chassis and checking operation.

With the exception of leakage across a winding, the test setup shown in Fig. 607 may be used to detect leakage in many cases. This setup is especially useful in cases where leakage shows up only when high voltages are present. These leakages can be greater than 1,000 megohms, which is the highest resistance which can be read on the "ohms" scales of the v.t.v.m. The external voltage source can be any d.c. voltage from 50 to 500 or more. The supply is connected to one end of the resistance and d.c. voltage readings are taken with the v.t.v.m. at points A and B. Resistance is computed by Ohm's law as follows:

$$R_x = \frac{R_{in}(\text{volts at A} - \text{volts at B})}{\text{volts at B}}$$

where  $R_{IN}$  is the input resistance of the v.t.v.m. on d.c. voltage measurements.

When a power transformer operates hotter than usual, the trouble may be caused by an overload in the receiver or power supply circuits or by shorted turns in the transformer itself. Because leaky or shorted filter capacitors are a frequent source of trouble, the transformer can be checked by first disconnecting the rectifier and filter circuits to see if an overload in the B plus circuits is responsible. If the transformer continues to run in an overheated condition, the transformer itself is probably defective. One side of the filament circuit for all tubes except the power rectifier is usually grounded to the chassis. Shorts in the filament circuit of the receiver are best checked by unsoldering the grounded transformer lead and taking resistance measurements to chassis.

Power supply filter chokes, vertical deflection output transformers and audio output transformers can be checked by measuring the d.c. resistance of the windings and employing some of the same tests just mentioned.

### A.g.c. circuit troubles

Because of the wide variety of symptoms, troubles in the a.g.c. circuit may be very difficult to diagnose. This is true because the a.g.c. stage is usually fed from the second detector or from the video amplifier and, in keyed a.g.c. systems, a signal is also tapped off the high-voltage transformer and fed back to the a.g.c. amplifier. The rectified output voltage from the a.g.c. stage is usually applied through one or two separate buses to the grid of the r.f.

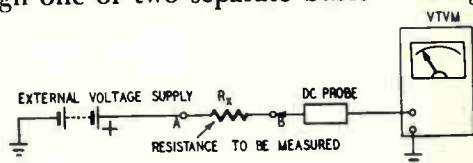

Fig. 607. If the leakage resistance of a component is high, an ordinary resistance check is useless. Use an external voltage supply, set the v.t.v.m. to read voltage, and calculate the resistance.

amplifier in the tuner and to the grids of the first and second picture i.f. amplifiers. A defective a.g.c. stage can cause difficulty from two aspects. A shorted or open component can modify the loading on the second detector or the video amplifier, causing a change in operating conditions on these stages. Likewise, these defects can result in a radical change in the a.g.c. output voltage fed to the i.f. and tuner bias buses. If too much bias is applied, both picture and sound may be seriously attenuated or cut out altogether. If no bias is provided, sound and picture operation may be erratic or cease completely. Some other symptoms of improper a.g.c. action are:

1. Overloading (loss of picture, raster and possibly sound)
2. Unstable picture, horizontal pulling
3. Excessive picture contrast
4. Insufficient picture contrast
5. Gradual increase or decrease in contrast
6. Critical horizontal hold adjustment
7. Poor sync noise immunity
8. Excessive airplane flutter
9. Snow in picture
10. Buzz in sound

Normal voltage on the a.g.c. buses usually runs from 0.1 volt or less to several volts. If voltage measurements in the a.g.c. circuit and on the buses fail to give a positive indication of trouble, an external bias may be applied. This bias may be obtained from a small battery which is equipped with a potentiometer for adjusting bias to the exact required value. A simple bias source may be constructed as shown in Fig. 608. Two clip leads are provided for connection to the separate tuner and i.f. amplifier buses. The buses should be disconnected from the a.g.c. stage before the battery is connected.

With the external bias applied, the v.t.v.m. should be connected to a point in the circuit which shows an abnormal B voltage. The receiver should be turned on, a station tuned in and receiver controls set for normal operation. The bias potentiometer should then

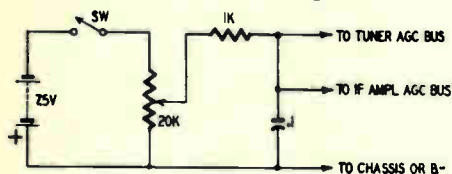

Fig. 608. Circuit of an external bias supply.

be adjusted while the technician watches the v.t.v.m. and checks for effects on picture and sound reproduction. If the a.g.c. system is faulty, correct external bias should restore the a.g.c.-fed stages to their proper operating condition and picture and sound performance should be noticeably improved. If the technician is in luck and performance is restored, it is almost certain that the a.g.c. system is at fault. If no change in performance is accomplished, the a.g.c. circuit can probably be eliminated as the source of trouble.

## Troubleshooting tuners

TV tuners are simple devices in principle but can be very complicated in construction. Wafer-switch types of tuners make troubleshooting especially difficult, particularly if any of the small components are suspected. Very often improper tuner operation may result from incorrect supply and a.g.c. voltages being fed from other parts of the receiver. There are, however, a number of ways of checking voltages which do not require that the tuner be dismantled.

Most tuners are equipped with a readily accessible terminal strip to which the filament voltage, a.g.c. voltage and one or more

B plus leads are connected. When tuner trouble is encountered, voltage measurements should first be made at these accessible terminals. If the voltages are abnormally high or low, these leads should be disconnected and resistance measurements taken from the tuner terminal points to ground. Useful voltage and resistance checks may also be made by removing the tubes from the tuner and measuring the pin voltages or resistances to ground from the top of the socket. Remember that with the tube removed, B voltages may read somewhat high and proper allowance should be

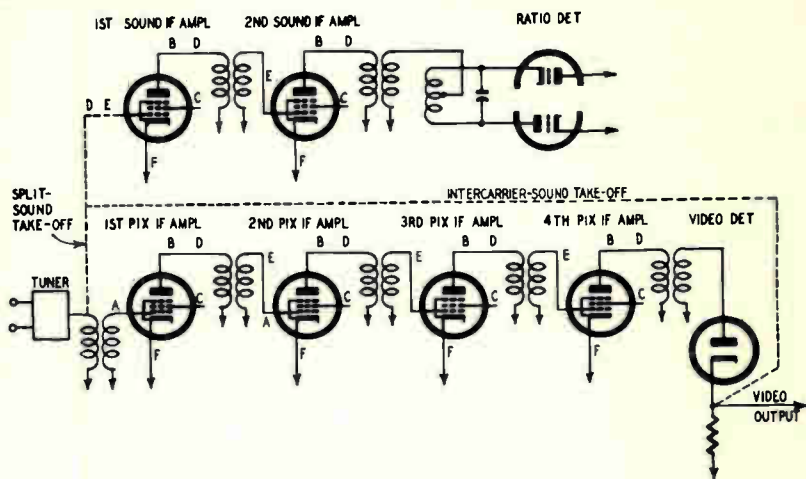

Fig. 609. Test points in split-sound and intercarrier type TV receivers.

made. Remember, also, to count pin numbers in a *counterclockwise* direction around the top of the tube socket. Test-point adapters, which connect between the tube and the socket, provide a convenient means of checking tube voltages under actual operating conditions.

In practice, improper tuner operation is usually caused by: (1) faulty tuner tubes, (2) improper supply voltages and (3) defective switches and dirty tuner contacts. Dirty contacts, a common source of tuner trouble on wafer, rotary and Inductuner type tuners, can usually be cleaned by removing shielding and applying a cleaning solvent with an artist's small paint brush. It should seldom be necessary to dismantle the tuner. If it is, it should not be attempted unless suitable alignment equipment including a sweep generator, marker generator and oscilloscope are available, because component lead dress and placement can affect r.f. alignment. If it is necessary to disturb high-frequency r.f. leads, try to put them back into their original positions.

## Troubleshooting picture and sound i.f. amplifiers

Fig. 609 shows, in simplified fashion, the test points in the picture and sound i.f. amplifiers where the v.t.v.m. may be used for troubleshooting and signal tracing. When trouble is encountered, d.c. voltage readings should be taken first at points A, B, C and F. Table 5 identifies the measurements recommended and lists the type of probe to be used.

The v.t.v.m. can be used with a high-frequency probe to trace the r.f. signal through the i.f. stages. A high-impedance probe is

**TABLE 5**

Key Letter in Fig. 609	To Read	V.T.V.M. Setting (Volts)	Probe Type
A	A.g.c. bias voltage	- D.C.	D.c. isolating probe
B	D.c. plate voltage	+ D.C.	"
C	D.c. screen voltage	+ D.C.	"
D	R.f. plate-signal voltage	$\pm$ D.C.*	R.f. or high freq. probe
E	R.f. grid-signal voltage	$\pm$ D.C.*	"
F	Cathode-bias voltage	+ D.C.	D.c. isolating probe

\*Polarity of v.t.v.m. setting depends on the polarity of the output voltage from the high frequency probe.

necessary to prevent complete detuning of the r.f. circuit. The probe should be connected directly to the plate or grid circuit and the short ground clip, which is usually attached to these probes, should be grounded as near as possible to the r.f. test point. An extension prod or wire should not be attached to the probe tip because of possible instability. The rectified r.f. signal is read on the d.c. voltage scales of the v.t.v.m. In many receivers, only a well designed r.f. probe can be depended upon to give reliable readings.

Begin by reading the r.f. signal at the plate of the first picture i.f. amplifier. The probe and its ground clip should then be moved to the next stage for a reading. With this technique it is possible to trace the signal through the amplifier, *provided the signal is of sufficient magnitude to operate in the linear portion of the high-frequency rectifier characteristic.*

### Intermittent troubles

Intermittent troubles in the sound and picture i.f. amplifier sections may often be detected by employing the v.t.v.m. as a voltage monitor, as shown in Fig. 610. When intermittent picture trouble is encountered in a split-sound type receiver, the v.t.v.m. should be set up to measure the d.c. voltage developed by the picture

signal across the load resistor of the second detector. If the intermittent is located in the video amplifier, the picture will be affected, but the d.c.-voltage read on the v.t.v.m. should remain essentially the same. If the intermittent trouble is located in the picture i.f. section, both the picture and the reading on the v.t.v.m. will be affected. This same technique can be applied to the sound i.f. amplifier and audio sections in either a split-sound or inter-carrier receiver. The v.t.v.m. should be connected across the discriminator or ratio detector load. If the intermittent affects the sound from the loudspeaker and the voltage reading on the v.t.v.m.

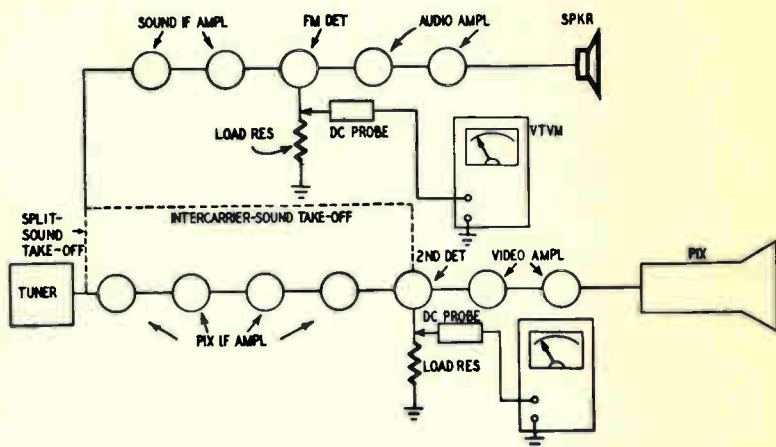

Fig. 610. The v.t.v.m. (set to read d.c. volts) and a d.c. probe can be used to monitor the picture or sound sections of a TV receiver. For servicing intermittents, it is generally preferable to use a signal generator rather than depend upon a television station as the signal source.

remains unchanged, look for trouble in the audio section. A change in sound level accompanied by a change in voltage output at the FM detector indicates trouble in the sound i.f. amplifier. Discovery of intermittent troubles in these sections of the receiver requires that a signal be available to provide output for the loudspeaker, picture tube and v.t.v.m. If a broadcast signal is not available, it will be necessary to use a modulated signal generator which can provide output at the sound and picture intermediate frequencies.

### Plotting a bandpass curve

Although a bandpass response curve can be plotted more quickly with sweep alignment equipment, it is possible to plot an accurate curve using only the v.t.v.m. and an r.f. signal generator. The



test setup required for this operation is shown in Fig. 611. Procedure is as follows:

1. Disconnect the antenna from the receiver and short the receiver antenna terminals together.
2. Connect voltage leads from the a.g.c. bias box to the i.f. amplifier bias bus. Adjust the bias-box potentiometer to provide 1 or 2 volts more bias than can be generated by a strong TV signal.
3. Set up the v.t.v.m. to measure d.c. voltage and connect it across the load resistor of the picture detector. The polarity of the output voltage depends upon the type of receiver being tested.
4. Connect the r.f. output cable from the r.f. signal generator to the mixer stage of the tuner. There are two recommended

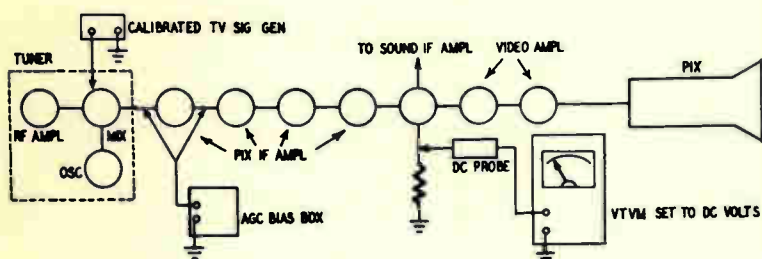

Fig. 611. Setup for plotting the bandpass of a TV i.f. amplifier.

methods of injecting the r.f. signal into the mixer. One is to raise the mixer tube shield so that it is not grounded to the chassis and clip the cable to the shield. The signal will be capacitively coupled into the mixer circuit. The other way is to clip the r.f. cable onto the insulated portion of the mixer grid lead.

5. The response may now be measured. The r.f. signal generator is tuned to deliver an unmodulated output signal at 0.25-mc intervals throughout the expected bandpass of the amplifier. A typical response curve obtained by using 0.25-mc intervals is illustrated in Fig. 612. This curve was drawn on a receiver using sound and picture intermediate frequencies of 41.25 mc and 45.75 mc, respectively. The generator should be tuned first to the lowest frequency and adjusted for the required output voltage. Avoid injecting too much signal voltage into the mixer as too strong a signal voltage can overload the i.f. amplifier and give an inaccurate representation of the true response. Unless the generator has essentially uniform voltage output over the entire range of frequencies used, it will be necessary to measure the generator output voltage and reset the output attenuator, if necessary, whenever the plotting frequency is changed. Once the output level of the generator

has been set, do not change the control setting unless the output voltage is too high or too low.

## Trap alignment

Alignment of the r.f. traps in the TV receiver is usually accomplished before bandpass alignment is attempted. The purpose of a trap is to act as a block to a signal of a specific frequency and keep the signal out of a particular circuit. Most tuners utilize one or more traps whose arrangement depends on the tuner design. Some

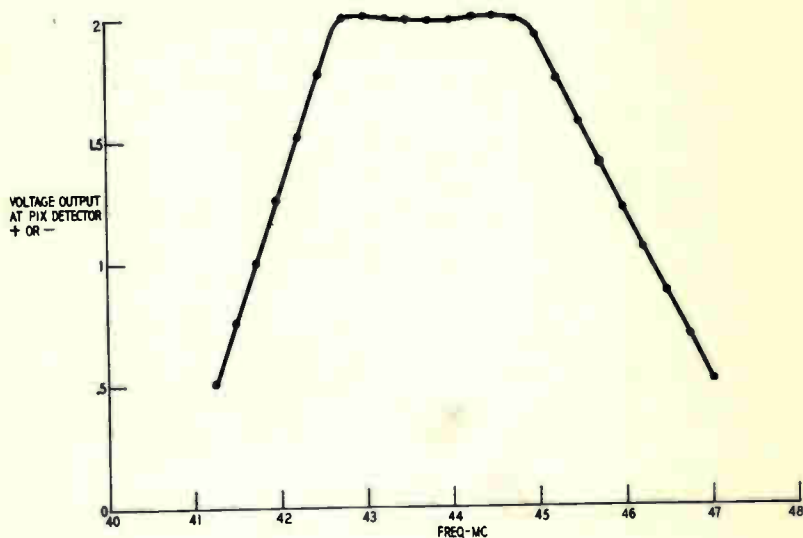

Fig. 612. Response curve of an i.f. amplifier using the technique shown in Fig. 611.

of the most important traps are found in the i.f. and video sections of the receiver. The older, split-sound type of receiver used several traps to attenuate the adjacent sound and picture carriers and to block out accompanying sound from the picture i.f. channel. Some split-sound sets also employ a 4.5-mc trap in the video section to keep beat interference between accompanying sound and picture carriers from affecting the reproduced picture.

The adjacent-channel sound and picture carrier traps and accompanying sound traps are located in the picture i.f. amplifier section. The frequencies to which these traps are tuned depends upon the picture and sound intermediate frequencies used in the receiver. These differ between different makes of sets.

The v.t.v.m. is the best instrument, when used in conjunction with a TV signal generator, for indicating alignment. The actual

procedure is relatively simple and consists of feeding a signal of the trap frequency into the tuner mixer stage and adjusting the trap with an insulated screwdriver. The v.t.v.m. is set up to measure the d.c. output voltage and is connected across the load resistor of the second detector. When the resonant trap is tuned to the exact frequency of the r.f. signal from the generator, the d.c. output voltage will be minimum. An external bias voltage should be used to override the normal a.g.c. voltage. Take care to prevent too much signal from being injected into the mixer. The location of the various traps in a typical split-sound receiver is shown in Fig. 613.

TV receivers which use the intercarrier-sound system do not employ the same traps as those used in the split-sound receiver. Except for trap circuits in the tuner, the intercarrier set employs only a 4.5-mc sound trap in the video amplifier. This trap must be adjusted carefully, especially on sets having wide bandpass, to reduce the possibility of 4.5-mc beat interference in the video channel. On some intercarrier receivers, the sound i.f. takeoff point is located ahead of the last picture i.f. amplifier. In these sets, the last picture i.f. amplifier may contain a trap which is tuned to the receiver sound intermediate frequency. The test signal for 4.5-mc video traps is fed into the first video stage. The test signal for the sound trap in the picture i.f. amplifier is fed into the grid circuit of the mixer stage.

### **Troubleshooting in the video amplifier**

Video amplifiers of modern TV receivers may use either one or two stages and are relatively simple in design. The output of the video amplifier may be fed to either the cathode or grid of the picture tube. Troubleshooting in the video section of the receiver consists mostly of voltage measurements at tube-socket terminals, followed by resistance measurements.

Troubles in the video amplifier can affect other sections of the receiver, however, and this fact should be kept in mind. In most intercarrier receivers, the sound takeoff point is located in the video amplifier stage. A signal for the a.g.c. circuit may also be tapped off in a circuit associated with the video amplifier. Because the video amplifier must pass all the video information, these stages usually contain one or two peaking coils which help increase the bandpass and, hence, the amount of picture detail. When high-frequency response is seriously affected, the peaking coils should

not be overlooked. They may be checked by voltage and resistance measurements.

## Checking a defective picture tube

A faulty picture tube may often be discovered by visual inspection of the picture. The most common symptoms are excessive warmup time, gradually increasing brightness over the operating period, lack of proper brightness with full high voltage and a

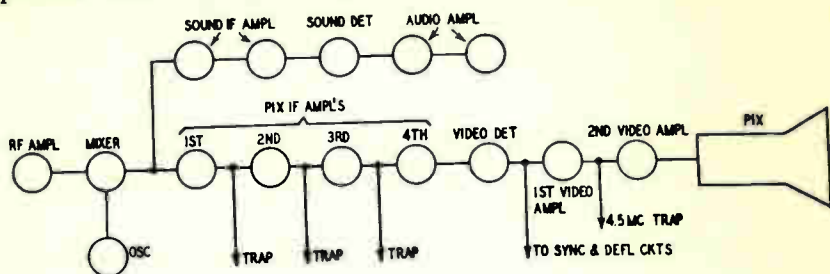

Fig. 613. Split-sound receiver usually has traps in the pix i.f. and video-amplifier circuits.

washed-out picture. A more positive check may be had by checking the tube with a v.t.v.m. The check is simple and is made as follows:

1. Turn on the receiver and check to see that the picture tube filament is lighted. Check adjustment of the ion-trap magnet and the focus coil or magnet.
2. If the picture tube heater is not lighted, remove the socket from the tube and check continuity between the heater pins with the v.t.v.m. Also check the heater-to-cathode resistance. In some tubes, leakage may not show up until the tube has been operated for some length of time.
3. Measure the voltages to ground at the kinescope socket terminals. Vary the setting of the brightness control and note the effect on the grid and cathode voltage readings. The grid should always be negative with respect to the cathode.
4. Check for a.c. video voltage at the grid or cathode terminal of the kinescope socket.
5. Replace the tube socket and measure the high voltage with a high-voltage probe. Vary the brightness control and note the effect on the high voltage.
6. If high voltage is lower than normal, measure the B plus and boosted B plus. If B plus is normal and the boosted B plus is low, install a new damper tube and notice the effect on the boosted

B plus voltage. If this doesn't help, install new tubes in the horizontal oscillator and horizontal output deflection stages.

7. If B plus and boosted B plus voltages are both normal, install a new high-voltage rectifier tube.

If none of these tests indicate other possible trouble sources, then it may be concluded that the picture tube is faulty.

## Troubleshooting sync and deflection circuits

Fig. 614 shows a stage-by-stage lineup of the synchronizing and deflection sections of a representative TV receiver. The vertical

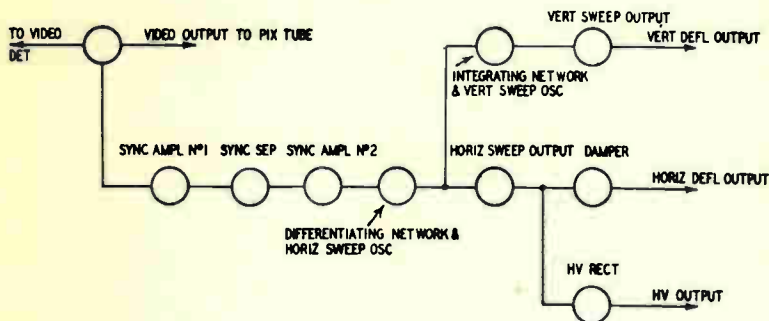

Fig. 614. Block diagram of the various sweep circuits used in a TV receiver. These circuits can be checked through with a v.t.v.m. by making voltage and resistance measurements. A.c. voltages are best measured with a peak-to-peak reading v.t.v.m.

and horizontal sync circuits are among the most critical sections of the receiver primarily because of their relative complexity and the values and tolerances of the resistors and capacitors employed. The integrating and differentiating networks, especially, can be a perplexing source of trouble when components become defective.

Fortunately, trouble in sync stages is usually easy to diagnose because of the effect of the sync action of the picture. Trouble in any stage between the video amplifier and the second sync amplifier, if used, will probably result in loss of both vertical and horizontal sync. Trouble in the integrating network will affect vertical sync; trouble in the differentiating network will have its greatest effect on horizontal sync.

Troubles of this type are best attacked with a v.t.v.m. by use of voltage measurements first and then resistance measurements. Changes in resistance values or a leaky, changed-value or open capacitor in any of the sync circuits can cause erratic sync action or complete loss of sync. Because of the complexity of these circuits, it is usually best to disconnect one end of the suspected part



picture brightness (a high-voltage function) and to raster dimensions (scanning function). Failure of V1 and V2 usually results in no raster because no high voltage is available. When this trouble is encountered, these tubes should be checked. Damper tube failure (V3) may affect brightness and raster size. Sweep may also be affected by V1 and V2. Keystoning of the raster indicates a defective yoke.

In cases where new tubes fail to clear up the difficulty, the B plus voltage should be checked first to make sure that power supply troubles are not responsible. D.c. voltage measurements can then be made at points A, B, C, D, E, F and G. The voltage is usually negative at the grid of the horizontal output tube, V1.

A.c. voltage measurements should not be attempted at points X, Y and Z because of the large impedances or high a.c. or d.c. voltages in these circuits. The high d.c. output voltage at point H can be measured with the v.t.v.m. if a high-voltage probe is used.

Design of these circuits will vary with different receiver models but the circuits are basically the same. Troubleshooting of FM sound detectors and the audio amplifier sections is described in Chapter 7.

# am-fm alignment and repair

**T**he glamour of television has put the radio receiver in second place in the minds of many service technicians. But, the radio repair business offers more profit opportunities than ever before because more radio receivers are being manufactured and sold today than at any time in the past. Each of these millions of radios represent a profit opportunity to the alert service technician because, sooner or later, each receiver will find its way to the repair shop. While average radio repair costs are considerably less than for the TV receiver, there are several advantages for the technician who is set up to handle radio repairs.

## **Am broadcast receivers**

Radio receiver troubles are usually simple to diagnose and the average repair can be made quickly. This is especially true with the popular table-model a.c.-d.c. radio which uses readily available tubes and standard components. Also, these receivers utilize well established circuits which are simple in design. From a time-money standpoint alone, the radio repair can be as profitable as the TV repair job.

Radio receiver troubles can be classified in this way:

1. Tube failures
2. Component failures
3. Intermittents
4. Misalignment



## Tube failures

Tube failures, the most common source of trouble, can be discovered by different methods, depending upon the type of receiver involved. A defective tube in the series-string type receiver is usually found by tube substitution or with a tube tester. These two methods are ordinarily employed when the chassis is left installed in the cabinet. Either of these methods will often reveal a tube which has an open heater or other defect. This approach has the disadvantage, however, of requiring that each tube be removed

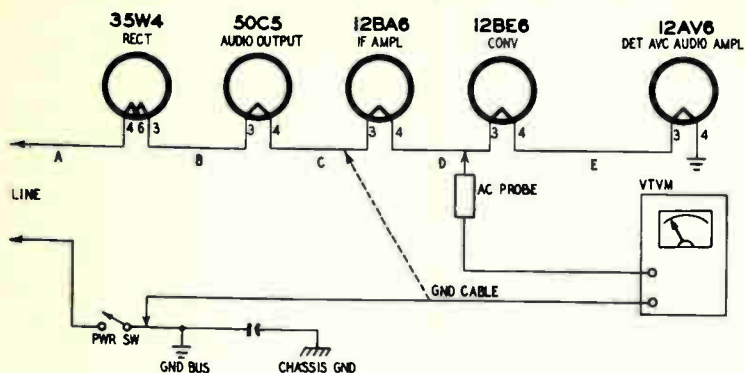

Fig. 701. The v.t.v.m. can be used to check the heater wiring of filament circuits.

and tested or else replaced by a good tube. These methods can be time-consuming.

The v.t.v.m. provides a quicker means of finding an "open" tube because the a.c.-d.c. receiver uses a series hookup for the tube heaters. Failure of one tube heater will remove power from all tubes in the string. The defective tube can be located quickly with the v.t.v.m. if the chassis is removed from the cabinet so that voltage measurements can be made. Fig. 701 shows the heater wiring arrangement of a typical a.c.-d.c. radio receiver employing five tubes. Suppose the heater in the fourth tube in the string, the 12BE6, should open. With the receiver chassis removed, the v.t.v.m. can be used to locate the "open" tube quickly. Set up the v.t.v.m. for a.c. voltage measurements. Connect the ground clip to the minus B common bus wiring of the receiver. This can usually be located at the power switch terminals. With the receiver power switch turned on, voltage readings can be taken from points A through E. Because of the exceedingly small current drawn by the v.t.v.m., the voltage drop through the tube heaters will be negligible and the v.t.v.m. should read the approximate value of the

line voltage at all points except E. At E, the reading will be zero because of the open heater. If voltage is also read at E, it may be concluded that the 12AV6 is defective.

Tube defects other than open heaters will usually cause a change in the normal operating voltages at the tube pins. The d.c. bias voltage developed at the cathode or grid pins is a good indication of how the stage is functioning. Plate and screen voltages, which are supplied by the B plus power supply section, will often increase or decrease considerably when circuit or tube troubles arise.

The v.t.v.m. may be used to check for a gassy tube which might otherwise pass with a conventional tube tester. The presence of

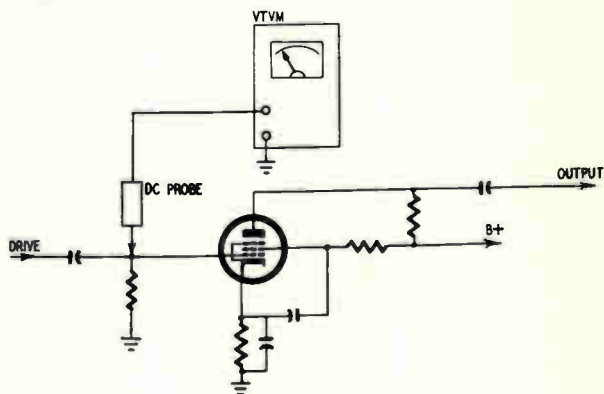

Fig. 702. This test is effective for locating gassy tubes and leaky coupling capacitors.

gas in an output tube or a.v.c.-controlled tube can impair the function of an entire receiver. In an R-C coupled circuit, a gassy tube will cause a positive bias to be developed at the grid. Adjust the v.t.v.m. for d.c. voltage measurements on a low range, as shown in Fig. 702 and measure the tube bias from control grid to ground. A leaky coupling capacitor can produce the same results. To determine whether the positive bias is caused by a gassy tube or by a leaky capacitor, connect the v.t.v.m. across the grid-return resistor of the suspected tube. Remove the tube from its socket. If the incorrect bias voltage remains the same, or nearly so, then the coupling capacitor is defective. Sometimes a gassy tube (having a glass envelope) can be checked visually. If the tube glows blue, or if there is a whitish deposit on the inside of the glass near the base end, then the tube is defective.

Testing by removal of a tube can be done quite easily when all filaments are in parallel. In series operated filaments, you can clip

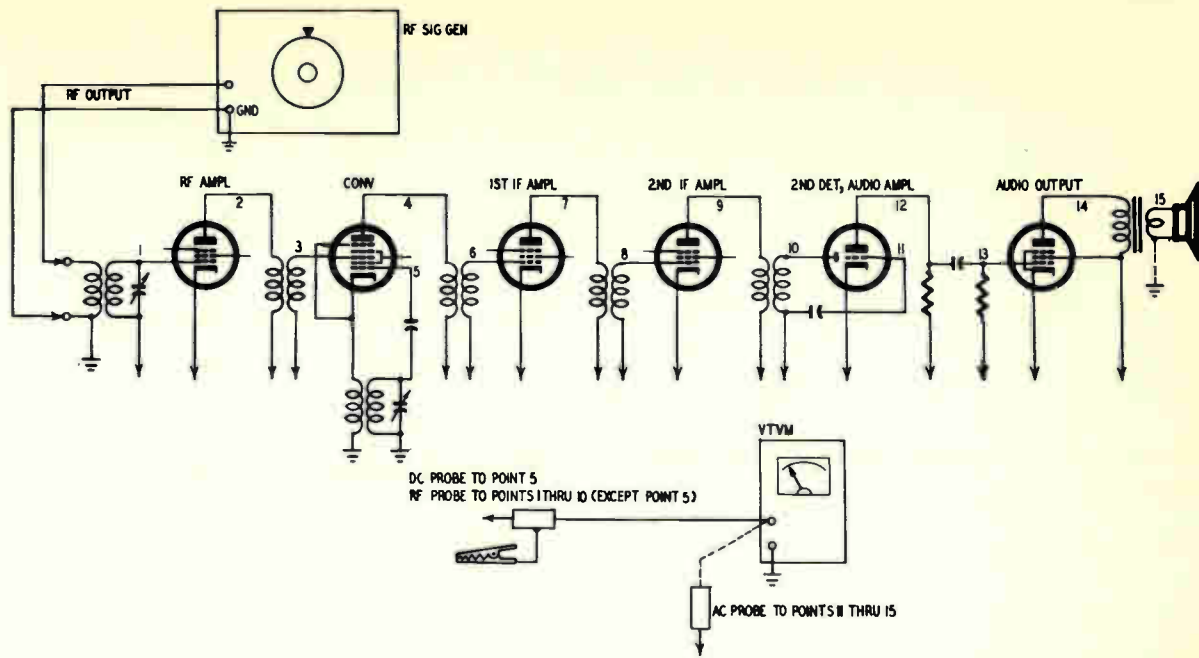

Fig. 703. Simplified circuit arrangement of an AM broadcast receiver showing the various check points. The high-impedance feature of the v.t.v.m. permits tests to be made without disturbing circuit operation. Note that three different probes are needed if a complete examination of the set is to be made. With this setup you can trace a signal completely through from the front end to the speaker, quickly locate the point at which the signal disappears. At the same time this method of testing helps you determine the effectiveness of operation of each particular stage.

a resistor of the proper value across the filament terminals of the socket.

Shorts between tube elements can be detected by resistance measurements with the v.t.v.m. Heater-to-cathode shorts and grid-to-cathode shorts are the most common types of internal shorts encountered. Remember, however, that these shorts may have a very high resistance, often in the order of several hundred megohms. Also, the shorts may not show up when the tube is cold. It is sometimes helpful to connect the v.t.v.m. leads to the tube pins and to tap the tube while watching the meter reading.

### **Component failures**

Failure of capacitors, resistors and other circuit elements are best discovered by first isolating the defective section or stage in the receiver. When the trouble has thus been narrowed down, the component tests discussed in Chapter 6 can be employed to ascertain the condition of individual components.

Because these component checks cannot be made until the faulty section or stage is first located, it is important that the techniques for isolating the defective stage be understood. There are several ways of doing this, the correct way depending upon the type of receiver trouble.

### **Signal tracing**

Signal tracing with the v.t.v.m. provides a quick means of locating a defective stage when the cause of trouble is not readily apparent. An r.f. signal generator is required to feed a signal into the antenna terminals of the receiver, as shown in Fig. 703. The generator should be able to deliver approximately 0.1-volt output and should have an adjustable output attenuator to permit adjustment of the output signal to the desired level. If the receiver uses a loop antenna, it is usually sufficient to bring the "hot" clip of the generator cable close to the loop, or to fasten it to the frame of the loop.

This is the procedure for tracing the signal through the receiver:

1. Disable the a.v.c. circuit by disconnecting the a.v.c. bus at the second detector stage or by applying an external bias. Since the control grids of one or more tubes get their ground return through the a.v.c. bus, disconnection of this line can leave such grids floating. If you do not use an external bias supply you should disconnect the bus and ground it. Simply grounding the bus without

checking the a.v.c. circuit first will often result in shorting the audio signal since in many circuits the volume control is made part of the a.v.c. line. The word ground means either chassis or B minus, depending upon the circuit arrangement of the receiver.

2. Connect the r.f. output cable from the generator to the antenna terminal of the receiver. Connect a ground lead between the receiver and the generator.

3. Turn the generator modulation switch on. Tune the generator and the receiver to the same frequency in the broadcast band. Set the receiver volume control for maximum volume.

4. Set up the v.t.v.m. for r.f. voltage measurements on its lowest range. In all measurements for the r.f. probe, always connect its ground clip as near as possible to the test point. Connect the r.f. probe to point 1 and adjust the receiver tuning for maximum reading on the v.t.v.m. Use the high output from the generator and adjust the generator output attenuator as required to obtain a suitable meter deflection.

5. Move the r.f. probe to point 2. The signal voltage should be greater at this point if the r.f. amplifier is functioning correctly.

6. Place the r.f. probe at point 3. Put the ground clip of the probe to a ground point near the converter-tube socket. No signal at this point indicates trouble in the transformer or in the converter input circuit.

7. Transfer the probe to point 4. Retune the receiver slightly to obtain maximum reading on the meter. The ratio between the voltages at this point and at point 3 is the approximate *conversion gain* of the stage. The signal at point 4 will be the receiver intermediate frequency. No signal at this point indicates trouble in the oscillator section of the converter.

8. Check the oscillator section by measuring the oscillator d.c. bias voltage at point 5. Use a d.c. probe at this point.

9. Move the r.f. probe to point 6 and move the ground clip to a new point near the socket of the first i.f. amplifier stage. If the first i.f. transformer and the grid circuit of the stage are functioning properly, a meter indication approximately equal to that obtained at point 4 will be read.

10. Transfer the r.f. probe to the plate of the i.f. amplifier (point 7). The meter reading should increase, indicating amplification in the stage.

11. Check performance at the grid (point 8) and plate (point 9) of the second i.f. amplifier. A considerable increase in gain should be noted between these two points. Check r.f. signal at the

diode plate of the second detector to make sure the secondary of the last i.f. transformer is not open or shorted.

12. Remove the r.f. probe and set up the v.t.v.m. for a.c. voltage measurements. Connect the ground cable to the receiver chassis. Connect the probe to the grid of the first audio amplifier (point 11). Read the output directly from the a.c. voltage scales on the v.t.v.m.

13. Check the audio signal at point 12 and on the output side of the coupling capacitor (point 13). Move the probe to point 14. A considerable increase in signal should be noted.

14. Measure the audio output signal from the receiver by connecting the probe to the speaker voice-coil lead at point 15. Connection of the probe to the speaker voice coil will *not* give a voltage reading unless one side of the voice coil is grounded. First, run a continuity test between voice coil and chassis, using your v.t.v.m. for this. If the voice coil is "floating," that is, if one side is not grounded, you can make a voice-coil voltage measurement in either of two ways. You can put the probe on one of the voice-coil terminals and the v.t.v.m. ground clip on the other, or else you can ground one side of the voice coil (either side).

Signal tracing with the v.t.v.m. can be a valuable trouble shooting method with proper experience. It has the advantage of providing the technician with an overall picture of receiver performance. Other methods of locating a defective stage, however, can be used to find trouble quickly. After you are satisfied that tubes are not responsible, start checking performance of the receiver from the audio section back toward the r.f. stage. A quick check of the audio section consists simply of touching the grid pin of the first audio amplifier with a screwdriver. If the volume control is turned up all the way and if the audio section is functioning properly, a loud hum should be heard. It may be helpful to touch the metal shaft of the screwdriver with a finger. The hum is introduced by stray pickup into the grid circuit through the screwdriver. A rough check of performance in the rest of the receiver may be had by scraping the grid pins of the converter and r.f. stages with a screwdriver. In a properly operating receiver, this action should produce noise from the loudspeaker.

Keep in mind that there is some hazard involved in checking a direct line connected receiver without an isolation transformer. In Fig. 703, for example, if the signal generator happened to be grounded and the receiver power plug happened to be inserted so that the high side of the line was connected to B minus, the test leads might melt due to the direct short across the line that would

exist. A properly fused power line would prevent such an accident. Although success of these rough checks depends somewhat on

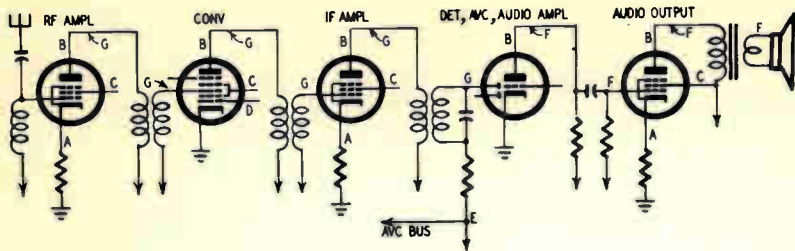

Fig. 704. Simplified circuit of AM receiver showing voltage test points.

experience, they can be very helpful in eliminating two or three stages as probable sources of trouble.

### Voltage measurements

Troubleshooting by measurement of circuit operating voltages is probably the most used method of locating a defective stage or section. The schematic diagram in Fig. 704 shows the signal-handling section of a six-tube receiver together with the test points at which operating voltages can be measured. Table 6 describes the

TABLE 6

Key Letter in Fig. 704	To Measure	V.T.V.M. Setting (Volts)	Probe Type
A	Cathode-bias voltage	+ D.C.	D.c. isolating probe
B	D.c. plate voltage	+ D.C.	"
C	D.c. screen voltage	+ D.C.	"
D	Oscillator grid-bias volt.	- D.C.	"
E	A.v.c. voltage	- D.C.	"
F	Audio signal voltage	A.C.	Direct probe
G	R.f. signal voltage	± D.C.*	R.f. or high-freq. probe

\*Polarity of v.t.v.m. setting depends on the polarity of the output voltage from the high frequency probe.

voltages to be measured at those points and the v.t.v.m. setup and type of probe to be used.

Some receivers do not utilize an r.f. amplifier stage and the signal is fed directly to a converter stage which serves as a combined detector and oscillator. Two i.f. transformers are ordinarily used in these receivers, one for the input and one for the output of the single i.f. stage. The fourth stage (Fig. 704) combines the functions

of the second detector (diode) and first audio amplifier (triode). The a.v.c. voltage is tapped off in this stage and is fed back to the r.f. amplifier, converter, i.f. amplifier or any combination of these stages, depending on the type of receiver.

The d.c. voltages used in most radio receivers are much lower than those used in TV receivers. With the exception of the power supply and the audio output stage, the voltages are usually less than 100. The correct operating voltages are given in the service

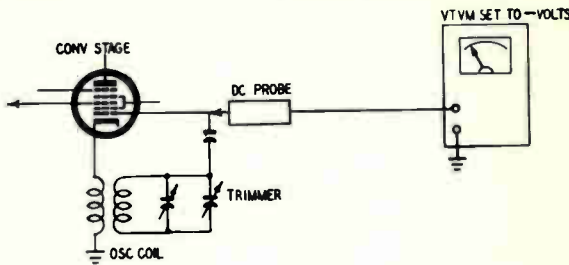

Fig. 705. Test setup for checking the local oscillator.

notes for the receiver. A deviation of  $\pm 20\%$  from the specified voltages is generally permissible. A defective stage will probably show excessively high or low d.c. voltages, an indication that the technician should check component values and circuit continuity

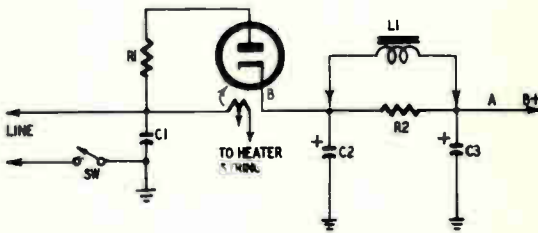

Fig. 706. Test points in simple half-wave power supply.

with the v.t.v.m. Methods of checking different components were described in Chapter 6.

Keep in mind that in the superheterodyne type of receiver, the local oscillator frequency beats with the frequency of the incoming signal in the converter stage to produce an intermediate (difference) frequency which is fed to the i.f. amplifier. If the oscillator section of the receiver is defective, no intermediate frequency will be produced and, consequently, no output is possible.

The v.t.v.m. can be used to check the oscillator section for proper oscillation by setting up the instrument for negative d.c.



voltage measurement on its lowest range and measuring the bias developed at the oscillator grid terminal of the converter tube (Fig. 705). This is usually in the order of 1 to 10 volts. The voltage developed depends upon the intensity of the oscillation, and upon the setting of the oscillator section of the tuning capacitor. The reading obtained may be confirmed as being the result of oscillation by touching the grid terminal with a finger. This action loads the oscillator sufficiently to detune it, reduce the voltage reading noticeably, or stop oscillations entirely.

### Checking power supplies

If d.c. operating voltages are low throughout the receiver, check the B plus output of the power supply. Most a.c.-d.c. receivers utilize a simple half-wave rectifier circuit similar to that shown in Fig. 706. One side of the line is connected to the chassis, either directly or through an R-C circuit. In this circuit a single diode, such as a 35Z5-GT is used. R1 is used to limit the peak current during each portion of the cycle that the rectifier draws current. Its primary purpose is to increase the rectifier life by keeping the peak rectifier current within the limits specified by the tube manufacturer. C1 serves to bypass any incoming hash or noise and helps to keep undesired interference out of the receiver. The rectified d.c. voltage is taken from the cathode and filtered by C2, C3 and R2. Receivers which use a field-coil speaker will employ the field coil (L1) as a filter choke in place of R2.

With a line voltage of 117, the output at the cathode terminal (point B) will generally be about 130 to 150 volts. Approximately 5 to 15 volts will be dropped through the filter section. Receiver B plus should be measured with the v.t.v.m. at point A. If line voltage is correct and B plus is low, change the rectifier tube. If installation of a new tube does not correct the difficulty, check electrolytic capacitors C2 and C3 for excessive leakage and replace if necessary. A severe leak or short in either C2 or C3 may cause the rectifier filament to open. If C3 is shorted, R2 may burn out.

### Hum

Excessive a.c. hum is a common complaint in a.c.-d.c. receivers. When hum is encountered, first determine whether it is coming from the power supply or from the signal-handling section of the receiver. If the hum originates in any section of the receiver ahead of the volume control, it should change in level as the control is

rotated. If the hum is not tunable, use the v.t.v.m. to check the ripple voltage at the output of the power supply. The instrument should be set up for a.c. voltage measurements and the direct probe connected to point A. As little as 2 or 3 volts of a.c. measured here may cause considerable hum. If excessive ripple voltage is found, the filter capacitors may be leaking or heater-to-cathode leakage may exist in the rectifier tube. Capacitor leakage may be detected by measuring the resistance of the capacitors when they are disconnected from the circuit. Discharge the filter capacitor before making resistance measurements. Heater-to-cathode leakage in the rectifier tube as high as several hundred megohms can cause considerable hum. If these checks do not indicate trouble in

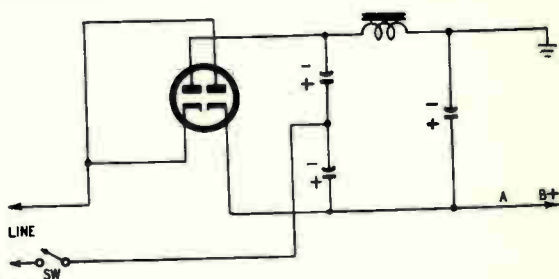

Fig. 707. Full-wave voltage doubler circuit.

the power supply, the audio amplifier tubes should then be checked for heater-to-cathode leakage.

The full-wave voltage doubler circuit shown in Fig. 707 is found most often in older models of transformerless receivers designed only for a.c. operation. Two separate diodes may be used or, as is most often the case, a twin-diode (such as the 25Z6) which has separate cathodes, is used. This circuit has the advantage of supplying a much higher B plus voltage — almost twice the value of the line voltage — without requiring a transformer. In this circuit, the speaker field coil is connected in the negative lead of the supply to reduce the voltage on the coil. B plus output voltage and ripple can be measured with the v.t.v.m. at point A.

A.c.-operated transformer type receivers employ a circuit such as that shown in Fig. 708. Receivers which use this type of supply usually employ a B plus voltage of from 225 to 325. The filter choke, L1, is sometimes replaced by a speaker field coil or, in sets with moderate current drain, by a high-wattage resistor. Troubleshooting of transformer type power supplies is simple. D.c. voltages are measured with the v.t.v.m. at points A and B. The v.t.v.m. can also be used to measure the a.c. voltage output from the trans-

former. Measurement is made from each side of the high-voltage winding (points C to chassis).

### Intermittents

Occasionally a tube heater will open up intermittently, usually when the line voltage fluctuates. These intermittents may be very difficult to detect by tube substitution. The v.t.v.m. can simplify the repair, however, by using the instrument to monitor the voltage drop across the heater of the suspected tube. For example, in Fig. 701, if the 12BA6 is suspected, connect the v.t.v.m. directly across the heater pins. Under normal operating conditions, approximately 12.6 volts will be read. If the heater opens, however,

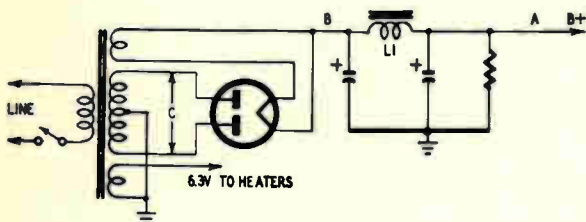

Fig. 708. Test points in a transformer-type full-wave power supply.

the v.t.v.m. will read almost the full value of the line voltage. If the intermittent reduces the reading to zero, the v.t.v.m. should be connected across other tubes until the faulty tube is discovered. An adjustable-voltage transformer, which permits application of a line voltage as high as 130, is often helpful in breaking down the intermittent.

Other intermittent troubles may be localized by using the v.t.v.m. to monitor signal and operating voltages in different sections of the receiver. For example, if sound is intermittent, the B plus voltage from the power supply can be monitored by using the d.c. measurement feature of the v.t.v.m. If the signal stops and the B plus changes, the trouble may be due to an open plate, screen, or cathode circuit. The lower current drain will then cause the voltage at point 4 to increase. The signal also may stop due to a shorted screen or shorted cathode resistor. If B plus does not change when the intermittent shows up, the fault is in the signal-handling section of the receiver. The v.t.v.m. should then be set up for a.c. voltage measurements and connected to the grid pin of the first audio amplifier stage (point 2). If the trouble is between the r.f. stage and the first audio amplifier, the a.c. signal

voltage measured on the v.t.v.m. will change when the intermittent trouble develops. If the reading is unchanged, look for trouble between the v.t.v.m. test point and the loudspeaker. The trouble source can be further narrowed down by moving the a.c. probe to point 3, the grid of the audio output stage. See Fig. 709.

The r.f. probe can be used to monitor the signal at point 1 or elsewhere in the r.f. section of the receiver. Because of the very low signal level in this section of the receiver, however, it may be necessary to employ an r.f. signal generator to obtain a signal of suitable strength.

### R.f. and i.f. alignment

Receivers frequently drift out of alignment because of com-

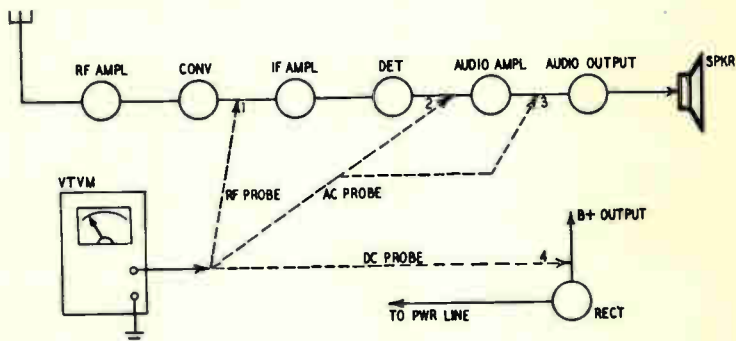

Fig. 709. An intermittent receiver can be monitored by connecting the v.t.v.m. to the check points shown in this block diagram.

ponent aging, or they may require realignment when certain components are replaced. Also, it is not unusual for the home "mechanic" to satisfy his curiosity by turning trimmer screws to see what happens. It usually "happens" that the receiver ends up in the repair shop.

The symptoms of receiver misalignment are:

1. Whistling between or on stations (similar to effect produced by oscillation)
2. Constant hiss, except on very strong stations
3. Weak signals throughout entire tuning range, or weak signals or no signals throughout part of the tuning range
4. No signals
5. Dial out of calibration
6. Receiver tunes only part of signal in at one end of band — cannot tune in other stations on extreme ends of the band

These are common complaints and can usually be corrected in

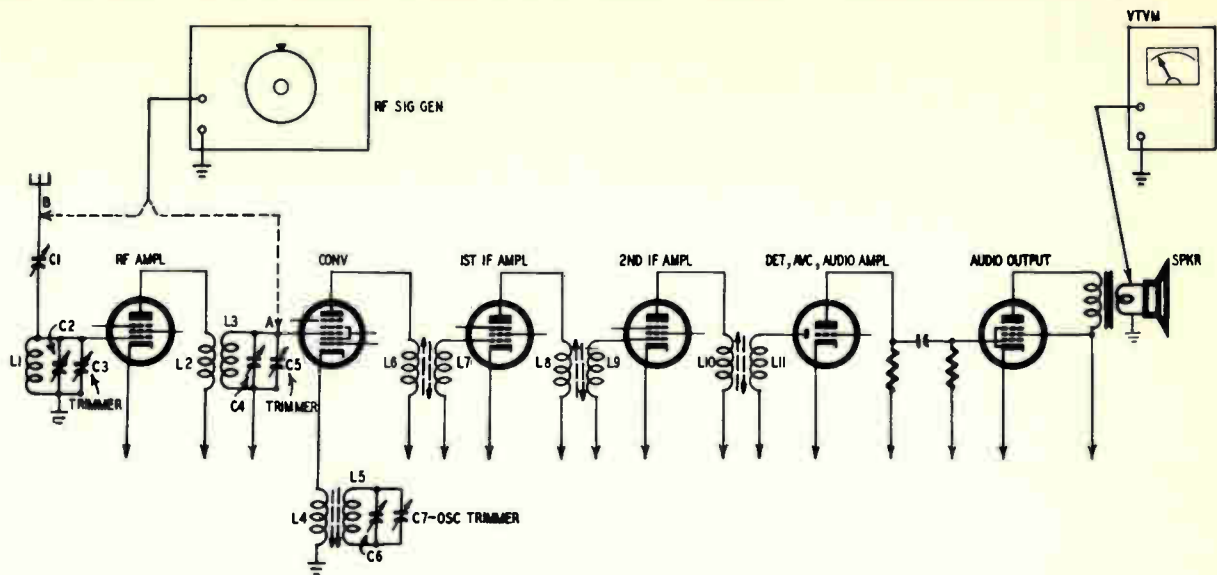

Fig. 710. Setup for the alignment of an AM broadcast receiver. The output signal of the r.f. generator is connected to the input of the r.f. amplifier. If the receiver does not have such a stage, then the generator voltage is fed into the signal grid of the converter. The v.t.v.m. is set to read low a.c. volts and is connected across the voice coil, as shown. If one side of the voice coil is not grounded, then it should be connected to the ground clip of the v.t.v.m. Note that we do not show the use of an a.c. probe (rectifying probe). Whether such a probe is needed or not at this point depends entirely upon the design of the v.t.v.m.'s use rectifying probes for all a.c. measurements, while others use rectifying probes simply to extend the frequency range of the instrument.

a few minutes by "touching up" the i.f. transformers and trimmers in the oscillator and r.f. stages.

The alignment adjustments provided in a typical AM receiver are shown in the simplified schematic of Fig. 710. This receiver employs an r.f. amplifier, converter stage (combined oscillator and mixer functions) and two i.f. amplifier stages. Complete r.f. and i.f. alignment requires adjustment of trimmers in all four of these stages. In addition, an antenna trimmer capacitor (C1) is located in the r.f. amplifier input section.

While receivers vary considerably in the design and the number of alignment adjustments provided, the procedure and recommendations of the alignment technique which follows can be used generally on any AM radio receiver. The v.t.v.m. and an r.f. signal generator are the only test instruments required.

### **The test setup**

The r.f. signal generator should have a shielded output cable, an adjustable-output attenuator to permit setting the signal at the desired level, and internal modulation. Most generators are modulated at 400 c.p.s., but any frequency within the audio range is sufficient. If a transformerless receiver is to be aligned, an isolation transformer should be used.

Before starting alignment, it is generally advisable to disable the a.v.c. circuit to prevent the a.v.c. voltage from affecting the gain of the front end and i.f. amplifiers of the receiver although, on some receivers, it is possible to perform alignment without disconnecting the a.v.c. if the input signal is kept extremely low.

The i.f. amplifier section is aligned first. This is the complete alignment procedure:

1. Disable the a.v.c. circuit and tune the receiver to a quiet spot at the high end of the dial. Put the oscillator out of operation by shorting the oscillator tuning-capacitor plates together with a screwdriver or piece of wire.
2. Set up the v.t.v.m. for a.c. voltage measurements on a low range and connect the v.t.v.m. across the speaker voice coil.
3. Connect the ground cable of the signal generator to the chassis or ground bus of the receiver. Connect the r.f. output cable to the signal grid pin of the converter tube (point A). (It is sometimes sufficient to clip the cable to the insulation of the grid lead.)
4. Turn the receiver volume control to its maximum-volume position and the attenuator control on the generator to a low setting.

5. Set the generator dial to the intermediate frequency of the receiver (usually 455 kc). If the receiver is not completely misaligned, a small voltage will be read on the v.t.v.m.

6. Starting with the secondary of the last i.f. transformer and using an insulated screwdriver or alignment tool, adjust the slug in L11 (Fig. 710) for maximum voltage reading on the v.t.v.m. If the i.f. amplifier stage is operating correctly, it should be possible to tune the i.f. slug through a peak on the v.t.v.m. (The i.f. alignment adjustments shown in Fig. 710 are adjustable slugs which vary the inductance of the i.f. coils. Some receivers employ small mica trimmer capacitors instead of slugs but the alignment procedure is the same.)

7. Working toward the converter stage, similarly adjust the slugs for L10, L9, L8, L7 and L6 for maximum voltage output across the voice coil. *Keep the injected signal from the generator as low as possible* while still obtaining a voltage reading on the v.t.v.m. This precaution will prevent overloading of the i.f. amplifiers. The i.f. amplifiers are now aligned.

8. Remove the short from the oscillator tuning capacitor (C6) and move the r.f. output cable to the antenna terminal (point B). (It is sometimes advisable to couple the signal loosely by laying the cable near the antenna circuit.) On receivers employing built-in antennas, the chassis, if possible, should be installed in the cabinet before r.f. adjustments are made. Tune the signal generator and the receiver to 1,400 kc.

9. Adjust oscillator trimmer C7 for maximum reading on the v.t.v.m.

10. Retune the generator and the receiver to 1,400 kc and adjust r.f. amplifier trimmer C3 and antenna trimmer C1 for maximum voltage output.

11. Retune the generator and the receiver to 600 kc. Adjust the oscillator tuning slug in L5 for maximum output on the v.t.v.m. Rock the tuning capacitor back and forth while making this adjustment.

12. Repeat steps 8, 9, 10 and 11, if necessary, to get precise alignment. If this procedure is followed, the receiver should track well throughout the broadcast band.

Receiver manufacturers make different provisions for alignment adjustments. Besides conventional trimmer capacitor and coil slugs, "cut" and "slotted" rotor plates are used and the wire turns of built-in antennas may be bent to accomplish the desired tuning condition. The "cut" rotor, used in the oscillator section, consists of plates having a smaller size than those used in the r.f. and an-

tenna sections. The "slotted" rotor contains one or two plates with slots cut into the metal to permit bending the plates to obtain the desired tracking action at the low-frequency end of the dial.

## FM receivers

Troubleshooting FM receivers with the v.t.v.m. utilizes the techniques used in troubleshooting AM broadcast receivers. Except for the operating frequencies and the types of second detectors involved, the FM set is similar to the AM broadcast receiver. Block diagrams of two superheterodyne FM and one AM receiver are shown in Fig. 711. It is evident that these three superhets are

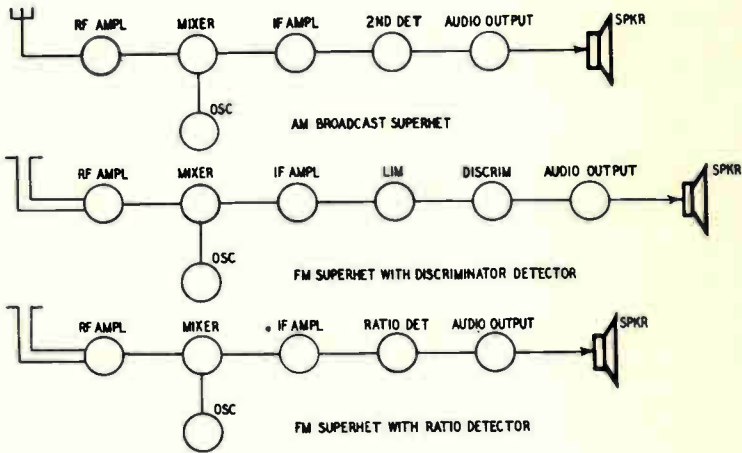

Fig. 711. Block diagrams of three superheterodyne receivers.

similar. The FM receivers differ primarily in the method of signal detection and in the use of an extra stage (limiter) in the discriminator type receiver.

In addition to troubleshooting problems already discussed, the technician will be required to align the FM receiver. Alignment of these receivers is especially important because misalignment can affect sensitivity and tonal quality. The v.t.v.m. and the r.f. signal generator are needed to do a first-class FM alignment job. Alignment of the i.f. amplifier and the detectors is simple and the technique differs only slightly between the receivers shown in Fig. 711. Both FM types commonly employ an intermediate frequency of 10.7 mc. The FM detectors used in intercarrier TV receivers employ a sound intermediate frequency of 4.5 mc and are aligned in the same manner as conventional FM receivers.



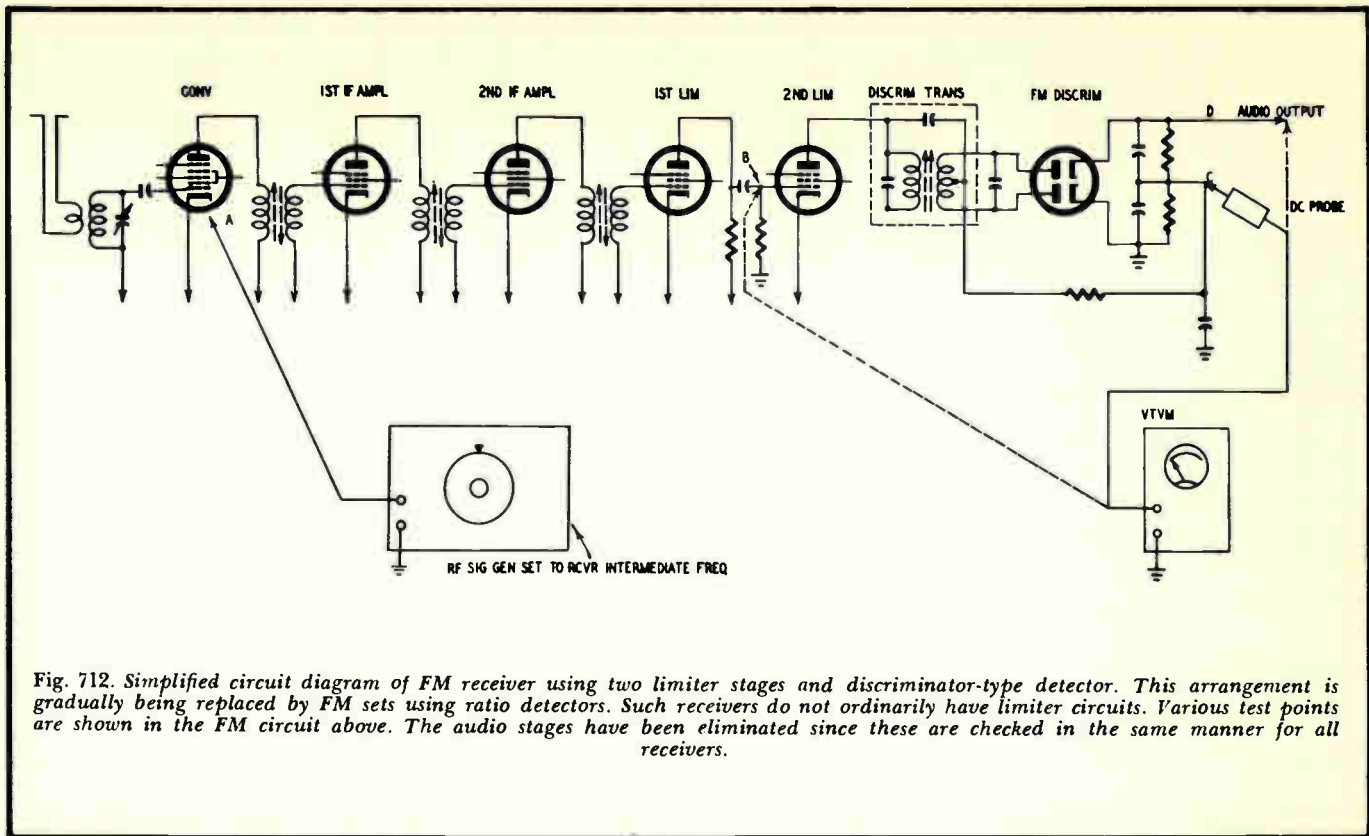

Fig. 712. Simplified circuit diagram of FM receiver using two limiter stages and discriminator-type detector. This arrangement is gradually being replaced by FM sets using ratio detectors. Such receivers do not ordinarily have limiter circuits. Various test points are shown in the FM circuit above. The audio stages have been eliminated since these are checked in the same manner for all receivers.

## Discriminator detectors

The test setup for alignment of FM receivers having a discriminator detector is shown in the simplified schematic in Fig. 712. Many receivers will employ an r.f. amplifier stage ahead of the converter; others only a single limiter stage before the detector.

1. Tune the r.f. signal generator to the receiver intermediate frequency (10.7 mc) and connect the output cable to the shield of the converter tube (point A). Lift the shield from the chassis to prevent shorting the signal to ground. Set the generator output control to a low level.

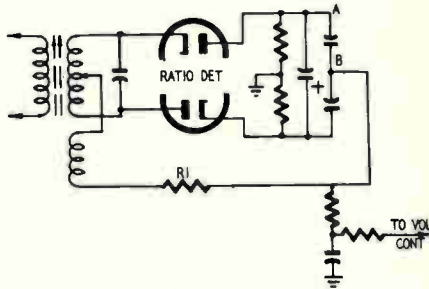

Fig. 713. Ratio-detector circuit.

2. Set the v.t.v.m. for negative d.c. voltage measurements on a low range and connect the d.c. probe to the grid leak of the limiter stage (point B).

3. With an insulated alignment tool, adjust the secondary of the third i.f. transformer for maximum voltage at point B. (The transformer may either be slug or capacitor-tuned, depending upon the type of receiver.)

4. Adjust the primary tuning of the third i.f. transformer for maximum voltage indication.

5. Similarly adjust the tuning of the second and first i.f. transformers, working from secondary to primary windings and toward the converter stage. Keep signal level from the generator low to avoid overloading. The i.f. amplifier should now be properly aligned.

6. Move the d.c. probe to point C. Detune the secondary of the discriminator transformer slightly and tune the *primary* winding for maximum negative voltage reading on the v.t.v.m. Disconnect the d.c. probe from point C.

7. Rotate the zero-adjust control on the v.t.v.m. to position the meter pointer at the center-scale zero. On some vacuum-tube voltmeters, it may be necessary to set the function switch to +VOLTS

to center the pointer. Connect the d.c. probe to point D in the discriminator.

8. Carefully tune the *secondary* of the discriminator transformer for an exact zero-center reading on the v.t.v.m. (The exact setting of this trimmer may be critical. Turn the alignment tool slowly.) Because the secondary winding is above ground or "floating," the circuit may be very sensitive to hand capacitance. Use a long-handled, nonmetallic alignment tool.

### Ratio detectors

Receivers which employ ratio detectors do not usually employ a limiter stage preceding the detector, although in some receivers the last i.f. stage provides limiting to a small extent. The i.f. amplifier and ratio detector stages are aligned by observing voltage changes only in the detector stage.

A *balanced* ratio detector circuit is shown in Fig. 713. Alignment of this type receiver is as follows:

1. Feed the i.f. signal from the generator into the mixer (or converter) as described in step 1 in the preceding section.
2. Set up the v.t.v.m. for negative d.c. voltage measurements and connect the d.c. probe to point A.
3. Align the i.f. transformers as described earlier.
4. Tune the *primary* of the ratio detector transformer for maximum voltage reading on the v.t.v.m. at point A. Disconnect the d.c. probe.
5. Rotate the zero-adjust control on the v.t.v.m. to position the meter pointer at the center-scale zero. (On some vacuum-tube voltmeters, it may be necessary to set the function switch to +VOLTS to center the pointer.) Connect the d.c. probe to point B.
6. Adjust the *secondary* of the ratio detector transformer for a zero-center reading.

The *unbalanced* type of ratio detector is aligned with the same procedure except for step 5. The v.t.v.m. is left at -VOLTS and the secondary of the discriminator transformer is adjusted for a minimum d.c. voltage reading. This procedure is recommended because unbalanced detectors usually cannot be adjusted for an exact zero-center reading. For the unbalanced type, two resistors of about 56,000 ohms, (use 1% resistors) are connected across the single ratio detector load resistor in series, during adjustment. A center tap is thus available for alignment.

# servicing audio amplifiers

**T**he audio servicing field is still an unexploited source of revenue for many technicians, although it offers lucrative profit possibilities. The installation and repair of public-address systems, intercoms and high-fidelity equipment provides a good living for many alert service technicians who specialize in audio. There is no reason, however, why the radio and TV service technician should hesitate to encourage business from this direction.

With few exceptions, audio amplifiers are relatively simple and straightforward. Circuits are fairly well standardized and the equipment can be serviced quite thoroughly with the v.t.v.m. In some applications, such as signal tracing and checking frequency response, an audio signal generator and a scope are also necessary. For the majority of audio service work, however, a little understanding and a v.t.v.m. are sufficient equipment for the job.

In general, the public-address amplifier differs in design from the high-fidelity amplifier in having less complicated tone control and feedback circuits and simplified compensating networks in the input stages. Public-address amplifiers frequently provide for the mixing of two or more input signals, however, requiring more than one volume (mixing) control.

## Troubleshooting and signal tracing

Aside from differences in tone-control and mixing networks different audio amplifiers can usually be serviced with the same techniques. Except for special speaker systems and the phonograph



mechanisms involved, these amplifiers use tubes and parts which are the same as, or similar to, those used in radio and TV receivers. Consequently, techniques for troubleshooting individual components are the same as described in Chapter 6.

The schematic diagram of a typical high-fidelity amplifier is shown in Fig. 801. Trouble in amplifiers of this type is approached in the conventional manner. Measurement of the d.c. operating voltages with the v.t.v.m. is important in localizing trouble. If an audio signal generator is available, the v.t.v.m. can be used to trace the input signal through the individual stages. Here is a good procedure to follow:

1. Set up the audio signal generator to deliver a signal within the response range of the amplifier, such as 400 c.p.s.
2. Connect the generator cable to the input jack of the amplifier chassis.
3. Set the input switch to the position corresponding to the channel being tested. Turn the volume control up to a suitable level.
4. Set up the v.t.v.m. for a.c. voltage measurements on a low range and connect the ground clip to the amplifier chassis. Connect the a.c. probe to the grid of the preamplifier, V1. A voltage reading at this point indicates that the signal is getting through the input circuit.
5. Move the probe to the plate pin of the preamplifier. The voltage reading should increase, indicating that the stage is functioning.
6. Check interstage coupling by moving the a.c. probe to the grid of the next stage. Check output of this stage at the plate pin. (The approximate voltage gain of this stage, as well as other amplifier stages, may be computed by dividing the value of the a.c. signal at the plate by the value of a.c. grid signal. For example, if a 1-volt signal is measured at the grid and 10 volts a.c. at the plate, the voltage gain of the stage is 10.)
7. Move the a.c. probe to the grid of V2. Rotate the treble and bass controls and note the effect upon the voltage reading. Similarly check the output signal at the plate.
8. Check the driving signal on the grids of the phase inverter V3. The output signals at the plate, pin 6, and cathode, pin 8, should be approximately equal if the tube and circuit components are operating correctly.
9. Check the a.c. signal at the grids and plates of output tubes V4 and V5. Measure the output signal across the speaker voice coil.

If the v.t.v.m. readings at any point indicate that gain is reduced or that the signal is lost, look for trouble between that point and the last test point at which a signal was measured. D.c. operating voltages should be checked first followed by resistance readings of suspected components.

## **Making amplifier adjustments**

Many amplifier systems can reproduce sound with utmost fidelity. The performance of these units is commonly gauged by such factors as hum level, frequency response, phase characteristics and measurement of amplitude, harmonic, and intermodulation distortion (IM).

A necessary first step to the evaluation of any amplifier is adjustment of circuit components and operating conditions. If best performance is to be obtained from a well-designed circuit, both static and dynamic voltages and currents must be measured and adjusted to their proper values. The v.t.v.m. is an essential instrument for making these measurements and adjustments. It is especially valuable to the designer and constructor because it aids him in setting the plate, screen, bias and driving voltages to the values recommended by the tube manufacturer. It is important in audio design that these voltages do not exceed these values because amplifier efficiency and overall distortion are affected directly by the static and dynamic operating voltages.

The importance and usefulness of the v.t.v.m. in the adjustment of a typical amplifier is illustrated in Fig. 802. This is a Williamson type amplifier circuit used in many high-quality audio systems. The features and advantages of this circuit depend heavily on the proper setting of the internal adjustments. The amplifier shown does not include any of the preamplifier, tone-control or input-switching circuits. Separate adjustments are provided for setting the operating bias of the output stage (R14), for adjusting signal balance in the output tubes (R13), and for adjusting the a.c. signal drive in each section of the output stage (R12). In output stages which operate at this power level, the tubes must handle an equal amount of power not only to insure operation within ratings but to make certain that we do not exceed an acceptable distortion level. Additional features of the circuit shown include direct coupling between the first and second amplifier stages, negative feedback, and triode operation throughout.

When an amplifier of this type is first put into operation, the adjustments in the power output stage should be made first.

Never operate an amplifier having a moderate to high power rating without first connecting the loudspeaker or an equivalent load across the output transformer. A high wattage resistor with a resistance equal to the normal voice coil impedance may be used. The resistor should have a wattage rating equal to twice the maximum power output of the amplifier.

The cathode circuit of the output stage should be adjusted first to prevent possible damage to the tubes. The operating level of the

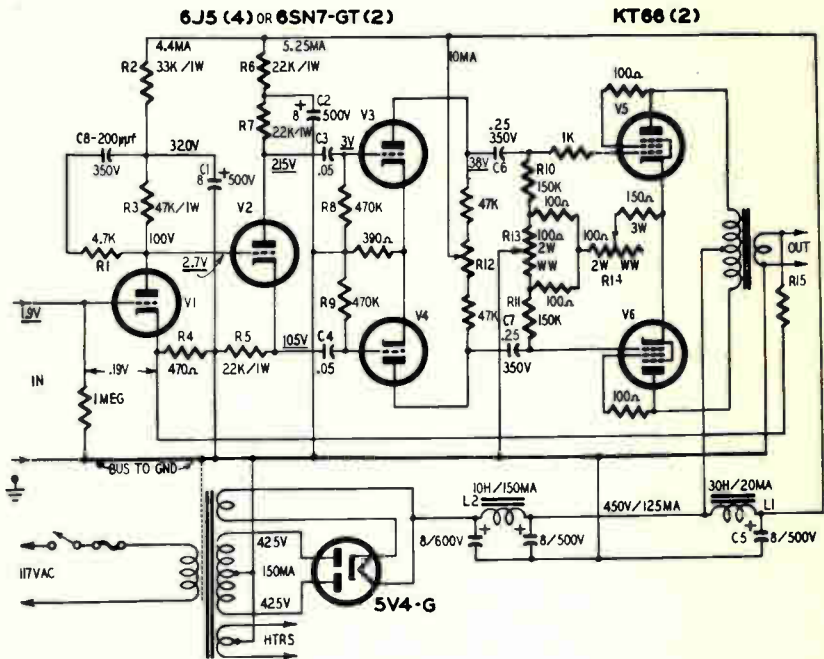

Fig. 802. Williamson-type amplifier circuit. Proper performance of this amplifier depends upon careful adjustment of signal and d.c. operating voltages.

stage is set by adjustment of the cathode bias, which is determined by the total current for both tubes. The current measurement section of the v.t.v.m. can be used to check total tube current. Potentiometer R14 is used to limit the total current. Remember, most vacuum-tube voltmeters which can measure direct current are not protected against meter burnout on current ranges. To avoid damage, double-check polarity of current-lead connections and always set the v.t.v.m. range switch one or two ranges higher than the expected current. With power applied to the amplifier, switch the v.t.v.m. range control down to the range desired.



The v.t.v.m. leads should be connected so that the "negative" current lead is in series with the ground side of the circuit. The "positive" current lead connects to the section of the circuit nearest the cathode. Because this adjustment is for static tube current, no input signal is required and it is usually advisable to short the input terminals. Allow about ten minutes' warmup time and then adjust R14 for approximately 125-ma current reading on the v.t.v.m.

The individual tube currents must be set next by means of potentiometer R13 to insure approximate d.c. balance between the two tubes. Each tube should handle half the current load, or 62.5 ma. Readings in both cathode circuits should be obtained. Do this by inserting the v.t.v.m. in series between the cathode of V5 and the cathode resistor. Repeat this operation with V6.

With the tubes adjusted for equal currents, the rest of the amplifier can be checked for proper operation. The v.t.v.m. is used to check individual stages for proper current drain, static operating and dynamic (signal) voltages. In Fig. 802, d.c. voltages are indicated and the correct signal voltages obtained at the 15-watt power level are underlined.

The current and d.c. voltage readings should be made with no signal applied. For current readings, circuit leads will have to be unsoldered to permit connection of the v.t.v.m. D.c. voltage readings are made with the d.c. probe.

The a.c. measurement section of the v.t.v.m. is used to check signal voltages. A 400-c.p.s. signal from an audio oscillator should be fed into the input stage and the direct probe used at the underlined signal points. Perfect dynamic balance between the two halves of push-pull stages is not usually obtainable with fixed components because of the slight differences between tubes and components. Consequently, the driving signals at the grids of the output tubes may be different. In the circuit of Fig. 802, good dynamic balance may be obtained by adjustment of potentiometer R12. The v.t.v.m. is set up for a.c. measurements on a low a.c. range. The ground cable should be connected to the amplifier chassis and the a.c. probe to the center tap of the output transformer primary winding. Potentiometer R12 should be adjusted for minimum a.c. voltage reading on the v.t.v.m.

### **Eliminating hum**

Hum is a "bug" which shows up in many amplifiers and frequently requires considerable experimenting to eliminate. It is

usually the result of insufficient or faulty power supply filtering or is caused by faulty tubes or components or by improper lead dress and parts placement. Power supply ripple (which can produce hum in the output) can be measured directly with the v.t.v.m. If excessive ripple is not present, the trouble usually lies in another section of the amplifier.

When troubleshooting hum, set the v.t.v.m. for a.c. voltage measurements on a low range and connect it across the speaker voice coil. Operate the amplifier at maximum volume setting with no signal applied. Turn the bass control to maximum and the treble control to minimum. Because the v.t.v.m. is much more sensitive to changes in hum level than is the human ear, the meter reading should be noted whenever a corrective measure is made in the amplifier.

Some typical causes of internal hum and their suggested remedies are listed next. Usually two or more factors are responsible. Whenever a circuit change reduces the hum reading on the v.t.v.m., the change should be incorporated in the amplifier and further experimenting attempted until an acceptable hum level is obtained. It is not always possible to eliminate completely a hum voltage at the output and the experimenter will have to set his own limits of acceptance. Here are some causes and remedies:

1. *Heater-to-cathode leakage in power output stage* which results from the difference in heater-to-cathode voltage. This situation may sometimes be corrected by applying a small voltage to the tube heaters by means of a balancing potentiometer across the heater winding of the power transformer. The center tap or arm of the potentiometer is connected to the cathodes of the output tubes, as shown by the 500-ohm potentiometer in the power supply of Fig. 801. When making this test, short the input jack and put the v.t.v.m. across the speaker voice coil. Set the amplifier gain control to maximum. Start with a high a.c. setting on the v.t.v.m. and reduce the range setting as you adjust the potentiometer.

2. *Excessive heater-to-cathode leakage* in other tubes in the amplifier can sometimes be reduced by changing tubes. In some cases, where amplifier gain is high, it may be necessary to try more than one new tube to obtain the desired reduction.

3. *Inadequate power-supply filtering* can cause hum. Additional ripple filtering or a decoupling network may be required in the B+ leads going to the preamplifier stage.

4. *Poor lead dress* can result in hum, especially in a low-level high-gain stage which has a sensitive lead placed in the power

field. Try moving grid and plate leads around while watching the effect on hum level being measured by the v.t.v.m.

5. *Inadequate shielding* in high-gain stages. Make sure that control-grid leads and switching circuits are shielded and grounded. Use grounded shields on high-gain amplifier tubes. Do not assume that all metal tubes are properly grounded just because they are metal. When in doubt, scrape the top surface of the tube to expose the metal, and then make a connection between tube and chassis. If hum goes down put a shield around the tube or replace it. If the amplifier chassis has no bottom plate, try using one.

6. *Improper grounding*. Try changing ground points of bypass capacitors while watching the meter reading. If poor grounding is source of trouble, run a ground bus which is tied to chassis only at input end of the amplifier.

7. *Poor parts placement*. Reorient power transformer, filter chokes or output transformer to change direction of magnetic field. This is not too easy to do, since chassis punchouts are usually designed to hold transformers in one position. With these parts in operation, turn them slowly and note effect on v.t.v.m. reading.

### **Frequency-response measurements**

The frequency response of an amplifier, tone-control circuit or equalizer is an important factor in evaluating any audio system. Remember, however, that an audio system is only as good as its poorest unit. Overall system fidelity depends not only on amplifier characteristics but also on the quality of the sound source — phono or tape pickup — and upon the speaker system. Because the sound must pass through all of these units in the ordinary audio setup, frequency response is limited by the unit which has the narrowest response characteristics. The v.t.v.m. and an audio signal generator can be used to check the frequency response of the audio system from the *output* of the sound pickup, such as the phonograph cartridge, to the input to the speaker system. Checks which can be made with these two test instruments do not cover the response characteristics of the pickup or the loudspeaker itself. Response characteristics of phono pickups are best measured by use of a special test record. The sound output of the loudspeaker system can be checked only through use of a calibrated microphone-amplifier system. This latter test setup is usually costly and is consequently restricted to the laboratory or sound studio.

It is possible, however, for the audio experimenter to obtain a

complete overall check with the v.t.v.m., a test record and an audio generator. If the response characteristics of the loudspeaker have been accurately plotted by the manufacturer *and if the speaker is housed in the same type of enclosure used by the manufacturer when he compiled the speaker-response data*, the experimenter can obtain an accurate evaluation of his entire audio system.

Before frequency-response tests are run on any equipment, check the equipment to make sure that it is in proper operating condition. Test amplifier response wherever possible with the loudspeaker mounted in its proper enclosure and connected to the amplifier. This is desirable because the speaker impedance is reflected back into the amplifier and has an effect on the amplifier output signal. If the amplifier is tested at a high power level, the reproduced sound may not be tolerable. In this case, a noninductive dummy load can be used. In any case, a high-power amplifier should never be operated without a load connected to the output transformer. Failure to observe this precaution may result in burnout of the transformer. If a dummy load is used, it should consist of a resistance equal to the voice coil impedance and should have a wattage rating equal to approximately twice the amplifier rated power output. Wirewound resistors are generally used because of their high-wattage dissipation. The inductance of these resistors is usually not high enough to cause undesirable reactance at audio frequencies.

### **Preliminary considerations**

The frequency response of amplifiers, tone-control circuits and equalizers is measured by feeding a signal of fixed voltage level from the audio oscillator into the input terminals of the unit under test and measuring the voltage output with the v.t.v.m. Readings are taken with the v.t.v.m. at different frequency intervals throughout the bandpass of the unit. It is necessary that the voltage of the generator signal fed to the unit under test be kept at the same level for all frequencies. This requires that the generator have essentially flat output throughout its tuning range. The v.t.v.m. can be used to check the output voltage, if desired, whenever the frequency is changed. The output voltage control on the generator can be used to set the voltage to the required value.

The output circuit of the generator should also be able to work into the input impedance of the unit under test to preserve the waveshape of the test signal. Most generators are equipped

with an output selector switch which permits setting up the generator for external loads ranging from a few ohms (voice coil impedances) to several hundred thousand ohms (high-impedance amplifier input). Cathode-follower amplifiers, employed in various stages of some audio amplifiers, generally have a very high input impedance and an output impedance of a few thousand ohms at best. Amplifiers used in broadcast and professional audio work frequently utilize transformer input designed to match 250- and 500-ohm audio lines. Crystal microphones and crystal pickups usually connect to amplifiers having input impedances from 50,000 ohms to 1 megohm. Magnetic pickups for tape and disc recordings

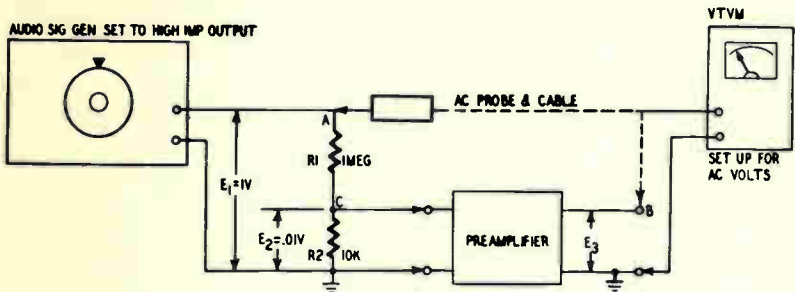

Fig. 803. Test setup for the measurement of very low a.c. voltages. With this technique the approximate voltage gain of a preamplifier can be measured easily.

may work into either a high or low impedance, depending upon the pickup characteristics.

In many measurements, such as those on very low-level preamplifiers, it is necessary to use a very small input signal voltage. The voltage required may be difficult to measure. In these applications, a larger signal voltage which can be measured easily is applied across a resistance attenuator, as shown in Fig. 803. The ratio of resistance  $R_2$  to  $R_1$  is 100 and corresponds to the voltage ratios between the two resistors. The generator is set to the HIGH impedance output and the v.t.v.m. is set up for a.c. voltage measurements and connected to point A. It is assumed that an input voltage of .01 is required at the amplifier. The output control on the generator is adjusted for a reading of 1.0 volt at point A. If resistance ratios are correct, .01 volt will be obtained at point C. The a.c. probe of the v.t.v.m. is then moved to point B and the output voltage measured. The approximate *voltage gain* of the amplifier is obtained by dividing the output voltage by the input voltage. For example, if the measured output is 0.2 volt, the amplifier has a voltage gain of 20 ( $E_3/E_2 = 0.2/.01 = 20$ ).

## Frequency-response checks

It is general practice to plot five curves on an amplifier which contains tone-control circuits. Individual curves are plotted with tone controls set for flat response and for maximum and minimum bass and treble response. The test for flat response can be made first. Try this procedure:

1. Set up the v.t.v.m., amplifier and audio-signal generator as shown in Fig. 804.
2. Set the amplifier volume control to a position which corresponds to the power output level at which the test is to be made.
3. With a signal of the desired voltage applied to the amplifier input, set the tone controls so that they have a minimum effect on

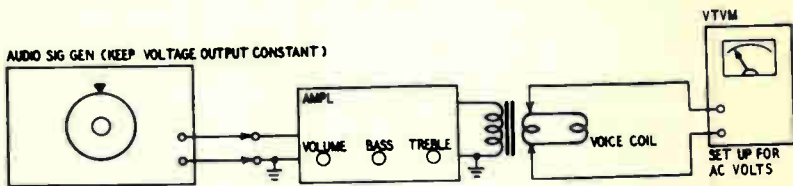

Fig. 804. Technique for checking the frequency response of an audio amplifier.

the frequency response of the amplifier. On some amplifiers, the "flat" positions for these controls are indicated. In other cases, the points of minimum effect will have to be determined experimentally.

4. Tune the generator to a frequency just below the estimated bass limit of the amplifier. With the v.t.v.m. connected across the speaker voice coil, record the a.c. voltage reading.

5. Tune the signal generator to the next highest frequency at which the measurement is to be made. Record the v.t.v.m. reading. Below 200 c.p.s., a reading can be taken every 20 cycles. The interval can be increased to 1,000 cycles when readings begin to level off. The interval can be reduced to 100 c.p.s. on the high end when readings start to decrease. Keep the audio-generator output constant for all test frequencies.

6. Tune the generator to a frequency in the treble range (3,000 c.p.s. is a good starting point). Vary the bass control and note the effect on the output voltage. Similarly vary the treble control. If the treble control produces a large voltage change, lower the frequency of the audio generator. Alternately vary the bass and treble controls and adjust the frequency of the generator until a frequency is found at which both bass and treble controls have minimum effect on the output voltage. This frequency can be used

as a reference frequency for plotting a curve of output voltage *vs.* frequency. The effect of varying the bass control should be plotted from the lower limit of the amplifier up to the reference level, while the effect of varying the treble control should be plotted from the reference frequency to the upper frequency limit of the amplifier.

Assume that 1,000 c.p.s. is found to be the frequency at which

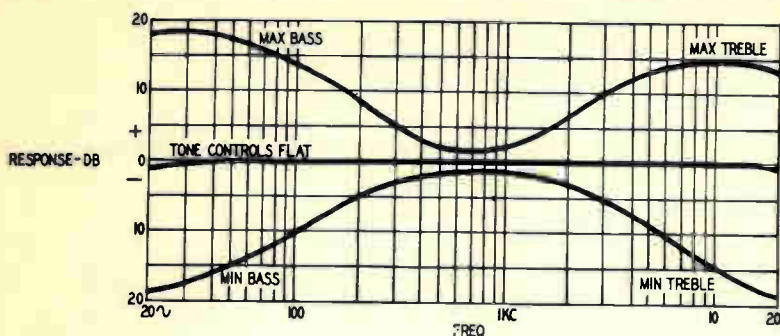

Fig. 805. Typical curves obtained for various settings of the audio-amplifier controls.

the bass and treble controls have the least effect on the output voltage. Set the bass control to minimum and take output voltage readings with the frequency varied from 30 to 1,000 cycles. Set the bass control to maximum and repeat the output voltage readings as the frequency is varied. The same process is followed in determining the effect of the treble control except that the output voltage reading need not be taken below 1,000 cycles.

From these voltage readings, curves such as those shown in Fig. 805 may be plotted. The curves are plotted in decibel units so that comparison of the results can be seen. These curves indicate the frequency response of the amplifier with minimum and maximum bass and treble. The flat line corresponds to the response obtained at the flat setting of these controls.

### Frequency test records

If it is desired to check the response of the phonograph pickup along with the amplifier, a calibrated test record must be used. Different types of records which contain recordings of specific frequencies at a constant voltage level are available.

Two general types of records are used — *banded tone* and *gliding tone*. Banded-tone records are recorded with a number of constant frequencies which may be played in sequence; they are

generally used when measurements are being made. Gliding-tone records are useful when it is desired to check for peaks but may also be used for frequency-response measurements by appropriate timing. These normally commence at a high frequency, maintain constant velocity characteristics down to the crossover frequency, then follow the recording characteristic down to the final frequency (approximately at the rate of 6 db/octave). In some cases the high-frequency response follows the recording characteristic.

The test is made by playing the record on the phonograph and monitoring the voltage output of the amplifier with the v.t.v.m.

### Checking phonograph equalizers

Phonograph equalizers are simple networks used to compensate for attenuation or boost at certain frequencies which is introduced

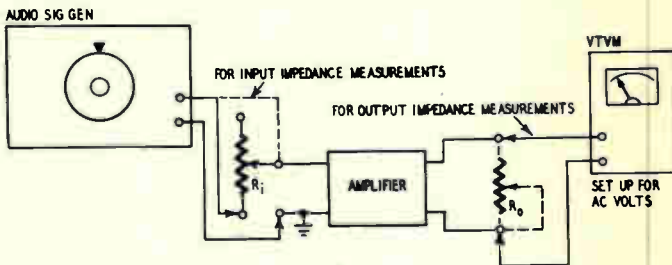

Fig. 806. Test method for determining the input and output impedances of an audio amplifier. The same procedure can be used for impedance measurements of circuits other than audio amplifiers.

in the record during the recording process. The usual crossover frequencies (the frequency below which the bass is attenuated) are 250, 300, 350 and 500 c.p.s. Various record manufacturers use different crossover frequencies and consequently they have different recording curves.

Equalizer networks are designed to match a specific recording curve. A properly designed equalizer in an ideal amplifier will have an output which is the inverse of the recording curve. In other words, if the recording attenuates frequencies below 500 c.p.s. at a certain rate, the equalized amplifier must boost these frequencies at the same rate. The curves for these units are plotted in the same manner as described earlier.

### Determining input and output impedances

The input and output impedances of amplifiers and similar circuits may be determined quickly with the v.t.v.m. and a signal



from the audio generator. This method, shown in Fig. 807, is accurate if the impedance is resistive; approximate if it is reactive.

Since most amplifiers have inputs which are mostly resistive, it is sufficient to check the input impedance with a low-frequency signal. A frequency of 50 c.p.s. may be used when checking a high-fidelity amplifier. For checking the input impedance of a public-address system or an amplifier with limited low-frequency response, a test frequency of 100 c.p.s. may be used. The circuit shown in Fig. 806 is used to determine both high and low input impedances. For high-impedance circuits use the high-impedance output of the generator, for low-impedance circuits use the low-impedance output.  $R_i$  is used for input impedance measurements,  $R_o$  for output impedance measurements.

Set the frequency of the generator to either 50 or 100 c.p.s., depending on the quality of the equipment under test. Connect the generator to the amplifier; set the output control so that there is a convenient reading on the a.c. scale of the v.t.v.m. Keep the signal level low so that the amplifier is not overloaded. Connect the potentiometer ( $R_i$ ) into the circuit and vary its resistance until the voltage indicated on the v.t.v.m. is one-half the original value. The resistance of the potentiometer is then equal to the input impedance.

Output impedances are measured by the same technique except that the potentiometer ( $R_o$ ) is shunted across the output of the amplifier. Since the output impedance changes as the frequency is varied, it is advisable to check the output impedance over a wide band of frequencies.

### **Decibel measurements**

To study the relationship between the output voltages measured with the v.t.v.m. in audio applications and the frequency response of an amplifier, it is helpful to plot a curve showing the a.c. voltage output in decibels against frequency. The conversion table shown in Fig. 807 offers a convenient means of changing voltage readings to decibels. Unless the same reference level and load impedance is used, however, the figures obtained from the chart will be relative values.

### **Graph for conversion of r.m.s. voltages to dbm values**

The graph can be used to determine dbm values corresponding to a.c.-voltage values (r.m.s.) across a 600-ohm resistive load. A dbm

value is defined as the number of decibels above or below a zero reference level of 1 milliwatt in 600 ohms at 1,000 c.p.s. Zero dbm, therefore, would indicate a power level of 1 milliwatt; 10 dbm, 10 milliwatts; and 20 dbm, 100 milliwatts.

The graph makes possible rapid conversion of r.m.s. voltages to corresponding dbm values. Associated power levels can be read along the top of the graph. If the r.m.s. voltage is measured across a resistive load other than 600 ohms, the correction factor given here must be added algebraically to the dbm values read from the graph in Fig. 807. For resistive loads not given in Table 7, the following formula should be used for determining the correction factor:

$$\text{Correction factor} = 10 \log \frac{600}{R}$$

where R is the load in ohms. If R is greater than 600 ohms, the correction factor is negative.

**TABLE 7 — CORRECTION FACTORS**

Resistive Load at 1000 cps	DBM*
600	0
500	+0.8
300	+3.0
250	+3.8
150	+6.0
50	+10.8
15	+16.0
8	+18.8
3.2	+22.7

Because dbm are defined with respect to a 600-ohm load, power levels correspond to voltage values. Dbm can be measured in terms of r.m.s. voltages across a 600-ohm resistive load. For example, 0.775 r.m.s. volt indicates 0 dbm and 7.75 r.m.s. volts indicates 20 dbm. The decibel and ear-response curves have their closest correlation at 1,000 cps.

By examining Fig. 807 you will see that 0.775 volt (r.m.s.) is indicated by a vertical line (dashed line). If you will move your finger straight up this line to the top of the graph, you will note

\*DBM is the increment to be added algebraically to the dbm value read from the chart in Fig. 807.

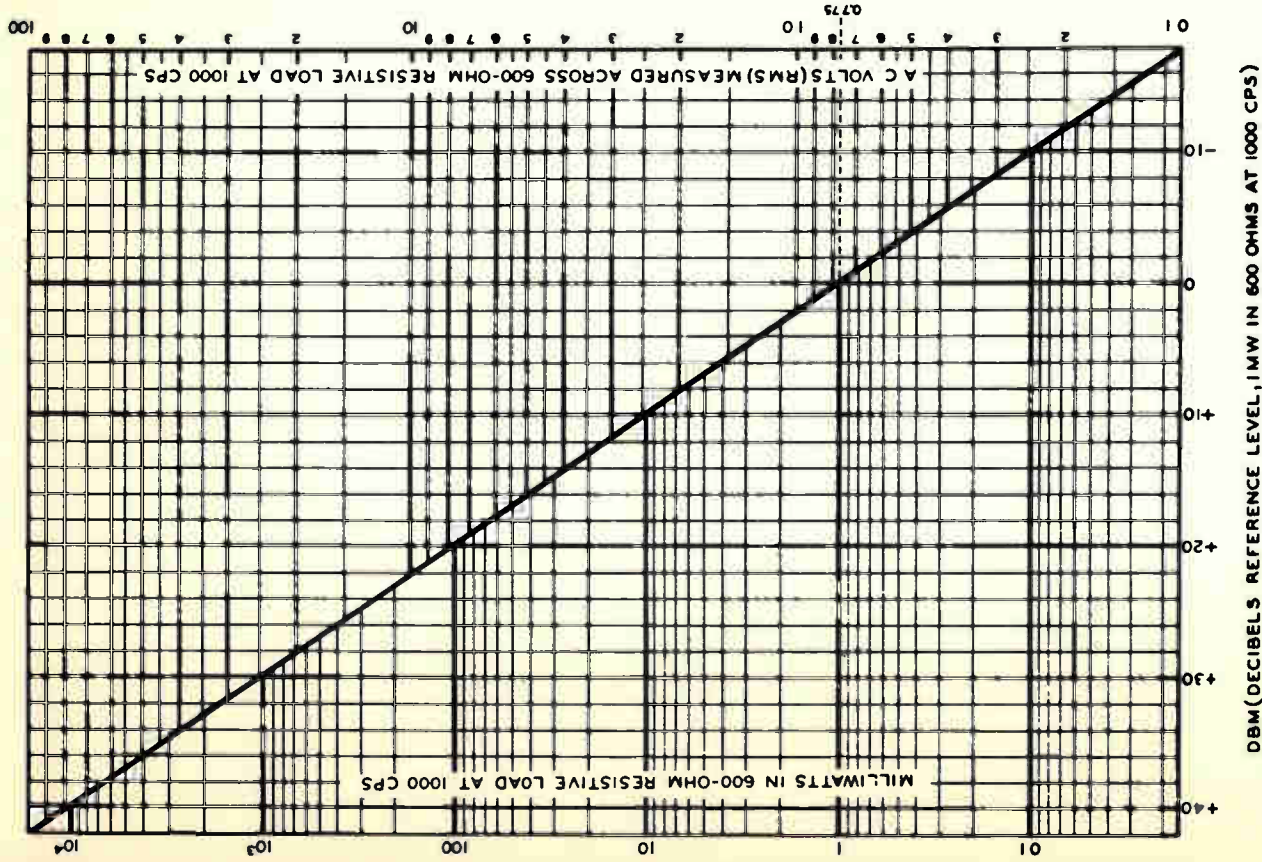

Fig. 807. Graph for conversion of rms. voltages to dbm values. The db reference level is 1 milliwatt in 600 ohms.

that it corresponds to 1 milliwatt. Repeat this process, but this time stop at the diagonal line and then move to the left side of the graph. The corresponding dbm value is zero. Similarly, 2 volts corresponds to 8 dbm and slightly less than 7 milliwatts.

The decibel may be defined in a number of ways, including the following equations:

$$\text{db} = 10 \log \frac{P_2}{P_1} \quad \text{db} = 20 \log \frac{E_2}{E_1} \quad \text{db} = 20 \log \frac{I_2}{I_1}$$

In these equations  $P_1$  is the input power in watts,  $P_2$  is output power in watts,  $E_1$  is the input voltage in volts,  $E_2$  the output voltage in volts,  $I_1$  is the input current in amperes, and  $I_2$  is output current in amperes.

### Standard reference levels

In making any series of measurements, it is necessary to employ a standard specified set of conditions. If this standard is to be

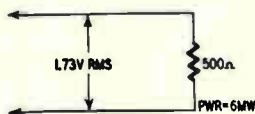

Fig. 808. This standard is 6 mw across 500 ohms.

expressed in terms of voltage and power, the resistance of the load used must be specified. Two different reference levels are commonly used. These standards are shown in Fig. 808 and Fig. 809.

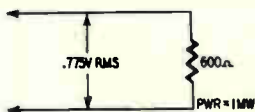

Fig. 809. This standard is 1 mw across 600 ohms.

The standard shown in Fig. 809 is that employed in making up the chart in Fig. 807 and is finding increased use. In Fig. 808, a 500-ohm resistor is used as the standard load resistance and the zero reference level (zero db) corresponds to an r.m.s. voltage of 1.73 volts developed across the resistance. In Fig. 809, a 600-ohm load is used, with the zero-reference level corresponding to an r.m.s. voltage of 0.775 volt developed across the load. Any voltage readings above either of these values are plus, and voltages lower than these have a negative value. On v.t.v.m.'s equipped with decibel scales, the zero-reference point is usually placed in the midscale region. Decibel units to the right of zero on a v.t.v.m.

scale are marked plus and units to the left are marked minus. The standard load and zero-reference level employed in calibrating these meters is stamped on the meter face plate or is given in the instruction manual.

While the chart shown in Fig. 807 is extremely useful, a similar, but more direct approach can be used. Thus, if extensive work is to be done with a constant load resistance, power level, or voltage value, the technician can easily modify his v.t.v.m. to provide readings of decibel values directly from the face of the meter. This procedure is described in detail in Chapter 10.

## the v.t.v.m. in the ham shack

**T**he radio amateur who has not yet discovered the value of the v.t.v.m. around the ham shack has overlooked a helpful and versatile accessory to his hobby. The many advantages which make the v.t.v.m. such a useful instrument in radio, TV, audio troubleshooting, alignment, and adjustment, make it an extremely desirable service aid in the ham shack. The v.t.v.m. can be put to good work in troubleshooting communications receivers, frequency meters, variable-frequency and crystal oscillators, exciter units, r.f. amplifiers, power supplies of all sizes, modulators and speech amplifiers, and many other types of specialized equipment used by the amateur.

The basic troubleshooting methods described in earlier chapters can be applied equally well to amateur equipment. Many of the parts used in amateur apparatus are the same as or similar to the parts used in radio and television receivers. Capacitors, coils, transformers, resistors, and other components used by amateurs are subject to the same types of defects and breakdowns that occur in broadcast receivers. Therefore, troubleshooting methods used in localizing faulty operation in a section or stage in amateur equipment are similar to those employed in repairing radio and TV sets. The procedures for testing individual components are the same as those discussed in Chapter 6.

In most amateur applications the v.t.v.m. is even more useful because of its flexibility and accuracy. The communications receiver, for example, utilizes many of the conventional circuits

found in better-quality broadcast receivers and also employs additional circuits, such as beat-frequency oscillators, crystal filters, and voltage-regulated power supplies. Because the communications receiver is designed for stable performance and has a high degree of sensitivity and selectivity, adjustment, maintenance and alignment are obviously important. Good test procedures and a v.t.v.m. are, therefore, especially necessary.

Some new and interesting applications, most of which involve familiar procedures, can be found in servicing the amateur transmitter. In oscillator and exciter stages, for example, proper operating voltages, good regulation, and correct driving voltages are essential for frequency stability and a clean output signal. The v.t.v.m. is especially useful in checking and adjusting such stages. In checking receiving, transmitting and special-purpose equipment, the v.t.v.m. is valuable because of its high sensitivity, low-loading characteristics, and adaptability to special-purpose probes and cables.

### **The amateur transmitter**

Because equipment used in the amateur station is designed for a particular function, it presents some special measurement considerations which should be understood before the v.t.v.m. is used. The considerations listed here are included because they pertain to the safety of the amateur and his v.t.v.m. and because they will also help avoid erroneous or inaccurate readings.

### **Special considerations**

1. Remember that there is danger inherent in testing amateur equipment which operates at hazardous voltages. Therefore, the amateur should thoroughly familiarize himself with the equipment under test before working on it, *bearing in mind that high voltages may appear at unexpected points in defective equipment.*

2. It is good practice to remove power before connecting test leads to high-voltage points. If this is impractical, be especially careful to avoid accidental contact with equipment racks and other objects which can provide a ground. Working with one hand in your pocket and standing on a properly insulated floor lessens the danger of shock.

3. Filter capacitors may store a charge large enough to be hazardous. Therefore, discharge filter capacitors before attaching test leads.

4. Remember that leads with broken insulation provide the additional hazard of high voltages appearing at exposed points along the leads. Check test leads for frayed or broken insulation before working with them. This is most important when making measurements with the high-voltage probe.

5. To lessen the danger of accidental shock, disconnect the test leads immediately after the test is completed.

6. Remember that the risk of severe shock is only one of the possible hazards. Even a minor shock can place the operator in hazard of more serious risk such as a bad fall or contact with a source of higher voltage.

7. The experienced amateur continuously guards against injury and does not work on hazardous circuits unless another person is available to assist in case of accident.

8. Do not attempt to make measurements in circuits containing high-level r.f. signals. If an accessory r.f. probe is used, make sure the d.c. and r.f. voltages do not exceed the input rating of the probe. It is generally impossible to measure the r.f. signal of exciter and power stages with the v.t.v.m. because of the relatively large r.f. signal voltages.

9. Take special care to ground the v.t.v.m. thoroughly when making any high-frequency measurements. Remember that the presence of stray r.f. fields can cause some weird effects and upset normal a.c. and d.c. voltage measurements.

10. Make sure the RANGE and FUNCTION switches on the v.t.v.m. are set correctly *before* connecting the v.t.v.m. to the circuit to be tested. Failure to observe this precaution can result in damage to the v.t.v.m.

### Checking oscillator stages

In the amateur transmitter, the adjustment of the oscillator stage and its power supply is probably the most critical application in which the v.t.v.m. can be used.

The setting of the operating voltages are of great importance in the oscillator stage and are usually specified by the tube manufacturer in his published data for the particular tube type. If operating voltages are too high, or if they are not proportioned correctly to different circuits (such as the plate and screen circuits) tube ratings may be exceeded and the amplitude and frequency stability of the output from the oscillator may be seriously affected. Operating voltages which are too low may result in poor regulation and insufficient output power.



For example, in crystal oscillators, the plate and screen voltages must be adjusted properly to assure operation, not only within the tube's ratings, but also to prevent excessive grid-circuit current from damaging the crystal. In both crystal and variable-frequency oscillators, improper d.c. voltages can cause frequency shift or chirp under keying conditions. In variable frequency oscillator circuits, excessive frequency drift may result from improper operating voltages.

Two basic types of oscillators employed in amateur transmitters are shown in Fig. 901. Both the crystal oscillator shown in Fig. 901-a and the variable-frequency oscillator in Fig. 901-b have many variations in their circuit design. If the amateur is familiar with the requirements for making measurements in both the types of oscillators shown here, however, he should be able to make measurements without difficulty in nearly every type of oscillator.

The crystal oscillator of Fig. 901-a provides output on a frequency fixed by the crystal in the control-grid circuit. The supply voltage from the power supply is fed to the B plus and B minus terminals. The correct value of screen voltage is obtained by dropping the higher B plus voltage through the screen-grid resistor. In tetrode and pentode oscillators, the screen voltage exercises a great influence on performance of the stage, and this voltage should be measured with the v.t.v.m. set up for d.c. voltage measurements. If the oscillator is keyed, the plate and screen voltages should be measured under both key-up and key-down conditions because, unless a voltage-regulated power supply is used, the key-down (load) voltage will be lower than the key-up voltage.

If the oscillator must deliver much power, the plate voltage should be measured with the v.t.v.m. at point D rather than at any point between D and the plate pin (G) because the plate circuit will contain a relatively strong r.f. signal which will disrupt the voltage reading. The capacitor from point D to ground serves to keep r.f. energy from getting into the supply line and also permits the measurement to be made. Because there is no dropping resistor in this plate circuit, the d.c. voltage measured at D should be the same as that at the plate. In crystal-oscillator stages, as in doubler and amplifier stages, the tuning of the plate-tank circuit will affect plate and screen voltages. Off-resonance tuning will cause plate current to increase, resulting in a change in the d.c. voltages at the tube pins.

It is not usually possible to measure the r.f. signal voltages at points E and F in power oscillators because the peak values of these

voltages normally exceed the maximum allowable input voltages of the r.f. probes used with v.t.v.m.'s. Crystal-diode type r.f. probes generally have a much lower signal-handling rating than have the vacuum-tube probes. Before r.f. measurements are attempted, therefore, the amateur should be sure that the v.t.v.m. and the r.f. probe can handle the estimated signal voltage without damage to the measurement equipment.

The screen voltage should be measured with the d.c. probe at point C, which is at r.f. ground because of the bypass capacitor.

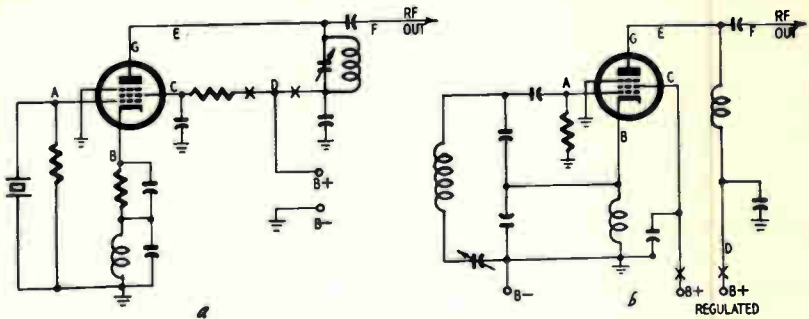

Fig. 901-a, -b. Crystal oscillator (a) and variable-frequency oscillator (b) can be checked at the various test points shown in the circuits.

If a considerable amount of power is being drawn from the oscillator under key-down conditions, the amateur should make sure that the screen voltage does not exceed the permissible limit when the key is up. The degree of voltage change depends upon power-supply regulation.

The developed grid bias, which can be measured at point A with the d.c. probe, provides an indication of how the stage is functioning. This voltage is negative at point A with respect to the cathode and is measured from the control grid to cathode of the oscillator stage. The amount of bias voltage will increase with the strength of oscillation and should decrease as the load on the plate circuit is increased. Cathode bias (point B) is always positive and is measured from the cathode pin to ground.

### Current measurements

If the v.t.v.m. has facilities for measuring direct current, the meter can be inserted at the points marked "X" in the plate and screen leads to read the plate and screen currents. The amount of current flow will depend upon the tuning of the plate tank circuit and also upon the load connected to point F. Remember that both

these leads are above ground and caution should be exercised when connecting the v.t.v.m. into the circuit. For additional considerations on current measurements, see the section on direct current measurements in Chapter 5.

A variable-frequency oscillator is shown in Fig. 901-b. The operating frequency of this oscillator is determined by the tuning of the split-stator capacitor in the grid circuit. Supply voltages, grid bias, and output-signal voltages are measured with the v.t.v.m. with the same procedures used in checking the crystal-oscillator stage shown in Fig. 901-a. In the variable-frequency oscillator stage, however, tuning of the grid capacitor may produce changes in the output signal, in the bias and operating voltages. Because these oscillators are usually constructed to cover a specified range of frequencies, the grid tank circuit should be designed to give uniform output throughout the tuning range. If essentially flat (uniform) output cannot be obtained, the circuit should be adjusted to give peak output near the center of the range. The v.t.v.m. is especially important in checking these variable-frequency oscillators because they are more susceptible to power-supply voltage changes and keying. The v.t.v.m. is extremely valuable in debugging such stages. Plate and screen currents can be read at points marked "X".

### **Amplifier and multiplier stages**

As in the case of oscillator stages, it is important that plate, screen, and bias voltages be set correctly in amplifier (buffer) and frequency-multiplier stages to prevent damage to tubes and also to minimize the generation of parasitics and harmonics. The typical operating conditions specified in manufacturers' tube-data sheets should be followed to insure maximum operating efficiency. If it is necessary to operate any element of the tube at a voltage different from that specified, other voltages, with exception of the tube-heater voltage, should be changed proportionately.

Fig. 902 shows typical circuit arrangements used in amplifier and multiplier stages of transmitters. The differences between these two circuits are in the way signal and d.c. voltages are fed to the grids and plates of the tubes. The stage in Fig. 902-a shows series plate feed, and in Fig. 902-b we have parallel plate feed. In the latter arrangement the plate-tank circuit does not contain any d.c. voltage.

In both these types of amplifiers, the tuning of the tank circuit will affect the grid, screen, and plate current flow and also affect

the voltages. The bias voltage measured at points A in both circuits, for example, will depend upon the drive from the preceding stage and upon the tuning of the plate tank circuit. In Fig. 902-b, grid-tank tuning also influences the measured bias voltage. The bias voltage will usually increase with increased excitation and at grid circuit resonance. Grid, screen, and plate voltages are measured with the d.c. probe with respect to cathode. The cathode bias (point B) is measured with respect to ground. Points E and F are at r.f. potential and should not be used for measurement when excitation is applied.

### Measurement of screen voltage

In adjusting any r.f. amplifier or multiplier stage, care should be taken to prevent the screen voltage from exceeding the maxi-

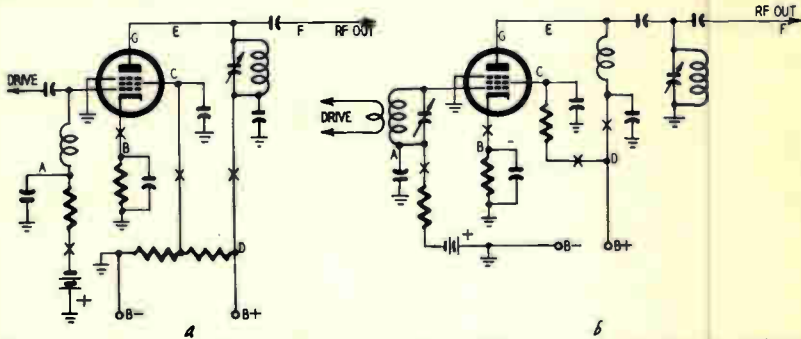

Fig. 902-a, -b. Two different types of r.f. amplifier circuits (buffer or voltage amplifier). The drawing at the left (a) and that at the right (b) differ in the way in which they are coupled to the driver and also in the arrangement of the plate-tank circuit.

imum specified value when the key is up. A voltage divider and bleeder, such as that shown in Fig. 902-a, is recommended for c.w. stages. The series-dropping resistor arrangement used in the screen circuit of Fig. 902-b is usually satisfactory for phone operation because excitation is applied continuously to the stage. In either circuit arrangement, the v.t.v.m. should be used to measure the screen voltage under key-up and key-down conditions. The screen bypass capacitor puts the screen circuit at r.f. ground potential, permitting d.c.-voltage measurements at this point to be made with the v.t.v.m.

### Checking grid bias

The grid-bias voltage of an r.f. stage is obtained in a number of ways. Transmitter amplifier stages usually are operated class C

— which means that no plate current flows when excitation is removed (key up). Some final amplifiers used in c.w. transmitters are operated under class AB<sub>1</sub>, AB<sub>2</sub> or class B conditions, however, and a small amount of plate current may flow under key-up conditions. Usually, however, bias is adjusted to a cut-off or below cut-off value recommended by the tube manufacturer. For class-C phone amplifier operation, the bias is usually increased to approximately two and a half times the amount required for plate-current cut-off.

Grid current can be measured in both of the stages shown by inserting the meter at points marked "X" in the grid circuits. These points should not contain r.f., which can disrupt the meter reading. Total tube current is checked at points "X" in the cathode circuits. The proper test points for screen and plate current (C and D) are also shown. See Table 8 for complete data on oscillator and amplifier measurements.

**TABLE 8**

Key Letter in Fig. 901 and Fig. 902	To Measure	V.T.V.M. Setting (Volts)	Probe Type
A	Grid bias	—D.C.	D.c. isolating probe
B	Cathode bias	+D.C.	"
C	D.c. screen voltage	+D.C.	"
D	Plate supply voltage	+D.C.	"
E	R.f. signal voltage	±D.C.*	R.f. probe
F	R.f. output signal voltage	±D.C.*	R.f. probe
G	D.c. plate voltage	+D.C.	D.c. isolating probe

\*Polarity of v.t.v.m. setting depends on the polarity of the output voltage from the r.f. (high-frequency) probe.

Several different methods of obtaining grid bias are used in transmitter stages, some of which are shown in Fig. 903. In all the arrangements shown (except Fig. 903-f) the total tube bias voltage is measured with the v.t.v.m. by connecting the ground cable of the v.t.v.m. to the chassis (because the cathodes are grounded) and measuring the d.c. operating bias ( $E_{op}$ ) on the —DC VOLTS ranges of the v.t.v.m. Bias should be measured under both key-up and key-down conditions because the bias voltage may change appreciably with removal and application of the excitation. In Fig. 903-a, the operating bias voltage,  $E_{op}$ , depends on the excitation and is developed by grid current flow through the resistor, R<sub>1</sub>.

Fixed or protective bias ( $E_{pr}$ ) is used in Figs. 903-b to 903-e inclusive. The operating bias in Fig. 903-c and Fig. 903-e is the total of the fixed bias and the developed grid-leak bias. Both protective and operating bias are provided by the arrangement

shown in Fig. 903-f although this method should not be employed in c.w. stages.

In the circuits shown in Fig. 903, bias under key-up conditions can be measured by connecting the ground cable of the v.t.v.m. to the chassis and connecting the d.c. probe to the control grid pin of the tube. Not all grid-circuit arrangements contain an r.f. choke or r.f. bypass capacitor and the accuracy of measurement of the grid bias at the tube pin under key-down or phone conditions will

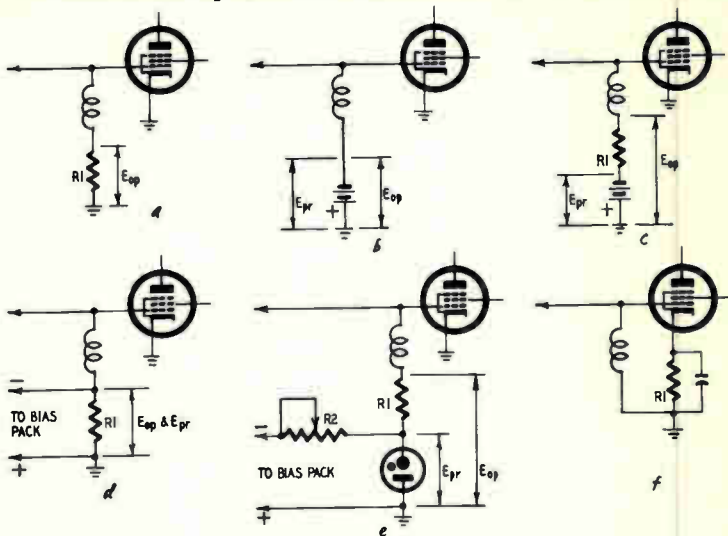

Fig. 903-a to f. Bias arrangements for transmitter tubes. Circuit a uses grid-leak bias while the battery in circuit b could represent a bias (power supply) pack. Circuit c uses a combination of the types shown in a and b. In circuit d,  $R_1$  is the bleeder across the bias pack. Circuit e has the advantage of using a gas-tube regulator across the bias pack output. Bias is developed across the cathode resistor,  $R_1$ , in circuit f.

depend upon the driving power and the stability of the v.t.v.m. under r.f. conditions.

Bias in the circuit shown in Fig. 903-f should be measured by connecting the ground cable of the v.t.v.m. to the chassis and connecting the d.c. probe to the cathode pin of the tube.

### Adjustment of high-power amplifiers

For several reasons, high-power r.f. amplifiers deserve special consideration when measurements are involved. The high plate and screen voltages used in these amplifiers are hazardous and measurement techniques must allow for the possibility of an insulation breakdown in both the transmitter and measurement equipment. (See "Special Considerations" at beginning of this

chapter.) Also, misadjustment of tuning controls or operating voltages may damage costly tubes and components. These pitfalls are especially liable to be encountered when newly constructed equipment is first tried out.

While the r.f. transmitter circuit shown in Fig. 904 may differ considerably in design from those found in many ham rigs, the v.t.v.m. measurement techniques and precautions described for it apply generally to all transmitter r.f. amplifiers. In all high-power equipment, the checking and adjustment of a.c. filament voltages is especially important to tube life and performance. Grid bias voltages are equally critical because they have a direct effect upon the screen and plate dissipation of the tube under key-up conditions. The value of the grid voltage also affects drive requirements and sets the operating level (class of operation) of the amplifier stage. In tetrodes, screen voltages may be critical and should be carefully set to insure that screen dissipation is kept within proper limits under both key-up and key-down conditions. Plate voltages, as well as total plate current should be determined exactly when the operating power level borders on the legal input-power limit or the maximum permissible rating for the tube type.

### **Preliminary checks**

In setting up an r.f. amplifier for the first time, the v.t.v.m. can be used to make several precautionary measurements before plate and screen voltages are applied. In checking out a high-power amplifier such as that shown in Fig. 904 the following procedure should be used:

1. Apply filament and grid bias voltages. Remove excitation.
2. Set up the v.t.v.m. for a.c. voltage measurements. Check the filament voltage of each tube *directly at the tube filament pins (xx)* by connecting the ground cable of the v.t.v.m. to one pin and the a.c. probe to the other pin of the same tube socket. The filament voltage should be within at least  $\pm 5\%$  of the recommended filament voltage for the tube type.
3. Similarly check the filament voltage of the other amplifier tube (yy). The voltage should be the same as that measured on the first tube. If the voltage measured at either filament is off more than  $\pm 5\%$ , measure the line voltage on the primary side of the filament transformers. Use the v.t.v.m. set to read a.c. volts for this check. Make sure the RANGE switch is in the proper position. Too low or too high a line voltage may be the cause of improper filament voltages. If the line voltage is correct, the voltage drop

in the filament leads may be responsible, in which case a heavier conductor should be used, or one of the filament transformers may need to be replaced because of improper turns ratio. In no event should the high-power tubes be operated outside their filament-voltage ratings when B+ voltages are applied.

4. Set up the v.t.v.m. for minus d.c. voltage measurements. Connect the ground cable to the amplifier chassis. The d.c. bias supplied by the separate bias supply should be checked at the control grid pins of both amplifier tubes by connecting the d.c. probe to these points. This is a wise precaution, especially in equipment which is not relay protected against grid-bias failure. If equally correct voltages are measured, the operator may be

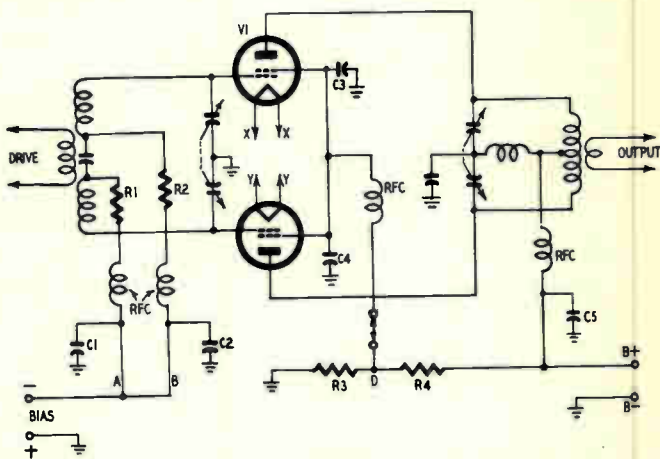

Fig. 904. *Transmitter push-pull power amplifier. Voltage checks with the v.t.v.m. will help prolong the life of expensive transmitting tubes.*

sure that wiring is correct and that the bias supply is functioning properly.

The separate bias-supply leads feeding the two halves of the grid circuit are provided as a means of checking the balance of the push-pull circuit. Grid-bias voltage measurements (taken from control grid to chassis) in the amplifier circuit should not be attempted when excitation is applied because of the large circulating r.f. current.

5. Adjust the grid-tank tuning and the coupling to obtain the required amount of grid-current. If the v.t.v.m. is equipped with a current-measuring circuit, the instrument can be used as a milliammeter. Open the bias leads at point A, apply excitation, and read the amount of direct current on the meter. Repeat at point B.



Both readings should be the same. If not, then R1 and R2 should be adjusted until both readings are identical. We are assuming, of course, that the coupling from the driver stage is such that both V1 and V2 receive equal amounts of excitation. Bias due to excitation or drive is developed across R1 and R2. The r.f. chokes (RFC) and capacitors C1 and C2 will keep r.f. out of the v.t.v.m. After obtaining the correct value of grid drive, remove excitation.

6. The amplifier should now be checked for plate current cut-off or, if the amplifier is to be run with a small amount of static plate current flowing, the amplifier can be checked for the desired static plate-current flow.

With bias applied and excitation removed, apply plate and screen voltages. Note the plate-current flow, if any, and adjust the bias voltage from the bias supply, if necessary, to give the required cut-off or static current. Remove the high voltage.

7. The plate and screen circuits can now be checked with excitation applied. In circuits which employ high-perveance tubes, special care should be taken to prevent excessive plate and screen current flow while tuning adjustments are made. Unless dial settings of plate-tank resonant points are first established by means of a grid-dip oscillator, a considerably reduced plate voltage should be employed for tuning operations. The value of this voltage depends upon the plate characteristics and permissible dissipation of the tube type employed and can best be determined from the manufacturers' tube data for the type involved. The plate-supply voltage should be measured at point C and the screen-supply voltage should be measured at point D. The radio-frequency choke (RFC) and capacitor C5 will keep r.f. out of the v.t.v.m. when making a measurement of the supply voltage for the plate at point C. Similarly, the radio-frequency choke and capacitors C3 and C4 keep point D at r.f. ground potential. Resistors R3 and R4 act as a voltage divider to put the proper amount of d.c. voltage on the screens. If, when making d.c. voltage measurements of screen potential you find that the screen voltage is too low, then the tie point at D should be moved further up on R4 (toward point C). Similarly, if the screen voltage is too high, then D should be moved down on the voltage divider toward ground.

### **Measuring high voltage**

The maximum d.c. voltage limit of commercial vacuum-tube voltmeters is between 1,000 and 1,500 volts. Plate supply voltages higher than these values can be measured with the v.t.v.m. by use

of an accessory high-voltage probe. When these probes are equipped with the proper value of multiplying resistor (see Chapter 4), it is possible to measure d.c. voltages up to 30,000 volts or higher.

Unfortunately for the amateur fraternity, the high-voltage probe is a valuable, but unexploited accessory in the ham shack. The accuracy and versatility of these accessories is sufficient to compete with fixed voltmeters, while their cost is usually considerably below that of an insulated panel meter equipped with one or more external multipliers.

While the electrical and mechanical characteristics of these probes has already been discussed, the measurement procedure bears repeating. The high-voltage measurement should be made as follows:

- a. Remove all B plus voltages from the transmitter.
- b. With probe and ground cable properly connected to the v.t.v.m. connect the ground clip of the high-voltage probe and/or the ground cable to the transmitter chassis.
- c. Connect the tip of the high-voltage probe to the high-voltage test point. If measurements and circuit adjustments are to be made simultaneously the probe should be clamped or taped firmly in position.
- d. Make sure that the v.t.v.m. is set up for plus d.c.-voltage measurements and that a suitable voltage range is selected on the v.t.v.m. Apply plate, screen voltage and grid drive to the amplifier stage. The voltage regulation (see also Chapter 10) of the high-voltage power supply may be determined by measuring the output voltages under two conditions; (1) with no excitation and no load attached to the amplifier and (2) with excitation applied and a load attached. As the load on the amplifier increases, the supply voltage will tend to decrease. The power input to the amplifier stage can be determined simply by multiplying the plate voltage as read on the v.t.v.m. by the total amount of plate current (in amperes) drawn from the supply.

### **The v.t.v.m. as a neutralizing indicator**

When used in conjunction with a high-frequency (rectifying) probe, the v.t.v.m. becomes an excellent neutralizing indicator for r.f. power-amplifier stages. Amplifier neutralization is normally accomplished with plate voltages removed and with excitation applied. If the amplifier is not properly neutralized, some r.f. energy will be coupled into the plate-tank circuit. Proper adjust-



The tuned circuit consists simply of a coil and capacitor which can be adjusted to the operating frequency. The coil is tapped about a third of the length along its turns. The v.t.v.m. set to read low voltage d.c. is connected to the tap through the r.f. (rectifying) probe and the circuit is tuned for maximum reading on the v.t.v.m. The readings obtained will be relative because the field strength will vary considerably with the power input to the equipment and the orientation of the antenna. A small length of wire may be added to the tuned circuit to increase the r.f. pickup.

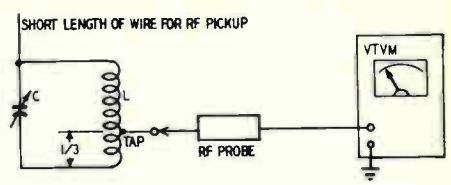

Fig. 906. The v.t.v.m. can be used as a field-strength meter.

### Checking and adjusting voltage-regulator circuits

Special filter circuits which utilize voltage-regulator tubes are commonly used in communications receivers, frequency meters, and power supplies for variable-frequency oscillators in amateur equipment. Using gas tubes, these regulator circuits (usually

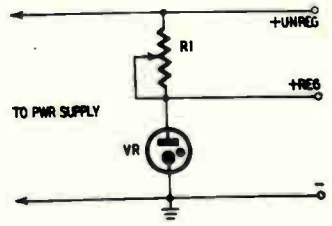

Fig. 907. Typical voltage-regulator circuit.

inserted between the load and the d.c. output of the power-supply filter) help maintain the d.c. supply voltage at a fairly constant level despite variations in the load. Voltage regulator circuits must be adjusted so the regulator tubes draw the required amount of current under both no-load and load conditions to insure that the gas-type voltage regulator tubes fire properly and do not become extinguished under load conditions. When these circuits are properly adjusted, voltage regulation in the order of one percent can be obtained.

Two typical voltage-regulator circuits are illustrated in Figs.

907 and 908. Regulator tubes can be obtained for 75, 90, 105 and 150 volts. Such tubes can be connected in series, as shown in Fig. 908, to provide two or more regulated voltages. The same supply can furnish an unregulated voltage by tapping off at a point prior to that at which regulation takes place.

The v.t.v.m. can be used in setting the adjustment for current through the tubes. A starting voltage approximately 30 percent higher than the operating voltage is required to fire the tubes. (Voltage regulation will not be obtained unless the gas tube fires.) The value of the current limiting resistor R must be between that

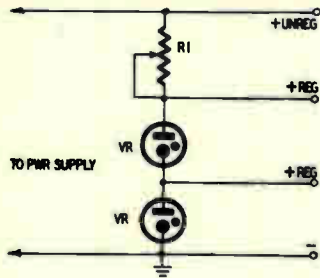

Fig. 908. VR tubes connected in series.

which permits minimum tube current to flow and that which just passes the maximum amount of current allowed with the tube type. The value of the resistor can be computed as follows:

$$R = \frac{1,000 (E_s - E_r)}{I}$$

In this formula R is the limiting resistance in ohms,  $E_s$  is the voltage measured with the v.t.v.m. across the output from the power supply,  $E_r$  is the rated voltage drop of the regulator tube, and I is the current in milliamperes through the tube. The formula is simply Ohm's law, with a multiplying factor of 1,000 because the current is expressed in milliamperes instead of amperes.

The v.t.v.m. can be used to check the regulation by measuring the regulated output under load and no-load conditions. In troubleshooting circuits of this type, failure of the regulator tube to light may indicate too great a load on the regulated output or insufficient firing voltage from the power supply. The load should be disconnected from the circuit and voltage measurements taken in the power supply and regulator circuits.

# miscellaneous applications

The v.t.v.m., because of its relatively wide frequency response, can be used to check the output level of audio oscillators and r.f. signal generators. If the output is at a high r.f. frequency, an r.f. probe can be used with the v.t.v.m.

## Calibrating voltage output of generators and oscillators

The test setup for making output measurements is shown in Fig. 1001. If it is desired to check the voltage output of an audio-

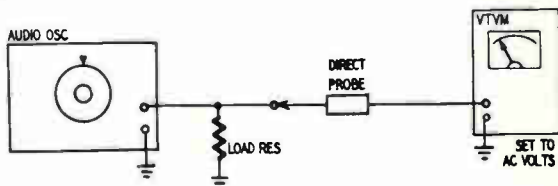

Fig. 1001. Test setup for checking the output of an audio oscillator. The load resistor stabilizes generator output.

signal generator, for example, a suitable load resistor should be connected across the generator output terminals. Load resistors of different values will be required for the different output impedance taps on the generator. If no load resistor is used, the voltage may be higher than normal and may be different at different frequencies. Voltage readings should be taken at intervals throughout the tuning range of the generator. Output should be plotted at maximum-output setting of the attenuator control. The a.c.

(direct) probe of the v.t.v.m. should be used for all audio and low radio frequencies; the r.f. probe should be used for frequencies above the normal a.c.-response range of the v.t.v.m. When measuring low frequency a.c. set the v.t.v.m. to read a.c. volts. For high frequency a.c. use an r.f. probe and set the v.t.v.m. to read d.c. volts.

A well designed generator should have essentially flat voltage output throughout its rated frequency range if the correct load resistance is used. Many r.f. signal generators, however, show a decrease in output as frequency is increased. This factor should be

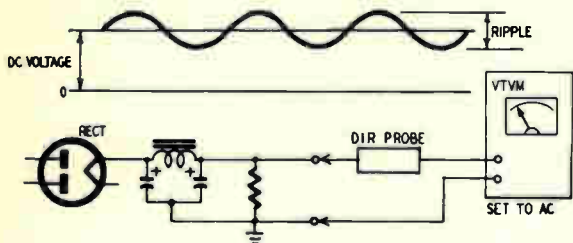

Fig. 1002. Test procedure for measuring the ripple output of a power supply. The v.t.v.m. will read the r.m.s. value of the ripple.

kept in mind when using the generator to make frequency-response and voltage-gain tests. Once the output has been calibrated for different loads and frequencies, a correction chart can be drawn up for use in these tests.

### Measurement of power-supply ripple and regulation

The filtering action of power-supply filters may be determined easily by measuring the a.c. component at the output of the filter. The v.t.v.m. is well suited for this application because of its ability to measure a.c. in the presence of d.c. voltage. The ripple voltage in radio and TV receiver power supplies is low, usually in the order of a few tenths of a volt to two volts. Ripple is measured by setting up the v.t.v.m. for a.c. voltage measurements on a low range, connecting the ground cable to the negative side of the power-supply filter section and the a.c. (or direct) probe to the positive side. Fig. 1002 shows the setup and a representation of the ripple and d.c. components of the output voltage. The v.t.v.m. will indicate only the r.m.s. value of the ripple component.

The effectiveness of the filter can be expressed in terms of percent of ripple which is the ratio of the r.m.s. value of the ripple to the value of the d.c. voltage. For example, if the d.c. voltage is

250 volts and the measured ripple voltage is 1.25 volts, the percentage of ripple is 0.5. The percentage of ripple is usually greater under load than without load because the a.c. component remains relatively unchanged when the d.c. output voltage is dropped by the load current. In general, the amount of ripple which can be tolerated in audio amplifiers and radio receivers is less than 1 percent.

Power-supply regulation can be determined simply by measuring the d.c. output voltage under load ( $E_{\text{minimum}}$ ) and no-load conditions ( $E_{\text{maximum}}$ ). Percentage of regulation is equal to:

$$\frac{E_{\text{maximum}} - E_{\text{minimum}}}{E_{\text{minimum}}} \times 100$$

Power-supply regulation depends primarily upon the value of the load current, the power-transformer rating, the resistance of the filter chokes or resistors, the type of filter, and the amount of filter capacitance.

### Checking battery voltages

The output voltages of nearly every type of battery can be checked with the v.t.v.m. *provided that a suitable load is attached*



Fig. 1003. Method of testing battery voltage.

*to the battery.* It is a characteristic of nearly all batteries that the load voltage decreases with battery age and use. Often, after extensive use, a battery will deliver a considerably lower voltage under load than will be measured across the open terminals. This is due to the fact that the used battery develops an increased internal resistance which acts to lower the output voltage when load current is drawn.

Because of this characteristic, the battery voltage should always be measured under load in the equipment in which it is installed as the extremely high loading resistance of the v.t.v.m. will not provide a suitable load. In the case of portable radios, the voltage should be measured with batteries connected to the receiver and the power switch turned on. If the batteries are not installed in the receiver, a suitable external resistance (see Fig. 1003) should



be temporarily connected across the output terminals. The value of this load resistance can be calculated by Ohm's law. The resistor should draw an amount of current equal to that drawn from the battery under normal load. The resistor should have a wattage rating sufficient to handle the current drawn during the test. The v.t.v.m. should be set to read d.c. volts and a suitable range scale should be selected.

### Checking bias cells

The v.t.v.m. can also be used to measure the voltage output of bias cells. Because these low-voltage cells are designed for extremely low current loads, the v.t.v.m. should not be left connected for a period longer than necessary to make the required

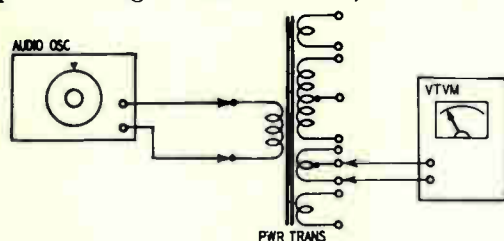

Fig. 1004. System for checking transformers.

voltage reading. In making this test, do not shunt the cell with a load resistor. Make the measurement using an isolating probe and with the v.t.v.m. set to read on a low-voltage d.c. scale.

### Checking transformers

The average radio junk box usually contains one or more multiple-winding transformers for which no data are available. Because it is not always possible to pair up leads by means of their color codings, the v.t.v.m. can be used to determine which leads are connected internally and what voltage ratings they have.

The windings of power transformers should be paired up first by means of resistance measurements. Filament windings will have a very low resistance, usually a few ohms or less, while the plate winding has the highest resistance, ordinarily 100 ohms or more. The resistance of the primary winding will vary, although it is more than that of the filament windings and less than that of the plate winding. The primary resistance ranges from about 1 to 5 ohms. Center taps of filament and plate windings should also be determined.

The turns ratio of the transformer can be determined only by voltage measurements; resistance measurements cannot provide an accurate indication. After the related leads have been identified, the transformer turns ratio can be found by applying an a.c. voltage to the primary winding of the transformer and measuring the a.c. output voltage with the v.t.v.m. connected, in turn, across each winding. If the primary winding could not be clearly identified by resistance measurements, only a low test voltage should be applied to determine the turns ratio. A filament voltage from another transformer or an audio-oscillator signal can be used. The setup is shown in Fig. 1004. Using only enough test voltage

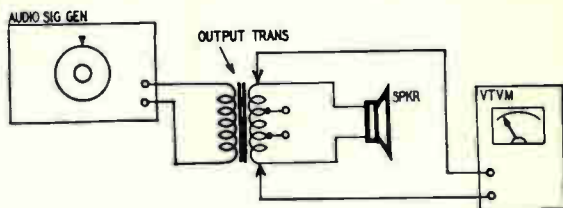

*Fig. 1005. Audio-output transformers are often supplied with multiple taps on the secondary. The v.t.v.m. can be used for finding the best impedance match between the voice coil of the speaker and the secondary winding. A listening test is not as conclusive as the method shown here.*

to produce an adequate reading from the remaining windings, the output voltage of each winding can be measured.

There will be a considerable variation in the voltage you will measure depending upon which winding is being checked. For this reason you should have the RANGE switch set to read high-voltage a.c. at the beginning of each test. Rotate the RANGE switch control (in a counter-clockwise direction) one step at a time, until you get a suitable indication on the meter scale.

The v.t.v.m. can also be used to advantage in checking windings of audio transformers. A rough approximation of the impedance of voice coils may be obtained by measuring the resistance of the winding with the v.t.v.m. and multiplying the reading by 1.5. Sometimes, in the case of multi-tap output transformers, it is desired to identify the best or most efficient winding for use with a particular loudspeaker. If listening tests fail, the setup shown in Fig. 1005 can be used.

With a signal from an amplifier or an audio-signal generator fed to the primary of the output transformer, connect the speaker to each of the voice-coil taps of the secondary winding and note the a.c. voltage reading. The tap which provides the highest voltage

reading on the v.t.v.m. should be used. Use a low-frequency test signal, such as 1,000 c.p.s. and make your measurements with the v.t.v.m. set to read low volts a.c.

### **Checking for gassy tubes**

The presence of gas in a class-A amplifier tube can often be determined by using the v.t.v.m. to measure the d.c. voltage at the control grid pin. Under normal operating conditions, no voltage or a negative voltage will be measured. If the tube is gassy the grid will draw current, resulting in a positive d.c. voltage at the grid. If a positive-voltage reading is obtained, the technician should double check the condition by removing the tube and measuring the voltage at the socket pin. If the grid-to-plate coupling capacitor is leaking, a positive voltage reading could result.

### **Checking potentiometers**

The overall resistance, taper, value of tone-control taps, and general condition of potentiometers can be determined easily with the v.t.v.m. Few of these controls used in radio and television receivers and audio equipment exceed a maximum value of 10 megohms. Consequently, the controls can be checked with considerable accuracy with the v.t.v.m., which has a center-scale value of 10 megohms on its highest resistance range.

Fortunately for the service technician, potentiometers have a reputation for becoming noisy. This is not always due to the design of the control but can be caused by rough handling, insufficient power rating, poor choice of type for the circuit involved, high humidity, defective circuitry, or wear.

The best test for noisy operation, of course, is to try the potentiometer in an operating circuit. A good approximation of the condition of the control may be had by connecting the v.t.v.m. (set to read ohms) across the arm and one end of the control and varying the position of the shaft. If the control is in good condition, the resistance should change smoothly as the shaft is rotated. A spotty control will cause the meter pointer to flicker or jump in spots as the shaft is turned.

If the control is used in high-gain circuits especially susceptible to noise, however, such as audio preamplifier stages, the true condition can be determined only by installing the pot and listening for noise in the output. Some of these circuits are extremely sensitive and only a new control of good design and high quality will give noise-free performance. Unless a spotty control can be

repaired, it should be discarded immediately to prevent its finding its way back to the stock drawer.

Spotty controls often can be repaired by applying a few drops of anti-noise solution to the base of the shaft and turning the shaft back and forth several times. In a pinch, cigarette-lighter fluid will also do the trick. In cases where a new control fails to correct the noise it is wise to check the circuitry in the stage and make sure that a leaky capacitor or other defective component is not causing trouble in the control circuit.

Potentiometers are manufactured with a variety of tapers. Basically, the taper indicates the rate of change of resistance per unit of rotation throughout the range of the control. The taper of a potentiometer may be determined by plotting resistance readings against degrees of rotation on a graph. A small dial, calibrated from zero to 300 degrees, can be placed around the shaft, and a pointer knob used to indicate the exact amount of rotation.

In most radio repair work, the value of the potentiometer is not critical. When replacing controls, however, care should be taken when cutting the shaft to proper length that excess force does not cause the shaft to loosen. Rough handling can make a new control noisy.

When replacing these controls in TV and FM receivers, careless handling of adjacent leads should also be avoided. This is especially true in small FM receivers where improper lead dress can cause a bad case of hum. In sets where wiring is compact, it is a good idea to make a pencil sketch of adjacent leads, if no wiring schematic is available, to make sure leads are dressed in their original positions.

### **Calibrating an oscilloscope**

The v.t.v.m. can be used to calibrate the vertical-deflection amplifier of an oscilloscope. A voltage-calibrated oscilloscope is extremely valuable in troubleshooting TV receivers and other electronic equipment because calibration makes possible simultaneous waveshape display and voltage measurement on the screen of the oscilloscope.

The maximum deflection sensitivity of an oscilloscope is expressed as the number of volts required at the scope input terminals to produce one inch of vertical deflection on the oscilloscope screen when the scope controls are set for maximum gain. For example, if the input attenuator on the scope is set to its minimum attenuation (maximum gain) position and 1 volt applied to the

input terminals produces a waveform one inch high on the screen, the scope is said to have a vertical sensitivity of one volt per inch. If scope amplification is linear, five volts applied at the input should produce full-screen deflection on a five-inch cathode ray tube. It is possible, therefore, to calibrate or scale the screen of the cathode-ray tube directly in terms of volts. The v.t.v.m. is used in the initial calibration. Once calibrated, the scope may be used in voltage measurements without requiring the addition of the v.t.v.m.

The test setup required consists of the oscilloscope, v.t.v.m., and an audio oscillator. Before proceeding with the calibration, however, it is necessary that some of the characteristics of the scope be understood or established. The following are important:

1. Some scopes do not provide linear deflection at all points on the tube screen. Nonlinearity is usually greatest near the edges of the screen. Therefore, it may not be possible to obtain *linear* deflection over more than two-thirds or three-fourths of the screen height. In these cases, the calibration should be confined to the center section of the screen or it will be necessary to plot a non-linear voltage scale. In the example which follows, both linear and nonlinear scales will be plotted.

2. The frequency response range of the oscilloscope vertical amplifier should be established. The response of the instrument will not be the same at all frequencies, and the range over which amplification is uniform should be determined. Unless this range is established, inaccurate voltage measurements may be obtained. For example, if scope response is flat from 30 cps to 500 kc a one-volt input signal of any frequency within that range should produce the same amount of vertical deflection on the screen. A one-volt signal of 1.5 mc, however, might produce only one quarter the amount of vertical deflection on the screen — an error of 75%. The frequency of the calibrating voltage, therefore, should lie somewhere within the flat response range of the scope.

3. The attenuation ratio of the vertical-input attenuator should be established by experiment. It is desirable that these positions on the attenuator switch have a fixed attenuation ratio between each other. If the ratio is a factor of ten, it is possible to use one base scale for all the attenuator positions. If the attenuator positions have a different ratio, a separate scale must be laid out on the scope screen for each attenuator-switch position.

The test setup for calibrating the scope is shown in Fig. 1006. The output from the audio oscillator is fed to the VERTICAL-INPUT

of the scope and also to the v.t.v.m. The v.t.v.m. is set up for a.c. voltage measurements and the direct probe of the v.t.v.m. is used. The scope may be calibrated in either r.m.s. or peak-to-peak voltage values, although peak-to-peak values are more useful in troubleshooting TV receivers and other equipment where complex waveforms are encountered. If the v.t.v.m. does not have peak-to-peak voltage scales, it will be necessary to multiply the

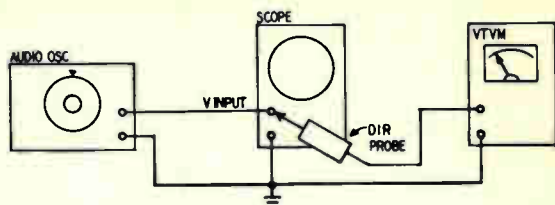

Fig. 1006. The v.t.v.m. can be used to calibrate or monitor a scope by using the procedure shown above.

a.c. meter reading by 2.83 to obtain the equivalent peak-to-peak value. Calibration procedure is as follows:

1. Connect the equipment as shown in Fig. 1006. Set the VERTICAL-ATTENUATOR input switch on the scope to the most sensitive (maximum gain) position.

2. Adjust the frequency of the audio oscillator to a suitable frequency within the response range of the scope — 1,000 c.p.s. for example.

3. Set the VERTICAL-GAIN FINE-ADJUST control on the scope to its maximum-gain setting. *This setting should not be changed during the rest of the calibrating procedure.* The scope should be equipped with a cross-hatch (cartesian coordinate) graph made of plastic.

4. Adjust the OUTPUT ATTENUATOR on the audio oscillator to give a trace of the maximum desired height on the usable area of the scope screen. Adjust the position of the trace by means of the VERTICAL and HORIZONTAL CENTERING controls. Set the SWEEP and SYNC controls on the scope to give one or two locked-in wave-shapes. Keep the SYNC control at the minimum setting that will give a locked-in waveform. Set the RANGE switch of the v.t.v.m to a position which gives a voltage reading nearest the full-scale point.

5. Mark the upper and lower limits of the trace on the screen with a pen or grease pencil and draw a straight line between these two points. This line is the voltage scale with zero volts at the bottom and full-scale volts at the top. Mark the bottom of the vertical scale with a zero.

6. Observe the peak-to-peak voltage reading on the v.t.v.m. or calculate the value from the r.m.s. reading. Mark this figure at the top of the scope scale.

7. Divide the scale into the number of equal parts which give the desired voltage divisions. Reduce the output from the audio oscillator by adjustment of the OUTPUT ATTENUATOR until the waveform is reduced in amplitude by an amount equal to one major division on the scale drawn on the scope screen. Zero the bottom of the trace on the zero axis of the screen by adjusting the centering controls.

8. Note the reading on the v.t.v.m. Transcribe this voltage reading to the scale division opposite the top of the waveshape on the screen.

9. Similarly calibrate the other divisions on the vertical scale by reducing the output signal from the audio oscillator and transcribing the v.t.v.m. voltage reading to the appropriate dividing line on the scope-screen scale. Rezero the bottom of the trace on the zero line before transcribing the readings.

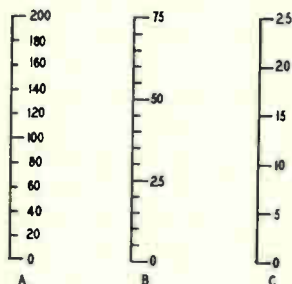

Fig. 1007. Voltmeter scales for an oscilloscope.

This procedure may be repeated for different settings of the VERTICAL-INPUT ATTENUATOR switch. If two or more of the input positions have a 10 to 1 attenuation ratio, the same scale on the screen may be used. In this case, it will be necessary to multiply or divide the indicated value by 10, depending upon the full-scale value selected for the scale. If the attenuator positions do not bear a fixed relationship, it will be necessary to plot separate scales for each attenuator setting. DO NOT change the setting of the VERTICAL FINE-GAIN adjustment during any of this procedure. Any changes made in the deflection of the calibration waveshape should be made by adjusting the output from the audio oscillator and scaling the graph screen accordingly. A scope screen plotted with different scales is shown in Fig. 1007. The letters A, B, and C at

the bottom of the scales are keyed to the different RANGE-switch settings on the attenuator. On this scope, the attenuator switch has three positions.

### Zero-center null indications

Because of its high sensitivity, the v.t.v.m. is an excellent null indicator in applications such as that shown in Fig. 1008. The circuit shown is that of a Wheatstone bridge, an instrument which is

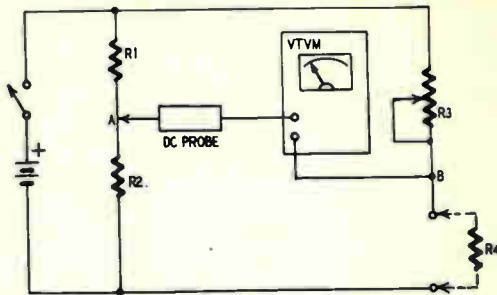

Fig. 1008. The v.t.v.m. can be used as a sensitive null indicator.

especially useful for measuring resistance values to very close tolerances.

The Wheatstone bridge contains three resistors and provision for connecting in the resistance to be measured ( $R_4$ ). Resistors  $R_1$  and  $R_2$  are selected to have equal values, the value selected depending upon the range of resistance values to be measured on the bridge.  $R_3$  is a calibrated resistor, either a precision adjustable resistor or a decade-resistance box.

When the switch is closed, current will flow through both the left- and right-hand halves of the bridge. If the resistance in both halves is equal, equal currents will flow.

The v.t.v.m. is set up for zero-center (null) measurements on d.c. volts (using a d.c. probe) and connected across the bridge as shown. When the voltages at points A and B are equal, the meter pointer will rest at the center-scale zero. The value of the unknown resistor is determined by adjusting  $R_3$  to produce the zero-center reading.  $R_3$  is calibrated to provide a direct-reading indication when the v.t.v.m. is zeroed.

### Modifying the v.t.v.m. for resistance matching

The range and usefulness of the v.t.v.m. in resistance measure-



ments can be increased by modification of the instrument as shown in Fig. 1009. Parts required include two banana-plug jacks and a well-insulated s.p.d.t. switch having low leakage. The switch and jacks should be mounted on the front panel and connected as shown by the heavy lines in Fig. 1009. The switch is inserted in series with the divider network.

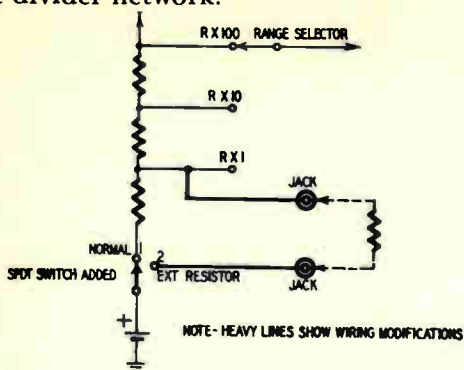

Fig. 1009. Modification of v.t.v.m. for resistance matching.

Operation of the v.t.v.m. is normal when the switch is in position 1. To increase the resistance range of the meter, zero the meter with the jacks open and the switch set to position 1. Set the RANGE selector to the  $R \times 1$  position, set the s.p.d.t. switch to position 2, and insert a suitable precision multiplier resistor in the jacks. Two resistors can be matched closely by connecting one across the v.t.v.m. ohms leads and plugging the other into the jacks. If the resistors are of equal value, the meter pointer will rest at exactly the mid-scale mark on the ohms scale.

The precise value of any resistor can be determined by connecting it to the ohms test leads and connecting a decade-resistance box to the banana jacks. The decade box is adjusted for exact center-scale reading on the meter. The resistance of the decade box is then equal to the value of the unknown resistor. The v.t.v.m. is used somewhat as a null indicator in this application.

When modifying the v.t.v.m. for this application, take care to avoid overheating the divider resistors with the soldering iron because excessive heat may permanently change the values of the precision resistors and cause inaccurate ohms readings.

### Checking selenium-rectifier circuits with the v.t.v.m.

Selenium-rectifier power supplies are finding increased use in

transformerless radio and TV receivers. A typical voltage-doubler circuit employing two of these rectifiers is shown in Fig. 1010. The v.t.v.m. can be used to check operating voltages as follows:

1. Set up the v.t.v.m. for a.c.-voltage measurements. With power removed from the supply, connect the ground lead to the B-minus bus and connect the a.c. probe to point A. Apply power. The v.t.v.m. will read the line voltage.

2. Move the probe to point B. R1 is a surge-current limiting resistor of low value. Little or no drop in the voltage reading should be noticed unless the resistor has increased in value. If resistance is increased, look for a leaky or shorted filter capacitor (C2 or C3) or faulty rectifier (CR1 or CR2).

3. Move the a.c. probe to the output of the rectifier section and measure the ripple content at the input to the filter section (point

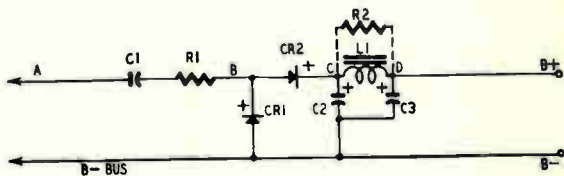

Fig. 1010. Test points in a typical voltage-doubler type power supply using selenium rectifiers.

C). Using the d.c. probe, measure the d.c. voltage. Under no-load conditions, the d.c. voltage will be approximately 2 to  $2\frac{1}{2}$  times the a.c. voltage (r.m.s.) measured at point B.

4. Measure the d.c. output voltage at point D. The a.c. output ripple voltage should also be measured at this point.

In some supply circuits, a filter resistor (R2) may be used in place of choke, L1. If the resistance of the choke or resistor is known, the amount of d.c. load current may be determined by Ohm's law. Subtract the voltage measured at point D from the voltage at point C and divide the difference by the resistance of L1 or R2.

When replacing defective rectifiers in either half-wave or voltage-doubler circuits, make sure to observe correct polarity when installing the new unit. If rectifier connections are reversed and power is applied, the rectifier may be damaged quickly. Although selenium rectifiers are best checked by means of current measurements in a specially designed tester, the front-to-back resistance ratio as measured with the v.t.v.m. will usually indicate a shorted or damaged unit.

## Checking TV antennas and transmission lines

TV antennas and twin-line lead-ins can be checked easily with the v.t.v.m. for continuity, shorts, and intermittent conditions in test applications like those shown in Figs. 1011-a and -b. In installations which employ a continuous system (folded dipole antenna), overall continuity can be checked at the TV receiver by disconnecting the transmission line at the set and measuring the continuity as shown in Fig. 1011-a. The resistance of a properly

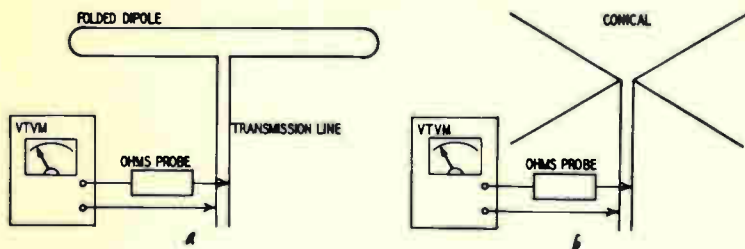

Fig. 1011-a, -b. *Technique for testing transmission lines and TV antennas. Disconnect the line from the receiver terminals before making the check.*

operating antenna system will vary, depending upon the length of transmission line employed, but should be in the vicinity of 2 to 5 ohms per hundred feet of transmission line. A shorted system will give a very low resistance reading or indicate zero resistance. A break in the line or at any connection point on the antenna should give an infinite resistance reading. In the system shown in Fig. 1011-b, a short in the line will cause a reading. Properly connected, this arrangement should give an infinite resistance reading.

When checking resistance and continuity of any antenna system, clip the v.t.v.m. leads to the line and move or shake the transmission line while watching the v.t.v.m. indication. An intermittent condition in a line may show up only under these conditions and produce erratic readings. Because most breaks in an antenna system occur at the antenna connections or in places where the line rubs against the building or other structure, these spots should be inspected closely when the v.t.v.m. indicates trouble.

This same technique can also be applied for the testing of coaxial cable. With the v.t.v.m. set to read ohms, connect the ground clip to the shield braid of the cable and the probe tip to the center conductor. You should get an infinite resistance reading. If at all possible, flex the cable while observing the meter scale. Any flick of the needle indicates an intermittent short. Use

this same method for checking cables used with test instruments. Such cables, subjected to considerable flexing while in use, can develop shorts, particularly where the cable is connected to the probe.

### Checking reactance and impedance with the v.t.v.m.

The v.t.v.m. may be used in the simple test setup shown in Fig. 1012 to check the reactance or impedance of different components, such as inductors, capacitors, chokes, speaker voice coils, and transformers. The setup makes use of the a.c. measurement

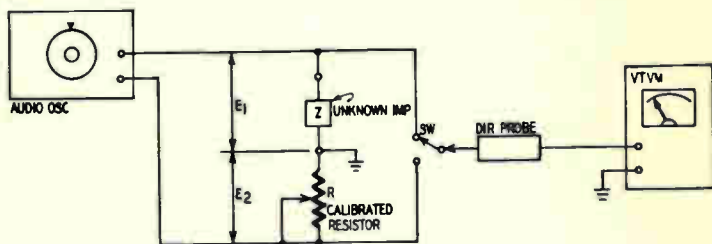

Fig. 1012. The v.t.v.m. and a generator can be used to measure the impedance of a coil or a capacitor, or combination of resistance, inductance and capacitance.

function of the v.t.v.m. and will give a close approximation of the reactance or impedance at audio and low radio frequencies.

The setup requires use of a calibrated potentiometer or adjustable resistor. The component under test is connected in series with the resistance, and the junction point of the two components is connected to ground of the v.t.v.m. A low-frequency test signal, from 400 to 1,000 c.p.s., is applied across the two components. The s.p.d.t. switch is supplied to permit reading the individual voltage drops across the resistor and the component under test. Repeated readings are taken while the resistor is adjusted until the voltage drops ( $E_1$  and  $E_2$ ) across both the calibrated resistor and the unit under test are the same. Equal voltage drops across the units indicate that the reactance or impedance of the component under test is equal to the resistance of the calibrating resistor.

If a calibrated resistor is not available, a good quality potentiometer may be used. The potentiometer is adjusted as described above for equal voltage drops. The potentiometer is then removed from the circuit and its resistance checked with the v.t.v.m. The setting of the pot should not be changed before the resistance measurement is made. Power transformers may be checked using

a 60-c.p.s. signal from a filament transformer. In these applications, a signal generator is not required. The setup for checking the impedance of the primary of a power transformer is shown in Fig. 1013. Be careful not to short any secondary windings of the transformer under test. Each of the windings of the power transformer can be checked in turn. Several different test potentiometers (R) may be required if the impedances to be measured have a wide range. Thus, you may need one test potentiometer for

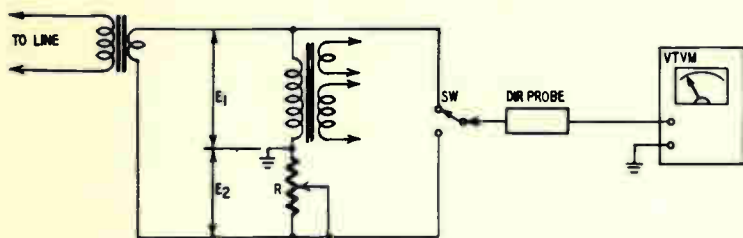

Fig. 1013. Method for determining the impedance of a transformer winding. The test frequency should be that at which the transformer will be used.

low impedances (a few ohms) and another for checking higher impedances (50 ohms or more).

### Q and inductance measurements with the v.t.v.m.

The Q of r.f. and i.f. coils and chokes can be approximated by using the v.t.v.m. in a test setup like that shown in Fig. 1014. The inductance under test is connected across a variable capacitor of approximately 350  $\mu\text{f}$ . An r.f.-signal generator is used to furnish an r.f. test signal which is loosely coupled into the tuned circuit through a small one- or two-turn loop at the end of the output cable. The v.t.v.m. is set up for d.c.-voltage measurements and an r.f. probe is used. To make this test:

1. Set the v.t.v.m. RANGE switch to its lowest range.
2. Set the tuning capacitor to its center position.
3. Starting at the high-frequency end, slowly tune the r.f.-signal generator through its tuning range until a reading is obtained on the v.t.v.m. If the v.t.v.m. reading is too low, turn the generator attenuator for greater output. Also couple L1 closer to L2.
4. Readjust the tuning of both the generator and the tuned circuit under test for maximum reading on the v.t.v.m. Note the frequency setting of the generator dial and the exact reading on the v.t.v.m. Record this frequency as  $F_1$ .
5. Carefully retune the generator to a frequency higher than

$F_1$  until the v.t.v.m. reads 70 percent of the previous maximum voltage. Note and record the frequency setting on the generator as  $F_2$ .

6. Retune the generator to a frequency below that obtained in step 4 which gives a 70 percent reading. Record the frequency setting of the generator as  $F_3$ .

The  $Q$  of the coil may be approximated by the following formula:

$$Q = \frac{F_2 - F_3}{F_1}$$

If coil  $Q$  is high, points  $F_2$  and  $F_3$  will be relatively close together. If coil  $Q$  is low, the points will be farther apart in frequency. As the coupling of the generator loop  $L_1$  will affect the  $Q$ , use only enough coupling to obtain a usable reading.

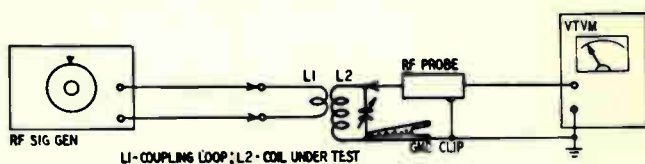

Fig. 1014. This procedure can be used for checking the  $Q$  of various types of coils. The  $Q$  of a coil is defined as the ratio of the inductive reactance of the coil to its d.c. resistance.

The setup of Fig. 1014 may also be used for determining the inductance values of coils and chokes over a range from a few microhenries to several millihenries. The inductance test requires an r.f. signal generator which has relatively high output and a high-dielectric capacitor of approximately 100  $\mu\text{f}$  capacitance. The procedure is:

1. Connect the inductance under test across the capacitor of known value.
2. Couple the r.f. signal to the circuit with a one or two-turn loop. Use loose coupling to avoid detuning the circuit.
3. Set the v.t.v.m. for measurements on its lowest d.c. range and connect the r.f. probe to one end of the tuned circuit. Connect the ground clip of the probe to the other end of the circuit, as shown in the illustration.
4. Starting at the high end of the signal generator's tuning range, tune slowly down the band while watching the v.t.v.m.
5. When a resonant point is indicated by a reading on the v.t.v.m., adjust the generator tuning for peak indication. Note the frequency of the dial setting.

The value of the unknown inductance can be calculated from the formula:

$$L = \frac{25,400}{F^2C}$$

L is in microhenries, F is in megacycles, and C is the exact value of the capacitor in micromicrofarads. The accuracy of this process depends upon the tolerance of the capacitor employed, the dial accuracy of the signal generator, and the loading effect of the v.t.v.m. As the loading capacitance of most r.f. probes is in the order of 2 to 4  $\mu\text{mf}$ , this capacitance may be subtracted from the value of C, or may be ignored in the computation.

### **Direct decibel readings with the v.t.v.m.**

Although few v.t.v.m.'s are equipped with decibel-measurement scales, it is possible to modify the instruments simply and without disturbing any circuitry to enable them to provide direct reading of decibel values. Direct-reading scales are especially valuable to the audio experimenter in plotting curves for high-fidelity amplifiers and other audio equipment in which it is desired to know exact performance characteristics for comparison purposes.

The modification process consists of making a series of simple computations and adding the results to the regular scales on the v.t.v.m. scale-plate. Fig. 1015 shows three v.t.v.m. scales which have been modified by addition of decibel scales. The lower parts of these scales, which are linear, are the original a.c.-voltage, current, or power scales. These three scales were chosen because they are representative of the scales and ranges used on many v.t.v.m.'s. The calibrations on the upper parts of these scales represent the decibel equivalents of the voltage, current, or power being measured.

By use of the conversion scales, the linear voltage, current, or power measurements can be transformed at a glance to decibel measurements during the actual measurement process without requiring intermediate computations. This has the advantage of avoiding a tedious amount of arithmetic, plus elimination of the possibilities of making errors in doing such work.

While the calibration of the bottom scales is linear, the calibration of the equivalent decibel scales is nonlinear. This nonlinearity is due to the fact that, with a given resistance, the power is proportional to either the square of the voltage across the resistance or the square of the current through the resistance. Since the conversion to decibels is made for some values that are squared (voltage

or current) and for some values that are not squared (power or watts), two separate sets of decibel values are provided. The larger values are used for readings based on current and voltage measurements; the smaller figures (in parentheses) are based on power measurements.

The scales in these examples are drawn with respect to 1.5 as the reference value, since this permits the number of decibels

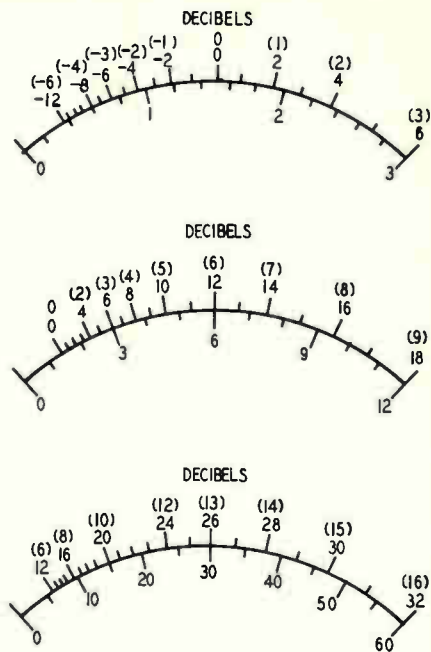

Fig. 1015. Modification of v.t.v.m. scales to permit the direct reading of decibels.

to be a whole number at full scale. In addition, 1.5 volts of audio signal applied to the 8-ohm voice coil of a good loudspeaker represents close to  $\frac{1}{4}$  watt of electrical power, constituting a good average sound level for music reproduction in a family-size living room when neither bass nor treble boost is used. A 1.5-volt signal across a 500-ohm load also represents 4.5 milliwatts of power, which is reasonably close (1.3 db) to the older standard power reference level of 6 milliwatts across 500 ohms.

In practice, the scales are used by noting the current, voltage, or power readings along the linear bottom scale and reading the equivalent decibel rating from one of the upper scales. If the figures directly above the scale are used for voltage and the small



figures in parentheses are used for power measurements, the proper decibel values will be found quickly, without requiring calculations and without extracting additional figures from a decibel conversion table.

Transforming these measurements, which are given with respect to 1.5, into measurements referred to some other value is simple. If, for example, the measurements are to be obtained with respect to 1 volt, first perform the conversion in the usual way, with respect to 1.5.

Now operate on the 10-volt range. Referring to the 0-12 volt range, 10 volts in linear measurement corresponds to 16.5 db, still with respect to 1.5. To find the final set of values, take each of the decibel values of the measurements (with respect to 1.5) and find the difference between them (subtract 16.5 db from each value). The answer will be in decibels, referred to 10 volts.

Or, for example, if the power readings are to be given with respect to 1 watt, the readings are first converted to decibels by using the values in parentheses. Since the 0-3 range shows that 1 watt corresponds to  $-1.75$  db, the difference is found between  $-1.75$  db and other power readings. Each value in the measurement has 1.75 db added to it. In this way, the final power measurement is found in decibels, with respect to 1 watt.

### **Checking r.f.-amplifier gain with the v.t.v.m.**

A rough check of the gain of a TV r.f. amplifier stage can be had by using the v.t.v.m. and an r.f.-signal generator as shown in Fig. 1016. The procedure is as follows:

1. Tune the TV receiver to a local station, touch up settings of controls, then disconnect the antenna at the set.
2. Set up the v.t.v.m. for d.c.-voltage measurements on a low range (use the d.c. probe) and connect it across the output load resistor of the second detector. Disable the a.g.c. and use an external bias supply (see page 92). For this test, the r.f. amplifier should operate at maximum gain. Advance the generator attenuator control until the output shown on the v.t.v.m. reads maximum, then reduce the generator output until the meter reading just begins to drop off.
3. Tune the r.f. signal generator to the channel picture-carrier frequency or, if a low-frequency generator is used, tune to a frequency which will supply a harmonic at the carrier frequency. Connect the r.f. output of the generator to the antenna terminals of the set (position 2). Note v.t.v.m. reading.

4. Move the output cable of the generator to the mixer stage of the tuner (position 1). The v.t.v.m. reading should be noticeably decreased.

If possible, this test should be made on all channels to provide an overall picture of r.f.-amplifier performance.

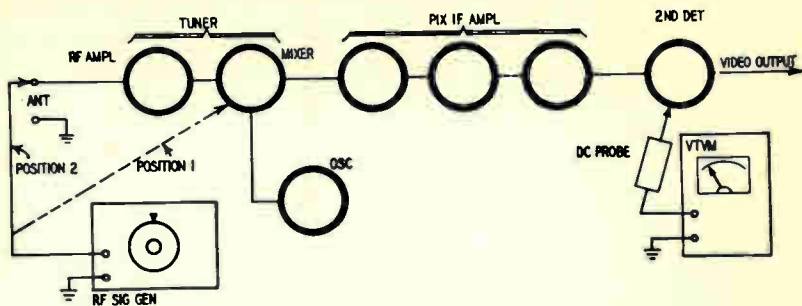

Fig. 1016. Setup for making a rough check of the gain of an r.f. amplifier stage. Although the block diagram shows a TV receiver, the same technique can be used for r.f. amplifiers in AM and FM sets.

### A preamplifier for the v.t.v.m.\*

In many audio signal-tracing and frequency-measurement applications a.c. voltages must be measured in the millivolt region. Because commercial v.t.v.m.'s cannot respond to voltages lower than a few tenths of a volt, it is sometimes necessary to employ a special, extra-sensitive v.t.v.m., such as an audio voltmeter, equipped with special low-voltage scales. This relatively costly solution to the problem can be avoided by use of a simple preamplifier with the service-type v.t.v.m. to increase its measurement sensitivity. Such a preamplifier is described here. The preamplifier unit is simple in design and construction and can be assembled and tested in a reasonable length of time. The unit can be permanently attached to the v.t.v.m. case, as shown in Fig. 1017.

The preamplifier is a two-stage resistance-coupled unit employing a single 12AX7 twin-triode and making use of inverse feedback. B+ and heater voltages are taken from the v.t.v.m. power supply. The preamplifier may be permanently attached to the v.t.v.m. without affecting its use in conventional service applications. The unit is equipped with an output jack to receive the a.c. probe of the v.t.v.m. When the preamplifier is calibrated, the v.t.v.m. RANGE switch is set to its lowest a.c. range and millivolt readings are taken directly from the corresponding low-a.c. scale.

\*Based on an article, "The Milvamp" by Forrest H. Frantz, Sr., in RADIO-ELECTRONICS magazine, Dec. 1955.

The preamplifier provides an additional gain factor of approximately 100. The lowest full-scale sensitivity, therefore, is 0.01 times the full-scale value of the lowest v.t.v.m. range. For example, the lowest range on the v.t.v.m. shown here has a full-scale value of 1.5 volts. With addition of the preamplifier, the full-scale sensitivity is increased to 0.015 volt, or 15 millivolts. The frequency response of the modified unit is within  $\pm 1$  db from 25 to 30,000



Fig. 1017. The preamplifier is attached to the case of the v.t.v.m.

c.p.s. The low-frequency response can be extended by increasing the value of the a.c.-input capacitor in the v.t.v.m.

### Construction

The metal case for the preamplifier may be purchased or constructed from a small sheet of aluminum. The layout is shown in Fig. 1018. The tube socket mounts on the small bracket. Components should be connected and soldered to the socket before the bracket is installed in the case. Keep all signal leads short to prevent hum pickup and feedback. (Miniature input and output capacitors are used for this purpose.) Supply voltage leads from

the v.t.v.m. should be made long enough to permit the v.t.v.m. to be taken out of the case without requiring disconnection of the preamplifier. The complete circuit appears in Fig. 1019. The R-C

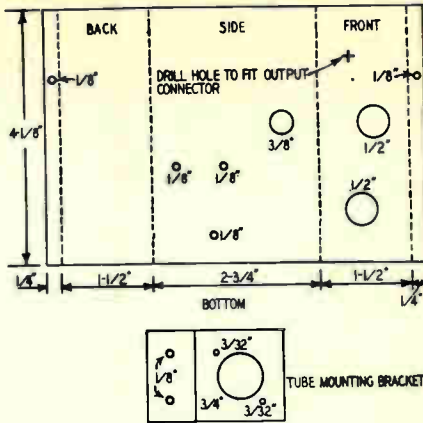

Fig. 1018. Chassis layout of the preamplifier unit.

filter network, shown at the bottom of the circuit, is installed in the v.t.v.m. to isolate and filter the B supply to the preamplifier.

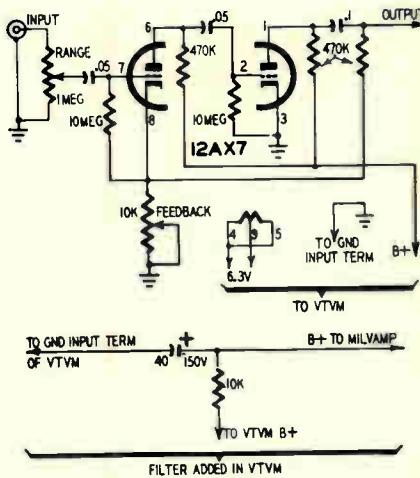

Fig. 1019. Diagram of the v.t.v.m. preamplifier. The circuit is that of a resistance-coupled amplifier.

A small notch is cut in the v.t.v.m. case (lower left-hand corner) for the voltage supply-lead grommet. Two holes are drilled in the side of the case to permit attachment of the preamplifier with self-

tapping screws. An underchassis view of the v.t.v.m. preamplifier showing connections to the v.t.v.m. is illustrated in Fig. 1020.

The B plus in the v.t.v.m. shown here is 50 volts. Other v.t.v.m.'s may employ higher voltages. If so, the frequency response of the preamplifier may be extended because a greater amount of feedback can be used. In any event, the B-plus voltage supplied to the preamplifier should be limited to 75 volts by using a larger filter resistance in place of the 10,000-ohm resistor shown in Fig. 1019. Voltages higher than 75 volts might impose too heavy a load on the v.t.v.m. voltage divider and cause unstable v.t.v.m. operation.

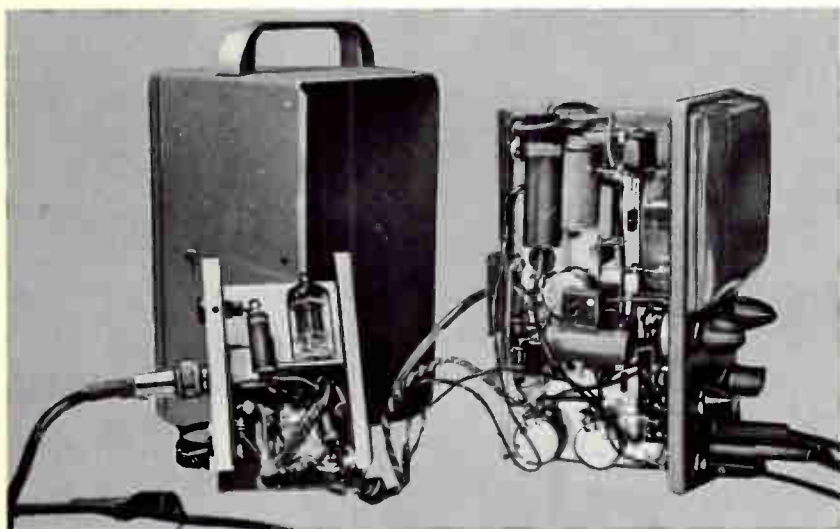

Fig. 1020. Underchassis view of the preamplifier shows connections to the v.t.v.m.

The arrangement shown does not affect the stability or calibration accuracy of the v.t.v.m. to any measurable extent.

The voltage divider for the preamplifier consists of a 1-megohm potentiometer having an audio taper. Control settings corresponding to 0.015, 0.05, 0.15, and 0.5 are marked on the preamplifier panel.

### Calibration

Basic calibration of the preamplifier consists of applying a 0.01-volt signal to the input and adjusting the feedback control so the v.t.v.m. reads full scale on its lowest range. The 1-megohm range control should be set to maximum during this adjustment. The preamplifier may be calibrated by means of an accurate audio

voltmeter or by using the simple calibration setups shown in Figs. 1021 and 1022. When using these test setups, procedure is as follows:

1. Set up the v.t.v.m. for a.c. measurements and measure the line voltage.
2. Connect the ground cable to the bottom end of the 2,000-ohm pot and connect the a.c. probe to the wiper arm. Adjust the control to give a reading of 0.01 (one-hundredth) the value of the line voltage. For example, if the line voltage is 115 volts, adjust

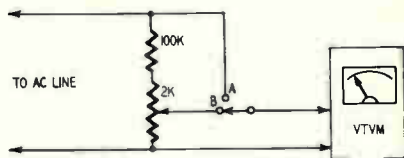

Fig. 1021. Preliminary calibration procedure.

the pot for a v.t.v.m. reading of 1.5 volts. DO NOT change the setting of this control during the remainder of the calibrating procedure.

3. Disconnect the setup from the a.c. line.
4. Connect the potentiometer and 100,000-ohm resistor as shown in the setup of Fig. 1022. Set the v.t.v.m. RANGE control to

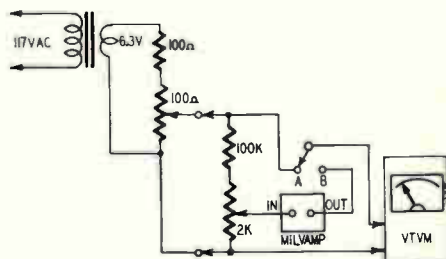

Fig. 1022. Calibration of the v.t.v.m. using the preamplifier.

its lowest setting. Connect the common lead to the bottom of the 2,000-ohm control and the a.c. probe to the arm of the 100-ohm control. Adjust the 100-ohm control for exactly full-scale reading.

5. Plug the a.c. probe into the output jack of the preamplifier. Connect the preamplifier input probe to the arm of the 2,000-ohm control.

6. Adjust the feedback control for exact full-scale setting of the meter pointer. Preamplifier gain has now been set.

To make calibration easy, the 1-megohm pot should have an audio taper. The input lead to the preamplifier should be shielded and can be made up from a short piece of coaxial cable. All ground leads should be returned to a common point on the chassis and this point should be connected to the input ground terminal of the v.t.v.m. If the meter pointer does not return to zero when the preamplifier input leads are shorted, check to see that the heater leads are dressed against the preamplifier chassis. In some cases, it may be necessary to reverse the preamplifier heater connections in the v.t.v.m. When reinstalling the v.t.v.m. in its case, take care to avoid shorting the voltage-supply leads.

---

### Parts for the v.t.v.m. preamplifier

**Resistors:** 1—10,000, 3—470,000 ohms, 2—10 megohms,  $\frac{1}{2}$  watt; 1—10,000-ohm potentiometer; 1—1-megohm potentiometer (audio taper).

**Capacitors:** 2—.05, 1—0.1  $\mu$ f, 400 volts (Aerovox P-82 or equivalent); 1—40  $\mu$ f, 150 volts, electrolytic.

**Miscellaneous:** 1—12AX7 and socket; 2—connectors (input and output); 1—chassis  $1\frac{1}{2} \times 4\frac{1}{2} \times 2\frac{3}{4}$  inches (ICA 29078 or equivalent); 2—terminal strips.

---

### Modifying the v.t.v.m. for current measurements

Although most v.t.v.m.'s do not provide facilities for the measurement of direct current, the meter movement used in many of these instruments is readily available for such a purpose. The meter movement is a sensitive one, requiring from 50 microamperes to 1 milliampere of direct current flow through the meter for full-scale deflection of the pointer. It is possible to change the v.t.v.m. and utilize the sensitive meter for various types of current measurements, including those of high values. See Fig. 1023-a, -b.

The modification includes the addition of a double-pole, double-throw switch and two binding posts to which the test circuit is connected. A good quality switch having low leakage and low contact resistance should be used. A wafer switch which can be mounted on the top or side of the v.t.v.m. is recommended. The binding posts should be well insulated from the instrument case as the meter is inserted directly in series with the test circuit for current measurements and therefore is at the same potential.

As discussed in Chapter 2, the meter can be connected between the plates or cathodes of the bridge circuit, depending upon the type of v.t.v.m. When making current checks the v.t.v.m. need not be connected to the power line. Remember, also, that the meter is not protected against burnout when used in this manner.

If the meter is used without an external shunt connected across the binding posts, the maximum current limit will be equal to the amount of current required for full-scale deflection. The sensitivity of the meter (amount of current needed to move the pointer needle to right-hand maximum) is usually given in the schematic diagram or parts list for the v.t.v.m. Current readings should be taken from a linear voltage scale.

The value of the external meter shunt will be determined by

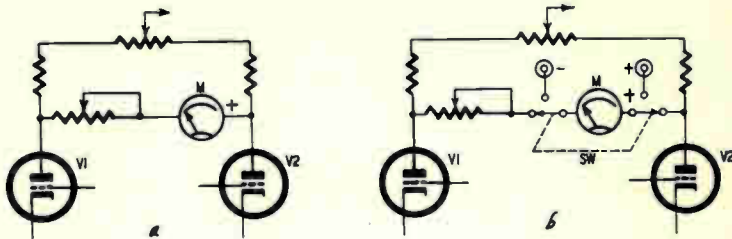

Fig. 1023-a, -b. The meter in the bridge circuit (a) can be connected to a double-pole, double-throw switch (b) for making current measurements. The meter can be provided with external shunts for increasing its current-measuring range.

the amount of current you wish to measure. The larger the current, the lower will be the value of the meter shunt resistance. The shunt resistance can easily be calculated from the formula:

$$\text{Shunt resistance} = \frac{\text{meter current}}{\text{shunt current}} \times \text{meter resistance}$$

The resistance of the meter in the v.t.v.m. can be supplied by the manufacturer, but often appears in the circuit diagram for the instrument. As an example, suppose that your meter has a resistance of 50 ohms and a sensitivity of 1,000 ohms-per-volt. This means that a current of 1 milliampere will produce full-scale deflection. Let us also suppose that you wish to measure a current of 25 milliamperes.

To protect the meter movement, it would be advisable to have a shunt whose resistance value would permit the meter needle to come to rest at about center scale. This can easily be done if you estimate the shunt to carry twice the required amount of current. Thus, in this example we would calculate the value of a 50-milliampere shunt ( $2 \times 25$  milliamperes). Substituting these values in our formula we would have: Shunt resistance =  $(.001/.05) \times 50 = 1$  ohm. The maximum current you could measure with this shunt would be 51 milliamperes, since under such conditions 50 milliamperes would flow through the shunt, and 1 milliampere would go through the meter, producing full



scale deflection. If you wanted to measure a larger amount of current you would have to calculate and supply another shunt resistor.

A conversion chart utilizing a straight line can be plotted, showing voltage in terms of current. If another current meter is avail-

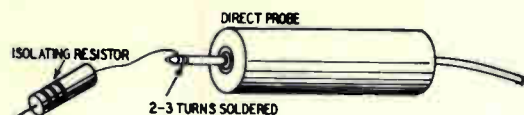

Fig. 1024. Temporary isolating probe is easily made.

able, the v.t.v.m. meter should be calibrated, as meter movements may vary somewhat in sensitivity.

### Hints and kinks for the v.t.v.m.

There are many ways of getting your v.t.v.m. to do more for you. These are but a few suggestions that have been tried by service technicians.

#### Special isolating probe

In some applications, it is necessary to make d.c.-voltage measurements in sensitive a.c. circuits characterized by high impedance. At other times, the measurement must be made in tight,

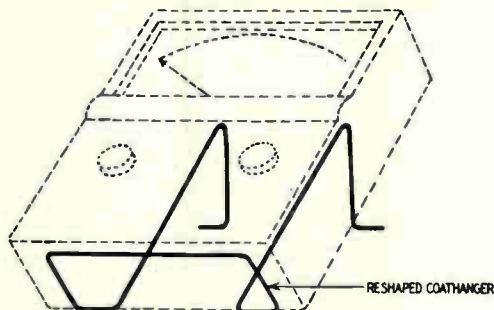

Fig. 1025. Convenient mounting stand for the v.t.v.m.

inconvenient places which will not admit a bulky probe. These difficulties can be overcome by a makeshift isolating probe made up of a suitable value of isolating resistor (usually 1 megohm) soldered to the tip of a direct probe. The test-point end of the resistor should be cut short, as shown in Fig. 1024. With careful construction, the effective loading capacitance of this probe can be reduced to less than  $1 \mu\text{f}$ . This probe is especially useful in applications involving measurements of developed grid bias,

checking oscillator injection voltage, and in receiver and converter alignment.

### Storage of spare probes

Accessory probes can be located quickly when they are needed if they are attached to small spring clips attached to the v.t.v.m. case. As most of these accessory probes are round, they can be snapped into spring fuse holders, mounted on the top or side of the case. These clips are available in a variety of sizes, and can be mounted to the case by self-tapping screws.

### Mounting stand for v.t.v.m.

Fig. 1025 shows a convenient wire mounting stand which can be used to hold the v.t.v.m. in a slanted, easy-to-read and easy-to-use

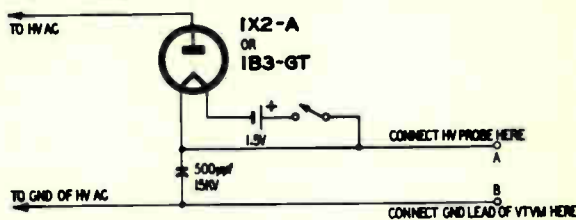

Fig. 1026. High-voltage rectifying probe for a.c. measurements. Plate and filament leads should be well insulated to guard against shock.

position on the test bench. The rack can be made by straightening out a wire coat hanger and rebending it to shape. The wire stand can be wrapped with electrical tape to prevent scratching the meter case and to prevent slipping on the bench.

### Hint for cable plug tips

Many v.t.v.m.'s are equipped with pin jacks for connection of test leads. With usage, the pin plugs (or tips) on the cables become worn and the cable pulls out of the jack. The situation may be corrected by coating the tips with a thin film of solder. The solder is soft enough to allow the pin tip to make a force fit with the jack.

### The v.t.v.m. as a precision resistor

The v.t.v.m. can be used as a precision resistor in special applications where it is necessary to use a resistor of close tolerance. When the v.t.v.m. is switched to d.c. volts, the precision voltage divider in the d.c.-voltage measurement section is connected in series with

the d.c. probe and the ground lead. The total value of this network, which is usually within  $\pm 1\%$  of the rated value, can be determined by adding the values of all the series resistors, including the isolating resistor in the probe tip. The v.t.v.m. should be disconnected from the power line when used in these applications.

### **A high-voltage rectifying probe for a.c. measurements**

In some special applications, it is necessary to measure a.c. voltages which are higher than those which can be measured with the v.t.v.m. alone. Because it is not practical or safe to use a conventional d.c. high-voltage probe in conjunction with the a.c. measurement section of the v.t.v.m., a special rectifying circuit must be used. Such a circuit is shown in Fig. 1026. The special circuit is made up of a high-voltage diode rectifier tube, such as a 1B3-GT or a 1X2-A, a 1.5-volt flashlight cell, and a TV high-voltage mica filter capacitor. If the circuit is to be used in different applications, it can be built into the form of a probe. Because these applications involve dangerously high voltages, construction and application of the probe should take all safety factors into consideration.

It is important that the unit be constructed to keep lead and stray capacitance at a minimum. Excessive capacitance can affect accuracy, especially in measurements at radio frequencies. If the 1X2-A is used, it should be remembered that the tube has an inverse peak rating of 18,000 volts. The 1B3-GT, which has an inverse peak rating of 30,000 volts, is a better tube choice for use in television service work and other applications employing voltages up to 15,000 volts. It will be necessary to calibrate the v.t.v.m. for the type of waveform being measured.

If the probe is used in applications where the voltages exceed these values, the probe may function without trouble, but only at the risk of damaging the tube. As the success of applying this method of voltage measurement depends largely upon individual construction and calibration, accuracy of readings cannot be guaranteed. If accurate readings are required, it will be necessary to calibrate the probe against a high-voltage a.c. voltmeter of known accuracy.

### **An experimental v.t.v.m. for home construction**

For the technician who may wish to experiment with the construction of his own v.t.v.m. but does not want to make a costly investment in special parts, the simple v.t.v.m. illustrated in the

schematic diagram of Fig. 1027 may be of interest. The instrument utilizes only a few readily available components, a single twin-section tube (6SN7-GT) and an inexpensive 500-microampere meter movement. Designed for use on a.c. and d.c. voltage measurements, the v.t.v.m. can be compactly constructed to suit the needs of the builder. The instrument can be used as an auxiliary device, as a portable v.t.v.m. in the service chest, or as an emergency unit in the event that the regular v.t.v.m. is in for repairs.

Designed as a compromise between the extremes of expense and impracticability, this simplified v.t.v.m. will perform most of the

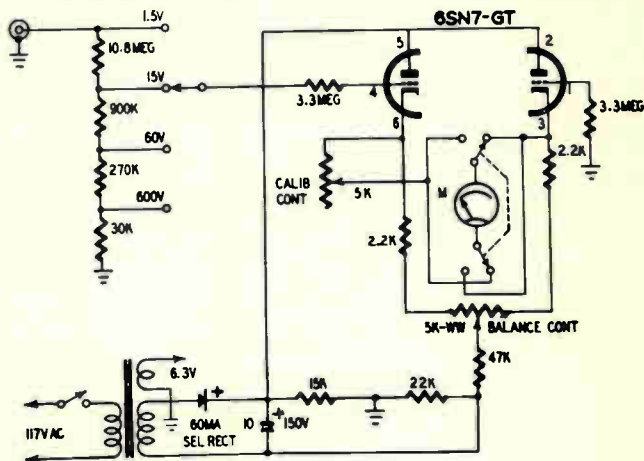

Fig. 1027. Schematic diagram of simplified v.t.v.m.

functions of larger models, but at a considerable saving in cost. The instrument has no facility for making ohms tests, but omission of the resistance-measuring circuits makes possible an extremely simple design because elaborate switching arrangements and provisions for an ohms battery have been omitted.

### Construction details

The unit can be mounted in any small aluminum or steel case (or in a shielded box). These can be purchased from any parts distributor. A small shelf or chassis is required as a mount for the tube socket, selenium rectifier and terminal strips. The v.t.v.m. could have been made still more compact by using a transformerless power supply, but this is not recommended because of frequent applications involving transformerless and a.c.-d.c. receivers. Any small power transformer delivering about 120 volts at 40 ma (or more) is suitable. This voltage, furnished to the rectifier and

filter will provide a relatively low and stable d.c. output voltage. The transformer should also have a filament winding for the v.t.v.m. bridge tube. Although a 6SN7-GT is shown in the circuit, a miniature type 12AU7 can be substituted.

A variety of meter movements having different basic sensitivities can be used. The circuit shown will work well with a movement of 500-microampere sensitivity, although a meter having a greater sensitivity (such as a 200-microampere type) should provide better performance because it will permit operation over a smaller portion of the tube's characteristic curve and make for increased linearity and accuracy.

The voltage divider network, consisting of four half-watt carbon

---

### Parts for the experimental v.t.v.m.

**Resistors:** 2—2,200, 1—15,000, 1—30,000, 1—47,000, 1—270,000, 1—900,000 ohms, ½ watt; 1—1.2, 2—3.3, 1—10.8 megohms, ½ watt; 1—22,000 ohms, 1 watt; 2—5,000-ohm wirewound potentiometers.

**Capacitors:** 1—.003, 1—.01  $\mu$ f, paper; 1—10  $\mu$ f electrolytic, 150 volts.

**Switches:** 1—single-pole, 5-positions; 1 s.p.s.f., 1-d.p.d.f.

**Miscellaneous:** 1-60-ma selenium rectifier; 1-1N23 crystal; 1-half-wave power transformer, 117-120 volts, 40 ma or more, 6.3 volts, 1 amp or more; 1 meter, as per text; 1-6SN7-GT tube and socket for same; jack; plug material; hardware; wiring, etc.

---

resistors in series, provides for four voltage ranges of 1.5, 15, 60 and 600 volts, a.c. or d.c. The resistances are the inexpensive half-watt variety, but should be selected with care to assure values as close as possible to 30,000, 270,000, 900,000, and 10.8 megohms. Since the basic accuracy of the meter depends directly on the tolerance of these resistors, selections should be made from stock with an accurate ohmmeter. Precision or close-tolerance resistors can be used, but their cost might defeat the purpose of the instrument.

An ON-OFF toggle switch is provided for the transformer primary and a pilot lamp can be connected if desired. Other controls include a RANGE-SELECTOR switch, a BALANCE-control (zero-set) potentiometer, POLARITY-REVERSING switch, and connectors for the two test leads. The CALIBRATION control, a 5,000-ohm potentiometer, is mounted inside the instrument case.

### Circuit operation

Operation centers around the vacuum-tube bridge circuit, which is similar to those discussed in Chapter 2. The BALANCE control provides a means of adjusting the two halves of the bridge so that

the voltages appearing at the cathodes are equal with no signal applied. A change in control grid voltage at pin 4 will upset the balance of the bridge, causing current to flow through the meter movement. The amount of meter-pointer deflection depends upon the amount of current flow. The 6SN7-GT has sufficiently straight characteristic curves to produce linear voltage readings over the instrument's basic operating range from  $-1.5$  volts to  $+1.5$  volts, as measured at grid pin 4.

## Test probe

The d.c.-isolating probe can be constructed from any suitable plastic tubing and an insulated or coaxial lead. A 1.2-megohm isolating resistor should be connected in series with the probe tip to reduce the capacitance loading of the cable and instrument on

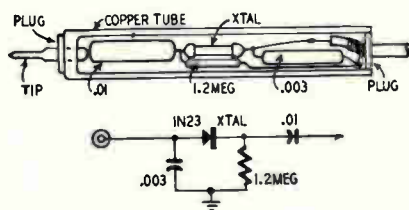

Fig. 1028. Circuit and assembly details of simple rectifying probe.

the test circuit. For a.c. measurements, a simple rectifying probe, as shown in Fig. 1028 can be constructed. The probe contains a crystal diode, two capacitors, and a resistor. Mechanical parts can probably be taken from the junk box. For example, the probe can be constructed from a short section of half-inch thin-wall copper tubing. Formica plugs for the ends can be cut with a coping saw and filed down to size. The screw tip can be made from a screw-type earphone tip, threaded into the front plug. A microphone-type connector can be used at the instrument end of each cable to connect the probe and coaxial cable to the instrument. Shielded cable is recommended to reduce the effects of hand capacitance. The scale readings for a.c. measurements are a trifle higher than the actual values but, as the difference is in the order of only 10 per cent, it can be ignored when making comparative measurements.

## Calibration

Before attempting calibration, the builder should disassemble the meter and remove the face plate. A new face plate containing

blank scales drawn in ink or pencil can be pasted over the old scales. Calibration consists simply of making d.c. voltage readings with another v.t.v.m. of known accuracy and transcribing the readings to the points indicated on the blank scale when the home-constructed instrument is connected to the same voltage source. The calibration control should be adjusted to provide for most accurate readings at the full-scale points.

### **Checking approximate stage gain in audio amplifiers**

Remove or disable one of the i.f.-amplifier tubes so that external signals cannot reach the audio. Set up the v.t.v.m. to measure a.c. voltage on a low range (see Fig. 1029), and adjust the signal generator to deliver an audio output signal.

1. Connect the output cable of the signal generator to the grid of the output tube, shown as point 1 in Fig. 1029. Connect the v.t.v.m. to the same point. Adjust the output of the signal generator to produce 1.0 r.m.s. volt of signal at the control grid. Shift the v.t.v.m. probe to the plate of the stage and measure the audio signal voltage at point 2. The approximate voltage gain of the stage is equal to the numerical value of the signal voltage at the plate. For example, with 1.0 volt of signal at the grid and 15 volts of signal at the plate, the approximate gain is equal to  $15/1$  or 15.

In a.c.-d.c. radio receivers and in some small a.c. receivers, considerable hum, up to 10 or 15 volts, may be present at the plate of the output tube. To minimize the error that this can cause, it is necessary to measure the hum voltage separately at the plate and subtract the hum voltage from the previous reading. The hum voltage should be measured without application of an audio signal. When checking the gain of an audio-output stage, it is essential to have a speaker connected to the output transformer because the gain of the output stage without a load is much higher than normal.

### **Correcting for the effects of contact potential**

When making i.f.-gain checks, if the second detector of the receiver is a vacuum-tube diode, it may be necessary to correct readings because of the existence of contact potential. The effect of contact potential within the tube is to produce a d.c. voltage across the detector load resistor. This voltage usually ranges from about 0.1 volt across a video load resistor of a few thousand ohms, to about 0.5 volt across an audio load resistor of about 100,000 ohms.

In gain checks which deal with a relatively weak signal at the second detector, it is advisable to correct for contact potential. This may be done as follows:

1. Kill any input signal to the second detector, by removing or disabling an i.f. tube if necessary.

2. Measure the d.c. voltage across the load resistor with the v.t.v.m. This voltage is the result of contact potential.

3. Suppose, for example, that the voltage across the load resistor, without input signals, is 0.1 volt. Assume, also, that when the desired signal is applied, the voltage across the load resistor is 0.5 volt. The actual voltage produced by the signal in this example is 0.5 volt minus 0.1 volt, or 0.4 volt.

The effect of contact potential is also evident in some limiter

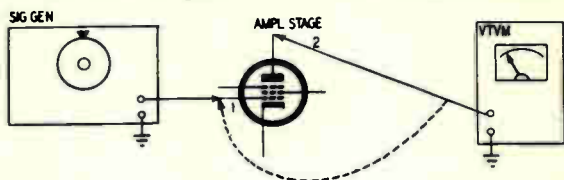

Fig. 1029. Test procedure for checking the approximate stage gain of an audio amplifier. This technique is also useful for determining if a particular tube is functioning properly.

and amplifier stages, such as the last sound-i.f. amplifier in many television receivers which operate without fixed grid bias and without cathode bias. The grid and cathode in these cases may be regarded as a diode section, and the grid resistor as the diode load. With no input signal, a small d.c. voltage will be produced across the grid resistor as a result of contact potential in the tube.

## Servicing the shorted receiver

When servicing a receiver which the customer complains is smoking or blowing fuses, it is a wise precaution to make one or two simple resistance checks with the v.t.v.m. before applying power to the set. For example, a short in the power transformer or a shorted line bypass capacitor in the primary of the transformer may cause serious damage unless the trouble is corrected before power is applied.

In such cases the v.t.v.m. should be used to measure the resistance of the primary by connecting the v.t.v.m. cables across the prongs of the line plug and turning the receiver power switch to the on position. This resistance may be very low, less than one ohm. Additional checks can be made from the line plug to chassis



ground. If this test indicates resistance to ground, however, the technician should check the primary circuit to make sure that one side of the line is not connected to chassis through a resistor, which is common practice in some sets. If the primary circuit check out is satisfactory, the rectifier tube should be removed before power is applied to make sure that a short in the power supply is not responsible.

It is entirely possible to have a short in either the primary or one of the secondary windings and to be unable to detect the short by making a resistance check. A shorted turn, for example, will have such a very slight effect on the overall resistance of the wind-

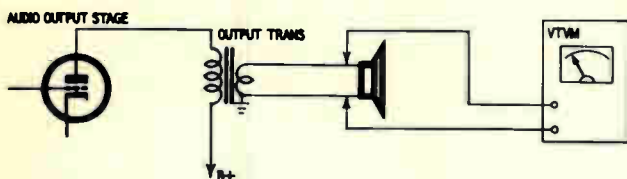

Fig. 1030. Test procedure for power-output measurements.

ing that it is difficult to detect. If the transformer gets unduly hot and if resistance checks with the v.t.v.m. do not reveal the source of trouble, disconnect all wires going to the secondary taps. Make certain that none of the secondary leads touch each other. Now apply power to the primary of the power transformer. If the transformer still gets hot or smokes, a short definitely exists and the transformer can be discarded.

### Measuring power output

The v.t.v.m. can be used to measure the power output of an audio amplifier by means of the test set-up shown in Fig. 1030. The v.t.v.m. is set up for a.c. measurements and is connected across the voice coil leads of the loudspeaker. If high-power checks are to be made, the speaker can be replaced by a resistance load which is equal to the impedance of the speaker voice coil.

The receiver or audio amplifier must be fed a suitable signal from a signal generator. If a receiver is involved, the r.f. generator should be modulated by an audio signal to provide an output from the audio stage. The signal should be tuned in carefully.

With the signal applied and volume turned up, the output voltage is read on the v.t.v.m. The power output can be calculated simply by squaring the measured voltage and dividing it by the resistance of the load resistor or impedance of the loudspeaker

voice coil. For example, if the speaker has a 3.2-ohm voice coil and an output signal of 10 volts is measured on the v.t.v.m., the power output is:

$$\frac{3.2^2}{10} = \frac{10.24}{10} = 1.24 \text{ watts}$$

To obtain a good idea of the overall performance of the system, the power measurements should be made at different power levels and at different frequencies throughout the audio range.

### Checking voltage output of phonograph cartridges

The v.t.v.m. can be used without introducing serious loading in measurement of the output voltage of many types of phonograph pickup cartridges. The input circuits of amplifiers employing three

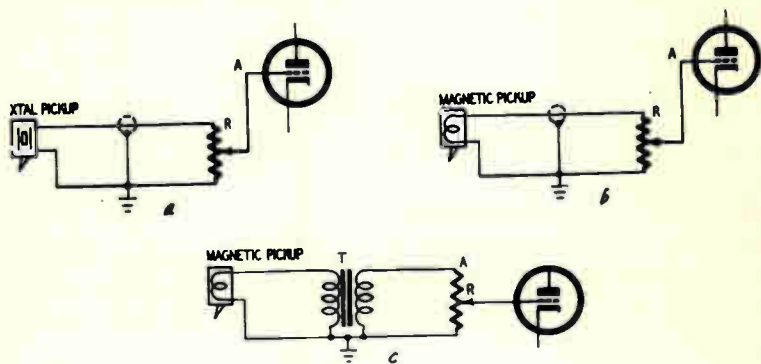

Fig. 1031-a, -b, -c. The v.t.v.m. can be used to check the output of phonograph cartridges. Use a constant amplitude test record for making these measurements.

of the most common types are shown in Fig. 1031. In all three circuits, the v.t.v.m. is set up for a.c. measurements on a low a.c. scale and the a.c. probe connected to test points A. The v.t.v.m. ground lead connects to the ground side of the potentiometer.

In Fig. 1031-a, a crystal cartridge is connected to the arm of the input volume control. A maximum voltage reading will be obtained when the arm is at the top (maximum volume position) of the resistor. In this position, the signal is fed directly to the control grid of the amplifier.

Two input circuits for magnetic cartridges are shown in Fig. 1031-b and Fig. 1031-c. A matching transformer, which steps up the output voltage from the magnetic pickup is used in Fig. 1031-c. In all three of these circuits, an input signal from a

phonograph record is required. If a banded-tone test record is available, the frequency response of the cartridge can be determined.

In making these tests of pickup units, the most convenient point at which to clip the test lead is the control grid of the pre-amplifier tube (point A in Fig. 1031). Another test spot is the lead connected to the moving arm of the potentiometer. Do not clip the probe directly to the pickup unit itself or to the wire leading from the pickup, since this could upset the weight and balance of the tone arm. The lead could damage the test record. You can also use this method for checking the flatness of output of the record.

Although we have given various miscellaneous applications in this chapter, the ideas suggested here are not a complete list by any means. The value of the v.t.v.m. is limited only by the resourcefulness and ingenuity of the user. In the hands of a skilled technician this instrument can do many jobs over and beyond those originally intended by the manufacturer of the v.t.v.m.

# troubleshooting the v.t.v.m.

**O**f the many tools and instruments used in servicing, probably no other device is taken so much for granted as the v.t.v.m. In most shops this reliable instrument is turned on early in the morning and shut off with the lights at night. During this time the v.t.v.m. may be used in dozens of different tests. Because of its versatility and dependability many technicians consider it an almost fool-proof device, immune to the electronic gremlins that afflict the sets on which the v.t.v.m. is used. The technician who places such faith in this number-one instrument is often shaken when he discovers that something has gone wrong with the v.t.v.m. In the "one-meter shop," a mild case of panic can ensue.

Because the v.t.v.m. is basically a simple instrument, it should present no complicated troubleshooting problem. The technician who can work with the much more involved circuitry of a modern TV receiver should have little or no trouble in repairing his own v.t.v.m. quickly and easily if a few basic characteristics of the instrument are understood. This chapter describes some of the more common circuit arrangements employed in commercial v.t.v.m.'s and suggests specific remedies for the more frequent types of troubles. A detailed troubleshooting analysis of a representative v.t.v.m. is also included. If the technician understands the basic principles of operation, such as those described in Chapter 2, he can feel confident in correcting any type of v.t.v.m. defect.

The best way of eliminating breakdown of the v.t.v.m. is to prevent trouble in the first place. As is the case with an automo-

bile, the v.t.v.m. should be inspected and serviced at frequent intervals to insure continued reliable operation. There are a number of routine checks and adjustments which can be made periodically to keep the v.t.v.m. in top condition. Such checks and adjustments are classified as *preventive maintenance*.

### **Preventive maintenance**

Improper use of the v.t.v.m. is a major cause of failure. Misuse can result in costly repairs. Some of the most frequent mistakes made by the technician include improper setting of the FUNCTION control or the application of too much voltage to the input circuits. For example, many v.t.v.m.'s are returned to their manufacturer for repairs because the low-value precision resistors in the ohms network have been damaged or burned out due to the fact that the technician has set up the v.t.v.m. for ohms measurement and applied a high d.c. or a.c. voltage to the instrument. Since the ohms network uses precision resistors having a very low wattage rating, misuse can easily result in damage. Immediate repair of such damage is not always possible because the resistors are usually made specially for the instrument in which they are used. If replacement parts cannot be obtained locally, the technician must obtain these from the instrument manufacturer.

Repairs of this nature are often expensive and require two to three weeks "down" time for the instrument. A little additional care and double checking by the technician when he is using the instrument can prevent this type of trouble.

Improper connection of probes and cables, and failure to provide transformer isolation of other equipment from the power line in a.c.-d.c. or transformerless applications can also cause similar costly repairs. Damage resulting from such misapplication can be prevented by use of an isolation transformer, as described on page 76.

Probes and cables are a frequent source of trouble because they receive a great deal of physical handling. The constant flexing and bending of cables causes the wires to break or mechanical connections to loosen. Detachable probes may be lost or damaged if a heavy chassis is set down on them or if they are dropped to the floor. This frequent source of trouble can be eliminated by clamping the probe to the instrument case when the probe is not being used. Insulation of probes and cables can also be damaged if it comes into contact with a hot soldering iron. Out-of-the way placement of the soldering-iron stand can prevent this.

Rough handling or dropping of the instrument is a frequent source of trouble and invariably results in damage to the meter movement. Meter bearings and coil mountings are relatively delicate and, while the v.t.v.m. is a sturdy instrument, it should be remembered that the movement can be damaged by heavy jars or shocks. The shop v.t.v.m. should be firmly mounted in a suitable place on the bench or shelf where it cannot be moved or pulled onto the floor when cables are handled. Even the best constructed meter movements cannot be expected to withstand a four-foot drop.

While the preventive measures described here appear to be obvious, they are, nevertheless, frequent sources of trouble. These measures are concerned primarily with the everyday use of the v.t.v.m. Below are listed some of the instrument checks and periodic servicing tips which can extend the trouble-free life of the instrument.

### Ohms battery

Failure of the ohms-measurement function can be prevented by periodic inspection or replacement of the ohms battery. The condition of the battery may be checked as follows:

1. Set FUNCTION switch to "ohms."
2. Set RANGE control to " $R \times 1$ " position.
3. Rotate the OHMS ADJUST control to bring the pointer to full-scale deflection. If it is impossible to adjust the pointer to full scale, the battery should be replaced.
4. Short the ohms cable to the ground cable for about 10 seconds.
5. Open the short circuit and observe the scale indication. Any appreciable deviation of the pointer from full-scale deflection indicates a weak battery.

Exhausted batteries should not be left in the instrument. If inspection at any time shows that the battery is leaking or corroded, it should be replaced at once and any chemical deposits or corrosion on the battery contacts or inside the case should be removed. When replacing the ohms battery in a holder with spring contacts, the contacts should be sanded clean and the tension adjusted to insure solid contact and as low a contact resistance as possible. In some instruments the internal ohms connections are soldered directly to the battery terminals. It is important, also that correct polarity be observed. In some v.t.v.m.'s, the positive

contact is grounded. In other instruments, the negative contact is grounded.

## General troubleshooting

Of necessity a v.t.v.m. contains electronic and mechanically operated components. Mechanical parts, such as FUNCTION and RANGE switches, are in constant use, often require repair or replacement.

## Switches

The apparently complicated construction of switches used in the v.t.v.m. is a big source of difficulty to many technicians. Indeed, the switches and their connections are the most difficult aspect of troubleshooting the v.t.v.m. If the switches could be removed, the v.t.v.m. would be an extremely simple instrument. With a little patience and careful circuit tracing, however, the technician should be able to follow through and understand the switching circuits without difficulty.

Three symbolic methods of drawing rotary switches are shown in Fig. 1101. These types are widely used for the FUNCTION and RANGE switches in schematic diagrams of v.t.v.m.'s. These drawings show how contacts, permanent connections, and wiper arms are symbolized. In Fig. 1101-b the numbered terminals are used to connect to seven different points of a resistance network in a v.t.v.m. which has seven measurement ranges. Contact 1 corresponds to the first or left-hand position of the RANGE control. The unnumbered terminal is the wiper contact. In nearly all v.t.v.m. schematics, the switches are shown in their maximum counterclockwise positions.

A five-position switch of similar construction is shown symbolically in Fig. 1101-c. In this illustration, the wiper arms are shown in position 1 (the first RANGE position). As the switch is rotated to the right, the wiper arm will move up to positions 2, 3, 4, and 5. Ganging of the switch sections is shown by the dotted line. Ganged switch sections may also be identified by symbol numbers, such as S1-a and S1-b.

As is necessary in repairing and maintaining TV tuners, the v.t.v.m. switches should be checked and attended to periodically to keep them in good working order. This is an important preventive measure because switch replacements are costly and are best done by the factory. Panel nuts on switch shafts should be kept tight to prevent movement of the switch assembly, broken leads

and shorted components. Because many of the precision resistors used in the v.t.v.m. are mounted directly on the switch assemblies, care should be taken when soldering to prevent overheating or mechanically scraping the resistors. Excessive heating may permanently change the value of the resistors and result in inaccurate meter readings. A pair of long-nose pliers may be clamped to the lead between the resistor being soldered and the point of connection at the switch to dissipate as much heat as possible. Care should also be taken to prevent twisting or loosening of the switch con-

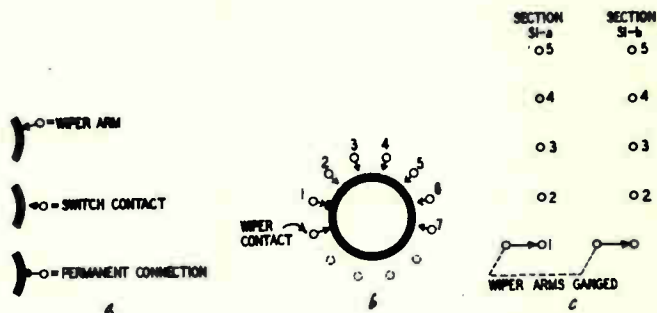

Fig. 1101-a, -b, -c. Rotary switches used in v.t.v.m.'s can be represented in these three different ways in circuit diagrams.

tacts and to prevent solder from getting down into the switch. Contacts should be cleaned periodically with a good contact cleaner.

## Replacement parts

Whenever possible parts should be obtained from the instrument manufacturer to insure exact replacement. Individual components for meter movements are often not stocked, however, and the meter movement must be repaired by a shop which specializes in such work.

When replacing selenium rectifiers in the v.t.v.m. or when replacing crystal diodes in high-frequency probes, be sure to observe polarity. Incorrect installation of these parts may result in damage or improper circuit operation.

## Tube replacement

Most v.t.v.m.'s are supplied with tubes which have been specially aged at the factory before installation in the instrument. In some instruments it is necessary to select tubes. Tubes are picked or



aged to insure a low value of gas and contact-potential current. While the tube replacement requirements may differ somewhat between instruments of different manufacturers, it is usually desirable to age replacement tubes for bridge circuit and a.c.-signal rectifier applications.

Proper selection and aging of the bridge tube is usually required in v.t.v.m.'s which utilize bridge circuits of the types described in Chapter 2. Unless the tube has suitable operating characteristics and a low value of gas current, it may cause off-zero deflection of the meter pointer when the RANGE switch is changed from the lowest d.c.-voltage range to the higher ranges. This condition requires that the operator rezero the meter pointer whenever ranges are changed. Often, a tube will prove unsuitable for installation, even after a lengthy aging period. The acceptability of a tube for bridge-circuit use will depend upon the design of the v.t.v.m. and the manufacturer's recommendations. In most cases, however, a change of one or more divisions in the meter-zero setting as the RANGE switch is changed indicates that the tube requires more aging or that the tube is unacceptable for use in the v.t.v.m. If a number of new tubes are available, they should be installed in the instrument, one at a time, before aging, to determine which tube has the lowest value of gas. The tube which produces the least amount of off-zero deflection as the range is changed is the best tube to select for aging.

Single or twin diodes used in the a.c.-signal rectifying section may or may not require selection or aging before installation. As requirements for replacement will depend upon circuit design and the particular v.t.v.m. involved, the manufacturer's recommendations should be followed. In general, however, the tube selected should provide a minimum amount of off-zero deflection of the meter pointer when the FUNCTION switch is changed from d.c. volts or ohms to a.c. volts as well as a minimum amount of deflection as the RANGE switch is rotated. Internal adjustments are provided on many instruments, however, to compensate for differences between various signal-rectifier tubes, hence tube selection and aging may not be critical.

A new tube may be aged by installing it in the v.t.v.m. and running the instrument for a number of hours or days. An alternate and ordinarily quicker method of tube aging makes use of a simple external setup such as that shown in Figure 1102. This setup may be used for either triodes or diodes. In the case of triodes, the grids and cathodes are tied to one side of the a.c. line and the plates are

tied to the other side of the line. Filaments should be operated at a normal filament voltage supplied by a separate transformer. Diodes can be aged in the same way, except that no grid connections are required.

The aging period required is from 24 to 100 hours, depending upon the type of tube and instrument involved. Aging of tubes by this method usually requires a shorter length of time than when the tube is aged in the instrument.

Whenever a new tube is installed in the v.t.v.m., the instrument should be checked for calibration and accuracy. In some instru-

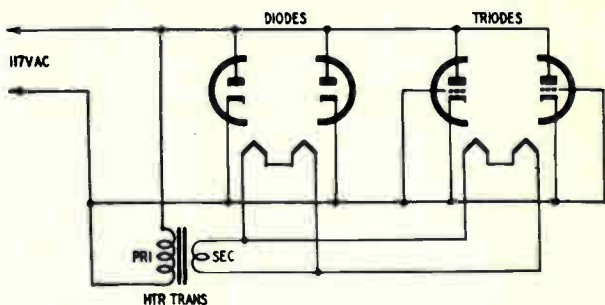

Fig. 1102. Setup for aging diodes and triodes to be used in the v.t.v.m.

ments it may be necessary to recalibrate to insure accurate a.c. and d.c. voltage measurements.

### Measurement accuracy

The degree of accuracy or inaccuracy with which a v.t.v.m. will provide a voltage reading is usually expressed in percent of full-scale reading. A typical figure is  $\pm 3\%$  for d.c.-voltage measurements. The error is introduced primarily by two factors: (1) error in the meter movement and (2) variance in the values of the precision resistors used in the divider networks. These errors may be cumulative. For example, if the meter movement causes a reading which is low by two percent and the resistor network introduces an additional error of minus one percent, the v.t.v.m. will indicate a value which is three percent lower than the actual value of the test voltage. It is also possible for the tolerance of the meter movement to be off in one direction and for the error in resistance value to be off in the opposite direction so that the total measurement error is only 1%. The error can be high or low.

Before the technician decides that his v.t.v.m. is providing scale indications which are out of tolerance with the manufacturer's

specifications, however, he should make sure that the standard which he is using is accurate. It is not sufficient to make a comparison with the readings of other voltmeters. The v.t.v.m. readings should be checked against those provided by a laboratory standard or against a calibrating voltage which is carefully regulated.

When it is suspected that changed-value divider resistors are causing incorrect readings, these components should be checked on an accurately calibrated resistance bridge. Because many resistors used in commercial v.t.v.m.'s are designed to be accurate to three and four numerical places, conventional resistance-measuring meters cannot be depended upon to measure their values accurately.

Factory-fresh flashlight cells are a fair substitute for a voltage standard for checking measurement accuracy on d.c.-voltage ranges. When new, a flashlight cell should provide a voltage of 1.55 volts under the high-resistance load of the v.t.v.m. Two of the cells can be connected in series to make a three-volt test source.

### **Mechanical zero setting of the meter**

When the v.t.v.m. is switched to "off", the meter pointer should come to rest at the left-hand zero mark. If the pointer comes to rest above or below the zero mark, the mechanical zero should be adjusted. This is an adjustment which is accessible from the front of the meter case and may be either a small set screw or a lever. On some v.t.v.m.'s, the screw head of the adjustment is accessible through a hole in the meter case. This hole may be covered with a small cap or screw plug. The cap or plug should be removed and the set screw adjusted with a small screw driver to bring the pointer into line. V.t.v.m.'s equipped with a lever adjustment can be zeroed by inserting a small scriber or similar tool into the hole and moving the lever right or left, as required. When making lever adjustments, however, take extreme care to avoid inserting the scriber into the movement. Always replace the screw plug (or cap) as this part is provided as a dust and hermetic seal.

### **Analyzing and localizing trouble**

When troubleshooting a defective v.t.v.m., the technician should apply the same methods of analysis he employs in troubleshooting a defective radio or television receiver. Like the TV set, the v.t.v.m. has a number of individual sections and circuits which

perform specific functions. In the v.t.v.m., however, some of these circuits, such as the a.c.-signal rectifier and the ohms-divider network, are used only for one or two types of measurements. These circuits are inoperative (disconnected) for all other functions. Other circuits, such as the power supply, bridge circuit, and indicating meter, are employed for all operations of the v.t.v.m.

To make an intelligent analysis of the v.t.v.m. defect, therefore, the technician should understand the function of the different

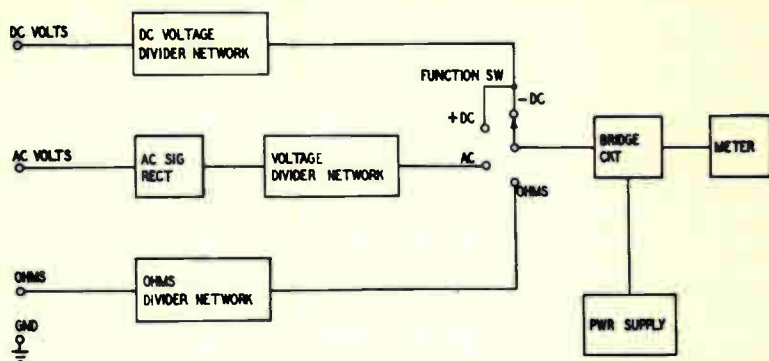

Fig. 1103. This block diagram represents the circuit arrangement in many v.t.v.m.'s.

circuit sections. These functions and typical circuits are described in Chapter 2.

The first step to be taken in localizing trouble consists of inspecting the performance of the v.t.v.m. on all ranges and functions. The FUNCTION switch should be set to the first position, (-D.C. VOLTS, for example) and the RANGE switch rotated to each of its settings. The FUNCTION switch should then be turned to the next position and the RANGE switch again rotated through all its positions. This procedure should be repeated for all remaining settings of the FUNCTION and RANGE controls. Probes and cables should be tested in a routine application at each step of the inspection to determine whether v.t.v.m. operation is normal. When this complete check has been made, the technician should have a complete picture of overall performance. If the v.t.v.m. is inoperative on all functions, the trouble can be looked for in sections or circuits common to all functions. If the defect occurs only on one or two functions or ranges, the technician should look for trouble in the corresponding sections of the instrument.

If the cause of the trouble is not immediately apparent, the technician should make a simple block diagram of the instrument,

tracing out the basic circuits on the schematic diagram provided in the instruction manual. Representative block diagrams of two v.t.v.m.'s are shown in Fig. 1103 and Fig. 1104. Different commercial instruments will present numerous variations in design from the layouts shown here, but the circuit switching and relationships of the voltage-dividers and electron-tube circuits are similar.

Fig. 1103 shows a simplified and straightforward layout common to many commercial v.t.v.m.'s. This circuit employs three different voltage dividers for d.c. volts, a.c. volts, and ohms measurements. Analysis of the diagram will show that only one of these divider circuits is operative at any one time. When the FUNCTION switch is set to plus or minus d.c. volts, for example, the ohms and a.c. networks are disconnected from the circuit. The bridge circuit, power supply, and indicating meter, however, are employed on all three functions.

The technician should have little difficulty in localizing trouble in an instrument of this design. For example, if the v.t.v.m. fails to indicate on any function, the trouble must lie in the three sections common to all functions — the bridge circuit, power supply, or meter. Faulty operation on ohms measurements only would pinpoint the source of trouble to the ohms divider network, the ohms probe and cable, or the associated circuitry. The preliminary checks described here are important to localizing and detecting the source of trouble.

When troubleshooting the defective v.t.v.m., the technician should not overlook the probes and cables as a source of trouble. These accessories should be inspected carefully during the preliminary tests and moved and flexed about during each step of the inspection to make sure no intermittent shorts or opens are responsible.

A v.t.v.m. of somewhat different design is shown in block-diagram form in Fig. 1104. This arrangement is similar to the design employed in the RCA WV-97A Senior VoltOhmyst and other commercial instruments. As is common with many v.t.v.m.'s, a single input circuit is used for both a.c. and d.c.-voltage measurements and a single test cable is used for both functions. The input is switched inside the v.t.v.m. to channel the test voltage to the proper circuit.

The probe used with this type of v.t.v.m. may be a switch type, such as that described in Chapter 4, to permit removal or addition of an isolating resistor for d.c.-voltage measurements. The instrument of Fig. 1104 employs a common voltage divider for both a.c.

and d.c. voltage measurements. On d.c. volts, the input signal is fed directly to the voltage divider and then to the bridge circuit. On a.c. volts, the signal is first rectified by the a.c.-signal rectifier and then fed to the voltage divider as a d.c. voltage. A defect in the a.c.-d.c. voltage-divider network will affect operation of the v.t.v.m. on both these voltage functions. Improper operation on a.c.-voltage measurements only would point to the a.c.-signal rectifier section as a source of trouble.

The a.c. signal section incorporates a special high-voltage divider network between the a.c.-voltage terminal and the signal rectifier section. This network usually consists of two or three precision

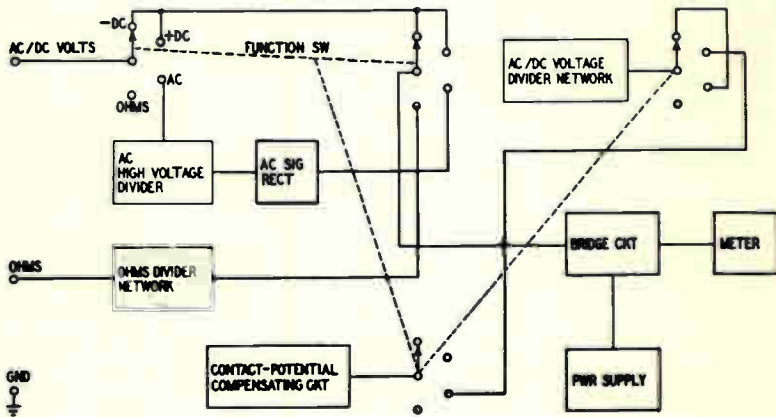

Fig. 1104. Block diagram of the various circuits of a v.t.v.m. This instrument uses a contact-potential compensating circuit for a.c. voltage measurements.

resistors which are switched into operation only on the highest a.c.-voltage ranges. The function of the divider is to attenuate high a.c. voltages before they are applied to the relatively low-voltage signal rectifier. This design feature prevents overloading and possible damage to the rectifier tube on high a.c.-voltage measurements (500 to 1,500 volts r.m.s.).

A compensating circuit for contact potential is provided with this v.t.v.m. The circuit is operative only when the v.t.v.m. is set up for a.c.-voltage measurements as compensation is not required on d.c.-voltage and ohms functions. The switch wafer in this section is ganged to the FUNCTION switch. The output from this section is fed either to the bridge circuits, as shown, or to the a.c.-signal rectifier section. Operation of contact-potential compensating and bucking circuits is discussed in detail in Chapter 2.

A complete schematic diagram for a v.t.v.m. which employs this arrangement is shown in Fig. 1105.

### Description and analysis of two commercial v.t.v.m.'s Simpson 303

The complete schematic diagram of a typical commercial v.t.v.m. is shown in Fig. 1105. This instrument, the Simpson model 303, will measure resistance values up to 1,000 megohms and a.c. and

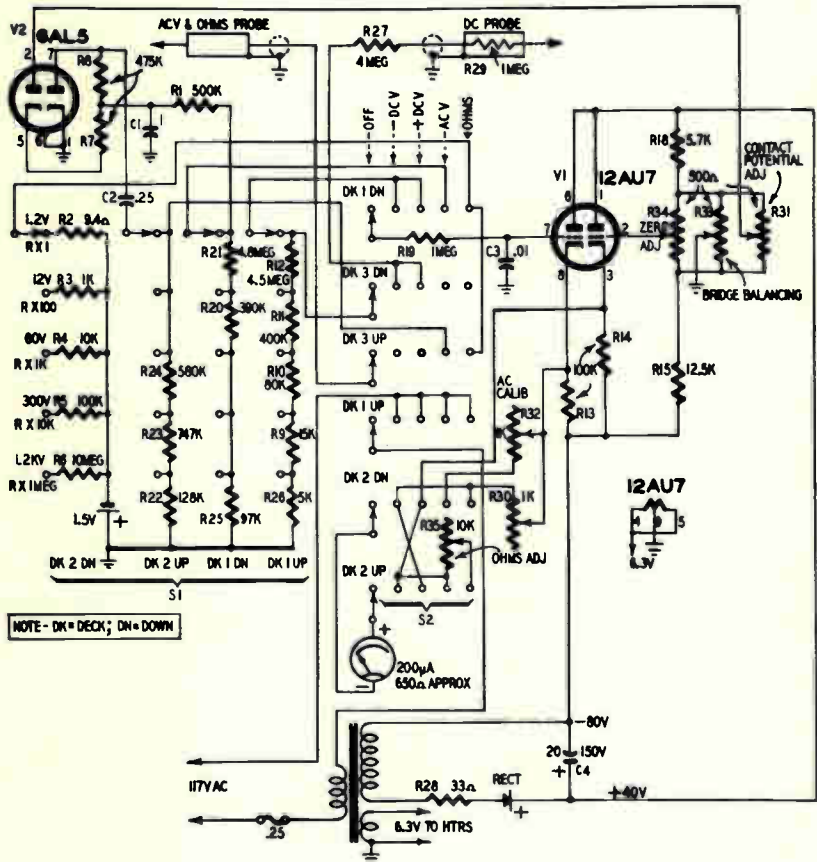

Fig. 1105. Complete diagram of a vacuum-tube voltmeter. The circuit is analyzed in the text and in the illustrations which follow.

d.c. voltages up to 1,200 volts in five ranges. A single probe is used for both a.c. volts and ohms measurements. A separate d.c.-voltage probe is provided. An r.f. signal-tracing probe (not shown in





Fig. 1106 shows the simplified diagram of the circuit used for d.c.-voltage measurements. The circuit selector is set to the +DC position and the RANGE switch is set to the 1.2 v position. On d.c. volts, the total input resistance of the 303 is 10 megohms and consists of the resistance of the divider resistors, R26, R9, R10, R11, R12, R27, and the isolating resistor in the probe, R29. This input resistance is constant for all ranges. The divider and associated bridge circuitry is designed so that the voltage required at the grid of bridge tube V1 for full-scale deflection is the same on all ranges, regardless of the setting of the range selector. Resistor R19 and capacitor C3 constitute a filter circuit to keep a.c. and r.f. out of the bridge circuit. A fixed negative bias is applied to the cathodes of V1 from the power supply through resistors R13 and R14, which provide a small amount of self bias. The relatively high values of R13 and R14 result in degeneration in the cathode circuits, thereby promoting stability and linear operation.

Potentiometer R33 is provided to permit balancing the two sections of the 12AU7 bridge tube. R30 is connected in series with the meter on all d.c.-voltage ranges and is the calibrating control for d.c. voltage measurements. Both R30 and R33 are adjusted at the factory.

When the d.c. probe and ground cable are connected to a d.c.-voltage source, the test voltage is applied across the complete divider network. A proportional amount of the voltage is tapped off by means of the RANGE switch. This voltage is fed to the grid of the left-hand bridge tube, causing a meter reading which is proportional to the applied voltage.

Examination of the circuit arrangement used on a.c.-voltage measurements (Fig. 1107) shows that a different divider is employed in conjunction with a 6AL5 twin diode-rectifier. A.c.-signal voltages up to 60 volts are fed directly to the rectifier tube. On higher voltage ranges, a special divider network, consisting of R22, R23, and R24, is switched in automatically for measurements on the 300- and 1,200-volt ranges in an arrangement like that shown in Fig. 1104. Capacitor C2 serves as a blocking capacitor to keep d.c. voltage out of the circuit on all RANGE switch settings. The rectified output voltage (d.c.) is applied across the voltage divider made up of R20, R21, and R25, and is fed to the bridge circuit.

Potentiometer R31 is provided as a contact-potential adjustment. To avoid the necessity for resetting the zero adjustment when switching from a.c. to d.c. voltage measurements, or vice versa, the contact-potential voltage developed by the rectifier sec-



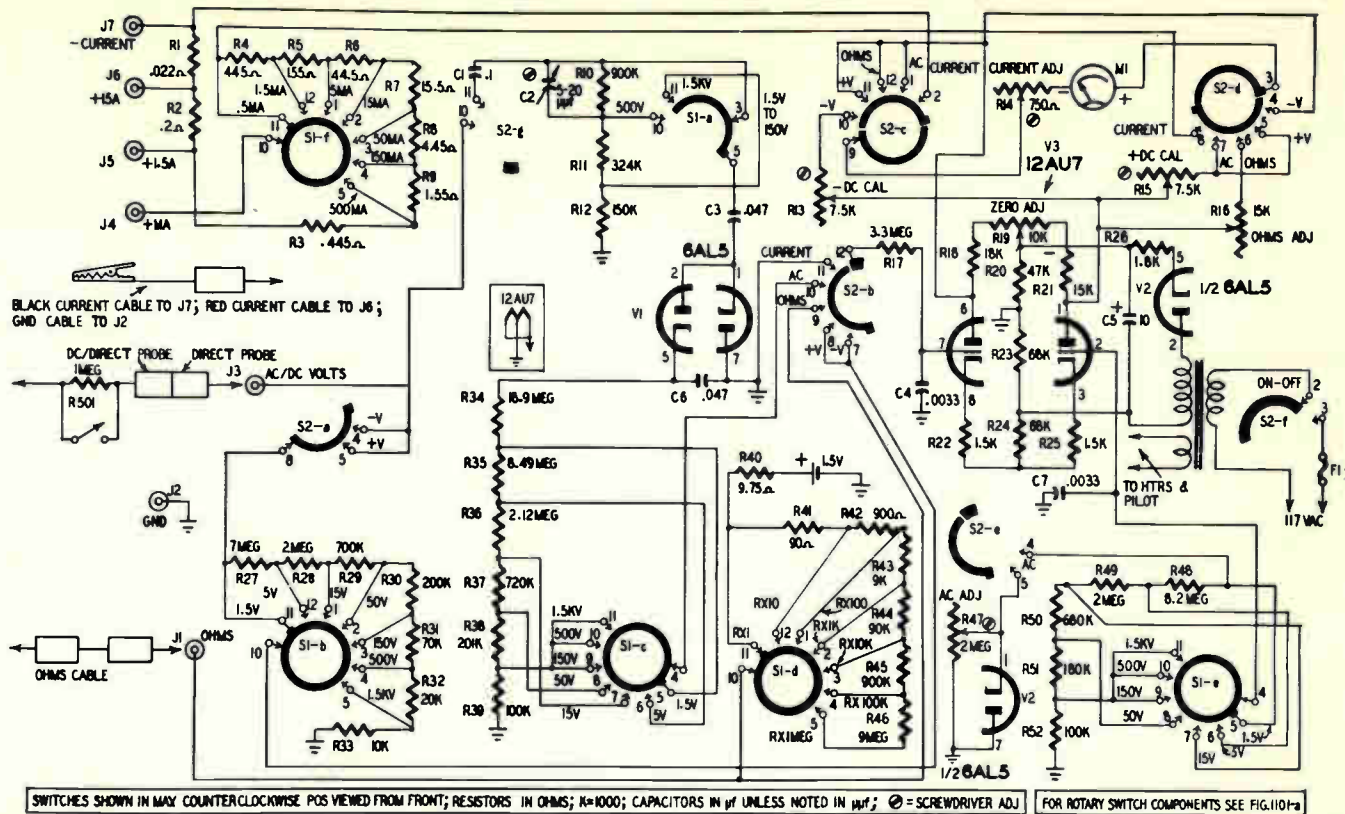

Fig. 1109. Complete circuit diagram of the vacuum-tube voltmeter described in the text. The troubleshooting procedure for this instrument can be applied to any v.t.v.m.

is shown in Fig. 1109. This instrument will measure resistance values up to 1,000 megohms, d.c. and a.c. (r.m.s.) voltages up to 1,500 in seven ranges, and direct current from 10 microamperes to 15 amperes in nine ranges. A simplified block diagram is shown in Fig. 1110. Examination of the block diagram shows that separate resistance dividers are used for each of the major functions

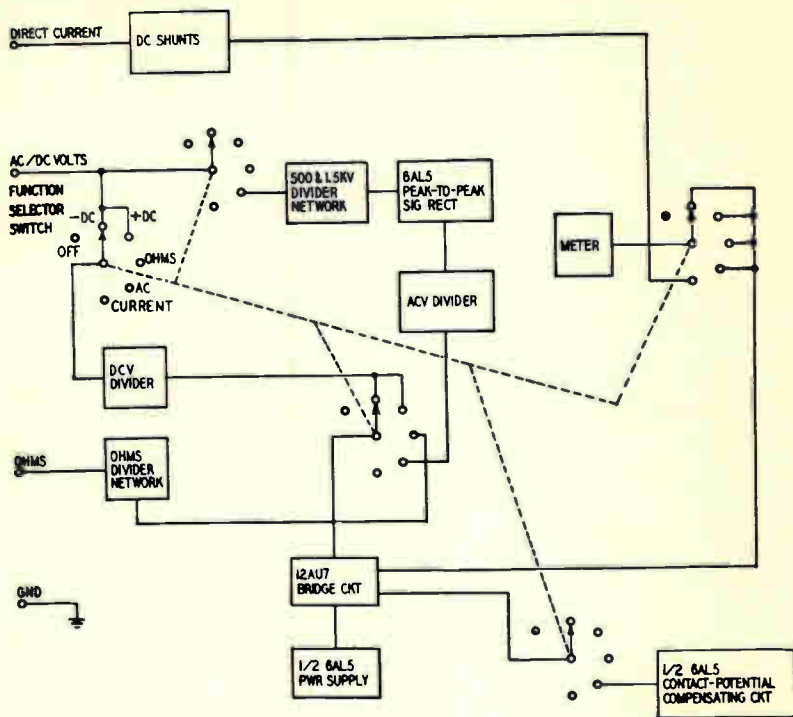

Fig. 1110. Complete block diagram of the v.t.v.m. illustrated in Fig. 501. This instrument has provisions for measuring direct current, up to a maximum of 15 amperes.

and that the vacuum-tube bridge circuit is not used when the v.t.v.m. is employed to measure current. In block-diagram form, the instrument appears in its simplest form and the relationships between the different circuits and functions is readily apparent. A front-panel view of the Master VoltOhmyst is illustrated in Fig. 501. Two interior views are shown in Figs. 1111 and 1112.

To gain some experience with circuit tracing and to acquaint ourselves with some of the problems and techniques encountered in troubleshooting any defective v.t.v.m., let us anticipate a variety of possible troubles and, from examination of the block and sche-

matic diagrams, list the possible causes. Because v.t.v.m.'s have so much in common in their design and operation, we should be able to apply much of the following discussion to other instruments.

(Note: At this point, the technician might wish to list a number of operating defects and, with the aid of the schematic diagram, list for himself some of the possible causes. When the list has been completed, it can be checked against the possible causes listed below.) Components and tubes, described in the list of v.t.v.m. troubles on this and following pages, are illustrated in Figs. 1109, 1111, and 1112.

## General Troubles

### Symptom

1. Instrument fails to operate on all functions except current; tubes do not light.

### Possible Causes

- a. Line cord broken or not making contact at outlet.
- b. Switch section S2F defective.
- c. T1 defective. Check continuity of windings and resistance to ground.
- d. Fuse F1 open.

### Symptom

2. Instrument fails to operate on all functions except current; tubes light, ZERO ADJ does not work.

### Possible Causes

- a. Broken lead in ground cable or J2 defective.
- b. Incorrect operating voltages on bridge tube. Measure voltages with another voltmeter.
- c. V2 or C3 defective.
- d. Open or short circuit in V3 bridge circuit. Check out with ohmmeter. Check R26, C5, T1 secondary (plate winding), and meter leads.
- e. Switch section S2B, S2C, or S2D defective.

### Symptom

3. Meter pointer sticks.

### Possible Causes

- a. Cracked or broken jewel bearing in meter.

- b. Scale plate of meter is loose and is striking meter pointer (remove meter from case and tighten screws).

### Symptom

4. Meter pointer bangs hard left or right, depending upon setting of FUNCTION switch.

### Possible Causes

- a. Open or short circuit in bridge circuit.

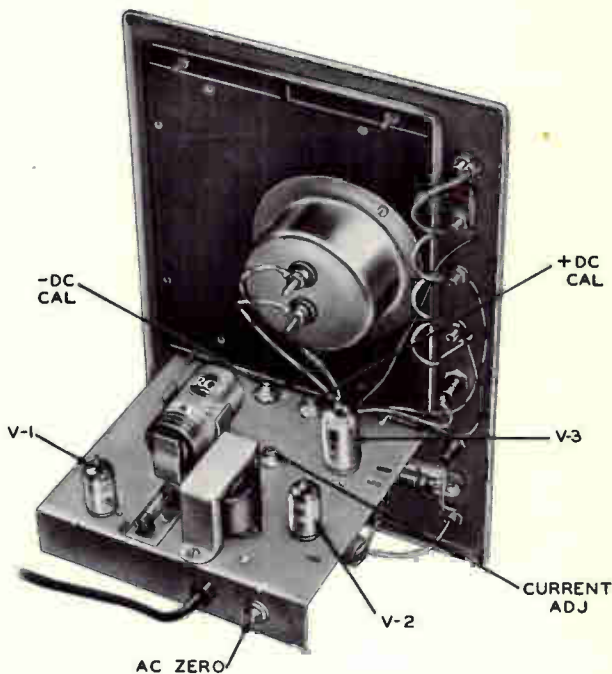

Fig. 1111. View of the interior of a v.t.v.m. Voltage and current calibration adjustments are easily available, can easily be made with a screwdriver. The battery (used for ohms measurements) is clamped into place, but a new unit can be readily substituted.

### Symptom

5. Intermittent operation on all functions except current.

### Possible Causes

- a. Loose or broken connection in ground cable. (Check by flexing cable and observing meter readings.)
- b. Wiper contact on S2B, S2C, or S2D defective.
- c. Loose or broken connection in bridge circuit wiring. With

power applied, check wiring, connections, and components with insulated probe.

- d. V2 or V3 defective.

## **Ohms-Function Troubles**

### **Symptom**

1. Instrument fails to operate on OHMS; works normally on A.C.- and D.C.-voltage measurements.

### **Possible Causes**

- a. Battery exhausted or not making contact.
- b. Loose or broken connection in ohms cable. Check by flexing cable and observing meter readings.
- c. Defective wiper contact on switch section S1D.
- d. Open circuit in resistor network, or burned out resistor around switch section S1D (ohms-divider section). Note: This network is made up of resistors which are added in series as the switch is rotated. Therefore, one faulty resistor may cause improper operation on one or more ranges.
- e. OHMS jack, J1, or its attaching lead is open or shorted to other wiring or to instrument case. Check resistance to case and adjacent wiring.
- f. Loose or broken "ohms" contact on switch section S2C (terminal 12) or S2D (terminal 6).
- g. Cable connector not making contact.

### **Symptoms**

2. OHMS ADJ control fails to give infinity setting on resistance scale.

### **Possible Causes**

- a. Ohms battery exhausted.
- b. Ohms adjustment potentiometer, R16, defective.
- c. V3 defective.

### **Symptoms**

3. Readings inaccurate on some or all resistance ranges.

### **Possible Causes**

- a. One or more resistors in network around switch section S1D have changed value.
- b. Excessive leakage in "ohms" circuit. Check switch wafers on

S1D and S2B for dirt or damage. Note: High humidity may cause leakage and inaccurate readings on high ohms scales. Bake out inside of instrument with low-wattage light bulb.

- c. Poor contact from ground jack to ground bus of chassis.
- d. Shorted wiring in resistor network around S1D.
- e. Faulty or high-resistance connections in "ohms" circuit.

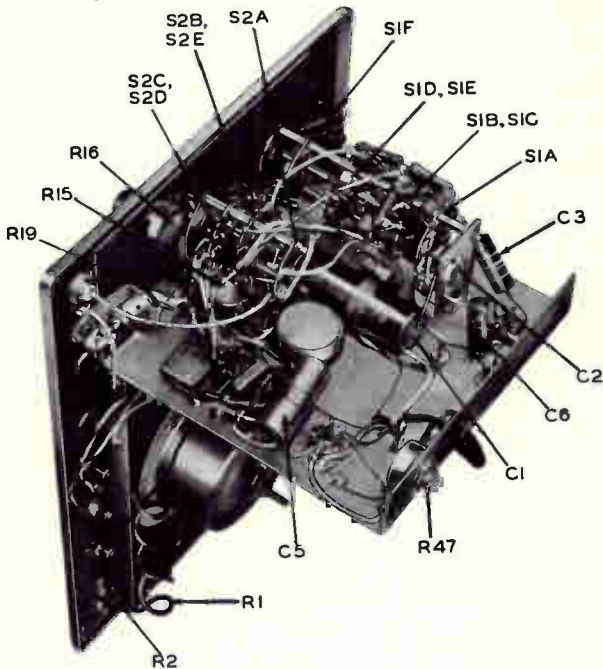

Fig. 1112. Underchassis view of a v.t.v.m. Note the way in which parts are mounted on the wafer switches. Components with code numbers can be identified by reference to the circuit diagram in Fig. 1109 on page 210.

### Symptoms

- 4. Meter pointer moves off infinity mark when RANGE switch is changed.

### Possible Causes

- a. Replace V3 with 12AU7 having a low value of gas current. Note: A small deviation should be considered acceptable.
- b. Excessive leakage in "ohms" circuit, possibly caused by high humidity. Check by baking out for several hours with light bulb. Do not overheat and damage capacitors.



## A.C.-Voltage Measurement Troubles

### Symptoms

1. Instrument fails to operate on any A.C.-voltage range; works normally on OHMS and D.C. VOLTS.

### Possible Causes

- a. V1 defective.
- b. A.c. volts contact on S2A, S2B, S2C or S2D defective.
- c. Faulty wiper contact on S1A.
- d. Open or short circuit in circuitry associated with V1. Check out wiring and components with ohmmeter.
- e. C1 or C3 open, C6 shorted, or R34 open.

### Symptoms

2. Meter pointer moves off zero when ranges are changed.

### Possible Causes

- a. A.c. zero potentiometer out of adjustment. If adjustment fails to correct trouble, then do steps b and c.
- b. Interchange V1 and V2 or replace one or both tubes.
- c. Resistor network around S1E defective. Check continuity and values with ohmmeter.

### Symptoms

3. A.c.-voltage readings inaccurate on some or all a.c. ranges; performance on OHMS and D.C.-voltage ranges is normal.

### Possible Causes

- a. Resistor network around switch S1C defective. Check values with ohmmeter.
- b. Defective contacts or wipers or excessive leakage in S1C. Check for loose or dirty contacts.
- c. V1 defective.
- d. C6 leaky.
- e. R34 changed in value.

Note: If instrument is inaccurate on 500- and 1,500-volt ranges only, check R10, R11, R12, and C2. If inaccurate on 1.5-volt range only, replace V1.

## D.C.-Voltage Measurement Troubles

### Symptoms

1. Instrument fails to operate on any range of +VOLTS or -VOLTS; works normally on OHMS and A.C. VOLTS.

### **Possible Causes**

- a. D.c. (isolating) probe is defective. Try applying low d.c.-voltage directly to direct-probe tip.
- b. D.c.-voltage contacts on switch sections S2A, S2B, S2C, or S2D defective. Check for loose or broken contacts.

### **Symptoms**

2. Instrument fails to operate on any range of +VOLTS but normal on -VOLTS or vice versa; works normally on OHMS and A.C. VOLTS.

### **Possible Causes**

- a. Potentiometer R15 or R13 defective. Check out with ohmmeter. Check R15 when +VOLTS is defective; check R13 when -VOLTS is defective.
- b. Defective contacts on switch sections S2A, S2B, S2C, or S2D. Check switches for loose or broken contacts.

### **Symptoms**

3. Voltage readings inaccurate on +VOLTS, -VOLTS, or both; a.c. voltage and resistance readings are correct.

### **Possible Causes**

- a. R13 and R15 out of adjustment.
- b. Isolating resistor in d.c. (isolating) probe has changed value. Measure resistance on OHMS function. Note: If one or more of the low-value resistors in the network around S1B have changed value, it is possible that the meter reading may be inaccurate on the 500- and 1,500-volt ranges but the inaccuracy may not be apparent on the lower ranges.

### **Symptoms**

4. D.c.-voltage readings incorrect; resistance readings correct.

### **Possible Causes**

- a. Resistance in network around S1B has changed value. Check out with ohmmeter and replace defective resistors.
- b. Switch contacts on S1B or S2A defective. Check for loose or broken contacts or foreign material.

### **Symptoms**

5. Instrument fails to function on d.c.-voltage measurements; works normally on OHMS function.

### **Possible Causes**

- a. Check d.c. (isolating) probe and cable and connectors.
- b. S1B network open.

### **Symptoms**

6. +D.c. and a.c. voltage readings incorrect; —d.c. normal.

### **Possible Causes**

- a. Recalibrate R15.
- b. R15 defective.

## **Current-Measurement Troubles**

### **Symptoms**

1. Instrument fails to operate on any current range. A.c. and D.C. VOLTS and OHMS functions normal.

### **Possible Causes**

- a. Switch contact on S2C (terminal 2) or S2D (terminal 8) defective.

### **Symptoms**

2. Instrument fails to operate on +MA current range; +1.5A and +15A ranges normal.

### **Possible Causes**

- a. Faulty wiper contact on S1F.
- b. Check +MA terminal for broken lead.

### **Symptoms**

3. Instrument operates only on low-current ranges, or no operation on any current range; A.C. and D.C. VOLTS and OHMS functions normal.

### **Possible Causes**

- a. Resistor network R1 through R9 defective. Check out with ohmmeter.
- b. Switch contact on S1F, S2C, or S2D defective.

A.C.:			
High-Voltage Rectifying Probe			
for			
Measurements, Wide-Range		136	
Frequency Response in	10		
Measuring Circuits	28		
Probes	49		
R.M.S. Scales	42		
A.C. Voltage:			
Measurement Troubles		216	
Measurements	71, 75		
Test Setup for Measurement of			
Low		132	
Voltage Scales		42	
Voltage Section of V.T.V.M.		207	
Accuracy, Measurement		201	
Adjustments:			
Alignment		118	
Audio Amplifier		126	
Meter Level		202	
A.G.C. Circuit Troubles		91	
Aging Tubes for the V.T.V.M.		200	
Aging Tubes, Setup for		201	
Alignment:			
Adjustments		118	
AM Receiver	103, 116,	117	
FM		103	
I.F.		115	
Ratio Detector		122	
R.F.		115	
Trap		97	
AM Receiver Test Points		106, 110	
AM Repair		103	
Amateur Radio		141	
Amateur Transmitters		141	
Amplifier:			
Adjustments, Making		126	
Audio, Checking Frequency			
Response of		133	
Circuit, High-Fidelity		124	
Circuits, R.F. Transmitter		147	
Control Settings, Audio		134	
Input and Output Impedances		135	
Neutralization		153	
Stages in Transmitter		146	
Amplifiers:			
Adjustment of High-Power		149	
Buffer		147	
Measurements in Audio		125	
Servicing Audio		123	
Analysis of Commercial V.T.V.M.		206	
Analysis of V.T.V.M. Defects		203	
Analyzing the Defective TV Receiver		79	
Analyzing Trouble in the V.T.V.M.		202	
Antenna Intermittents		170	
Antennas, Checking TV		170	
Applications of V.T.V.M.		62, 63	
Audio Amplifiers:			
Adjustments, Making		126	
Checking Frequency Response of		133	
Checking Stage Gain in		190	
Control Settings		134	
Measurements in		125	
Servicing		123	
Balanced Ratio Detector		122	
Banded Tone Records		134	
Bandpass Curve, Plotting a		95	
Bass Control		134	
Battery, Ohms		197	
Battery Voltages, Checking		159	
Bias:			
Arrangements		149	
Cathode		148	
Cells, Checking		160	
Checking Grid		147	
Fixed		148	
Grid		148	
Grid-Leak		148	
Operating		148	
Oscillator		145	

Protective .....	148
Supply, External .....	92
Breakdown of V.T.V.M. ....	196
Bridge:	
Balancing the .....	19
Circuit .....	16, 17
Circuit, Cathode-Metered ..	17
Circuit, Open .....	212
Circuit Operation, Cathode-	
Metered .....	20
Circuit, Plate-Metered .....	17
Wheatstone .....	167
Buffer Amplifiers .....	147
Burnout, Meter .....	127
Burnout-Resistant Meter Circuit	11
Buzz in Sound .....	91
Cable, Checking Coaxial .....	170
Cable Plug Tips .....	185
Cables .....	46, 46
Cables, Failure of .....	196
Calibrating an Oscilloscope ..	163
Calibrating Voltage Output of	
Generators .....	157
Calibration of V.T.V.M. Preamplifier	180
Cap, Meter .....	202
Capacitance, Excessive in Probe	186
Capacitor Leakage .....	113
Capacitors, Checking .....	83
Capacitors, Leaky Coupling ..	106
Cartridge, Checking Voltage Output	
of .....	193
Cathode Bias, Measuring .....	148
Cathode Follower Impedance ..	132
Cathode-Metered Bridge Circuit	
Operation .....	20
Causes of Hum .....	129
Cells, Checking Bias .....	160
Characteristics, Instrument ..	7
Checking:	
Battery Voltages .....	159
Bias Cells .....	160
Coaxial Cable .....	170
Current .....	182
Defective Picture Tubes .....	99
Frequency Response .....	133
Gassy Tubes .....	162
Impedance .....	171
Inductance .....	172
Local Oscillator .....	111
Ohms Battery .....	197
Phonograph Equalizers .....	135
Pickups .....	193
Potentiometers .....	162
Power Supplies .....	112
Power Transformers .....	172
Precision Resistors .....	168
Q of Coils .....	173
Reactance .....	171
R.F. Amplifier Gain .....	176
Selenium Rectifier Circuits ..	168
Stage Gain in Audio Amplifiers	190
Transformers .....	160
Transmission Lines .....	170
TV Antennas .....	170
Voltage Output of Phonograph	
Cartridges .....	193
Voltage Regulator Circuits ..	155
Circuit:	
Arrangement of V.T.V.M. ....	203
Control .....	65
Loading .....	8
Coaxial Cable, Checking .....	170
Coils, Checking .....	89
Coils, Checking Q of .....	173
Combined Probe .....	49, 50
Commercial V.T.V.M.'s, Analysis	206
Component Failures .....	103, 107
Construction of Preamplifier for the	
V.T.V.M. ....	179
Contact Potential .....	30, 205
Contact Potential, Correcting for	
Effects of .....	190

Contrast, Excessive Picture .....	91
Contrast, Insufficient Picture ..	91
Control:	
Circuit .....	65
Function .....	65, 198
Ohms Adjust .....	65
Range .....	65, 198
Selector .....	65
Zero-Adjust .....	19, 43
Controls, Bass and Treble .....	134
Controls, Front-Panel .....	65
Conversion Scales, DB .....	174
Conversion Table for Sine Waves ..	26
Crossover Frequencies .....	135
Crystal:	
Diode Rectifier Probes .....	49, 51, 52
Oscillator .....	144
Pickup, Checking .....	193
Curing Hum .....	129
Current:	
Gas in V.T.V.M. Tube .....	200
Grid .....	148
Measurements .....	145
Measurements, Meter Burnout in	182
Measurements, Modifying .....	
V.T.V.M. for .....	182
Measurements, Troubles in .....	218
Measuring Circuit .....	34
Readings with the V.T.V.M. ....	183
Cut Rotor Plates .....	118
DB:	
Conversion Scales .....	174
Measurements .....	136
Readings with the V.T.V.M. ....	174
Scales .....	175
DBM .....	137
DBM vs. R.M.S. Voltages .....	136
D.C.:	
Input to V.T.V.M. ....	21
Isolating Probe, Making a .....	189
Plate Voltage, Measuring .....	148
Probe .....	48
Screen Voltage, Measuring .....	148
Voltage-Divider Network .....	20
Voltage Measurement Troubles ..	216
Voltage Measurements .....	47, 70
Voltage Measuring Section of	
the V.T.V.M. ....	207
Decibel:	
Measurements .....	136
Readings with the V.T.V.M. ....	174
Scales .....	175
Defective Selenium Rectifier,	
Replacing .....	169
Deflection Circuits, Troubleshooting	100
Deflection, Off-Zero .....	200
Deflection Sensitivity of Scope ..	163
Demodulator Probe .....	49
Detail, Soft Picture .....	101
Detector:	
Alignment of Ratio .....	122
Balanced Ratio .....	122
Circuit, Ratio .....	121
Discriminator .....	121
Probes .....	49
Ratio .....	122
Unbalanced Ratio .....	122
Dial Out of Calibration .....	115
Direct Current Measurements .....	33, 72
Direct Probes .....	46
Discriminator Detectors .....	121
Divider Probes .....	56
Divisions, Scale .....	39
Doubler, Full-Wave Voltage .....	113
Dress, Lead .....	163
Dress, Poor Lead .....	129
Dummy Load .....	131
Eliminating Hum .....	128
Equalizers, Checking Phonograph ..	135
Error, Tracking .....	76
Experimental V.T.V.M. ....	186



Field-Strength .....	154	Picture Tube, Checking a Defective .....	99
Lever Adjustment .....	202	Placements of Parts, Poor .....	130
Loading Effect .....	9	Plate Feed, Series and Parallel .....	146
Mechanical Zero Setting of .....	202	Plate Supply Voltage, Measuring .....	148
Resistance .....	9	Plotting a Bandpass Curve .....	95
Screw Plug .....	202	Plug Tips .....	185
Shunts .....	183	Polarity of Ohms Battery .....	197
Misalignment .....	103, 115	Potential, Contact .....	30, 205
Miscellaneous Applications .....	157	Potential, Contact, Correcting for Effects of .....	190
Misuse of the V.T.V.M. ....	196	Potentiometers:	
Modifying the V.T.V.M. for Current Measurements .....	182, 183	Checking .....	162
Modifying the V.T.V.M. Scales for DB Readings .....	175	Noisy .....	162
Monitoring a TV Set .....	95	Taper of .....	163
Mounting Stand for the V.T.V.M. ....	185	Power:	
Multiplier:		Input to Amplifier .....	153
Factor .....	38	Output, Measuring .....	192
Probes .....	56	Output Stage, Heater-to- Cathode Leakage in .....	129
Resistor .....	57, 58	Power Supplies:	
Stages in Transmitter .....	146	Checking .....	112
Multipliers .....	67	Checking Selenium Rectifier .....	168
Neutralizing Indicator .....	153	Filtering Inadequate in .....	129
Neutralizing Triodes .....	154	Regulation of .....	156, 169
Noisy Potentiometers .....	162	Ripple in .....	158
Nonlinear Scales .....	41, 174	Testing Voltage Doubler .....	169
Null Indication .....	73	Tests of .....	88
Null Indications, Zero-Center .....	167	Voltage Regulated .....	156
Off-Zero Deflection .....	200	Power Transformers, Checking .....	172
Ohms:		Preamplifier for the V.T.V.M. ....	177
Adjust Control .....	65	Preamplifier Voltage Gain, Measurement of .....	132
Battery .....	197	Precision Resistors, Checking Value of .....	168
Battery Polarity .....	197	Precision Resistor, Using the V.T.V.M. as a .....	185
Battery, Replacing .....	197	Preventive Maintenance of the V.T.V.M. ....	196
Function Troubles .....	214	Probes:	
Measurements .....	71, 74	A.C. ....	49
Scale .....	41	Combined .....	49, 50
Open Tubes .....	104	Crystal Diode .....	49
Operating Bias .....	148	Damage to .....	196
Oscillator:		D.C. ....	48
Bias .....	145	Demodulator .....	49
Checking Local .....	111	Design of .....	50
Crystal .....	144	Detector .....	49
Operating Voltages .....	143	Direct .....	46
Stages, Checking .....	143	Divider .....	56
Variable-Frequency .....	144	Failure of .....	196
Oscillators, Calibrating Voltage Output of .....	157	High-Frequency .....	49
Oscillators, Testing of .....	144	High-Voltage .....	56
Oscilloscope:		Isolating .....	47, 134
Calibration of .....	163	Isolating Effect of .....	47
Frequency Response of .....	164	Making D.C. Isolating .....	189
Voltmeter Scales for .....	166	Making Rectifying .....	189
Output:		Multiplier .....	56
Measuring Power .....	192	Peak-to-Peak .....	55
Stage, Heater-to-Cathode Leakage in .....	129	Rectifying .....	49
Transformer Load .....	127	Resistance of .....	21
Tube Hum .....	190	R.F. ....	49
Voltage vs. Frequency Response .....	136	Storage of .....	185
Output and Input Impedances, Audio Amplifier .....	135	Switch Type .....	49
Overloading .....	91	Vacuum Tube .....	49, 53, 54
Parallel Plate Feed .....	146	Protective Bias .....	148
Parasitics .....	146	Push-Pull Transmitter Power Amplifier .....	151
Parts Placement, Poor .....	130	Q Measurements .....	172
Parts, Replacement of .....	199	Range Control .....	65, 198
Peak-to-Peak:		Range Switch .....	38, 40
Probes .....	55	Ratio Detector:	
Rectifier .....	33	Balanced .....	122
Rectifier Circuit .....	29	Circuit .....	121
Scales .....	42	Unbalanced .....	122
Value of Sine Wave .....	25	Reactance, Checking .....	171
Peak Value of Sine Wave .....	25	Receiver:	
Percentage of Regulation .....	159	Alignment, AM .....	116, 117
Phonograph Cartridges, Checking Voltage Output of .....	193	Circuit, FM .....	120
Phonograph Equalizer, Checking .....	135	FM .....	119
Pickups, Checking .....	193	Servicing the Shorted .....	191
Picture I.F. Amplifiers, Trouble- shooting .....	94	Records:	
		Banded Tone .....	134

Gliding Tone .....	134	Selenium Rectifier Circuits,	
Test Frequency .....	134	Checking .....	168
Rectifier:		Selenium Rectifier, Replacing	
Circuits, Checking Selenium .....	168	Defective .....	169
Circuits, Peak-to-Peak .....	29	Sensitivity of the V.T.V.M. ....	10
Peak-to-Peak .....	33	Series Plate Feed .....	146
Probes, Crystal-Diode .....	51, 52	Servicing Audio Amplifiers .....	123
Replacing Defective Selenium .....	169	Servicing the Shorted Receiver .....	191
Rectifying:		Setup for Aging Tubes .....	201
Probe, Making a .....	189	Setup for AM Alignment, Test .....	117, 118
Probes .....	49	Shielding .....	78
Probes for High-Voltage A.C.		Shielding, Inadequate .....	130
Measurements .....	186	Shock Hazard .....	142
Reference Levels, Standard .....	189	Shorted Receiver, Servicing the .....	191
Regulation, Percentage of .....	159	Shunts, Meter .....	183
Regulation, Power-Supply .....	156, 158	Signal Tracing .....	107
Regulator, Gas-Tube .....	156	Signal Tracing Audio Amplifiers .....	123
Repairs, AM .....	103	Sine Waves, Conversion Table for .....	26
Repairs, FM .....	103	Slip on Probes .....	46
Replacement of Tubes in the		Slotted Rotor Plates .....	118
V.T.V.M. ....	199	Snow in Picture .....	91
Replacement Parts for the		Soft Picture Detail .....	101
V.T.V.M. ....	199	Sound I.F. Amplifiers, Trouble-	
Resistance:		shooting .....	94
Matching, Modifying the		Sound, Intermittent .....	114
V.T.V.M. for .....	167	Spare Probes, Storage of .....	185
Measurement Network .....	23	Split-Sound TV, Test Points in .....	93
Measuring Circuit of the		Stage Gain in Audio Amplifiers,	
V.T.V.M. ....	209	Checking .....	190
Of Meter .....	9	Standard Reference Levels .....	139
Of Transformer Windings .....	160	Storage of Spare Probes .....	185
Of V.T.V.M. Input .....	21	Subdivision Marks on Scales .....	39
Probe .....	21	Substitution Tests, Capacitor .....	86
Readings Over Wide Ranges .....	12	Switch, Range .....	38, 40
Resistor:		Switch-Type Probe .....	49
Isolating .....	47, 184	Switches:	
Multiplier .....	57	Defective .....	212
V.T.V.M. as a Precision .....	185	Ganged .....	198
Resistors, Checking .....	87	Rotary .....	199
Response:		Troubleshooting V.T.V.M. ....	198
Curve, I.F. ....	97	Switching Arrangements in the	
Measurements, Frequency .....	130	V.T.V.M. ....	207
Of V.T.V.M., Frequency .....	27	Sync Circuits, Troubleshooting .....	100
R.F.:		Sync Noise Immunity, Poor .....	91
Alignment .....	115	Taper of Potentiometers .....	163
Amplifier Circuits, Transmitter .....	147	Test Points:	
Amplifier Gain, Checking .....	176	AM Receiver .....	110
Amplifier, Testing .....	150	FM Receiver .....	120
Output Signal Voltage,		Half-Wave Supply .....	111
Measuring .....	148	Intermittent Receiver .....	115
Probes .....	49	Transformer Full-Wave Supply .....	114
Signal Voltage, Measuring .....	148	Voltage-Doubler Supply .....	169
Voltages, Measuring .....	52	Test Probe, Making a .....	189
Ripple, Power-Supply .....	158	Test Records, Frequency .....	134
R.M.S. Value of Sine Wave .....	25	Test Setup for AM Alignment .....	117, 118
R.M.S. Voltages vs. DBM .....	136	Test Setup for Measurement of	
Rotary Switches in the V.T.V.M. ....	199	Low A.C. Voltages .....	132
Rotor Plates, Cut and Slotted .....	118	Testing:	
Safety .....	142	Amplifier Input and Output	
Scales:		Impedances .....	135
A.C., R.M.S. ....	42	Battery Voltages .....	159
A.C. Voltage .....	42	Oscillators .....	144
DB Conversion .....	174	TV High-Voltage Circuits .....	101
Division of .....	39	Time, Transit .....	51
For an Oscilloscope, Voltmeter .....	166	Tips, Plug .....	185
How to Read .....	39	Tracing, Signal .....	107
Linear and Nonlinear .....	41	Tracking Error .....	76
Low A.C. Voltage .....	42	Transformer:	
Modifying for DB Readings .....	175	Impedance Matching .....	161
Ohms .....	41	Isolation, Need for .....	109
Peak-to-Peak .....	42	Load, Output .....	127
Sharing of .....	38	Turns Ratio .....	161
Subdivisions of .....	39	Transformers, Checking .....	89, 160
Zero-Center .....	43	Transit Time .....	51
Scope (see also Oscilloscope):		Transmission Lines, Checking .....	170
Calibration of .....	163	Transmitter:	
Deflection Sensitivity .....	163	Amateur .....	141
Frequency Response of .....	164	Amplifier Stages .....	146
Linear Deflection of .....	164	Harmonics .....	146
Screen Voltage Measurements in		Multiplier Stages .....	146
Transmitter .....	147	Trap Alignment .....	97
Screw Plug, Meter .....	202	Treble Control .....	134
Selector Control .....	65	Triode Neutralization .....	154



Trouble in the V.T.V.M., Analyzing and Localizing	202	Field-Strength Meter	155
Troubles, Tube	80	General Troubles in the	212
Troubleshooting:		Hints and Kinks for	184
Audio Amplifiers	123	Improper Use of	196
Defective Components	83	Localizing Trouble in the	202
Deflection Circuits	100	Maintaining Switches in the	198
FM Receivers	119	Measurement Accuracy of	201
Picture I.F. Amplifiers	94	Meter, Setting of the	202
Sound I.F. Amplifiers	94	Miscellaneous Applications	157
Switches in the V.T.V.M.	198	Mounting Stand for	185
Sync Circuits	100	Preventive Maintenance of	196
Tuners	92	Replacement Parts for	199
TV	79	Rotary Switches in	199
Video Amplifiers	98	Switching Arrangements in the	207
Vacuum-Tube Voltmeters	195	Troubleshooting	195
Tube:		Troubleshooting Switches in the	198
Failures	103, 104	Tube Replacement in the	199
Heaters, Open	114	Voltage Standard	202
Hum in Output	190	V.T.V.M. Defects:	
Replacement	199	A.C. Voltage Range Defective	216
Troubles	80	A.C. Voltage Readings	
Tubes:		Inaccurate	216, 218
Aging for the V.T.V.M.	200	A.C. Zero Potentiometer Out of	
Checking Gassy	162	Adjustment	216
Gassy	105	Analysis of	203
Open	104	Broken Connection in Ohms	
Setup for Aging	201	Cable	214
Tuner Operation, Improper	93	Broken Ground Cable	212
Tuners, Troubleshooting	92	Cable Connector Not Making	
Turns Ratio of Transformers	161	Contact	214
TV:		Cracked Jewel Bearing in Meter	212
Antennas, Checking	170	Current Range Does Not Work	218
High-Voltage Circuit	101	D.C. Probe Defective	217
Troubleshooting	79	D.C. Voltage Readings	
Unbalanced Ratio Detector	122	Incorrect	217, 218
Unstable Picture	91	Defective Wiper Contact	214
Vacuum-Tube Probes	49, 53, 54	Excessive Leakage in Ohms	
Vacuum-Tube Rectifying Probe	51	Circuit	214
Variable-Frequency Oscillator	144	Exhausted Battery	214
Video Amplifier, Troubleshooting		Falls to Operate	212
in the	98	Faulty Resistors	214
Voice-Coil Impedance Matching	161	Faulty Wiper Contact	216
Voice-Coil Load Impedance	131	Fuse Open	212
Voltage:		Inaccurate Reading	214
Checking Battery	159	Instrument Does Not Read D.C.	
D.C. Plate	148	Voltages	217
D.C. Screen	148	Instrument Fails to Work on	
Divider Network, D.C.	20	Ohms	214
Doubler, Full-Wave	113	Intermittent Operation	213
Doubler Power Supply, Testing	169	Isolating Probe, Defective	217
Gain	132	Loose Connection in Ohms Cable	214
Measurement of Screen	147	Loose or Dirty Contacts	216
Measurement Troubles, A.C.	216	Meter Pointer Off Scale	213, 215
Measurements	75, 110	Meter Pointer Off Zero	216
Measurements, Low-Circuit		Meter Pointer Sticks	212
Loading in	8	Ohms Adjustment Control Fails	
Measuring High	152	to Give Infinity Setting	214
Output of Generators and		Ohms Adjustment Potentiometer	
Oscillators, Calibrating	157	Defective	214
Plate Supply	148	Ohms Jack Shorted	214
Regulated Supply	156	Open Bridge Circuit	212
Regulator Circuits, Gas Tube	155	Open Resistor Network	214
R.F. Output Signal	148	Probe Isolating Resistor Changes	
R.M.S. vs. DBM	136	Value	217
Sources for Ohms Measurements	23	Transformer Defective	212
Standard for the V.T.V.M.	202	Tubes Do Not Light	212
Voltmeter Scales for the		Zero Adjust Does Not Work	212
Oscilloscope	166	Wheatstone Bridge	167
V.T.V.M.:		Whistling Between Stations	115
A.C. Voltage Section of	207	Weak Signals	115
Aging Tubes for	200	Wide-Range Frequency Response	
Analysis of Commercial	206	in A.C. Measurements	10
Analyzing Trouble in the	202	Width, Insufficient	101
As a Precision Resistor	185	Zero-Adjust Control	19, 43, 65
Circuit Arrangement of	203	Zero-Center Null Indication	167
Complete Circuit of	206	Zero-Center Scales	43
D.C. Voltage Measuring Section	207	Zero Setting of the Meter,	
Experimental	186	Mechanical	202