

**elementary
radio
servicing**

RADIO • CRAFT LIBRARY

NO. 37

50 cents

RADIO • CRAFT LIBRARY No. 37

Concord Radio Corp.
Chicago
19918

elementary radio servicing

Prepared

By the Editors of



PUBLISHED BY

RAD CRAFT PUBLICATIONS, INC.

25 west broadway

new york 7, n. y.

Copyright, 1947
BY HUGO GERNSBACK
All Rights Reserved

First Printing—Feb. 1947
Second Printing—June 1947

Printed in United States of America

Elementary Radio Servicing

Planning the Service Shop— <i>Robert Dixon</i>	5
Equipping the Shop— <i>Fred Thompson</i>	9
Check List for Repairmen— <i>N. M. Smith</i>	11
Systematic Circuit Tests— <i>R. E. Altomare</i>	17
Signal-Tracing Methods	27
Servicing Midgets— <i>Harold Davis</i>	31
Soldering Pitfalls— <i>Eric Leslie</i>	36
Servicing Volume Controls— <i>J. Beever</i>	40
Servicing Radio Speakers— <i>Fred Shunaman</i>	44
Station Riding— <i>Leo G. Sands</i>	50
Service Sans Instruments— <i>Virgil R. Sears</i>	54
Service by Observation— <i>Lyle Treakle</i>	58
Useful Speaker Tester— <i>Archie V. Carpenter</i>	63

preface

THIS BOOK attempts to present to the beginner in radio repair a number of systems and methods already well known to the experienced serviceman. Works directed at "the serviceman" often unconsciously assume that the reader is familiar with the simpler aspects of the art. The beginner definitely does not possess that familiarity and finds such books difficult in spite of their obvious simplicity of style and terminology.

In this text, little previous knowledge of the business of radio repairing is assumed. Starting from scratch, it deals first with planning and equipping the shop. Fundamental service methods are then discussed, including some which are almost never mentioned in the literature of today. They are important because they form part of the store of knowledge of every old-timer in the game, applied unconsciously as the quickest and simplest means of shooting certain types of trouble.

The newcomer to servicing often has to start with a minimum of equipment. This is also taken into account. The important role of the radioman's own five senses and how he can use them (with the aid of simple accessories) is pointed out. Some special points which present difficulties to the beginner, such as certain methods of work and the repair of components, are covered. While of course no attempt can be made to be exhaustive in a book of this size, we hope that the new serviceman will find here material for which he may have looked in vain in other "simple" works on the subject.

Planning The Service Shop

THE FIRST step in planning a radio shop is to decide just where the shop is to be located. The beginner may set up in his kitchen or cellar, but when he has progressed to the point where he is able to go into business in earnest, we may assume that he is interested in a store site. Getting a business started is not always a simple matter. Details of electric light and power must be handled and arrangements for paying rent straightened out. As part of planning the shop, the serviceman finds it necessary to plan on stretching out his available capital. When first starting, he may not have a lot of money on hand, and what he does have may quickly be used up in buying test equipment, parts, and other things.

A telephone must be installed and someone must be on hand to answer the phone when he goes out on a job, for otherwise he will be greatly limited in what he can do. He should have a car, particularly if he lives in the country. In a city—for awhile—he may be able to get by without a car or truck, but it will be tough sledding. If he has a wife, girl friend, brother, or someone who loves him enough to work for practically nothing, that person may be enlisted to answer the phone. Later on, he can hire a youngster to do the job and to do minor errands around the shop.

Getting a toehold is the hardest part. After the ball is rolling, things won't be so difficult. It's like getting a stalled car to roll; once you gather momentum, your own motion helps to carry you along.

In the beginning you may not be so choosy about the location selected

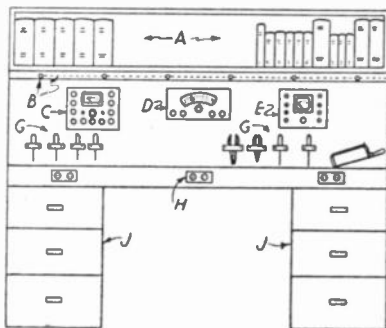

Fig. 1—Well arranged service bench. A—Books and manuals. B—Antenna jacks. C—Tube tester. D—Signal generator. E—Multimeter. G—Loops for tools. H—Electric outlets. J—Drawers.

for the simple reason that you can't afford to pay the rent for a choicer place. You may be content with a hole in the wall, as the saying goes. Small stores don't cost so much to rent, but they have to be cleaned up and painted, all of which costs money and takes time. Much can be done with ambition and a paintbrush. A bright, shining store front is an inducement to a customer to come in and find out what you have to offer. A distinctive store front will help in attracting trade, and in bucking competition. The man who is able to sell himself and his service will be the successful man, while the slovenly individual who allows his shop to look like a junk yard will find he doesn't get as much business as he could.

Clean, attractive show-windows are important

The windows, or window if there is only one, should be periodically washed, so that the public can look in and see something worthwhile. An old collection of defunct and dirty radio tubes thrown around willy-nilly is not a good way to use the space. The use of appropriate window dressing material is of great value. If your finances permit it, you may rig up an ordinary cathode-ray oscilloscope and arrange to have a periodic trace move across the screen, which will attract plenty of attention. The first step in getting a customer is to attract him, and a dynamic, vital window display will help. Later, too, a neon sign, particularly one that flashes on and off, will be of value.

When you have reached the point where you have sufficient capital to branch out into a real store and wish to select a site, bear in mind that you want a location near convenient transportation if possible. For example, in a city it is a great convenience to be located a block away from a bus or subway stop rather than six blocks away, making it easy for your customers to get to you and for your employees to get to radio distributors. If you are in a town, a location near the center of the town will be of greatest value. If you visualize the hub or center of a wheel and see the spokes radiating in all directions, it's going to be easy for you to get to any particular part of the town. If you are at the tail end of town and someone calls up from the other side, a good deal of time and energy is wasted in useless traveling on service calls. Too often this important point is completely ignored. Servicemen don't seem to think much about where they locate, leaving things pretty much to chance. There may be some justification for this, but where a choice presents itself the choice should be (other factors being equal) that of a central location. Just because you live on the far side of town, it doesn't necessarily follow that your shop should be located there.

In such cities as New York, where d.c. lines are still used, it may be necessary to arrange with the power company to bring a special a.c. line from the street into the shop; and if it can't be done for some reason, a location where a.c. is available should be chosen as an alternative.

Otherwise, fussing with unsatisfactory rotary converters and all sorts of trouble may be expected. Most test equipment operates on a.c. and the line regulation should be fairly good.

The lighting arrangements in the shop should be *the best you can afford*. In the beginning they may be anything but the best. A counter of some sort and a test bench will be needed. A desk and chair will be required, and a stool for the test bench. That all-important gadget, the cash register, will come later. The beginner simply may not be in a position to lay out the money for a cash register, and a tin box of some sort may be used temporarily. Whether a tin box or a cash register is used, a daily trip to the bank is advisable, particularly in large cities where crooks are often encountered. *Don't leave money lying around*, nor make an obvious show of cash in dealing with the public.

Another important, but practical business point, is that of locating the cash register when finally you do acquire one. Put it in the back of the store. It is also desirable to have the counter or work bench toward the back. If the customer starts to walk out of the shop with a midget radio under his arm, without paying for the repair (or new set) the distance that must be traversed between the counter and the door will mean that a certain amount of time will be required for him to get out of the store. More often than not, if you look up and see the set disappearing and yell bloody murder, he will drop it like a hot cake and run. Some bartenders keep a baseball bat behind the bar, and one behind the counter is not a bad idea. In a large city especially, all kinds of screwballs are on the loose. Trust no stranger. Be gentlemanly, courteous, but firm.

A bell arranged to ring when the front door is opened is also another valuable and worth-while idea. If you are selling midget sets, have the line cords *tacked down*, so that it will be somewhat difficult to remove the radios without attracting attention.

As for the service bench, every technician has his own pet ideas and the bench is usually more carefully thought out than the points men-

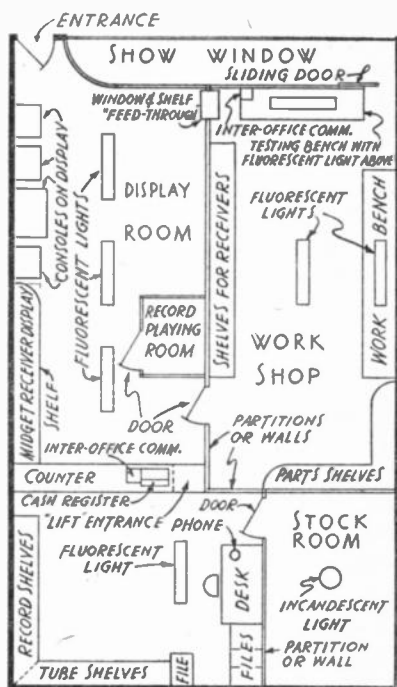

Fig. 2—An efficient layout for radio sales and service. It is desirable to separate the stock room and work shop as indicated, to permit a closer check on parts and tubes.

tioned above. Little will therefore be said about it. In the beginning, you may have only a volt-ohmmeter, signal generator and tube tester—the bare essentials. Later, you may add a condenser bridge, frequency-modulated generator, oscilloscope and signal tracer. A convenient gadget is a wood strip about $\frac{3}{4}$ -inch thick run across the top of the test bench. The strip has mounted on it tip jacks which are wired to the antenna. The set on the bench can then be connected to the antenna by means of a test lead which has an alligator clip on one end and a phone tip for plugging into the tip jack on the other end. A typical arrangement is shown in Fig. 1.

The layout of the shop will be directly related to your planned scope of activities. If you plan to sell sets as well as service, or to have booths where customers can listen to records, more space will be required. In congested city districts, space is at a premium and must be used efficiently. Rents are high. Your original service shop may evolve gradually into a shop where sales are important as well as service. In many cases sales become more important. As you gain experience in selling the public, you can branch out and sell appliances.

A service and sales shop is shown in Fig. 2. Note that the console-type radios, which can't be taken out readily, are put up front, while the midget sets and records are toward the rear. An office communicator is used for communicating between the rear of the shop and the servicing section. Unimportant details have been omitted from the drawing. To get to the rear of the store and to buy something cheap, such as a tube, a customer must pass the console radios and midgets. In passing, his eye may be attracted to a set, and there you have a potential purchaser of a receiver.

Booth for playing records a valuable asset

The booth used for playing records is a very profitable addition to the shop. It should be well constructed. It is desirable to use heavy wood and sound-absorbing material. The main thing is absence of excessive reverberation and barrel effect, and exclusion of noise that may be present outside. The music lovers won't mind standing inside the cramped space of the booth; some of them seem to love it. To compensate for some of the deficiencies of the booth, the amplifier should be equipped with bass and treble controls to permit altering the tone to fit the individual's ears. A high-quality heavy-duty speaker such as a good 12-inch job, which will not rattle on bass, should be used. A pair of type 6B4-G tubes in the output will give plenty of undistorted signal power; triodes are better for purity of tone than harmonic-generating pentodes or tetrodes unless inverse feedback is used.

EQUIPPING THE SHOP

“WHAT TEST equipment should I buy?”

A complete answer to this question would involve writing a book. Three essential pieces of test apparatus are necessary; a good volt-ohmmeter, signal generator and tube tester. The apparatus selected should be made by a well-known firm of good reputation. Cheap equipment is no better in radio than in a suit.

The volt-ohmmeter should be capable of measuring resistances as high as 10 or 20 megohms and voltages, a.c. and d.c., as high as 1,000. Special apparatus may be necessary for television sets, but the average service job can be handled efficiently using the above apparatus. The signal generator should be well shielded and equipped with a clear, accurately calibrated dial. It should be capable of covering a range from 100 kc to as high as 20 or 30 mc. Later, a special high-frequency generator for television and frequency-modulation work may be added, since very high frequencies are used for FM and television in the new bands.

The tube tester should be accurately calibrated. It is particularly important that the purchaser obtain with the instrument at the time of purchase full calibration data and instructions. The tester should be capable of testing all of the latest types of tubes used in receivers, especially miniatures and those with high-voltage heaters. Building a tube tester is utterly impractical. You would have no means of calibrating the instrument; a manufacturer may run tests on hundreds of tubes in developing a suitable tube tester, then construct an accurate master model. His testers placed on the market, then, are merely copies of the master model into which a great deal of research has gone. It is sheer folly to build your own instrument if accuracy is desired.

Later, a signal tracer, frequency-modulated generator, cathode-ray oscilloscope and capacity bridge may be added to the test bench. Many expert servicemen have no need for a signal tracer and scoff at the idea of using one—because they know fundamental radio principles very well and are able to apply them in testing.

Next most important question is: “What radio parts should I stock?”

Go slowly at first—buy only what you need. After doing a few jobs you will know what to order to meet your own requirements. In general, a number of small 16- or 20- μ f 150-volt electrolytics of the single negative, two positive terminal type will be useful. These may be midget varieties because they will fit easily into compact sets. It is important to distinguish between common negative and common positive condensers. A number of small 8- μ f and 16- μ f condensers rated at 450 volts may be used to replace filters in a.c. sets having power transformers and full-wave rectifiers. The 150-volt electrolytics are used in a.c.-d.c. sets. Refer to the diagram of the receiver you are servicing and to the manufacturer's data. A number of 400-volt paper condensers are useful. Obtain several in the following sizes: .01, .05, .006, .1 and .25 μ f. These will meet practically all requirements. Buffer condensers in auto sets often fail. These are high-voltage types rated at 1,200 or 1,500 volts. The higher voltage rating is desirable to minimize breakdowns.

Where to obtain diagrams

A third question frequently asked is: "Where may I obtain radio circuit diagrams?"

The answer might be "almost anywhere," but we can be more specific. Diagrams may be obtained through radio distributors and mail order houses; they appear in some radio servicing magazines; they may be obtained by writing directly to the manufacturers (some manufacturers have bound service manuals available at a reasonable cost); they may be purchased from firms specializing in selling service manuals, whose advertisements appear in radio servicing magazines. Some radio schools offer a diagram service to students.

Many people think radio is very technical and difficult to learn. They ask: "I've no mechanical ability beyond handling a screwdriver and pliers; can I learn radio?" In practically all cases, the answer is *yes!* Enroll in a good radio school. That is the most efficient way of getting started. Some individuals can learn by self-study, but a great amount of time is required. Some individuals—of unusual ability—may become better radiomen than the average product of radio schools; others, less brilliant, will not be thoroughly trained. For the average person, radio school training is essential. Even radio amateurs can benefit by taking a radio course, and thereby secure greater enjoyment from a fascinating hobby.

CHECK LIST FOR REPAIRMEN

A LARGE NUMBER of men who have taken courses in radio and electronics desire to go into the radio repair business. Many of them will open shops of their own. A *check list* will be an aid to these well-trained newcomers in the business as they go about repairing those all-important first few radios. This chart may also be of some help to other servicemen who have felt a need for a systematic, thorough procedure to be followed, but just "never got around to it."

This check list is not a ten-minute course in radio repairing. Previous training and experience are required to perform each step mentioned in the list. The items are listed as a reminder to the trained man of the necessary steps that must be taken to properly service a customer's inoperative radio.

A detailed explanation of each item in the check list is presented in the text of this article. The check list may be clipped out, pasted to a piece of cardboard, and located in a conspicuous place above the service bench. If this card is tacked to the vertical part of the work bench at eye level, the repairman is able to refer to it merely by glancing up from his work. Strategically located, this check list is a constant reminder that an orderly, thorough repair job is a satisfaction in itself and pays off in the form of added profits.

<u>C H E C K L I S T</u>	
1	VISUAL INSPECTION
2	TUBE CHECK
3	VOLTAGE MEASUREMENT
4	SIGNAL TRACING
5	REPAIR
6	TEST ALL CONTROLS
7	VIBRATION TEST
8	SENSITIVITY CHECK
9	ALIGNMENT
10	TWO HOUR CHECK

1. Visual inspection

a—Carefully inspect for defective a.c. cord and plug, fuse, and pilot light.

b—Look over the antenna, speaker, and ground connections.

c—The tubes also warrant a good visual check. You may find tubes loose in their sockets, or even cracked or broken glass envelopes.

d—On the upper side of the chassis, look for loose grid cap clips,

broken wires, shorted tuning condenser, and broken or slipping dial drive belt.

e—On the under side look for charred resistors or condensers, shorts, broken wires, defective power switch, tar from power transformer, excessive melting of filler in the condensers, and poorly soldered joints.

2. Tube check

a—Two things must be kept in mind when testing tubes:

A serviceman is never wasting time in *carefully* testing the tubes in a dead receiver.

Few, if any, tube testers have a conclusive test for a gassy tube. Watch for tubes that seem to have a mutual conductance above rated value, or those whose emission is above that given on the chart of the tube tester—they may be gassy.

b—If the radio is one of the popular a.c.-d.c. models and the filaments do not light, check *all* tubes.

c—If the rectifier, 35Z3, 35Z5, 25Z6, etc., is bad, check the high-voltage filter condenser in the set before turning on the power with a new tube in the socket.

d—If the radio has a power transformer, and one or more of the tubes do not light, check these first. but *test all tubes*.

3. Voltage measurements

a—Voltage measurements should be taken with the best voltmeter available. Many radio circuits have very high impedance and a voltage measurement is practically meaningless unless taken with a voltmeter whose sensitivity is 1,000 ohms per volt or better. *A vacuum-tube voltmeter is highly recommended.*

b—Measure the B-supply voltage on each side of the filter. In an a.c.-d.c. set this should be at least 90 volts on the filtered side, and about 115 volts on the cathode of the rectifier tube. In sets powered by a transformer the B voltage will vary from 200 to 400.

c—Measure the plate voltage of each amplifier tube. All tubes except the resistance-coupled audio stages and the second-detector diode should have a plate voltage very near the filtered B-supply voltage. The r-c stage or stages should have a plate voltage of about $\frac{2}{3}$ the B supply, depending on the type of voltmeter used. The second-detector diode plates should have a low voltage, either positive or negative, depending on the particular circuit used, but it should vary as the dial is tuned across a station if all stages from the antenna to the second-detector are functioning properly.

d—Measure the screen-grid voltage of all tubes. Whether or not an a.c.-d.c. model, the voltage should be about 100 volts on the r.f. amplifier, mixer, and i.f. amplifier tubes. Output tubes, if they are pentodes or beam-power tubes, usually are operated with the screen grids at full B voltage.

e—Measure the cathode voltage of all tubes. Cathode voltages will be either zero or a low positive value. If a cathode voltage is as high as the screen-grid or plate voltage, it indicates an open cathode bias resistor or an open lead between cathode and ground. The cathode voltage of the output tube will be the highest of any of the tubes if the set is operating properly and will vary from about 6 volts in an a.c.-d.c. receiver to about 60 in a large transformer set with a push-pull output

f—Measure the voltage between the control grid and cathode of all tubes. With a few exceptions, the grid should be negative with respect

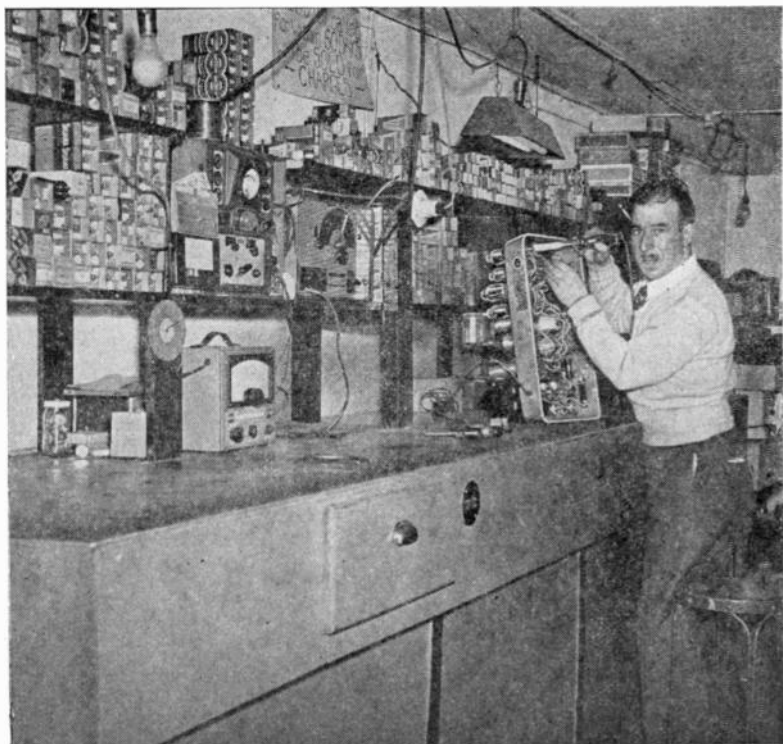

Fig. 3—A clean, neat shop saves time and promotes efficiency. Tools can be placed in cupboards under the bench.

to its cathode. If the output tube is a 6AC5 or 25AC5 the grid voltage may be about 15 volts above its cathode. If the grid voltage of any stage other than a direct-coupled stage employing a tube similar to a 6AC5 is more positive than its cathode, check the coupling condenser or transformer between the grid and the plate of the tube preceding it.

g—Measure the a.v.c. voltage if you have a vacuum-tube voltmeter or a voltmeter whose sensitivity is better than 5,000 ohms per volt. An a.v.c. voltage measurement taken with a lower sensitivity voltmeter is not reliable, and would be meaningless in most cases, since it would place a low-resistance shunt across the high-impedance a.v.c. circuit.

4. Signal tracing

a—A form of signal tracing is employed by every serviceman, whether or not it is known by that name. Two methods of signal tracing are in use today: The screwdriver method; and the instrument method. Each has its advantages and disadvantages, but the instrument method is strongly recommended. A signal-tracing instrument is nothing more than a detector followed by a high-gain audio amplifier. When signal tracing in the audio stages of a receiver, the detector stage of the signal tracer is bypassed by some switching arrangement or biasing scheme and the instrument is merely an audio amplifier.

b—Place the probe of the signal tracer on the antenna post of the receiver. Several stations should be heard.

c—Advance to the grid of the r.f. amplifier (or mixer grid if the set has no r.f. amplifier) and tune in a station with the receiver's station selector (tuning condenser).

d—Next, check the plate of the stage—the signal should be stronger. Follow through all r.f., mixer (converter) and i.f. stages, testing grids and plates for the signal. If the signal is not heard at one of these points, you have located a stage that is not functioning properly. Trace out the circuit around this point with an ohmmeter, watching for open circuits, shorts, etc. This information, together with voltages already measured, will enable you to determine the trouble and correct it.

e—After the r.f. and i.f. stages have been tested, the signal tracer is changed over to audio, and the audio stages are tested in the same manner.

f—If the shop does not have a signal tracer, the screwdriver method is used. The grid of the output stage is momentarily shorted to chassis or ground with a metal screwdriver. A click should be heard in the speaker. Then short the grid of the tube feeding the output tube. A louder click should be heard. When a grid is shorted that does not produce a noise in the speaker, you have located the faulty circuit. Repair and continue back through the set until at last you are shorting the antenna post to ground. The click in the output should be heard. See also page 54.

g—An audio oscillator and r.f. signal generator may be substituted for a screwdriver, but their use will require more time than either of the two methods just described. These two instruments will be used for alignment and test, so for merely isolating trouble, save as much time as possible and locate the fault quickly.

5. Repairs and replacements

a—Use exact replacement parts supplied by the radio's manufacturer whenever possible.

b—When replacing resistors, bypass condensers, etc., use a quality part. You will save money in the long run by using quality resistors, condensers, coils and transformers and your repair work will stand up, thus giving you and your business a good reputation.

c—Use rosin-core solder, and make neat soldered joints. Soldered joints that look like tinned cabbage heads are a risk electrically and mechanically.

d—As to tubes—be honest with yourself and your customer. If a substitution must be made, use the closest substitute available. Do not replace a high- μ triode with a low- μ triode. Most commercial radios are well engineered, and they will not give standard performance if unwise tube substitutions are made. By all means, give the customer the best job of which you are capable.

6. Test all controls

a—The actual repair of the receiver is now completed, and all circuits are in working order. If an r.f. coil, i.f. transformer, or oscillator coil



Fig. 4—Another systematic service bench arrangement which will save time and speed up work. A telephone on the bench saves time in answering customers' calls.

has been replaced, you may have to roughly align the set at this point before continuing with this series of checks.

b—Test the tuning control for mechanical operation and note whether the dial calibration is correct.

c—Throw the main power switch several times to see that its action is positive.

d—In like manner try the volume control, tone control, phono-radio switch, and band-changing switches.

e—Tune the receiver across a station and observe the action of the tuning indicator or “eye”, if the receiver is equipped with one.

7. Vibration test

a—Select a station on the receiver and listen a few minutes to accustom yourself to the tonal quality and background noise of the receiver.

b—Test for noisy or microphonic tubes by sharply tapping each tube with the wooden handle of a screwdriver or similar instrument.

c—Rap the chassis on the work bench or strike it several times with a heavy rubber mallet to see if vibration produces any noise in the output.

d—A noise in the output produced by vibration indicates a defective component or connection, and should be eliminated.

8. Sensitivity check

a—If the manufacturer's data on absolute sensitivity of a set is known, you should try to bring up the sensitivity of the receiver to that value. However, this information is usually not available to the serviceman and other tests must be devised.

b—Compare the repaired receiver's performance with that of a comparable receiver known to be in very good condition. Use the same antenna on both receivers when making this test. The sensitivity should be tested on several stations scattered over the entire tuning range of the receiver. If the sensitivity of a receiver after repair is appreciably below that of a receiver with comparable tube line-up and power supply, it indicates that complete alignment is necessary. However, if its sensitivity is good, the serviceman should use his own judgment as to whether or not a particular receiver needs a complete realignment.

9. Alignment procedure

a—If the sensitivity of the receiver is below par, it should be aligned according to manufacturer's directions.

b—If neither manufacturer's procedure nor circuit manuals are available, standard procedure for superhet alignment should be used. This can be found in nearly any radio handbook. (It is assumed that the greatest percentage of receivers will be superheterodynes.)

c—The serviceman will encounter some t.r.f. receivers, and it goes without saying that t.r.f. alignment procedure will be used on this type.

10. Two-hour check

a—Now that the receiver has been repaired, aligned, and its sensitivity checked, it should be removed from the service bench and set up at some other location in the shop. It is turned on, tuned to a station, and allowed to play for about two hours.

b—At the end of this *time trial*, the sensitivity is again checked. If the set still is satisfactory, it is ready for delivery to the customer.

SYSTEMATIC CIRCUIT TESTS

THERE ARE four distinct and logical steps in servicing electronic equipment. These are:

- a. General diagnosis or analysis.
- b. Localizing the defective stage.
- c. Isolating the defective component.
- d. Replacement or repair of the defective part.

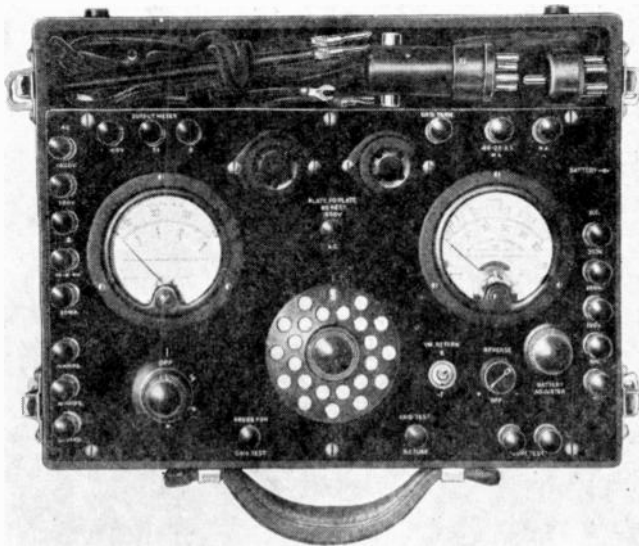

Fig. 5—A radio set analyzer of a type widely used a few years ago. (Photo courtesy Weston Electrical Instrument Co.)

a. General diagnosis.

The general diagnosis is important, as it may save much time. It includes noting the effects or type of trouble, and we should try to deduce logically the probable cause of the effect. The few moments this takes are well spent. Ask brief questions of the operator of the equipment to determine the history of the complaint. Did the set stop operating suddenly? How long has this trouble been manifest? It also includes looking

for surface defects such as: Do all the tubes light up (or get warm if they are metal tubes)? Are there any obviously broken connections, etc?

b. *Localizing the defective stage and*

c. *Isolating the defective component.*

The next steps should be to localize the defective stage and then isolate the defective part. For simplicity of presentation the two procedures will be discussed together. These steps are the most important in troubleshooting.

All methods of analysis fall into one of the following, or may be a modification or combination of one or more of them:

1. Set analyzer method.
2. Point-to-point resistance and voltage analysis.
3. Circuit disturbance method of isolation.
4. Stage squelching and elimination.
5. Signal substitution.
6. Signal tracing.
7. Visual dynamic analysis.

The first five will be described here. Signal tracing is the subject of the next section, and visual dynamic analysis cannot be considered a part of *elementary* servicing procedure.

1. The analyzer method

At one time the set analyzer was a common item around most radio service shops. The panel instrument consists of 2 or 3 meters, a few tube sockets, an assortment of push-button switches and jacks, and a rotary selector switch. Also included was a cable terminating in a 4- or 5-prong plug. Fig. 5 shows a typical instrument of this type having 2 meters. The meters include a multi-range d.c. voltmeter, a multi-range d.c. milliammeter and in some models an a.c. voltmeter.

The set analyzer is an instrument which checks the operating voltage and current to each tube element in a receiver or other electronic device by means of the plug and cable and the tube sockets on its panel. The tube of the suspected stage is removed from the chassis and placed in the proper socket on the analyzer, while the analyzer plug, with the proper adapter, is placed in the chassis socket vacated by the tube. Now, by rotating the selector switch or pressing the proper buttons on the analyzer, it is possible to check all voltages and currents, etc., since the switch automatically connects the proper meter in the circuit to measure the desired quantity.

Thus, obviously, we have a simple method of diagnosis. Observe that in the case of a radio receiver, it is not even necessary to remove the chassis from the cabinet, giving us the extreme advantage of simplicity.

In spite of these advantages, the set analyzer has become obsolete. It was at its best in the days of the 26, 27 and 71 or 45 tubes, when all sockets were either 4- or 5-pronged, and when there were only a few

tubes of more or less uniform type. Now we have 6-prong, large and small 7, octal, loctal, and bantam tubes and sockets. It is necessary to consult a manual frequently, even to find out which prongs are those of the filament. The danger of making wrong switch connections and damaging the instrument is great. To make matters worse, capacity between leads in the cable detunes some circuits. Before the gang condenser was common this was unimportant—now it throws the receiver out of operation and makes testing impossible.

Two reasons warrant consideration of the set analyzer: Special set analyzers are often furnished by manufacturers of military equipment for the armed forces, and the *free point analyzer*, an improved outgrowth of the set analyzer, is in quite common use today.

The special set analyzers are designed to check only the tubes and stages of a particular piece of equipment. Consequently, it is not necessary to incorporate in their design facilities for checking tubes other than those actually in the device to be checked. The set-up is therefore simplified and has a minimum of parts and accessories. A person trouble-shooting where such a special tester is available, is well advised to study and learn the technique by applying the instructions always provided.

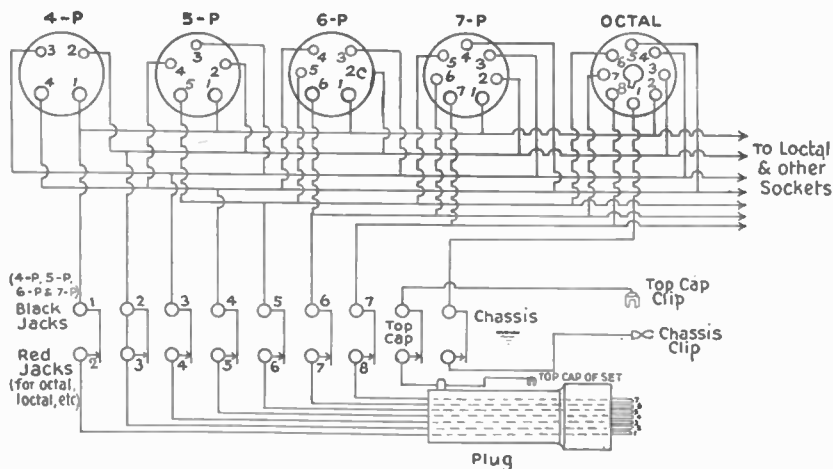

Same as Triplett 1220-A with sockets added.

Use Black Jacks only for voltage & resistance measurements.
For octals & loctals use corresponding Black Jack.

Fig. 6—Schematic circuit of a free-point set checker.

2. The point-to-point method

The free point analyzer does not include any meters or selector switches in its makeup. It consists, rather, of one each of all type sockets and a cable with an arbitrary plug (most often a large 7-prong plug) and one adapter for each type tube socket. The sockets are wired with an arbitrary prearranged plan, as is typified in Fig. 6. Note that in this case all the

No. 1 prongs are connected together and form one wire of the cable. Each line also includes two jacks, one set of which may be colored red and the other black. An alligator clip usually connects to the chassis, or B—, of the device under test.

It can be seen that it is a simple matter to check the voltage or resistance (with the set off) between any two elements of a tube or between any element and ground. A separate volt-ohm-milliammeter must be used. The black jacks are used exclusively for these tests. To measure the current drawn by any element the red jacks come into use. Now it is only necessary to connect the leads of the current meter, using the proper range and polarity, one lead to the red jack and the other to the corresponding black jack. Suppose it is necessary to measure the plate current of a 6J7 tube. A tube manual would tell us that the No. 3 prong is the plate in this tube. Placing the negative lead of the milliammeter in the No. 2 black jack on the analyzer and the positive lead in the No. 3 red jack, will determine the plate current, which is read on the milliammeter. When we measure current in this manner, a lead placed in any of the red jacks automatically opens the circuits to the line, placing the current-measuring device in series with that line.

Notice that in order to measure the current drawn by any element, it is not necessary to unsolder the lead to that element. As with a set analyzer, the radio receiver chassis does not even have to be removed from the cabinet, an advantage which is often ignored even by professional servicemen.

Finding the defective part

When we have isolated the defective stage and circuit with the set analyzer (or any of the methods to follow), it becomes necessary to track down the trouble to the defective part. In this case, it is desirable to turn the chassis upside down and use a multi-range volt-ohmmeter. We may use either voltage analysis, resistance analysis or both.

A typical application might aid in illustration. Consider the diagram of Fig. 7 which shows the plate-cathode circuit of a typical audio-amplifier stage. Use of the set analyzer may have indicated that this stage lacked plate voltage. With the set on we connect our voltmeter from the cathode to point (a) on the B+ line. If the proper d.c. voltage is available at this point the cathode resistance is probably O.K. The trouble lies in the plate circuit between point (a) and the plate.

Assume that moving the prod to point (b) shows no voltage. This could indicate an open in R_r , the decoupling resistance, or it may indicate a shorted decoupling condenser, C_r , although in this event the voltage at (a) would be somewhat lower than normal. Often the serviceman does not have the manufacturer's data available, so it would seem advisable to investigate further by shutting off the set, removing the line cord from the wall socket, and using the ohmmeter to check the resistance from point (b) to chassis. Zero or a very low resistance would point

definitely to a shorted condenser, whereas a check from (a) to (b) would tend to indicate an open in R_f . *Note:* Some experts recommend that the tubes be removed from their sockets when making ohmmeter measurements.

At one time, John F. Rider suggested that point-to-point resistance analysis be more widely used and in the Rider Manuals there appeared reference resistance values from various points to chassis. Apparently this advantage would apply only to the professional serviceman and commercial broadcast receivers. Furthermore, it is not advised that the trouble-shooter proceed from one end to the other of the chassis in order to locate a defective stage.

3. Circuit disturbance method

The set analyzer, or free point tester, supplemented by point-to-point analysis, was an ideal combination in the older days of radio, when sets were simple and there were few complex circuits appearing. Faster methods must be employed today whenever possible.

The circuit disturbance method of isolation may be a real timesaver, especially in the case of a receiver or an electronic device in which headphones or other indicator may be connected to the output. A limitation of this method is that it is adaptable generally only to dead or weak equipment.

In such cases we may simply and quickly determine the defective stage. In general it is unnecessary to remove the chassis from the cabinet. Refer to the block diagram of the typical superheterodyne receiver of Fig. 8. This receiver is dead and it is desired to locate the defective stage. With the set on, pulling the power amplifier tube out of its socket should produce a loud click in the speaker, since a fairly large plate current is interrupted and the resulting signal voltage is transmitted to the speaker. Failure to hear a loud click might indicate a power amplifier stage which is not operating. No click from any tube would usually indicate that no d.c. operating voltages were being delivered to the tubes by the rectifier-filter, and we would look for our trouble there.

Suppose the power amplifier did produce a click. We could now proceed toward the antenna one stage at a time to find out which stage was at fault. While the earlier stages involve plate currents of smaller magnitude than that of the power stage, and it might seem that the click will be weaker, let us keep in mind that we now have available the gain of the following stages to amplify the noise signal and make it even more audible. Let us say that in this case, pulling the first i.f. tube out of its

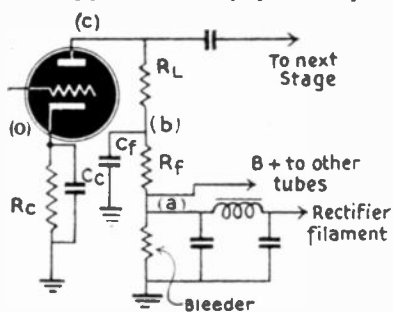

Fig. 7—Critical points in an audio stage.

socket produced no click, while a click was forthcoming from the following stages. We could conclude logically that the trouble lay in this first i.f. stage. Now the use of the free point tester (or set analyzer, if available and usable) to indicate the defective circuit, and the multimeter to track down the ailing part, would soon locate the trouble.

It should be pointed out at this time that we actually used a combination of three methods. Now, you see, we are developing a technique—and saving time!

If a receiver is afflicted with noise, regeneration, and oscillation, or hum* not originating from the power supply, the use of the analyzer or the multimeter will avail us nothing. But there is a time-saving method to localize this type of trouble. Let us presume we have a case of noise in the typical receiver blocked in Fig. 8. Before proceeding, we must determine whether the noise actually comes from the receiver. This may be done by shorting the antenna terminal or loop antenna to ground (short the input terminals in the case of an electronic device and use an output meter). If the noise disappears, it is outside static, while if it persists, it may be due to some imperfect component in the receiver.

4. Stage squelching

Oddly enough, to use the system we are about to describe, the only testing apparatus required is a piece of wire, preferably terminated in clip leads, and a large paper capacitor of about .5- μ f capacitance. In

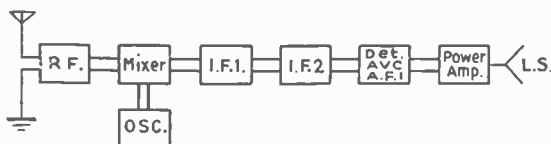

Fig. 8—Standard superheterodyne block diagram, used to show squelch points.

this system, we mute, or squelch, each stage individually, thereby eliminating one stage at a time until we locate the faulty stage.

To illustrate the use of the system in the case brought up, we start by squelching or silencing every stage of the receiver except the last one. It is only necessary to short-circuit the grid of the power tube to ground. As Fig. 9 will indicate, this prevents signals originating in any stage before the power stage from being heard in the speaker. Hence, if the noise, which is an a.c. signal in nature, is native to the power stage, it will be audible in the speaker when previous stages are squelched. If the noise disappears, it will be necessary to proceed, one stage at a time, toward the antenna, until the critical stage is found. The critical stage is that one which, when its grid is grounded, will fail to exclude the noise, though the following stage stopped the noise when its grid was grounded.

*NOTE: When a receiver is afflicted with hum, time may be saved by going immediately to the power supply and checking the filter condensers first. The simplest check is to bridge the suspected filter condenser with a good one and listen for decrease of the hum level.

Thus, if in the block diagram of Fig. 8, the grid of the second i.f. stage had been grounded and the noise disappeared, and then when we grounded the grid of the first i.f. stage the noise persisted, we would have located the critical stage as the first amplifier. Apparently, we have saved much time, since we are now sure the noise is originating some-

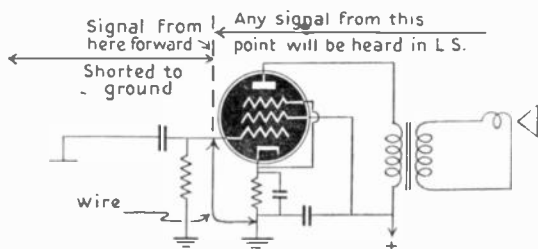

Fig. 9—Effect of squelching in any given stage. Noise in a certain stage may be quickly located.

where between the control grids of the first and second i.f. amplifiers. This means we will not waste time checking suspected parts in remote stages.

By extending the system, we may even localize the noise further, reducing the local "sphere of trouble." Suppose we short the plate of the first i.f. amplifier to ground. Since the set is on, we ground the high-voltage d.c. as well as the a.c. component (the noise signal). This is where our capacitor proves useful. If we ground the plate through it we short out (bypass) the a.c. signal, including the noise, but since d.c. will not flow through a condenser it will remain unaffected.

If the noise disappears upon making this connection, we see that the "sphere of trouble" only extends from the grid to the plate of this stage. The tube itself is checked or replaced to make sure the trouble is not in it, and, travelling even further, we check the circuit associated with each element by grounding that element and noting the results. (Be sure to use the capacitor when a d.c. component also exists at that element.) In many cases it is feasible to short out isolated parts.

Some experienced trouble shooters use a simplified method of "squelching" before actually using the technique presented above. The faulty stage is localized very quickly by pulling the tubes out of their sockets one at a time, starting with the r.f. tube. When a stage is reached which stops the noise we may use this stage as the basis for further diagnosis as described above.

It should be borne in mind that an a.c.-d.c. receiver, or any device with a series filament string, will give dubious results with this method, since the removal of a tube will, in effect, shut off the receiver.

It might well be pointed out that in grounding the control grids of class AB_2 or class B power amplifiers, it is imperative to use our capacitor, as it may preclude dangerously high currents. This system is never used in transmitter class C amplifiers or high-level oscillators, as

expensive parts may be damaged if a grid, which depends upon excitation from a previous stage to obtain bias, is robbed of this signal.

5. Signal substitution

Modern radio and electronic equipment—being more complex in form—often requires refined technique to properly locate trouble. Some ailments cannot be located easily by means of either the set analyzer-free point tester, or the volt-ohm-milliammeter. A splendid but simple illustration is the case where an i.f. transformer has a shorted trimmer. No d.c. voltages will be influenced by this short circuit.

Therefore, the system of signal substitution has found wide application among some trouble shooters. We know that each stage of any piece of equipment has a definite function. Furthermore, each stage handles a definite type of signal which is of a particular frequency (or band of frequencies), amplitude, and wave form. The audio-amplifier stages handle the frequencies of the audio spectrum, and the i.f. stage amplifies the intermediate frequency only. If the receiver, blocked in Fig. 8, is a broadcast receiver, and its intermediate frequency is 465 kc, the r.f. amplifier will be tunable and will cover from 550 to 1,700 kc. The same goes for the mixer input circuit. The oscillator will generate a radio-frequency signal and will be tunable from 1,015 kc to 2,165 kc. The i.f. amplifier peaks at 465 kc.

If we are familiar with the functions of the stages involved, we may substitute the proper type signal at the control grid of any stage and note whether this stage passes or amplifies this signal. The system of signal substitution presupposes that we have signals of the proper type which we may select at will. It also is desirable to use an output meter.

A signal generator which continuously covers the radio frequencies required, and which may be modulated or unmodulated, is desirable. In addition, the audio-modulating frequency should be available separately. This frequency is usually 400 cycles, which is recommended by the Institute of Radio Engineers. This frequency also is used to modulate the r.f. signal at about 30 percent modulation.

While an output meter is to be recommended, it is not always on hand, so for purposes of illustration, we will use the loudspeaker.

This receiver is dead and all of the systems previously described give us dubious information as to the source of trouble. Let us now observe the diagram of Fig. 10.

Since it is advisable to proceed from the power stage backward, turn on the signal generator and allow to warm up. Switch it to a.f. position and advance the audio control fully clockwise. Connect the return lead to the chassis. Now, with the chassis upside down, connect the hot signal generator lead to point 13, the power amplifier control grid. A loud 400-cycle note should be heard in the speaker, whereupon we may advance (toward antenna) to the control grid (point 11 in diagram) of

the Det-a.v.c.-1st a.f. tube. Again, a 400-cycle note should be heard. We also should determine if any gain exists.

We now come to the detector diode and may ask if we should set our signal generator to give an r.f. signal. Since the function of any detector is to rectify and filter, either an a.f. signal or a modulated r.f. signal of any frequency should be rectified by the diode. So we might have tried a.f. first and then switched the signal generator to the i.f. (modulated, of course).

Apply a modulated 465-kc signal to the grid (point 8) of the second i.f. amplifier. The 400-cycle note should be heard in the speaker, if this, and all following stages, operate correctly. Keep in mind that the 400-cycle a.f. modulates the radio frequencies in the signal generator and the

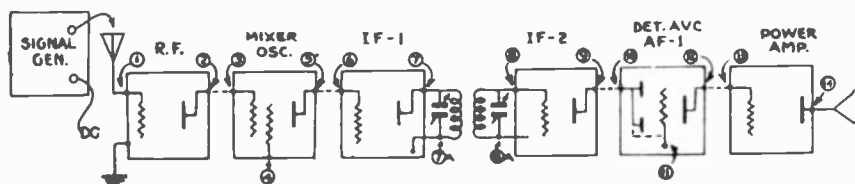

Fig. 10—Points at which a signal generator can be connected to localize circuit trouble.

detector of the receiver demodulates, or separates, them again, getting rid of the unwanted r.f. and passing the 400-cycle a.f. on to the speaker.

We can go on this way until we reach the antenna, or until no signal is forthcoming from the speaker when the proper signal is substituted at the input to the stage.

When working on the mixer or r.f. grid, the receiver dial must be tuned to the same frequency as that of the signal generator, 1,000 kc being a commonly used frequency. We may feed both the i.f. of 465 kc and the frequency to which the dial is tuned to the mixer grid (point 3). The mixer should pass both frequencies. If it passes the i.f. and not the r.f., look for a dead local oscillator.

A further check on a dead local oscillator is to apply an *unmodulated* signal to point 4, the oscillator grid. If this signal is 465 kc *more* than the station to which the dial is tuned, the station should be heard while this artificial signal is being applied.

Note that connections have been made to control grids thus far. This should always be done in alignment, since the input impedance of the control grid is comparatively high and little loading on the signal generator results with no consequent change in its frequency. For test purposes, it is often advantageous to connect our signal generator lead directly to a plate. Due to the comparatively low plate impedance, we never use this connection for alignment. If the signal generator does not have a small blocking capacitor, it is well to use one externally to prevent application of the high voltage from the plate to the attenuator of the generator.

In practice, application of a 465-kc modulated i.f. to point 8 of Fig. 10 may produce a 400-cycle note, whereas application of the same signal to point 5 produces no output. Some time may now be saved by connecting the generator lead to point 7 through our capacitor. This will show whether the trouble is in the plate and coupling circuit from points 7 to 8, or in the tube circuit itself (again we assume the tube was checked for obvious defects).

Continuing our example, if it was determined that no signal was getting through point 7, we could remove our ground clip from the chassis and connect to point 8a, setting the hot generator lead back to point 8. We now have applied a signal directly across a tuned circuit. Likewise, we may make connection across points 7 and 7a.

Signal substitution has many ramifications. The above procedure is simple enough in the cozy confines of a serviceman's shop but, as one can see, it requires a signal generator and constant retuning and manipulation of the instrument.

What we need is a magic signal generator; one which will change to the frequency you want without even rubbing Aladdin's lamp.

The multivibrator

This magic device may be a *multivibrator*, which is nothing more than a motorboating two-stage audio amplifier, and has the property of generating harmonics, often up to the 200th. If we connect the output of the multivibrator to any grid of a receiver, a signal should be supplied to that grid, amplified, and heard in the speaker. This is an extremely quick check on any stage of most electronic equipment.* The author makes use of a small-size multivibrator, powered with a 67.5-volt B-battery, and using a type XXB tube.

Square-wave generators also put out signals with many harmonics, and a more symmetrical wave-form than the multivibrator. This advantage, however, is realizable chiefly in work with a cathode-ray oscilloscope.

Even simpler than the electronic multivibrator is the mechanical multivibrator. This has been used by many radio servicemen and consists essentially of a high-frequency buzzer. One can be made from a few hundred turns of wire wound on an armature with a spring contact for make and break, or an old code-practice buzzer may be found. Operation can be had with a single flashlight cell. A commercial unit is mounted in a pencil-size holder with clip. This device works by virtue of the sparks produced. Hertz proved to us long ago that sparks produce radio waves with an unusually broad frequency characteristic.

The operation of the mechanical vibrator is not as positive as the electronic multivibrator, but comes in handy where speed is essential.

*The use of the multivibrator in servicing is too wide in scope to be covered here.

SIGNAL-TRACING METHODS

MODERN SERVICING by signal tracing is a quicker and surer method of locating trouble in radio receivers. It is unsurpassed for clearing intermittents. Especially is it useful to the beginner, as it not only helps make a servicing job easier but also permits the trouble-shooter to *hear* what happens in various parts of the circuit.

Signal-tracing equipment can be comparatively simple and inexpensive, containing few hard-to-obtain tubes and circuit components. For this reason, a number of small signal tracers have recently been described in technical literature, or have appeared on the market. One such manufactured instrument is illustrated in Fig. 11 and shown diagrammatically in Fig. 12. It uses only a single tube, which is housed in the probe. With the exception of the phones, all parts are contained in a box 5 by 6 by 7 inches in dimensions. The 1T4 pentode in the probe is used as a triode with the screen and plate tied together. The 300- μf mica condenser serves a dual purpose. It acts as a blocking condenser to prevent the application of d.c. to the grid of the tube, and also acts as an attenuator network in combination with the 20-megohm resistor. The resistor also provides the bias voltage for the tube and serves as a grid return.

The circuit is essentially a vacuum-tube voltmeter designed to function as a signal tracer. It will indicate relative signal intensity directly on the meter. Since it is desirable to hear the signal quality as well as to measure the relative signal intensity, a switch is provided to disconnect the meter and cut in a pair of phones. The phones may be of any impedance above 2,000 ohms but must be of the magnetic type.

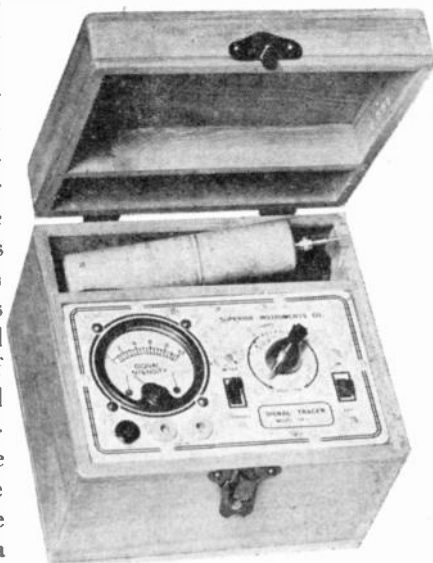

Fig. 11—A portable signal tracer (Photo courtesy Superior Instruments Co.)

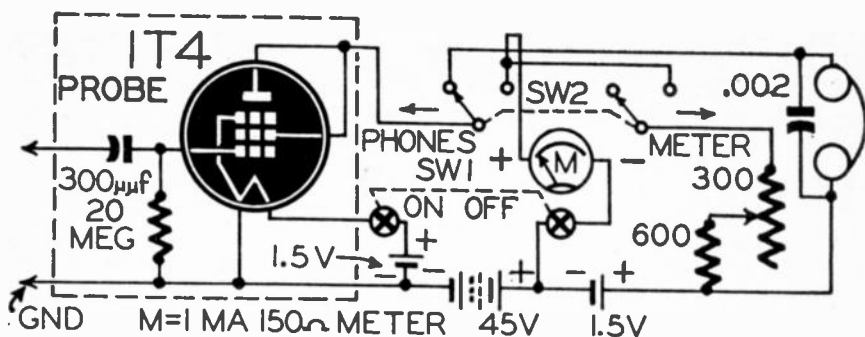

Fig. 12—Schematic of the signal tracer. Parts shown within dashed lines are in the probe.

The flashlight cells should be changed whenever the balance-adjuster control can no longer bring the meter to zero. Polarity should be observed at all times on these, and they should not be allowed to short against each other, or the tube may be damaged. The 45-volt B-battery should last a long time with reasonable usage, as a total of only two milliamperes is drawn from it by the internal circuit.

Fig. 13 shows a standard 5-tube a.c.-d.c. circuit with the filament wiring and other irrelevant parts omitted. This circuit can be used as an illustrative example. Suppose the power supply has been checked and is found proper. Signal tracing involves using the signal as a basis of measurement, so the signal must be *located* at some point in the receiver before it is to be *traced*.

Signal tracing can begin at the antenna. Here the serviceman will hear the signal without benefit of the receiver's tuned circuits, or perhaps he will hear a multitude of signals. Then the probe can travel along through the set from the control grid to the plate of each tube, noting the amplification of that tube; to the grid of the next, and so on through the circuit. When a point is reached where no signal is found, the fault lies between it and the last point checked.

The alternative method is to start with the speaker and trace back to the antenna. Place the probe tip against the plate B (Fig. 13) of the output tube. If a strong signal is indicated at this point and no signal is heard in the loudspeaker, it safely may be assumed that the speaker is defective.

To check the speaker, open one connection between the voice coil of the speaker and the output transformer C, then connect the clip of the test lead (ground) to the output transformer wire.

Now touch the probe to the other output transformer wire. If a signal is indicated, the voice coil of the speaker is either shorted or open. Touch the probe tip to the voice coil wire. No signal means an open voice coil, a signal means a shorted voice coil. If when touching the other end of the output transformer, no signal is heard, the speaker (output) trans-

former is defective. If no signal is heard at the plate B of the output tube (the ground clip being connected to the receiver chassis), place the probe tip to the grid D of the output tube. A signal at this point means that the signal is being lost after the grid of the tube. The cause of trouble may be a defective tube, an open cathode resistor F, or shorted bypass condenser E. The bypass condenser E can be tested by simply disconnecting one lead. If the condenser is shorted, the signal will now be heard in the speaker. To check the cathode resistor, place the probe tip to the cathode of the tube. A loud signal at this point means an open cathode resistor.

The next point to check is the coupling condenser H. If when touching the probe tip to the plate G of the preceding tube, a signal is heard but none when touching the grid D of the output tube, the condenser is open.

If no signal is heard at point G, advance the probe tip to the grid J. A signal at this point, but no signal at G means a defective first audio stage. This tube and its associated parts should be checked in the manner outlined above. L, the coupling condenser between the volume control and the first audio grid J, should be tested by first placing the probe tip at the first audio grid J and then at M (the "hot" side of the volume control). A signal at point M but none at J means an open coupling condenser L or a defective volume control.

Although the i.f. and r.f. sections of a receiver can be checked using broadcast station signals, it is always desirable to use a signal generator as the signal source because the modulation frequency and output are controllable. Tune your signal generator to the intermediate frequency of

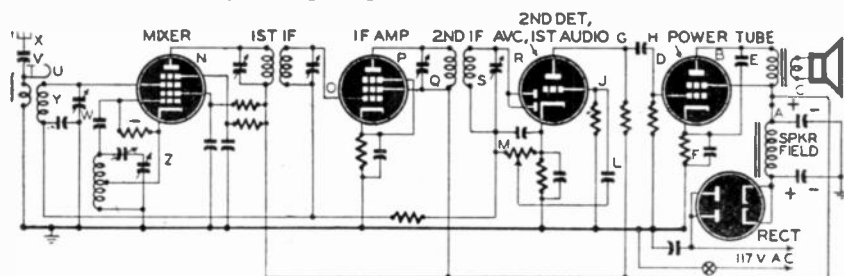

Fig. 13—Typical receiver schematic marked to show where tracer probe is to be applied.

the set under test. Connect the "hot" lead of the signal generator to N, the mixer plate, through a .0001- μ f condenser and ground the other lead. The probe should be touched to this point N to verify the presence of a signal. If phones are used, be sure to modulate the signal generator.

When checking the i.f. amplifier, it is best to start at the signal source N and work your way to the diode R. The probe point is therefore touched to point O, the grid of the first i.f. transformer. If no signal is indicated at this point, check the i.f. transformer. It may be detuned, open, or shorted. To check the latter two, use an ohmmeter. To check the former, try retuning. The plate P of the i.f. amplifier is checked next.

If a low signal is indicated, try retuning the plate winding Q of the second i.f. transformer. No signal points to a defective tube or its associated parts. If a loud signal is indicated at point P, touch the probe tip to R, the diode plates. A low signal at the diode plates R and a loud signal at P, means that the secondary winding S of the second i.f. transformer is out of tune, open, or shorted.

Checking the antenna stage

The antenna stage is checked in the same manner as the i.f. amplifier of the receiver, using a signal generator or broadcast signals. Place the probe tip at point X to verify the presence of a signal. If, by touching the probe tip to T, a signal is detected, the antenna condenser V is not open. The probe tip is then touched to point U, which is the grid connection of the mixer tube and the stator of the variable condenser. Absence of a signal at this point indicates loss of signal in the antenna coil. It may be caused by either a shorted or open coil or a shorted variable condenser.

To check the oscillator section of the receiver hold the probe tip near Z, the oscillator section stator of the tuning condenser. It is not necessary to make a direct connection. An indication should be had on the meter. Rotate the tuning condenser. If the indication drops considerably, the oscillator is going out of oscillation and should be checked for a bad tube, bad resistors, or bad condensers.

When using a signal generator, modulation always should be on. This will permit both visual and aural indications. When the signal from a broadcast station is used (tune the receiver to a loud broadcast station), modulation will be shown by a fluctuation of the meter. A steady indication usually means the presence of hum. This is especially true in the audio section.

In all of these tests, either the visual indicator (the meter) or the aural indicator (the phones), can be used. Aural indication is usually more sensitive than visual indication.

SERVICING MIDGETS

THE NEED for *speed* in radio servicing has long been recognized by those who have seen a volume of radio business move through the larger shops. Since the début of the midget set, a majority of all servicing has been of this type. For years the question has been, "How are we going to make money servicing midgets?" The answer is and always has been—turn out more of them!

This statement brings on the natural question—how? And the answer to this one-word inquiry requires careful attention and consideration.

Looking at the rosy side of the picture, there are several things in favor of the midget. First, it is usually brought in by the customer, thereby eliminating the necessity of making a call. Few servicemen realize what it costs them to make calls. Besides the actual time lost, there is

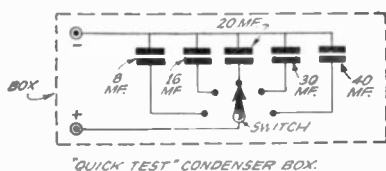
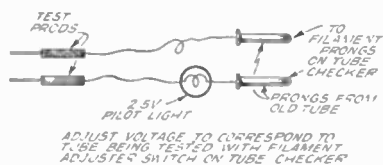

Fig. 14—left—Tube filament checker. Fig. 15—right—Simple condenser substitution box.

the question of automobile expense. It costs money to sit and wait for a red light, and it is your time that is wasted when you stand in the doorway and listen to a customer jabber about something that doesn't mean a thing to you. It is almost impossible to charge enough for service calls to break even on them.

Second, since the customer brings the set in, he usually returns for it, and it is a well-known fact that customers pay better when they come to the shop for their sets. The more cash business a serviceman can get, the less time he has to spend in bookkeeping and collecting. And it might be mentioned that getting the customer into the store or shop affords the alert serviceman an opportunity to show or sell him additional merchandise.

Getting right down to technicalities, the little sets are far easier to service than the big sets—that is, *if you know your stuff!*

All servicemen will agree, I think, that in the majority of cases de-

fective tubes are the cause of midget set failure. In a majority of these cases, it is the *power tube*. In approximately half of the power tube cases there is *filter condenser* trouble.

Simple test routine for "midgets"

Accordingly a simple routine for servicing midgets is to check the tubes first. Since tube failure is practically always caused by open filaments, if some simple means is used to check filaments without the bother of placing each tube in a checker and waiting for it to heat, considerable time can be saved. There are several ways to do this, the simplest being to utilize the *ohmmeter*. If a low scale is used open filaments can usually be detected without removing the tube from the socket. However, occasionally the circuit will afford a roundabout reading that is misleading. A simple gadget for checking filaments quickly can be rigged up with the aid of an old tube checker. A pair of test leads are rigged with tube prongs on one end so that they can be inserted in the filament positions of one of the sockets on the tube checker (Fig. 14). A pilot lamp of the 2.5-volt variety is wired in series. The proper voltage is fed from the tube checker through the pilot lamp and to the tube as the test prods are touched across the filaments. If the filament of the tube being tested is open, the pilot lamp will not burn or will burn very dimly.

On *midget* sets, filter condensers are found *open* more often than *shorted*. If the power tube is O.K. but voltage is low or insufficient to read, one or both of the filters are usually open or have lost their capacity. All servicemen are accustomed to placing another filter across the various sections to locate the defective one. This is usually a tedious job, between trying to make connection and keep from getting shocked. However, if a few minutes are given to installing a series of condensers with a switching arrangement in a box which has provisions for plugging in a pair of test leads, not only will this job be *speeded up*, from the standpoint of locating the proper condenser, but also in determining the proper value to use in the replacement (Fig. 15).

A few precautions are in order here. If one section of the pack only is replaced, the other should be checked thoroughly for both *leakage* and *capacity*. The section replaced should *always* be removed from the circuit, as defective low-capacity condensers are low power factor, and cause an unnecessary drain on the circuit, even if they do not become heated and short.

Some servicemen are of the opinion that the only requirement for the replacement of a filter is to get enough capacity. This is not always correct, especially in the case of close-cathode rectifiers such as the 25Z6 and 6X5. If too high capacity condensers are used immediately following these types, the condensers can pull enough current on quick charges, such as occur when the set is turned off and on rapidly or during

line interruptions, to completely melt the cathode. This is what happens when a filter shorts and often happens when the serviceman shorts around in the set with a screw driver to see if he has any voltage.

A good way to reduce the number of returned sets is to insert a 50-ohm resistor in series with the plate of the half-wave rectifier, even if the original circuit didn't include it. This will greatly increase rectifier and filter condenser life in a.c.-d.c. sets.

However, it is safe to use 16 to 20 μf and if this amount eliminates the hum, no increase should be made unless the proper value is known.

Other common defects with the midget sets are the general run of troubles, *shorted bypasses, open fields, output transformers* and *i.f.'s*. However, these troubles are scattered and easily isolated.

Very frequently the serviceman will neglect *aligning* the "little fellows," because he does not feel justified in wasting the required time to do the job right. Excellent alignment can be obtained in only a few minutes with the following procedure (for superhets). Connect the signal generator to the antenna and ground connection through a 100,000-ohm resistor or a 100- or 250- μf condenser. Feed in an i.f. signal from the signal generator and stop the receiver oscillator by placing a finger on the oscillator section of the tuning condenser. This stopping of the oscillator is not always necessary but is advisable. Adjust i.f.'s to maximum

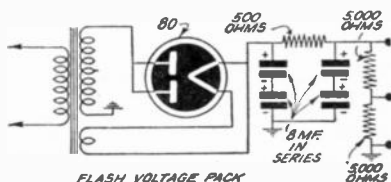

Fig. 16—A flash-voltage pack proves handy for locating intermittents or poor joints.

signal with set volume control "wide open" but signal generator turned down to where the signal is barely audible. If a weak signal is used, the set can be peaked by ear, without connecting an output meter.

When the i.f.'s have been aligned, the r.f. and oscillator trimmers can be adjusted by switching the signal generator to 1,400 kc or by removing it entirely and tuning in a weak signal in the vicinity of 1,400 kc.

On sets using loops as both antenna and antenna transformer, coupling is best accomplished by feeding the signal generator into a loop of similar size and number of turns, and holding this loop near the one in the set. Such a loop is easily made by winding a few turns of wire on four nails correctly spaced on a piece of plywood, and will serve for testing practically all loop sets.

Nothing slows up service work more than *intermittents*. And there is no known system that will solve intermittents consistently. The busy serviceman can save himself much trouble and time by proceeding cautiously when he is called to service an intermittent receiver. If the set is

cutting out only occasionally and if there is nothing that can be done to make it cut out, it had best be left alone. Many unprofitable hours can be saved, even though it may seem at the time that business is being lost.

If, however, the intermittent is fairly consistent and of a definite nature, it is up to the serviceman to find this trouble in the least possible time. The most successful way to do this that we have found is to cause a breakdown of the defective part. This is done by applying high voltage to the part suspected of causing the trouble.

The serviceman should have a power supply capable of delivering a flash voltage of 800 to 1,000 volts. This can be probed across condensers, resistors, and coils, and while not high enough to short a good condenser or open a good resistor or winding, often will break down defective parts. In the case of a.c.-d.c. sets, the voltage has to be reduced to approximately 250 across electrolytic condensers.

Tests for Intermittents

High voltage not only breaks down defective parts, but will also show up loose connections and intermittent grounds. We once had a Philco 610 that had a scratching noise like a defective output or driver transformer. All ordinary checks revealed nothing. The trouble was isolated to the plate circuit of the first audio, but a substitution of parts did not clear it up. However, high voltage touched on the plate, with the set off, stopped the noise immediately. No cause for it was ever found.

Another case was an RCA that tuned in an 850-kc station at 600 on the dial and would pick up nothing on the high-frequency end. Hours were spent checking. It was found that the oscillator was far *off frequency*, but no cause could be established. Finally, the high voltage was applied and an arcing was observed under the tuning condenser. It was found that the bond from the tuning condenser to chassis was a cold joint. The high voltage arced across, showing it up.

Sets can be operated on the high voltage by removing the rectifier tube and feeding the external positive high voltage to the filament or cathode pin of the empty rectifier socket. The external negative lead will go to chassis or B—. When the set becomes hot, the intermittent usually will show up.

A pack for supplying the high flash voltage is shown in Fig. 16. This is built with parts that can usually be found lying around the shop. The gadget will save many hours, and if used to final-check all sets that go through the shop, the number of kick-backs will be reduced to a minimum. The parts lost in the application of the high voltage that might otherwise get by are negligible.

Some intermittents are allergic to low voltages instead of high. A variable line transformer, Fig. 17, which can be bought for a nominal sum, will serve to vary the line voltage both *above* and *below* the normal

value. Low voltage will cause a weak oscillator to cut out or will cause *distortion* and *drifting*.

When the set is checked on high line voltage it not only raises the d.c. supply, but also increases the filament voltage, causing the tubes to get hotter and thereby breaking down internal shorts, weak filaments, and other troubles.

Not only must the modern serviceman apply every known trick to turn out his work *faster*, but also a conservation of skilled labor is

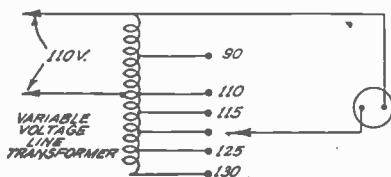

Fig. 17—A variable voltage line transformer is useful when checking for intermittents.

necessary. This can be done by diverting into the hands of others that part of the service work that does not require technical knowledge. This includes removing sets from cabinets, cleaning, checking tubes, installing parts, etc.

A simple and effective routine is to have the *non-skilled* man remove the chassis, clean it, and check the tubes. He then passes it to the serviceman, who diagnoses the trouble. While the set is being diagnosed, the helper cleans and polishes the cabinet and removes the second chassis. The serviceman passes the diagnosed set back for the installation of the defective part. While the helper installs the part, the serviceman diagnoses set number 2. He then passes set number 2 to the helper for installation of part, and takes back set number 1 for final check. No time is lost and maximum efficiency is obtained from both serviceman and helper.

Careful diagnosis of the job from the standpoint of how long it will take and how much can be charged for it, will save the busy serviceman much time and trouble. Jobs that are not routine should be avoided whenever possible. Or at least they should be on a *time plus material* basis. The serviceman must get at least \$3.00 per hour for his time and facilities. He should get \$5.00, which is the price charged for work at machine shops, sheet metal shops, etc.

SOLDERING PITFALLS

ONE OF the beginner's worst problems is the soldered joint. All the instruction books say that joints must be "well soldered" after making sure that the connection is both electrically and mechanically good *before soldering*. He sees the neat, smooth joints of manufactured radios and tries to make his own look the same. This is where his troubles begin. The metal will not "take" solder—it rolls off as fast as he puts it on. His flux disappears in clouds of evil-smelling smoke. When the job is done, it looks like one of those old stereoscope pictures of Niagara Falls in winter. Worse, when he inspects the job, he finds the solder is all attached to one wire, and the other can be moved or turned freely in the "joint." In extreme cases, his "soldered joint" is a perfect insulator, and instead of lowering the resistance by soldering, he has raised it to infinity!

The chief reason for the beginners' troubles is that little is said in text-books or other places, about the actual process of getting wire and solder together. Authors assume, because they learned to solder so long ago that it seems second nature to them, that their students also must have an inherent knowledge of the subject.

Having had some experience with tinsmithing, we had no difficulty with our first radio, and continued to listen to the one-lunger far on into the summer, in spite of the horrible static of the warm season. A neighboring experimenter, however, pronounced the trouble certainly something else than static, which he said sounded entirely different. Investigation showed that the queer sounds were coming from the soldered joints of the set, which, carefully fluxed with muriatic acid, were rapidly becoming non-conductors. The radio had to be torn apart and resoldered. Then, having learned one of the first lessons in soldering, it was possible to sit down and find out what static really sounds like!

Another newcomer to radio, intent on putting his first set together, was duly warned of the horrors of acid soldering, and impressed with the fact that rosin (or do you prefer resin?) was the only flux that should be used. He reported next day that after soldering his set, reception dropped to zero. Investigation showed not one, but several joints with so much rosin in them that they insulated the wires one from another to such good effect that no current could get through.

So much for what may happen through ignorance of the rules of soldering. Now, what are these rules?

There is only one rule for successful soldering: The metal parts to be joined must be thoroughly clean! When solder refuses to stick to a metal surface, it is because that surface is covered with a layer of dirt or oxide. Keep a dull knife and a piece of fine sandpaper handy. Scrape the part till it shines, then polish it up with the sandpaper. Steel wool is another good cleaning medium. As long as there are microscopic specks of unscraped metal surface, there is a possibility of a poor soldering job.

A good cleaning job done on the wire and on the lug or other part to which it is to be soldered, the next step is to make a good connection without solder. See Fig. 18.

The Underwriters' Rules insist that all electrical connections must be perfect *mechanically and electrically* before soldering. The mechanical part is worth noting. Wires should not be laid side by side, for instance, with the solder used to hold them together, but should be properly spliced first, before solder is applied. Adherence to the rule will pay dividends in the long run, though it may seem unnecessary in many individual cases.

The only really important tool in soldering is the soldering bit, or "iron", (invariably made of copper). To put this in working condition, its surface must be covered with a coating of solder. This process is known as *tinning the iron*. The beginner's best method of tinning, if he has an electric iron, is to clean it thoroughly with an *old* file. It can be plugged in and heating while being filed. When it reaches a certain heat, you will note that the bright metal bared by the file immediately darkens, a reddish-brown color spreading rapidly over the surface. *Solder will not adhere to this surface*, which is oxide of copper. If you rub the surface with a piece of rosin immediately after filing, the metal remains bright. The melted rosin protects the copper from the oxygen of the air. Now, as soon as the iron is hot enough to melt solder, rub a small stick or piece of wire solder all over its surface, leaving a thin layer of solder on it. It is now ready to use.

If you use an iron heated by gas or coal flame, it is necessary to remove it from the fire and file it bright, waiting till it is barely hot enough to melt solder before applying rosin and solder. Otherwise the rosin flux will burn up, leaving the iron covered with not only oxide but carbonized flux. Rosin-core solder can be used to good advantage in tinning as well as in soldering.

Having a clean joint and a tinned iron, you now are ready to start soldering. Here is where the amateur usually makes his second mistake. *Never let rosin-core solder get near a hot iron.* Hold the iron on the

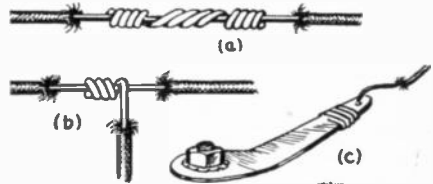

Fig. 18—Be sure electrical joints are mechanically strong before applying solder.

joint, and as the wire temperature rises, apply the end of your wire of solder to the joint and watch the rosin melt and run out, fluxing the joint, then the solder melt and run into the joint after it. Keep the iron in contact till the solder has penetrated thoroughly. You will find that you have done a professional job (unless you have used too much solder). See Fig. 19.

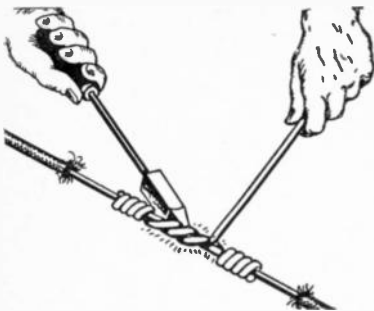

Fig. 19—Heat the joint thoroughly with hot iron before applying solder and flux.

The iron and applied. The wire or other surface *must be hot enough to melt the solder*, or you will get a “plastered” joint with the solder not really attached to the metal. As you become proficient you will find that the solder itself can be used to conduct heat from the iron to the parts being soldered.

In soldering large pieces of metal, such as chassis, it may be found that the metal carries the heat away very rapidly, so that it is difficult to get it hot enough to work on. The temptation to do a little “plastering” should be resisted. Get a bigger iron! A plumber’s large soldering bit should be kept in reserve for just such emergencies. It can be heated on the gas stove, or with a blow torch or coal fire.

Techniques for special metals

So far we have spoken of soldering copper with ordinary solder. This is made of lead and tin, usually mixed half-and-half (strictly). Strange to say, the mixture melts at a lower temperature than does either pure lead or pure tin. Copper, tin, zinc, and brass have a natural affinity for this alloy, and can be soldered very easily, with rosin as a flux to prevent oxidization. Some radio parts are nickel or cadmium-plated. These metals do not care to associate with ordinary solder, and must be carefully scraped and sandpapered before soldering to the metal below.

Iron cannot be soldered with ordinary solder and rosin flux. It is usual to flux iron with a solution containing zinc, which makes it easy to solder. A commercial paste recommended for soldering iron may be used. Since iron will be encountered only in non-electric soldered joints, and usually on large pieces such as chassis, it is better to use your plumber’s iron, and keep your radio iron out of the paste.

This should be as big and heavy as possible, as at (b) in Fig. 20, whereas your regular radio iron should be a small, long-pointed type as at (a) in the same figure. The “hackett” bit at (c) is particularly useful for chassis work; its shape permits transferring a maximum of heat to the seams.

Other metals can be soldered with special alloys, usually of the metal to be soldered and some other to reduce the melting point. If you have any special job to do, look up a book of formulas or ask someone who works with that kind of metal. (A jeweler usually knows a great deal about soldering). Aluminum is the extreme case of "keep the surface clean." Even with special solders, it is very hard to solder this metal. This is because it oxidizes so quickly that it is impossible to flux it. The only method is to clean it by rubbing with the tip of the iron *under* a coating of flux and special solder. When no air can reach the part during the cleaning process, the flux or solder has a chance, and a good job of soldering can be done.

Soldering pastes

Many experimenters may protest that they use non-corrosive soldering paste for all their radio work, and never have any trouble. This may well be true. The experience of the writer has been that it is impossible to tell by looking at a paste—or even by tasting it—whether it is certainly non-corrosive. It surely cannot be done by looking at the label on the box! The safe way is to stick to rosin. It may sometimes be all right to use "strictly non-corrosive" paste for tinning the iron, if all the paste is carefully wiped off with a damp woolen rag (which every solderer should have at hand to keep his iron clean with).

This brings us back to the point we started out from, and which cannot be over-emphasized: **KEEP THE METAL CLEAN!** *If the surfaces to be joined are free from dirt or oxide, and are hot enough to melt solder, you can't help making a good job!*

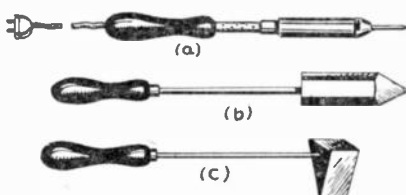

Fig. 20—Several types of soldering irons: a—Electric; b and c—externally heated.

SERVICING VOLUME CONTROLS

VOLUME CONTROLS may be divided roughly into two types, wire-wound and carbon-element, of which the latter type is by far the most predominant in home receivers. The wire-wound type found great popularity in the early days of receiver construction when control resistances ran to values between 6 ohms (filament rheostats) and 10,000 ohms (bias control resistors). Since about 1933, however, the practice has been largely to control volume in the grid circuits of audio amplifiers or at the load resistances of diode detector circuits. These applications require very high resistances, varying from one-tenth megohm to two and one-half megohms. For such high-resistance values, wire-wound types are impractical.

The wire-wound type of control consists of a flexible insulating strip wrapped with a resistive metallic conductor, such as nichrome or similar alloys, the entire strip bent into the arc of a circle described by the movement of the rotating contact arm. The arm is terminated by a slider contact, designed to tap off current from the resistive section.

The only service procedure possible with any lasting results is cleaning the contacting parts, namely the slider arm, wire element and arm bushing, which usually is the only means of connection between the slider arm and the center tap lug. Accumulations of greasy dust will cause leakages and bad contacts resulting in noisy operation.

However, the main cause of failure with these units is the wearing through of the wire wrapping. It is possible to repair this breakage by soldering a small strip of copper or brass foil across the open section, but this procedure is not advised except in a case of absolute necessity, since the wearing through of any section indicates that the whole strip must be badly worn and susceptible to subsequent break-through at other adjacent points. Suffice it to say that trouble caused by anything other than dirt in this type of unit calls for replacement in preference to repair.

The carbon-element type of control is essentially the same as the wire-wound, except for the resistance element which is usually a circular strip of paper coated through about 300 degrees of its arc with a compound

containing carbon or graphite as its conductive substance. This compound may be coated to various thicknesses in different portions of the arc to give the control "taper." Taper is a method of spreading, i.e., making more gradual, the progressive resistance change of the control over that section of the arc of rotation which is most sensitive in its action in the circuit. The object is to prevent a critical point at which the volume may suddenly go from high to low level (Fig. 21). Controls use various methods of mounting the sliding contacts or wipers to minimize friction with a view of extending the usable life of the carbon element. As a rule, the wiper is insulated from the rotating shaft and bushing, since the wiper is often the terminating point of a sensitive circuit which would be affected by body capacity through the knob. In-

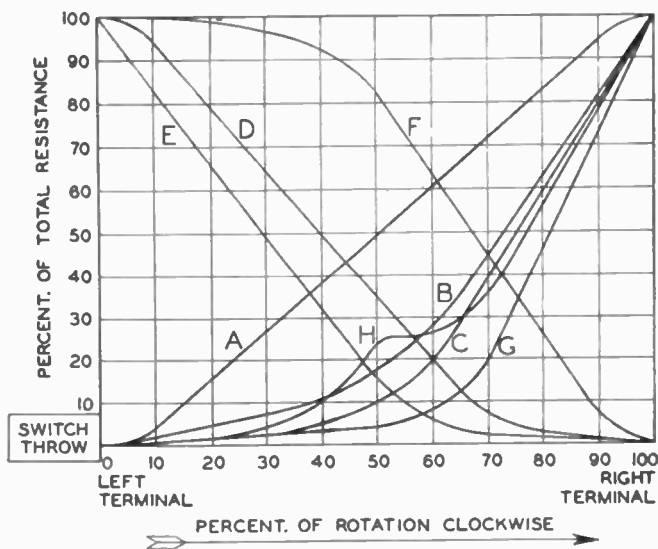

Fig. 21—Chart showing percent of total resistance obtained at various degrees of volume control rotation for 8 different tapers. (Chart courtesy International Resistance Co.)

sulation is achieved by various methods depending on the manufacturer's design, usually by means of a slip ring and wiper contact on the contact shoe, which is mounted on a fiber section turned by the shaft and knob.

The first step in correcting defective units is to determine the original resistance value of the element as recommended by the set manufacturer. Once this is done, disconnect the control from its associated circuits and measure the total resistance of the element. Compare the two figures thus obtained. If the present value of the resistance is within plus or minus 20 percent of that given by the manufacturer, service measures are in order. Should the discrepancy be greater, discard the control and replace with a new unit. A value 20 percent or more below the specified resistance indicates a leakage of current through the insulating portions

of the control. A value 20 percent greater than specified resistance indicates failure of the element. The author's observations have been that *90 percent of carbon-element volume-control failure is not due to failure of the element.*

It may be noticed in checking a set with noisy controls that the knob of the volume control may be pulled outward with considerable reduction in the crackling caused in the output by this type of trouble. This is a significant observation. If the carbon element were cracked or the arc burned, this could have no appreciable effect on its conducting ability. *The real cause is usually accumulation of oxidized grease or oil on the slip ring of the wiper arm.*

At the time of assembly, the manufacturer usually coats the slip ring with a type of grease which inhibits oxidation of these brass or phosphor bronze contact areas. As a rule, this grease coating will maintain its original condition for one or two years. It eventually becomes hardened, and being a non-conductor finally causes the slip ring to make imperfect contact, giving evidence of itself by noise in the output of the set. The obvious remedy is removal of the offending substance. Controls may be quieted by the mere process of working them repeatedly through their arc of rotation while immersed in a grease solvent such as carbon tetrachloride or gasoline, but we do not recommend this procedure since it does not allow for thorough cleaning or replacement of the lubricant. The only real method of repair entails the disassembling of the control, which is not nearly so difficult as some repairmen seem to believe.

Disassembly of volume control

In taking apart, the first step is to remove the switch or dust cover, as the case may be. Next it will be noted that the shaft is held in the bushing by a split retainer ring pressed into a groove in the shaft. This may be removed by clamping the control shaft in a bench vise, leaving just enough of the shaft exposed to work on the washer. A small piece of sheet metal, fairly stiff (the back of a hacksaw blade has been found useful), pressed against the open portion of the washer will push it back far enough for a pointed tool to be inserted in the gap exposed and the washer removed. The wiper arm and shaft will then push out through the mounting bushing.

Inspection of the slip ring, which will be found on the rear of the plate which carries the contact shoes or springs, will usually show a green waxy substance which can be picked off easily with the fingernail. This is the original grease, the coloring coming from the metallic sulphides and oxides which the metal has formed with atmospheric acids and gases. The slip-ring wiper will usually be found to be a horseshoe-shaped piece of metal which straddles the shaft of the control and usually has two raised portions which bear against the slip ring, the tension being obtained from the arch formed by a bend in the legs of the horseshoe-shaped portion.

Inspection of the element will show that it is polished where the contact shoe has rubbed in its travels back and forth. This is natural and not harmful. Do not try to remove the shine. Inspect the contact shoe. This will show a polished area surrounded by an accumulation of dust from the carbon surface.

Immerse the disassembled sections in a grease solvent (carbon tetrachloride, gasoline, benzine, etc.), and clean thoroughly by brushing with a small soft paintbrush. A half-inch brush will be found most economical. Some controls have a separate tiny washer with a polished surface on one side and a small hole bored through the center as a contact shoe. The rotor arm of this type has a pointed flat spring on the insulating disc which fits into the hole of this washer, thus moving it around on the element. With this type, insert the point of a penknife into the hole of the washer and rotate the blade once or twice, thus insuring a good contact between the washer and spring. Other controls have a flat nickel-plated bronze spring in the form of a loop with a little less diameter than the outer edge of the element. This is held clear of the element by spring tension and pressed down to make contact at various portions by the action of a pad on the end of the rotor arm. The only thing necessary here is cleaning by the previously described procedure, making sure to follow when dry by a small spot of vaseline on the side of the contact spring which carries the rotor arm. It is hardly necessary to point out that care should be taken not to get too much vaseline into the unit.

It is advisable on these units to inspect the rivet which fastens the spring to the frame of the control. This customarily mounts the terminal lug on its other end. Should this be loose it will result in noisy or intermittent operation. If inspection shows this to be the case, do not attempt to rivet tighter. The usual result of these efforts is a cracked case. Solder both sides of the rivet, using the least possible amount of solder and carefully cleaning away excess flux.

When the various parts of the volume control are thoroughly dry take an ordinary pencil eraser, or better, a pencil equipped with an eraser, and rub the parts of the slip ring or wipers which bear on one another. This will result in a bright polish without scarring the surface of the metal. *Never use sandpaper.* When sufficiently bright, use the paintbrush again to remove all traces of rubber dust which may remain in the case. It is advisable at this time to increase the tension of the various springs by a little judicious bending. Be careful not to bend so far or hard as to cause excessive pressure which may result in undue wear.

Next apply a small amount of vaseline to the sliding portions of these contacts, *with the exception of those which contact the element.* Never use oil or graphite grease, since the former cannot be depended on to stay where it belongs and the latter contains a conducting substance.

Reassembly is merely a reversal of the process of taking apart, with the exception of the split washer, which is simply pushed into place and squeezed shut with a pair of pliers.

SERVICING RADIO SPEAKERS

IT HAS long been the practice of efficient radiomen to *replace* defective loudspeakers. A quick job is assured and a permanent repair guaranteed, but it is not always possible to get the correct speaker for replacement on short notice. Thus the question of speaker repair arises, together with that of using the large number of damaged units now gathering dust on the shelves of the shop junk-room.

The loudspeaker consists of three main parts; field (or magnet), output transformer, and cone assembly, each with its characteristic defects. Of these three, the output transformer is the most prolific source of trouble. It invariably goes bad because of a burned-out primary.

The output transformer may be rewound. The job usually takes too much time to make it worth while on any but the most expensive jobs. It also may be replaced with a new one of similar characteristics. If a new one is not available, it is in order to look around and see what use may be made of units on hand, now attached to speakers discarded because of broken cones or burned-out fields.

Three conditions must be met: The transformer must be big enough to carry the currents required, without excessive voltage drop or magnetic saturation; the primary impedance must be suited to the output impedance of the tube or tubes which will feed into it; and the secondary must have the correct number of turns to match the impedance of the voice coil on the speaker with which it is to be used.

If we require an output transformer to work between a pair of push-pull 2A3's and a 4-ohm voice coil, the first thing to do would be to look for a transformer which was used in an exactly similar circuit. Assume however, that we have no such transformer, but have one that was used between a pair of 6L6's and a 4-ohm voice coil. Can it be used?

From the tube manual, we find that the primary impedance of a transformer used with push-pull 2A3's is likely to lie between 3,000 or 5,000 ohms. The same source—or a transformer catalog—shows that output transformers used with 6L6's are likely to have an impedance varying from a little over 3,500 ohms to more than 6,000. Obviously the impedance is not likely to be too low for the triode amplifier, and as the efficiency of an output transformer in a triode circuit drops off rather

slowly as its impedance is increased above the optimum value (see Fig. 22), you will never notice if it is too high.

Let us look at the opposite picture. We need a transformer to work out of a pair of 6L6's and have one from a set using push-pull 2A3's. Will it be useful?

First of all, we note that the set used fixed bias for the 2A3's and that the transformer impedance would therefore be very near the lower 3,000-ohm limit, if not actually below it. Since 6L6's invariably work into impedances somewhat higher than this, the impedance is apparently too low. Add that the circuit may have been designed for a considerably higher impedance—up to 6,000 ohms or so—and that too low an output transformer impedance has an immediate and noticeable effect on the quality of reproduction, and we have to abandon the idea of using the transformer.

We now turn to a transformer originally used for a pair of 6F6's. The output impedance of most 6F6 circuits is in the order of 10,000 ohms, so this might appear to be a prospect. At first glance, however, we see that the transformer is only half as big as the one it is to replace. Voltage drops across it would probably be too great; our signal current would use up too much energy heating the transformer and too little moving the voice coil. Distortion would be high and efficiency low.

If you have a transformer with a primary winding suited to the job on hand, but the wrong secondary winding, it is a simple matter to take off the old secondary—which is invariably on the outside—and rewind it. Suppose you have a transformer which has worked into a 2-ohm voice coil. You want to use it on a speaker whose voice coil has a resistance of 4 ohms. Unwinding the secondary, you find it has 50 turns. How many turns do we need for an impedance of 4 ohms?

We know that the impedance ratio of a transformer increases with the square of the turns ratio—that the impedance is proportional to the square of the number of turns. So all we have to do is square our 50 (2,500), double that (5,000), and take the square root (71 approximately). Our new secondary should have 71 turns.

(Incidentally, this suggests a method by which we might find the impedance of a primary. Knowing the secondary impedance [by direct measurement of the resistance of the voice coil to which it is attached], we can put the primary across the 115-volt line, and measure the sec-

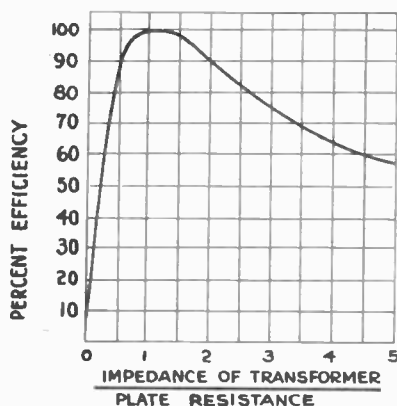

Fig. 22—The power transfer efficiency of the triode output tube varies with the output load impedance, falling slowly from the maximum as impedance increases.

ondary voltage. This will give us the approximate turns ratio, which is the square root of the impedance ratio.)

Our new 4-ohm winding will have higher voltages and lower currents for the same power, so we can use finer wire in winding it. Thus the 71 turns can be put into the same space as the former 50.

Cones give the radioman more trouble and exacting work than any other part of the speaker. Some of this is avoidable. Many of the tears and cracks in speaker cones are the result of accidents in removing them from sets, or during transportation and even while on the service bench.

The speaker cone is made of a heavy paper, and is either cemented directly to the frame around its outside edge, or—in the higher-grade speakers—fastened to strips of bookbinders' leather which in turn are fastened to the frame. A cylindrical voice-coil former is attached to the center of the cone. This may be of paper or thin bakelite.

Common speaker troubles

On all but the smallest speakers, some means of centering the cone in the gap around the center pole-piece is provided. See Fig. 23. On the largest speakers, the whole frame on which the cone is mounted is bolted to the assembly, with the holes through which the bolts pass slightly oversize. Thus with the bolts loosened, the cone can be centered, then tightened into position. In many cases there is a spider in the center of the cone, which is fastened to the center pole-piece with a machine-screw. Other speakers have the spider underneath the cone, also fastened with a pair of screws in such a way as to make centering possible.

Tears and cracks are a common trouble. One "remedy" is only too well known to many repairmen, who have seen many a set come into the shop with stiff, heavy paper patches on the cone. Both the sensitivity of the speaker and quality of reproduction must suffer as a result.

The right way to repair a small crack is to take well-thinned cement and a small brush, and work a little of it in along each side of the crack. In most cases a patch will not be necessary, as the edges of the crack, reinforced by the cement, will remain firmly together. As little extra stiffness and weight is added to the cone as is consistent with doing a good repair job. Jagged broken tears must of course be patched, thin paper or cellulose (Scotch) tape being used.

Another common cone trouble is the open voice coil. This is readily located by a continuity check or the absence of speaker hum though voltages on the output stage are normal and the output transformer primary is in good condition. The open is usually due to a poor connection between the wire of the voice coil and the flexible strip which connects it to the output transformer. It can be found by removing the piece of paper usually cemented over it and resoldering. This is an easy repair job. It is usually due to a hurried soldering job on the original connection, or to the use of corrosive soldering paste.

Sounds resembling those caused by a cracked cone may often be traced

to a loose voice coil—one not properly cemented to the cone. Some old Majestics were especially bad offenders in this connection. The remedy is to cement and let the assembly dry for a day before putting signals through it. A cone loose along the edge will make itself known with characteristic sounds, and simple cementing is all that is needed to put it into good condition.

The off-center voice coil is more troublesome. The symptom of this trouble—high-pitched scratching sounds—is well known to every radio-man. It can be readily verified by pushing the cone in and out with the two thumbs, holding the ear close (no signal being received). The scraping of the cone on the pole-pieces can be heard easily (Fig. 24).

If this scraping has continued long, the insulation may be worn off the wire over part of the voice coil. In such cases all dust and metal fragments should be brushed off, and a layer of *thin* cement applied to the spot, to prevent possible short-circuits.

The cone now should be centered. Loosen the screws which hold the cone in center position, insert three or four shims between the voice-coil form and the center pole-piece, as shown in Fig. 25, and when you are certain that the cone is exactly centered, tighten the screw or screws again, remove the shims, and check for scraping. Shims of different thicknesses may be purchased, or they can be cut from old photo film, heavier sheet celluloid, or thin electrical fiber. Metal shims are not recommended, as they can scrape or cut the paper form in which they are inserted. The shims should be thick enough to fit snugly, but not tightly.

Some of the smaller midget cones have no provision for centering. These have to be released from the frame, centered as above, and re-cemented. The cone can be removed by applying lacquer thinner or

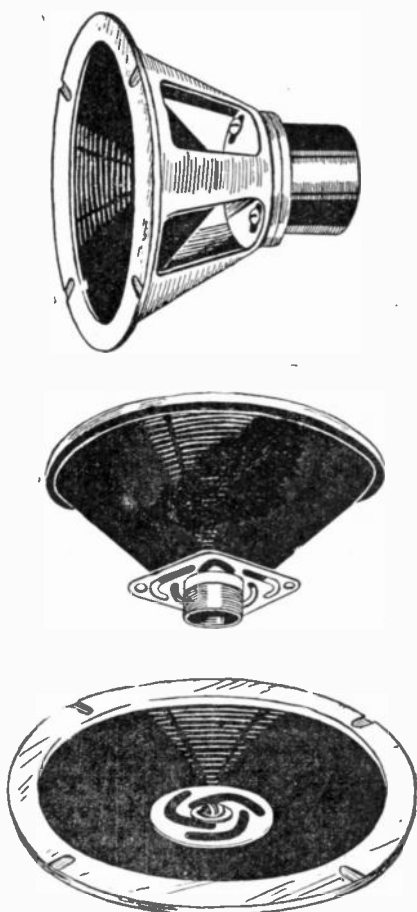

Fig. 23—The cone may be centered by: top—an adjustable frame; middle—an external spider or; bottom—a spider centered on the magnet core.

cement solvent to the rim, softening the cement. Keep on going around with a brush till the cement is soft, then slip a thin knife between the frame and the cone. If it does not come away readily, continue applying solvent.

A sound like that of an off-center cone will often be caused by iron filings or other matter between the voice coil and the magnet. These can often be located by drawing the coil out as far as possible and examining the surface of the wire for scratches. Once discovered, the iron may be worked out with strips of stiff, slightly dampened paper. If the speaker is of the field-coil type, some servicemen connect the field across an a.c. voltage source while removing metal scraps, to destroy any magnetism which might cause the filings to adhere to the pole-piece. It is claimed that in many cases the filings may then be knocked out with a few taps on the frame.

In a few cases the cone will be found to be distorted in shape, due to exposure to damp air, which causes it to sag. In some cases this may be helped by ironing it out with a hot flatiron. The voice-coil form may also get out of shape. The traditional method of straightening it out is to insert a round cork tightly and put it away over the weekend.



Fig. 24—How to find scraping voice coil.

In the early days of the cone speaker, constructors used to buy their own paper and construct cones — sometimes more than a yard across. We have never attempted this, but there is no reason an attempt to replace a badly damaged cone should not be successful. The old cone—or what is left of it—could be used as a pattern for the new one in the event that a replacement cone was not available. Don't attempt this procedure with wide-range speakers.

The field gives less trouble than any other part of the speaker. When trouble does occur, it is because of an open or shorted coil. Few repairmen have ever attempted to make repairs in such cases, though a speaker field is the easiest of all coils to rewind. If the wire is carefully run off onto a spool, meanwhile carefully watching for corroded green spots, most of it will be found in good condition, and can be wound back on again.

A winding jig will be needed of course, and the job takes a certain amount of time, but the work is worth doing, especially on large and expensive speakers.

Should the corroded area be found near the center of the coil, close to the cardboard former, it may be assumed to be due to chemicals in

the cardboard, and several layers of insulating varnish or coil cement should be applied to the form and let dry before rewinding.

In many cases field coils from speakers discarded for other defects can be used. If the coil is of approximately the same physical size and resistance, it will work all right. This can be done to good effect in small speakers, where it is often possible to find the exact duplicate of the defective coil.

In some of the smaller speakers the difficulty is to get the coil out. Large speakers almost invariably are made in three parts: a frame holding the cone; the top of the pot magnet, in the center of which is the hole for the voice coil; and the pot itself, with the center pieces holding the field coil. Some of the smaller speakers are also bolted together, and the coil may be removed by taking out the bolts. Others are made with a one-piece frame, into which the pole-piece is set.

To get the coil out of one of these, remove the cone. Then lay the speaker on its face on the bench or shop floor, and, using a good-sized hammer and a punch or cylindrical piece of iron as near the size of the pole-piece as possible, drive it out—with one blow, if possible. Some pole-pieces project slightly through the back of the frame and have been expanded. In such cases they should be ground level before any attempt is made to remove them. The pole-piece may be easily re-installed, using a mallet or lead hammer, to avoid damage to that part which will be inside the voice coil. It will practically center itself. The process is shown in Fig. 26.

Certain types of Philco speakers are put together with a special screw with no slot in the head. They look puzzling, but the screw can be driven back out with a hammer and punch. Replace with ordinary bolts and nuts. Some old RCA speakers really were put together to stay, and can be taken apart only with a hack saw and put together with a welder. If another field coil is available, this job is quite practical, drastic as it may sound.

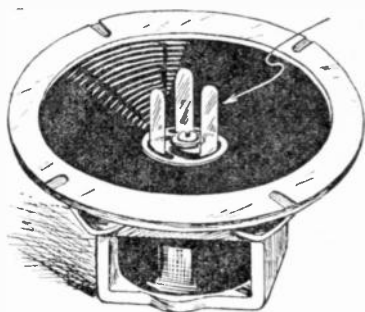

Fig. 25—Shims in position for centering coil.



Fig. 26—How to remove some speaker fields.

STATION RIDING

THE TERM "station riding" was first heard by the writer in San Francisco in 1930. It was used by radio technicians of the Bay City to describe a type of radio interference very prevalent in that area. Station riding is the type of interference that allows an unwanted signal to "ride" the carrier of a wanted signal. When a signal is tuned in on a radio receiver and station riding is present, two or more signals are heard at the same time. When the receiver is detuned, neither the de-

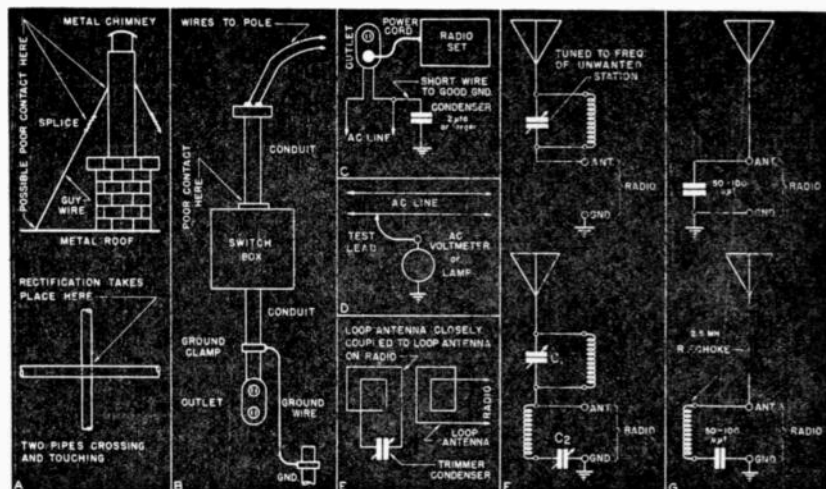

Fig. 27—Various methods of overcoming "station

sired nor the undesired signals are heard. In the case of a broad-tuning or non-selective receiver, interfering signals are usually heard between stations. Station riding affects highly selective radio receivers as well as receivers with poor selectivity.

To rid the receiver of this annoying interference, many schemes were tested. Changing the antenna, a better ground connection, wave traps, etc., were tried. These methods often reduced or eliminated the interference. In other cases, the source of interference had to be located and the remedy applied there.

The source of station riding is usually hard to locate unless a radio interference locating device or a sensitive portable radio receiver is used. Typical causes of station riding are poor electrical contact between sheets of metal on a metal roof, two pipes touching but not making good electrical contact, antenna touching metal drain pipe, poor electrical contact at splices on guy wires attached to antenna mast or metal chimney, or almost any mass of metal making poor electrical contact to another mass of metal. (Fig. 27-a). The theory that is advanced on the cause of this station riding claims that rectification of strong radio signals takes place at the point of poor electrical contact. When two or more radio signals are rectified at these points, their sum and difference frequencies are radiated by the metal objects. The more signals that are picked up and rectified, the larger is the number of radiated beats. When several signals are rectified in this fashion, near-by receivers may pick up jumbled signals every few kilocycles on the receiver tuning range.

In one instance, the writer was called to diagnose a case where the listener complained that the radio was unusable. It was found that half a dozen mixed signals were being received every ten kilocycles throughout the broadcast band. Every carrier, including the high-power local stations, was accompanied by half a dozen interfering signals. Line filters and wave traps were tried to no avail. Being a loop antenna type receiver, an outdoor antenna and ground were tried. The owner felt that it must be the fault of the radio receiver. One of another make was tried and the results were found to be just as bad.

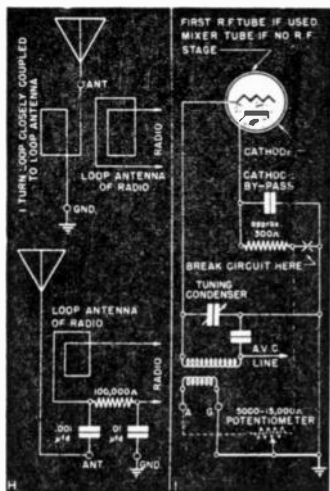

riding" are illustrated.

A construction company tool shack. A switch box was located on the wall of the shack. The wires were fed to the switch box through a vertical piece of conduit. From the bottom of the switch box, another short piece of conduit terminated in an outlet box. This lower piece of conduit was grounded. Upon examining the switch box, the writer slammed its door shut. The interference ceased. Moving the conduit caused the interference to reappear. Poor electrical contact between the top piece of conduit and the switch box apparently caused rectification of radio signals (Fig. 27-b). Tightening the conduit to the box cleared the trouble.

Another case of severe station riding occurred with a popular brand multi-tube receiver which was normally quite selective. The receiver was located less than one-quarter of a mile from a five-kilowatt broadcast station. This station did not cause interference, but a ten-kilowatt station fifteen miles away rode every signal that could be tuned in on the broadcast band. The writer tried every trick in the bag including a check of the house wiring. One peculiar condition of this case was the fact that the interference ceased every day between the hours of noon and one P.M., apparently due to load changes on near-by power lines. Since the radio was one of a very popular brand, the distributor was anxious to keep the radio sold, so a factory engineer was dispatched to the scene. He too tried every trick he knew including the replacement of the built-in loop antenna with an antenna transformer and an outdoor vertical rod antenna. Nothing seemed to reduce the interference, so the dealer who sold the radio exchanged it for one of another make. This receiver worked fine without a trace of station riding. The first receiver used variable capacitor tuning and the second receiver used permeability tuning. However, this proves nothing, as in other locations receivers with permeability tuning suffered from station riding just as badly as those with capacitor tuning.

Grounding line cures some cases

Still another case. This radio receiver was one of good design with exceptionally good selectivity, but it too suffered from severe station riding. The writer found that running a short ground lead to the grounded side of the a.c. line at the outlet to which the radio was connected completely eliminated the trouble. (The reader should be cautioned not to try this unless he has definitely determined which side of the line is grounded. For safety reasons, a paper dielectric condenser [2.0 μ f or larger] should be used in series with the ground lead.) In this case, the cure did not work unless a sufficiently large condenser was used. (See Figs. 27-c and d.) Another word of warning to the reader is to be careful not to violate underwriter rulings.

In cases where the source of interference has been found to be caused by two pipes touching, insulate the pipes from each other or bond them together so that a better electrical contact is established. On buildings with metal roofs, it is suggested that the individual metal plates be bonded together and then grounded. Watch the antenna and lead-in, making sure they do not touch near-by metal objects. In the case of rusted guy wires, break them up with strain insulators or clean and solder the splices. Metal clothes lines terminated at rusty hooks or pulleys should be checked.

In cases where it is not practicable or economical to cure the station riding at its source, or where the source is too difficult to locate, other measures may be tried. In receivers using a loop antenna where only one

interfering signal is present, a loop type wave trap should be tried. This consists of an extra loop antenna strapped to the loop antenna in the receiver, shown in Fig. 27-e. This extra loop is shunted by a trimmer condenser of sufficient capacity to tune it to the frequency of the interfering signal. Adjust the trimmer condenser until the attenuation of the interfering signal is maximum.

For receivers designed for use with an external antenna and ground, wave traps of the resonant or anti-resonant types may be tried. A combination of both types may be used as shown in Fig. 27-f. Adjust both wave traps for maximum attenuation of the interfering signal. Where interference is general from stations at the high-frequency end of the broadcast band, the interference may be reduced by shunting the antenna and ground connections with a small mica condenser of approximately 50- to 100- μmf capacity. If the receiver has short-wave bands and the listener uses these bands, place an r.f. choke of approximately 2.5 millihenries in series with the condenser (Fig. 27-g). Reactance of the choke will be so high on the short-wave bands as to nullify the effect of the condenser, but still make it effective on the broadcast band.

A good ground connection often helps in reducing radio interference. (We have seen a nail driven into a flower pot used as a ground—this is *not* a good ground connection!) Use of a properly designed line filter aids materially, especially with a.c.-d.c. type receivers. Loop antenna type receivers often perform better when used with a vertical rod type outdoor antenna. See Fig. 27-h for methods of connecting outdoor antenna to loop antenna receivers. The one-turn loop coupled to the receiver's loop antenna works quite effectively, especially with receivers using two- or three-turn low-impedance loop antennas.

When image interference is strong, a sensitivity control as shown in Fig. 27-i often will make the receiver more usable. Control may be installed on the rear of the receiver chassis and adjusted to a position where reception is most satisfactory, then left that way.

There is no definite cure-all for all cases of station riding, and some cases will give the radio technician quite a tussle before the answer is found.

SERVICE SANS INSTRUMENTS

MUCH HAS been written explaining how to service radio receivers with the aid of various test equipment, but little on servicing *without the use of any equipment*. To apply such a method, one must know his radio theory and be conversant with radio circuits in detail.

Let us assume that you are confronted with a dead receiver; the trouble could be any place between antenna post and voice coil. Further, assume that the circuit hook-up conforms to that shown in Fig. 28. The only service equipment available for our work is a screwdriver. A signal generator may be needed when it is found that the owner decided his set had a few loose screws that needed tightening up—the screws being located on i.f. transformers. For the present, assume that the alignment screws have not been molested.

The first thing to suspect is of course the tubes. Since we have no tube tester, we must devise some system to determine if the tubes are in working order. Plug the receiver into the 115-volt a.c. receptacle. The tubes should light up. It will be impossible to see whether or not they light if they are of the metal type. In such a case, try substituting their glass equivalent or a reasonable facsimile. In other words, a 6K6-G or a 6V6-G may be used in place of a 6F6, 6L6, etc., for test purposes. Any tube that doesn't light (or warm up) should be replaced, of course.

During the plug-in operation stand ready to unplug the set should the rectifier plate (or any other plate for that matter) shows signs of color. Suppose upon turning the receiver on, the plates of the rectifier get red hot. This would indicate a short-circuit existed from point X of Fig. 28 to ground. An inspection of the diagram reveals that C1 would cause this condition if it were shorted. If it is at fault, the receiver should become operative when it is disconnected from the circuit; however, a loud hum will result. Should the filter choke, CH, become shorted to ground, the plates of the 5Y3-G may show color after a few minutes of operation. It is doubtful whether a short at C2 would overload the rectifier to such an extent that it would show signs of color. In this case CH would heat up to a dangerous degree within a very short time. In making all of these tests do not leave the receiver on too long at one time. Work fast and with care. A short at C2 may be found by shorting

momentarily from point X to ground and repeating at point Y. If we get a strong spark at X but none at Y, disconnect C2. If still no spark, suspect an open in the filter choke. Disconnect CH at point Y. From this we can ascertain whether or not CH is open. We should get a strong spark each side of CH if it is *not* open.

Some insist that shorting the high voltage to ground as pointed out above is detrimental to the receiver. The writer is not of this opinion, for he has done this many times without ill effects. However, it should be made plain that this should be done only *momentarily*.

In our set-up, an open bleeder R1 would not be evident without test equipment. The receiver would still perform. In some receivers this resistor or a part of it furnishes bias for the set. Should an open develop in this case, the receiver would be inoperative. If we suspect the resistor of being open, disconnect it at point Z and touch the disconnected end of the resistor to point X; a spark should be seen. The spark ordinarily will not be very large.

The writer has never seen a shorted bleeder resistor at this position in

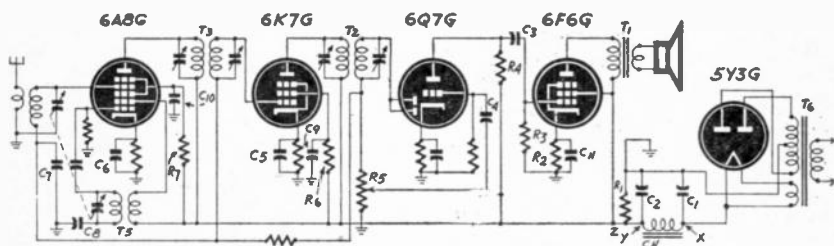

Fig. 28—Typical a.c. superhet used as illustration of trouble-shooting technique.

a circuit. A shorted resistor may be found by the same procedure as outlined above for a short at C2.

If C1 and C2 should lose part of their capacity, a hum will develop, the magnitude of which will depend upon the amount of capacity lost. In some cases severe distortion and oscillation may develop.

One word of caution before leaving the rectifier section—never replace a dead rectifier tube without questioning the condition of C1, C2, and CH. Such practice will prove expensive in terms of rectifier tubes.

Sure that the rectifier section is not at fault, let us proceed to the 6F6-G power output stage in Fig. 28.

We will start at the speaker and work backward to the antenna. The first thing to confront us is the voice coil of the speaker. Should no sound come from the speaker, the fault is either in the high-voltage supply (no voltage) or the speaker (including the output transformer).

An open voice coil usually can be found (if it is the only defect) by tuning the receiver to a strong station and advancing the volume control. The lamination of the output transformer will vibrate and the station may be heard faintly when the ear is placed near the transformer. Care should be taken not to prolong this test as the insulation on the output

transformer may puncture. If the secondary side of the output transformer is open, it can be found by the same procedure as outlined above for an open voice coil. With the primary of T1 open, there will be no voltage on the plate of the 6F6-G tube. In this case, the screen grid will turn red, and there will be no spark when the plate of the tube is shorted to the chassis. It is usually possible to detect an open primary of T1 before removing the chassis from the cabinet.

An open at R2 may be determined by shorting from the cathode to chassis. The set should operate, though not well. If you suspect C11 of being open, shunt it with a good condenser. If it is shorted, distortion would be present and shunting it with a good condenser would not clear up the trouble. If R3 opens, the grid would become so negative in a short period of time that the grid would block.

How to apply simple tests

From an inspection of the diagram, it will be obvious that a positive grid would result should C3 develop a short circuit. The set would develop a case of severe distortion or might fail to perform altogether. One case we recall was a receiver that would play for about 30 seconds and die away. It was found that the control grid of the output tube was several volts positive. Observation showed the grid was red hot.

If all output stage parts are in order we should hear a faint click if the grid of the 6F6-G tube is touched with a screwdriver. Next touch the grid of the 6Q7-G; in this case, the sound in the speaker should be louder. If we get no sound, we must stop and search for the trouble in this stage. Try a new tube. Short from plate to chassis for a second. The voltage here will not be very high as R4 is usually large. Should this portion be in order, advance the volume control and touch the diode plates with your screwdriver. A click of about the same volume as from the grid should be heard.

We may expedite matters a little by placing our screwdriver on the grid of the 6A8-G mixer tube. If no sound here, touch the plate. No sound, touch the grid of the 6K7-G i.f. tube and then the plate of the 6K7-G. Suppose we get a sound by touching the grid of the 6K7-G but a similar action on the plate of the 6A8-G tube yields no response. The trouble will probably be in the input i.f. transformer, T3. If the primary is open, there will be no voltage on the plate of the 6A8-G.

A shorted trimmer on either primary or secondary would put the transformer out of action. You will have to use your own ingenuity in order to find whether or not they are shorted, once the trouble is isolated to the transformer.

Suppose a noise is heard when the antenna post is touched, yet the receiver will not pick up stations. Now, what could be the trouble? This condition is typical of a local oscillator that is not functioning. Check for voltage on the oscillator anode grid (#2) with the tip of your screwdriver.

If the primary of antenna coil is open, the receiver should play to some small degree if you connect the antenna to the control grid of the 6A8-G.

We recall one case that may bring out the fact that the ordinary types of test instruments, such as multimeters, do not always lend themselves readily to the solution of tough service problems. A very noisy receiver was brought in for repairs. The antenna and ground terminals were tied together to help determine if the noise was originating within the set or being picked up from the outside. It was found to be coming from within the set. Upon switching from the broadcast band to the 25-meter band the noise disappeared. This indicated bad broadcast coils. A little theorizing isolated the oscillator coil for the broadcast band as being at fault. A visual inspection was made to see if it were arcing but with no results. The anode of the mixer tube was shorted momentarily to the chassis, upon which the coil opened. It was replaced with good results.

Many other defects can and do occur which cannot be covered here. A few will be mentioned.

1. Rubbing condenser plates on tuning assembly.
2. Noisy volume and tone control.
3. Oscillation due to open filter condensers, bypass condensers, loose shields, grid wire near plate lead in r.f. stages, floating metal tube shield (tube housing), etc.
4. Hum due to open or partially open filter condensers.
5. Motorboating (audio oscillation) due to open filter condensers.
6. Failure of a.c.-d.c. sets to light up because of open tube filament, open line cord resistor, or an open panel lamp.

We used a simple receiver for sake of illustration. The same line of reasoning, along with a sound knowledge of radio theory, may be applied to any receiver. *Many defects do require the use of test instruments to repair*; this is especially true where the intermediate-frequency alignment has been tampered with.

There will be some, no doubt, who will look askance at this method of servicing and denounce it as "screwdriver" tactics (which it is). However, there *are* occasions when these tactics have their value. And the man who knows his screwdriver tactics thoroughly will find the knowledge useful when servicing *with* instruments.

SERVICE BY OBSERVATION

DURING LONG years of radio servicing we have noticed many beginners (and some not beginners!) tinkering with radios and getting nowhere. We have worked with a few so-called "engineers" and have seen them search for many hours to discover trouble that would have been apparent at once, if they had but used their knowledge and observed some things that are quite plain to see.

Careful observation will locate at least 75 percent of all radio troubles. The following system is one we use all the time, and it leads to the trouble quickly, in most cases. Oldtimers will agree that observation is well worthwhile, but beginners will find the system something they have wished for since they first became interested in "fixing" radios. These instructions are not likely to be of much use to the man who has so much confidence in his native luck that he plunges into a radio chassis with screwdriver, pliers, and soldering iron and really "fixes" the set—so that it needs rebuilding!

Let us suppose that we have a six-to-ten-tube superheterodyne on the bench and are preparing to analyze the trouble. (This system may be



adapted to any other type of circuit, if proper consideration is given to certain differences of circuit action.)

A—First, see that all tubes are in their proper sockets. Often the owner has removed the tubes for testing and replaced them in the wrong sockets.

B—Next, turn on the set. If tubes do not light (or heat up, if metal), check the line cord for breaks. On portables especially, check the power switch.

C—Watch the rectifier tube for signs of overheating, plates turning red, etc.

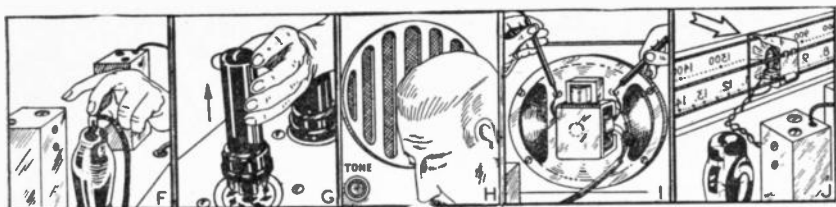

D—Turn chassis over and look for wires touching, burned-out resistors, shorted filter condensers, shorted sockets, or shorted transformer windings.

E—Have the dial set to the channel of a strong local station and the volume control at maximum position.

F—Touch the grid cap of the first audio tube. In the case of the single-ended tubes, touch a test prod to the center of the volume control to get the same results. A loud, clear buzz should be heard if all is well in the audio end.

G—If not, pull out the power tube. It should make a thump in the speaker if there is voltage on the plate of the tube.

H—If not, listen closely to the speaker. There should be some hum if there is any voltage at all on the power tube.

I—If not, check for open voice coil.

J—On midgets, make sure the pilot lamp is O.K.

K—Listen to the output transformer. You can hear it singing if the voice-coil circuit is broken.

L—Feel the output transformer. It often becomes warm when excess current is flowing through the plate winding.

M—The small tone-compensating condenser connected from plate to cathode (or ground) may be shorted. Disconnect it and see. If a.f. is resistance-coupled, the interstage coupling condenser may be leaking, developing a positive voltage at the grid and causing the output tube to draw excessive current.

N—Watch the tuning indicator, if the set has one. If it indicates a signal, the r.f. end is probably O.K. Electron-ray indicator tubes appear to glow red when no voltage is supplied to their anodes.

O—Connect a test prod to the lead-in from a long antenna. Touch it to the grid of the last i.f. tube. Noise coming through will indicate the stage is in passable condition. Work back stage-by-stage toward the antenna post.

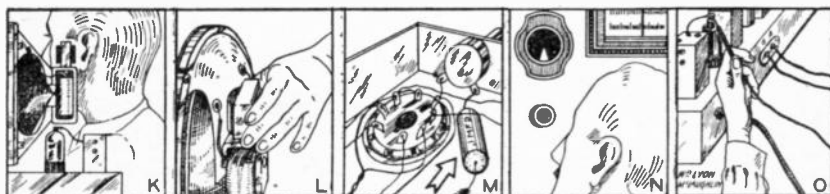

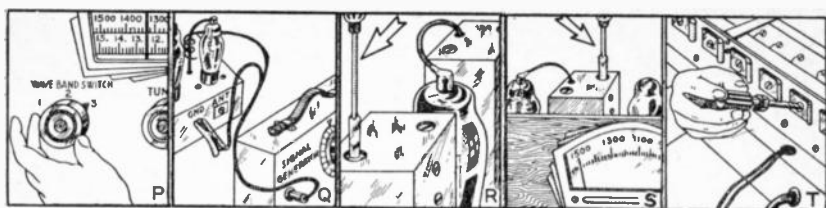

P—Be sure the wave-band switch is set for the broadcast band. If the noise still comes through, but no signal, the set's local oscillator is probably not functioning. (Occasionally a strong signal will force its way through the i.f. section when the oscillator has stopped.)

Q—Check for oscillator failure by coupling the signal generator to the grid of the mixer tube and setting it at the frequency of a local station plus the intermediate frequency of the receiver. The local station will come through if that is your only trouble, since the signal generator is functioning as the local oscillator.

R—Try adjusting the i.f. trimmers to be sure some home mechanic hasn't discovered they were loose and tightened them. Mark the original settings and don't turn them far off without returning to the original—especially if you have no signal generator.

This procedure should not have taken over five minutes, and the serviceman, with a little reasoning, should have a good idea where the trouble is—at least, in which stage it lies.

S—If you are without a signal generator, you still can do a fair job of alignment on a receiver by using the noise pickup from your antenna. If you are in an interference-free location, generate noise with a buzzer or spark coil.

Set the dial at a point where no station is heard. Turn up the volume control and adjust the i.f. trimmers for the highest noise level. The noise has very little effect on the a.v.c. action and accurate adjustment can be made in this manner.

T—Next, tune in a station on the high-frequency end of the dial, and adjust the oscillator trimmer until the station is received best at its correct dial marking. Tune the dial off the station (still at high-frequency end of dial) and adjust the r.f. trimmers for maximum noise level. Lastly, set dial to a known station near 600 kc and adjust the oscillator padder (if one is used) for maximum signal at the correct dial marking. The broadcast band is now aligned.

(This system will work only on sets in which no accident has caused the oscillator frequency to be "off". Where the oscillator trimmer or padder has been misadjusted so that the intermediate frequency generated is—say—300 kc, an attempt to align will leave the i.f. tuned to 300 kc instead of the normal 450-465 kc used on most radios. The result is that stations will come in only on that part of the dial at which the receiver has been "aligned."—*Editor*)



Short-wave bands can be aligned by using the standard frequency stations of the Bureau of Standards at 2.5, 5, 10, and 15 mc to set the oscillator trimmers, and the noise level to adjust the r.f. trimmers. Generally, the short-wave bands should be aligned first.

A war or two on cut-out cases. Locate the section giving the trouble: Then concentrate on that section.

U—Connect a pair of headphones through a small condenser to the grid of the first audio tube. If no signal is heard the fault is in the detector, r.f., or i.f. stages. Check them as in steps N-T. If a signal *does* come through the phones, the trouble is somewhere in the a.f. stages. Shift the phones to the grid of the second audio tube. If the signal is heard, go on to the plate of the second a.f. tube. If signal still is heard, go on to the voice coil. The part or stage between the last point where signal is heard and the first no-signal test point will contain the cause of the trouble.

V—Connect the signal generator to the antenna and tune in the signal. Turn off the modulation. Turn up the receiver volume control. Any loose connections easily can be heard by probing and tapping.

W—When a suspected open condenser is to be bridged with another on a cut-out job, touch one lead of the bridging condenser to one terminal of the suspected condenser in the usual manner. Then, holding the other lead of the bridging condenser with the forefinger and thumb, touch the other terminal with the little finger, charging the bridging condenser slowly through the fingers before completing the connection. This will prevent a sudden surge which often will make an intermittent radio start operating normally.

X—If the set is full of “birdies”, an r.f. or i.f. stage may be oscillating. This can be located best by touching the point of a pencil to the plate lug of each r.f. and i.f. tube socket. A loud click will be heard when you have located the oscillating tube. If it proves to be an i.f. stage and all parts test normal, connect a resistor of as high a value as possible across the primary winding of the i.f. transformer. This will stop the oscillation. Usually 50,000 ohms will take care of it.

Distortion is the cause of many complaints, so here is some information, especially for the new serviceman, which may be an aid in locating the trouble:

After a little practice the serviceman will be able to distinguish by ear whether the trouble is in the r.f.-i.f. section, audio section, or speaker.

However, touching the first audio tube grid may tell the story. A rattle will indicate speaker trouble. A distorted buzz proves the trouble is in the audio, a clear buzz indicates it is probably in the r.f.-i.f. section.

If the distortion is traced to the audio amplifier, check all voltages carefully, especially bias voltages. Be sure they are correct.

Y—Check grid-to-cathode voltage of each tube. If stage is resistance-coupled you won't get much indication of voltage, with an ordinary d.c. meter, but there should be some indication on the output stage.

Z—Control-grid voltages must be negative with respect to cathode. If not, check the coupling condensers (see M).

AA—A shorted output transformer will cause poor tone. If it shows evidence of having been replaced, be sure its impedance matches the characteristics of the power tube.

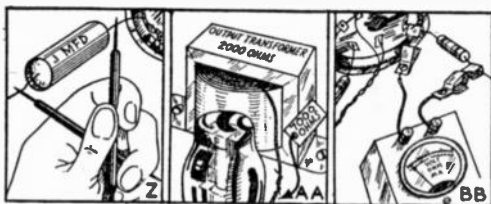

BB—If you are using the usual 1,000-ohms-per-volt test meter, place its leads from grid to ground on each stage to see if any stage has a floating grid (open grid resistor). This may clear up the distortion. If so, replace the grid resistor. If the first audio tube is of the pentode type with a series screen resistor you may not read much voltage. However, set the voltmeter for a lower voltage range. This may not increase the deflection, but it will lower the supply voltage to the screen. A high voltage here will cause distortion.

If the distortion trouble has shown up since you have been working on the set, probably you have caused it yourself. Check for defective parts, poor soldering, or wrong connections.

R.f. distortion may be due to misalignment or to wrong bias voltages. Check for both.

If distortion occurs only on strong signals, disconnect the antenna. If this clears up distortion you can be sure it is due to wrong bias voltage in the r.f. or i.f. stages. On the older sets using 24's or similar tubes, potentials under 25 volts on the screen or over minus 12 volts on the grid will cause distortion. It will be necessary to install super-control tubes or a local-distance switch to lessen pickup.

Recheck all tubes to be sure they are in their proper sockets. A sharp cut-off type such as a 6SJ7 will not replace a super-control tube such as a 6SK7 in sets where the volume is controlled by varying the control-grid bias, either manually or with automatic volume controls (most sets use one or the other method).

Be thorough. Don't skip a stage until you have checked everything.

USEFUL SPEAKER TESTER

BY USING this unit, consisting of a universal output transformer, a small speaker, switches, and jacks, it is possible to substitute a speaker or transformer, or both, with little lost time.

If the radio has a push-pull output circuit, jacks J1 and J3 are connected to the plates and J2 to B+. Where there is only a single output tube, jack J1 is connected to the plate and J2 to B+.

After the proper plate connections have been made it is necessary to

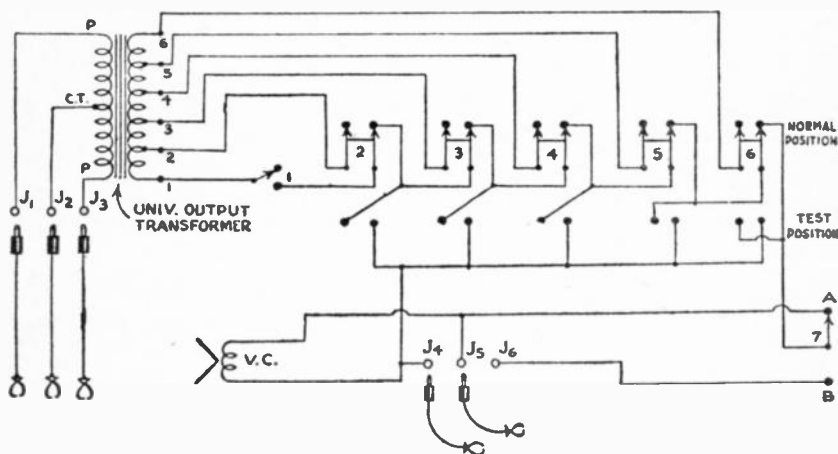

Fig. 29—A flexible loudspeaker tester which permits connecting the speaker to any type output circuit. It also enables the operator to quickly test the speaker or output of a set without removing it.

connect the voice coil to the proper secondary terminals of the output transformer.

The correct terminals may be determined by referring to the chart which usually accompanies universal transformers in their cartons.

If terminals 3 and 5 are indicated, throw switches 3 and 5 to Test Position, and the speaker is connected to the radio with proper impedance ratio.

If the chart is not handy the proper switches may be found by trial. But only two switches should be in Test Position at any one time, and switch No. 7 must be in position A.

When desired, the loudspeaker on the radio set may be tested simply by disconnecting the voice coil of the speaker from its associated output transformer, and using leads with clips to connect the voice coil of the speaker to J4 and J6, with switch 7 in position B.

Matching the impedance

The impedance may be matched by throwing the proper pair of matching switches to test position.

If the output transformer in the radio is O.K., and the trouble is with the speaker, the test speaker can be connected to the output transformer of the radio by connecting the clips to the secondary of the output transformer through J4 and J5. Switch 7 should be in position B. The output transformer of the tester is not used, and there is no means of matching impedance—it simply provides a check on the output transformer of the radio set.

Now a word in explanation of the use of the six matching switches. Each switch is connected to the corresponding terminal on the universal output transformer, and when in Test Position connects one side of the voice coil to the corresponding secondary terminal of the output transformer. By using a certain pair of switches, the voice coil may be connected to a corresponding pair of terminals.

The above may sound somewhat complicated, and the unit in fact looks so. but in practice it will be found that a few settings are standard for practically all speakers tested. If a few labels are pasted under the switches, all operations and settings become clear to even a new user of the instrument.

This unit is quite useful, as it facilitates the removal of a receiver to the shop without bothering with the speaker. And where an output transformer is to be replaced, if the same type of transformer is used for replacement as the one in the tester, it will help to determine the correct pair of secondary terminals to use.

List of Parts

5—Tip plugs	1—S.p.s.t. toggle switch
5—Pee-wee battery clips with insulators	5—D.p.d.t. toggle switches
1—PM speaker	1—S.p.d.t. toggle switch
1—Universal output transformer	6—Tip jacks

10 New Books

RADIO-CRAFT LIBRARY SERIES

Each book in this new series is crammed full of meaty material for immediate, practical application. All are set in modern easy-to-read type, carefully printed and illustrated. 50c each.

29—HANDY KINKS AND SHORT CUTS. A compilation of practical methods of overcoming difficulties encountered by every radio man. Here are kinks on antennas, servicing, the shop, power supplies, etc. — arranged by sections for easy reference, and illustrated.

30—UNUSUAL PATENTED CIRCUITS 1944-46. A digest of new radio-electronic patents, many the result of wartime research, valuable to anyone in the electronics field. Covers: Control Circuits; Power Supplies; Detectors and Amplifiers; Foreign Patents and others. Simplified circuit diagrams.

31—RADIO QUESTIONS AND ANSWERS. Here are answers to questions most frequently asked the "Question Box" editor of RADIO-CRAFT. The material selected is well diversified and chosen for practical application to workaday problems. Many diagrams.

32—ADVANCED SERVICE TECHNIQUE. An up-to-date collection of information on specialized phases of servicing, appealing to the advanced serviceman. The book is a diversified library of ideas, methods, and procedures not found in other books for professional servicemen.

33—AMPLIFIER BUILDER'S GUIDE. A valuable book for the designer and constructor of sound equipment. Theory and construction of audio amplifiers are treated. It contains a wide range of technical data on amplifier design, followed by constructional details for a variety of amplifiers.

34—RADIO-ELECTRONIC CIRCUITS. Here is an extensive collection of circuit diagrams with a brief description of each, to serve as a source of inspiration to the experimenter bent on developing new circuits. Constructional data is purposely limited to allow space for a maximum number of circuits.

35—AMATEUR RADIO BUILDER'S GUIDE. Here is a book for the "ham" who builds his own. Practical and down-to-earth, it is divided into sections on receivers, transmitters, and accessory eqpt. (antennas, converters, and other equipment). The book is packed with information.

36—RADIO TEST INSTRUMENTS. Every radio man can use this new book on building test equipment. Among the instruments described are signal tracers, capacity meters, portable and bench multichecks, signal generators, tube checkers, and electronic voltmeters.

37—ELEMENTARY RADIO SERVICING. How to get started and keep going. A wide range of essentials is covered: Planning and Equipping the Shop, Systematic Circuit Checks, Signal Tracing Methods, Servicing Midget Receivers, and other fundamental servicing topics.

38—HOW TO BUILD RADIO RECEIVERS. Here is a book for the set builder. 18 modern sets are described including short-wave, broadcast, v.h.f., portable, a.c.-operated, a.c.-d.c., and miniature types—a sufficient variety to appeal to practically every radio fan.

