

ALLIED'S RADIO DATA HANDBOOK

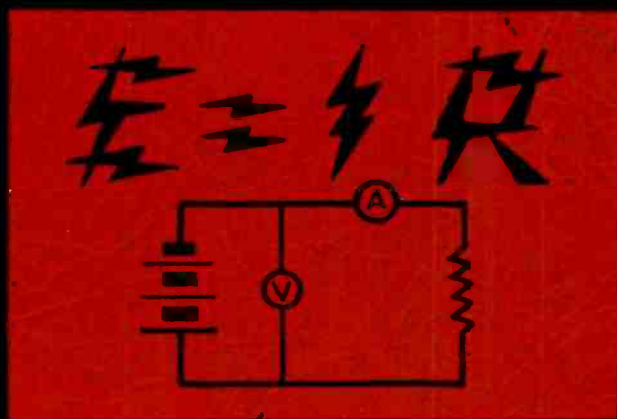

ALLIED RADIO CORPORATION
CHICAGO



ALLIED'S RADIO DATA HANDBOOK

A Compilation of Formulas and Data Most Commonly Used in the Field of Radio and Electronics

Written and Compiled by the
Technical Staff of
ALLIED RADIO CORPORATION

Edited by

NELSON M. COOKE,

Lieutenant, United States Navy,

Naval Research Laboratory, Anacostia Station, Washington, D. C.
Member, Institute of Radio Engineers. Author, "Mathematics for
Electricians and Radiomen".

Published by

Allied Radio Corporation, Chicago, Illinois, U. S. A.

FOREWORD

Allied Radio Corporation has long recognized the need for a comprehensive and condensed handbook of formulas and data most commonly used in the field of radio and electronics. It was felt also that such a book should serve entirely as a convenient source of information and reference and that all attempts to teach or explain the basic principles involved should be left to classroom instruction and to the many already existing publications written for this distinct purpose.

The *Radio Data Handbook*, therefore, consists entirely of formulas, tables, charts and data. Every effort has been made to present this information clearly and to arrange it in a convenient manner for instant reference. All material was carefully selected and prepared by *Allied's* technical staff to serve the requirements of many specific groups in the radio and electronics field. It is hoped that our objectives have been successfully attained and that this *Handbook* will serve as: (1) A valuable adjunct to classroom study and laboratory work for the student and instructor; (2) A dependable source of information for the beginner, experimenter and set builder; (3) A reliable guide for the service engineer and maintenance man in his everyday work; (4) A time-saving and practical reference for the radio amateur, technician and engineer, both in the laboratory and in the field of operations.

The publishers are indebted to the McGraw-Hill Book Company, Inc., for their permission to use material selected from "*Mathematics for Electricians and Radiomen*" by Nelson M. Cooke. *Allied* also takes this opportunity to thank those manufacturers who so generously permitted our use of current data prepared by their engineering personnel. Special recognition and our sincere appreciation are extended to Lieutenant Cooke for his helpful suggestions and generous contribution of his time and specialized knowledge in editing the material contained in this book.

☆ *Any opinions or assertions contained herein are those of the publisher and are not to be construed as official or reflecting the views of the Navy Department or the naval service at large.*

ALLIED RADIO CORPORATION

TABLE OF CONTENTS

Fundamental Mathematical Data	4-5
Mathematical Constants	4
Mathematical Symbols	4
Decimal Parts of an Inch	4
Fundamental Algebraic Formulas	5
Most Used Radio and Electronic Formulas	5-20
Decibels	5
Resistance	6
Capacitance	6
Inductance	6-7
Reactance	7
Resonance	7
Frequency and Wavelength	7
"Q" Factor	8
Impedance	8-10
Conductance	11
Susceptance	11
Admittance	11
Transient <i>I</i> and <i>E</i> in <i>LCR</i> Circuits	12-13
Steady State Current Flow	13
Transmission Line Formulas	14
Capacity of a Vertical Antenna	14
Vacuum Tube Formulas and Symbols	15
R.M.S., Peak and Average Volts and Current	15
D-C Meter Formulas	16-17
Ohms Law for A-C and D-C Circuits	18-19
Trigonometric Functions and Formulas	20
Engineering and Servicing Data	21-39
Metric Relationships and Conversion Chart	21
R-F Coil Winding Formulas	22
Wire Tables	22-23
R-F Coil Winding Data Chart	24-25
Inductance, Capacitance and Reactance Charts	25-28
Radio Color Codes	29-32
Resistors	29
Mica Capacitors	29
Power Transformers	30
Battery Cables	30
Speaker Leads and Plug Connections	31-32
I-F Transformers	32
Audio and Output Transformers	32
Pilot Lamp Data	33
Plug-In Ballast Resistors	34
Interchangeable Tubes	35-37
Abbreviations and Letter Symbols	38
Schematic Diagram Symbols	39
Log and Trig Tables	40-47
Four-Place Common Log Tables	40-41
Four-Place Trigonometric Functions	42-47
Cross Reference Index	48

Mathematical Symbols

- × or · Multiplied by
- ÷ or : Divided by
- + Positive. Plus. Add
- Negative. Minus. Subtract
- ± Positive or negative. Plus or minus
- ∓ Negative or positive. Minus or plus
- = or :: Equals
- ≡ Identity
- ≈ Is approximately equal to
- ≠ Does not equal
- > Is greater than
- ≫ Is much greater than
- < Is less than
- ≪ Is much less than
- ≥ Greater than or equal to
- ≤ Less than or equal to
- ∴ Therefore
- ∠ Angle
- Δ Increment or Decrement
- ⊥ Perpendicular to
- ∥ Parallel to
- |n| Absolute value of n

Mathematical Constants

- $\pi = 3.14$
- $2\pi = 6.28$
- $(2\pi)^2 = 39.5$
- $4\pi = 12.6$
- $\pi^2 = 9.87$
- $\frac{\pi}{2} = 1.57$
- $\frac{1}{\pi} = 0.318$
- $\frac{1}{2\pi} = 0.159$
- $\frac{1}{\pi^2} = 0.101$
- $\frac{1}{\sqrt{\pi}} = 0.564$
- $\sqrt{\pi} = 1.77$
- $\sqrt{\frac{\pi}{2}} = 1.25$
- $\sqrt{2} = 1.41$
- $\sqrt{3} = 1.73$
- $\frac{1}{\sqrt{2}} = 0.707$
- $\frac{1}{\sqrt{3}} = 0.577$
- $\log \pi = 0.497$
- $\log \frac{\pi}{2} = 0.196$
- $\log \pi^2 = 0.994$
- $\log \sqrt{\pi} = 0.248$

Decimal Inches

- Inches × 2.540 = Centimeters
- Inches × 1.578 × 10⁻⁵ = Miles
- Inches × 10³ = Mils

Inches		Decimal Equivalent	Millimeter Equivalent
1/64	1/32	.0156 .0313	0.397 0.794
3/64	1/16	.0469 .0625	1.191 1.588
5/64	3/32	.0781 .0938	1.985 2.381
7/64	1/8	.1094 .1250	2.778 3.175
9/64	5/32	.1406 .1563	3.572 3.969
11/64	3/16	.1719 .1875	4.366 4.762
13/64	7/32	.2031 .2188	5.159 5.556
15/64	1/4	.2344 .2500	5.953 6.350
17/64	9/32	.2656 .2813	6.747 7.144
19/64	5/16	.2969 .3125	7.541 7.937
21/64	11/32	.3281 .3438	8.334 8.731
23/64	3/8	.3594 .3750	9.128 9.525
25/64	13/32	.3906 .4063	9.922 10.319
27/64	7/16	.4219 .4375	10.716 11.112
29/64	15/32	.4531 .4688	11.509 11.906
31/64	1/2	.4844 .5000	12.303 12.700
33/64	17/32	.5156 .5313	13.097 13.494
35/64	9/16	.5469 .5625	13.891 14.287
37/64	19/32	.5781 .5938	14.684 15.081
39/64	5/8	.6094 .6250	15.478 15.875
41/64	21/32	.6406 .6563	16.272 16.669
43/64	11/16	.6719 .6875	17.067 17.463
45/64	23/32	.7031 .7188	17.860 18.258
47/64	3/4	.7344 .7500	18.653 19.049
49/64	25/32	.7656 .7813	19.446 19.842
51/64	13/16	.7969 .8125	20.239 20.636
53/64	27/32	.8281 .8438	21.033 21.430
55/64	7/8	.8594 .8750	21.827 22.224
57/64	29/32	.8906 .9063	22.621 23.018
59/64	15/16	.9219 .9375	23.415 23.812
61/64	31/32	.9531 .9688	24.209 24.606
63/64	1.0	.9844 1.0000	25.004 25.400

Algebra

Exponents and Radicals

$$a^x \times a^y = a^{(x+y)}, \quad \frac{a^x}{a^y} = a^{(x-y)}$$

$$(ab)^x = a^x b^x, \quad \left(\frac{a}{b}\right)^x = \frac{a^x}{b^x}$$

$$\sqrt[x]{\frac{a}{b}} = \frac{\sqrt[x]{a}}{\sqrt[x]{b}}, \quad a^{-x} = \frac{1}{a^x}$$

$$(a^x)^y = a^{xy}, \quad \sqrt[x]{\sqrt[y]{a}} = \sqrt[xy]{a}$$

$$\sqrt[x]{ab} = \sqrt[x]{a} \sqrt[x]{b}, \quad a^{\frac{x}{y}} = \sqrt[y]{a^x}$$

$$\frac{1}{a^x} = \sqrt[x]{\frac{1}{a}}, \quad a^0 = 1$$

Solution of a Quadratic

Quadratic equations in the form

$$ax^2 + bx + c = 0$$

may be solved by the following:

$$x = \frac{-b \pm \sqrt{b^2 - 4ac}}{2a}$$

Transposition of Terms

If $A = \frac{B}{C}$, then $B = AC$, $C = \frac{B}{A}$.

If $\frac{A}{B} = \frac{C}{D}$, then $A = \frac{BC}{D}$,

$$B = \frac{AD}{C}, \quad C = \frac{AD}{B}, \quad D = \frac{BC}{A}$$

If $A = \frac{1}{D\sqrt{BC}}$, then $A^2 = \frac{1}{D^2BC}$,

$$B = \frac{1}{D^2A^2C}, \quad C = \frac{1}{D^2A^2B}, \quad D = \frac{1}{A\sqrt{BC}}$$

If $A = \sqrt{B^2 + C^2}$, then $A^2 = B^2 + C^2$,

$$B = \sqrt{A^2 - C^2}, \quad C = \sqrt{A^2 - B^2}$$

Decibels

The number of db by which two power outputs P_1 and P_2 (in watts) may differ, is expressed by

$$10 \log \frac{P_1}{P_2};$$

or in terms of volts,

$$20 \log \frac{E_1}{E_2};$$

or in current,

$$20 \log \frac{I_1}{I_2}$$

While power ratios are independent of source and load impedance values, voltage and current ratios in these formulas hold true only when the source and load impedances R_1 and R_2 are equal. In circuits where these impedances differ, voltage and current ratios are expressed by,

$$db = 20 \log \frac{E_1 \sqrt{R_2}}{E_2 \sqrt{R_1}} \quad \text{or,} \quad 20 \log \frac{I_1 \sqrt{R_1}}{I_2 \sqrt{R_2}}$$

DB Expressed in Watts & Volts

DB *	Above Zero Level		Below Zero Level	
	Watts	Volts	Watts	Volts
0	0.00600	1.73	6.00x10 ⁻³	1.73
1	0.00755	1.94	4.77x10 ⁻³	1.54
2	0.00951	2.18	3.78x10 ⁻³	1.38
3	0.0120	2.45	3.01x10 ⁻³	1.23
4	0.0151	2.74	2.39x10 ⁻³	1.09
5	0.0190	3.08	1.90x10 ⁻³	0.974
6	0.0239	3.46	1.51x10 ⁻³	0.868
7	0.0301	3.88	1.20x10 ⁻³	0.774
8	0.0378	4.35	9.51x10 ⁻⁴	0.690
9	0.0477	4.88	7.55x10 ⁻⁴	0.614
10	0.0600	5.48	6.00x10 ⁻⁴	0.548
11	0.0755	6.14	4.77x10 ⁻⁴	0.488
12	0.0951	6.90	3.78x10 ⁻⁴	0.435
13	0.120	7.74	3.01x10 ⁻⁴	0.388
14	0.151	8.68	2.39x10 ⁻⁴	0.346
15	0.190	9.74	1.90x10 ⁻⁴	0.308
16	0.239	10.93	1.51x10 ⁻⁴	0.275
17	0.301	12.26	1.20x10 ⁻⁴	0.245
18	0.378	13.75	9.51x10 ⁻⁵	0.218
19	0.477	15.44	7.55x10 ⁻⁵	0.194
20	0.600	17.32	6.00x10 ⁻⁵	0.173
25	1.90	30.8	1.90x10 ⁻³	0.0974
30	6.00	54.8	6.00x10 ⁻³	0.0548
35	19.0	97.4	1.90x10 ⁻²	0.0308
40	60.0	173.	6.00x10 ⁻²	0.0173
45	190.	308.	1.90x10 ⁻¹	0.00974
50	600.	548.	6.00x10 ⁻¹	0.00548
60	6,000.	1,730.	6.00x10 ⁻²	0.00173
70	60,000.	5,480.	6.00x10 ⁻³	0.000548
80	600,000.	17,300.	6.00x10 ⁻⁴	0.000173

*Zero db = 6 milliwatts into a 500 ohm load. Power ratios hold for any impedance, but voltages must be referred to an impedance load of 500 ohms.

Most Used Formulas

Resistance

In series $R_t = R_1 + R_2 + R_3 \dots \text{etc.}$

In parallel $R_t = \frac{1}{\frac{1}{R_1} + \frac{1}{R_2} + \frac{1}{R_3} \dots \text{etc.}}$

Two resistors in parallel $R_t = \frac{R_1 R_2}{R_1 + R_2}$

Capacitance

In parallel $C_t = C_1 + C_2 + C_3 \dots \text{etc.}$

In series $C_t = \frac{1}{\frac{1}{C_1} + \frac{1}{C_2} + \frac{1}{C_3} \dots \text{etc.}}$

Two capacitors in series $C_t = \frac{C_1 C_2}{C_1 + C_2}$

The Quantity of Electricity Stored Within a Capacitor is Given by

$$Q = CE$$

where Q = the quantity stored, in coulombs,

E = the potential impressed across the condenser, in volts,

C = capacitance in farads.

The Capacitance of a Parallel Plate Capacitor is Given by

$$C = 0.0885 \frac{KS(N-1)}{d}$$

where C = capacitance in mmfd.,

K = dielectric constant,

* S = area of one plate in square centimeters,

N = number of plates,

* d = thickness of the dielectric in centimeters (same as the distance between plates).

* When S and d are given in inches, change constant 0.0885 to 0.224. Answer will still be in micromicrofarads.

DIELECTRIC CONSTANTS

Kind of Dielectric	Approximate* K Value
Air (at atmospheric pressure).....	1.0
Bakelite.....	5.0
Beeswax.....	3.0
Cambric (varnished).....	4.0
Fibre (Red).....	5.0
Glass (window or flint).....	8.0
Gutta Percha.....	4.0
Mica.....	6.0
Paraffin (solid).....	2.5
Paraffin Coated Paper.....	3.5
Porcelain.....	6.0
Pyrex.....	4.5
Quartz.....	5.0
Rubber.....	3.0
Slate.....	7.0
Wood (very dry).....	5.0

* These values are approximate, since true values depend upon quality or grade of material used, as well as moisture content, temperature and frequency characteristics of each.

Self-Inductance

In series $L_t = L_1 + L_2 + L_3 \dots \text{etc.}$

In parallel $L_t = \frac{1}{\frac{1}{L_1} + \frac{1}{L_2} + \frac{1}{L_3} \dots \text{etc.}}$

Two inductors in parallel $L_t = \frac{L_1 L_2}{L_1 + L_2}$

Coupled Inductance

In series with fields *aiding*

$$L_t = L_1 + L_2 + 2M$$

In series with fields *opposing*

$$L_t = L_1 + L_2 - 2M$$

In parallel with fields *aiding*

$$L_t = \frac{1}{\frac{1}{L_1 + M} + \frac{1}{L_2 + M}}$$

In parallel with fields *opposing*

$$L_t = \frac{1}{\frac{1}{L_1 - M} + \frac{1}{L_2 - M}}$$

where L_t = the total inductance,
 M = the mutual inductance,
 L_1 and L_2 = the self inductance of the individual coils.

Mutual Inductance

The mutual inductance of two r-f coils with fields interacting, is given by

$$M = \frac{L_A - L_O}{4}$$

where M = mutual inductance, expressed in same units as L_A and L_O ,
 L_A = Total inductance of coils L_1 and L_2 with fields *aiding*,
 L_O = Total inductance of coils L_1 and L_2 with fields *opposing*.

Coupling Coefficient

When two r-f coils are inductively coupled so as to give transformer action the coupling coefficient is expressed by

$$K = \frac{M}{\sqrt{L_1 L_2}}$$

where K = the coupling coefficient; — ($K \times 10^2$ = coupling coefficient in %),

M = the mutual inductance value,
 L_1 and L_2 = the self-inductance of the two coils respectively, both being expressed in the same units.

Resonance

The resonant frequency, or frequency at which inductive reactance X_L equals capacitive reactance X_C , is expressed by

$$f_r = \frac{1}{2\pi \sqrt{LC}}$$

also $L = \frac{1}{4\pi^2 f_r^2 C}$

and $C = \frac{1}{4\pi^2 f_r^2 L}$

where f_r = resonant frequency in cycles per second,
 L = inductance in henrys,
 C = capacitance in farads,
 $2\pi = 6.28$
 $4\pi^2 = 39.5$

Reactance

of an inductance is expressed by

$$X_L = 2\pi fL$$

of a capacitance is expressed by

$$X_C = \frac{1}{2\pi fC}$$

where X_L = inductive reactance in ohms, (known as positive reactance),
 X_C = capacitive reactance in ohms, (known as negative reactance),
 f = frequency in cycles per second,
 L = inductance in henrys,
 C = capacitance in farads,
 $2\pi = 6.28$

Frequency from Wavelength

$$f = \frac{3 \times 10^5}{\lambda} \text{ (kilocycles)}$$

where λ = wavelength in *meters*.

$$f = \frac{3 \times 10^4}{\lambda} \text{ (megacycles)}$$

where λ = wavelength in *centimeters*.

Wavelength from Frequency

$$\lambda = \frac{3 \times 10^5}{f} \text{ (meters)}$$

where f = frequency in *kilocycles*.

$$\lambda = \frac{3 \times 10^4}{f} \text{ (centimeters)}$$

where f = frequency in *megacycles*.

Q or Figure of Merit

of a simple reactor

$$Q = \frac{X_L}{R_L}$$

of a single capacitor

$$Q = \frac{X_C}{R_C}$$

where Q = a ratio expressing the figure of merit,

X_L = inductive reactance in ohms,

X_C = capacitive reactance in ohms,

R_L = resistance in ohms acting in series with inductance,

R_C = resistance in ohms acting in series with capacitance,

Impedance

In any a-c circuit where resistance and reactance values of the R , L and C components are given, the absolute or numerical magnitude of impedance and phase angle can be computed from the formulas which follow.

In general the basic formulas expressing total impedance are:

for series circuits,

$$Z_t = \sqrt{R_t^2 + X_t^2}$$

for parallel circuits,

$$Z_t = \frac{1}{\sqrt{G_t^2 + B_t^2}}$$

See page 11 for formulas involving impedance, conductance, susceptance and admittance.

In series circuits where phase angle and any two of the Z , R and X components are known, the unknown component may be determined from the expressions:

$$Z = \frac{R}{\cos \theta} \qquad Z = \frac{X}{\sin \theta}$$

$$R = Z \cos \theta \qquad X = Z \sin \theta$$

where Z = magnitude of impedance in ohms,

R = resistance in ohms,

X = reactance (inductive or capacitive) in ohms.

Nomenclature

Z = absolute or numerical value of impedance magnitude in ohms

R = resistance in ohms,

X_L = inductive reactance in ohms,

X_C = capacitive reactance in ohms,

L = inductance in henrys,

C = capacitance in farads,

R_L = resistance in ohms acting in series with inductance,

R_C = resistance in ohms acting in series with capacitance,

θ = phase angle in degrees by which current leads voltage in a capacitive circuit, or lags voltage in an inductive circuit. In a resonant circuit, where X_L equals X_C , θ equals 0° .

Degrees $\times 0.0175$ = radians.
1 radian = 57.3° .

Numerical Magnitude of Impedance . . .



of resistance alone

$$Z = R$$

$$\theta = 0^\circ$$



of resistance in series

$$Z = R_1 + R_2 + R_3 \dots \text{etc.}$$

$$\theta = 0^\circ$$

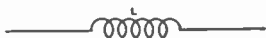

of inductance alone

$$Z = X_L$$

$$\theta = +90^\circ$$

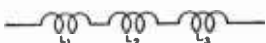

of inductance in series

$$Z = X_{L1} + X_{L2} + X_{L3} \dots \text{etc.}$$

$$\theta = +90^\circ$$



of capacitance alone

$$Z = X_C$$

$$\theta = -90^\circ$$



of capacitance in series

$$Z = X_{C1} + X_{C2} + X_{C3} \dots \text{etc.}$$

$$\theta = -90^\circ$$



or where only 2 capacitances C_1 and C_2 are involved,

$$Z = \frac{1}{2\pi f} \left(\frac{C_1 + C_2}{C_1 C_2} \right)$$

$$\theta = -90^\circ$$



of resistance and inductance in series

$$Z = \sqrt{R^2 + X_L^2}$$

$$\theta = \text{arc tan } \frac{X_L}{R}$$



of resistance and capacitance in series

$$Z = \sqrt{R^2 + X_C^2}$$

$$\theta = \text{arc tan } \frac{X_C}{R}$$



of inductance and capacitance in series

$$Z = X_L - X_C$$

$$\theta = -90^\circ \text{ when } X_L < X_C$$

$$= 0^\circ \text{ when } X_L = X_C$$

$$= +90^\circ \text{ when } X_L > X_C$$



of resistance, inductance and capacitance in series

$$Z = \sqrt{R^2 + (X_L - X_C)^2}$$

$$\theta = \text{arc tan } \frac{X_L - X_C}{R}$$

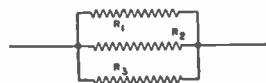

of resistance in parallel

$$Z = \frac{1}{\frac{1}{R_1} + \frac{1}{R_2} + \frac{1}{R_3} \dots \text{etc.}}$$

$$\theta = 0^\circ$$

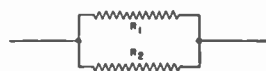

or where only 2 resistances R_1 and R_2 are involved,

$$Z = \frac{R_1 R_2}{R_1 + R_2}$$

$$\theta = 0^\circ$$

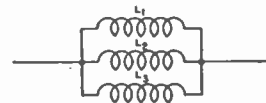

of inductance in parallel

$$Z = \frac{1}{\frac{1}{X_{L1}} + \frac{1}{X_{L2}} + \frac{1}{X_{L3}} \dots \text{etc.}}$$

$$\theta = +90^\circ$$



or where only 2 inductances R_1 and R_2 are involved,

$$Z = 2\pi f \left(\frac{L_1 L_2}{L_1 + L_2} \right)$$

$$\theta = + 90^\circ$$

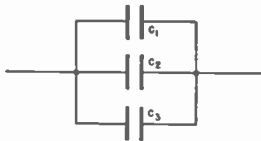

of capacitance in parallel

$$Z = \frac{1}{\frac{1}{X_{C1}} + \frac{1}{X_{C2}} + \frac{1}{X_{C3}} \dots \text{etc.}}$$

$$\theta = - 90^\circ$$

or where only 2 capacitances C_1 and C_2 are involved,

$$Z = \frac{1}{2\pi f (C_1 + C_2)}$$

$$\theta = - 90^\circ$$

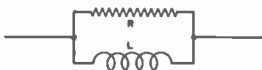

of inductance and resistance in parallel,

$$Z = \frac{RX_L}{\sqrt{R^2 + X_L^2}}$$

$$\theta = \text{arc tan } \frac{R}{X_L}$$



of capacitance and resistance in parallel,

$$Z = \frac{RX_C}{\sqrt{R^2 + X_C^2}}$$

$$\theta = - \text{arc tan } \frac{R}{X_C}$$

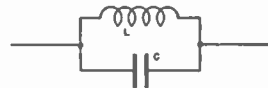

of inductance and capacitance in parallel,

$$Z = \frac{X_L X_C}{\sqrt{X_L^2 - X_C^2}}$$

$$\theta = 0^\circ \text{ when } X_L = X_C$$

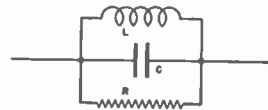

of inductance, resistance and capacitance in parallel

$$Z = \frac{RX_L X_C}{\sqrt{X_L^2 X_C^2 + (RX_L - RX_C)^2}}$$

$$\theta = \text{arc tan } \frac{RX_C - RX_L}{X_L X_C}$$

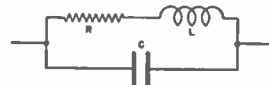

of inductance and series resistance in parallel with capacitance

$$Z = X_C \sqrt{\frac{R^2 + X_L^2}{R^2 + (X_L - X_C)^2}}$$

$$\theta = \text{arc tan } \left(\frac{X_L X_C - X_L^2 - R^2}{RX_C} \right)$$

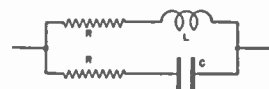

of capacitance and series resistance in parallel with inductance and series resistance

$$Z = \sqrt{\frac{(R_L^2 + X_L^2)(R_C^2 + X_C^2)}{(R_L + R_C)^2 + (X_L - X_C)^2}}$$

$$\theta = \text{arc tan } \frac{X_L(R_C^2 + X_C^2) - X_C(R_L^2 + X_L^2)}{R_L(R_C^2 + X_C^2) + R_C(R_L^2 + X_L^2)}$$

Conductance

In direct current circuits, conductance is expressed by

$$G = \frac{1}{R}$$

where G = conductance in mhos,

R = resistance in ohms.

In d-c circuits involving resistances R_1 , R_2 , R_3 , etc., in parallel,

the total conductance is expressed by

$$G_{\text{total}} = G_1 + G_2 + G_3 \dots \text{etc.}$$

and the total current by

$$I_{\text{total}} = E G_{\text{total}}$$

and the amount of current in any single resistor, R_2 for example, in a parallel group, by

$$I_2 = \frac{I_{\text{total}} G_2}{G_1 + G_2 + G_3 \dots \text{etc.}}$$

R , E and I in Ohm's law formulas for d-c circuits may be expressed in terms of conductance as follows:

$$R = \frac{1}{G}, \quad E = \frac{I}{G}, \quad I = EG,$$

where G = conductance in mhos,

R = resistance in ohms,

E = potential in volts,

I = current in amperes.

Susceptance

In an alternating current circuit, the susceptance of a series circuit is expressed by

$$B = \frac{X}{R^2 + X^2}$$

or, when the resistance is 0, susceptance becomes the reciprocal of reactance, or

$$B = \frac{1}{X}$$

where B = susceptance in mhos

R = resistance in ohms,

X = reactance in ohms

Admittance

In an alternating current circuit, the admittance of a series circuit is expressed by

$$Y = \frac{1}{\sqrt{R^2 + X^2}}$$

Admittance is also expressed as the reciprocal of impedance, or

$$Y = \frac{1}{Z}$$

where Y = admittance in mhos,

R = resistance in ohms,

X = reactance in ohms,

Z = impedance in ohms.

R and X in Terms of G and B

Resistance and reactance may be expressed in terms of conductance and susceptance as follows:

$$R = \frac{G}{G^2 + B^2}, \quad X = \frac{B}{G^2 + B^2}.$$

G, B, Y and Z in Parallel Circuits

In any given a-c circuit containing a number of smaller parallel circuits only,

the effective conductance G_t is expressed by

$$G_t = G_1 + G_2 + G_3 \dots \text{etc.},$$

and the effective susceptance B_t by

$$B_t = B_1 + B_2 + B_3 \dots \text{etc.}$$

and the effective admittance Y_t by

$$Y_t = \sqrt{G_t^2 + B_t^2}$$

and the effective impedance Z_t by

$$Z_t = \frac{1}{\sqrt{G_t^2 + B_t^2}} \text{ or } \frac{1}{Y_t}$$

where R = resistance in ohms,

X = reactance (capacitive or inductive) in ohms,

G = conductance in mhos,

B = susceptance in mhos,

Y = admittance in mhos,

Z = impedance in ohms.

Transient *I* and *E* in LCR Circuits

The formulas which follow may be used to closely approximate the growth and decay of current and voltage in circuits involving *L*, *C* and *R*:

- where *i* = instantaneous current in amperes at any given time (*t*),
- E* = potential in volts as designated,
- R* = circuit resistance in ohms,
- C* = capacitance in farads,
- L* = inductance in henrys,
- V* = steady state potential in volts,
- V_C* = reactive volts across *C*,
- V_L* = reactive volts across *L*,
- V_R* = voltage across *R*

RC = time constant of *RC* circuit in seconds,

$\frac{R}{L}$ = time constant of *RL* circuit in seconds,

t = any given time in seconds after switch is thrown,

ϵ = a constant, 2.718 (base of the natural system of logarithms),

Sw = switch

The time constant is defined as the time in seconds for current or voltage to fall to $\frac{1}{\epsilon}$ or 36.8% of its initial value or to rise to $(1 - \frac{1}{\epsilon})$ or approximately 63.2% of its final value.

Charging a De-energized Capacitive Circuit

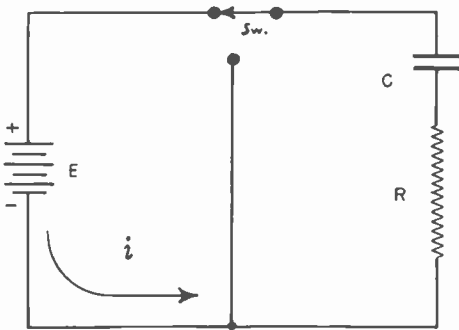

E = applied potential.

$$i = \frac{E}{R} \epsilon^{-\frac{t}{RC}}$$

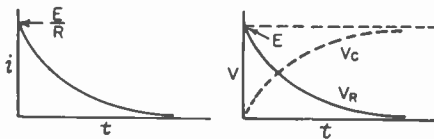

$$V_C = E \left(1 - \epsilon^{-\frac{t}{RC}} \right) \quad V_R = E \epsilon^{-\frac{t}{RC}}$$

Discharging an Energized Capacitive Circuit

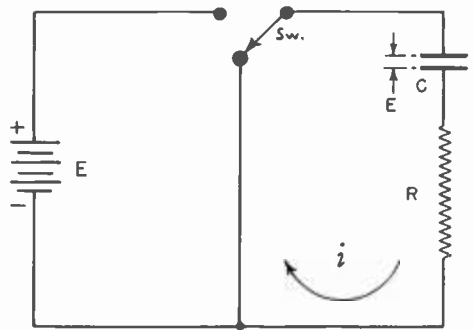

E = potential to which *C* is charged prior to closing *Sw*.

$$i = \frac{E}{R} \epsilon^{-\frac{t}{RC}}$$

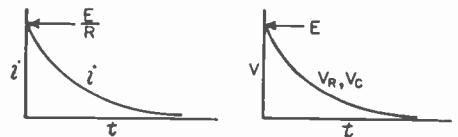

$$V_C = V_R = E \epsilon^{-\frac{t}{RC}}$$

Voltage is Applied to a De-energized Inductive Circuit

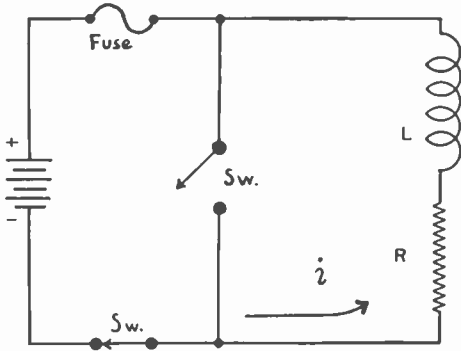

$E =$ applied potential

$$i = \frac{E}{R} \left(1 - e^{-\frac{Rt}{L}} \right)$$

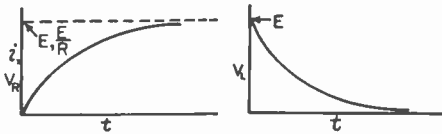

$$V_R = E \left(1 - e^{-\frac{Rt}{L}} \right)$$

$$V_L = E e^{-\frac{Rt}{L}}$$

An Energized Inductive Circuit is Shorted Circuit

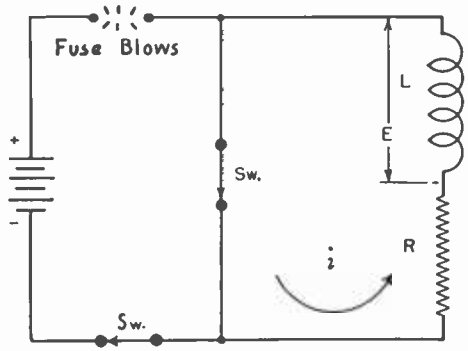

$E =$ counter potential induced in coil when switch is closed.

$$i = \frac{E}{R} e^{-\frac{Rt}{L}}$$

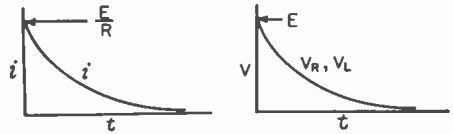

$$V_L = V_R = E e^{-\frac{Rt}{L}}$$

Steady State Current Flow

In a Capacitive Circuit

In a capacitive circuit, where resistance loss components may be considered as negligible, the flow of current at a given alternating potential of constant frequency, is expressed by

$$I = \frac{E}{X_C} = \frac{E}{\left(\frac{1}{2\pi fC} \right)} = E (2\pi fC)$$

where $I =$ current in amperes,
 $X_C =$ capacitive reactance of the circuit in ohms,
 $E =$ applied potential in volts.

In an Inductive Circuit

In an inductive circuit, where inherent resistance and capacitance components may be so low as to be negligible, the flow of current at a given alternating potential of a constant frequency, is expressed by

$$I = \frac{E}{X_L} = \frac{E}{2\pi fL}$$

where $I =$ current in amperes,
 $X_L =$ inductive reactance of the circuit in ohms,
 $E =$ applied potential in volts.

Transmission Line Formulas

Concentric Transmission Lines

Characteristic impedance in ohms is given by

$$Z = 138 \log \frac{d_1}{d_2}$$

R-f resistance in ohms per foot of copper line, is given by

$$r = \sqrt{f} \left(\frac{1}{d_1} + \frac{1}{d_2} \right) \times 10^{-3}$$

Attenuation in decibels per foot of line, is given by

$$\alpha = \frac{4.6\sqrt{f}(d_1 + d_2)}{d_1 d_2 \left(\log \frac{d_1}{d_2} \right)} \times 10^{-6}$$

where Z = characteristic impedance in ohms,

r = radio frequency resistance in ohms per foot of *copper line*,

α = attenuation in decibels per foot of *line*,

d_1 = the *inside* diameter of the *outer conductor*, expressed in inches,

d_2 = the *outside* diameter of the *inner conductor*, expressed in inches,

f = frequency in megacycles.

Two-Wire Open Air Transmission Lines

Characteristic impedance in ohms is given by

$$Z = 276 \left(\log \frac{2D}{d} \right)$$

Inductance in microhenrys per foot of *line* is given by

$$L = 0.281 \left(\log \frac{2D}{d} \right)$$

Capacitance in micromicrofarads per foot of *line* is given by

$$C = \frac{3.68}{\log \frac{2D}{d}}$$

Attenuation in decibels per foot of *wire* is given by

$$db = \frac{0.0157 R_f}{\log \frac{2D}{d}}$$

R-f resistance in Ohms per loop-foot of *wire*, is given by

$$R_f = \frac{2 \times 10^{-3} \sqrt{f}}{d}$$

where Z = characteristic impedance in ohms,

D = spacing between wire centers in inches,

d = the diameter of the conductors in inches,

L = inductance in microhenrys per foot of *line*,

C = capacitance in micromicrofarads per foot of *line*,

db = attenuation in decibels per foot of *wire*,

R_f = r-f resistance in ohms per loop-foot of *wire*

f = frequency in megacycles

Vertical Antenna

The capacitance of a vertical antenna, shorter than one-quarter wave length at its operating frequency, is given by

$$C_a = \frac{17l}{\left[\left(\log \epsilon \frac{24l}{d} \right) - 1 \right] \left[1 - \left(\frac{fl}{246} \right)^2 \right]}$$

where C_a = capacitance of the antenna in micromicrofarads,

l = height of antenna in feet,

d = diameter of antenna conductor in inches,

f = operating frequency in megacycles.

ϵ = 2.718 (the base of the natural system of logarithms).

Vacuum Tube Formulas and Symbols

Vacuum Tube Constants

Amplification factor (*Mu* or μ) is given by

$$\mu = \frac{\Delta E_p}{\Delta E_g} \text{ (with } I_p \text{ constant)}$$

Dynamic plate resistance in ohms, is given by

$$r_p = \frac{\Delta E_p}{\Delta I_p} \text{ (with } E_g \text{ constant)}$$

Mutual conductance in mhos, is given by

$$g_m = \frac{\Delta I_p}{\Delta E_g} \text{ (with } E_p \text{ constant)}$$

Vacuum Tube Formulas

Gain per stage is given by

$$\mu \left(\frac{R_L}{R_L + r_p} \right)$$

Voltage output appearing in R_L is given by

$$\mu \left(\frac{E_s R_L}{r_p + R_L} \right)$$

Power output in R_L , is given by

$$R_L \left(\frac{\mu E_s}{r_p + R_L} \right)^2$$

Maximum power output in R_L which results when $R_L = r_p$, is given by

$$\frac{(\mu E_s)^2}{4r_p}$$

Maximum undistorted power output in R_L which results when $R_L = 2r_p$, is given by

$$\frac{2(\mu E_s)^2}{9r_p}$$

Required cathode biasing resistor in ohms, for a single tube is given by

$$\frac{E_g}{I_k}$$

Vacuum Tube Symbols

Mu or μ = Amplification factor

r_p = Dynamic plate resistance in ohms,

g_m = Mutual conductance in mhos,

E_p = Plate voltage in volts,

E_g = Grid voltage in volts,

I_p = Plate current in amperes,

R_L = Plate load resistance in ohms,

I_k = Total cathode current in amperes,

E_s = Signal voltage in volts,

Δ = change or variation in value, which may be either an increment (increase), or a decrement (decrease).

Peak, R.M.S., and Average A-C Values of *E* & *I*

Given Value	To get . . .		
	Peak	R.M.S.	Av.
Peak		$0.707 \times \text{Peak}$	$0.637 \times \text{Peak}$
R.M.S.	$1.41 \times \text{R.M.S.}$		$0.9 \times \text{R.M.S.}$
Av.	$1.57 \times \text{Av.}$	$1.11 \times \text{Av.}$	

D-C Meter Formulas

Meter Resistance

The d-c resistance of a milliammeter or voltmeter movement may be determined as follows:

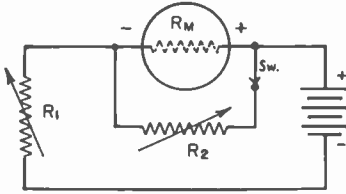

1. Connect the meter in series with a suitable battery and variable resistance R_1 as shown in the diagram above.
2. Vary R_1 until a full scale reading is obtained.
3. Connect another variable resistor R_2 across the meter and vary its value until a half scale reading is obtained.
4. Disconnect R_2 from the circuit and measure its d-c resistance.

The meter resistance R_m is equal to the measured resistance of R_2 .

Caution: Be sure that R_1 has sufficient resistance to prevent an off scale reading of the meter. The correct value depends upon the sensitivity of meter, and voltage of the battery. The following formula can be used if the full scale current of the meter is known:

$$R_1 = \frac{\text{voltage of the battery used}}{\text{full scale current of meter in amperes}}$$

For safe results, use twice the value computed. Also, never attempt to measure the resistance of a meter with an ohmmeter. To do so would in all probability result in a burned-out or severely damaged meter, since the current required for the operation of some ohmmeters and bridges is far in excess of the full scale current required by the movement of the average meter you may be checking.

Ohms per Volt Rating of a Voltmeter

$$\Omega/V = \frac{1}{I_{fs}}$$

where Ω/V = ohms per volt,

I_{fs} = full scale current in amperes.

Fixed Current Shunts

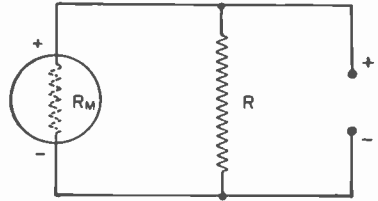

$$R = \frac{R_m}{N - 1}$$

R = shunt value in ohms,

N = the new full scale reading divided by the original full scale reading, both being stated in the same units.

R_m = meter resistance in ohms.

Multi-Range Shunts

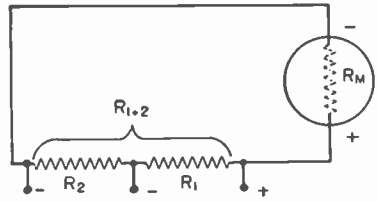

$$R_1 = \frac{R_{1+2} + R_m}{N}$$

R_1 = intermediate or tapped shunt value in ohms,

R_{1+2} = total resistance required for the lowest scale reading wanted,

R_m = meter resistance in ohms,

N = the new full scale reading divided by the original full scale reading, both being stated in the same units.

Voltage Multipliers

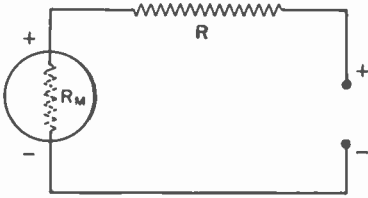

$$R = \frac{E_{fs}}{I_{fs}} - R_m$$

- R = multiplier resistance in ohms,
- E_{fs} = full scale reading required in volts,
- I_{fs} = full scale current of meter in amperes,
- R_m = meter resistance in ohms.

Measuring Resistance

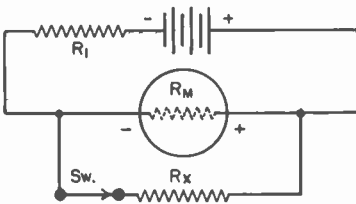

with Milliammeter and Battery*

$$R_x = R_m \left(\frac{I_2}{I_1 - I_2} \right)$$

- R_x = unknown resistance in ohms,
- R_m = meter resistance in ohms, or effective meter resistance if a shunted range is used,
- I_1 = current reading with switch open,
- I_2 = current reading with switch closed,
- R_1 = current limiting resistor of sufficient value to keep meter reading on scale when switch is open.

* Approximately true only when current limiting resistor is large as compared to meter resistance.

Shunt Values for 27-Ohm 0-1 Milliammeter

FULL SCALE CURRENT	SHUNT RESISTANCE
0-10 ma	3.0 ohms
0-50 ma	0.551 ohms
0-100 ma	0.272 ohms
0-500 ma	0.0541 ohms

Measuring Resistance—(Continued)

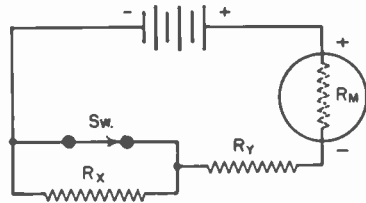

with Milliammeter, Battery and Known Resistor

$$R_x = (R_y + R_m) \left(\frac{I_1 - I_2}{I_2} \right)$$

- R_x = unknown resistance in ohms,
- R_y = known resistance in ohms,
- R_m = meter resistance in ohms,
- I_1 = current reading with switch closed,
- I_2 = current reading with switch open.

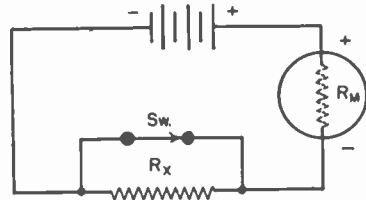

with Voltmeter and Battery

$$R_x = R_m \left(\frac{E_1}{E_2} - 1 \right)$$

- R_x = unknown resistance in ohms,
- R_m = meter resistance in ohms, including multiplier resistance if a multiplied range is used,
- E_1 = voltmeter reading with switch closed,
- E_2 = voltmeter reading with switch open.

Multiplier Values for 27-Ohm 0-1 Milliammeter

FULL SCALE VOLTAGE	MULTIPLIER RESISTANCE
0-10 volts	10,000 ohms
0-50 volts	50,000 ohms
0-100 volts	100,000 ohms
0-250 volts	250,000 ohms
0-500 volts	500,000 ohms
0-1,000 volts	1,000,000 ohms

Ohm's Law for A-C Circuits

The fundamental Ohm's law formulas for a-c circuits are given by

$$I = \frac{E}{Z}, \quad Z = \frac{E}{I},$$

$$E = IZ, \quad P = EI \cos \theta$$

where I = current in amperes,
 Z = impedance in Ohms,
 E = volts across Z ,
 P = power in watts,
 θ = phase angle in degrees

Phase Angle

The phase angle is defined as the difference in degrees by which current leads voltage in a capacitive circuit, or lags voltage in an inductive circuit, and in series circuits is equal to the angle whose tangent is given by the

ratio $\frac{X}{R}$ and is expressed by

$$\text{arc tan } \frac{X}{R}$$

where X = the inductive or capacitive reactance in ohms,

R = the non-reactive resistance in ohms,

of the combined resistive and reactive components of the circuit under consideration.

Therefore

in a purely resistive circuit, $\theta = 0^\circ$
 in a purely reactive circuit, $\theta = 90^\circ$
 and in a resonant circuit, $\theta = 0^\circ$

also when

$\theta = 0^\circ$, $\cos \theta = 1$ and $P = EI$,
 $\theta = 90^\circ$, $\cos \theta = 0$ and $P = 0$.

Degrees $\times 0.0175$ = radians.
 1 radian = 57.3° .

Power Factor

The power-factor of any a-c circuit is equal to the true power in watts divided by the apparent power in volt-amperes which is equal to the cosine of the phase angle, and is expressed by

$$p.f. = \frac{EI \cos \theta}{EI} = \cos \theta$$

Where

$p.f.$ = the circuit load power factor,
 $EI \cos \theta$ = the true power in watts,
 EI = the apparent power in volt-amperes,
 E = the applied potential in volts,
 I = load current in amperes.

Therefore

in a purely resistive circuit,

$$\theta = 0^\circ \text{ and } p.f. = 1$$

and in a reactive circuit,

$$\theta = 90^\circ \text{ and } p.f. = 0$$

and in a resonant circuit,

$$\theta = 0^\circ \text{ and } p.f. = 1$$

Ohm's Law for D-C Circuits

The fundamental Ohm's law formulas for d-c circuits are given by,

$$I = \frac{E}{R}, \quad R = \frac{E}{I},$$

$$E = IR, \quad P = EI.$$

where I = current in amperes,

R = resistance in ohms,

E = potential across R in volts,

P = power, in watts.

Ohms Law Formulas for D-C Circuits

Known Values	Formulas for Determining Unknown Values of . . .			
	<i>I</i>	<i>R</i>	<i>E</i>	<i>P</i>
<i>I & R</i>			IR	I^2R
<i>I & E</i>		$\frac{E}{I}$		EI
<i>I & P</i>		$\frac{P}{I^2}$	$\frac{P}{I}$	
<i>R & E</i>	$\frac{E}{R}$			$\frac{E^2}{R}$
<i>R & P</i>	$\sqrt{\frac{P}{R}}$		\sqrt{PR}	
<i>E & P</i>	$\frac{P}{E}$	$\frac{E^2}{P}$		

Ohm's Law Formulas for A-C Circuits

Known Values	Formulas for Determining Unknown Values of . . .			
	<i>I</i>	<i>Z</i>	<i>E</i>	<i>P</i>
<i>I & Z</i>			IZ	$I^2Z \cos \theta$
<i>I & E</i>		$\frac{E}{I}$		$IE \cos \theta$
<i>I & P</i>		$\frac{P}{I^2 \cos \theta}$	$\frac{P}{I \cos \theta}$	
<i>Z & E</i>	$\frac{E}{Z}$			$\frac{E^2 \cos \theta}{Z}$
<i>Z & P</i>	$\sqrt{\frac{P}{Z \cos \theta}}$		$\sqrt{\frac{PZ}{\cos \theta}}$	
<i>E & P</i>	$\frac{P}{E \cos \theta}$	$\frac{E^2 \cos \theta}{P}$		

Trigonometric Relationships

In any right triangle, if we let

θ = the acute angle formed by the hypotenuse and the base leg,

ϕ = the acute angle formed by the hypotenuse and the altitude leg,

H = the hypotenuse,

A = the side adjacent θ and opposite ϕ ,

O = the side opposite θ and adjacent ϕ ,

then $\text{sine of } \theta = \sin \theta = \frac{O}{H}$

$\text{cosine of } \theta = \cos \theta = \frac{A}{H}$

$\text{tangent of } \theta = \tan \theta = \frac{O}{A}$

$\text{cosecant of } \theta = \csc \theta = \frac{H}{O}$

$\text{secant of } \theta = \sec \theta = \frac{H}{A}$

$\text{cotangent of } \theta = \cot \theta = \frac{A}{O}$

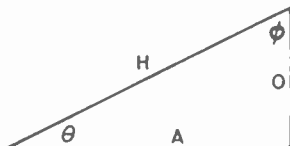

also $\sin \theta = \cos \phi$ $\csc \theta = \sec \phi$
 $\cos \theta = \sin \phi$ $\sec \theta = \csc \phi$
 $\tan \theta = \cot \phi$ $\cot \theta = \tan \phi$

and $\frac{1}{\sin \theta} = \csc \theta$ $\frac{1}{\csc \theta} = \sin \theta$

$\frac{1}{\cos \theta} = \sec \theta$ $\frac{1}{\sec \theta} = \cos \theta$

$\frac{1}{\tan \theta} = \cot \theta$ $\frac{1}{\cot \theta} = \tan \theta$

The expression "arc sin" indicates, "the angle whose sine is" . . . ; likewise arc tan indicates, "the angle whose tangent is" . . . etc. See formulas in table below.

Known Values	Formulas for Determining Unknown Values of . . .				
	A	O	H	θ	ϕ
A & O			$\sqrt{A^2 + O^2}$	$\text{arc tan } \frac{O}{A}$	$\text{arc tan } \frac{A}{O}$
A & H		$\sqrt{H^2 - A^2}$		$\text{arc cos } \frac{A}{H}$	$\text{arc sin } \frac{A}{H}$
A & θ		$A \tan \theta$	$\frac{A}{\cos \theta}$		$90^\circ - \theta$
A & ϕ		$\frac{A}{\tan \phi}$	$\frac{A}{\sin \phi}$	$90^\circ - \phi$	
O & H	$\sqrt{H^2 - O^2}$			$\text{arc sin } \frac{O}{H}$	$\text{arc cos } \frac{O}{H}$
O & θ	$\frac{O}{\tan \theta}$		$\frac{O}{\sin \theta}$		$90^\circ - \theta$
O & ϕ	$O \tan \phi$		$\frac{O}{\cos \phi}$	$90^\circ - \phi$	
H & θ	$H \cos \theta$	$H \sin \theta$			$90^\circ - \theta$
H & ϕ	$H \sin \phi$	$H \cos \phi$		$90^\circ - \phi$	

Metric Relationships

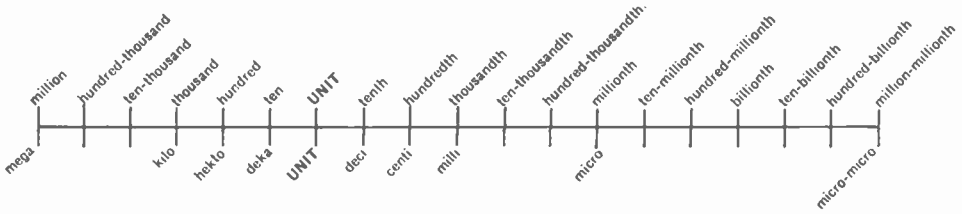

The above chart shows the relation between the American and the metric systems of notation.

This chart also serves to quickly locate the decimal point in the conversion from one metric expression to another.

Example: Convert 5.0 milliwatts to watts. Place the finger on milli and count the number of steps from there to units (since the

term watt is a basic unit). The number of steps so counted is three, and the direction was to the left. Therefore, 5.0 milliwatts is the equivalent of .005 watts.

Example: Convert 0.00035 microfarads to micromicrofarads. Here the number of steps counted will be six to the right. Therefore 0.00035 microfarads is the equivalent of 350 micromicrofarads.

Metric Conversion Table

ORIGINAL VALUE	DESIRED VALUE							
	Mega	Kilo	Units	Deci	Centi	Milli	Micro	Micromicro
Mega		3->	6->	7->	8->	9->	12->	18->
Kilo	<- 3		3->	4->	5->	6->	9->	15->
Units	<- 6	<- 3		1->	2->	3->	6->	12->
Deci	<- 7	<- 4	<- 1		1->	2->	5->	11->
Centi	<- 8	<- 5	<- 2	<- 1		1->	4->	10->
Milli	<- 9	<- 6	<- 3	<- 2	<- 1		3->	9->
Micro	<- 12	<- 9	<- 6	<- 5	<- 4	<- 3		6->
Micromicro	<- 18	<- 15	<- 12	<- 11	<- 10	<- 9	<- 6	

The above metric conversion table provides a fast and automatic means of conversion from one metric notation to another. The notation "Unit" represents the basic units of measurement, such as amperes, volts, ohms, watts, cycles, meters, grams, etc. To use the table, first locate the original or given value in the left-hand column. Now follow this line horizontally to the vertical column headed by the prefix of the desired value. The figure and arrow at this point indicates number of places and direction decimal point is to be moved.

Example: Convert 0.15 ampere to milliamperes. Starting at the "Units" box in the left-hand column (since ampere is a basic unit of measurement), move horizontally to the column headed by the prefix "Milli", and read 3->. Thus 0.15 ampere is the equivalent of 150 milliamperes.

Example: Convert 50,000 kilocycles to megacycles. Read in the box horizontal to "Kilo" and under "Mega", the notation <-3, which means a shift of the decimal three places to the left. Thus 50,000 kilocycles is the equivalent of 50 megacycles.

Coil Winding Data

Turns Per Inch

Gauge (AWG) or (B&S)	Number of Turns per Linear Inch			
	Enamel	S.S.C.	D.S.C. and S.C.C.	D.C.C.
1	—	—	3.3	3.3
2	—	—	3.8	3.6
3	—	—	4.2	4.0
4	—	—	4.7	4.5
5	—	—	5.2	5.0
6	—	—	5.9	5.6
7	—	—	6.5	6.2
8	7.6	—	7.4	7.1
9	8.6	—	8.2	7.8
10	9.6	—	9.3	8.9
11	10.7	—	10.3	9.8
12	12.0	—	11.5	10.9
13	13.5	—	12.8	12.0
14	15.0	—	14.2	13.8
15	16.8	—	15.8	14.7
16	18.9	18.9	17.9	16.4
17	21.2	21.2	19.9	18.1
18	23.6	23.6	22.0	19.8
19	26.4	26.4	24.4	21.8
20	29.4	29.4	27.0	23.8
21	33.1	32.7	29.8	26.0
22	37.0	36.5	34.1	30.0
23	41.3	40.6	37.6	31.6
24	46.3	45.3	41.5	35.6
25	51.7	50.4	45.6	38.6
26	58.0	55.6	50.2	41.8
27	64.9	61.5	55.0	45.0
28	72.7	68.6	60.2	48.5
29	81.6	74.8	65.4	51.8
30	90.5	83.3	71.5	55.5
31	101.	92.0	77.5	59.2
32	113.	101.	83.6	62.6
33	127.	110.	90.3	66.3
34	143.	120.	97.0	70.0
35	158.	132.	104.	73.5
36	175.	143.	111.	77.0
37	198.	154.	118.	80.3
38	224.	166.	126.	83.6
39	248.	181.	133.	86.6
40	282.	194.	140.	89.7

Coil Winding Formulas

The following approximations for winding *r-f* coils are accurate to within approx. 1% for nearly all small air-core coils, where

- L* = self inductance in microhenrys,
- N* = total number of turns,
- r* = mean radius in inches,
- l* = length of coil in inches,
- b* = depth of coil in inches.

Single-Layer Wound Coils

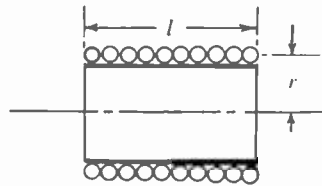

$$L = \frac{(rN)^2}{9r + 10l}$$

$$N = \frac{\sqrt{L(9r + 10l)}}{r}$$

Multi-Layer Wound Coils

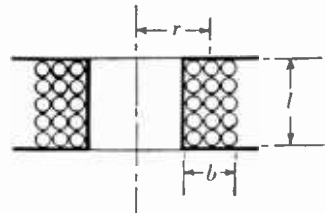

$$L = \frac{0.8(rN)^2}{6r + 9l + 10b}$$

Single-Layer Spiral Wound Coils

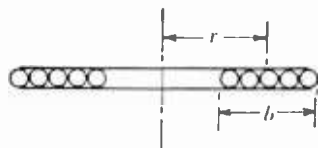

$$L = \frac{(rN)^2}{8r + 11b}$$

Table of Standard Annealed Bare Copper Wire
Using American Wire Gauge (B & S)

Gauge (AWG) or (B & S)	DIAMETER INCHES			AREA	WEIGHT	LENGTH	RESISTANCE AT 68° F			Gauge (AWG) or (B & S)
	Min.	Nom.	Max.	Circular Mils	Pounds per M'	Feet per Lb.	Ohms per M'	Feet per Ohm	Ohms per Lb.	
0000	.4554	.4600	.4646	211600.	640.5	1.561	.04901	20400.	.00007652	0000
000	.4055	.4096	.4137	167800.	507.9	1.968	.06180	16180.	.0001217	000
00	.3612	.3648	.3684	133100.	402.8	2.482	.07793	12830.	.0001935	00
0	.3217	.3249	.3281	105500.	319.5	3.130	.09827	10180.	.0003076	0
1	.2864	.2893	.2922	83690.	253.3	3.947	.1239	8070.	.0004891	1
2	.2550	.2576	.2602	66370.	200.9	4.977	.1563	6400.	.0007778	2
3	.2271	.2294	.2317	52640.	159.3	6.276	.1970	5075.	.001237	3
4	.2023	.2043	.2063	41740.	126.4	7.914	.2485	4025.	.001966	4
5	.1801	.1819	.1837	33100.	100.2	9.980	.3133	3192.	.003127	5
6	.1604	.1620	.1636	26250.	79.46	12.58	.3951	2531.	.004972	6
7	.1429	.1443	.1457	20820.	63.02	15.87	.4982	2007.	.007905	7
8	.1272	.1285	.1298	16510.	49.98	20.01	.6282	1592.	.01257	8
9	.1133	.1144	.1155	13090.	39.63	25.23	.7921	1262.	.01999	9
10	.1009	.1019	.1029	10380.	31.43	31.82	.9989	1001.	.03178	10
11	.08983	.09074	.09165	8234.	24.92	40.12	1.260	794.	.05053	11
12	.08000	.08081	.08162	6530.	19.77	50.59	1.588	629.6	.08035	12
13	.07124	.07196	.07268	5178.	15.68	63.80	2.003	499.3	.1278	13
14	.06344	.06408	.06472	4107.	12.43	80.44	2.525	396.0	.2032	14
15	.05650	.05707	.05764	3257.	9.858	101.4	3.184	314.0	.3230	15
16	.05031	.05082	.05133	2583.	7.818	127.9	4.016	249.0	.5136	16
17	.04481	.04526	.04571	2048.	6.200	161.3	5.064	197.5	.8167	17
18	.03990	.04030	.04070	1624.	4.917	203.4	6.385	156.5	1.299	18
19	.03553	.03589	.03625	1288.	3.899	256.5	8.051	124.2	2.065	19
20	.03164	.03196	.03228	1022.	3.092	323.4	10.15	98.5	3.283	20
21	.02818	.02846	.02874	810.1	2.452	407.8	12.80	78.11	5.221	21
22	.02510	.02535	.02560	642.4	1.945	514.2	16.14	61.95	8.301	22
23	.02234	.02257	.02280	509.5	1.542	648.4	20.36	49.13	13.20	23
24	.01990	.02010	.02030	404.0	1.223	817.7	25.67	38.96	20.99	24
25	.01770	.01790	.01810	320.4	.9699	1031.	32.37	30.90	33.37	25
26	.01578	.01594	.01610	254.1	.7692	1300.	40.81	24.50	53.06	26
27	.01436	.01442	.01448	201.5	.6100	1639.	51.47	19.43	84.37	27
28	.01251	.01264	.01277	159.8	.4837	2067.	64.90	15.41	134.2	28
29	.01115	.01126	.01137	126.7	.3836	2607.	81.83	12.22	213.3	29
30	.00993	.01003	.01013	100.5	.3042	3287.	103.2	9.691	339.2	30
31	.008828	.008928	.009028	79.7	.2413	4145.	130.1	7.685	539.3	31
32	.007850	.007950	.008050	63.21	.1913	5227.	164.1	6.095	857.6	32
33	.006980	.007080	.007180	50.13	.1517	6591.	206.9	4.833	1364.	33
34	.006205	.006305	.006405	39.75	.1203	8310.	260.9	3.833	2168.	34
35	.005515	.005615	.005715	31.52	.09542	10480.	329.0	3.040	3448.	35
36	.004900	.005000	.005100	25.00	.07568	13210.	414.8	2.411	5482.	36
37	.004353	.004453	.004553	19.83	.06001	16660.	523.1	1.912	8717.	37
38	.003865	.003965	.004065	15.72	.04759	21010.	659.6	1.516	13860.	38
39	.003431	.003531	.003631	12.47	.03774	26500.	831.8	1.202	22040.	39
40	.003045	.003145	.003245	9.888	.02993	33410.	1049.	0.9534	35040.	40
41	.00270	.00280	.00290	7.8400	.02373	42140.	1323.	.7559	55750.	41
42	.00239	.00249	.00259	6.2001	.01877	53270.	1673.	.5977	89120.	42
43	.00212	.00222	.00232	4.9284	.01492	67020.	2104.	.4753	141000.	43
44	.00187	.00197	.00207	3.8809	.01175	85100.	2672.	.3743	227380.	44
45	.00166	.00176	.00186	3.0976	.00938	106600.	3348.	.2987	356890.	45
46	.00147	.00157	.00167	2.4649	.00746	134040.	4207.	.2377	563900.	46

Single-Layer Wound Coil Chart

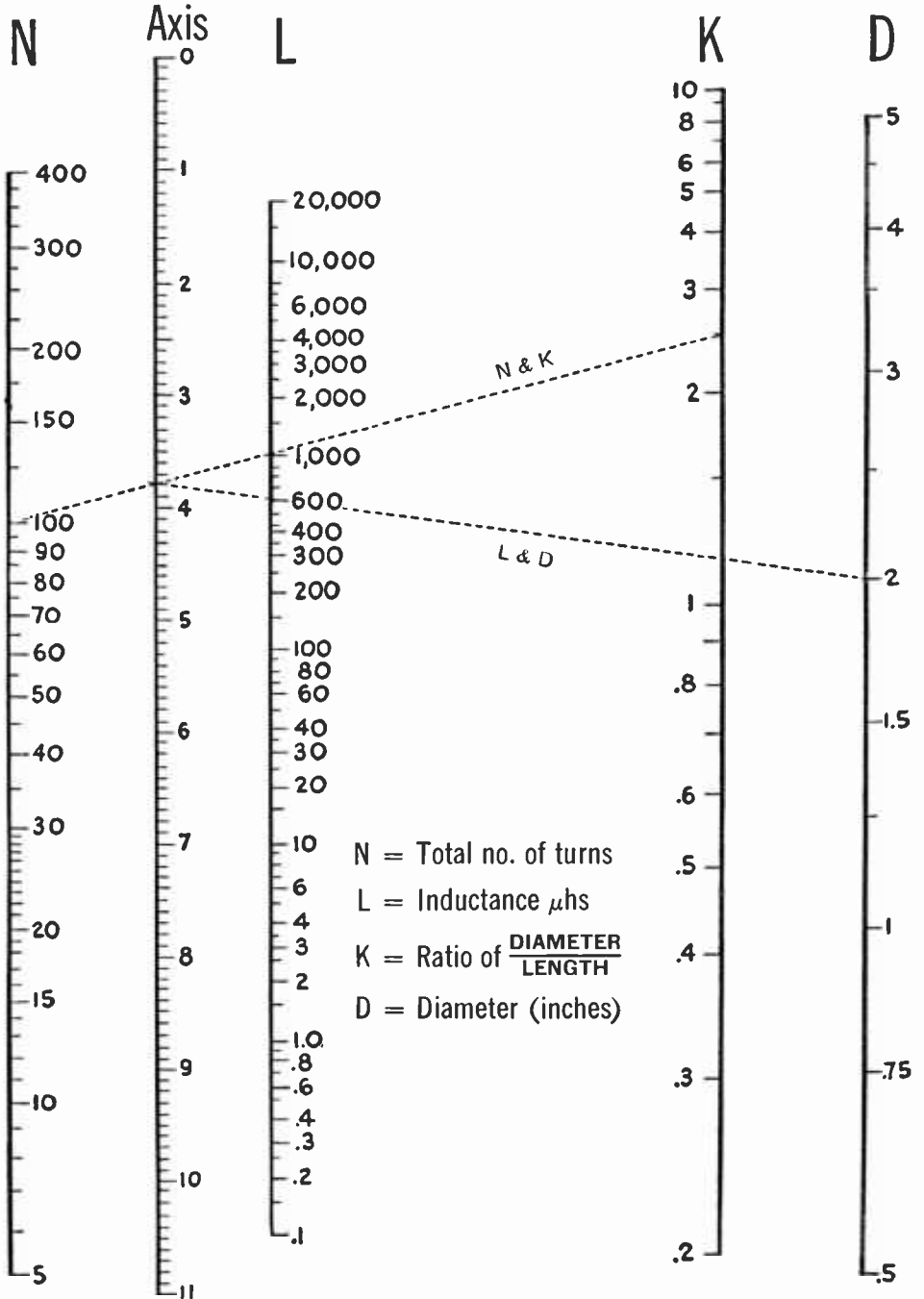

Courtesy, P. R. Mallory & Co., Inc.

Single-Layer Wound Coil Chart

The chart on the opposite page provides a convenient means of determining the unknown factors of small sized single-layer wound r-f coils. Values thus found so closely approximate those determined by measurement or mathematical calculation as to be entirely satisfactory for all practical purposes of experimentation, design, and repair work. Since in all coils of this type, the difference between the mean and inner diameter of the winding is so slight as to be negligible, **D** in all instances may be either the mean or inner diameter as desired.

Example: Given the total number of turns, winding length and diameter of a coil,— to find the inductance:

1. Place a straightedge on the chart so as to form a line intersecting the number of turns **N**, and the ratio of diameter to length **K**, and note the point intersected on the linear **axis** column.

2. Now move the straightedge so as to form a second line which will intersect this same point on the **axis** column, and the diameter **D**.
3. The point where this line intersects the **L** column indicates the inductance of the coil in microhenries.

Example: Given the diameter, winding length and inductance in microhenries,— to find the number of turns;

1. Simply reverse the process outlined above for determining inductance.
2. After finding the number of turns, consult the wire table on page 22 and determine the size of wire to be used.

The dotted lines appearing on the chart illustrate the correct plotting of a 600-microhenry coil consisting of 100 turns of wire, wound to 51/64" on a form 2" in diameter.

Inductance, Capacitance, Reactance Charts

The direct-reading charts appearing on the following three pages are designed for determining unknown values of frequency, inductance, capacitance and reactance components operating in a-f and r-f circuits.

The simplifications embodied in these charts make them extremely useful. The frequency range covered comprises the frequency spectrum from 1 cycle per second up to 1000 megacycles per second. All of the scales involved are plotted in actual magnitudes so that no computations are required to determine the location of the decimal point in the final result.

To make these conditions possible the frequency spectrum has been divided into three parts:

Chart I (page 26)—Covers the range from 1 cycle to 1000 cycles.

Chart II (page 27)—From 1 kilocycle to 1000 kilocycles.

Chart III (page 28)—From 1 megacycle to 1000 megacycles.

Inductance, capacitance, reactance and frequency have been plotted so that the reactance offered by an inductance or capacitance at any frequency may be readily determined by placing a straight-edge across the chart connecting the known quantities.

Since $X_L = X_C$ at resonance in most radio circuits, the charts may also be used to find the resonant frequency of any combination of *L* and *C*.

To illustrate with a simple example, suppose the reactance of a 0.01 μ f. capacitor is desired at a frequency of 400 cycles. Place a straight-edge across the proper chart so as to connect the points 0.01 μ f. and 400 cycles per sec. The quantity desired is the point of intersection with the reactance scale which is 40,000 ohms. The straight-edge also intersects the inductance scale at 15.8 henrys indicating that this value of inductance likewise has a reactance of 40,000 ohms at 400 cycles per sec. and furthermore, that these values of *L* and *C* produce resonance at this frequency.

There are many practical uses for these charts. The radio experimenter, maintenance man and engineer will find them helpful in the rapid solution of many reactance problems. Unusual care was exercised in laying out the various scales in order to secure a high degree of accuracy for the charts. Results should be obtainable which are at least as accurate as might be secured with a ten-inch slide rule.

Inductance, Capacitance, Reactance—(Continued)

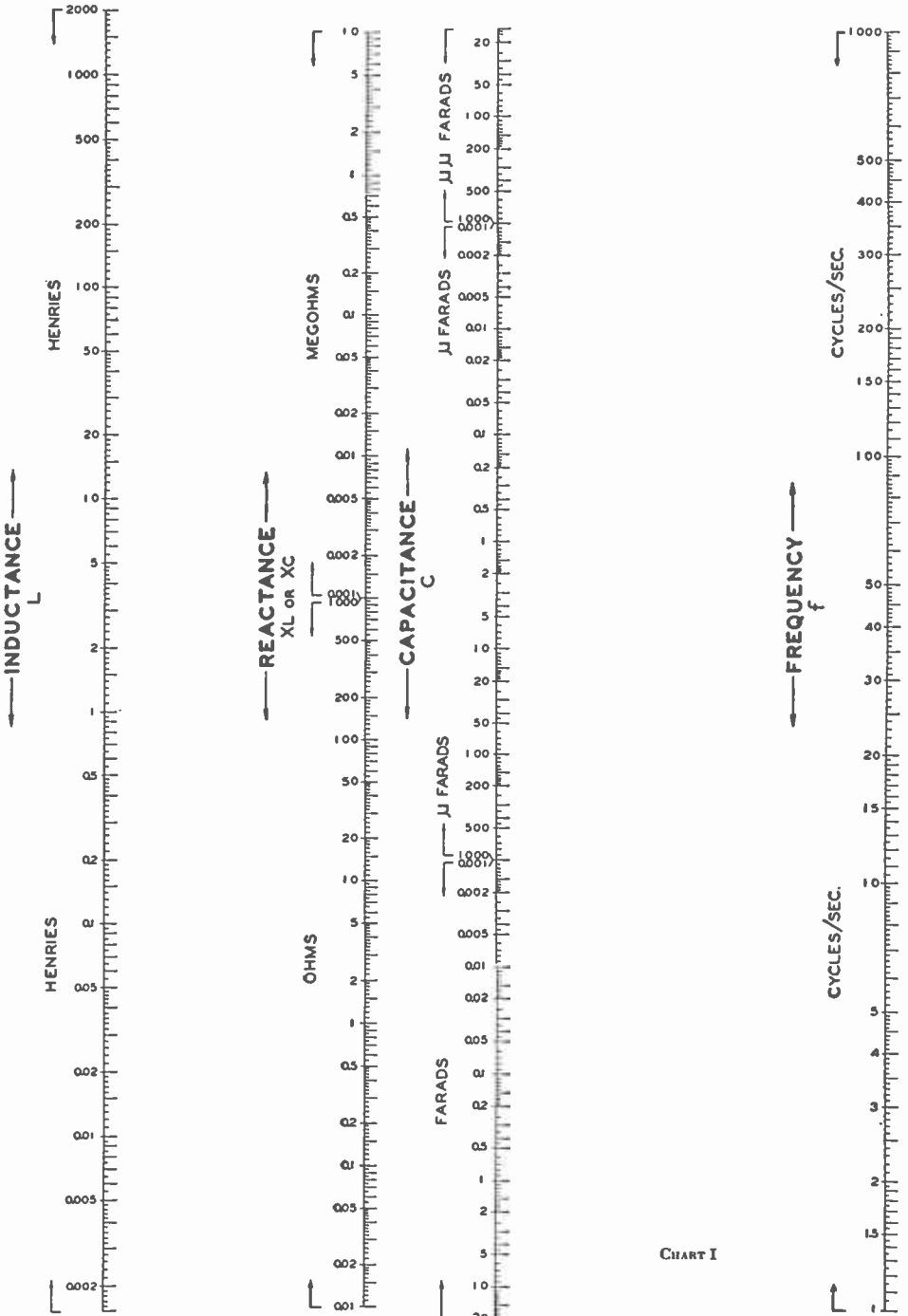

CHART I

Courtesy, Sylvania Electric Products Inc.

Inductance, Capacitance, Reactance—(Continued)

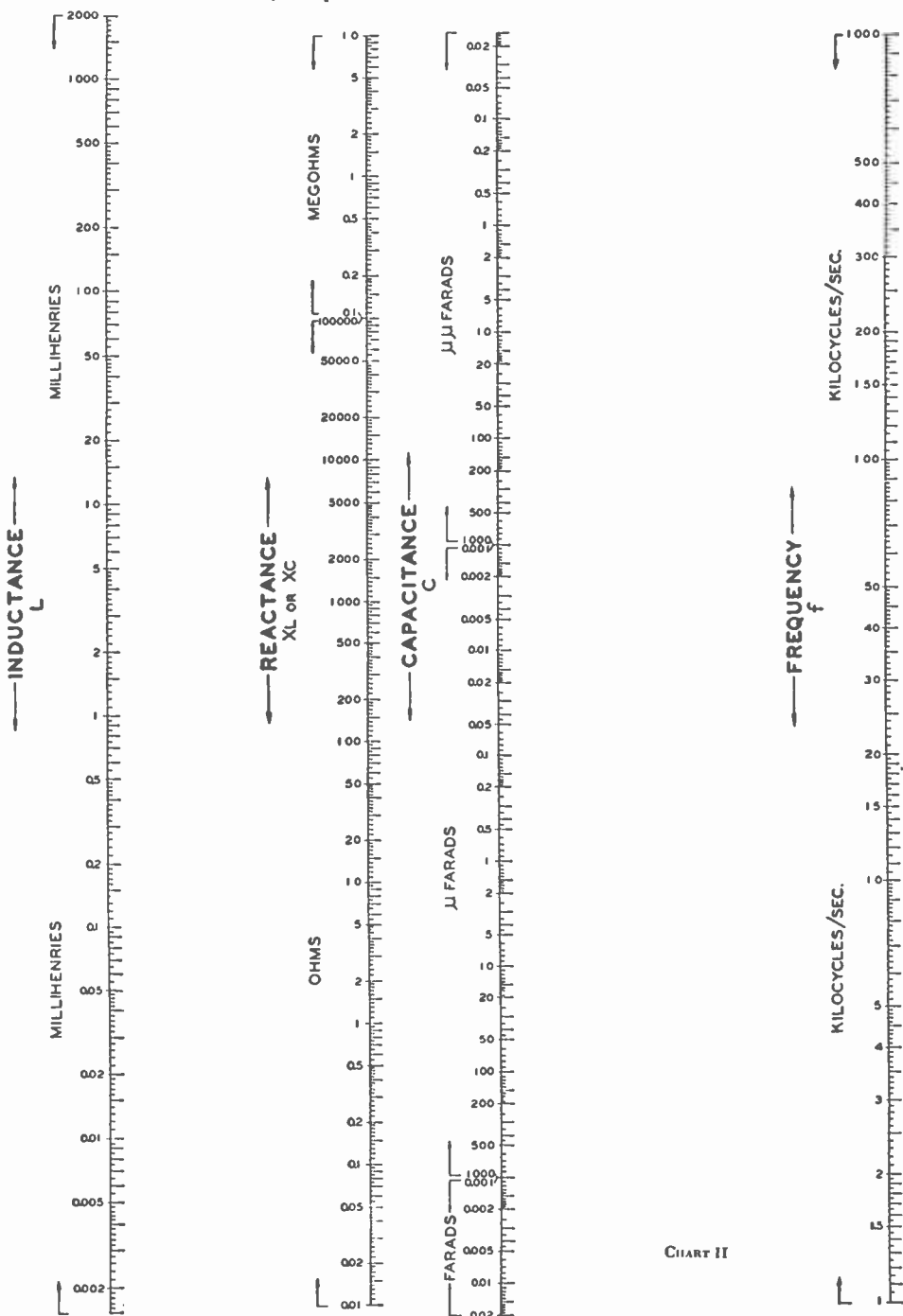

CHART II

Courtesy, Sylvania Electric Products Inc.

Inductance, Capacitance, Reactance—(Continued)

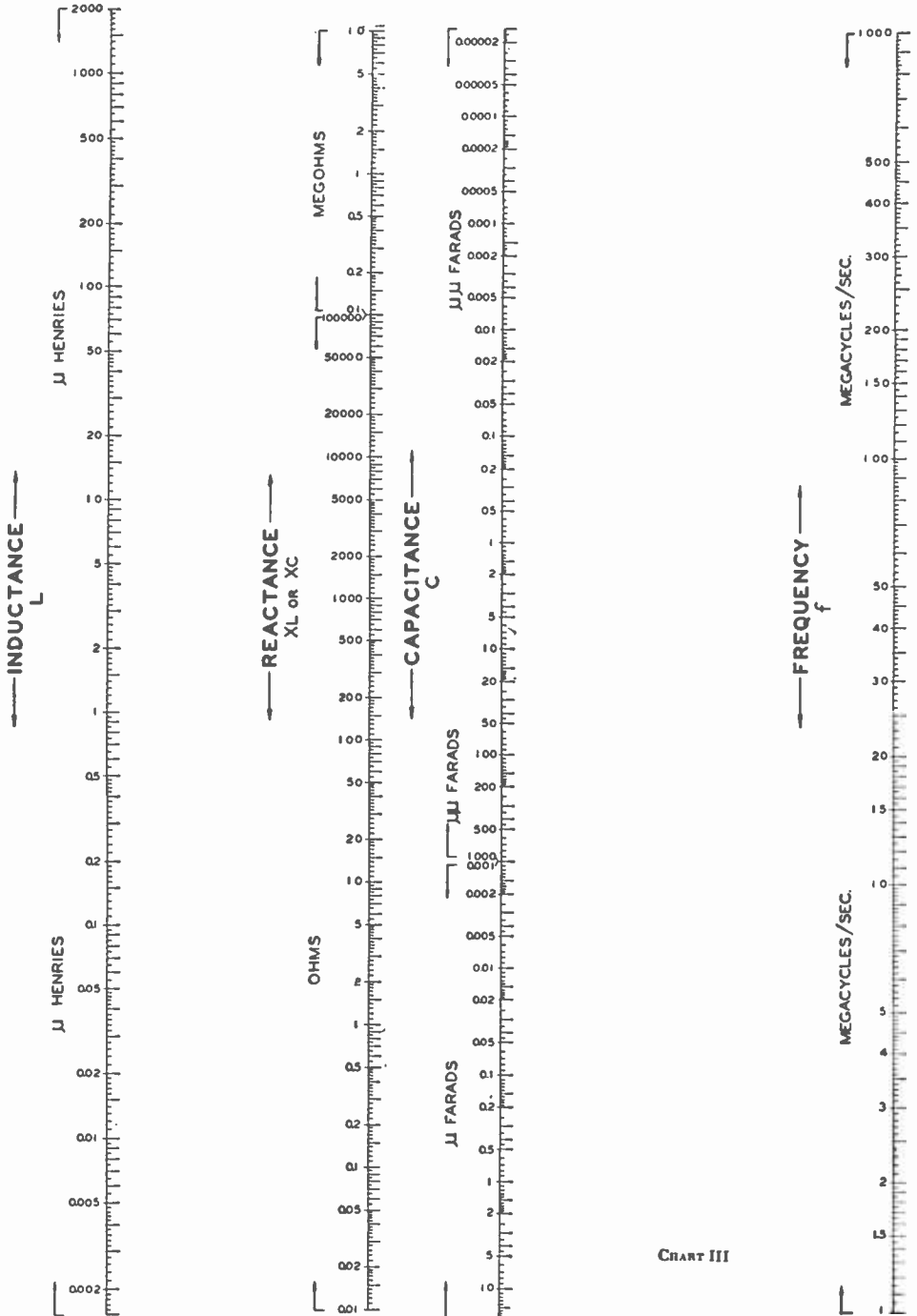
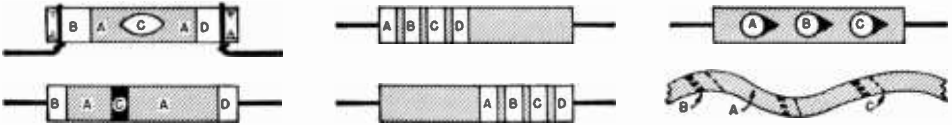

CHART III

Courtesy, Sylvania Electric Products Inc.

Resistor Color Codes



Values in Ohms

Color A	1st Significant Figure	Color B	2nd Significant Figure	Color C	Decimal Multiplier	Color D	Resistive Tolerance
Black	0	Black	0	Black	—	None	± 20%
Brown	1	Brown	1	Brown	10	Silver	± 10%
Red	2	Red	2	Red	100	Gold	± 5%
Orange	3	Orange	3	Orange	1,000		
Yellow	4	Yellow	4	Yellow	10,000		
Green	5	Green	5	Green	100,000		
Blue	6	Blue	6	Blue	1,000,000		
Violet	7	Violet	7	Violet	10,000,000		
Grey	8	Grey	8	Grey	—		
White	9	White	9	White	—		

Mica Capacitor Color Codes

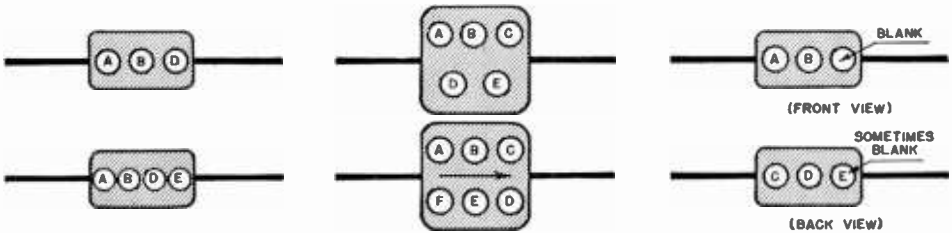

Capacitance in micromicrofarads ($\mu\mu\text{f.}$)

Dot Color	Significant Figures			Decimal Multiplier	Capacitive Tolerance	DC Test Voltage	Dot Color
	(A)	(B)	(C)				
Black	0	0	0	—	—	—	Black
Brown	1	1	1	10	± 1%	100	Brown
Red	2	2	2	100	± 2%	200	Red
Orange	3	3	3	1,000	± 3%	300	Orange
Yellow	4	4	4	10,000	± 4%	400	Yellow
Green	5	5	5	100,000	± 5%	500	Green
Blue	6	6	6	1,000,000	± 6%	600	Blue
Violet	7	7	7	10,000,000	± 7%	700	Violet
Grey	8	8	8	100,000,000	± 8%	800	Grey
White	9	9	9	1,000,000,000	± 9%	900	White
Gold	—	—	—	0.1	± 5%	1,000	Gold
Silver	—	—	—	0.01	± 10%	2,000	Silver
No Color	—	—	—	—	± 20%	500	No Color

RMA Color Codes

The color codes on the preceding and two following pages are used by most radio and instrument manufacturers in the wiring of their products, and by parts manufacturers for identifying lead placement or resistor and capacitor values, ratings, and tolerances. These have been included for whatever help they may provide in identifying parts and

leads when shooting trouble. Since all manufacturers do not use these codes, however, due caution must be observed to determine whether or not the set, instrument, or part under examination does or does not follow the code colors given here. A quick check with a voltmeter, ohmmeter, or continuity meter is usually all that is needed to establish this fact.

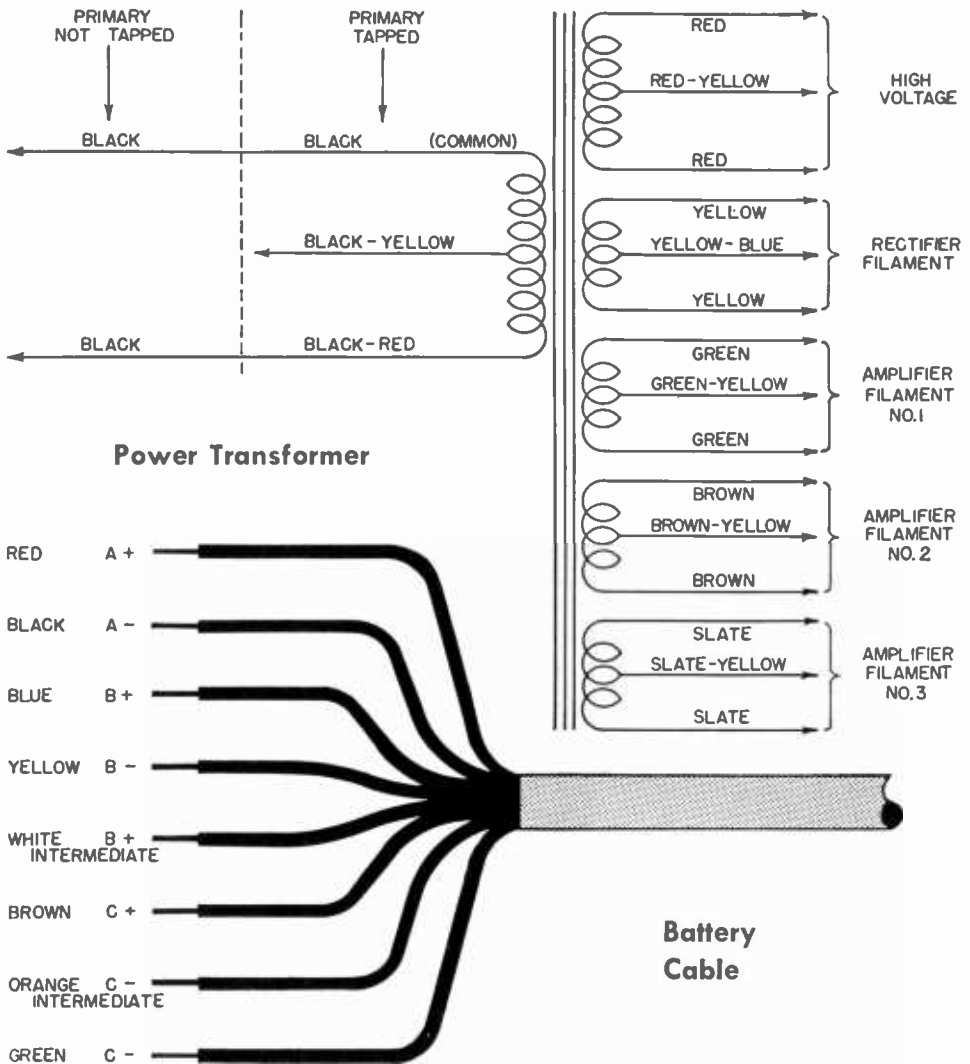

RMA Color Codes—(Continued)

Speaker Leads and Plug Connections

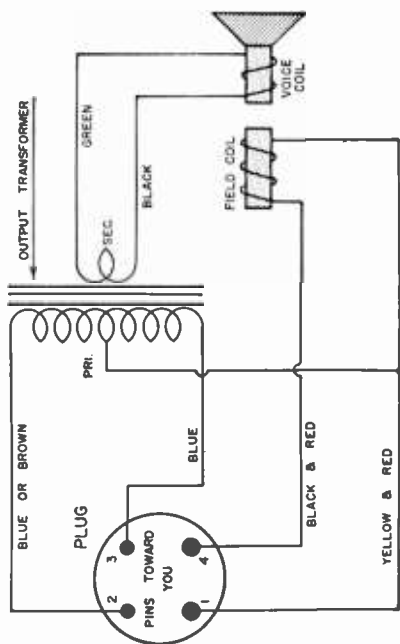
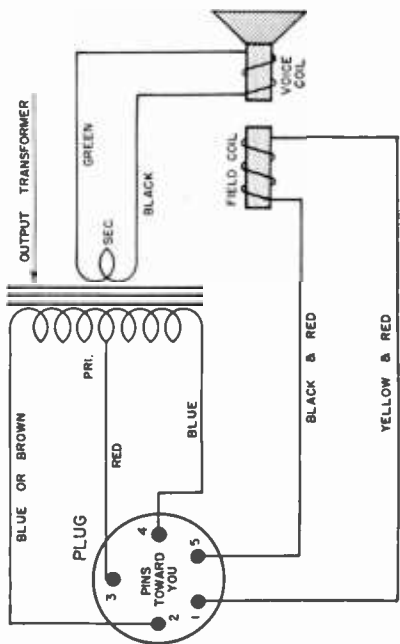

Speaker Leads and Plug Connections

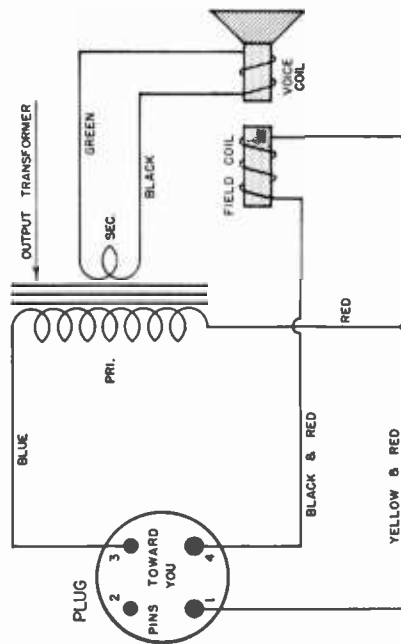
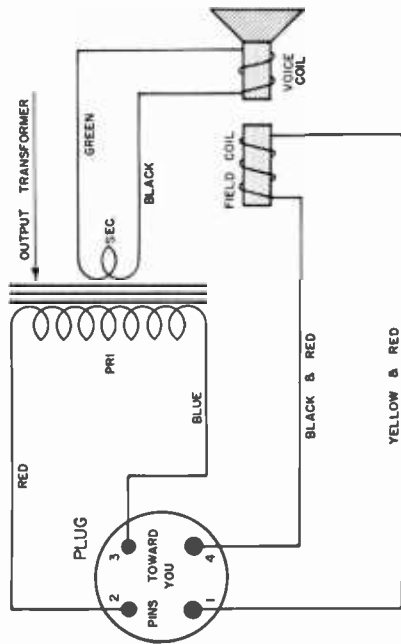

Speaker Lead Color Codes—(Continued)

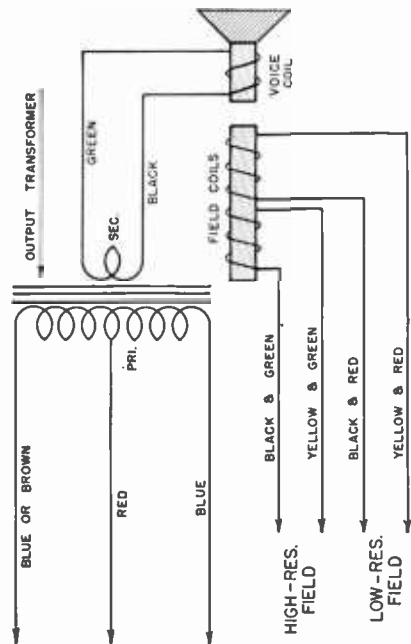
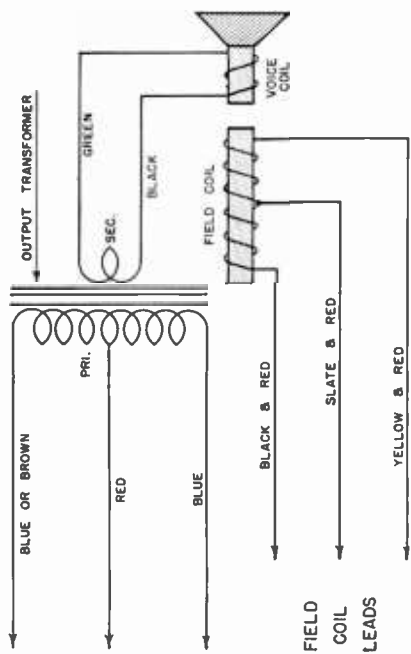

RMA Color Codes—(Continued)

I-F Transformers

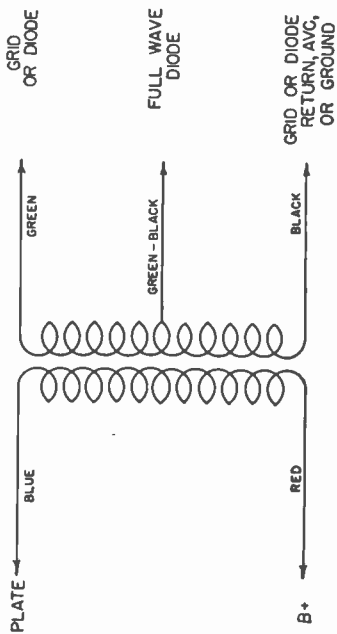

Audio & Output Transformers

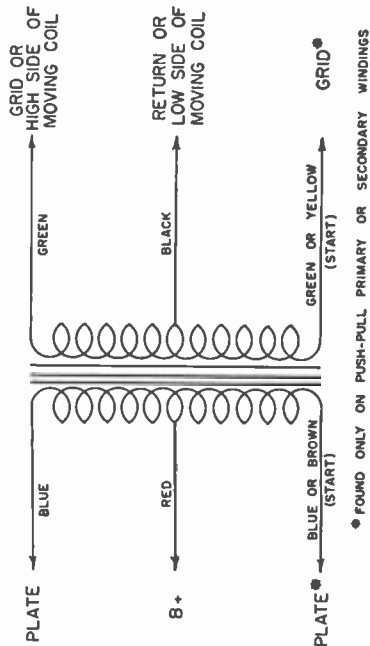

Pilot Lamp Data

Maximum Size See Chart below for dimensions					
	Type No.	T-3/4	T-3/4	G-3 1/2	G-3 1/2
Base	Screw (Miniature)	Bayonet (Miniature)	Screw (Miniature)	Bayonet (Miniature)	Bayonet (Miniature)
Bulb	Tubular	Tubular	Small Round	Small Round	Large Round
Lamp Numbers	40 41 42 46 48 292	40A 43 44 45 47 49 49A 292A	50	51	55

Lamp No.	Bead Color	Base (Miniature)	Bulb Type	RATING		Used for	Maximum Dimensions (See illustrations above)		
				Volts	Amps.		A	B	C
40	Brown	Screw	T-3 1/4	6-8	0.15	Dials.....	1 1/2"	2 1/2"	1 1/8"
40A†	Brown	Bayonet	T-3 1/4	6-8	0.15	Dials.....	1 1/2"	2 1/2"	1 1/8"
41	White	Screw	T-3 1/4	2.5	0.5	Dials.....	1 1/2"	2 1/2"	1 1/8"
42	Green	Screw	T-3 1/4	3.2	‡	Dials.....	1 1/2"	2 1/2"	1 1/8"
43	White	Bayonet	T-3 1/4	2.5	0.5	Dials and Tuning Meters.....	1 1/2"	2 1/2"	1 1/8"
44	Blue	Bayonet	T-3 1/4	6-8	0.25	Dials and Tuning Meters.....	1 1/2"	2 1/2"	1 1/8"
45	*	Bayonet	T-3 1/4	3.2	‡	Dials.....	1 1/2"	2 1/2"	1 1/8"
46^	Blue	Screw	T-3 1/4	6-8	0.25	Dials and Tuning Meters.....	1 1/2"	2 1/2"	1 1/8"
47†	Brown	Bayonet	T-3 1/4	6-9	0.15	Dials.....	1 1/2"	—	1 1/8"
48	Pink	Screw	T-3 1/4	2.0	0.06	Battery Set Dials.....	1 1/2"	2 1/2"	1 1/8"
49§	Pink	Bayonet	T-3 1/4	2.0	0.06	Battery Set Dials.....	1 1/2"	2 1/2"	1 1/8"
■	White	Screw	T-3 1/4	2.1	0.12	Dials.....	1 1/2"	—	—
49A§	White	Bayonet	T-3 1/4	2.1	0.12	Dials.....	1 1/2"	2 1/2"	1 1/8"
50	White	Screw	G-3 1/2	6-8	0.2	Auto-Radio Dials; Flashlights.....	1 1/2"	2 1/2"	1 1/8"
51^	White	Bayonet	G-3 1/2	6-8	0.2	Auto-Radio Dials; Panel Boards.....	1 1/2"	1 1/2"	1 1/8"
—	White	Screw	G-4 1/2	6-8	0.4	Auto-Radio Dials; Flashlights.....	1 1/2"	—	—
55	White	Bayonet	G-4 1/2	6-8	0.4	Auto-Radio Dials; Parking Lights.....	5/8"	1 1/2"	1 1/8"
292*	White	Screw	T-3 1/4	2.9	0.17	Dials.....	1 1/2"	2 1/2"	1 1/8"
292A*	White	Bayonet	T-3 1/4	2.9	0.17	Dials and Coin Machines.....	1 1/2"	2 1/2"	1 1/8"
1455	Brown	Screw	G-5	18.0	0.25	Coin Machines.....	—	—	—
1455A	Brown	Bayonet	G-5	18.0	0.25	Coin Machines.....	—	—	—

* White in G.E. and Sylvania; Green in National Union Raytheon and Tung-Sol.

‡ 0.35 in G.E. and Sylvania; 0.5 in National Union Raytheon and Tung-Sol.

† 40A and 47 are interchangeable.

§ 49 and 49A are interchangeable.

^ Have frosted bulb.

■ Replace with No. 48.

• Use in 2.5 volt sets where regular bulb burns out too frequently.

Plug-In Ballast Resistor Data

Plug-in ballast resistors which are numbered in accordance with RMA standards, are coded as follows:

First: A prefix *K*, *L*, or *M*, where *K* denotes #40 6.3 v. 0.15 a. pilot lamp, *L* denotes #46 6.3 v. 0.25 a. pilot lamp, *M* denotes #51 6.3 v. 0.2 a. pilot lamp.

A letter *B* prefixing *K*, *L*, or *M*, indicates ballast action on pilot light section.

A letter *X* following *K*, *L*, or *M*, denotes a 4-prong base type mounting.

Second: A number, which indicates the voltage drop across the entire resistor unit, including pilot lamp section, at the standard current of 0.3 ampere.

Third: A letter A, B, C, D . . . etc., representing

the circuit arrangement as designated by the lettered diagrams shown below.

Fourth: A suffix *G*, *MG*, or *J*, where

G indicates a glass type envelope, *MG* indicates a metal-glass type envelope, *J* indicates a direct zero resistance connection between #3 and #4, or #6 and #7, or #5 and #3 prongs of the base.

Voltage drop values and tube complements most commonly used with plug-in ballast resistors, are as follows:

80 V. drop for 2-6.3 V., and 1-2.5 V., tubes,
 55 V. drop for 2-6.3 V., and 2-2.5 V., tubes,
 49 V. drop for 3-6.3 V., and 2-2.5 V., tubes,
 42 V. drop for 4-6.3 V., and 2-2.5 V., tubes,
 36 V. drop for 5-6.3 V., and 2-2.5 V., tubes,
 23 V. drop for 3-6.3 V., and 3-2.5 V., tubes.

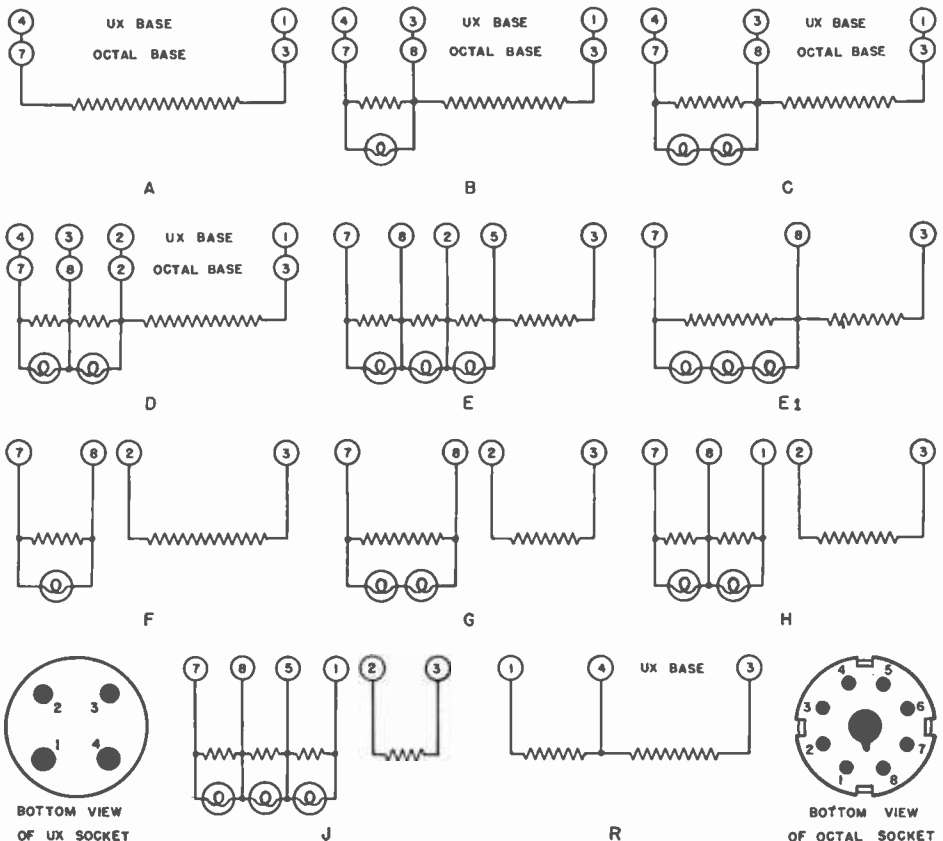

Interchangeable Tubes

Tube Number	Replace with	Tube Number	Replace with	Tube Number	Replace with
01AA	01A	5Z4MG	5Y3GT/G	6K5G	6K5GT
0Z4A	CK1003/0Z4A	6A7M	6A8	6K5GT	{ 6K5G or 6K5GT/G
1	1-v	6A8	•6A8GT	6K6G	6K6GT/G
1A4	34	6A8MG	•6A8GT	6K6GT	6K6GT/G
1A4P	34	6AB5	6AB5/6N5	6K6MG	6K6GT/G
1A4T	§1A4-P	6AC5G	6AC5GT/G	6K7	•6K7GT
1A5G	1A5GT/G	6AC5GT	6AC5GT/G	6K7M	6K7
1A5GT	1A5GT/G	6AC5GT/G	6AC5GT	6K7MG	•6K7GT
1B4/951	32	6AE5G	6AE5GT/G	6K8	6K8GT
1B4P	32	6AE5GT	6AE5GT/G	6K8G	•6K8
1B4T	§1B4P	6B6M	6B6G	6L6	6L6G
1B5/25S	*1H6G	6B7M	6B8	6L7	6L7G
1B7G	1B7GT	6B8	6B8G	6L7MG	•6L7
1B7GT	1B7G	6B8GT	6B8G	6N5	6AB5/6N5
1C5G	1C5GT/G	6C5	{ 6J5GT/G or 6C5GT/G	6N6	6N6G
1C5GT	1C5GT/G		{ 6J5GT/G or 6C5GT/G	6N6MG	6N6G
1E5G	1E5GP	6C5G	{ 6J5GT/G or 6C5GT/G	6N7G	6N7GT/G
1F6	*1F7G		{ 6J5GT/G or 6C5GT/G	6N7GT	6N7GT/G
1F7GH	1F7G	6C5GT	{ 6J5GT/G or 6C5GT/G	6N7MG	6N7
1G4G	1G4GT/G	6C5GT/G	6J5GT/G	6P5G	6P5GT/G
1G4GT	1G4GT/G		6J5GT/G	6P5GT	6P5GT/G
1G6G	1G6GT/G	6C5MG	{ 6J5GT/G or 6C5	6P5GT/G	6P5GT
1G6GT	1G6GT/G		{ 6J5GT/G or 6C5	6Q6G	6T7G
1P5G	1P5GT	6D7	†6C6	6Q7	•6Q7GT
1Q5G	1Q5GT/G	6E7	†6D6	6Q7MG	•6Q7GT
1Q5GT	1Q5GT/G	6F5	•6F5GT	6R7	6R7GT
2A3H	2A3	6F5MG	•6F5GT	6R7MG	6R7GT
2A6S	•2A6	6F6	6F6G	6S7	6S7G
2A7S	•2A7	6F6GT	6F6	6SA7	6SA7GT/G
2B7S	•2B7	6F6GT/G	6F6G	6SA7GT	•6SA7GT/G
2Y2	2X2/879	6F6M	6F6	6SC7	*7F7
3Q5G	3Q5GT/G	6F6MG	6F6	6SF5	6SF5GT
3Q5GT	3Q5GT/G	6F7S	•6F7	6SF5GT/G	6SF5GT
5T4	5U4G	6G5	6U5/6G5	6SJ7	6SJ7GT
5W4	5Y3GT/G	6H5	6U5/6G5	6SK7	6SK7GT/G
5W4G	{ 5Y3GT/G or 5W4GT/G	6H6	6H6GT/G	6SK7GT	6SK7GT/G
5W4GT	{ 5Y3GT/G or 5W4GT/G	6H6G	6H6GT/G	6SQ7	6SQ7GT/G
5W4GT/G	5Y3GT/G	6H6GT	6H6GT/G	6SQ7G	6SQ7GT/G
5Y3G	5Y3GT/G	6H6MG	6H6GT/G	6SQ7GT	6SQ7GT/G
5Y3GT	5Y3GT/G	6J5	6J5GT/G	6T5	6U5/6G5
5Z4	5Y3GT/G	6J5G	6J5GT/G	6T7G/6Q6G	6T7G
5Z4G	5Y3GT/G	6J5GT	6J5GT/G	6U5	6U5/6G5
5Z4GT/G	5Y3GT/G	6J5MG	6J5GT/G		
		6J7	6J7GT		
		6J7MG	6J7GT		

* Socket change necessary.

† A close fitting shield is necessary.

‡ When heaters are connected in parallel.

■ Be sure power transformer can supply extra heater current.

◆ In r-f or i-f stage use a close fitting tube shield.

▲ In a pentagrid converter or mixer stage, it may be necessary to realign the oscillator tuning condenser with the r-f tuning condenser.

§ Depends on receiver circuit.

◆ Where space permits.

Interchangeable Tubes—(Continued)

Tube Number	Replace with	Tube Number	Replace with	Tube Number	Replace with
6V6	6V6GT/G	13	80	40Z5GT	45Z5GT
6V6G	6V6GT/G	13B	80	43MG	} 25A6GT or 25A6
6V6GT	6V6GT/G	14A7	14A7/12B7		
6X5	6X5GT/G	14Z3	12Z3	44	39/44
6X5G	6X5GT/G	16	81	50Y6G	50Y6GT/G
6X5GT	6X5GT/G	16B	81	50Y6GT	50Y6GT/G
6X5MG	6X5GT/G	24	24A	51	35/51 or 35
6Y5S	6Y5	24S	•24A	51S	•35
6Y6GT	♦6Y6G	25/25S	*1H6G	55S	•55
6Z3	1-v	25A6	25A6GT	56A	†76
6Z4	84/6Z4	25A6G	} 25A6GT or 25A6GT/G	56AS	†•76
6Z5/12Z5	6Z5			56S	•56
7A7LM	7A7	25A6GT	25A6GT/G	57A	†6C6
7B5LT	7B5	25A6GT/G	25A6GT	57AS	†•6C6
7B6LM	7B6	25A6MG	25A6GT	57S	•57
12B7GL	14A7/12B7	25A7G	25A7GT/G	58A	†6D6
12B7ML	14A7/12B7	25A7GT	25A7GT/G	58AS	†•6D6
7B8LM	7B8	25AC5G	25AC5GT/G	58S	•58
7C5LT	7C5	25AC5GT	25AC5GT/G	64	†36
7G7	7G7/1232	25AC5GT/G	25AC5GT	64A	†36
12A8G	} 12A8GT or 12A8GT/G	25L6	25L6GT/G	65	†39/44
		25L6G	25L6GT/G	65A	†39/44
12A8GT	12A8GT/G	25L6GT	25L6GT/G	67	†37
12B7	14A7/12B7	25S	1B5/25S	67A	†37
12J7G	12J7GT/G	25Y5	25Z5	68	†38
12J7GT	12J7GT/G	25Z5MG	} 25Z6GT/G or 25Z6	68A	†38
12K7G	12K7GT				
12K7GT	} 12K7G or 12K7GT/G	25Z6	} 25Z6GT/G or 25Z5MG	71	71A
				71B	71A
12K8	12K8GT	25Z6G	25Z6GT/G	75S	•75
12K8GT	12K8	25Z6GT	25Z6GT/G	80M	■83
12Q7G	} 12Q7GT or 12Q7GT/G	25Z6MG	25Z6GT/G	84	84/6Z4
		27HM	56	85S	•85
12Q7GT	12Q7GT/G	27S	•27	88	■83
12SA7	12SA7GT/G	35	35/51	95	2A5
12SA7G	12SA7GT/G	35A5LT	35A5	98	84
12SA7GT	12SA7GT/G	35L6G	35L6GT/G	110	10
12SF5	12SF5GT	35L6GT	35L6GT/G	117L7GT	117L/M7GT
12SF5GT/G	12SF5GT	35Z3LT	35Z3	117L7GT } 117M7GT }	117L/M7GT
12SJ7	12SJ7GT	35Z5G	35Z5GT/G		
12SJ7GT/G	12SJ7GT	35Z5GT	35Z5GT/G	117L7GT/G	117L/M7GT
12SK7	12SK7GT/G	36A	36	117M7GT	117L/M7GT
12SK7GT	12SK7GT/G	37A	37	117P7GT	117N7GT
12SQ7	12SQ7GT/G	38A	38	117Z6G	117Z6GT/G
12SQ7GT	12SQ7GT/G	39	39/44	117Z6GT	117Z6GT/G
12Z5/6Z5	6Z5	39A	39/44	124	24A
				126	26

- * Socket change necessary.
- † A close fitting shield is necessary.
- ‡ When heaters are connected in parallel.
- Be sure power transformer can supply extra heater current.
- In r-f or i-f stage use a close fitting tube shield.

- ▲ In a pentagrid converter or mixer stage, it may be necessary to realign the oscillator tuning condenser with the r-f tuning condenser.
- § Depends on receiver circuit.
- ♦ Where space permits.

Interchangeable Tubes—(Continued)

Tube Number	Replace with	Tube Number	Replace with	Tube Number	Replace with
127	27	240	40	430	30
130	30	245	45	431	31
131	31	247	47	432	32
132	32	250	50	433	33
133	33	264	864	434	34
134	34	280	80	435	35
135	35	281	81	436	36
136A	36	310	10	437	37
137A	37	313	80	438	38
138A	38	313B	80	439	39/44
139A	39/44	316	81	441	41
145	45	316B	81	442	42
147	47	324A	24A	444	39/44
150	50	326	26	445	45
171A	71A	327	27	446	46
180	80	330	30	447	47
181	81	331	31	450	50
182A	71A	332	32	456	56
183	183/483	333	33	457	57
210	10	334	34	458	58
213	80	335	35	471A	71A
213B	80	336	36	480	80
216	81	337	37	481	81
216B	81	338	38	482	82
224A	24A	345	45	482A	71A
226	26	347	47	483	183/483
227	27	350	50	551	35
230	30	371A	71A	585	50
232	32	374	874	586	50
233	33	380	80	951	32 or 1B4P
234	34	381	81	986	83
235	35	410	10	1232	7G7/1232
236	36	424A	24A	1852	6AC7/1852
237	37	426	26	1853	6AB7/1853
238	38	427	27		

Tube Number	Replace with	Tube Number	Replace with	Tube Number	Replace with
AC22	24A	H250	1223	PZH	2A5
AD	1-v	K27	27	RE1	80
AF	82	KR1	1-v	SS6C5G	SS6J5GT/G
AG	83	KR25	2A5	SS6K6G	SS6K6GT/G
D _{1/2}	81	KR28	84	SS6N7G	SS6N7GT/G
D1	80	LA	6A4	SS6V6G	SS6V6GT/G
DE1	27	P861	84	SS6X5G	SS6X5GT/G
G84/Z22	Z22/G84	PZ	47		

* Socket change necessary.

† A close fitting shield is necessary.

‡ When heaters are connected in parallel.

■ Be sure power transformer can supply extra heater current.

• In r-f or i-f stage use a close fitting tube shield.

▲ In a pentagrid converter or mixer stage, it may be necessary to realign the oscillator tuning condenser with the r-f tuning condenser.

§ Depends on receiver circuit.

◆ Where space permits.











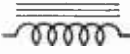







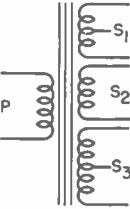

















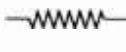

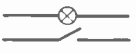
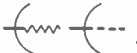

Abbreviations and Letter Symbols

Many of the abbreviations given are in lower-case letters. Obviously, however, there will be occasions such as when the abbreviations are used in titles where the original word would have been capitalized. In these cases, the abbreviation should be similarly capitalized.

A two-word adjective expression should contain a hyphen.

<i>Term</i>	<i>Abbreviation</i>	<i>Term</i>	<i>Abbreviation</i>
Admittance.....	<i>Y</i>	Low-frequency (adjective).....	<i>l-f</i>
Alternating-current (adjective)....	<i>a-c</i>	Low-frequency (noun).....	<i>l.f.</i>
Alternating current (noun).....	<i>a.c.</i>	Magnetic field intensity.....	<i>H</i>
Ampere.....	<i>a</i>	Megacycle.....	<i>Mc</i>
Angular velocity ($2\pi f$).....	ω	Megohm.....	$M\Omega$
Antenna.....	<i>ant.</i>	Meter.....	<i>m</i>
Audio-frequency (adjective).....	<i>a-f</i>	Microampere.....	μa
Audio frequency (noun).....	<i>a.f.</i>	Microfarad (mfd).....	μf
Automatic volume control.....	<i>a.v.c.</i>	Microhenry.....	μh
Automatic volume expansion.....	<i>a.v.e.</i>	Micromicrofarad (mmfd).....	$\mu\mu f$
Capacitance.....	<i>C</i>	Microvolt.....	μv
Capacitive reactance.....	X_C	Microvolt per meter.....	$\mu v/m$
Centimeter.....	<i>cm</i>	Microwatt.....	μw
Conductance.....	<i>G</i>	Milliamperere.....	<i>ma</i>
Continuous waves.....	<i>c.w.</i>	Millihenry.....	<i>mh</i>
Current.....	<i>I, i</i>	Millivolt.....	<i>mv</i>
Cycle per second.....	\sim	Millivolt per meter.....	<i>mv/m</i>
Decibel.....	<i>db</i>	Milliwatt.....	<i>mw</i>
Direct-current (adjective).....	<i>d-c</i>	Modulated continuous waves.....	<i>m.c.w.</i>
Direct current (noun).....	<i>d.c.</i>	Mutual inductance.....	<i>M</i>
Double cotton covered.....	<i>d.c.c.</i>	Ohm.....	Ω
Double pole, double throw.....	<i>d.p.d.t.</i>	Power.....	<i>P</i>
Double pole, single throw.....	<i>d.p.s.t.</i>	Power factor.....	<i>p.f.</i>
Double silk covered.....	<i>d.s.c.</i>	Radio-frequency (adjective).....	<i>r-f</i>
Electric field intensity.....	<i>E</i>	Radio frequency (noun).....	<i>r.f.</i>
Electromotive force.....	<i>e.m.f.</i>	Reactance.....	<i>X</i>
Frequency.....	<i>f</i>	Resistance.....	<i>R</i>
Frequency modulation.....	<i>f.m.</i>	Revolutions per minute.....	<i>r.p.m.</i>
Ground.....	<i>gnd.</i>	Root mean square.....	<i>r.m.s.</i>
Henry.....	<i>h</i>	Self-inductance.....	<i>L</i>
High-frequency (adjective).....	<i>h-f</i>	Short wave.....	<i>s.w.</i>
High frequency (noun).....	<i>h.f.</i>	Single cotton covered.....	<i>s.c.c.</i>
Impedance.....	<i>Z</i>	Single cotton enamel.....	<i>s.c.e.</i>
Inductance.....	<i>L</i>	Single pole, double throw.....	<i>s.p.d.t.</i>
Inductive reactance.....	X_L	Single pole, single throw.....	<i>s.p.s.t.</i>
Intermediate-frequency (adjective)	<i>i-f</i>	Single silk covered.....	<i>s.s.c.</i>
Intermediate frequency (noun)....	<i>i.f.</i>	Tuned radio frequency.....	<i>t.r.f.</i>
Interrupted continuous waves.....	<i>i.c.w.</i>	Ultra high frequency.....	<i>u.h.f.</i>
Kilocycle.....	<i>kc</i>	Vacuum tube voltmeter.....	<i>v.t.v.m.</i>
Kilohm.....	$k\Omega$	Volt.....	<i>v</i>
Kilovolt.....	<i>kV</i>	Voltage.....	<i>E, e</i>
Kilovolt ampere.....	<i>kva</i>	Volt-Ohm-Milliammeter.....	<i>v.o.m.</i>
Kilowatt.....	<i>kw</i>	Watt.....	<i>w</i>

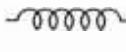
Schematic Symbols Used in Radio Diagrams

	ANTENNA (AERIAL)		IRON-CORE CHOKO COIL		SWITCH (ROTARY OR SELECTOR)
	GROUND (OR CHASSIS CONNECTION)		R. F. TRANSFORMER (AIR CORE)		CRYSTAL DETECTOR
	LOOP AERIAL (USUALLY BUILT INTO CABINET OF RECEIVER)		A. F. TRANSFORMER (IRON CORE)		LIGHTNING ARRESTER
	CONNECTION	 <p>POWER TRANSFORMER P: 115-VOLT PRIMARY S₁: CENTER-TAPPED SECONDARY FOR FILAMENTS OF SIGNAL CIRCUIT TUBES S₂: SECONDARY WINDING FOR RECTIFIER TUBE FILAMENT S₃: CENTER-TAPPED HIGH-VOLTAGE SECONDARY WINDING</p>		FUSE	
	NO CONNECTION			PILOT LAMP	
	NO CONNECTION (WHEN CONNECTIONS ARE INDICATED BY DOTS)			HEADPHONES	
	CONNECTION (WHEN NO CONNECTION CROSS-OVERS ARE INDICATED BY HALF- CIRCLES)			FIXED CONDENSER (MICA OR PAPER)	
	TERMINAL		FIXED CONDENSER (ELECTROLYTIC)		LOUDSPEAKER, P. M. DYNAMIC
	ONE CELL OR "A" BATTERY		ROTOR PLATES VARIABLE CONDENSER		LOUDSPEAKER, ELECTRODYNAMIC
	MULTI-CELL OR "B" BATTERY		GANG TUNING CONDENSER		PHONO PICK-UP
	RESISTOR		TRIMMER AND PADDER CONDENSER		FILAMENT
	POTENTIOMETER		I. F. TRANSFORMER (DOUBLE-TUNED)		CATHODE
	TAPPED RESISTOR OR VOLTAGE DIVIDER		POWER SWITCH (S. P. S. T.)		GRID
	RHEOSTAT		SWITCH (S. P. D. T.)		PLATE
	RHEOSTAT		SWITCH (D. P. S. T.)		3-ELEMENT VACUUM TUBE
	AIR-CORE CHOKO COIL		SWITCH (D. P. D. T.)		ALIGNING KEY OF OCTAL BASE

Common Logarithms

N	0	1	2	3	4	5	6	7	8	9	N
10	0000	0043	0086	0128	0170	0212	0253	0294	0334	0374	10
11	0414	0453	0492	0531	0569	0607	0645	0682	0719	0755	11
12	0792	0828	0864	0899	0934	0969	1004	1038	1072	1106	12
13	1139	1173	1206	1239	1271	1303	1335	1367	1399	1430	13
14	1461	1492	1523	1553	1584	1614	1644	1673	1703	1732	14
15	1761	1790	1818	1847	1875	1903	1931	1959	1987	2014	15
16	2041	2068	2095	2122	2148	2175	2201	2227	2253	2279	16
17	2304	2330	2355	2380	2405	2430	2455	2480	2504	2529	17
18	2553	2577	2601	2625	2648	2672	2695	2718	2742	2765	18
19	2788	2810	2833	2856	2878	2900	2923	2945	2967	2989	19
20	3010	3032	3054	3075	3096	3118	3139	3160	3181	3201	20
21	3222	3243	3263	3284	3304	3324	3345	3365	3385	3404	21
22	3424	3444	3464	3483	3502	3522	3541	3560	3579	3598	22
23	3617	3636	3655	3674	3692	3711	3729	3747	3766	3784	23
24	3802	3820	3838	3856	3874	3892	3909	3927	3945	3962	24
25	3979	3997	4014	4031	4048	4065	4082	4099	4116	4133	25
26	4150	4166	4183	4200	4216	4232	4249	4265	4281	4298	26
27	4314	4330	4346	4362	4378	4393	4409	4425	4440	4456	27
28	4472	4487	4502	4518	4533	4548	4564	4579	4594	4609	28
29	4624	4639	4654	4669	4683	4698	4713	4728	4742	4757	29
30	4771	4786	4800	4814	4829	4843	4857	4871	4886	4900	30
31	4914	4928	4942	4955	4969	4983	4997	5011	5024	5038	31
32	5051	5065	5079	5092	5105	5119	5132	5145	5159	5172	32
33	5185	5198	5211	5224	5237	5250	5263	5276	5289	5302	33
34	5315	5328	5340	5353	5366	5378	5391	5403	5416	5428	34
35	5441	5453	5465	5478	5490	5502	5514	5527	5539	5551	35
36	5563	5575	5587	5599	5611	5623	5635	5647	5658	5670	36
37	5682	5694	5705	5717	5729	5740	5752	5763	5775	5786	37
38	5798	5809	5821	5832	5843	5855	5866	5877	5888	5899	38
39	5911	5922	5933	5944	5955	5966	5977	5988	5999	6010	39
40	6021	6031	6042	6053	6064	6075	6085	6096	6107	6117	40
41	6128	6138	6149	6160	6170	6180	6191	6201	6212	6222	41
42	6232	6243	6253	6263	6274	6284	6294	6304	6314	6325	42
43	6335	6345	6355	6365	6375	6385	6395	6405	6415	6425	43
44	6435	6444	6454	6464	6474	6484	6493	6503	6513	6522	44
45	6532	6542	6551	6561	6571	6580	6590	6599	6609	6618	45
46	6628	6637	6646	6656	6665	6675	6684	6693	6702	6712	46
47	6721	6730	6739	6749	6758	6767	6776	6785	6794	6803	47
48	6812	6821	6830	6839	6848	6857	6866	6875	6884	6893	48
49	6902	6911	6920	6928	6937	6946	6955	6964	6972	6981	49
50	6990	6998	7007	7016	7024	7033	7042	7050	7059	7067	50
51	7076	7084	7093	7101	7110	7118	7126	7135	7143	7152	51
52	7160	7168	7177	7185	7193	7202	7210	7218	7226	7235	52
53	7243	7251	7259	7267	7275	7284	7292	7300	7308	7316	53
54	7324	7332	7340	7348	7356	7364	7372	7380	7388	7396	54
N	0	1	2	3	4	5	6	7	8	9	N

Common Logarithms (Continued)

N	0	1	2	3	4	5	6	7	8	9	N
55	7404	7412	7419	7427	7435	7443	7451	7459	7466	7474	55
56	7482	7490	7497	7505	7513	7520	7528	7536	7543	7551	56
57	7559	7566	7574	7582	7589	7597	7604	7612	7619	7627	57
58	7634	7642	7649	7657	7664	7672	7679	7686	7694	7701	58
59	7709	7716	7723	7731	7738	7745	7752	7760	7767	7774	59
60	7782	7789	7796	7803	7810	7818	7825	7832	7839	7846	60
61	7853	7860	7868	7875	7882	7889	7896	7903	7910	7917	61
62	7924	7931	7938	7945	7952	7959	7966	7973	7980	7987	62
63	7993	8000	8007	8014	8021	8028	8035	8041	8048	8055	63
64	8062	8069	8075	8082	8089	8096	8102	8109	8116	8122	64
65	8129	8136	8142	8149	8156	8162	8169	8176	8182	8189	65
66	8195	8202	8209	8215	8222	8228	8235	8241	8248	8254	66
67	8261	8267	8274	8280	8287	8293	8299	8306	8312	8319	67
68	8325	8331	8338	8344	8351	8357	8363	8370	8376	8382	68
69	8388	8395	8401	8407	8414	8420	8426	8432	8439	8445	69
70	8451	8457	8463	8470	8476	8482	8488	8494	8500	8506	70
71	8513	8519	8525	8531	8537	8543	8549	8555	8561	8567	71
72	8573	8579	8585	8591	8597	8603	8609	8615	8621	8627	72
73	8633	8639	8645	8651	8657	8663	8669	8675	8681	8686	73
74	8692	8698	8704	8710	8716	8722	8727	8733	8739	8745	74
75	8751	8756	8762	8768	8774	8779	8785	8791	8797	8802	75
76	8808	8814	8820	8825	8831	8837	8842	8848	8854	8859	76
77	8865	8871	8876	8882	8887	8893	8899	8904	8910	8915	77
78	8921	8927	8932	8938	8943	8949	8954	8960	8965	8971	78
79	8976	8982	8987	8993	8998	9004	9009	9015	9020	9025	79
80	9031	9036	9042	9047	9053	9058	9063	9069	9074	9079	80
81	9085	9090	9096	9101	9106	9112	9117	9122	9128	9133	81
82	9138	9143	9149	9154	9159	9165	9170	9175	9180	9186	82
83	9191	9196	9201	9206	9212	9217	9222	9227	9232	9238	83
84	9243	9248	9253	9258	9263	9269	9274	9279	9284	9289	84
85	9294	9299	9304	9309	9315	9320	9325	9330	9335	9340	85
86	9345	9350	9355	9360	9365	9370	9375	9380	9385	9390	86
87	9395	9400	9405	9410	9415	9420	9425	9430	9435	9440	87
88	9445	9450	9455	9460	9465	9469	9474	9479	9484	9489	88
89	9494	9499	9504	9509	9513	9518	9523	9528	9533	9538	89
90	9542	9547	9552	9557	9562	9566	9571	9576	9581	9586	90
91	9590	9595	9600	9605	9609	9614	9619	9624	9628	9633	91
92	9638	9643	9647	9652	9657	9661	9666	9671	9675	9680	92
93	9685	9689	9694	9699	9703	9708	9713	9717	9722	9727	93
94	9731	9736	9741	9745	9750	9754	9759	9763	9768	9773	94
95	9777	9782	9786	9791	9795	9800	9805	9809	9814	9818	95
96	9823	9827	9832	9836	9841	9845	9850	9854	9859	9863	96
97	9868	9872	9877	9881	9886	9890	9894	9899	9903	9908	97
98	9912	9917	9921	9926	9930	9934	9939	9943	9948	9952	98
99	9956	9961	9965	9969	9974	9978	9983	9987	9991	9996	99
N	0	1	2	3	4	5	6	7	8	9	N

Natural Sines, Cosines, and Tangents
0°-14.9°

Degs.	Function	0.0°	0.1°	0.2°	0.3°	0.4°	0.5°	0.6°	0.7°	0.8°	0.9°
0	sin	0.0000	0.0017	0.0035	0.0052	0.0070	0.0087	0.0105	0.0122	0.0140	0.0157
	cos	1.0000	1.0000	1.0000	1.0000	1.0000	1.0000	0.9999	0.9999	0.9999	0.9999
	tan	0.0000	0.0017	0.0035	0.0052	0.0070	0.0087	0.0105	0.0122	0.0140	0.0157
1	sin	0.0175	0.0192	0.0209	0.0227	0.0244	0.0262	0.0279	0.0297	0.0314	0.0332
	cos	0.9998	0.9998	0.9998	0.9997	0.9997	0.9997	0.9996	0.9996	0.9995	0.9995
	tan	0.0175	0.0192	0.0209	0.0227	0.0244	0.0262	0.0279	0.0297	0.0314	0.0332
2	sin	0.0349	0.0366	0.0384	0.0401	0.0419	0.0436	0.0454	0.0471	0.0488	0.0506
	cos	0.9994	0.9993	0.9993	0.9992	0.9991	0.9990	0.9990	0.9989	0.9988	0.9987
	tan	0.0349	0.0367	0.0384	0.0402	0.0419	0.0437	0.0454	0.0472	0.0489	0.0507
3	sin	0.0523	0.0541	0.0558	0.0576	0.0593	0.0610	0.0628	0.0645	0.0663	0.0680
	cos	0.9986	0.9985	0.9984	0.9983	0.9982	0.9981	0.9980	0.9979	0.9978	0.9977
	tan	0.0524	0.0542	0.0559	0.0577	0.0594	0.0612	0.0629	0.0647	0.0664	0.0682
4	sin	0.0698	0.0715	0.0732	0.0750	0.0767	0.0785	0.0802	0.0819	0.0837	0.0854
	cos	0.9976	0.9974	0.9973	0.9972	0.9971	0.9969	0.9968	0.9966	0.9965	0.9963
	tan	0.0699	0.0717	0.0734	0.0752	0.0769	0.0787	0.0805	0.0822	0.0840	0.0857
5	sin	0.0872	0.0889	0.0906	0.0924	0.0941	0.0958	0.0976	0.0993	0.1011	0.1028
	cos	0.9962	0.9960	0.9959	0.9957	0.9956	0.9954	0.9952	0.9951	0.9949	0.9947
	tan	0.0875	0.0892	0.0910	0.0928	0.0945	0.0963	0.0981	0.0998	0.1016	0.1033
6	sin	0.1045	0.1063	0.1080	0.1097	0.1115	0.1132	0.1149	0.1167	0.1184	0.1201
	cos	0.9945	0.9943	0.9942	0.9940	0.9938	0.9936	0.9934	0.9932	0.9930	0.9928
	tan	0.1051	0.1069	0.1086	0.1104	0.1122	0.1139	0.1157	0.1175	0.1192	0.1210
7	sin	0.1219	0.1236	0.1253	0.1271	0.1288	0.1305	0.1323	0.1340	0.1357	0.1374
	cos	0.9925	0.9923	0.9921	0.9919	0.9917	0.9914	0.9912	0.9910	0.9907	0.9905
	tan	0.1228	0.1246	0.1263	0.1281	0.1299	0.1317	0.1334	0.1352	0.1370	0.1388
8	sin	0.1392	0.1409	0.1426	0.1444	0.1461	0.1478	0.1495	0.1513	0.1530	0.1547
	cos	0.9903	0.9900	0.9898	0.9895	0.9893	0.9890	0.9888	0.9885	0.9882	0.9880
	tan	0.1405	0.1423	0.1441	0.1459	0.1477	0.1495	0.1512	0.1530	0.1548	0.1566
9	sin	0.1564	0.1582	0.1599	0.1616	0.1633	0.1650	0.1668	0.1685	0.1702	0.1719
	cos	0.9877	0.9874	0.9871	0.9869	0.9866	0.9863	0.9860	0.9857	0.9854	0.9851
	tan	0.1584	0.1602	0.1620	0.1638	0.1655	0.1673	0.1691	0.1709	0.1727	0.1745
10	sin	0.1736	0.1754	0.1771	0.1788	0.1805	0.1822	0.1840	0.1857	0.1874	0.1891
	cos	0.9848	0.9845	0.9842	0.9839	0.9836	0.9833	0.9829	0.9826	0.9823	0.9820
	tan	0.1763	0.1781	0.1799	0.1817	0.1835	0.1853	0.1871	0.1890	0.1908	0.1926
11	sin	0.1908	0.1925	0.1942	0.1959	0.1977	0.1994	0.2011	0.2028	0.2045	0.2062
	cos	0.9816	0.9813	0.9810	0.9806	0.9803	0.9799	0.9796	0.9792	0.9789	0.9785
	tan	0.1944	0.1962	0.1980	0.1998	0.2016	0.2035	0.2053	0.2071	0.2089	0.2107
12	sin	0.2079	0.2096	0.2113	0.2130	0.2147	0.2164	0.2181	0.2198	0.2215	0.2232
	cos	0.9781	0.9778	0.9774	0.9770	0.9767	0.9763	0.9759	0.9755	0.9751	0.9748
	tan	0.2126	0.2144	0.2162	0.2180	0.2199	0.2217	0.2235	0.2254	0.2272	0.2290
13	sin	0.2250	0.2267	0.2284	0.2300	0.2318	0.2334	0.2351	0.2368	0.2385	0.2402
	cos	0.9744	0.9740	0.9736	0.9732	0.9728	0.9724	0.9720	0.9715	0.9711	0.9707
	tan	0.2309	0.2327	0.2345	0.2364	0.2382	0.2401	0.2419	0.2438	0.2456	0.2475
14	sin	0.2419	0.2436	0.2453	0.2470	0.2487	0.2504	0.2521	0.2538	0.2554	0.2571
	cos	0.9703	0.9699	0.9694	0.9690	0.9686	0.9681	0.9677	0.9673	0.9668	0.9664
	tan	0.2493	0.2512	0.2530	0.2549	0.2568	0.2586	0.2605	0.2623	0.2642	0.2661
Degs.	Function	0'	6'	12'	18'	24'	30'	36'	42'	48'	54'

Natural Sines, Cosines, and Tangents—(Continued)

15°-29.9°

Degs.	Function	0.0°	0.1°	0.2°	0.3°	0.4°	0.5°	0.6°	0.7°	0.8°	0.9°
15	sin	0.2588	0.2605	0.2622	0.2639	0.2656	0.2672	0.2689	0.2706	0.2723	0.2740
	cos	0.9659	0.9655	0.9650	0.9646	0.9641	0.9636	0.9632	0.9627	0.9622	0.9617
	tan	0.2679	0.2698	0.2717	0.2736	0.2754	0.2773	0.2792	0.2811	0.2830	0.2849
16	sin	0.2756	0.2773	0.2790	0.2807	0.2823	0.2840	0.2857	0.2874	0.2890	0.2907
	cos	0.9613	0.9608	0.9603	0.9598	0.9593	0.9588	0.9583	0.9578	0.9573	0.9568
	tan	0.2867	0.2886	0.2905	0.2924	0.2943	0.2962	0.2981	0.3000	0.3019	0.3038
17	sin	0.2924	0.2940	0.2957	0.2974	0.2990	0.3007	0.3024	0.3040	0.3057	0.3074
	cos	0.9563	0.9558	0.9553	0.9548	0.9542	0.9537	0.9532	0.9527	0.9521	0.9516
	tan	0.3057	0.3076	0.3096	0.3115	0.3134	0.3153	0.3172	0.3191	0.3211	0.3230
18	sin	0.3090	0.3107	0.3123	0.3140	0.3156	0.3173	0.3190	0.3206	0.3223	0.3239
	cos	0.9511	0.9505	0.9500	0.9494	0.9489	0.9483	0.9478	0.9472	0.9466	0.9461
	tan	0.3249	0.3269	0.3288	0.3307	0.3327	0.3346	0.3365	0.3385	0.3404	0.3424
19	sin	0.3256	0.3272	0.3289	0.3305	0.3322	0.3338	0.3355	0.3371	0.3387	0.3404
	cos	0.9455	0.9449	0.9444	0.9438	0.9432	0.9426	0.9421	0.9415	0.9409	0.9403
	tan	0.3443	0.3463	0.3482	0.3502	0.3522	0.3541	0.3561	0.3581	0.3600	0.3620
20	sin	0.3420	0.3437	0.3453	0.3469	0.3486	0.3502	0.3518	0.3535	0.3551	0.3567
	cos	0.9397	0.9391	0.9385	0.9379	0.9373	0.9367	0.9361	0.9354	0.9348	0.9342
	tan	0.3640	0.3659	0.3679	0.3699	0.3719	0.3739	0.3759	0.3779	0.3799	0.3819
21	sin	0.3584	0.3600	0.3616	0.3633	0.3649	0.3665	0.3681	0.3697	0.3714	0.3730
	cos	0.9336	0.9330	0.9323	0.9317	0.9311	0.9304	0.9298	0.9291	0.9285	0.9278
	tan	0.3839	0.3859	0.3879	0.3899	0.3919	0.3939	0.3959	0.3979	0.4000	0.4020
22	sin	0.3746	0.3762	0.3778	0.3795	0.3811	0.3827	0.3843	0.3859	0.3875	0.3891
	cos	0.9272	0.9265	0.9259	0.9252	0.9245	0.9239	0.9232	0.9225	0.9219	0.9212
	tan	0.4040	0.4061	0.4081	0.4101	0.4122	0.4142	0.4163	0.4183	0.4204	0.4224
23	sin	0.3907	0.3923	0.3939	0.3955	0.3971	0.3987	0.4003	0.4019	0.4035	0.4051
	cos	0.9205	0.9198	0.9191	0.9184	0.9178	0.9171	0.9164	0.9157	0.9150	0.9143
	tan	0.4245	0.4265	0.4286	0.4307	0.4327	0.4348	0.4369	0.4390	0.4411	0.4431
24	sin	0.4067	0.4083	0.4099	0.4115	0.4131	0.4147	0.4163	0.4179	0.4195	0.4210
	cos	0.9135	0.9128	0.9121	0.9114	0.9107	0.9100	0.9092	0.9085	0.9078	0.9070
	tan	0.4452	0.4473	0.4494	0.4515	0.4536	0.4557	0.4578	0.4599	0.4621	0.4642
25	sin	0.4226	0.4242	0.4258	0.4274	0.4289	0.4305	0.4321	0.4337	0.4352	0.4368
	cos	0.9063	0.9056	0.9048	0.9041	0.9033	0.9026	0.9018	0.9011	0.9003	0.8996
	tan	0.4663	0.4684	0.4706	0.4727	0.4748	0.4770	0.4791	0.4813	0.4834	0.4856
26	sin	0.4384	0.4399	0.4415	0.4431	0.4446	0.4462	0.4478	0.4493	0.4509	0.4524
	cos	0.8988	0.8980	0.8973	0.8965	0.8957	0.8949	0.8942	0.8934	0.8926	0.8918
	tan	0.4877	0.4899	0.4921	0.4942	0.4964	0.4986	0.5008	0.5029	0.5051	0.5073
27	sin	0.4540	0.4555	0.4571	0.4586	0.4602	0.4617	0.4633	0.4648	0.4664	0.4679
	cos	0.8910	0.8902	0.8894	0.8886	0.8878	0.8870	0.8862	0.8854	0.8846	0.8838
	tan	0.5095	0.5117	0.5139	0.5161	0.5184	0.5206	0.5228	0.5250	0.5272	0.5295
28	sin	0.4695	0.4710	0.4726	0.4741	0.4756	0.4772	0.4787	0.4802	0.4818	0.4833
	cos	0.8829	0.8821	0.8813	0.8805	0.8796	0.8788	0.8780	0.8771	0.8763	0.8755
	tan	0.5317	0.5340	0.5362	0.5384	0.5407	0.5430	0.5452	0.5475	0.5498	0.5520
29	sin	0.4848	0.4863	0.4879	0.4894	0.4909	0.4924	0.4939	0.4955	0.4970	0.4985
	cos	0.8746	0.8738	0.8729	0.8721	0.8712	0.8704	0.8695	0.8686	0.8678	0.8669
	tan	0.5543	0.5566	0.5589	0.5612	0.5635	0.5658	0.5681	0.5704	0.5727	0.5750
Degs.	Function	0'	6'	12'	18'	24'	30'	36'	42'	48'	54'

Natural Sines, Cosines, and Tangents—(Continued)
30°-44.9°

Degs.	Function	0.0°	0.1°	0.2°	0.3°	0.4°	0.5°	0.6°	0.7°	0.8°	0.9°
30	sin	0.5000	0.5015	0.5030	0.5145	0.5060	0.5075	0.5090	0.5105	0.5120	0.5135
	cos	0.8660	0.8652	0.8643	0.8634	0.8625	0.8616	0.8607	0.8599	0.8590	0.8581
	tan	0.5774	0.5797	0.5820	0.5844	0.5867	0.5890	0.5914	0.5938	0.5961	0.5985
31	sin	0.5150	0.5165	0.5180	0.5195	0.5210	0.5225	0.5240	0.5255	0.5270	0.5284
	cos	0.8572	0.8563	0.8554	0.8545	0.8536	0.8526	0.8517	0.8508	0.8499	0.8490
	tan	0.6009	0.5032	0.6056	0.6080	0.6104	0.6128	0.6152	0.6176	0.6200	0.6224
32	sin	0.5299	0.5314	0.5329	0.5344	0.5358	0.5373	0.5388	0.5402	0.5417	0.5432
	cos	0.8480	0.8471	0.8462	0.8453	0.8443	0.8434	0.8425	0.8415	0.8406	0.8396
	tan	0.6249	0.6273	0.6297	0.6322	0.6346	0.6371	0.6395	0.6420	0.6445	0.6469
33	sin	0.5446	0.5461	0.5476	0.5490	0.5505	0.5519	0.5534	0.5548	0.5563	0.5577
	cos	0.8387	0.8377	0.8368	0.8358	0.8348	0.8339	0.8329	0.8320	0.8310	0.8300
	tan	0.6494	0.6519	0.6544	0.6569	0.6594	0.6619	0.6644	0.6669	0.6694	0.6720
34	sin	0.5592	0.5606	0.5621	0.5635	0.5650	0.5664	0.5678	0.5693	0.5707	0.5721
	cos	0.8290	0.8281	0.8271	0.8261	0.8251	0.8241	0.8231	0.8221	0.8211	0.8202
	tan	0.6745	0.6771	0.6796	0.6822	0.6847	0.6873	0.6899	0.6924	0.6950	0.6976
35	sin	0.5736	0.5750	0.5764	0.5779	0.5793	0.5807	0.5821	0.5835	0.5850	0.5864
	cos	0.8192	0.8181	0.8171	0.8161	0.8151	0.8141	0.8131	0.8121	0.8111	0.8100
	tan	0.7002	0.7028	0.7054	0.7080	0.7107	0.7133	0.7159	0.7186	0.7212	0.7239
36	sin	0.5878	0.5892	0.5906	0.5920	0.5934	0.5948	0.5962	0.5976	0.5990	0.6004
	cos	0.8090	0.8080	0.8070	0.8059	0.8049	0.8039	0.8028	0.8018	0.8007	0.7997
	tan	0.7265	0.7292	0.7319	0.7346	0.7373	0.7400	0.7427	0.7454	0.7481	0.7508
37	sin	0.6018	0.6032	0.6046	0.6060	0.6074	0.6088	0.6101	0.6115	0.6129	0.6143
	cos	0.7986	0.7976	0.7965	0.7955	0.7944	0.7934	0.7923	0.7912	0.7902	0.7891
	tan	0.7536	0.7563	0.7590	0.7618	0.7646	0.7673	0.7701	0.7729	0.7757	0.7785
38	sin	0.6157	0.6170	0.6184	0.6198	0.6211	0.6225	0.6239	0.6252	0.6266	0.6280
	cos	0.7880	0.7869	0.7859	0.7848	0.7837	0.7826	0.7815	0.7804	0.7793	0.7782
	tan	0.7813	0.7841	0.7869	0.7898	0.7926	0.7954	0.7983	0.8012	0.8040	0.8069
39	sin	0.6293	0.6307	0.6320	0.6334	0.6347	0.6361	0.6374	0.6388	0.6401	0.6414
	cos	0.7771	0.7760	0.7749	0.7738	0.7727	0.7716	0.7705	0.7694	0.7683	0.7672
	tan	0.8098	0.8127	0.8156	0.8185	0.8214	0.8243	0.8273	0.8302	0.8332	0.8361
40	sin	0.6428	0.6441	0.6455	0.6468	0.6481	0.6494	0.6508	0.6521	0.6534	0.6547
	cos	0.7600	0.7649	0.7638	0.7627	0.7615	0.7604	0.7593	0.7581	0.7570	0.7559
	tan	0.8391	0.8421	0.8451	0.8481	0.8511	0.8541	0.8571	0.8601	0.8632	0.8662
41	sin	0.6561	0.6574	0.6587	0.6600	0.6613	0.6626	0.6639	0.6652	0.6665	0.6678
	cos	0.7547	0.7536	0.7524	0.7513	0.7501	0.7490	0.7478	0.7466	0.7455	0.7443
	tan	0.8693	0.8724	0.8754	0.8785	0.8816	0.8847	0.8878	0.8910	0.8941	0.8972
42	sin	0.6691	0.6704	0.6717	0.6730	0.6743	0.6756	0.6769	0.6782	0.6794	0.6807
	cos	0.7431	0.7420	0.7408	0.7396	0.7385	0.7373	0.7361	0.7349	0.7337	0.7325
	tan	0.9004	0.9036	0.9067	0.9099	0.9131	0.9163	0.9195	0.9228	0.9260	0.9293
43	sin	0.6820	0.6833	0.6845	0.6858	0.6871	0.6884	0.6896	0.6909	0.6921	0.6934
	cos	0.7314	0.7302	0.7290	0.7278	0.7266	0.7254	0.7242	0.7230	0.7218	0.7206
	tan	0.9325	0.9358	0.9391	0.9424	0.9457	0.9490	0.9523	0.9556	0.9590	0.9623
44	sin	0.6947	0.6959	0.6972	0.6984	0.6997	0.7009	0.7022	0.7034	0.7046	0.7059
	cos	0.7193	0.7181	0.7169	0.7157	0.7145	0.7133	0.7120	0.7108	0.7096	0.7083
	tan	0.9657	0.9691	0.9725	0.9759	0.9793	0.9827	0.9861	0.9896	0.9930	0.9965
Degs.	Function	0'	6'	12'	18'	24'	30'	36'	42'	48'	54'

Natural Sines, Cosines, and Tangents—(Continued)

45°-59.9°

Degs.	Function	0.0°	0.1°	0.2°	0.3°	0.4°	0.5°	0.6°	0.7°	0.8°	0.9°
45	sin	0.7071	0.7083	0.7096	0.7108	0.7120	0.7133	0.7145	0.7157	0.7169	0.7181
	cos	0.7071	0.7059	0.7046	0.7034	0.7022	0.7009	0.6997	0.6984	0.6972	0.6959
	tan	1.0000	1.0035	1.0070	1.0105	1.0141	1.0176	1.0212	1.0247	1.0283	1.0319
46	sin	0.7193	0.7206	0.7218	0.7230	0.7242	0.7254	0.7266	0.7278	0.7290	0.7302
	cos	0.6947	0.6934	0.6921	0.6909	0.6896	0.6884	0.6871	0.6858	0.6845	0.6833
	tan	1.0355	1.0392	1.0428	1.0464	1.0501	1.0538	1.0575	1.0612	1.0649	1.0686
47	sin	0.7314	0.7325	0.7337	0.7349	0.7361	0.7373	0.7385	0.7396	0.7408	0.7420
	cos	0.6820	0.6807	0.6794	0.6782	0.6769	0.6756	0.6743	0.6730	0.6717	0.6704
	tan	1.0724	1.0761	1.0799	1.0837	1.0875	1.0913	1.0951	1.0990	1.1028	1.1067
48	sin	0.7431	0.7443	0.7455	0.7466	0.7478	0.7490	0.7501	0.7513	0.7524	0.7536
	cos	0.6691	0.6678	0.6665	0.6652	0.6639	0.6626	0.6613	0.6600	0.6587	0.6574
	tan	1.1106	1.1145	1.1184	1.1224	1.1263	1.1303	1.1343	1.1383	1.1423	1.1463
49	sin	0.7547	0.7559	0.7570	0.7581	0.7593	0.7604	0.7615	0.7627	0.7638	0.7649
	cos	0.6561	0.6547	0.6534	0.6521	0.6508	0.6494	0.6481	0.6468	0.6455	0.6441
	tan	1.1504	1.1544	1.1585	1.1626	1.1667	1.1708	1.1750	1.1792	1.1833	1.1875
50	sin	0.7660	0.7672	0.7683	0.7694	0.7705	0.7716	0.7727	0.7738	0.7749	0.7760
	cos	0.6428	0.6414	0.6401	0.6388	0.6374	0.6361	0.6347	0.6334	0.6320	0.6307
	tan	1.1918	1.1960	1.2002	1.2045	1.2088	1.2131	1.2174	1.2218	1.2261	1.2305
51	sin	0.7771	0.7782	0.7793	0.7804	0.7815	0.7826	0.7837	0.7848	0.7859	0.7869
	cos	0.6293	0.6280	0.6266	0.6252	0.6239	0.6225	0.6211	0.6198	0.6184	0.6170
	tan	1.2349	1.2393	1.2437	1.2482	1.2527	1.2572	1.2617	1.2662	1.2708	1.2753
52	sin	0.7880	0.7891	0.7902	0.7912	0.7923	0.7934	0.7944	0.7955	0.7965	0.7976
	cos	0.6157	0.6143	0.6129	0.6115	0.6101	0.6088	0.6074	0.6060	0.6046	0.6032
	tan	1.2799	1.2846	1.2892	1.2938	1.2985	1.3032	1.3079	1.3127	1.3175	1.3222
53	sin	0.7986	0.7997	0.8007	0.8018	0.8028	0.8039	0.8049	0.8059	0.8070	0.8080
	cos	0.6018	0.6004	0.5990	0.5976	0.5962	0.5948	0.5934	0.5920	0.5906	0.5892
	tan	1.3270	1.3319	1.3367	1.3416	1.3465	1.3514	1.3564	1.3613	1.3663	1.3713
54	sin	0.8090	0.8100	0.8111	0.8121	0.8131	0.8141	0.8151	0.8161	0.8171	0.8181
	cos	0.5878	0.5864	0.5850	0.5835	0.5821	0.5807	0.5793	0.5779	0.5764	0.5750
	tan	1.3764	1.3814	1.3865	1.3916	1.3968	1.4019	1.4071	1.4124	1.4176	1.4229
55	sin	0.8192	0.8202	0.8211	0.8221	0.8231	0.8241	0.8251	0.8261	0.8271	0.8281
	cos	0.5736	0.5721	0.5707	0.5693	0.5678	0.5664	0.5650	0.5635	0.5621	0.5606
	tan	1.4281	1.4335	1.4388	1.4442	1.4496	1.4550	1.4605	1.4659	1.4715	1.4770
56	sin	0.8290	0.8300	0.8310	0.8320	0.8329	0.8339	0.8348	0.8358	0.8368	0.8377
	cos	0.5592	0.5577	0.5563	0.5548	0.5534	0.5519	0.5505	0.5490	0.5476	0.5461
	tan	1.4826	1.4882	1.4938	1.4994	1.5051	1.5108	1.5166	1.5224	1.5282	1.5340
57	sin	0.8387	0.8396	0.8406	0.8415	0.8425	0.8434	0.8443	0.8453	0.8462	0.8471
	cos	0.5446	0.5432	0.5417	0.5402	0.5388	0.5373	0.5358	0.5344	0.5329	0.5314
	tan	1.5399	1.5458	1.5517	1.5577	1.5637	1.5697	1.5757	1.5818	1.5880	1.5941
58	sin	0.8480	0.8490	0.8499	0.8508	0.8517	0.8526	0.8536	0.8545	0.8554	0.8563
	cos	0.5299	0.5284	0.5270	0.5255	0.5240	0.5225	0.5210	0.5195	0.5180	0.5165
	tan	1.6003	1.6066	1.6128	1.6191	1.6255	1.6319	1.6383	1.6447	1.6512	1.6577
59	sin	0.8572	0.8581	0.8590	0.8599	0.8607	0.8616	0.8625	0.8634	0.8643	0.8652
	cos	0.5150	0.5135	0.5120	0.5105	0.5090	0.5075	0.5060	0.5045	0.5030	0.5015
	tan	1.6643	1.6709	1.6775	1.6842	1.6909	1.6977	1.7045	1.7113	1.7182	1.7251
Degs.	Function	0'	6'	12'	18'	24'	30'	36'	42'	48'	54'

Natural Sines, Cosines, and Tangents—(Continued)

60°-74.9°

Degs.	Function	0.0°	0.1°	0.2°	0.3°	0.4°	0.5°	0.6°	0.7°	0.8°	0.9°
60	sin	0.8660	0.8669	0.8678	0.8686	0.8695	0.8704	0.8712	0.8721	0.8729	0.8738
	cos	0.5000	0.4985	0.4970	0.4955	0.4939	0.4924	0.4909	0.4894	0.4879	0.4863
	tan	1.7321	1.7391	1.7461	1.7532	1.7603	1.7675	1.7747	1.7820	1.7893	1.7966
61	sin	0.8746	0.8755	0.8763	0.8771	0.8780	0.8788	0.8796	0.8805	0.8813	0.8821
	cos	0.4848	0.4833	0.4818	0.4802	0.4787	0.4772	0.4756	0.4741	0.4726	0.4710
	tan	1.8040	1.8115	1.8190	1.8265	1.8341	1.8418	1.8495	1.8572	1.8650	1.8728
62	sin	0.8829	0.8838	0.8846	0.8854	0.8862	0.8870	0.8878	0.8886	0.8894	0.8902
	cos	0.4695	0.4679	0.4664	0.4648	0.4633	0.4617	0.4602	0.4586	0.4571	0.4555
	tan	1.8807	1.8887	1.8967	1.9047	1.9128	1.9210	1.9292	1.9375	1.9458	1.9542
63	sin	0.8910	0.8918	0.8926	0.8934	0.8942	0.8949	0.8957	0.8965	0.8973	0.8980
	cos	0.4540	0.4524	0.4509	0.4493	0.4478	0.4462	0.4446	0.4431	0.4415	0.4399
	tan	1.9626	1.9711	1.9797	1.9883	1.9970	2.0057	2.0145	2.0233	2.0323	2.0413
64	sin	0.8988	0.8996	0.9003	0.9011	0.9018	0.9026	0.9033	0.9041	0.9048	0.9056
	cos	0.4384	0.4368	0.4352	0.4337	0.4321	0.4305	0.4289	0.4274	0.4258	0.4242
	tan	2.0503	2.0594	2.0686	2.0778	2.0872	2.0965	2.1060	2.1155	2.1251	2.1348
65	sin	0.9063	0.9070	0.9078	0.9085	0.9092	0.9100	0.9107	0.9114	0.9121	0.9128
	cos	0.4226	0.4210	0.4195	0.4179	0.4163	0.4147	0.4131	0.4115	0.4099	0.4083
	tan	2.1445	2.1543	2.1642	2.1742	2.1842	2.1943	2.2045	2.2148	2.2251	2.2355
66	sin	0.9135	0.9143	0.9150	0.9157	0.9164	0.9171	0.9178	0.9184	0.9191	0.9198
	cos	0.4067	0.4051	0.4035	0.4019	0.4003	0.3987	0.3971	0.3955	0.3939	0.3923
	tan	2.2460	2.2566	2.2673	2.2781	2.2889	2.2998	2.3109	2.3220	2.3332	2.3445
67	sin	0.9205	0.9212	0.9219	0.9225	0.9232	0.9239	0.9245	0.9252	0.9259	0.9265
	cos	0.3907	0.3891	0.3875	0.3859	0.3843	0.3827	0.3811	0.3795	0.3778	0.3762
	tan	2.3559	2.3673	2.3789	2.3906	2.4023	2.4142	2.4262	2.4383	2.4504	2.4627
68	sin	0.9272	0.9278	0.9285	0.9291	0.9298	0.9304	0.9311	0.9317	0.9323	0.9330
	cos	0.3746	0.3730	0.3714	0.3697	0.3681	0.3665	0.3649	0.3633	0.3616	0.3600
	tan	2.4751	2.4876	2.5002	2.5129	2.5257	2.5386	2.5517	2.5649	2.5782	2.5916
69	sin	0.9336	0.9342	0.9348	0.9354	0.9361	0.9367	0.9373	0.9379	0.9385	0.9391
	cos	0.3584	0.3567	0.3551	0.3535	0.3518	0.3502	0.3486	0.3469	0.3453	0.3437
	tan	2.6051	2.6187	2.6325	2.6464	2.6605	2.6746	2.6889	2.7034	2.7179	2.7326
70	sin	0.9397	0.9403	0.9409	0.9415	0.9421	0.9426	0.9432	0.9438	0.9444	0.9449
	cos	0.3420	0.3404	0.3387	0.3371	0.3355	0.3338	0.3322	0.3305	0.3289	0.3272
	tan	2.7475	2.7625	2.7776	2.7929	2.8083	2.8239	2.8397	2.8556	2.8716	2.8878
71	sin	0.9455	0.9461	0.9466	0.9472	0.9478	0.9483	0.9489	0.9494	0.9500	0.9505
	cos	0.3256	0.3239	0.3223	0.3206	0.3190	0.3173	0.3156	0.3140	0.3123	0.3107
	tan	2.9042	2.9208	2.9375	2.9544	2.9714	2.9887	3.0061	3.0237	3.0415	3.0595
72	sin	0.9511	0.9516	0.9521	0.9527	0.9532	0.9537	0.9542	0.9548	0.9553	0.9558
	cos	0.3090	0.3074	0.3057	0.3040	0.3024	0.3007	0.2990	0.2974	0.2957	0.2940
	tan	3.0777	3.0961	3.1146	3.1334	3.1524	3.1716	3.1910	3.2106	3.2305	3.2506
73	sin	0.9563	0.9568	0.9573	0.9578	0.9583	0.9588	0.9593	0.9598	0.9603	0.9608
	cos	0.2924	0.2907	0.2890	0.2874	0.2857	0.2840	0.2823	0.2807	0.2790	0.2773
	tan	3.2709	3.2914	3.3122	3.3332	3.3544	3.3759	3.3977	3.4197	3.4420	3.4646
74	sin	0.9613	0.9617	0.9622	0.9627	0.9632	0.9636	0.9641	0.9646	0.9650	0.9655
	cos	0.2756	0.2740	0.2723	0.2706	0.2689	0.2672	0.2656	0.2639	0.2622	0.2605
	tan	3.4874	3.5105	3.5339	3.5576	3.5816	3.6059	3.6305	3.6554	3.6806	3.7062
Degs.	Function	0'	6'	12'	18'	24'	30'	36'	42'	48'	54'

Natural Sines, Cosines, and Tangents—(Continued)

75°-89.9°

Degs.	Function	0.0°	0.1°	0.2°	0.3°	0.4°	0.5°	0.6°	0.7°	0.8°	0.9°
75	sin	0.9659	0.9664	0.9668	0.9673	0.9677	0.9681	0.9686	0.9690	0.9694	0.9699
	cos	0.2588	0.2571	0.2554	0.2538	0.2521	0.2504	0.2487	0.2470	0.2453	0.2436
	tan	3.7321	3.7583	3.7848	3.8118	3.8391	3.8667	3.8947	3.9232	3.9520	3.9812
76	sin	0.9703	0.9707	0.9711	0.9715	0.9720	0.9724	0.9728	0.9732	0.9736	0.9740
	cos	0.2419	0.2402	0.2385	0.2368	0.2351	0.2334	0.2317	0.2300	0.2284	0.2267
	tan	4.0108	4.0408	4.0713	4.1022	4.1335	4.1653	4.1976	4.2303	4.2635	4.2972
77	sin	0.9744	0.9748	0.9751	0.9755	0.9759	0.9763	0.9767	0.9770	0.9774	0.9778
	cos	0.2250	0.2232	0.2215	0.2198	0.2181	0.2164	0.2147	0.2130	0.2113	0.2096
	tan	4.3315	4.3662	4.4015	4.4374	4.4737	4.5107	4.5483	4.5864	4.6252	4.6646
78	sin	0.9781	0.9785	0.9789	0.9792	0.9796	0.9799	0.9803	0.9806	0.9810	0.9813
	cos	0.2079	0.2062	0.2045	0.2028	0.2011	0.1994	0.1977	0.1959	0.1942	0.1925
	tan	4.7046	4.7453	4.7867	4.8288	4.8716	4.9152	4.9594	5.0045	5.0504	5.0970
79	sin	0.9816	0.9820	0.9823	0.9826	0.9829	0.9833	0.9836	0.9839	0.9842	0.9845
	cos	0.1908	0.1891	0.1874	0.1857	0.1840	0.1822	0.1805	0.1788	0.1771	0.1754
	tan	5.1446	5.1929	5.2422	5.2924	5.3435	5.3955	5.4486	5.5026	5.5578	5.6140
80	sin	0.9848	0.9851	0.9854	0.9857	0.9860	0.9863	0.9866	0.9869	0.9871	0.9874
	cos	0.1736	0.1719	0.1702	0.1685	0.1668	0.1650	0.1633	0.1616	0.1599	0.1582
	tan	5.6713	5.7297	5.7894	5.8502	5.9124	5.9758	6.0405	6.1066	6.1742	6.2432
81	sin	0.9877	0.9880	0.9882	0.9885	0.9888	0.9890	0.9893	0.9895	0.9898	0.9900
	cos	0.1564	0.1547	0.1530	0.1513	0.1495	0.1478	0.1461	0.1444	0.1426	0.1409
	tan	6.3138	6.3859	6.4596	6.5350	6.6122	6.6912	6.7720	6.8548	6.9395	7.0264
82	sin	0.9903	0.9905	0.9907	0.9910	0.9912	0.9914	0.9917	0.9919	0.9921	0.9923
	cos	0.1392	0.1374	0.1357	0.1340	0.1323	0.1305	0.1288	0.1271	0.1253	0.1236
	tan	7.1154	7.2066	7.3002	7.3962	7.4947	7.5958	7.6996	7.8062	7.9158	8.0285
83	sin	0.9925	0.9928	0.9930	0.9932	0.9934	0.9936	0.9938	0.9940	0.9942	0.9943
	cos	0.1219	0.1201	0.1184	0.1167	0.1149	0.1132	0.1115	0.1097	0.1080	0.1063
	tan	8.1443	8.2636	8.3863	8.5126	8.6427	8.7769	8.9152	9.0579	9.2052	9.3572
84	sin	0.9945	0.9947	0.9949	0.9951	0.9952	0.9954	0.9956	0.9957	0.9959	0.9960
	cos	0.1045	0.1028	0.1011	0.0993	0.0976	0.0958	0.0941	0.0924	0.0906	0.0889
	tan	9.5144	9.6768	9.8448	10.02	10.20	10.39	10.58	10.78	10.99	11.20
85	sin	0.9962	0.9963	0.9965	0.9966	0.9968	0.9969	0.9971	0.9972	0.9973	0.9974
	cos	0.0872	0.0854	0.0837	0.0819	0.0802	0.0785	0.0767	0.0750	0.0732	0.0715
	tan	11.43	11.66	11.91	12.16	12.43	12.71	13.00	13.30	13.62	13.95
86	sin	0.9976	0.9977	0.9978	0.9979	0.9980	0.9981	0.9982	0.9983	0.9984	0.9985
	cos	0.0698	0.0680	0.0663	0.0645	0.0628	0.0610	0.0593	0.0576	0.0558	0.0541
	tan	14.30	14.67	15.06	15.46	15.89	16.35	16.83	17.34	17.89	18.46
87	sin	0.9986	0.9987	0.9988	0.9989	0.9990	0.9990	0.9991	0.9992	0.9993	0.9993
	cos	0.0523	0.0506	0.0488	0.0471	0.0454	0.0436	0.0419	0.0401	0.0384	0.0366
	tan	19.08	19.74	20.45	21.20	22.02	22.90	23.86	24.90	26.03	27.27
88	sin	0.9994	0.9995	0.9995	0.9996	0.9996	0.9997	0.9997	0.9997	0.9998	0.9998
	cos	0.0349	0.0332	0.0314	0.0297	0.0279	0.0262	0.0244	0.0227	0.0209	0.0192
	tan	28.64	30.14	31.82	33.69	35.80	38.19	40.92	44.07	47.74	52.08
89	sin	0.9998	0.9999	0.9999	0.9999	0.9999	1.000	1.000	1.000	1.000	1.000
	cos	0.0175	0.0157	0.0140	0.0122	0.0105	0.0087	0.0070	0.0052	0.0035	0.0017
	tan	57.29	63.66	71.62	81.85	95.49	114.6	143.2	191.0	286.5	573.0
Degs.	Function	0'	6'	12'	18'	24'	30'	36'	42'	48'	54'

INDEX

- Abbreviations 38
Admittance 11
Algebraic Formulas 5
Algebraic Symbols 4
Average Current 15
Average Volts 15
Ballast Resistors 34
Capacitance 6, 14, 24-28, 29
Capacitors 6, 29
Coefficient of Coupling 7
Coils 22, 24-25
Concentric Transmission Lines 14
Conductance 11
Constants 4, 6, 15
Conversion Chart 21
Coulombs 6
Coupled Inductance 6
Coupling Coefficient 7
Decay of E & I in LCR Circuits . . . 12-13
Decibels 5
Diagram Symbols 39
Dielectric Constants 6
Exponents and Radicals 5
Fractional Inches 4
Frequency 7, 14, 25-28
Growth of E & I in LCR Circuits . . 12-13
Impedance 8-10, 14
Inches to Millimeters 4
Inductance 6, 7, 22, 24-28
Interchangeable Tubes 35-37
Log Tables 40-41
Mathematical Constants 4
Mathematical Symbols 4
Meter Formulas 16-17
Metric Relationships 21
Millimeters to Inches 4
Multipliers 16-17
Mutual Inductance 7
Ohm's Law 18-19
Open-Air Transmission Lines 14
Peak Current 15
Peak Volts 15
Phase Angle 18
Pilot Lamp Data 33
Plug-In Ballast Resistors 34
Power Factor 18
"Q" Factor 8
Quadratic Equations 5
R-F Coils 22, 24-25
RMA Color Codes 29-32
R.M.S. Current 15
R.M.S. Volts 15
Radicals and Exponents 5
Radio Color Codes 29-32
Reactance 7, 25-28
Resistance 6, 17, 18-19, 29, 34
Resistors 29
Resonance 7, 25-28
Schematic Symbols 39
Self-Inductance 6
Shunts 16-17
Solution of a Quadratic 5
Steady State I and E 12-13
Susceptance 11
Symbols 38-39
Transients 12-13
Transmission Lines 14
Trigonometric Formulas 20
Trigonometric Functions 20
Trigonometric Tables 42-47
Vacuum Tube Constants 15
Vacuum Tube Formulas 15
Vacuum Tube Symbols 15
Vertical Antenna, Capacitance 14
Wavelength 7, 14, 25-28
Wire Tables 22-23

**Consult Your ALLIED Catalog
for Everything in Radio and Electronics**



