

RADIOTRON

Designer's Handbook

THIRD EDITION



THE
RADIOTRON
Designer's Handbook

THIRD EDITION

Edited by

F. LANGFORD SMITH

B.Sc., B.E. (1st class honours), Member I.R.E. (U.S.A.),

M.I.R.E. (Australia), A.M.I.E.E., A.M.I.E. (Aust.).

COPYRIGHT: ALL RIGHTS RESERVED

1st Impression 1940, 10,000

2nd Impression 1940, 2,000

3rd Impression 1941, 3,000

4th Impression 1941, 4,000

Published by

THE WIRELESS PRESS

for

**AMALGAMATED WIRELESS VALVE COMPANY
PTY. LTD.,**

47 YORK STREET, SYDNEY, AUSTRALIA

Distributed in U. S. A. by

R C A MANUFACTURING COMPANY, INC.

Registered at the General Post Office, Sydney, for transmission through the post as a book. Wholly set up and printed in Australia by Radio Printing Press Pty. Ltd., 146 Foveaux Street, Sydney.

FOREWORD.

This Handbook has been prepared expressly for the radio set designer, but will be found invaluable to all radio engineers, experimenters and service mechanics. The information is arranged so that all those interested may derive some knowledge with the minimum of effort in searching.

Wholly reproduced in U. S. A. by lithographic process
under direction of
R C A MANUFACTURING COMPANY, INC.
Harrison, New Jersey
Sole Agents in U. S. A.

November, 1941

CONTENTS.

PART I	AUDIO FREQUENCIES	Page
Chapter 1	Audio Frequency Voltage Amplifiers	1
Chapter 2	Audio Frequency Power Amplifiers	13
Chapter 3	The Relationship between the Power Output Stage and the Loudspeaker	20
Chapter 4	Biasing, By-passing and Decoupling	24
Chapter 5	Fidelity and Distortion	31
Chapter 6	Negative Feedback	34
Chapter 7	Miller Effect	46
Chapter 8	Audio Amplifier Design	49
Chapter 9	Tone Compensation and Tone Control	58
Chapter 10	Volume Expansion and Compression	74
Chapter 11	Recording, Pickups, Microphones and Microphone Amplifiers	75
Chapter 12	Audio Frequency Mixing Systems	81
Chapter 13	Decibels, Nepers, Volume Units and Phons	84
PART II RADIO FREQUENCIES		
Chapter 14	Radio Frequency Amplifiers	90
Chapter 15	Frequency Conversion	99
Chapter 16	Part 1 Tuned Circuits	115
	Part 2 Calculation of Inductance	140
	Part 3 Design of Low-Loss Inductances	152
Chapter 17	Intermediate Frequency Amplifiers	157
Chapter 18	Detection	161
Chapter 19	Automatic Volume Control	168
Chapter 20	Automatic Frequency Control and the Correction of Frequency Drift	180
Chapter 21	Reflex Amplifiers	183
PART III RECTIFICATION, FILTERING AND HUM		
Chapter 22	Rectification	185
Chapter 23	Filtering	191
Chapter 24	Hum	199
PART IV RECEIVER COMPONENTS		
Chapter 25	Voltage Dividers and Dropping Resistors	203
Chapter 26	Transformers and Iron-Core Inductances	205
Chapter 27	Voltage and Current Regulators	221
Chapter 28	Tuning Indicators	224
PART V TESTS AND MEASUREMENTS		
Chapter 29	Receiver and Amplifier Tests and Measurements	227
Chapter 30	Valve Testing	240
Chapter 31	Valve Voltmeters	250
Chapter 32	Measuring Instruments	263
PART VI VALVE CHARACTERISTICS		
Chapter 33	Valve Constants	264
Chapter 34	Graphical Representation of Valve Characteristics	268
PART VII GENERAL THEORY		
Chapter 35	Resistance, Capacitance, Inductance	295
Chapter 36	Vectors	303
Chapter 37	Complex Algebra	304
Chapter 38	Simple Trigonometry	306
Chapter 39	Units	307
PART VIII SUNDRY DATA		
Chapter 40	Tables, Charts and Sundry Data	310
INDEX		345

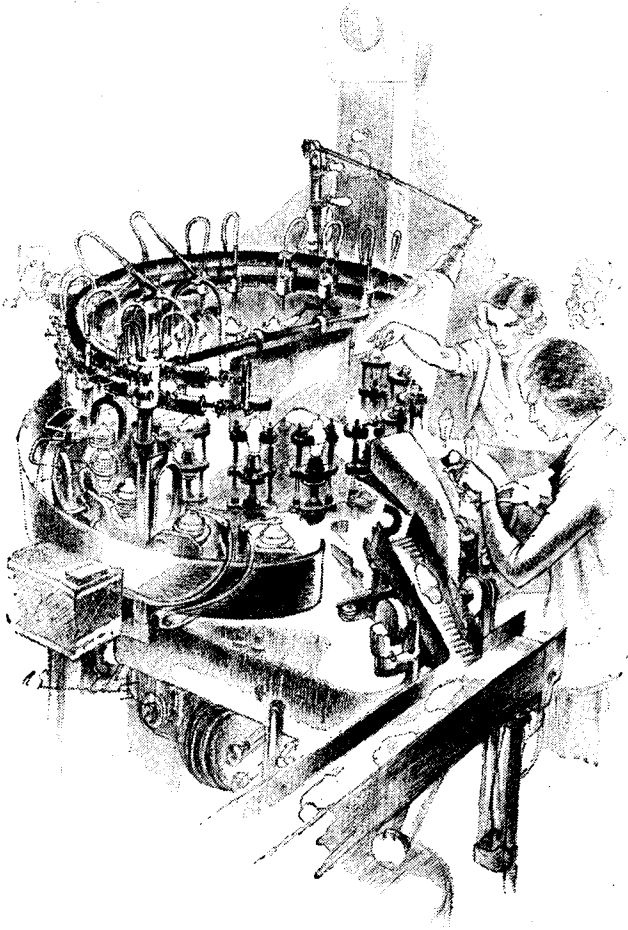

One of the many intricate machines used in the Australian Radiotron Valve Factory for the manufacture of broadcast receiving type valves, is the "Sealex" Machine, illustrated above. Only two manual operations are performed; the machine automatically seals the bulb on the stem, evacuates it, raises the electrodes to incandescence, getters the valves, and finally seals and lifts them on to a moving belt.

CHAPTER 1

Audio Frequency Voltage Amplifiers

Voltage Amplifiers — Transformer Coupling — Resistance Coupling, (a) Triode Valves, (b) Pentode Valves — Choke-Capacitance Coupling — Parallel Feed Transformer Coupling — Auto-Transformer Coupling — Wide-Band Amplifiers — Low Impedance Resistance Coupling — "D-C" Amplifiers — Phase Splitting.

Voltage Amplifiers

A Voltage Amplifier is one in which the voltage gain is the criterion of performance. To be perfectly correct it is not possible to have voltage without power since infinite impedance does not exist in amplifiers, but for all ordinary purposes a "voltage amplifier" is one in which a "voltage" output is required. Voltage Amplifiers generally work into high impedances of the order of 1 megohm, but in certain cases lower load impedances are used and there is no sharp demarcation between "voltage" and "power" amplifiers. In cases where transformer coupling is used between stages,

the secondary of the transformer may be loaded only by the grid input impedance of the following stage and the numerical value of the impedance may not be known. In such cases the transformer is usually designed to operate into an infinite impedance, and the effect of normal input impedances on the transformer is very slight compared with the primary loading.

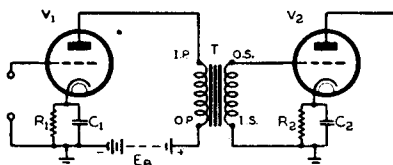

Figure 1

Voltage Amplifiers may be divided into

- (a) Transformer coupled,
- (b) Resistance-Capacitance coupled, and
- (c) Miscellaneous amplifiers.

Transformer Coupling

Transformer coupling is used principally in the plate circuits of general purpose triode valves (Fig. 1). The total gain per stage is approximately equal to the amplification factor of the valve multiplied by the secondary-

primary turns-ratio of the transformer. A valve having a plate resistance of from 7,500 to 12,000 ohms with a plate current of about 5 mA. is particularly suitable. The transformer primary inductance should be increased as the plate resistance of the valve is increased, in order to maintain equivalent bass response. A table of transformer inductances for specified conditions is given in Chapter 26. The inductance should be measured under operating conditions with the normal plate current flowing in the primary. When the plate current exceeds 5 or 6 mA. it may be more economical to adopt Parallel Feed (see later section in this Chapter). As an alternative in certain circumstances it may be possible to over-bias the valve so as to reduce the plate current. For audio transformer design reference should be made to Chapter 26. The maximum peak output voltage may be calculated graphically (see Chapter 34), but is somewhere near 65% of the supply voltage for a transformer ratio of 1 : 1. This is higher than is possible with any form of resistance coupling with the same supply voltage. With resistance coupling, however, the supply voltage may generally be increased to twice that permissible for transformer operation, thereby giving a proportional increase in output voltage. With a step-up transformer the voltage on the following grid will be nearly equal to the step-up turns ratio of the transformer multiplied by the A.C. voltage on the primary.

Over the audible frequency range the fidelity of a transformer-coupled amplifier may be made as good as is desired. The cost of a transformer having linear response over a wide frequency range is considerable, and since equally good response may generally be obtained by a very simple resistance-coupled amplifier the transformer is only used under circumstances where its particular advantages are of value. Some of these advantages are:—

- (1) High output voltage for limited supply voltage,
- (2) Stepping up from, or down to, low-impedance lines,
- (3) When used with split or centre-tapped secondary for the operation of a push-pull stage, and
- (4) When a low D.C. resistance is essential in the grid circuit of the following stage.

In some circumstances "loaded" transformers are employed. Either the primary or secondary is shunted by a resistance which tends to flatten out the response characteristic. Even apart from the additional shunt loading there is a loading on the primary equal to the plate resistance of the valve. Under no conditions should the total load resistance referred to the primary* be less than the recommended load of the valve as a Class A power amplifier; nor should it be less than twice the valve plate resistance.

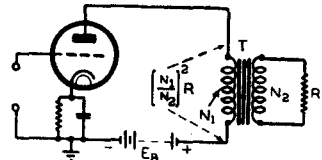

Figure 2

When the secondary of an ideal transformer is loaded by a resistance R (Fig. 2) there is reflected into the primary an effective resistance equal to $(N_1/N_2)^2 R$, where N_1 and N_2 are the primary and secondary turns respectively. The ratio N_1/N_2 is known as the turns ratio. In specifying the turns ratio care should be taken to state whether it is secondary to primary or vice versa.

When two or more stages with transformer coupling are used, it is usually necessary to employ decoupling (see Chapter 4).

*See Chapter 26 on transformer operation.

Resistance Coupling

(a) Triode Valves:

A typical resistance-coupled triode stage is shown in Fig. 3 in which R_{L1} is the plate load resistor of V_1 , C_2 the coupling condenser, and R_{g2} the grid resistor of the following valve. Cathode-bias is to be preferred and is provided by R_{K1} with bypass C_{K1} .

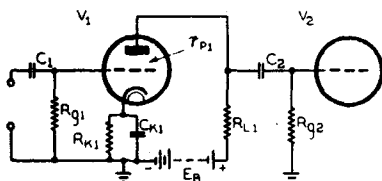

Figure 3

A convenient approximate formula for the choice of a cathode bias resistor (R_K) for a resistance coupled triode is

$$R_K = \frac{R_L}{\mu}$$

This should only be used when insufficient data is available for a more accurate calculation since the optimum value depends on other

factors, including the shunting effect of the following grid resistor and the input voltage.

If the peak grid voltage required by V_2 is only a very small fraction of E_B , then the design is not at all critical, and values of R_{K1} , R_{L1} , and R_{g2} , may be varied within wide limits. If, however, the peak grid voltage is required to be as high as possible, then care should be taken on the following points:—

- (1) R_{g2} should be as high as is permitted for V_2 .
- (2) R_{L1} should be several times as high as the plate resistance of V_1 , but preferably should not exceed one quarter of R_{g2} , and
- (3) R_{K1} should be such as to give the optimum bias for selected values of R_{L1} , R_{g2} , and E_B .

Due to the wide range of such a choice there are innumerable combinations.

When it is not necessary to obtain the maximum output voltage it is possible to reduce the harmonic distortion by operating the valve with a lower value of grid bias. The limit is set by the possibility of running into grid current, and the optimum bias is therefore given approximately by

$$E_c = (E_o/M) + 1 \text{ volts}$$

where E_c = bias voltage applied to V_1 ,

E_o = peak grid voltage required by V_2 , and

M = stage gain from grid of V_1 to grid of V_2 .

In this calculation the minimum instantaneous grid voltage on V_1 is taken as 1 volt which is a reasonable value for most general purpose valves. With choke or transformer coupling this method of calculating the bias voltage should not be used unless care is taken to check the plate current and dissipation. For additional information it is desirable to make graphical calculations (see Chapter 34).

The following points are of general interest:—

1. The upper frequency response is not appreciably affected by the value of R_{L1} , since the plate resistance of the valve is normally much lower than R_{L1} , but it is noticeably affected by the "Miller Effect" (see Chapter 7), whereby there is reflected into each grid circuit an effective shunt impedance. This shunt is largely capacitive and there-

fore causes loss of the higher frequencies. The loss as affecting V_1 may be decreased by

- (a) reducing the grid-plate capacitance of V_2 ,
- (b) reducing the stage gain of V_2 ,
- (c) reducing the effective impedance from the grid of V_2 to earth, or
- (d) reducing the plate resistance of V_1 .

In many cases V_2 will not be similar to V_1 , and the "Miller Effects" may be different. It should be noted that the shunt impedance in the grid circuit of V_2 , due to the "Miller Effect" in V_2 , forms a load on V_1 in parallel with RL_1 , R_{g_2} and r_{p_1} . With triodes having comparatively low values of r_p (say less than 20,000 ohms), the "Miller Effect" is small due to the low effective impedance from grid to earth. With high- μ triodes the "Miller Effect" is much more pronounced, due partly to the high r_p , and partly to the higher stage gain. With an input circuit as for V_1 (Fig. 3) the shunt must be considered not only as across R_{g_1} but across the impedance of the input source parallel with R_{g_1} .

2. The low frequency limit for linear response is affected by C_2 and Ck_1 in relationship to R_{g_2} and Rk_1 , respectively. The loss of voltage due to C_2 may be calculated by the use of a vector diagram or by the following formula on the assumption* that r_{p_1} is small compared with R_{g_2} .

$$E_g/E_i = R_{g_2}/Z$$

Where E_g = voltage on grid,

E_i = voltage input to C_2 ,

Z = series impedance of C_2 and R_{g_2}

$$= \sqrt{R_{g_2}^2 + X_c^2}, \text{ where } X_c = 1/2\pi fC_2$$

If $R_g = 1$ megohm and $f = 50$ c/s, the following results will be obtained:

db. loss	E_g/E_i	X_c/R_g	X_c	C_2
1	0.891	0.51	0.51 megohm	0.00624 μF
2	0.794	0.76	0.76 "	0.00419 "
3	0.708	1.00	1.0 "	0.00318 "

In certain cases a low value of C_2 is adopted intentionally to reduce the response to hum. In high fidelity amplifiers a fairly large value of C_2 is generally adopted, this not only improving the bass frequency response but also reducing phase shift and possibly also improving the response to transients. Typical values of C_2 for high fidelity† amplifiers are:

Grid Resistor.	Coupling Condenser.
10,000 ohms	2.5 minimum μF
50,000 "	0.5 " "
100,000 "	0.25 " "
250,000 "	0.1 " "
500,000 "	0.05 " "
1,000,000 "	0.025 " "

With high- μ triodes the loss under stated conditions is slightly less, since as the impedance of C_2 increases so the effects of the shunt A.C. load across RL_1 become less severe. However, since the gain of a triode valve is only slightly affected by a change of load impedance (the load being considerably greater than the plate resistance) the effect is so slight that it may be neglected in practice.

*This assumption is reasonably accurate for general purpose triodes.

†On the basis of approximately 1 db. loss per stage at 12.5 c/s.

The minimum value of C_K for bypassing the cathode resistor R_K is given in Chapter 4. When A.C. heating is used it is desirable to use a high capacitance ($25 \mu\text{F.}$) for C_K in order to bypass the hum voltage.

GRID LEAK BIAS AND HIGH-MU TRIODES: The optimum bias of a high-mu triode is fairly critical, and varies from valve to valve due to variations in contact potential and characteristics. In order to avoid any possibility of positive grid current such valves are generally biased more negatively than is desirable from other aspects. A method which has certain good features is to use grid leak bias with a grid resistor of about 10 megohms returned to the cathode. Positive grid current flows at all times, but the effective input resistance is about half the resistance of the grid leak and may therefore be quite high. Measurements of the performance of a stage employing grid-leak bias show that the distortion is reasonably low.

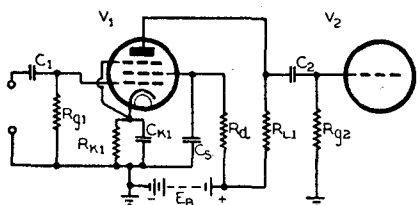

Figure 4

low grid-plate capacitance of pentodes, the "Miller Effect" is generally negligible and no appreciable loss of high frequencies occurs even with a very high grid-earth impedance.

Due to the high plate resistance of pentodes, the following factors enter into the operation of a voltage amplifier circuit such as that shown in Fig. 4,

- (1) the value of R_{L1} affects the upper frequency limit,
- (2) a slightly smaller value of C_2 may be used for the same low frequency response,
- (3) the plate circuit filtering requires to be better than for triodes, and
- (4) the "Miller Effect" grid impedance of the subsequent stage has a more pronounced effect.

For general use it is recommended that R_L be 0.25 megohm for all pentode valves, and operating data have been published for this condition. The approximate limits of frequency response with variation of R_L are:

R_L	Upper Frequency Limit *
0.1 megohm	25,000 c/s
0.25 ..	10,000 ..
0.5 ..	5,000 ..

The choice of R_{L1} is also affected by R_{g2} , and it is preferable for R_{g2} to be not less than twice R_{L1} when high peak grid voltages are required. If a small decrease in stage gain be required, it is preferable to obtain this by decreasing R_{L1} rather than by decreasing R_{g2} , unless only very limited output voltage is required.

*For a total shunt capacitance of $75 \mu\text{mF.}$ in the plate circuit (corresponding to type 2A3 in following stage together with stray capacitances) the loss at these frequencies is approximately 2 db. With a valve having less input capacitance the loss will be correspondingly less.

(b) Pentode Valves:

The design and operating characteristics of resistance-coupled pentodes are very different from those of triodes. Pentodes give higher gain per stage, higher output voltage for the same supply voltage, and less harmonic distortion for the same output voltage, than triodes. Due to the very

The plate circuit filtering may be improved by the addition of a resistance-capacitance filter or by neutralisation (see Chapters 23 and 24).

The screen should for preference be supplied through a dropping resistor from B+, and with this arrangement quite a small (0.5 μ F.) bypass condenser is sufficient to give good filtering and decoupling. The use of a screen dropping resistance in conjunction with cathode bias reduces variations from valve to valve and enables standardised data to be prepared. (See Chapter 4 for design formulae.) The value of C_2 may be taken as being approximately the same as for triode valves. The value of CR_1 may be determined as above in Chapter 4, although a large capacitance (25 μ F.) is usually employed to assist in bypassing hum voltages.

The choice of operating conditions for a resistance coupled pentode is very wide (see Chapter 34), but it is sufficient to adjust the plate current to the optimum value. The optimum plate current for high level operation is approximately $0.56E_B/R_L$ so that if $E_B = 250$ volts and $R_L = 0.25$ megohm, I_p should be 0.56 mA. This may be arranged by adjusting either R_k or R_a , in other words by adjusting the grid bias or screen voltage. In this adjustment the grid should be maintained sufficiently negative to avoid grid current and in the published data R_k has been standardised at 2,000 ohms for all types. It thus only remains to decide upon a value of R_a to give 0.56 mA., and a suitable value may be determined by trial or by reference to the published data.

As a conservative guide for calculating the maximum output voltage under typical conditions the following approximation may be used:—

$$E_{\text{peak}} = 0.21 E_B \text{ for } R_{g2} = 0.5 \text{ megohm} \\ \text{or } 0.25 E_B \text{ for } R_{g2} = 1.0 \text{ megohm}$$

where E_{peak} = peak audio output voltage

E_B = plate supply voltage

R_{L1} = 0.25 megohm.

and the distortion is 3% total.

Miscellaneous Types of Amplifiers

Choke-Capacitance-Coupling

The resistor R_{L1} in Fig. 3 may be replaced by an inductance. Under these conditions the operation is similar to that of a transformer-coupled amplifier (Fig. 1) with a transformer ratio 1 : 1, except that C_2 must be designed as in a resistance-coupled amplifier so as to avoid low frequency attenuation. An amplifier of this description produces a higher output voltage than one resistance coupled. The inductance should be the same as that of a suitable transformer primary.

Parallel-Feed Transformer-Coupling

It is preferable to design the intervalve transformer so that the plate current may be passed through the primary of the transformer without approaching saturation, but occasionally circumstances arise where this is not convenient. A very simple method in such cases is to employ parallel-feed. A typical circuit is shown in Fig. 5 in which the condenser C blocks the Direct Current and prevents it from passing through the primary of the transformer; a load resistance R_L is inserted in a similar manner to a resistance coupled amplifier.

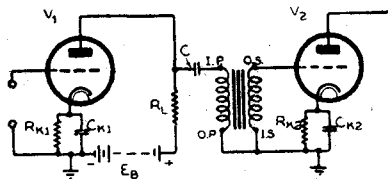

Figure 5

Due to the drop in R_L the average plate voltage will be considerably less than the supply voltage and this may restrict the maximum output voltage. It is preferable to increase the supply voltage until the actual plate voltage reaches the normal maximum for the valve in order to increase the output level before distortion sets in. If the supply voltage is limited it is desirable to make R_L a resistance of 3 or 4 times the plate resistance of the valve. Higher values of R_L result in decreased maximum output voltage and increased distortion at low frequencies due to the elliptical load-line. Lower values of R_L result in lower gain and increased distortion at all frequencies.

The optimum value of C is dependent upon the transformer primary inductance, and the following values are suggested:—

$L = 10$	20	30	50	100	150	Henries
$C = 4.0$	2.0	2.0	1.0	0.5	0.5	$\mu F.$

These values of capacitance are sufficiently high to avoid resonance at an audible frequency. Use is sometimes made of the resonance between C and the inductance of the primary to give a certain degree of bass boosting. By this means a transformer may be enabled to give uniform response down to a lower frequency than would otherwise be the case. It should be noted that the plate resistance of the valve, in parallel with R_L , forms a series resistance in the resonant circuit. The lower the plate resistance, the more pronounced should be the effect.

It is frequently so arranged that the resonant frequency is sufficiently low to produce a peak which is approximately level with the response at middle frequencies, thereby avoiding any obvious bass boosting while extending the frequency range to a maximum.

Auto-Transformer Coupling

An "auto-transformer" is a single tapped inductance which is used in place of a transformer. Fig. 6 shows a Parallel-Fed Auto-Transformer Coupled Amplifier. The Auto-Transformer may be treated as a double-wound transformer (i.e., with separate primary and secondary) having primary turns equal to those between the tap and earth, and secondary turns equal to the total turns on the inductance. A step-up or step-down ratio may thus be arranged. An ordinary double-wound transformer may be connected with primary and secondary in series (with sections aiding) and used as an auto-transformer, but capacitance effects between windings may affect the high-frequency response of certain types of windings.

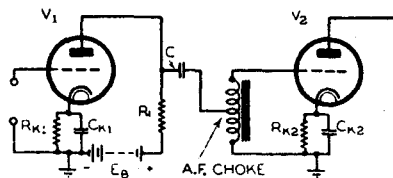

Figure 6

The inductance between the tapping point and earth should be the same as for a satisfactory transformer primary. With the parallel-feed arrangement of Fig. 6 the plate current does not flow through the inductance, but an alternative arrangement is to omit the parallel-feed and to add a grid coupling condenser and grid resistor for V_2 .

Wide-Band Amplifiers

For certain purposes it is necessary to design amplifiers to cover very wide frequency bands. In such cases resistance-coupled pentodes may be used very successfully. In order to operate at very low frequencies the grid coupling condensers and cathode bypass condensers may be increased as desired. In order to operate at very high frequencies,

- (a) the plate load resistors are decreased,
- (b) the "Miller Effect" is reduced by the use of valves having low values of C_{gp} , and in the extreme case by using Acorn types (eg. 954),
- (c) inductances or parallel resonant circuits ("tone compensation") are employed in series with the plate load resistors to lift the highest frequencies,
- (d) the wiring and layout are carefully designed,
- (e) the grid resistors are decreased,
- (f) multiple stages of low stage gain are employed, and
- (g) negative feedback may be used to improve the frequency response and reduce phase distortion.

If Television Pentodes (e.g. 1851, 1852, 1853) are employed the "Miller Effect" and shunt capacitances would be sufficient to give serious attenuation at very high frequencies if the plate load resistors were not reduced to a few thousand ohms. The very high mutual conductances of these valves (5,000 to 9,000 μ mhos) is sufficient to give usable gain even with load resistors of 2,000 to 3,000 ohms.

Low Impedance Resistance Coupling

When a power stage, for example, requires a very low grid circuit resistance it is possible to use resistance coupling provided that a valve of low plate resistance is employed in the earlier stage. The value of R_L should not be less than the recommended load as a power amplifier, and the value of R_g may be about twice R_L or even lower provided that the distortion is permissible or is balanced out by push-pull operation. This same arrangement may also be used with a phase splitter.

"D-C" Amplifiers

There is much misunderstanding regarding so-called "D-C Amplifiers" which should be divided into

- (1) Zero-frequency resistance-loaded amplifiers, and
- (2) "Direct-Coupled" Amplifiers which do not respond to zero frequency.

An example of (1) is given in Fig. 7 in which a resistance loaded pentode (V_1) is used to excite a triode (V_2). The power supply should be a battery or difficulty may be experienced in

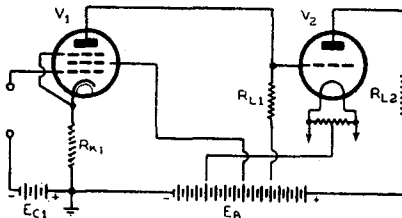

Figure 7

obtaining sufficiently low impedance between tappings. No condensers, not even in the power-supply or filter, are permissible for uniform frequency response. The grid bias for the first stage may be obtained from an un-bypassed cathode resistor R_{k1} , if desired in place of the battery E_{c1} , but there will then be degeneration and loss of gain. This amplifier responds to the slowest changes, and is thus

subject to slow drift, particularly when not used with battery supply. Due to the difficulties which are experienced with this type of amplifier it is not used except for special cases when no other type is permissible.

Amplifiers of the second type have been used for many years, but the low frequency response is limited, and is frequently worse than with resistance-capacitance coupling. The reason for this is that although the coupling from plate to grid is "direct," the coupling from cathode to cathode involves a condenser and/or inductance (e.g. field coil).

The high-frequency cut-off point of "D-C" amplifiers is limited by shunt stray capacitances and "Miller Effect" in a similar manner to resistance-capacitance coupled amplifiers.

PHASE SPLITTING

In any amplifier incorporating push-pull operation, it is necessary to provide some method of phase splitting to derive two input signals 180 degrees out of phase. One of the best known of these methods is that shown in Fig. 8 in which a transformer is used having a centre tapped secondary. Since the secondary of the transformer provides two equal voltages 180 degrees out of phase, the arrangement is entirely satisfactory provided that the transformer is of correct design. This method may be used with almost any type of amplifier and the arrangement illustrated is merely typical. For example, fixed bias operation or operation with triodes in place of pentodes could equally well be adopted.

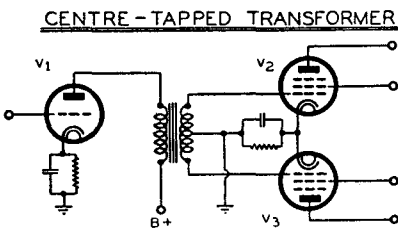

Figure 8

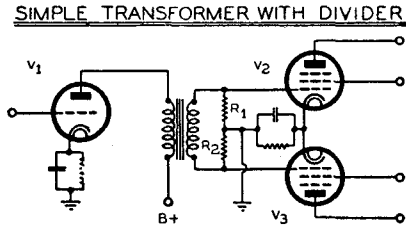

Figure 9

An alternative arrangement which does not require centre-tapping of the transformer secondary is shown in Fig. 9. In this case an ordinary transformer with a single secondary winding is used and a resistance divider is placed across the secondary of the transformer and centre tapped in order that it may be returned to earth. The resistances R_1 and R_2 need careful consideration since they form a load on the valve V_1 . The load reflected into the plate circuit of V_1 is equal to

$$\frac{R_1 + R_2}{N^2}$$

where N is the step up ratio of the transformer. For example, if R_1 and R_2 are each 100,000 ohms, their sum is 200,000 ohms and if the ratio of the transformer is 3 : 1 step up, the load reflected into the plate circuit is 200,000 divided by 9 or 22,000 ohms. This load is lower than a number of general purpose triode valves are capable of handling without noticeable distortion, and it might therefore be necessary to increase the values of R_1 and R_2 until a suitable value is reached. The maximum limit to the values of R_1 and R_2 is set by the grid circuit resistance which may be permitted with valves V_2 and V_3 . It will be seen that this arrangement necessarily introduces more resistance into the grid circuit than does a centre tapped transformer. The centre tapped transformer is therefore less likely to give severe distortion when the valves are slightly overloaded and run into grid current.

An alternative method which is sometimes used is to reduce the transformer to its simplest form, namely that of an audio frequency choke. If a centre tapped choke is used it is possible by means of the circuit shown in Fig. 10 to obtain reasonably satisfactory push-pull operation. This arrangement has the disadvantage over a correctly designed transformer that perfect symmetry between the two sides cannot readily be obtained. As compared with the transformer there will be less gain since the gain in the coupling circuit will be less by the total step-up ratio of the transformer.

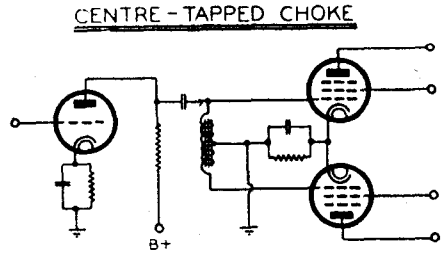

Figure 10

A number of methods are available for phase splitting by the use of valves and resistance coupling. In many cases these are to be preferred to any method employing an iron core transformer since excellent fidelity may be obtained at comparatively low cost. One of the simplest of these arrangements is shown in Fig. 11 and has been very widely used with entire satisfaction. In this circuit valve V_1 is an ordinary amplifying valve which may well be a resistance coupled pentode. V_2 is the phase splitting valve and may be any general purpose triode having an indirectly heated cathode. A sharp cut-off pentode such as the 6J7G functions well when connected as a triode with screen tied to plate. Similar resistances are inserted in both cathode and plate circuits, and it will be seen that these two resistors in series form the load on the valve. Since the input from the preceding stage is applied between the grid of V_2 and earth, there will be a degenerative action resulting in a considerable loss of gain. The

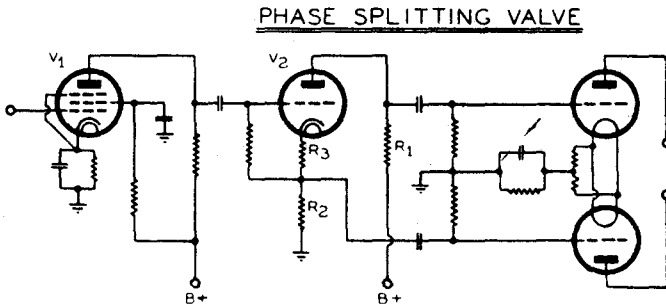

Figure 11

actual gain between the input to V_2 and the output to either side of the push-pull stage is slightly less than unity. In a practical case this is generally found to be about 0.9 each side or a gain of 1.8 times grid to grid. This low gain means that the valve does very little amplification and really takes the place of the transformer or centre tapped choke in other arrangements. Although this may appear extravagant with regard to valves, it is frequently the most economical arrangement. It possesses a number of particular advantages among which are low distortion and excellent frequency fidelity. Owing to the capacitance between heater and

cathode of V_2 there will be a slight out-of-balance between the two push-pull valves at high audio frequencies, but this is slight and occurs only at high frequencies, where no appreciable disadvantage results. It will be noticed that the cathode bias resistor R_3 is not bypassed, this being unnecessary since R_3 is considerably smaller than $(R_1 + R_2)$ and the loss of gain through the omission of the bypass condenser is negligible. If a low- μ valve had been used there might have been an advantage in bypassing R_3 , since R_3 would then be comparable in resistance with R_1 or R_2 . A further advantage in using a valve having a fairly high μ is that the degeneration is thereby increased, with consequent additional reduction of distortion.

The degeneration with this arrangement is known as "Negative Current Feedback" and is treated in detail in Chapter 6. The major effects are the reduction of harmonic distortion, improvement in frequency response, and high input impedance. The input impedance is approximately 10 times the value of the grid resistor; a smaller value of grid condenser may therefore be used.

A by-pass condenser from the cathode to earth should be avoided since it would unbalance the push-pull operation.* An important point in connection with this system of phase splitting is that the phase splitting valve should be operated immediately in front of the push-pull power stage or separated from it by a low gain push-pull stage. If a high gain amplifier is placed between V_2 and the output stage, hum may be troublesome. Part of the hum is due to the considerable difference of potential between the heater and cathode V_2 . This may be reduced by operating the heater of V_2 from a separate transformer winding which is connected to a suitable point in the circuit which is at an average potential approximating to that of the cathode. The maximum voltage output which the phase splitter is capable of delivering is similar to that which would apply to an ordinary resistance coupled triode. It is usually safe with general purpose triodes to assume a grid to grid voltage output of 22% of the plate supply voltage to V_2 . With 250 volts supply this will reach 55 volts output, while with 400 volts supply the output will be 83 volts. This latter condition is just sufficient to drive two push-pull Class A 2A3 valves operating with 250 volts on the plates. If the phase splitter is used to drive more sensitive output valves there will be no difficulty in supplying the necessary excitation to the grids.

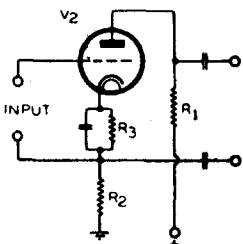

Figure 12

If in the preceding arrangement the input to V_2 is taken between grid and cathode instead of between grid and earth, the degenerative effect will be avoided and the full gain of V_2 will be obtained. A circuit showing this is given in Fig. 12. It will be seen that the input circuit is floating and for this reason cannot generally be used satisfactorily with a pick-up although it may be used under some circumstances in a radio receiver. This circuit is particularly prone to suffer from hum as the gain of V_2 amplifies the hum from its cathode. As in the previous case, this hum may be minimised by adjusting the potential on the heater to approach that of the cathode.

*This method has been used as a tone control, since a bypass condenser from cathode to earth reduces the degeneration for the higher frequencies and therefore provides greater amplification for the higher than for the lower frequencies. The output with this arrangement will be out-of-balance for the higher frequencies.

An arrangement which is not free from criticism, but has given reasonably satisfactory results over a number of years, is shown in Fig. 13. This is an arrangement in which the grid voltage of V_2 is obtained from a tapping on the output of V_1 . There are various methods of obtaining this tapping for the grid, but the one illustrated is fairly typical. The value of R_2 is given by the formula

$$R_2 = \frac{R_1 + R_2}{M}$$

where M is the stage gain of V_1 . It is essential for the adjustment of R_2 to be made under working conditions in order that correct balance may be obtained between the two sides. Apart from the necessity for accurate adjustment, this circuit is extremely satisfactory although the effective gain of V_2 is only unity. This valve is therefore used only as a phase splitter and does not add to effective amplification. In this circuit the output of valve V_1 is required to excite only one grid of the push-pull stage. Valves V_1 and V_2 are often combined in a single bulb by using twin triodes such as the 6N7-G(6A6) or 1J6-G(19). In this circuit, since the cathodes are almost at earth potential, the hum introduced in the stage is very low.

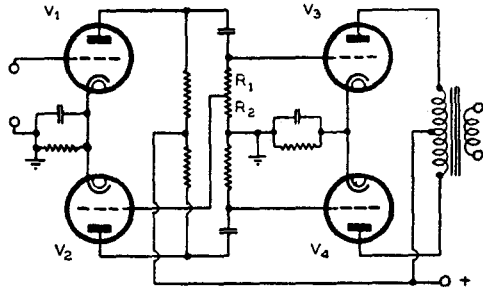

Figure 13

A circuit known as the "Floating Paraphase" is shown in Fig. 14. In order to visualise the operation of this circuit consider firstly the situation with V_2 removed. Resistors R_5 and R_6 in series form the load on valve V_1 , and the voltage at the

point X will be in proportion to the voltage at the grid of V_3 . When V_2 is replaced, the voltage initially at point X will cause an amplified opposing voltage to be applied to resistors R_7 and R_6 . If resistor R_7 is slightly greater than R_6 , it will be found that the point X is nearly at earth potential. If the amplification of V_2 is high, then R_7 may be made equal to R_6 and point X will still be nearly at earth potential.

The point X is therefore floating, and the circuit being a true Paraphase the derivation of the name "Floating Paraphase" is obvious. This circuit has certain advantages over the arrangement of Fig. 11, since V_1 and V_2 each excite only one grid (V_3 and V_4) and since V_1 and V_2 may both be pentodes, thereby again providing a higher voltage output. A further advantage is that provided V_1 and V_2 are pentodes, series negative feedback may be used with pentode or tetrode valves in positions V_3 and V_4 ; this arrangement is, however, not essentially stable, and motor-boating may be experienced. When feedback is used the preferred arrangement is that of Fig. 11 of Chapter 6.

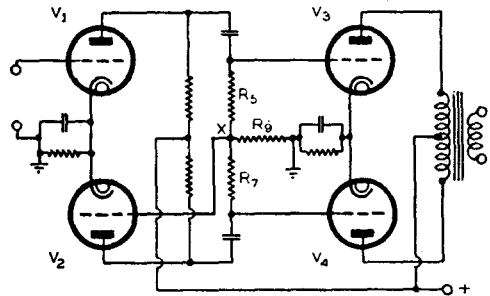

Figure 14

CHAPTER 2

Audio Frequency Power Amplifiers

Types of Power Amplifiers — Class A, AB and B operation — (1) Power Output — (2) Power Efficiency — (3) Sensitivity — (4) Harmonic Distortion — (5) Loudspeaker Damping — (6) Overload Performance — (7) Power Supply Regulation — (8) Parasitic Oscillation — (9) Special Components — The Design of Class B Amplifiers.

Power Amplifiers may be divided into

- (1) Triodes in Class A1, single; Class A1, AB1, AB2 and B Push Pull,
- (2) Pentodes in Class A1 single; Class A1, AB1 and AB2 Push Pull, with or without feedback,
- (3) Beam Power Tetrodes in Class A1 single; Class A1, AB1 and AB2 Push Pull, with or without feedback.

Class A Operation is the normal condition of operation for a single valve, and indicates that the plate current is not cut off for any portion of the cycle.

Class AB Operation indicates overbiased conditions, and is used only in push-pull to balance out the even harmonics.

Class B Operation indicates that the valves (which are necessarily in push-pull) are biased almost to the point of plate current cut-off.

The numeral "1" following A or AB indicates that no grid current flows during any part of the cycle, while "2" indicates that grid current flows for at least part of the cycle. With Class B operation the "2" is usually omitted since operation with grid current is the normal condition.

The various types of amplifiers are considered under headings corresponding to criteria of performance.

(1) Power Output.

For a limited supply voltage Class A1 gives the lowest power output with given valves, while Class AB1 and Class AB2 give successively higher outputs. Pentodes and Beam Tetrodes give greater power output than triodes under the same conditions. Negative feedback does not affect the maximum power output.

(2) Power Efficiency.

The Power Efficiency is the ratio of the audio frequency power output to the D.C. plate and screen power input. It is least for Class A1, and increases with Class AB1, AB2 and B. It is less for Class A1 triodes than for Class A1 pentodes or beam power tetrodes.

(3) Sensitivity.

The sensitivity is the ratio of milliwatts output to the square of the R.M.S. grid voltage. Pentodes and beam power tetrodes have considerably greater sensitivity than triodes. Class AB1 or any push-pull operation decreases the sensitivity. Amplifiers with grid current must be treated as power amplifiers since power is required in the grid circuit; sensitivity cannot be quoted for such types except for the whole section, including the driver valve.

(4) Harmonic Distortion.

Single Class A1 triodes are usually operated with 5% second harmonic at maximum output, while the third and higher order harmonics are small under the same conditions. All published data for such valves are based on 5% second harmonic. With push-pull Class A1 triodes the even harmonics are cancelled and only very small third and higher order harmonics remain. Push-pull class A1 triode operation is regarded as providing the highest standard of fidelity.

As the bias is increased for Class AB1 operation the odd harmonic distortion increases only slightly until cut-off is reached during the cycle, beyond which point the higher order odd harmonics become more prominent.

When the bias approaches the static cut-off point (Class B operation) this higher order odd harmonic distortion tends to become objectionable, and special means are taken to reduce it in certain cases such as for Class B modulation in transmitters. For minimum distortion, special valves having very high "mu" are used, and may even be arranged with a slightly "variable-mu" grid so as to reduce the low-level distortion (e.g., type 805).

Power Pentodes operated under Class A1 conditions on a resistive load may have very slight second harmonic distortion but from 7% to 13% total distortion. This is largely third harmonic with appreciable higher order harmonics. When operated into a loudspeaker load the harmonic distortion is much more severe at low and high frequencies due to the variation of loudspeaker impedance with frequency. An average loudspeaker has an impedance at the bass resonant frequency and at about 5,000 c/s. of about 6 times that at 400 c/s. A resistance-capacitance filter ("tone control") may be used to reduce the rise of impedance at high frequencies, but does not assist at low frequencies. Negative feedback may be used to reduce distortion at all frequencies.

The rise of loudspeaker impedance at low and high frequencies does not have any detrimental effect with Class A1 or AB1 triodes, since an increased load resistance provides decreased distortion. Class AB2 or Class B triodes have characteristics somewhat similar to Class AB2 pentodes and the variation in load resistance has a somewhat similar effect in both cases.

With a load of varying impedance, such as a loudspeaker, there is a selective effect on the harmonic distortion. For example, if the impedance of the load is greater to a harmonic than to the fundamental, the harmonic percentage will be greater than with constant load resistance equal to that offered to the fundamental. This matter is treated in detail in Chapter 3.

Owing to the fact that the dominant harmonic with Power Pentodes is the third, there is very little reduction of distortion due to push-pull operation. If, however, the load resistance per valve is decreased, the effect is to increase the second harmonic per valve (which is cancelled out in push-pull) and to decrease the third harmonic, and thus to improve the fidelity.

Much of the distortion occurring with Class AB2 or Class B operation is due to the effect of grid current on the input circuit. The design of such amplifiers is treated more fully later in this Chapter.

Normally the harmonic distortion is stated for full power output, but the rate of increase is also of importance. Second harmonic distortion (Class A1 triodes or beam power tetrodes) increases more or less linearly from zero to full power. Third harmonic distortion in pentodes increases less rapidly at first, and then more rapidly as full output is approached. Higher order odd harmonics show this effect even more markedly.

Class B amplifiers show a very rapid rise of distortion to a peak at some low power output level, beyond which the distortion may remain level or may decrease. For this reason Class B amplifiers are preferably operated at or near maximum output.

Beam Power Tetrodes in Class A1 have considerable second harmonic, but less third and higher order harmonics. When operated in push-pull the second harmonic is cancelled, and the total harmonic distortion on a constant resistive load is small. On a loudspeaker load, however, the same objections apply as for pentodes, and negative feedback is recommended in all cases where good fidelity is required.

For further information on Fidelity, Distortion, and Cross Modulation see Chapter 3.

(5) Loudspeaker Damping.

Every loudspeaker has a certain amount of internal damping, due to its construction, but in most cases the damping is insufficient to give good reproduction of transients. The plate resistance of the output valve, as reflected through the coupling transformer, acts as an additional shunt damping resistance. Since the audio output voltage and the damping resistance are both passed through the same transformer, the effect may be considered as on the primary. We need only be concerned with the ratio of the load resistance to the effective plate resistance (R_o), and this ratio (RL/R_o) is called the "damping factor."* Triodes have good damping factors, but pentodes and beam power tetrodes, due to their high plate resistance, have very poor damping factors. (See also Chapters 3 and 26). The application of negative (voltage) feedback will reduce the plate resistance of a pentode or beam tetrode, and if sufficient feedback is applied the damping factor may be made even greater than with triodes (See Chapter 6.)

(6) Overload Performance.

When an accidental overload is applied to the power stage due to too great a signal voltage, it is important that the resultant sound should not be too distasteful. Part of the effect is due to the flow of grid current, and is more pronounced with resistance-coupling than with transformer coupling. A slight improvement with resistance-coupling may be obtained by the use of a "grid stopping resistor" of 5,000 to 10,000 ohms directly in series with the grid of the power valve. Additional improvement may be obtained by the use of a low resistance grid resistor when this is permissible.

Pentodes, and to a less extent beam tetrodes, have a natural "cushion" effect as the overload point is approached. The distortion becomes fairly

*This has been used for want of a better term, and is to be distinguished from the damping factor as applied to a resonant circuit.

severe before grid current or plate current cut-off is reached, and as the characteristics are cramped together in these regions the excursion into grid current is comparatively slight.

Pentodes or beam tetrodes with negative feedback lose most of this "cushion effect," and more closely resemble triodes as regards overload.

(7) Power Supply Regulation.

When the D.C. plate current remains nearly constant at all output levels the regulation of the power supply is not important as regards the output power. With Class AB1 operation there is a greater variation in current drain from zero to maximum signal, and improved regulation is required in the power supply in order to avoid loss of power and increased distortion. Class AB2, and particularly Class B Amplifiers, require extremely good power supply regulation owing to the large variations in current drain.

The use of self-bias reduces the variation of plate current due to change of signal level, and frequently enables less expensive rectifier and filter systems to be used, although the output may be slightly reduced and the distortion slightly increased as a result.

(8) Parasitic Oscillation.

Parasitic Oscillation in the power stage is sometimes encountered, either of a continuous nature or only under certain signal conditions. High-mutual-conductance valves are particularly liable to this trouble, which is best cured by the application of negative feedback. Class AB2 or Class B Amplifiers sometimes suffer due to negative slope on portion of the grid characteristic. This may sometimes be recognised by a "rattle" in the loudspeaker. Improvement in most cases may be secured by the use of one or more of the following expedients:—

Small condensers from each plate to earth.

Condenser from each grid to earth (with transformer input only).

Series stopping resistors in grid and plate circuits, arranged as close as possible to the valve.

Improved layout with short leads.

Input and output transformers with less leakage inductance.

(9) Special Components.

A Class AB2 or Class B amplifier requires a driver stage and coupling transformer in addition to the final stage. These, together with the additional cost due to the good regulation power supply, should all be considered in calculating the total cost. It is desirable to consider the whole combination of driver valve, special transformer and push-pull power stage as forming the Power Amplifier, and the input voltage to the driver will generally be comparable with that required by a single power pentode.

When fixed bias is required for a class AB1, AB2 or B amplifier, this may be obtained from a battery or from a separate rectifier and filter. In order to reduce the cost, back-bias with the addition of a heavy bleeder resistance is frequently used. Some variation in bias is inevitable with this arrangement, and a loss of power output and an increase of distortion will result. The additional cost of the power supply and filter needed to handle the total current of valves and bleeder must also be considered.

When the screens of pentodes or beam power tetrodes are operated at a lower voltage than the plates, heavy voltage dividers or separate power supplies are required except for Class A1 operation.

THE DESIGN OF CLASS B AMPLIFIERS

A description of the main features of Class B Amplifiers is given in Chapter 34. For convenience in design a comparatively simple and reasonably accurate method is given in this section, arranged in stages for greater simplicity in application. It should be understood, however, that the complete design of a Class B amplifier is a very complicated and difficult matter, and one which, with the present limits of knowledge, demands the application of methods involving successive approximations. There being so many dependent variables in this design, it will be assumed in the following treatment that at least one (the load resistance) has already been determined, and that the plate supply voltage and power output are known. Certain assumptions are also necessary regarding the design of the Class B transformer.

Procedure

1. Assume a convenient plate supply voltage (E_B).
2. Assume a value of plate-to-plate load resistance. This may be obtained from the published data, although in some circumstances advantage may be gained by using some other value. If it is desired to obtain an optimum value it is necessary to complete the design for each of several values. A higher load resistance results in lower maximum power output, increased plate circuit efficiency, and decreased driving power for maximum output.
3. The load resistance (R_L) for a single valve will then be one-quarter of the load resistance plate-to-plate.
4. Draw on the $I_p E_p$ characteristics a load line corresponding to the load resistance for a single valve, passing through the E_p axis at the supply voltage point (for method see Chapter 34).
5. Assume a value of power output for both valves. The published data may be used as a guide to selecting the maximum power output under given conditions, but lower values of power output may be selected for calculation.
6. Determine the peak A.F. plate voltage (E_P) from the equation

$$E_P = 2 \sqrt{W.R_L}$$

where W = watts output per valve
 $= 0.5 \times$ watts output for 2 valves
 and R_L = load resistance per valve
 $= 0.25 \times$ load resistance plate-to-plate.

7. Determine the minimum plate voltage ($e_{p \text{ min.}}$) which occurs at the negative peak A.F. plate voltage;

$$e_{p \text{ min.}} = E_B - E_P$$

where E_B = plate supply voltage
 and E_P = peak A.F. plate voltage

8. Determine the point on the loadline corresponding to $e_{p \text{ min.}}$ and hence the corresponding positive grid voltage.
9. Determine from the grid current characteristics the instantaneous value of grid current at the plate voltage ($e_{p \text{ min.}}$) and positive grid voltage just determined. This will be the peak grid current ($I_g \text{ peak}$).

10. Select a suitable negative grid bias voltage E_c ($E_c = 0$ for zero bias types) to give a small plate current at no signal. The published data may be used as a guide in selecting the optimum no-signal plate current.
11. Determine the total peak A.F. grid voltage ($E_{g \text{ peak}}$) with respect to the working point by adding the bias voltage and the peak positive voltage. For certain selected conditions this value may be obtained directly from the published data.
12. Determine the peak grid power defined by

$$W_{g \text{ peak}} = E_{g \text{ peak}} \times I_{g \text{ peak}}$$

From this information it is possible to select a driver valve which will give a peak power output equal to at least

$$\frac{W_{g \text{ peak}}}{\eta}$$

where η = peak power driver transformer efficiency.

Since on a resistive load the peak power output of the driver valve is twice the average power output, it will be necessary to select a driver valve having a published Maximum Undistorted Power Output of at least

$$\frac{0.5 W_{g \text{ peak}}}{\eta}$$

Since the driver valve is required to operate into a minimum load resistance which is greater than that for M.U.P.O. it is advisable to select one having an ample margin of output. Values of peak power transformer efficiency depend on the transformer design but practical efficiencies obtainable with good design are usually in the region of 70%. If a driver valve having a M.U.P.O. equal to the peak grid power ($W_{g \text{ peak}}$) be selected it will generally be found to be fairly close to the requirements.

Having selected an apparently suitable driver valve the procedure is then:—

1. Assume as a convenient basis that the load (RL) on the driver valve is 4 times its plate resistance (r_p).
2. The maximum peak A.F. plate voltage ($E_{p \text{ max.}}$) on the driver valve will then be given by

$$E_{p \text{ max}} = 0.8 \mu E_{c1}$$

where μ = amplification factor of driver valve

and E_{c1} = grid bias on driver valve for normal Class A1 operation.

3. Determine the transformer ratio (T) from primary to half secondary from the approximation

$$T = \frac{E_{p \text{ max.}}}{E_{g \text{ peak}}} \sqrt{\eta}$$

where $E_{g \text{ peak}}$ = total peak A.F. grid voltage.

(For a more accurate determination of T see Chapter 26.)

4. The plate resistance (r_p) of the driver valve reflected into the secondary of the transformer (r_p') is given approximately by $r_p' = r_p/T^2$. For a more accurate determination of r_p' see Chapter 26.

For good design r_p' should not exceed about

- (a) $0.1 R_{g \text{ peak}}$ for a Class B stage operating with high negative bias
 or (b) $0.2 R_{g \text{ peak}}$ for a zero bias Class B stage.

The final choice of r_p' and T will depend on the permissible distortion. It is obvious that in the case of a negatively biased Class B stage there will be a wider range of grid input resistance over the cycle than in the case of a zero bias stage, necessitating a lower ratio of $r_p'/R_{g \text{ peak}}$.

The distortion which occurs in the driver stage is largely the result of a curved loadline (see Chapter 34.)

The foregoing treatment assumes that no resistive loading is used on the driver valve or on the secondary of the transformer.

The design of the driver transformer should then be checked to see whether the efficiency agrees with the assumed value at the peak grid power under the conditions already determined. In order to simplify calculations, one half of the loss may be taken as core loss, one-quarter as primary resistance loss, and one-quarter as secondary resistance loss.

On this basis the resistance of each half of the secondary winding should be

$$R_{g \text{ peak}} \left(\frac{1 - \eta}{4\eta} \right)$$

If $\eta = 0.7$, this resistance will be $0.107 R_{g \text{ peak}}$. Similarly the resistance of the primary winding should be approximately $T^2 \times$ the resistance of the secondary. Sufficiently large gauges of wire should therefore be used to enable these low resistances to be obtained.

The inductance of the primary should be as high as that for an A.F. transformer operating into a high impedance grid circuit, since during portion of the cycle the secondary operates approximately under no load conditions.

The leakage inductance of the transformer should be as small as possible in order to give good frequency response and to reduce any tendency towards parasitic oscillation. In the preceding calculations, leakage inductance has been assumed to be negligible.

CHAPTER 3

The Relationship between the Power Output Stage and the Loudspeaker

Loudspeaker Characteristics—Effect of Shunt Reactances—Selective Distortion—Output—Effect of Transformer Inductance—Effect of Transformer Losses—“Damping Factor”—Tone Control—Combination Tones—Cross Modulation—Acoustic Output.

Loudspeaker Characteristics.

The operation of an output valve on a loudspeaker load differs greatly from the operation on a fixed resistive load. The impedance characteristic of a typical loudspeaker is shown in Fig. 1 and it will be seen that the impedance at 400 c/s., at which the loudspeaker is generally rated, is almost the lowest impedance at any frequency within the normal audio frequency range. At the bass resonant frequency the impedance rises to a value about six times that at 400 c/s. and to a somewhat similar level at 10,000 c/s. The impedance is resistive at two frequencies only, as shown in Fig. 2, and at other frequencies is largely inductive or capacitive.

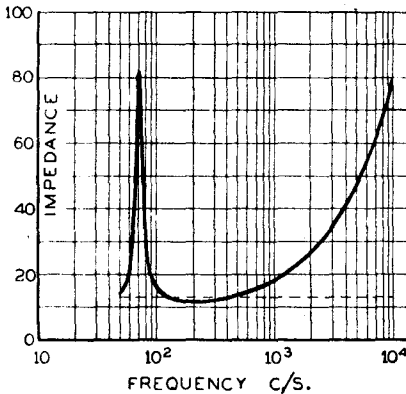

Figure 1

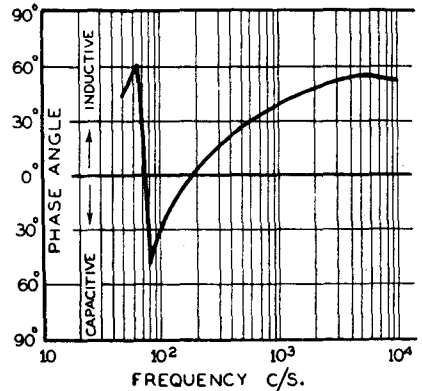

Figure 2

Loudspeakers are generally tested for response by placing them in the plate circuit of a low impedance triode valve or else by applying a constant voltage of varying frequency to the loudspeaker transformer in series with a resistance of the order of 1,000 ohms which forms the equivalent of the plate resistance of a triode valve. It will be seen that in this test it is the voltage across the voice coil and not the power which is maintained constant at all frequencies. As the impedance increases so the power in the voice coil decreases due to the smaller current.

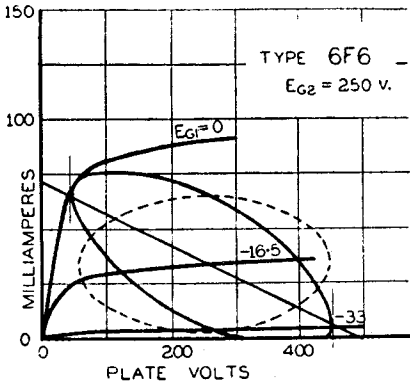

Figure 3

the combination of the resistive load line and the reactive load line is shown as a solid line ellipse. The result of such shunt reactive loading is to reduce the available output power and voltage for the same distortion. Such an arrangement may be used satisfactorily provided that the input voltage is reduced. A shunt reactive load may be caused by low inductance of the loudspeaker transformer or by a condenser connected as a tone control between plate and earth.

If constant power were applied at all frequencies the acoustic output of the loudspeaker would be very much greater at all frequencies than that at 400 c/s. In such a case the bass and high audio frequencies would be reproduced at excessively high levels, and the reproduction would be most unnatural.

Shunt Reactance

A shunt reactance across the load of a power valve results in an elliptical load line as shown in Fig. 3. The load line for the reactance alone is shown with a broken line while the resultant load line formed by

Selective Distortion.

When the load imposes a greater impedance to the harmonic than to the fundamental the measured harmonic distortion increases. At a frequency equal to one-half of the bass resonant frequency the second harmonic rises to a peak since the second harmonic frequency is equal to that of the bass resonance (Fig. 4). Similarly at a frequency equal to one-third the frequency of the bass resonance, the third harmonic rises to a peak, and so with higher harmonics. For a similar reason at frequencies above about 1,000 c/s. all harmonics tend to increase since the impedance of the load to the harmonics is greater than the

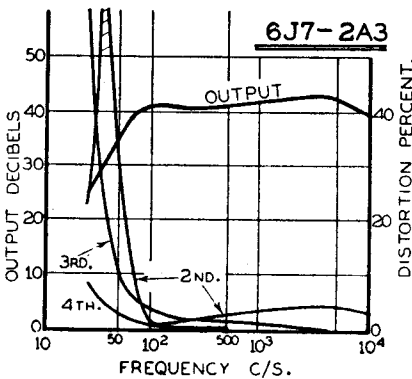

Figure 4

impedance to the fundamental. This is offset to some extent by the fact that with a triode valve or with most of the commonly used negative feedback circuits, as the load impedance is increased, so the distortion decreases. The nett effect is found by the combination of these separate effects.

Output.

Since with a loudspeaker we are concerned with voltage across the voice coil and not with power output, it is found with an ideal transformer that at the bass resonant frequency a slight rise in output occurs with a

triode valve. With a pentode or beam tetrode valve a very pronounced rise in output voltage occurs at the bass resonant frequency. At high audio frequencies similar rises occur with both triodes and pentodes, the former being very slight and the latter pronounced.

Effect of Transformer Inductance.

With a triode valve, low primary inductance causes loss of response at low audio frequencies. The slight rise of response at the bass resonant frequency, which is only obvious when a transformer having high primary inductance is employed, may be completely masked by this effect. With pentodes or beam power tetrodes, low inductance in the primary of the transformer may be used to compensate for too great rise of response at the resonant frequency. This will, however, result in decrease of power output at this frequency for limited distortion. The inductance required for specific conditions is given in Chapter 26.

Effect of Transformer Losses

As a result of resistance in the transformer windings a transformer reflects into the primary circuit a higher impedance than that which is calculated from the impedance presented to the secondary divided by the square of the turns ratio from secondary to primary. As a result of transformer core loss the reflected impedance is decreased, and when the core loss is one half of the total transformer losses the reflected impedance is approximately the same as for an ideal transformer (see Chapter 26).

Damping Factor.

The "damping factor"* of a power output stage is equal to R_L/r_p , where R_L and r_p are the load resistance and valve plate resistance respectively, referred either to the primary or secondary of the transformer. The damping factor is not much affected by losses in the transformer (see Chapter 26).

The damping at frequencies at which the impedance of the loudspeaker rises above its impedance at 400 c/s. is greater than that at 400 c/s. since R_L is greater and thus an effective damping factor of up to six times the nominal damping factor is obtained. This is particularly beneficial in improving the reproduction at the bass resonant frequency.

Measuring Output of Receiver or Amplifier

It is desirable to measure the output of a receiver as the voltage across either the primary or the secondary of the loudspeaker transformer. The voltage across the primary of the transformer is not influenced to any great extent by the characteristics of the transformer except the primary inductance. Voltage measured across the secondary of the transformer will be less than the ideal voltage owing to the losses in the transformer. Similar remarks apply to amplifiers.

Negative Feedback.

All types of negative feedback result in decreased harmonic distortion. Negative voltage feedback also results in improved damping and more

*For definition and description of "Damping Factor" see Chapter 2.

uniform frequency response and its effect is similar to that obtained by the use of a triode valve. Negative voltage feedback has an increased effect at the peaks of loudspeaker response. Negative current feedback results in decreased damping and a more peaked frequency response curve. This matter is considered in greater detail in Chapter 6.

Tone Control.

The effect of a tone control is considered in detail in Chapter 9. A tone control consisting of a condenser shunted across the load has the effect of reducing the maximum undistorted power output. A reduction of undistorted output to about one-third of that available from the valve is possible with severe use of such a tone control, although this effect is not so serious as it otherwise would be since at the higher frequencies at which the effect of the tone control is greatest, the acoustic power is likely to be limited.

Combination Tones and Cross Modulation.

These features are considered in detail in Chapter 5.

Acoustic Output.

Published curves of the acoustic output of loud-speakers generally show the output at a point on the axis of the loudspeaker. Due to the focussing effect of the loudspeaker it is obvious that at other angles the output from the speaker will be deficient in higher frequencies. Curves of this character should therefore be interpreted with full knowledge of the situation. When a loudspeaker is used in a room the effect on a listener of the high frequency response is more or less proportional to the mean hemispherical high frequency response from the loudspeaker in the same way as occurs with a lamp and with reflections from the walls.

Bibliography.

For further information refer to F. Langford Smith, "The Relationship between the Power Output Stage and the Loudspeaker." Proc. World Radio Convention, Sydney, April (1938); reprinted in the *Wireless World*, February 9 and 16 (1939).

CHAPTER 4

Biasing, By-passing and Decoupling

Biasing — Self Bias or Cathode Bias — Back Bias — Effect on Maximum Values of Grid Resistors — Self Bias with Push-Pull Operation — By-passing of Cathode Bias Resistor — By-passing with Back Bias — By-passing Screen Grids — Capacitance of By-pass Condenser — Mathematical Formulae for Cathode and Screen By-pass Capacitances — Decoupling — Condition for Stability — Methods of Decoupling.

Biasing.

There are many methods of obtaining the bias voltage to apply to the control grid of a valve. Of these the simplest is Battery Bias. If the battery has low internal resistance, constant voltage and low capacitance to earth* it may be regarded as an ideal source of bias voltage. Due, however, to the limited life and far from ideal characteristics of batteries, other methods of bias are widely used.

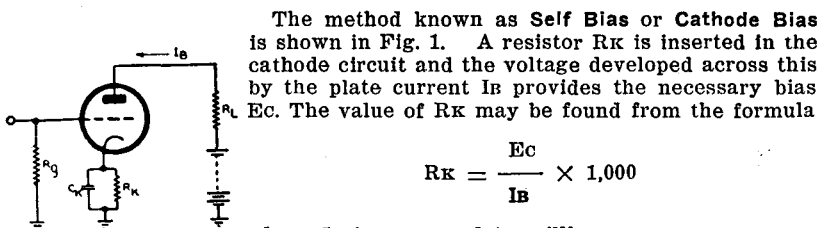

Figure 1

It is easy to remember that for a plate current of 1 mA and grid bias of 1 volt, the cathode bias resistor should be 1,000 ohms. The by-pass capacitance C_k is considered in detail under the section on By-passing .

An alternative form of bias supply is commonly known as Back Bias and is shown for a typical two-stage amplifier in Fig. 2. The general principle in this case is identical to that for self-bias except that a single tapped resistance is inserted in the common B- lead and the current through it will therefore be the total of the cathode currents of all valves in the amplifier together with any bleeder current such as that due to a voltage divider. The total resistance in the Back Bias Resistor is determined as for self-bias, but on the basis of the total current of the amplifier

*Low capacitance to earth is only a desirable feature when the bias source is required to be at other than earth potential.

and the greatest bias voltage required by any valve. For example in Fig. 2.

$$\begin{aligned} \text{If } I_{B1} &= 6 \text{ mA.} \\ I_{B2} &= 10 \text{ mA.} \\ E_{C1} &= 2 \text{ volts} \\ E_{C2} &= 8 \text{ volts} \end{aligned}$$

$$\begin{aligned} \text{Then } (R_1 + R_2) &= \frac{8}{6 + 10} \times 1,000 \\ &= 500 \text{ ohms} \end{aligned}$$

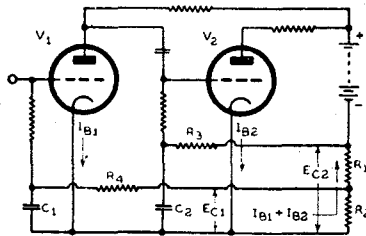

Figure 2

Since the whole of the bias is required for V2 the grid return of V2 is taken to B—. Since V1 only requires one-quarter of the bias for V2 the bias resistor should be tapped so that $R_2 = 125$ ohms and $R_1 = 375$ ohms, and the grid return of V1 taken to the junction of the two resistances. With this arrangement each grid return should be separately by-passed to earth. This by-passing action is improved by the resistors R3 and R4 as will be mentioned in the section on By-passing.

Self-bias has the advantage that individual variations in plate current are to some extent compensated by automatic adjustment of the bias, and for this reason a larger value of maximum grid resistor is permissible with power valves using self-bias. It is also of value with resistance coupled pentode or high- μ triode valves which are being operated near the maximum peak output voltage since it accommodates changes in valves with a minimum of effect on the output voltage. When fixed bias is used, lower values of grid resistors are frequently specified, and these should not be exceeded owing to the risk of damage to the valve. With back bias the effect is intermediate between that with self-bias and that with fixed bias. The maximum value of grid resistor should therefore be calculated on a proportional basis, depending upon the percentage of the total current passing through the valve under consideration. If the greater part of the amplifier current passes through the power valve the grid resistor may be made to approach that for self-bias operation, but if it forms only a small proportion of the total current the value of the grid resistor should approach that for fixed bias operation.

For the reasons which have been given, self-bias is to be preferred for the power stage in radio receivers from the point of view of maximum valve life and reliability. Back bias is quite satisfactory for R.F. and converter stages, and may also be used for audio frequency voltage amplifier stages where the required output voltage is well below the maximum available from the valve. Self-bias is desirable in all cases where an audio frequency amplifier is operated so as to give maximum output voltage.

With a push-pull stage it is generally possible to use a common cathode resistor for the two valves. If there is an appreciable second harmonic component of the plate current in either valve, this cathode resistor should be by-passed, although under some circumstances it is possible to omit the by-pass condenser without any serious increase in distortion. When the valves are not sufficiently well matched it is preferable to employ separate cathode bias resistors for each valve, each adequately by-passed.

By-passing.

A cathode bias resistor is usually by-passed by a condenser (Ck in Fig. 1) in order

- (1) to avoid degeneration and loss of gain, and
- (2) to avoid hum.

If Ck were omitted the amplifier would operate with Negative Current

Feed-back (see Chapter 6). The capacitance C_k when used to avoid degeneration should normally have a reactance which is low compared with R_k at the lowest frequency required to be amplified. If accurate calculations of this capacitance for specified frequency response are required the formula at the end of this section may be used. For most practical purposes C_k may be a 25 μF . electrolytic condenser, and although such a high capacitance is often unnecessary for frequency response it is valuable in by-passing hum voltage originating between the heater and cathode.

With a Back Bias circuit as Fig. 2 the condensers C_1 and C_2 serve to by-pass the audio frequency component and so avoid coupling between stages. If the plate supply is from rectified A.C. or from D.C. mains, C_1 and C_2 also serve to provide improved filtering. The decoupling and filtering action may be made more effective by inserting resistors (R_3 and R_4), although these are not necessary in all cases.

In a similar manner the screen grid of a tetrode or pentode valve may be by-passed to earth (Fig. 3). If a screen dropping resistor from B+ is used, a comparatively small capacitance only is required and 0.5 μF . is ample for the lowest audio frequencies in a normal resistance coupled stage. When the screen is supplied from a voltage divider a higher capacitance is required for equivalent by-passing, although in some circumstances where no coupling exists through the voltage divider the by-pass may be entirely omitted. With R.F. pentodes it is necessary to use a small by-pass condenser (about 0.1 μF .) from screen to earth, although a common voltage divider and by-pass condenser may be used for R.F., Converter and a single I.F. stage. Two I.F. stages with their screens supplied from a common source may be unstable, and some decoupling is desirable; a voltage divider made from two 1 watt resistors, or alternatively a single dropping resistor, may be used for one I.F. stage together with a separate by-pass condenser.

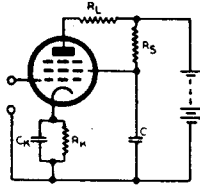

Figure 3

When a common cathode resistor is used for two valves in push-pull it is generally desirable to use a by-pass condenser in order to by-pass second harmonic components of the plate current. The second harmonic voltages would otherwise be fed back in phase to both grids, and produce a secondary form of harmonic distortion in the output. If the valves are operated under conditions such that the average plate current does not remain constant for all signal levels, it is necessary to employ a very large value of capacitance (frequently 50 μF . or more) in order to avoid harmonic distortion. Considerable difficulties arise in the application of self-bias to Class AB2 stages, and the arrangement is therefore not generally to be recommended and a form of back bias with a heavy bleeder current is to be preferred.

In many other circuit arrangements Bypass Condensers are employed, but their action is sufficiently obvious to need no description.

The capacitance of a bypass condenser is normally a function of the resistance which is being by-passed, and also of the lowest frequency which is required to be amplified. The higher the resistance to be bypassed, the smaller will be the capacitance required to bypass it effectively at a given frequency. Similarly the lower the frequency required to be by-passed, the greater will be the capacitance.

Reference should be made to the Table of Reactances* in order to select capacitances which, at the lowest working frequency, have reactances sufficiently below the values of the resistances which are to be by-passed.

*See Chapter 40.

In the by-passing of a cathode bias resistor there are special features to be considered. The voltage developed across the cathode circuit impedance is equal to the total voltage developed in the plate circuit multiplied by the ratio of cathode circuit impedance to total plate circuit impedance. The cathode circuit impedance is the vector resultant of the reactance of the by-pass condenser in parallel with the resistance of the cathode bias resistor. The total plate circuit impedance is the vector resultant of the cathode circuit impedance, the plate resistance of the valve and the load resistance, in series. The voltage developed in the plate circuit is equal to the grid voltage multiplied by the amplification factor of the valve. The loss of gain due to degeneration is a function of all these values, and cannot be calculated accurately by considering merely the values of the cathode bias resistor and the by-pass condenser. With pentodes or beam power tetrodes the value of the cathode bias resistor has only a slight effect on the required value of by-pass condenser which is mainly a function of the mutual conductance of the valve.

CATHODE AND SCREEN BY-PASSING

Mathematical Formulæ for Calculations

Cathode By-pass.

$$\left| \frac{M''}{M} \right| = \sqrt{\frac{1 + (\omega C_k R_k)^2}{(1 + \alpha M R_k)^2 + (\omega C_k R_k)^2}}$$

$$\text{where } \alpha = \frac{1}{M(R_L + r_p)} + \frac{1}{R_L}$$

= $1/R_L$ approximately for high gain resistance coupled amplifiers,

M'' = the stage gain with the cathode resistor partially bypassed,

M = the stage gain with the cathode resistor completely by-passed,

$\omega = 2\pi f$,

f = the frequency at which M'' is to be calculated,

C_k = the cathode bypass capacitance,

R_k = the cathode bias resistance,

R_L = the plate load resistance, and

r_p = the valve plate resistance.

For ease of calculation on a slide rule

- (1) Find $(1 + \alpha MR_k)^2$
- (2) Find $(\omega C_k R_k)^2$
- (3) Make the necessary additions to find numerator and denominator,
- (4) Divide the numerator by the denominator on the upper scales of the slide rule, and read the square root on the lowest scale.

A fairly close approximation for pentodes is to make ωC_k equal to $2.2 g_m$ for a drop of 2 db., (i.e. for $M''/M = 0.8$). This approximation is particularly interesting since it is not affected by the value of R_k .

For ease in applying this approximation, approximate values of g_m for the standard operating conditions of resistance coupled pentodes are given below. In the case of power pentodes or beam power tetrodes the published values of g_m may be used.

RESISTANCE COUPLED PENTODES.

Type	Supply Voltage	Plate Load Resistor	Screen Dropping Resistor	Cathode Bias Resistor	app. g_m (micro-mhos)
6J7-G (6C6)	250	0.1 megohm	0.3 megohm	2000 ohms	1080
		0.25 "	1.5 "	2000 "	750
6B8-G (6B7)	250	0.25 "	1.75 "	2000 "	475
6G8-G (6B7S)	250	0.25 "	*	2000 "	465
1K5-G (1K4)	135	0.25 "	0.75 "	**	375
1K7-G (1K6)	135	0.25 "	1.0 "	**	380

* Screen voltage from voltage divider consisting of 1.0 and 0.25 megohm resistors.

** Bias -1.5 volts.

Screen By-pass.

$$\left| \frac{M'}{M} \right| = \sqrt{\frac{a^2 + a^2 R_s^2 \omega^2 C_s^2}{(a + R_s)^2 + a^2 R_s^2 \omega^2 C_s^2}} \quad *$$

$$\text{where } a = \frac{\mu_t}{g_m} \cdot \frac{i_p}{i_s} \cdot \frac{1 + Z_L/r_p}{1 - \mu_t/\mu}$$

$$= \frac{\mu_t}{g_m} \cdot \frac{i_p}{i_s} \text{ approximately.}$$

M' = the stage gain with the screen partially bypassed,

M = the stage gain with the screen completely bypassed,

μ_t = the triode amplification factor,

μ = the pentode amplification factor,

g_m = the pentode mutual conductance,

i_p = the plate current,

i_s = the screen current,

Z_L = The plate load impedance,

r_p = the pentode plate resistance,

R_s = the resistance of the screen dropping resistor,

C_s = the capacitance of the screen bypass condenser.

$\omega = 2\pi f$, and

f = the frequency at which M' is to be calculated.

Decoupling.

When two circuits operating at the same frequency have an impedance common to both there is coupling between them, and the phase relation-

*The derivation of this formula was given in Radiotronics 98, 23rd May, 1939, Pages 34-35.

ships may be such that the coupling is either regenerative or degenerative. In the former case instability may result.

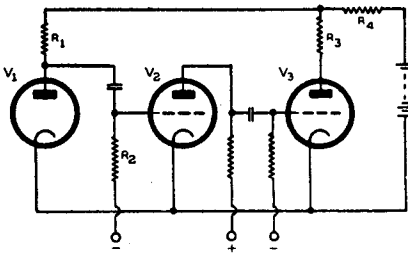

Figure 4

A two-stage resistance coupled audio amplifier has degenerative coupling through the common power supply since the plate currents are out of phase. A third stage would be in phase. This decoupling need only be incorporated in one stage, either first or third, and the second stage may

be grouped with either first or third stage. When more than three stages are operated from a common power supply serious difficulties usually arise due to the high gain, and elaborate decoupling becomes necessary.

Condition for Stability

In a typical three-stage resistance coupled amplifier (Fig. 4) it may be shown* that the amplifier will be stable when

$$\frac{M\mu_3 R_4}{R_1(r_{p3} + R_3 + R_4) \sqrt{\left(\frac{1}{R_1} + \frac{1}{R_2} + \frac{1}{r_{p1}}\right)^2 + \left[\left(\frac{1}{R_1} + \frac{1}{r_{p1}}\right)^2 / (R_2\omega C)^2\right]}} < 1$$

- where M = gain from grid of V₂ to grid of V₃,
- μ₃ = amplification factor of V₃,
- r_{p1} = plate resistance of V₁,
- r_{p3} = plate resistance of V₃,
- ω = 2πf.
- C = coupling condenser to grid of V₂,

and R₁, R₂, R₃, R₄ are as shown in the diagram.

For a high degree of stability this expression should be considerably less than 1.

METHODS OF DECOUPLING

The application of decoupling is illustrated in Fig. 5, where V is a resistance coupled audio frequency triode amplifier, but the method may be applied to any type of amplifier. The load resistance R_L is not affected, but an additional decoupling resistance of R_D is inserted with a bypass condenser C returned to earth. If the reactance of C at any frequency to which the amplifier will respond is considerably less than R_D plus the internal resistance of the B supply, then the decoupling will appreciably reduce the coupling through the common supply. The factor by which the coupling is reduced is

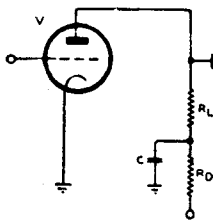

Figure 5

$$\frac{X_c}{R_D + R_4}$$

where R₄ is the internal resistance of the B supply.

*Radiotronics 75, Page 27-29, 30th April, 1937.

For resistance coupled audio frequency amplifiers R_D may be made one-fifth of R_L , or greater if the voltage of the supply is sufficiently high, and C may be $8 \mu F$. The decoupling circuit (R_D, C) will also assist in reducing the hum. In some circuits an arrangement is used for the reduction of hum alone, the amplifier being inherently stable (see Chapter 24).

If the resistance of R_D is a disadvantage, a choke may be used in its place. In audio frequency amplifiers a smoothing choke or speaker field coil may be used, and may be common to two successive stages (Fig. 6). Since with this arrangement the first stage would have insufficient smoothing, the decoupling circuit is also used for smoothing.

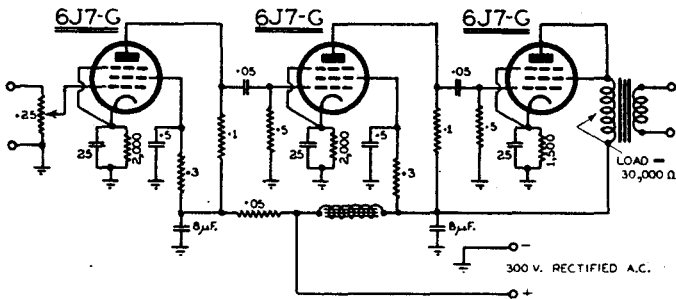

Figure 6

It is preferable to regard the voltage at the lower potential end of the decoupling resistor as the "supply voltage" for the resistance coupled stage. The characteristics of this stage may then be determined by reference to the published data. For convenience in design it is desirable firstly to select a suitable "supply voltage" for the stage; for a 300 volt source it would be satisfactory to allow 50 volts drop in the decoupling resistor and thus provide 250 volts "supply voltage." The plate current, and screen current if any, may be determined from the published data and the resistance of the decoupling resistor may then be calculated from

$$R_D = \frac{E_D}{I_p + I_{s2}} \times 1000$$

where R_D = decoupling resistor in ohms,

E_D = voltage drop in R_D ,

I_p = plate current in milliamperes, and

I_{s2} = screen current in milliamperes.

It is desirable in all cases to reduce the internal resistance of the power supply, so that even at very low frequencies there may be no tendency towards the production of relaxation oscillations ("Motor-boating"). Power supplies having good regulation generally have low effective internal impedance; in extreme cases thermionic valve type voltage regulators are sometimes desirable and have the feature of retaining low internal impedance characteristics down to the lowest frequencies.

CHAPTER 5

Fidelity and Distortion

Classification of Distortion — Limits of Distortion of Various Harmonics — Total Harmonic Distortion — Frequency Distortion — Phase Distortion — Scale Distortion — Distortion of Transients — Cross Modulation — Combination Tones — Requirements for Fidelity Reproduction.

Fidelity and Distortion

True fidelity is perfect reproduction of the original. Distortion is due to the addition of features not in the original or the absence of features present in the original. Distortion may be classified under a number of headings:—

1. **Harmonic distortion** (the production of harmonics not present in the original).
2. **Frequency distortion** (unequal amplification of all frequencies).
3. **Phase distortion** (phase angle not a linear function of frequency).
4. **Scale distortion** (acoustic unbalance which is a function of output level).
5. **Distortion of transients.**
6. **Cross modulation** (audio frequency).
7. **The production of spurious combination tones.**

A **Harmonic**, sometimes called an overtone, is a tone at a frequency twice, thrice, etc., the frequency of a "fundamental tone." For example, if the fundamental has a frequency of 100 c/s., the second harmonic will be 200 c/s., the third harmonic 300 c/s. and so on. All sounds have certain relationships between the fundamental and harmonic frequencies, and it is such relationships that give the sound its particular quality. If certain harmonics are unduly stressed or suppressed in the reproduction, the character of the sound will be changed. For example, it is possible for a displeasing human voice to be reproduced, after passing through a suitable filter, so as to be more pleasing, or vice versa. True fidelity, however, is fidelity to the original.

The critical ability of the human ear to distinguish harmonic distortion depends upon the frequency range being reproduced. Thus with wide frequency range reproduction the limit of harmonic distortion which can be tolerated is lower than in the case of limited frequency range. The following arbitrary limits have been suggested * and are given as a guide

*F. Langford Smith "The Relationship between the Power Output Stage and the Loudspeaker," Proceedings of the World Radio Convention, Sydney, April, 1938; also reprinted in "Wireless World," February 9 and 16, 1939.

to the percentages of the various harmonics which may be permitted under differing conditions.

	Good Fidelity Wide Range Critical Listener	Fair Fidelity Restricted Range Less Critical Listener
2nd Harmonic	5%	10%
3rd "	2.5%	5%
4th "	Not important since small	
5th "	0.5%	1%
7th "	(say) 0.1%	(say) 0.2%

Higher percentages of harmonics exist in most radio receivers at or approaching full output with high percentages of modulation. The severe restriction of the higher order odd harmonics is partly on account of the production of spurious combination tones. In addition, the seventh harmonic is not on the musical scale, and should therefore be below the threshold of audibility.

The total harmonic distortion percentage is defined as

$$D = \frac{\sqrt{I_2^2 + I_3^2 + \dots + I_n^2}}{I_1} \times 100$$

where I_1 = amplitude of the fundamental current and
 I_2 = amplitude of the second harmonic current, etc.

If the percentages of the various harmonics are known, the total harmonic distortion may be found from

$$D = \sqrt{H_2^2 + H_3^2 + \dots + H_n^2}$$

where H_2 = second harmonic percentage,
 H_3 = third harmonic percentage, etc.

The total harmonic distortion is not a measure of the degree of distastefulness to the listener, and it is recommended that its use should be discontinued.* When the class of amplifier is specified (e.g., Class A1 single triode) the "total harmonic distortion" may be interpreted sufficiently, but it is always preferable to specify each harmonic separately.

Frequency Distortion needs little comment. The audible band of frequencies varies considerably with individuals and with age. For the purposes of musical reproduction there is little lost by restricting the frequency range to 40 — 12,000 c/s., while good fidelity may be maintained by a range 60 — 10,000 c/s. Mediocre reproduction may be restricted to 100 — 5,000 c/s., while many radio receivers are limited to 100 — 3,500 c/s. It should be understood that the frequency range is taken as overall, including the loss of sidebands and including the loudspeaker. Wide frequency range is only comfortable to the listener so long as other forms of distortion are negligible.

One form of frequency distortion which is particularly objectionable is that due to alternate sharp peaks and troughs in the output, such as may be caused by loudspeaker cone resonances, especially at high frequencies.

Phase Distortion, although serious in television work, does not appear to be objectionable in sound reproduction.

*D. Massa, "Combination Tones in Non-linear Systems, Electronics, September, 1938, Page 20.

"Scale Distortion" may be due to operation of the loudspeaker at a volume level other than that of the original sound, and may be corrected by the use of suitable compensation networks.

Distortion of Transients is a serious form of distortion which is noticeable through the "hang-over" effect following a percussion noise. While many factors contribute, the damping of the loudspeaker, both internal and through the plate resistance of the power valve, is extremely important. A very wide frequency range is also essential for realistic reproduction of transients.

Cross Modulation occurs when a variation in the amplitude of one input signal affects the output amplitude of another signal of different frequency, but having constant input. This effect is sometimes observed while listening to a violin or similar instrument with an organ accompaniment, the amplitude of the higher frequency sound varying in accordance with the more powerful low frequency accompaniment.

Combination Tones only occur when two or more input frequencies are applied to a non-linear device, such as an amplifier producing harmonic distortion. The output in such a case will consist of the two original frequencies together with various sum and difference combinations between the fundamental or any harmonic of one and the fundamental or any harmonic of the other.* The number and strength of these combination tones increase as the harmonic percentage increases, and also increase as the order of the harmonic increases; in other words, fifth harmonic produces more serious combination tones than an equal percentage of third harmonic, seventh more than fifth, and so on. It is largely for this reason that the percentages of the higher order odd harmonics must be limited so severely. It is probable that the indirect effects of harmonic distortion which become evident as spurious combination tones are far more distasteful to the listener than the harmonics themselves.

Requirements For Fidelity Reproduction.

In addition to the reduction of the previously-described forms of distortion to negligible magnitude, it is necessary for certain other requirements to be met. Among these are:—

1. Sufficiently high maximum undistorted power output
- and 2. Sufficiently low residual noise (hum, etc.) to give the required dynamic range.

In all these considerations, the amplifier and loudspeaker should be considered as a unit, and measurements should be made, if possible, on the acoustic output. Failing this, it is at least desirable to make all tests on the secondary of the output transformer with normal voice coil loading (see Chapter 3).

*F. Langford Smith, Proc. World Radio Convention, April, 1933; F. Massa, Electronics, September, 1938.

CHAPTER 6

Negative Feedback

Feedback, Positive and Negative — Feedback over single stage — two stages — three or more stages — The Effect of Feedback — Negative Voltage Feedback — Negative Current Feedback — Derivation of Formulae for Negative Voltage Feedback — Gain — Gain Reduction Factor — Harmonic Distortion — Noise — Frequency Response — Plate Resistance — Derivation of Formulae for Negative Current Feedback — Plate Resistance — Gain — Input Resistance — Application of Negative Feedback — Single Ended and Push Pull Amplifiers — Summarised Design Data for Negative Voltage Feedback and Negative Current Feedback.

Feedback — Positive and Negative

Positive Feedback is feedback which has a component in phase with the input voltage. Negative Feedback is feedback which has a component out of phase with the input voltage.

Due to the effect of reactances in the circuit, phase rotation may occur so that the voltage which is fed back is not wholly in phase or out of phase with the input voltage.

For example in Fig. 1 if e is the input voltage, then the output voltage E and the feedback voltage βE will ideally be 180° out of phase for an odd number of resistance coupled stages. If there is a change of phase due to a reactive component, the effect may be as shown at E' , and the feedback voltage $\beta E'$ will be at an angle θ' with OE . The effective negative feedback voltage is therefore OA which is equal to $\beta E' \cos \theta'$. When the angle θ is 90° there is no feedback. When the angle θ is greater than 90° it has a component $\beta E'' \cos \theta''$ in phase with the input voltage e , and therefore giving positive feedback.

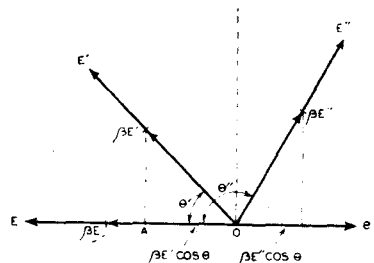

Figure 1

A single resistance-capacitance coupled stage can never cause a phase angle rotation of more than 90° , even at the extreme limits of frequency.

It is possible (generally at very low or very high frequencies) for regeneration to occur with feedback over two or more resistance stages, although by careful design and by limitation of the feedback it is possible to retain stability up to 3 or even 4 stages. In such cases it is desirable to arrange one stage to have the maximum permissible attenuation at low and at high frequencies, and to design the remaining stages for very low attenuation, and hence very low phase angle rotation.

By this means the phase angle rotation for a given attenuation is reduced, and a higher feedback factor may be used before instability occurs. Even with feedback over two stages it is desirable for one stage to have considerably greater attenuation than the other at low and high frequencies.

When increasing feedback factors are applied to a single resistance-capacitance coupled stage the effect on the frequency response is to increase the frequency range for a given maximum attenuation. The effect is identical to that obtained by conventional methods of increasing the frequency range without feedback.

With feedback over two such stages the effect* is to produce peaks of response at low and high frequencies at which the phase angle rotation with feedback is $\pm 90^\circ$. As the feedback factor is increased, the frequencies at which the peaks occur become somewhat more remote, but the peaks become much more pronounced and may be the cause of serious distortion. These peaks of response are caused by regeneration, brought about through sufficient phase angle rotation to convert negative feedback to positive. If one stage has a considerably flatter characteristic than the other, the peaks become smaller and further removed in frequency. A two stage resistance loaded amplifier will not oscillate if adequate screen and cathode bypassing is used.

With feedback over three such stages a somewhat similar effect occurs, but oscillation will take place if the feedback exceeds a certain critical value. The feedback which may be employed before oscillation occurs is increased if one stage has a considerably flatter characteristic than the other two, or if two stages have considerably flatter characteristics than the remaining one.

Instability in Push-Pull Amplifiers is considered under "The Application of Negative Feedback."

The Effect of Feedback

Positive Feedback in audio frequency amplifiers tends to produce instability and to increase distortion; Negative (or Inverse) Feedback provides—

1. Greater stability, including constancy of characteristics with changes in valves or applied voltages,
2. A reduction of harmonic distortion,
3. A reduction of phase distortion,
4. An improvement in the linearity of the response with frequency,
5. A reduction of sensitivity,
6. A reduction of noise,
7. A modification of the effective internal resistance of the amplifier.

*F. E. Terman and Wen-Yaun Pan, "Frequency Response Characteristic of Amplifiers Employing Negative Feedback," *Communications*, pp. 5-7, March (1939).

Negative Feedback

"Negative Voltage Feedback" occurs when the voltage which is fed back is proportional to the voltage across the output load, and provides a reduction in the effective internal resistance of the amplifier.

"Negative Current Feedback" occurs when the voltage which is fed back is proportional to the current through the output load, and provides an increase in the effective internal resistance of the amplifier.

The arrangement for voltage feedback is shown in schematic form in Fig. 2. A voltage divider (R_1 , R_2) across the load (R_L) provides a voltage βE , where $\beta = R_1/(R_1 + R_2)$, which is fed back in opposition to the input voltage e' . It is assumed that $(R_1 + R_2)$ is very much greater than R_L .

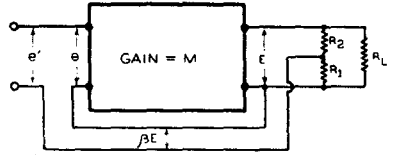

Figure 2

The gain of the amplifier without feedback is M where $M = E/e$. If the overall gain with feedback is M' , then if the input voltage e' is increased to give the same output voltage E

$$M' = \frac{E}{e'} = \frac{E}{e - \beta E}$$

The gain reduction factor due to feedback is therefore

$$\frac{M}{M'} = \frac{E/e}{E/(e - \beta E)} = 1 - \frac{\beta E}{e} = 1 - \beta M$$

(The feedback factor β is negative for negative feedback, and therefore M' will be less than M).

The Reduction of Harmonic Distortion

Let D = distortion voltage in the output without feedback, and D' = distortion voltage in the output with feedback, at the same output level.

Then the distortion voltage which is fed back to the input is $-\beta D'$, and since this is of different frequency from the input voltage there is no cancellation and the output voltage due to it is $-\beta M D'$. Since this distortion $-\beta M D'$ is out of phase with the distortion D which would be present without feedback, the resultant distortion voltage will be

$$\begin{aligned} D' &= D + \beta M D' \\ \therefore D' (1 - \beta M) &= D \\ \therefore D' &= \frac{D}{1 - \beta M} \end{aligned}$$

This treatment is not entirely rigorous, and certain assumptions are made which are not quite correct.* It is however a fairly close approximation for practical purposes.

*F. Langford Smith, Proc. World Radio Convention, April, 1938, pp. 9-10 and bibliography.

It will thus be seen that the harmonic distortion is reduced by a factor approximately equal to the gain reduction factor.

The noise introduced in the section of the amplifier covered by the feedback tends to be cancelled out in the same manner as the distortion. There is no advantage however in applying this method for the reduction of noise in low level amplifiers, since the loss of gain necessitates additional amplification which also brings up the noise. The hum from a poorly filtered power supply tends to be reduced by feedback, but there are other contributing factors such as the change of effective plate resistance (due to feedback) which also affects the hum.

The Effect of Voltage Feedback on Frequency Response

Let M = gain of amplifier at one frequency
and N = gain of amplifier at another frequency.

Then the ratio of gains without feedback will be M/N .

With feedback the gains will be

$$M' = \frac{M}{1 - \beta M}$$

$$\text{and } N' = \frac{N}{1 - \beta N}$$

∴ The ratio of gains with feedback will be

$$\frac{M'}{N'} = \frac{M}{1 - \beta M} \cdot \frac{1 - \beta N}{N} = \frac{M}{N} \cdot \frac{1 - \beta N}{1 - \beta M}$$

This is equal to the ratio of gains without feedback multiplied by the factor

$$\frac{1 - \beta N}{1 - \beta M}$$

and the result is that the gains at the two frequencies are more nearly identical owing to feedback.

It can also be shown* that

- if f_1 = the frequency below the middle range at which the attenuation without feedback is x db,
- and f_2 = the frequency above the middle range at which the attenuation without feedback is x db,

then the corresponding frequencies (f_1' and f_2') with feedback are given by

$$f_1' = \frac{f_1}{1 - \beta M}$$

$$\text{and } f_2' = f_2 (1 - \beta M).$$

These results hold only for feedback over a single stage.

The Effect of Voltage Feedback on R_o

Voltage feedback causes a reduction in the "internal generator impedance" (R_o) of the amplifier. The plate resistance of the final valve

*F. E. Terman and Wen-Yaun Pan, Communications, pp. 5-7, March (1939).

in the feedback circuit is not changed by feedback, but owing to the action of the feedback the effect is similar to that due to a change in the plate resistance. However the effect is similar whether the feedback is taken to the grid of the final valve, or to some earlier point, provided that the gain reduction factor is constant.

Let E_s = source of voltage inserted in the output circuit (see Fig. 3) with no voltage applied to the input,

r_p = plate resistance of final valve,

= "internal generator impedance" without feedback,

R_o = internal generator impedance with feedback,

R_L = load resistance,

and I = current flowing in plate circuit.

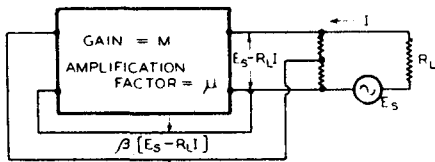

Figure 3

Then the total voltage effective in producing the current I in the plate circuit is

$$\begin{aligned} & E_s - \beta\mu (E_s - R_L I) \\ &= (1 - \beta\mu) E_s + \beta\mu R_L I \end{aligned}$$

The total resistance in the plate circuit is $r_p + R_L$.

The current (I) circulating in the plate circuit is given by

$$I = \frac{(1 - \beta\mu) E_s + \beta\mu R_L I}{r_p + R_L}$$

$$\therefore I (r_p + R_L - \beta\mu R_L) = (1 - \beta\mu) E_s$$

$$\therefore I = \frac{(1 - \beta\mu) E_s}{(1 - \beta\mu) R_L + r_p}$$

$$\therefore I = \frac{E_s}{R_L + [r_p / (1 - \beta\mu)]}$$

This is the current which, with an applied voltage E_s , would flow through a resistance

$$R_L + \frac{r_p}{1 - \beta\mu}$$

and therefore the "internal generator impedance" of the amplifier is given by

$$R_o = \frac{r_p}{1 - \beta\mu} = \frac{1}{(1/r_p) - \beta g_m}$$

where g_m = Mutual conductance of the output valve.

It should be noted that the plate resistance is reduced by a factor $1/(1 - \beta\mu)$ while the gain is reduced by a factor $1/(1 - \beta M)$. Since β is negative $(1 - \beta\mu)$ is greater than 1.

Current Feedback

The arrangement for Current Feedback is shown in Figs. 4 and 5. A resistance, R_c in series with the load R_L , provides a voltage drop IR_c which is fed back in opposition to the input voltage e' . For the same gain reduction factor, Current Feedback provides the same decrease in Harmonic Distortion as Voltage Feedback.

The Effect of Current Feedback on R_o and Gain

A similar method to that used for voltage feedback gives the result

$$R_o = r_p + (\mu + 1) R_c$$

The increase in the effective internal resistance makes this type of feedback less desirable for use with the final stage when this is a pentode or tetrode feeding a loudspeaker, but in other applications (e.g., phase splitter) it is of value. The most common form of Current Feedback is that in which the plate load resistance is divided, part being common to both input and output circuits (Figs. 4 and 5).

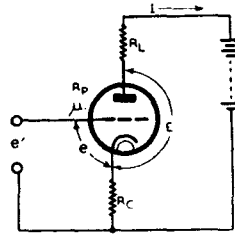
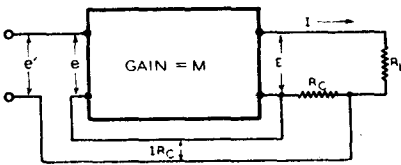

Figure 4 (above), and Figure 5 (at right).

The gain of the stage shown in Figs. 4 and 5, considering the total voltage across R_c and R_L as the output voltage, may be shown to be

$$\frac{E}{e'} = M' = \frac{\mu (R_c + R_L)}{R_c (\mu + 1) + R_L + r_p}$$

If $R_c = R_L = R$ as for a phase splitter,

$$M' = \frac{2\mu R}{R (\mu + 2) + r_p}$$

which is always less than 2.

If $R_c = R$ and $R_L = 0$ as for cathode loading,

$$M' = \frac{\mu R}{R (\mu + 1) + r_p} = \frac{1}{1 + [R + r_p] / \mu R}$$

which is always less than unity.

The Effect of Current Feedback on Input Resistance

The input resistance (R_i) of the phase splitter arrangement shown in Fig 6 is

$$R_i = \frac{e'}{I} = \frac{e + (M'/2)e'}{I} = \frac{e}{I} + \frac{M'}{2} \frac{e'}{I}$$

$$= R_g + (M'/2)R_i$$

$$\therefore R_i = \frac{R_g}{1 - (M'/2)}$$

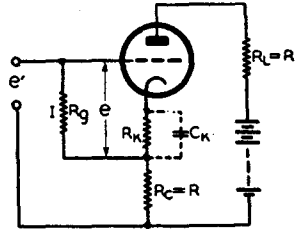

Figure 6

If $M' = 1.8$ then $R_i = 10 R_g$.

When $R_L = 0$ as for cathode loading, $R_i = R_g / (1 - M')$, where M' is calculated on R_g as total load.

If $M' = 0.9$ then $R_i = 10 R_g$.

Application of Negative Feedback

There are many methods of applying Negative Feedback, but reference can only be made to a few. When a single power valve is used with transformer coupling to its grid, the circuit of Fig. 7 may be used. In this circuit the feedback factor $\beta = R_2 / (R_1 + R_2)$, provided that the reactance of C is negligible.

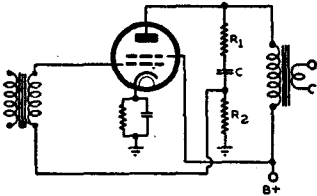

Figure 7

When two valves are used in push-pull with transformer coupling there is a tendency for positive feedback to occur at certain frequencies, possibly resulting in instability. By means of a special design of transformer* it is possible to avoid this instability but the cost is considerable as compared with that for resistance coupling. Alternatively the secondary sections of the transformer may be shunted by a resistance and capacitance in parallel, the values of both components being selected by trial. On account of the cost of a special transformer together with the risk of instability due to unpredictable effects of varying transformer construction, resistance coupling is to be preferred.

With resistance coupling either Series or Parallel Feedback may be used. A simple type of parallel feedback is shown in Fig. 8. The feedback factor is approximately $R / (R + R_2)$ where R is the resultant impedance of R_1 in parallel with the plate resistance and load resistance of the preceding valve. A serious disadvantage of this arrangement is that the input impedance of the power valve is made very low, and C_1 must be increased in capacitance to provide adequate bass response. C_2 is merely a blocking condenser. An improved parallel arrangement is shown in Fig. 9. In this the feedback factor is approximately $R / (R + R_2)$ where

$$R = \frac{1}{\frac{1}{r_{p1}} + \frac{1}{R_1} + \frac{1}{R_2}}$$

*Radiotronics 76 (26th May, 1937), pp. 42-44.

With all forms of parallel feedback it is found that as the feedback factor is increased, a critical value will be reached at which the amplification is zero and the attenuation of the stage is therefore infinite. This

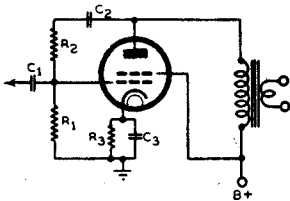

Figure 8

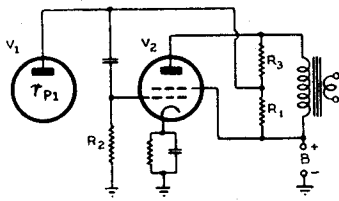

Figure 9

effect has been used for the purpose of attenuation, but is not normally encountered with practical amplifiers. The approximate formulae given for the feedback factor should be applied only for small values of feedback.

A particularly satisfactory arrangement is the Series Feedback Circuit (Fig. 10). In this, the feedback factor is

$$\frac{R_s}{R_s + R_L} \cdot \frac{R_2}{R_1 \left(\frac{R_2}{R_s + R_L} + 1 \right) + R_2}$$

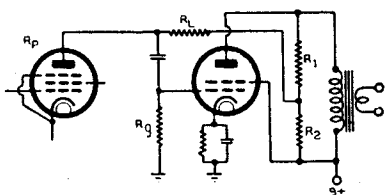

Figure 10

where $R_s = \frac{r_p \cdot R_g}{r_p + R_g}$

If $(R_s + R_L) \gg R_2$, as is generally the case, the feedback factor is approximately

$$\frac{R_s}{R_s + R_L} \cdot \frac{R_2}{R_1 + R_2}$$

The Series Feedback Circuit has been fully described elsewhere*.

All these methods of obtaining Negative Feedback with resistance coupling are best used with a pentode in the preceding stage. This is because

1. There is less shunting of the feedback voltage due to the plate resistance of this valve.
2. A pentode may be used with any value of load resistance without serious distortion, while a triode valve gives serious distortion when the load resistance is decreased much below the plate resistance; in the extreme case the triode may even reach plate current cutoff during part of the cycle and the distortion is then very distressing,
3. The gain of the pentode is inherently higher, so that an appreciable gain reduction still leaves a reasonable stage gain, whereas an additional stage may be required with triodes.

*Radiotronics 74 (31st March, 1937), p. 18. Radiotronics 81 (15th November, 1937), p. 87. Wireless World (17th November, 1938), pp. 437-438.

Negative Feedback with a resistance coupled push-pull amplifier may introduce instability at certain (usually very low) frequencies. The circuit shown in Fig. 11, in which feedback is taken over three stages to the screen of the first stage, is normally free from instability. However, as the feedback voltage is taken from only one side of the output transformer, there should be tight coupling between the two halves of the primary, although on a resistive load it is probable that this circuit would be regenerative at very low and very high frequencies, as described earlier in the Chapter, it is found on a loudspeaker load that no trouble is normally experienced. The small condenser (100 μF .) from the plate of the first valve to earth has the effect of avoiding high frequency parasitics due to lack of balance in the output transformer.

With the preceding arrangement any unbalance in the circuit, or imperfect coupling between the two halves of the transformer primary, has the effect of increasing the overall distortion, even though it may still be much less than without feedback. An improvement may be effected by

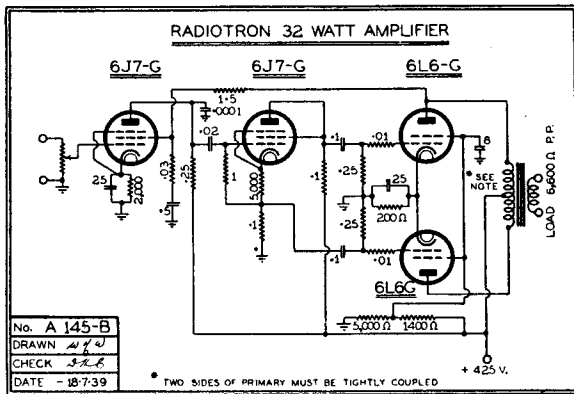

Figure 11

taking the feedback voltage from both plates to suitable points in the circuit. Care should be taken to avoid instability which may arise if there is any mutual coupling between the two sides of the amplifier.

In the circuit of Fig. 11, if $\mu g_1 g_2$ is the amplification factor of the first valve from g_1 to g_2 , the feedback factor will be

$$\beta = \frac{R_1}{R_1 + R_2} \cdot \frac{1}{\mu g_1 g_2}$$

referred to the grid of the first stage

where R_1 = resistance from screen to blocking condenser (in this case 0.03 megohm)

and R_2 = resistance from screen to plate of output stage (in this case 1.5 megohm).

If the value of $\mu g_1 g_2$ is not available, it may be taken as approximately equal to the triode amplification factor μ_t . Its value may be determined by direct measurement on a valve bridge, or may be calculated in certain cases from published curves. In applying the usual formulae, the gain (M) must then be calculated from the grid of the first stage to one plate of the output stage (see Chapter 8).

One of the outstanding advantages of this circuit is that, since the feedback is essentially external to the amplifier proper, each stage is only required to deliver the same output voltage as would be the case without feedback.

DESIGN DATA FOR NEGATIVE VOLTAGE FEEDBACK

Let β = fraction of output fed back to the grid, being negative for negative feedback,

R_o = effective plate resistance with feedback,

μ' = effective amplification factor with feedback,

M = voltage gain of stage at one frequency without feedback,

M' = voltage gain of stage at one frequency with feedback,

N = voltage gain of stage at a second frequency, without feedback,

N' = voltage gain of stage at the second frequency with feedback,

μ = amplification factor of valve,

g_m = mutual conductance of valve,

r_p = plate resistance of valve,

D = harmonic distortion without feedback,

D' = harmonic distortion with feedback,

f_1 = frequency below the middle range at which the attenuation without feedback is x db,

f_2 = frequency above the middle range at which the attenuation without feedback is x db,

f_1' = frequency below the middle range at which the attenuation with feedback is x db,

and f_2' = frequency above the middle range at which the attenuation with feedback is x db.

Formulae

$$\mu' = \frac{1}{(1/\mu) - \beta} = \text{approximately, } - \frac{1}{\beta}$$

$$R_o = \frac{1}{(1/r_p) - \beta \cdot g_m} = \text{approximately, } - \frac{1}{\beta \cdot g_m}$$

$$\beta = - \frac{1 - (R_o/r_p)}{R_o \cdot g_m} = \text{approximately, } - \frac{1}{R_o \cdot g_m}$$

$$\frac{M}{M'} = 1 - \beta \cdot M = \text{gain reduction factor}$$

$$M' = \frac{M}{\text{gain reduction factor}}$$

$$M' = \frac{M}{1 - \beta M}$$

$$\beta = - \frac{M - M'}{MM'}$$

To reduce gain to half (i.e. $M/M' = 2$) :- $\beta = - 1/M$

$$D' = \frac{D}{1 - \beta M} \text{ approximately}$$

$$\frac{M'}{N'} = \frac{M}{N} \cdot \frac{1 - \beta N}{1 - \beta M}$$

$$f_1' = \frac{f_1}{1 - \beta M}$$

$$f_2' = f_2 (1 - \beta M)$$

$$\text{Power Sensitivity} = \frac{\text{Power sensitivity without feedback}}{(\text{gain reduction factor})^2}$$

DESIGN DATA FOR NEGATIVE CURRENT FEEDBACK

Let $R_c =$ portion of load ($R_L + R_c$) common to both input and output circuits,

$R_L =$ portion of load solely in output circuit,

$R_g =$ grid resistor from grid to cathode,

$\mu =$ amplification factor of valve,

$r_p =$ plate resistance of valve,

$R_o =$ effective plate resistance with feedback,

and $M' =$ gain with feedback (output voltage taken across $R_L + R_c$).

Formulae

$$R_o = r_p + \mu R_c$$

$$M' = \frac{\mu (R_c + R_L)}{R_c (\mu + 1) + R_L + r_p} \dots \text{for general case}$$

$$M' = \frac{2\mu R}{R(\mu + 2) + r_p} \dots \text{for phase splitter} \quad (R_c = R_L = R)$$

$$M' = \frac{\mu R}{R(\mu + 1) + r_p} \dots \text{for cathode loading} \quad (R_c = R \text{ and } R_L = 0)$$

Input resistance of phase splitter

$$= \frac{R_g}{\left(1 - \frac{M'}{2}\right)}$$

$$= 10 R_g \text{ when } M' = 1.8.$$

Editor's Note

Since the preparation of this chapter, a careful investigation has been made of a stage having a divided plate load resistance (Fig. 5). One result of the investigation (which has not yet been published) is to show that the cathode portion of the load resistance (R_c) is subject to negative voltage feedback, while the plate portion (R_L) is subject to negative current feedback. The output resistance across R_L is given by

$$R_o = r_p + (\mu + 1) R_c$$

while that across R_c is given by

$$R_o = \frac{1}{g_m + 1/R_c + \frac{1}{r_p + R_L}}$$

or when $R_L = 0$ as for cathode loading,

$$R_o = \frac{1}{g_m + \frac{1}{R_c} + \frac{1}{r_p}}$$

which is approximately equal to the inverse of the mutual conductance.

CHAPTER 7

Miller Effect

The Miller Effect — with resistive load — example — with partially reactive load — effect on tuned R.F. amplifier — change of input capacitance with grid bias — method of avoiding change of input capacitance with grid bias — automatic tone control.

Miller Effect

The grid input impedance of a valve with a load in the plate circuit is different from its input impedance with zero plate load: This effect is known as the Miller Effect. If the load in the plate circuit is a resistance, the input impedance is purely capacitive, but if the load impedance has a reactive component the input impedance will have a resistive component.

The case for a resistive load is readily calculated with reference to Fig. 1. The voltage on the grid is e_s , and therefore the voltage on the plate is $-M \cdot e_s$, where M is the voltage gain from grid to plate. The difference in voltage between grid and plate is therefore

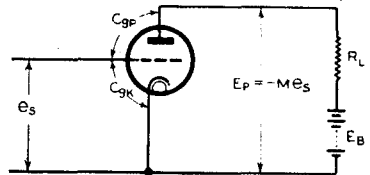

Figure 1

$$e_s - (-M \cdot e_s) \text{ or } e_s (M + 1).$$

In any condenser, $Q = C.E.$ and therefore the charge on the grid due to the grid-cathode capacitance C_{gk} is $q_1 = C_{gk} \cdot e_s$.

In a similar manner the charge on the grid due to the grid plate capacitance C_{gp} and the potential difference $e_s (M + 1)$ is $q_2 = C_{gp} (M + 1) e_s$.

$$\therefore q_1 + q_2 = [C_{gk} + (M + 1) C_{gp}] e_s$$

The input capacitance corresponding to a charge of $(q_1 + q_2)$ is therefore

$$C_i = C_{gk} + (M + 1) C_{gp} \tag{1}$$

As a practical example take a 6B6-G (75) valve with

$$C_{gk} = 1.7 \mu\mu F$$

$$C_{gp} = 1.7 \mu\mu F$$

and $M = 60$ times.

$$\begin{aligned} \text{We have therefore } C_i &= 1.7 + (60 + 1) 1.7 \mu\mu F \\ &= 1.7 + 61 \times 1.7 \\ &= 105 \mu\mu F, \end{aligned}$$

which is 31 times the input capacitance with no load in the plate circuit. The fact that the input capacitance of a pentode valve is very much less

than that of a high- μ triode is one reason why pentodes are often preferred as A.F. amplifiers. In all practical cases, of course, the stray capacitance from grid to plate should also be considered.

When the load is partially reactive the input impedance is equivalent to that of a capacitance C' and a resistance R' in parallel from grid to cathode where

$$C' = C_{gk} + (1 + M \cos \theta) C_{gp} \quad (2)$$

$$R' = - \left(\frac{1}{2\pi f C_{gp} M \sin \theta} \right) \quad (3)$$

and θ is the angle by which the voltage across the load impedance leads the equivalent voltage acting in the plate circuit (θ will be positive for an inductive load).*

When $\theta = 0$, $\sin \theta = 0$ and $\cos \theta = 1$, and these two expressions become similar to the results previously obtained for a resistive load (1). When the load is inductive, R' is negative and self-oscillation may occur. When the load is capacitive, R' is positive and there is reduced tendency to instability. When the load is purely reactive the input capacitance becomes the same as for no load ($C' = C_{gk} + C_{gp}$).

With an R.F. amplifier having a tuned plate circuit, when tuned to resonance the load is resistive and the input capacitance is given by (1); when tuned to a frequency lower than the resonant frequency the load becomes inductive, the input capacitance decreases, and the input resistance becomes negative and tends to cause self-oscillation; when tuned to a frequency higher than the resonant frequency the load becomes partially capacitive, the input capacitance decreases, and the input resistance becomes positive.

One of the results of the Miller Effect is that in an R.F. or I.F. amplifier with A.V.C. applied to the signal grid, the capacitance across the tuned grid circuit varies with the signal strength and a certain amount of detuning occurs. In such amplifiers it is usually satisfactory to align the tuned circuits on a weak signal and to accept the detuning on strong signals. However in a sharply tuned (e.g., I.F.) amplifier, it is desirable to adopt a tuning capacitance of not less than 100 $\mu\mu\text{F}$, and a value of 200 $\mu\mu\text{F}$ is frequently adopted because, amongst other reasons, it more completely "swamps" the change of input capacitance. In a variable selectivity I.F. Amplifier the Miller Effect is undesirable, and it is preferable to employ a low gain (low M) buffer stage to which A.V.C. may be applied without appreciable detuning.

Negative Feedback may be used ** to compensate for this change in input capacitance. An unbypassed cathode resistor of suitable resistance provides negative current feedback which gives approximately constant input capacitance with change of grid bias when

$$R_k = \frac{(C_s + C_f)}{C_{gk} \cdot g_{1k}}$$

where R_k = cathode resistor,

C_s = increase in input capacitance due to space charge,

*For derivation see F. E. Terman "Radio Engineering," pp. 231-233, McGraw-Hill, Second Edition (1937); also Bibliography at end of Chapter.

**R. L. Freeman "Use of feedback to compensate for vacuum-tube input capacitance variations with grid bias," Proc. I.R.E., Vol. 26, pp. 1360-1366; November (1938)

C_r = increase in input capacitance due to feedback through C_{gp} ,
 and g_{rk} = transconductance between the grid and all other elements
 whose current flows through R_k .

It will be seen that not only the effect of feedback through C_{gp} , but also the change in input capacitance due to space charge, are avoided by a suitable selection of R_k . Fortunately it is found that the required value of R_k is very close to the value required for self-bias, so that all that is necessary in many cases is to omit the cathode bypass condenser. This results in a loss of gain, but its use may frequently be justified by the advantages conferred in the way of constancy of input capacitance, increased plate resistance and improved stability. When this arrangement is used, it may be found practicable to decrease the tuning capacitance of the I.F. transformers and obtain increased transformer gain and selectivity which may partly offset the loss of valve gain. Alternatively the cathode resistor may be included in the secondary circuit of the input transformer by returning the condenser to cathode and the inductance to earth, but in this case the resistance should be only about 10 or 20 ohms. With the latter arrangement the loss of valve gain is negligibly small.

The Miller Effect may be utilised to provide Automatic Tone Control in an audio A.V.C. stage. An artificial increase in C_{gp} is made by the addition of a small condenser, and the input capacitance, being approximately proportional to the gain, varies from $(C_{gk} + C_{gp})$ to $[C_{gk} + (M + 1) C_{gp}]$. Since the highest input capacitance occurs with weak signals there is a consequent attenuation of the higher audio frequencies on weak signals similar to that provided by the conventional manual tone control. The principal difficulty in the application of this arrangement is to obtain sufficient variation of M through audio A.V.C. action, without introducing distortion and overloading elsewhere in the circuit.

One of the most valuable applications of the Miller Effect is to the Control Valve or Electronic Reactance used in A.F.C. Circuits (see under Automatic Frequency Control).

Bibliography

Historical

- J. M. Miller, Bureau of Standards Bulletin, No. 351 (1919),
 H. W. Nichols, Physical Review, p. 405, Vol. 13 (1919),
 Stuart Ballantine, Physical Review, p. 409, Vol. 15 (1920).

For Reference

- E. L. Chaffee, "Theory of Thermionic Vacuum Tubes," pp. 272-280,
 McGraw Hill (1933),
 F. E. Terman, "Radio Engineering," pp. 231-238, Second Edition,
 McGraw Hill (1937),
 H. J. Reich, "Theory and Applications of Electron Tubes," pp. 85-88,
 McGraw Hill (1937)
 and various articles in Wireless Engineer, Proc. I.R.E., and other periodicals.
 See also Chapter 14 (Radio Frequency Amplifiers) under "Input Loading of Receiving Valves at Radio Frequencies."

CHAPTER 8

Audio Amplifier Design

Input and output specifications — Examples of design — (1) Amplifier with triode output — (2) Amplifier with pentode output — (3) Push-pull amplifier with triode output stage — (4) Push-pull amplifier with pentode output stage — (5) Single beam power tetrode with feedback — Frequency Response — Examples — Equivalent Circuits for resistance capacitance amplifiers.

Amplifier Design

In this chapter it is proposed to give an outline of the methods to be used in the accurate design of amplifiers on the basis of information which is available to the radio engineer. A high degree of accuracy is possible and there is no reason for leaving to chance the gain, frequency response or distortion of an amplifier.

The first step in the design of an amplifier is to set out the input voltage and output power which are required for the particular application. If these values are given in terms of decibels it is recommended that they be converted into volts and watts respectively before commencing the design. Reference may be made to the chapter on decibels for remarks on errors which are possible in decibel calculations and which are likely to be encountered in practice. Since the rating of microphones and similar sources of input voltage is often misunderstood, it is suggested that in place of these published ratings the approximate input voltage from the chosen microphone or pick-up should be determined. In order to allow for variations in recording, or distance from the microphone, it is preferable to allow an amplifier voltage gain of three or four times the calculated minimum gain. An attenuator (volume control) in the amplifier may then be used to give any desired gain.

A number of examples are given, and it is suggested that the general method of such calculations be followed if accuracy is desired.

Gain

Example 1. Amplifier with Triode Output

Let us assume that an output of 3.5 watts is required from a triode. The obvious choice will be a 2A3 valve which gives an output power of 3.5 watts with a load of 2,500 ohms, a plate voltage of 250 volts, and a grid bias of -45 volts. Actually the peak grid voltage for the commencement of grid current will be less than 45 volts since the filament is directly heated and the centre tap returned to earth, but it will be convenient to work to the value of 45 volts. If self-bias is used, and it is recommended

that it should be used in every case where permissible, the maximum grid resistor is 0.5 megohm; in order to suit this resistor, the coupling condenser may be $0.05 \mu\text{F}$. (see Chapter 1). It is now necessary to consider a suitable earlier stage capable of delivering 45 volts peak into a load of 0.5 megohm.

Type 6J7-G (6C6), with 250 volts supply, plate load resistance 0.25 megohm, screen dropping resistor 1.5 megohm, cathode resistor 2,000 ohms and following grid resistor 0.5 megohm, gives a gain of 125 times at 0.25 volt R.M.S. input, these values being obtained from the Radiotron data sheet on Resistance Coupled Pentodes. Suitable values of by-pass condensers are $0.5 \mu\text{F}$. from screen to earth and $25 \mu\text{F}$. from cathode to earth. The input voltage will be $45/125 = 0.36$ volt peak. The grid resistor of the 6C6 should not exceed 1 megohm maximum; values of 1.0 or 0.5 megohm could be used. The coupling condenser may be $0.02 \mu\text{F}$. for 1 megohm or $0.05 \mu\text{F}$. for 0.5 megohm. The input voltage of this stage is suitable for an ordinary magnetic type of pick-up and the grid resistor may be made the volume control. A crystal pick-up may also be used but the volume control will need to be turned down lower than with a magnetic pick-up owing to the greater output voltage. Note that no decoupling is required with a two stage amplifier (see Chapter 4).

If it is desired to operate the amplifier from a microphone it will be necessary to add a preamplifying stage which may consist of a second 6J7-G (6C6) valve. Since this makes three stages in all, it will be necessary to decouple one stage which may be the first stage. With the same operating data as for the second stage and with a 1 megohm resistor following, the gain will be 150 times and the input voltage $0.36/150 = 0.0024$ volt peak. If a 0.5 megohm resistor is used for the following valve, this voltage will be $0.36/125 = 0.0029$ volt peak. Since the output of a crystal microphone of the sensitive (diaphragm) type is approximately 0.01 volt R.M.S., it will be seen that the voltage gain of the amplifier is five or six times as high as is necessary for the full power output specified. If the specified load resistance for the microphone is 5 megohms and only 2 megohms are inserted in the grid circuit of the first valve, it will then be necessary to insert 3 megohms in series with the microphone so that the input voltage to the amplifier will therefore be $2/(2 + 3)$ or 0.4 of the voltage developed by the microphone. Alternatively a 5 megohm grid resistor may be used, and the heater voltage reduced to 4.5 volts. For further information see Chapter 11.

It is necessary to insert in the amplifier a volume control which should not be in the first stage since the level is too low and noise may be encountered. It is suggested that this control should be in the second stage where it may form the control either for microphone or for pick-up input.

The amplifier thus consists of three stages and the inputs to the first and second stages are 0.0024 and 0.36 volt peak, respectively. The distortion in the first stage will be negligible since the level is so low, while in the second stage the output voltage is well under the maximum output voltage (which is given for 3% distortion) and the distortion may therefore again be neglected. The sole remaining distortion is therefore that of the power stage which is approximately 5% second harmonic distortion and negligible third and higher harmonic distortion on a resistive load. On a loudspeaker load the distortion will vary with frequency, but normally will never exceed 5% over the audio frequency range.

Example 2. Amplifier with Single Pentode Valve Output

The method to be adopted in this case is identical with that of Example 1.

Example 3. Push-Pull Amplifier with Triode Output Stage

(See Chapter 1, Fig. 11, for circuit diagram)

Let us assume that an output of 7 watts is required; in this case two type 2A3's in Class A1 push-pull will be suitable. Reference to the characteristics shows that the load resistance plate to plate should be 5,000 ohms and the input voltage 90 volts peak from grid to grid. If self-bias is used the grid resistor may be 0.5 megohm and the coupling condenser may be $0.05 \mu\text{F}$. for each grid. A resistance coupled phase splitter is recommended in preference to a transformer, and if one having equal plate and cathode resistors is adopted, it may be treated (so far as its output voltage is concerned) as a straightforward resistance-coupled amplifier working into a total load equal to the sum of the cathode and plate load resistors. Type 6J7-G (6C6) connected as a triode is suitable for this position but any other general-purpose triode could be used with no appreciable difference in either gain or output. Reference to the table of resistance coupled amplifiers* shows that a peak output of 88 volts is obtainable with a supply of 300 volts, but since this is barely sufficient for requirements the supply voltage should be increased to 400 volts, which will decrease the distortion in the stage and also allow for decoupling, if required. Loads of 0.05 megohm in cathode and plate circuits give a total load of 0.1 megohm; a decoupling resistor of one-fifth this value, namely, 20,000 ohms, is suitable. For this load a cathode resistor of 4,000 ohms has been found suitable. The gain is approximately 1.8 times from the input (grid of the phase changer to earth) to the output (from grid to grid). The input voltage is therefore $90/1.8 = 50$ volts peak from grid to earth. Note that the input voltage from grid to cathode will be 5 volts peak and that there will be no overloading in this stage due to grid current since the remaining 45 volts peak of the input go towards counteracting the degenerative voltage in the cathode resistor. If a 1 megohm grid resistor were used for the phase splitting stage, this would be returned to the junction of the cathode bias resistor and the 0.05 megohm cathode load, and the input impedance of the stage would then be 10 megohms owing to negative current feedback (see Chapter 6). The coupling condenser therefore need only be $0.005 \mu\text{F}$. but it is suggested that as $0.05 \mu\text{F}$. is used for other stages, its use should be standardised although such a high capacitance is not necessary.

An additional stage is required before a pick-up can be operated, and a second type 6J7-G (6C6) is recommended as a resistance coupled pentode. The gain is given in the table as 150 times with a grid resistor of 1 megohm for the following stage, and it will therefore be slightly greater than 150 times with 10 megohms. The input voltage is therefore approximately $50/150$ or 0.33 volt peak, which is within the capabilities of most pick-ups. If a volume control be included in the amplifier it is suggested that it be incorporated in this grid circuit.

If a preceding stage is required for operation from a microphone, the same method may be adopted as for Example 1.

Example 4. Push-Pull Amplifier with Pentode Output

The treatment of this amplifier is identical to that for Example 3.

Example 5. Single Beam Power Tetrode with Feedback

(See Chapter 6, Fig. 10, for circuit diagram)

In order to demonstrate the method by which the gain of an amplifier with feedback is calculated, let us assume a 6V6-G valve and the "series feedback" circuit. This valve gives 4.25 watts output into a load of 5,000 ohms with 12.5 volts peak grid input voltage. Firstly it is necessary to

*Radiotron loose-leaf valve data book.

calculate the gain of the preceding stage without feedback. Since the 6V6-G grid resistor is limited to 0.5 megohm with self bias, the gain of a 6J7-G (6C6) stage will be 125 times, and the input to its grid 12.5/125 or 0.1 volt peak. Since this gain is unnecessarily high, a gain reduction factor of 2 or 3 times due to feedback is quite permissible. Since it is the gain reduction factor and not the percentage of feedback which is important it is now necessary to choose a percentage of feedback to give such a gain reduction factor. Since the load resistance is 5,000 ohms, let us assume that the percentage of feedback is sufficient to reduce the effective plate resistance to 2,500 ohms (i.e., $R_L/r_p = 2$) to be comparable with a triode. Reference to Chapter 6 gives the approximate formula: The feedback factor β is given by

$$\beta = -1/(R_o \cdot g_m)$$

where R_o is the effective plate resistance in ohms (2,500 ohms)
and g_m is the mutual conductance in mhos (4,100 μ mhos or 0.0041 mho).

This formula gives $\beta = -0.098$ or -9.8% approximately. The gain reduction factor is $(1 - \beta M)$ where M is the voltage gain of the 6V6-G from grid to plate under working conditions without feedback. The peak grid voltage is 12.5 volts for 4.25 watts output into 5,000 ohms, and therefore the audio plate voltage is $\sqrt{4.25 \times 5,000}$ or 146 volts R.M.S. which is equivalent to $146 \sqrt{2}$ or 206 volts peak. The voltage gain is therefore $206/12.5$ or 16.5. The gain reduction factor $(1 - \beta M)$ is therefore $1 + 0.098 \times 16.5$ which is 2.62 times approximately. If the accurate formula given in Chapter 6 had been used the gain reduction factor would have been calculated as 2.53 so that the error due to the approximate formula is small. The voltage input to the 6J7-G (6C6) is therefore 0.1×2.53 or 0.253 volt peak (0.179 volt R.M.S.), the gain reduction factor 2.53 and the effective plate resistance half the load resistance. The distortion produced by a 6V6-G with a resistive load is given as 4.5% second harmonic and 3.5% third harmonic; since the distortion is reduced by a factor equal to the inverse of the gain reduction factor, the distortion with feedback will be approximately $4.5/2.53$ or 1.78% second harmonic and $3.5/2.53$ or 1.38% third harmonic. On a loudspeaker load the distortion will vary with frequency but will not rise much above these levels over the audio range.

In order to provide 9.8% feedback, the voltage divider across the load must be such as to allow for the shunting effect of the grid resistor (0.5 megohm) and the plate resistance of the preceding valve under working conditions (say 4 megohms) in parallel, or an effective shunt of 0.445 megohm from grid to earth. The feedback voltage at the grid is therefore $0.445/(0.445 + 0.25)$ or 0.64 of the voltage fed back from the voltage divider connected across the load. The voltage divider across the load must therefore feed back $9.8/0.64$ or 15.3% of the audio plate voltage. The total resistance of the voltage divider should be high compared with the load resistance. Suitable resistances are 9,000 and 50,000 ohms. If a higher input voltage is permissible the percentage of feedback may be increased up to 20% as desired.

Example 6. Push-Pull Beam Tetrodes with Feedback

When it is desired to use push-pull beam tetrodes with feedback, the calculation depends largely on the circuit arrangement. The circuit of Fig. 11 of Chapter 6 will be adopted for this example. Let us assume that an output of 32 watts is required from 6L6-G valves with self-bias. A peak grid voltage of 28.5 volts is required for each valve for self-bias operation giving 32 watts into a load of 6,600 ohms plate to plate. If no feedback is used and the first stage is a 6J7-G (6C6) resistance coupled pentode and the second stage a similar type connected as a triode phase splitter, the total gain from the first grid to one grid of the push-pull stage will be

approximately 150×0.9 or 135 times as in Example 3. The input voltage to the first grid will therefore be $28.5/135$ or 0.211 volt peak.

Let it be assumed that the feedback is taken from the appropriate 6L6-G plate through a voltage divider to the screen of the first valve. The gain in a 6J7-G (6C6) from control grid to screen is approximately 20 times, and therefore the gain from 6J7-G screen to one 6L6-G grid is $135/20$ or 6.75 times. The R.M.S. plate voltage of each 6L6-G at full output is calculated from the square root of half the power output times half the load resistance plate to plate, i.e. $\sqrt{16 \times 3,300} = 230$ volts R.M.S. or 325 volts peak. The gain in each 6L6-G is therefore $325/28.5$ or 11.4. The total gain from 6J7-G screen to one 6L6-G plate is therefore 6.75×11.4 or 77.

If a gain reduction factor of say 2 or 3 is required we may use the formula

$$\text{Gain reduction factor} = 1 - M\beta$$

where M = gain from 6J7-G screen to 6L6-G plate

and β = feedback factor (being negative for negative feedback).

If a voltage divider consisting of 30,000 ohms and 1.5 megohm is adopted for convenience, β will be $-0.03/1.53$ or -0.0196 and the gain reduction factor $1 + 77 \times 0.0196$ or 2.51. The input voltage will therefore be 0.211×2.51 or 0.53 volt peak, equivalent to 0.37 volt R.M.S. The input voltage for any other feedback factor may be calculated similarly, and the effective plate resistance may be calculated as in Example 5.

In the foregoing treatment it has been assumed that there is no shunting of the arm of the voltage divider between screen and earth, caused by the valve. Such shunting will result in a slight reduction in the effective feedback factor.

Frequency Response

In any amplifier it is necessary to commence at the output end and work towards the input in order to determine the frequency response.

EXAMPLE: To find the amplification of the circuit of Fig. 1 at 10,000 c/s. and at 50 c/s.

In this case the output valve is a 2A3 and the maximum output power is 3.5 watts into 2,500 ohms. The voltage across the load is therefore

$$\sqrt{3.5 \times 2,500} = 94 \text{ volts R.M.S., or } 132 \text{ volts peak.}$$

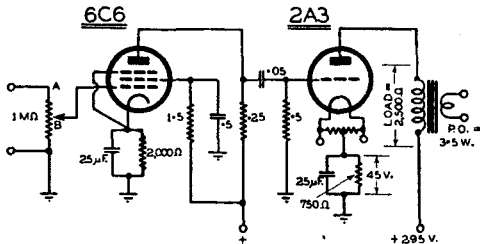

Figure 1

For this output a peak input voltage of 43 volts is required, and the voltage stage gain is $132/43$ or 3 approximately.

The interelectrode capacitances are

2A3: $C_{gt} = 9 \mu\mu\text{F.}$

$C_{gp} = 13 \mu\mu\text{F.}$

$C_{pt} = 4 \mu\mu\text{F.}$

6C6: $C_{input} = 5 \mu\mu\text{F.}$

$C_{sp} = 0.007 \text{ max. } \mu\mu\text{F.}$

$C_{output} = 6.5 \mu\mu\text{F.}$

The input capacitance of the 2A3 is therefore (see Chapter 7)

$$9 + [(3 + 1) \times 13] \text{ or } 61 \mu\mu\text{F.}$$

Allowing $7.5 \mu\mu\text{F.}$ for stray capacitances and adding $6.5 \mu\mu\text{F.}$ for the output capacitance of the 6C6, the total shunt capacitance across the input to the 2A3 is $75 \mu\mu\text{F.}$ At 10,000 c/s, the reactance (X_c) of $75 \mu\mu\text{F.}$ is 0.212 megohm.

The resistance of the load resistor (0.25 megohm) and the grid resistor (0.5 megohm) in parallel is

$$\frac{0.25 \times 0.5}{0.75}, \text{ or } 0.167 \text{ megohm.}$$

The ratio X_c/R_L is therefore 0.212/0.167 or 1.27. Reference to the Table of Shunt Capacitances (Chapter 9) gives, by interpolation $M'/M = 0.80$ approximately. The only other source of high frequency loss is in the input to the 6C6. The gain of the 6C6 stage is 125 times and the input capacitance is

$$5 + [(125 + 1) \times 0.007] \text{ or } 5.88 \mu\text{F. maximum.}$$

This is negligible at 10,000 c/s. even with an input source (Z) of very high impedance, while with a comparatively low value of Z the effect is still less. An interesting feature occurs with a low impedance input source when the volume control is moved. When the contact is at maximum (A, Fig. 1) the grid input impedance is the resultant impedance of Z and 1.0 megohm in parallel, this being lower than Z. The effect of even a large input capacitance is therefore quite slight. As the contact is moved towards the centre (B) the resistance from grid to earth may rise, and the point of greatest input resistance is the point of greatest high frequency attenuation.

In the case of Fig. 1 the input capacitance is so small that the effect of the input circuit on the high frequency response is negligible under all conditions. The overall response at 10,000 c/s. is therefore 80% of that at 400 c/s., this corresponding to a drop of 2 db. If less drop is desirable and a slight loss of average gain is permissible the 0.25 megohm plate load resistor might be reduced to 0.1 megohm. If the 2A3 were replaced by a pentode, or if the 6C6 were replaced by a general purpose triode, the high frequency loss in the coupling between the stages would be reduced. If however a high- μ triode were used in place of the 6C6, the input capacitance would be very high and high frequency loss would occur unless a low resistance grid input circuit were adopted.

The amplification at 50 c/s is affected by the 0.05 μF . grid coupling condenser and the three bypass condensers.

Grid Coupling Condenser

The reactance of 0.05 μF at 50 c/s is 63,700 ohms. This is in series with a total resistance of

$$R_g + \frac{r_p \times R_L}{r_p + R_L}$$

or in other words the grid resistor plus the combined resistance of the plate resistance and the load resistor in parallel. In this case

$$\begin{aligned} R_g &= 0.5 \text{ megohm} \\ r_p &= 4 \text{ megohms (approximately)} \\ R_L &= 0.25 \text{ megohm} \end{aligned}$$

and the total resistance is

$$0.5 + \frac{4 \times 0.25}{4.25} \text{ or } 0.74 \text{ megohm}$$

The input voltage to the 2A3 is therefore

$$\frac{0.74}{\sqrt{0.74^2 + 0.0637^2}}$$

or 0.996 of that at 400 c/s.

Cathode Bypass Condensers

The effect of the cathode bypass condenser of the 2A3 may be calculated from the formula given in Chapter 4.

$$\left| \frac{M''}{M} \right|^2 = \frac{1 + (\omega C_K \cdot R_K)^2}{(1 + aMR_K)^2 + (\omega C_K \cdot R_K)^2}$$

$$\begin{aligned} \text{where } a &= \frac{1}{M(R_L + r_p)} + \frac{1}{R_L} \\ &= \frac{1}{3(2500 + 800)} + \frac{1}{2500} = 0.0005 \end{aligned}$$

$$R_K = 750 \text{ ohms}$$

$$M = 3$$

$$\text{and } \omega C_K = 2\pi 50 \times 25 \times 10^{-6} = 0.00785.$$

$$\begin{aligned} \therefore (1 + aMR_K)^2 &= (1 + 0.0005 \times 3 \times 750)^2 = 4.52 \\ (\omega C_K R_K)^2 &= (0.00785 \times 750)^2 = 34.6 \end{aligned}$$

$$\therefore \left| \frac{M''}{M} \right|^2 = \frac{1 + 34.6}{4.52 + 34.6} = \frac{35.6}{39.12} = 0.91$$

$$\therefore \left| \frac{M''}{M} \right| = 0.954$$

The effect of the cathode bypass condenser of the 6C6 stage may be calculated similarly. In this case

$$a = 1/R_L \text{ approx.} = 4 \times 10^{-6} \text{ approx.}$$

$$R_K = 2000 \text{ ohms}$$

$$M = 125$$

$$\text{and } \omega C_K = 2\pi 50 \times 25 \times 10^{-6} = 0.00785.$$

$$\begin{aligned} \therefore (1 + aMR_K)^2 &= (1 + 4 \times 10^{-6} \times 125 \times 2000)^2 = 4.0 \\ (\omega C_K R_K)^2 &= (0.00785 \times 2000)^2 = 246. \end{aligned}$$

$$\therefore \left| \frac{M''}{M} \right|^2 = \frac{1 + 246}{4 + 246} = 0.988$$

$$\therefore \left| \frac{M''}{M} \right| = 0.994$$

Screen Bypass Condenser

The effect of the screen bypass condenser of the 6C6 may be calculated from the formula given in Chapter 4.

$$\left| \frac{M'}{M} \right| = \sqrt{\frac{\alpha^2 + \alpha^2 R_s^2 \omega^2 C_s^2}{(\alpha + R_s)^2 + \alpha^2 R_s^2 \omega^2 C_s^2}}$$

where $R_s = 1.5 \text{ megohm} = 1.5 \times 10^6 \text{ ohms}$
 $\omega C_s = 2\pi 50 \times 0.5 \times 10^{-6} = 1.57 \times 10^{-4}$
 $\mu_t = 20 \text{ approximately}$
 $g_m = 750 \text{ } \mu\text{mhos} = 750 \times 10^{-6} \text{ mhos}$

$$\frac{i_p}{i_s} = \frac{2.0}{0.5} = 4$$

$$\alpha = \frac{\mu_t}{g_m} \times \frac{i_p}{i_s} \text{ approximately}$$

$$= \frac{20}{750 \times 10^{-6}} \times 4 = 1.07 \times 10^5 \text{ approx.}$$

$$\begin{aligned} \therefore \alpha^2 &= 1.145 \times 10^{10} \\ (\alpha + R_s)^2 &= 2.582 \times 10^{12} \\ \alpha^2 R_s^2 \omega^2 C_s^2 &= 5.798 \times 10^{14} \end{aligned}$$

$$\begin{aligned} \therefore \left| \frac{M'}{M} \right| &= \sqrt{\frac{1.145 \times 10^{10} + 5.798 \times 10^{14}}{2.582 \times 10^{12} + 5.798 \times 10^{14}}} \\ &= \sqrt{\frac{5.7981 \times 10^{14}}{5.8238 \times 10^{14}}} \\ &= \sqrt{0.99557} \\ &= 0.998 \end{aligned}$$

The total reduction of gain at 50 c/s is approximately the product of the four individual gain ratios

$$\text{i.e., } 0.996 \times 0.953 \times 0.994 \times 0.998 = 0.941$$

or approximately 0.5 db.

The gain of the complete amplifier is therefore approximately down 2 db. at 10,000 c/s and down 0.5 db. at 50 c/s.

Equivalent Circuits for Resistance Capacitance Amplifiers

Equivalent circuits are frequently of use in amplifier calculations. An equivalent circuit is generally restricted to audio (or radio) frequencies only, and no regard is paid to D.C. so that care is necessary to avoid errors due to misunderstanding. A valve may be considered as a generator of a constant voltage equal to $-\mu e_g$ in the plate circuit, the negative sign indicating the change of phase in the valve. The internal resistance of the "generator" is the plate resistance r_p . From this understanding the equivalent circuit for Fig. 2 may be evolved.

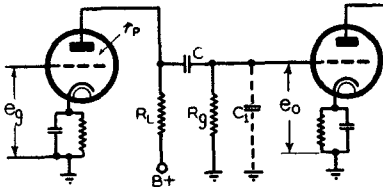

Figure 2

Fig. 3 shows one form of equivalent circuit at high frequencies when the reactance of C may be neglected. The load resistance R is obviously equal to that of R_L and R_z in parallel.

For certain purposes it is sometimes convenient to adopt a different form of equivalent circuit as shown in Fig. 4. In this arrangement the generator is assumed to deliver a constant current of $-g_m \cdot e_g$. In this case the load is equivalent to r_p , R_L and R_z in parallel. For further information see F. E. Terman "Radio Engineering" (Second Edition) McGraw-Hill 1937,

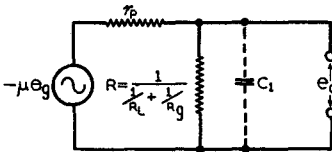

Figure 3

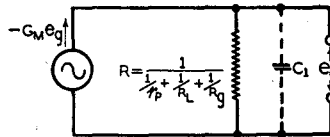

Figure 4

Page 172 et seq., also W. G. Dow "Fundamentals of Engineering Electronics," McGraw-Hill 1937, Pages 266, 281, 318 et seq., also W. A. Barclay "The Variation of Magnification with Pitch in Resistance Capacity Coupled Amplifiers," Wireless Engineer, Vol. 8, No. 94, pp. 362-369, July (1931).

CHAPTER 9

Tone Compensation and Tone Control

Types of Tone Compensation circuits — (a) Resonant — effect of plate resistance of preceding valve — method for increasing effective plate resistance — typical circuits and frequency characteristics — boosting at resonance — attenuation at resonance — effect on apparent volume — parallel-fed audio transformer — defects of resonant circuits — (b) Non-resonant circuits — using inductances — using combinations of resistance and capacitance — (1) shunt capacitance — (2) grid coupling condenser — (3) screen and cathode bypass condensers — (4) general filter circuit for constant voltage supply — (5) for constant current supply — (6) negative feedback — using tapping switch — selective harmonic distortion — to avoid effect on apparent volume — compensation for change in volume level — bass boosting for pick-up — Summary — Bibliography.

Tone Compensation and Tone Control

An "ideal" audio frequency amplifier is one having a response which is linear and level over the whole audio frequency range. It is sometimes desirable to control the frequency response so as to compensate for certain non-linear components such as pickups or loudspeakers, or to enable the listener to adjust the tone to suit his taste. Such methods of control are known by many names, such as Tone Compensation, Tone Control, and Bass Boosting.

There are various methods which may be used to obtain special forms of tone compensation. Complicated "electrical networks" with many component inductances, resistances and capacitances are used largely by telephone engineers, in broadcast transmitting stations, and for the compensation of high quality pickups; but their design is beyond the scope of this handbook.

Comparatively simple combinations of resistance, capacitance and inductance may be used, in conjunction with amplifying valves, to produce a fairly wide range of frequency characteristics. These combinations may be divided into two principal groups

- (a) Resonant
- (b) Non-resonant.

RESONANT types of tone compensation circuits incorporate values of inductance and capacitance which resonate within or close to the audio frequency range. Fig. 1 shows a parallel tuned resonant circuit L, C, in the grid

circuit of V_2 . At frequencies far from resonance, the presence of L and C has no appreciable effect. At resonance, however, the dynamic resistance of the tuned circuit becomes large, and the total impedance from the grid to V_2 to earth is increased. If R_1 is considerably less than the value of R_L and the plate resistance (r_p) of V_1 in parallel, there will be an increase in the gain of the amplifier at the resonant frequency. If, however, R_1 is nearly as great as, or greater than, R_L and r_p in parallel the effect at resonance will be slight. If V_1 is a resistance-coupled pentode, its plate resistance will be very great, and as a fair approximation may be regarded

as having no shunting effect in comparison with that of R_L . If, on the other hand, V_1 is a triode, then its plate resistance will normally be less than R_L , and R_1 must be considerably lower than r_p , for there to be any appreciable rise of output voltage at resonance. With a triode valve the load resistance should preferably be higher than the plate resistance, for if lower than the plate resistance there is danger of serious distortion unless the input voltage is very small. It is for these reasons that the circuit of Fig. 1 is more satisfactory with a pentode valve than with a triode.

A resistance inserted (point X in Fig. 1) between the plate of V_1 and the coupling condenser C_1 may be used with a triode valve to increase the effective "internal generator impedance" so as to be equivalent to the use of a pentode valve. This results in a serious drop in gain but may be permissible in certain cases. An equivalent arrangement is used in Figs. 11, 13, 15, 16 and 17 which are described later in this chapter.

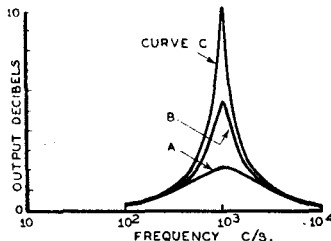
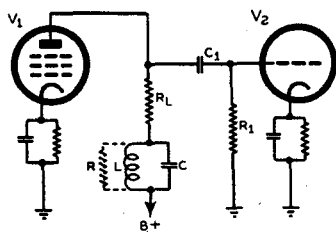

Figure 2 (left) and figure 3 (right). Frequency Characteristics in fig. 3 are obtained when $V_1 =$ Pentode; $R_L = 40,000$ ohms; $L = 2.5$ henries; $C = 0.01$ μ F.; $C_1 = 0.02$ μ F. or higher; $R_1 = 1.0$ megohm; and R is (curve C), infinity, (curve B), 50,000 ohms, (curve A), 15,000 ohms.

Fig. 2 is a variation of Fig. 1, with the resonant circuit in series with the plate load resistance. The increase of gain at resonance is only appreciable when R_L is considerably smaller than r_p and R_1 in parallel. For this reason the circuit of Fig. 2 is more suitable for use with a pentode than with a triode.

Fig. 3 shows the effect of a typical amplifier using a pentode valve for V_1 and the circuit of either Fig. 1 or Fig. 2. Three curves are shown, "A" corresponding to fairly heavy damping of the tuned circuit, "B" to

decreased damping, and "C" to minimum damping. In Fig. 1 the total shunt resistance across the tuned circuit, with the resistance R omitted, is

$$R_1 + \left(\frac{r_p R_L}{r_p + R_L} \right)$$

and in Fig. 2 it is

$$R_L + \left(\frac{r_p R_1}{r_p + R_1} \right)$$

The damping on the tuned circuit may be increased by the addition of the shunt resistance R shown in Figs. 1 and 2.

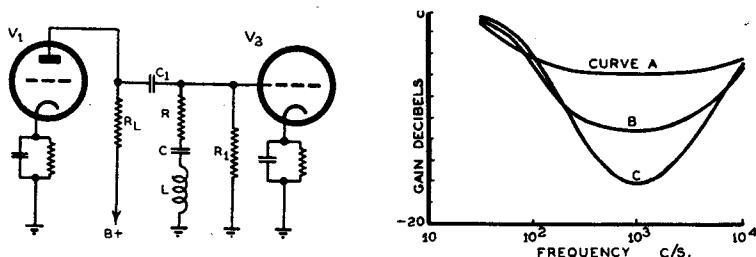

Figure 4 (left) and figure 5 (right). Frequency Characteristics in fig. 5 are obtained when $V_1 =$ Pentode; $R_L = 0.25$ megohm; $L = 2.5$ henries; $C = 0.01 \mu\text{F.}$; $C_1 = 0.5 \mu\text{F.}$ or higher; $R_1 = 1.0$ megohm; and R is (curve A), 0.2 megohm, (curve B), 75,000 ohms, (curve C), 35,000 ohms.

A series resonant circuit is shown in Fig. 4 and the corresponding frequency response curve in Fig. 5. At the resonant frequency the tuned circuit acts as an absorption filter and reduces the gain of the amplifier. Curves A, B, C in Fig. 5 correspond to varying values of the series resistance R. At resonance, the total load on the valve is approximately the resultant of R_L , R_1 and R in parallel. A pentode valve is desirable for V_1 , but a triode valve may be used provided that the input voltage is very low.

A slightly modified arrangement is shown in Fig. 6 with the corresponding experimental frequency response curves in Fig. 7. This arrangement may be used to compensate for the apparent loss of bass and treble when listening at a low volume level.

All simple methods of continuously-variable tone control have an effect on the apparent volume, and a movement of the tone control generally necessitates a further adjustment of the volume control. The effect may be seen clearly from Fig. 7 in which there is a loss of nearly 12 db at 1000 c/s. between curves A and C. This is because these circuits merely attenuate certain frequencies, and the maximum gain at any frequency must always be less than the maximum gain of the amplifier under normal conditions for resistance-coupling.

A special case of a resonant tone compensation circuit is that of a parallel-fed audio-frequency transformer, in which the frequency at which resonance occurs may be arranged to provide bass boosting, or to offset the bass attenuation due to low primary inductance (see Chapter 1).

There are certain defects in all resonant types of tone compensation circuits, among which are the following:—

- (1) If the resonant circuit be lightly damped there is a danger of distortion, particularly with transients. Any sudden electrical disturbance causes the tuned circuit to oscillate at its natural frequency. The lower the damping, the longer this undesirable oscillation persists before it has decayed to a negligible level.
- (2) The shape of the characteristic is such that, for light damping and hence for large rise in gain at the resonant frequency, the response is too sharply peaked.
- (3) The resonant frequency is often critical, and in such cases both the inductance and capacitance should be within rigidly narrow limits. The inductance of iron-core inductances varies with change of either direct-current or A.C. flux.
- (4) The inductance tends to pick up stray electromagnetic fields, and may give rise to hum, etc. Electrostatic screening (e.g. in aluminium can) is frequently of little value, while heavy iron shield cans are generally undesirable.

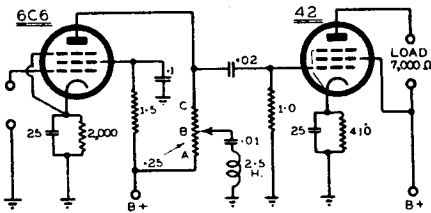
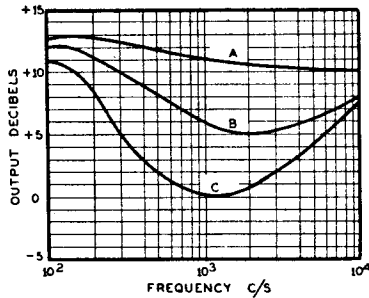

Figure 6 (above) and Figure 7 (right). Frequency characteristics shown in Fig. 7 correspond to positions A, B and C, respectively, of control in Fig. 6.



Non-Resonant Circuits

Non-resonant circuits including inductances have certain drawbacks compared with circuits using capacitances, among which are the following:—

- (1) The cost of inductances is very high compared with that of condensers for the values usually required.
- (2) Inductances resonate with the stray self and circuit capacitances causing a peak or dip which may fall within the desired range of uniform response.
- (3) Inductances are liable to pick up considerable hum voltages from a nearby power transformer, and are therefore unsuitable for use in the early stages of an amplifier.

On account of these defects, the following treatment will be limited to combinations of resistance and capacitance.

(1) Shunt Capacitance

One of the most common methods of tone control is to shunt the plate circuit of a valve by a capacitance, so as to attenuate the higher audio frequencies. The attenuation is a function of the plate resistance of the valve and the load resistance as well as of the frequency and capacitance.

The following formula may be used to calculate the relative amplification with and without a shunt capacitance:—

$$\left| \frac{M'}{M} \right| = \frac{1}{\sqrt{1 + (R^2/X_c^2)}}$$

$$\text{where } R = \frac{R_L \times r_p}{R_L + r_p},$$

R_L = total effective load resistance in plate circuit,

r_p = plate resistance of valve,

X_c = reactance of shunt capacitance across R_L ,

$$\text{and } X_c^2 = 1/\omega^2 C^2$$

In many cases this formula may be used directly, and is reasonably simple for slide-rule calculations. In cases in which there is a following grid resistor (R_g) as well as a plate load resistor (R_L). R_L should be taken as the resultant of R_L' and R_g in parallel. The formula may also be stated as a function of R_L/X_c provided that the ratio of R_L/r_p is known.

The following table has been calculated from this formula, and gives the relative gain with and without a shunt capacitance.

Table

Gain with capacitive shunt as a fraction of gain without shunt

$\frac{X_c}{R_L}$	M'/M			
	$R_L/r_p = 10$	$R_L/r_p = 5^*$	$R_L/r_p = 2^{**}$	Pentodes
0.05	0.48	0.29	0.15	0.05
0.10	0.74	0.51	0.29	0.10
0.20	0.91	0.77	0.51	0.20
0.30	0.957	0.87	0.67	0.29
0.40	0.974	0.92	0.77	0.37
0.50	0.983	0.95	0.83	0.45
0.60	0.988	0.96	0.87	0.51
0.80	0.994	0.98	0.92	0.63
1.0	0.996	0.986	0.95	0.71
2.0	0.999	0.997	0.986	0.90
5.0	0.9999	0.9995	0.998	0.98
10.0	0.99996	0.99986	0.9995	0.995
20.0	0.99999	0.99997	0.99986	0.999

*Suitable for most general purpose triodes.

**Suitable for most high- μ triodes.

(2) Grid Coupling Condenser

The low audio frequency attenuation due to a grid coupling condenser may be used for purposes of tone control where bass attenuation is required.

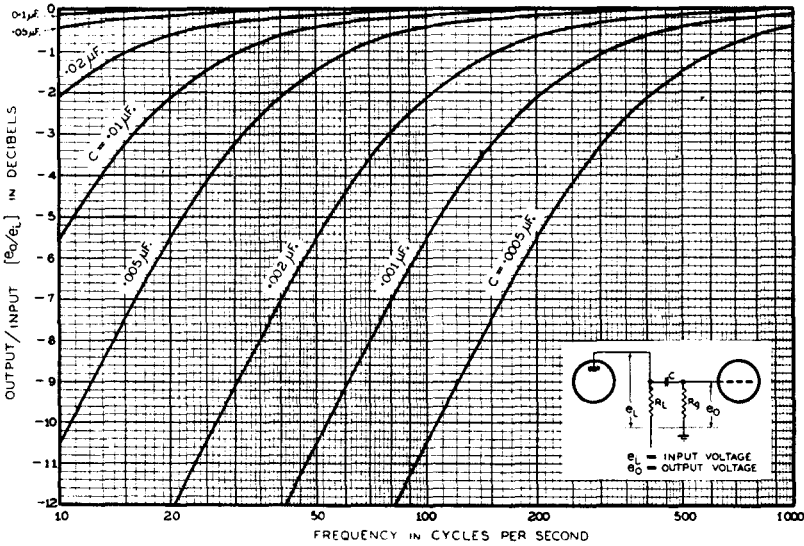

Figure 8. Frequency characteristics due to grid coupling condenser with a grid resistor (R_g) 1.0 megohm. It is assumed that the plate resistance and load resistance in parallel of the preceding valve are negligibly small in comparison with R_g . When this does not hold (as with a pentode valve in the preceding stage), the attenuation is less than is shown by the curves, but may be obtained accurately by making R_g represent the grid resistor, in series with r_p and R_L in parallel. These curves may be applied to any value of R_g by multiplying the values of C shown on the curves by a factor equal to that by which R_g is reduced (e.g., for $R_g = 0.5$ megohm multiply values of C by 2.).

ed. The calculation of the loss of gain is treated in Chapter 1, to which reference should be made. The attenuation curves obtained under typical conditions are shown in Fig. 8.

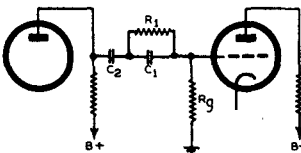

Figure 9

If the bass attenuation is required to be more gradual, or not to exceed a given value, the circuit of Fig. 9 may be used. In this circuit C_2 is a blocking condenser and may be large in comparison with C_1 . The resistor R_1 limits the loss of gain to the value

$$\frac{R_1}{R_1 + R_g}$$

at very low frequencies, neglecting the effect of C_2 . This circuit is a particular case of the general type to be considered.

Two or more stages having similar attenuation characteristics may be arranged in cascade to provide a steeper attenuation characteristic.

(3) Screen and Cathode Bypass Condensers for Tone Control

A low value of cathode bypass condenser results in limited* bass attenuation. A low value of screen bypass condenser results in bass attenuation, particularly when the screen supply is from a high resistance dropping resistor. A sharper attenuation characteristic may be obtained by adjusting both screen and cathode bypass capacitances to produce simultaneous commencement of attenuation at the specified frequency. A still sharper attenuation characteristic may be obtained by using two or more such stages in cascade, or by combining with the above arrangement the simultaneous commencement of attenuation due to the grid coupling condensers.

Reference should be made to Chapter 4 for the calculation of the attenuation due to inadequate screen and cathode bypassing.

(4) General Filter Circuit for Constant Voltage Supply

The circuit shown in Fig. 10 may be used for the purpose of obtaining many forms of tone compensation. The values of the six components may be varied as desired to provide bass boosting or attenuation as well as treble boosting or attenuation. It is to be understood that the choice of values extends from zero to infinity, this being equivalent to the optional short-circuiting or open-circuiting of any one or more resistors or condensers. This form of filter is intended for use with a constant input voltage (E_L). This holds approximately when a triode valve is used

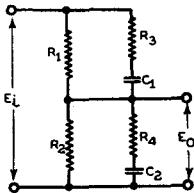

Figure 10. General filter circuit for constant voltage input. In the following treatment (Figures 11-18, inclusive), the values selected for the components as a basis for the frequency characteristics are:—

$$R_1 = R_2 = 0.1 \text{ megohm.}$$

$$R_3 = R_4 = 15,900 \text{ ohms.}$$

$$C_1 = C_2 = 0.01 \mu\text{F. (} X_c = 15,900 \text{ ohms at } 1,000 \text{ c/s.)}$$

to supply the input voltage provided that the minimum load presented to the valve is not less than about $5r_p$. A pentode valve may be used provided that the minimum load presented by the filter network is not less than five times the plate load resistor.

A number of special cases of this general circuit are shown in Figs. 11 to 19 inclusive.

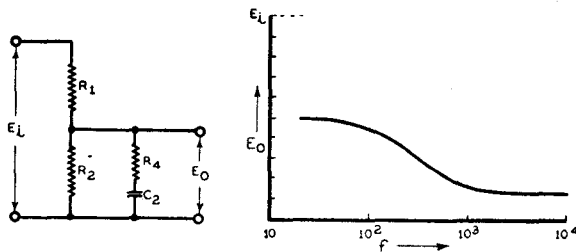

Figure 11

*Even with no bypass, the attenuation is limited since it is due to negative current feedback brought about by the cathode resistor being common to both input and output circuits (see Chapter 6). Under no conditions is infinite attenuation possible by this means.

Fig. 11 shows an arrangement which may be used for bass boosting or for limited treble attenuation. The curve of frequency response may be moved bodily to the left or to the right by increasing or decreasing respectively the capacitance of C_2 . The curve is asymptotic* to the values

$$E_o = E_i \left(\frac{R_2}{R_1 + R_2} \right) \text{ and } E_o = E_i \left(\frac{R_s}{R_1 + R_s} \right)$$

$$\text{where } R_s = \left(\frac{R_2 \cdot R_4}{R_2 + R_4} \right)$$

This network is equivalent to any valve (pentode or triode) in which R_1 represents the plate resistance, and R_2 represents the resultant of the plate load resistance and the grid resistance in parallel. Resistor R_2 (Fig. 11) may be in the form of a volume control.

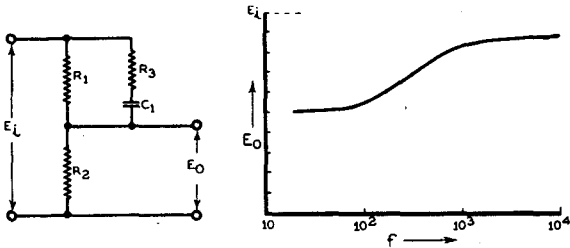

Figure 12

Fig. 12 is identical with Fig. 11 except that it is inverted, and may be used for limited bass attenuation or for limited treble boosting. The curve is asymptotic to the values

$$E_o = E_i \left(\frac{R_2}{R_s + R_2} \right) \text{ and } E_o = E_i \left(\frac{R_2}{R_1 + R_2} \right)$$

$$\text{where } R_s = \left(\frac{R_1 \cdot R_3}{R_1 + R_3} \right)$$

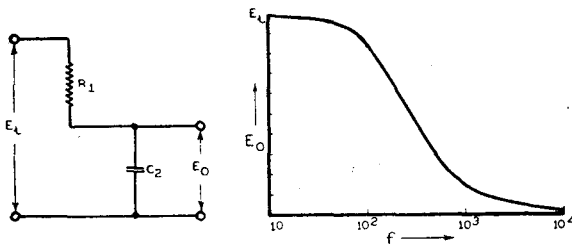

Figure 13

*A curve is asymptotic to a straight line when it approaches it gradually, but does not reach it except at an infinite distance.

Fig. 13 is a simple arrangement frequently used for treble attenuation. the curve is asymptotic to

$$E_o = E_i \text{ and } E_o = 0.$$

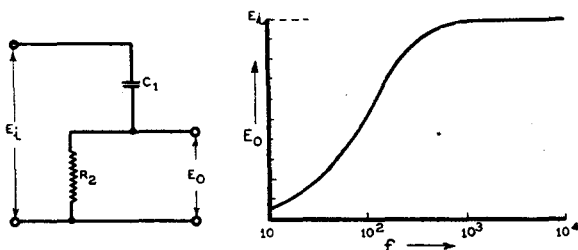

Figure 14

Fig. 14 is the inverse of Fig. 13 and may be used for bass attenuation. It is equivalent to the common arrangement in which C_1 is the grid coupling condenser and R_2 is the grid resistor. The curve is asymptotic to

$$E_o = E_i \text{ and } E_o = 0.$$

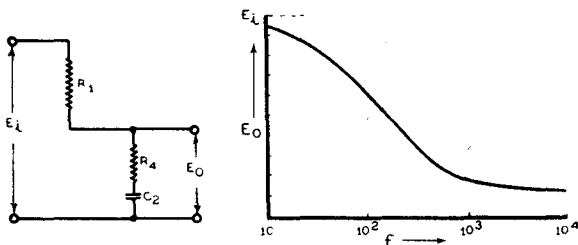

Figure 15

Fig. 15 is similar to Fig. 11 except that the resistor R_2 has been removed. This circuit is particularly useful for bass boosting, but has the disadvantage that there is no resistor in the filter network which may be used as a volume control. The curve is asymptotic to

$$E_o = E_i \text{ and } E_o = E_i \left(\frac{R_4}{R_1 + R_4} \right)$$

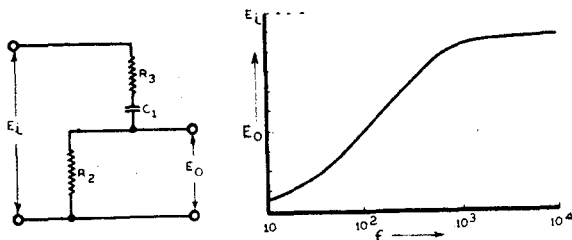

Figure 16

Fig. 16 is the inverse of Fig. 15 and may be used for bass attenuation. This circuit is equivalent to a valve in which R_3 represents the plate resistance and plate load resistance in parallel, C_1 represents the grid condenser and R_2 the grid resistor. The curve is asymptotic to

$$E_o = E_i \left(\frac{R_2}{R_2 + R_3} \right) \text{ and } E_o = 0$$

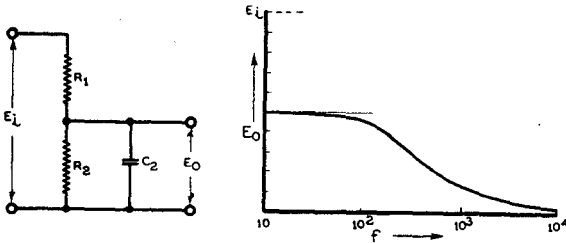

Figure 17

Fig. 17 may be used for treble attenuation. It is equivalent to an arrangement in which R_1 is the valve plate resistance, R_2 the plate resistor, and C_2 a shunt capacitance from plate to cathode. The curve is asymptotic to

$$E_o = E_i \left(\frac{R_2}{R_1 + R_2} \right) \text{ and } E_o = 0$$

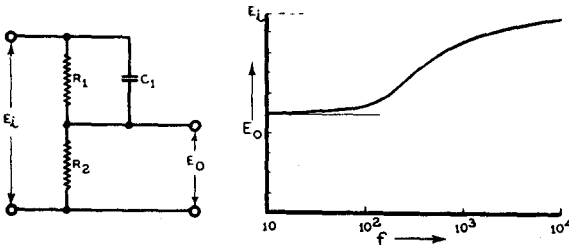

Figure 18

Fig. 18 is the inverse of Fig. 17 and may be used for limited bass attenuation or treble boosting. The curve is asymptotic to

$$E_o = E_i \text{ and } E_o = E_i \left(\frac{R_2}{R_1 + R_2} \right)$$

(5) Filter Networks for Constant Current Supply

A pentode valve, when operated with a load which is always very much smaller than its plate resistance, may be considered as a source of **constant current**. Some typical filter networks which may be used with a source of constant current (I) are shown in Figs. 19 and 20.

Fig. 19 is a network which may be used for bass boosting or treble attenuation. R_1 may represent the plate load resistor in parallel with the

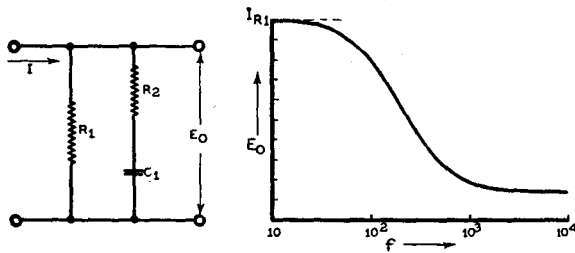

Figure 19. General filter circuit for constant current input (I). The frequency characteristic is obtained when $R_1 = 0.1$ megohm; $R_2 = 15,900$ ohms; and $C_1 = 0.01\mu\text{F}$.

grid resistor; the grid coupling condenser is assumed to have negligible reactance. The curve is asymptotic to

$$E_o = IR_1 \text{ and } E_o = I \left(\frac{R_1 R_2}{R_1 + R_2} \right)$$

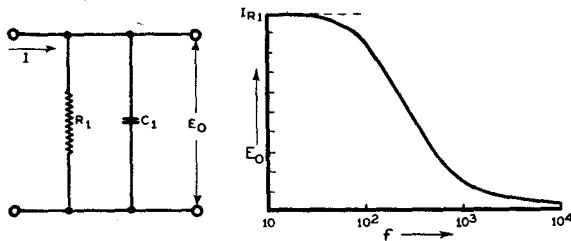

Figure 20. Filter circuit for constant current input (I). The frequency characteristic is obtained when $R_1 = 0.1$ megohm and $C_1 = 0.01 \mu\text{F}$.

Fig. 20 is similar to Fig. 19, but with R_2 short-circuited. The curve is asymptotic to

$$E_o = IR_1 \text{ and } E_o = 0$$

(6) Tone Control by Negative Feedback

One of the most attractive methods of Tone Control is by the use of Negative Feedback. If the feedback network is designed to feed back at one frequency a greater voltage than that at a second frequency, the degeneration will be greater at the first frequency than that at the second frequency. For example, if the voltage fed back at 400 c/s is greater than that at 50 c/s, there will be greater degeneration at 400 c/s than at 50 c/s, this being equivalent to bass boosting. By suitable choice of circuits and constants it is possible to obtain any combination of bass boosting or attenuation and treble boosting or attenuation.

It is unfortunate that this method of tone control is liable to produce instability due to change of the phase angle of the voltage which is fed

back. This is less likely to occur when the voltage is fed back over one stage only, but under all circumstances care should be taken to check for stability. Instability may occur at very low or at very high frequencies which may be beyond the range of audible frequencies, but may, nevertheless, result in distortion or "motor-boating."

Reference should be made to numerous articles in periodicals, some of which are included in the Bibliography at the end of the chapter.

TONE CONTROLS USING TAPPING SWITCH

A tapping switch with two or more positions may be used to provide pre-selected tone combinations.

For **Speech** it is desirable to give slight bass attenuation, particularly if the loudspeaker has a pronounced bass resonance at a frequency at or above 100 c/s.

For **Short-wave Reception** it is desirable to give (at least as an alternative) both bass and treble attenuation.

For **Music** it may be desirable to have two positions, the first giving slight bass boosting alone, and the second increased bass boosting and either treble boosting or, preferably, wide I.F. band-pass.

Special combinations may be arranged to suit individual requirements.

Selective Harmonic Distortion

When a signal containing harmonics is applied to the grid of a tone-compensating stage, the harmonic distortion components may be either increased or decreased owing to the frequency response characteristic of the stage. This effect is quite independent of any harmonic distortion which may be introduced by the tone-compensating stage.

For example, consider a tone-compensating stage which has the following characteristic:—

Frequency	Gain above that at 400 c/s
1,000 c/s	0 db
2,000 c/s	4 db
3,000 c/s	8 db

If now an input voltage having a fundamental frequency of 1,000 c/s, with 5% second harmonic and 3% third harmonic distortion, is applied to the grid, the output will have 7.9% second harmonic and 7.5% third harmonic components. Since these harmonic frequencies were not present in the original signal their presence in the output voltage constitutes genuine distortion. It is this distortion which is one of the most objectionable features of amplifiers which give a large degree of treble boosting, and cannot be avoided by any circuit arrangement or special device.

The converse of this effect also holds, and treble attenuation results in a reduction of harmonic distortion for frequencies having greater attenuation of the harmonic frequencies than of the fundamental. A similar reduction of harmonic distortion for a certain band of frequencies results from the use of bass boosting. In both cases it is assumed that the tone-compensating stage itself does not introduce any distortion.

To Avoid Effect on Apparent Volume

Whenever possible, it is desirable to reduce the effect on the apparent volume brought about by so-called "bass boosting," which in reality amounts to attenuation of a wide band of frequencies in the middle of the audio range. If the "boosting" does not extend appreciably into the range

of middle frequencies, it will be satisfactory to maintain the middle frequencies at a constant level. In an amplifier using a tapping-switch tone-control it is possible to remove the bass (or treble) boosting without any serious effect on the apparent volume by short-circuiting the reactance which provides the increased impedance at the frequencies being boosted. For example in Fig. 11, a typical circuit for bass boosting, condenser C2 may be short-circuited to remove the bass boosting without a serious effect on the apparent volume. If the degree of boosting is pronounced, or if it extends somewhat into the range of middle frequencies, a closer approximation to constant volume on both positions may be made by switching C2 (Fig. 11) out of circuit and replacing it by a suitable resistor, the resistance of which may be determined by trial.

With resonant methods of tone compensation (Figs. 1 and 2) a similar effect may be obtained by cutting out the tuned circuit and replacing it by a suitable value of resistance. In any other particular arrangement the method to be adopted should be sufficiently obvious to need no description.

Although change in apparent volume may easily be avoided with a tapping-switch type of tone control, it is very difficult to avoid with a continuously variable type of control. One practicable arrangement is to use two audio channels, one of which handles the extreme bass without attenuation, and portion of the middle frequencies with progressively increasing attenuation, and the other handles the extreme treble without attenuation and portion of the middle frequencies with attenuation. A single control may then be used to give a suitable balance between bass and treble. The same principle may be extended to cover three or more frequency bands.

Compensation for Change in Volume Level

If the whole of the equipment from microphone to loudspeaker inclusive has a uniform frequency response, the reproduction will only sound natural if the acoustic level of the reproduction is the same as that of the original sound. At lower levels, due to the characteristics of the human ear, there will be a pronounced drop in the apparent bass, and a less pronounced drop in the apparent treble. If the closest possible approach to the impression of the original sound is required at a lower acoustic level, it is necessary to provide the requisite degrees of bass and treble boosting.

One method which has good features is to combine the requisite tone-compensation with the volume control, so that at high settings of the volume control there is very little tone-compensation, while the degree of compensation increases as the setting is reduced. This method is only satisfactory if the input voltage to the volume control remains nearly constant over the whole range of conditions for which compensation is required. The method is only a compromise when used with a normal 5 valve receiver with A.V.C., since the signal voltage may vary by as much as 16 db or more over the range of signal strengths likely to be encountered.

A typical arrangement is shown in Fig. 21 in which a tapped volume control is used. The maximum degree of compensation is obtained when the moving contact is at the tapping point, and this point should therefore be arranged so as to suit the conditions found in a particular receiver. The filter circuit may be of any design, and may be arranged to give bass boosting only, or a suitable balance between bass boosting and treble boosting. The one shown is only for the purpose of illustration, and incorporates a series resonant circuit tuned to 1,000 c/s which

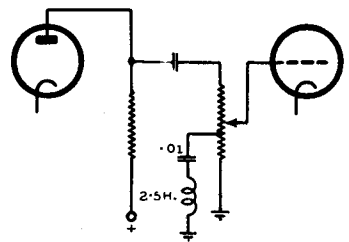

Figure 21

incorporates a series resonant circuit tuned to 1,000 c/s which

provides both bass and treble boosting. A more effective arrangement may be devised by the use of two tapplings, each with a suitable filter network.

It should be noted that the lower portion of the volume control acts as a shunt on the filter circuit and thereby affects the frequency characteristic.

Bass Boosting for Pickup

The circuit of Fig. 22 may be used for insertion between the pickup and the amplifier to give bass boosting. As with other such circuits there is a considerable loss of gain at middle frequencies, and it is only at low audio frequencies that the output voltage more nearly approaches that given by the pickup. As a close approximation, the maximum voltage output at middle and high frequencies may be taken as

$$\frac{R_2 R_3}{R_1 R_2 + R_1 R_3 + R_2 R_3} E_i$$

where E_i is the input voltage from the pickup.

At very low frequencies the voltage output may be taken as being approximately

$$\frac{R_3}{R_1 + R_3} E_i$$

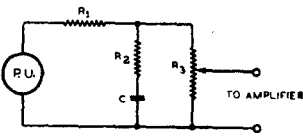

Figure 22. Filter circuit for bass boosting, intended for insertion between the pickup and the grid of the first amplifier stage.

It is desirable for the load presented to the pickup at middle and high frequencies to be that recommended by the manufacturer of the pickup. This load is equal to

$$R_1 + \frac{R_2 R_3}{R_2 + R_3}$$

At low frequencies the load will approach the value $(R_1 + R_3)$.

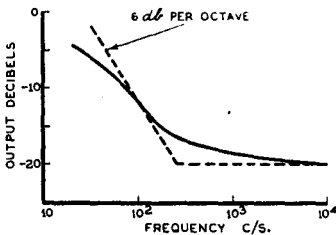

Figure 23 (left). Frequency characteristic (solid line) of Fig. 22 when $R_1 = 0.225$ megohm; $R_2 = 25,000$ ohms; $R_3 = 1.0$ megohm potentiometer; and $C = 0.02 \mu F$. Under these conditions, the bass boost approaches the 6 db. per octave (broken line) required for complete compensation of recording loss.

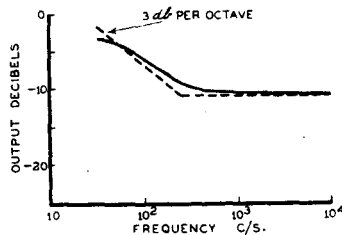

Figure 24 (right). Frequency characteristic (solid line) of Fig. 22 when $R_1 = 0.1775$ megohm; $R_2 = 75,000$ ohms; $R_3 = 1.0$ megohm potentiometer; and $C = 0.01 \mu F$. Under these conditions the arrangement provides only partial compensation (approaching 3 db. per octave) for recording loss.

The frequency response curves obtained with selected values of components are given in Figs. 23 and 24. Fig. 23 shows an arrangement which provides approximately the full compensation (6 db. per octave*) required by a pickup which, in itself, provides no increased bass response. The output curve of the pickup is assumed, for simplicity, to be straight and horizontal. Such a degree of compensation should not be used with a pickup which, as is generally the case, itself provides a certain amount of bass boosting, unless an exaggerated bass response is required. Fig. 24 shows the frequency curve of an arrangement giving less pronounced bass boosting.

Both Figs. 23 and 24 are taken for values of components which give a load on the pickup of 0.25 megohm at middle and high frequencies. If, for example, the load on the pickup is required to be 0.5 megohm, then the values of the three resistances should be multiplied by 2, and the value of the capacitance should be divided by 2, to give a similar frequency curve.

Summary of General Features

1. All methods of tone compensation result in a serious loss of gain over the portion of the frequency band which is not required to be "boosted."
2. Most methods of tone compensation give a more or less slight decrease in gain at the frequency of greatest gain as compared with that obtainable with normal resistance coupling.
3. The frequency characteristic is dependent upon the impedance of the source of input voltage as well as upon the filter network.
4. The maximum input voltage which may be applied without distortion to the grid of a valve having a filter network in its plate circuit is, in most cases, very much less than would be the case with normal resistance coupling.
5. If any appreciable degree of "boosting" is required, it is at least desirable, and in many cases necessary, to have an additional stage of amplification. In most cases this stage should be the first stage in the amplifier, and in all cases should be operated at a low volume level.

Bibliography

General Articles

- W. T. Cocking, "Tone Control Systems," *Wireless World*, Vol. 44, No. 23, pp. 532-537, June 8 (1939).
- B. Ephraim, "Frequency-Response Control Networks," *Communications*, Vol. 19, No. 6, pp. 12-13, 32, 34, June (1939).
- G. Builder, "Tone Control in Radio Receivers," *Radio Review of Australia*, Vol. 4, No. 11, pp. 14, 15, 22, November (1936).
- W. Winder, "Valves for Tone Correction," *Wireless World*, Vol. 38, No. 19, pp. 465-466, May 8 (1936).
- M. G. Scroggie, "Flexible Tone Control," *Wireless World*, Vol. 41, No. 11, pp. 263-266, September 10 (1937).
- J. H. Reyner, "Amplifier Correction and Waveform," *Wireless World*, Vol. 40, No. 26, pp. 602-603, June 25 (1937).
- F. Langford Smith, "Tone Compensation in Broadcast Receivers," *Radio Review of Australia*, Vol. 4, No. 7, pp. 6-12, July (1936).
- E. O. Powell, "Tone Control," *Wireless World*, Vol. 46, No. 14, p. 491, Dec. (1940).

*An octave is a frequency ratio of 2 to 1.

Special Methods

- J. E. Varrall, "New Tone Control Circuit," *Wireless World*, Vol. 44, No. 19, pp. 449-450, May 11 (1939).
- "Music-Speech Control Circuit," *Service*, Vol. 5, No. 6, p. 252 and front cover, June (1936).
- A. G. Manke, "Tone Fidelity Switch," *Electronics*, Vol. 10, No. 5, pp. 34-39, 106-107, May (1937).
- "Tone Control Unit," *Wireless World*, Vol. 42, No. 1, pp. 12-14, January 6 (1938).
- "A Dual-Channel A.F. Amplifier," *Radio-Craft*, Vol. 8, No. 6, p. 337, December (1936).
- M. G. Scroggie, "Electric Gramophone," *Wireless World*, Vol. 44, No. 19, pp. 432-436, May 11 (1939).

Tapped Volume Control Methods

- P. A. D'Orio and R. De Cola, "Bass Compensation Design Chart," *Electronics*, Vol. 10, No. 10, October (1937) — This chart and description cover the design of a tapped volume control with a filter network consisting of a condenser and resistor in series.

Negative Feedback, for Tone Control, and Stability With

- R. B. Dome, "Notes on Feedback Amplifiers," *R.M.A. Engineer*, Vol. 1, No. 1, pp. 2-8, November (1936) — This article considers the question of stability and illustrates the application of polar diagrams.
- G. H. Fritzinger, "Frequency Discrimination by Inverse Feedback," *Proc. I.R.E.*, Vol. 26, No. 1, January (1938).
- B. D. H. Tellegen and V. C. Henriquez, "Inverse Feedback; its Application to Receivers and Amplifiers," *Wireless Engineer*, Vol. 14, No. 167, pp. 409-413, August (1937).
- L. I. Farren, "Some Properties of Negative Feedback Amplifiers," *Wireless Engineer*, Vol. 15, No. 172, pp. 23-25, January (1938) — This is a comprehensive general article.
- D. G. Reid, "The Necessary Conditions for Instability (or Self-Oscillation) of Electrical Circuits," *Wireless Engineer*, Vol. 14, No. 170, pp. 588-596, November (1937) — Fundamental article on stability.
- G. S. Brayshaw, "Regeneration in Linear Amplifiers," *Wireless Engineer*, Vol. 14, No. 170, pp. 597-605, November (1937) — Covering stability, phase-shift, etc.

CHAPTER 10

Volume Expansion and Compression

Volume Expansion — Volume Compression — Typical volume expander — Requirements for received sound to be identical with that in the studio.

It is possible in an amplifier to vary the gain in such a manner that the greater the input the greater the gain. Such procedure is called volume expansion and the reverse action is called volume compression. It is not possible here to comment on the desirability of such systems since many factors have to be considered. Various types of expansion or contraction characteristics can be produced and a wide variation of the time constant can be obtained. In general a time constant of about one-fifth of a second is usually considered reasonably satisfactory, but with elaborate amplifiers it is possible to obtain a more rapid pickup and a slower decline.

A typical arrangement of a volume expander is a resistance-capacitance coupled super-control pentode which is used to amplify the incoming signals, and a separate amplifier also operated from the incoming signal, the output of which is used to feed a diode rectifier and thence to provide negative bias to the control grid of the super-control amplifier. Many arrangements may be adopted, either single or push-pull, the push-pull arrangement being preferable since even harmonic distortion is balanced out. The super-control valve may be either an ordinary R.F. pentode or one of the 6L7-G type.

In the latter case use is made of the two separate grids, one being used for the signal input and the other for the control. A very widely used arrangement is shown in Fig 1, which is reasonably satisfactory provided that the input voltage does not exceed 0.25 volt R.M.S.; at higher input voltages the distortion becomes appreciable. In order to avoid microphonic troubles the controlled stage should be Radiotron 1612, this being a non-microphonic equivalent of the 6L7.

Volume compressors are somewhat similar to volume expanders except that the action is inverted.

All existing types of volume expanders and compressors necessarily need to be a compromise. If it is desired to make the received sound identical with that in the studio, it is necessary to have identical contraction and expansion characteristics, and zero time delay. This can only be obtained or approached closely by a system in which a monitor signal is transmitted in order to control the gain in the reproducing amplifier to correspond with the compression in the studio.

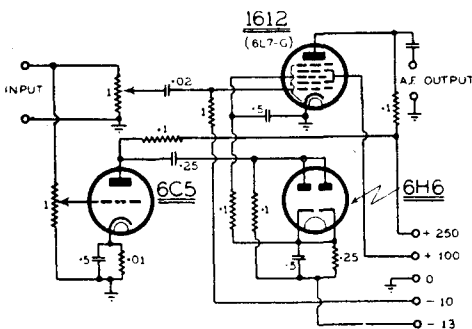

Figure 1

CHAPTER 11

Recording, Pickups, Microphones and Microphone Amplifiers

Gramophone records — Pickups — Microphones — High and low impedance types — Microphone transformers — Mixing and attenuation — Ratings of output level — Coupling of crystal microphones — Microphone amplifiers — Appendix.

Gramophone Records

Standard "lateral-cut" gramophone records are recorded with a characteristic in which the amplitude of the needle movement is proportional to the input voltage for frequencies above 250 c/s. Due to the fact that for constant acoustic power the amplitude increases as the frequency is decreased, a point is reached beyond which there is danger of one groove cutting into the next.

Consequently below 250 c/s. the recording is made to follow a "Constant Amplitude Characteristic," which means that the same amplitude holds for a given applied acoustic power at all frequencies. This is equivalent to a drop in output of 6 db. per octave (1 octave = frequency ratio 2 : 1), or to a voltage ratio of 2 : 1 per octave.

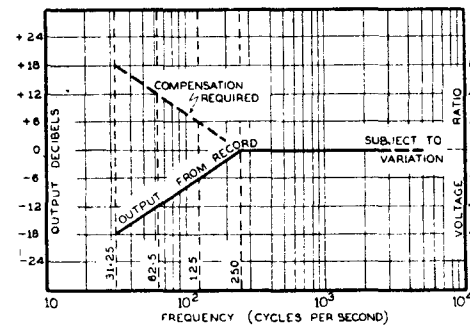

Figure 1

theoretical output given by an ideal uncompensated pickup, and also the compensation required (upper curve with broken line) for overall level response.

Pickups

There are many types of pickups in use and a complete survey is not practicable in this Handbook. All types, including crystal types, suffer to a greater or less extent from the following:—

- (1) Mechanical resonances of the pickup either in part or whole.
- (2) Mechanical resonance of the arm and pickup as a whole,
- (3) Harmonic distortion of the output due to non-linear relationship between the movement of the needle and the output voltage,
- (4) Non-uniform output voltage at all audible frequencies.
- (5) Wear of the record due to weight, poor tracking, mechanical damping, etc.

Mechanical resonances at the higher audio frequencies are objectionable, and may only be reduced by a modification in the internal structure of the pickup. Nearly all pickups employ some form of damping (usually mechanical) to reduce these resonances to some extent, but complete elimination is not practicable owing to wear caused on the record.

Resonance of the arm as a whole is unavoidable, and is frequently used in popular types to improve the bass response, thereby giving some compensation for the recording characteristic.

Harmonic distortion from many types of pickups is quite appreciable.

The frequency response is one of the few characteristics generally available. In the case of most types for home use there is some internal bass compensation, but the compensation is generally rather poor, being too great at some frequencies and too small at others. Most crystal pickups give an accentuated response from a very low frequency to a frequency above 400 c/s. A typical crystal pickup response curve is shown in

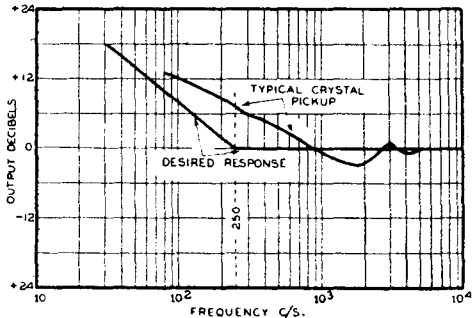

Figure 2

Fig. 2 so that it may be compared with the desired characteristic. The relative placing of the two characteristics was arranged so that the response above 900 c/s. agrees very closely with the desired characteristic. The output of the crystal pickup is then 5 db. above the desired characteristic at 125 and 400 c/s., and 7 db. above at 200 to 250 c/s. At very low frequencies the output from the pickup does not continue to rise so rapidly as the desired characteristic, and the difference between the two curves becomes less. The overall result is that this crystal pickup gives an output which is accentuated at all frequencies below 800 c/s., with the greatest accentuation between 200 and 250 c/s. This is not true bass boosting, nor does it give correct bass compensation for the recording. A close approach to the desired characteristic may, however, be made by adding an absorption filter tuned to about 250 c/s.

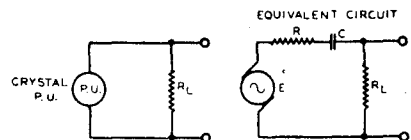

Figure 3

The equivalent circuit of a crystal pickup (Fig. 3) is a voltage source (E) in series with a low resistance (R) and a capacitance (C) equal to that of the crystal. This series capacitance may be looked upon as the coupling condenser to the amplifier and load resistor. The bass response will be reduced if the resistance of the load resistor is low in the same manner as with a coupling condenser and grid resistor in a resistance coupled amplifier (see the Appendix at the end of this chapter for the mathematical formula).

All popular types of pickups require a frequency correction filter in order to obtain correct compensation. A correction filter which gives compensation in accordance with the theoretical curve (Fig. 1) will not provide correct compensation if there is any non-linearity in the pickup response curve. For further information on simple frequency correction circuits see Chapter 9.

Record wear is unavoidable with all popular types of pickups, due to the weight which is necessary to prevent the needle from leaving the bottom of the groove. Wear of the walls of the groove is more serious than wear on the bottom, and may be caused by bad tracking, needle wear or heavy mechanical damping of the pickup. It is not possible to obtain good tracking with a simple straight arm, although a long arm is less harmful than a short one. Most good pickups have either a bent arm or inclined needle in order to provide good tracking. In all cases the instructions provided by the pickup manufacturer should be followed in mounting the arm.

The volume control should have a resistance value as recommended by the manufacturer. It must be understood that the resistance of the volume control should not be made equal to the impedance of the pickup. Operation with an incorrect resistance of volume control will in most cases affect the frequency response.

The leads from the pickup should be as short as possible, shielded and earthed. The pickup arm or case, if of metal, should be earthed. It is generally also advisable to earth the motor and turntable. Even with these precautions hum may be experienced. Some types of motors induce hum into certain pickups, and this can be discovered by moving the pickup to and from (or across) the record. It may also be found with certain motors that the hum may be reduced by reversing the connections to the motor. If there is any difference in hum level with the motor switched on or off it is preferable for the connections to be arranged so that the hum is a minimum with the motor running.

With high resistance volume controls it may be found that the hum is worst when the moving contact is about midway, since at higher settings the impedance of the pick-up is in parallel with the resistance of the volume control. This latter type of hum may be due to hum voltage picked up by the lead from the volume control to the grid of the valve. This lead should be short and thoroughly screened.

Microphones

Microphones may be divided into two groups:

- (1) Low impedance
- (2) High impedance.

In the first group are various types of carbon or granule, velocity (or ribbon), and dynamic microphones. In the second group are condenser and crystal microphones. The latter may be subdivided into:

- (a) Diaphragm types, giving greater output but having poorer fidelity,
- and (b) Sound cell types in which the air pressure operates directly on the crystal face.

All low impedance types of microphones are normally used with transformers which operate into a loaded line and which reflect into the primary a load suited to the particular type of microphone (Fig. 4).

If the rated load for a particular microphone is R , and the transformer has a step-up turns ratio of N times, then the secondary should be loaded by a resistance N^2R .

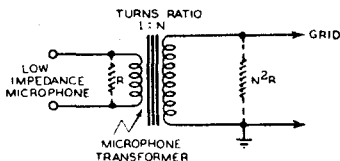

Figure 4

If the rated microphone load resistance is 50 ohms, and the secondary is to feed a 500 ohm line, then the transformer turns ratio (neglecting losses) should be

$$N = \sqrt{500/50} = 3.16$$

The "loading" is not due to the microphone or to the transformer, but must be introduced by a resistance. If this load resistance is applied to the secondary of the transformer the "reflected" load resistance on the

primary is equal to this resistance divided by the square of the transformer step-up turns ratio. For further information on transformers see Chapter 26.

If the secondary of the transformer is to feed directly into the grid of a valve (as is generally the case with low level microphones) the transformer step-up ratio may be very high. There is difficulty in the design of very high-ratio transformers owing to imperfect coupling between windings (i.e., leakage inductance) and the ratio may be restricted for this or other reasons. A secondary load impedance of 100,000 ohms is a fairly typical value under these conditions.

Mixing and attenuation with low level microphones is preferably carried out after pre-amplification so as to avoid any increase of noise level. With high level microphones (say -45 db or above where 0 db = 6 mW.) mixing may be carried out, if desired, between the microphone and the first grid. For mixing methods see Chapter 12.

The "level" of microphones is frequently given in terms of decibels (see Chapter 13) but care should be taken to avoid errors due to confusion. Some low impedance microphones appear to be rated in terms of decibels of power on a basis of 0 db = 6 mW. although the basis of 0 db = 1 mW. is used very widely. Other reference levels used by certain microphone manufacturers are 10 mW. and 12.5 mW.,* the latter being used by R.C.A. At least some crystal microphones are rated in terms of decibels of voltage, on a basis of 0 db = 1 volt for a sound wave having a pressure of 1 dyne per square centimetre. The reason for the voltage rating is that the internal resistance of crystal microphones is very small compared with the load resistance, and their output voltage at middle and high frequencies is therefore approximately constant for widely differing values of load resistance. A further rating of microphone level, and one which has much to commend it, is in Volume Units (vu)†. The level in "vu" is numerically equal to the number of decibels above a standard reference volume level of 1 milliwatt. For further information see Chapter 13.

It is impossible to stress too strongly the necessity for stating the zero reference level in connection with all decibel ratings for microphones. Serious errors have frequently arisen owing to the omission of the reference level in specifications. Many manufacturers of microphones fail to state what reference levels are used, and as a consequence the output voltage can only be guessed at.

It is also necessary for the sound pressure to be stated, but fortunately a pressure of 1 dyne per square centimetre is becoming standardised for studio type microphones. A sound pressure of 10 dynes per square centimetre is frequently used for microphones which are intended to be used in close proximity to the speaker, as more closely resembling typical operating conditions. To convert from a pressure of 10 dynes/cm.² to that of 1 dyne/cm.² it is only necessary to subtract 20 db. It is advisable to avoid using the term "1 bar" as indicating 1 dyne per square centimetre, since 1 bar (correctly used) represents 10^6 dynes per square centimetre.

Coupling of Crystal Microphones

Crystal microphones require a high load resistance, generally of the order of 5 megohms. Since this is well above the maximum permitted in the grid circuit of a valve it is necessary to find a way out of the difficulty.

*The reference level of 12.5 mW. appears to be used in conjunction with a sound pressure of 10 dynes per square centimetre, and due allowance should be made for the latter.

†Howard A. Chinn, "Broadcast Studio Audio-Frequency Systems Design," Proc. I.R.E. February, 1939, page 83.
H. A. Affel, H. A. Chinn and R. M. Morris, "A Standard VI and Reference Level," Communications, April, 1939, pp. 10-11 ff.

Fig. 5 shows one method which is satisfactory with all types of resistance coupled valves. The load is divided into sections of 3 and 2 megohms, and the 2 megohms section only is in the grid circuit. This results in a loss of gain of approximately 8 db.

An arrangement which may be used only with particular types of valves is to reduce the heater voltage until grid emission in the valve is negligible, in which case the grid resistor may be increased to 5 megohms (Fig. 6).

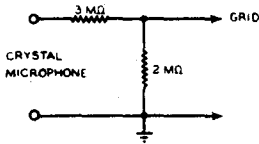

Figure 5

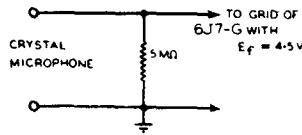

Figure 6

This is possible with types 6J7-G or 6C6, in which the heater voltage may be reduced to 4.5 volts. Only resistance coupling may be used with such a high grid circuit resistance, and the total cathode current is limited to 1 mA. Other types of valves should not be used at low heater voltages unless specifically recommended for this application by the valve manufacturers.

Microphone Amplifiers

Either triode or pentode valves or combinations of both, may be used in microphone amplifiers. Pentode valves have the advantage that the input circuit is very little influenced by the Miller Effect and a high impedance source may be used. Low Mu triodes may also be used with a high impedance input circuit, but have the disadvantage of low stage gain. High Mu triode valves may only be used for fidelity with a low impedance source.

The pentode has the advantage of giving a very high gain (40 db or more) in a single stage, but is more subject to hum pickup in the plate circuit or the grid circuit of the following stage. Due to the high impedance of the combined plate and grid circuit, extreme care is necessary to avoid hum pickup due to the proximity of A.C. leads. For this reason, a valve having a grid brought out to a top cap is desirable, since the grid circuit may be screened effectively from the heater leads. The lead to the grid should be completely screened. Heater leads should be twisted and wired so as to be least likely to cause induction into other leads.

Owing to the characteristics of a pentode valve, it is necessary for the following stage to have low input capacitance, and hence low Miller-Effect capacitance. A pentode may be followed by a low Mu triode stage or by a second pentode stage, but should not be followed by a high Mu triode stage owing to the excessive Miller-Effect capacitance. See also Chapter 8.

The use of a valve which has been specially designed for low level microphone amplifier work is strongly to be recommended. Type 1603 is a glass valve particularly suited for use with A.C. operated amplifiers, and in addition to being non-microphonic it should be found less likely to cause hum. An equivalent valve in the metal series is type 1620. The return point from the heater circuit may be made from a centre tapped resistor across the heater terminals, although in certain cases a slight advantage is obtained through varying the tapping point slightly to one side or the other along the divider. It will generally be found that there is a point at which minimum hum occurs. In many cases it will be sufficient merely to centre-tap the resistor across the heater terminals and to return this point to

earth. When extremely high gain is used the heater may be returned to a point of variable D.C. voltage, having a range of up to say 12 volts either positive or negative with respect to the cathode.

Low level microphones require extremely high amplification so that noises, due to electron movements either in circuit impedances or in the valve, assume large proportions. Care should be taken to select resistors which have the minimum of noise, since considerable variations exist between different makes. However, even with perfectly made resistors, the residual noise is unavoidable, and any decrease of impedance with a view to decreasing the noise results in a greater decrease of signal level. The valve noise and resistor noise are due to the fact that an electric current is not a perfectly smooth uniform stream, but is equivalent to the passage of large numbers of discrete electron charges. Due to the nature of electricity, it is impossible to avoid such noise when extremely high amplification is used.

In order to avoid noise from attenuators, it is advisable to carry out attenuation or mixing at an intermediate level. Thus, the amplifier usually consists of a preamplifier between the microphone and the attenuator, and a main amplifier beyond the attenuator.

Appendix

A crystal microphone or crystal pickup is equivalent to a capacitance having small internal resistance. Owing to the low internal resistance, the output voltage at middle frequencies is almost entirely independent of the load resistance. The loss of gain due to long leads is given in decibels by

$$20 \log_{10} (1 + C_1/C_2)$$

where C_1 represents the capacitance of the load and C_2 that of the crystal device.

The capacitance of the crystal may be considered as a coupling capacitance between the source of voltage and the load (Fig. 3). The lower the load resistance, the greater the loss of low frequencies, so that attenuation of the bass may be obtained by operating with a lower value of load resistance than is recommended.

The loss in db. at a frequency f is

$$10 \log_{10} [1 + (159,000/fCRL)^2]$$

where RL = load resistance in ohms

and C = capacitance of crystal together with capacitance of cable (if any) in μF .

References to Pick-up Alignment

- E. A. Chamberlain, "Correct Pick-up Alignment," *Wireless World*, Vol. 26, No. 13, pp. 339-340, March 26 (1930).
- P. L. Wilson, *The Gramophone* (1934).
- R. P. Glover, "A Record-Saving Pick-up," *Electronics*, Vol. 10, No. 2, pp. 31-32, February (1937).
- J. R. Bird and C. M. Chorpening, "The Offset Head Crystal Pick-up," *Radio Engineering*, Vol. 17, No. 3, pp. 16-18, March (1937). See also addendum below;
- D. G. Knapp, "The Offset Head Crystal Pick-up" (addendum), *Communications*, Vol. 18, No. 2, pp. 28-29, February (1938).
- B. Olney, "Phonograph Pick-up Tracking Error," *Electronics*, Vol. 10, No. 11, pp. 19-23, 81, November (1937).

CHAPTER 12

Audio Frequency Mixing Systems

Simple mixing devices — Series and parallel arrangements — T attenuators — Bridge circuit — Common plate load for two valves — Means for preventing loading of one stage by the plate resistance of the other — Use of pentode valves — Complete mixing systems.

In studio equipment, it is generally necessary to provide some convenient method of changing the source of input. The simplest method is to use a change-over switch (Fig. 1), which may have as many contacts as desired. Rotating such a switch, however, gives rise to voltage surges, which if not injurious to the output valves, at least cause objectionable "thumps" in the reproduction. Hence it is usually necessary to insert a volume control after the switch, which may be turned down during the change-over.

When it is desired to "mix" the inputs in controllable proportions, more complicated circuits become necessary.

The simple series mixer of Fig. 2 has three serious drawbacks. (a) Both sides of input B are above earth. (b) Stray capacitances to earth of channel B tend to by-pass the high frequencies of channel A. (c) Any hum picked up in channel B is fed without appreciable attenuation to the following grid. With care the system may be made to give reasonable results, but is limited in its usefulness.

A more satisfactory circuit is shown in Fig. 3. The inputs are really in parallel and one side of each is returned directly to earth. The series resistors R_3 and R_4 prevent either control short-circuiting the other. Too low a value will reduce their effectiveness. The upper limit is set both by the maximum permissible grid resistance and the input capacitance of the following valve.

For very high-Mu triodes, such as type 75, which have a comparatively large input capacitance, attenuation at high audio frequencies becomes serious if R_3 and R_4 exceed 0.25 megohm. For most other valves, 0.5 megohm may be considered a practical limit.

If R_3 and R_4 be each 0.5 megohm, then the potentiometers R_1 and R_2 may have any values up to 0.5 megohm, which is the correct load for high impedance or crystal pick-ups. Under these conditions the maximum loss is 6 db.

Figs. 4 and 5 show two methods widely used in communication engineering. The first uses a pair of T-attenuators, which provide constant input and output impedances for all settings. The second is a bridge circuit. Both circuits are intended for use with low impedance lines, and are too costly for the average experimenter.

Possibly the most satisfactory arrangement is to feed the two inputs to the grids of two valves which have a common plate load. In this way the input circuits are quite isolated and the setting of one control can have no effect on the other.

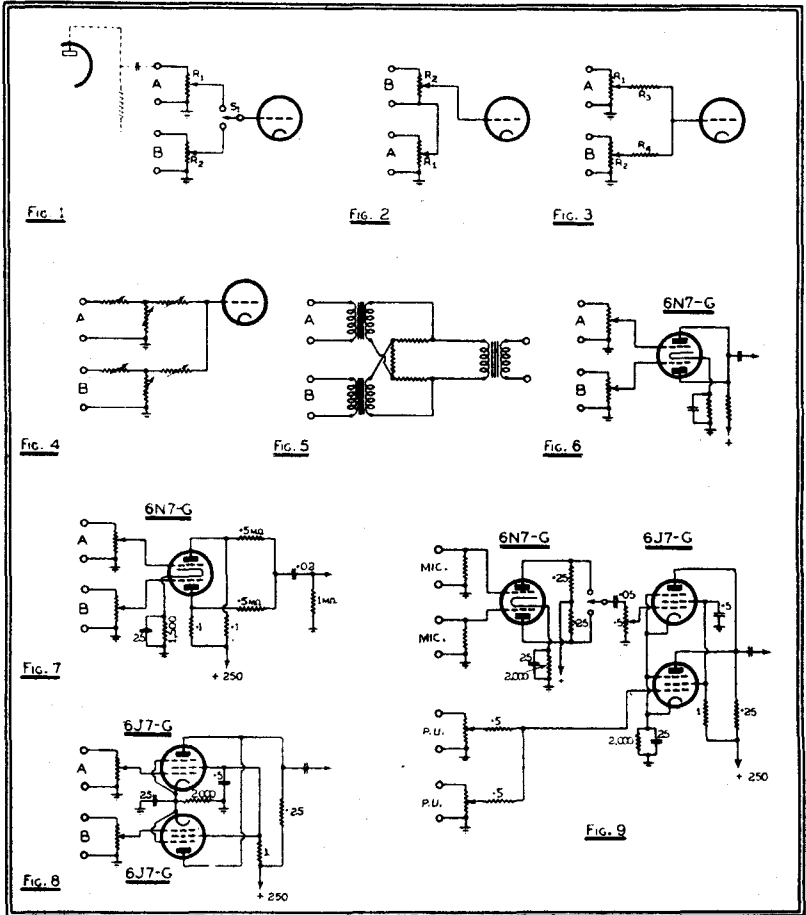

Figures 1 to 9, inclusive

Fig. 6 shows the simplest possible arrangement, using a 6N7-G twin triode valve. It is obvious that the plate resistance of the two sections are in parallel, so that each triode works into an A.C. load less than its own plate resistance. Under such conditions the voltage output for a given percentage of distortion is seriously limited.

The effect is greatly reduced by the insertion of isolating resistors as in Fig. 7. With this arrangement a stage gain of 10 may be obtained with a peak voltage output capability of 35 volts.

The performance of such a mixer may still further be improved by replacing the two triode units with a pair of pentodes. The plate resistance of Radiotron 6J7-G as a resistance coupled amplifier is in the order of 3

megohms, so that the isolating resistors of Fig. 7 are not necessary, and very nearly the full gain of the pentode stage may be realised. With the circuit as Fig. 8 the stage gain will be 120, with a peak voltage output of approximately 45 volts. Omission of the cathode by-pass condenser reduces the gain by one-half, but improves the linearity of the stage.

In any mixing system it is desirable that the input voltages to all channels be as nearly equal as possible, so that similar settings of the controls will produce similar output voltages. Hence where the output from a pick-up is to be mixed with that of a low-level microphone, it will generally be desirable to incorporate one stage of amplification between the microphone and the mixer stage to raise its level to that of the pick-up (cf. Fig. 1).

Fig. 9 illustrates a fairly large mixing system which provides adequate control of two microphones and two pick-ups and has sufficient gain to provide from them an output of about 30 volts. Note that no controls have been used in the grid circuits of the 6N7-G, since the low level microphones can never overload that valve.

CHAPTER 13

Decibels, Nepers, Volume Units and Phons

Bels — Decibels — Reference level — Application of decibels — Barely perceptible changes — Use of decibels for voltage ratings — Errors due to incorrect use — Microphone ratings — Nepers — Volume units — Phons.

Bels and Decibels

It has been found that the impression of magnitude of many physical quantities is approximately proportional to the logarithm of their magnitudes. Therefore a convenient method of comparing them would be on a logarithmic basis.

The common logarithm of the ratio of two powers defines a number which is expressed in "bels." The more commonly used unit is the "decibel," which is one-tenth of the bel.

Thus, the number of decibels difference in level between W_1 watts and W_2 watts is

$$10 \log_{10} \frac{W_2}{W_1}$$

Since $W = E \times I = E^2/R$, the ratio W_2/W_1 is equal to E_2^2/E_1^2 provided that R is the same in each case.

In this case the difference in magnitude is

$$10 \log_{10} \frac{E_2^2}{E_1^2} = 20 \log_{10} \frac{E_2}{E_1} \quad (R \text{ being constant})$$

The same holds in the case of A.C. circuits provided that the impedances Z_1 and Z_2 across which E_1 and E_2 are measured are equal.

When the impedances are not equal the gain in decibels is equal to

$$\begin{aligned} & 20 \log_{10} \frac{E_2}{E_1} + 10 \log_{10} \frac{Z_1}{Z_2} + 10 \log_{10} \frac{k_2}{k_1} \\ &= 20 \log_{10} \frac{I_2}{I_1} + 10 \log_{10} \frac{Z_2}{Z_1} + 10 \log_{10} \frac{k_2}{k_1} \end{aligned}$$

where Z_1 and Z_2 are the corresponding impedances and k_1 and k_2 the power factors of these impedances. The expression for decibel gain of two power

magnitudes is not affected by the impedances.

$$\text{i.e., the gain in decibels} = 10 \log_{10} \frac{W_2}{W_1} \text{ db.}$$

Since decibels refer to ratios, they may only be used as a measure of absolute magnitude when referred to a **reference level**. For example, "20 db. (0 db. = 0.006 W.)" is a measure of power which may be expressed in milliwatts by the use of the expression already given.

Let W_1 represent the power to be determined (expressed in Watts) and W_2 be the reference level (=0.006W.)

$$\text{Then } 20 = 10 \log_{10} \frac{W_1}{W_2} = 10 \log_{10} \frac{W_1}{0.006}$$

A simple application of logarithms shows that $\log_{10} 100 = 2$

$$\therefore \frac{W_1}{0.006} = 100, \therefore W_1 = 100 \times 0.006 = 0.6 \text{ W.}$$

Unfortunately there is no reference standard which has been universally adopted and until such standardisation has been accomplished it is always necessary to state what reference level is being used. In telephone practice 6 milliwatts into 500 ohms is generally used, although 6 milliwatts into 600 ohms is also used. Other reference levels in use are 1, 10 and 12.5 milliwatts.

The Application of Decibels.

The normal application of decibels is to indicate a change of power. Suppose for example that a power valve driving a loudspeaker is delivering 1 watt which is then increased to 2 watts. To say that the power has "increased by one watt" is misleading unless it is also stated that the original level was 1 watt. A far more satisfactory way is to state that a rise of 3 db. has occurred. This may be calculated quite simply since the gain in decibels is

$$10 \log_{10} (2/1) = 10 \log_{10} 2 = 10 \times 0.301 = 3.01 \text{ db.}$$

or approximately 3 db.

In a similar manner a decrease from 2 watts to 1 watt is a change of approximately -3 db.

It has been found that a change in level of 1 db is barely perceptible to the ear, while an increase of 2 db is only a slight apparent increment. For this reason attenuators are frequently calibrated in steps of 1 db or slightly less. In a similar manner an increase from 3 watts to 4.75 watts is only a slight audible increment, being an increase of 2 db.

In order to simplify the understanding of barely perceptible changes the following table has been prepared, and it will be seen that a move from one column to the nearest on left or right is equivalent to a change of 2db. In this table 0 db is taken as 3 watts.

db.:	-10	-8	-6	-4	-2	0	+2	+4	+6	+8	+10	+12
Watts:	0.30	0.47	0.75	1.2	1.9	3.0	4.75	7.5	12	19	30	47.5

In addition to the application of decibels to indicate a change in level at one point, they may also be used to indicate a difference in level between two points such as the input and output terminals of a device such as an amplifier or attenuator. For example, consider an amplifier having an input of 0.006 watt into 500 ohms and an output of 6 watts. The power gain is $6/0.006$ or 1,000 times, and reference to the tables shows that this is equivalent to 30 db. The amplifier may therefore be described as having a gain of 30 db, this being irrespective of the input or output impedance. Since the input is 0.006 watt into 500 ohms this also may be described as being an input of 1.73 volt into 500 ohms, but care should be taken to state the impedance of the circuit across which the voltage is measured.

Difficulty is experienced immediately an attempt is made to apply similar methods to an amplifier having a "voltage" input.

Devices such as pickups and microphones are equivalent to a source of constant voltage in series with the equivalent internal resistance and calculations which do not take this fact into account are liable to be in error. However, in order to demonstrate the principles involved in a simple calculation, a typical example will be taken and the weaknesses of such a procedure will be emphasised.

Consider an amplifier having an input of 1 volt across 1 megohm, and an output of 2 watts into a load of 5,000 ohms. The voltage across the load may readily be calculated, since

$$\frac{E_2^2}{5000} = 2 \quad \therefore E_2^2 = 10,000 \quad \therefore E_2 = 100 \text{ V.}$$

The gain in decibels is

$$20 \log \frac{E_2}{E_1} + 10 \log \frac{Z_1}{Z_2}$$

where $E_1 = 1$ volt
 $E_2 = 100$ volts
 $Z_1 = 1$ megohm
 $Z_2 = 5000$ ohms

The gain is therefore

$$20 \log 100 + 10 \log 200$$

i.e., $20 \times 2 + 10 \times 2.301$

i.e., $40 + 23.01$ or 63 db approximately.

A similar calculation shows that if the same output is obtained from another amplifier having an input of 1 volt across 0.5 megohm, the amplifier gain is 60 db. Now it is a characteristic of a crystal pickup that the output voltage at middle frequencies is very nearly constant, irrespective of the load resistance, and the difference in voltage developed across loads of 0.5 and 1.0 megohm is very slight. Consequently it will be seen that in one case the amplifier will be "rated" as having 63 db gain, and in the other case 60 db, although the same pickup and the same amplifier are used in each case. Even greater errors are frequently encountered in such calculations.

There is no logarithmic unit for indicating the voltage gain of amplifiers and as a consequence the decibel is frequently used, although incorrectly, for a rating of voltage gain. The use of decibels in this manner is very

undesirable and apt to be misleading. In effect it is the result of omitting the second term of the expression

$$20 \log_{10} \frac{E_2}{E_1} + 10 \log_{10} \frac{Z_1}{Z_2}$$

and therefore gives a so-called decibel gain which differs from the true decibel gain unless $Z_1 = Z_2$. If the use of some such unit is unavoidable, it is suggested that it be termed "decibels of voltage" or dbv.

These errors may be avoided by making the necessary calculations in voltages rather than in decibels and this method is recommended, although if care is taken to interpret correctly the decibel ratings there is no reason why they should not be used when preferred.

Microphones are sometimes rated in terms of decibels below 1 volt. The voltage output in such cases may readily be calculated by reference to the table. For example

-50 db.	corresponds to	0.003162	volt R.M.S.	
-55 db.	"	"	0.001778	volt R.M.S.
-60 db.	"	"	0.001	volt R.M.S.
-65 db.	"	"	0.00056	volt R.M.S.
-70 db.	"	"	0.00032	volt R.M.S.

Care should be taken to avoid confusion through the rating of microphones or other input sources in "decibels" without any basis being stated. Typical examples of correct specifications for microphones are:—

- (a) -54 db. (0 db. = 1 volt); sound pressure 1 dyne/cm.²; load resistance 5 megohms.
- (b) -78 db. (0 db. = 0.006 watt into 500 ohms); sound pressure 1 dyne/cm.²; load resistance 250 ohms.

In the specifications for amplifiers it is necessary to state

- (i) The input impedance,
- (ii) The output impedance, and
- (iii) Either (a) the decibel gain,
 - (b) the input or output level in decibels, and
 - (c) the decibel reference level,
 or (a) the input in volts or watts, and
 - (b) the output in volts or watts.

Whether decibel or volts/watts ratings are used is largely a matter of convenience. The examples given may be taken as preferable to the alternatives in each particular case. For example, decibel ratings of microphones are extremely convenient whereas voltage ratings are so minute as to be difficult. In the case of pickups the output is sufficiently high to be capable of overloading the grid of a valve in certain cases, and the voltage output is very convenient since it can be used immediately for checking overloading as well as for the calculation of gain.

Nepers

Two powers W_1 and W_2 are said to differ by N nepers when

$$N = \frac{1}{2} \log_e (W_1/W_2)$$

The Neper thus bears a resemblance to the decibel, although differing in numerical value. The Neper is based on Naperian logarithms to the base e .

To convert nepers to decibels, multiply by 8.686.

To convert decibels to nepers, multiply by 0.1151.

Volume Units

The use of decibel ratings for indicating power has led to much confusion owing to the lack of standardisation of the reference level. The recently devised rating known as Volume Units* (vu) has the advantage of a definite reference level. The volume level in vu is numerically equal to the number of db above a reference level of 1 milliwatt in 600 ohms. To state the volume level of an amplifier in vu is therefore equivalent to giving a definite power rating which may be converted immediately into the equivalent power in watts. When a level is given in db it is necessary also to state the reference level. When a level is given in vu there is no necessity to state the reference level since it is implied in the definition.

It is desirable therefore to state a volume level in vu, but where ratios are involved the db should always be used. For example the output of an amplifier or microphone should be given in vu, but the gain of an amplifier or the loss in an attenuator should be given in db.

It should be noted that the programme volume level when given in vu implies the use of the new standard Volume-level Indicator[†], although where steady sine-wave power is concerned it may be measured with any suitable instrument and converted to vu.

The Phon.

The Unit of Loudness.

This name is of recent origin and was standardised by the British Standards Institution as a unit of loudness. There tends to be confusion between the Decibel which is not a loudness unit but a unit of change of power, and the Phon which is a true loudness unit. If the ear were equally responsive to all frequencies, the Phon and the Decibel would be identical. The Decibel bears no relation whatever to the frequency response of the ear but rather to the conditions existing in an electrical circuit. The Phon being a unit of loudness is directly affected by the characteristic of the ear and therefore there is no direct relationship between Decibels and Phons over the audio range.

For convenience the frequency of 1,000 c/s has been taken as a common basis so that at this frequency the level in Decibels is identical numerically with the level in Phons, provided that the same zero reference level is used in each case. At other frequencies due to the non-linear frequency response of the ear, the level in db and the level in Phons will be different. The definition of the measure of loudness may be given as: "The loudness of sound in Phons is numerically equal to the sound intensity in Decibels of an equally loud 1,000 c/s pure tone." It is therefore possible to compare different sounds for loudness by comparing each with a pure 1,000 c/s tone from an oscillator fed to a

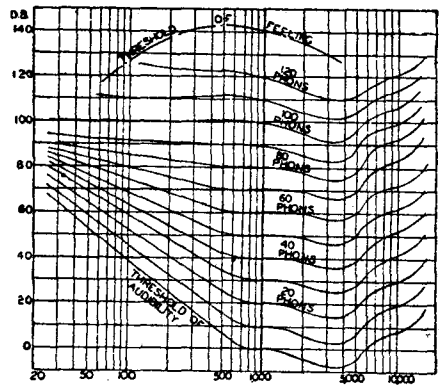

Figure 1

by comparing each with a pure 1,000 c/s tone from an oscillator fed to a

*H. A. Affel, H. A. Chinn and R. M. Morris, "A Standard VI and Reference Level," Communications, April, 1939, pp. 10-11 ff.

head phone and controlled by an attenuator calibrated in Decibels. The attenuator is adjusted until the loudness from the head phone at one ear is judged to be equally loud as the sound entering the uncovered ear. The loudness of the sound in Phons is then said to be numerically equal to the intensity of the reference tone in Decibels.

Zero reference level is taken as the average limit of audibility which has been standardised as 0.0002 dyne per sq. cm. (10^{-16} watts per sq. cm.).

Taking as a typical case a level of 70 Phons which is somewhat like the average loudness from an ordinary radio set, it will be obvious from the definition that at 1,000 c/s the power level in relation to the standard zero will be 70 db. At 100 c/s 70 Phons will be equivalent to 80 db, while at 50 c/s it will be equivalent to 84 db. (Fig. 1). At the most sensitive frequency for the human ear, which is between 3,000 and 4,000 c/s, the equivalent level is 67 db, while at 10,000 c/s where the ear is less sensitive, the level is 83 db. From this it will be evident that a loudspeaker which is to give equal loudness at all frequencies will need to handle greater power at very low frequencies and at very high frequencies than it does at 1,000 c/s. In practice it is rarely found that a high level exists at the higher frequencies but it does very frequently occur at the lower audio frequencies. An amplifier of the type mentioned which is to give equal loudness at 50 and 1,000 c/s will need to deliver 14 db. more acoustic power at 50 cycles than it does at 1,000 c/s.

The real value of the Phon is as a measure of loudness and the following table, which has been compiled in England, will give an interesting comparison.

No. of phons.	Comparable Sound.
130	Threshold of feeling or pain.
110-120	Vicinity of aeroplane engine.
105-110	Vicinity of pneumatic drill.
100-105	Vicinity of loud motor horn.
90-95	Interior of tube train, windows open.
90	Interior of noisy motor vehicle; loud radio set.
80	Interior main-line train, windows open.
70	Interior of quiet motor car; medium radio set.
60-75	Conversation (average to loud).
40-50	Suburban residential district.
20-30	Quiet country residence.
0	Threshold of audibility.

In this table zero level corresponds to an RMS pressure of 0.0002 dyne per sq. cm.

CHAPTER 14

Radio Frequency Amplifiers

Advantages of R.F. stage — Coupling for maximum gain — Expression for gain at resonance — Effective Q of transformer — Coupled impedance — Effect of primary inductance — Variation of amplification with frequency — Capacitive coupling — R.F. transformers at high frequencies — Input loading of receiving valves at radio frequencies.

Radio Frequency Amplifiers

Although many radio receivers are not fitted with a Radio Frequency amplifying stage the advantages of such a stage are considerable. Increased sensitivity is one obvious result of the addition of an R.F. stage, but the gain obtained with this arrangement, if gain is the only factor to be considered, could be exceeded if the same valve were operated as an additional I.F. amplifier. Amplification ahead of the converter stage results in decreased noise level, and if the gain is of the order of 10 to 15 times or more, the noise due to the converter stage is almost inaudible. In such cases almost the whole of the noise which is heard will be that due to the valve noise of the R.F. stage itself, which is much smaller than that occurring in a converter operated at the same overall sensitivity, together with the thermal agitation noise in the input circuit to the grid.

With superheterodyne receivers the image ratio may be much improved by the addition of a selective R.F. stage. With an intermediate frequency of 175 Kc/s at least two tuned circuits ahead of the converter valve are desirable to eliminate the "second spot." Although two coupled tuned circuits may be used without an R.F. stage (sometimes spoken of as "band pass" or "pre-selector" circuits) these result in a loss of gain and therefore a higher noise level on any given station. The addition of the R.F. stage gives the advantage of better selectivity together with higher gain and lower noise.

Another important feature of the operation of the R.F. stage is that by applying A.V.C. to its grid the converter may be operated at fixed bias; this is frequently of advantage with short-wave reception. Alternatively the converter valve may be protected from overloading or from severe cross modulation. Since the effectiveness of A.V.C. action depends upon the gain between the controlled stage and the A.V.C. diode, it is evident that A.V.C. applied to the R.F. stage is more effective than when applied singly to any other stage in the receiver.

The gain of the R.F. stage is usually measured between its grid and the grid of the following (converter) stage. Although the aerial coil has a pronounced effect on the overall performance of the receiver, this is not generally considered as being part of the R.F. stage. The gain of the R.F. stage, as usually measured, is affected by regeneration or degeneration caused by the converter valve and by regeneration existing between grid and plate circuits.

In order to obtain the highest gain from any given valve and secondary of the coupling transformer, the coupling should be such that the impedance presented to the valve is equal to the valve plate resistance. With pentode R.F. amplifiers this is quite impracticable, and in any case is undesirable since it would give very poor selectivity. The final design to be adopted must therefore be a compromise between gain and selectivity. Neglecting regeneration, the gain at resonance of an R.F. amplifier valve, followed by a transformer with untuned primary and tuned secondary, is given approximately* by

$$\text{Gain} = \frac{g_m (\omega M) Q_s}{1 + \frac{(\omega M)^2 Q_s}{\omega L_s r_p}} \quad (1)$$

where g_m = mutual conductance of valve,
 r_p = plate resistance of valve,
 M = mutual inductance between primary and secondary,
 L_s = inductance of secondary,
 Q_s = Q factor of secondary = $\omega L_s / R_s$,
 R_s = series resistance of secondary,
 and $\omega = 2\pi \times \text{frequency}$.

The effective Q of the whole transformer, as affecting the overall selectivity, is always less than the Q of the tuned secondary alone (Q_s). The ratio between the effective Q of the amplification curve and the actual Q of the tuned secondary (Q_s) is given by the relation

$$\frac{\text{Effective Q}}{Q_s} = \frac{R_s}{R_s + [(\omega M)^2 / r_p]}$$

where the symbols have the same meaning as in (1). When optimum coupling is obtained (i.e., $\omega M = \sqrt{r_p R_s}$) the effective Q is half Q_s , and as the coupling is decreased below the optimum the effective Q increases, with a limit equal to Q_s when the coupling is reduced to zero. For practical R.F. amplifiers, therefore, the effective Q is between 0.5 and 1.0 times Q_s .

The "coupled impedance" of the transformer at resonance is

$$\frac{\omega^2 M^2}{R_s} = \frac{\omega^2 M^2 Q_s}{\omega L_s}$$

which is the load impedance presented in the plate circuit of the valve.

The effect of the primary inductance is to give a resonant frequency which is slightly higher than that of the secondary alone.

The amplification of a tuned R.F. amplifier varies approximately with frequency in the same way as does the current in a series-resonant circuit having a Q the same as the effective Q of the transformer. The amplification at any frequency off resonance can then be determined by reference to the Universal Resonance Curve (Chapter 16).

For a more detailed treatment of tuned circuits see Chapter 16.

The foregoing treatment is on the assumption that capacitive coupling is negligible and that the frequency is not higher than that of the broadcast

*Neglecting the primary impedance in comparison with the secondary reflected impedance.

band. For a treatise covering the capacitive coupling case, reference may be made to H. Diamond and E. Z. Stowell, "Note on Radio-Frequency Transformer Theory" (Proc. I.R.E., Vol. 16, No. 9., September, 1928). For a treatment on the design of R.F. amplifiers at high frequencies the reader is referred to Bernard Salzberg "Notes on the Theory of the Single Stage Amplifier" (Proc. I.R.E., June, 1936, pp. 879-897).

Input Loading of Receiving Valves at Radio Frequencies*

The input resistance of an R.F. amplifier valve may become low enough at high radio frequencies to have appreciable effect on the gain and selectivity of a preceding stage. Also, the input capacitance of a valve may change enough with change in A.V.C. bias to cause appreciable detuning of the grid circuit. It is the purpose of this Note to discuss these two effects and to show how the change in input capacitance can be reduced.

Input Conductance.

It is convenient to discuss the input loading of a valve in terms of the valve's input conductance, rather than input resistance. The input conductance, g_i , of commercial receiving valves can be represented approximately by the equation

$$g_i = k_c f + k_h f^2 \dots \dots \dots (1)$$

where f is the frequency of the input voltage. A table of values of k_c and k_h for several R.F. valve types is shown at the foot of this page. The approximate value of a valve's input conductance in micromhos at all frequencies up to those in the order of 100 megacycles can be obtained by substituting in Eq. (1) values of k_c and k_h from the table. In some cases, input conductance can be computed for conditions other than those specified in the table. For example, when all the electrode voltages are changed by a factor n , k_h changes by a factor which is approximately $n^{-1/2}$. The value of k_c is

Table of Approximate Values k_c and k_h for Several Valve Types

Valve Type	Heater Volts	Plate Volts	Screen Volts	Signal-Grid Bias Volts	Sup-pressor Volts	k_c Micro-mhos/Mc	k_h Micro-mhos/Mc ²
6A8	6.3	250	100	-3	-	0.3	-0.05*
6J7	6.3	250	100	-3	0	0.3	0.05
6K7	6.3	250	100	-3	0	0.3	0.05
6K8	6.3	250	100	-3	-	0.3	-0.08†
6L7	6.3	250	100	-3	-	0.3	0.15‡
6SA7 ¹	6.3	250	100	0	-	0.3	-0.03§
6SA7 ²	6.3	250	100	-2	-	0.3	-0.03§
6SJ7	6.3	250	100	-3	0	0.3	0.05
6SK7	6.3	250	100	-3	0	0.3	0.05
954	6.3	250	100	-3	0	0.0	0.005
1851	6.3	250	150	-2	0	0.3	0.13
1852	6.3	250	150	-2	0	0.3	0.13
1853	6.3	250	200	-3	0	0.3	0.065

*For oscillator-grid current of 0.3 ma. through 50,000 ohms.

†For oscillator-grid current of 0.15 ma. through 50,000 ohms.

‡For wide range of oscillator-grid currents.

§For grid No. 1 current of 0.5 ma. through 20,000 ohms.

¹Self-excited. ²Separately excited.

practically constant for all operating conditions. Also, when the transconductance of a valve is changed by a change in signal-grid bias, k_h varies directly with transconductance over a wide range. In the case of converter types, the value of k_h depends on oscillator-grid bias and oscillator voltage amplitude. In converter and mixer types, k_h is practically independent of oscillator frequency.

In Eq. (1), the term $k_e f$ is a conductance which exists when cathode current is zero. The term $k_h f^2$ is the additional conductance which exists when cathode current flows. These two terms can be explained by a simple analysis of the input circuit of a valve.

Cold Input Conductance.

The input impedance of a valve when there is no cathode current is referred to as the cold input impedance. The principal components of this cold impedance are a resistance due to dielectric hysteresis, and a reactance due to input capacitance and cathode-lead inductance. Because these components are in a parallel combination, it is convenient to use the terms admittance, the reciprocal of impedance, and susceptance, the reciprocal of reactance. For most purposes, the effect of cathode-lead inductance is negligible when cathode current is very low. The cold input admittance is, therefore, a conductance in parallel with a capacitive susceptance. The conductance due to dielectric hysteresis increases linearly with frequency. Hence, the cold input conductance can be written as $k_e f$, where k_e is proportional to the power factor of grid insulation and is the K_e of Eq. (1).

Hot Input Conductance.

The term $k_h f^2$, the input conductance due to the flow of electron current in a valve, has two principal components, one due to electron transit time and the other due to inductance in the cathode lead. These two components can be analysed with the aid of Fig. 1. In this circuit, C_h is the capacitance between grid and cathode when cathode current flows, C_g is the input capacitance due to capacitance between grid and all other electrodes except cathode, g_t is the conductance due to electron transit time, and L is the cathode-lead inductance. Inductance L represents the inductance of the lead between the cathode and its base pin, together with the effect of mutual inductances between the cathode lead and other leads near it. Analysis of the circuit of Fig. 1 shows that, with L small as it generally is, the input conductance, g_h , due to the presence of cathode current in the valve, is approximately

$$g_h = g_m \omega^2 L C_h + g_t \dots \dots \dots (2)$$

where $\omega = 2\pi f$. The term $g_m \omega^2 L C_h$ is the conductance due to cathode-lead inductance. It can be seen that this term varies with the square of the frequency. In this term, g_m is the grid-cathode transconductance because the term is concerned with the effect of cathode current flowing through L . In a pentode, and in the 6L7, this transconductance is approximately equal to the signal-grid-to-plate transconductance multiplied by the ratio of D.C. cathode current to D.C. plate current. In the converter types 6A8, 6K8 and 6SA7, the signal-grid-to-cathode transconductance is small. Cathode circuit impedance, therefore, has little effect on input conductance in these types.

For an explanation of the conductance, g_t , due to electron transit time, it is helpful to consider the concept of current flow to an electrode in a valve. It is customary to consider that the electron current flows to an electrode only when electrons strike the surface of the electrode. This con-

cept, while valid for static conditions, fails to account for observed high-frequency phenomena. A better concept is that, in a diode for example, plate current starts to flow as soon as electrons leave the cathode. Every electron in the space between cathode and plate of a diode induces a charge on the plate; the magnitude of the charge induced by each electron depends on the proximity of the electron to the plate. Because the proximity changes with electron motion, there is a current flow to the plate through the external circuit due to the motion of electrons in the space between cathode and plate.

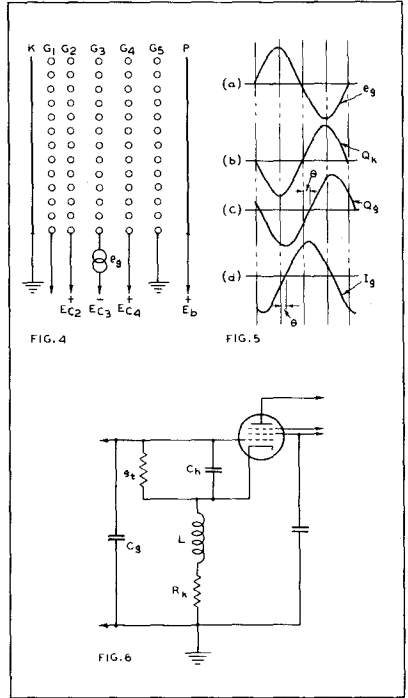
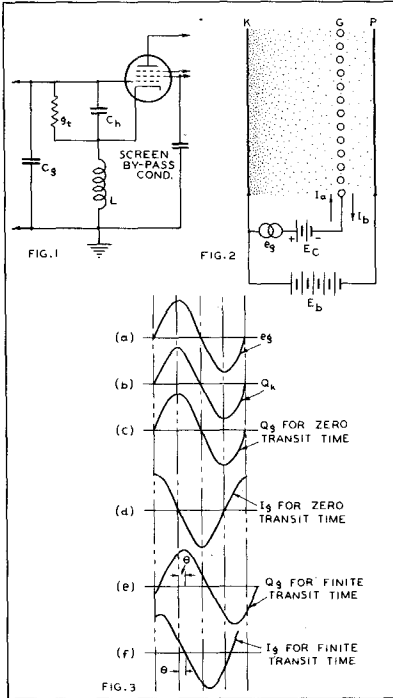

Figures 1 to 6, inclusive

Consider the action of a conventional space-charge-limited triode as shown in Fig. 2. In this triode, the plate is positive with respect to cathode and the grid is negatively biased. Due to the motion of electrons between cathode and grid, there is a current I_a flowing into the grid. In addition, there is another current I_b flowing out of the grid due to the motion of electrons between grid and plate receding from the grid. When no alternating voltage is applied to the grid, I_a and I_b are equal and the net grid current (I_g) is zero.

Suppose, now, that a small alternating voltage (e_g) is applied to the grid. Because the cathode has a plentiful supply of electrons, the charge represented by the number of electrons released by the cathode (Q_k) is in phase with the grid voltage, as shown in Figs. 3a and 3b. The charge induced on the grid (Q_g) by these electrons would also be in phase with the grid voltage if the charges released by the cathode were to reach the plane of the grid in zero time, as shown in Fig. 3c. In this hypothetical case, the grid current due to this induced charge (Fig. 3d) leads the grid voltage by 90 degrees, because by definition, current is the time rate at

which charge passes a given point. However, the charge released by the cathode actually propagates towards the plate with finite velocity; therefore, maximum charge is induced on the grid at a time later than that corresponding to maximum grid voltage, as shown in Fig. 3e. This condition corresponds to a shift in phase by an angle θ of Q_g with respect to e_g ; hence, the grid current lags behind the capacitive current of Fig. 3d by an angle θ , as shown in Fig. 3f. Clearly, the angle θ increases with frequency and with the time of transit τ . Expressed in radians, $\theta = \omega\tau$.

The amplitude of Q_g is proportional to the amplitude of the grid voltage; the grid current, which is the time rate of change of Q_g , is thus proportional to the time rate of change of grid voltage. For a sinusoidal grid voltage, $e_g = E_g \sin \omega t$, the time rate of change of grid voltage is $\omega E_g \cos \omega t$. Therefore, for a given valve type and operating point, the amplitude of grid current is

$$I_g = KE_g \omega$$

and the absolute value of grid-cathode admittance due to induced charge on the grid is

$$Y_t = \frac{I_g}{E_g} = K\omega \tag{3}$$

The conductive component (g_t) of this admittance is

$$g_t = Y_t \sin \theta = Y_t \theta = K\omega \theta \text{ (for small values of } \theta \text{)}$$

Because $\theta = \omega\tau$, this conductance becomes, for a given operating point,

$$g_t = K\omega^2 \tau \tag{4}$$

Thus, the conductance due to electron transit time also varies with the square of the frequency. This conductance and the input conductance, $g_{m\omega^2} L C_b$, due to cathode-lead inductance, are the principal components of the term $k_1 f^2$ of Eq. (1).

This explanation of input admittance due to induced grid charge is based on a space-charge-limited valve, and shows how a positive input admittance can result from the induced charge. The input admittance due to induced grid charge is negative in a valve which operates as a temperature-limited valve, that is, as a valve where cathode emission does not increase when the potential of other electrodes in the valve is increased. The emission of a valve operating with reduced filament voltage is temperature limited; a valve with a screen interposed between cathode and grid acts as a temperature-limited valve when the screen potential is reasonably high. The existence of a negative input admittance in such a valve can be explained with the aid of Fig. 4.

When the value of E_{c2} in Fig. 4 is sufficiently high, the current drawn from the cathode divides between G_2 and plate; any change in one branch of this current is accompanied by an opposite change in the other. As a first approximation, therefore, it is assumed that the current entering the space between G_2 and G_3 is constant and equal to ρv , where ρ is the density of electrons and v is their velocity. G_2 may now be considered as the source of all electrons passing to subsequent electrodes.

Suppose now, that a small alternating voltage is connected in series with grid G_3 , as shown in Fig. 4. During the part of the cycle when e_g is increasing, the electrons in the space between G_2 and G_3 are accelerated and their velocities are increased. Because the current (ρv) is a constant, the density of electrons (ρ) must decrease. In this case, therefore,

the charge at G_2 is 180 degrees out of phase with the grid voltage, as shown at A and B of Fig. 5. This diminution in charge propagates toward the plate with finite velocity and induces a decreasing charge on the grid. Because of the finite velocity of propagation, the maximum decrease in grid charge occurs at a time later than that corresponding to the maximum positive value of e_g , as shown in Fig. 5c. The current, which is the derivative of Q_g with respect to time, is shown in Fig. 5d. If there were no phase displacement ($\theta = 0$), this current would correspond to a negative capacitance; the existence of a transit angle θ , therefore, corresponds to a negative conductance. By reasoning similar to that used in the derivation of Eqs. 3 and 4, it can be shown that the absolute value of negative admittance due to induced grid charge is proportional to ω , and that the negative conductance is proportional to ω^2 . These relations are the same as those shown in Eqs. 3 and 4 for the positive admittance and positive conductance of the space-charge-limited case.

A negative value of input conductance due to transit time signifies that the input circuit is receiving energy from the "B" supply. This negative value may increase the gain and selectivity of a preceding stage. If this negative value becomes too large, it can cause oscillation. A positive value of input conductance due to transit time signifies that the signal source is supplying energy to the grid. This energy is used in accelerating electrons toward the plate and manifests itself as additional heating of the plate. A positive input conductance can decrease the gain and selectivity of a preceding stage.

It should be noted that, in this discussion of admittance due to induced grid charge, no mention has been made of input admittance due to electrons between grid and plate. The effect of these electrons is similar to that of electrons between grid and cathode. The admittance due to electrons between grid and plate, therefore, can be considered as being included in Eq. (3).

Change in Input Capacitance.

The hot grid-cathode capacitance of a valve is the sum of two components, the cold grid-cathode capacitance, C_c , which exists when no cathode current flows, and a capacitance, C_t , due to the charge induced on the grid by electrons from the cathode. The capacitance C_t can be derived from Eq. (3), where it is shown that the grid-cathode admittance due to induced grid-charge is

$$Y_t = K\omega$$

The susceptive part of this admittance is $Y_t \cos\theta$. Since this susceptance is equal to ωC_t , the capacitance C_t is

$$C_t = K \cos\theta = K \text{ (for small values of } \theta \text{)}$$

Hence, the hot grid-cathode capacitance C_h is

$$C_h = C_c + K$$

The total input capacitance of the circuit of Fig. 1, when the valve is in operation, includes the capacitance C_h and a term due to inductance in the cathode lead. This total input capacitance, C_i , can be shown to be approximately

$$C_i = C_g + C_h - g_m g_t L \dots \dots \dots (5)$$

where the last term shows the effect of cathode-lead inductance. This last term is usually very small. It can be seen that if this last term were made equal in magnitude to $C_g + C_h$, the total input capacitance would be made zero. However, the practical application of this fact is limited be-

cause g_m and g_c change with change in electrode voltages, and g_c changes with change in frequency.

When cathode current is zero, the total input capacitance is practically equal to $C_r + C_c$. Subtracting this cold input capacitance from the hot input capacitance given by Eq. (5), we obtain the difference, which is $K - g_m g_c L$. In general, K is greater than $g_m g_c L$. Therefore, in a space-charge-limited valve, where K is positive, the hot input capacitance is greater than the cold input capacitance. In a temperature-limited valve, where K is negative, the hot input capacitance is less than the cold input capacitance. In both valves K changes

1851, 1852

TYPICAL CHARACTERISTICS

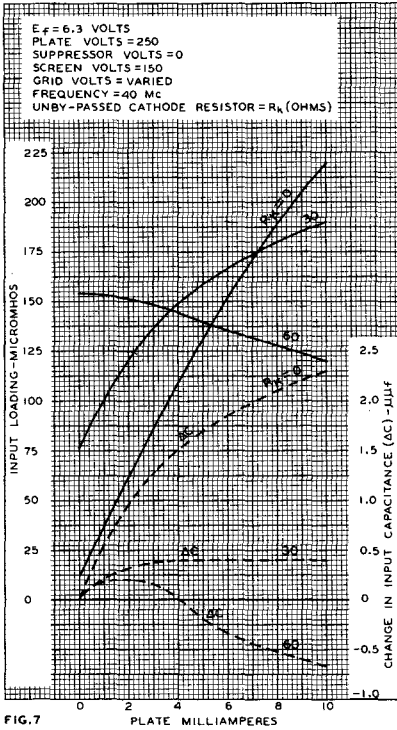

FIG. 7

Figure 7

1853

TYPICAL CHARACTERISTICS

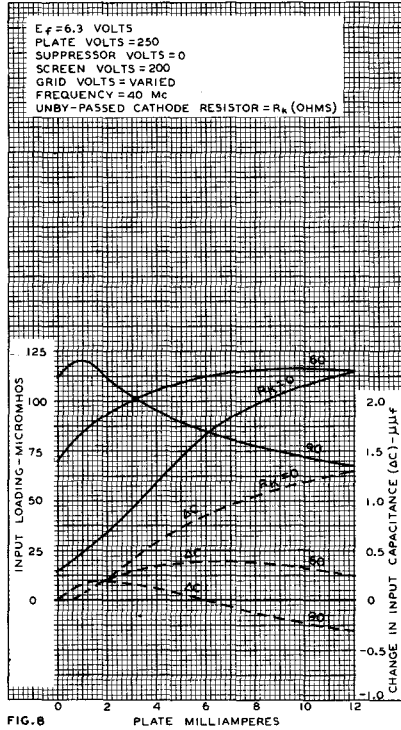

FIG. 8

Figure 8

with change in trans-conductance. Because of this change, the input capacitance changes somewhat with change in A.V.C. bias. In many receivers, this change in input capacitance is negligible because it is small compared to the tuning capacitances connected in the grid circuits of the high-frequency stages. However, in high-frequency stages where the tuning capacitance is small, and the resonance peak of the tuned circuit is sharp, change in A.V.C. bias can cause appreciable detuning effect.

Reduction of Detuning Effect

The difference between the hot and the cold input admittances of a space-charge-limited valve can be reduced by means of an unby-passed

cathode resistor, R_k in Fig. 6. The total hot input admittance of this circuit is made up of a conductance and a capacitive susceptance $\omega C_1'$. Analysis of Fig. 6 shows that, if cathode-lead inductance is neglected, the total hot input capacitance, C_1' , is approximately.

$$C_1' = C_g + C_c \frac{1 + K/C_c}{1 + g_m R_k} \quad (6)$$

Inspection of this equation shows that if K is positive and varies in proportion with g_m , the use of the proper value of R_k will make C_1 independent of g_m . In a space-charge-limited valve, K is positive and is found by experiment to be approximately proportional to g_m . It follows that the proper value of R_k will minimise the detuning effect of A.V.C. in a space-charge-limited valve. Eq. (6) is useful for illustrating the effect of R_k but is not sufficiently precise for computation of the proper value of R_k to use in practice. This value can be determined by experiment. It will be found that this value, in addition to minimising capacitance change, also reduces the change in input conductance caused by change in A.V.C. bias. The effect of unby-passed cathode resistance on the change in input capacitance and input conductance of a 1852 and 1853 is shown in Figs. 7 and 8. These curves were taken at a frequency of 40 megacycles. The curves for the 1852 also hold good for the 1851.

It should be noted that, because of degeneration in an unby-passed cathode resistor, the use of the resistor reduces gain. The reduced gain is $1/(1 + g_m R_k)$ times the gain with the same electrode voltages but with no unby-passed cathode resistance. The hot input conductance of a valve with an unby-passed cathode resistor can be determined by modification of the values of k in the table on page 92. The value of k_h in the table should be multiplied by $g_m/(1 + g_m R_k)$. The resultant value of k_h , when substituted in Eq. (1), with k_c from the table, gives the input conductance of a valve with an unby-passed cathode resistor. In the factor $(1 + g_m R_k)$, g_m is the grid-cathode transconductance when R_k is by-passed.

When an unby-passed cathode resistor is used, circuit parts should be so arranged that grid-cathode and plate-cathode capacitances are as small as possible. These capacitances form a feedback path between plate and grid when there is appreciable impedance between cathode and ground. To minimise plate-cathode capacitance, the suppressor and the screen by-pass condenser should be connected to ground rather than to cathode.

CHAPTER 15

Frequency Conversion

The principle of the Superheterodyne — Constructional features of Converters — Characteristics of Converters and Mixers — Special features of Converters (1) Gain, (2) Space charge coupling, (3) Capacitive coupling from oscillator grid to signal grid, (4) Capacitive coupling from oscillator plate to signal grid, (5) Capacitive coupling from signal grid to plate, (6) Signal frequency degeneration, (7) D.C. signal grid current flow (transit time), (8) Input loading, (9) Frequency shift, (10) Negative transconductance between signal grid and oscillator, (11) Effect of the I.F. amplifier, (12) Noise — The Application of Converters — Formulae for oscillator tracking.

The Principle of the Superheterodyne

In a receiver there are certain advantages in changing the frequency of the incoming signal so that the resultant frequency (Intermediate Frequency or I.F.) is constant for all signal frequencies. These advantages include

- (a) Fixed tuned circuits for the I.F. amplifier.
- (b) More nearly constant sensitivity and selectivity over the waveband.
- (c) Higher possible gain per stage in the I.F. amplifier than in an R.F. amplifier, especially when the I.F. is a lower frequency than the signal frequency.*
- (d) Improved selectivity, especially when the I.F. is a lower frequency than the signal frequency.*
- (e) Better control of overall fidelity (i.e., sideband cutting) by means of variable selectivity.

The change of frequency is accomplished by mixing the signal voltage with a local oscillator voltage at a suitable frequency (this operation taking place in a "mixing valve") and by selecting the sum or difference frequency by means of a tuned circuit in the output.

In the plate circuit of the mixer there will appear many frequencies, the strongest of which will be the signal frequency, the oscillator frequency and the sum and difference of the signal and oscillator frequencies. In

*Even when the I.F. is a higher frequency than the signal frequency, improved selectivity and gain may be obtained owing to the greater possible efficiency of fixed tuned circuits as compared with a tunable system.

addition there will also appear other frequencies due to combinations of the fundamentals and harmonics of the signal and oscillator frequencies.

For example if the signal frequency is 1,000 Kc/s and the oscillator frequency 1,465 Kc/s the frequencies in the output will include:—

Signal Frequency	1,000 Kc/s
Oscillator Frequency . .	1,465 Kc/s
Sum	2,465 Kc/s
Difference	465 Kc/s

Of these frequencies it can be assumed that the desired intermediate frequency is 465 Kc/s and the undesired frequencies are 1,000, 1,465 and 2,465 Kc/s. These undesired frequencies will normally be filtered out by the sharply tuned circuits in the I.F. amplifier.

With an oscillator operating at 1,465 Kc/s it is obvious that an incoming signal having a frequency of 1,930 Kc/s will provide a difference frequency of 465 Kc/s with the oscillator frequency, which also will be capable of passing through the I.F. amplifier. Reception of this kind is known as Image Reception. This image or double spot should be avoided in good receiver design. If a low frequency is used for the I.F. it is difficult to attenuate the second spot without using at least two tuned R.F. circuits which, with the oscillator, necessitate at least three tuned circuits in the receiver. For this reason frequencies in the region of 450-465 Kc/s are very widely used since the desired signal and the second spot are then 900 to 930 Kc/s apart. Reasonable performance can thus be given by receivers having only one tuned R.F. circuit in addition to the oscillator. On the short-wave band a receiver of this nature will bring in the image at appreciable strength although by good coil design it is possible to reduce the strength of the image quite considerably. Superheterodyne receivers, designed specially for short-wave communication work, usually have a higher frequency for the I.F., from about 1,600 to 3,000 Kc/s, and may also incorporate double frequency changing. For example the receiver may change the incoming signal first to 3,000 Kc/s and then to 465 Kc/s or lower. By this arrangement the second spot may be made less prominent and the advantages of the good selectivity provided by the low intermediate frequency may still be retained.

In the superheterodyne receiver difficulties are experienced in obtaining correct tracking between the signal and oscillator circuits so that the resulting difference frequency is constant over the whole wave band. In most receivers the oscillator operates at a higher frequency than the signal and the oscillator circuit is not required to cover such a wide ratio of maximum to minimum as the signal circuits. The most common method of obtaining approximately correct tracking is to insert a "series padder" condenser in the oscillator tuned circuit and suitably adjust the inductance of the oscillator coil so that correct tracking is obtained at three points over the band and approximately correct tracking at intermediate points. Formulae for calculating the inductances and capacitances in such circuits are given later in this Chapter.

Under certain conditions regeneration may be applied to the converter stage in order to improve the performance, particularly in "communication" receivers. This matter is treated by H. C. C. Erskine-Maconochie, "Regeneration in the Superheterodyne," *Wireless World*, Vol. 45, No. 4, pp. 77-80, July 27 (1939).

Constructional Features of Converters

The construction features of five main groups of converter valves are shown in Figs. 1 to 5 inclusive. Type 6A8-G has five "grids," but of these the second or anode grid consists of two vertical rods without any of the usual turns. Types 6L7-G and 6J8-G are similar so far as the

mixer section is concerned, but the 6J8-G also incorporates a small triode section using the lower end of the common cathode. The grid of the triode is internally connected to grid No. 3 of the mixer. Both 6L7-G and 6J8-G have suppressor grids in order to increase the plate resistance.

Type 6K8-G is in principle very similar to type 6A8-G but the oscillator anode has been removed completely from the electron stream between cathode and mixer plate. The oscillator grid, which also forms the first grid of the mixer, completely surrounds the cathode, the side towards the oscillator plate acting as an oscillator control grid and the side facing the mixer serving to modulate the cathode stream at oscillator frequency. Owing to this peculiar construction a single grid is used to fulfil the functions of screen between the first grid and the signal grid and also between the signal grid and the plate. The signal control grid is made in the form of a flat wound grid with one half of the windings removed. Two

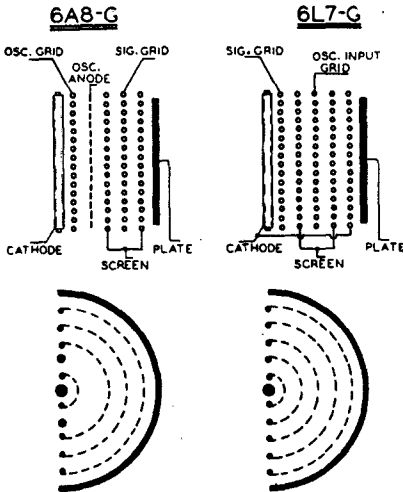

Figure 1 (left), Figure 2 (right).

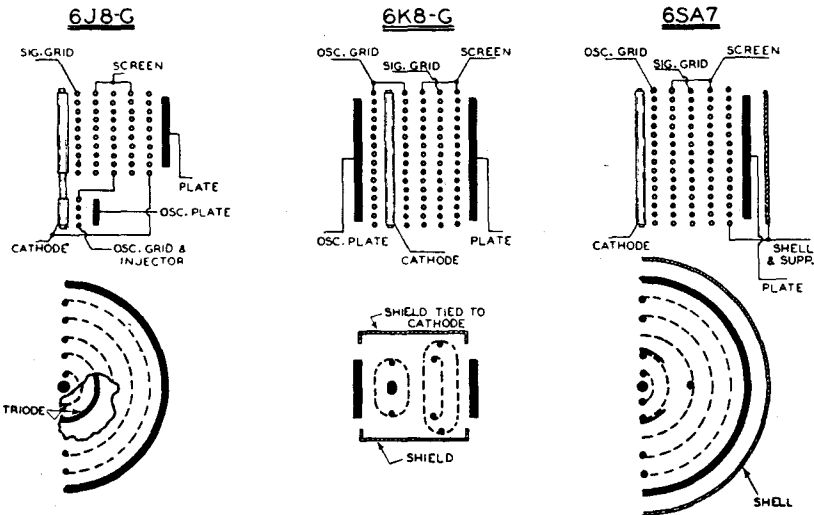

Figure 3 (left), Figure 4 (centre), Figure 5 (right).

metal shields which are connected to the cathode prevent stray electrons from causing undesired couplings; they also isolate the oscillator and mixer sections. Although no suppressor grid is used in the 6K8-G the fact that the plate is situated at some distance from the screen and that the extremities of the side shields are brought sufficiently close to the electron stream to cause a point of minimum potential between the screen and plate, is sufficient to result in considerably higher plate resistance than would otherwise be the case. No suppressor grid is therefore necessary with this construction.

The 6SA7 is somewhat similar in construction to the 6L7-G but No. 3 grid has a super control characteristic whereas in the 6L7-G the first grid has a super control characteristic. In the 6SA7 the third grid is arranged with its side rods in the centre of the cathode stream so as to cause a division due to its negative potential. Two collector plates are fitted to the sides of No. 2 grid so that electrons turned back from No. 3 grid are prevented from reaching No. 1 grid. This action is made necessary by the curved electron paths brought about by the side rods of the grid No. 3. The 6SA7 has a suppressor grid in order to increase the plate resistance.

Characteristics of Converters and Mixers

(1) Autodyne

A screen grid or pentode valve may be used as an autodyne frequency changer and in this service provides high plate resistance, good sensitivity and good signal to noise ratio. The operation is normally limited to the broadcast band owing partly to the difficulty of maintaining oscillation at higher frequencies, and partly to the fact that comparatively large voltages of oscillator frequency appear across the tuned signal grid circuit. A sharp cut-off valve is preferred for sensitivity and signal to noise ratio, but a valve having a super control characteristic may be used in order to enable A.V.C. to be applied.

(2) Triode-pentode (6F7)

A triode oscillator and pentode mixer may be used either with separate valves or with the two combined in a single envelope as with the 6F7. This arrangement provides good sensitivity but the operation is only satisfactory on the broadcast band since comparatively large voltages of oscillator frequency appear across the signal grid circuit.

(3) Pentagrid (6A8-G)

The pentagrid converter*, of which a typical example is the 6A8-G, gives good sensitivity on the broadcast band and on the short-wave band down to about 25 metres, but below this wavelength the sensitivity drops, the falling off being particularly rapid below 20 metres. A.V.C. may be applied on the broadcast band but when applied on the short-wave band there is a pronounced frequency shift due to the operation of A.V.C. The oscillator stability with variation in the supply voltage is not very good. For these reasons other types are frequently preferred for operation on the short-wave band.

(4) Pentagrid mixer (6L7-G) with separate oscillator

The 6L7-G† has a sensitivity on the broadcast band which is generally slightly less than that of the 6A8-G due to lower conversion conductance, but this is offset to some extent by the very high plate resistance. Operation on the short-wave band is very nearly as good as on the broadcast band provided that the screen voltage and negative grid bias are increased to prevent positive grid current from flowing. A.V.C. may be applied at all frequencies up to about 25 Mc/s provided that the initial bias is increased. At still higher frequencies the valve may be used provided that the grid circuit resistance is low, necessitating operation at fixed bias. Variations of electrode voltages in the 6L7-G have very little effect on the oscillator frequency, although change of signal grid voltage results in a greater frequency shift than with the 6K8-G. The 6L7-G has a lower noise level than pentagrid or 6K8-G types of converters.

*See also W. A. Harris, "The Application of Superheterodyne Frequency Conversion Systems to Multirange Receivers," Proc. I.R.E., p. 279, April (1935).

†See also C. F. Nessler, E. W. Herold and W. A. Harris, "A New Tube for Use in Superheterodyne Frequency Conversion Systems," Proc. I.R.E., p. 207, February (1936).

(5) Triode-heptode (6J8-G)

The 6J8-G is equivalent to the 6L7-G (except for slightly lower conversion conductance) with an oscillator combined in the same envelope; the remarks as for the 6L7-G also apply. The low noise level of this type makes it popular for receivers without an R.F. stage.

(6) Triode-hexode (6K8-G)

The 6K8-G has less sensitivity on the broadcast band than the 6A8-G owing to lower conversion conductance, although the plate resistance is higher. A.V.C. may be applied at all frequencies and the drift of oscillator frequency with variation in control grid voltage is less than that with types 6A8-G, 6J8-G or 6L7-G. There is a slight tendency to flutter due to this effect, but it may be avoided by the use of an 8 μ F. filter condenser in the oscillator plate circuit. At very high frequencies the conversion gain of the 6K8-G rises; below 20 metres this type gives an extremely good performance.

(7) 6SA7 type pentagrid

The 6SA7 type of converter valve has a higher gain at broadcast frequencies than other types of converters owing to a fairly high conversion conductance and high plate resistance. The operation up to 6 Mc/s (50 metres) is excellent, but some falling off is evident at higher frequencies owing to the difficulty of maintaining optimum oscillation. With separate excitation improved performance may be obtained at high frequencies. A.V.C. may be applied at all frequencies and does not result in any serious change in oscillator frequency. The oscillator frequency is also reasonably stable with variations in supply voltage. This type of pentagrid should not be confused with other pentagrids since it is of an entirely different construction and the different grids are employed for different purposes. Special circuit arrangements are necessary with this type, and the Hartley oscillator circuit is generally employed, using a single tapped coil.

Special Features of Converters

(1) Gain

When the load consists of a single parallel tuned circuit the gain of a converter valve is given by the equation:—

$$\text{Gain} = \frac{S_c r_p R_L}{r_p + R_L}$$

Where S_c = conversion conductance,

r_p = plate resistance,

R_L = dynamic resistance of tuned circuit at resonance.

When coupled tuned circuits are used the value of R_L should be the dynamic resistance of the primary with the secondary coupled under normal conditions (i.e., coupled impedance).

(2) Space Charge Coupling

The space charge in the vicinity of the signal grid, changing at oscillator frequency, causes a displacement current to flow in the signal grid circuit and a voltage to appear across the tuned grid circuit which, when the oscillator frequency is higher than the signal frequency, is 180° out of phase with the oscillator voltage and gives lower conversion conductance and lower gain, particularly at high frequencies. Valve types 6L7-G and 6J8-G are practically free from this effect.

Neutralisation of this effect may be accomplished by means of a very small capacitance (preferably in series with a resistance in order to give satisfactory neutralisation over a range of frequencies) between oscillator grid and signal grid. The capacitance may be adjusted so as to give maximum sensitivity at or near the high frequency end of the short-wave band. Alternatively it may be adjusted so as to give minimum oscillator voltage across the signal grid coil. Omission of this neutralising condenser may result in positive grid current at high frequencies. When a high resistance grid return circuit is used (as with A.V.C.) the effect of the positive grid current is to cause additional negative bias with loss of sensitivity. Even if positive grid current does not flow there is a loss of gain due to space charge coupling, this being very apparent below 20 metres. With the 6SA7, neutralisation is not satisfactory unless separate excitation is used.

(3) Capacitive Coupling from Oscillator Grid to Signal Grid

Although a comparatively minor effect, this is experienced with all types of converter valves, independently of space charge coupling, with the result that a voltage at oscillator frequency appears across the signal grid tuned circuit. The capacitance between oscillator grid and signal grid is of the order of $0.1 \mu\mu\text{F}$. for all types. At very high frequencies the impedance of the tuned circuit to the oscillator frequency is high and the voltage at oscillator frequency may exceed the bias and cause positive grid current to flow. If the oscillator frequency is higher than the signal frequency, the oscillator voltage appearing in the signal grid circuit is in phase with the oscillator voltage. This results in slightly higher conversion gain. If the oscillator frequency is lower than the signal frequency the reverse occurs and results in lower conversion gain. This effect is much less pronounced than that of space charge coupling and is opposite in phase.

(4) Capacitive Coupling from Oscillator Plate to Signal Grid

This coupling is in phase with the space charge coupling and is only appreciable with type 6A8-G.

(5) Capacitive Coupling from Signal Grid to Plate

A certain voltage at oscillator frequency is developed across the primary of the intermediate frequency transformer, and is fed back to the signal grid through the capacitance between signal grid and plate. The effect is negligible with types other than the 6A8-G and is very small even with this type.

(6) Signal Frequency Degeneration

Since the signal frequency is higher than the intermediate frequency, the first I.F. transformer presents a capacitive load to the signal frequency. This produces degeneration through decreased input conductance and decreased Q of the tuned grid circuit. This is most marked at signal frequencies approaching the intermediate frequency (e.g., 550 Kc/s). The value of the resistive component of the input impedance due to this effect is R_g .

$$\text{where } R_g = \frac{C}{S_m C_{gp}}$$

and $C =$ effective capacitance of load

$S_m =$ mutual conductance from signal grid to plate with the oscillator oscillating (with the 6A8-G this is about 700 micromhos).

$C_{gp} =$ capacitance from grid to plate.

It is for this reason that a large condenser for tuning the I.F. transformer primary is desirable when valves such as the 6A8-G, having appreciable degeneration due to high capacitance from signal grid to plate, are employed.

(7) D.C. Signal Grid Current Flow (Transit Time)

Types 6L7-G and 6J8-G produce positive signal grid current flow at high frequencies due to a transit time effect. Electrons accelerated by the positive voltage peak on G_3 may not reach G_3 until its voltage is decreasing and they are therefore deflected back to G_2 and G_1 . Some of these are collected by G_2 , thereby increasing the screen current, and the others go through G_2 and may approach G_1 with sufficient velocity to overcome the negative bias and cause positive current to flow in the G_1 circuit. This effect may be minimised by operating with increased bias on G_1 and, where permissible, also increased voltage on G_2 in order to retain the conversion conductance (6L7-G only).

With the 6SA7 during the negative portion of an oscillation cycle the cathode may swing more negative than the signal grid. If this occurs the signal grid will draw current unless the oscillator grid is sufficiently negative to cut off cathode current. The remedy for the trouble is to increase the excitation until sufficient negative bias is developed.

(8) Input Loading

The loading of the tuned signal grid circuit, due to the input conductance resulting from transit time losses, is important at high frequencies. Types 6J8-G and 6L7-G give positive loading and a lower coil Q. Types 6A8-G, 6K8-G and 6SA7 give negative loading and a higher Q, these providing higher R.F. stage gain and an increase in the image ratio.

We thus have negative loading with inner modulated types (6A8-G, 6K8-G, 6SA7) and positive loading with outer modulated types (6L7-G and 6J8-G). Increased bias on the signal grid reduces the loading effect on all types. It has been found that negative loading reverses and becomes positive loading at high values of negative signal grid bias.

(9) Frequency Shift

(a) Frequency Shift due to Change of Supply Voltages

In all converters there is some change in oscillator frequency when the voltages supplied to certain electrodes, in the mixer as well as in the oscillator, are varied. Of these, the voltages applied to the screen of the mixer and to the plate of the oscillator are the most critical. The resultant change of frequency when the voltage of the supply source is varied is the sum or difference of the changes of frequency occurring when the voltage of each electrode is varied. With types 6A8-G and 6K8-G the individual changes of frequency are considerable, but the resultant is the difference of the two and is less than either separately. With type 6J8-G the resultant is the sum of the two, but since both are extremely small the resultant is also extremely small. Type 6SA7 has no separate oscillator plate, and the effect of the change in screen voltage is most prominent.

Of the types mentioned, type 6J8-G is the most stable, types 6K8-G and 6SA7 are intermediate and 6A8-G is least stable in respect to changes of supply voltage.

One effect of such instability is a tendency towards "flutter" or motor-boating. With type 6A8-G the anode-grid supply is sometimes taken from the filament of the rectifier valve, through a dropping resistor with a

large bypass condenser to earth in order to reduce the tendency to "flutter" and to give additional hum filtering.

(b) Frequency Shift due to Voltage on Signal Grid

Type 6A8-G produces a considerable change of oscillator frequency due to change in the bias of the signal grid. This effect causes detuning through A.V.C. action during fading and is particularly serious when sharply peaked I.F. transformers are used. On an ideal frequency changer the D.C. voltage of the signal grid should not have any effect on the frequency of the oscillator. Types 6J8-G, 6L7-G and 6SA7 are much better in this respect than the 6A8-G, whilst with the 6K8-G the change is so small over practical limits to be negligible.

(10) Negative Transconductance Between Signal Grid and Oscillator Plate

The value of the transconductance between the signal grid and the oscillator plate gives an indication of the interference between these two electrodes. In the 6A8-G, as the signal grid is made more negative the oscillator plate current increases and therefore the mutual conductance is negative. The mutual conductance in the 6A8-G between signal grid and oscillator plate is about -400 micromhos; in other types it is practically negligible. In addition to an effect on the frequency of the oscillator there is also a "pulling-in" effect sometimes observed with the 6A8-G. This may be eliminated by using a separate oscillator.

(11) The Effect of the I.F. Amplifier

A sharply peaked I.F. amplifier may only be used satisfactorily when the oscillator frequency is very nearly constant, say within ± 1.5 Kc/s. On the broadcast band there is no great difficulty in such an attainment, but on the short-wave band great difficulty is encountered through frequency drift. The effect of reasonably small degrees of frequency drift may be made less serious if the I.F. amplifier is designed with a more or less "flat-top" response curve. Even in this case serious distortion, possibly accompanied by some form of instability, occurs as the frequency approaches the limits of the flat-top. The design of "flat-top" I.F. amplifiers is considered in Chapter 17.

(12) Noise

Without going deeply into the involved subject of background noise, it is possible to divide such noise into two main divisions

- (1) Thermal Agitation Noise (sometimes called "Johnson Noise")
- (2) Valve Noise.

Thermal Agitation Noise occurs in all impedances but is most apparent in those at the input of the first stage of a radio receiver or microphone amplifier owing to the large amplification following. The Thermal Agitation Noise at the tuned grid circuit of the first stage in a radio receiver is about $3\mu\text{V}$. on the broadcast band and about $1\mu\text{V}$. on the short-wave band.

Valve Noise may be best considered as occurring at the grid of the valve and is about $1\mu\text{V}$. for a super-control pentode R.F. amplifier. When a valve is used as a converter the noise voltage is approximately doubled. So that a pentode as converter under ideal conditions will give about $2\mu\text{V}$. valve noise, referred to its grid. A pentagrid type of converter gives about $4\mu\text{V}$. valve noise since the design of such types makes them inherently somewhat more noisy than R.F. pentodes. When the oscillator voltage does not completely modulate the converter current, the noise will increase.

Since both Thermal Agitation Noise and Valve Noise are referred to the grid, the two voltages may be combined and the resultant will be the square root of the sum of the squares of the individual noise voltages. For example if the valve noise is $4\mu\text{V}$. and the thermal agitation noise is $3\mu\text{V}$., the resultant noise will be $\sqrt{4^2 + 3^2}$ or $5\mu\text{V}$. This same method holds for any number of combined noise voltages.

When an R.F. stage is used ahead of the converter, the noise from the grid of the converter may be referred to the grid of the R.F. valve by dividing by the R.F. stage gain. Thus with a normal R.F. stage gain the converter noise becomes practically negligible either on the broadcast band or on short-waves, leaving the resultant of the thermal agitation noise and the valve noise of the R.F. stage as the total noise referred to the grid of the R.F. stage.

The noise at the grid of the first stage may be referred to the aerial terminal by dividing it by the gain of the aerial coil. The design of the aerial coil is therefore one of the principal features of the design of a receiver having high sensitivity.

The signal-to-noise ratio* for any given signal strength is the criterion of performance as regards noise, and is particularly important in a receiver having a sensitivity approaching $1\mu\text{V}$. Increasing the gain of a converter valve decreases the noise referred to its grid, since the noise originates in the plate circuit. Consequently there is distinct advantage in obtaining maximum stage gain from the converter. No increase or decrease of gain following the converter has any effect on the signal-to-noise ratio. The selectivity of the I.F. amplifier, and the fidelity of the A.F. amplifier, affect the noise output as well as the higher audio frequencies in the signal. For communication purposes, where only limited fidelity is required, it is usual to cut the higher audio frequencies by using an extremely selective I.F. channel together with a manually operated A.F. tone control. The noise is reduced by this means in proportion as the audio frequency bandwidth is reduced, although the intelligibility is also reduced.

There are many articles on Noise to which reference may be made for further information. A short and simple survey is given by D. A. Bell, "Receiver Noise," *Wireless World*, March 16, 1939. For the relationship between noise and bandwidth see V. D. Landon, "A Study of the Characteristics of Noise," *Proc. I.R.E.*, November, 1936. A good book on the subject is by E. B. Moullin, "Spontaneous Fluctuations of Voltage," (Oxford University Press).

The Application of Converters

Fig. 6 shows a typical *autodyne* circuit using valve type 6C6 although almost any other screen grid or pentode valve could be used in a similar manner. It can be seen from the circuit that the impedance of the tuned circuit is in series with the oscillator voltage as applied between grid and cathode. If the impedance of the tuned circuit at the oscillator frequency is appreciable (as will normally be the case with shortwave reception) then appreciable voltage of oscillator frequency will appear across the tuned circuit, thus tending to cause radiation, and the oscillator voltage appearing between grid and cathode will be reduced, thus causing inefficient operation. For these reasons the simple autodyne circuit as shown is not suitable for the higher frequencies, although there is a modified circuit which may be used.

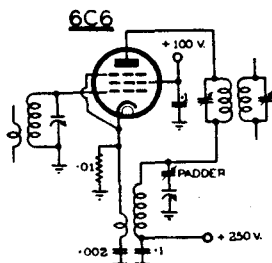

Figure 6.

*The signal to noise ratio under different conditions may only be compared when the input signal remains constant, or when the noise voltage is calculated in "ensi" (see Chapter 29).

Fig. 7 shows the circuit of the 6F7, a typical triode pentode valve. Similar remarks apply as for the autodyne. Fig. 8 shows a circuit incorporating the 6A8-G pentagrid converter. This circuit is equally suitable for operation at broadcast or higher frequencies. The values of components, as given on the circuit, are typical although some variation in the grid condenser and the oscillator grid leak is sometimes made. Neutralisation between oscillator grid and signal grid is frequently employed in order to improve the operation at the highest frequencies on the short-wave

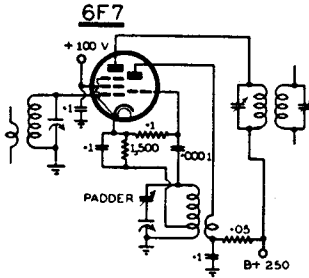

Figure 7.

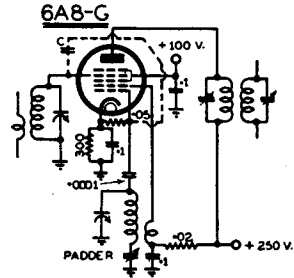
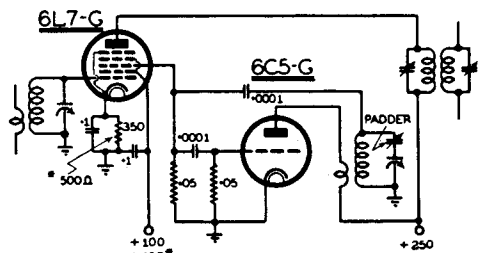

Figure 8.

band. This is obtained by a small condenser (see C in the diagram) which would normally be of the order of $1\mu\mu\text{F}$. This needs to be adjusted under operating conditions for optimum results. Owing to the frequency drift caused by A.V.C. on the short-wave band, it is preferable for the 6A8-G to be operated at fixed bias on this band, but alternatively if A.V.C. is applied the I.F. amplifier may be arranged with a comparatively flat "top" so that reasonable drifts in frequency are permissible. The maximum voltage which should be applied to the anode grid of the 6A8-G is 200 volts; when operated from a higher voltage a dropping resistor is necessary. In order to avoid flutter the anode grid is frequently supplied directly from the filament of the rectifier valve through a dropping resistor with a suitably large by-pass condenser from the low voltage end of this resistor; good filtering is required to avoid modulation hum.

Fig. 9 shows a typical circuit of the 6L7-G mixer with a 6C5-G (or 6J7-G triode) oscillator. Either direct or capacitive coupling is possible between the oscillator and the mixer with slight differences in operation between the two methods, and any of several oscillator arrangements may be adopted. The one shown may be regarded as only typical. On very high frequencies it is advisable to operate the 6L7-G with fixed bias in place of A.V.C. and to decrease the resistance of the grid circuit to the minimum. On the short-wave band it is also desirable to increase the minimum bias



* RECOMMENDED FOR SHORT-WAVE RECEPTION

Figure 9

on No. 1 grid to -6 volts and then, in order to prevent loss of sensitivity, the screen voltage may be increased to 150 volts.

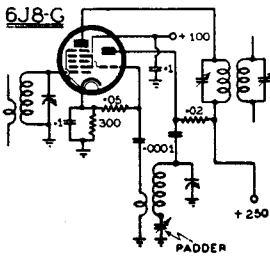

Figure 10.

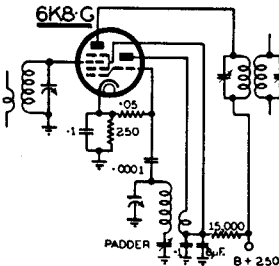

Figure 11.

to obtain the greatest stability in oscillator frequency it is desirable to use a common dropping resistor of 15,000 ohms from B + to both screen and oscillator plate. A by-pass condenser of about $8 \mu\text{F}$. is sufficient to avoid all traces of flutter. Special high dynamic resistance I.F. transformers are not required for the 6K8-G although some benefit is given by an improvement in this direction.

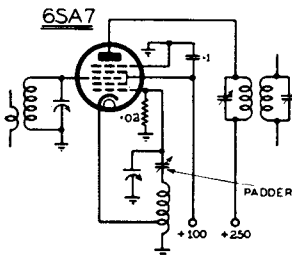

Figure 12.

Fig. 10 shows a typical operating circuit for the 6J8-G triode-heptode converter. Direct coupling between the triode and the mixer is provided inside the valve but in other respects the operation is very similar to the 6L7G. No increase of screen voltage is permissible in the 6J8-G but this does not appear necessary in practice on the ordinary short-wave band. A.V.C. may be applied to this valve at all normal short-wave frequencies. Plate tuning is frequently used in the oscillator in order to improve the strength of oscillation and to provide better stability. Owing to the high plate resistance and low conversion conductance it is desirable to use a following I.F. transformer having high dynamic resistance. One method of assisting the attainment of a high dynamic resistance is to increase the L/C ratio by increasing the inductance and decreasing the capacitance to a limit of about $70 \mu\text{F}$.

Fig. 11 shows a typical operating circuit for the 6K8-G triode-hexode and it will be seen that the circuit is essentially similar to that for 6A8-G. Owing to the fact that the voltage which may be applied to the oscillator plate is limited to 100 volts some modification of the 6A8-G circuit is necessary. In order

Fig. 12 shows a typical circuit incorporating the 6SA7 converter. A Hartley oscillator is employed in this circuit and only a single tapped coil is required. Various other alternative arrangements of the coil are possible. At the higher frequencies some improvement is possible by adopting a separate oscillator since otherwise it is difficult to obtain complete modulation. With self-excitation neutralisation similar to that with the 6A8-G is not satisfactory but with a separate oscillator it is beneficial. Owing to the high plate resistance, high dynamic resistance I.F. transformers are advantageous, but not necessary in most cases, since the conversion conductance is high.

Formulae for Oscillator Tracking in Superheterodyne Receivers

For correct tracking,* the oscillator frequency must be maintained at a constant frequency difference from the R.F. signal frequency, the oscillator frequency generally but not always being higher than that of the signal. When the oscillator frequency is higher than the signal frequency, the band-frequency-ratio of the oscillator circuit must be less than that of the signal circuit, and if similar ganged condenser sections are used

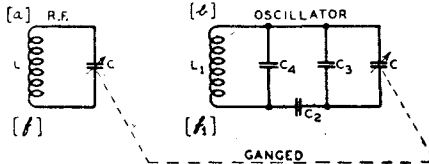

Figure 13.

for both it is necessary to restrict the capacitance range of the oscillator section. This is generally accomplished by means of a padder condenser inserted in series with a section of the ganged condenser (Fig. 13). By suitable adjustment of the inductance of the oscillator coil and the padder and trimmer condensers of the oscillator circuit, it is possible to secure exact tracking at three frequencies over the band. It is usual so to adjust these values that exact tracking is obtained at a slight distance from each end of the band and at a point somewhere near the centre of the band.

A tracking diagram* for the broadcast band is shown in Fig. 14 on which, in addition to the optimum value of oscillator coil inductance L_1 ,

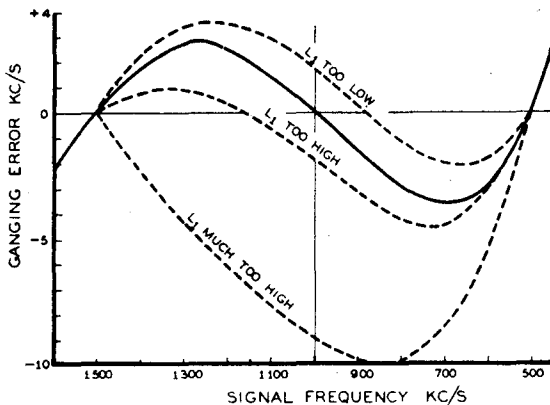

Figure 14.

there are shown the curves for higher and lower inductances. The maximum tracking error over the band 540-1,600 Kc/s need not exceed about 3 Kc/s, this deviation being negligible since the oscillator tuning "takes charge" and the lack of alignment only affects the R.F. and aerial circuits, which are relatively unselective.

It is advisable to select values of L_1 and C_2 (padder) by calculation as a first step and then to check experimentally on the middle frequency to determine whether the choice of L_1 was sufficiently close. No matter what value of L_1 is taken, it is possible to obtain correct tracking at at least two frequencies, and if a fairly close approximation is taken tracking will be correct for three frequencies, but the in-between frequency will not be centrally situated unless the correct value of L_1 is selected.

On the short-wave band conditions are different, and in most cases the padder is omitted or is of fixed capacitance. If the padder is omitted

*See A. L. M. Sowerby, "Ganging the Tuning Controls of a Superheterodyne Receiver," *Wireless Engineer*, Vol. 9, No. 101, pp. 70-75, February (1932); also "Design of Oscillator Circuit for Superheterodyne Receivers," *Electronics*, Vol. 12, No. 1, January (1939); C. P. Singer, "Ganging a Superhet," *Wireless Engineer*, Vol. 13, No. 153, p. 307, June (1936); V. D. Landon and E. A. Sveen, "A Solution of the Superheterodyne Tracking Problem," *Electronics*, p. 250, August (1932); I. M. Wald, "Ganging Superheterodyne Receivers," *Wireless Engineer*, Vol. 17, No. 198, pp. 105-109, March (1940).

the inductance is adjusted to give correct tracking towards the low frequency end, and the trimmer towards the high frequency end. Aerial coupling introduces tracking difficulties on the short-wave band, particularly when interwound coils are used, and where three point tracking is required it is advisable to use coils with high impedance primaries.

Formulae for Superheterodyne Oscillator Design

C , C Gang condenser + trimmer capacitance on R.F. circuit.

C_2 Padder capacitance.

C_3 (Oscillator trimmer capacitance) — (R.F. trimmer capacitance).

C_4 Distributed capacitance of L_1 .

If C_4 is small compared to C_2 it may be considered as part of C_3 .

Let f_1 be the resonant frequency of the oscillator circuit

f be the resonant frequency of the R.F. circuit.

and f_o be the I.F.

$$\therefore f_1 = f + f_o \text{ for exact tracking.}$$

Exact tracking can only be obtained with this circuit at three frequencies F_1 , F_2 and F_3 which should be situated one near (but not at) each end of the band and F_2 near the centre of the band. Let the value of C at a frequency F_o be C_o .

Then if L is expressed in microhenries,

C_o is expressed in micromicrofarads,

F_o is expressed in megacycles,

$$L = \frac{25330}{C_o F_o^2}$$

$$\text{Let } a = F_1 + F_2 + F_3$$

$$b^2 = F_1 F_2 + F_1 F_3 + F_2 F_3$$

$$c^3 = F_1 F_2 F_3$$

$$d = a + 2 f_o$$

$$l^2 = \frac{(b^2 d - c^3)}{2 f_o}$$

$$m^2 = l^2 + f_o^2 + ad - b^2$$

$$n^2 = \frac{(c^3d + f_o^2 l^2)}{m^2}$$

$$A = C_o F_o^2 \left(\frac{1}{n^2} - \frac{1}{l^2} \right)$$

$$B = \frac{C_o F_o^2}{l^2} - C_3.$$

Case 1. C_4 very much less than C_2 and considered as part of C_3 (the usual case)

$$C_2 = C_o F_o^2 \left(\frac{1}{n^2} - \frac{1}{l^2} \right)$$

$$C_3 = \frac{C_o F_o^2}{l^2}$$

$$L_1 = L \cdot \frac{l^2}{m^2} \cdot \frac{C_2 + C_3}{C_2}.$$

Case 2. When $C_3 = 0$

$$C_2 = \frac{C_o F_o^2}{n^2}$$

$$C_4 = \frac{C_o F_o^2}{l^2 - n^2}$$

$$L_1 = L \cdot \frac{l^2}{m^2} \cdot \frac{C_2}{C_2 + C_4}.$$

Case 3. When C_4 is known

$$C_2 = A \left\{ \frac{1}{2} + \sqrt{\frac{1}{4} + \frac{C_4}{A}} \right\}$$

$$C_3 = \frac{C_o F_o^2}{l^2} - \frac{C_2 C_4}{C_2 + C_4}$$

$$L_1 = L \cdot \frac{l^2}{m^2} \cdot \frac{C_2 + C_3}{C_2 + C_4}$$

Case 4. When C_3 is known

$$C_2 = \frac{C_o F_o^2}{n^2} - C_3$$

$$C_4 = \frac{C_2 B}{C_2 - B}$$

$$L_1 = L \cdot \frac{l^2}{m^2} \cdot \frac{C_2 + C_3}{C_2 + C_4}$$

Check formulae:

Equation for oscillator frequency:—

$$f_1 = m \sqrt{\frac{f^2 + n^2}{f^2 + l^2}}$$

Equations for l^2 , m^2 and n^2 in terms of oscillator constants:—

$$l^2 = \frac{C_o F_o^2}{\left\{ C_3 + \frac{C_2 C_4}{C_2 + C_4} \right\}}$$

$$m^2 = \frac{C_o F_o^2}{\frac{L_1}{L} \left\{ C_4 + \frac{C_2 C_3}{C_2 + C_3} \right\}}$$

$$n^2 = \frac{C_o F_o^2}{C_2 + C_3}$$

These formulae give accurate results provided that the signal frequency circuits are not associated with resonant primaries.

In practice, however, this is often far from the truth. If a signal frequency secondary circuit is coupled to a primary of natural resonant

frequency f' , and the coupling factor is K , then the inductance L of the secondary alters to an apparent value L' , where

$$L' = L \left(1 - \frac{K^2}{1 - (f'/f)^2} \right)$$

The change of inductance is a function of the inverse square of the signal frequency f and is greatest at the end of the tuning range at which f most nearly approaches f' . When f' is lower than f , L' is less than L , and the divergence increases as f' approaches the low frequency end of the band. A lower value of padding condenser in the oscillator circuit, about 10% or 20% less than calculated, is usually required before tracking errors are minimised.

When the oscillator primary coil resonance lies near the high frequency end of the oscillator tuning range L'_1 is greater than L_1 . A reduction of both the minimum tuning capacitance and padding capacitance provides satisfactory compensation.

Therefore, in practical cases, the oscillator circuit constants calculated from these formulae can be taken as a guide only, and experimental work is necessary to determine the correct values. A sound practical rule is to arrange that the ratio f'/f does not lie between $\sqrt{1.5}$ and $1/\sqrt{2}$, for which condition $L' = L(1 \pm 2K^2)$. When $K = 0.1$, the inductance ratio L'/L becomes 0.98 to 1.02. When the ratio f'/f is near unity, L' diverges widely from L , and it is almost impossible to obtain good tracking over a practical range of signal frequencies.

CHAPTER 16

Tuned Circuits, Calculation of Inductance and Design of Low Loss Inductances

Part 1 — Tuned Circuits

Natural resonant frequency — Resonant frequency —
 Logarithmic decrement—Series impedance of tuned circuit
 —Series resonance—Currents and voltages—Q factor—
 Parallel resonance—Currents—Equivalent series and shunt
 resistances—Dynamic resistance—Selectivity—Phase angle
 —Experimental method for determination of Q—Trans-
 former with tuned secondary—Transformer with tuned
 primary and tuned secondary—Critical coupling factor—
 Transitional coupling factor—Band width between peaks—
 Determination of points on selectivity curve—Graphical
 method for two identical tuned circuits—Case when the two
 resistances are not equal—Maximum possible selectivity—
 Methods of coupling other than mutual inductive—High
 impedance (top) coupling—Low impedance (bottom)
 coupling—Values for K for various couplings—Effect of
 increasing coupling above critical—Position of peaks rela-
 tive to centre frequency—Tuning over a wide range of fre-
 quencies—Combined couplings—Tuned circuits in cascade
 —Limit to selectivity by reduction of coupling—Universal
 selectivity calculator—Bibliography—Summary of formulae
 for tuned circuits.

Tuned Circuits

When a violin is tuned, the tensions of its strings are adjusted to permit vibration at particular frequencies. In radio, when an arrangement of L, C, and R responds to particular frequencies, it is called a "tuned" circuit.

In principle, the tuned circuit is similar to a pendulum or violin string, tuning fork, etc.—it has the property of storing energy in an oscillating (vibrating) state, regularly changing from kinetic form (magnetic field, when current flows through the coil) to potential form (electric field, when the condenser is charged) and back again at a frequency called the **natural resonant frequency**.

In Fig. 1 let the condenser C be charged. It will discharge its energy through the inductance L, causing the current to increase all the while, until it reaches the maximum when there is **no potential** across C. At that instant the energy is all magnetic, and the current continues, fed by the magnetic field, to build a voltage of reversed polarity across C. When all the energy has been transferred from L to C, the voltage across C has its original value, but is reversed in sign, and the current is diminished to zero. The process then reverses, and repeats itself indefinitely, cycle after cycle.

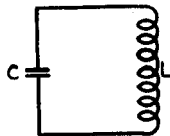

Figure 1.

Were there no loss of energy, each cycle would be identical with the preceding one, but this is not the case in practice, as there is always resistance in the coil. The loss of energy is in proportion to the energy remaining in the circuit.

For a detailed and accurate account of the processes involved, reference should be made to standard textbooks relating to the theory of radio circuits. A list of several such books is given in the accompanying bibliography.

In Fig. 2, if I_0 be the maximum current amplitude that occurs during a given cycle of the oscillation, and we measure the time t from the instant of this maximum, then the current i at any subsequent instant is given by the equation.

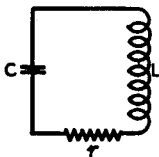

Figure 2.

$$i = I_0 e^{-at} \cos \omega_n t$$

where $\omega_n = 2\pi \times f_n$, f_n being the **natural resonant frequency**,

$$\omega_n = \sqrt{\frac{1}{LC} - \frac{r^2}{4L^2}}$$

$$a = r/2L = \text{damping factor,}$$

where L is in Henries, C is in Farads, r is in Ohms, and f_n is in Cycles per second.

When the resistance r in the circuit is zero, the **resonant frequency** f_0 is given by

$$\omega_0 = 2\pi f_0 = \sqrt{1/LC}$$

The ratio of the natural resonant frequency to the resonant frequency is

$$f_n/f_0 = \sqrt{1 - (1/4Q^2)}$$

$$\text{where } Q = \frac{\omega_0 L}{r} = \frac{2\pi f_0 L}{r} = \frac{\text{Reactance of the coil}}{\text{Series resistance}}$$

This relation indicates how little the natural frequency differs from the resonant frequency. Q must be less than four before f_n differs from f_0 by as much as 1%. Q is normally greater than 50, for which value the two frequencies differ by one part in roughly twenty thousand.

In the equation for the current i , if t be increased by an amount $2\pi/\omega_n$, the period of one cycle, we arrive at the corresponding point in the next cycle, and

$$\begin{aligned} i' &= I_0 e^{-a[t+(2\pi/\omega_n)]} \cos \omega_n [t + (2\pi/\omega_n)] \\ &= e^{-2\pi a/\omega_n} i \end{aligned}$$

or $i'/i = e^{-\pi r/\omega_n L}$, since $a = r/2L$

This is the ratio of the amplitude of one cycle to that of the one next preceding.

Logarithmic decrement is defined as

$$\delta = \frac{\pi r}{\omega_n L} = \log_e \frac{i}{i'}$$

and is thus the naperian logarithm of the ratio of the amplitudes of two successive cycles.

The series impedance z of the circuit in Fig. 2 at any frequency ($f = \omega/2\pi$) is given by the relation

$$z = \sqrt{r^2 + [\omega L - (1/\omega C)]^2}$$

If an alternating voltage of frequency f be applied in series with the circuit, we find that the current reaches a maximum when the second term in the square root is zero, or $\omega = 1/\sqrt{LC} = \omega_0$, the resonant frequency.

It is perhaps surprising that the condition for maximum current is independent of the circuit resistance r , and does not occur when the applied frequency is equal to the natural frequency f_n . The condition for maximum current flow is designated "series resonance."

If the R.M.S. value of the alternating voltage applied in series with the circuit be E , then the R.M.S. value I of the current produced is

$$\begin{aligned} I &= E/z = \frac{E}{\sqrt{r^2 + [\omega L - (1/\omega C)]^2}} \\ &= E/r \text{ when } \omega = 1/\sqrt{LC} = \omega_0 \end{aligned}$$

The voltages across the several parts of the circuit under this condition of resonance are

$$\begin{aligned} rI &= E \text{ across the resistance,} \\ \omega_0 LI &\text{ across the inductance,} \\ \text{and } -(1/\omega_0 C)I &\text{ across the condenser.} \end{aligned}$$

The voltages across the inductance and the condenser are equal and opposite in sign, thus cancelling each other, and they are usually large compared with the voltage across the resistance.

The voltage across the inductance is also equal to $(\omega_0 L/r)E$, since $I = E/r$, and therefore its ratio to the voltage E applied in series with the circuit is $\omega_0 L/r$. This ratio, usually designated Q , is the ratio of the

reactance of the coil to the resistance in series with it, and is called the "coil magnification factor," or "energy factor." Thus,

$$Q = \frac{\omega_0 L}{r} = \frac{1}{r} \sqrt{\frac{L}{C}} = \frac{1}{\omega_0 C r}$$

If L , C , and r be all connected in series, as in Fig. 2, and the alternating voltage be applied across the condenser C , instead of in series with the circuit, the current divides between the two branches.

The current in L and r is

$$I_L = \frac{E}{\sqrt{r^2 + \omega^2 L^2}}$$

and the current in C is $I_c = -\omega C E$, assuming the condenser loss to be negligible. Taking the sum of the two currents, with due regard to their phase relation,

$$I = E \sqrt{\left(\omega C - \frac{\omega L}{r^2 + \omega^2 L^2} \right)^2 + \left(\frac{r}{r^2 + \omega^2 L^2} \right)^2}$$

When $\omega C = \omega L / (r^2 + \omega^2 L^2)$, the total current is in phase with the applied voltage E , and has the value

$$I = E \left(\frac{r}{r^2 + \omega^2 L^2} \right) \text{ at resonance.}$$

This is the minimum current for varying values of f , and is the condition for what may be called "parallel resonance" as distinct from the "series resonance" case considered before. The currents in the condenser and coil are large compared with the current in the external circuit, because they are very nearly opposite in phase.

The value of ω at which resonance occurs is

$$\omega = \frac{1}{\sqrt{LC}} \cdot \frac{1}{\sqrt{1 + (r^2/\omega^2 L^2)}}$$

It was pointed out before that $\omega L/r$, the ratio of reactance of the coil to resistance in series with the circuit, is usually greater than 50. Thus, with an error of about one part in five thousand at $\omega L/r = 50$, and with still smaller errors for larger values, we may write for the parallel resonance frequency $\omega_0 = 1/\sqrt{LC}$, which is the same result as that obtained in the series resonance case.

With a similarly small degree of error we may write the following simple relations for the currents at resonance: The current in the external circuit

$$\begin{aligned} &= E \cdot \frac{r}{\omega_0^2 L^2} = E \cdot Cr/L = E \cdot \omega_0^2 C^2 r, \\ &= \frac{E}{\omega_0 L} \cdot \frac{1}{Q} = \frac{E}{R_e} = \frac{E \cdot \omega_0 C}{Q} \end{aligned}$$

where $Q = \omega_0 L/r$ as before, and $R_e = L/Cr$, as shown in Figs. 4a and 4b.

The current in the coil and resistance is very closely equal to that in the condenser, or

$$I_L = -I_c = E/\omega_0 L = -\omega_0 C E,$$

and is Q times larger than the current in the external circuit.

A far more important practical case than any others considered so far is the circuit shown in Fig. 3, in which a second resistance R appears in shunt with the condenser C. R represents the effect of all insulation losses in the condenser, the coil, wiring, switches, and valves, together with the input or plate resistance of valves.

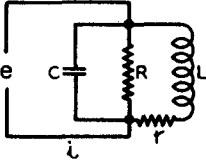

Figure 3.

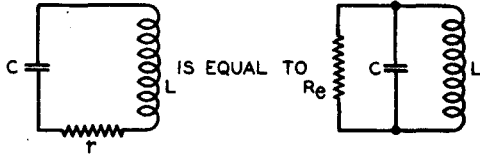

Figure 4a (left), Figure 4b (right).

We saw in the last case that the series resistance r may be considered instead as a resistance $L/Cr = R_e$ shunted across the condenser. This equivalence is shown in Figs. 4a and 4b. It may be shown further that $Q = \omega_0 L/r = (1/r) \cdot \sqrt{L/C}$, as for the series resonance case. Hence

$$R_e = L/Cr = Q \cdot \omega_0 L = Q/\omega_0 C = Q\sqrt{L/C}.$$

In the present case we have R in parallel with L/Cr , and the resultant "dynamic resistance" is

$$R_D = \frac{1}{(1/R) + (Cr/L)}$$

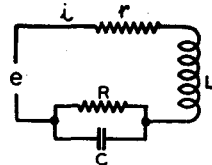

Figure 5. General case of series circuit.

Therefore the resultant value of Q is

$$Q = \sqrt{C/L} \cdot R_D = \frac{1}{1/R \sqrt{L/C} + r \sqrt{C/L}} = \frac{1}{(\omega_0 L/R) + (r/\omega_0 L)}$$

The expression $\sqrt{L/C}$ is equal to the reactance of both the inductance and the condenser at the resonant frequency. That is,

$$\omega_0 L = \sqrt{L/C} = 1/\omega_0 C.$$

In the circuit of Fig. 3 we saw that the resistance r in series with L may be considered as a resistance L/Cr in shunt with condenser C. By similar reasoning the converse case may be shown for the shunt resistance R, which may be considered as a resistance L/CR in series with r. The resultant equivalent series resistance is $r' = r + (L/CR)$.

At other frequencies such as f, which do not coincide with the resonant frequency f_0 , the reactances of the coil and the condenser no longer balance. In the series circuit the resistance r becomes an impedance z which is

greater than r . In the parallel circuit the dynamic resistance R_D becomes an impedance Z which is less than R_D . The ratios of these quantities determine the selectivity or response of the circuit, and are related to Q and f by the following expression:

$$\frac{m_o}{m} = \frac{z}{r} = \frac{R_D}{Z} = \frac{1}{\sqrt{1 + Q^2 \left(\frac{f}{f_o} - \frac{f_o}{f} \right)^2}} = Q \left(\frac{f}{f_o} - \frac{f_o}{f} \right)$$

approximately when $m_o/m > 10$, where m_o is the gain at a frequency f_o and m is the gain at a frequency f .

The phase angle between the current in the external circuit and the applied voltage is such that

$$\tan \phi = -Q \left(\frac{f}{f_o} - \frac{f_o}{f} \right) = -Q \cdot \frac{\Delta f_o}{f_o} \cdot \frac{2 + (\Delta f_o/f_o)}{1 + (\Delta f_o/f_o)}$$

where $\Delta f_o = f - f_o$.

The reactance varies with the frequency f , and equals the resistance r or R_D when the phase angle is 45° , or when

$$\tan \phi = 1, \text{ and } z/r = R_D/Z = \sqrt{2}.$$

For values of $\Delta f_o/f_o$ small compared with unity, $\tan \phi = Q(2\Delta f_o/f_o)$ approximately, and the error does not exceed 1% when $\Delta f_o/f_o$ is not greater than $1/60$. Thus, when $Q = 100$ the reactance equals the resistance when $\Delta f_o = 1/200 f_o$, or 0.5% of f_o .

When the phase angle is 45° , we have

$$\tan \phi = 1 = Q [(f/f_o) - (f_o/f)]$$

$$\text{and } Q = \frac{1}{(f/f_o) - (f_o/f)}$$

$$= f_o / (2\Delta f_o) \text{ approximately,}$$

with an error of 1% when $Q = 50$, which diminishes at higher values of Q .

Under this condition, since the impedance of the circuit is such that

$$m_o/m = z/r = R_D/Z = \sqrt{2},$$

the voltage developed across the coil or the condenser is $1/\sqrt{2}$ of that at resonance. This occurs at two frequencies f_1 and f_b which are related f_o as follows (See Fig. 17):

$$f_1 = f_o - \Delta f_o$$

$$f_b = f_o + \Delta f_o$$

That is, $f_h - f_1 = 2\Delta f_o$,

$$\text{and } Q = \frac{f_o}{f_h - f_1} = \frac{\text{centre frequency}}{\text{Band width of selectivity curve at } 1/\sqrt{2} \text{ of maximum response.}}$$

This relation forms the basis of an experimental method for the determination of Q . A very low loss valve voltmeter shunted across the coil or the condenser of the tuned circuit indicates when the voltage has fallen to $1/\sqrt{2}$ of the resonance value, and the frequencies f_o , f_1 and f_h are obtained from the calibration of the radio frequency generator employed.

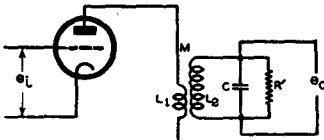

Figure 6.

Fig 6 illustrates a typical case of the application of a high frequency transformer with tuned secondary in a radio receiver.

From the theory of high frequency transformers (see bibliography), when the primary reactance is negligible compared with the reflected resistance $\omega_o^2 M^2 / r_2$ of the resonant secondary, and when the stray capacitances shunting the primary are sufficiently small to ensure that its resonance frequency is at least ten times that of the secondary, the following approximate expression may be used to determine the gain of the valve and transformer at the resonance frequency of the secondary:

$$\begin{aligned} \frac{e_o}{e_i} = m_o &= \frac{g_m}{(M/r_p L_2) + (1/\omega_o M Q_2)} = \frac{g_m K R_D \sqrt{L_1/L_2}}{1 + K^2 (R_D/r_p) \cdot (L_1/L_2)} \\ &= g_m \omega_o M Q_2 = g_m K R_D \sqrt{L_1/L_2} \end{aligned}$$

when r_p is sufficiently large for $K^2 R_D (L_1/L_2)$ to be less than five per cent of r_p , where

- g_m = mutual conductance of the valve in mhos,
- r_p = plate resistance of the valve in ohms,
- L_1 = primary inductance in henries,
- L_2 = secondary inductance in henries,
- M = mutual inductance between L_1 and L_2 , in henries,
- $K = M/\sqrt{L_1 L_2}$ = coupling factor,
- Q_2 = ratio of secondary reactance to resistance at the resonant frequency,
- $\omega_o = 2\pi \times$ resonant frequency of secondary in cycles per second, and
- $R_D = \omega_o L_2 Q_2 =$ dynamic resistance of secondary in ohms.

If the inductances L_1 and L_2 have similar ratios of diameter to length, or form factor, and the turns are N_1 and N_2 respectively, then $\sqrt{L_1/L_2}$ in the above formula may be replaced by N_1/N_2 .

The plate resistance r_p of the valve is reflected as a resistance $(r_p/K^2) \cdot (L_2/L_1)$ in parallel with R_D across the secondary circuit. If $(r_p/K^2) \cdot (L_2/L_1)$ be less than twenty times R_D the shunting action should

be taken into account when determining the selectivity of the circuit from the expression

$$R'/Z = \sqrt{1 + Q'_2{}^2 [(f/f_0) - (f_0/f)]^2}$$

in which

$$R' = \frac{1}{(1/R_D) + [(K^2/r_p) \cdot (L_1/L_2)]}$$

$$\text{and } Q'_2 = \frac{R'}{\omega_0 L_2} = \frac{1}{(1/Q_2) + [(K^2/r_p) \cdot \omega_0 L_1]}$$

However, R' and Q'_2 should not be used in place of R_D and Q_2 in the calculation of the gain m_0 .

The circuit shown in Fig. 7 is a typical example of the application of a high frequency transformer with a tuned primary and tuned secondary. Intermediate frequency transformers in superheterodyne receivers are usually of this type. Very thorough discussions of such transformers have been given from the theoretical point of view by Aiken (Proc. I.R.E., Vol. 25, No. 2, p. 230, February 1937), and from the design point of view by Scheer (Proc. I.R.E., Vol. 23, No. 12, p. 1483, Dec. 1935). Both of these sources of information should be consulted.

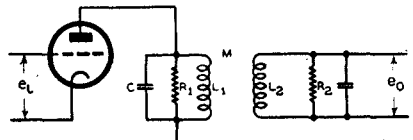

Figure 7.

It may be shown that the gain of the circuit in Fig. 7 at resonance is

$$\frac{e_0}{e_1} = m_0 = \frac{g_m \sqrt{R'R_2}}{K\sqrt{Q'Q_2} + \frac{1}{K\sqrt{Q'Q_2}}}$$

$$\text{where } \frac{1}{R'} = \frac{1}{r_p} + \frac{1}{R_1},$$

$$\text{and } \frac{1}{Q'} = \frac{\omega_0 L_1}{r_p} + \frac{1}{Q_1}.$$

All symbols have the same significance as before.

The expression for calculating the selectivity is lengthy and complicated, and a graphical treatment to be given later is recommended. Alternatively, reference should be made to Aiken's work.

There are some simple and useful relationships for certain special conditions.

As K is increased, the gain increases until $K\sqrt{Q'Q_2} = 1$, after which it decreases. The value of $K = 1/\sqrt{Q'Q_2}$ is designated the critical coupling factor.

When Q' is equal to Q_2 and K is increased beyond this critical value, the resonance curve has two frequencies of maximum response. These are separated by equal amounts above and below the value $f_0 = \omega_0/2\pi$, at which the single maximum response occurs below critical coupling.

When Q' is not equal to Q_2 , two peaks of maximum response do not appear as soon as K is increased above critical value. The value of K at which the two peaks just appear in place of one has been defined as "transitional coupling factor" by Aiken (Proc. I.R.E., Vol. 25, No. 2, p. 230, February 1937). In terms of Q' and Q_2 its value is $\sqrt{\frac{1}{2}[(1/Q'^2) + (1/Q_2^2)]}$. It will be seen at once that when Q' equals Q_2 , the values of K for transitional and critical coupling are coincident.

When the inductance, capacitance and resistance of the primary are the same as the secondary

Band width between peaks

$$= (1/2\pi L) \sqrt{\omega_0^2 M^2 - r^2}, \text{ where } L_1 = L_2 = L, \text{ and } r_1 = r_2 = r$$

$$= Kf_0 \sqrt{1 - (1/K^2 Q'^2)}, \text{ where } Q' = Q_2 = Q.$$

The frequency band width between the points on either flank of the resonance curve at which the response is equal to the minimum in the "valley" between the two peaks is $\sqrt{2}$ times the peak separation.

From the foregoing it will now be seen that five points on the resonance curve for two similar overcoupled circuits can be obtained very simply. Further points on the resonance curve may be found from the relation

$$\frac{m_0}{m} = \sqrt{\left[1 - \frac{Q^2 Y^2}{1 + K^2 Q^2}\right]^2 + \left[\frac{2QY}{1 + K^2 Q^2}\right]^2},$$

where $Y = [(f/f_0) - (f_0/f)]$ and $L, C,$ and r are equal for both circuits.

This expression may well be solved graphically according to the following procedure developed by Beatty (Wireless Engineer, Vol. IX, No. 109, p. 546, October 1932).

Graphical Method

A single tuned circuit in the plate load of a valve has the well-known frequency characteristic shown in Fig. 8. At the resonant frequency, where the reactance becomes zero, there is a peak of response, and the gain falls off on either side. The curve may be plotted graphically by the construction of Fig. 9. The ratio of gain at resonance, to the gain at any frequency off tune may be termed the attenuation function of the stage, and may be plotted as a vector quantity, having magnitude and phase. As the frequency is varied, it may be shown that the vector OP in Fig. 9 rotates about its own origin, O , and that its extremity traces out a linear path, P_0P . At resonance, the ratio m_0/m is unity, and has its least value. If OP_0 is the vector representing the condition of resonance it will be perpendicular to the line P_0P . The distance P_0P for any frequency is equal to $Q(f/f_0 - f_0/f)$, and is seen to be governed by the Q factor as well as the frequency. Where f is nearly equal to f_0 , the resonant frequency P_0P may be taken as approximately $2Q \Delta f_0/f_0$, where $\Delta f_0 = (f - f_0)$. Thus the length P_0P , close to resonance, is very nearly proportional to the amount of detuning.

It is found that when two identical tuned circuits are coupled, either by some common reactance component in the circuit or by mutual magnetic

coupling, the locus of the end of the radius vector OP becomes a parabola (see Fig. 10), instead of a straight line. The form of the parabola is seen to depend upon the Q factor of the coils, and the coupling co-efficient K. The distance OT is the criterion of form and may be expressed $2/\sqrt{1 + K^2Q^2}$. It is found that where $OT < \sqrt{2}$, corresponding to $KQ > 1$, there are two frequencies of maximum gain, corresponding to the vectors OP', OP' in Fig. 10. If the attenuation is plotted against Δf , as in Fig. 11, it is clear that a much flatter top may be attained by using coupled pairs of circuits than could ever be realised with single isolated tuners. Fig. 11 serves also to show the variation in band width with variations of OT (that is, changes of KQ since $OT = 2/\sqrt{1 + K^2Q^2}$). It should be noted that the form of the skirt of the curve remains practically similar for all values of KQ.

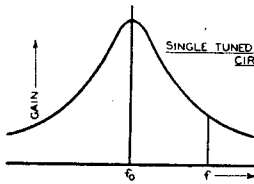

FIG. 8

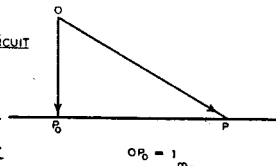

FIG. 9

$$OB = 1$$

$$OP = \frac{m_0}{m}$$

$$BP = Q \left[\frac{f}{f_0} - \frac{f_0}{f} \right]$$

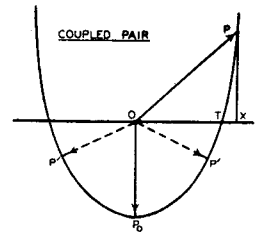

FIG. 10

WHERE m_0 = GAIN AT RESONANCE
 m = GAIN AT f
 f_0 = RESONANT FREQUENCY
 $Q = \frac{2\pi f_0 L}{R}$
 $Y = \left[\frac{f}{f_0} - \frac{f_0}{f} \right]$
 K = COEFFICIENT OF COUPLING.

$$OB = 1$$

$$OP = \frac{m_0}{m}$$

$$OX = \frac{2OY}{1 + K^2Q^2}$$

$$XP = 1 - \frac{OY^2}{1 + K^2Q^2}$$

$$OT = \frac{2}{\sqrt{1 + K^2Q^2}}$$

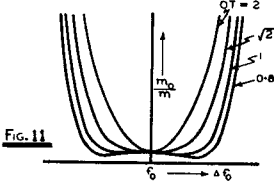

FIG. 11

Figures 8 to 11, inclusive.

When the circuit resistances r_1 and r_2 are not equal, the selectivity curve remains symmetrical, but as coupling is increased the amplitude of the two peaks decreases. From data given by Aiken (Proc. I.R.E., Feb., 1937), when the L and C values of two coupled circuits are equal, but the ratio of r_1 to r_2 is 10, the amplitude of the response at critical coupling being regarded as unity, the amplitude of the peaks is about 0.67 at three times critical coupling. He states also that

$$\text{Band width between peaks} = \frac{1}{2\pi L} \sqrt{\omega_0^2 M^2 - \frac{r_1^2 + r_2^2}{2}}$$

which may be reduced to $Kf_0 \sqrt{1 - \frac{1}{2K^2} \left(\frac{1}{Q_1^2} + \frac{1}{Q_2^2} \right)}$

The last expression holds also when L_1 is not equal to L_2 , but $L_1 C_1 = L_2 C_2$, for mutual inductive coupling (see editorial by G. W. O. Howe, Wireless Engineer, June, 1937), and is therefore a particularly useful practical result. It can also be shown that the band width between the points on the flanks of the selectivity curve level with the minimum response in the "valley" between the peaks is $\sqrt{2}$ times the peak separation.

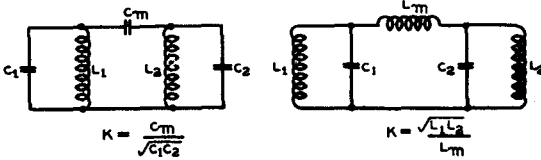

Figure 12 (left), Figure 13 (right).

When mutual inductance is increased above the critical value and the two peaks appear in place of one, they are placed symmetrically on either side of the centre frequency. Further increase of coupling causes both peaks to move equal intervals further away from the centre frequency. No other types of coupling, such as those shown in Figs. 12, 13, 14, 15 and 16, possess this useful characteristic.

When the highest possible selectivity without too much loss of gain is desired from a pair of tuned coupled circuits, a practical compromise is to reduce coupling to 0.5 of critical, when the gain is 0.8 times the maximum possible.

The selectivity then approaches that which would be obtained by separating the two circuits with a valve (assuming this is done without altering Q' and Q_2). For other relationships between gain and selectivity, refer to Reed, *Wireless Engineer*, July 1931, or to Aiken, *Proc. I.R.E.*, Feb. 1937.

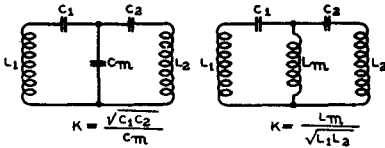

Figure 14 (left), Figure 15 (right).

There are other types of coupling which may be used between tuned circuits as alternatives to mutual inductance. Four such circuits are shown in Figs. 12, 13, 14, and 15. A fifth type is "link" coupling shown in Fig. 16, in which a relatively small coupling inductance L'_1 is coupled to L_1 and similarly L'_2 to L_2 , and L'_1 is connected directly in series with L'_2 .

The behaviour of this circuit is the same as that to be described for Fig. 15.

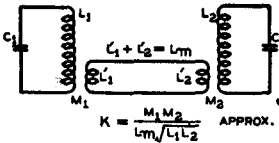

Figure 16.

In Figs. 12 and 13 high impedance or "top" coupling is used, while in Figs. 14 and 15 low impedance or "bottom" coupling is shown. Howe (editorial, *Wireless Engineer*, Sept. 1932) defines coupling between two circuits from a general point of view as the relation between the possible rate of transfer of energy and the stored energy of the circuits. Application of this principle leads to the result that for high impedance coupling,

$$K = \sqrt{X_1 X_2} / X_m,$$

while for low impedance coupling,

$$K = X_m / \sqrt{X_1 X_2}$$

where X_m is the reactance of the coupling, and X_1 and X_2 are the reactances of either the coils or the condensers with which the circuits are tuned.

For high impedance coupling X_m must be taken in parallel with the tuning reactance to obtain X_1 or X_2 , and for low impedance coupling it must be taken in series with X_1 or X_2 . The tuning reactance is of the same nature as X_m .

Thus the following relations hold:

Circuit	K (exact)	K (approximate)
Fig. 12	$\frac{C_m}{\sqrt{(C_1 + C_m)(C_2 + C_m)}}$	$\frac{C_m}{\sqrt{C_1 C_2}}, \text{ when } C_m \ll (C_1, C_2)$
Fig. 13	$\sqrt{\frac{L_1 L_2}{(L_1 + L_m)(L_2 + L_m)}}$	$\frac{\sqrt{L_1 L_2}}{L_m}, \text{ when } L_m \gg (L_1, L_2)$
Fig. 14	$\sqrt{\frac{C_1 C_2}{(C_1 + C_m)(C_2 + C_m)}}$	$\frac{\sqrt{C_1 C_2}}{C_m}, \text{ when } C_m \gg (C_1, C_2)$
Fig. 15	$\frac{L_m}{\sqrt{(L_1 + L_m)(L_2 + L_m)}}$	$\frac{L_m}{\sqrt{L_1 L_2}}, \text{ when } L_m \ll (L_1, L_2)$
Fig. 16	$L_m \sqrt{\left(L_1 - \frac{M_1^2}{L_m}\right) \left(L_2 - \frac{M_2^2}{L_m}\right)}$ <p style="text-align: center;">or</p> $\frac{K_1 K_2}{\sqrt{(1 - K_1^2)(1 - K_2^2)}}$	$\frac{M_1 M_2}{L_m \sqrt{L_1 L_2}}, \text{ when individual couplings are small.}$ $K_1 K_2, \text{ when individual couplings are small.}$
<p>where $L_m = L'_1 + L'_2$,</p> $K_1 = \frac{M_1}{\sqrt{L_1 L_m}},$ <p>and $K_2 = \frac{M_2}{\sqrt{L_2 L_m}}$</p>		

In the cases of Figs. 12, 13, 14, 15, and 16, as coupling is increased beyond critical, one peak remains approximately on the original centre frequency for small coupling, while the other peak moves away to one side. The stationary peak is determined by $1/\sqrt{L_1 C_1} = 1/\sqrt{L_2 C_2}$ in all four cases. The second peak is lower in frequency than the stationary one in Figs. 12 and 15, but higher in Figs. 13, 14 and 16. It is theoretically possible, though not usually practically convenient, to combine two types of coupling, in equal amounts, such as Figs. 12 and 14, so that the peaks spread symmetrically on either side of the centre frequency*. Normally it is convenient to use mutual inductive coupling.

Sometimes in the tuned radio frequency stages of a receiver a coupled pair of circuits may be required to tune over a wide range of frequencies. A single type of coupling cannot perform satisfactorily over a tuning range as wide as a two or three to one ratio of frequency. Two types of coupling are required. One is adjusted for optimum selectivity and gain near the

*Radiotronics No. 82, pp. 89-91, December 15 (1937); No. 84, pp. 105-107, March 15 (1938), and No. 85, p. 120, April 19 (1939).

low frequency end of the tuning range, while the other is similarly adjusted near the high frequency end. Aiken (Proc I.R.E., p. 246, Feb. 1937) gives a direct practical procedure for arriving at the best average results over the whole tuning range.

Most often the best results are obtained by a combination of mutual inductance M and low impedance coupling capacity C_m as shown in Fig. 14. The resultant coupling reactance is $\omega M + (1/\omega C_m)$ at any frequency $f = \omega/2\pi$ in the tuning range. The equivalent coupling factor is

$$K = \frac{\omega M + (1/\omega C_m)}{\omega \sqrt{L_1 L_2}} \text{ approximately (for } K < 0.05 \text{)}$$

When the types of coupling in Figs. 12 and 14 are combined, the equivalent coupling factor is

$$K = \frac{C_m \text{ (top)}}{\sqrt{C_1 C_2}} + \frac{\sqrt{C_1 C_2}}{C_m \text{ (bottom)}} \text{ approximately (for } K < 0.05 \text{)}$$

which varies more widely over a given tuning range than does the combination of M and C_m described above.

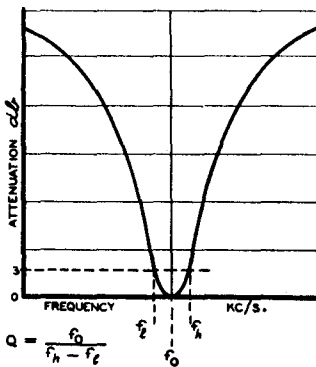

Figure 17.

When K has been determined in this manner, the frequency separation between the peaks and the selectivity may be found from the same expressions quoted earlier for mutual inductive coupling. Also, when the greatest possible selectivity is desired without much loss of gain, the value of $KQ = 0.5$ suggested previously for mutual inductive coupling may be applied again.

When two or more amplifier stages having identical circuits and values are connected in cascade, the resultant or overall gain and selectivity is the product of the gains and selectivities of all stages. For n stages the gain is $(m_o)^n$ and the selectivity is

$$(m/m_o)^n = \frac{1}{(1 + Q^2 Y^2)^{n/2}}$$

for single tuned circuits, and

$$(m/m_o)^n = \frac{1}{\left[\left(1 - \frac{Q^2 Y^2}{1 + K^2 Q^2} \right)^2 + \left(\frac{2QY}{1 + K^2 Q^2} \right)^2 \right]^{n/2}}$$

for coupled pairs.

When K^2Q^2 is very small, the selectivity of n coupled pairs is almost the same as that of $2n$ single tuned circuits. Thus there is a limit to the improvement of selectivity obtained by reduction of the coupling of coupled pairs of tuned circuits. When it is possible to increase Q , there is a corresponding improvement in selectivity. The tendency with several stages of single tuned circuits is to produce a very sharp peak at the centre frequency, which may seriously attenuate the higher audio frequencies of a modulated signal. Conditions are much better with coupled pairs, because two peaks with small separation appear as Q is increased, if the coupling is not too close. Difficulties occur when Q is increased so much that a deep "valley" or trough occurs between the peaks. The practical limit is usually a two or three to one ratio of overall gain between the response at the bottom of the valley and that at the two peaks. It is then good practice to add another stage employing a single tuned circuit which substantially removes the "valley" of the preceding circuits. The procedure by which the best results may be obtained is described by Ho-Shou Loh, Proc. I.R.E., Vol. 26, No. 4, p. 469, April 1938 (Errata, Vol. 26, No. 12, p. 1430, Dec. 1938). In this manner a very flat response may be

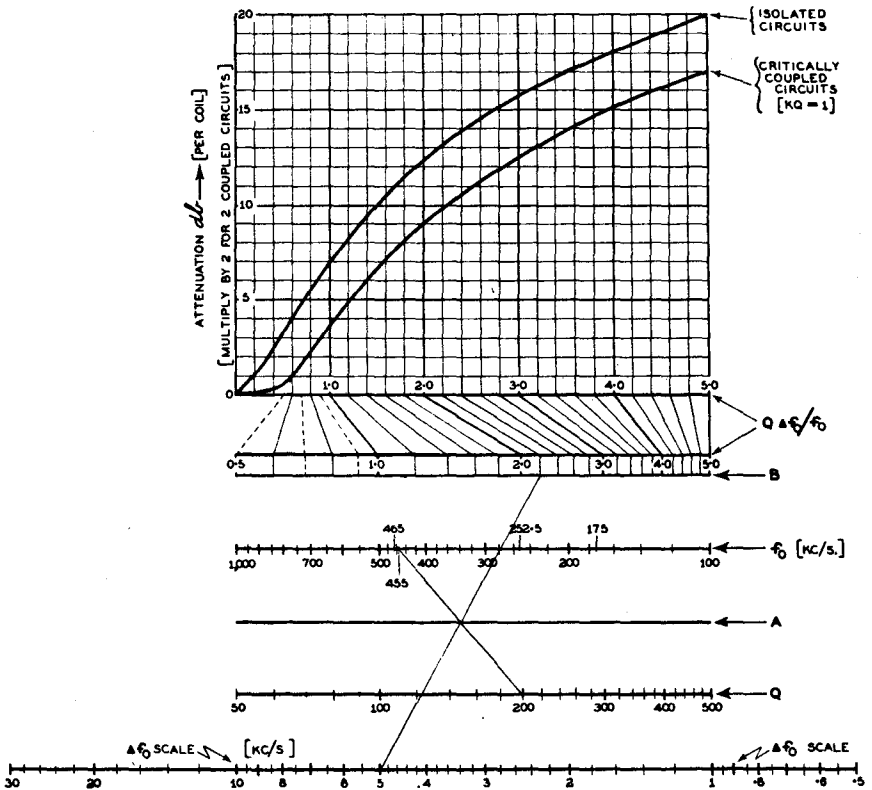

FIGURE 18: UNIVERSAL SELECTIVITY CALCULATOR

For use with electronic coupling (isolated circuits) and critically coupled circuits for values of Q not less than 25. Note that for 2 coupled circuits the value of attenuation in decibels per coil should be multiplied by 2, and similarly for other multiples. For explanation and example see text on pages 129 and 130.

obtained over a range of frequencies 10 Kc/s to 20 Kc/s wide, with very sharp discrimination against frequencies 20 Kc/s or more away from the centre frequency, 460 Kc/s.

Universal Selectivity Calculator

For the benefit of designers of R.F. and I.F. circuits, a "universal selectivity calculator" has been constructed (Fig. 18). It is a family of curves of attenuation as functions of $Q \Delta f_0/f_0$. The attenuation is expressed in decibels to make the curves generally applicable for any number of

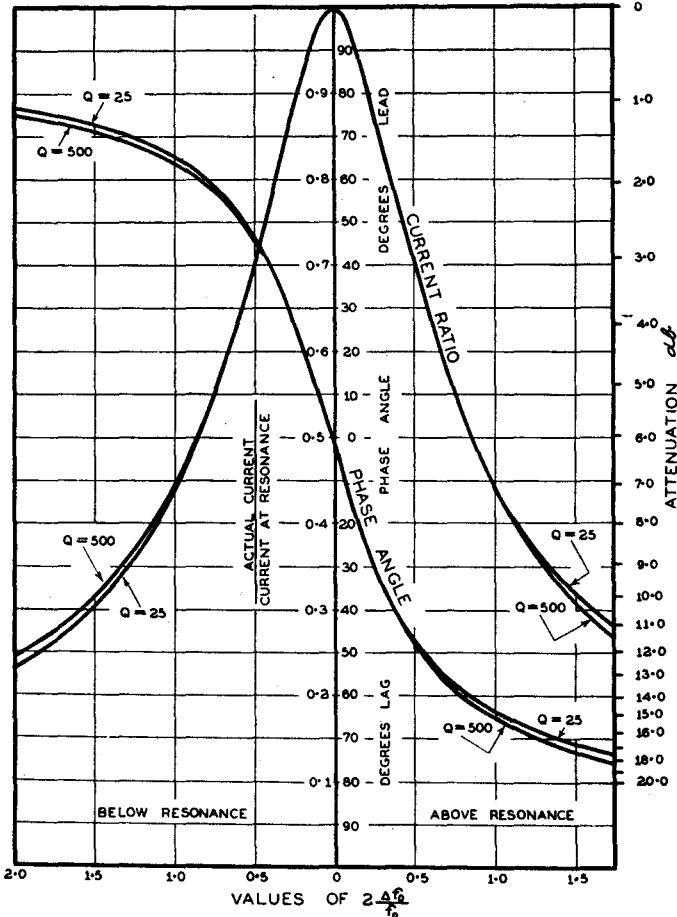

FIGURE 19: UNIVERSAL RESONANCE CURVES

For determination of current ratio and phase angle for a series resonant circuit having a Q factor between 25 and 500. These curves may be used for a parallel resonant circuit by taking the vertical scale to represent the ratio of parallel impedance off resonance to the dynamic resistance at resonance; in this case the phase angles as shown should be reversed from leading to lagging and vice versa.

circuits. If one circuit suppresses a certain frequency by 30 db, then two circuits would attenuate that frequency by 60 db, and so on. It is conventional to express the attenuation of tuned circuits in a voltage ratio as so many "times down." The decibel scale may be converted to a voltage scale by taking the anti-logarithm of one-twentieth of the decibel figure, or by reference to the Decibel Table in Chapter 40.

It should be noted that the attenuation which is given on the diagram is the mean of that on each side of resonance and is approximately independent of the value of Q provided that Q is not less than 25. It may, however, be seen from the Universal Resonance Curve (Fig. 19) that the curve for a specified value of Q is not necessarily symmetrical about the resonant frequency.

To use the curves, a line is drawn from the frequency, on the " f_0 " line, through the "A" line to the appropriate point on the "Q" line. The line drawn from the frequency off tune on the " Δf_0 " line through the point of intersection on the "A" line intersects the "B" line at the point $Q \Delta f_0 / f_0$. By following the oblique guide lines to the abscissa, the attenuation may be read from the ordinate corresponding to that particular point of the curve. For coupled circuits, the curves are given for $K \cdot Q = 1$. For smaller coupling coefficients, the designer may interpolate between the curves for coupled circuits and isolated (electronically coupled) circuits. The curves for coupled circuits are given as half the selectivity of a pair for that reason. For frequencies greater than 2 Mc/s. the value of $Q \Delta f_0 / f_0$ should be calculated.

The lines drawn on the diagram are for a particular example in which $f_0 = 455$ Kc/s., $Q = 200$, and $\Delta f_0 = 5$ Kc/s. A line is first drawn from $f_0 = 455$ to $Q = 200$; a second line is then drawn from the point of intersection of the first line and the "A" line, through $\Delta f_0 = 5$, and projected to meet "B" line, thereby giving the value $Q \Delta f_0 / f_0 = 2.2$. By tracing upwards it may be found that the attenuation is 13.2 db for a single isolated circuit, and 9.9 db per coil, or 19.8 db total for 2 critically coupled circuits.

When using the curves for pairs of coupled circuits, it should be remembered that the number of circuits is twice the number of pairs.

A very useful family of curves for values of coupling above and below critical is given by Maynard (Electronics, p. 15, February 1937).

Bibliography

1. Books Dealing with Radio Tuned Circuit Theory

Where possible, references are given to the reviews of these books, which should be consulted when further information is desired.

- O. F. Brown and E. L. Gardiner, "The Elements of Radio Communication," (2nd. ed.) reviewed Proc. I.R.E., p. 418, June 1939.
- Knox McIlwain and J. G. Brainerd, "High Frequency Alternating Currents," (2nd ed.) reviewed Proc. I.R.E., p. 420, June 1939.
- Gaylord P. Harnwell, "Principles of Electricity and Magnetism," reviewed Proc. I.R.E., p. 296, April 1939.
- R. R. Ramsey, "Experimental Radio," reviewed Proc. I.R.E., p. 232, March 1939 and p. 1116, September 1935.
- G. E. Sterling, "The Radio Manual," reviewed Proc. I.R.E., p. 233, March 1939.
- F. E. Terman, "Fundamentals of Radio," reviewed Proc. I.R.E., p. 1178, September 1938.
- H. A. Brown, "Radio Frequency Electrical Measurements," (2nd ed.), reviewed Proc. I.R.E., p. 1175, September 1938.

- F. E. Terman, "Radio Engineering," (2nd ed.) reviewed Proc. I.R.E., p. 122, January 1938.
- W. L. Everitt, "Communication Engineering," reviewed Proc. I.R.E., p. 159, January 1937.
- R. D. Bangay, "Elementary Principles of Wireless Telegraphy and Telephony," reviewed Proc. I.R.E., p. 909, May 1931.
- J. H. Morecroft, "Elements of Radio Communication," reviewed Proc. I.R.E., p. 2297, December 1929.
- F. E. Terman, "Measurements in Radio Engineering," reviewed Proc. I.R.E., p. 1567, December 1935.
- August Hund, "Phenomena in High Frequency Systems," reviewed Proc. I.R.E., p. 942, June 1936.
- A. R. Nilson and J. L. Hornung, "Practical Radio Communication," reviewed Proc. I.R.E., p. 1568, December 1935.
- Keith Henney, "Principles of Radio," reviewed Proc. I.R.E., p. 1765, October 1930.
- J. H. Morecroft, "Principles of Radio Communication," reviewed Proc. I.R.E., p. 1071, December 1927.
- R. S. Glasgow, "Principles of Radio Engineering," reviewed Proc. I.R.E., p. 1622, December 1936.
- E. B. Moullin, "Radio Frequency Measurements," reviewed Proc. I.R.E., p. 1509, August 1931.
- L. S. Palmer, "Wireless Principles and Practice," reviewed Proc. I.R.E., p. 1268, September 1923.
- Bureau of Standards Circular No. 74
- August Hund, "High Frequency Measurements."
- Keith Henney, "Radio Engineering Handbook," reviewed Proc. I.R.E., p. 663, April 1936.
- H. Lauer and H. L. Brown, "Radio Engineering Principles," reviewed Proc. I.R.E., p. 1429, October 1928.
- American Radio Relay League, "Radio Amateur's Handbook," reviewed Proc. I.R.E., p. 663, April 1936.
- "Admiralty Handbook of Wireless Telegraphy, 1938," Vol. 1, Magnetism and Electricity; Vol. 2, Wireless Telegraphy Theory.

2. References to the Theory of Radio Frequency Single Tuned Circuits and Couplings.

- M. Reed, "The Design of High Frequency Transformers," Experimental Wireless and Wireless Engineer, Vol. VIII, No. 94, p. 349, July (1931).
- H. A. Wheeler and W. A. MacDonald, "The Theory and Operation of Tuned Radio Frequency Coupling Systems," Proc. I.R.E., Vol. 19, No. 5, p. 738, May 1931, and discussion by L. A. Hazeltine, Vol. 19, No. 5, p. 804, May (1931).
- H. A. Wheeler, "Image Suppression in Superheterodyne Receivers," Proc. I.R.E., Vol. 23, No. 6, p. 569, June (1935).
- B. de F. Bayly, "Selectivity, a Simplified Mathematical Treatment," Proc. I.R.E., Vol. 19, No. 5, p. 873, May (1931).
- E. S. Purington, "Single- and Coupled-Circuit Systems," Proc. I.R.E., Vol. 18, No. 6, p. 983, June (1930).
- V. G. Smith, "A Mathematical Study of Radio Frequency Amplification," Proc. I.R.E., Vol. 15, No. 6, p. 525, June (1927).
- M. V. Callendar, "Problems in Selective Reception," Proc. I.R.E., Vol. 20, No. 9, p. 1427, September (1932).
- Satoru Takamura, "Radio Receiver Characteristics Related to the Sideband Coefficient of the Resonance Circuit," Proc. I.R.E., Vol. 20, No. 11, p. 1774, November (1932).
- E. K. Sandeman, "Generalised Characteristics of Linear Networks," Wireless Engineer, Vol. XIII, No. 159, p. 637, December (1936).

- W. L. Everitt, "Output Networks for Radio Frequency Power Amplifiers," Proc. I.R.E., Vol. 19, No. 5, p. 725, May (1931).
- L. E. Q. Walker, "A Note on the Design of Series and Parallel Resonant Circuits," Marconi Review, No. 63, p. 7, December (1936).

3. References to the Theory of Tuned Coupled Circuits

- M. Reed, "The Design of High Frequency Transformers," Experimental Wireless and Wireless Engineer, Vol. VIII, No. 94, p. 349, July (1931).
- C. B. Aiken, "Two-Mesh Tuned Coupled Circuit Filters," Proc. I.R.E., Vol. 25, No. 2, p. 230, February (1937), and errata Vol. 26, No. 6, p. 672, June 1937.
- F. H. Scheer, "Notes on Intermediate-Frequency Transformer Design," Proc. I.R.E., Vol. 23, No. 12, p. 1483, December (1935).
- N. R. Bligh, "The Design of the Band Pass Filter," Wireless Engineer and Experimental Wireless, Vol. IX, No. 101, p. 61, February (1932).
- G. W. O. Howe, Editorials, Wireless Engineer, Vol. XIV, No. 165, p. 289, June (1937), and No. 166, p. 348, July (1937), and Vol. IX, No. 108, p. 486, September (1932).
- G. H. Buffery, "Resistance in Band Pass Filters," Wireless Engineer, Vol. IX, No. 108, p. 504, September (1932).
- R. T. Beatty, "Two Element Band Pass Filters," Wireless Engineer, Vol. IX, No. 109, p. 546, October (1932).
- C. W. Oatley, "The Theory of Band-Pass Filters for Radio Receivers," Wireless Engineer, Vol. IX, No. 110, p. 608, November (1932).
- H. A. Wheeler and J. K. Johnson, "High Fidelity Receivers with Expanding Selectors," Proc. I.R.E., Vol. 23, No. 6, p. 595, June (1935).
- W. T. Cocking, "Variable Selectivity and the I.F. Amplifier," Wireless Engineer, Vol. XIII, Nos. 150, 151, 152, pp. 119, 179, 237, March, April and May (1936).
- M. Reed, "The Analysis and Design of a Chain of Resonant Circuits," Wireless Engineer, Vol. IX, Nos. 104 and 105, pp. 259 and 230, May and June (1932).
- C. Baranovsky and A. Jenkins, "A Graphical Design of an Intermediate Frequency Transformer with Variable Selectivity," Proc. I.R.E., Vol. 25, No. 3, p. 340, March (1937).
- Ho-Shou Loh, "On Single and Coupled Circuits Having Constant Response Band Characteristics," Proc. I.R.E., Vol. 26, No. 4, p. 469, April (1938). and errata, No. 12, p. 1430, December (1938).
- A. J. Christopher, "Transformer Coupling Circuits for High Frequency Amplifiers," Bell System Technical Journal, Vol. 11, p. 608, October (1932).
- "Tuned Impedance of I.F. Transformers" (nomogram), Communications, Vol. 18, No. 2, p. 12, February (1938).
- W. Van B. Roberts, "Variable Link Coupling," Q.S.T., Vol. XXI, No. 5, p. 27, May (1937).
- A.R.T.S. and P. Co. Bulletin No. 73, "A Generalised Theory of Coupled Circuits," 8th May (1939).
- V. D. Landon, "The Band-Pass — Low-Pass Analogy," Proc. I.R.E., Vol. 24, No. 12, p. 1582, December (1936).
- C. P. Nachod, "Nomograms for the Design of Band-Pass R-F Circuits," Radio Engineering, Vol. XVI, No. 12, p. 13, December (1936).
- C. V. Erickson, "A Graphical Presentation of Band-Pass Characteristics," Radio Engineering, Vol. XVII, No. 3, p. 12, March 1937, and No. 4, p. 13, April 1937. Also see Vol. XVII, No. 6, p. 19, June (1937).
- H. Dudley, "A Simplified Theory of Filter Selectivity," Communications, Vol. 17, No. 10, p. 12, October (1937).
- W. L. Everitt, "Coupling Networks," Communications, Vol. 18, Nos. 9 and 10, pp. 12 and 12, September and October, 1938.

4. References on Universal Selectivity Curves

- F. E. Terman, "Radio Engineering," (1st ed.) p. 52.
 J. E. Maynard, "Universal Performance Curves for Tuned Transformers,"
Electronics, p. 15, February (1937).
 H. T. Budenbom, "Some Methods for Making Resonant Circuit Response
 and Impedance Calculations," *Radio Engineering*, Vol. XV, No. 8, p. 7,
 August (1935).

5. Unpublished Papers

- R. H. Errey, L. G. Dobbie.

Summary of Formulae for Tuned Circuits

Nomenclature :

- L = inductance (in Henries unless otherwise stated)
 C = capacitance (in Farads unless otherwise stated)
 f_0 = resonant frequency (in cycles per second unless otherwise stated)
 f_n = natural resonant frequency (in cycles per second unless otherwise stated)
 f = any frequency (e.g., $f_1, f_2 \dots$) (in cycles per second unless otherwise stated)
 $\Delta f = f_0 - f$
 $\pi = 3.1416$ approximately
 K = coefficient of coupling
 $\omega = 2\pi f, \omega_0 = 2\pi f_0, \omega_n = 2\pi f_n$ radians per second
 R_e = effective shunt resistance (in ohms)
 r = series resistance (in ohms)
 r' = resistance of a series resonant circuit at resonance (in ohms)
 R = shunt resistance (in ohms)
 R_D = dynamic resistance (in ohms)
 e = voltage across the circuit at a time t
 E = initial voltage of charged condenser
 $\epsilon = 2.718$ (ϵ is the base of Napierian Logarithms)
 t = time (in seconds)
 α = damping factor
 δ = logarithmic decrement
 λ = wavelength in metres
 i = current at frequency f (in amperes)
 i_n = current at resonant frequency f_0 (in amperes)
 m = gain at frequency f
 m_0 = gain at frequency f_0
 Q = circuit magnification factor

Natural Resonant Frequency (f_n)

Exact formula :—

$$f_n = \frac{1}{2\pi} \sqrt{\frac{1}{LC} - \frac{r^2}{4L^2}} \text{ cycles per second.}$$

Approximate formula for use when r is small compared with $2\sqrt{L/C}$:—

$$f_n \doteq f_o = \frac{1}{2\pi \sqrt{LC}} \text{ c/s.}$$

For numerical use this may be put in the form

$$f_n \doteq f_o = \frac{159200}{\sqrt{LC}} \text{ c/s where } L \text{ is in microhenries} \\ \text{and } C \text{ is in microfarads.}$$

$$= \frac{159200}{\sqrt{LC}} \text{ Kc/s where } L \text{ is in microhenries} \\ \text{and } C \text{ is in micromicrofarads.}$$

Wavelength (λ)

$$\text{Wavelength (in metres)} = 1885\sqrt{LC}$$

where L is in microhenries
and C is in microfarads.

$$\text{Wavelength} \times \text{frequency} = 2.9989 \times 10^8 \text{ metres per second,} \\ = 3 \times 10^8 \text{ approximately}$$

$$\text{Wavelength} = \frac{300,000}{\text{frequency in Kc/s.}} \\ = \frac{300}{\text{frequency in Mc/s.}}$$

L, C, and ω_o
For resonance

$$LC\omega_o^2 = 1$$

$$\omega_o L = 1/\omega_o C \text{ ohms}$$

$$\omega_o = 1/\sqrt{LC} \text{ radians/second}$$

$$\omega_o L = \sqrt{L/C} \text{ ohms}$$

$$\omega_o C = \sqrt{C/L} \text{ mhos}$$

L, C and f_o

For resonance

$$2\pi f_o L = 1/2\pi f_o C \text{ ohms}$$

$$LC = \frac{1}{39.48 f_o^2} \text{ henries} \times \text{ farads}$$

$$\text{or } LC = \frac{2.533 \times 10^{10}}{f_o^2} \mu\text{H} \times \mu\text{F}$$

where L is in microhenries
and C is in microfarads.

Damped Train of Waves

$e = Ee^{-at} \cos \omega_0 t$, where $a = r/2L$ (damping factor)

$\delta = r/2f_0 L$ (logarithmic decrement)

Q Factor

$$Q = \frac{1}{(1/R \cdot \sqrt{L/C}) + (r \cdot \sqrt{C/L})}$$

$$= \frac{1}{\omega_0 L/R + r/\omega_0 L}$$

$$= \frac{1}{1/\omega_0 CR + \omega_0 Cr}$$

If $1/R \cdot \sqrt{L/C} = \omega_0 L/R$ is very much smaller than $r \cdot \sqrt{C/L} = r/\omega_0 L$ this may be written

$$Q = 1/r \cdot \sqrt{L/C} = \omega_0 L/r = 1/\omega_0 Cr \text{ approximately.}$$

For a single tuned circuit

$$Q = \frac{f_0}{f_h - f_l} = \frac{\text{Resonant frequency}}{\text{Band width of selectivity curve at 0.707 of maximum response.}}$$

To Convert Series Resistance to Effective Shunt Resistance

$$R_e = L/CR \text{ at resonance.}$$

Similarly to convert shunt resistance to effective series resistance

$$r_e = L/CR \text{ at resonance.}$$

DYNAMIC RESISTANCE (at resonance)

Parallel Resonant Circuit:—

$$R_D = \frac{1}{1/R + Cr/L}$$

If R is infinite (i.e., no resistance is shunted across the circuit)

$$R_D = L/CR = Q/\omega_0 C = \omega_0 LQ = Q^2 r.$$

Series Resonant Circuit:—

$$r' = r + L/CR$$

If R is very great

$$r' = r \text{ approximately.}$$

SELECTIVITY (Current at and off Resonance)

Parallel Resonant Circuit

$$i/i_0 = \sqrt{1 + Q^2 (f/f_0 - f_0/f)^2} = Q (f/f_0 - f_0/f) \text{ approximately, when } i/i_0 > 10.$$

When f/f_0 is near unity, and $\Delta f_0 = \nu - f_0$

$$i/i_0 = \sqrt{1 + 4Q^2 (\Delta f_0/f_0)^2} \text{ approximately.}$$

The phase angle (ϕ) is given by

$$\begin{aligned} \tan \phi &= -Q (f/f_0 - f_0/f) = -Q \Delta f_0/f_0 \cdot \frac{2 + (\Delta f_0/f_0)}{1 + (\Delta f_0/f_0)} \\ &= -2Q \cdot \Delta f_0/f_0 \text{ approximately;} \end{aligned}$$

i leads i_0 when $f > f_0$ and i lags behind i_0 when $f < f_0$.

Series Resonant Circuit

$$\begin{aligned} i_0/i &= \sqrt{1 + Q^2 (f/f_0 - f_0/f)^2} = Q (f/f_0 - f_0/f) \text{ approxi-} \\ &\hspace{15em} \text{mately, when } i_0/i > 10. \\ &= \sqrt{1 + 4Q^2 (\Delta f_0/f_0)^2} \\ &\hspace{15em} \text{when } f/f_0 \text{ is near unity;} \end{aligned}$$

$$\begin{aligned} \tan \phi &= Q (f/f_0 - f_0/f) = Q \Delta f_0/f_0 \cdot \frac{2 + (\Delta f_0/f_0)}{1 + (\Delta f_0/f_0)} \\ &= 2Q \Delta f_0/f_0 \text{ approximately;} \end{aligned}$$

i lags behind i_0 when $f > f_0$ and i leads i_0 when $f < f_0$.

MAGNIFICATION BY TUNED CIRCUIT

Parallel Resonant Circuit:—

Ratio of total input current to total circulating current = $1/Q$.

Series Resonant Circuit:—

Ratio of total voltage across the circuit to voltage across either reactance = $1/Q$.

R.F. TRANSFORMER, UNTUNED PRIMARY, TUNED SECONDARY

$$\text{Gain} = \frac{g_m}{\frac{1}{KR_D} \sqrt{\frac{L_2}{L_1}} + \frac{K}{r_p} \sqrt{\frac{L_1}{L_2}}} = \frac{g_m}{\frac{M}{r_p L_2} + \frac{1}{\omega_0 M Q_2}}$$

where $K = M/\sqrt{L_1 L_2}$ (coupling factor).

The expression for gain may be put into the alternative forms

$$\text{Gain} = \frac{g_m}{\frac{\omega_0 C_2}{K Q_2} \sqrt{\frac{L_2}{L_1}} + \frac{K}{r_p} \sqrt{\frac{L_1}{L_2}}} = \frac{g_m \omega_0 M Q_2}{1 + \frac{(\omega_0 M)^2 Q_2}{\omega L_2 r_p}}$$

$$\text{Gain} = \frac{\mu \omega_0 M Q_2}{r_p + \frac{(\omega_0 M)^2 Q_2}{\omega_0 L_2}} = \frac{\mu \omega_0 M Q_2}{r_p + \frac{(\omega_0 M)^2}{r_2}}$$

The effective Q of the circuit is given by

$$Q' = \frac{1}{\frac{\omega_0 L_2}{R_D} + \frac{K^2 \omega_0 L_1}{r_p}} = \frac{1}{\frac{1}{Q_2} + \frac{K^2}{r_p} \cdot \omega_0 L_1}$$

from which the selectivity may be calculated as for a parallel resonant circuit.

The coupled impedance at resonance is given by

$$\frac{\omega_0^2 M^2}{r_2} = \frac{\omega_0^2 M^2 Q_2}{\omega_0 L_2} = \frac{M^2}{L_2^2} R_D = K R_D \frac{L_1}{L_2}$$

neglecting the primary impedance.

R.F. TRANSFORMER, TUNED PRIMARY, TUNED SECONDARY

Gain

$$\text{Gain} = \frac{g_m \sqrt{R'R_2}}{K\sqrt{Q'Q_2} + [1/(K\sqrt{Q'Q_2})]}$$

where $1/R' = (1/r_p) + (1/R_1)$

$$K = M/\sqrt{L_1 L_2}$$

and $1/Q' = (\omega_0 L_1/r_p) + (1/Q_1)$

When $K = 1/\sqrt{Q'Q_2}$ (i.e., critical coupling factor),

gain = $g_m \sqrt{R'R_2}/2$, which is the maximum for any coupling factor.

Selectivity (Two similar coupled circuits)

$$\frac{m_0}{m} = \sqrt{\left\{ \left[1 - \frac{Q^2 Y^2}{1 + K^2 Q^2} \right]^2 + \left[\frac{2QY}{1 + K^2 Q^2} \right]^2 \right\}}$$

where $Y = (f/f_0 - f_0/f)$

and $Q = Q' = Q_2$.

Selectivity (Two coupled circuits of differing Q)

When $L_1 = L_2$ and $C_1 = C_2$ (or for mutual inductive coupling when $L_1C_1 = L_2C_2$) the preceding formula for m_o/m may be used by taking Q as $\sqrt{Q'Q_2}$. When the ratio between Q' and Q_2 does not exceed 1.5 : 1 this will give a result which is in error by not more than 2%.

When K^2Q^2 is very much greater than unity, and Δf_o is very much smaller than $f_o^2K^2$,

$$\begin{aligned} \frac{m_o}{m} &\doteq \frac{1}{f_o K} \sqrt{f_o^2 K^2 - 8 \Delta f_o^2} \text{ approximately,} \\ &\doteq \sqrt{1 - \frac{8 (\Delta f_o)^2}{f_o^2 K^2}}. \end{aligned}$$

Impedance across the primary circuit at resonance

$$\text{(Coupled Impedance)} = \frac{Q \omega_o L}{1 + K^2 Q^2} = \frac{R_D}{1 + K^2 Q^2}$$

where R_D is the dynamic resistance of either of the two circuits when $K = 0$.

At critical coupling $KQ = 1$ and the Coupled Impedance becomes $R_D/2$

BAND-PASS CIRCUITS

(Mutual Inductive Coupling)

Let f_1 and f_2 be the frequencies of the two peaks. Then, in the general case,

$$\frac{f_1 - f_2}{f_o} = K \sqrt{1 - \frac{1}{2K^2} \left(\frac{1}{Q'^2} + \frac{1}{Q_2^2} \right)}$$

where $L_1C_1 = L_2C_2$.

When $Q' = Q_2 = Q$,

$$(f_1 - f_2)/f_o = K \sqrt{1 - (1/K^2 Q^2)}$$

When $Q' = Q_2 = Q$ and $1/K^2 Q^2 \gg 1$,

$$\frac{f_1 - f_2}{f_o} \doteq K.$$

When $KQ = 0.5$ the gain is reduced to 0.8 of its optimum value.

High Impedance Coupling*

$$K \doteq \frac{C_m}{\sqrt{C_1 C_2}} \text{ for capacitive coupling (Fig. 12)}$$

$$\doteq \frac{\sqrt{L_1 L_2}}{L_m} \text{ for inductive coupling (Fig. 13)}$$

where C_m = coupling capacitance

L_m = coupling inductance.

Low Impedance Coupling*

$$K \doteq \frac{\sqrt{C_1 C_2}}{C_m} \text{ for capacitive coupling (Fig. 14)}$$

$$\doteq \frac{L_m}{\sqrt{L_1 L_2}} \text{ for inductive coupling (Fig. 15)}$$

where C_m = coupling capacitance

L_m = coupling inductance.

Link Coupling*

$$K \doteq \frac{M_1 M_2}{L_m \sqrt{L_1 L_2}} \text{ (Fig. 16)}$$

where M_1 = mutual inductance between L_1 and L_m ,

and M_2 = mutual inductance between L_2 and L_m .

*For exact values see table in text on page 126.

CHAPTER 16 (continued)

Part 2—Calculation of Inductance

1(a) : Solenoids, unscreened—"current sheets"—corrections for round wire—for high frequencies—for self and stray capacitances—Palermo's method for estimating self capacitance of single layer coils—formulae for inductance—curves for determining A, B and K—effect of thickness of the insulation—conditions for which the low frequency inductance differs from the "current sheet" inductance by less than 1%—formulae for slide rule computation of A, B and K — Wheeler's formula for current sheet inductance — Esnault-Pelterie's formula for K and current sheet inductance — Nagaoka's constant for very short solenoids — Wheeler's formula for short solenoids—Hayman's formula for total number of turns—curves for determination of the current sheet inductance.

1(b) : Solenoids inside concentric cylindrical screens.

2 : Multilayer circular coils of rectangular cross section—Bunet's approximate formula—accuracy obtained—correction for insulating space — effect of shield can — Wheeler's formula for multilayer coils of small winding space.

3 : Single Layer Spiral. 4 : Mutual Inductance.

Bibliography.

1(a). Solenoids, unscreened.

The methods and formulae to be given below are accurate within the stated limits for "current sheets" composed of turns of indefinitely thin tape lying edge to edge with negligibly small separation.

For round wire with appreciable separation between turns, a correction may be applied which is accurate for low frequencies. At high frequencies, due to "skin effect," the current crowds towards the inside radius of the turns, and the effective radius of the coil approaches that of the form. There is no known simple correction that may be applied to determine the effective radius at which the current may be considered to flow.

Self capacitance and other stray capacitances affect the apparent inductance and resistance of coils at high frequencies. If such capacitances

resonate the coil at a frequency $f_0 = (1/2\pi) \cdot (1/\sqrt{LC})$, and the behaviour of the coil is being considered at another frequency f , then

$$\text{apparent } L = \text{actual } L \times \frac{1}{1 - (f/f_0)^2}, \text{ and}$$

$$\text{apparent } R = \text{actual } R \times \left(\frac{1}{1 - (f/f_0)^2} \right)^2$$

The self capacitance of single layer coils may be estimated by Palermo's method (Proc. I.R.E., Vol. 22, p. 897, July, 1934, and in nomogram form in Electronics, p. 31, March, 1938).

Inductance Formulae.

Putting L = inductance in microhenries of equivalent cylindrical "current sheet,"

L_0 = inductance in microhenries of the coil at low frequencies,

K = Nagaoka's constant (see Fig. 2),

N = total number of turns,

$d/2 = a$ = radius of the coil out to the centre of the wire, in inches,

p = pitch of winding, centre to centre of adjacent turns, in inches,

$l = pN$ = length of coil, in inches,

D = wire diameter, in inches, excluding any insulating covering,

$\pi = 3.1416$, and

$$S = D/p = \frac{\text{diameter of wire}}{\text{winding pitch}} = \text{wire diameter} \times \text{turns per inch.}$$

$$\text{then } L = 0.02506 (d^2 N^2 / l) K = 0.10024 (a^2 N^2 / l) K,$$

$$\text{and } L_0 = L \left(1 - \frac{1(A+B)}{\pi a N K} \right) = L - 0.0319 a N (A+B)$$

$$\text{or } L_0 = L \left(1 - \frac{P}{\pi a K} (A+B) \right)$$

The constants A and B may be obtained from the curves given in Fig. 1, and Nagaoka's constant K from the curves in Fig. 2. The whole of this data is either based upon or taken directly from information and tables given in Part III of the Bureau of Standards Circular No. 74 (p. 252). The data in the latter circular permits calculations with an accuracy of about one part in one thousand.

In practical cases with turns wound close together the wire diameter to winding pitch ratio S usually lies between 0.8 and 0.95, depending upon the thickness of the insulation. In this range of S , $A = 0.4 \pm 0.1$. If the winding consists of more than ten turns, $B = 0.3 \pm 0.035$. Therefore $(A+B) = 0.7$ with a possible maximum error of 20%. For ratios of d/l between 0.5 and 1.7, Nagaoka's constant $K = 0.7$, also with an accuracy not poorer than 20%.

We can now determine the value of p/a or $1/aN$ for which L_0 will differ from L by the order of 1%. The condition is that

$$\frac{p}{\pi a K} (A+B) = 0.01 = \frac{p}{a} \cdot \frac{0.7}{3.14 \times 0.7}, \text{ approximately}$$

and p/a should not exceed 0.03.

(Continued at top of page 143)

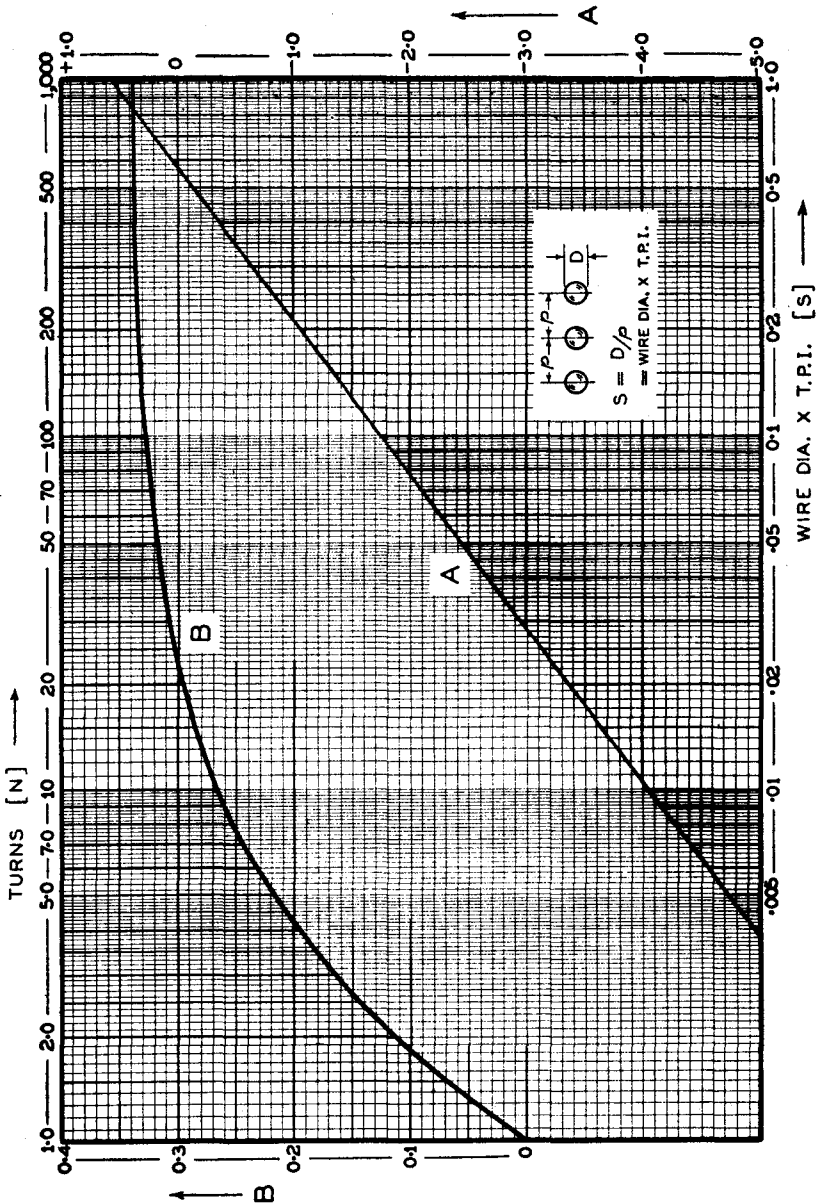

Figure 1: Constants A and B as used in the formula for the correction of "current sheet" formulae for application to round wire with spaced turns,

$$L_o = L - 0.0319aN (A + B)$$

where L_o = low frequency inductance (μH); L = "current sheet" inductance (μH); N = total number of turns; and a = radius of coil to centre of wire (in inches).

(Continued from page 141)

For a coil form $\frac{3}{4}$ " diameter, $a = 0.375$ ", and therefore p should be less than 0.0112 ", or the turns per inch of the winding should be more than 89 for the difference between L and L_0 to be less than 1% . Therefore the wire gauge should not exceed 30 B. & S. in enamel covering.

Coils wound with heavier gauges of wire at fewer turns per inch will show more than 1% difference between the true low frequency inductance L_0 and the "current sheet" value L . Hence it is most important when using the simple "current sheet" formula to check at the same time the order of magnitude of the correction. The correction sometimes amounts to 15% .

(Continued on page 144)

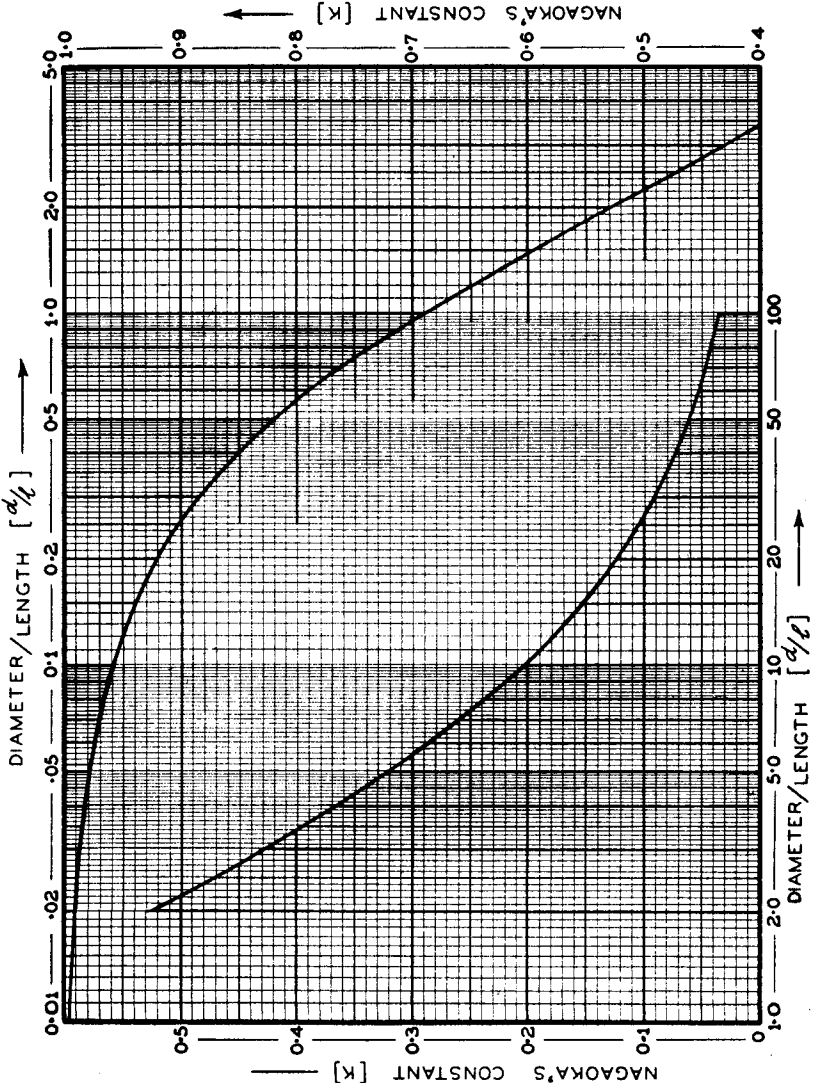

Figure 2: Nagaoka's Constant (K) for a wide range of d/l.

As an alternative to reference to tables and curves for the values of Nagaoka's constant K and the constants A and B , the following formulae are suitable for slide rule computation.

$$A = 2.3 \log_{10} 1.73 S,$$

accurate within 1% for all values of S .

$$B = 0.336 [1 - (2.5/N) + (3.8/N^2)],$$

accurate within 1% when N is not less than five turns. The value of B from this formula is about 5% high at $N = 4$ and 20% high at $N = 3$.

$$K = \frac{1}{1 + 0.45 (d/l)},$$

accurate within 1% for all values of d/l less than 3.0; that is, for all solenoids whose length exceeds one-third of the diameter.

Using this value of K , the "current sheet" inductance is

$$\begin{aligned} L &= 0.02506 (d^2 N^2 / l) K \\ &= \frac{d^2 N^2}{40 l [1 + 0.45 (d/l)]} = \frac{d^2 N^2}{18d + 40 l} \\ &= \frac{a^2 N^2}{9a + 10 l} \quad (\text{Wheeler's formula}), \end{aligned}$$

also accurate within 1% for all values of d/l or $2a/l$ less than 3.0. As stated before, d , a and l are expressed in inches and L is obtained directly in microhenries. Wheeler's formula gives a result about 4% low when $2a/l$ is 5.0

Esnault-Pelterie quotes

$$K = \frac{1}{0.9949 + 0.4572 (d/l)}$$

accurate to 0.1% for all values of d/l between 0.2 and 1.5. The corresponding "current sheet" value of inductance is

$$L = 0.252 \frac{d^2 N^2}{1 + 0.46 (d/l)}$$

also accurate within 0.1% for all values of d/l between 0.2 and 1.5.

Neither of the above expressions for Nagaoka's constant is valid for very short solenoids. For such cases the first expression may be modified to

$$K = \frac{1}{1 + 0.45 (d/l) - 0.005 (d/l)^2}$$

accurate to 2% for all values of d/l from zero to twenty. It is not often that solenoids shorter than one twentieth of their diameter have to be considered.

For short solenoids Wheeler's formula therefore becomes

$$L = \frac{a^2 N^2}{[9 - (a/5l)] a + 10l}$$

also accurate to 2% for all values of $2a/l$ from zero to 20. The error approaches +2% when $d/l = 2.0$ to 3.5, and at $d/l = 20$. The error approaches -2% in the range $d/l = 10$ to 12.

Most often we know the value of inductance required, and the number of turns and winding length are to be determined. For this purpose Hayman has altered the form (but not the degree of accuracy) of Wheeler's formula by substituting nl for N , where n is the number of turns per inch, and writing $x = 20/nd^2 = 5/na^2$. Then

$$N = Lx [1 + \sqrt{1 + (9/aLx^2)}]$$

He quotes a practical example as follows: A 380 microhenry coil two inches in diameter wound with 33 turns per inch is desired.

$$(a) \quad x = \frac{20}{nd^2} = \frac{20}{33 \times 4} = 0.151,$$

$$(b) \quad x^2 = 0.0227,$$

$$(c) \quad \frac{9}{aLx^2} = \frac{9}{1 \times 380 \times 0.0227} = 1.042,$$

$$(d) \quad \therefore N = 380 \times 0.151 \times 2.43 = 139 \text{ turns.}$$

$$(e) \text{ and } l = N/n = 139/33 = 4.2 \text{ inches.}$$

Thus there are five steps involving only simple slide rule calculation. A check back by Wheeler's formula proves the accuracy of the final results.

The best wire diameter for spaced turn windings to be used at frequencies from 4 to 25 megacycles per second is given by Pollack as 0.7 of the winding pitch. (See Chapter 16, Part 3, Design of Low Loss Inductances).

Curves for Determination of the "Current Sheet" Inductance (L).

The curves of Figures 3 and 4 may be used for a ready determination of the "current sheet" inductance L . This is not equal to the measured inductance either at low or high frequencies, but a correction (Figure 1) may be applied to determine the low frequency inductance (L_0). Alternatively the low frequency inductance may be calculated from the approximation

$$L_0 = L - 0.0223 aN$$

where $L_0 =$ low frequency inductance (μH),

$L =$ "current sheet" inductance as determined from the curves (μH),

$a =$ radius of coil to centre of wire in inches,

and $N =$ total number of turns.

easily determined from Fig. 4. The diameter of a coil is considered to be the distance from centre to centre of the wire.

To Design a Coil Having Required "Current Sheet" Inductance.

Determine a suitable diameter and length, and from Fig. 3 read off the "current sheet" inductance of a pitch of 10 T.P.I. The required inductance may then be obtained by varying the number of turns per inch. The correct number of turns may be found by calculating the ratio of the required inductance to that read from Fig. 3, and referring it to Fig. 4, which will give the required turns per inch.

Alternatively if the wire is to be wound at a certain pitch, a conversion factor for that pitch may first be obtained from Fig. 4, and the required inductance divided by that factor. The resultant figure of inductance is then applied to Fig. 3, and suitable values of diameter and length determined.

To Find the "Current Sheet" Inductance of a Coil of Known Dimensions.

Knowing the diameter and length, determine from Fig. 3 the inductance for a pitch of 10 T.P.I. Then from Fig. 4 determine the factor for the par-

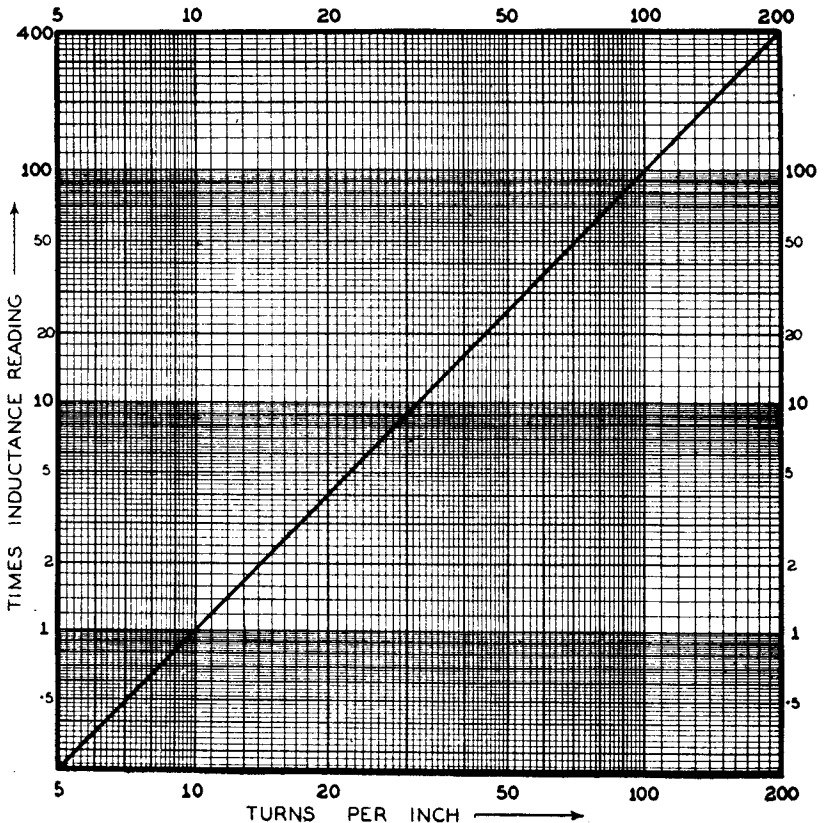

Figure 4: Winding pitch correction for Figure 3.

ticular pitch used, and multiply the previously determined value of inductance by this factor.

1(b). Solenoids Inside Concentric Cylindrical Screens.

The formulae given in the preceding section for the "current sheet" inductance L and actual low frequency inductance L_0 should be multiplied by a factor K_s , depending upon the relative dimensions of the coil and the screen. Calling L_s the value of low frequency inductance in the presence of the screen,

$$L_s = K_s L_0 = (1 - k^2) L_0,$$

where k = coupling factor between the coil and the screen.

Curves have been published (R.C.A. Radiotron Division Application Note No. 48, June 12th, 1935, reprinted in Radio Engineering, p. 11, July, 1935) for k^2 in terms of the ratio of coil to shield radius and of coil length to diameter. It is stated that the values of k have been calculated and verified experimentally. The screen has no ends, and should exceed the length of the coil by at least the radius of the coil.

The following approximate formula for K_s has been derived from these curves:

$$K_s = 1 - \frac{1.55}{1 + 0.45 (d/l)} \cdot (d/d_s)^3,$$

where $\frac{1}{1 + 0.45 (d/l)} = K$, Nagaoka's constant,

and d_s = diameter of screen.

The accuracy of the values of K_s is 2% from $d/l = 0.5$ to $d/l = 5.0$, at any value of d/d_s up to 0.6. The accuracy is 5% from $d/l = 0.2$, to $d/l = 5.0$, at all values of d/d_s up to 0.7.

2. Multilayer Circular Coils of Rectangular Cross Section.

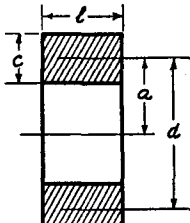

Figure 5

The Bureau of Standards Circular No. 74 provides formulae and tables capable of one part in one thousand accuracy for a very wide range of coil shapes.

This data has been put in the form of families of curves by J. E. Maynard ("Multilayer Coil Inductance Chart," Electronics, p. 33, January, 1939).

Bunet (Revue Generale de l'Electricite., Tome XLIII, No. 4, p. 99, Jan. 22nd, 1938) gives the following approximate formula, which has been converted to inch and microhenry units:

$$L = 0.0251 \cdot (d^2 N^2 / l) \cdot \frac{1}{1 + 0.45 (d/l) + 0.64 (c/d) + 0.84 (c/l)}$$

$$\text{or } L = \frac{a^2 N^2}{9a + 10l + 8.4c + 3.2 (c/a)} \text{ microhenries}$$

where a , d , l and c have the significance indicated in Fig. 5. When the winding depth c is very small, Bunet's formula reduces to Wheeler's formula for solenoids. The accuracy is

1% for c/a zero to $1/20$ and $2a/l$ zero to 3.0 ; -4% at $2a/l = 5.0$

1% for $c/a = 1/5$ and $2a/l$ zero to 5.0 ; -1.9% at $2a/l = 10.0$.

1% for $c/a = 1/2$ and $2a/l$ zero to 2.0 ; $+2.8\%$ at $2a/l = 5.0$

1% for $c/a = 1$ and $2a/l$ zero to 1.5 ; $+4.7\%$ at $2a/l = 5.0$

As in the case of "current sheet" formulae for solenoids, a correction is required when the percentage of the cross section of the winding occupied by insulating space is large. The correction is

$$L_o = L \left(1 + \frac{l}{\pi a N K} (2.3 \log_{10} \frac{p}{D} + 0.155) \right)$$

$$\text{where } K = \frac{1}{1 + 0.9 (a/l) + 0.32 (c/a) + 0.84 (c/l)}$$

p = winding pitch, centre to centre of wires, and
 D = wire diameter.

In most practical cases this correction is less than 1%.

The effect upon the inductance of a multilayer coil of a concentric cylindrical shield will be less than that for a solenoid of equal outside dimensions. At very small winding depths the correction will be almost exactly the same as for solenoids.

Wheeler gives a formula for multilayer coils of very small winding space (Proc. I.R.E., Vol. 17, p. 582, March, 1929).

$$L = \frac{a N^2}{13.5} \log_{10} \left(\frac{4.9a}{l + c} \right) \text{ microhenries,}$$

accurate to 3% when $(l + c)$ is not larger than a , and all dimensions in inches. The accuracy is claimed to be good as $(l + c)$ decreases indefinitely. Bunet's formula becomes inaccurate when l is much less than a . Thus each formula has its own special range of application, and the two ranges overlap when the winding length l is about equal to the mean radius a .

3. Single Layer Spiral.

An accurate method of calculating the inductance of flat spirals is given in the Bureau of Standards Circular No. 74.

Wheeler gives an approximate formula (Proc. I.R.E., Vol. 16, p. 1398, October, 1938),

$$L = \frac{a^2 N^2}{8a + 11c} \text{ microhenries,}$$

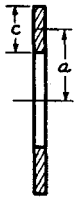

Fig. 6

accurate to 5% when c is larger than $0.2 a$. The significance of a and c is indicated in Fig. 6.

4. Mutual Inductance.

Accurate methods for the calculation of mutual inductance between coils of many different shapes and relative dispositions are given in the Bureau of Standards Circular No. 74. The case of two coaxial single layer

coils is dealt with very exactly by Grover (Proc. I.R.E., Vol. 21, p. 1039, July, 1933). The Bureau of Standards Scientific Paper No. 169 also provides exact formulae and tables. The possible accuracy of these methods is always better than one part in one thousand.

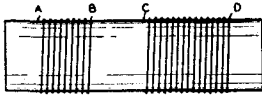

Figure 7

There are few simple formulae which can be used for the more common practical cases, such as are possible with self inductance. The following exact method may be used for two windings on the same former with a space between them, both windings being similar in pitch and wire diameter.

Assume that the space between the windings is wound as a continuation of the windings on the two ends, to form a continuous inductance from A to D with tapings at points B and C (Fig. 7). Then the required mutual inductance (M) between the two original windings is given by

$$M = \frac{1}{2}(LAD + LBC - LAC - LBD)$$

where LAD is the inductance between points A and D, and similarly for other values. These several inductances may be calculated from the formulae given earlier in this section.

Bibliography.

1. Exact Methods of Calculating Self and Mutual Inductance.

- Bureau of Standards Circular No. 74 (1924).
- Bureau of Standards Scientific Paper No. 169 (1912).
- H. Nagaoka, "The Inductance Coefficients of Solenoids," *Journal of the College of Science, Tokyo*, Vol. XXVII, Art. 6, p. 1, August 15 (1909).
- F. W. Grover, "Tables for the Calculation of the Mutual Inductance of any Two Coaxial Single Layer Coils," *Proc. I.R.E.*, Vol. 21, No. 7, p. 1039, July, 1933 (includes further bibliography).
- G. Reber, "Optimum Design of Toroidal Inductances," *Proc. I.R.E.*, Vol. 23, No. 9, p. 1056, September (1935).

2. Approximate Formulae for Self Inductance.

- H. A. Wheeler, "Simple Inductance Formulas for Radio Coils," *Proc. I.R.E.*, Vol. 16, No. 10, p. 1398, October (1928), and discussion *Proc. I.R.E.*, Vol. 17, No. 3, p. 580, March (1929).
- M. R. Esnault-Pelterie, "On the Coefficient of Self Inductance of a Solenoid," *Comptes Rendus*, Tome 205, No. 18, p. 762, November 3 (1937), and No. 20, p. 885, November 15 (1937).
- P. Bunet, "On the Self Inductance of Circular Cylindrical Coils," *Revue General de l'Electricite*, Tome XLIII, No. 4, p. 99, January 22 (1938).
- W. G. Hayman, "Approximate Formulae for the Inductance of Solenoids and Astatic Coils," *Experimental Wireless and Wireless Engineer*, Vol. VIII, No. 95, p. 422, August (1931).

3. Nomograms and Charts for Self Inductance.

- E. M. Shiepe, "The Inductance Authority," published by Herman Bernard, New York, N.Y., 1933 (contains 50 large sized charts based on formulae and tables of Bureau of Standards Circular No. 74).
- H. Seki, "A New Abac for Single Layer Coils," *Wireless Engineer*, Vol. X, No. 112, p. 12, January (1933), (nomogram based upon Hayman's formula).
- J. E. Maynard, "Multilayer Coil Inductance Chart," *Electronics*, p. 33, January (1939).
- R. T. Beatty, "Radio Data Charts," published by Iliffe and Sons, London.
- C. P. Nachod, "Nomogram for Coil Calculations," *Electronics*, pp. 27-28, January (1937).

4. The Effects of Metal Screens on Coils.

- R.C.A. Radiotron Division Application Note No. 48, June 12, 1935, reprinted in *Radio Engineering*, p. 11, July (1935).
- A. L. M. Sowerby, "The Modern Screened Coil," *Wireless World*, September 23, 30, and October 7, 14 (1931).
- G. W. O. Howe, editorials, *Wireless Engineer*, Vol. XI, No. 126, p. 115, March (1934), and Vol. XI, No. 130, p. 347, July (1934).
- W. G. Hayman, "Inductance of Solenoids in Cylindrical Screen Boxes," *Wireless Engineer*, Vol. XI, No. 127, p. 189, April (1934).
- "Formulas for Shielded Coils," *Radio Engineering*, Vol. XVI, No. 12, p. 17, December (1936).
- S. Levy, "Electro-magnetic Shielding Effect of an Infinite Plane Conducting Sheet Placed between Circular Coaxial Coils," *Proc. I.R.E.*, Vol. 24, No. 6, p. 923, June (1936), (contains further bibliography).
- F. Moeller, "Magnetic Screening with a Plane Sheet at Audio Frequencies," *Elektrische Nachrichten Technik*, Band 16, Heft 2, p. 48 (February 1939).

The Editor wishes to acknowledge the assistance of Mr. L. G. Dobbie, M.E., in compiling this chapter.

CHAPTER 16 (continued)

Part 3—Design of Low Loss Inductances

Division of coils for high frequency tuned circuits into three classes—papers dealing with the practical and theoretical design—Pollack's summary—Barden and Grimes' summary—Harris and Siemen's summary—Butterworth's conclusions—Austin's summary—dielectric losses—eddy currents—skin effect—current in coil concentrates at the minimum diameter—multistrand (litz) wires—solid round wires—insulating materials—screens—iron core materials—Bibliography.

Coils for high frequency tuned circuits may be divided into three main classes:—

- (1) Coils for frequencies higher than 3 Mc/s., which are usually air cored solenoids employing solid round wire, with spaced turns above 10 Mc/s.
- (2) Multilayer air cored coils of single or multistrand (Litz) type, usually arranged in two to four plies, unless the progressive method of winding is used. These are suitable for frequencies less than 3 Mc/s.
- (3) Single and multilayer coils adapted specially for the use of high permeability iron core materials, also suitable for frequencies less than 3 Mc/s.

The subject as a whole is too large to be treated in detail here, and instead a summary with a representative bibliography is provided.

For short wave coils, the work by Pollack, Harris and Siemens, and Barden and Grimes is very complete from the practical design viewpoint. The papers by Butterworth, Palermo and Grover, and Terman are basically theoretical. Austin has provided an excellent summary and practical interpretation of Butterworth's four papers.

Pollack summarises the procedure for the optimum design of coils for frequencies from 4 to 25 Mc/s. as follows:—

1. **Coil diameter and length of winding:** Make as large as is consistent with the shield being used. The shield diameter should be twice the coil diameter, and the ends of the coil should not come within one diameter of the ends of the shield.
2. A bakelite coil form with a shallow groove for the wire, and enamelled wire may be used with little loss in Q. The groove should not be any deeper than is necessary to give the requisite rigidity. The use of special coil form constructions and special materials* does not appear to be justified.

*Except for the reduction of frequency drift due to temperature changes.—Ed.

3. Number of turns: Calculate from

$$N = \sqrt{L (102S + 45)/D}$$

where S = ratio of length to diameter of coil,
 D = diameter of coil in centimetres,
 and L = inductance in microhenries.

(See Chapter 16, Part 2, for alternative formulae using inch units for turns calculation).

4. Wire size: Calculate from

$$d_o = b/\sqrt{2} N,$$

= optimum diameter in cms.

where b = winding length in cms.

That is, the optimum wire diameter is $1/\sqrt{2}$ times the winding pitch, measured from centre to centre of adjacent turns.

Barden and Grimes recommend for coils working near 15 Mc/s. that No. 14 or No. 16 g., B & S., enamelled wire on a form not less than one inch diameter at a winding pitch equal to twice the wire diameter is desirable. The screen diameter should be not less than twice the coil diameter. A comparison of coils of equal inductance on 0.5" and 1" forms in screens double the coil diameter indicates that the value of Q is twice as great for the larger diameter coil. No. 24 g. B.&S. wire was used for the small diameter coil.

Harris and Siemens quote the following conclusions:—

- (1) Q increases with coil diameter.
- (2) Q increases with coil length, rapidly when the ratio of length to diameter is small, and very slowly when the length is equal to or greater than the diameter.
- (3) Optimum ratio of wire diameter to pitch is approximately 0.6 for any coil shape. Variation of Q with wire diameter is small in the vicinity of the optimum ratio; hence, selection of the nearest standard gauge is satisfactory for practical purposes.

Butterworth's paper deals with the copper loss resistance only, and insulation losses must be taken into account separately. Insulation losses are minimised by winding coils on low loss forms, using a form or shape factor which provides the smallest possible self capacity with the highest power factor. Thus air is the best separating medium for the individual turns, and the form should provide only the very minimum mechanical support. Multilayer windings in one pie have high self capacity due to proximity of the high and low potential ends of the winding. The same inductance obtained by several pies close together in series greatly reduces the self capacity and associated insulation losses. Heavy coatings of poor quality wax of high dielectric constant may introduce considerable losses.

The shape of a coil necessary for minimum copper loss (from **Butterworth's** paper) is stated by **Austin** as follows:—

- (1) **Single layer solenoids:** Winding length equal to one-third of the diameter.
- (2) **Single layer discs (pancake):** Winding depth equal to one-quarter of the external diameter.
- (3) **Multilayer coils:** There is a wide range of choice, any of which is nearly equally efficient. The limits are fixed roughly by the rule that five times winding depth plus three times winding length should be equal to the external diameter.

Dielectric losses present in the self capacity of the coil are reduced by altering the shape to separate the high potential end from all low potential parts of the circuit. These losses become relatively more important the higher the frequency. Thus, the shape of a solenoid for minimum total losses may need to be increased beyond one-third of the diameter to half or two-thirds.

The high frequency alternating field of a coil produces eddy currents in the metal of the wire, which are superimposed upon the desired flow of current. The first effect is for the current to concentrate at the outside surface of the conductor, leaving the interior relatively idle. This phenomenon is designated "skin effect," and is the only effect in straight wires clear of neighbouring conductors. In a coil, where there are numbers of adjacent turns carrying current, each has a further influence upon its neighbour.

In turns near the centre of a solenoid the current concentrates on the surface of each turn where it is in contact with the form, i.e., at the minimum diameter. In turns at either end of a solenoid the maximum current density occurs still near the minimum diameter of the conductor, but is displaced away from the centre of the coil.

Thus most of the conductor is going to waste. Multistrand or litz (litzendraht) wires have been developed to meet this difficulty. A number of strands (5, 7, 9, 15 being common) is woven together, each being of small cross section and completely insulated by enamel and silk covering from its neighbours. Due to the weaving of the strands, each wire carries a nearly similar share of the total current, which is now forced to flow through a larger effective cross section of copper. The former tendency towards concentration at one side of a solid conductor is greatly overcome, and the copper losses are correspondingly reduced.

Litz wire is most effective at frequencies between one-third and three megacycles per second. Outside of this range comparable results are usually possible with round wire of solid section, because at low frequencies "skin effect" steadily disappears while at high frequencies it is large even in the fine strands forming the litz wire, and is augmented by the use of strands having increased diameter.

The insulating materials covering the wire and composing the form on which a coil is wound should be treated to reduce moisture content as far as possible. Baking for a period of about one hour at a little higher temperature than the boiling point of water, followed by impregnation with moisture resisting wax or varnish, is an important procedure that should not be neglected if permanence of high quality performance be desired. Multilayer coils are particularly susceptible to atmospheric humidity unless carefully impregnated. The presence of moisture within the insulating material allows ionisation of soluble impurities, and perhaps of the material itself. Electrolytic conduction between turns and strands is then possible, with consequent increase in insulation losses.

Screens placed around coils of all types at radio frequencies should be of non-magnetic good conducting material to introduce the least losses. In other words, the Q of the screen considered as a single turn coil should be as high as possible. In addition, the coupling to the coil inside it should be low to minimise the screen losses reflected into the tuned circuit. For this reason the screen diameter should if possible be at least double the outside diameter of the coil. A ratio smaller than 1.6 to 1 causes a large increase of losses due to the presence of the screen.

The design of coils for use with iron core materials depends mainly upon the type of core material and the shape of the magnetic circuit proposed. Nearly closed core systems are sometimes used with high permeability low loss material. More commonly, however, the core is in the

form of a small cylindrical plug which may be moved by screw action along the axis of the coil and fills the space within the inside diameter of the form. The main function of the core in the latter case may be only to provide a means of tuning the circuit rather than of improving its Q. When improvement in Q is possible with a suitable material, the maximum benefit is obtained by insuring that the largest possible percentage of the total magnetic flux links with the core over as much of its path as possible; the ultimate limit in this direction is of course the closed core. The compromise between cost and quality of performance usually results in a coil of three or four pies of small winding depth, or a progressive winding between one and two diameters long, traversed by a cylindrical plug of magnetic material. The wall thickness of the form should be as small as is consistent with mechanical strength; between 0.010" and 0.020" is usual for 0.25" to 0.375" diameter forms.

For further detailed information it is suggested that reference should be made to the papers listed in the latter part of the following bibliography.

Bibliography

- D. Pollack, "The Design of Inductances for Frequencies between 4 and 25 Megacycles," R.C.A. Review, Vol. II, No. 2, p. 184, October, 1937, and Electrical Engineering, September, 1937.
- W. A. Harris and R. H. Siemens, "Superheterodyne Oscillator Design Considerations," R.C.A. Radiotron Division Publication No. ST-41, November, 1935.
- W. S. Barden and D. Grimes, "Coil Design for Short Wave Receivers," Electronics, p. 174, June, 1934.
- F. H. Scheer, "Notes on Intermediate-Frequency Transformer Design," Proc. I.R.E., Vol. 23, No. 12, p. 1483, December, 1935.
- A. L. M. Sowerby, "The Modern Screened Coil," Wireless World, September 23, 30, and October 7, 14, 1931.
- S. Butterworth, "The Effective Resistance of Inductance Coils at Radio Frequency," Wireless Engineer, Vol. III, Nos. 31, 32, 34, 35, pp. 203, 309, 417, 483, April, May, July, August, 1926.
- B. B. Austin, "The Effective Resistance of Inductance Coils at Radio Frequency" (abstract of paper by S. Butterworth, 1926), Wireless Engineer, Vol. XI, No. 124, p. 12, January, 1934.
- E. B. Moullin, "Radio Frequency Measurements," p. 341, 1931 ed., Charles Griffin and Co., Ltd., London.
- A. J. Palermo and F. W. Grover, "A Study of the High-Frequency Resistance of Single Layer Coils," Proc. I.R.E., Vol. 18, No. 12, p. 2041 December, 1930, and supplementary note Vol. 19, No. 7, p. 1278, July, 1931.
- Bureau of Standards Circular No. 74, p. 304, 1924.
- F. E. Terman, "Some Possibilities for Low Loss Coils," Proc. I.R.E., Vol. 23, No. 9, p. 1069, September, 1935.
- G. Reber, "Optimum Design of Toroidal Inductances," Proc. I.R.E., Vol. 23, No. 9, p. 1056, September, 1935.
- D. R. Parsons, "Winding Short Wave Coils," Wireless World, Vol. XLIV, No. 22, p. 507, June 1, 1939 (erratum, p. 555, June 15, 1939).
- W. J. Polydoroff, "Ferro Inductors and Permeability Tuning," Proc. I.R.E., Vol. 21, No. 5, p. 690, May, 1933.
- A. Schneider, "Iron-Content Cores for High-Frequency Coils," Wireless Engineer, Vol. X, No. 115, p. 183, April, 1933.
- G. W. O. Howe, editorials, Wireless Engineer, Vol. X, Nos. 112, 117, 120, pp. 1, 293, 467, January, June, September, 1933.

- E. R. Friedlaender, "Iron Powder Cores," *Wireless Engineer*, Vol. XV, No. 180, p. 473, September, 1938 (see editorial by G. W. O. Howe, p. 471 of same issue).
- C. Austin and A. L. Oliver, "Some Notes on Iron-Dust Cored Coils at Radio Frequencies," *Marconi Review*, No. 70, p. 17, July-September, 1938.
- J. N. Britton, "The Application of Iron in High-Frequency Circuits." *Proc. World Radio Convention*, Sydney, April, 1938.
- A. W. Simon, "Winding the Universal Coil," *Electronics*, p. 22, October, 1936 (errata, p. 52, November, 1936).
- H. A. Wheeler, "Design of Radio Frequency Choke Coils," *Proc. I.R.E.*, Vol. 24, No. 6, p. 850, June, 1936.
- A. A. Joyner and V. D. Landon, "Theory and Design of Progressive Universal Coils," *Communications*, Vol. 18, No. 9, p. 5, September, 1938.
- "Coil Design Factors," *Radio Review of Australia*, p. 32, March, and p. 16, May, 1936.
- H. Nottenbock and A. Weis, "Sirufer 4," *Radio Review of Australia*, p. 5, April, 1936.
- H. L. Crowley, "High-Frequency Magnetic Material," *Radio Engineering*, Vol. XVI, No. 10, p. 15, October, 1936.
- S. W. Place, "Coil Forms," *Radio Engineering*, Vol. XVI, No. 5, p. 9, May, 1936.
- W. L. Carlson, "Magnetite-Core I.F. Coils," *Radio Engineering*, Vol. XVI, No. 5, p. 18, May, 1936.
- P. C. Michel, "Factor-of-Merit of Short Wave Coils," *General Electric Review*, Vol. 40, No. 10, pp. 476-480, October (1937).
- F. N. Jacob, "Permeability Tuned Push-Button Systems," *Communications*, Vol. 18, No. 4, p. 15, April 1938.

The Editor wishes to acknowledge the assistance of Mr. L. G. Dobbie, M.E., in compiling this chapter.

CHAPTER 17

Intermediate Frequency Amplifiers

One or two stages ? — Selectivity — Crystal filter — Regeneration — Requirements for high fidelity — Variable Selectivity (1) Mutual inductance, (2) Tertiary coils, (3) Bottom coupling, (4) Top coupling — Choice of frequency — Stability — Detuning due to Miller Effect and A.V.C.

I.F. amplifiers are required for amplification, for selectivity and for the application of A.V.C. All three requirements must be considered in designing an I.F. amplifier.

Should the I.F. amplifier have one or two stages ? A single stage has the merits of simplicity and low cost and in many cases it is quite satisfactory for the requirements of the receiver. It has, however, certain defects which may be overcome by the use of two or more stages. Even when high gain I.F. transformers are employed there is difficulty in obtaining sufficient amplification for use on the short wave band. On the broadcast band two stages are not generally required for amplification, but it is advantageous to employ two low gain stages in place of one high gain stage and to apply A.V.C. to the first stage only. By this means modulation rise and distortion on strong signals may be very much reduced (see Chapter 19). The additional tuned circuits available with two I.F. stages are very helpful in obtaining satisfactory selectivity curves, as will be mentioned later.

In most radio receivers the I.F. transformers have tuned primaries and tuned secondaries, the reason being that the selectivity may be improved and the loss of sidebands reduced by this means. For optimum results the first I.F. transformer should be of a different design from that of the final I.F. transformer which feeds a diode valve.

Selectivity

The requirements of selectivity are:—

- (1) That the response should be reasonably uniform within a limited frequency range.
- (2) That the response should be well down at ± 10 Kc/s. for all cases except for local reception.
- (3) That the skirt of the curve should be very low at frequencies ± 20 Kc/s. or more off resonance.

For extreme selectivity a crystal filter is sometimes used in communications receivers. This is particularly valuable for telegraphic communication and may be used for the reception of voice frequencies by a certain degree of detuning although the distortion introduced is considerable.

Regeneration is sometimes used in order to obtain improved selectivity, but has the disadvantage of giving an asymmetrical selectivity curve since the circuits are regenerative only on one side of resonance.

For high fidelity it is desirable to obtain a nearly flat selectivity curve for frequencies up to 10 Kc/s. from resonance, giving a total band width of up to 20 Kc/s. This may be obtained by means of over-coupling in the I.F. transformers, preferably in combination with a suitable single hump transformer so as to give a triple hump with all three humps at the same level. In order to obtain this result it is necessary to select the Q's of the individual coils. For best results it is also desirable to have multiple tuned stages.

Variable Selectivity

Any method giving variable coupling may be used to provide variable selectivity.

Variable coupling* by means of pure mutual inductance is the only system in which mistuning of the transformer does not occur. As the coupling is increased above the critical value, the "trough" of the resonance curve remains at intermediate frequency. (See C. B. Aiken, "Two-mesh Tuned Coupled Circuit Filters," Proc. I.R.E., p. 230, Feb., 1937).

With any other type of coupling which has no mutual inductance component, one of the two humps remains at intermediate frequency. The mistuning is then half the frequency band width between humps.

The method of switching tertiary coils approximates far more closely to the curve for pure mutual inductance (M in Fig. 1) than it does to the other curve. The tertiary coil may have no more than 5% of the turns on the main tuning coil, and less than 0.5% ratio of inductance. The symmetry of the overall selectivity curves is usually good.

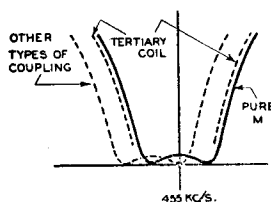

Figure 1

Variable capacitive coupling may be used and the coupling condenser may be either a small condenser linking the top end of the primary to the top end of the secondary, or it may be a common condenser in series with both primary and secondary circuits. This latter is commonly known as "bottom coupling."

For "top coupling" very small capacitances are required and the effect of stray capacitances is inclined to be serious, particularly in obtaining low minimum coupling. It may, however, be used with a differential condenser arrangement whereby continuously variable selectivity is obtained†. The differential condenser in this case adds to or subtracts from the capacitance in the primary and secondary circuits to give the requisite tuning. The disadvantage of this arrangement is that sufficiently low minimum coupling is very difficult to obtain and the condenser is a non-standard type.

"Bottom coupling" has results similar to top coupling, but is easier to handle for switching and also has advantages for low coefficients of coupling. A two or three step tapping switch may be used to give corresponding degrees of band width provided that simultaneously other switch contacts insert the necessary capacitances in primary and secondary circuits for each switch position to give correct tuning.

For further information on methods of coupling, see Chapter 16, Part 1.

Choice of Frequency

Various frequencies are used for the I.F. amplifiers of radio receivers. A frequency of 110 Kc/s. has been used widely in Europe where the long wave band is in use. This gives extremely good selectivity but serious side

*See also "The Modern Receiver Stage by Stage," Wireless World, April 6, 1939, pp. 329-331.

†Radiotronics 84 (15th March, 1938), Page 105.

band cutting. A frequency of 175 Kc/s. has been used for broadcast band reception both in America and Australia for a number of years but its use on the short-wave band is not very satisfactory. A frequency in the region of 250-270 Kc/s. has also been used to a limited extent as a compromise between 175 and 465 Kc/s. The most common frequencies for dual wave receivers are between 450 and 465 Kc/s.* and, particularly if iron cored I.F. transformers are used, this frequency band is a very good compromise. For short-wave receivers which are not intended for operation at lower frequencies, an intermediate frequency of 1,600 Kc/s. or higher may be used. This has the advantage of decreasing the difference in frequency between the signal and intermediate frequencies, thereby giving improved performance from the converter valve. At such a high frequency one or two additional I.F. stages are necessary to provide sufficient gain. For additional information regarding the choice of I.F. see Chapter 15.

Stability

A certain amount of regeneration is provided through the grid to plate capacitance of the I.F. valve, but when the I.F. transformers are of normal design this should not be sufficient on its own to cause any appreciable instability. Additional sources of regeneration are :—

- (1) Grid leads which are badly located,
- (2) Imperfect layout,
- (3) I.F. transformers in close proximity to one another or to other parts of the I.F. circuit. The shield cans of I.F. transformers do not provide perfect screening and should not be relied upon in this respect. Round seamless cans of good conducting and non-magnetic material are most satisfactory.

Since the effect of even slight regeneration is an asymmetrical wave form and since changes in atmospheric conditions or the replacement of valves may result in a greater tendency towards instability, it is good practice to design for the absolute minimum of regeneration.

Detuning Due to A.V.C.

Due to the Miller Effect (see Chapter 7) there is reflected into the grid circuit of the valve a capacitance which is a function of the gain of the valve. If A.V.C. is applied to the valve the gain changes and the Miller Effect capacitance also changes, thereby causing detuning. This may be avoided

- (1) By omitting the cathode bypass condenser and thereby causing degeneration as well as giving approximate cancellation of the change of capacitance†.
 - (2) By applying A.V.C. only to a stage which is broadly tuned or has low gain.
 - (3) By including a small part (10 or 20 ohms) of the cathode resistor, unbypassed, in series with the secondary circuit of the preceding I.F. transformer‡.
- or (4) By using high tuning capacitances in the grid circuits of the controlled stages.

*A frequency of 455 Kc/s. is receiving universal acceptance as a standard frequency, and efforts are being made to maintain this frequency free from radio interference.

†R. L. Freeman, "Use of feedback to compensate for vacuum-tube input-capacitance variations with grid bias," Proc. I.R.E., Vol. 26, No. 11, pp. 1360-1366, November (1938).

Method (1) results in loss of gain as well as a reduction in the degree of automatic volume control on the I.F. stage, but is simple and effective. Method (2) is usually practicable only when two or more I.F. stages are used. Method (3) requires an additional component in the circuit, but does not result in more than a slight gain reduction, and in this respect is preferable to Method (1). Method (4) is a compromise which results in limited gain and selectivity. A capacitance of 200 $\mu\mu\text{F}$. or more is desirable to reduce detuning, although capacitances of 70 to 100 $\mu\mu\text{F}$. are used in commercial receivers. Within limits, a degree of detuning is permissible on strong signals; lining up should be carried out at a low signal level.

CHAPTER 18

Detection

Diodes — Requirements for low distortion — Input voltage — A.C. shunting — Circuit for compensating the effect of A.C. shunting — Grid detection — Power grid detection — Plate detection — Reflex detection — Mathematical consideration — (1) A.C. Shunting — (2) Audio frequency voltage output.

Diodes

A diode has two electrodes, namely plate and cathode. It is therefore identical in structure with a power rectifier but the term is generally restricted to valves which are used for detection or A.V.C. and distinct from rectifiers which are used for power supply. The operation of diodes with A.V.C. is considered in detail in Chapter 19. The operation of a diode on a modulated wave is quite different from the operation of a power rectifier, and it is necessary to consider the characteristic curves of a diode valve if a full understanding of the operation is to be obtained. Reference should be made to Chapter 34 where a section deals with the operation of diodes on a modulated input. It is shown that the percentage

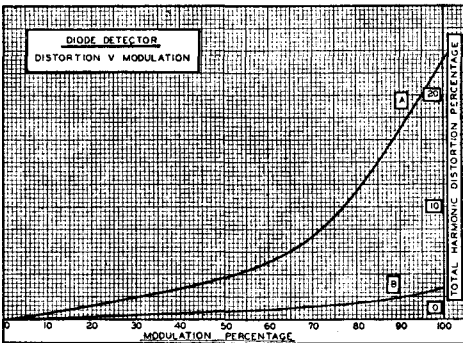

Figure 1

distortion at 100% modulation for a diode operating with an input voltage in excess of 10 volts peak is quite small. Fig. 1 shows the distortion of a diode operating firstly under ideal conditions with no A.C. shunting (Curve B) and secondly the distortion resulting when a load of 1 megohm is shunted across a diode load resistance of 0.5 megohm. The respective percentages of harmonic distortion at 100% modulation are approximately 3 and 23% so that the presence of such shunting

has a very marked effect on the performance.

The design of a diode detector for low distortion is therefore based on the following requirements:—

- (1) That the input voltage should not be less than 10 volts peak.
- (2) That no appreciable A.C. shunting should be present.

The first of these two requirements is easily met for local stations and a voltage from 10 to 20 volts is quite common in receivers fitted with A.V.C.

The second requirement is one which is difficult to satisfy. Shunting of the diode load may be due to

- (1) The A.V.C. system,
- (2) the following grid resistor, or
- (3) a Magic Eye tuning indicator.

The circuit of a typical diode detector is shown in Fig. 2 in which the diode load proper is R_2 together with R_1 which, in conjunction with C_1 and C_2 , form an R.F. filter so that the R.F. voltage passed on to the audio system may be a minimum. R_1 is generally made 10% of R_2 and typical values are 50,000 ohms and 0.5 megohm. The capacitances of C_1 and C_2 depend upon the frequency of the carrier; for an I.F. of 455 Kc/s. they may both be 100 $\mu\mu\text{F}$.

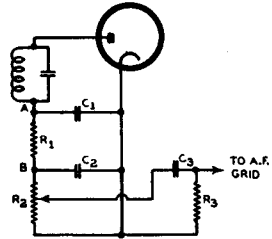

Figure 2

If the volume control (R_2) is turned to maximum the shunting effect due to R_3 will be appreciable since R_3 cannot exceed 1 megohm with most types of valves. If, however, grid leak bias is used on a high- μ triode valve, R_3 may be approximately 10 megohms and the input resistance of the valve will then be of the order of 5 megohms. This is sufficiently high to be unimportant but for lower values of R_3 the distortion with the control set near maximum will be severe. It is found in most conventional receivers that the A.F. gain is considerably higher than that required for strong carrier voltages and under these conditions the control will be turned to a low setting. The A.C. shunting effect due to R_3 is practically negligible provided that the control is below one-fifth of the maximum position.

Distortion due to the A.V.C. system has been treated in detail in Chapter 19 where it is shown that by the use of the conventional form of delayed A.V.C. the direct shunting on the diode circuit may be removed. Slight distortion also occurs at the point at which the A.V.C. diode commences to conduct, this distortion being known as that due to **Differential Loading**. It is shown in Chapter 19 that this form of distortion is comparatively unimportant provided that the delay voltage is 3 volts or less.

The A.C. shunting due to the addition of a Magic Eye to the diode detector circuit is a serious one and difficult to avoid. In order to reduce the distortion to a minimum the resistor feeding the grid of the Magic Eye may be made 2 megohms and the effect will then only become apparent at high percentages of modulation. If the Magic Eye is connected to the A.V.C. system it will not operate at low carrier strengths unless the delay voltage is extremely small. One possible method where the utmost fidelity is required is to use the same circuit as for delayed A.V.C., but with a de-

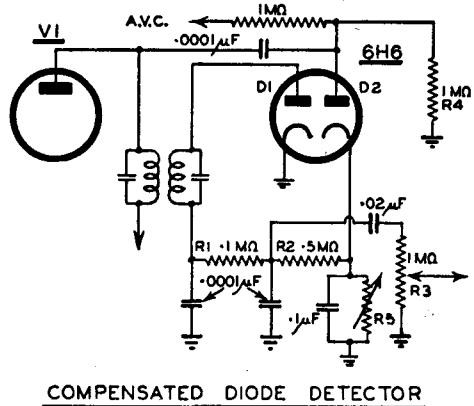

Figure 3

lay voltage of zero, and to connect the Magic Eye to this A.V.C. circuit. With this arrangement A.C. shunting due to the A.V.C. and the Magic Eye is entirely eliminated, while differential loading no longer occurs.

An interesting arrangement* for counteracting the effect of A.C. loading is accomplished by the use of the circuit of Fig. 3. In this arrangement a positive bias is applied to the diode anode in such a way as to be proportional to the carrier input. A fixed positive bias would not be satisfactory since it would only give low distortion at one carrier level and would give severe distortion at other levels. A suitable value for R_c is 0.25 megohm maximum.

Summing up the characteristics of the diode, it may be stated that its performance, as regards harmonic distortion and frequency response, is excellent provided that the input voltage is sufficiently high and that A.C. shunting is reduced to a minimum. All forms of detectors suffer from distortion at low input levels, but the diode has the particular advantage that the input may be increased to a very high level with consequent reduction of distortion, without any overloading effect such as occurs with other forms of detectors.

Other Forms of Detectors

Grid Detection

Leaky grid or "cumulative detection" has been used for many years and is still widely used for certain applications. The theory of its operation is essentially the same as that of the diode except that a triode is also used for amplification. The derivation of a leaky grid detector from the combination of a diode and triode is shown in Fig. 4. Whether the grid condenser and grid leak are inserted as shown (as is usual with the diode) or at the point X is immaterial from the point of operation. The diode is directly coupled to the triode and therefore the audio frequency voltages developed in the diode detector are passed on to the triode grid, but at the same time

this grid is given a D.C. bias through the D.C. voltage developed in a similar manner to that by which A.V.C. is obtained. Consequently the operating point on the triode varies along the curve from zero grid towards more negative bias voltages as the carrier voltage is increased. This is identically the same in effect as is obtained when the diode is omitted (Fig. 5) since the grid and cathode of the triode act as a diode and produce the same results. The illustration given was purely to demonstrate the derivation of the one from the other and not to be a practical form of detector since no advantage is gained by retaining the diode in circuit.

It will be seen that the operating point varies along the characteristic curve between zero bias and the cut-off point (Fig. 6). There will be a certain strength of carrier at which the detection will be most satisfactory,

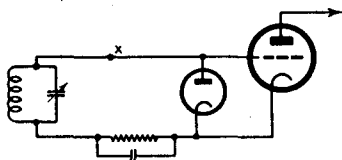

Figure 4

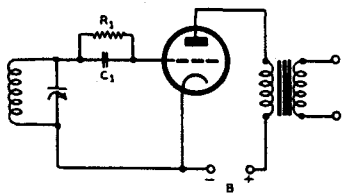

Figure 5

* Radiotronics No. 74, pp. 21, March 31, (1937).

but at lower or higher levels detection will not be so satisfactory on account of improper operating conditions. If with a certain carrier input voltage the D.C. bias on the grid is OA , then the point corresponding to peak modulation is B where OB equals twice OA . If the point B is on the curved part of the characteristic, or in the extreme case actually beyond the cut-off, the distortion will be severe. A valve having low μ and low g_m is capable of operating with a higher carrier voltage than a valve with improved characteristics, but the gain in the detector stage will be less. There is a further difficulty in that the plate current at no signal or at very weak signals may be excessively high, and if transformer coupling is used this may in extreme cases damage the valve or pass too much direct-current through the transformer unless the plate supply voltage is reduced. If resistance coupling or parallel-feed is used the efficiency of the detector is decreased. As with diode detection there is distortion at low levels due to the "diode characteristics" but, as distinct from the diode, the overload point occurs at quite a low carrier voltage. This method of detection is therefore very much limited in its application.

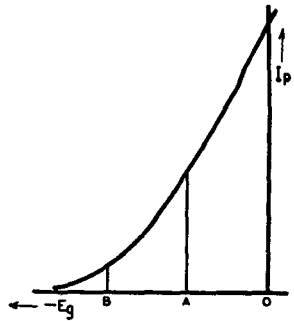

Figure 6

Power Grid Detection

Power grid detection is a modification of leaky grid or cumulative detection and the circuit is identical, but the operating conditions are so chosen that the valve will operate on higher carrier voltages without overloading. In order to obtain a short time constant in the grid condenser and grid leak, the condenser is decreased in capacitance and the grid leak decreased in resistance thereby improving the high audio frequency reproduction. Under optimum conditions the distortion is at least as high as that of a diode together with increased distortion due to the curvature of the characteristic. The overload point, even though higher than that of ordinary leaky grid detection, is at a much lower level than that with diode detection.

All forms of grid detection, particularly "power grid detection," involve damping of the grid circuit due to grid current and this damping causes loss of sensitivity and selectivity. Grid detection is thus similar to diode detection in that it damps the input circuit. It has the advantage over diode detection that gain is obtained in the detector which can be still further increased if transformer coupling is used between it and the following stage. Transformer coupling can of course only be used when the valve has a low plate resistance.

The foregoing comparison between a diode and a grid detector is on the basis of the detector alone. In modern practice the diode detector is frequently in the same envelope with a voltage amplifier, and the total gain is therefore quite high.

Plate Detection

Plate detection or "anode bend detection" involves operation towards the point of plate current cut-off so that non-linearity occurs, thereby giving rectification. Owing to the slow rate of curvature the detection efficiency is small, but there is an advantage in that the amplification which is obtained to a certain extent makes up for the poor detection. Due to the gradual curvature the distortion is very great with low input voltages, and even with the maximum input before overload occurs the distortion is rather high with high percentages of modulation. An important advan-

tage of plate detection is, however, that the grid circuit is not damped to any extent, and the detector is therefore sometimes spoken of as being of infinite impedance, although this term is not strictly correct.

With pentode valves, it is possible to use either "Bottom Bend Rectification" as with triodes, or "Top Bend Rectification" peculiar to pentodes. This "top bend" in resistance coupled pentode characteristics is shown in Fig. 12, Chapter 34.

A similar effect occurs with triodes, but only in the positive grid region, and for this reason is incapable of being used for plate rectification. For top bend rectification with a pentode valve, it is desirable to operate the valve with a plate current in the region of $0.95 \times (E_p/R_L)$. The exact operating point for optimum conditions depends upon the input voltage.

Pentode valves are particularly valuable as plate detectors since the gain is of such a high order. If resistance coupling is used the gain is reduced very considerably, and in order to eliminate this loss it is usual to adopt choke coupling using a very high inductance choke in the plate circuit, shunted by a resistor to give more uniform frequency response. If the shunt resistor were omitted the low frequencies would be very severely reduced in relative level.

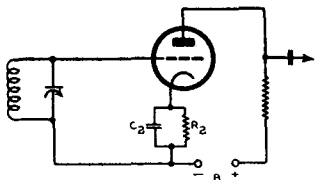

Figure 7

been used as plate detectors very satisfactorily for a number of years, although the distortion is too high for them to be used in any but the cheapest radio receivers at the present time. Such a detector is, however, permissible for some types of short-wave reception and for amateur communication work where its high grid input impedance results in higher sensitivity and selectivity.

The cathode bypass condenser (C_2 , Fig. 7) should be capable of bypassing both radio and audio frequencies. A 25 μ F. electrolytic in parallel with a 0.0005 μ F. mica condenser is sometimes necessary for the best results.

Reflex Detector

The reflex detector is essentially a plate detector with negative feedback. Any amount of feedback may be applied from zero to 100%, and as the feedback increases, so the distortion decreases and the stage gain decreases until in the final condition with 100% feedback the gain is very close to unity. The reflex detector has an even higher input impedance than the plate detector, and is therefore valuable in certain applications. Under certain conditions the input resistance may be negative. The degree of feedback may be adjusted to give any required gain, but the distortion increases with the gain, and if low distortion is required the maximum gain is limited to about three or four times even with a pentode valve. With maximum degeneration the distortion is possibly slightly less than that of a diode operating under similar input voltage conditions, while the reflex detector has the distinct advantage of high input impedance. One application which appears to be of importance is to fidelity T.R.F. receivers, but since reflex detectors do not provide A.V.C. they are

With all forms of plate detectors the bias is critical and since different valves of the same type require slightly different values of bias the use of fixed bias is not recommended. A very high value of cathode resistor is usually adopted to bias the valve very nearly to cut-off, and in such a way that if valves are changed or vary during life, the operating point maintains itself near the optimum (Fig. 7). Screen grid and pentode valves with self-bias have

not at present used in normal broadcast receivers. Amplified A.V.C. may well be employed in combination with a reflex detector in order to provide a receiver having good characteristics.

A limitation of the reflex detector is that there is a definite maximum limit to the input signal voltage for freedom from grid current flow. A further increase of input causes rectification at the grid with damping of the circuits connected to the grid, and a steady increase of distortion. An increase in the supply voltage raises the threshold point for grid current.

See also J. E. Varrall, "Distortionless Detection," *Wireless World*, Vol. 45, No. 5, pp. 94-96, August 3, (1939).

Mathematical Consideration

(1) A.C. Shunting (R_3 and R_4)

When the diode load resistance (R_2 in Fig. 2) is shunted by parallel A.C. loads R_3 (i.e., with volume control set at maximum) and R_4 (R_4 being the effective A.V.C. shunt load resistance), the total A.C. resistance in the diode circuit neglecting the effect of C_1 and C_2 , will be

$$\begin{aligned} R_{AC} &= R_1 + \frac{1}{\frac{1}{R_2} + \frac{1}{R_3} + \frac{1}{R_4}} \\ &= R_1 + \frac{R_2}{1 + (R_2/R_8)} \end{aligned}$$

where $R_8 = \frac{R_3 R_4}{R_3 + R_4} =$ total A.C. shunt load.

Obviously the total D.C. resistance will be

$$R_{DC} = R_1 + R_2.$$

The maximum percentage of modulation for limited distortion is given approximately by

$$M_{max} = \frac{R_1 + \frac{R_2}{1 + (R_2/R_8)}}{R_1 + R_2} \times 100.$$

This expression may also be put into a form giving the minimum value of R_8 for a specified percentage of modulation (M).

$$R_{8 \min} = \frac{R_2}{R_1 + R_2} \left(\frac{MR_2}{100 - M} - R_1 \right)$$

If as a numerical case we take

$$R_1 = 0.05 \text{ megohm}$$

$$R_2 = 0.5 \text{ megohm}$$

$$R_3 = 1 \text{ megohm}$$

$$R_4 = 1 \text{ megohm}$$

Then by the formula given above

$$R_8 = 0.5 \text{ megohm}$$

$$\text{and } M_{\max} = \frac{0.05 + [0.5/(1 + 1)]}{0.55} \times 100 = 55\% \text{ approx.}$$

Similarly if $R_8 = 1$ megohm and $R_1 = 0$ (in order to compare with Fig. 1).

$$M_{\max} = \frac{0.5/(1 + 0.5)}{0.5} = 67\%$$

Reference to Fig. 1 shows that this corresponds to 6.5% total harmonic distortion.

(2) Audio Frequency Voltage Output

The Peak Audio Frequency Voltage Output (E.A.F.) of the preceding arrangement, neglecting the effect of C_1 and C_2 will be

$$\text{E.A.F.} = \frac{\eta \frac{M}{100} \text{ E.I.F.} \frac{R_2 \cdot R_8}{R_2 + R_8}}{R_1 + \frac{R_2 \cdot R_8}{R_2 + R_8}}$$

where η = diode rectification efficiency factor
($\eta = 1$ for 100% efficiency)

M = modulation percentage

and E.I.F. = peak I.F. voltage applied to the diode.

CHAPTER 19

Automatic Volume Control

A.V.C.— Simple A.V.C.— Delayed A.V.C.— Differential distortion — Methods of feed — Series feed — Shunt feed — Maximum resistances in grid circuits — Typical Circuits — A.V.C. Application — Amplified A.V.C.— Audio A.V.C.— Modulation rise — A.V.C. with battery valves and zero bias — Special case with simple A.V.C.— Time constants — A.V.C. Characteristic Curves.

An automatic volume control is a device which automatically reduces the total amplification of the signal in a radio receiver with increasing strength of the received signal carrier wave. In practice the usual arrangement is to employ valves having "super control" or "variable- μ " grids and to apply to them a bias which is a function of the strength of carrier. A.V.C. systems may be divided into simple A.V.C. and delayed A.V.C.

Simple A.V.C.

In order to obtain simple A.V.C. it is only necessary to add resistor R_1 and condenser C_1 to the ordinary diode detector circuit shown in Fig. 1. In any diode detector there is developed across the load resistor (R_1 and R_2 in series) a voltage which is proportional to the strength of carrier at the diode. The diode end of the load resistor is negative with respect to earth (Fig. 1) and therefore a negative A.V.C. voltage is applied to the controlled grids. R_1 and C_1 form a filter to cut out the audio component and leave only the direct component.

Since a condenser in series with a resistance takes a finite time to charge or discharge, the A.V.C. filter circuit has a "time constant." The time constant of R_1 and C_1 is equal to $R_1 \cdot C_1$, where R_1 is expressed in megohms and C_1 in microfarads, the time being in seconds. For example, if R_1 is 1 megohm and C_1 is 0.25 μF . the time constant will be 0.25 second. In this circuit the time constant is also influenced by R_1 during the charge and by R_2 during the discharge, but since R_1 is small compared with R_2 , it will be sufficiently close for practical

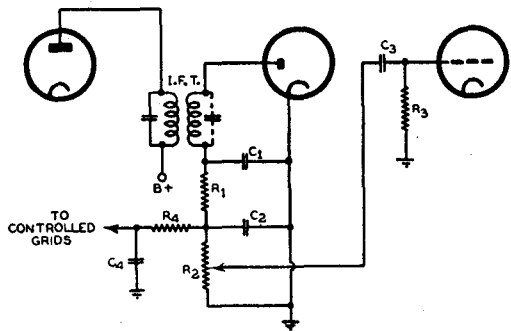

Figure 1

purposes to regard $R_1 \cdot C_1$ as giving the time constant. This is treated in detail in the Appendix at the end of the chapter.

It is evident that the peak voltage on the diode is equal to the A.V.C. voltage for 100% rectification efficiency. Owing to losses, the A.V.C. voltage is always slightly less than the peak carrier voltage, and since in general a higher voltage is required for the A.V.C. than for detection, this forms a limitation of simple A.V.C.

With critically coupled circuits of equal L , C , and Q , the voltage across the secondary is equal to the voltage across the primary. When a transformer designed for critical coupling under light loading conditions is used to drive the diode the ratio of secondary to primary voltage may fall to 0.7 or even 0.5. This is due to the fact that the additional loading on the secondary has reduced the coupling considerably below the critical value.

The diode load consists of R_1 and R_2 in series, R_1 being used for filtering purposes to remove the major part of the R.F. component in conjunction with condensers C_1 and C_2 , while R_2 is frequently spoken of as the "volume control." R_2 is shunted at audio frequencies by means of R_3 , C_3 , and also by R_4 , C_4 when the volume control is set at maximum. Since the reactances of C_3 and C_4 may be neglected compared with the resistances R_3 and R_4 , the effective A.C. shunt load with the volume control at maximum is equal to the resultant of R_3 and R_4 in parallel. At a low setting of the volume control the effective shunting is mainly that due to R_4 . This shunting has a considerable effect on harmonic distortion, and measurements show that when R_2 is 0.5 megohm and R_4 1 megohm, the resulting total harmonic distortion* is 23% for 100% modulation at 400 c/s. This value of distortion is due to the shunting by R_4 alone, and still higher distortion would occur with the volume control at maximum when the shunting would be that of R_3 and R_4 in parallel.

It is found that there is a tendency for noise to occur when the volume control (R_2) is moved. This is due to the direct current flowing through it, and may be avoided by placing the volume control in the position of R_3 . However, the distortion due to this arrangement is severe, as already indicated, and any considerable reduction of the distortion necessitates a high ratio R_3/R_2 , say, 5 : 1 or more. This is not always practicable, and the slight noise due to movement of the volume control in the position (R_2) as shown may be tolerated in preference.

In Fig. 1 R_4 is shown connected to the junction of R_1 and R_2 , but if desired it could be connected to the top end of R_1 in order to obtain slightly greater A.V.C. voltage. Since R_1 is comparatively small it is immaterial which arrangement is adopted.

Owing to the effects of contact potential in the diode together with unavoidable noise voltages, there is a voltage developed across R_2 even with no carrier input. With a weak carrier input this voltage is increased. Consequently it will be seen that with the weakest carrier likely to be received there is an appreciable negative voltage which would be applied to the controlled grids. If no means were taken to compensate for this, there would result a decreased sensitivity of the receiver. Fortunately it can readily be compensated for, by applying a lower minimum negative bias to the controlled stages.

Delayed A.V.C.

The "delay" in delayed A.V.C. refers to voltage delay, not time delay. A delayed A.V.C. system is one which does not come into operation (i.e., it is delayed) until the carrier strength reaches a pre-determined level. The result is that no A.V.C. voltage is applied to the grids of the controlled

*See Chapter 18, Fig. 1.

stages until a certain carrier strength is reached. Delayed A.V.C. necessitates the use of two diode anodes, although a common cathode may be used.

Delayed A.V.C. makes possible improved rectification efficiency in the A.V.C. circuit, thus producing slightly greater A.V.C. voltage for the same peak diode voltage. This is on account of a higher value of A.V.C. diode load resistance (R_1 in Fig. 2). With the arrangement shown in Fig. 2 a higher voltage is applied to the A.V.C. diode D_2 than to the detector diode D_1 because D_2 is coupled through a small condenser C_7 to the primary of the I.F. transformer. Since the voltage across the primary is greater than the voltage across the secondary, this gain is quite material. C_7 should be a very small capacitance and $100 \mu\mu\text{F.}$ is frequently used; the insulation of this condenser is extremely important. A further advantage of this arrangement of delayed A.V.C. is that the shunting due to R_4 is removed from the secondary circuit of the I.F. transformer. Owing to the shunting effect of R_4 on R_7 there will be some distortion of the modulated carrier voltage at the primary of the transformer, which will be passed on to the secondary. It seems, however, that this distortion is much less serious than that due to A.C. shunting in the secondary circuit. With this arrangement, since the overall selectivity up to the primary of the I.F. transformer is less than at the secondary, the A.V.C. will commence to operate further from the carrier frequency than if fed from the secondary.

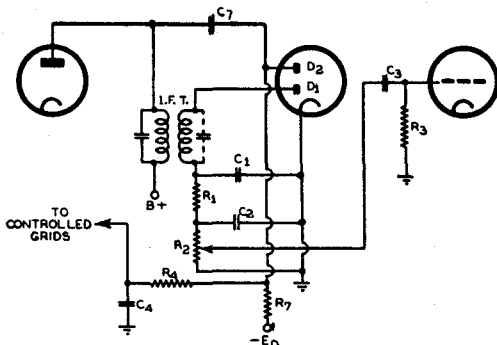

Figure 2

The A.V.C. diode is sometimes fed from the secondary of the I.F. transformer instead of from the primary. This results not only in a decreased A.V.C. voltage, but also in serious shunting of the detector diode load.

Differential distortion is frequently mentioned as a serious disadvantage inherent in delayed A.V.C. Careful measurements have shown that the additional distortion occurring just as the A.V.C. diode commences to conduct is quite small provided that the delay voltage is small. With a delay voltage (E_D , Fig. 2) of 3 volts the total harmonic distortion was found to increase from an average level of about 2.5% to a peak of 4%. Not only is the amount of distortion fairly small but it only occurs over a limited range of input signal which, with a small delay voltage such as 3 volts or less, occurs at such weak signal strengths as to be unimportant. A slight increase in distortion on weak signals is not generally regarded as a serious detriment. From all the evidence available, it appears that the effect of differential distortion is a comparatively minor one when the circuit is correctly designed, but the importance of the small delay voltage cannot be too strongly stressed.

If it is desired to apply full A.V.C. voltage to certain controlled stages and a fractional part only to another stage, this may be done by tapping R_1 at a suitable point and by adding a similar filter circuit to that of R_4 . C_4 .

The time constant of the circuit shown in Fig. 2 is equal to $R_4 \cdot C_4$ during charge and $(R_4 + R_7) \cdot C_4$ for discharge.

When a duo-diode-triode or a duo-diode-pentode amplifying valve is used with cathode bias the value of the bias is usually between 2 and 3

volts. Such a voltage is suitable for A.V.C. delay; a very simple arrangement is possible by returning R_7 to earth as in Fig. 7. If back bias is used R_7 must be returned to a suitable negative voltage.

Methods of Feed

The A.V.C. voltage may be fed through the secondary of the R.F. transformer to the grid of the valve (sometimes called "Series Feed") or directly to the grid, and therefore in parallel with the tuned circuit (sometimes called "Shunt Feed"). In the latter case it is necessary to use a blocking condenser between the top of the tuned circuit and the grid, to avoid short-circuiting the A.V.C. voltage. Note that the use of the terms "Series" and "Shunt" has no bearing on the type of A.V.C. filter circuit which may be series, shunt, or a combination of both. The two types of A.V.C. feed circuits are considered in further detail.

(a) Series Feed

One arrangement of series feed is shown in Fig. 3 and it will be seen that in each R.F. tuned circuit a blocking condenser (C_b , C_a) is used so that the rotor of the ganged condenser may be earthed and the A.V.C. voltage fed to the lower ends of the coils. In the R.F. stages the use of this blocking condenser will reduce the band coverage and for this reason a high capacitance is desirable. On the other hand a high capacitance increases the time constant which is approximately equal to $(C_1 + C_5 + C_6)$ multiplied by the resistor R_4 (Fig. 2). The sum of these capacitances ($C_1 + C_5 + C_6$) is usually between 0.05 and 0.25 μF . The restriction on the tuning range may readily be calculated by considering the maximum capacitance of the ganged condenser in series with the blocking condenser. Resistors R_5 and R_6 are generally each made about 100,000 ohms, and are intended to provide decoupling between their respective circuits.

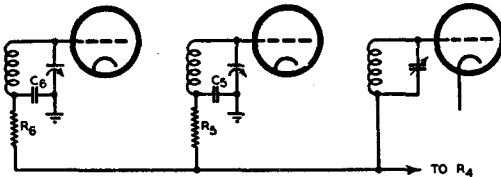

Figure 3

proximately equal to $(C_1 + C_5 + C_6)$ multiplied by the resistor R_4 (Fig. 2). The sum of these capacitances ($C_1 + C_5 + C_6$) is usually between 0.05 and 0.25 μF . The restriction on the tuning range may readily be calculated by considering the maximum capacitance of the ganged condenser in series with the blocking condenser. Resistors R_5 and R_6 are generally each made about 100,000 ohms, and are intended to provide decoupling between their respective circuits.

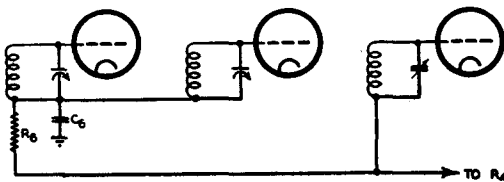

Figure 4

the lower side of the tuned circuit of the I.F. stage to earth, as well as being part of the A.V.C. filter.

An alternative arrangement is to insulate the rotor of the ganged condenser and to bypass it to earth by a single condenser (C_b , Fig. 4). This enables the A.V.C. voltage to be applied without any blocking condenser in the R.F. tuned circuits, and has the further advantage that the time constant of the A.V.C. circuit may be made very short, but the arrangement has obvious disadvantages and is little used.

(b) Shunt Feed

The "shunt feed" circuit is shown in Fig. 5. In this arrangement the blocking condenser is not placed in the tuned circuit but in the grid circuit.

It is therefore necessary to employ a suitable value of grid leak (for example 0.5 megohm) in order that the A.V.C. voltage may be applied to the grid. This grid leak will introduce a certain amount of damping on the tuned circuit but the damping of a 0.5 megohm resistor on a typical tuned R.F. circuit is negligible. The effect on the I.F. circuit is greater, but it is possible to use

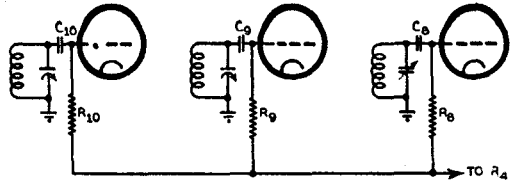

Figure 5

a combination of shunt feed for the R.F. stages and series feed for the I.F. stage if this is desired. Shunt feed for the R.F. stages is sometimes more convenient than series feed and appears satisfactory in most respects, although it has been found that grid blocking is more likely to occur with shunt feed than with series feed. For this reason shunt feed is only recommended in cases where grid blocking is not likely to occur.

With any method of feed it is important that the total resistance in the grid circuit should not exceed the maximum for which the valves are rated. The valve manufacturers give the following as recommended maxima:—

For one controlled stage	3 megohms
„ two „ stages	2.5 „
„ three „ „	2 „

These resistances are to be measured between the grid of any valve and its cathode.

Typical Circuits

A typical circuit of a simple A.V.C. system with three controlled stages, using a duo-diode high-mu triode valve, is shown in Fig. 6. In order to provide the simplest arrangement the cathode of the duo-diode valve is earthed and its grid obtains bias by the grid leak method using a resistor of 10 megohms. This places the minimum additional shunting on the

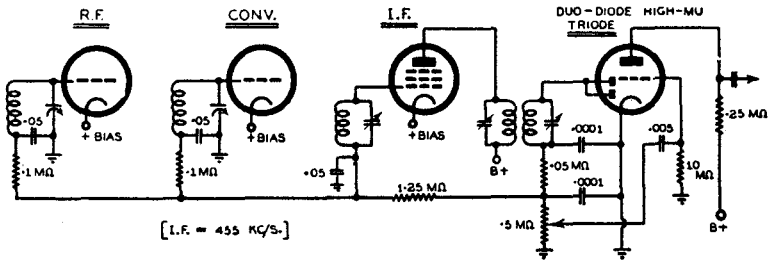

Figure 6

diode load resistor. The cathodes of the controlled stages should be returned to a positive voltage such that under working conditions on a weak carrier the grid voltage is equal to the recommended minimum grid voltage for the valves. For I.F. = 455 Kc/s. the two R.F. bypass condensers on the diode load are each made 0.0001 μF. An A.V.C. resistor of 1.25 megohms is used so that the total resistance to earth from any grid does not exceed

2 megohms. If there were only two controlled stages this could be increased to 1.75 megohms with consequent decreased A.C. shunting. The time constant for this arrangement is approximately 0.15×1.3 or 0.195 second for charging.

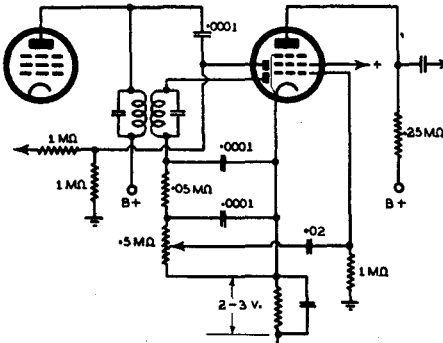

Figure 7

A.V.C. diode exceeds the delay voltage. The controlled stages would normally be arranged with self-bias equal to the recommended minimum bias.

A circuit of a typical delayed A.V.C. stage using a duo-diode pentode valve is shown in Fig. 7. Self-bias is used and, since the bias will normally be from two to three volts, this provides a suitable A.V.C. delay voltage without any further complication. The condenser from the plate of the I.F. amplifier to the A.V.C. diode is $0.0001 \mu\text{F}$. and should not be increased above this value. With this arrangement the A.V.C. bias on the controlled valves is zero until the peak voltage on the

A.V.C. Application

A.V.C. is normally applied to the converter on the broadcast band, irrespective of valve type. On the short-wave band some types of converters give very satisfactory operation with A.V.C., while others introduce difficulties. When no R.F. stage is used it is essential to apply A.V.C. to the converter, but when an R.F. stage is used it is frequently advantageous to operate valve types 1A7-G, 1C7-G, 6A8-G and 6D8-G on fixed bias. Valve types 6J8-G, 6K8-G, and 6SA7 may be used with A.V.C. on all wave bands.

In a receiver having an R.F. stage, converter and single I.F. stage the A.V.C. is normally applied to all three stages. If decreased modulation rise is required it is preferable to operate the I.F. stage with about one-half the full A.V.C. bias or alternatively to supply its screen from a dropping resistor. If A.V.C. is applied to both R.F. and Converter stages on all wavebands it is possible to omit control of the I.F. stage without losing much of the effectiveness of the A.V.C. system, with the result that modulation rise is negligible.

In a receiver without an R.F. stage it is difficult to avoid overloading with heavy input signals, and A.V.C. is applied to both stages even though modulation rise may be objectionable with very high inputs. In order to obtain maximum control the screen of the I.F. valve would normally be supplied from a voltage divider.

In a receiver having two I.F. stages the second I.F. stage should preferably be operated at fixed bias in order to reduce the modulation rise. Since the effectiveness of control on any stage is proportional to the gain from its grid to the A.V.C. diode it is obvious that control on the R.F. stage is most valuable, while control on the final stage is least valuable from the control point of view. The final I.F. amplifier, operating at fixed bias, may in fact be regarded as an amplifier for the A.V.C. voltage, and in many ways the operation is similar to amplified A.V.C. except that in this case the amplification takes place before rectification. It is for these reasons that when two I.F. stages are available the second is normally operated on fixed negative bias. When a valve such as the 1M5-G or other type operating at zero bias is used in the second I.F. stage, it is preferable to operate it with some small negative bias in order to avoid grid

current, but alternatively a 1 megohm resistor may be used from its grid to earth so that any positive grid current would produce additional negative bias. At the same time the screen should be supplied through a dropping resistor from B +.

Amplified A.V.C.

There are a number of methods whereby the voltage to be applied to the grids of the controlled stages is amplified, either before or after rectification.

(1) One or more stages of amplification may be used to form an A.V.C. amplifier channel operating parallel to the signal channel, and having a separate diode rectifier. If the total gain of the A.V.C. amplifier channel is greater than the total gain of the equivalent section of the signal channel, there is effectively a system of amplified A.V.C. This is more effective than the usual arrangement with a single channel, since it retains the full amplification of the A.V.C. channel under all conditions. It also has advantages in flexibility due to the isolation of the two channels, and the A.V.C. channel may be designed to have any desired selectivity characteristics.

(2) If a common I.F. channel is used, it is possible to add a further I.F. stage with fixed bias for A.V.C. only, followed by a separate A.V.C. rectifier. By this means it is possible to avoid the distortion due to shunting of the diode load resistor, or to "differential loading" at the point where the A.V.C. delay is just being overcome.

(3) A D.C. amplifier may be used to amplify the voltages developed at the rectifier. This method has the disadvantage that it is difficult to obtain satisfactory and consistent performance from a D.C. amplifier.

Audio A.V.C.

Audio A.V.C. is used in conjunction with A.V.C. on the R.F. and I.F. stages, and is a device to flatten out the A.V.C. characteristic by applying the whole or part of the A.V.C. voltage to an audio frequency amplifier having a super-control characteristic. Conventional systems of this nature tend to introduce considerable audio frequency distortion if operated at a high level so that the arrangement is not widely used. In the design of a receiver to use audio A.V.C. it is desirable first to obtain the best possible characteristics apart from the audio amplifier and then to add just enough A.V.C. voltage to the audio system to make the A.V.C. characteristic sufficiently flat. For a typical Audio A.V.C. characteristic see Fig. 8, or the improved form in Fig. 9.

Modulation Rise

When a modulated carrier is amplified by a valve having a curved characteristic the modulation percentage will increase. This modulation rise is noticed in the output as audio frequency harmonic distortion, mainly second harmonic. Practically all modulation rise occurs in the final I.F. stage. 20% modulation rise is equivalent approximately to 5% second harmonic. Modulation rise with fixed bias is extremely small even with super control valves, but there is a slight advantage in operating with an equivalent valve having a sharp cut-off characteristic. Modulation rise may be decreased by operating the I.F. stage on a fraction of the A.V.C. voltage, but this adds to the expense of the receiver. Alternatively, a noticeable improvement may be made by supplying the screen from a dropping resistor from B+. This is recommended for circuits having an R.F. and one I.F. stage. Modulation rise may be reduced by increasing the gain from

the grid of the final I.F. valve to the A.V.C. diode, that is by producing a higher A.V.C. voltage for the same plate voltage excursion in the I.F. amplifier. The use of the delayed A.V.C. circuits of Figs. 2 and 7 will assist in this direction. Modulation rise may also be reduced by improving the control on earlier stages, for example by reducing the screen voltage on the R.F. or converter valve so that an earlier cut-off is provided. This is likely, however, to result in cross modulation when the receiver is used in proximity to a strong station. See also the later section on A.V.C. characteristics and Fig. 8.

A.V.C. With Battery Valves and Zero Bias

When 2 volt battery valves operating at zero bias are used it is possible to obtain delayed A.V.C. by incorporating a duo-diode-triode or duo-diode-pentode valve having a diode plate situated at each end of the filament. A delay of between 1 and 2 volts is obtainable by this means and makes a very simple and satisfactory arrangement. The diode at the positive end of the filament is used for A.V.C. and its return is taken to filament negative. The diode at the negative end of the filament is used for detection and its return taken to filament positive.

Special Case with Simple A.V.C.

When simple A.V.C. is used with a duo-diode-triode or duo-diode-pentode valve operating with self-bias, the diode load return will be two or three volts above earth, and it is necessary to provide additional negative voltage for minimum bias on the controlled stages.

Time Constants

Suitable values of time constants are as follows:—

Broadcast good fidelity receivers	0.25 to 0.5 second
Broadcast receivers	0.1 to 0.3 second
Dual or triple wave receivers	0.1 to 0.2 second

Too rapid a time constant reduces the audio frequency bass response since rapid periodic fading is equivalent to bass frequency modulation. It is for this reason that a slow A.V.C. system is required for good fidelity broadcast receivers. A more rapid time constant is required for short-wave operation on account of the fading characteristics for these frequencies.

A.V.C. Characteristics

A.V.C. Characteristic Curves may be plotted on 6-cycle log-linear graph paper as shown in Fig. 8. The input is usually taken from $1 \mu\text{V}$. to $10^5 \mu\text{V}$. or 1 volt. The output is usually shown in decibels, with an arbitrary zero. With care in the experimental work, A.V.C. curves are extremely valuable to the receiver designer, not only to demonstrate the effectiveness of the A.V.C., but also to indicate modulation-rise, and the input voltage at which the A.V.C. commences to operate.

For design purposes it is also helpful to draw on the same graph

- (a) A curve of distortion against input voltage for 30% modulation at 400 c/s.,
- (b) A curve of the developed A.V.C. voltage against input voltage, and
- (c) Curves of the total bias voltages of the controlled stages against input voltage.

If fixed minimum bias is used, curves (b) and (c) will differ merely by the bias voltage. If self-bias is used they will differ by the minimum bias voltage with no input voltage, and will tend to run together at high input voltages. For methods of conducting the experimental measurements see Chapter 29.

Fig. 8 shows several A.V.C. curves, each corresponding to a particular condition. In taking these curves two separate diodes were used so as to maintain constant transformer loading and other conditions. Contact potential in the diode results in a slight increase in the standing bias of the controlled valves, but does not affect the delay voltage.

Curve A is the "No Control" characteristic and is the curve which would be followed, with A.V.C. removed from the receiver, up to the point at which overloading commences. This curve is a straight line with a slope of 20 db. per 10 times voltage.

Curve B is the A.V.C. Characteristic for a delay of -9 volts. From 3 to $18 \mu\text{V}$. the experimental curve follows the "no control" line exactly, and then deviates sharply at inputs above $18 \mu\text{V}$. From 18 to $500,000 \mu\text{V}$. the curve follows an approximately straight course with an average slope of 3.25 db. per 10 times voltage. Above $500,000 \mu\text{V}$. the curve tends sharply upward, indicating severe modulation rise.

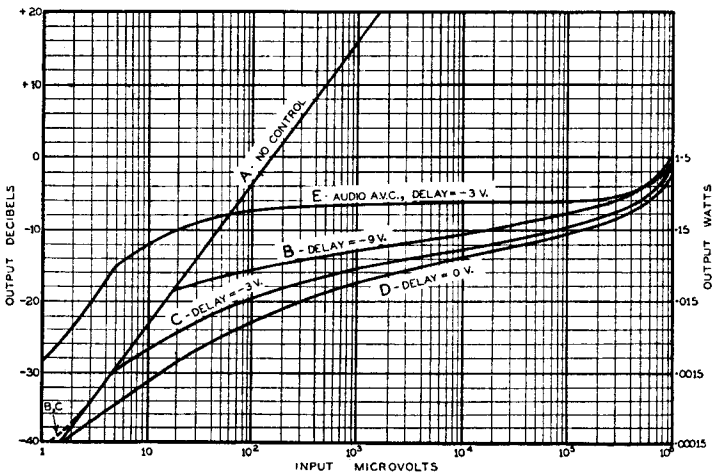

Figure 8

Curve C is the A.V.C. Characteristic for a delay of -3 volts. The A.V.C. comes into operation at a lower input voltage, and the average slope is steeper than for the higher delay voltage. In both cases, however, the "knee" of the curve as it leaves the no control line is very sharp and clearly defined.

Curve D is the A.V.C. Characteristic for a delay of zero voltage, with due compensation for the effect of contact potential on the standing bias of the controlled valves.

Curve E is the Characteristic obtained with a typical Audio A.V.C. System. Over the range from 100 to $500,000 \mu\text{V}$. the total rise is only 3 db.

Curve B has been drawn according to the conventional method whereby the output is adjusted to half the maximum output of the receiver at an input of 1 volt. Curves C and D were then taken directly, without any

further adjustment to the volume control. Owing to a slight effect on the gain of the receiver when the delay voltage is varied, Curves C and D fall slightly below the datum line at an input of 1 volt. Curve E has been drawn to correspond with Curve C, since both have the same delay voltage. The volume control, however, was advanced considerably for Curve E. It should be noted that no conclusions should be drawn from the relative vertical positions of A.V.C. Characteristics drawn according to the conventional method since the volume control settings are unknown.

An Improved Form of A.V.C. Characteristic

The conventional A.V.C. Characteristics do not give all the desired information concerning the operation of A.V.C. and an improved form, due to M. G. Scroggie*, is as follows:—

Instead of commencing at an input of 1 volt and adjusting the volume control to give one-quarter or one-half of the maximum power output at 30% modulation, Scroggie's method is to commence at a low input with the volume control at maximum. The input is increased until the output is approximately one-quarter maximum, and the volume control is then set back to reduce the power output to one-tenth of the reading. This process is repeated until an input of 1 volt (or the maximum limit of the signal generator) is reached.

This method is illustrated in Fig. 9 which applies to the same receiver as was used to obtain Fig. 8. The scale of power output in watts represents the output which would be obtained with the volume control at maximum and 30% modulation, provided that no overloading occurred in the audio amplifier. A number of interesting facts may be obtained from an examination of these curves:

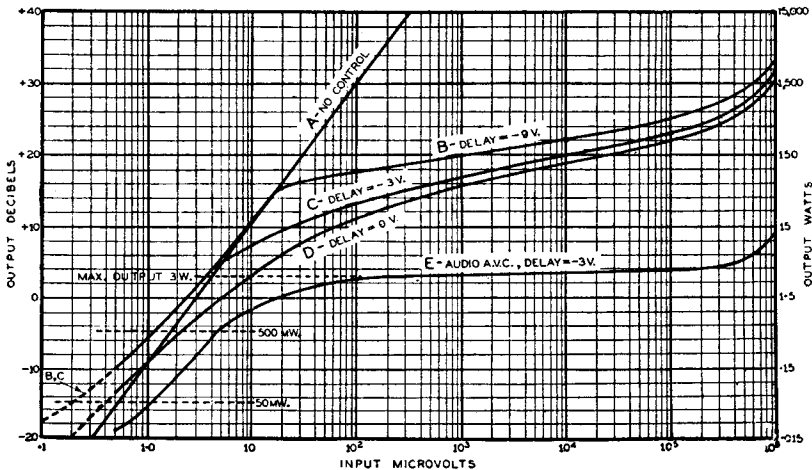

Figure 9

- (1) The residual noise level of the receiver may be shown (this applies particularly to receivers of fairly low sensitivity).
- (2) The sensitivity of the receiver in microvolts input for any selected output level (e.g., 50 or 500 mW.) may be read directly from the curves. It should be noted that the output includes noise.

*See Bibliography.

- (3) The power output corresponding to any selected input voltage and any position of the volume control may be obtained. For example, with a delay of -3 volts, the A.V.C. commences to operate at an output level of slightly over 3 watts, with 30% modulation and the volume control at maximum. As a further example take the same curve at an input of $1000 \mu\text{V.}$, where the output is shown as approximately 75 W. for 30% modulation and maximum volume control setting. The setting of the volume control to give 3 watts at 100% modulation is therefore

$$\sqrt{(30/100)^2 \times (3/75)} = 0.3 \sqrt{0.04} = 0.06$$

or approximately 1/16.7 of the maximum setting.

- (4) The voltage at the detector (and the A.V.C. bias voltage if excited from the secondary of the I.F. transformer) may be calculated from a knowledge of the audio gain and detector efficiency.

The Audio A.V.C. Characteristic (Fig. 9) gives an excellent example of the information which may be derived from this improved representation. At the knee of the curve the A.V.C. characteristic is about 9 db below the curve having the same (-3 volts) delay. This loss is all in the audio amplifier, and is the result of using a valve having lower gain. The difference between the two curves increases to 22 db at an input of $500,000 \mu\text{V.}$, thus indicating an audio control of $22-9$ or 13 db at this point. With this particular arrangement the output with 30% modulation is 3 watts plus or minus 2 db from 30 to $500,000 \mu\text{V.}$

This method enables greater accuracy to be obtained at very low input signals since the output power is quite high on the scale of a typical output meter. With the conventional method the output under similar input conditions is too small to measure accurately with a standard output meter.

It will be seen that at low input levels the output is higher than the "no control" line; this indicates the presence of noise. At extremely low levels the output is difficult to measure accurately due to fluctuations in the readings.

APPENDIX

Time Constant

Time constant in seconds = Resistance in ohms \times capacitance in farads
 = Resistance in megohms \times capacitance in microfarads.

The time constant is the time in seconds for the condenser to charge up to a potential of $[1-(1/\epsilon)]$ of the applied potential, where $\epsilon = 2.718$ and $[1-(1/\epsilon)] = 0.632$. (The Greek letter ϵ -epsilon-is the base of the Napierian Logarithm). Similarly the time constant is the time in seconds for the condenser to discharge to a potential of $1/\epsilon$ or 0.368 of the initial potential.

In Fig. 1 the total resistance during discharge is $(R_1 + R_2)$ and the time constant is $(R_1 + R_2) C_4$. During charge the diode conducts and the total resistance is approximately R_1 and the time constant approximately $(R_1 \cdot C_1)$. In this approximation the resistance of R_1 is neglected in comparison with R_4 .

The time constants of the circuits of Fig. 3 in combination with Fig. 1 are as follows:—

2 Stages.

Charge Constant:

$$R_1 (C_2 + C_4 + C_5) + R_4 (C_1 + C_5) + R_2 C_5$$

Discharge Constant:

$$C_5 (R_3 + R_4 + R_2) + C_4 (R_1 + R_2) + C_1 (R_1 + R_2) + C_2 R_2$$

3 Stages

Charge Constant:

$$R_1 (C_2 + C_4 + C_5 + C_6) + R_4 (C_4 + C_5 + C_6) + R_5 C_5 + R_6 C_6.$$

Discharge Constant:

$$C_2 (R_2 + R_4 + R_5) + C_5 (R_4 + R_1 + R_2) + C_4 (R_4 + R_2) + C_1 (R_1 + R_2) + C_2 R_3.$$

Bibliography (A.V.C.)

- K. R. Sturley, "Time Constants for A.V.C. Filter Circuits," *Wireless Engineer*, Vol. 15, No. 180, pp. 480-494, September (1938).
- K. R. Sturley, "Distortion produced by delayed diode A.V.C.," *Wireless Engineer*, Vol. 14, No. 160, pp. 15-27, January (1937).
- M. G. Scroggie, "The A.V.C. Characteristic," *Wireless World*, Vol. 44, No. 18, pp. 427-428, May 4 (1939).
- W. T. Cocking, "Distortionless A.V.C. Systems," *Wireless World*, Vol. 38, No. 24, pp. 574-577, June 12 (1936).
- W. T. Cocking, "Is Automatic Volume Control Worth While?" *Wireless World*, Vol. 38, No. 21, pp. 502-504, May 22 (1936).
- E. W. Kellogg & W. D. Phelps, "Time Delay in Resistance Capacity Circuits," *Electronics*, Vol. 10, No. 2, pp. 23-24, February (1937).
- F. E. Terman, "Radio Engineering," Chap. 10, McGraw-Hill, 2nd edition.
- E. G. James & A. J. Biggs, "A.V.C. Characteristics and Distortion," *Wireless Engineer*, Vol. 16, No. 192, pp. 435-443, September (1939).
- R. W. Sloane, "Graphical Estimation of the Signal Handling Capacity of Screen-Grid Valves," *Phil. Mag.* Vol. 22, p. 529 (1937).
- W. T. Cocking, "The Design of A.V.C. Systems," *Wireless Engineer*, Vol. 11, p. 406 (1934).
- Radiotronics, No. 77, pp. 47-50, June 30 (1937); No. 78, pp. 55-56, July 28 (1937); No. 80, pp. 69-71, October 11 (1937); No. 81, p. 86, November 15 (1937).

CHAPTER 20

Automatic Frequency Control and the Correction of Frequency Drift

Automatic Frequency Control — Frequency Discriminator — Round (Travis) Circuit — Foster-Seeley Circuit — Control Valve — Resistance in Series with Condenser — Quadrature Circuits — Miller Effect Circuits — Correction of Frequency Drift.

Automatic Frequency Control

More correctly known as automatic tuning correction, A.F.C. provides a means by which the tuning of the oscillator of superheterodyne receivers is "pulled in" automatically, to tune to any station to which the manual tuning circuits have been approximately tuned. It may be applied to the greatest advantage in receivers having automatic tuning systems, e.g., push-button switches, and cam or motor driven variable condensers. In such cases the tuning may not be quite accurate over extended time periods, and A.F.C. may be used effectively to carry out the final adjustment when the respective capacitances and/or inductances have been selected by the automatic tuning system.

The two requirements for any A.F.C. system are:—

- (1) A frequency discriminator.
- (2) A variable reactance.

The frequency discriminator must provide a controlling voltage for the electronic reactance. When the signal frequency circuits are exactly in tune, the voltage output from the discriminator should be the same as that provided in the absence of signal, i.e., the reactance should have its normal value. At frequencies above and below the correct frequency, the controlling voltage should be appropriately above and below the mean voltage. Normally, the discriminator is placed in the I.F. circuits of a receiver, and comprises a specialised form of selective circuit with two diodes giving a response curve as shown in Fig. 1.

There are two well known circuits in use.

(1) The Round (Travis) circuit (shown in Fig 2) has two L.C. circuits, one tuned slightly above, the other slightly below the I.F. Each circuit has its own diode and the diode loads are connected in D.C. opposition. At the correct I.F. the voltage across the combined diode loads is zero, and rises and falls above and below the balance point (Fig. 1).

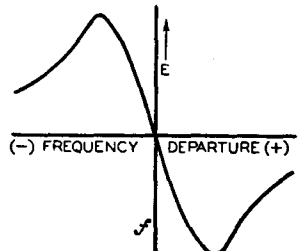

Figure 1

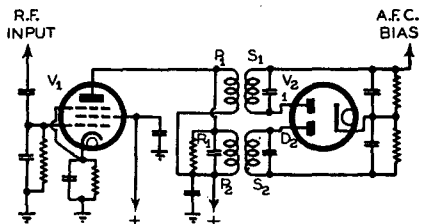

Figure 2

(2) The Foster-Seeley* circuit (see Fig. 3) relies on the phase difference between primary and secondary in coupled tuned circuits. A 90° phase difference exists between the primary and secondary potentials of a double tuned, loosely coupled transformer when the resonant frequency

is applied, and this phase angle varies as the applied frequency varies. The potentials at either end of a secondary winding with respect to a centre tap on that winding are 180° out of phase. If the centre tap of the secondary is connected to one end of the primary the potentials between the other end of the primary and each end of the secondary will reach maxima, one above and the other below

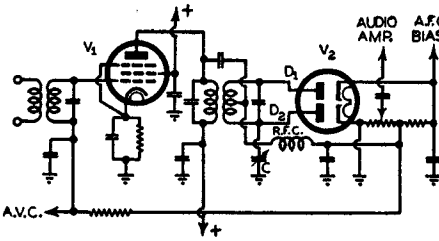

Figure 3

the centre frequency. At the centre frequency the resultant difference of potential between the two is zero.

The Foster-Seeley circuit is easier to align, as all circuits are adjusted to exact intermediate frequency, and, in the absence of a frequency modulated oscillator, the discriminator secondary can be adjusted approximately to correct frequency by tuning it to give a minimum of output from the receiver. The discriminator secondary does not aid signal amplification and is in a condition of absorptive resonance.

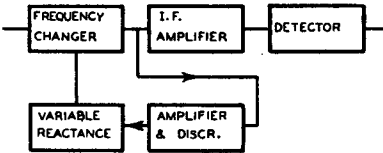

Figure 4

It is possible to obtain audio frequency voltage from one diode load in the Foster-Seeley discriminator without encountering serious distortion. The selectivity ahead of the discriminator must not be too sharp, as the response is required on either side of the I.F. Since the dis-

criminator secondary in the Foster-Seeley arrangement does not contribute to overall selectivity, one extra tuned circuit is needed to regain the same order of selectivity as compared with a similar receiver not employ-

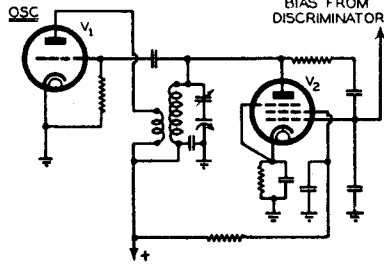
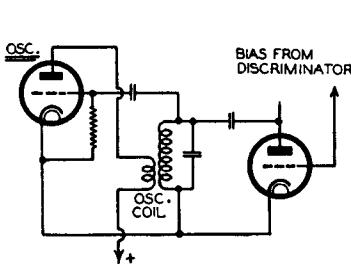

Figure 5 (left) and Figure 6 (right)

ing A.F.C. When high selectivity is required, the I.F. stages may be connected as shown in Fig. 4, splitting to separate channels for I.F. amplification and discrimination.

The Control Valve, or Electronic Reactance may take one of three forms:

(1) Resistance in series with condenser (Fig. 5). This imposes severe resistive loading on the oscillator circuit, and is not advised.

*D. E. Foster and S. W. Seeley, Proc. I.R.E. March (1937).

(2) "Quadrature" circuits (Fig. 6). The grid is fed from the plate through a resistor—reactance network, to provide a voltage at the grid almost 90° out of phase with plate voltage. The plate resistance of the valve represents a parallel load. The 6J7-G may be used as a pentode in quadrature circuits.

(3) Miller effect circuits (Fig. 7) rely on the change of input capacitance of a triode when the gain is varied. Due to stray capacitance in the plate circuit, the input capacitance of the valve is shunted by an input resistance; Miller effect electronic reactances may be used most successfully with a fixed tuned circuit (e.g., in frequency modulated oscillators) when the input resistance can be made almost infinite by tuning the plate circuit with a low Q circuit.

All electronic reactances are controlled by varying the grid bias to alter the mutual conductance. The Miller effect system is simple and has a wide range of control. The quadrature circuit arranged as an electronic inductance gives wide and more uniform control over the whole tuning range. For further information on Control circuits see Travis (Proc. I.R.E., Vol. 23, No. 10, pp. 1132-1141, October, 1935).

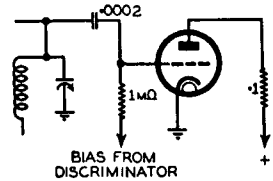

Figure 7

Correction of Frequency Drift

In superheterodyne receivers it is found that for an hour or more after switching on the oscillator frequency tends to drift, thereby necessitating adjustments of the tuning dial, particularly during short-wave reception. The adjustment necessary to ensure correct tuning is always towards the higher frequency end of the band. This drift represents a decrease in oscillator frequency with increasing temperature of the receiver. The drift is most pronounced at the higher frequencies and is approximately proportional to the cube of the frequency. The drift is most apparent at the high frequency end of the highest frequency range of the receiver.

The cause of the drift is complex, but in general it can be stated that the effect of the valve (apart from the valve base) is comparatively small after a few minutes and usually negligible after 10 minutes. Frequency drift in the oscillator circuit is caused largely by poor dielectric materials, such as varnished cambric, synthetic resin, rubber and similar materials. It may be very much reduced by avoiding the use of such materials and replacing them by such dielectrics as good quality porcelain or other well known dielectrics having similar properties.

All high loss dielectrics appear to show positive temperature co-efficients. A positive temperature co-efficient is defined as an increase in capacitance with an increase in temperature. A negative temperature co-efficient is a decrease in capacitance with an increase in temperature.

A receiver may be made stable by the elimination of as much as possible of poor dielectric materials and then the smaller drift remaining may be balanced out by the use of negative co-efficient condensers so adjusted in relation to the other circuit components that approximate balance is obtained. By this means it is possible to avoid any serious change of frequency after the first few minutes.

For further information see "Thermal Drift in Superhet. Receivers," by John M. Mills, *Electronics*, November, 1937, page 24. For information on negative co-efficient condensers, refer to technical data published by the manufacturers of such components. A general article on the subject is "Stabilising Condensers," *Wireless World*, Vol. 44, No. 11, pp. 245-246, March 16 (1939). See also M. L. Levy "Frequency Drift Compensation," *Electronics*, Vol. 12, No. 5, pp. 15-17, May (1939).

CHAPTER 21

Reflex Amplifiers

Reflex amplifiers—multiple valves—typical circuit arrangements—distortion—“minimum volume effect”—advantages of reflex amplifiers — overall gain — optimum operating conditions.

Reflex Amplifiers

Reflexed Amplifiers have the advantage of being economical. One valve (Figs. 1 and 2) is made to amplify simultaneously at I.F. and A.F., or R.F. and I.F. (where considerable difference in frequency exists between R.F. and I.F.).

Multiple valves such as the 6B8-G (6B7), 6GS-G (6B7S) and 1K7-G (1K6) readily lend themselves to reflexed applications. The diodes may also be used for purposes of detection and A.V.C.

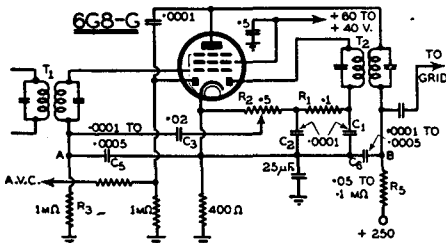

Figure 1

The circuit arrangement shown in Figs. 1 and 2 is typical. The I.F. carrier is applied to the control grid. The amplified I.F. carrier is passed to the diode rectifier T_2 from the I.F. transformer T_2 . On passing through the filter C_1 , R_1 , C_2 the A.F. appearing across the volume control R_2 is connected through the I.F. filter C_3 , R_3 , C_5 back to the control grid. The A.F. is amplified simultaneously in the valve and appears across the audio load R_5 , thence passing on for further amplification.

It is important that C_5 , C_6 provide sufficient by-passing for the I.F. carrier at the points A and B without attenuating to any appreciable extent the higher audio frequencies. Typical values for C_5 , C_6 are 100—500 μF . The reflexed amplifier introduces serious distortion when strong carrier voltages are applied to the control grid. The curvature of the control grid characteristic produces harmonic distortion at audio frequencies. The control grid characteristic should be linear over a range sufficient to handle peak values of both the I.F. carrier and the audio voltage. This is seldom achieved and rectification by the amplifier valve occurs. Rectification of the I.F. carrier ahead of the diode detector produces A.F. components across the audio load R_5 and are passed directly to the output valve.

This is called the “minimum volume effect” as the signal may still be heard with the A.F. volume control turned “off.” This distortion increases rapidly if the optimum grid bias is increased; thus the application of A.V.C. bias to a reflex amplifier becomes impracticable.

This is called the “minimum volume effect” as the signal may still be heard with the A.F. volume control turned “off.” This distortion increases rapidly if the optimum grid bias is increased; thus the application of A.V.C. bias to a reflex amplifier becomes impracticable.

Reflex Amplifiers find their chief application in receivers where cheapness, weight and battery consumption are of paramount importance. Straight amplifiers are to be preferred to Reflex Amplifiers wherever the use of the additional valve is admissible.

The overall gain of a well designed Reflex Amplifier may approach within 6 db. of the gain of a similar amplifier using separate valves.

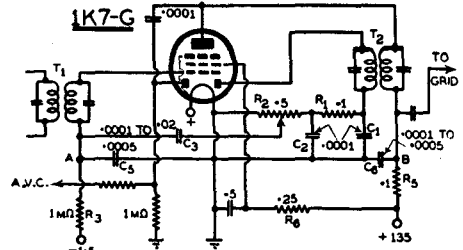

Figure 2

Optimum Operating Conditions for Reflex Amplifiers

Valve type	6B7, 6B7S, 6B8-G, 6G8-G	1K6, 1K7G
Resistance R_s	0.1	0.1 megohm
Plate Supply Voltage	250	135 volts
Screen Voltage	40	— volts
Screen Dropping Resistor R_s	—	0.25 megohm
Optimum Control Grid Voltage	-1.2	-1.5 volts

PART 3 RECTIFICATION, FILTERING AND HUM

(Chapters 22 to 24, inclusive)

CHAPTER 22

Rectification

Rectifiers and their subdivisions—application of rectifiers—advantages of vacuum rectifiers—choice of a filter system—parallel operation—regulation—theory of rectification—ripple voltage—output voltage of mercury vapour rectifiers—rectifier ratios—voltage relationships—current relationships—maximum ratings—form factor—how to use published curves—transformer heating—bibliography.

Rectifiers

Rectifier valves may be subdivided into the following groups:—

- (1) **High Vacuum**
 - (a) High Impedance (e.g., 5Y3-G)
 - (b) Low impedance (e.g., 5V4-G)
- (2) **Gaseous** (principally mercury vapour)
 - (a) Screened (e.g., 866A)
 - (b) Unscreened (e.g., 866)
 - (Full wave, e.g., 82, 83)

Each subdivision may further be divided into directly and indirectly heated; also half and full wave.

The choice of a suitable rectifier valve depends on the type of service and the following represents typical practice:—

A.C. Radio Receivers with Class A Power Stage:—

High vacuum full wave (e.g., 5Y3-G, 5U4-G)

A.C. Radio Receivers with Class AB₁ Power Stage:

With self-bias—High vacuum full wave (e.g., 5Y3-G, 5U4-G, 5V4-G)

With fixed bias—Low impedance high vacuum full wave (e.g., 5V4-G)

A.C. Radio Receivers with Class B or AB₂ Power Stage:

Low impedance high vacuum full wave (e.g., 5V4-G)

or Full wave mercury vapour with precautions against radio interference (e.g., 82, 83).

A.C./D.C. Radio Receivers:

Indirectly heated low impedance high vacuum half wave types with heaters operating at 0.3A (e.g., 25Z6-G).

Battery operated radio receivers with non-synchronous vibrators:

Indirectly heated low impedance high vacuum full wave types (e.g., 6ZY5-G, 6X5-G).

Amplifiers:

As for radio receivers except that mercury vapour types are more widely used.

In general, vacuum rectifiers are to be preferred to mercury vapour types of small size on account of

- (1) long and trouble-free service,
 - (2) the lower transformer voltage which is required for a given D.C. output voltage, due to the use of condenser input to the filter;
- and (3) self protection against accidental overload due to their fairly high impedance.

The less efficient vacuum rectifiers, that is those having high impedance, are more capable of self protection than more efficient types, but their use is restricted to Class A output stages.

With directly-heated rectifiers it is generally found preferable to connect the positive supply lead to one side of the filament rather than to add the further complication of a centre-tap on the filament circuit.

The choice of a filter system is dependent upon the type of rectifier valve and the regulation which is required.

A Condenser Input Filter is generally preferred since a higher D.C. output voltage is obtained by its means, but the regulation is poor. Mercury vapour rectifiers cannot normally be used with condenser input owing to the excessively high peak current. The usual capacitance of the first filter condenser (C1) is between 2 and 8 μF ., but high values (up to 32 μF .) are often used with half-wave rectifiers as in A.C./D.C. receivers in order to obtain a high D.C. working voltage and better regulation.

A Choke Input Filter is normally essential for mercury vapour valves, and is also used in order to obtain good regulation with vacuum rectifiers. The inductance of the choke should normally be not less than 20 henries. A "swinging choke" is sometimes used in order to obtain almost perfect regulation, the choke in this case saturating at the higher D.C. outputs and so giving an approach towards condenser input with the accompanying rise of voltage (see Chapter 23).

Parallel operation of similar types of vacuum rectifiers is possible, but it is preferable to connect together the two units in a single full-wave rectifier and to use a second similar valve as the other half-rectifier if full-wave rectification is required. With low impedance rectifiers as used in A.C./D.C. receivers (e.g., 25Z6G) it is desirable to limit the peak current. When two units are connected in parallel it is also desirable to obtain equal sharing; in such cases a resistance of 100 ohms should be connected in series with each plate, and then the two units connected in parallel.

Mercury vapour rectifiers may only be connected in parallel if a resistance sufficient to give a voltage drop of about 25 volts is connected in series with each plate, this being in order to secure equal sharing of the load.

Regulation

The regulation* of a rectifier and filter is the constancy of the D.C. output voltage for all values of current output. A choke-input filter provides better regulation than one having condenser input. A mercury vapour rectifier has more constant voltage drop than a vacuum rectifier, and therefore provides better regulation. The regulation is also affected by the regulation of the transformer (primary resistance, secondary resistance, leakage inductance), and by the resistance of the filter choke(s). The regulation of a given supply, particularly with a choke input filter, is improved by the addition of a bleeder which draws an initial current usually between 10% and 30% of the load current. The value of minimum inductance of a choke input filter for good regulation is covered in Chapter 23.

*The regulation may be defined as the ratio of the change of voltage (for a specified change in current) to the initial voltage: it is frequently given in the form of a percentage.

The Theory of Rectification

Diagram A in Fig. 1 shows a sine wave voltage of which the peak, and R.M.S. values are shown as E_{PEAK} and E_{RMS} . With ideal-half-wave rectification and a resistive load with no filter, the upper peaks would also represent the load current, while the lower peaks would be suppressed; the average voltage would be shown by $E_{AVGE. (HALF-WAVE)}$. With full wave rectification the current through the load resistance would be similar each half cycle, the lower peak being replaced by the dash line in A. The D.C. voltage would be the average voltage or 0.9 of the RMS voltage for a sine wave. For half-wave rectification the average D.C. voltage over a period would be one half that for full wave rectification under the same conditions.

Diagram B illustrates ideal full wave rectification with a condenser input filter.* The voltage at the first filter condenser C follows the line ABA'B', the condenser charging between A and B but discharging between B and A'. The mean level of ABA'B' is the effective D.C. voltage. The shaded area between the curve APB and the curve AQB represents the voltage by which the transformer voltage exceeds that of C. The current through the plate circuit of the rectifier only flows for the interval between A and B and between A' and B' because at other parts of the cycle the transformer voltage is below the voltage of C. The current through the rectifier, shown in diagram C, is similar in form* to the difference in voltage between the curves APB and AQB.

The ripple voltage may be determined from the shape of ABA'B', and the ripple frequency fundamental and harmonic components may be calculated by Fourier analysis. On the assumption that the ripple consists of regular symmetrical triangular waves, the RMS values of the components will be:—

- Fundamental ripple frequency voltage 0.575 E_r .
 - Third harmonic ripple frequency voltage 0.064 E_r .
 - Fifth harmonic ripple frequency voltage 0.023 E_r .
 - Seventh harmonic ripple frequency voltage 0.0117 E_r .
- where E_r = peak amplitude of ripple voltage.

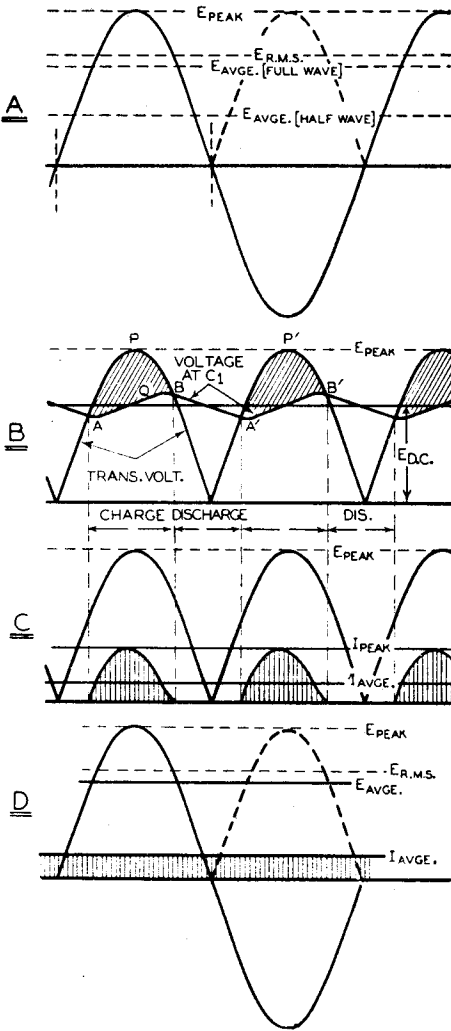

Figure 1

*On the assumptions that the supply impedance (including the rectifier) may be represented by a constant equivalent resistance and that the load current passes through a filter choke of high impedance.

As the load resistance is increased, BA' becomes more nearly horizontal and the area APB becomes smaller until in the extreme case when the load resistance is infinite the D.C. voltage is equal to the peak voltage. This graphical method may be applied to any rectifier with condenser input followed by a high inductance choke. The assumption is made that the current through the inductance remains constant, that is to say that the lines BA', B'A'', etc., are straight.

With a choke input the conditions are as shown in diagram D, assuming a high impedance choke. With practical chokes there will necessarily be a certain amount of ripple in the load current.

For further information see the Bibliography at the end of this chapter, and also see chapter 23.

The Output Voltage of Mercury Vapour Rectifiers

Curves are not published for mercury vapour rectifiers since the output voltage is constant for any load current and the voltage drop in the valve is approximately 15 volts in all cases. The D.C. output voltage is not equal to the RMS voltage, but to the average voltage of the A.C., this being 0.9 of the RMS voltage.

The output voltage (D.C.) of any full wave mercury vapour rectifier with choke input is therefore

$$(0.9 E_{RMS} - 15) \text{ volts,}$$

where E_{RMS} is the RMS voltage per plate.

Rectifier Ratios

The following relationships refer to ideal rectifiers with sine wave input, zero valve drop, no filter, and resistive load. In this table A.C. (RMS) voltage = RMS transformer voltage per valve.

Voltage Relationships

	Half Wave	Full Wave
<u>Average (D.C.) voltage</u>		
A.C. (RMS) voltage	0.45	0.9
<u>A.C. (RMS) voltage</u>		
Average (D.C.) voltage	2.22	1.11
<u>Peak inverse voltage</u>		
Average (D.C.) voltage	3.14	3.14
<u>Average (D.C.) voltage</u>		
Peak inverse voltage	0.318	0.318
<u>Peak inverse voltage</u>		
A.C. (RMS) voltage	1.41	2.82
<u>A.C. (RMS) voltage</u>		
Peak inverse voltage	0.707	0.3535

Current Relationships

With Choke-Input Filter.

	Half Wave	Full Wave
Average current per plate		
Total D.C. load current	1.0	0.5
Peak current per plate		
Average current per plate	2.0	2.0
Peak current per plate		
Total D.C. load current	2.0	1.0

Maximum Ratings

In any rectifier application reference should be made to the **maximum ratings**. The maximum A.C. voltage for vacuum rectifiers is generally given as an RMS voltage, but in some cases the peak inverse maximum voltage is also given. Neither of these limits should be exceeded, but for single phase rectification it will generally be found that the peak inverse voltage is 2.8 times the RMS voltage, this corresponding to full wave operation with sine wave input.

With low impedance vacuum and with mercury vapour rectifiers the ratings also include a **maximum peak plate current**. With a high-inductance filter input the peak current is not much greater than the average current, but with a low inductance ("swinging choke") or condenser input the peak current limit is likely to be exceeded and care must be taken to check this matter (see Chapter 23).

Form Factor

The Form Factor of a wave is the ratio of the R.M.S. value to the average value. Typical form factors* are:—

Full square topped wave	1.00
Half wave rectified square topped wave	$1.41 = \sqrt{2}$
Full (isosceles) triangular wave	$1.15 = 2/\sqrt{3}$
Half wave rectified triangular wave	$1.63 = 4/\sqrt{6}$
Full sine wave	$1.11 = \pi/2\sqrt{2}$
Half wave rectified sine wave	$1.57 = \pi/2$
Full wave rectified sine wave	$1.11 = \pi/2\sqrt{2}$

It will be seen that the form factor of a full wave rectified wave is the same as that for the original alternating wave, and that for a half wave rectified wave is 1.41 times that for the alternating wave.

How to Use the Published Curves

Published curves for all Radiotron rectifier valves of the vacuum type are in common use. By means of these curves it is possible to predict with reasonable accuracy the voltage output for any transformer voltage or direct-current load. The curves usually apply to transformer voltages such as 300, 350, 400 etc., and when it is desired to calculate the output for an intermediate voltage such as 385 volts this can be done by simple interpolation. The curve nearest to 385 volts would be that for 400 volts, the difference being 15. The D.C. output voltage for the desired load current and for 400 volts RMS may then be determined from the curves, and

*For further information see L. E. W. Jolley "Alternating Current Rectification," Part I, Chapter 1.

it is only necessary to subtract the difference (i.e., 15) in order to obtain the approximate D.C. voltage for 385 volts RMS.

The variation of voltage with load, that is the regulation, may be determined in a similar manner by taking readings at the maximum- and minimum-signal average direct-current loads.

With choke input for vacuum rectifier types the following method is satisfactory. From the published curves obtain the values of D.C. voltages from adjacent curves of transformer voltage in the region of the working voltage, corresponding to the known direct-current load. Plot D.C. voltage vertically against transformer voltage horizontally, and draw a smooth curve through the points so obtained. From this curve the required voltage may be obtained.

Transformer Heating

Due to the waveform of the rectified current, the heating of the transformer windings will be different from that on an equivalent load without rectification. With single phase full wave rectification using a centre-tapped secondary winding on the transformer, each half winding operates as supplying a half-wave rectifier. If a **choke input filter** is used the RMS value of the current in each winding will be* 70.7% of the total direct-current load. If a **condenser input filter** is used the RMS value of the current will vary with the load resistance, the capacitance and the regulation, but for most radio design purposes it may be taken as approximately* 78.5% of the total direct-current load. This severe heating is due to the poor "form factor" of the rectified current.

As an example, take a transformer with centre tapped secondary which is required to deliver 100 mA. D.C. into a certain load resistance. With choke input and full wave rectification the heating value of the current in each half of the secondary will be equivalent to that of a current of 70.7 mA. RMS. Under similar conditions with typical condenser input this figure will increase to approximately 78.5 mA. RMS.

The **primary volt-amperes** for choke input will be 1.11 times the D.C. power in watts. In the case of a transformer which also supplies heating current, a portion of the load will be purely resistive and as a consequence the primary VA will approach more closely to the total secondary power output. For information on Power Transformer Design refer to Chapter 26.

Bibliography

- L. B. W. Jolley, "Alternating Current Rectification," (Chapman and Hall, 1928).
- D. C. Prince and F. B. Vogdes, "Principles of Mercury Arc Rectifiers and their Circuits" (McGraw-Hill, 1927).
- D. McDonald, "The Design of Power Rectifier Circuits," Wireless Engineer, Vol. 8, No. 97, pp. 522-531, October (1931).
- M. B. Stout, "Behaviour of Half Wave Rectifiers," Electronics, Vol. 12, No. 9, pp. 32-34, September (1939), including further references.
- W. P. Overbeck, "Critical Inductance and Control Rectifiers," Proc. I.R.E., Vol. 27, No. 10, pp. 655-659, October (1939).
- H. Rissik, "The Fundamental Theory of Arc Converters" (Chapman and Hall, 1939).
- D. M. Duinker, "Filters for Rectifiers," Philips Transmitting News, Vol. 4, No. 2, pp. 1-16, May (1937).
- C. R. Dunham, "Some Considerations in the Design of Hot Cathode Mercury Vapour Rectifier Circuits," Jour. I.E.E., Vol. 75, No. 453, p. 278, September (1934); also discussion by D. M. Duinker, Vol. 76, No. 460, p. 421 (1935).
- M. B. Stout, "Analysis of Rectifier Filter Circuits," Elect. Eng., Vol. 54, No. 9, pp. 977-984, September (1935).

*The values quoted are for certain ideal conditions and do not hold accurately in practice.

CHAPTER 23

Filtering

Filter design—condenser input filter—ripple voltage—choke input—design of first section—regulation—procedure when load resistance is not constant—filter tuned to ripple frequency—swinging choke—peak current—second section of filter—examples of filter design—resistance capacitance filters.

Filter Design

It is possible to design filters mathematically with a fair degree of accuracy to give any desired attenuation of ripple. In this treatment it is convenient to treat the filter in sections, firstly the input section and secondly any subsequent section(s).

(Continued overleaf)

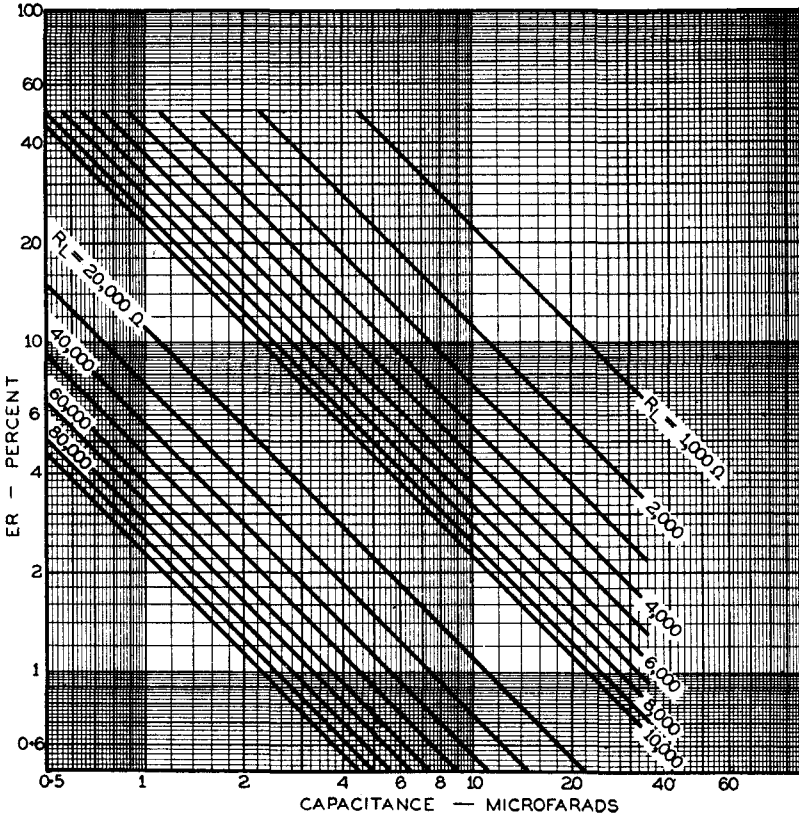

Figure 1: Calculation of Ripple Voltage (E_R) as a percentage of the D.C. voltage, for the first shunt condenser (C) of a condenser input filter, for full wave rectification on a 50 c/s supply.

With a condenser input filter the input section consists of the first shunt condenser only. The degree of smoothing contributed by this section is shown in Fig. 1 and depends upon the capacitance of the condenser and the resistance of the load. This curve is calculated from the formula*

$$\frac{\text{Ripple voltage (RMS) of fundamental ripple frequency}}{\text{D.C. output voltage}} = \frac{\sqrt{2}}{\omega RC}$$

and is fairly accurate for small percentages of ripple but is only approximate above 10%. The curve applies only to a ripple frequency of 100 c/s, being the fundamental ripple frequency for full wave rectification and a

(Continued facing page)

*See Terman "Radio Engineering," 1st Edit., p. 414.

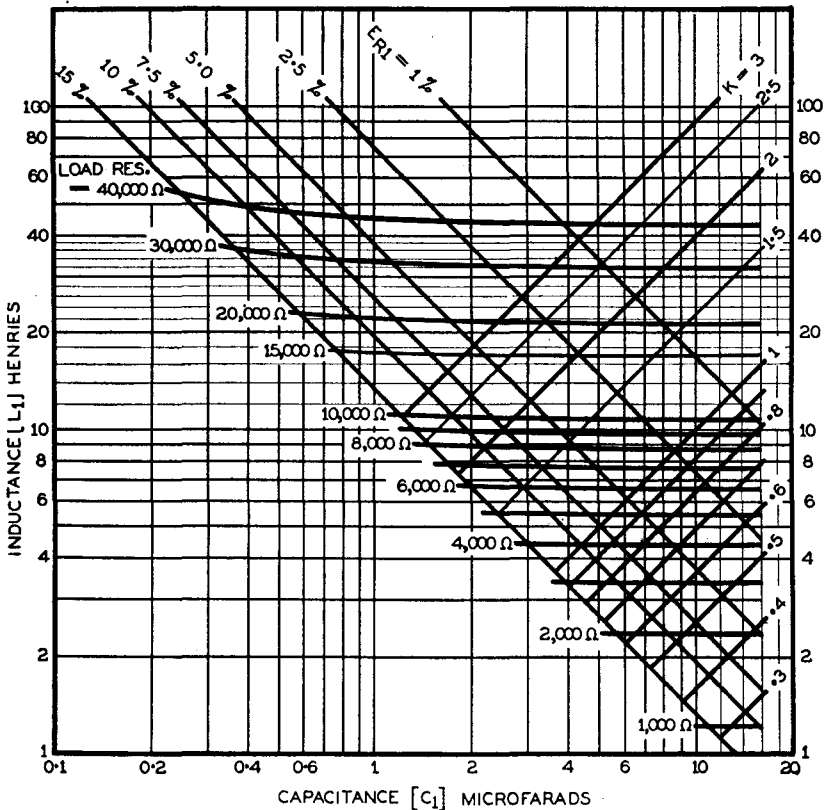

Figure 2: Calculation of Ripple Voltage (E_{R_1}) as a percentage of the D.C. voltage, for the first section (L_1, C_1) of a choke input filter, for full wave rectification on a 50 c/s supply. These curves may be used independently of the load resistance and K curves. To check for satisfactory regulation it is necessary to observe whether the operating point is above the corresponding load resistance curve. To check for satisfactory peak current it is necessary to refer to the table for the value of K corresponding to the valve type and transformer voltage in use, and then to note whether the operating point is to the left of, and above, the K curve.

50 c/s supply. It may be applied to other frequencies by multiplying the values of capacitance by the factor 2 for 25 c/s, 1.25 for 40 c/s or 0.83 for 60 c/s. It may also be applied to half-wave rectification by multiplying the capacitance by a factor of 2.

With a choke input filter it is necessary to use the curves of Fig. 2. Any desired degree of smoothing in the first section consisting of a series inductance L_1 and shunt capacitance C_1 (Fig. 6) may be obtained, but it is frequently more economical to design the filter with two sections (Fig. 7) the first (L_1C_1) affecting the regulation and the peak plate current and contributing something towards the smoothing, and the second section (L_2C_2) completing the smoothing. The design of the first section of a choke input filter is complicated by having to consider simultaneously several factors, but it is generally convenient to make a first trial by assuming a ripple voltage percentage at the output from the first section, and then to check for regulation and peak plate current. The E_{R_1} curves of Fig. 2 may be used independently of the other curves, so that any combination of L_1 and C_1 may be selected to provide the desired ripple voltage. In order to check whether the regulation is good it is only necessary to observe whether the operating point on the curves is above the load resistance* curve. In cases in which the load resistance is not constant it is necessary to design on the basis of the maximum resistance. If it is found that the selected operating point is below the maximum load resistance it is usually necessary either to increase L_1 or to add a bleeder resistance to decrease R_L . Alternatively L_1 may be tuned to the fundamental ripple frequency by means of a condenser (C) shunted directly across it (Fig. 8). This will increase the impedance of the arm at one frequency but not at ripple harmonic frequencies, so that a second filter section becomes necessary. In such a case the first section contributes the major part of the smoothing for the fundamental frequency and the second section the greater part of the smoothing for harmonic frequencies. When L_1 is tuned it may have a comparatively low inductance thereby providing greater economy. It is necessary for the tuning to be accurate at the minimum load current and a slight detuning due to change of inductance with direct current at normal load is generally permissible.

In cases where good regulation is required over a wide range of load resistance, a swinging choke may be employed. Such a choke has high inductance at low D.C. loads, and a much lower inductance (due to partial saturation) at high D.C. loads. The use of the curves of Fig. 2 will enable the maximum and minimum inductances to be determined for both extremes of load resistance.

Peak Current

Finally it is necessary to check for peak current, and in order to facilitate the calculation a table has been prepared from the formula

$$L_1 = K^2 C_1$$

where L_1 = Henries

C_1 = Microfarads

K = $E_{RMS}/(I_{MAX} \times 1110)$

E_{MAX} = RMS transformer voltage per valve

and I_{MAX} = Peak plate current rating of valve in amperes.

*These R_L curves are based on the formula $XL - Xc = 0.667 R_L$.

Table Giving Value of K

K							
Valve Type	82	83	836	866	866A	872	872A
IMAX	0.4	0.8	1.0	1.0	1.0	5.0	5.0
ERMS (volts)							
300	0.672	0.336	0.27	0.27	0.27	0.054	0.054
400	0.896	0.448	0.36	0.36	0.36	0.072	0.072
500	1.12	0.56	0.45	0.45	0.45	0.09	0.09
750	—	—	0.675	0.675	0.675	0.135	0.135
1000	—	—	0.9	0.9	0.9	0.18	0.18
1250	—	—	1.125	1.125	1.125	0.225	0.225
1500	—	—	1.35	1.35	1.35	0.27	0.27
1750	—	—	1.575	1.575	1.575	0.315	0.315
2000	—	—	—	1.8	1.8	0.36	0.36
2500	—	—	—	2.25	2.25	0.45	0.45
3000	—	—	—	—	2.70	—	0.54
3500	—	—	—	—	3.15	—	0.63

From this table it is possible to obtain values of "K" for the type of valve and transformer voltage to be employed, and reference may then be made to the nearest corresponding K curve in Fig. 2. The operating point should be to the left of, and above, the corresponding K curve in order to limit the peak current.

Second Section of Filter

From the design of the first section of the filter the ripple voltage applied to the input of the second section is known. It is only necessary to refer to Fig 3, to select values of L_2 and C_2 , to refer these to the ER_1 curve, and to read off the value of ER_2 . If a third section is added the method is similar. These curves are based on the formula

$$\frac{ER_2}{ER_1} = \frac{1}{\omega^2 LC - 1}$$

from which any calculations may be made.

A popular treatment of the subject is given by M. G. Scroggie, "Choke v. Condenser Input," *Wireless World*, Vol. 43, No. 10, pp. 224-226, September 8 (1938).

Examples of Filter Design

EXAMPLE 1: Condenser Input Filter:

Q. A condenser input filter in which $C = 8\mu F$, $L_1 = 20$ Henries and $C_1 = 8\mu F$ (Fig. 4) is to be used with a full wave vacuum rectifier on a 50 c/s supply. The D.C. output is 260 volts 65 mA. It is required to find the percentage of ripple.

A. The effective resistance of the load (R_L) is $260/0.065$ or 4000 ohms. Reference to Fig 1 shows that the curve for 4000 ohms cuts the $8\mu F$ line at $ER = 7\%$. This is therefore the ripple in the input to the second section of the filter. In the second section the product $L_2 \times C_2$ is 20×8 or 160, and the 7% ER_1 curve cuts $L_2 C_2 = 160$ at $ER_2 = 0.11\%$ which is therefore the ripple in the output. If any further filtering is required, a second stage may be added (Fig. 5) and the ripple voltage may be calculated by again using Fig. 3.

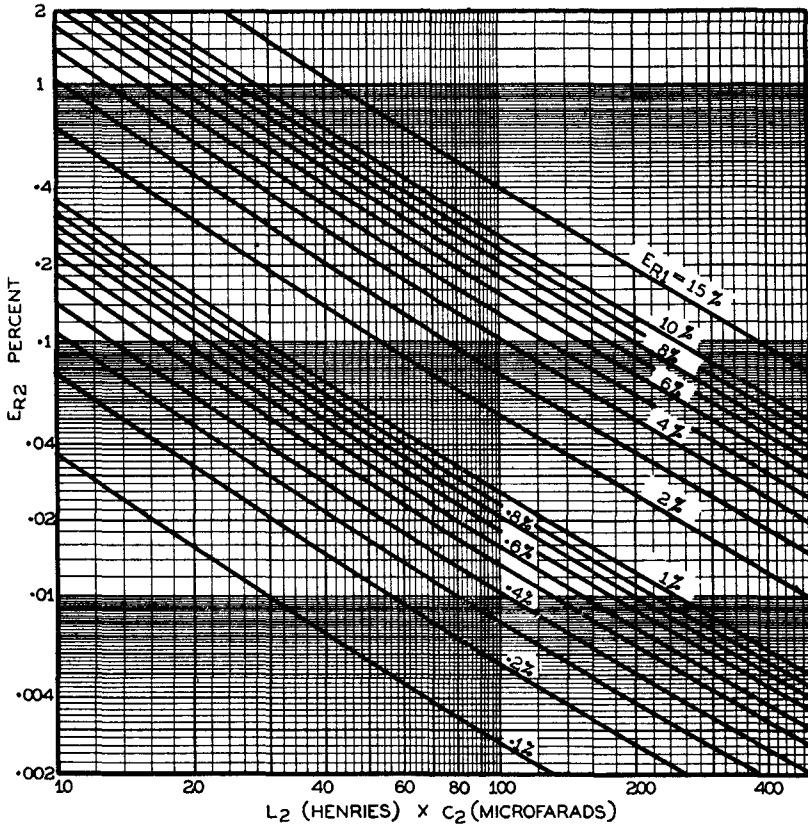

Figure 3: Calculation of the ripple voltage (ER_2) at the output of the second or any subsequent stage of a filter (L_2C_2) when the ripple voltage (ER_1) at the input to this stage is known, for full wave rectification and a 50 c/s supply. These curves also apply in the case of a condenser input filter for the first choke and following condenser (L_1C_1 in Fig. 4).

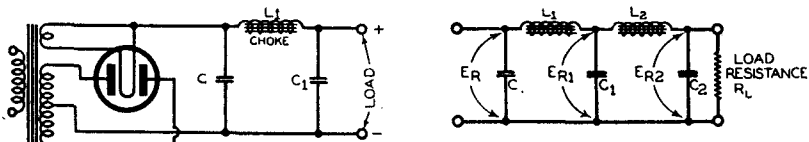

Figure 4 (left): Single stage condenser input filter and associated circuit. Figure 5 (right): Two stage condenser input filter.

EXAMPLE 2: Choke Input Filter:

Q. One type 83 rectifier is to be used with a 500-500 volt transformer to supply a high power amplifier drawing 160 mA. on no signal and 200 mA. on maximum signal. It is required to design a suitable filter.

A. The D.C. output voltage will be $0.9 \times 500 = 450$ volts. The load resistance R_L is therefore $450/0.16$ or 2720 ohms at no signal and $450/0.2$ or 2175 ohms at maximum signal. Now since the variation in

current is comparatively small, the regulation of a good choke input circuit filter is sufficient (Fig. 6). As a first step in the design let the choke inductance (L_1) be selected as 20 Henries and the following capacitance, (C_1) $8\mu\text{F}$. Reference to Fig. 2 shows that the ripple voltage under these conditions is 1%. Assuming that this degree of smoothing is sufficient, or that it will be followed by a second filter stage, it is now necessary to check for regulation and peak plate current. Since the selected values of L_1 and C_1 give an operating point on the curves considerably above 2175-2720 ohms for R_L there is no danger of poor regulation due to insufficient inductance. Reference to the table given earlier in this chapter shows that the value of K for type 83 at 500 volts RMS is 0.56. It is evident that the operating point is well to the left and above the curve for $K = 0.56$ and therefore the selected conditions are satisfactory for peak current.

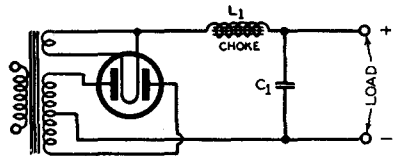

Figure 6: Single stage choke input filter and associated circuit.

We have so far shown that the selected values for L_1 and C_1 give satisfaction regarding regulation and peak current. If the smoothing is not sufficiently good, a second section (Fig 7) may be added and this would consist of $C_2 = 8\mu\text{F}$ and $L_2 = 20$ H. Reference to Fig. 3 shows that with $L_2 C_2 = 160$, the ripple will be reduced from $E_{R1} = 1\%$ to $E_{R2} = 0.016\%$.

There is no danger of poor regulation due to insufficient inductance. Reference to the table given earlier in this chapter shows that the value of K for type 83 at 500 volts RMS is 0.56. It is evident that the operating point is well to the left and above the curve for $K = 0.56$ and therefore the selected conditions are satisfactory for peak current.

ripple voltage will be 1% and the

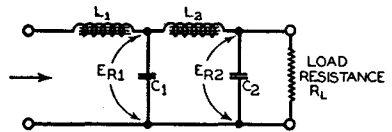

Figure 7: Two stage choke input filter.

Even this degree of smoothing may not be sufficient for the preliminary stages in the amplifier, but it is quite satisfactory to obtain the additional filtering by a Resistance Capacitance Filter (see Fig. 9).

Even this degree of smoothing may not be sufficient for the preliminary stages in the amplifier, but it is quite satisfactory to obtain the additional filtering by a Resistance Capacitance Filter (see Fig. 9).

EXAMPLE 3: Swinging Choke:

Q. An amplifier incorporating a Class B stage requires 50 mA. at no signal and 250 mA. at maximum signal, at 400 volts on the plates of the Class B valves which operate at zero bias. Design a suitable power supply and filter.

A. Type 83 rectifier is indicated and under maximum voltage ratings the transformer voltage is 500-500 volts RMS (no load) and the rectified output $0.9 \times 500 = 450$ or 435 volts, which allows for 35 volts drop in the power transformer, smoothing chokes and output transformer. In order to obtain the best possible regulation a swinging choke input is suggested.

The load resistance is $435/0.05$ or 8700 ohms at zero signal and $435/0.25$ or 1740 ohms at maximum signal. The condenser C_1 (Fig. 7) may be selected as $8\mu\text{F}$ and the minimum inductance of L_1 at the maximum signal current must now be selected. The value of K as given by the table is 0.56, and it is necessary to select a value for L_1 which with $C_1 = 8\mu\text{F}$ gives an operating point on or slightly above $K = 0.56$. If L_1 is chosen as 2.5 H. the ripple voltage will be 10% and the operating point is above $R_L = 1740$ ohms, and the selection may be regarded as satisfactory.

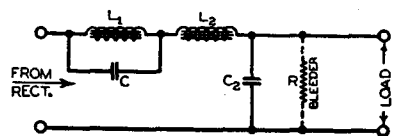

Figure 8: Filter in which the first choke is tuned to the fundamental ripple frequency.

If L_1 is chosen as 2.5 H. the ripple voltage will be 10% and the operating point is above $R_L = 1740$ ohms, and the selection may be regarded as satisfactory.

It is now necessary to consider the conditions for no-signal current. Under these conditions $R_L = 8700$ ohms and with $C_1 = 8\mu F$ the minimum value of inductance for good regulation will be 9.3 H so that a selection of 10 H would give a slight margin. In certain cases it may be preferred to use a bleeder to decrease the value of R_L for no-signal conditions and so permit a lower value of L_1 to be used.

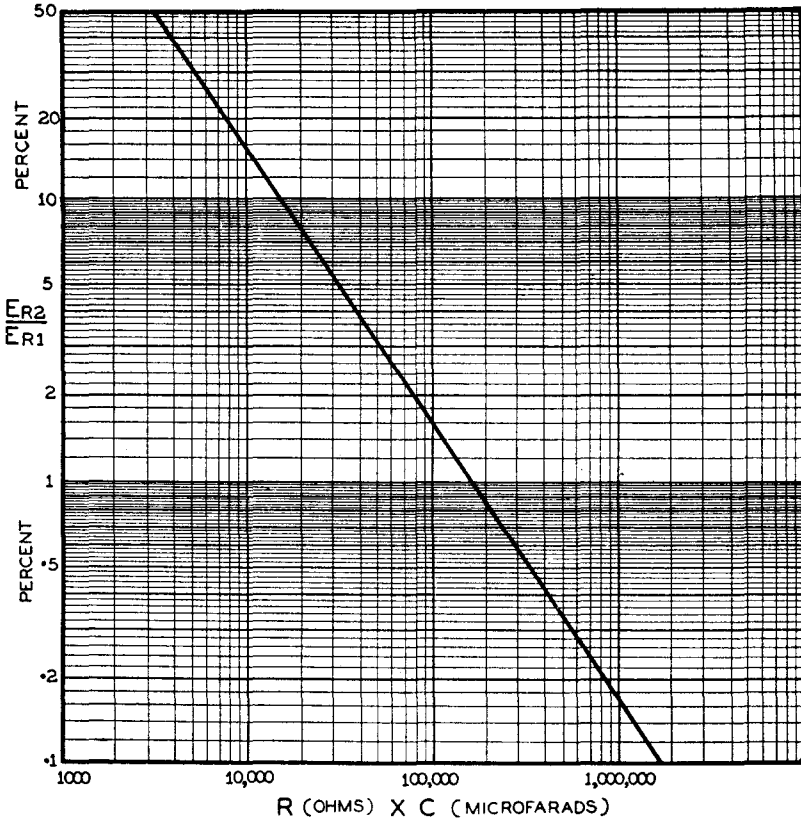

Figure 9: Curve for determining the smoothing effect of a resistance capacitance (RC) filter, for full wave rectification and a supply frequency of 50 c/s.

The calculation of the voltage regulation is rather involved and will not be considered here. Those interested are referred to Prince and Vodges "Mercury-arc Rectifiers and their Circuits" (McGraw-Hill, 1927).

Finally it is necessary to design a suitable second section of the filter as in Example 2.

Resistance Capacitance Filters

In many cases it is possible to use resistance-capacitance filters, particularly in the earlier stages of an amplifier. As an example, the dropping resistor and bypass condenser to the screen of a resistance coupled pentode

form an effective filter. An approximate formula for calculating the smoothing effect of such a filter is.

$$\frac{E_{R_2}}{E_{R_1}} = \frac{1}{\omega CR}$$

and is reasonably accurate for values of CR above 10,000 ($\mu F. \times ohms$). It should not be used for low values of CR . This formula is used as the basis of the curve of Fig. 9.

A resistance capacitance filter circuit described by H. H. Scott, * and claimed to give almost complete attenuation at any one desired frequency, is shown in Fig 10. In this arrangement the resistance of R_B and the tapping point on R_4 are adjusted for balance at the desired frequency. At slightly higher frequencies the attenuation decreases, but at still higher frequencies it rises again, although the attenuation at the higher frequencies is always less than that with the conventional form of filter. In some cases a sufficiently close approach to balance may be made by returning R_B to one end of R_4 .

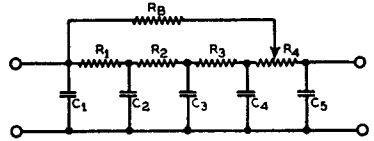

Figure 10: Resistance capacitance filter circuit giving complete attenuation at any one desired frequency (after H. H. Scott).

For bibliography see at end of Chapter 22.

* Electronics, Vol. 12, No. 8, pp. 42-48, August (1939).

CHAPTER 24

Hum

Causes of hum—insufficient filtering—neutralising hum—hum-bucking coil—induction hum—electromagnetic coupling—R.F. interference from mercury vapour rectifier—valve or barretter in magnetic field—capacitive coupling—heater to cathode leakage—emission from heater—emission from cathode to heater—modulation hum—miscellaneous cures for hum — vibrator interference.

Hum in a receiver or amplifier may be due to numerous causes such as

- (1) lack of sufficient filtering,
 - (2) induction into a high impedance circuit from a neighbouring conductor,
 - (3) electro-magnetic coupling from the power transformer or filter choke to an A.F. iron-core transformer or choke, or in certain cases even an air-core inductance,
 - (4) R.F. oscillation in a mercury vapour rectifier which is picked up by the receiver,
 - (5) the presence of a magnetic field near a valve,
 - (6) capacitive coupling between the heater and other electrodes,
 - (7) leakage through heater-cathode insulation,
- or (8) emission from the heater to other electrodes, or vice versa.

The cure for hum due to lack of sufficient filtering is obvious. The hum in the filtered B supply of a typical radio receiver is about 0.1 Volt R.M.S. (0.04% with 250V. D.C.) with $C_1 = 8 \mu\text{F}$., $L = 2000$ ohm speaker field and $C_2 = 8 \mu\text{F}$.. Increasing C_2 to $16 \mu\text{F}$.. reduces the ripple to 0.06 Volt R.M.S. (0.024%), the supply frequency being 50 c/s in both cases. This figure is the R.M.S. value of the ripple frequency (100 c/s) with all its harmonics. Since the various harmonics bear a fixed relationship to the fundamental it is immaterial with such a filter whether the ripple voltage is measured as total R.M.S. or fundamental ripple frequency R.M.S. The inductance of a typical 8" or 10" speaker field having a resistance of 2,000 ohms is 15 Henries,* but lower resistance windings tend to have lower inductance and in such cases there may be difficulty in obtaining sufficient filtering. In such cases a second section may be added to the filter, the additional components being a choke and condenser. The inductance of the choke may be quite small (see Chapter 23).

*The following are typical inductances for 2,000 ohms in all cases:—

- Large 12" speaker, 20 Henries.
- Medium 8"—10" speaker, 15 Henries.
- Light 12" speaker, 13 Henries.
- Light 5"—6½" speaker, 8—9 Henries.

For economy it is generally preferable to determine the stage or stages in the circuit at which a reduction of hum is most beneficial, and to increase the filtering on these stages only. If the supply voltage is fairly high, and the current low, it is sometimes possible to gain sufficient filtering by a resistance-capacitance filter. As a certain measure of hum neutralisation usually occurs, it may be found that additional smoothing in one stage may actually increase the hum, and it is frequently possible to balance out the greater part of the hum voltage by careful adjustment. This neutralisation should however be conducted with caution, since any variation such as the aging of the valves is likely to bring back the hum.

A rather interesting method of **neutralising hum** is shown in Fig. 1 in which, by means of a capacitance voltage divider, a predetermined hum voltage is fed to the screen of a pentode amplifier valve, being consequently 180° out of phase with the hum in the plate circuit. This arrangement is only practicable when the screen is fed from a high resistance dropping resistor or voltage divider.

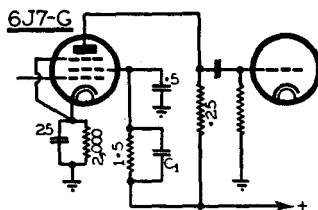

Figure 1

A **hum-bucking coil** is frequently used in series with the speaker voice coil to introduce a hum voltage in opposition to the normal hum but even with careful adjustment this cannot entirely eliminate hum owing to phase differences and harmonics.

Induction hum is particularly objectionable since it consists of a large proportion of higher order harmonics to which the ear is more sensitive than to the fundamental frequency. It is readily detected by ear owing to the higher pitched and rather rough tone. It is usually caused by capacitive coupling, and the cure is isolation or shielding.

Electromagnetic Coupling may be reduced by the use of a non-magnetic chassis or a separate power chassis, but the effect may sometimes be reduced by rotation of one component to obtain minimum coupling.

R.F. interference from a mercury vapour rectifier may be isolated by enclosing the rectifier in a shield can and by inserting screened R.F. chokes in each plate lead. Owing to this difficulty, M.V. rectifiers are not generally used in radio receivers, although used very widely in amplifiers and transmitters.

A high gain amplifying valve should not be placed in a **magnetic field** such as near a power transformer, filter choke, or speaker field. A barretter (which has an iron filament) should also be kept well away from a magnetic field.

Capacitive coupling between a heater pin carrying A.C. and a nearby grid pin is sufficient to cause hum in a high gain amplifier. This may be reduced by earthing the side of the heater nearest the grid pin or by fitting a potentiometer across the heater, the moving contact being earthed and adjusted for minimum hum. This form of hum is almost eliminated by the use of valves having grids brought out to top caps.

Hum due to **heater-cathode leakage** may be reduced by generous by-passing, or by connecting the cathode directly to the chassis, or by adjusting the voltage between heater and cathode.*

Hum due to **emission** from the heater to the cathode may usually be eliminated by operating the heater at a voltage which is positive with respect to the cathode. Hum due to internal emission from cathode to heater may be eliminated by operating the heater at a voltage which is negative with respect to the cathode. In both cases it is inadvisable to use a voltage which is higher than is necessary to reduce the hum.

*See "Heater-Cathode Leakage as a Source of Hum," *Electronics*, Vol. 13, No. 2, p. 48, February, (1940).

With amplifiers having high gain it is sometimes advisable to operate the heater of the first stage from a D.C. source.

Modulation hum is hum which is only apparent when the receiver is tuned to a carrier. It may be due to any of a wide variety of causes such as

- (1) Lack of sufficient filtering,
- (2) Coupling from the mains, generally through the power transformer,
- (3) Inefficient earthing of the receiver,
- (4) Inefficient earthing of the conduit carrying power mains in the vicinity,
- (5) Heater-cathode leakage in converter or R.F. amplifier valve.

It is advisable always to employ an electrostatic screen in the power transformer between primary and secondary windings. In cases where this is ineffective, a line filter may be included in the power lead. The filter should be in a metal box which should be earthed separately from the receiver, and the leads between the filter and the receiver may also be shielded and earthed.

In modern superheterodyne receivers modulation hum may be due to insufficient filtering of the oscillator plate supply, particularly when the plate is fed through a resistance-capacitance filter directly from the filament of the rectifier valve.

Miscellaneous Cures for Hum

1. Bypass cathodes to earth.
2. Connect a potentiometer across the heater of the valve most critical to hum and earth the moving contact.
3. Bypass both ends of such a heater to earth.
4. Use separate chassis, one for power amplifier and power pack and the other for tuner and low level audio amplifiers.
5. Use non-magnetic metal for chassis.
6. Apply negative feedback (degeneration) to a stage introducing hum.
7. Add electrostatic screening to prevent capacitive pick-up. Separate screened compartments are preferable to shielded wire since the latter has considerable capacitance and may seriously affect the sensitivity or frequency response.
8. Add electromagnetic screening (i.e., heavy iron or steel case or several such cases inside one another) to prevent inductive pickup to audio transformers, etc. An improvement may also be effected by decreasing the leakage inductance of the power transformer, filter chokes, audio transformers, etc.
9. Arrange wiring to give minimum hum pickup. Use short leads and rigid wiring.
10. Twist together return leads carrying A.C. or radio frequencies.
11. If the chassis is used for earthing, cathodes and heaters should be wired separately to the chassis, and screen grid bypass condensers should be wired directly from the screen grid to the cathode on the socket. Do not use an earth busbar.
12. Check for dry soldered joints.
13. Bypass screen grids, etc., at the valve socket, not at a common voltage divider tapping.
14. Check that valve shield cans make good contact with the chassis.
15. Neutralise the hum by adding an out-of-phase hum voltage.

Vibrator Interference

The reduction of hum and "hash" from a vibrator unit is a difficult one, and a full treatment is not possible in this handbook. The following papers may be consulted for assistance in this matter:—

- V. C. McNabb, "Power Transformer Design for Vibrators," *Electronics*, Vol. 7, No. 5, p. 149, May (1934).
- A. S. Nace, "Vibrators—Theory and Practice," *Service*, Vol. 4, Nos. 7, 8, 9, pp. 302-303, 335-336, 393-394, July, August, September (1935).
- W. Garstang, "Vibrators—History, Design and Applications," *Radio Engineering*, Vol. 15, No. 11, p. 18, November (1935).
- Editorial, "Vibrators," *Electronics*, p. 25, February (1936).
- G. A. Gerber, "The Practical Application of Vibrator 'B' Power," *R.M.A. Engineer*, Vol. 2, No. 1, p. 16, November (1937).
- J. W. Alexander, "A Vibrator for the Connection of Alternating Current Receivers to the Direct Current Mains," *Philips Technical Review*, Vol. 2, No. 11, p. 346, November (1937).
- J. C. Smith, "Automobile Receiver Design," *R.C.A. Review*, Vol. 1, No. 4, p. 94, April (1937).
- Graham G. Hall, "Vibrator Power Units," *Proceedings World Radio Convention*, Sydney, April (1938).
- W. H. Cazaly, "Vibrators, A Simplified Explanation of How They Work," *Wireless World*, Vol. 44, No. 26, p. 594, June 29 (1939).
- Graham G. Hall, "Design Problems in Automobile Radio Receivers," *Proc. I.R.E. (Aust.)*, Vol. 2, No. 4, pp. 69-79, April (1939). Also reprinted *A.W.A. Technical Review*, Vol. 4, No. 3, pp. 105-126, November 17 (1939).

Chapters 25 to 28, inclusive

CHAPTER 25

Voltage Dividers and Dropping Resistors

Voltage dividers and dropping resistors—for R.F. stage—common dropping resistor for R.F. and converter—A.C. receivers—6A8-G and 6K8-G—battery receivers using 1C7-G—anode grid dropping resistor—screen supply for I.F. stage—when no R.F. stage is used—Magic Eye Tuning Indicator—resistance coupled audio amplifier pentodes.

In the R.F. and I.F. stages of a receiver it is possible to use either a voltage divider or dropping resistors as means for providing the correct voltages on the screen grids of valves. There are advantages in both methods for certain applications, and no general rule can be made to cover all circumstances. In the case of R.F. amplifiers it is preferable that the screen voltage should be obtained from a source of fixed voltage. This will give the most effective A.V.C. action and thereby assist in preventing overloading and distortion in the I.F. amplifier. In the case of a battery receiver the voltage may be obtained from a tapping on the B battery, or if no suitable tapping point is available to give the exact voltage required, the lowest tapping point above the required voltage may be used and a small dropping resistor fitted to decrease the voltage to the desired value. In a battery receiver it is possible to use a common dropping resistor for the R.F. and converter valves and this will have the effect of providing fairly constant voltage under all conditions, since the screen current of the pentagrid converter is generally higher than the screen current of the R.F. valve and increases slightly as the control grid voltage is made more negative.

In an A.C. receiver the arrangement to be adopted depends upon the type of converter valve. With type 6A8-G it is preferable to use a voltage divider to supply a fixed voltage to the screen, and the same tapping may also be used for the R.F. stage. When the supply voltage exceeds 200 volts, an anode-grid dropping resistor should be employed. A value of 20,000 ohms is suitable for a 250 volt supply.

With the 6A8-G, to avoid "flutter" on short wave operation it is advisable to series feed the screen grid and anode grid by a resistance capacitance circuit directly from the unfiltered side of the supply. At the same time, the A.V.C. should not be applied to this stage.

When type 6K8-G is employed the recommended arrangement is to use a common dropping resistor for the screen and oscillator plate. For a supply of 250 volts the value of the dropping resistor should be 15,000 ohms. Since the screen voltage of this type is fairly critical it is advantageous to adjust the resistance when lower supply voltages are used, so that the screen voltage is 100 volts on an average valve. Although a voltage divider may be used for the screen and oscillator plate of the 6K8-G, its use is not recommended since the frequency drift with change of grid voltage is much more pronounced.

In the case of a battery receiver, using Radiotron 1C7-G (1C6) under the recommended conditions, it is essential to use a screen dropping resistor. In such a case the dropping resistor may be adjusted to suit the R.F. stage in addition. A resistance of 60,000 ohms is recommended for the 1C7-G (1C6) alone while a resistance of 50,000 ohms is recommended when both the R.F. and converter valves are operated from the same dropping resistor.

Radiotron 1C7-G (1C6) should be operated with an anode grid dropping resistor of 50,000 ohms for the broadcast band and 20,000 ohms for the short-wave bands.

The screen of an I.F. amplifier should preferably have its supply from an individual dropping resistor. The reason for this is that if A.V.C. is used on this stage the screen voltage will increase as the grid is made more negative, with the result that the valve gives less distortion on strong signals than would otherwise be the case. This applies particularly to valves having a short grid base such as the 1D5-G (1A4) or 1M5-G (1C4) in the battery series. It is also desirable with Radiotron 6G8-G (6B7S) when used as an I.F. amplifier. It is not necessary although it may be desirable in the case of Radiotron 6U7-G (6D6). In a receiver having an R.F. stage and with A.V.C. applied to three stages in all, a dropping resistor for the screen of the I.F. stage causes no appreciable loss in the efficacy of the A.V.C. system. If no R.F. stage is used a compromise is necessary and it will generally be desirable to supply the screen of the I.F. amplifier with a constant voltage, such as would be obtained from a voltage divider, in order that the A.V.C. may be fully effective.

In a Magic Eye Tuning Indicator the plate supply may be obtained from any point having a potential of approximately 250 volts, the exact voltage not being critical. On the other hand, the voltage applied to the target is critical and should not under any circumstances exceed 250 volts. It is strongly desirable to obtain this voltage by means of the correct value of dropping resistor rather than from a voltage divider in order that more consistent operation may be obtained. The dropping resistor gives a considerable self-regulating effect which is most valuable in this application, where the supply voltage is above 200 volts. In order that longer life may be obtained from the Magic Eye it is preferable to maintain the target voltage below 250 volts, from 180 to 220 volts being recommended. This may be accomplished by the use of a 20,000 ohm dropping resistor from a supply of 250 volts. This resistor need not be by-passed.

In normal resistance coupled audio amplifier pentodes the screen supply should always be obtained from a dropping resistor. This will give very much improved self-regulating effect and is necessary if the full performance of the stage is required under all conditions without individual adjustment. The correct values of dropping resistors are given in the table in the loose leaf Radiotron Valve Data Book, and these values should rigorously be adhered to. In the case of the 6G8-G (6B7S) a dropping resistor is not generally satisfactory, and it is preferable to use a special divider consisting of a 1.0 megohm and a 0.25 megohm resistor in series as shown in the table.

CHAPTER 26

Transformers and Iron Core Inductances

Ideal transformers — impedance calculations — multiple secondaries—practical transformers—the effect of losses—audio frequency transformers—Class B. transformers—output transformers—the design of power transformers—calculation of core loss—measurement of inductance—calculation of inductance—design of iron core filter chokes carrying D.C.

Ideal Transformers

An Ideal Transformer is one having no primary or secondary resistance, and no leakage inductance or core loss. It has therefore a voltage ratio equal to the turns ratio, i.e. (see Fig. 1)

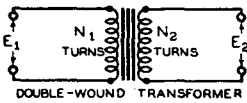

Figure 1

$$E_2/E_1 = N_2/N_1$$

The type of transformer illustrated in Fig. 1 is known as a Double Wound Transformer because separate windings are used for the primary and secondary. An Auto-Transformer as shown in Fig. 2 is "single-wound" with a tapping in a suitable position to give the required turns ratio. For most purposes an Auto-Transformer may be regarded as similar to a double wound transformer having equivalent primary and secondary turns, except that the windings are electrically connected. An Auto-Transformer is generally more economical to construct for the same efficiency than a double-wound transformer, particularly when the ratio of turns is about 2 : 1 or 1 : 2, but offers very slight advantages for high turns ratios. One reason for the increased economy is that fewer total turns are required. Another reason is that the current in primary and secondary sections is exactly out of phase, and the resultant current flowing through the common portion of the winding is the difference between the primary and secondary currents. If the ratio is 2 : 1 (or 1 : 2) the currents in both sections will be equal. If the ratio is greater than 2 : 1 the current flowing through the common portion (N_1) will be the greater, while if the ratio is less than 2 : 1 the current through the common portion (N_1) will be the less. The Auto-Transformer will be no longer considered separately in this treatment, but included in the more general case of the double wound transformer.

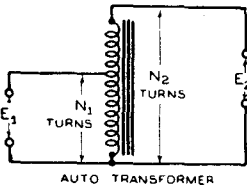

Figure 2

Transformer Impedance Calculations

When the secondary of an ideal transformer (T in Fig. 3) is loaded with a resistance (R) there is reflected on to the primary of the transformer a resistance

$$(N_2/N_1)^2 \times R.$$

Since the voltage ratio between primary and secondary is equal to the turns ratio, the resistance reflected on to the primary is also

$$(E_1/E_2)^2 \times R.$$

Consider a more complicated case with a centre-tapping on the primary as in Figure 4. In this case if the turns ratio $N_1:N_2$ is 3.16:1, the square of the turns ratio is 10:1. Now if the secondary load is 500 ohms

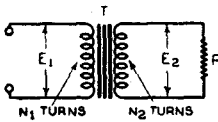

Figure 3

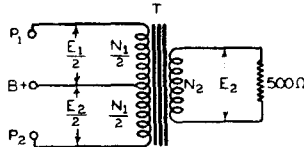

Figure 4

the load reflected back to the primary is 5000 ohms (P_1 to P_2). The load reflected to one half of the primary is however

$$(3.16/2)^2 \times 500 = 1250 \text{ ohms}$$

or one-quarter of that between P_1 and P_2 .

This transformer would be suitable for use as an output transformer from a push-pull amplifier to a 500 ohm line, but if one side of the primary were not used, the remaining side would present a load of 1250 ohms to a single ended amplifier.

A transformer merely "reflects" on to its primary circuit a load imposed on the secondary, and does not (apart from its own losses) impose a load on the primary circuit unless a load is applied to the secondary. It is the turns ratio between primary and secondary, not the number of turns in the primary, which governs the reflected impedance. For example, a transformer with 3000 turns on the primary and 1000 turns on the secondary has a turns ratio of 3:1. If the number of turns on the primary could be increased to 6000 and the turns ratio maintained at 3:1, the secondary would then have 2000 turns and the reflected impedance of the secondary load would be as before, provided that the load applied to the secondary remained constant.

Multi-tapped windings may be calculated in a similar manner (Fig. 5). In this example all the secondary windings in series are used for a 500 ohm load, and the number of turns ($N_2 + N_3 + N_4$) may be found in the usual manner from the number of turns in the primary multiplied by the square root of the impedance ratio. In order to find the correct number of turns for matching an output of 10 ohms it is only necessary to write

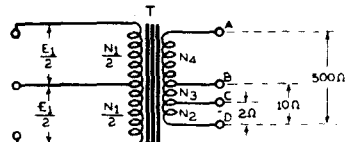

Figure 5

$$\left(\frac{N_2 + N_3 + N_4}{N_2 + N_3} \right)^2 = \frac{500}{10} = 50$$

$$\therefore \frac{N_2 + N_3 + N_4}{N_2 + N_3} = \sqrt{50} = 7.07$$

so that the number of turns included in the 10 ohm section is approximately one-seventh of that for 500 ohms.

Similarly the number of turns in the 2 ohm section (N_2) is found from

$$\frac{N_2 + N_3 + N_4}{N_2} = \sqrt{500/2} = 15.81$$

from which it is evident that the number of turns in the 2 ohm winding is 1/15.81 of the number of turns in the 500 ohm winding.

In the case of a multi-tapped transformer of this nature it is sometimes convenient to make use of additional ratios by connection to intermediate tappings. For example the impedance between terminals A and B is

$$\left(\frac{N_4}{N_2 + N_3 + N_4} \right)^2 \times 500$$

so that if the number of turns in each section is known, any combination of tappings may be calculated. If the number of turns is not known it is possible to calculate from the impedances, since the square

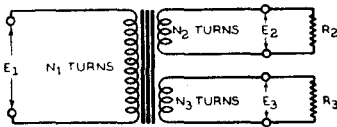

Figure 6

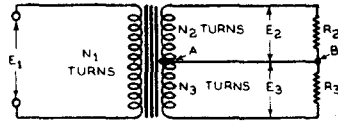

Figure 7

root of the total impedance is equal to the sum of the square roots of the impedance of each section in series. That is

$$\begin{aligned} \sqrt{500} &= \sqrt{10} + \sqrt{Z_{AB}} \\ \therefore \sqrt{Z_{AB}} &= \sqrt{500} - \sqrt{10} = 22.36 - 3.16 = 19.2 \\ \therefore Z_{AB} &= 19.2^2 = 369 \text{ ohms} \end{aligned}$$

Transformers with Multiple Secondaries

Special problems arise when more than one secondary winding is employed (Fig. 6). In this case

$$E_2/E_1 = N_2/N_1 \text{ and } E_3/E_1 = N_3/N_1$$

and therefore by simple algebra

$$E_3/E_2 = N_3/N_2.$$

It is sometimes convenient to redraw the diagram as in Fig. 7 which is equivalent in every way to Fig. 6. If, as a special case

$$N_2/N_3 = R_2/R_3$$

then the voltages of the two points A and B will be identical and the connection between A and B may be omitted without any effect. The currents in both sections of the transformer and in R_2 and R_3 will then be the same.

If the preceding relationship does not hold, the following may be deduced:—

Let $W_2 =$ watts dissipated in R_2

$W_3 =$ watts dissipated in R_3

and $W_1 = W_2 + W_3 =$ watts input to primary, then:—

$$W_2 = E_2^2/R_2 \text{ and } W_3 = E_3^2/R_3$$

$$\therefore W_1 = W_2 + W_3 = (E_2^2/R_2) + (E_3^2/R_3)$$

$$\text{and } W_3/W_2 = (R_2/R_3) \times (E_3^2/E_2^2) = (R_2/R_3) \times (N_3^2/N_2^2) \dots (1)$$

If the two secondary load resistances (R_2, R_3) and the transformer turns ratio are known, then the load reflected on to the primary will be given by

$$R_1 = \frac{R_2 R_3}{(N_3/N_1)^2 \cdot R_2 + (N_2/N_1)^2 \cdot R_3} \dots (2)$$

An interesting case is when a known power output (W_1) from a power amplifier is required to operate into a known impedance (R_1) with two secondaries each feeding a loudspeaker. If the two loudspeakers have impedances R_2 and R_3 and are required to operate with power inputs of W_2 and W_3 (where $W_2 + W_3 = W_1$), the required transformer ratios are given by

$$\frac{N_2^2}{N_1^2} = \frac{R_2}{R_1} \cdot \frac{W_2}{W_2 + W_3} = \frac{R_2}{R_1} \cdot \frac{W_2}{W_1} \dots (3)$$

$$\text{and } \frac{N_3^2}{N_1^2} = \frac{R_3}{R_1} \cdot \frac{W_3}{W_2 + W_3} = \frac{R_3}{R_1} \cdot \frac{W_3}{W_1} \dots (4)$$

For example if $W_2 = 3$ watts, $W_3 = 4$ watts, W_1 must therefore be 7 watts. If $R_1 = 7,000$ ohms, $R_2 = 500$ ohms and $R_3 = 600$ ohms then

$$\frac{N_2^2}{N_1^2} = \frac{500}{7000} \cdot \frac{3}{7} = \frac{1}{32.7} \therefore \frac{N_2}{N_1} = \frac{1}{5.72}$$

$$\text{and } \frac{N_3^2}{N_1^2} = \frac{600}{7000} \cdot \frac{4}{7} = \frac{1}{20.4} \therefore \frac{N_3}{N_1} = \frac{1}{4.51}$$

If $N_1 = 3000$ turns then N_2 will be $3000/5.72$ or 525 turns and N_3 will be $3000/4.51$ or 665 turns.

This may be put into a general form which may be used with any number of secondary windings:—

$$N_n/N_1 = \sqrt{R_n/R_1 \cdot W_n/W_1} \dots (5)$$

where $N_n =$ number of turns on any secondary,

$N_1 =$ number of turns on primary,

$R_n =$ load across secondary having N_n turns,

$R_1 =$ load reflected across primary,

$W_n =$ watts dissipated in R_n ,

and $W_1 =$ total watts input to primary.

When separate transformers are used for each load the turns ratio from secondary to primary of any transformer will be given by (5)

If a transformer is supplying power to two or more loads, such as loudspeakers, and one of these is switched out of circuit, the impedance reflected on to the primary will change due to the reduction of loading on the secondary. In order to avoid the resultant mismatching it is advisable to switch in a resistive load, having a resistance equal to the nominal (400 c/s.) impedance of the loudspeaker, so as to take the place of the loudspeaker which has been cut out of circuit. In this case the resistance should be capable of dissipating the full maximum power input to the loudspeaker. Such an arrangement will also have the result that the volume from the remaining speakers will be unchanged.

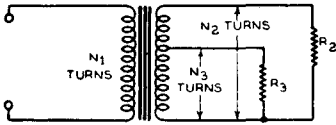

Figure 8

Alternatively if it is desired to switch off one loudspeaker and to apply the whole power output to a single speaker, it will be necessary to change the number of secondary turns so as to give correct matching. This change may generally be arranged quite satisfactorily by the use of a tapped secondary

winding. In this case the loudspeaker would be used on the intermediate tap when both speakers are in use, and on the whole winding for single speaker operation.

It does not matter whether two or more separate secondary windings or a single tapped winding is employed (Fig. 8). The arrangement shown in Fig. 8 is effectively identical to that of Fig. 6.

Practical Transformers

The Effect of Losses

The preceding treatment has been on the assumption that no losses occur in the transformer. In practical transformers there are losses and other effects due to

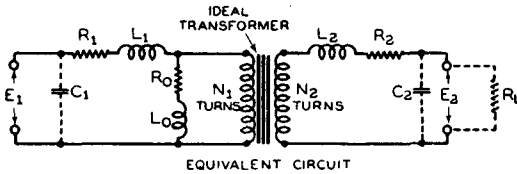

Figure 9

- (1) Primary Resistance
- (2) Secondary Resistance
- (3) Core Loss
- (4) Primary Leakage Inductance
- (5) Secondary Leakage Inductance
- (6) Capacitances.

The Equivalent Circuit of a typical iron-core transformer is shown in Fig. 9 in which

- R_1 = equivalent primary resistance
- L_1 = equivalent primary leakage inductance
- R_2 = equivalent secondary resistance
- L_2 = equivalent secondary leakage inductance
- R_0, L_0 = equivalent core loss network
- C_1, C_2 = primary and secondary equivalent lumped capacitances.

In this Equivalent Circuit the transformer as shown is assumed to have ideal characteristics and all the essential causes of departure from the ideal characteristics are shown externally. From this equivalent circuit diagram it is possible, although the process is somewhat laborious, to calculate the performance of the transformer under all practical conditions with a high degree of accuracy. However, it is possible to make certain simplifications, which are sufficiently accurate for most purposes, as shown in the Simplified Equivalent Circuit of Fig. 10. It will be seen that the leakage inductances, capacitances, and inductive component in the core loss network have been neglected.

Since the transformer shown in Fig. 10 is assumed to have ideal characteristics it is possible to refer everything to the primary side (or to the secondary if more convenient). Fig. 11 shows that R_1 and R_0 remain unaltered, R_2 and R_L become greater by a factor $(N_1/N_2)^2$, and the output voltage E_2 becomes greater by a factor (N_1/N_2) . If a transformer is available for measurement it is possible to determine R_1 , R_2 and R_0 , without much difficulty. If however a transformer is in the process of design, there are so many unknown quantities that progress is difficult unless

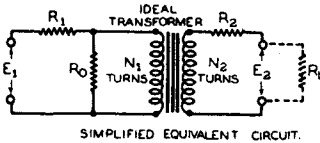

Figure 10

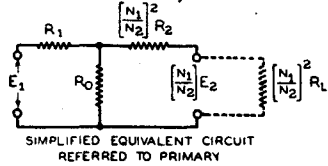

Figure 11

certain assumptions are made. If the transformer is intended to supply power it is generally most economical to make the primary loss equal to the secondary loss. For most transformers it is also fairly reasonable to assume that the core loss is equal to the sum of the primary and secondary resistance losses. Then if the input power is W_1 and the efficiency is given by the Greek letter η (eta)

$$\begin{aligned} \text{Power output} &= \eta W_1 \\ \text{Power loss} &= (1-\eta) W_1 \\ \text{Primary (copper) loss} &= \frac{1}{4} (1-\eta) W_1 \\ \text{Secondary (copper) loss} &= \frac{1}{4} (1-\eta) W_1 \\ \text{Core loss} &= \frac{1}{2} (1-\eta) W_1 \end{aligned}$$

(Note that $\eta = 1$ for an ideal transformer)

By means of these assumptions it is possible to obtain results which are very useful in transformer calculations.

Voltage Ratio

Let the turns ratio secondary to primary be T .

Then the voltage ratio from secondary to primary will be given by

$$\frac{E_2}{E_1} = \frac{3\eta + \eta^2}{1 + 3\eta} \cdot T$$

By substituting numerical values for η the following values are obtained:—

η	0.5	0.6	0.7	0.8	0.9	1.0
E_2/E_1	0.7T	0.772T	0.835T	0.894T	0.949T	1.0T

As an approximation, with a maximum error of only 1% for values of η between 0.5 and 1.0, we can use the expression

$$E_2/E_1 = \sqrt{\eta} \cdot T$$

Impedance Ratio

If the secondary of a transformer is loaded by a resistance R_L , the load presented by the primary to the source of power is a function of the losses in the transformer. If the preceding assumption is made regarding the allocation of losses between core ($\frac{1}{2}$), primary ($\frac{1}{4}$), and secondary ($\frac{1}{4}$), it may be shown that the load resistance presented by the primary is almost exactly equal to R_L/T^2 for values of η between 0.5 and 1.0, the error due to this assumption being only 2% at $\eta = 0.5$.

If less than one half of the total losses occur in the core, the load resistance presented by the primary will be greater than R_L/T^2 . Similarly if more than one half of the losses occur in the core, the load resistance presented by the primary will be less than R_L/T^2 .

In any specific case in which the transformer constants are known it is possible to calculate the load presented by the primary from the equation

$$r = R_1 + \frac{R_o (R'_2 + R'_L)}{R_o + R'_2 + R'_L}$$

where r = load resistance presented by the primary.

R_1 = primary resistance,

R_o = equivalent core-loss shunt resistance,

$R'_2 = R_2/T^2$ = secondary resistance referred to the primary,

$R'_L = R_L/T^2$ = load resistance referred to the primary,

R_2 = secondary resistance,

R_L = load resistance,

and T = turns ratio secondary to primary,

Damping on Loudspeaker

The damping imposed by the plate resistance of the power valve on the voice coil of the loudspeaker is also affected by losses in the transformer. However, on the previously assumed allocation of losses, the damping factor* will be approximately the same as for a perfect transformer.

AUDIO FREQUENCY TRANSFORMERS No Grid Current

With audio frequency transformers it is necessary to consider not only the turns ratio and losses, but also the primary inductance and the effect of leakage inductance and distributed capacitances in both primary and secondary.

Primary (or Choke) Inductance

The inductance of the primary governs the relative amplification at low audio frequencies. The amplification at low frequencies with relation to that at middle frequencies is given by the expression

$$\text{Relative Amplification} = \frac{1}{\sqrt{1 + (r_p/\omega L)^2}}$$

where r_p = effective valve plate resistance

$\omega = 2\pi \times \text{frequency}$

and L = primary inductance.

From this formula the following tables have been derived:—

Loss of	Relative Amplification	$\omega L/r_p$
1 db	0.89	1.94
2 db	0.79	1.3
3 db	0.71	1.00
6 db	0.50	0.58

It will be seen that for 3 db loss, $\omega L = r_p$, i.e., the reactance of the primary is equal to the plate resistance of the valve.

*See Chapters 2 and 3.

PLATE RESISTANCE OF VALVE	BASS RESPONSE DOWN 2 db AT			
	150 c/s.	100 c/s.	50 c/s.	30 c/s.
7,500 ohms	10.5H.	15.75H.	31.5H.	52.5H.
10,000 "	14 H.	21.0 H.	42.0H.	70.0H.
15,000 "	21 H.	31.5 H.	63 H.	105 H.
20,000 "	28 H.	42 H.	84 H.	140 H.
30,000 "	42 H.	63 H.	126 H.	210 H.
50,000 "	70 H.	105 H.	210 H.	350 H.
100,000 "	140 H.	210 H.	420 H.	700 H.

For the bass response to be down 1 db under similar conditions, the inductances should be increased by a factor of 1.5 (approx.).

Leakage Inductance and Capacitances

Leakage inductance occurs in both primary and secondary windings, and results in loss of high audio frequency response. In order to reduce this to a minimum it is usual to wind good audio frequency transformers in three or more sections with primary and secondary alternating. The equivalent leakage inductance may be determined (for the worst conditions) by short-circuiting the secondary and measuring the inductance of the primary.

If it were not for capacitances in the windings, together with external stray and valve capacitances, leakage reactance would be far less important. Due to these capacitances there is always a peak in the response curve at a frequency, generally from 5,000 c/s. to 12,000 c/s. in good transformers, at which the equivalent leakage reactance resonates with the total equivalent capacitances. In order to raise this frequency of resonance to a high value, both leakage inductance and capacitances must be kept to a minimum. In order to reduce the amplitude of the peak the secondary is wound with the finest practicable gauge of wire, or alternatively with wire having a higher resistance than copper. If the peak is still too prominent, a shunt load resistance may be connected across the secondary. A higher value of valve plate resistance will reduce the peak although also affecting the bass response.

In order to reduce winding capacitances each section of the winding may be divided into sub-sections spaced apart by short distances.

Turns Ratio (Inter-valve transformers)

With a given winding arrangement there is a limit to the number of secondary turns which can be employed for a fixed high audio frequency response. If a large number of turns are used on the primary the turns ratio will be limited. Consequently a high turns ratio can only be obtained by reducing the number of turns, and therefore the inductance, of the primary. If high incremental permeability steel is used for the core, some reduction of primary turns may be made without reducing the inductance below a satisfactory figure.

In most cases a ratio of 1 : 3½ is the greatest which can be attained with normal inductance and methods of winding. Increased inductance and improved high audio frequency response may be obtained with the same core by increasing the primary turns and decreasing the secondary turns to provide a ratio of 1 : 2 or 1 : 2½. When a centre tapped secondary is used the turns ratio is calculated for the whole secondary.

A typical audio frequency transformer may be constructed with 5,000 turns on the primary and 15,000 on the secondary, both windings being 40 B.&S. enamelled wire. The turns ratio will be 1 : 3. This transformer will give fair fidelity with a valve having a plate resistance of 10,000 ohms and drawing a plate current less than 5 mA.

The inductance will, of course, depend upon the type of iron laminations used, and a high incremental permeability grade of silicon steel is desirable.

A transformer with push-pull primary and push-pull secondary may be constructed with 7,000 turns on the primary and 14,000 on the secondary, both being centre tapped. Both windings may be 40 B.&S. enamelled wire, and the turns ratio will be 1 : 2 (whole primary to whole secondary).

With both these transformers the response above about 5,000 c/s. will be attenuated unless the secondary is wound in at least two sections.

In transformers of this nature the primary is generally wound next to the core, with the secondary outside it. Under these conditions the correct arrangement of connections is

Inner Primary to Plate
Outer Primary to B+
Inner Secondary to C—
Outer Secondary to Grid.

With push-pull windings both halves should be symmetrical, and one way by which this may be accomplished is to wind two identical bobbins, each containing one-half of the primary turns on top of which is wound one-half of the secondary turns. These windings are then placed end to end but with one rotated 180° so that corresponding sides are together. Both sections of primary and secondary are then connected in series by respectively connecting together the inside ends of the secondary and the outside ends of the primary. The connections will then be

Two Inner Primaries to Plates
Common Outer Primary to B+
Common Inner Secondary to C—
Two Outer Secondaries to Grids.

Class B Transformers

The transformers driving the grids of a Class B or AB2 stage are required to deliver power, and must therefore be regarded as power transformers with careful attention to efficiency. In general, the primary inductance should be the same as for a Class A1 transformer. Leakage inductance should be kept to the lowest possible value since its presence tends to cause parasitic oscillation in the grid circuit. Capacitances in general are of less importance since a step-down ratio is usually employed. Design on a basis of 70% peak current efficiency with 7.5% loss in the primary, 7.5% in the secondary and 15% in the core is typical of fairly good practice.

Output Transformers

(a) Triode Power Valves (Class A1)

With triode power valves the effective resistance shunted across the primary of the output transformer is the resultant of the plate resistance and the load resistance in parallel. If the load resistance is a fixed resistive load and is assumed to be twice the plate resistance, the resultant will be 0.67 times the plate resistance, and this may be regarded as sufficiently close for most design purposes. However, with a speaker load the secondary load impedance at the bass resonant frequency will be considerably higher than at 400 c/s. For most popular types of loudspeakers it may be assumed to be six times that at 400 c/s. On this basis the load resistance will be approximately twelve times the plate resistance at the bass resonant frequency, giving a resultant shunt impedance of 0.92 times the plate resistance. This is so close to unity that there does not seem to be any appreciable advantage in using it as a basis for inductance.

Consequently, the following table has been calculated on the basis of plate resistance shunting only.

Plate Resistance (Triode Valve) Ohms	Primary Inductance in Henries for response 2 db down at resonant frequency of:			
	150 c/s	100 c/s	75 c/s	50 c/s
800	1.12	1.68	2.24	3.36
1,000	1.4	2.1	2.8	4.2
1,200	1.68	2.52	3.36	5.04
1,500	2.1	3.15	4.2	6.3
2,000	2.8	4.2	5.6	8.4
3,000	4.2	6.3	8.4	12.6
4,000	5.6	8.4	11.2	16.8
5,000	7.0	10.5	14.0	21.0
10,000	14.0	21.0	28.0	42.0

These values of inductances should be multiplied by a factor of approximately 1.5 for a reduction in response of only 1 db.

The ratio of an output transformer should be designed to reflect into the primary an impedance of the rated value for the power valve in use. This will be affected by the losses in the transformer (see earlier part of this chapter) but is given approximately by

$$\text{Ratio} = \frac{N_1}{N_2} = \sqrt{\frac{\text{Rated load resistance of power valve}}{\text{Voice coil impedance at 400 c/s.}}}$$

The impedance of a transformer with loudspeaker load may be measured by means of a suitable bridge circuit.*

(b) Pentode and Beam Tetrode Valves

With pentode and similar power valves the plate resistance is so much higher than the load resistance that the load resistance becomes the sole controlling factor. Due to the rise of loudspeaker impedance at the bass resonant frequency, the voltage applied to the voice coil through an ideal transformer would rise to a very high value, and the reproduction would have excessive bass response over a small frequency range. In order to give more uniform response the inductance is generally decreased so that the resultant load on the valve at the bass resonant frequency is of the order of the nominal load resistance. The following table has been calculated on the basis of $\omega L = RL$ and gives the transformer primary inductance for output voltage at the bass resonant frequency equal to that at middle frequencies.

Nominal Load Resistance* Ohms	Inductance* in Henries to give equal Voltages across voice coil at middle frequencies and at a bass resonant frequency of:			
	150 c/s	100 c/s	75 c/s	50 c/s
2,500	2.7	4.0	5.4	8.0
4,000	4.3	6.4	8.6	12.8
5,000	5.3	3.0	10.6	16.0
6,000	6.4	9.6	12.8	19.2
7,000	7.5	11.2	15.0	22.4
8,000	8.5	12.8	17.0	25.6
10,000	10.7	16.0	21.4	32.0
15,000	16.0	24.0	32.0	48.0

*Plate-to-plate for push-pull operation.

*J. B. Rudd "Impedance Measurements on Loudspeaker Transformers," A.R.T.S. and P. Bulletin No. 69.

Although these values of inductance will place on the valve at the bass resonant frequency a load impedance approximately equal to the nominal load resistance, the load will be largely reactive and the loadline will be a very open ellipse. This will limit the power output for permissible distortion to a value very much less than the rated output of the valve. However, this effect is unavoidable if the low value of inductance is used to act as an appreciable shunt across the load.

In many cases a compromise is made and an inductance up to twice the values given in the table is adopted so as to give some bass boost without spoiling the tonal balance.

References to Articles on Audio Transformer Design.

Glenn Koehler: "The Design of Transformers for Audio Frequency Amplifiers with Pre-assigned Characteristics," Proc. I.R.E., Vol. 16, p. 1742, December (1928).

Paul W. Klipsch: "Design of Audio Frequency Amplifier Circuits Using Transformers," Proc. I.R.E., Vol. 24, p. 219, February (1936). (This article deals with resistance loading of the secondary).

J. G. Story: "Design of Audio Input and Intervalve Transformers," Wireless Engineer, Vol. 15, No. 173, February (1938).

For general reading see also the following books:—

F. E. Terman, "Radio Engineering."

R. S. Glasgow, "Principles of Radio Engineering."

Distortion in Transformer Cores.

An excellent series of articles on this subject was given by N. Partidge in the "Wireless World," commencing in the issue June 22 (1939), p. 572.

The Design of Power Transformers

The design of power transformers has been very adequately dealt with elsewhere.* It is not possible in this hand-book to treat the subject adequately but a few comments are made regarding the design of small power transformers for supplying power to rectifiers for radio receivers and amplifiers.

For transformers of this kind an overall efficiency of about 85% is usual. This loss may be approximately one-half core loss and the other half resistance losses in the primary and secondary. Since the regulation in any case is rather poor, it is usual to neglect the effects of leakage reactance as of small importance.

The optimum effective core area in square inches is given approximately by

$$A = \sqrt{W}/5.58$$

where W = volt-amperes output.

The number of turns (N) on the primary is determined from the formula:

$$N = \frac{0.225 \times 10^8 E}{f B_{\max} \cdot A}$$

Where E = primary voltage,

f = frequency in c/s,

B_{\max} = maximum A.C. flux density,

and A = cross sectional area of core in square inches.

*G. Kapp, "Transformers" (Whittaker).

A. Still, "Principles of Transformer Design" (John Wiley and Son).

A. Still, "Elements of Electrical Design" (McGraw-Hill).

If $B_{\max} = 80,000$ maxwells per square inch (a usual value for radio receiver power transformers) this reduces to

$$N = \frac{280 E}{f A}$$

If $E = 250$ volts and $f = 50$ c/s, this becomes

$$N = 1400/A$$

If, in addition, the effective core area is $1\frac{1}{2}$ square inches, the primary turns will be 1120, or 4.5 turns per volt. For an effective core area of 1 square inch the primary turns will be 1400, or 5.6 turns per volt.

Reference should be made to Chapter 22 for the effects of transformer heating due to the form factor of the current. It is satisfactory to base the design on a current in the secondary winding supplying a rectifier equal to $0.78 \times$ direct-current for condenser input filter, or $0.707 \times$ direct-current for choke input filter.

In the case of half-wave rectifiers these factors should be doubled.

Allowance should be made for the fact that the primary volt-amperes will be 1.11 times the D.C. power output for a choke input filter, the D.C. output being considered as the total output including voltage drop in the rectifier (see Chapter 22). For most transformers of this nature, it is satisfactory to choose the gauge of wire for the windings on the basis of 1200 to 1500 circular mils per ampere.

The Calculation of Core Loss

The manufacturers of transformer laminations usually supply values of core loss for various A.C. flux densities. The maximum† A.C. flux density in a transformer is given by

$$B_{\max.\text{A.C.}} = \frac{\sqrt{2} \times 10^8 E}{2\pi f N A} \text{ Maxwells per sq. inch,}$$

where $E =$ R.M.S. voltage across primary,
 $f =$ frequency,
 $N =$ number of turns,
 $A =$ cross-sectional area of core in square inches.

If $B_{\max.}$ A.C. is known, the core loss may be ascertained from published data. As an example, the core loss for Baldwin's No. 4 or equivalent 0.014" laminations at 50 c/s. is given below, for no D.C. flux:

A.C. flux density ($B_{\max.\text{A.C.}}$) Maxwells/sq. inch	Core loss	
	Watts/lb.	Watts/cu. inch.
40,000	0.272	0.068
80,000	1.02	0.252

From knowledge of the input power, permissible percentage of core loss, maximum A.C. flux density and core loss per cubic inch, it is possible to select a suitable core.

The Measurement of Inductance.

For the accurate measurement of inductance, one of the Bridge methods is essential; the Owen and Hay bridges‡ are very satisfactory for this purpose, the latter being widely used for the measurement of incremental inductance (i.e., with D.C. flowing).

†Maximum in this application has a similar meaning to "peak" in A.C. theory.
 ‡See F. E. Terman, "Measurements in Radio Engineering," pp. 44-58.

An approximate method which may be used for inductances intended to be used in choke input filters is given by Terman [(Figure 40, pp. 57-58).

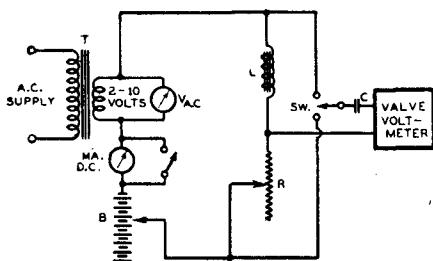

Figure 12

A method for measuring the impedance of an inductance is shown in Fig. 12. A valve voltmeter is used as the indicating device and the voltage drop across the inductance L is balanced against that across a variable resistance R . Any desired direct-current is passed through the inductance by adjusting the tapping on the battery B until the milliammeter shows the required deflection.

Since any adjustment to R causes a change in direct-current, it will be necessary to readjust the battery tapping each time that the adjustment to R is made. The secondary voltage of the transformer T may be from 2 to 10 volts for most purposes unless tests are required to be conducted at high A.C. flux density. Smaller A.C. voltages are not practicable with this arrangement owing to the insensitivity of the valve voltmeter.

A blocking condenser C is used to prevent D.C. deflection of the valve voltmeter: a value of $0.1 \mu\text{F}$. may be used. A switch may be used to short-circuit the D.C. milliammeter if it is desired to reduce the A.C. voltage drop across it. When this switch is closed the A.C. voltage across L will be half that of the secondary of the transformer T .

The adjustment is made by varying the value of R until the deflection of the valve voltmeter is the same for both positions of the switch SW . It is obvious that the voltage drop across L is that due to the impedance and not to the inductance alone, but for many purposes the accuracy obtained is sufficient, if it is assumed that the impedance is equal to the inductance. In this case

$$L = R/2\pi f$$

or if the supply frequency is 50 cycles per second.

$$L = R/314 \text{ henries.}$$

The Calculation of Inductance

(a) No Direct Current Component

Interleaved Laminations: The inductance is given by

$$L = \frac{3.2 \times 10^{-8} \times N^2 \times \mu \times A}{l} \text{ Henries}$$

where N = number of turns,

μ = incremental (A.C.) permeability,

A = effective cross sectional area of core in square inches,

and l = length of path of magnetic circuit in inches.

In this formula no allowance has been made for any gap in the magnetic circuit. The value of μ depends on the type of iron used in the laminations, as well as on the A.C. and D.C. flux densities.

The length of the magnetic path is the distance travelled in a complete circuit of the core (Fig. 13). The path taken will be along the centre line of each leg, except that when there are two windows each

path through the centre leg will be along a line one quarter way across the leg. Note that in this latter case only a single circuit (around one window) is considered in the calculation of the length of magnetic path.

The approximate incremental permeability of commercial grades of electrical steel such as Lysaght-Sankey's "Stalloy," Baldwin's "Grade 4" and Armco's "TranCor 3" is given in the following table:—

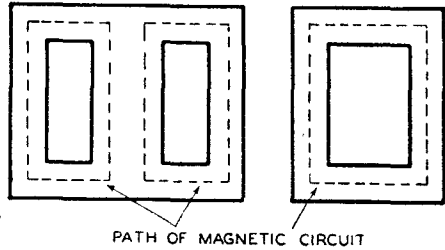

Figure 13

Gauss	A.C. Flux Density Maxwell/sq. inch	Incremental Permeability μ (approx.)
	Very low flux density	1,000
100	640	1,200
200	1,280	1,320
400	2,560	1,600
500	3,200	1,700
1,000	6,400	2,000
2,000	12,800	2,700
4,000	25,600	3,000
7,000	44,800	2,000
10,000	64,000	1,000

In the case of audio frequency transformers, which may be operated at very low A.C. flux density, the value of μ should be taken as for very low flux density, namely 1000. The increase of μ at higher flux densities will result in increased inductance under these conditions.

(b) Direct Current Component

When Direct Current flows through a winding the incremental permeability of the core is decreased. The incremental permeability with heavy D.C. flux density may be improved by making an air gap in the core. The ratio of air gap to total magnetic length of path is called the gap ratio. There is an optimum gap ratio for all values of D.C. flux density as will be seen from the following table. In this table A.T./in. = ampere turns per inch length of magnetic path.

TABLE FOR HIGH INCREMENTAL PERMEABILITY SILICON STEEL.

Table gives value of μ under specified conditions.*

Gap Ratio	1.0		2.0		5.0		10		20		40	
	A.T./in.	A.T./in.	A.T./in.	A.T./in.	A.T./in.	A.T./in.	A.T./in.	A.T./in.	A.T./in.	A.T./in.	A.T./in.	A.T./in.
0	1000	820	490	340	250	140						
0.0005	720	700	680	560	360	170						
0.001	530	520	510	490	410	250						
0.0015	—	425	410	400	370	270						

*Values of μ are for very low A.C. flux density.

For example take the following transformer: —

Width of core under winding	= 0.5 inch,
Stack of laminations	= 0.55 inch,
Effective iron thickness	= 0.5 inch,
Cross sectional area of core	= 0.25 sq. inch,
Length of magnetic path	= 5 inches,
Primary turns	= 5000.

When the primary direct-current is 1 mA. the number of ampere turns will be $(0.001 \times 5,000)$ or 5, and the ampere turns per inch will be 5/5 or 1. The incremental permeability will therefore be 1,000.

If the primary direct-current be increased to 5 mA. the A.T./in. will be 5 and the incremental permeability will be only 490. It will be seen that for a gap ratio of 0.0005 the incremental permeability will increase to 680. For this to be effected the gap should be 0.0005×5 or 0.0025 inch. This is almost exactly the equivalent gap of a close butt joint. At higher values of ampere turns per inch a wider gap becomes necessary, and the two sections of the core may be held apart by a suitable thickness of fibre or thin board. With the "E" type of lamination the effective gap is twice the thickness of the spacing since two gaps are inserted in series. This is particularly advantageous when large air gaps are employed. For typical small audio frequency transformers the following is a fairly reliable guide:

No. D.C.	— Interleaved.
Up to 5 mA. D.C.	— Butt joint,
Above 5 mA. D.C.	— Butt joint with gap.

With push-pull audio transformers allowance should be made for an out-of-balance current of about 15% of the nominal current for one valve. In some cases where high permeability material is used it is necessary to make special arrangements for plate current balancing.

When an air gap is employed the characteristics of the laminations become less important, and with large air gaps the incremental permeability of the iron alone is relatively unimportant.

The Design of Iron Core Filter Chokes Carrying D.C.

(Hanna's Method)

The following design holds only for conditions in which the direct-current is considerably greater than the peak A.C. current. A further assumption is that the cross-sectional area of the core is constant throughout the magnetic path, so that in a shell type core the outside legs should each be half the cross-sectional area of the centre leg.

- Let N = number of turns.
 I = direct-current.
 L = inductance in henries at low A.C. flux density.
 l = length of magnetic circuit (inches).
 a = length of air gap (inches).
 a/l = gap ratio.
 A = cross-sectional area of core.
 $V = lA$ = volume of iron in cubic inches.

Procedure.

Knowing the required L and I , and assuming suitable values for l , A and V , to determine N and a —

- (1) Calculate (Ll^2/V) then refer to table to find (NI/l) .
- (2) Determine N from (NI/l) .
- (3) Refer to table to find corresponding gap ratio (a/l) .
- (4) Determine "a" (for large gaps the effective value of "a" will be somewhat less than the measured value).

The inductance will be greater with larger A.C. flux densities, i.e., the filtering efficiency of an iron core choke is greater when the ripple voltage is higher.

With any particular core the highest inductance is obtained by winding the largest possible number of turns in the space available (limited by

the maximum D.C. resistance and by minimum gauge of wire) and by increasing the air gap until the inductance is a maximum.

TABLE FOR 4% SILICON STEEL.

(LI ² /V)	(NI/l)	(a/l) = gap ratio
0.00027	3.18	0.0002
0.00115	6.6	0.0004
0.00197	10.2	0.0006
0.00336	13.7	0.0008
0.00475	17.5	0.0010
0.00647	21.9	0.0012
0.00852	26.0	0.0014
0.0108	30.8	0.0016
0.0135	36.0	0.0018
0.0169	43.0	0.0020

The following guide may be used in the design of filter chokes for use with single phase rectifiers.

	(LI ² /V)	(NI/l)	(a/l) = gap ratio
Initial Choke*	0.05	96	0.0046
Following Chokes	0.08	148	0.0062

The following simple method may be used for calculating the inductance of chokes or transformers with fairly large air gaps :—

$$L = \frac{3.2 A N^2}{a \times 10^8}$$

where the symbols have the same meanings as for the preceding case. For accuracy "a" should be calculated as the actual air gap plus the air gap equivalent of the iron core.

The flux density (B) in lines per square inch will be given by

$$B = 3.2 NI/a$$

*The first choke in a choke input filter.

CHAPTER 27

Voltage and Current Regulators

Gaseous voltage regulators — Valve voltage regulators — Barretters and Current Regulators.

Gaseous Voltage Regulators

Certain cold cathode gas-filled tubes may be used to provide nearly constant voltage since their characteristics are such that the voltage drop across the tube remains nearly constant for a wide range of currents.

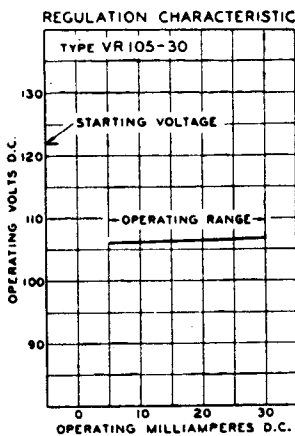

Figure 1

The regulation characteristic of a typical gaseous voltage regulator tube is shown in Fig. 1 and it will be seen that the starting voltage is considerably higher than the voltage drop across the tube for normal operating currents. It is therefore necessary to apply a supply voltage equal to or higher than the "starting voltage." This must be applied through a series resistor (Fig. 2) so that the maximum current

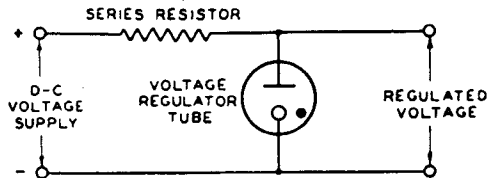

Figure 2

drawn by the tube does not under any circumstances exceed its maximum rating. This resistor also serves another purpose since it enables the output voltage to be regulated by the characteristics of the tube. With a high load resistance almost the whole current drain from the supply goes through the regulator tube and very little through the load. With a low load resistance the current through the load is increased and the current through the tube decreased. A similar effect occurs when a variable D.C. supply voltage is used with a constant load resistance so that in all cases the voltage applied to the load remains approximately constant. The current through

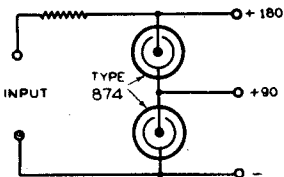

Figure 3

the regulator tube should not be allowed to fall below the rated minimum since its characteristics for very low currents are unreliable.

Two or more tubes may be connected in series to obtain higher voltages which are multiples of the single tube drop and tapings may be taken from the junctions between them (Fig. 3). The voltage drop across a tube cannot be changed except by changing the type of tube.

The resistance of the series resistance (Fig. 2) is given by

$$R = \frac{E_i - E_o}{I_{max}}$$

where E_i = supply voltage,

E_o = output (regulated) voltage.

and I_{max} = maximum rated current of tube.

Valve Voltage Regulators

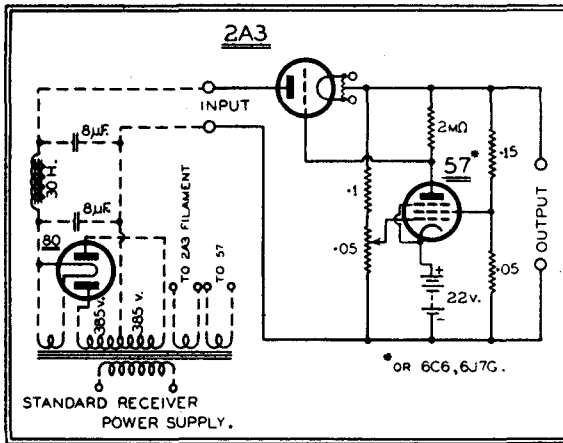
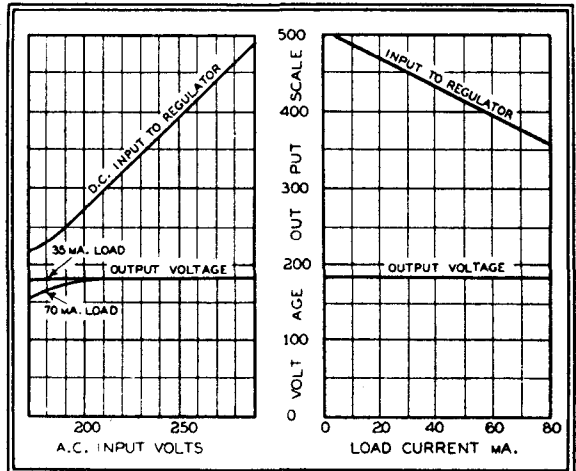

Figure 4. Typical valve type voltage regulator capable of delivering 180 v., D.C., at current drains up to 80 mA.

Figure 5. Regulation characteristics of valve-type voltage regulator shown in Fig. 4.



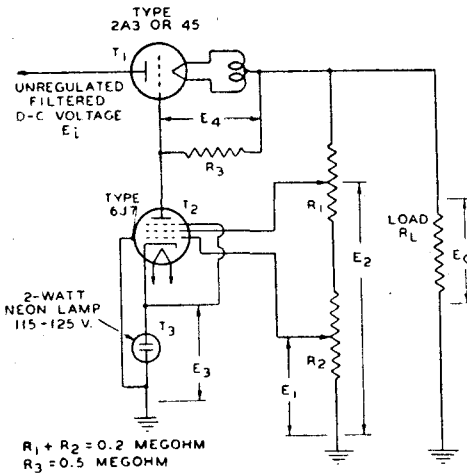

Figure 6

A triode valve which is capable of passing considerable plate current may be used in a suitable circuit as a supply of almost constant voltage. One satisfactory arrangement is shown in Fig. 4 and is suited to an output voltage of approximately 180 volts D.C. and a current drain up to 80 mA. total maximum. The regulation characteristics are given in Fig. 5.

In an alternative arrangement the bias battery is replaced by a neon lamp. The circuit arrangement* for this is shown in Fig. 6.

Type 0A4-G (gaseous triode) may also be used very satisfactorily in a voltage regulator.

Barretters and Current Regulators

A barretter or current regulator is a device incorporating a filament (usually of iron) mounted in an atmosphere of gas (usually hydrogen), the characteristics of which are that the current passing through the filament remains very nearly constant for a wide range in voltage drop. A barretter

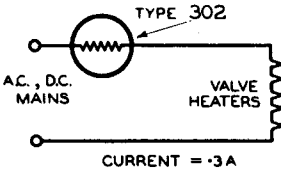

Figure 7

may be used, for example, in series with the heaters of the valves in a radio receiver provided that the barretter is suited to the valves being used (Fig. 7). Since the filament of a barretter is generally of iron it should not be mounted in proximity to any magnetic field, otherwise damage may be done to the barretter. A considerable amount of power is dissipated by most types of barretters and good ventilation is essential. A barretter

should be mounted in a vertical position and as far as possible from other components.

Occasionally it is desired to increase by a small amount the current controlled by a barretter and this may be done within certain limits by operating it in parallel with a fixed resistance. This is not normally recommended since the effectiveness of the barretter is reduced. It may be used fairly satisfactorily for an increase of current up to about 10% of the current in the barretter.

If the barretter is required to control a current which is smaller than the current rating of the barretter, this may be accomplished by shunting the current-regulated device by a resistor. In this case there is no limit to the degree of shunting.

*R.C.A. Application Note No. 96.

CHAPTER 28

Tuning Indicators

Millimeter Type — Saturated Reactor Type — Magic Eye Tuning Indicator — Null Point Indicator using Magic Eye.

Tuning Indicators

A tuning indicator is a device which indicates, usually by means of a maximum or minimum deflection, when a receiver is correctly tuned. One form which such an indicator may take is a millimeter in the plate circuit of a valve which is controlled by A.V.C. Another form is the saturated reactor tuning indicator. In this type a pilot lamp, in series with a special form of iron-cored inductance, is excited

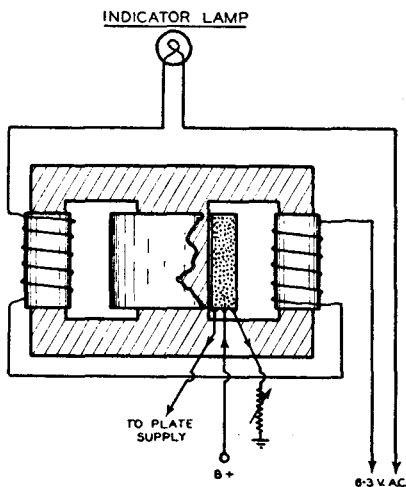

Figure 1. Saturated Reactor Tuning Indicator.

from a suitable winding on the power transformer. A second winding on the inductance carries the plate current of one or more valves which are controlled by A.V.C. In this simple form the maximum plate current is sufficient to saturate the core, and so reduce the impedance in series with the pilot lamp. In order to make the pilot lamp reach full brilliance when the receiver is tuned to a station, a “bucking” current is passed through another winding so that saturation occurs when the plate current is very small (Fig. 1).

Another, and extremely popular, form is the **Magic Eye Tuning Indicator**, such as Radiotron 6U5/6G5, which operates from either the signal diode or A.V.C. diode circuit. The Magic Eye is not limited to use on receivers with A.V.C., since it operates so as to indicate a change of voltage across any part of the circuit. For example it may be connected to the signal diode circuit irrespective of the presence of A.V.C. or it may be connected across the cathode bias resistor of an “anode bend” detector. The correct type of Magic Eye Tuning Indicator to be selected for any position depends on the controlling voltage available.

The most popular types of Magic Eye have a triode amplifier incorporated in the same envelope, so that the voltage necessary to obtain full deflection is decreased. In most types this amplifier has a super-control characteristic so that the sensitivity may be high for weak signals and yet not cause “overlapping” on strong signals. Type 6E5 has a linear characteristic and is occasionally used for special applications. Type 6AF6-G has two independent Ray-Control Electrodes, one of which may be used for strong signals and the other for weak signals, but has no amplifier incorporated in the same envelope.

In a typical receiver with delayed A.V.C. the Magic Eye may be connected to either the signal or the A.V.C. circuit, but since it will give no indication until the diode commences to conduct, it will not operate on weak signals when connected to a delayed A.V.C. circuit. Consequently most delayed A.V.C. receivers employ the signal diode circuit for exciting the Magic Eye. There is one objection to this arrangement, since there is an A.C. shunting effect on the diode load resistance causing distortion at high modulation levels. This may be minimised by using a resistor in the grid circuit of the Magic Eye having a resistance at least four times the resistance of the diode load resistor. In order to prevent flicker due to modulation it is necessary to add a smoothing condenser ($0.05 \mu\text{F}.$) at the grid of the Magic Eye as shown (Fig. 2). If simple A.V.C. (i.e., common diode and no delay voltage) is used, it is preferable to operate the Magic Eye from the A.V.C. line to avoid more shunting on the diode load resistor than that already incurred by using simple A.V.C. (Fig. 2).

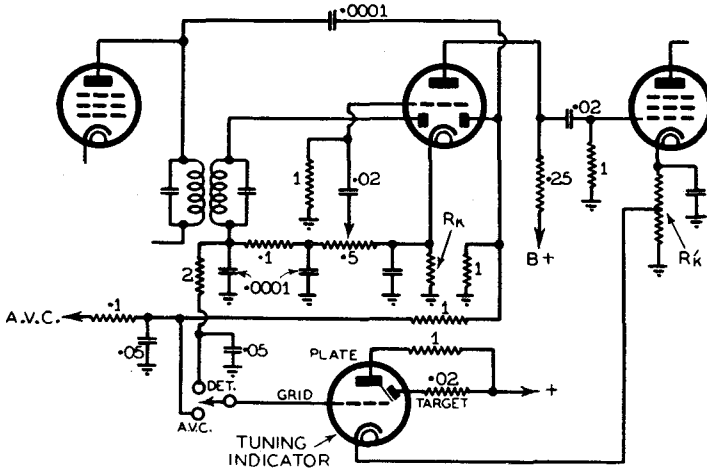

Figure 2: Circuit diagram illustrating the application of the Magic Eye Tuning Indicator. With the switch in the "Det." position the grid of the tuning indicator is connected through a 2 megohm resistor to the detector diode circuit. With the switch in the "A.V.C." position it is connected directly to the A.V.C. line. The cathode of the Tuning Indicator is returned to a suitable tapping point on the cathode bias resistor of the power valve.

The cathode of the Magic Eye should be as closely as possible at the same potential as the cathode of the diode. If its cathode is more negative than that of the diode, grid current may flow, increasing the initial bias on the controlled stages and reducing the sensitivity of the receiver. Consequently if the diode cathode is earthed, the Magic Eye cathode should also be earthed, but if the diode cathode is positive then the Magic Eye cathode should also be positive by an approximately equal value. One satisfactory method of obtaining this positive voltage, which however may only be used when a Class A power valve is used, is to connect the cathode of the Magic Eye to a tapping on the cathode bias resistor of the power valve (Fig. 2). With this arrangement it is advisable for the tapping to be adjusted to make the cathode of the Magic Eye about 0.5 volt more negative than that of the diode in order to allow for contact potential in the Magic Eye, the "delay" due to this small voltage being negligible.

Alternatively the cathode return of the Magic Eye may be taken to a suitable tapping point on a voltage divider across the B supply. Due to the fairly heavy and variable cathode currents drawn by the older types of Magic Eye Tuning Indicators it is essential that any voltage divider or other source of voltage should not appreciably be affected in voltage by a current drain of from 0 to 8 mA. It is for this reason that it is not satisfactory to tie the cathode of the Magic Eye to that of the diode valve. With the newer "space-charge grid" construction the cathode currents remain more nearly constant throughout life, and this allowance for change of current need not be made. However, it is advisable not to base calculations for cathode bias resistors on the published values of cathode currents since these are higher in some cases than the average currents with valves of the new construction.

Overlapping of the two images is possible on very strong signals, whatever type of Magic Eye may be selected, but it is generally found with a remote cut-off type such as the 6U5/6G5 that under service conditions this is not very general. Certain arrangements have been devised to reduce the tendency to overlapping, but none is free from criticism. Desensitisation of the Magic Eye is readily applied, but also affects weak signals. The use of two separate Magic Eyes, or a single 6AF6-G with two separate amplifiers, one for weak and the other for strong signals, is excellent but expensive. If the grid of the Magic Eye is excited from the moving contact of the Volume Control the deflection will depend upon the setting of the control, and "silent-tuning" will not be possible.

Wide Angle Tuning with a maximum angle of 180° is practicable if an external triode amplifier is added.* With this circuit (Fig. 3) the edges of the pattern are sharp from 0° to about 150° to 180°

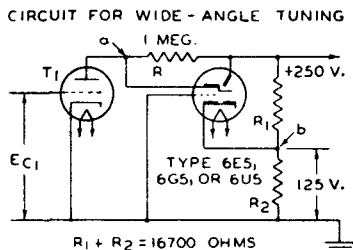

Figure 3

Null Point Indicator Using Magic Eye

A Magic Eye Tuning Indicator may be used in many applications as an indicating device, one of these being as a null point indicator for use with A.C. bridge circuits. Such an arrangement is preferable to the use of head phones or sensitive instruments, since it may be used without disturbance from external noises and is capable of withstanding considerable overload without damage. The sensitivity of Radiotron 6E5 is 0.1 volt R.M.S. for a very clearly marked indication. When used as a null point indicator the 6E5 grid is biased approximately 4 volts negative and the A.C. voltage is applied between grid and cathode. Any suitable pre-amplifying stage may be used to increase the sensitivity of the device if desired. When an A.C. voltage is applied the sharp image will change to a blurred half-tone and as the null point is reached the image will again become sharp. A heavy overload may cause overlapping of the two sides but this is not detrimental to the valve.

*R.C.A. Application Note No. 82, reprinted in Radiotronics 86, p. 128, May, 1938.

(Chapters 29 to 32, inclusive)

CHAPTER 29

Receiver and Amplifier Tests and Measurements

Introduction—definitions of terms—summary of tests—static tests—dynamic tests—sensitivity—gain of single stage—apparent aerial coil gain—converter valve gain—oscillator grid current—tests with reduced battery voltages—tracking—selectivity—bandwidth—cross modulation—blocking interference—image ratio—noise level—oscillator frequency drift—A.V.C. characteristic—overall distortion—fidelity—audio frequency response and distortion—audio linearity and distortion—overall frequency response and distortion—modulation distortion—residual hum—modulation hum.

Introduction:—The following test-procedure has been set down to determine the practical performance of modern radio receivers. Although there are many other tests which could have been included, it is considered that, as these are of a very specialized nature, their inclusion is not warranted.

The tests listed below and described in detail later, are those which are the most important for purposes of design. In general they agree with the "Standards on Radio Receivers, 1938" laid down by the I.R.E. (U.S.A.) with, of course, due regard to Australian conditions.

No attempt has been made to describe any acoustic tests as this subject is one in which there is considerable divergence of opinion. Such tests are left to the choice of the individual designer.

Many of the tests listed are not necessary for production schedules but, if carried out during the initial design work in the laboratory, the receivers produced can be kept within the accepted limits by means of simpler tests.

Definitions of Terms

1. Standard Test Frequencies.

Broadcast Band:—

	600 Kc/s
550 Kc/s to 1600 Kc/s	1000 Kc/s
	1500 Kc/s

Short-Wave Bands:—

No standards have been set, but the following are recommended, and if other bands are used similar points may be chosen.

Band	Test at
35 metres -- 105 metres	} 37.5 metres — 8.0 Mc/s 50 metres — 6.0 Mc/s 90 metres — 3.33 Mc/s
8.58 Mc/s — 2.36 Mc/s	
16 metres — 51 metres	
18.75 Mc/s — 5.88 Mc/s	
13 metres — 39 metres	} 14 metres — 21.4 Mc/s 25 metres — 12.0 Mc/s 35 metres — 8.58 Mc/s
23.1 Mc/s — 7.7 Mc/s	

2. Standard Input Voltages.

Four standard input voltages have been specified for certain tests (cross modulation, etc.).

1. "Distant-signal voltage": 86db below 1 Volt = $50\mu\text{V}$.
2. "Mean-signal voltage": 46db below 1 Volt = $5000\mu\text{V}$.
3. "Local-signal voltage": 20db below 1 Volt = $100,000\mu\text{V}$.
4. "Strong-signal voltage": 6db above 1 Volt = 2 Volts.

3. Sensitivity Test Input.

Sensitivity test input is expressed in microvolts and is the least input signal which, when modulated 30% at 400 cycles per second and fed into a receiver, will produce standard output with all gain controls at maximum.

4. Standard Output.

(1) For receivers capable of delivering one watt maximum undistorted output the Standard Output* is an audio frequency power of 500 milliwatts delivered to a standard dummy load.

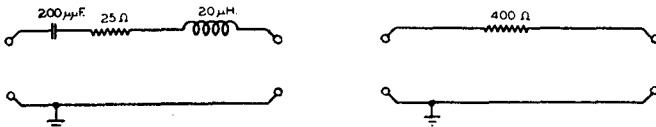

Figure 1 (left). Dummy antenna for broadcast frequencies.

Figure 2 (right). Dummy antenna for frequencies above 2.5 Mc/s.

(2) For receivers having less than one watt maximum undistorted output the Standard Output is an audio frequency power of 50 milliwatts delivered to a standard dummy load. When this value is used, it should be so stated. Otherwise the 500 milliwatts value is assumed.

5. Interference Test Output.

The interference test output is 30 decibels less than (or 0.001 of) the power of the standard test output, i.e., an output of 0.5 milliwatt.

*At the time of going to press the "standard output" of 500 mW. has not been universally accepted, and there is much difference of opinion on the matter. In view of this position our laboratory conducts tests with an output of 50 mW. on all receivers, and takes additional tests with an output of 500 mW. on receivers having a rated output exceeding 1 Watt.—Ed.

6. Standard Dummy Antennae.

Until recently two dummy antennae have been set down as standard; one for use at broadcast frequencies and up to 2.5 Mc/s, and the other for frequencies above 2.5 Mc/s. These are shown in Figs. 1 and 2 respectively.

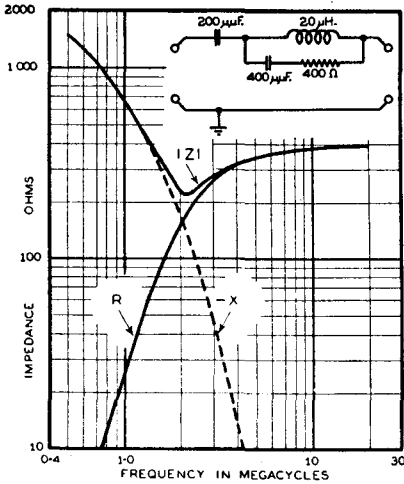

Figure 3 (Inset): Dummy antenna for all frequencies.
 Figure 4: Impedance characteristic of dummy antenna shown in Fig. 3.

A new dummy antenna, standardised by the I.R.E. (U.S.A.) in 1938, was designed to approximate the above two antennae over their essential frequency ranges. It is shown in Fig. 3 together with its impedance characteristic (Fig. 4).

The new dummy antenna has a particular advantage in testing receivers which include the frequencies between two and three megacycles in their tuning range. With the old type dummy antenna there is a sudden large change of impedance between the two so that replacing one by the other results in different measured values of receiver sensitivity. The new dummy antenna provides a gradual transition between the two impedances as would occur with aerials. At other frequencies outside the range of 2 Mc/s to 3 Mc/s there is no outstanding advantage either way between the new and the old dummy antennae.

Summary of Tests

A. Static Tests.

- Voltage.
- Current.
- Resistance.
- Line Voltage.

B. Dynamic Tests.

- Sensitivity Sensitivity at various points.
 Absolute sensitivity.
 Gain of a single stage.
 Apparent aerial coil gain.
 Converter valve gain.
 Converter valve oscillator grid current.
 Tracking.
- Selectivity Bandwidth.
 Cross modulation (Two-Signal Generator test)
 Blocking Interference.
 Image Ratio.
- Noise Level E.N.S.I.
- Oscillator Frequency Shift (On short waves).
- A.V.C. Characteristics A.V.C. curve.
 Overall distortion with variable input to aerial terminal at 400 c/s and constant output.

Fidelity	Audio Frequency Response and Distortion with both speaker and resistive load. Linearity and Distortion, speaker load only. Overall Frequency Response from aerial terminal at 5,000 μ V input 30% modulated, speaker and resistive load.
Modulation Distortion	Distortion at constant output with 5,000 μ V input modulated at 400 c/s.
Hum	Residual Hum. Modulation Hum.

In all the following tests the receiver should be allowed to operate for a sufficient time to reach stability before testing is commenced.

A. Static Tests

All voltages throughout a receiver should be checked before any dynamic measurements are made. Particular care should be taken to see that the screen and grid bias voltages are as specified. Modern pentode valves have high mutual conductance and are necessarily critical as to these voltages. The heater voltage also should be kept within close limits.

The above measurements should be made with a voltmeter of the high resistance type (at least 1,000 ohms per volt). Where measurements are made on resistance coupled audio frequency amplifiers a more sensitive meter should be used, preferably one having a resistance of 20,000 ohms per volt.

A check should also be made of the line voltage, and if testing is made over any length of time this check should be repeated at regular intervals, and an allowance made to compensate for the rise or fall of voltage.

B. Dynamic Tests

Sensitivity:

A signal modulated 30% at 400 c/s. is applied directly between grid and earth (or the negative terminal of the bias source in the case of back biased receivers) of the valve in the stage under measurement. The grid circuit direct current path is through the attenuator to earth or to the bias point. The reading of sensitivity is the input which produces standard output* with all gain controls and tone control set for maximum output.

Absolute Sensitivity:

Where appreciable noise is present with the signal, as is generally the case at the aerial terminal, the normal sensitivity figure is not a true indication.

Absolute sensitivity is the input modulated 30% at 400 c/s which will give standard output* at a frequency of 400 c/s. only. This is carried out by adjusting the input to the receiver until the difference in output with modulation switched on and switched off is equal to the standard output* in milliwatts. That is, the difference in output between signal plus noise and noise alone is equal to the standard output.*

This method holds good only when the noise power output is less than the signal power output. In receivers of very poor design the noise power output may exceed the signal power output, in which case it is necessary to use a tuned band pass filter for 400 c/s.

*Standard output may be either 50 or 500 milliwatts; see earlier section in this Chapter under Standard Output.

Gain of Single Stage (not converter stage).

The gain of a single stage or valve may be measured by means of valve voltmeters placed across both input and output. There is some difficulty in doing this, however, due to stray capacitances introduced by the wiring and also the time required to carry out a test of this nature on each stage.

The approximate gain may be calculated quite simply from the individual stage sensitivity figures.

$$\text{e.g. Gain} = \frac{\text{Input to Stage 2}}{\text{Input to Stage 1.}}$$

By reference to valve ratings, and with a knowledge of the coils or I.F. transformers in use an approximate check on gain may be made.

$$\text{Gain} = g_m \cdot \frac{R_L \times r_p}{R_L + r_p}$$

where g_m = mutual conductance
 r_p = plate resistance
 R_L = dynamic load resistance } Under working conditions

Apparent Aerial Coil Gain:

When measurements are made to determine the apparent gain of an aerial coil, care should be taken to make due allowance for noise by using absolute sensitivities.

At high frequencies the gain of a coil may be quite low, owing to damping imposed by the grid impedance of the following valve.

Converter Valve Gain:

The gain of a converter valve as an amplifier at intermediate frequency may be calculated in a similar manner to the gain calculation for other stages. Conversion gain, however, is not readily calculable, although the apparent conversion gain may be calculated in a similar manner to the intermediate frequency gain. This does not give a true indication, as the gain may be vastly different with and without a tuned signal grid circuit.

This phenomenon is apparent both on the broadcast band and on short waves, and is due partly to degenerative or regenerative effects which also affect the Q of the tuned circuit, but more largely to the fact that a current at oscillator frequency flows in the signal-grid circuit. When the grid circuit offers impedance to oscillator frequency, a voltage of oscillator frequency appears across the grid circuit and increases or decreases the conversion gain depending upon the phase relations. When a low resistance grid circuit is employed, as would be the case when a signal generator is applied between grid and earth, the impedance presented to this current of oscillator frequency is so low that no appreciable voltage of oscillator frequency appears on the signal grid, and the performance is therefore different from that with a tuned grid circuit.

A fairer comparison between different converter valves and/or different receivers may be made by measuring the sensitivity at the grid of the first intermediate frequency amplifier and also at the stage preceding the converter valve (Aerial terminal or grid of R.F. stage). The gain over the two stages may be calculated from these two measurements and this, together with a knowledge of the intermediate frequency transformer, may be used as a basis for comparison.

Converter Valve Oscillator Grid Current:

The oscillator grid current of the converter valve in a receiver, whether it be pentagrid, triode-hexode, or mixer with separate oscillator, should be measured by inserting a 0—1 milliammeter in the "cold" end of the oscillator grid leak. The grid current should be measured at each of the standard test frequencies. On each short wave band, it is particularly important that it should also be measured at the low frequency end of the band, where the condenser gang is at maximum capacity and the L/C ratio is very low.

With battery receivers it is necessary that the above tests be repeated with reduced battery voltages in order to ensure that oscillation will still take place when the batteries are near the end of their useful life.

To approximate the internal resistance of a partly used battery the following table* of resistors is recommended to be inserted in the "B" battery lead when using fresh batteries.

When 135 Volt Battery Drops to	Equivalent Internal Resistance
120 V.	60 ohms.
102 V.	300 ohms.
90 V.	660 ohms.
72 V.	1500 ohms.

When other than 135 volts is used the internal resistance should be calculated as a proportion from the above figures.

The filament voltage should also be reduced to simulate a rundown A battery. In the case of a 2 volt accumulator the voltage should be brought down to 1.8 volts or less. In the case of 1.4 volt valves the voltage may be reduced to 1.1 volt for broadcast band operation, or 1.2 volt for dual-wave receivers.

Tracking:

Tracking tests should be carried out at each of the standard test frequencies in each wave-band. This test is most easily carried out with a "Resonator" which can easily be made from a short length of $\frac{3}{4}$ " diameter bakelite tubing. A small plug of brass is inserted in one end and a small plug of high frequency iron in the other end.

The test is carried out by placing one end of the resonator into the coil in question. If the brass end gives an increase in output the inductance is too large, whilst if the iron end gives an increase in output the inductance is too small. If both ends cause a decrease the LC ratio is correct and the circuit is at resonance.

No limits on allowable tracking errors have been standardised by overseas Standards Committees. The following limits are suggested and have been used in practical production work. They can be maintained once a suitable design has been found for a set of coils.

	Good	Fair	Bad
Broadcast Band	0.5 db.	1 db.	2 db.
Short-wave Band			

The output should not increase by more than the amount shown in this table when the circuits are brought into resonance. Note that the values given in this table are not meant to be used as an indication of the sensitivity taken over a particular band, this being a function of the coils used.

*P. Marsal, "Battery Radio Design," Electronics, January (1938), pp. 12-14.

Selectivity:**(a) Bandwidth.**

This test should preferably be carried out at 600 Kc/s. and 1500 Kc/s. The signal generator, modulated 30% at 400 c/s, is set at one of the above frequencies, the receiver aligned to it, and the input adjusted to give standard output. The signal generator is detuned on each side of resonance and the input voltage increased until standard output is obtained. Observations are repeated at intervals until the ratio of the input off resonance to the input at resonance is 10,000 times.

These results may then be plotted as a curve on linear-logarithmic graph paper with frequency plotted horizontally on the linear scale and the ratio of the two inputs plotted vertically on the logarithmic scale. If the test is made at one frequency only this should be at 1000 Kc/s. For comparison of the selectivity of the I.F. section with that of the complete receiver the bandwidth test may be done in the same manner by feeding directly at intermediate frequency to the control grid of the converter valve instead of to the aerial terminal as previously. The difference between the two curves will show the effect on the bandwidth of the R.F. section of the receiver.

(b) Cross Modulation: Two Signal Generator Test.

The bandwidth test is not a sufficient check on the selectivity of a receiver, especially one which is to be used in close proximity to strong stations. When a receiver is tuned to a signal and there is a strong signal on a nearby channel, the interfering signal may cause cross-modulation, this being dependent upon the selectivity preceding the converter valve.

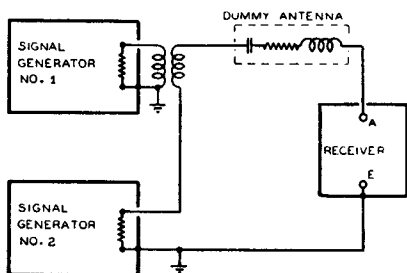

Figure 5: Arrangement of apparatus for two signal generator test of cross modulation.

The test is carried out by feeding signals from two signal generators to the aerial terminal of the receiver. The standard dummy antenna is used and the generators are coupled together as shown in Fig. 5. These two signals are the desired (No. 1) and interference (No. 2) signals. The receiver is tuned to the desired signal which is set at one of the standard input voltages of $50\mu\text{V}$., $5,000\mu\text{V}$., or $100,000\mu\text{V}$., modulated 30% at 400 c/s. and supplied by signal generator No. 1. The volume control of the receiver is adjusted to give standard output (500 mW.), after which the modulation is switched off. Signal generator No. 2 which supplies the interference or undesired signal (modulated 30% at 400 c/s.) is then switched on and tuned to various points on either side of the desired signal. At each point the input is adjusted to give standard interference test output (0.5 mW.).

The coupling transformer from generator No. 1 is not critical, but the secondary inductance should be small in comparison with the inductance in the dummy antenna itself. A low inductance transformer of approximately unity turns ratio will provide the $50\mu\text{V}$ and $5000\mu\text{V}$ desired signals, but careful design may be needed to obtain the $100,000\mu\text{V}$ desired signal unless signal generator No. 1 can deliver more than 0.5 volt at the primary.

Alternatively the transformer and dummy antenna may be combined, the $20\mu\text{H}$ inductance of the latter becoming the secondary of the transformer. Loose Coupling (less than 30%) should then be used between primary and secondary in order to avoid upsetting the constants of the dummy antenna. The primary inductance should be such that its reactance

is of similar order to the impedance of the signal generator at maximum output.

The voltage transfer ratio of the coupling transformer does not have to be known, since a substitution method is used in order to obtain the desired signal from signal generator No. 1. With signal generator No. 1 switched off and No. 2 switched on, the receiver output is adjusted to 500 mW. by means of the volume control, and signal generator No. 2 is switched off. Generator No. 1 modulated 30% at 400 c/s is next switched on and the input adjusted, at the standard frequency selected, until 500 mW output is again noted. Modulation is then removed from the output of generator No. 1.

Generator No. 2 is again switched on (modulated 30% at 400 c/s) and the generator tuned to each side of the desired signal. At each point the input to give standard interference output (0.5 mW) is noted. Observations should be taken at least every 10 Kc/s above and below the desired signal frequency until the undesired signal input reaches 1 volt. It is not necessary to test with an interfering signal less than 10 Kc/s. from the desired signal, as 10 Kc/s. is the minimum channel width employed and also because beat note interference would give false results.

This test should be repeated with each of the other standard input voltages and curves may then be drawn as for the bandwidth selectivity curves, undesired signal input in microvolts being plotted vertically and interference frequency in Kc/s. off resonance horizontally.

If two standard signal generators are not available, a modulated oscillator may be used in place of signal generator No. 1 provided that it will give the required output, and that the modulation is 30% and remains constant with change of output from the oscillator.

(c) Blocking Interference.

The strength of the undesired signal carrier in the cross modulation test may be such that the desired signal output is reduced. This may be due to overloading or a poorly designed A.V.C. system. It is not shown up by the cross modulation test but can easily be distinguished by the following method.

After each point on the cross-modulation curve is noted the modulation on the interfering frequency is switched off, the desired signal modulation is switched on, and the output of the desired signal noted. These points may then be plotted as curves on the cross modulation graph, the desired output being plotted linearly on the horizontal axis. If no blocking is present, this will be indicated by the production of straight lines instead of curves.

(d) Image Ratio.

Superheterodyne receivers respond mainly to two signal frequencies, which differ by twice the intermediate frequency.

One only of these is the desired signal frequency, the other being referred to as the image frequency.

Image Ratio is defined as the ratio of signal voltage input at the image frequency to that required at the desired signal frequency for the same output from the receiver. The value of the image ratio is determined largely by the selectivity of the tuned circuits preceding the converter valve. It should be checked at each of the standard test frequencies, but is most important on the higher frequency bands.

The test is carried out by measuring the sensitivity of the receiver at the aerial terminal at a frequency equal to the signal frequency plus twice the intermediate frequency if the oscillator frequency is higher than the signal, or minus twice the intermediate frequency if the oscillator frequency is lower than the signal frequency. This figure of sensitivity divided by the sensitivity at signal frequency gives the Image Ratio.

Noise Level:

E.N.S.I.—The Equivalent-Noise-Sideband-Input is the equivalent input voltage of all random noise which appears in the output of a receiver, and thus of all the noise which is passed by the frequency response of the receiver. This test is used in preference to the measurement of the noise level in milliwatts at some selected input since over a limited range it is not appreciably affected by changes in carrier input.

It is calculated from the results of measurements, by means of the formula*.—

$$E_n = mE_s (E'_n/E'_s) = mE_s \sqrt{P'_n/P'_s}$$

where E_n = E.N.S.I. in microvolts,
 E_s = Signal carrier input voltage, in microvolts,
 E'_n = Output voltage; noise only,
 E'_s = Output voltage; signal only,
 m = Signal modulation factor,
 P'_n = Output power; noise only,
 and P'_s = Output power; signal only.

Two standard input voltages have been set down for the noise level test.

For Receivers having an**Absolute Sensitivity of:**under $5\mu\text{V}$.under $50\mu\text{V}$.over $50\mu\text{V}$.**Test for E.N.S.I. at** $5\mu\text{V}$. $50\mu\text{V}$.Noise level test not
necessary

The tone control of the receiver should be set for maximum treble response, whilst the volume control should be set to avoid overloading the audio system. The input from the signal generator, modulated 30% at 400 c/s. is fed into the receiver through the standard dummy antenna. The input should be set to one of the standard input voltages depending upon the absolute sensitivity of the receiver. The noise output only is measured by switching off the modulation. The 400 c/s. output may be measured alone by either a highly selective 400 c/s. filter in series with the output, or more simply by measuring noise and signal together. Signal output alone may be calculated by subtracting the noise output from the combined output. The output meter should have as small a wave form error as possible or alternately a correction can be used for the meter. The noise level in terms of E.N.S.I. may then readily be calculated from the formula already given.

Oscillator Frequency Drift:

This test should be carried out on all short wave bands, and in particular on the high frequency end of the highest wave band covered. There are three principal factors which influence the oscillator frequency stability of a converter (whether pentagrid, triode hexode or heptode), namely

1. Signal grid bias voltage variation.
2. Oscillator anode voltage variation.
3. Screen voltage variation.

Of these the first is particularly important, for with A.V.C. this voltage is changed when the signal strength is changed. The second and third occur when the supply voltage fluctuates, or when the output voltage from the filter varies owing to fluctuating current drain. The latter effect is the cause of "flutter" on short waves.

*For ready calculation the nomogram given in Chapter 40 may be used.

In order to carry out a direct test on the change of oscillator frequency with variation of signal grid bias it would be necessary to arrange for constant voltages to be applied to the oscillator anode and screen. This is often not convenient and a combined test may be carried out by operating the

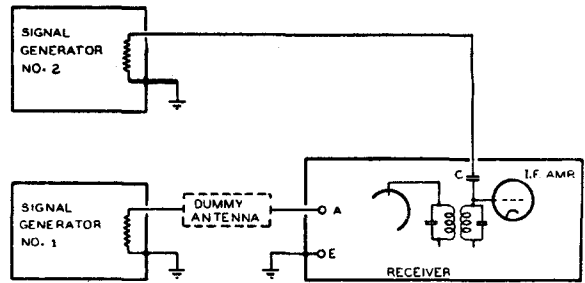

Figure 6: Arrangement of apparatus for measuring oscillator frequency drift.

receiver in a normal fashion and varying the input from $10 \mu\text{V}$ to $100,000 \mu\text{V}$, the oscillator frequency shift being measured at convenient intervals. Owing to the regulation of the power supply, as the A.V.C. operates so the current drain varies, thereby affecting the voltages applied to the other electrodes. This combined test may be carried out most easily by using two signal generators as shown in Fig. 6.

Signal generator No. 1 supplies the variable signal voltage whilst signal generator No. 2, operating at intermediate frequency, is fed into the I.F. amplifier through a very small condenser (C) to minimise loading effects. This produces a beat note in the loudspeaker.

The frequency of Generator No. 2 is set to give zero beat with the signal frequency at $10 \mu\text{V}$. from Generator No. 1. The input is increased in convenient steps up to $100,000$ microvolts and Generator No. 2 is adjusted to zero beat at each point, the new intermediate frequency being caused by the change in oscillator frequency. Observations of the frequency shift are taken at each point and these results may be plotted as a curve on logarithmic paper.

This test may be supplemented by a test of oscillator frequency stability with line voltage variation. The line voltage should be varied say 10%, on either side of the correct voltage, and the drift measured by the same method as in the previous test. In order to simplify the test the heaters should be operated from a source of fixed voltage. The results may again be plotted as a curve on linear graph paper.

Alternatively measurements may be made to indicate freedom from "flutter" by operating the heater of the converter valve from a fixed voltage source, but in all other respects following the procedure in the preceding test.

A.V.C. Characteristics:

The A.V.C. Characteristic of a receiver should be checked at the central standard test frequency in each band covered by the receiver. The signal generator is modulated 30% at 400 c/s., the input being fed to the aerial terminal of the receiver through a standard dummy antenna. The volume control of the receiver is adjusted so that, with a signal of two volts applied to the aerial terminal, the output system is not overloaded. The overload point may, for the purpose of this test, be considered as one-half the maximum output.

The input is varied from one microvolt to two volts in suitable steps and the output is observed at each of these points. These points should be taken at close intervals around the "knee" of the curve where the A.V.C. comes into operation, and also with inputs from $100,000$ microvolts to 2 volts where "modulation rise" is likely to take place.

These results may be plotted as a curve on log-linear paper, output in decibels to any convenient reference level being shown vertically on the linear scale and input horizontally on the log. scale.

A.V.C. Characteristic: Alternative Method.

An alternative method due to M. G. Scroggie is described in detail in Chapter 19. In this method the volume control is set for maximum gain, the input signal increased until a pre-determined fraction of the maximum power output is reached, the volume control set back to reduce the output by a known amount (with due allowance in plotting the curve) and the process continued until complete. The curve, when drawn according to this method, will show the output power which would correspond to the input voltage at the maximum setting of the volume control if no overloading occurred in the audio system.

Overall Distortion:

In order to determine the harmonic distortion which appears in a receiver due to causes other than in the audio amplifier, an Overall Distortion Test is employed. Of the causes of such distortion the A.V.C. system is the most likely, and the method of test is as follows:—

A signal modulated 30% at 400 c/s. is fed into the receiver through the standard dummy antenna and is varied from one microvolt to two volts. The output is held constant at some convenient low level (say 50 mW.) in order that the distortion due to the audio system, although present, may be a constant factor.

The distortion measuring device which is most convenient for this test is a "Distortion Factor Meter." This consists of a highly selective band pass filter, and measures total distortion at 400 c/s. This instrument is connected across the output load, which should be resistive for this test, and the percentage distortion measured at each level of input.

The results of this test may then be plotted on the same graph as the A.V.C. characteristic, thus giving a direct check on distortion due to the A.V.C. system used in the receiver.

Fidelity:

(a) Audio Frequency Response and Distortion.

The frequency response of an amplifier or audio section of a receiver should be tested both with loudspeaker load and resistive load on the output stage. A beat frequency oscillator is fed into the input or pick-up terminals, as the case may be, and the frequency varied from 30 c/s. to 10,000 c/s., whilst the input voltage is kept constant. The input voltage should be increased until, at the frequency giving maximum output, grid current just commences to flow in the power valve, or a predetermined output is reached.

Some device for measuring distortion at any frequency is connected across the output load. A "Wave Analyser" is the most satisfactory instrument for this work, giving fundamental and harmonic voltage components directly. If the fundamental is set to read 100 volts the harmonics will read directly as percentages, provided that the amplifier has a reasonably flat response. The results should then be plotted as a curve on logarithmic paper, frequency being plotted horizontally to a logarithmic scale and the output in decibels and the distortion as a percentage plotted vertically to a linear scale. Maximum output is most conveniently considered as zero level (0 db) and the curve will then give directly the output in "db down" from maximum output at any frequency.

By suitable adjustment of scales and their position on the graph it is possible to arrange the curves of harmonic distortion in the lower section, and the output curve in the upper section. There is no need to measure beyond the fifth harmonic except in special cases, and for most work if the distortion is low it is sufficient to measure second and third harmonic distortion only.

If a tone control is fitted to the apparatus under test, this should be in the position for maximum high frequency response. If necessary the test can be repeated with the tone control set in various positions.

The test should be repeated in its entirety with a resistive load replacing the loudspeaker used in the previous test and from the characteristics obtained, the effect of the variable load presented by the loudspeaker may be seen.

(b) Audio Linearity and Distortion.

The output of an audio frequency amplifier is not directly proportional to the input, owing to curvature of valve characteristics. From the following test a curve may be drawn showing output and distortion against input voltage.

The same set up of apparatus is used for this test as for audio frequency response, but the test need only be done with a loudspeaker load. The test frequency is 400 c/s. and the input signal should be adjusted for maximum rated output.

Both output and distortion are observed as the input is reduced in suitable steps to zero. The results are plotted as curves on linear graph paper, input horizontally and output and distortion percentages vertically to a suitable scale. The output should be in terms of voltage across the load to give the curve showing linearity.

(c) Overall Frequency Response and Distortion.

This test is carried out over the whole of the receiver, from aerial terminal to loudspeaker, to determine the fidelity of both audio frequency and R.F. sections of the receiver combined. From these results together with the audio section response curves the designer may see the effect of the I.F. amplifier, through side-band attenuation, on the high frequency response.

The signal generator is externally modulated 30% from the beat frequency oscillator whose frequency range should be variable from 30 c/s. to 10,000 c/s. A Wave Analyser is connected across the output load as for the audio response curve. The output load should consist of the loudspeaker and the test should be repeated using a resistive load.

The standard input signal for this test is 5,000 μ V. 30% modulated, and the output is adjusted to maximum by means of the audio frequency volume control with a modulating frequency (generally from 400 c/s. to 1,000 c/s.) which gives maximum gain throughout the receiver.

The input to the receiver is kept constant (both carrier level and modulation percentage) throughout the test and the frequency is varied in suitable steps from 30 c/s. to 10,000 c/s. At each frequency test point readings of output and distortion are taken.

Results should be drawn out as curves in a similar manner to that used for the audio response curves. If a selectivity and/or tone control is fitted to the receiver this should be set in the high or treble position and the test repeated if necessary at other settings of these controls.

Modulation Distortion:

This test is carried out to determine the distortion produced in a receiver when the modulation percentage of a constant signal is varied from 10% to 100%.

A 5,000 μ V, 1,000 Kc/s. signal modulated at 400 c/s. is fed to the aerial terminal through the standard dummy antenna. The output of the receiver is maintained constant, by means of the audio volume control, at some convenient low level (say 50 mW.) so that any distortion due to the audio system, although present, may be a constant factor.

The modulation percentage should be varied from 10% to 100% in convenient steps and the distortion measured at each point. As with Overall Distortion measurements the "Distortion Factor Meter" is the

most convenient instrument for this test. The results may be drawn as a curve on linear graph paper.

Hum:

Hum is present to some degree in the output of any receiver whose power is derived from A.C. mains. In the case of 50 c/s. mains, the hum present is mainly second harmonic (100 c/s.) produced during rectification, although the fundamental (50 c/s.) and higher harmonics are present in small proportions. Hum may be due to either or both of:—

- (i) **Residual Hum** which remains when only the audio frequency section of the receiver is in operation.
- (ii) **Modulation Hum** which is produced in the R.F. and I.F. stages of a receiver when a carrier is being received and which takes the form of spurious modulation of the carrier at hum frequency.

(i) Residual Hum:

Residual Hum is due to lack of sufficient filtering in the high tension supply or to stray coupling between grid leads and others carrying 50 c/s. and harmonic voltages.

The volume control of the receiver is set to maximum, the tone control turned to the treble position and the last I.F. amplifier valve removed from its socket, this being done so that any hum picked up by the diode circuits may be included.

In the case where a 6B8-G or 6G8-G valve is used as the last I.F. amplifier and detector it is not possible to remove it, but by disconnecting the screen supply voltage the effect will be the same.

The hum may be measured by any suitable output meter of high impedance or by a cathode-ray oscillograph. The test should be carried out with both loudspeaker and resistive load.

(ii) Modulation Hum.

A 1,000 Kc/s. signal modulated 30% at 400 c/s. is fed into the receiver at each of the four standard input voltages. The tone control, if fitted, is turned to the treble position, the volume control is adjusted to give approximately the maximum undistorted output obtainable with the given signal, and the modulation is then switched off. The hum components are measured with the same apparatus as for the residual hum test. Hum modulation at each component frequency is given by the equation

$$m = 30 E_h/E_s$$

where m = hum modulation percentage,

E_h = hum output voltage,

and E_s = signal output voltage.

This test can only be carried out accurately if the modulation hum is considerably greater than the residual hum. If this is not the case, the test is relatively unimportant and may be neglected.

In all hum measurements it is essential that an actual listening test be made of the receiver with the speaker intended to be used, mounted in the cabinet.

References:

- "Standards on Radio Receivers, 1938," The Institute of Radio Engineers (U.S.A.).
- "R.M.A. Specification for Testing and Expressing the Overall Performance of Radio Receivers," I.E.E. (England), Vol. 81, p. 104 (1937), and reprinted in the Proceedings of the Wireless Section, Vol. 12, No. 36, p. 179, September (1937).
- "British Standard Specification for Testing and Expressing the Overall Performance of Radio Receivers" (in preparation at time of going to press).

CHAPTER 30

Valve Testing

Valve testing — shorts test — emission — service emission tester — plate and screen currents—gas — mutual conductance—special tests—microphony—noise — heater-cathode leakage—blue glow and fluorescence—Class B valves—frequency converters—diodes—vacuum rectifiers.

Valve testing as carried out in the valve factory requires elaborate and expensive equipment which is unlikely to be available except in well equipped research laboratories. In most cases the valve user does not wish to duplicate these tests in their entirety, although specific tests may be required.

A number of important tests will be outlined in this chapter so that valve users may satisfy themselves that their valves are satisfactory in certain respects.

It will be realised that no single test or small number of simple tests can be regarded as comprehensive, and the reading of a valve checker or similar instrument can only be regarded as one of the many tests which may be applied. Consequently, it is not sufficient merely to test a valve for emission and short circuits in order to demonstrate that it is satisfactory. From the point of view of the user, the principal requirement is that the valve should operate satisfactorily in the position in which it is to be used. The most satisfactory test in radio service work is therefore the direct substitution of a new valve for the old. The difference in performance may be demonstrated by the use of a modulated oscillator and output meter.

Shorts Tests

It is very important that a test for short circuits should be made before more delicate tests are applied to the valve. A Shorts Test is generally required to be sufficiently sensitive to indicate a leakage resistance of 0.25 megohm. It is desirable to test a valve with about 110 volts applied between any pair of electrodes and to use a 110 volt neon lamp as an indicating device. For a complete test it is desirable to apply voltages between all electrodes and the arrangement shown in Fig. 1 is recommended as very satisfactory. Care should be taken owing to the high voltages employed between certain electrodes, and the hand should not be allowed to touch the bulb during the time that the voltage is applied, owing to the risk of bulb breakage. It will be seen with this arrangement that short circuits between any pair out of eight electrodes are indicated.

It is permissible to tap the valve gently with a pencil fitted with a rubber band, in order to make sure that no intermittent short circuits exist. Many types of battery valves, if tapped too severely, will show a flicker through the filament approaching the grid owing to excessive vibration. This is not a fault in the valve and is only to be expected under severe treatment.

With most valve types, lamp No. 1 (Fig. 1) will indicate filament or heater continuity; with a few types having unusual pin connections, some other lamp may correspond to the filament or heater. Condensers (0.01 μ F.) are shunted across all neon lamps to avoid slight glow due to the capacitance of the wiring, etc.

A simpler test to construct, although slower to operate, is one employing a single 110 volt transformer winding and single neon lamp. These are connected in turn to each of the possible combinations of pairs of electrodes, either by means of a switch or flexible leads.

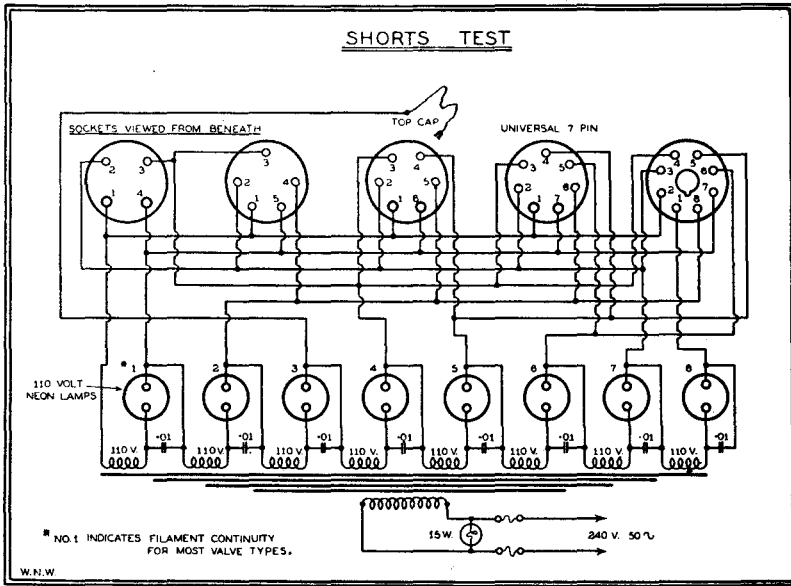

Figure 1

Hot cathode shorts tests are sometimes used. In one possible arrangement a heavy negative D.C. bias voltage is applied to the control grid so that no thermionic current flows. An alternative arrangement uses neon lamps which have two similar electrodes, one only glowing on D.C., but both glowing on A.C. Any valve electrode drawing thermionic current will result in a glow on one side only of the neon lamp; a short circuit, however, will cause both sides of the neon lamp to glow. The usefulness of this test is limited by the fact that certain valve electrodes (e.g., suppressor grids) do not draw sufficient thermionic current to result in neon glow.

Emission

Emission testing is important, but its importance is inclined to be overrated. There is no such standard as "100% emission," but every Radiotron valve leaving the valve factory has been tested to ensure that it reaches a certain minimum emission under specified operating conditions. Any valve having emission above this limit is satisfactory, but no appreciable difference in performance can be observed between valves having emission greater than this limit. Readings on valve testers showing "100% emission" are therefore misleading. It is preferable for the scale to be marked

"Good," "Doubtful" and "Bad" without any further distinction. The centre of the "Doubtful" section should correspond with the end of life point as discussed in the section on mutual conductance. Slight structural changes which exist between valves of different makes may show a difference of indicated emission up to 25% without there being any increase whatever in true emission. A further factor to be considered in interpreting the readings is that the emission does not decrease steadily throughout the life of a valve, but it frequently happens that a valve shows greater emission after some hours of life than it does when new. The difficulties which have been brought forward are sufficient to explain why emission tests alone are somewhat inconclusive, and why mutual conductance testing is to be preferred for determination of the "end of life" point. Emission tests do, however, provide valuable data which may be used in conjunction with other tests.

Service Emission Tester

The circuit diagram of an emission tester for service use is shown in Fig. 2. In this emission tester valves are operated at the rated filament voltage and a fixed A.C. plate voltage of 30 volts RMS is applied between the cathode and all other electrodes tied together. A series resistor is placed in circuit, having the value of: —

- A. 200 ohms for all types other than diodes, or battery valves having limited emission, but including power rectifiers.
- B. 1,000 ohms for battery valves having limited emission.
- C. 5,000 ohms for diodes exclusive of power rectifiers.

It will be seen that three instruments* are required; a multi-range

A.C. filament voltmeter, a 40 volt A.C. plate voltmeter and a D.C. indicating milliammeter. The voltmeter should be set to the rated filament voltage, the plate meter to read 30 volts RMS, and the milliammeter used to indicate the emission. In certain circumstances it might be possible to omit the filament voltmeter provided that multiple tapings were arranged on the filament winding and sufficiently good regulation provided for the voltage to read correctly under all conditions of loading in either the filament or plate circuit. If the filament voltmeter is omitted, the plate voltmeter may be used as an indicating device, and a single rheostat and transformer would then be used.

This instrument is intended to read only a single value, namely, the "end-of-life point." The readings of emission on new valves have no direct significance provided that they are above this limit and the instrument should not be used indiscriminately for indicating the advantages of one valve over another. This emission tester does not indicate any faults in the valve other than loss of emission, and it is quite possible for a valve to be at fault in some particular and yet show a satisfactory reading for

*Alternatively a single multi-purpose instrument may be used, with suitable switching.

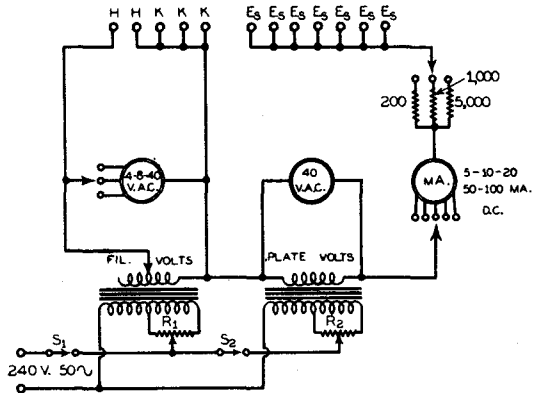

Figure 2.

emission. If a valve is suspected of being faulty and yet shows good emission, it should be checked for the points outlined elsewhere in this chapter.

In order to calibrate this instrument it is necessary for valves to be checked for "end-of-life" by an accurate mutual conductance test for ordinary valves, or in the case of Class B amplifiers a power output test, while a rectifier test should be used for rectifiers and diodes. As a general rule the end-of-life point will be for

Power amplifiers:	70% of rated mutual conductance.
Voltage amplifiers:	70% of rated mutual conductance.
Converters:	60%* of rated oscillator mutual conductance.
Diodes:	20% drop in rated diode rectification current.
Vacuum rectifiers:	20% drop in rated operating current.
Gas-filled rectifiers:	25 volts D.C. drop at 70 deg. F.

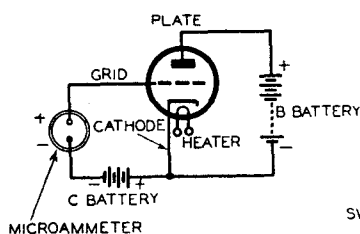

Figure 3.

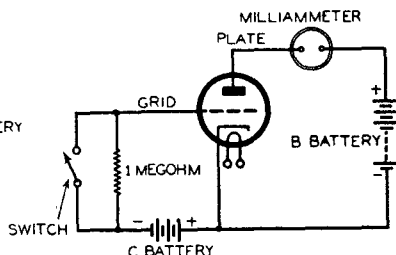

Figure 4.

Testing For Plate And Screen Currents

One of the most important tests for a valve is the measurement of plate and screen currents under typical operating conditions of filament (or heater), grid, screen and plate voltages. It is essential to employ either separate voltmeters or a single voltmeter with a switching device, so that the voltages of all electrodes may be measured under working conditions.

Testing For Gas

Gas current and other forms of negative grid current may be measured by means of a microammeter connected in the grid circuit with the valve under normal operating conditions (Fig. 3). The gas current in a small valve should not be greater than $1 \mu\text{A}$., while in the case of power valves it should not be greater than 2 to 5 μA . for most types, and 10 to 15 μA . for type 50. An alternative method of measuring gas is shown in Fig. 4 in which a resistance of 1 megohm in the grid circuit is intermittently short-circuited. Any gas current in the grid circuit will show up as a change of plate current as the switch is moved, the gas current in microamperes being approximately equal to the change of plate current in milli-amperes multiplied by the mutual conductance of the valve in mA/V. This may also be shown as

$$I_{\text{gas}} = (I_{p1} - I_{p2}) \cdot (1000/g_m)$$

(provided that the grid resistor is 1 megohm)

where I_{gas} is measured in μA .

I_{p1} and I_{p2} are measured in μA .

g_m is measured in micromhos.

*The drop in oscillator mutual conductance which may occur before the valve stops oscillating depends upon many factors, including the type of circuit, design of coils, frequency coverage, etc.

Mutual Conductance

One of the most important tests which can be made on a valve in order to determine whether it is capable of satisfactory operation is that for Mutual Conductance. A test of this kind is usually far more comprehensive than one for emission, although each serves a useful purpose and both tests are desirable. The reading of Mutual Conductance may be obtained under normal working conditions, and is therefore quite definite and free from ambiguity.

Mutual Conductance is the valve characteristic which determines stage amplification and power output in receiver operation. A certain minimum of emission is necessary in any valve to give normal performance. Emission currents above this value do not materially improve the performance, and the mutual conductance remains nearly constant. Similarly, the emission of a valve must fall to this minimum value, before the valve performance begins to be impaired. Below this value, falling emission indicates decreasing performance. For this reason, in an emission test, the fact that the emission exceeds the minimum emission is more important than the actual value of emission, while in a mutual conductance test the result obtained is a direct indication of valve performance as it would be in a receiver.

Mutual Conductance (also known as Transconductance) is the relationship between the signal voltage and the plate current for zero load resistance, and is measured in micromhos (microamperes per volt) or millimhos (milliamperes per volt). It is actually the slope of the plate current—grid voltage characteristic of the valve.

There are two common methods of testing for mutual conductance, the static (or "grid shift method") and the dynamic method. The static test may be carried out without any special instruments beyond those usually employed for measuring electrode voltages and plate current. The filament or heater should be operated at the rated voltage, this being measured at the valve pins in order to eliminate errors due to voltage drop in the wiring. In the case of triodes the plate voltage is critical while with pentodes the screen voltage is critical.

The plate voltage of a tetrode or pentode valve is less critical than the screen voltage. The control grid voltage is particularly critical and every effort should be made towards the highest accuracy.

The static test (Fig. 5) is accomplished by taking a reading of plate current with a grid bias say 0.5 volt less than the rated bias, followed immediately by a reading of plate current with a bias 0.5 volt greater than the rated bias. By this means a "grid shift" of 1 volt is produced, and the difference between the plate current readings is equal to the mutual conductance. For example, if the readings of plate current are 6.5 and 5.0 mA. respectively, the difference is 1.5 mA. and the slope is 1.5 mA. per volt or 1,500 micromhos.

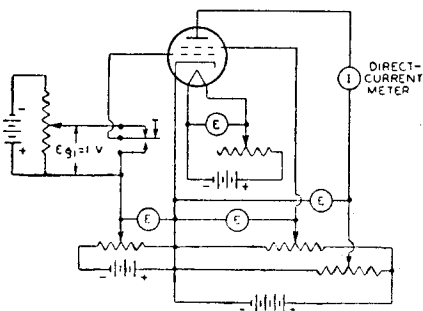

Figure 5.

It is important to choose the two bias voltages so that they are situated equidistant on each side of the rated bias voltage since otherwise the inevitable curvature of the characteristic will introduce error. The change in voltage may be accomplished by means of a steady voltage supply together with a second supply which is adjusted to give a voltage of 1.0 volt which is switched in or out of circuit as desired. This arrangement requires two separate voltmeters for accurate measurements, and a simpler although slightly less accurate arrangement would be to adjust the voltage divider to the two voltages in succession.

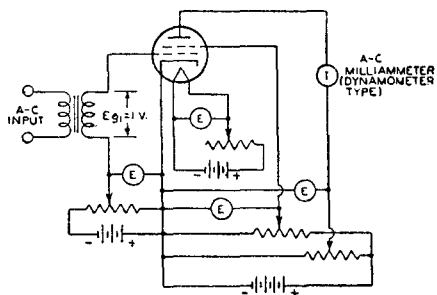

Figure 6.

The mutual conductance in micromhos is equal to 1,000 times the A.C. plate current in milliamperes. That is to say that a reading of 2.0 mA. (A.C.) represents a mutual conductance of 2,000 micromhos. With this test it is essential for the plate and screen circuits to be of low resistance in order to avoid errors. The dynamometer type milliammeter may, if desired, be replaced by an audio frequency choke of low D.C. resistance, across which is connected a large blocking condenser and a rectifier type milliammeter. The accuracy of this arrangement is less than that with the dynamometer instrument, and it is usually necessary to calibrate it from a more accurate instrument. It does, however, make a very valuable comparative test.

Valves are usually capable of operating satisfactorily until the mutual conductance falls to 70% of the rated value for voltage or power amplifier valves.

Special Tests

Tests may also be made for amplification factor, mutual conductance at points approaching cut-off, plate resistance and transconductance between any two electrodes by means of more elaborate testing equipment such as is described in text books on laboratory testing.

Testing For Microphony (Acoustic Feedback)

The most satisfactory way of testing a valve which is suspected of being microphonic is in an actual chassis or amplifier similar to one in which it is intended to be used. The method of socket mounting and the position of the valve, in relation to the loudspeaker, are very important. A cabinet, particularly a small table cabinet, exercises a pronounced effect, and valves should therefore be tested under ordinary working conditions. It is frequently found that a valve which appears to be microphonic under certain special conditions is satisfactory in many other chassis, the effect

This static test does not enable very rapid tests to be made since the plate and screen voltage controls need resetting for each reading, owing to the varying drain on the voltage dividers.

The dynamic test (Fig. 6) is preferable since the valve is tested under conditions more nearly those of actual operation. It will be seen that a signal input of 1.0 volt R.M.S. is applied to the grid, and the alternating component of plate current is read by means of a dynamometer-type of milliammeter. With this arrangement

often being that a valve is most sensitive to microphonics at a particular frequency, and this frequency may be very strongly accentuated at the particular point where the valve is placed.

Testing For Noise

Noise should be distinguished from microphony and the term should only be used to describe the output from the loudspeaker which exists when no acoustic feedback occurs. It is best observed when the loudspeaker is placed at some considerable distance from the valve under examination. Noise generally appears as a hissing or crackling sound which may be due to any one of a great number of causes. Among these causes are bad contact in the socket, and moisture or leakage across the socket or valve base. These causes should be eliminated before the valve can be claimed as being noisy.

Testing For Heater-Cathode Leakage

When a voltage is applied between heater and cathode of an indirectly heated valve there may be current flow due to

- (a) emission from cathode to heater,
- (b) emission from heater to cathode, or
- (c) leakage.

If the current changes when the applied voltage is reversed in polarity, it is evident that at least part of the current is due to either (a) or (b) or a combination of the two. Pure leakage current is not affected by the polarity of the applied voltage, but is comparatively rare. Complete breakdown of the insulation may occur due to chipped coating of the heater, even though there may have been no leakage current up to the time of breakdown.

Emission between heater and cathode may cause hum in high gain amplifiers (see Chapter 24), but is usually not detrimental in a radio receiver. For most radio service work it is sufficient to test only for complete breakdown.

Blue Glow And Fluorescence

Blue or blue-violet glow in a valve under operating conditions may exist between the cathode and the plate due to ionisation of gas. Its presence indicates that a certain amount of gas exists in the valve but due to the heavy current used in large power valves a slight amount of glow may be observed, even with the valve within its rated limits of gas current. Vacuum rectifiers may have a considerable amount of glow before any damage occurs in the valve.

Fluorescence is to be distinguished from blue glow since it has no harmful effect whatever and is rather an indication of a good vacuum. It may be observed as an extremely thin layer of colour existing at a small distance from the glass bulb, plate or other parts inside the valve. It is commonly seen on the bulb and frequently fluctuates with the signal. Fluorescence is caused through electron bombardment of the glass or other portions of the structure. The black coating inside the bulbs of many types of valves reduces the tendency towards fluorescence as well as the secondary emission from the bulb.

Testing Class B Power Valves For Output

Since a Class B Power Valve cannot conveniently be tested for mutual conductance, a power output test is desirable as an indication of satisfactory performance. It is preferable to test such a valve separately for each triode unit, and therefore the plate load should be one quarter the recommended load from plate to plate. In order to simulate the conditions obtaining with a driver valve and transformer, a resistance is inserted in series with the grid, and a 50 c/s A.C. voltage is then applied to the grid circuit. The conditions of operation of certain types are given in the table below, and the circuit diagram is shown in Fig. 7.

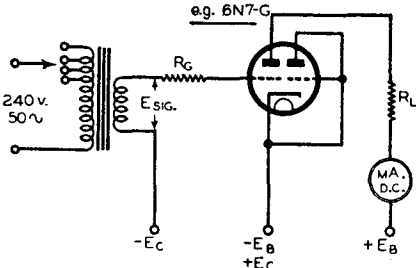

Figure 7.

The approximate formula for power output for one unit only, on the assumption that the standing plate current is very small compared with that at full output, is

$$\text{Power Output} = 2.47 I_{dc}^2 R_L$$

where I_{dc} = Average (DC) current for one plate at full output
and R_L = Load resistance for one plate.

Type	E _F Volts	E _B Volts	E _{C_g} Volts	E _{SIG} A.C.-RMS Volts	R _G Ohms	R _L Ohms	Bogie* P.O. Watts	End Point P.O. Watts
6A6	6.3	295	-5	35	500	2500	5.4	2.8
6N7								
6N7-G								
53								
19	2.0	135	-5	30	1500	2500	1.1	0.6
1J6-G								
79	6.3	250	-2	35	500	2500	4.65	2.4
1G6-G(T)	1.4	90	0	20	500	3000	0.36	0.24
6Z7-G	6.3	180	-2	25	250	3000	2.1	1.1
6AC5-G	6.3	250	0	35	500	2350	5.0	2.8

The unit not under test should be tied to the cathode.

Testing Frequency Converters

In addition to the usual static tests, a Frequency Converter valve is generally tested in the valve factory for conversion conductance, together with an oscillator test which may take the form of a mutual conductance test or of a dynamic oscillating test. Any falling-off in performance during life will affect the emission, the conversion conductance and the oscillator

*The "bogie" is the result which should be obtained from a normal new valve.

mutual conductance. It is therefore generally sufficient as an indication of "end of life" to take one of these, and the one most generally satisfactory is the oscillator mutual conductance.

The permissible "end of life" point will vary with the application and the conditions of operation. It frequently happens that a valve which fails to operate over the whole of an extended short-wave band will operate quite satisfactorily in another receiver or on the broadcast band. These differences are due to the design of the receiver and not to the valve. The most satisfactory test for radio service work is therefore operation in the receiver concerned,

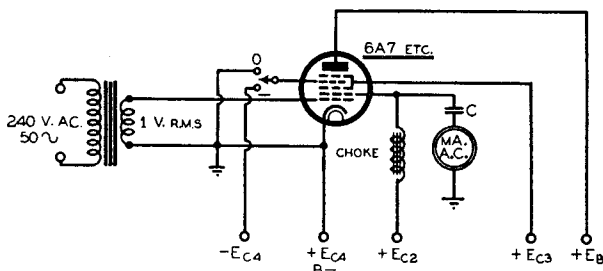

Figure 8.

When it is necessary to conduct a test apart from the receiver it is most satisfactory to test for oscillator mutual conductance under the conditions specified in the table following, with the circuit shown in Fig. 8.

Valve Type	Fil. Volts	Plate Volts	Oscill. Grid Volts	Oscill. Anode Volts	Screen Volts	Signal Grid Volts	OSC. MUTUAL COND.	
							Normal	End of Life
1A6 } 1D7-G }	2.0	180	0	135	67.5	-3	575	330
1A7-G(T)	1.4	90	0	90	45	0	600	360
1C6 } 1C7-G }	2.0	180	0	135	67.5	-3	1050	600
2A7 } 6A7 } 6A8(G) }	2.5 } 6.3 } 6.3 }	180	0	180	55	-0.5	1150	750
6D8-G	6.3	135	0	135	67.5	-3	1500	900
6J8-G	6.3	180	0	100	55	-0.5	1600	960
6K8(G)	6.3	180	0	100	55	-0.5	3000	1900
6SA7	6.3	100	0	—	100	0	4500	2700

In filament types all voltages are with respect to the negative filament terminal. In metal types the shell pin should be connected to the cathode.

Diode Testing

Diodes may be tested for diode rectification current by operating them at normal heater (or filament) voltage with a diode load resistance of suitable value, suitably shunted by a capacitance. Each diode should be tested separately in accordance with the following table, which is for 50 c/s supply.

Valve Type	Load Resistance (megohm)	Capacitance μ F.	Applied Volts	RECTIFIED CURRENT (microamperes)	
				Normal	End of Life
A.C. duo-diode amplifier valves ..	0.25	2	50	240	200
Directly-heated duo-diode amplifier battery valves .	0.25	2	50	{ 240 235*	{ 200 195*
6H6(G)	0.034	2	125	4,500	3,600

*These values apply to the diode situated near the end of the filament remote from the load resistance.

Vacuum Rectifier Testing

Vacuum rectifiers may be tested as full wave (or half wave) rectifiers under normal operating conditions with full load current, and the voltage across the load may be compared with the published curves for the type.

Alternatively if greater accuracy is required, they may be tested as half-wave rectifiers in a similar manner to Diodes, except that the load resistance, capacitance, A.C. voltage and rectified currents will be as given in the following table.

Type	E _F Volts	E _{AC} RMS Volts	C μ F	R _L Ohms	RECTIFIED CURRENT Normal	RECTIFIED CURRENT End of life
5W4	5	400	12	6800	63mA	50mA
5Z3	5	550	6	3550	141	113
5X4-G						
5U4-G						
5Z4	5	500	4	9000	66	53
6X5(G)	6.3	400	12	12000	41	33
12Z3	12.6	300	16	5600	66	53
25Z5	25	250	16	4000	71	57
25Z6(G)						
1V	6.3	400	8	8100	60	48
80	5	550	4	8000	72	58
5Y3-G						
5Y4-G						
81	7.5	1100	4	12000	98	78
83V	5	450	5	4200	113	90
5V4-G						
84	6.3	400	8	15000	32	26

CHAPTER 31

Valve Voltmeters

Valve voltmeters—loading effect—probe construction for high frequencies—acorn diode type—R.M.S. reading voltmeters—Mean-reading voltmeters—Peak-reading voltmeters—A.C. operated linear reflex peak voltmeter—Battery operated valve voltmeter.

Valve Voltmeters

Owing to its relatively high input impedance, the valve voltmeter provides a convenient method for the accurate measurement, across high impedance sources, of both D.C. voltages and A.C. voltages up to very high radio frequencies. The input impedance is a complex function of the frequency of the applied voltage, having resistive and reactive components, which are due principally to the electron transit-time and input capacitance respectively of the valve employed.

The resistive component imposes a loading effect* on the source of voltage and is inversely proportional to the squares of the frequency of the applied voltage and the electron transit time, so that, at high radio frequencies the voltmeter input resistance decreases to a small fraction of its value at low frequencies, at which it may be considered infinite. The reduction of the resistive component due to transit-time effects is a function of the total space current and may be very much reduced by arranging for the mean space current to be small.

The reactive component, due to the input capacitance, is inversely proportional to the frequency of the applied voltage, and although it decreases to a low value at high frequencies, being a quadrature component the mean energy absorbed from the source is zero. The main effect of the reactive component is to produce detuning of the source when the latter consists of a tuned circuit. In general, however, such circuits can usually be retuned and the effect of the reactive component thereby eliminated.

The loading effect of a valve voltmeter on a source may be determined by connecting a second instrument of similar type and range in parallel across the source. The reading of the second voltmeter is observed and the first then removed. The change of indication of the second instrument is then a measure of the loading effect of the first on the source.

From the preceding consideration, it will be seen that considerable care must be exercised that the valve voltmeter is not used to measure voltages having frequencies which are sufficiently high for the loading effect of the voltmeter on the source to become appreciable. For this reason, standard type receiving valves, owing to their relatively high electron transit-times and input capacitances, resulting from the conventional

*The loading effect due to dielectric hysteresis is neglected in this treatment as being small compared with the transit-time effect.

electrode spacing and structures employed, are, in general, suitable for use in valve voltmeters only at relatively low frequencies not exceeding about 1.5 Mc/s. At higher frequencies, the loading effect of the resistive component across high impedance circuits becomes serious. In the case of type 6J7-G, the input resistance at 10 Mc/s. is approximately 150,000 ohms, while at 30 Mc/s it is reduced to 20,000 ohms. These values are comparable with values of dynamic impedance of tuned circuits which are attainable at these frequencies. Where the loading effects are permissible, however, suitable standard receiving type valves (e.g., type 6B6-G) may be used up to frequencies of approximately 20 Mc/s. without serious calibration errors.

For the measurement of voltages having frequencies above 1.5 Mc/s. and up to and above 30 Mc/s. without introducing appreciable loading it is necessary to employ valves of the "Acorn" type with a special "probe" construction, as shown in Fig. 3, to reduce lead impedance by allowing direct connection to be made from the voltage source to the grid lead of the valve. The loading effect of the grid resistor may be made negligible either by omitting it and the coupling condenser altogether when there is a conducting path for the bias through the source and there is no superimposed D.C. voltage on the A.C. voltage to be measured, or by making its value sufficiently high, e.g. 5 to 10 megohms. In this latter connection, however, it should be noted that the resistance of 5 to 10 megohm resistors, as measured under D.C. conditions, may fall to several thousand ohms at frequencies above 10 Mc/s, unless of a type specially designed for operation at very high radio frequencies. In order to reduce this effect, as well as to reduce the self-capacitance effect, it is preferable to use several smaller resistors of low self-capacitance connected in series.

A wider range of operation up to and above 100 Mc/s. may be obtained by the use of the "Acorn" type diode-rectifier with its lower input capacitance and transit-time, but although a high rectification efficiency and high average impedance may be obtained using a diode load of the order of 50 megohms, the application of this type of voltmeter is somewhat limited due to its very low input impedance during the peak of the positive half cycle of applied voltage and also the dependence of its reading on the impedance of the source, which results in a reduction of the applied voltage at the terminals of the voltmeter.

The type of voltmeter to be used in any particular case depends on the wave-form of the voltage, on the value required (i.e. R.M.S., Mean or Peak), the frequency of the voltage and the impedance across which the voltage is to be measured.

All A.C. voltmeters are essentially rectifiers, employing either diode, grid circuit or plate circuit rectification and may be grouped according to the value of the wave form of an applied voltage to which their readings are proportional, namely R.M.S., Mean or Peak values. A brief description is given in the following of the more important characteristics of some of these types, but for circuit arrangements and a detailed discussion reference should be made to the various papers listed in the bibliography at the end of this chapter.

R.M.S.-Reading Voltmeters.

The response of this type of voltmeter is proportional to the R.M.S. value of applied voltage and is obtained by employing a rectifier having a square law relation between applied input voltage and mean rectified current. Such voltmeters may therefore be used to measure R.M.S. values of voltages irrespective of wave form. The scale may be calibrated to read R.M.S. values of applied voltages, from which, peak and mean values of sinoidal voltages may then be obtained by multiplying the scale calibration by 1.414 and 0.9 respectively.

A characteristic, which is closely square law for a limited range of applied voltage (usually not exceeding about 1 volt peak) may be obtained by operating a triode or pentode valve as an anode bend (plate circuit) rectifier, at a point, on the lower curved portion of its mutual characteristic, for which plate current flows over the full cycle of applied voltage and the relation between grid voltage and transconductance is linear over the working range. To ensure that the negative peak of applied voltage does not approach too closely the cut-off bias for the valve, the static plate current must be slightly greater than twice the increment of plate current required to produce full scale deflection of the indicating meter. When operation commences from cut-off and the indication is dependent only on the positive half cycle of applied voltage, a square law characteristic cannot usually be obtained with existing valve types, owing to the non-linearity which occurs in the grid voltage-transconductance characteristic as cut-off is approached.

In order to obtain the true R.M.S. value of a voltage having a non-symmetrical wave form, full wave rectification is usually necessary, since the response of a square law rectifier is generally not equally dependent on both halves of the cycle of the applied voltage.

Values of applied voltage higher than one volt peak may be measured without departure from the square law characteristic, by using a voltage divider across the source of voltage and applying a known small fraction of the total voltage to the voltmeter terminals. Constant voltage division for both D.C. and high frequency A.C. voltages may be obtained by shunting each of the resistive sections of the voltage divider, by a capacitance of such a value that the time constants (C.R) of the two parallel circuits so formed, are equal.

The calibration of this type of voltmeter is essentially dependent upon the maintenance of the square law characteristic and frequent recalibration is usually necessary. The ranges available are also usually restricted, since it may not always be convenient or desirable to use a voltage divider to provide higher ranges, particularly in the measurement of voltages of high radio frequencies. Since grid current does not flow over any portion of the cycle of the applied voltage the input impedance is very high, subject, however, to the limitations referred to in the previous section.

Valve voltmeters employing diode and grid circuit rectification are also approximately R.M.S. reading for low values of applied voltage, but have the serious disadvantage of a low value of input resistance.

Mean-Reading Voltmeters.

In this type of voltmeter, a response proportional to the mean value of the applied voltage is obtained by employing a rectifier having a linear relation between applied input voltage and mean rectified current. The latter is proportional to the mean value of the positive excursions of applied voltage and the voltmeter reading is dependent on wave form. The voltmeter may be calibrated to read R.M.S. values of sinoidal voltages directly, from which the mean values of applied voltages of any wave form may then be obtained by multiplying the R.M.S. sinoidal calibration by the factor 0.9.

The rectifier employed may be either a simple diode rectifier without the usual shunt condenser, or a biased triode or pentode anode-bend rectifier operated from approximately cut-off over the linear portion of their respective characteristics. Owing to the non-linearity, which occurs at low voltage levels, a substantially linear response is obtained only for relatively large values of applied voltage. The linearity may be considerably improved by the use of a high diode load resistance in the case of the diode rectifier, and a high plate resistance and negative feedback in the case of the anode bend rectifier. The greatest degree of linearity in the characteristic of the

latter is usually obtained when all the loading resistance is placed in the cathode circuit, since the maximum amount of feedback is then obtained.

Stray capacitances of wiring, the valve and circuit components set a low limit to the maximum frequency at which this type of voltmeter remains mean reading. At higher frequencies the response tends to be peak reading.

Peak-Reading Voltmeters.

This type of voltmeter has a response which is proportional to the peak value of the applied voltage and is hence independent of wave-form when calibrated in peak volts. Peak reading voltmeters may be calibrated to read R.M.S. values for sinusoidal voltages, which then correspond to 0.707 of the peak value of voltages having complex wave forms. Such voltmeters include the diode, grid leak, reflex and slide-back type peak voltmeters.

The **Diode Peak Voltmeter** provides one of the most convenient and accurate methods of measuring peak voltages, especially at high radio frequencies. It consists of a conventional diode rectifier, having a capacitance of such a value, shunted across the load resistance, that the time constant of the circuit is large compared with the period of the applied voltage. Indication is exponential at low values of applied voltage, but is linear for voltages above about 10 volts R.M.S.

While a high rectification efficiency and high average input impedance may be obtained by using a very high value of load resistance, as stated previously, the indication of this type of voltmeter is dependent on the impedance of the voltage source, owing to the very low value to which the input impedance falls and the flow of current through the source during the positive half cycle of applied voltage.

When the rectified current through the load resistance is too small to be measured conveniently by means of a D.C. microammeter, the voltage developed across the load resistance may be applied to the grid of a D.C. amplifier. Under these conditions, the load resistance is usually connected across the diode and the input voltage applied to the plate of the latter through a condenser of negligible reactance at the frequency of operation.

The **Grid Leak Peak Voltmeter** consists of a grid circuit rectifier employing either a triode or pentode valve. Rectification takes place between grid and cathode in a similar manner to diode rectification, and grid current flows over the positive half cycle of the applied voltage. The input resistance, while substantially the same as that of the peak reading diode voltmeter, is considerably below that of the anode bend type. The scale is substantially linear and the response peak reading for all but low values of applied voltage, for which it is approximately square law. This type of voltmeter, although somewhat unstable with regard to calibration, is useful for measurements of voltages less than one volt providing, however, that the loading effect of its input circuit is permissible.

The **Reflex Peak Voltmeter** consists essentially of a self-biased anode bend rectifier, employing either a triode or pentode valve operated approximately from cut-off over the linear portion of the mutual characteristic. A response, which is substantially peak reading for all but low values of applied voltage, is obtained by shunting a cathode resistor, the negative voltage developed across which is used to bias the valve to cut-off, by a capacitance of such a value that plate current flows only at the positive peaks of applied voltage. The indications of this type of voltmeter are dependent on wave form. However, since the scale can be made substantially linear for all but very low values of applied voltages by the use of degeneration and the sensitivity independent of reasonably large variations in supply voltage, this is usually not considered a great disadvantage,

as the wave form of most of the voltages used in practice is sinoidal. In addition, since grid current does not flow over any portion of the cycle of the applied voltage, this type of voltmeter possesses the important advantage of a very high input impedance, subject, however, to the limitations previously stated.

Both the reflex and diode types give indications which approach more closely to peak reading as the rectification efficiency is made higher. Thus, when the rectification efficiency is 90 per cent, indication is a function of all the top section of the positive half cycle of applied voltage which exceeds 90 per cent, of the peak value. This may be a large fraction of the period of the whole cycle. For voltages of complex wave form, both diode and reflex types have similar errors at equal rectification efficiencies.

The **Slide Back Type Voltmeter** consists essentially of a threshold indicator, which is used to enable a D.C. voltage, the value of which is indicated on a D.C. voltmeter, to be made equal to the peak value of the applied voltage. A triode or pentode valve is operated at a very low value of plate current and the bias read on a D.C. voltmeter. The voltage to be measured is then applied to the grid in series with the grid bias and the latter is increased until the plate current is reduced to its initial value. The peak value of the applied voltage is then equal to the increase of grid bias, as indicated on the D.C. voltmeter, by subtracting the initial from the final reading.

This type of voltmeter is true peak reading and due to the method of operation is self-calibrating. It has also a very high input impedance and is completely independent of variations in operating voltages and valve characteristics. It also possesses the important advantage, that a wide range of applied voltage may be measured simply by increasing the slide-back voltage. Owing to the adjustment of the latter which is required, however, the application of this type of voltmeter is restricted to the measurement of steady voltages.

At the present stage of development, the "linear" reflex peak voltmeter employing an "Acorn" type triode, such as the triode-connected 954, with a flexible probe connection appears to be the most generally satisfactory type of valve voltmeter for general use, since by suitable design its frequency error and loading effect due to input impedance can be made small up to 50 Mc/s. Its application is, however, restricted to use with voltages of sinoidal wave form, so that for voltages of complex wave form a true peak reading voltmeter, such as the diode peak reading type, must be used. The use of the latter type, however, is restricted by the source impedance as previously described.

The valve voltmeters described in the following sections are typical of the peak reading types, and for the reasons previously given employ "Acorn" type valves.

A.C. Operated Linear Reflex Peak Voltmeter.

The circuit arrangement of a linear reflex* peak reading A.C. voltmeter of high input impedance, which has been designed for A.C. operation with either type 6J7-G or the "Acorn" type 954, depending upon the frequency range required, is shown in Fig. 1. For operation up to low radio frequencies type 6J7-G may be used, but where the voltmeter is intended for use across high impedance tuned circuits at frequencies up to and above 10 Mc/s, and in cases where the input capacitance must be kept small, the latter type is unsuitable and the type 954 should be employed. Both types are used as triodes with the suppressor connected to the cathode. D.C. voltages may also be measured by omitting the coupling condenser shown, but require a separate calibration.

The scale of the voltmeter is substantially linear on all but the lowest ranges and the response is closely peak reading for applied voltages above

*Reflex used in this connection indicates the application of negative feedback.

about 0.4 volt. Below this value, the response is approximately square law due to the curvature of the characteristic. The voltmeter readings are therefore subject to the usual wave form errors. The scale may be calibrated to read directly R.M.S. values of voltages of sinoidal wave form, which then correspond to 0.707 of the peak value of voltages having complex wave forms for voltages above 0.4 volt. The calibration is substantially independent of changes in the mains supply voltage of approximated ± 10 per cent, provided that the scale zero is reset when necessary. The effects of mains fluctuations are experienced only on the lowest ranges due to change of contact potential with heater voltage.

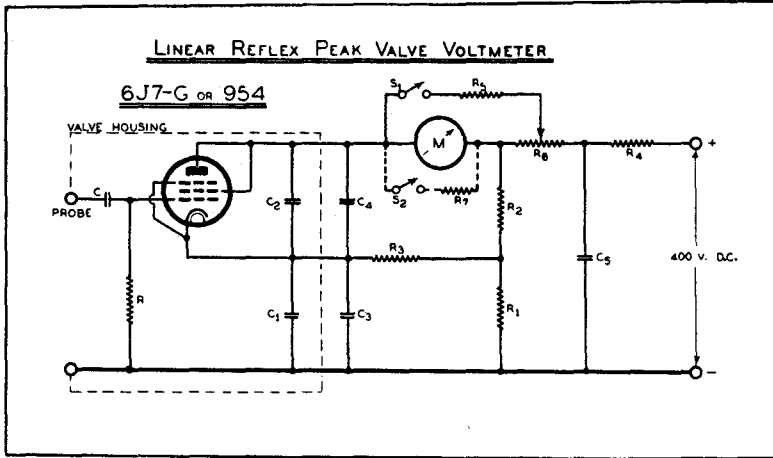

Figure 1. A.C. Operated Linear Reflex Peak Voltmeter.

- | | |
|--|---|
| $R = 5.0$ Megohms. | $R_5 = 0.1-0.5$ Megohm. |
| $C =$ Coupling Condenser. | $R_6 = 3000$ Ohms for Zero Balance Adjustment. |
| $C_1, C_2 = 0.005 \mu\text{F.}$ Mica Condenser | $R_7 =$ Protective Meter Shunt (100 —200 ohms) for use during adjustment. |
| $C_3, C_4:$ Refer Tables I and II. | $S_1 =$ Zero Balance Switch. |
| $C_5 = 16 \mu\text{F.}$ 500 volt Electrolytic Condenser. | $S_2 =$ Switch for Meter Shunt. |
| $M =$ Microammeter 0—100 $\mu\text{A.}$ | |
| $R_1, R_2, R_3, R_4:$ Refer Tables I and II. | |

The range of the voltmeter is determined by the values of the resistors R_1 , R_2 and R_3 and the full scale current of the meter M . The ratio of the values of the resistors R_2 and R_1 is made equal to the amplification factor of the valve and the latter biased to cut-off by means of the bias developed across the resistors R_1 and R_3 . On the lower ranges, however, the contact potential of the valve may appreciably reduce the developed bias and it is necessary to balance out by means of the zero-balance circuit (consisting of the resistor R_5 and the 3,000 ohm potentiometer R_6) the resulting plate current, which may be a large proportion of the full scale meter current. In the case of the type 6J7-G, this effect may be considerably reduced by operating the heater at 4.0 volts, which also allows a 5 megohm grid resistor to be used without excessive grid emission effects. For this purpose, a resistor of 8.8 ohms may be connected in series with the heater when the heater supply voltage is 6.3 volts. Operation of type 954, however, at reduced heater voltage is not recommended, since the total emission available is considerably less and heater operation is more

critical. The use of a 5 megohm resistor with type 954, under the conditions given, has been found satisfactory with actually less grid emission effect than experienced with type 6J7-G. The effect of grid emission, which in both cases is negligible, is to reduce the bias applied to the grid by the voltage developed across the grid resistor, with the result that a slight unavoidable shift of the zero occurs if a low resistance path is substituted for the 5 megohm resistor or the latter is short-circuited. Both this effect, however, and that above due to contact potential may be made negligible by using valves specially selected for low grid emission and low contact potential.

Suitable values of R_1 , R_2 , R_3 and R_4 for voltage ranges from 0—1 to 0—150 volts R.M.S. are shown in Tables I and II for the types 6J7-G and 954 respectively. The indicating instrument used on all ranges has a range of 0—100 μ A, so that satisfactory operation can be more easily obtained on the lowest ranges. This has the additional advantage that reduction of the input resistance at high frequencies due to transit-time effects is kept small. Range changing in a multi-range instrument is facilitated since the same values of R_1 and R_2 are used for all but the 0—100 and 0—150 volt ranges, which frequently are not required, so that to change the range of the voltmeter for ranges up to and including the 0—50 volt range it is only necessary to alter the values of R_3 and R_4 . For the two higher ranges, the value of R_1 must be increased to provide additional bias and the same values of R_1 and R_2 are then used for both ranges.

The voltmeter response is made substantially "peak reading" by shunting the bias resistors, R_1 and R_2 , by the capacitance C_3 , the value of which is such that the time constant of the network is made sufficiently great for the peak value of the bias voltage, developed across the latter, to remain appreciably constant during a cycle of the applied voltage, at the lowest frequency of operation. It is also necessary effectively to bypass for all frequencies the meter in the plate circuit, in order to avoid frequency discrimination effects due to the inductance of the moving coil of the meter movement.

Owing to the relatively large value of C_3 required for effective bypassing on the lower ranges, it is necessary to decrease this value proportionally as R_1 is increased on the higher ranges, in order to avoid the undesirable effect of excessive time constants of the cathode and plate circuits in slowing up the action of the indicating meter. Values of C_3 and C_4 are given in Tables I and II for a time constant of each circuit of approximately 0.1 second on each range, which enables a satisfactory response to be obtained for audio frequencies down to 20 c/s., while at the same time allowing reasonably rapid indication. Where the instrument is not intended for operation at such low frequencies, however, lower values of capacitance than those shown may be used. To ensure satisfactory bypassing at radio frequencies, mica condensers (C_1 and C_2) each of 0.005 μ F. capacitance should be connected in parallel with C_3 and C_4 at the valve socket.

To enable a wide range of adjustment of the zero on the low voltage ranges to be obtained, the resistance of R_5 should have a value of 0.1 megohm since the range of adjustment required is less and the divider current greater.

The supply voltage required for the operation of the voltmeter is 400 volts D.C. which may vary within ± 10 per cent. For this purpose, a type 6X5-G, indirectly heated, full-wave high-vacuum rectifier may be used with a half-secondary voltage of 350 volts R.M.S. and a condenser input filter, across which is connected a 15,000 ohm voltage divider.

TABLE I.

Circuit Constants for Use with Type 6J7-G.

Heater Voltage = 4.0 Volts.

Series Heater Dropping Resistor (from 6.3 Volts) = 8.8 ohms.

D.C. Plate Supply Voltage = 400 Volts.

Indicating Meter = 0—100 μ A. Microammeter. $C_1 = C_2 = 0.005 \mu$ F.

Range Volts R.M.S.	R_1 Ohms	R_2 Ohms	R_3^* Ohms	R_4 Megohms	C_3 μ F.	C_4 μ F.	IB† mA.
0—1.0	500	10,000	3,750	0.10	35.0	8.0	4.0
0—1.5	500	10,000	8,750	0.10	12.0	6.0	4.0
0—3.0	500	10,000	26,000	0.10	4.0	3.0	4.0
0—5.0	500	10,000	50,000	0.05	2.0	2.0	6.9
0—10	500	10,000	113,000	0.05	1.0	1.0	6.9
0—15	500	10,000	175,000	0.04	0.5	0.5	8.7
0—25	500	10,000	300,000	0.025	0.5	0.5	11.0
0—50	500	10,000	610,000	0.0125	0.25	0.25	16.2
0—100	5,000	100,000	1,175,000	0.075	0.25	0.25	2.5
0—150	5,000	100,000	1,800,000	0.04	0.10	0.10	3.2

*Approximate only; value must be adjusted to give full scale deflection.

†Total Supply Current.

TABLE II.

Circuit Constants for Use with Type 954.

Heater Voltage = 6.3 Volts.

D.C. Plate Supply Voltage = 400 Volts.

Indicating Meter = 0—100 μ A. Microammeter. $C_1 = C_2 = 0.005 \mu$ F.

Range Volts R.M.S.	R_1 Ohms	R_2 Ohms	R_3^* Ohms	R_4 Megohms	C_3 μ F.	C_4 μ F.	IB† mA.
0—1.0	500	10,000	2,500	0.06	35.0	8.0	6.0
0—1.5	500	10,000	8,000	0.075	12.0	6.0	5.0
0—3.0	500	10,000	25,000	0.075	4.0	3.0	4.9
0—5.0	500	10,000	48,000	0.075	2.0	2.0	4.9
0—10	500	10,000	107,500	0.05	1.0	1.0	7.0
0—15	500	10,000	175,000	0.05	0.5	0.5	8.0
0—25	500	10,000	300,000	0.035	0.5	0.5	9.0
0—50	500	10,000	600,000	0.0225	0.25	0.25	12.0
0—100	5,000	100,000	1,220,000	0.05	0.25	0.25	3.0
0—150	5,000	100,000	1,915,000	0.02	0.10	0.10	4.0

*Approximate only; value must be adjusted to give full scale deflection with individual valves.

†Total Supply Current.

Battery Operated Reflex Peak Voltmeter.

The circuit of a battery operated valve voltmeter using type 954 as a conventional reflex or self-biased anode-bend detector is shown in Fig. 2. Type 954 is triode-connected and two ranges are provided by means of the bias resistors R_1 and R_2 , low range, 1, and a high range, 2. The network composed of the resistors R_3 , R_4 and R_5 is used in conjunction with a 10—20 volt battery to balance out the initial reading of the meter M , due to the standing plate current, with the input terminals short-circuited. The scale of the voltmeter is substantially linear except at low input voltages, where it is approximately square law. The voltage range is determined by the sensitivity of the meter M and the value of the developed grid bias.

Typical calibration curves showing the meter range required for input voltages up to 14 volts R.M.S. are shown in Figs. 4 and 5.

The values of R_3 , R_4 , and R_5 depend upon the magnitude of the plate current to be balanced out, the resistance of the meter and the voltage of the battery supplying the balancing current. In general, R_3 should be large compared to the resistance of M ; R_4 and R_5 should be chosen to permit coarse adjustment by R_4 and fine adjustment by R_5 . For values of meter resistance and bucking-battery voltages other than those specified, the ratio of R_3 to the resistance of M and the ratio of R_4 to R_5 may be the same as those given. It is also necessary to make R_4 and R_5 sufficiently large so that the current drain from the bucking-battery is not excessive.

The D.P.S.T. switch opens and closes the heater, plate and zero balance circuits simultaneously. The filament current (150 mA.) should be supplied from four heavy duty dry cells.

It is essential that the circuits be adequately bypassed if a low frequency calibration is to hold at much higher frequencies. The bias resistors, R_1 and R_2 , must be well bypassed at the lowest and at the highest frequencies at which the voltmeter is to be used. For satisfactory bypassing at both low and high frequencies the bias resistor should be bypassed by a capacitance of 16 μ F. (electrolytic condenser of high voltage rating for low leakage) in parallel with a mica condenser of 500 μ F. By this arrangement, the calibration is made substantially independent of frequency from 50 c/s. up to 25 Mc/s.

The valve voltmeter may be constructed in three separate units:

(1) **The probe**, consisting of a metal housing, which contains valve type 954, its socket, C_1 , C_3 and a shielded four-wire cable terminating in a five-pin plug. These four leads, labelled b, c, d, and e connect the housing to the control unit (2); lead a is the shield surrounding the cable.

(2) **The control unit** containing C_2 , R_1 , R_2 , R_3 , R_4 , R_5 , S , and the D.P.S.T. Switch. This unit is equipped with a five-contact socket in which unit (1) is plugged.

(3) **The power unit**, consisting of the filament, plate and bucking batteries. The control unit may connect to the power unit by a plug and socket arrangement similar to that employed between units (1) and (2). Two voltmeters may be powered by the same batteries by having two sockets connected in parallel in unit (3).

If the voltmeter is to be connected to a source through a series condenser, no bias will be applied to the grid of the 954, and it is necessary to connect a resistor of high resistance across the input terminals to conduct the bias voltage to the grid. The value of this resistor will depend upon the permissible loading.

(Continued on page 260)

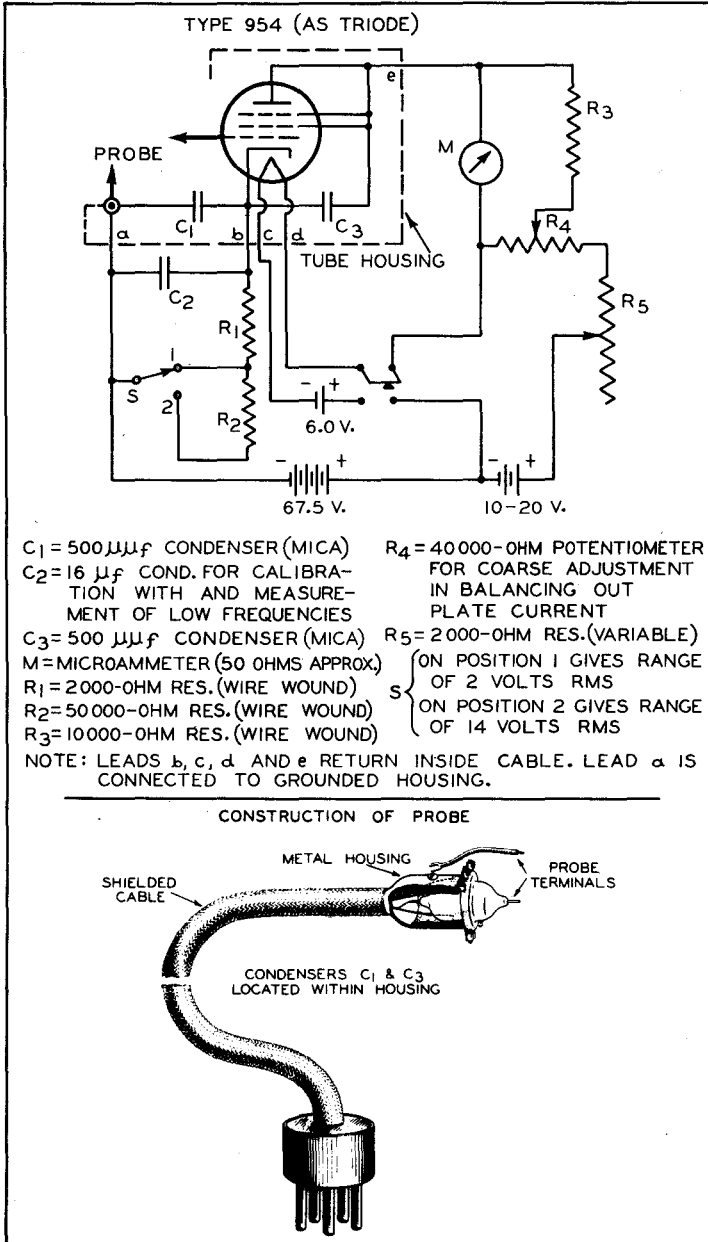

Figure 2 (upper): Battery operated valve voltmeter using type 954 acorn valve specially adapted for probe arrangement.

Figure 3 (lower): Construction of probe for acorn valve, either A.C. or battery operated.

(Continued from page 258)

The voltmeter described has been operated at frequencies up to 25 Mc/s. without serious loading effects or changes in calibration. Voltages, however, at somewhat higher frequencies may be measured, the upper limit depending upon the permissible loading.

This voltmeter is based on the description given in the R.C.A. Application Note No. 47, May 20, 1935.

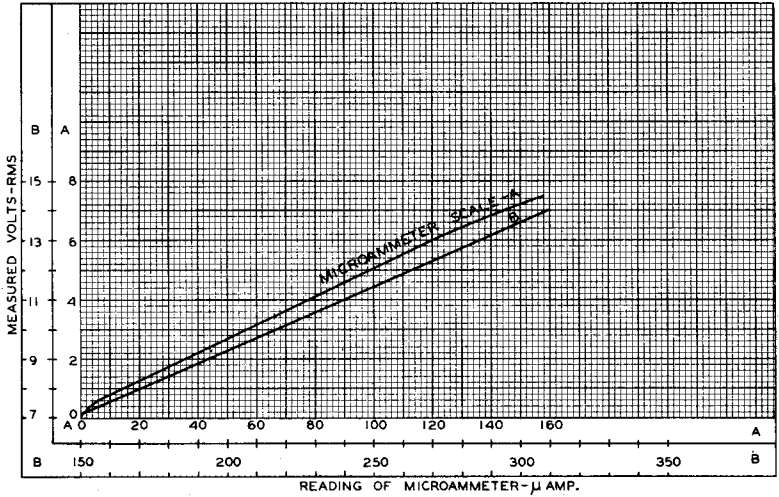

Figure 4: Calibration of battery operated valve voltmeter (Fig. 2) on high range. Bucking battery 16.5 volts.

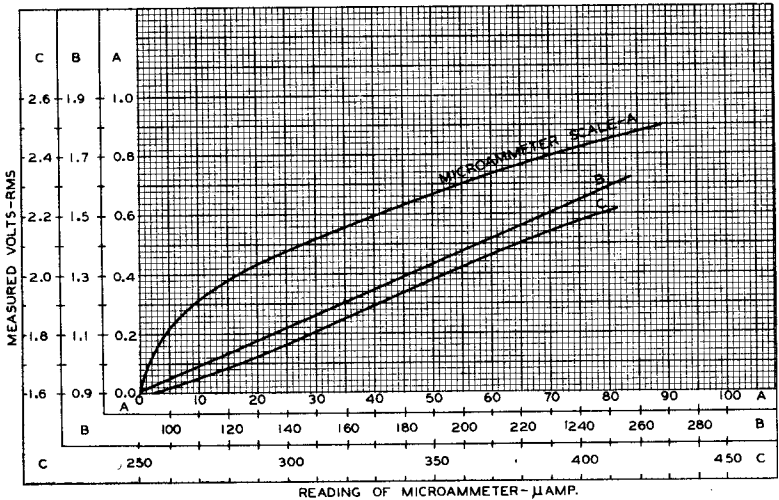

Figure 5: Calibration of battery operated valve voltmeter (Fig. 2) on low range. Bucking battery 16.5 volts.

Bibliography.

Input Impedance.

- W. R. Ferris, "Input Resistance of Vacuum Tubes as Ultra-High-Frequency Amplifiers," Proc. I.R.E. Vol. 24, No. 1, pp. 82-107, Jan. (1936).
- L. S. Nergaard, "A Survey of Ultra-High-Frequency Measurements," R.C.A. Review, Vol. 3, No. 2, pp. 170-175, Oct. (1938). "Electrical Measurements at Wavelengths Less than Two Metres," Proc. I.R.E. Vol. 24, No. 9, pp. 1207-1229, Sept. (1936).
- B. Salzberg and D. G. Burnside, "Recent Developments in Miniature Tubes," Proc. I.R.E., Vol. 23, No. 10, pp. 1142-1157, Oct. (1935).
- R. King, "Electrical Measurements at Ultra-High-Frequencies," Proc. I.R.E. Vol. 23, No. 8, pp. 885-934, Aug. (1935).
- J. G. Chaffee, "The Determination of Dielectric Properties at Very High Frequencies," Proc. I.R.E., Vol. 22, No. 8, pp. 1018-1020, Aug. (1934).
- R.C.A. Application Note, "Input Loading of Receiving Tubes at Radio Frequencies," Reprinted in Radiotronics Technical Bulletin No. 96, Mar. (1939), and also in Chapter 14 of this handbook.
- E. C. S. Megaw, "Voltage Measurements at Very High Frequencies," Wireless Engineer, Vol. 13, pp. 65-72 Feb., pp. 135-146 Mar., pp. 201-204 Apr. (1936).
- C. B. Aiken, "Theory of the Diode Voltmeter," Proc. I.R.E., Vol. 26, No. 7, pp. 859-876, July (1938).

Voltmeter Characteristics and Circuits.

- E. B. Moullin, "A Direct-Reading Thermionic Voltmeter and Its Applications," Journ. I.E.E. Vol. 61, pp. 295 (1923).
"A Thermionic Voltmeter for Measuring the Peak Value and the Mean Value of an Alternating Voltage of any Wave-Form," Journ. I.E.E., Vol. 66, No. 380, pp. 886-895, Aug. (1928).
"Some Developments of the Thermionic Voltmeter," Journ. I.E.E., Vol. 68, No. 404, pp. 1039-1051, Aug. (1930). (Bibliography of 16 References).
"The Theory and Practice of Radio Frequency Measurements," Charles Griffin and Company Ltd., Second Edition (1931). Chap. IV, pp. 127-158.
- E. G. James & G. R. Polgreen, "Instruments Incorporating Thermionic Valves and Their Characteristics," Journ. I.E.E., Vol. 85, No. 512, pp. 242-271, Aug. (1939), (Bibliography of 49 References).
- G. W. Warren, "The Electrometer Triode and Its Applications," G.E.C. Journal, Vol. 6, pp. 1 (1935).
- C. L. Fortescue, "Thermionic Peak Voltmeters for Use at Very High Frequencies," Journ. I.E.E., Vol. 77, pp. 429-432, Sept. (1935).
- F. N. Colebrook, "The Rectification of Small Radio-Frequency Potential Differences by Means of Triode Valves," Wireless Engineer, Vol. 2, pp. 867, 946 (1925), Vol. 3, pp. 34, 90 (1926).
- W. N. Tuttle, "Type 726A, Vacuum Tube Voltmeter," General Radio Experimenter, Vol. 11, No. 12 (1937).
- W. B. Medlam and U. A. Oswald, "The Thermionic Voltmeter," Wireless Engineer, Vol. 3, No. 37, pp. 589-598, Oct., No. 38, pp. 664-673, Nov. (1926).
"Further Notes on the Reflex Voltmeter," Wireless Engineer, Vol. 5, No. 53, pp. 56-60, Feb. (1928).
- C. N. Smyth, "A Multi-range Mains-operated Valve Voltmeter," Wireless Engineer, Vol. 10, No. 114, pp. 134-137 (1933).
- F. V. Hunt, "A Vacuum Tube Voltmeter with Logarithmic Response," Rev. Scientific Instruments, Vol. 4, No. 12, p. 672, Dec. (1933).
- J. Greig and H. N. Wroe, "A Low Reading Mean Voltmeter," Wireless Engineer, Vol. 15, No. 183, pp. 658-661, Dec. (1938).

- M. von Ardenne, "A Sensitive Valve Voltmeter Without Backing Off," *Wireless Engineer*, Vol. 6, No. 75, pp. 669-675, Dec. (1929).
- W. G. Hayman, "A Compensated Vacuum Tube Voltmeter with Balanced Bridge Output," *Wireless Engineer*, Vol. 7, No. 85, pp. 556-559, Oct. (1930), (Bibliography of 13 References).
- F. M. Colebrook, "A Valve Voltmeter with Retroactive Direct-Voltage Amplification," *Wireless Engineer*, Vol. 15, No. 174, pp. 138-142, Mar. (1938).
- M. Reed, "The Problem of Turn-Over," *Wireless Engineer*, Vol. 6, No. 69, pp. 310-315, June (1929).
- R. Lorenzen, "Vacuum-Tube Voltmeters," *Service Jan.* (1939). Reprinted in *Radio Technical Digest*, pp. 18-31, Mar. and Apr. (1939).
- H. G. Boyle, "A Highly Flexible V.T. Voltmeter," *Electronics*, pp. 32-34, Aug. (1936).
- G. Builder, "A Multi-Range Push-Pull Thermionic Voltmeter," *Journ. I.E. (Aust.)*, Vol. 6, No. 11, pp. 444-445, Nov. (1934).
- Lord Rothchild, "A Thermionic Voltmeter for Low Voltages," *Journ. Scientific Instruments*, Vol. 14, No. 11, pp. 373-375, Nov. (1937).
- R. E. Burgess, "An Improved Circuit for the Direct Current Amplifying Valve of a Valve Voltmeter," *Journ. Scientific Instruments*, Vol. 15, No. 5, pp. 171-174, May (1938).
- D. G. Reid, "A Thermionic Voltmeter with a Linear Law," *Journ. Scientific Instruments*, Vol. 15, No. 8, pp. 261-263, Aug. (1938).
- T. P. Hoar, "The Use of Triode and Tetrode Valves for the Measurement of Small D.C. Potential Differences," *Wireless Engineer*, Vol. 10, No. 112, pp. 19-25, Jan. (1933). (Bibliography of 28 References).
- H. J. Reich, "Theory and Application of Electron Tubes," McGraw-Hill, First Edition, Chap. 15, pp. 555-575 (1939). (Comprehensive Bibliography).
- A. Hund, "High Frequency Measurements," McGraw-Hill, First Edition, Chap. IV, pp. 137-161. (1933).
- R. King, "A Screen-Grid Voltmeter Without External Leak," *Proc. I.R.E.*, Vol. 22, No. 6, pp. 771-780, June (1934).
"A Screen-Grid Voltmeter and Its Application as a Resonance Indicator," *Proc. I.R.E.*, Vol. 18, No. 8, pp. 1388-1395, Aug. (1930).
- H. A. Brown, "Radio Frequency Electrical Measurements," McGraw-Hill, Second Edition.
- F. E. Terman, "Measurements in Radio Engineering," McGraw-Hill, First Edition, pp. 18-30 (1935).
- L. C. Waller, "Applications of Visual-Indicator Tubes," *R.C.A. Review*, Vol. 1, No. 3, pp. 111-125, Jan. (1937).
- W. Kouter, "Vacuum Tube Voltmeter, Capable of Standing Heavy Overloads," *Electronics*, p. 48, June (1937).
- C. T. Lane, "D.C. Amplifier for Measuring Potentials in Living Organisms," *Electronics*, pp. 31-32, June (1937).
- S. Ballantine, "Electronic Voltmeter Using Feedback," *Electronics* pp. 33-35, Sept. 1938.
- W. C. Michels, "Double Vacuum Tube Voltmeter," *Rev. Scientific Instruments*, Vol. 9, No. 1, pp. 10-12, Jan. (1938).
- G. Builder & J. E. Bailey, "Audio Frequency Level Indicators," *A.W.A. Technical Review*, Vol. 3, No. 6, pp. 321-339, Oct. (1938).
- H. R. Lubcke, "Vacuum Tube Voltmeter Design," *Proc. I.R.E.*, Vol. 17, No. 5, pp. 864-872, May (1929).
- R. M. Somers, "An Improvement in Vacuum Tube Voltmeters," *Proc. I.R.E.*, Vol. 21, No. 1, pp. 56-62, Jan. (1933).
- F. M. Colebrook, "A Valve Voltmeter for Audio Frequencies," *Wireless Engineer*, Vol. 10, No. 117, pp. 310-312, June (1933).
- L. A. Du Bridge and H. Brown, "An Improved D.C. Amplifying Circuit," *Rev. Scientific Instr.*, Vol. 4, No. 10, pp. 532-536, Oct. (1933).

CHAPTER 32

Measuring Instruments

Moving coil instruments—moving iron instruments—form factor—rectifier type instruments—valve voltmeters—hot wire and thermo-couple instruments—electrostatic voltmeters—bibliography.

A description of measuring instruments and their application is outside the range of this handbook. A few brief notes are appended regarding certain types of instruments.

Moving coil instruments indicate the average current. They are most satisfactory when used for D.C. measurements, but when used on rectified A.C. the deflection indicates the **average** value of the current.

Moving iron instruments indicate the R.M.S. value of the current. They may be used for D.C. measurements although most satisfactory for A.C. When used on rectified A.C. the deflection indicates the **R.M.S.** value.

The ratio of R.M.S. to average values is called the **Form Factor** (see also Chapter 22). This is therefore the ratio of the indication on rectified A.C. of a moving iron to that of a moving coil instrument.

Rectifier type instruments may be used for A.C. and audio frequencies, with only very slight error at the highest audio frequencies, and may be used with suitable correction factors at low radio frequencies. They are, however, only accurate when used on sinoidal waveform.

Valve voltmeters of the usual type do not indicate either true R.M.S. or true peak voltages. In most cases, therefore, valve voltmeters are only accurate when used on sinoidal waveform. For further information on valve voltmeters, see Chapter 31.

Hot-wire and Thermo-Couple Instruments indicate R.M.S. values and may be used up to high radio frequencies.

Electrostatic voltmeters may be used for measuring medium and high alternating and direct voltages, and have the advantage of not consuming any power. When calibrated on D.C. they indicate the R.M.S. value of A.C.

Bibliography

Reference should be made to the well known text books on Electrical Engineering and Radio Engineering, and also to the following books dealing particularly with radio frequency measurements:—

- H. A. Brown, "Radio Frequency Electrical Measurements" (McGraw-Hill, 2nd edition, 1938).
- A. Hund, "High Frequency Measurements" (McGraw-Hill, 1933).
- E. B. Moullin, "The Theory and Practice of Radio Frequency Measurements" (Griffin, 2nd edition, 1931).
- F. E. Terman, "Measurements in Radio Engineering" (McGraw-Hill, 1935).
- "Radio Instruments and Measurements," Circular C74, Bureau of Standards, January, 1937.

An excellent book giving a general treatment of the fitting and operation of a radio laboratory is M. G. Scroggie's "Radio Laboratory Handbook" (The Wireless World). This gives brief descriptions of many types of instruments and their operation, including an introduction to the cathode ray oscillograph.

For a more detailed treatment of the characteristics of cathode ray tubes, and the design of sweep circuits, etc., reference should be made to the R.C.A. Radiotron Manual TS-2, "Cathode Ray Tubes and Allied Types."

A summary of certain data on the application of cathode ray tubes, together with a useful bibliography, is given in Chapter 14 of A. L. Albert's "Fundamental Electronics and Vacuum Tubes" (The MacMillan Co., 1938).

(CHAPTERS 33 and 34)

CHAPTER 33

Valve Constants

Amplification factor—mutual conductance—plate resistance—durchgriff—plate conductance—differential coefficients—partial differential coefficients—valve constants expressed as differential coefficients—valve capacitances.

Valve Constants

Certain relationships between the voltages and currents of the electrodes of a valve are known as the Valve Constants. As the name implies, they may be considered as constants although their values depend upon the operating conditions.

Of these the best known are the amplification factor, mutual conductance, and plate resistance. These are defined as follow :—

The **amplification factor** (μ) is numerically equal to the rate of change of plate voltage with change of grid voltage, the plate current being maintained constant.

The **mutual conductance** (g_m) is the rate of change of plate current with change of grid voltage, the plate voltage being maintained constant.

The **plate resistance** (r_p) is the rate of change of plate voltage with change of plate current, the grid voltage being maintained constant. The relationship between these three "constants" may be expressed as

$$\mu = g_m \cdot r_p,$$

or
$$g_m = \frac{\mu}{r_p},$$

or
$$r_p = \frac{\mu}{g_m}.$$

The reciprocals of two of these constants are occasionally used and are as follow :—

$$\frac{1}{\mu} = D \quad \text{where } D \text{ is called the Durchgriff, or Penetration Factor, and which may be expressed as a percentage ;}$$

$$\frac{1}{r_p} = G_p \quad \text{where } G_p \text{ is called the Plate Conductance.}$$

In cases where the grid circuit cannot be considered as of infinite impedance the following may be used :—

Grid input resistance	R_1
„ „ conductance	g_1
„ „ reactance	X_1
„ „ susceptance	B_1
„ „ impedance	Z_1

Reference may be made to Chapter 39 for these and other units.

Valve constants, as well as other allied characteristics, may be expressed as **differential coefficients**. For a full explanation of differential coefficients reference should be made to a mathematical treatise on “The Differential and Integral Calculus.” In brief, however, $\frac{dy}{dx}$ is the ratio* between “an increment of y” and “an increment of x.” The letters “dx” or “dy” should be always treated as a combined symbol, not as two separate symbols. The ratio $\frac{dy}{dx}$ should also be considered as a combined symbol, and “dx” should not be considered apart from “dy” except as governed by the mathematical laws of differentiation.

The quantity $\frac{dy}{dx}$ represents the **slope** of the curve showing the relationship between x and y, at a particular point.

Partial differential coefficients, designated in the form $\frac{\partial y}{\partial x}$, (the symbol ∂ being pronounced “der” to distinguish from “d” in $\frac{dy}{dx}$) are used in considering the relationship between two of the variables in systems of more than two variables, such as the volume of an enclosure having rectangular faces, the sides being of length x, y and z respectively:

$$v = x y z.$$

* Strictly speaking, the finite increments should be designated δx and δy , and then $\frac{dy}{dx}$ is the limit (as δx and δy approach zero) of $\frac{\delta y}{\delta x}$.

Thus, the rate of change of volume with the change in length of the side x , while the sides y and z remain constant, is

$$\frac{\partial v}{\partial x} = y z.$$

Similarly $\frac{\partial v}{\partial y} = z x$, where z and x are constant,

and $\frac{\partial v}{\partial z} = x y$, where x and y are constant.

In three-dimensional differential geometry, the equation representing a surface may be represented generally in the form

$$y = f(x, z).$$

In this case, the partial differential coefficient $\frac{\partial y}{\partial x}$ represents the slope at the point (x, y, z) of the tangent to the curve of intersection of the surface with a plane parallel to the plane passing through the x and y axes and separated by a fixed distance z from the latter.

Thus $\frac{\partial y}{\partial x}$ represents the slope of a tangent to a cross section of a three-dimensional solid, the partial derivative reducing the three-dimensional body to a form suitable for two-dimensional consideration. " $\frac{\partial y}{\partial x}$ " is equivalent to " $\frac{dy}{dx}$ (z constant)" when there are three variables, x , y and z .

Partial differentials are therefore particularly valuable in representing Valve Constants. The following list of equivalents may be used in many problems concerning valves and amplifiers.

Let e_p = A.C. component of plate voltage,
 e_g = A.C. component of grid voltage,
 and i_p = A.C. component of plate current.

(These may also be used with screen-grid or pentode valves provided that the screen voltage is maintained constant, and is completely bypassed for A.C.).

$$\text{Then } \mu = - \frac{\partial e_p}{\partial e_g} \quad (i_p = \text{constant}),$$

$$\text{or more completely } + \frac{\partial i_p / \partial e_g}{\partial i_p / \partial e_p}$$

$$g_m = + \frac{\partial i_p}{\partial e_g} \quad (e_p = \text{constant}).$$

$$r_p = + \frac{\partial e_p}{\partial i_p} (e_g = \text{constant}),$$

$$\text{or more correctly*} + \frac{1}{\partial i_p / \partial e_p}.$$

In a corresponding manner the gain (M) and load resistance (R_L) of a resistance-loaded amplifier may be given in the form of total differentials :—

$$|M| = \left| \frac{de_p}{de_g} \right| \dagger$$

$$R_L = - \frac{de_p}{di_p}$$

Particular care should be taken with the signs in all cases since otherwise serious errors may be introduced in certain calculations.

Conversion Factors : See Chapter 40.

Valve Capacitances.

- C_{gk} = capacitance from grid to cathode
 C_{gp} = " " " " plate
 C_{pk} = " " plate to cathode
 C_{gs} = " " control grid to screen.

The Static Input Capacitance is for a

- (1) Triode— C_{gk}
- (2) Screen grid or pentode— $C_{gk} + C_{gs}$

Note that the input capacitance for a pentode used as a pentode is $C_{gk} + C_{gs}$ while when used as a triode it is C_{gk} .

The Dynamic Input Capacitance is approximately equal to the static input capacitance + $(M + 1) C_{gp}$, where M = stage gain. (See Miller Effect, Chapter 7).

The Output Capacitance is the capacitance from the plate to all other electrodes.

* The simple inversion of partial differentials cannot always be justified.

† M is a complex quantity which represents not only the numerical value of the stage gain but also the phase angle between the input and output voltages. The vertical bars situated one on each side of M and its equivalent indicate that the numerical value only is being considered.

CHAPTER 34

Graphical Representation of Valve Characteristics

Characteristic curves—load line—plate characteristics—mutual characteristics—dynamic characteristic—grid current characteristics—grid load lines—positive grid drive—constant current curves—resistance coupled amplifiers—triode power amplifiers—driver valve for Class B output—pentode power amplifiers—beam tetrodes—rectification effects—push-pull amplifiers—amplifiers drawing grid current—screen current—diode curves—rectifier curves—regulation of supply—bibliography.

Characteristic Curves and Their Application

The most convenient method of expressing valve characteristics is in the form of Characteristic Curves. These are of three kinds:

- (1) The **plate characteristic** in which the plate current is plotted (vertically) against the plate voltage (horizontally), each curve being for constant grid voltage,
- (2) The **mutual characteristic** in which the plate current is plotted (vertically) against the grid voltage (horizontally), each curve being for constant plate voltage, and
- (3) The **constant current characteristic** in which the plate voltage is plotted against the grid voltage, each curve being for constant plate current.

Of these three types of curves, the first two are widely used for most applications, while the third is particularly valuable in the case of R.F. power amplifiers.

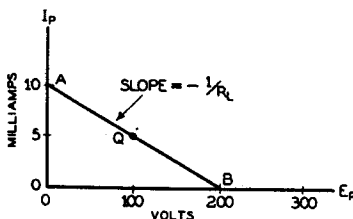

Figure 1

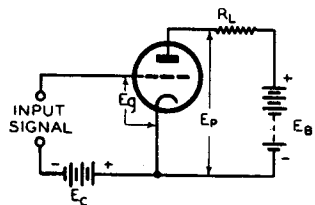

Figure 2

In addition to these plate current characteristics, it is sometimes necessary also to show the grid current or screen current characteristics, and these may be drawn either supplementary to the plate current curves, or on separate graphs. There are also special curves for diodes and rectifiers.

Characteristic curves represent experimental results, and are therefore accurate for an average valve, but certain variations are to be expected with most valves. It is therefore desirable to check the calculations made on the basis of the curves with representative batches of valves, or else to allow a safety margin.

Load Line

The usual plate (E_p, I_p) characteristics are drawn for zero plate load resistance, and if any load impedance is inserted in the plate circuit it is necessary to add the correct Load Line which will then, in association with the curves, give the locus of the operating point. In the case of the mutual (I_p, E_p) characteristics the effect of a plate load resistance is shown by the Dynamic Characteristic.

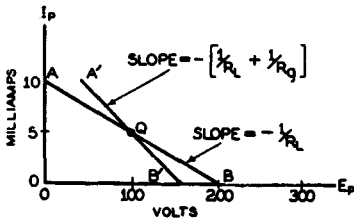

Figure 3

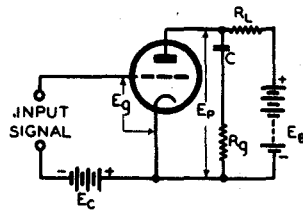

Figure 4

The Load Line may be drawn quite independently of the valve characteristics, a typical one being shown in Fig. 1 for a resistive load of 20,000 ohms and a supply voltage of 200 volts. Since E_p represents the voltage actually on the plate of the valve it is evident that the full supply voltage (200) can only be the plate voltage when the voltage drop in the load resistor (R_L in Fig. 2) is zero, that is when the current is zero. Point B of Fig. 1 is therefore the point of zero current and full supply voltage. Point A is the point at which the voltage across the valve is zero, that is when the full supply voltage (200) is across the load resistor (20,000 ohms), and the current is therefore $200/20,000$ or 10 mA. Point A is therefore the point of voltage (E_p) zero and current 10 mA. Since the load is a pure resistance it will obey Ohm's Law, and the relationship between current and voltage will be a straight line (AB). The slope of AB is actually $-1/R_L$, the sign being negative since the plate voltage is the difference between the supply voltage and the voltage drop in R_L , and the inverted form ($1/R_L$) is due to the way in which the valve characteristics are drawn with current vertically and voltage horizontally. The slope of AB is often loosely spoken of as being the resistance of R_L , the negative sign and inverted form being understood.

The quiescent operating point (Q) must essentially lie on the load line (except in the case of push-pull amplifiers), and if the load under dynamic conditions is the same as the D.C. load the instantaneous operating point must also always lie on the same load line. If however the A.C. load is different from the D.C. load, then the dynamic load line will pass through Q but will have a slope corresponding to the total A.C. load (Figs. 3 and 4). In Fig. 4 the D.C. load resistance R_L is shunted by a load resistance R_g , through which D.C. is prevented from passing by the condenser C which is assumed to have negligibly small impedance to A.C. The total A.C. load R is therefore given by the expression

$$1/R = (1/R_L) + (1/R_g)$$

and the dynamic loadline A'QB' therefore has a slope of $-(1/R_L + 1/R_g)$.

If R_L is replaced by an inductance L , forming a very high impedance to A.C., the slope of AB becomes the D.C. resistance of the choke, and the slope of $A'B'$ becomes $-1/R$ (Figs. 5 and 6).

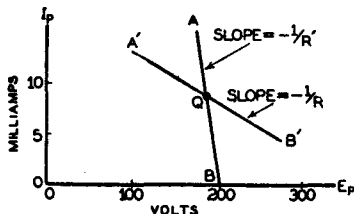

Figure 5

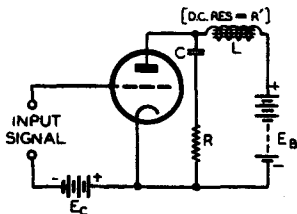

Figure 6

From this description it will be seen that the load lines are quite independent of the valve characteristics, except that the quiescent operating point Q is fixed by the intersection of the D.C. loadline (AB) and the selected valve curve. We may now return to a consideration of the valve curves themselves, and apply to them the proper loadlines.

Plate Characteristics

The Plate Characteristic family for a triode valve is shown in Fig. 7. It is assumed that the plate voltage has been selected as 180 volts, and the grid bias -4 volts. By drawing a vertical line from 180 volts on the E_p axis (point K), the quiescent operating point Q will be determined by its intersection with the " $E_g = -4$ " curve. By referring Q to the vertical scale (I_p) the plate current is found to be 6 mA. The plate resistance at the point Q is found by drawing a tangent (EF) to the curve for $E_g = -4$ so that it touches the curve at Q .

The plate resistance (r_p) at the point Q is then EK in volts (65) divided by QK in amperes (6 mA. = 0.006 A.) or 10,800 ohms.

The amplification factor (μ) is the change of plate voltage divided by the change of grid voltage for constant plate current. Line CD is drawn horizontally through Q , and represents a line of constant plate current. Points C and D represent grid voltages of -2 and -6 , and correspond to plate voltages of 142 and 218 respectively. The value of μ is therefore (218 - 142) plate volts divided by a change of 4 grid volts, this being 76/4 or 19.

The mutual conductance (g_m) is the change of plate current divided by the change of grid voltage for constant plate voltage. Line AB which is drawn vertically through Q represents constant plate voltage. Point A corresponds to 9.6 mA., while point B corresponds to 2.6 mA., giving a difference of 7 mA. Since points A and B also differ by 4 volts grid bias, the mutual conductance is 7 mA. divided by 4 volts or 1.75 mA./volt or 1,750 micromhos.

In these calculations it is important to work with points equidistant on each side of Q to reduce to a minimum errors due to curvature.

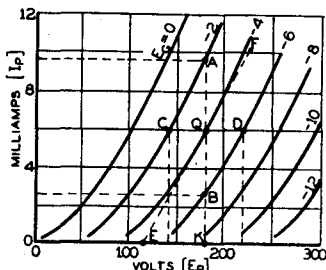

Figure 7

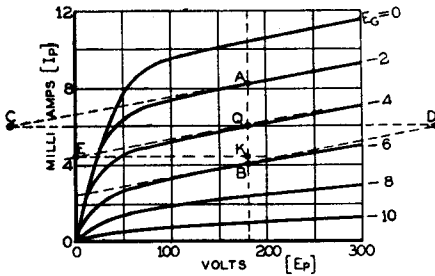

Figure 8

AB (4.1 mA.) divided by 4 volts change of grid bias, that is 1.025 mA./V. or 1025 micromhos. The amplification factor is the change of plate voltage (CD = 447 volts) divided by the change of grid voltage (4 volts) or 111.7. The plate resistance is EK/QK, i.e. 180/0.00165 or 109,000 ohms.

The plate characteristics of a beam tetrode are somewhat similar to those of a pentode except that the "knee" tends to be more pronounced.

The plate characteristics of a screen-grid or tetrode are in the upper portion similar to a pentode, but the "knee" occurs at a plate voltage slightly greater than the screen voltage and operation below the "knee" is normally inadvisable due to instability.

Mutual Characteristics

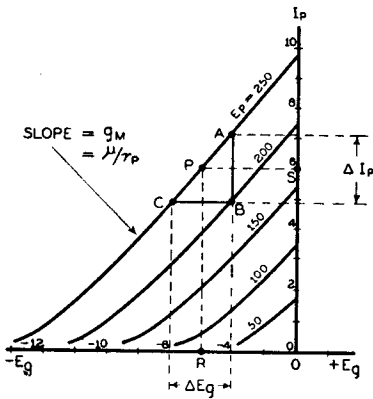

Figure 9

The Mutual Characteristics of a triode valve are shown in Fig. 9. Each curve corresponds to a constant plate voltage. Let P be a point on the $E_p = 250$ curve, and let us endeavour to find out what information is available from the curves. The bias corresponding to P is given by R (-6 volts) and the plate current is given by S (6 mA). Let now a triangle ABC be constructed so that AP = PC, AB is vertical, CB is horizontal and point B comes on the $E_p = 200$ curve.

The mutual conductance is given by AB/BC or 2.26 mA./4 volts which is 0.565 mA./volt or 565 micromhos. Thus the slope of the characteristic is the mutual conductance.

The amplification factor is given by the change of plate voltage divided by constant plate current, that is

$$\mu = \frac{E_{p1} - E_{p2}}{CB} = \frac{E_{p1} - E_{p2}}{\Delta E_g}$$

$$= \frac{250 - 200}{4} = 12.5$$

The plate resistance is given by the change of plate voltage divided by the change of plate current for constant grid voltage; that is

$$r_p = \frac{E_{p1} - E_{p2}}{\Delta I_p} = \frac{250 - 200}{2.26 \times 10^{-3}} = 22,100$$

These curves hold only if there is no series resistance in the plate circuit. They could therefore be used for a transformer coupled amplifier provided that the primary of the transformer had negligible resistance. In the present form they could not be used to predict the operation under dynamic conditions. The static operation point P may however be located by their use.

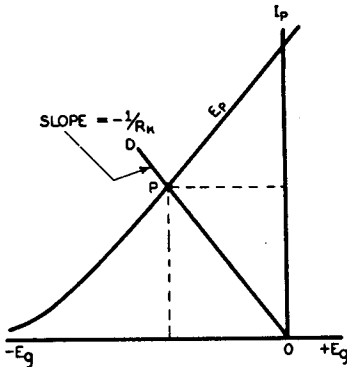

Figure 10

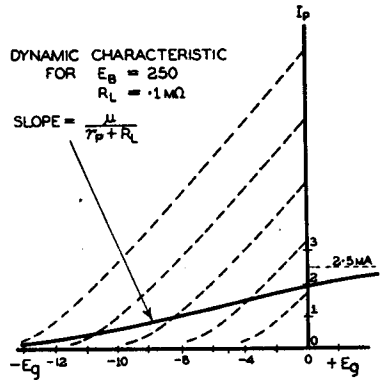

Figure 11

If self-bias is used, the static operating point may be determined, as shown in Fig. 10, by drawing from O a straight line OD, which has a slope $(-1/R_k)$ determined by the cathode resistance. The point P where OD intersects the curve corresponding to the plate voltage will be the static operating point.

Dynamic Characteristic

If a resistance load is inserted in the plate circuit the Dynamic Characteristic (Fig. 11) no longer takes the same form as the static characteristic but is affected by the load. While the slope of the static characteristic is g_m or μ/r_p , the slope of the dynamic characteristic is $\mu/(r_p + R_L)$. Owing to $(r_p + R_L)$ being more nearly constant than r_p , the Dynamic Characteristic is more nearly straight than the static curve.

The Dynamic Characteristic may be drawn by transferring points from along the Loadline in the Plate Characteristic to the Mutual Characteristic. An alternative method (which may only be used with a resistive load) is as follows (Fig. 11):—

When the plate current is zero, the voltage drop in the load resistance is zero, and the plate voltage is equal to the supply voltage (250). For the plate voltage to be 200 volts, there must be a drop of 50 volts in the

load resistor (100,000 ohms) and the plate current must therefore be 50/100,000 or 0.5 mA., and so on. A table may be prepared for ease of calculation:

Plate Voltage	Voltage Drop in Load Resistor	Plate Current (= volts drop / RL)
250	0	0
200	50	0.5 mA.
150	100	1.0
100	150	1.5
50	200	2.0

It will be seen that this table is not affected by the shape of the valve characteristics. The Dynamic Characteristic may then be plotted by taking the intersections of the various plate voltage curves with the plate current values given in the table.

The operating point on the Dynamic Characteristic may be determined by the applied grid bias or by the method already given for the static characteristic when self bias is employed.

The shape of the Dynamic Characteristic may be used as a measure of distortion. This will be treated in detail later in the chapter.

The Dynamic Characteristic of a Triode is curved gradually upwards over the whole range of negative voltages, but it has a "top bend" at some positive bias. It approaches, but never reaches, a plate current of E_B/RL .

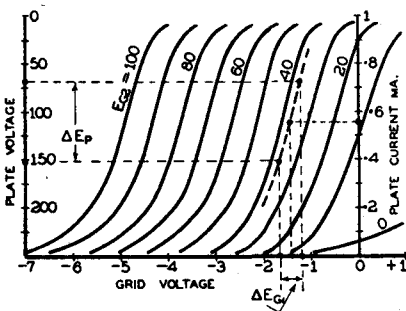

Figure 12

The Dynamic Characteristic of a Pentode* is of particular importance with resistance coupled amplifiers and will generally be found more convenient as a basis of calculations than the Plate Characteristic. A typical family of Pentode Dynamic Characteristics is shown in Fig. 12, these being for type 6J7-G (6C6). The curves for all screen voltages are very similar and have a fairly rounded bottom bend, a nearly straight portion, and a fairly sharp top bend. As a detector, either the top or bottom bend may be used, the top bend being more suitable for

small input voltages. As an amplifier, the operating point should be chosen so that the dynamic path does not leave the straight portion. If only a small output voltage is required, there is considerable latitude in the choice of operating point without the occurrence of perceptible distortion. When the maximum possible output voltage is required the working point should be at a current of about 0.56 E_B/RL . When $E_B = 250$ volts the $RL = 0.25$ megohm this becomes 0.56 mA.

It will be seen from the shape of the curves that those corresponding to the lower screen voltages have the longest straight portions. There is therefore an advantage in selecting a low screen voltage when a high output voltage is required. The limit to the choice of a low screen voltage is set by the occurrence of grid current (at a bias of about -0.7 volt for type 6J7-G). A screen voltage of 37 volts is a good compromise for the conditions of Fig. 12. The final adjustment of the operating point may be made by slight alteration of either screen or bias voltage, until the plate current is 0.56 E_B/RL .

*A detailed description of the dynamic characteristics of the 6C6 pentode was given in Radiotrons No. 69 (28th October, 1936).

Slightly higher gain may be obtained by operating at a higher plate current, since the point of maximum gain occurs at the point of inflexion immediately below the commencement of the top bend. Only a limited output voltage is obtainable, under these conditions, before distortion appears as a result of non-linearity. The adjustment of voltage is also considerably more critical than for the centre point of the nearly-straight portion of the curve.

A further reason for the choice of the lower operating point is that the distortion, even though small, is largely second harmonic, while that at the point of inflexion is largely third harmonic.

Since the plate current is also the current flowing through the load resistor, there is a linear relationship between the plate current and the plate voltage, either D.C. or A.C. Consequently the Dynamic Curves may be calibrated with a plate voltage scale in addition to plate current. In Fig. 12, for example, zero plate voltage corresponds to 1 mA., and 250 volts on the plate to zero current. Thus the gain of the valve under dynamic conditions ($\Delta E_p / \Delta E_{gr}$) is given by the slope of the dynamic characteristic. If the swing is sufficient to operate the valve beyond the limits of the nearly-straight portion of the curves, the gain will vary as the signal voltage is increased. For most practical purposes the ratio between the peak plate voltage and the peak grid signal voltage may be taken as the gain, since the excitation of the following stage is dependent upon the peak voltage.

When the D.C. load resistance is shunted by an A.C. load R_g , such as in the case where R_g is the grid resistor of the following valve, the gain and peak output voltage will be reduced. The modified gain under these conditions will be $R_g / (R_L + R_g)$ of the gain without any shunting. The peak output voltage will be reduced in the same proportion as the gain.

Since the curvature of the dynamic characteristic is a measure of the harmonic distortion the peak output voltage which may be delivered with limited distortion is readily calculable.

When self bias is employed, it is possible to apply the method previously given (Fig. 10) for determining the static operating point. With triodes the dynamic characteristic may be used directly as in Fig. 10, but with pentodes there must be an adjustment since the cathode current is the sum of the plate and screen currents. In this, use may be made of the fact that the ratio between screen and plate currents is nearly constant. If this constant is A , the intersection of the dynamic characteristic and a straight line from O having a slope of $-1/[Rk(1 + A)]$ will indicate the static operating point. If, for example, the published plate and screen currents are 2.0 and 0.5 mA. respectively, A will be $0.5/2$ or 0.25. The cathode resistor may be 2000 ohms, but the effective cathode resistor as regards the plate current only will be $2000(1 + 0.25)$ or 2500 ohms. If now the sloping line is drawn for 2500 ohms, its intersection with the dynamic characteristic will give the operating point.

Screen Dropping Resistor.

In order to determine the resistance of the screen dropping resistor, it is necessary to make use of the plate characteristics of the valve as a triode, that is, with the plate connected to the screen. To a fairly close approximation the screen current is equal to $A/(1 + A)$ of the triode cathode current (i.e., plate + screen electrode currents) where A is the ratio between screen and plate currents. The plate characteristics of the valve as a triode may therefore be used to represent the screen current—screen voltage characteristics provided that a new scale is added for screen current in which 1 mA. of screen current is equivalent to $(1 + A)/A$ milliamperes of cathode current (Fig. 13). Since a considerable

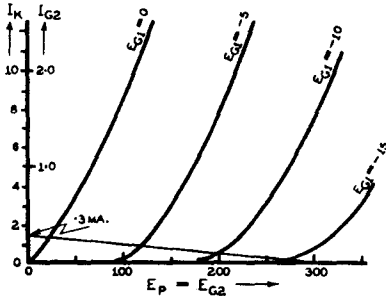

Figure 13

grid bias and screen voltage are known, the loadline may be drawn and the resistance calculated from its slope.

change of plate voltage results in only a slight change of cathode current, these characteristics may be regarded as being independent of plate voltage.

On these curves a loadline may be drawn, the slope being $-1/R_d$ where R_d is the resistance of the dropping resistor. The loadline drawn in Fig. 13 is for a screen supply voltage of 300 volts and a screen dropping resistance of 1 megohm. The intersection of the loadline and the corresponding grid bias curve gives the screen voltage. Alternatively, if the

Grid Current Characteristics

Grid Current Characteristics (Fig. 14) may be added to the plate mutual characteristics although it is usually desirable to employ an enlarged scale for the grid current since it is so much smaller than the plate current at negative or slightly positive bias voltages. Negative Grid Current ("Gas Current") flows from the point of plate current cutoff to the so called "Contact Potential Point." The peak gas current should never exceed $1\mu A$. for small valves, but may be $2\mu A$. or higher in the case of power valves. The initial gas current frequently tends to "clean up" during running, but all design should be based on the possible presence of some gas current.

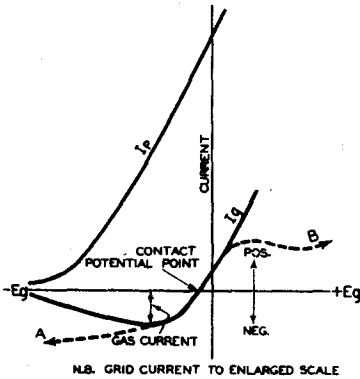

Figure 14

If any Grid Emission is present, the negative grid current tends to increase as the grid is made more negative (Curve A). Grid Emission may therefore be distinguished from Gas Current by testing at a point beyond plate cutoff immediately after the valve has been running under normal conditions for a considerable time. Once the plate current has ceased the heating of the plate and indirect heating of the grid will decrease, and the Grid Emission will also tend to decrease slightly.

The "Contact Potential Point" is the point at which the grid current is zero, being negative on one side and positive on the other. In indirectly heated valves it generally occurs about -0.3 to -0.7 volt, but individual valves may be anywhere within the range of 0 to -1.4 volt. Generally there is a tendency for the Contact Potential to approach towards -0.3 volt as valves become older, although high- μ triodes (e.g. 6B6-G) always tend to have more negative values than general purpose types.

Positive Grid Current flows at all grid voltages on the positive side of the Contact Potential Point. Occasionally there is sufficient secondary emission from the grid at some well-positive voltage to give a downward (negative) slope to the grid characteristic (Curve B in Fig. 14). If such a condition obtains, and a surge causes the grid to reach the negative

portion, it is possible for the grid to "block" and fail to return to its normal voltage until the power is switched off. In normal amplifiers this may generally be overcome by avoiding surges where possible, and by making the surge due to switching-on to be in a negative direction on the valve most likely to "block."

Grid Load Lines

When a valve is operated with a fixed negative grid bias, but has a total grid circuit resistance of R_g , the actual voltage on the grid may differ from the applied bias due to grid current. If negative grid current is present the condition will be as shown in Fig. 15 in which OA represents the applied bias. The plate current operating point with no grid current will obviously be Q but if the negative grid current characteristic is as shown, the grid operating point will be B and the plate operating point Q'. Point B is determined by the intersection of the grid current characteristic and a load line having a slope of $-1/R_g$. The shift in grid bias due to voltage drop across R_g will be ΔE_g or $R_g \cdot I_g$. The operating point can obviously never be swung beyond the contact potential point, so that the static plate current can never go beyond D (Fig. 15) due to negative grid current.

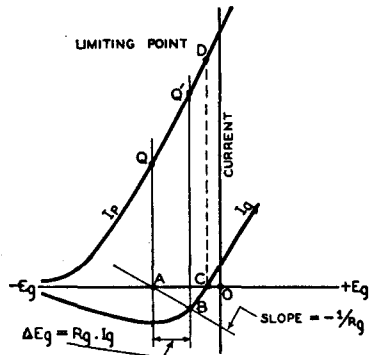

Figure 15

Positive Grid Drive

When a valve is operated so that the grid is driven appreciably positive, power is required in the grid circuit. Fig. 16 shows the grid current characteristic of a valve operating at a bias $-E_c$, when a signal of peak voltage E_g is applied. The grid current is shown by curve C and the peak grid current ($I_{g \text{ peak}}$) by point D. The peak grid input power is equal to the peak signal voltage multiplied by the peak current, or

$$W_{\text{peak}} = E_{g \text{ peak}} \times I_{g \text{ peak}} \\ = 2 \times \text{area of triangle ADF.}$$

The peak grid input resistance is $R_{i \text{ peak}}$ where

$$R_{i \text{ peak}} = E_{g \text{ peak}} / I_{g \text{ peak}}.$$

It is evident that the peak grid input resistance is given by the inverse of the slope of AB. The grid input resistance over a complete cycle may be shown by drawing a succession of lines similar to AD to intersect OCD at grid voltages corresponding to equal angular increments. Until the signal voltage exceeds E_c there will be no grid current, the grid input impedance will approach infinity and the grid input power will be zero.

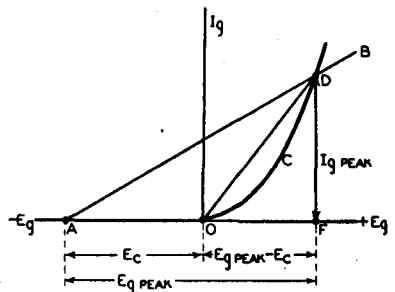

Figure 16

If zero bias had been used in the preceding example in place of $-E_c$ and $E_{g \text{ peak}}$ reduced so that the peak positive voltage remained as before, the peak grid input power would be represented by twice the area of the triangle ODF, and the peak grid input resistance by the inverse of the slope of OD.

The average values of input power and grid input resistance are generally of little assistance in design, although the average grid current is useful as a practical check on whether the grid drive is sufficient. It may be taken for granted that if the driver valve is capable of supplying the peak grid voltage and current, it is easily capable of supplying the smaller voltages and currents at other parts of the cycle, irrespective of the load on the driver, which is of minimum resistance at the peak voltage.

An interesting observation is that the input resistance over the cycle for push-pull operation is more nearly constant for zero bias operation than for high negative bias operation.

Constant Current Curves

The third type of valve characteristic is known as the "Constant Current" Characteristic. A typical family of Constant Current Curves is shown in Fig. 17, these being for a typical triode (type 801).

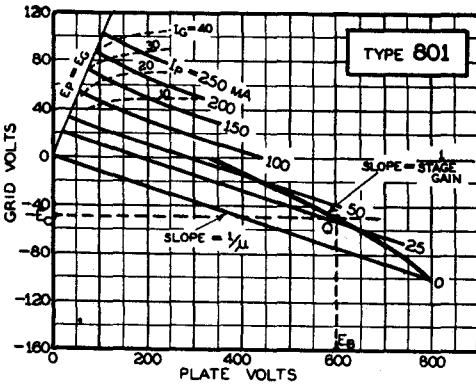

Figure 17

The slope of the curves indicates the amplification factor, and the slope of the loadline indicates the stage voltage gain. The operating point is fixed definitely by a knowledge of plate and grid supply voltages, but the loadline is only straight when both plate and grid voltages follow the same law (e.g., both sine wave). Distortion results in curved characteristics, so that this form of representation is not very useful except for tuned-grid tuned-plate or "tank-circuit" coupled R.F. amplifiers. Constant Current Curves may be drawn by transferring points

from the published characteristics. For a full treatment the reader is referred to

- (1) Mourontseff and Kozaowski: "Vacuum Tubes as Class C Amplifiers", Proceedings I.R.E., July, 1935.
- (2) "Making Life More Simple" (F. A. Everest) Radio, July, 1937, and Radio Digest, November, 1937.

Resistance-Coupled Amplifiers

The plate characteristics of a valve may be used, in association with the corresponding loadline, for the purpose of estimating the performance of the stage. Fig. 18 shows the plate characteristics of a triode on which has been superimposed the loadline AB corresponding to a supply voltage E_b and a D.C. load resistance R_L (Fig. 2), which determines the slope of AB. The operating point Q is determined by the intersection of AB and the curve corresponding to the applied grid bias E_{g1} . If now a rectangle OCDB is drawn so that CD passes through Q, the total area of OCDB re-

presents the total power ($E_B I_{p1}$) drawn from the B supply. If a vertical line QK is drawn through Q, the area of the rectangle OCQK represents the plate dissipation of the valve ($E_{p1} I_{p1}$), and the area of the rectangle KQDB represents the dissipation in the load resistance [$(E_B - E_{p1}) I_{p1} = I_{p1}^2 R_L$]. These only apply when no input is impressed.

The conditions obtaining when an input signal with a peak voltage of E_{g1} is impressed are shown in Fig. 19. The assumption is made in this diagram that Q is midway between E and G, that is to say that there is no second harmonic distortion or rectification effect. The power output (that is the A.C. power developed in R_L due to the impressed signal) is $\frac{1}{2} \times$ the area of the rectangle EFGH, or the area of the triangle MQJ. The D.C. dissipation in R_L is the area KQDB as before, but it must be realised that

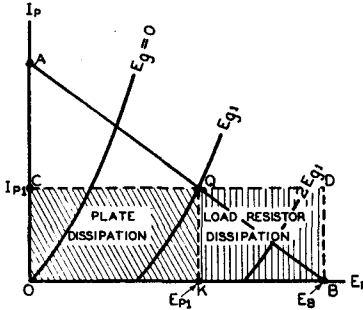

Figure 18

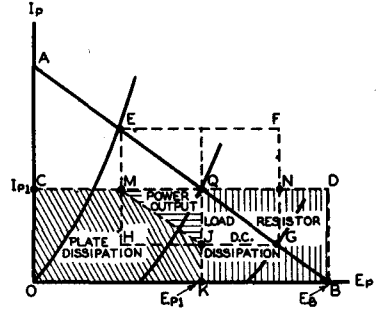

Figure 19

there is also being dissipated in R_L the A.C. power indicated by MQJ. The plate dissipation is reduced by the amount of the power output and is therefore indicated by the area of OCMJK. This decrease in plate dissipation under dynamic conditions occurs with all Class A Amplifiers, and it is for this reason that a pure Class A Amplifier is designed so as not to exceed its dissipation under static conditions.

In order to facilitate calculations of voltage gain the plate characteristic has been redrawn in Fig. 20. With a peak grid signal voltage E_{g1} , the operating point will move along the loadline from E to G. Since E corresponds to a plate voltage E' and G to G' it is evident that the plate voltage excursion corresponding to a grid excursion from 0 to $2E_{g1}$ is the difference in plate voltage between E' and G' . The stage gain is therefore $E'G'/2E_{g1}$. If an A.C. shunt load (R_s in Fig. 4) is added, the dynamic loadline will pass through Q and have a slope of $-1/R$ which is equal to $-[(1/R_L) + (1/R_s)]$. For the same grid voltage excursion as previously, the operating point will move from P to R and the plate voltage from P' to R' . The stage gain will therefore be $P'R'/2E_{g1}$. This stage gain may be compared with the valve gain with infinite A.C. loading which is $C'D'/2E_{g1}$. The progressive decrease in stage gain ($C'D'$, $E'G'$, $P'R'$) is evident.

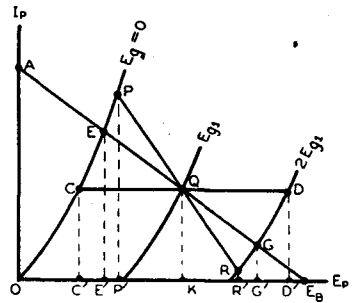

Figure 20

The peak output voltage under dynamic conditions ($P'K = KR'$ etc.) is the peak grid voltage for the following stage in a resistance-capacitance-coupled amplifier. If R_c is of comparatively low resistance, the dynamic loadline PR will slope steeply and may cut the zero plate current axis or

else R may be in the region of excessive curvature, either effect leading to distortion. If a high output voltage is required it is good practice to make R_x at least 4 times RL to reduce this effect. If however only a small output voltage is required, the ratio R_g/RL may reach unity or even lower in extreme cases. The distortion which occurs with a resistance-coupled triode is mainly second harmonic, and if PQ/QR (Fig. 20) does not exceed 1.22 this distortion does not exceed 5%. The shape of the characteristics indicates that minimum distortion occurs with any triode when E_{c1} is as small as possible without any risk of running into grid current. For the purposes of calculations the grid current point may be taken as

- 0.2 volt for 2 volt battery valves
- 0.7 volt for medium- μ indirectly heated valves
- and —1.0 volt for high- μ indirectly heated valves.

The bias should therefore be adjusted so that the peak signal voltage swings nearly up to these "grid current points." The optimum bias is therefore influenced by the load resistor and the following grid resistor as well as by the characteristics of the valve, the supply voltage and the required output voltage.

If the stage gain (M) is known, a close approximation to the optimum bias (E_c) is given by

$$E_c = -\left(0.3 + \frac{E_{peak}}{M}\right) \text{ for 2 volt battery valves,}$$

$$E_c = -\left(0.8 + \frac{E_{peak}}{M}\right) \text{ for medium-}\mu \text{ indirectly heated valves}$$

$$\text{or } E_c = -\left(1.1 + \frac{E_{peak}}{M}\right) \text{ for high-}\mu \text{ indirectly heated valves}$$

where E_{peak} = plate peak output voltage.

If M is not known it may be calculated approximately from

$$M = \frac{\mu}{1 + r_p [(RL + R_g)/(RL \cdot R_g)]}$$

When R_g is less than 2 RL , or when the peak output voltage exceeds 0.15 E_b , the graphical method should be used for greater accuracy.

The load resistance of a triode valve should not under any normal circumstances be lower than twice the plate resistance, while a value of 5 times the plate resistance is generally preferable. For general purpose triodes 0.1 megohm, and for high- μ triodes 0.25 megohm will be found suitable.

The plate characteristic of a pentode valve with resistance coupling is shown in Fig. 21. The general treatment of a pentode is somewhat similar to that of a triode, except that, due to the control of the voltage

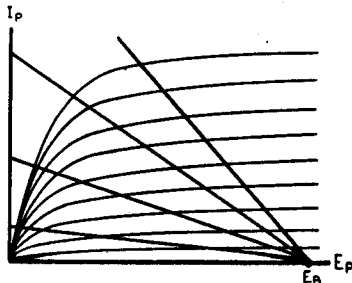

Figure 21

on the screen grid, it is possible so to adjust the operating conditions that the working part of the characteristic (the "straight" portion) is well away from the grid current region. Since with a pentode the operating point is arranged not to enter the grid-current region, the control-grid voltage swing is only limited by the curvature at each end of the dynamic characteristic, and the permissible peak A.C. plate voltage is much higher than for a triode with the same supply voltage and distortion. Although the plate characteristic of a resistance coupled pentode is the basis of calculation, it is more convenient to derive from it the dynamic mutual characteristic and to use the latter for further calculations. (See under Dynamic Characteristic).

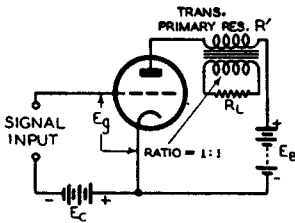

Figure 22

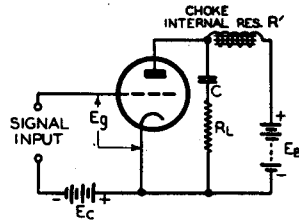

Figure 23

The plate load resistance of a pentode is not limited as with a triode and may be varied within wide limits. For general voltage amplifier application 0.25 megohm is recommended, while 0.1 megohm may be used for improved high frequency response, or where a very low following grid resistance is used, and/or where a slightly lower gain is desired. (See also Chapter 1.).

Triode Power Amplifiers

When maximum power output is required from a valve which is operated from a source of limited voltage it is generally used with transformer or choke coupling. These two methods are illustrated in Figs. 22 and 23 respectively, but are identical as regards the characteristic curves provided that the transformer ratio is unity. It is assumed that the inductance of the transformer primary and of the choke are sufficiently high to prevent any appreciable shunting of the A.C. load, that C offers negligible impedance to A.C. compared with R_L , and that no losses occur in any of these components.

The plate characteristic corresponding to either of these circuits is shown in Fig. 24, the assumption being made that no second harmonic or rectification effects are present. E_B represents the supply voltage and the line QEB has a slope $-1/R'$ where R' is the resistance of the transformer primary or choke. QEB intersects the curve corresponding to the bias E_{g1} at Q which is therefore the quiescent point. The loadline EQG is drawn through Q with a slope of $-1/R_L$. In a power amplifier it is generally assumed that for maximum power output the grid swing is taken to zero bias, even though a small amount of grid current may then flow. If it is desired to determine the power output for zero grid current this may readily be done by a reduction of grid swing.

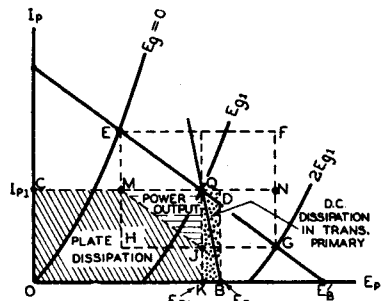

Figure 24

The quiescent point Q gives a plate voltage E_{p1} (Fig. 24). It is evident

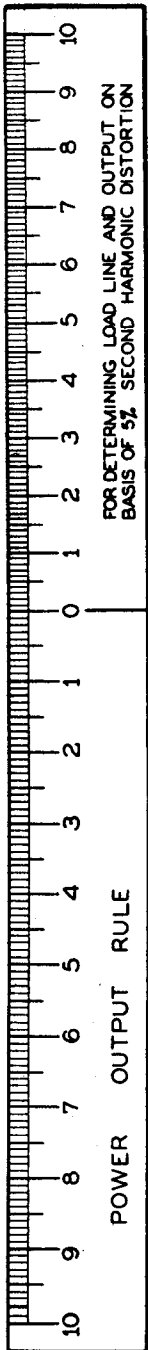

Figure 26

that the same operating point could have been reached in a resistance coupled amplifier by an increase of supply voltage from E_b to E'_b , where E'_b is the point where the extended loadline cuts the axis. In Fig. 24 the dissipation in the transformer primary is the area of the rectangle QDBK, and the total power from the B supply is the area of the rectangle OCDB. If there is no signal input the plate dissipation is OCQK, but if full signal excitation is applied the power output is $\frac{1}{2} \times$ the area of the rectangle EFGH, or the area of the triangle MQJ, and the plate dissipation decreases to the area OCMJK.

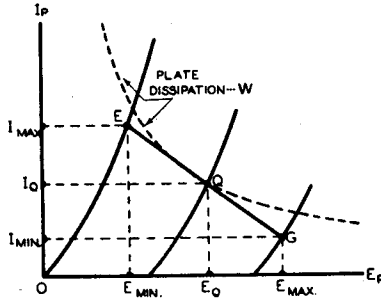

Figure 25

If the characteristics of a triode valve are available (Fig. 25) and it is required to select the operating conditions for maximum power output the procedure is as follows:—

- (1) Select the plate voltage. This may be the maximum rated voltage, or it may be limited by the B supply.
- (2) Note the maximum plate current. This may be limited by the plate dissipation, or by the rating limit or by the B supply.
- (3) Make a "5% distortion rule" as Fig. 26. This has each division to the left of 0 a length of 11/9 or 1.22 of the length of a corresponding division to the right of 0. It may be made with each left-hand division 11 millimetres and each right-hand division 9 millimetres. Each of these divisions may be divided into 10 equal subdivisions.
- (4) Place the "0" of the distortion rule at any likely operating point such that of maximum rated plate voltage and maximum rated plate current, and tilt the rule gradually until the reading on the rule corresponding to the zero bias curve is the same as the reading corresponding to the curve of twice the grid bias at the operating point. EQ/QG will then be 11/9 and the second harmonic distortion corresponding to EQG as a loadline will be 5%.
- (5) The power output corresponding to this loadline is approximately

$$\frac{(E_{\max} - E_{\min})(I_{\max} - I_{\min})}{8}$$

- (6) If I_{min} is less than $0.25 I_q$ it may generally be assumed that the loadline which has been selected is fairly close to the optimum. If I_{min} is greater than $0.25 I_q$ it is desirable to make one or more further trials, with slightly varying grid bias, and to calculate the power output from each. With the aid of these data the loadline for maximum "undistorted" (i.e., less than 5% second harmonic) power output may be selected.
- (7) The load resistance corresponding to the selected loadline is

$$R_L = \frac{E_{max} - E_{min}}{I_{max} - I_{min}}$$

Alternatively, a line may be drawn parallel to EG (Fig. 25) so as to cut both axes. The resistance is then equal to the voltage intercept divided by the current intercept.

- (8) For the greatest accuracy it is necessary to correct the loadline for "rectification" (see section later in this chapter).

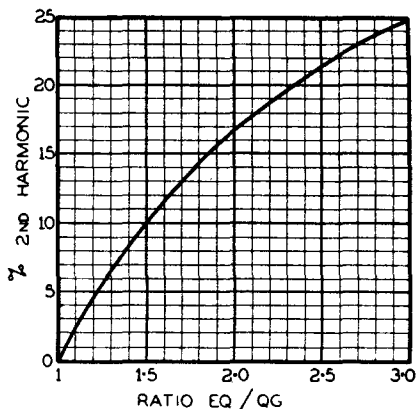

Figure 27

As a guide to the first choice of loadline (which should then be checked by the method already given in order to find the optimum) the following may be used:—

$$\text{Zero signal bias}^* = 0.675 E_B / \mu$$

$$I_{max} = 2 I_q.$$

Values of second harmonic distortion in addition to 5% may be calculated from the approximate formula

$$\% \text{ 2nd harmonic} = \frac{\frac{1}{2} (I_{max} + I_{min}) - I_q}{I_{max} - I_{min}} \times 100.$$

This is also given in Fig. 27, in which the second harmonic distortion is plotted against the ratio of the two portions of the loadline (EQ/QG). The curve of Fig. 27 was calculated from the formula (see Fig. 25).

$$\% \text{ 2nd harmonic} = \frac{EQ - QG}{2 (EQ + QG)} \times 100.$$

Driver Valves for Class B Output

When a Class AB₂ or Class B output stage is employed, the load on the driver valve varies during the cycle. If a negative bias is supplied to the

*The bias voltage which is determined by this method is to the negative end of the filament with D.C. heating. If the return is made to the centre-tap of an A.C. heated filament the bias should be increased by one half the filament voltage.

This should not be regarded as being an accurate formula since it does not take all factors into consideration. In general it will be found to give results which are smaller than the optimum bias for highly efficient valves, and greater than the optimum bias for less efficient valves.

output stage the grid impedance, up to the point where grid current flows, will be practically infinite and may be represented by a horizontal loadline

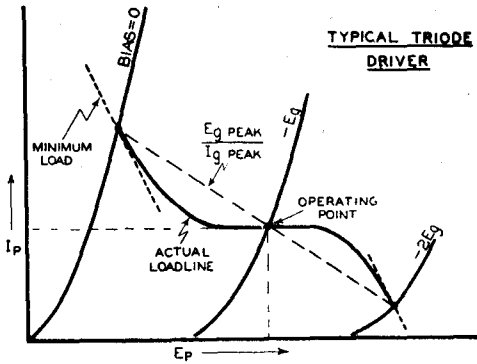

Figure 28

on the plate characteristic of the driver valve (Fig. 28). As the driving voltage increases the peak grid resistance decreases, and a curved loadline is produced. At the point of extreme excursion the "peak grid resistance" ($E_g \text{ peak}/I_g \text{ peak}$) determines the position of the end point of the loadline, and the incremental grid resistance determines the slope of the loadline at this point. This incremental grid resistance is determined by drawing a tangent to the grid current curve at the point of extreme excursion (Fig. 28).

The curvature of the loadline introduces distortion additional to that due to the straight loadline ($E_g \text{ peak}/I_g \text{ peak}$). The calculation of this distortion, and the determination of the optimum operating conditions for the driver stage are beyond the scope of this Handbook.

If the secondary of the driver transformer were loaded by a fixed resistance there would be no horizontal portion of the loadline, and the loadline would slope more steeply. Unless the power of the driver stage were increased, or the transformer step-down ratio decreased, the effect would be to increase the distortion.

Pentode Power Amplifiers

The plate characteristics of a typical power pentode are shown in Fig. 29. The general procedure is similar to that with a triode except that E_Q/QG is usually made equal to unity so that the second harmonic is zero. The third and higher harmonics are usually fairly large and must be considered.

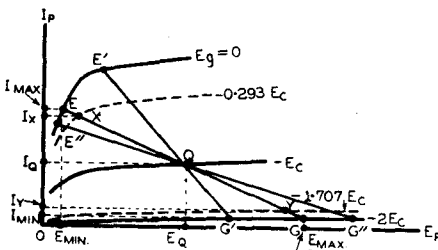

Figure 29

Sometimes a lower value of load resistance (loadline $E'QG'$) is adopted so as to decrease the third harmonic distortion with a small increase of second harmonic, and usually a slight decrease in power output. Higher values of load resistance should be avoided since they increase second and third harmonic distortion and, if the loadline cuts the zero grid bias curve below the knee, the screen current tends to rise unduly and the screen dissipation may be exceeded.

The formula for power output as used for triodes gives a result lower than the actual output when third harmonic distortion is appreciable and a more accurate formula suitable for pentodes (and other valves having appreciable third harmonic) is

$$\text{Power Output} = \frac{[I_{\text{max}} - I_{\text{min}} + 1.41 (I_x - I_y)]^2 R_L}{32}$$

where I_x and I_y are the plate currents corresponding to grid voltage 0.293 and 1.707 E_c respectively (Fig. 29).

Using the same method

$$R_L = \frac{E_{\max} - E_{\min}}{I_{\max} - I_{\min}}$$

$$\% \text{ 2nd harmonic} = \frac{I_{\max} + I_{\min} - 2I_0}{I_{\max} - I_{\min} + 1.41 (I_X - I_Y)} \times 100$$

$$\% \text{ 3rd harmonic} = \frac{I_{\max} - I_{\min} - 1.41 (I_X - I_Y)}{I_{\max} - I_{\min} + 1.41 (I_X - I_Y)} \times 100$$

This is known as the "5 Ordinate" method and is sufficiently accurate for most purposes where percentages of harmonics higher than the third are not required. A still more accurate method is the "11 Ordinate Method."

Eleven Ordinate Method

When the 5 Ordinate Method is not sufficiently accurate, or when it is required to calculate the fifth harmonic, the 11 Ordinate Method may be adopted. The "dynamic characteristic" is transferred from the $E_p I_p$ curves to a dynamic mutual characteristic (Fig. 30). The plate current is noted for grid voltages of 0, 0.2, 0.3, 0.5, 0.7, 1.0, 1.3, 1.5, 1.7, 1.8 and 2.0* times the bias voltage ($-E_c$). The full signal D.C. plate current is I^B , and may be derived experimentally or by the methods given under "Rectification Effects." Knowledge of the value of I^B is not necessary for the calculation of the various harmonics. These may be obtained from

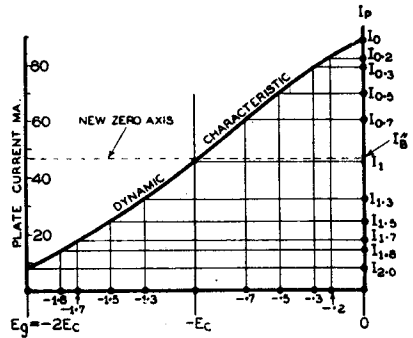

Figure 30

and may be derived experimentally or by the methods given under "Rectification Effects." Knowledge of the value of I^B is not necessary for the calculation of the various harmonics. These may be obtained from

$$\text{2nd Harmonic} = \frac{1}{4} (I_0 + I_2 - 2I_1) = H_2$$

$$\text{3rd Harmonic} = \frac{1}{6} (2I_{0.5} + I_2 - I_0 - 2I_{1.5}) = H_3$$

$$\text{4th Harmonic} = \frac{1}{8} (I_0 + 2I_1 + I_2 - 2I_{0.3} - 2I_{1.7}) = H_4$$

$$\text{5th Harmonic} = \frac{1}{10} (2I_{0.7} + I_0 + 2I_{1.8} - 2I_{0.2} - 2I_{1.3} - I_2) = H_5$$

$$\text{Fundamental} = \frac{1}{2} (I_0 - I_2) + H_3 - H_5 = H_1$$

(Note that all currents are peak values.)

Power due to fundamental

$$= \frac{1}{2} H_1^2 R_L.$$

*The exact values corresponding to these points are 0, 0.191, 0.293, 0.5, 0.691, 1.0, 1.309, 1.5, 1.707, 1.809, 2.0. The approximate values are, however, sufficiently accurate for most purposes.

Beam Tetrodes

The procedure for Beam Tetrodes is similar to that adopted for pentodes. The "knee" of the curve is more sharply defined than in the case of pentodes, and the loadline should not cut the zero bias curve below the knee owing to the sharp rise of screen current and unsatisfactory operation.

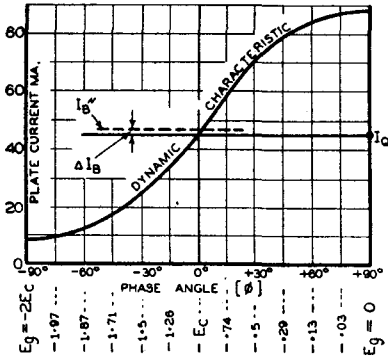

Figure 31

Rectification Effects

Rectification Effects, due to curvature of the valve characteristic, are found with all types of amplifiers, including pure Class A. One result is that the B current drain under dynamic conditions varies from the static value, and may be either higher or lower. The average D.C. current drain may be calculated by taking equal angular increments of the vector of grid voltage (e.g., 0°, 15°, 30°, 45°, etc.) as in Fig. 31, and finding the corresponding plate current at each point. The mean plate current (I''_B) may then be determined from

$$I''_B = \frac{1}{12} (\frac{1}{2}I_{90^\circ} + I_{75^\circ} + I_{60^\circ} + I_{45^\circ} + I_{30^\circ} + I_{15^\circ} + I_Q + I_{-15^\circ} + I_{-30^\circ} + I_{-45^\circ} + I_{-60^\circ} + I_{-75^\circ} + \frac{1}{2}I_{-90^\circ})$$

which is equivalent to

$$I''_B = \frac{1}{12} (\frac{1}{2}I_0 + I_{0.03} + I_{0.13} + I_{0.29} + I_{0.5} + I_{0.74} + I_Q + I_{1.26} + I_{1.5} + I_{1.71} + I_{1.87} + I_{1.97} + \frac{1}{2}I_{2.0})$$

A simple approximation is given by

$$\Delta I_B = \frac{1}{4} (I_{max} + I_{min} - 2 I_Q)$$

where ΔI_B = rise in B current from no signal to full signal. This formula may be put into a more convenient form for certain applications by making

$$I_{max} - I_Q \text{ equal to } I_X$$

$$\text{and } I_Q - I_{min} \text{ equal to } I_Y$$

$$\text{Then } I_{max} + I_{min} - 2I_Q = I_X - I_Y$$

$$\therefore \Delta I_B = \frac{I_X - I_Y}{4}$$

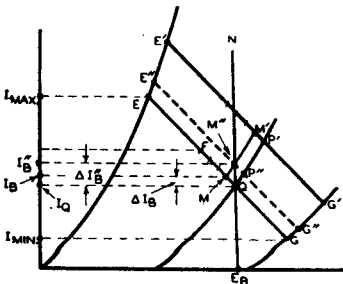

Figure 32

Fig. 32 shows a typical triode plate characteristic with an "uncorrected" loadline EQ. Since EQ is greater than QG there will be rectification and a rise of average plate current from I_Q to I_B where I_B is equal to $I_Q + \Delta I_B$. The point of intersection of I_B with the loadline may be determined graphically in the following manner.

From E lay off EF along EQ equal to QG. Divide FQ into four equal parts of which MQ is one. Then the current (I_B) corresponding to M is the average plate current for the loadline EQG. The justification for this procedure is that just as EQ corresponds to a current change I_x , and QG to a current change I_y , so MQ corresponds to a current change $(I_x - I_y)/4$ or ΔI_B .

It will be seen that the point M which corresponds to the average current on the loadline EQG does not correspond to the supply voltage loadline EbN and therefore this condition is not permissible. The loadline must therefore be lifted until the point on the loadline corresponding to average plate current corresponds with EbN. In most cases the position of the point M will change as the loadline is moved. It is therefore desirable to adopt some convenient method by which a laborious "trial and error" process may be avoided.

The suggested method is to draw any other loadline E'P'G'. In a similar manner to the previous case, the point on the loadline corresponding to the current axis (M') is determined, so that

$$M'P' = \frac{E'P' - P'G'}{4}$$

If now points M and M', corresponding to the current axes of the two loadlines, are joined by a straight line MM', the point where MM' intersects EbN will be on the maximum signal dynamic loadline. It only remains to draw through M" a loadline E"M"G" parallel to EQC, and this will be the desired maximum signal dynamic loadline.

It is evident that the change from the no signal quiescent point Q to the maximum signal dynamic loadline E"M"G" will be a gradual process. As the signal increases so will the loadline rise from EQG towards E"M"G". At intermediate signal voltages the loadline will be intermediate between the two limits. The average plate current for zero signal is I_Q , but this will rise to I''_B (corresponding to point M") at maximum signal.

It will be observed that M" does not correspond with P" which is the intersection of the loadline and the static bias curve. Point P" is not the quiescent point (which is Q) but may be described as "the point of instantaneous zero signal voltage on the dynamic loadline." Point P" must therefore be used in the calculations for harmonic distortion at maximum signal. The loadline E"M"P"G" provides the data necessary for the calculation of power output, second harmonic distortion, and average D.C. current. All these will, in the general case, differ from those indicated by the loadline EQG.

Summary

1. Power output is calculated from the loadline E"G" in the usual manner.
2. Second harmonic distortion at maximum signal = $\frac{2 M'P'}{E''G''}$
3. Average D.C. current at maximum signal = $I''_B = I_Q + \Delta I''_B$
= current corresponding to point M".
4. Rise of D.C. current from no signal to maximum signal = $\Delta I''_B$
= difference in currents corresponding to points M" and Q.

The graphical method outlined in this section is equally applicable to pentodes or beam tetrodes.

It should be noted that the rise of plate current, due to rectification, affects the bias when self-bias is employed.

Push Pull Triode Amplifiers

Although it is possible to treat graphically a single Class A Amplifier and then to make certain adjustments for two in push-pull, a more general, more illuminating and more accurate method is to draw composite characteristics and loadlines according to the method here given. In single Class A Amplifiers the second harmonic distortion is limited to a certain percentage, and the grid voltage swing is therefore limited. In a push-pull amplifier in which even harmonics are balanced out this limitation no longer holds, and in many cases the bias and grid swing may be increased, with consequent increase of power, up to the point where odd harmonic distortion becomes objectionable (see Chapter 5 on Fidelity, etc.).

Owing to the fact that push-pull amplifiers are normally terminated by a transformer or centre-tapped choke the alternating plate voltages are equal and opposite regardless of individual plate currents. Even though one valve may have cut off completely, its plate voltage may continue to rise. Due to this effect, the load on each valve is not constant but approximately equal to

$$\frac{1}{4} R_L (1 + r_{p1}/r_{p2})$$

where R_L = load resistance from plate to plate,

r_{p1} = plate resistance of valve V_1 , on which the load is being measured,

and r_{p2} = plate resistance of valve V_2 .

The proof of this statement is given in Radiotronics 79, 6th September, 1937, p. 64.

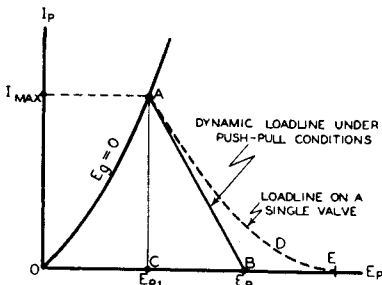

Figure 33

As a result of this effect, the loadline of each valve is curved, and if cutoff is reached the corresponding part of the loadline is horizontal (ADE in Fig. 33). For the greatest power output, neglecting distortion, each valve should operate into an effective load equal to its own plate resistance at every point throughout the cycle. This condition may be approached very closely under push-pull conditions.

On the other hand the dynamic loadline is a straight line passing through the point (B) of zero plate current and supply plate voltage E_b as well as through the point (A) of maximum plate current, zero grid voltage.

The dynamic loadline will therefore not pass through the individual quiescent operating point and its position will not be affected by the applied grid bias provided that the plate-to-plate load resistance remains constant. Under these conditions the power output is also unaffected by the grid bias.

Push-pull amplifiers are usually employed in order to produce the maximum power output rather than to give the greatest efficiency. It can be shown (Radiotronics 79, pp. 64-67) that maximum power output in a

push-pull amplifier occurs when the load is of such a resistance that the point of maximum current (A in Fig. 33) corresponds approximately to a plate voltage 0.6 E_b . With this assumption we have the following :—

$$\text{Power Output (2 valves)} = \frac{I_{\max} \cdot E_b}{5}$$

$$\text{Load Resistance (plate to plate)} = 1.6 \frac{E_b}{I_{\max}}$$

The grid bias for Class A operation may be anywhere between the value specified for single-valve operation and that equal to one-half the grid bias voltage required to produce plate current cut-off at a plate voltage of 1.4 E_b . Any further increase of bias will result in Class AB operation.

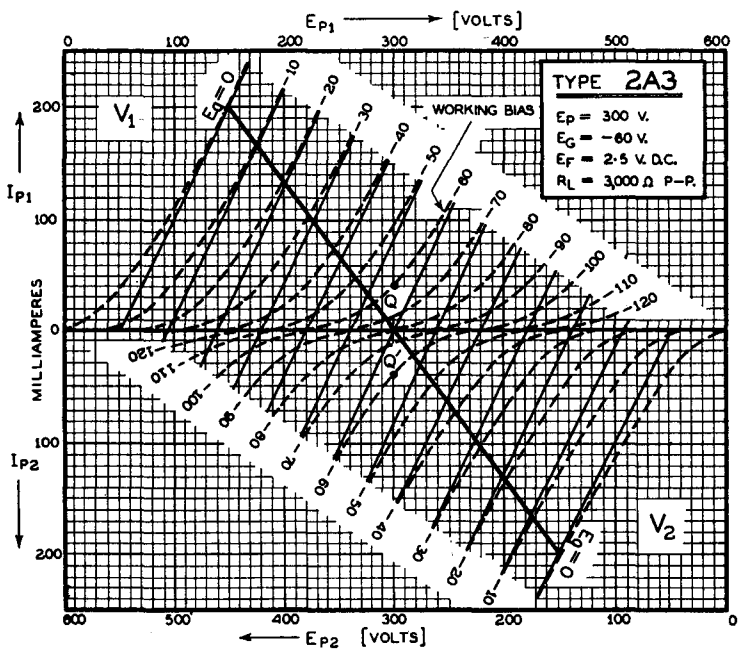

Figure 34

In order to determine distortion and average plate current it is desirable to draw **Composite Characteristics*** for both valves in push-pull as shown in Fig. 34. In this diagram, which is for 2A3's operating at 300 volts on the plates and -60 volts bias (for D.C. on filament), and with a quiescent plate current of 40mA. for each valve, the individual valve characteristics are shown with broken lines, and the Composite Characteristics with continuous lines. It will be seen that the lower characteristics are the same as the upper ones but turned over and placed so that the quiescent operating points Q, Q' are on the same vertical line. The Composite Characteristic corresponding to the static bias voltage (-60) is obtained by subtracting the currents of each of the single characteristics of the same bias voltage. Other composite characteristics are obtained by combining the single characteristics for bias voltages equally on either side of

*See B. J. Thompson, Proc. I.R.E. April, 1933, p. 591.

the static bias, e.g., -50 and -70, -40 and -80 and so on. Each of these Composite Characteristics is nearly a straight line. The points of intersection of these Composite Characteristics with the load line are used in the determination of harmonic distortion.

Harmonic Distortion may be calculated by methods as used for single amplifiers, or by special methods only suitable for push-pull amplifiers* which are outside the scope of this Handbook. A simple method which

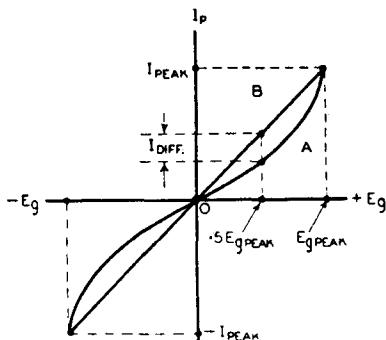

Figure 35

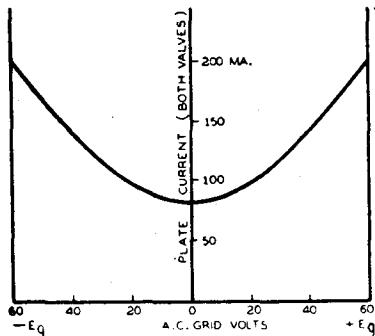

Figure 36

gives the percentage of third harmonic makes use of the "dynamic characteristic" as shown in Fig. 35. The curve A represents the dynamic characteristic while B is a straight line joining the two ends of A and passing through O. I_{diff} is the difference in plate current between curve A and line B at one half of the peak grid voltage. The percentage of third harmonic distortion is

$$\frac{2/3 I_{diff} \times 100}{I_{peak}} \dots (1)$$

$$I_{peak} - 2/3 I_{diff}$$

$$\text{or } \frac{2/3 I_{diff} \times 100}{I_{peak}} \text{ approx. } (2)$$

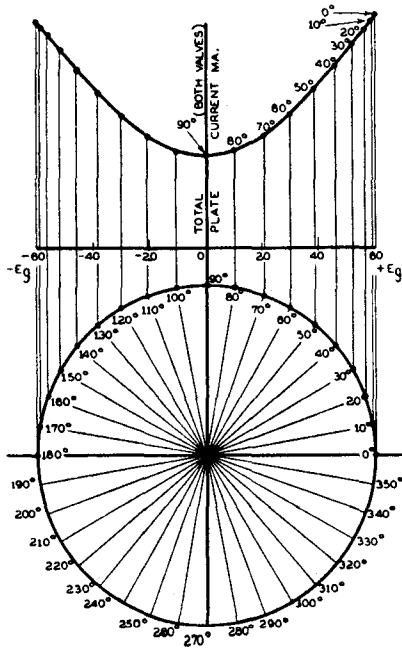

Figure 37

The Average Plate Current over the cycle is found by adding the two plate currents in Fig. 34 instead of subtracting them as for the Composite Characteristics. The total plate current may then be plotted as in Fig. 36 as a function of A.C. grid voltage. In order to find the average current it is generally most convenient to take equal angle increments over the cycle, for example, every 10° as shown in Fig. 37. The plate current should then be noted at each point corresponding to 10° increase in angle over the whole 360°. The average plate current is then the average of these individual values.

*Mouromtseff and Kozanowski, Proc. I.R.E. Sept., 1934.

In order to reduce the amount of work involved in this calculation, use may be made of the fact that each quadrant (90°) is similar. It is very easy to make an error in this calculation and the following method of obtaining the average from the plate current curve over one quadrant is therefore given.

This method is illustrated in Fig. 38, which shows the total plate current for both valves over one-quarter of a cycle. Grid voltages are shown as fractions of the peak grid voltage. The plate currents corresponding to grid voltages of 0, 0.17, 0.34, 0.5, 0.64, 0.77, 0.87, 0.94, 0.98 and 1.0 times the peak voltage are shown as $I_0, I_{0.17},$ etc. The average plate current (I_{av}) is then given by

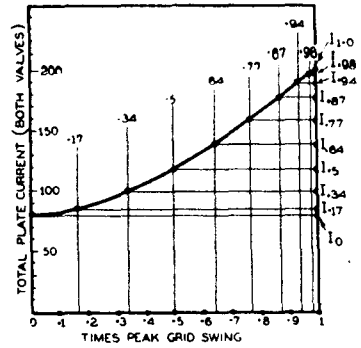

Figure 38

The average plate current (I_{av}) is then given by

$$I_{av} = \frac{1}{9} \left(\frac{1}{2} I_0 + I_{0.17} + I_{0.34} + I_{0.5} + I_{0.64} + I_{0.77} + I_{0.87} + I_{0.94} + I_{0.98} + \frac{1}{2} I_{1.0} \right)$$

Class AB_1 Amplifiers may be treated by the method already outlined. Class AB_2 and Class B Amplifiers may also be treated similarly so far as plate current is concerned, but require additional consideration on account of Grid Current.

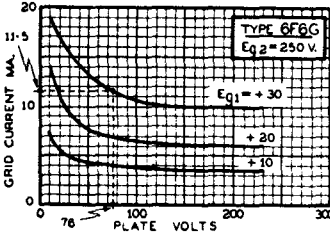

Figure 39 (above)

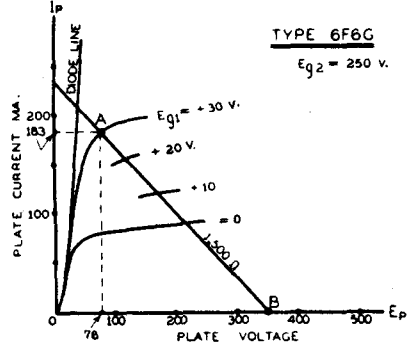

Figure 40 (right)

Amplifiers Drawing Grid Current

Amplifiers which are operated with flow of grid current over part or the whole of the cycle can only be designed completely if the valve grid current characteristics are available. Fig. 39 shows the grid characteristics (E_p, I_g) and Fig. 40 the plate characteristics of a typical pentode (Type 6F6-G). The treatment for other types such as beam tetrodes or triodes will be evident.

The procedure in the case of a Class AB_2 amplifier in which it is required to find the peak grid current and peak grid power is as follows:—

- (1) From the E_B point (350 volts) draw a loadline corresponding to a load resistance of one quarter the load resistance plate to plate (Fig.40).
- (2) On this loadline choose a point (A) of extreme positive grid swing.

This choice will be limited by the plate dissipation, available grid driving power and distortion. For the sake of an example, take A as corresponding to a grid voltage +30, plate current 183 mA. and plate voltage 76 volts.

(3) It is now necessary to refer to the grid characteristic (Fig 39) in order to find the grid current corresponding to a plate voltage of 76 and a grid voltage of +30. This is obviously 11.5 mA., and is the peak grid current.

(4) The peak grid voltage is equal to the negative bias voltage (38 volts) plus the peak positive swing (30 volts) or 68 volts. The peak grid power is therefore 68 volts \times 11.5 mA. or 782 mW. The input transformer will consequently be called upon to supply 782 mW. peak power into a resistance of 5,900 ohms (ie., 68/0.0115).

(5) If the peak power and peak grid voltage can be supplied, it is next advisable to calculate the power output. Neglecting distortion, the approximate power output for both valves is W where

$$W = \frac{EI}{2} = \frac{RI^2}{2} = \frac{E^2}{2R} \text{ watts}$$

where E = total plate voltage swing per valve.
 I = peak plate current in amperes.
 and R = load resistance per valve.

For more accurate calculation of power output, reference should be made to the earlier section on Push-Pull Amplifiers.

(6) The average plate current (both valves) may be calculated as for Push-Pull Amplifiers, but an approximation is possible for Class B Amplifiers biased almost to cut-off, in which

$$I_{av} = 0.637 I_{peak} \text{ approx.}$$

where I_{av} = average (DC) current for two valves.

(7) The average plate input power in watts is equal to the plate supply voltage multiplied by the average current in amperes.

(8) The plate dissipation is equal to the difference between the plate input power and the output power.

A useful guide which may be used in many cases where no other limitation of positive grid swing is available is as follows:—

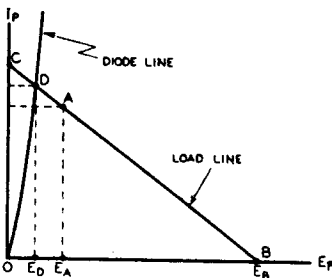

Figure 41

"The minimum plate voltage should be twice the diode line voltage at the peak current point."

This is illustrated in Fig. 41 in which the loadline cuts the diode line at point D corresponding to a plate voltage E_D . The grid swing is limited to point A where $E_A = 2 E_D$. The diode line is shown in many characteristic curves, and is the line where the grid loses control, in other words the minimum plate voltage for any specified plate current no matter how positive the grid may be.

For obvious reasons (distortion and excessive grid current) the drive should never reach the diode line.

Reference should be made to the treatment of grid current under the section on Mutual Characteristics. The method used in the design of Class B Amplifiers is given in Chapter 2.

Screen Current

In a pentode or beam tetrode, if the control grid bias is kept constant and only the plate voltage varied, the total cathode current (plate + screen) will remain very nearly constant, decreasing very slightly as the plate voltage is reduced down to the knee of the curve. Below this plate voltage the screen current increases more rapidly until zero plate voltage is reached at which point the screen current is a maximum (Fig. 42). It is evident therefore that if a dynamic loadline cuts the zero bias curve below the knee the screen current will rise rapidly and the screen dissipation may be exceeded. The average maximum-signal screen current may be calculated from the approximation

$$I_{g2 \text{ av.}} = \frac{1}{4} I_A + \frac{1}{2} I_Q$$

where I_A = screen current at minimum plate voltage swing and zero bias (point A).

and I_Q = screen current at no signal and normal bias.

The screen dissipation is therefore W_{g2} where

$$W_{g2} = E_{g2} (\frac{1}{4} I_A + \frac{1}{2} I_Q)$$

The variation of screen current with change of control grid voltage is such that the ratio between plate and screen currents remains approximately constant provided that the plate voltage is considerably higher than the knee of the curve. This ratio may be determined from the published characteristics.

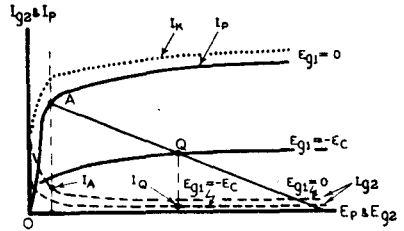

Figure 42

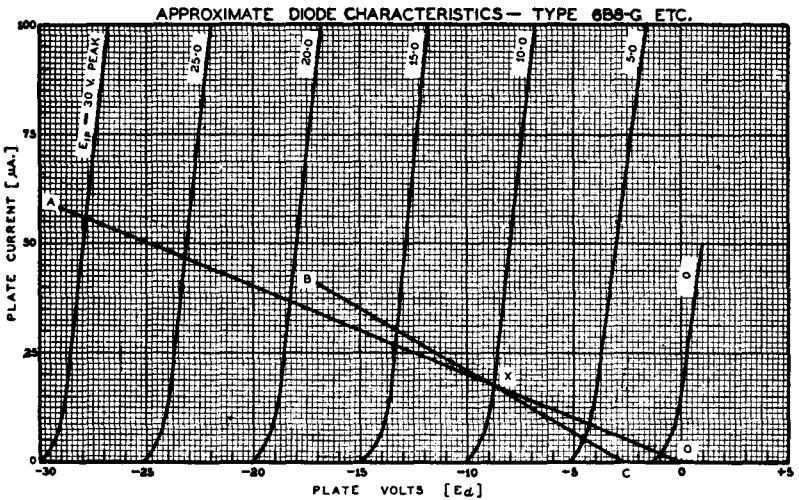

Figure 43

Diode Curves

The diode characteristics of a typical diode are shown in Fig. 43. Each curve corresponds to the peak voltage of a constant unmodulated carrier voltage. On this graph may be drawn loadlines corresponding to diode

load resistances in a similar manner as for triodes. The intersection of the applied loadline (OA) with the peak input voltage curve indicates the D.C. voltage developed by the diode and available for A.V.C. As the load resistance increases, so the D.C. voltage approaches the peak input voltage.

For example, if the input carrier is 10 volts peak and the diode load resistor 0.5 megohm, the diode current will be $17 \mu\text{A}$, and the D.C. voltage — 8.7 volts. If 100% modulation is applied to the carrier, the operating point will move at audio frequency along the loadline from the intersection with the "O" curve, through X to the intersection with the 20 volt curve. The distortion over this excursion is small (about 5% second harmonic) and may be reduced still further by operating with a higher carrier input voltage.

If however the D.C. load resistance of 0.5 megohm is shunted by an A.C. load (such as would occur due to the grid resistor of the following valve) the dynamic loadline will be similar to BC, which passes through the static operating point X but which has a slope corresponding to the total effective A.C. load resistance. This loadline (BC) reaches cutoff at about 75% modulation, and the distortion at higher percentages of modulation will consequently be severe. For any combination of D.C. and A.C. loads it is possible to draw the loadlines and determine the limiting percentage of modulation before distortion becomes severe.

Rectifier Curves.

The subject of Rectifier Curves is treated in Chapter 22.

Effect of Plate and Screen Supply Regulation

With a triode valve, the rise in average plate current at full output (due to rectification) causes a decrease in the effective plate voltage, due to the resistance of the B supply. The result is a comparatively slight reduction in power output, since the drop in plate voltage opposes the rise in current.

With a pentode or beam tetrode valve, however, the effect is much more pronounced. If the plate and screen operate at the same voltage from a common supply the drop in plate voltage due to the resistance of the B supply also causes a similar drop in the screen voltage. This drop in screen voltage results in a complete change of valve characteristics, the zero grid bias curve being then lower than with the full voltage. The cut-off grid voltage is then lower, and a lower grid bias voltage is required for optimum operation, possibly also accompanied by an increase in the optimum plate load resistance. The combined result is therefore to reduce the maximum power output and to reduce the grid input voltage required for full output.

It is obvious that a Class A amplifier is less affected by poor regulation in the B supply than is a Class AB₁ or other amplifier drawing considerably more current at full output than at no output.

For further consideration see Radiotronics 80 (October, 1937), pages 76-77.

Reference List

Valve Curves and Their Application.

- W. J. Brown, Proc. Phys. Soc. (London), Vol. 36, part 3, p. 28, April 15 (1924).
- J. C. Warner and A. V. Loughran, "The Output Characteristics of Amplifier Tubes," Proc. I.R.E. November (1926).

- C. E. Kilgour, "Graphical Analysis of Output Tube Performance," Proc. I.R.E., January (1931), p. 42.
- L. E. Barton, "High Audio Output from Relatively Small Tubes," Proc. I.R.E. July (1931), p. 1131.
- G. S. C. Lucas, "Distortion in Valve Characteristics," Wireless Engineer and Experimental Wireless, November (1931).
- J. R. Nelson, "Calculation of Output and Distortion in Symmetrical Output Systems," Proc. I.R.E. November (1932), p. 1763.
- B. J. Thompson, "Graphical Determination of Performance of Push-Pull Audio Amplifiers," Proc. I.R.E. April (1933), p. 591.
- J. R. Nelson, "Class B Amplifiers Considered from the Conventional Class A Standpoint," Proc. I.R.E. June (1933), p. 858.
- C. E. Fay, "The Operation of Vacuum Tubes as Class B and Class C Amplifiers," Proc. I.R.E. March (1932), p. 548.
- W. R. Ferris, "Graphical Harmonic Analysis for Determining Modulation Distortion in Amplifier Tubes," Proc. I.R.E. May (1935), p. 510.
- "Push Pull Triode Amplifiers," Radiotronics 79 and 80.
- "Use of the Plate Family in Power Output Calculations," R.C.A. Application Note reprinted in Radiotronics 80.

Calculation of Harmonic Distortion.

- I. E. Mourontseff and H. N. Kozanowski, "A Short-Cut Method for Calculation of Harmonic Distortion in Wave Modulation," Proc. I.R.E. September (1932), p. 1090.
- J. A. Hutcheson, "Graphical Harmonic Analysis," Electronics, January (1936), p. 16.
- J. H. Owen Harries, "Amplitude Distortion," Wireless Engineer, Vol. 14, No. 161, pp. 63-72, February (1937).

Books for General Reading.

- W. G. Dow, "Fundamentals of Engineering Electronics," John Wiley and Sons, 1937.
- R. S. Glasgow, "Principles of Radio Engineering," McGraw-Hill, 1936.
- F. E. Terman, "Radio Engineering" (Second Edition), McGraw-Hill, 1937.
- E. L. Chaffee, "Theory of Thermionic Vacuum Tubes," McGraw-Hill, 1933.
- Admiralty Handbook of Wireless Telegraphy, 1938.

CHAPTERS 35 TO 39, INCLUSIVE

CHAPTER 35

Resistance, Capacitance, Inductance

(1) Resistance—Ohm's Law—resistances in series and parallel—Kirchhoff's laws—application to voltage divider—power—(2) Capacitance—condensers in series and parallel—capacitive reactance—Ohm's law—impedance—power—unit of capacitance—capacitance of parallel plate condenser—resistance and capacitance in series—time constant—stored energy—(3) Inductance—inductances in series and parallel—inductive reactance—Ohm's law—impedance—power—kinetic energy—time constant—(4) Resistance, capacitance and inductance in series—(5) Resistance, capacitance and inductance in parallel—conductance, susceptance, admittance—graphical method for resistance and reactance in parallel.

1. Resistance

Ohm's Law: $I = E/R$ where $I =$ current in amperes,
 $E =$ voltage drop across R in volts,
 and $R =$ resistance in ohms.

Resistances in series:

$$R = R_1 + R_2 + R_3 + \dots$$

Resistances in parallel:

$$R = \frac{1}{(1/R_1) + (1/R_2) + (1/R_3) + \dots}$$

Two resistances in parallel:

$$R = \frac{R_1 R_2}{R_1 + R_2}$$

Kirchhoff's Laws:

(1) At any point in a network of conductors the sum of the currents flowing towards the point is equal to the sum of the currents flowing away from it.

(2) In any closed circuit in a network the sum of the electromotive forces introduced into the circuit is equal to the sum of the voltage drops across each of the conductors. In other words, in following any closed circuit in

a certain direction, clockwise or counter-clockwise, take as positive all electromotive forces which tend to produce currents in the selected direction and also take as positive the currents flowing in this direction. Opposing e.m.fs and currents are given a negative sign. For example in Fig. 1 any closed circuit may be selected, such as A B C D E F A. Commencing at A and following in a clockwise direction we have

$$+ e_1 + e_2 = i_1R_1 + i_2R_2 + i_3R_3 + i_4R_4$$

In a similar way any other closed circuit may be followed, for example A B C D A in which

$$+ e_1 = i_1R_1 + i_2R_2 - i_5R_5.$$

Similar expressions may be obtained from any other closed circuits, and these, together with the application of the first law, will solve the network.

As an example of the application of the first law, consider point D where the current flowing inwards is $i_2 + i_3$ and the current flowing outwards is i_5 .

$$\therefore i_2 + i_3 = i_5$$

If the direction of current assumed in any conductor is incorrect, the value for current in that conductor will be shown as negative.

One of the most important applications of Kirchoff's Laws in radio design is to a voltage divider, and the following example shows the method of calculation (Fig. 2).

Assume that the supply voltage E and the tapping voltages e_1 , e_2 and currents i_1 , i_2 as well as the current I_2 through the section R_2 are known, and that it is required to find the values of R, R_1 , R_2 , I and I_1 .

By applying Kirchoff's first law:

$$I = I_1 + i_1 \dots \dots \dots (1)$$

$$\text{also } I_1 = I_2 + i_2 \dots \dots \dots (2)$$

$$\therefore I = I_2 + i_1 + i_2 \text{ (by substitution)}$$

and since I_2 , i_1 and i_2 are known, I may be determined, and also by substituting this value in (1), I_1 may be found.

$$\begin{aligned} \text{Now } e_2 &= I_2R_2 \\ \text{also } e_1 - e_2 &= I_1R_1 \\ \text{and } E - e_1 &= IR \end{aligned}$$

so that R, R_1 and R_2 may be determined, and the solution is complete.

Power:

The power (watts) dissipated in a resistance is W where

$$W = EI = I^2R = E^2/R$$

2. Capacitance

The capacitance of Condensers in Parallel:

$$C = C_1 + C_2 + C_3 + \dots$$

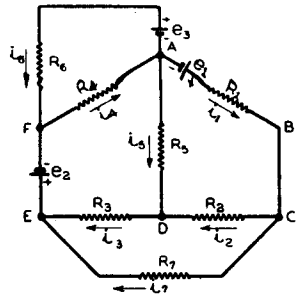

Figure 1

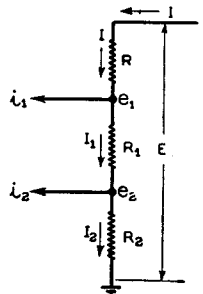

Figure 2

The capacitance of Condensers in Series:

$$C = \frac{1}{(1/C_1) + (1/C_2) + (1/C_3) + \dots}$$

The capacitance of two Condensers in Series:

$$C = \frac{C_1 C_2}{C_1 + C_2}$$

The Capacitive Reactance* (X_c) of a Condenser is

$$-\frac{1}{\omega C} = -\frac{1}{2\pi f C}$$

i.e. $X_c = -\frac{0.159}{fC}$ ohms, where $f =$ frequency (c/s) and $C =$ farads

or $X_c = -\frac{159000}{fC}$ ohms, where $f =$ frequency (c/s) and $C =$ microfarads

or $X_c = -\frac{159}{fC}$ ohms, where $f =$ frequency (Kc/s) and $C =$ microfarads.

Ohms law may be applied to capacitive reactance,

i.e. $I = E/X_c$

but the current through the condenser will lead the voltage by an angle $\pi/2$ (90°).

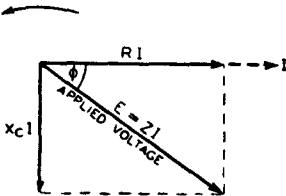

Figure 3: Vector diagram for R and C in series.

If a resistance R and a condenser C with reactance X_c are connected in series the combined impedance will be Z where

$$Z = \sqrt{R^2 + X_c^2}$$

and the resultant current will be I where

$$I = \frac{E}{Z} = \frac{E}{\sqrt{R^2 + X_c^2}}$$

and the current I will lead the voltage E by an angle ϕ whose tangent is X_c/R and whose cosine is $R/\sqrt{R^2 + X_c^2}$. (See vector diagram Fig. 3).

The current through the capacitance is "wattless," that is it does not represent any loss of power. The power is given by

$$W = E I \times \text{Power Factor}$$

where the Power Factor is the cosine of the angle ϕ by which the current leads the voltage,

i.e. $W = E I \cos \phi$

when $\phi = 0$, $\cos \phi = 1$ and $W = E I$

when $\phi = 90^\circ$, $\cos \phi = 0$ and $W = 0$.

Thus $\phi = 0$ represents a resistive load and unity power factor, while $\phi = 90^\circ$ represents a purely reactive ("Wattless") load and zero power factor.

*Capacitive reactance is conventionally considered negative reactance.

An examination of the Vector Diagram (Fig. 3) shows that

$$\cos \phi = \frac{RI}{ZI} = \frac{R}{Z} = \frac{R}{\sqrt{R^2 + X_C^2}}$$

$$\begin{aligned} \therefore W &= E I \cos \phi = E I \frac{R}{\sqrt{R^2 + X_C^2}} \\ &= I^2 R = \frac{E^2}{R} \frac{1}{1 + X_C^2/R^2} \end{aligned}$$

The total power dissipated in the circuit is only that dissipated by the resistance, but its magnitude is affected by the value of C for any given value of E .

A Condenser is said to have a capacitance of 1 farad when a charge of 1 coulomb raises it to a potential of 1 volt. Since the farad is too large for convenience, the capacitance of a condenser is generally expressed in microfarads ($\mu F.$) or micromicrofarads ($\mu\mu F.$).

$$Q = C E \text{ or } C = Q/E$$

where Q = charge in coulombs,
 C = capacitance in farads
 and E = potential across C in volts.

An imperfect condenser (i.e., one having losses) may be represented by a perfect condenser of the same capacitance, with a series resistance (r) or a shunt resistance (R) associated with it. If either r or R is known, the other may be calculated since

$$r = \frac{1}{R (2\pi f C)^2}$$

when r is very much less than X_C .

Such a condenser may be said to have a power factor equal to $2\pi f C r$ or $1/2\pi f C R$. This may also be expressed as a phase angle. The value of the phase angle in radians is equal to the power factor, e.g., a power factor of 0.01 represents a phase angle of 0.01 radian or 0.573° .

Resistance and Capacitance in Series:

$$E = R I + (Q/C)$$

If a steady voltage E is suddenly applied to a circuit with R and C in series, C having no initial charge, the charge in the condenser will increase according to the relation

$$q = Q (1 - e^{-t/CR})$$

where q = instantaneous charge on condenser,

$Q = EC$ = final charge on condenser,

$e = 2.718$

and t = time in seconds from the instant that the voltage E is applied.

The Time constant of the circuit is CR and is the time required for the charge to reach $[1 - (1/e)]$ or 0.632 of its maximum value.

In a similar manner

$$i = (E/R) e^{-t/CR}$$

The maximum current flow occurs when $t = 0$ and is equal to E/R . As t increases, q also increases, producing a counter e.m.f. (q/C) which cuts down the current and hence the rate at which the charge increases.

If a condenser having capacitance C , charged to a potential E , is discharged through a resistance R ,

$$q = EC e^{-t/CR}$$

$$\text{and } i = - (E/R) e^{-t/CR}$$

The negative sign for i indicates that the current is drawn out of the condenser. It will be seen that the current and charge both decrease logarithmically from their maximum values to zero.

The electro-potential energy stored in a condenser due to its charge is

$$\frac{1}{2} CE^2 \text{ joules.}$$

Capacitance of Parallel Plate Condenser of Known Dimensions:

$$C = \frac{AK}{11.31d} \text{ micromicrofarads}$$

where A = useful* area of one plate in square centimetres,
 K = dielectric constant ("specific inductive capacity")—for values see Chapter 40,
 and d = gap between plates in centimetres,
 = thickness of dielectric in centimetres.

Alternatively (in inch units)

$$C = \frac{AK}{4.45d} \text{ micromicrofarads}$$

where A = useful* area of one plate in square inches,
 and d = gap between plates in inches.

Capacitance with air dielectric, plates 1 mm. apart:—

$$C = 0.884 \mu\mu\text{F. per sq. cm. area of one plate.}$$

Capacitance with air dielectric, plates 0.10 inch apart:—

$$C = 2.245 \mu\mu\text{F. per sq. inch area of one plate.}$$

3. Inductance

The inductance of inductances in series:

$$L = L_1 + L_2 + L_3 + \dots$$

The inductance of inductances in parallel:

$$L = \frac{1}{1/L_1 + 1/L_2 + 1/L_3 + \dots}$$

The inductance of two inductances in parallel (not coupled together):

$$L = \frac{L_1 L_2}{L_1 + L_2}$$

The Inductive Reactance (X_L) of an inductance is ωL , or

$$\begin{aligned} X_L &= 2\pi fL & \left. \begin{array}{l} \text{where } f = \text{cycles per second} \\ \text{and } L = \text{henries,} \end{array} \right\} \\ \text{i.e. } X_L &= 6.28fL \text{ ohms} \\ \text{or } X_L &= 6.28fL \text{ ohms, where } f = \text{megacycles/second} \\ & \quad \text{and } L = \text{microhenries.} \end{aligned}$$

Ohm's law may be applied to inductive reactance

$$\text{i.e. } I = E/X_L$$

but the current through the inductance will lag behind the voltage by an angle $\pi/2$ (90°).

*The useful area is approximately equal to the area of the smaller plate when the square root of the area is large compared with the gap.

If a resistance R and an inductance L are connected in series the combined impedance (see Fig. 4) will be Z where

$$Z = \sqrt{R^2 + X_L^2}$$

and the resultant current will be I where

$$I = \frac{E}{Z} = \frac{E}{\sqrt{R^2 + X_L^2}}$$

and the current I lags behind the voltage by an angle ϕ whose tangent is X_L/R and whose cosine is $R/\sqrt{R^2 + X_L^2}$

The power is given by

$$W = EI \times \text{Power Factor}$$

$$= EI \cos \phi = EI \frac{R}{\sqrt{R^2 + X_L^2}} = I^2 R$$

The current through a pure inductance is "wattless."

The kinetic energy of an inductance of L henries carrying a current of I amperes is $\frac{1}{2}LI^2$ Joules.

If an e.m.f. E be suddenly applied to an inductance L in series with a resistance R , the current will be

$$i = E/R (1 - e^{-Rt/L})$$

The maximum rate of change of current occurs when the time $t = 0$, and as t increases the value of i approaches its limiting value $I = E/R$.

The time constant of this circuit is L/R and is the time in seconds for the current to reach 0.632 of its final value.

When the current through the inductance has reached its final value ($I = E/R$) and the input circuit is short-circuited, the current will be

$$i = (E/R) e^{-Rt/L}$$

in which case the time constant L/R is the time taken for the current to fall to $(1 - 0.632)$ or 0.368 of its original value.

4. Resistance Capacitance and Inductance in Series

If a Resistance R , Capacitance C and Inductance L are connected in series the impedance will be

$$Z = \sqrt{R^2 + X^2}$$

$$\text{where } X = 2\pi fL - (1/2\pi fC) = \omega L - (1/\omega C)$$

If a potential E is applied to the circuit, the current will be

$$I = \frac{E}{\sqrt{R^2 + [2\pi fL - (1/2\pi fC)]^2}}$$

This may be expressed in the form

$$I = \frac{E}{\sqrt{R^2 + [2\pi fL [1 - (f_0^2/f^2)]]^2}}$$

where $f_0 = 1/(2\pi\sqrt{LC})$

It will be seen that the inductive and capacitive reactances counteract one another. When $2\pi fL = 1/2\pi fC$ or $f = f_0$, the resultant reactance is nil and resonance occurs, the current then being $I = E/R$.

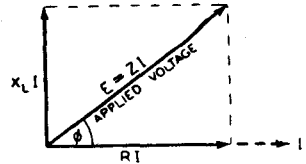

Figure 4: Vector diagram for R and L in series.

In a circuit including several impedances (Z_1, Z_2 etc. where $Z_1 = \sqrt{R_1^2 + X_1^2}$, etc.) in series, the numerical value of the resultant impedance (Z) may be found by adding the resistive components of all impedances, adding algebraically the reactive components of all impedances and by taking the resultant of the two in quadrature, i.e.

$$Z = \sqrt{(R_1 + R_2 + \dots)^2 + (X_1 + X_2 + \dots)^2}$$

or in complex algebra (see Chapter 37)

$$Z = (R_1 + R_2 + \dots) + j (X_1 + X_2 + \dots).$$

5. Resistance, Capacitance and Inductance in Parallel

When two or more impedances are connected in parallel the total current is the vector sum of the currents through each of the impedances. This fact may be used to determine the combined impedance.

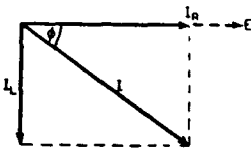

Figure 5: Vector diagram for R and L in parallel.

A vector diagram for the currents through a resistance and an inductance in parallel is shown in Fig. 5 where E is the applied voltage, I_r the current through the resistance ($I_r = E/R$) and I_L the current through the inductance ($I_L = E/X_L$, this lagging 90° behind I_r). The resultant current is $I = \sqrt{I_r^2 + I_L^2} = E/Z$ from which the numerical value of Z may be found. I is lagging behind E by an angle whose tangent is I_L/I_r or R/X_L .

When considering impedances in parallel it is often convenient to work in terms of conductance, susceptance and admittance (see also Chapter 39).

$$\frac{R}{R^2 + X^2} = G \text{ is called the conductance.}$$

$$\frac{X}{R^2 + X^2} = B \text{ is called the susceptance.}$$

$$\sqrt{G^2 + B^2} = Y \text{ is called the admittance.}$$

It is evident from this definition that

$$Y = \frac{1}{\sqrt{R^2 + X^2}} = \frac{1}{Z}$$

i.e. that the admittance (Y) is the reciprocal of the impedance (Z).

The conductance, however, is not the reciprocal of the resistance unless the reactance is zero. Similarly the susceptance is not the reciprocal of the reactance unless the resistance is zero.

R and X may also be expressed in terms of G and B :—

$$R = \frac{G}{G^2 + B^2}$$

and $X = \frac{B}{G^2 + B^2}$

When there are a number of circuits in parallel, their resultant conductance is given by the sum of their separate conductances:—

$$G = G_1 + G_2 + G_3 + \dots$$

Similarly when there are a number of circuits in parallel, their resultant susceptance is given by the sum of their separate susceptances:—

$$B = B_1 + B_2 + B_3 + \dots$$

The resultant admittance is therefore

$$Y = \sqrt{G^2 + B^2}$$

and the resultant impedance

$$Z = \frac{1}{Y} = \frac{1}{\sqrt{G^2 + B^2}}$$

Susceptance may be either positive (inductive) or negative (capacitive), and susceptances should therefore always be added algebraically. Admittance, conductance and susceptance are measured in reciprocal ohms (mhos).

In complex algebra (see Chapter 37)

$$\begin{aligned} Z_1 &= R_1 + jX_1 \\ \text{and } Y_1 &= G_1 - jB_1 \end{aligned}$$

When there are a number of impedances in parallel

$$Y = (G_1 + G_2 + \dots) - j(B_1 + B_2 + \dots).$$

Fig. 6 shows a simple graphical method for the determination of the impedance of a resistance R and a reactance X in parallel. OAB is a right angle triangle in which the length of OA represents R , OB represents X and OC , a perpendicular drawn from O to the hypotenuse, represents the resultant impedance. In these diagrams OC not only represents the absolute value of Z but the angle COA also gives the numerical value of the phase angle between the applied voltage and the resultant current.

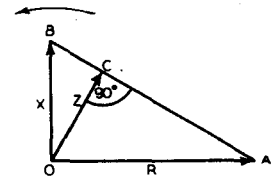

Figure 6: Graphical method for determining impedance of R and X in parallel.

Information on more complex graphical methods for impedances in parallel is given in *Electronics*, January 1938, p. 54, and in the "Standard Handbook for Electrical Engineers" (McGraw-Hill, 6th Edition) p. 103.

CHAPTER 36

Vectors

Vector notation—two vectors in series—three or more vectors in series—application of vectors.

Vector notation provides a comprehensive graphical method for A.C. calculations involving reactances and phase differences. The length of a vector (e.g. OB in Fig. 1) represents, to some arbitrary scale, the effective value of the alternating quantity, while the position of the vector with respect to a selected reference vector gives the phase displacement. Counter-clockwise rotation as shown by the arrow in Fig. 1 is always considered positive, so that vector OB leads vector OA by an angle ϕ .

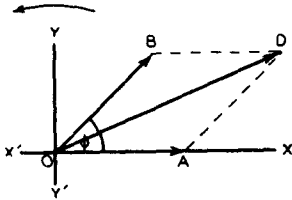

Figure 1

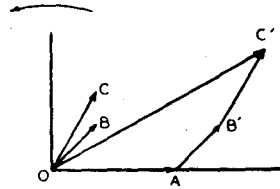

Figure 2

The resultant of two vectors in series may be found by completing the parallelogram ($OADB$ in Fig. 1) and taking the resultant OD .

Three or more vectors in series may be treated as shown in Fig. 2 where AB' is equal and parallel to OB and $B'C'$ equal and parallel to OC ; the resultant is OC' .

As is evident from the definitions, if the voltage drop RI across a resistance is drawn along the axis OX , the vector XLI , being the voltage drop across a pure inductance, will be along the axis OY and the vector XCI will be along OY' .

In considering a circuit including impedances in series, a vector diagram may be drawn which represents by a vector the voltage drop across each impedance (e.g. RI , XLI). Similarly with a circuit including impedances in parallel a vector diagram may be drawn which represents by a vector the current through each impedance.

CHAPTER 37

Complex Algebra

Complex algebra—operator j —modulus or absolute value —application—procedure—rules of complex algebra.

Many difficult problems can be solved by the methods of Complex Algebra, so that a working knowledge of the subject is of great assistance in the complete understanding of technical literature.

In this algebra, the operator j corresponds to a change of 90° in the phase angle. This idea can be represented graphically. If we take the ordinary graphical axes $x'Ox, y'Oy$ (Fig. 1) a quantity X

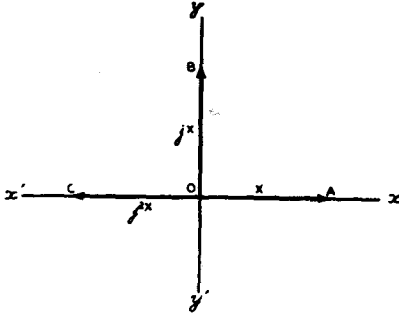

Figure 1.

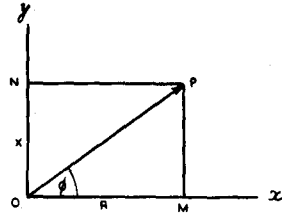

Figure 2.

can be represented by the length OA marked on the x axis. Application of the operator j is equivalent to rotating OA through 90° to the position of OB , so that jX is represented by OB . A further application of j rotates OB to the position OC , i.e. j^2X is represented by OC . But OC is opposite in direction to OA (OA having been rotated through 180°), so that $j^2X = -X$. Thus we may write $j^2 = -1$, or $j = \sqrt{-1}$. The number j (sometimes referred to as "imaginary") obeys all the ordinary laws of arithmetic, j^2 always being replaced by -1 . A "complex" number $R + jX$, where R and X are ordinary, real numbers, can be represented graphically by a vector OP (Fig. 2) which is such that $OM = R$ units and $ON = X$ units. The length OP , which is equal to $\sqrt{R^2 + X^2}$, is called the "modulus" or "absolute value" of the vector quantity $R + jX$. It will be seen that the quantity $R + jX$ can be interpreted as representing a vector R combined with a perpendicular vector X , the modulus $\sqrt{R^2 + X^2}$ corresponding to the resultant (or sum) of the two vectors; further, it will be seen that the phase-angle ϕ between the resultant OP and the horizontal vector R is given by: $\tan \phi = X/R$.

The complex notation is of particular importance in A.C. calculations. Thus, the impedance of a circuit consisting of a resistance R in series with an inductive reactance X_L may be represented as a vector $R + jX_L$. Similarly, if a resistance R is in series with an inductive reactance X_L and a capacitive reactance X_C the vector impedance is $R + j(X_L - X_C)$, the negative sign corresponding to the 180° phase angle between the inductive reactance and the capacitive reactance. When two impedances ($Z_1 = R_1 + jX_1$ and $Z_2 = R_2 + jX_2$) are connected in parallel the resultant impedance is

$$Z = \frac{Z_1 Z_2}{Z_1 + Z_2} = \frac{(R_1 + jX_1)(R_2 + jX_2)}{R_1 + R_2 + j(X_1 + X_2)}$$

In order to use the complex notation, each vector quantity is represented as a complex number; in the ensuing calculations, the operator j obeys all the ordinary laws of arithmetic, j^2 being replaced by -1 . The result is reduced to the form $R + jX$, and the modulus, or absolute value, $\sqrt{R^2 + X^2}$, then calculated.

Rules of Complex Algebra

$$Z_1 = R_1 + jX_1; Z_2 = R_2 + jX_2; j^2 = -1.$$

1. Addition.

$$Z_1 + Z_2 = (R_1 + jX_1) + (R_2 + jX_2) = (R_1 + R_2) + j(X_1 + X_2).$$

2. Subtraction.

$$Z_1 - Z_2 = (R_1 + jX_1) - (R_2 + jX_2) = (R_1 - R_2) + j(X_1 - X_2).$$

3. Multiplication.

$$\begin{aligned} Z_1 \times Z_2 &= (R_1 + jX_1)(R_2 + jX_2) \\ &= (R_1R_2 + j^2 X_1X_2) + j(X_1R_2 + R_1X_2) \\ &= (R_1R_2 - X_1X_2) + j(X_1R_2 + R_1X_2) \end{aligned}$$

4. Division.

$$\begin{aligned} \frac{Z_1}{Z_2} &= \frac{(R_1 + jX_1)}{(R_2 + jX_2)} = \frac{(R_1 + jX_1)(R_2 - jX_2)}{(R_2 + jX_2)(R_2 - jX_2)} \\ &= \frac{(R_1 + jX_1)(R_2 - jX_2)}{R_2^2 + X_2^2} \\ &= \frac{R_1R_2 + X_1X_2}{R_2^2 + X_2^2} + j \frac{X_1R_2 - R_1X_2}{R_2^2 + X_2^2} \end{aligned}$$

5. To find the modulus or absolute value.

$$|Z|, \text{ or mod } Z = \sqrt{R^2 + X^2}$$

6. Phase angle.

$$\tan \phi = \frac{X}{R}; \cos \phi = \frac{R}{\sqrt{R^2 + X^2}}; \sin \phi = \frac{X}{\sqrt{R^2 + X^2}}$$

7. Conjugate complex numbers.

The complex numbers $(R + jX)$ and $(R - jX)$ are said to be conjugate, and

$$(R + jX)(R - jX) = R^2 + X^2.$$

8.

$$\frac{1}{R + jX} = \frac{R - jX}{R^2 + X^2} = \frac{R}{R^2 + X^2} - j \frac{X}{R^2 + X^2}.$$

CHAPTER 38

Simple Trigonometry

Sine:	$\text{Sin}\theta$	=	AB/OA
Cosine:	$\text{Cos}\theta$	=	OB/OA
Tangent:	$\text{Tan}\theta$	=	AB/OB
Cosecant:	$\text{Cosec}\theta$	=	$\text{OA/AB} = 1/\text{Sin}\theta$
Secant:	$\text{Sec}\theta$	=	$\text{OA/OB} = 1/\text{Cos}\theta$
Cotangent:	$\text{Cot}\theta$	=	$\text{OB/AB} = 1/\text{Tan}\theta$

SIMPLE RELATIONSHIPS :

$$\text{Sin}^2\theta + \text{cos}^2\theta = 1$$

$$\text{Tan}\theta = \text{Sin}\theta/\text{cos}\theta$$

$$\text{Cot}\theta = \text{Cos}\theta/\text{sin}\theta$$

$$1 + \text{tan}^2\theta = \text{sec}^2\theta = 1/\text{cos}^2\theta$$

$$1 + \text{cot}^2\theta = \text{cosec}^2\theta = 1/\text{sin}^2\theta$$

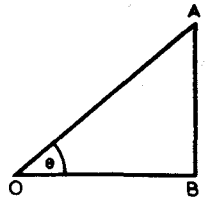

Figure 1

$$\text{sin}\theta = \frac{\text{tan}\theta}{\sqrt{1 + \text{tan}^2\theta}} = \frac{1}{\sqrt{1 + \text{cot}^2\theta}}$$

$$\text{cos}\theta = \frac{1}{\sqrt{1 + \text{tan}^2\theta}} = \frac{\text{cot}\theta}{\sqrt{1 + \text{cot}^2\theta}}$$

$$\text{sin}(-\theta) = -\text{sin}\theta$$

$$\text{cos}(-\theta) = \text{cos}\theta$$

$$\text{tan}(-\theta) = -\text{tan}\theta$$

$$\text{sin}2\theta = 2\text{sin}\theta \text{ cos}\theta$$

$$\text{cos}2\theta = \text{cos}^2\theta - \text{sin}^2\theta$$

$$= 1 - 2\text{sin}^2\theta$$

$$= 2\text{cos}^2\theta - 1$$

$$\text{tan}2\theta = \frac{2\text{tan}\theta}{1 - \text{tan}^2\theta}$$

$$\text{Sin}(A + B) = \text{sin}A \text{ cos}B + \text{cos}A \text{ sin}B$$

$$\text{Cos}(A + B) = \text{cos}A \text{ cos}B - \text{sin}A \text{ sin}B$$

$$\text{Tan}(A + B) = \frac{\text{tan}A + \text{tan}B}{1 - \text{tan}A \text{ tan}B}$$

$$\text{Sin}(A - B) = \text{sin}A \text{ cos}B - \text{cos}A \text{ sin}B$$

$$\text{Cos}(A - B) = \text{cos}A \text{ cos}B + \text{sin}A \text{ sin}B$$

$$\text{Tan}(A - B) = \frac{\text{tan}A - \text{tan}B}{1 + \text{tan}A \text{ tan}B}$$

For Natural Sines, Cosines and Tangents, see Table on page 344 (Chapter 40).

CHAPTER 39

Units

Quantity	English	Metric
Length	1 inch = 2.5400 cm.	1 centimetre = 0.3937 inch
	1 foot = 30.48 cm.	= 0.0328 foot
	1 yard = 0.9144 metre	1 metre = 1.094 yards
	1 mile = 1.6093 Km.	1 Kilometre = 0.6214 mile
	1 mil = 0.001 inch	1 mm. = 39.37 mils.
	= 0.00254 cm.	
		1 micron = 10 ⁻⁶ metre
		= 0.0001 cm.
		= 10,000 Angstroms
		1 Angstrom (A°) = 10 ⁻¹⁰ metre
	= 10 ⁻⁸ cm.	
	= 0.0001 micron	
Area	1 in. ² = 6.452 cm. ²	1 cm. ² = 0.1550 in. ²
	1 ft. ² = 929 cm. ²	= 0.001076 ft. ²
	= 0.0929 m. ²	1 m. ² = 10.76 ft. ²
Volume	1 in. ³ = 16.39 cm. ³	1 cm. ³ = 0.06102 in. ³
	= 0.01639 litres*	1 litre* = 61.02 in. ³
Mass	(Avoirdupois)	
	1 grain = 0.0648 grams	1 gram = 15.432 grains
	1 ounce = 28.35 grams	= 0.03527 ounce
	1 lb. = 7000 grains	= 0.002205 lb.
	= 453.6 grams	1 Kg. = 2.205 lb.
	= 0.4536 Kg.	1000 Kg. = 0.9842 ton
1 ton = 1016.1 Kg.	= 1 metric ton	
Force	1 lb. weight	1 dyne = 0.2248 × 10 ⁻⁵ lb. weight
	= 4.448 × 10 ⁵ dynes	1 dyne = 0.0010197 gram weight
		1 gram weight = 980.62† dynes
Intensity of Pressure	1 atmosphere	
	= 1.0132 × 10 ⁶ dynes/cm ²	1 dyne/cm ²
	= 760 m.m. mercury at 0°C.	= 0.9869 × 10 ⁻⁶ atmosphere
	1 inch mercury at 0°C.	1 m.m. mercury at 0°C.
	= 3.386 × 10 ⁴ dynes/cm ²	= 1.333 × 10 ⁵ dynes/cm ²
	= 34.53 grams/cm ²	= 1.359 grams/cm ²
	= 1.316 × 10 ⁻³ atmosphere	

*1 Litre = 2.202 lb. of fresh water at 62° F.
 † approx., at latitude 45°, on sea level.

Electrical Units

Quantity	Symbol	Unit	Relationship
Current	I, i	Ampere (A)	$I = E/R, I = E/Z,$ $I = Q/T$
Quantity } Charge }	Q, q	Coulomb	$Q = IT$
Resistance	R, r	Ohm (Ω)	$R = E/I$
Electromotive force (E.M.F.)	E, e	Volt (V)	$E = RI$
Capacitance	C	Farad (F) Jar	$C = Q/E$ $1 \text{ Jar} = 1000 \text{ cm.}$ $= 1.11 \times 10^{-9} \text{ F.}$
		Centimetre	$1 \text{ cm.} = 1.11 \times 10^{-12} \text{ F.}$ $= 1.11 \mu\mu\text{F.}$ $1\mu\mu\text{F.} = 0.9 \text{ cm.}$
Self inductance	L	Henry (H)	$L = X_L/2\pi f$
Mutual inductance	M	Henry (H)	
Inductive- reactance	X_L	Ohm (Ω)	$X_L = 2\pi fL$
Capacitive- reactance	X_C	Ohm (Ω)	$X_C = -1/2\pi fC$
Reactance	X	Ohm (Ω)	$X = [2\pi fL - (1/2\pi fC)]$
Impedance	Z	Ohm (Ω)	$Z = \sqrt{R^2 + X^2}$
Power	P	Watt (W)	$W = EI$ $1 \text{ Watt} = 10^7 \text{ ergs/second.}$
Energy or Work	—	Joule (J) Watt-hour	$1 \text{ Joule} = 10^7 \text{ ergs}$ $= 10^7 \text{ dyne-cm.}$
Conductance	G, g	Mho	$G = R/(R^2 + X^2)$
Susceptance	B, b	Mho	$B = X/(R^2 + X^2)$
Admittance	Y, y	Mho	$Y = 1/Z$
Angular Velocity	ω	Radians/ second	$\omega = 2\pi f$
Time	T, t	Second	$T = 1/f$
Frequency	f	Cycles per second (C/s) Kilocycles per second (Kc/s) Megacycles per second (Mc/s)	$f = 1/T$

Magnetic Units*

Quantity	Symbol	Unit	Relationship
Field intensity	H	Gauss (dynes/unit pole)	
Magnetic flux	ϕ	Maxwell	$\phi = \mu HA = BA$
Flux density	B	Gauss = Maxwell/cm. ²	$B = \phi/A$
Magnetising force	H	Oersted = Gilbert/cm.	$H = \frac{4\pi N I}{10 l}$
Magnetomotive force	F	Gilbert	$MMF = \frac{4\pi N I}{10}$
Permeability	μ	—	$\mu = B/H$
Reluctivity	—	—	$1/\mu$
Reluctance	R, S	—	$= \frac{MMF}{\phi} = \frac{l}{\mu A}$
Permeance	—	—	$1/R$

N.B. N = number of turns
 l = length of path in cm.
 A = area in square cm.
 I = electric current in amperes.

*British Standards Institution, "Glossary of Terms used in Electrical Engineering," November, 1936.

Photometric Units

Quantity	Symbol	Unit	Relationship
Light Flux	ϕ, F	Lumen	$1 \text{ Lumen} = \frac{1}{4\pi} \times \text{flux emitted by 1 candle}$
Light Intensity	I	Candle	$\text{Flux emitted by 1 candle} = 4\pi \text{ lumens}$
Illumination	E	Foot-candle = lumens/ft ² Phot = cm. candle = lumens/cm ² Lux = metre-candle = lumens/metre ²	

CHAPTER 40

Tables, Charts and Sundry Data

R.M.A. Colour Code for Resistors and Condensers

The standard Colour Code adopted by the Radio Manufacturers' Association (U.S.A.) uses distinct colours to represent the numerals 0—9 inclusive; thus the resistance or capacitance of fixed resistors or condensers may be indicated conveniently by combinations of various colours.

The ohm is used as the unit for the resistance code. The "body" colour represents the first digit; the "end" colour the second digit; and the "dot" colour the number of following ciphers. (e.g., a 500,000 ohm resistor has a green body (5), black end (0), and yellow dot (0000).

The condenser code uses the micromicrofarad ($\mu\mu\text{F.}$) as the unit. Condensers are usually marked by means of three coloured dots. For example, a 1500 $\mu\mu\text{F.}$ condenser has: first dot, brown (1); second dot, green (5); third dot, red (00).

The R.M.A. Colour Code gives values of resistance in ohms and capacitance in $\mu\mu\text{F.}$ correct to the first two integers, which is, in general, sufficiently accurate for most radio design work.

However, in some cases, such as a 1250 $\mu\mu\text{F.}$ condenser, the three digits may be indicated in the following manner:—The first two digits are indicated as usual; the third dot or ring is left blank. The remaining code appears in two dots or rings beside the blank. The dot or ring nearest the blank indicates the third digit, the other the number of ciphers. For example: 1250 $\mu\mu\text{F.}$, or 0.00125 $\mu\text{F.}$ condenser has; first dot, brown (1); second dot, red (2); third dot, green (5); fourth dot, brown (0).

R.M.A. RESISTOR COLOUR CODE.

Values in Ohms.

Body Colour	First Digit	End Colour	Second Digit	Dot Colour	Remaining Digits
Black	0	Black	0	Black	—
Brown	1	Brown	1	Brown	0
Red	2	Red	2	Red	00
Orange	3	Orange	3	Orange	000
Yellow	4	Yellow	4	Yellow	0000
Green	5	Green	5	Green	00,000
Blue	6	Blue	6	Blue	000,000
Violet	7	Violet	7	Violet	0,000,000
Grey	8	Grey	8	Grey	00,000,000
White	9	White	9	White	000,000,000

R.M.A. CONDENSER COLOUR CODE

Values in Micromicrofarads

First Dot	First Digit	Second Dot	Second Digit	Third Dot	Remaining Digits
Black	0	Black	0	Black*	—
Brown	1	Brown	1	Brown	0
Red	2	Red	2	Red	00
Orange	3	Orange	3	Orange	000
Yellow	4	Yellow	4	Yellow	0,000
Green	5	Green	5	Green	00,000
Blue	6	Blue	6	Blue	000,000
Violet	7	Violet	7	Violet	0,000,000
Grey	8	Grey	8	Grey	00,000,000
White	9	White	9	White	000,000,000

*Optional

Table Showing Popular Sizes of Resistors in the R.M.A. Code

Resistance in Ohms	Body Colour	End Colour	Dot Colour
50	Green	Black	Black
100	Brown	Black	Brown
150	Brown	Green	Brown
200	Red	Black	Brown
250	Red	Green	Brown
300	Orange	Black	Brown
350	Orange	Green	Brown
400	Yellow	Black	Brown
450	Yellow	Green	Brown
500	Green	Black	Brown
750	Violet	Green	Brown
1,000	Brown	Black	Red
1,500	Brown	Green	Red
2,000	Red	Black	Red
2,500	Red	Green	Red
3,000	Orange	Black	Red
3,500	Orange	Green	Red
4,000	Yellow	Black	Red
4,500	Yellow	Green	Red
5,000	Green	Black	Red
6,000	Blue	Black	Red
7,000	Violet	Black	Red
8,000	Grey	Black	Red
9,000	White	Black	Red
10,000	Brown	Black	Orange
12,000	Brown	Red	Orange
13,000	Brown	Orange	Orange
15,000	Brown	Green	Orange
17,000	Brown	Violet	Orange
18,000	Brown	Grey	Orange
19,000	Brown	White	Orange
20,000	Red	Black	Orange
22,000	Red	Red	Orange
25,000	Red	Green	Orange
27,000	Red	Violet	Orange
30,000	Orange	Black	Orange
35,000	Orange	Green	Orange
40,000	Yellow	Black	Orange
45,000	Yellow	Green	Orange
50,000	Green	Black	Orange
60,000	Blue	Black	Orange
70,000	Violet	Black	Orange
75,000	Violet	Green	Orange
80,000	Grey	Black	Orange
90,000	White	Black	Orange
100,000	Brown	Black	Yellow
125,000	Brown	Red	Yellow*
150,000	Brown	Green	Yellow
175,000	Brown	Violet	Yellow*
200,000	Red	Black	Yellow
225,000	Red	Red	Yellow*
250,000	Red	Green	Yellow
275,000	Red	Violet	Yellow*
300,000	Orange	Black	Yellow
350,000	Orange	Green	Yellow
400,000	Yellow	Black	Yellow
450,000	Yellow	Green	Yellow
500,000	Green	Black	Yellow
600,000	Blue	Black	Yellow
750,000	Violet	Green	Yellow
1 megohm	Brown	Black	Green
1½ megohms	Brown	Red	Green*
1¾ megohms	Brown	Green	Green*
1⅞ megohms	Brown	Violet	Green*
2 megohms	Red	Black	Green*
2¼ megohms	Red	Red	Green*
2½ megohms	Red	Green	Green*
3 megohms	Orange	Black	Green
4 megohms	Yellow	Black	Green
5 megohms	Green	Black	Green
10 megohms	Brown	Black	Blue

*The colour code does not extend beyond the first two digits, and consequently the code can only be used by dropping the third digit. Values shown by the asterisks are therefore only approximations.

TABLE SHOWING POPULAR SIZES OF CONDENSERS
IN THE R.M.A. CODE

Capacitance		First Dot	COLOURS		Third Dot
$\mu\mu\text{F}$	μF		Second Dot		
10	.00001	Brown	Black	(Black)*	
20	.00002	Red	Black	(Black)*	
25	.000025	Red	Green	(Black)*	
50	.00005	Green	Black	(Black)*	
100	.0001	Brown	Black	Brown	
250	.00025	Red	Green	Brown	
350	.00035	Orange	Green	Brown	
400	.0004	Yellow	Black	Brown	
500	.0005	Green	Black	Brown	
750	.00075	Violet	Green	Brown	
1,000	.001	Brown	Black	Red	
1,200	.0012	Brown	Red	Red	
2,000	.002	Red	Black	Red	
3,000	.003	Orange	Black	Red	
4,000	.004	Yellow	Black	Red	
10,000	.01	Brown	Black	Orange	
20,000	.02	Red	Black	Orange	
50,000	.05	Green	Black	Orange	
100,000	.1	Brown	Black	Yellow	
250,000	.25	Red	Green	Yellow	
500,000	.5	Green	Black	Yellow	

*May be left blank.

TOLERANCES AND VOLTAGE RATINGS OF CONDENSERS

The R.M.A. Colour Code may also be used to indicate tolerances and voltage ratings of condensers.

Tolerances are indicated by a single colour as follows:—

Brown	1%	Violet	7%
Red	2%	Grey	8%
Orange	3%	White	9%
Yellow	4%	Gold	5%
Green	5%	Silver	10%
Blue	6%	No Colour	20%

Voltage Ratings are indicated as follows:

Brown	100 volts	Violet	700 volts
Red	200 volts	Grey	800 volts
Orange	300 volts	White	900 volts
Yellow	400 volts	Gold	1000 volts
Green	500 volts	Silver	2000 volts
Blue	600 volts	No Colour	500 volts

In order to avoid confusion between the different markings the following arrangement is standard:

Condensers of polygonal cross section: Six markers (dots) are arranged in two horizontal rows of three each. The upper three indicate the digits of the capacitance, and the lower right hand marker indicates the number of following ciphers. The middle marker of the lower row indicates the tolerance, and the lower left hand marker indicates the voltage rating.

Condenser Tolerance and Voltage Ratings (Contd.)

Condensers of circular cross section: Six rings, three being wide and three narrow, are arranged around the body. When viewed with the three wide bands to the right of the three narrow bands the indications are:—

First digit of capacitance—left hand wide band.

Second digit of capacitance—next adjacent wide band.

Third digit of capacitance—third wide band.

Number of ciphers of capacitance—right hand narrow band.

Tolerance (if any)—next adjacent narrow band.

Voltage rating (if any)—third narrow band.

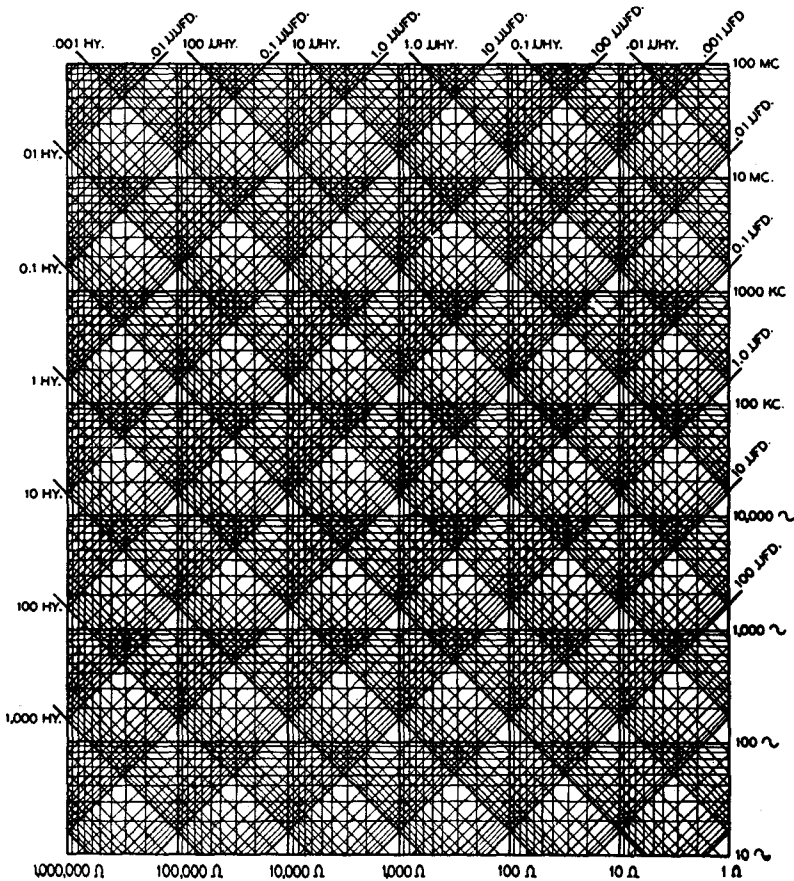
REACTANCE-FREQUENCY CHART

This Chart is reproduced by courtesy of Radio Ltd. and appeared in the issue of "Radio" for January, 1939.

INDUCTIVE REACTANCES (Correct to three significant figures) AUDIO FREQUENCIES

$$X_L = \omega L$$

Inductance (Henries)	REACTANCE IN OHMS AT:—					
	30 c/s	50 c/s	100 c/s	400 c/s	1000 c/s	5000 c/s
250	47,100	78,500	157,000	628,000	1,570,000	7,850,000
100	18,800	31,400	62,800	251,000	628,000	3,140,000
50	9,420	15,700	31,400	126,000	314,000	1,570,000
25	4,710	7,850	15,700	62,800	157,000	785,000
10	1,880	3,140	6,280	25,100	62,800	314,000
5	942	1,570	3,140	12,600	31,400	157,000
1	188	314	628	2,510	6,280	31,400
.1	18.8	31.4	62.8	251	628	3,140
.01	1.88	3.14	6.28	25.1	62.8	314
1000 μ H.	.188	.314	.628	2.51	6.28	31.4
200 μ H.	.0376	.0628	.126	.502	1.26	6.28
100 μ H.	.0188	.0314	.0628	.251	.628	3.14

RADIO FREQUENCIES

$$X_L = \omega L$$

Inductance (Henries)	REACTANCE IN OHMS AT:—					
	175 Kc/s	252 Kc/s	465 Kc/s	550 Kc/s	1000 Kc/s	1500 Kc/s
1	1,100,000	1,580,000	2,920,000	3,460,000	6,280,000	9,430,000
.1	110,000	158,000	292,000	346,000	628,000	943,000
.01	11,000	15,800	29,200	34,600	62,800	94,300
1000 μ H.	1,100	1,580	2,920	3,460	6,280	9,430
200 μ H.	220	317	484	691	1,260	1,890
100 μ H.	110	158	292	346	628	943

CAPACITIVE REACTANCES (Correct to three significant figures.) AUDIO FREQUENCIES

$$X_C = 1/\omega C$$

Capacitance Microfarads	REACTANCE IN OHMS AT:—					
	30 c/s	50 c/s	100 c/s	400 c/s	1000 c/s	5000 c/s
.00005	—	—	—	—	—	637,000
.0001	—	—	—	—	1,590,000	318,000
.00025	—	—	—	1,590,000	637,000	127,000
.0005	—	—	3,180,000	796,000	318,000	63,700
.001	—	3,180,000	1,590,000	398,000	159,000	31,800
.005	1,060,000	637,000	318,000	79,600	31,800	6,370
.01	531,000	318,000	159,000	39,800	15,900	3,180
.02	263,000	159,000	79,600	19,900	7,960	1,590
.05	106,000	63,700	31,800	7,960	3,180	637
.1	53,100	31,800	15,900	3,980	1,590	318
.25	21,200	12,700	6,370	1,590	637	127
.5	10,600	6,370	3,180	796	318	63.7
1	5,310	3,180	1,590	398	159	31.8
2	2,650	1,590	796	199	79.6	15.9
4	1,310	796	398	99.5	39.8	7.96
8	663	398	199	49.7	19.9	3.98
16	332	199	99.5	24.9	9.95	1.99
25	212	127	63.7	15.9	6.37	1.27
35	152	91.0	45.5	11.4	4.55	.910

RADIO FREQUENCIES

$$X_C = 1/\omega C$$

Capacitance Microfarads	REACTANCE IN OHMS AT:—					
	175 Kc/s	252 Kc/s	465 Kc/s	550 Kc/s	1000 Kc/s	1,500 Kc/s
.00005	18,200	12,600	6,850	5,800	3,180	2,120
.0001	9,100	6,320	3,420	2,900	1,590	1,060
.00025	3,640	2,530	1,370	1,160	637	424
.0005	1,820	1,260	685	579	318	212
.001	910	632	342	290	159	106
.005	182	126	68.5	57.9	31.8	21.2
.01	91.0	63.2	34.2	28.9	15.9	10.6
.02	45.5	31.6	17.1	14.5	7.96	5.31
.05	18.2	12.6	6.85	4.79	3.18	2.12
.1	9.10	6.32	3.42	2.89	1.59	1.06
.25	3.64	2.53	1.37	1.16	.637	.424
.5	1.82	1.26	.685	.579	.318	.212
1	.910	.632	.342	.289	.159	.106
2	.455	.316	.171	.145	.0796	.0531
4	.227	.158	.0856	.0723	.0398	.0265

B.A. Screw Threads

Dimensions given are only approximate.

B.A. No.	Outside dia.	Core dia.	Turns per in.	Clearing drill.	Tapping drill.
0	.236	.189	25.4	$\frac{1}{4}$ " or "B"	Nos. 10-12
1	.209	.166	28.3	Nos. 2-3	18-19
2	.185	.147	31.4	10-11	25-26
3	.161	.127	34.8	18-19	30-31
4	.142	.111	38.5	26-27	33-34
5	.126	.098	43.1	29-30	39-40
6	.110	.085	47.9	32-33	44
7	.098	.076	52.9	38-39	48
8	.087	.066	59.2	42-43	51
9	.075	.056	64.9	46-47	53
10	.067	.050	72.5	49-50	55

Wood Screws

Gauge No.	Shank dia.	Clearance drill No.	Gauge No.	Shank dia.	Clearance drill No.
1	.066	44	9	.178	9
2	.080	41	10	.192	4
3	.094	35	11	.206	2
4	.108	30	12	.220	1
5	.122	28	13	.234	$\frac{1}{4}$ "
6	.136	24	14	.248	$\frac{17}{64}$ "
7	.150	19	15	.262	$\frac{9}{32}$ "
8	.164	15	16	.276	$\frac{19}{64}$ "

Decimal Equivalents of Fractions

$\frac{1}{32}$03125	$\frac{17}{32}$53125
$\frac{1}{16}$0625	$\frac{9}{16}$5625
	$\frac{8}{32}$...	$\frac{19}{32}$59375
$\frac{1}{8}$125	$\frac{5}{8}$625
	$\frac{5}{32}$...	$\frac{21}{32}$65625
$\frac{3}{16}$1875	$\frac{11}{16}$6875
	$\frac{7}{32}$...	$\frac{23}{32}$71875
$\frac{1}{4}$25	$\frac{3}{4}$75
	$\frac{9}{32}$...	$\frac{25}{32}$78125
$\frac{5}{16}$3125	$\frac{13}{16}$8125
	$\frac{11}{32}$...	$\frac{27}{32}$84375
$\frac{3}{8}$375	$\frac{7}{8}$875
	$\frac{18}{32}$...	$\frac{29}{32}$90625
$\frac{7}{16}$4375	$\frac{15}{16}$9375
	$\frac{15}{32}$...	$\frac{81}{32}$96875
$\frac{1}{2}$5	1	...	1.0

Whitworth Screw Threads

Outside dia.	Core dia.	Threads per inch	Tapping drill
$\frac{1}{8}$ "	.093	40	41
$\frac{3}{16}$ "	.134	24	$\frac{9}{64}$ "
$\frac{1}{4}$ "	.186	20	No. 12
$\frac{5}{16}$ "	.241	18	$\frac{1}{4}$ "
$\frac{3}{8}$ "	.295	16	$\frac{5}{16}$ "
$\frac{1}{2}$ "	.393	12	$\frac{13}{32}$ "
$\frac{5}{8}$ "	.509	11	$\frac{17}{32}$ "
$\frac{3}{4}$ "	.622	10	$\frac{7}{8}$ "
1"	.840	8	$\frac{27}{32}$ "

TWIST DRILL SIZES

Drill No.	Dia. Inch	Drill No.	Dia. Inch	Drill No.	Dia. Inch	Drill No.	Dia. Inch
1	.2280	21	.1590	41	.0960	61	.0390
2	.2210	22	.1570	42	.0935	62	.0380
3	.2130	23	.1540	43	.0890	63	.0370
4	.2090	24	.1520	44	.0860	64	.0360
5	.2055	25	.1495	45	.0820	65	.0350
6	.2040	26	.1470	46	.0810	66	.0330
7	.2010	27	.1440	47	.0785	67	.0320
8	.1990	28	.1405	48	.0760	68	.0310
9	.1960	29	.1360	49	.0730	69	.02925
10	.1935	30	.1285	50	.0700	70	.0280
11	.1910	31	.1200	51	.0670	71	.0260
12	.1890	32	.1160	52	.0635	72	.0250
13	.1850	33	.1130	53	.0595	73	.0240
14	.1820	34	.1110	54	.0550	74	.0225
15	.1800	35	.1100	55	.0520	75	.0210
16	.1770	36	.1065	56	.0465	76	.0200
17	.1730	37	.1040	57	.0430	77	.0180
18	.1695	38	.1015	58	.0420	78	.0160
19	.1660	39	.0995	59	.0410	79	.0145
20	.1610	40	.0980	60	.0400	80	.0135

Multiples and Submultiples

Multiply Reading in	By	To obtain Reading in
Amperes	×1,000,000,000,000	micromicroamperes
Amperes	×1,000,000	microamperes
Amperes	×1,000	milliamperes
Cycles	×.000,001	megacycles
Cycles	×.001	kilocycles
Farads	×1,000,000,000,000	micromicrofarads
Farads	×1,000,000	microfarads
Farads	×1,000	millifarads
Henrys	×1,000,000	microhenrys
Henrys	×1,000	millihenrys
Kilocycles	×1,000	cycles
Kilowatts	×1,000	watts
Megacycles	×1,000,000	cycles
Mhos	×1,000,000	micromhos
Mhos	×1,000	millimhos
Microamperes	×.000,001	amperes
Microfarads	×.000,001	farads
Microhenrys	×.000,001	henrys
Micromhos	×.000,001	mhos
Microvolts	×.000,001	volts
Micromicrofarads	×.000,000,000,001	farads
Milliamperes	×.001	amperes
Millihenrys	×.001	henrys
Millimhos	×.001	mhos
Millivolts	×.001	volts
Milliwatts	×.001	watts
Volts	×1,000,000	microvolts
Volts	×1,000	millivolts
Watts	×1,000	milliwatts

Relative Resistance and Temperature Coefficients

(Approximate Only)

Material.	Relative Resistance at 20° C.	Temperature co-eff. per 1° C.		Approx. Zero Temp. coeff. at
		20° C.	100° C.	
Copper (annealed)*	1	.00393		25°-35° C.
Iron (99.98% pure)	5.8	.0050	.0068	
German Silver (18% Nickel)	19.1	.0004		
Eureka	28.4	.00001	.000033	
Advance (Constantan)	28.4	.00001	.000033	
Manganin	25.5	.00001	— .000042	
Nichrome	58	.0004		

*100% conductivity.

The values given may be used for all ordinary calculations, but there is considerable variation between alloys produced by different manufacturers. The temperature coefficients of resistivity vary considerably throughout the temperature range, particularly with iron, manganin and nichrome.

Solenoid Resistor Ratings

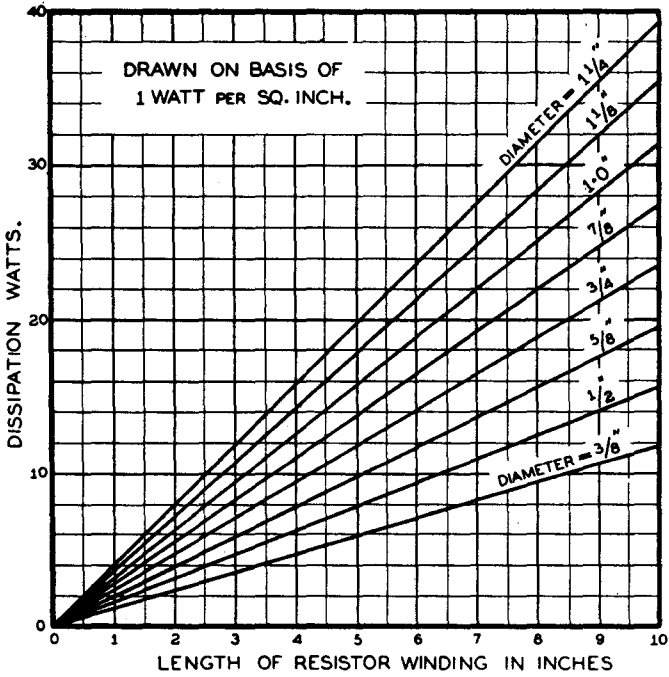

This chart has been drawn on the basis of 1 watt dissipation per square inch of winding. It may be used for other dissipation ratings by multiplying by the appropriate factor. It may also be used for lengths under 1" by dividing both the length and dissipation scale readings by 10.

The following factors may be used as an approximate guide.

CONTINUOUS DUTY	FACTOR	
	Temperature rise	
	250° C	100° C
	450° F	212° F
Free ventilation and 12" clearance	5	1.35
Reduced ventilation and clearance	2.5	.67
Cramped locations	1.25	.34
On cardboard formers (voltage dividers in radio receivers)	—	0.4

INTERMITTENT DUTY	FACTOR
On 15 seconds in 4 minutes	3
On 30 seconds in 4 minutes	2
On 60 seconds in 4 minutes	1.5
On 1 1/2 minutes in 4 minutes	1.3
On 2 minutes in 4 minutes	1.2

Fuse Wire Table

The fusing current of wire depends largely upon external conditions such as the atmospheric temperature, method of mounting, proximity of other objects, and time of operation. Copper wire is particularly subject to corrosion when operated continuously at a current approaching the fusing current and should preferably be coated with a metal which does not oxidise so readily. The following table applies only to conditions with the wire freely suspended in air.

The maximum safe working current may be taken as approximately 67% of the fusing current, under the same conditions.

Fusing Current Amps.	Copper.		Tin.		Allo-Tin.		Lead.	
	Dia. inch	S.W.G. Approx.	Dia. inch.	S.W.G. Approx.	Dia. inch.	S.W.G. Approx.	Dia. inch.	S.W.G. Approx.
1	.0021	47	.0072	37	.0083	35	.0081	35
2	.0034	43	.0113	31	.0132	29	.0128	30
3	.0044	41	.0149	28	.0173	27	.0168	27
4	.0053	39	.0181	26	.0210	25	.0203	25
5	.0062	38	.0210	25	.0243	23	.0236	23
10	.0098	33	.0334	21	.0386	19	.0375	20
15	.0129	30	.0437	19	.0506	18	.0491	18
20	.0156	28	.0529	17	.0613	16	.0595	17
25	.0181	26	.0614	16	.0711	15	.0690	15
30	.0205	25	.0694	15	.0803	14	.0779	14
40	.0248	23	.0840	14	.0973	13	.0944	13
50	.0288	22	.0975	13	.1129	11	.1095	12
70	.0360	20	.1220	10	.1413	9	.1371	9
100	.0457	18	.1548	8	.1792	7	.1739	7

R.M.A. (U.S.A.) Radio Colour Codes

I.F. TRANSFORMERS

Blue....plate lead.

Red....B+ lead.

Green...grid (or diode) lead.

Black...grid (or diode) return,

Note: If the secondary of the I.F.T. is centre-tapped in order to feed a full-wave diode rectifier, the second diode plate lead is green and black striped, and black is used for the centre-tap lead.

A.F. TRANSFORMERS

Blue....plate (finish) lead of primary.

Red....B+ lead (this applies whether the primary is plain or centre-tapped).

Brown...plate (start) lead on C.T. primaries. Blue may be used for this lead if polarity is not important.

Green...grid (finish) lead to secondary.

Black...grid return (this applies whether the secondary is plain or centre-tapped).

Yellow...grid (finish) lead on C.T. secondaries. Green may be used for this lead if polarity is not important.

Note: These markings apply also to line-to-grid, and valve-to-line transformers.

R.M.A. Colour Codes**LOUDSPEAKERS****MATCHING TRANSFORMERS**

Colour coding for loudspeaker transformer leads is identical with that for A.F. transformers, as given on page 320.

VOICE COILS

Green....finish.

Black....start.

FIELD COILS

Black and Redstart.

Yellow and Red....finish.

Slate and Red....tapping (if any).

Note: If two field coils are fitted to the same loudspeaker, the basic colour coding is used for the lower resistance field, and green is substituted for the red in the leads to the higher resistance field.

RADIO POWER TRANSFORMERS.

1. Primary Leads Black
If tapped—Common Black
—Tap Black & Yellow 50/50 Striped Design
—Finish Black & Red 50/50 Striped Design
2. Rectifier—Plate Winding Red
Centre Tap Red & Yellow 50/50 Striped Design
3. Rectifier—Filament Winding Yellow
Centre Tap Yellow & Blue 50/50 Striped Design
4. Amplifier—Fil. Winding No. 1 Green
Centre Tap Green & Yellow 50/50 Striped Design
5. Amplifier—Fil. Winding No. 2 Brown
Centre Tap Brown & Yellow 50/50 Striped Design
6. Amplifier—Fil. Winding No. 3 Slate
Centre Tap Slate and Yellow 50/50 Striped Design

RESISTORS FOR USE WITH AIR CELLS

Since the voltage delivered by an Air Cell considerably exceeds 2 volts, it is necessary to use a dropping resistor when an Air Cell "A" Battery is employed with 2 volt valves. The following table is based on the requirements that the applied voltage should not exceed 2.1 volts for any appreciable period, and should be from 1.95 to 2.0 volts over the greater portion of the battery life. The resistance of battery leads should be subtracted from the values given in this table in order to obtain the value of the additional dropping resistor.

Nominal Drain	Series Resistor including lead resistance
600 mA.	0.595 ohm
540 mA.	0.685 "
480 mA.	0.81 "
420 mA.	0.96 "
360 mA.	1.10 "

**RESISTORS FOR USE WITH 1.4 VOLT VALVES
OPERATED FROM DRY CELL "A" BATTERY.**

The voltage applied to the filaments of battery valves should not under any circumstances rise more than 10% above the rated voltage. In the case of 1.4 volt valves the limit is 1.54 volts, and it is advisable to keep below this limit in order to obtain better service from the valves. New dry cells give a voltage often as high as 1.6 volts, and it is recommended that a resistor be incorporated to bring about a total drop of 0.08 volt, including the drop in the battery leads.

Total Current Drain	Total Resistance Required in Filament Circuit
200 mA.	0.4 ohm
250 mA.	0.32 "
300 mA.	0.27 "
350 mA.	0.23 "
400 mA.	0.20 "
450 mA.	0.18 "

Musical Frequencies

There are many musical pitches in use, but the "physical pitch" which is adopted for electro-acoustical calculations is based on a frequency of 256 c/s. for middle C. The octaves of C are therefore

CCCC	CCC	CC	C	c ⁱ	c ⁱⁱ	c ⁱⁱⁱ	c ^{iv}	c ^v	
16	32	64	128	256	512	1024	2048	4096	c/s.

The "tempered scale" has the following frequency ratios within the octave, on the basis of $c = 1$.

c = 1	e = 1.2599	g# = 1.5874
c# = 1.05946	f = 1.3348	a = 1.6818
d = 1.1225	f# = 1.4142	a# = 1.7818
d# = 1.1892	g = 1.4983	b = 1.8877
		c' = 2.0000

It will be seen that increasing the frequency of any note by a factor 1.05946 raises its pitch by a semitone, while a further application of the factor raises it by a further semitone, and so on through the scale.

Two popular books which are well worth reading are Sir James Jeans "Science and Music" (MacMillan Company and Cambridge University Press) 1938, and John Mills "A Fugue in Cycles and Bells" (Chapman and Hall) 1936.

Visibility Curves of Human Eye, and Relative Spectral Energy Curves of Sunlight and Tungsten Lamp

The wavelength of light is measured in Angstrom Units (A°). One Angstrom Unit is equal to 1/10,000 of a micron, that is 1/10 of a millimicron. A micron is 1/1,000,000 (10⁻⁶) of a metre.

The wavelengths visible to the human eye extend from about 4,000 to 7,000 A°. Beyond these extends the region of "invisible light" which, although invisible to the human eye, may be detected by the photo-tube or other means.

The eye, when accustomed to high light intensity, is most sensitive to a wavelength of 5,550 A°, in the green-yellow region. The relative visibility curve for these conditions is Curve A, which is taken after H. E. Ives*. As the light intensity is reduced, the wavelength at which the eye is most sensitive decreases until at very low intensity it is approximately as shown in Curve B.

Different light sources have different spectral energy curves. The curve for sunlight (Curve C is for sunlight at the earth's surface at a zenith distance of 25°) is more nearly constant over the range of visible light than that for a tungsten lamp (Curve D is for a 1,000 watt gasfilled tungsten lamp, 20 lumens per watt). The relative positions of curves C and D are quite arbitrary.

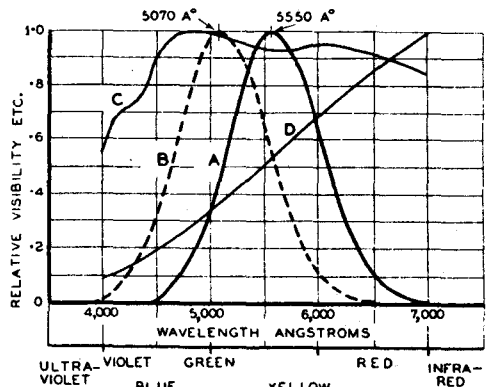

*See R. A. Houston, "Vision and Colour Vision," Longmans, Green and Co. (1932). Chapter 5.

Decibel Relationships

1. Decibels expressed as Power and Voltage Ratios.

Note that the Power Ratio columns give values which are equal to the number of milliwatts when the reference level is 1 mW., this being also numerically equal to the number of vu for steady sine-wave conditions.

The Voltage Ratio columns also give values which are equal to the number of volts when the reference level is 1 volt.

Interpolation: If it is required to find the power ratio corresponding to 23 db, or any other value which is not included in the table, the following procedure may be adopted:—

1. Take the next lowest multiple of 20 db (in this case 20 db), and note the corresponding power ratio (in this case 100).
2. Take the difference between the specified level and the multiple of 20 db (in this case $23 - 20 = 3$ db) and note the corresponding power ratio (in this case 1.995).
3. Multiply the two power ratios so determined (in this case $100 \times 1.995 = 199.5$).

DECIBELS EXPRESSED AS POWER AND VOLTAGE RATIOS.

Voltage Ratio	Power Ratio = mW to Ref. Level 1mW	db.	Voltage Ratio	Power Ratio = mW to Ref. Level 1mW
1.0000	1.0000	0	1.000	1.000
.8913	.7943	1	1.122	1.259
.7943	.6310	2	1.259	1.585
.7079	.5012	3	1.413	1.995
.6310	.3981	4	1.585	2.512
.5623	.3162	5	1.778	3.162
.5012	.2512	6	1.995	3.981
.4467	.1995	7	2.239	5.012
.3981	.1585	8	2.512	6.310
.3548	.1259	9	2.818	7.943
.3162	.1000	10	3.162	10.000
.2818	.07943	11	3.548	12.59
.2512	.06310	12	3.981	15.85
.2239	.05012	13	4.467	19.95
.1995	.03981	14	5.012	25.12
.1778	.03162	15	5.623	31.62
.1585	.02512	16	6.310	39.81
.1413	.01995	17	7.079	50.12
.1259	.01585	18	7.943	63.10
.1122	.01259	19	8.913	79.43
.1000	.01	20	10.000	100.00
.056	.00316	25	17.78	316.2
.03162	.001	30	31.62	1,000
.01778	.000316	35	56.23	3,162
.010	.0001	40	100.0	10,000
.0056	.0000316	45	177.8	31,620
.003162	.00001	50	316.2	100,000
.001	.000001	60	1,000	1,000,000
.0003162	.0000001	70	3,162	10,000,000
.0001	.00000001	80	10,000	100,000,000
.00003162	.000000001	90	31,620	1,000,000,000
.00001	.0000000001	100	100,000	10,000,000,000

(2) POWER AND VOLTAGE RATIOS EXPRESSED IN DECIBELS.

Ratio	db (Power Ratio)	db (Voltage Ratio)	Ratio	db (Power Ratio)	db (Voltage Ratio)
1.0	0	0	5.5	7.404	14.807
1.1	0.414	0.828	5.6	7.482	14.964
1.2	0.792	1.584	5.7	7.559	15.117
1.3	1.139	2.279	5.8	7.634	15.269
1.4	1.461	2.923	5.9	7.709	15.417
1.5	1.761	3.522	6.0	7.782	15.563
1.6	2.041	4.082	6.1	7.853	15.707
1.7	2.304	4.609	6.2	7.924	15.848
1.8	2.553	5.105	6.3	7.993	15.987
1.9	2.788	5.575	6.4	8.062	16.124
2.0	3.010	6.021	6.5	8.129	16.258
2.1	3.222	6.444	6.6	8.195	16.391
2.2	3.424	6.848	6.7	8.261	16.521
2.3	3.617	7.235	6.8	8.325	16.650
2.4	3.802	7.604	6.9	8.388	16.777
2.5	3.979	7.959	7.0	8.451	16.902
2.6	4.150	8.299	7.1	8.513	17.025
2.7	4.314	8.627	7.2	8.573	17.147
2.8	4.472	8.943	7.3	8.633	17.266
2.9	4.624	9.248	7.4	8.692	17.385
3.0	4.771	9.542	7.5	8.751	17.501
3.1	4.914	9.827	7.6	8.808	17.616
3.2	5.051	10.103	7.7	8.865	17.730
3.3	5.185	10.370	7.8	8.921	17.842
3.4	5.315	10.630	7.9	8.976	17.953
3.5	5.441	10.881	8.0	9.031	18.062
3.6	5.563	11.126	8.1	9.085	18.170
3.7	5.682	11.364	8.2	9.138	18.276
3.8	5.798	11.596	8.3	9.191	18.382
3.9	5.911	11.821	8.4	9.243	18.486
4.0	6.021	12.041	8.5	9.294	18.588
4.1	6.128	12.256	8.6	9.345	18.690
4.2	6.232	12.465	8.7	9.395	18.790
4.3	6.335	12.669	8.8	9.445	18.890
4.4	6.435	12.869	8.9	9.494	18.988
4.5	6.532	13.064	9.0	9.542	19.085
4.6	6.628	13.255	9.1	9.590	19.181
4.7	6.721	13.442	9.2	9.638	19.276
4.8	6.812	13.625	9.3	9.685	19.370
4.9	6.902	13.804	9.4	9.731	19.463
5.0	6.990	13.979	9.5	9.777	19.554
5.1	7.076	14.151	9.6	9.823	19.645
5.2	7.160	14.320	9.7	9.868	19.735
5.3	7.243	14.486	9.8	9.912	19.825
5.4	7.324	14.648	9.9	9.956	19.913
			10.0	10.000	20.000

Decibel Conversion Chart

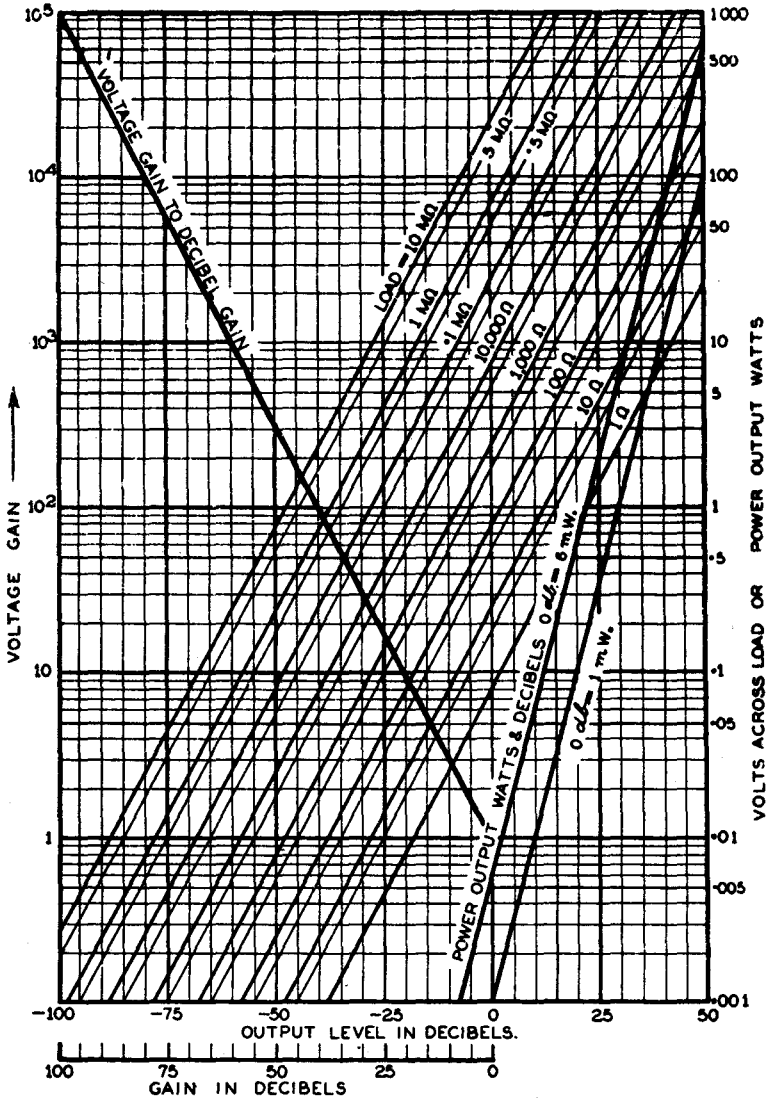

- THE OUTPUT OF A MICROPHONE AMPLIFIER ETC. MAY BE CONVERTED FROM DECIBELS TO VOLTS [OR VICE-VERSA] BY PROJECTION ONTO THE CORRECT* LOAD-LINE. THIS ONLY HOLDS WHEN REFERENCE LEVEL FOR 0 db IS EQUAL TO 6 MILLIWATTS INTO 500 OHMS.
- VOLTAGE GAIN MAY BE EXPRESSED IN DECIBELS [OR VICE-VERSA] BY PROJECTION ONTO THE VOLTAGE-DECIBEL GAIN LINE. FOR GAIN CALCULATIONS INPUT & OUTPUT IMPEDANCES MUST BE EQUAL.
- TO CONVERT POWER OUTPUT FROM WATTS TO DECIBELS [OR VICE-VERSA] REFER TO THE POWER OUTPUT LINE. REFERENCE LEVELS EITHER 1 OR 6 MILLIWATTS..

* LOAD-LINE REFERS TO THE VALUE OF THE AC. LOAD INTO WHICH A DEVICE WORKS.

3. Decibels above and below reference level expressed in watts and volts.

Reference level 6 milliwatts into 500 ohms

Note that the power in watts also holds for any impedance, but the voltage holds only for 500 ohms.

db. down		Power level db. - 0 +	db. up.	
Volts	Watts		Volts	Watts
1.73	6.00×10^{-3}	0	1.73	.00600
1.54	4.77×10^{-3}	1	1.94	.00755
1.38	3.87×10^{-3}	2	2.18	.00951
1.23	3.01×10^{-3}	3	2.45	.0120
1.09	2.39×10^{-3}	4	2.75	.0151
.974	1.90×10^{-3}	5	3.08	.0190
.868	1.51×10^{-3}	6	3.46	.0239
.774	1.20×10^{-3}	7	3.88	.0301
.690	9.51×10^{-4}	8	4.35	.0387
.615	7.55×10^{-4}	9	4.88	.0477
.548	6.00×10^{-4}	10	5.48	.0600
.488	4.77×10^{-4}	11	6.15	.0755
.435	3.87×10^{-4}	12	6.90	.0951
.388	3.01×10^{-4}	13	7.74	.120
.346	2.39×10^{-4}	14	8.68	.151
.308	1.90×10^{-4}	15	9.74	.190
.275	1.51×10^{-4}	16	10.93	.239
.245	1.20×10^{-4}	17	12.26	.301
.218	9.51×10^{-5}	18	13.76	.387
.194	7.55×10^{-5}	19	15.44	.477
.173	6.00×10^{-5}	20	17.32	.600
.0974	1.90×10^{-5}	25	30.8	1.90
.0548	6.00×10^{-6}	30	54.8	6.00
.0308	1.90×10^{-6}	35	97.4	19.0
.0173	6.00×10^{-7}	40	173	60.0
.00974	1.90×10^{-7}	45	308	190
.00548	6.00×10^{-8}	50	548	600
.00173	6.00×10^{-9}	60	1,730	6,000
.000548	6.00×10^{-10}	70	5,480	60,000
.000173	6.00×10^{-11}	80	17,300	600,000

Abac for Calculating Ensi

(See facing page)

Random noise may be expressed as "Equivalent Noise Sideband Input" (ensi) which may be expressed in microvolts. The equivalent noise sideband input voltage may be computed from the formula

$$E_N = m E_s \sqrt{P'_N/P'_s} \quad (\text{See Chapter 29})$$

or more readily in most cases by the use of this Abac. In this Abac the signal output power (P'_s) and noise output power (P'_N) are expressed in milliwatts, while the signal voltage (E_s) and ensi voltage are given in microvolts, the modulation percentage being 30%.

There are two scales for P'_N , that on the extreme right being used when $P'_s = 50$ mW (see key diagram No. 2) while the other is used when P'_s is other than 50 mW (key diagram No. 1).

Abac for Calculating Ensi

See descriptive matter at foot of facing page.

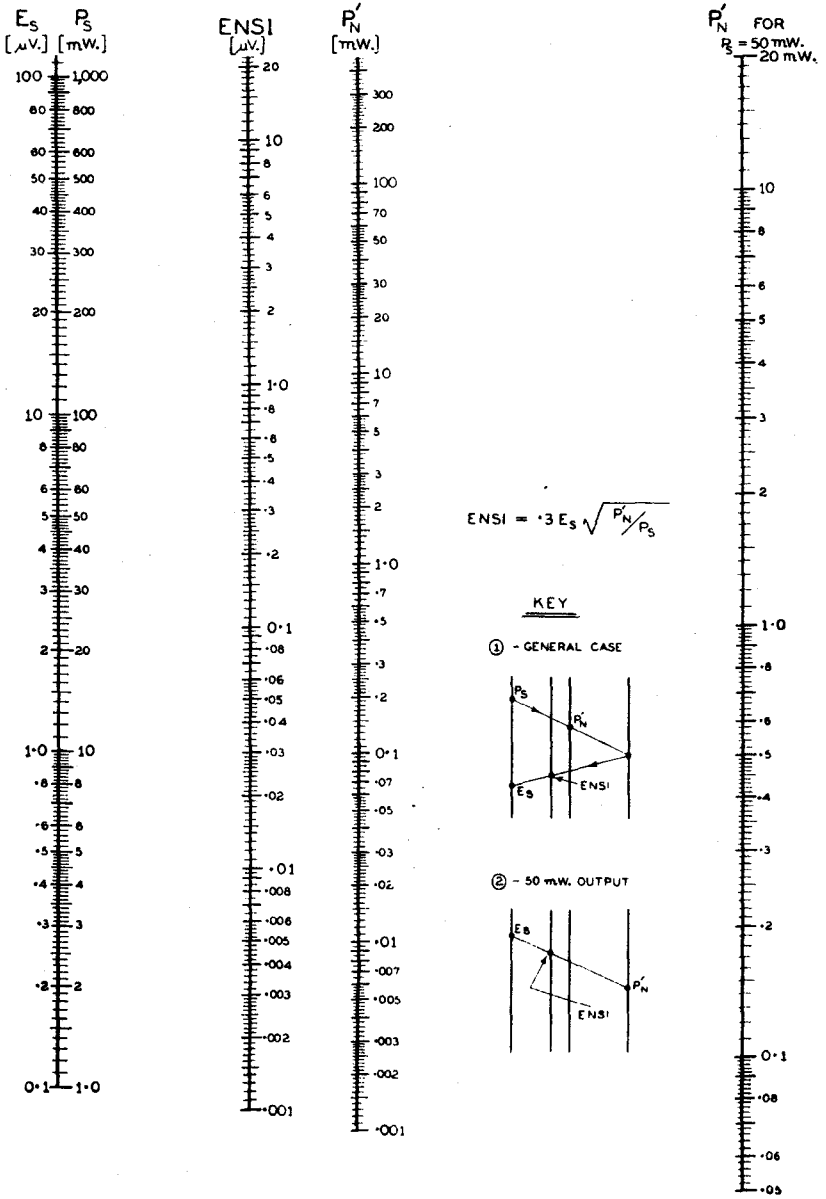

Numerical Values

$\pi = 3.141593$	$\epsilon = 2.71828$
$1/\pi = 0.318310$	$1/\epsilon = 0.367879$
$\pi^2 = 9.86960$	$\epsilon^2 = 7.38906$
$1/\pi^2 = 0.101321$	$\sqrt{\epsilon} = 1.64872$
$\pi^3 = 31.0063$	$\log_{10} \epsilon = 0.4343$
$1/\pi^3 = 0.0322515+$	1
$\sqrt{\pi} = 1.77245+$	-----
$1/\sqrt{\pi} = 0.56419$	$\log_{10} \epsilon$
$\sqrt{\pi/2} = 1.25331$	$1/2\pi = 0.159155$
$2\pi = 6.283186$	$(1/2\pi)^2 = 0.025330$
$(2\pi)^2 = 39.47840$	$\sqrt{2} = 1.4142$
$\log_{10} \pi = 0.4971$	$\sqrt{3} = 1.7321$
$\log_{10} (\pi/2) = 0.1961$	$1/\sqrt{2} = 0.70711$
$\log_{10} \pi^2 = 0.9943$	$1/\sqrt{3} = 0.57733$
$\log_{10} \sqrt{\pi} = 0.2486$	
Area of Circle = $(\pi/4) \times D^2 = 0.785398 D^2$	
Volume of Sphere = $(\pi/6) \times D^3 = 0.523599 D^3$	
1 Radian = $57^\circ 17' 44''.806$	
$= 57^\circ 17'.7468$	
$= 57^\circ .295780$	
1° = 0.0174533 Radian	

Valve Conversion Factors

It is sometimes necessary to determine the plate current, power output and other characteristics of a valve when the applied voltages are increased or decreased from the published typical operating conditions. The Conversion Factor Chart may be used for this purpose. The accuracy is reasonably high for small changes, but becomes less for larger voltage changes, and the chart is unsuitable for voltage changes exceeding 2.5 : 1.

Example: A pentode valve is rated as follows:—

Plate and screen voltage	250 volts
Control grid voltage	-15 volts
Plate current	30 mA.
Screen current	6 mA.
Mutual conductance	2000 μ mhos
Power output	2.5 watts

It is required to determine the optimum operating conditions for a plate voltage of 200 volts.

The Voltage Conversion Factor (F_v) = $200/250 = 0.8$

The new screen voltage will be $0.8 \times 250 = 200$ volts.

The new control grid voltage will be $-(0.8 \times 15) = -12$ volts.

Reference to the chart then gives the following:

Current Conversion Factor (F_i) 0.72

Mutual Conductance Conversion Factor (F_{gm}) 0.89

Power Output Conversion Factor (F_p) 0.57

The new plate current will be $0.72 \times 30 = 21.6$ mA.

The new screen current will be $0.72 \times 6 = 4.3$ mA.

The new mutual conductance will be $0.89 \times 2000 = 1780$ μ mhos.

The new power output will be $0.57 \times 2.5 = 1.42$ watts.

Note:— If only one voltage (e.g., plate or control grid voltage) is varied, the Conversion Factor Chart is unsuitable for the necessary calculations, which should then be made with μ , g_m and r_p .

Valve Conversion Factor Chart

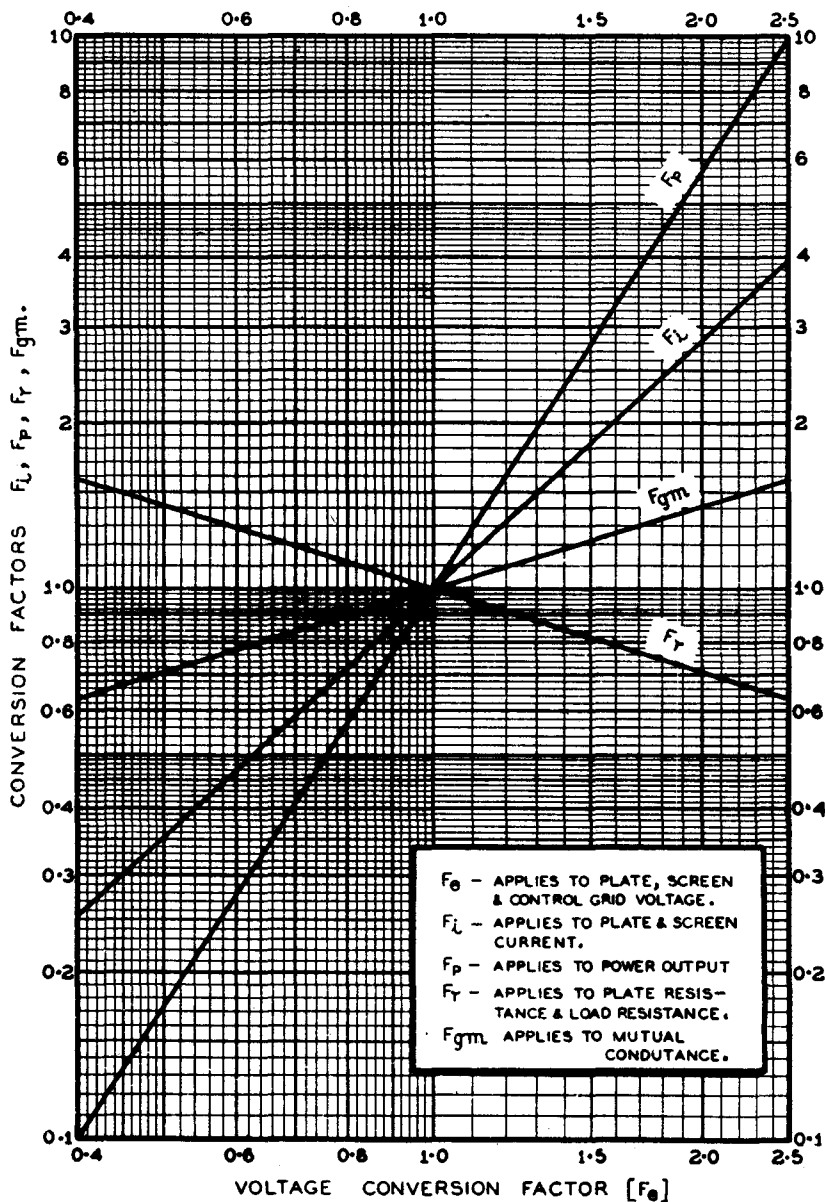

The Chart is based on the following relations:

$$F_{gm} = F_e^{1/2} = \sqrt{F_e}$$

$$F_i = F_e^{3/2} = \sqrt{F_e^3} = F_e \sqrt{F_e} = F_e F_{gm}$$

$$F_p = F_e^{5/2} = \sqrt{F_e^5} = F_e^2 \sqrt{F_e} = F_e F_i$$

Conversion of Temperature

Freezing Point of Water	= 32° Fahrenheit
(normal pressure)	= 0° Centigrade
	= 273.1° Kelvin (Absolute)
Bolling Point of Water	= 212° Fahrenheit
(normal pressure)	= 100° Centigrade
	= 373.1° Kelvin (Absolute)
1 Fahrenheit Degree	= 5/9 Centigrade degree
	= 0.5556 Centigrade degree
	= 0.5556 Kelvin degree
1 Centigrade Degree	= 1.800 Fahrenheit degree
	= 1.0 Kelvin degree
Temperature in °C	= 5/9(°F - 32)
Temperature in °F	= 1.8(°C) + 32
Temperature in °K	} = (°C) + 273.1
Absolute temperature	
Temperature in °C	= (°K) - 273.1
Absolute Zero	= 0°K
	= -273.1°C
	= -459.6°F

Dielectric Constants (K)

Values given cover a wide range of qualities of each material, but must only be taken as typical. There is a correction for temperature and frequency with each material.

Material.	K	Material.	K
Air (normal pressure) ..	1.00	Glass (crown)	6.2-7.0
Asphalt	2.7-3.1	Gutta Percha	2.5-4.9
Bakelite (moulded) .. .	4.5-7.5	Isolantite	6.1
Bakelite (paper base) ..	4.5-6.8	Marble	8.3-11.5
Beeswax	2.9-3.2	Mica	2.5-8.0
Cambric (varnished) ..	3.3-5.5	Mica (clear India) .. .	6.4
Castor oil	4.3-4.7	Paraffin wax (solid) ..	2.0-2.6
Celluloid	4.2-16	Paraffin waxed paper ..	3.5
Celluloid photo. film ..	6.7	Paper	2.0-2.6
Ebonite	1.9-3.5	Porcelain	5.7-6.8
Fibre (red)	4.8	Pyrex glass	4.5-4.9
Glass	5.1-9.9	Quartz	4.5-5.1
Glass photo. plate .. .	7.5	Rubber	2.0-3.5
Glass (window)	8.0	Shellac	2.9-3.7
Glass (flint)	7.0-9.9	Slate	6.6-7.4
Glass (plate-glass) .. .	6.8-7.6	Wood (dry)	2.0-7.7

Properties of Insulating Materials

For the detailed properties of the older materials reference should be made to the many excellent electrical handbooks. For a review of the more recent materials see

G. F. Bloomfield, "Insulating Materials for the Higher Frequencies," T. and R. Bulletin, May (1939), reprinted in Radio Technical Digest, September and October (1939); see also Industrial and Engineering Chemistry (Industrial Edition) March (1939) for further data on polystyrene; also "General Radio Experimenter," June, 1939.

WIRE TABLES

BARE COPPER WIRE, B. & S. (20° C. — 68° F.)

B. & S. No.	Diameter Mils.	Area Circular Mils.	Area Square Inches	Ohms per 1000 Feet	Ohms per Pound	Feet per Pound	Pounds per 1000 Feet
0000	460	211,600	.166.2	.04901	.00007652	1.561	640.5
000	410	167,400	.131.8	.06180	.0001217	1.968	507.9
00	364.8	133,100	.104.5	.07793	.0001935	2.482	402.8
0	324.9	105,500	.082.89	.09827	.0003076	3.130	319.5
1	289.3	83,700	.065.73	.1230	.0004891	3.947	253.3
2	257.6	66,400	.052.13	.1563	.0007778	4.977	200.9
3	229.4	52,600	.041.34	.1970	.001237	6.276	159.3
4	204.3	41,700	.032.78	.2485	.001966	7.914	126.4
5	181.9	33,100	.026.00	.3133	.003127	9.980	100.2
6	162.0	26,250	.020.62	.3951	.004972	12.58	79.46
7	144.3	20,820	.016.35	.4982	.007905	15.87	63.02
8	128.5	16,510	.01297	.6282	.01257	20.01	49.98
9	114.4	13,090	.010.28	.7921	.01990	25.23	39.63
10	101.9	10,380	.008.155	.9989	.03178	31.82	31.43
11	90.7	8,230	.006.467	1.260	.05053	40.12	24.02
12	80.8	6,530	.005.129	1.588	.08035	50.59	19.77
13	72.0	5,180	.004.067	2.003	.1278	63.80	15.68
14	64.1	4,110	.003.225	2.525	.2032	80.44	12.43
15	57.1	3,257	.002.558	3.184	.3230	101.4	9.858
16	50.8	2,583	.002.028	4.016	.5136	127.9	7.818
17	45.3	2,048	.001.609	5.064	.8167	161.3	6.200
18	40.3	1,624	.001.276	6.385	1.299	203.4	4.917
19	35.89	1,288	.001.012	8.051	2.065	256.5	3.899
20	31.96	1,022	.000.802,3	10.15	3.283	323.4	3.092
21	28.46	810	.000.636,3	12.80	5.221	407.8	2.452
22	25.35	642	.000.504,6	16.14	8.301	514.2	1.945
23	22.57	509	.000.400,2	20.36	13.20	648.4	1.542
24	20.10	404	.000.317,3	25.67	20.99	817.7	1.223
25	17.90	320.4	.000.251,7	32.37	33.37	1,031.0	0.9699
26	15.94	254.1	.000.199,6	40.81	53.06	1,300	0.7692
27	14.20	201.5	.000.158,3	51.47	84.37	1,639	0.6100
28	12.64	159.8	.000.125,5	64.90	134.2	2,067	0.4837
29	11.26	126.7	.000.099,53	81.83	213.3	2,607	0.3836
30	10.03	100.5	.000.078,94	103.2	339.2	3,287	0.3042
31	8.928	79.70	.000.062,60	130.1	539.3	4,145	0.2413
32	7.950	63.21	.000.049,64	164.1	857.6	5,227	0.1913
33	7.080	50.13	.000.039,37	206.9	1,364.0	6,591	0.1517
34	6.305	39.75	.000.031,22	260.9	2,168	8,310	0.1203
35	5.615	31.52	.000.024,76	329.0	3,448	10,480	0.09542
36	5.000	25.00	.000.019,04	414.8	5,482	13,210	.07568
37	4.453	19.83	.000.015,57	532.1	8,717	16,660	.06001
38	3.965	15.72	.000.012,35	659.6	13,860	21,010	.04759
39	3.531	12.47	.000.009,793	831.8	22,040	26,500	.03774
40	3.145	9.888	.000.007,766	1,049.0	35,040	33,410	.02993
(41)	2.75	7.5625	.000.005,940	1,370	59,990	43,700	.02289
(42)	2.50	6.2500	.000.004,909	1,660	87,700	52,800	.01892
(43)	2.25	5.0625	.000.003,976	2,050	133,700	65,300	.01532
(44)	2.00	4.0000	.000.003,142	2,600	214,000	82,600	.01211
(45)	1.75	3.0625	.000.002,405	3,390	356,200	107,900	.00927
(46)	1.50	2.2500	.000.001,767	4,610	676,800	146,800	.00681

BARE COPPER WIRE, S.W.G. (60° F.)

S.W.G. No.	Diameter Mils.	Area Circular Mils.	Area Square Inches	Ohms per 1000 Feet	Ohms per Pound	Feet per Pound	Pounds per 1000 Feet
4/0	400	160,000	.125,66	.06368	.00013146	2.064	484.4
3/0	372	138,400	.108,69	.0736	.00017574	2.390	418.9
2/0	348	121,100	.095,11	.0841	.0002295	2.730	366.7
1/0	324	105,000	.082,45	.0971	.0003054	3.147	317.8
1	300	90,000	.070,69	.1192	.0004155	3.670	272.5
2	276	76,180	.059,83	.1338	.0005800	4.338	230.6
3	252	63,500	.049,88	.1605	.0008345	5.200	192.3
4	232	53,820	.042,27	.1893	.0011617	6.139	162.9
5	212	44,940	.035,30	.2267	.0016661	7.348	136.1
6	192	36,860	.028,95	.2764	.002476	8.961	111.6
7	176	30,980	.024,33	.3289	.003507	10.66	93.8
8	160	25,600	.020,11	.3980	.005135	12.90	77.5
9	144	20,740	.016,286	.4914	.007827	15.93	62.78
10	128	16,380	.012,868	.6219	.012537	20.16	49.61
11	116	13,460	.010,568	.7570	.018587	24.55	40.74
12	104	10,820	.008,495	.942	.02877	30.54	32.75
13	92	8,464	.006,648	1.204	.04698	39.01	25.63
14	80	6,400	.005,027	1.592	.08216	51.60	19.38
15	72	5,184	.004,072	1.966	.12523	63.73	15.69
16	64	4,096	.003,217	2.488	.2006	80.65	12.40
17	56	3,136	.002,463	3.249	.3422	105.4	9.49
18	48	2,304	.001,809.6	4.422	.6340	143.3	6.98
19	40	1,600	.001,256.6	6.368	1.3146	206.4	4.844
20	36	1,296	.001,017.9	7.860	2.004	254.8	3.924
21	32	1,024	.000,804.2	9.950	3.209	322.6	3.100
22	28	784	.000,615.8	12.997	5.475	421.2	2.374
23	24	576	.000,452.4	17.69	10.144	573.4	1.744
24	22	484	.000,380.1	21.05	14.366	682.6	1.465
25	20	400	.000,314.2	25.47	21.03	825.8	1.211
26	18	324	.000,254.5	31.45	32.06	1,019	0.981
27	16.4	269	.000,211.2	37.88	46.52	1,229	0.814
28	14.8	219	.000,172.03	46.52	70.14	1,508	0.6632
29	13.6	185	.000,145.27	55.09	98.37	1,786	0.5600
30	12.4	153.8	.000,120.76	66.27	142.35	2,148	0.4655
31	11.6	134.6	.000,105.68	75.7	185.87	2,455	0.4074
32	10.8	116.6	.000,91.61	87.4	247.4	2,832	0.3581
33	10.0	100.0	.000,78.54	101.9	336.5	3,302	0.3028
34	9.2	84.64	.000,66.48	120.4	469.8	3,901	0.2563
35	8.4	70.56	.000,55.42	144.4	676.0	4,682	0.2136
36	7.6	57.76	.000,45.36	176.4	1,008.7	5,718	0.1749
37	6.8	46.24	.000,36.32	220.4	1,574	7,143	0.1400
38	6.0	36.00	.000,28.27	283.0	2,596	9,174	0.1090
39	5.2	27.04	.000,21.24	376.8	4,603	12,210	0.0819
40	4.8	23.04	.000,18.096	442.2	6,340	14,330	0.0698
41	4.4	19.36	.000,15.205	526.3	8,979	17,060	0.05862
42	4.0	16.00	.000,12.566	636.8	13,146	20,640	.04844
43	3.6	12.96	.000,10.179	786.3	20,040	25,480	.03924
44	3.2	9.734	.000,08.042	996.0	32,090	32,260	.03100
45	2.8	7.840	.000,06.158	1,299.7	54,750	42,120	.02374
46	2.4	5.760	.000,04.524	1,769	101,440	57,340	.01744
47	2.0	4.000	.000,03.142	2,547	210,300	82,580	.01211
48	1.6	2.560	.000,02.011	3,980	513,500	129,000	.00775
49	1.2	1.440	.000,01.131	7,077	1,623,000	229,400	.00436
50	1.0	1.000	.000,00.785,4	10,190	3,385,000	303,000	.00303

TURNS PER INCH AND INSULATED WIRE DIAMETER, B. & S.

Copper Wire.

B. & S. No.	Diameter (mils)		Turns per inch (exact winding)					
	*Enam.	D.C.C.	Bare	Enam.	S.C.C.	D.C.C.	S.C.C.	D.S.C.
8	130.6	142.5	7.78	7.65	7.32	7.01	—	—
9	116.5	126.4	8.74	8.58	8.23	7.91	—	—
10	104.0	112.9	9.81	9.61	9.26	8.85	—	—
11	92.7	100.2	11.02	10.7	10.4	9.98	—	—
12	82.8	90.3	12.37	12.0	11.6	11.07	—	—
13	74.0	81.5	13.89	13.5	12.9	12.27	—	—
14	66.1	73.6	15.60	15.1	14.4	13.59	—	—
15	59.1	66.6	17.52	16.9	16.1	15.0	—	—
16	52.8	60.3	19.68	18.9	17.9	16.5	18.9	18.2
17	47.1	54.8	22.1	21.2	19.8	18.2	21.1	20.2
18	42.1	49.8	24.8	23.7	22.0	20.0	23.6	22.5
19	37.7	45.4	27.8	26.5	24.4	22.0	26.3	25.0
20	33.8	41.5	31.3	29.5	27.0	24.1	29.4	27.7
21	30.2	38.0	35.1	33.1	29.8	26.3	32.7	30.7
22	27.0	33.8	39.4	37.0	33.5	29.5	36.6	34.1
23	24.1	31.1	44.3	41.4	36.9	32.1	40.6	37.5
24	21.5	28.6	49.7	46.5	40.6	34.9	45.2	41.4
25	19.2	26.4	55.8	52.0	44.6	37.8	50.0	45.6
26	17.1	24.4	62.7	58.4	49.0	40.9	55.8	50.0
27	15.3	22.7	70.4	65.3	53.4	44.0	61.7	54.9
28	13.6	21.1	82.8	73.5	58.4	47.3	68.4	60.2
29	12.2	19.8	88.8	81.9	63.2	50.5	75.1	65.3
30	10.8	18.5	99.7	92.5	68.9	54.0	83.3	71.4
31	9.7	17.4	112.0	103	74.6	57.4	91.7	77.5
32	8.7	16.5	125.8	114	80.0	60.6	100	83.3
33	7.7	15.6	141.2	129	86.2	64.1	109	90.0
34	6.9	14.8	158.6	144	92.5	67.5	120	97.0
35	6.2	14.1	178	161	99.9	70.9	131	104
36	5.5	13.0	200	181	111	76.9	142	111
37	4.9	12.5	224	204	117	80.0	153	117
38	4.4	12.0	252	227	125	83.3	166	125
39	3.9	11.5	283	256	133	86.9	181	133
40	3.5	11.1	318	285	140	90.0	196	140
(41)	3.05	—	363	327	—	—	—	—
(42)	2.64	—	400	378	—	—	—	—
(43)	2.37	—	444	421	—	—	—	—
(44)	2.12	—	500	471	—	—	—	—
(45)	1.91	—	571	523	—	—	—	—
(46)	1.72	—	666	581	—	—	—	—

*Nominal Value. Actual dimensions vary slightly.

TURNS PER INCH AND INSULATED WIRE DIAMETER, S.W.G.

Copper Wire.

S.W.G. No.	Diameter (mils)		Turns per inch (exact winding)					
	*Enam.	D.C.C.	Bare	Enam.	S.C.C.	D.C.C.	S.S.C.	D.S.C.
10	132	142	7.81	7.63	7.35	7.04	—	—
11	120	130	8.62	8.33	8.07	7.69	—	—
12	108	118	9.62	9.26	8.93	8.48	—	—
13	96	106	10.87	10.42	10.00	9.43	—	—
14	84	94	12.50	11.90	11.36	10.64	—	—
15	75.5	84	13.89	13.25	12.66	11.90	—	—
16	67.5	76	15.63	14.81	14.08	13.16	14.93	14.71
17	59	68	17.86	16.95	15.87	14.71	16.95	16.67
18	50.7	59	20.83	19.72	18.18	16.95	20.00	19.61
19	42.6	51	25.00	23.47	21.28	19.61	23.81	23.26
20	38.5	47	27.78	25.97	23.81	21.28	26.32	25.64
21	34.3	43	31.25	29.15	26.32	23.26	29.41	28.57
22	30.0	39	35.71	33.33	29.41	25.64	33.33	32.26
23	25.7	34	41.67	38.91	34.48	29.41	38.46	37.04
24	23.6	32	45.45	42.37	37.04	31.25	42.55	40.00
25	21.5	30	50.00	46.51	40.00	33.33	46.51	43.48
26	19.4	28	55.56	51.55	43.48	35.71	51.81	48.78
27	17.7	26.4	60.98	56.50	46.73	37.88	56.50	52.91
28	16.0	24.8	67.57	62.50	50.51	40.32	62.11	57.80
29	14.8	23.6	73.53	67.57	53.76	42.37	67.11	62.11
30	13.4	22.4	80.65	74.63	57.47	44.64	72.99	67.11
31	12.6	21.6	86.21	79.37	60.24	46.30	77.52	70.92
32	11.7	20.8	92.59	85.47	63.29	48.08	82.64	75.19
33	10.9	20.0	100.00	91.74	66.67	50.00	88.50	80.00
34	10.0	19.2	108.7	100.0	70.42	52.08	95.24	85.47
35	9.1	17.4	119.0	109.9	80.65	57.47	103.1	91.74
36	8.3	16.6	131.6	120.5	86.21	60.24	112.4	99.01
37	7.4	15.8	147.1	135.1	99.21	63.29	123.5	107.5
38	6.6	15.0	166.7	151.5	100.0	66.67	137.0	117.6
39	5.7	14.2	192.3	175.4	108.7	70.42	153.8	129.9
40	5.3	13.8	208.3	188.7	113.6	72.46	163.9	137.0
41	4.8	—	227.3	208.3	—	—	178.6	151.5
42	4.4	—	250.0	227.3	—	—	192.3	161.3
43	3.9	—	277.8	256.4	—	—	208.3	172.4
44	3.5	—	312.5	285.7	—	—	227.3	185.2
45	3.1	—	357.1	322.6	—	—	250.0	200.0
46	2.65	—	*416.7	377.4	—	—	277.8	217.4
47	2.25	—	500.0	444.4	—	—	312.5	238.1
48	—	—	—	—	—	—	—	—

*Nominal Value. Actual dimensions vary slightly.

MULTI-LAYER COIL WINDING AND WEIGHT OF INSULATED WIRE, B. & S.

Copper Wire.

B. & S. No.	Enamelled			D.C.C.		Weight—lbs. per 1000 ft.		
	Turns per Square Inch	Ohms per Cubic Inch	Turns per Square Inch Layer Insulated	Turns per Square Inch	Ohms per Cubic Inch	Enam.	D.C.C.	D.S.C.
8	57	.00315	Paper insulated each layer. 20% allowance for waste space at ends of layers.	48	.00263	50.55	51.15	
9	72	.00475		59	.00388	40.15	40.60	
10	90	.00748		76	.00631	31.80	32.18	
11	113	.01183		93	.00974	25.25	25.60	
12	141	.01878		114	.01519	20.05	20.40	
13	177	.0295		140	.0233	15.90	16.20	
14	221	.0464		171	.0359	12.60	12.91	
15	277	.0734		208	.0551	10.00	10.33	
16	348	.1162		260	.0869	7.930	8.210	7.955
17	437	.1840		316	.1331	6.275	6.540	6.315
18	548	.2910	378	.2008	4.980	5.235	5.015	
19	681	.4500	455	.3048	3.955	4.220	3.990	
20	852	.7200	545	.4605	3.135	3.373	3.173	
21	1,065	1.134	4 mil. paper	650	.6920	2.490	2.685	2.520
22	1,340	1.800		865	1.162	1.970	2.168	2.006
23	1,665	2.820		1,030	1.774	1.565	1.727	1.593
24	2,100	4.488		1,420	2.596	1.245	1.398	1.272
25	2,630	7.080		1,750	3.822	.988	1.129	1.018
26	3,320	11.27		2,030	5.740	.7845	.9140	.8100
27	4,145	17.75		2,620	8.330	.6220	.7560	.6450
28	5,250	28.34		3,250	12.15	.4940	.6075	.5140
29	6,510	44.32		3,920	17.30	.3915	.4890	.4130
30	8,175	70.15		4,780	25.15	.3105	.3955	.3330
31	10,200	110.4	3 mil. paper	3,330	36.05	.2465	.3257	.2678
32	12,650	172.6		3,720	50.76	.1960	.2700	.2170
33	16,200	279.0		4,140	71.30	.1550	.2270	.1750
34	19,950	433.2		4,595	99.77	.1230	.1928	.1412
35	25,000	684.5		5,070	138.7	.0980	.1600	.1130
36	31,700	1,094	2 mil. paper	5,550	191.6	.0776	.1361	.0920
37	39,600	1,723		6,045	263	.0616	.1204	.0740
38	49,100	2,693		6,510	357	.0488	.1049	.0623
39	62,600	4,332		6,935	480	.0387	.0937	.0504
40	77,800	6,770		7,450	650	.0307	.0838	.0429
				48,400				

**MULTI-LAYER COIL WINDING AND WEIGHT OF
INSULATED WIRE, S.W.G.
Copper Wire.**

SWG No.	Enamelled.			D.C.C.		Weight—lbs. per 1000ft		
	Turns per Square Inch	Ohms per Cubic Inch	Turns per Square Inch Layer Insulated	Turns per Square Inch	Ohms per Cubic Inch	Enam.	D.C.C.	D.S.C.
10	58.22	.00295	Paper insulated each layer. 20% allowance for waste space at ends of layers.	49.56	.00256	47.77	50.77	
11	69.39	.00437		59.14	.00373	44.40	41.83	
12	85.75	.00673		71.91	.00565	33.04	33.71	
13	108.6	.0109		88.92	.00893	25.89	26.50	
14	141.6	.0189		113.2	.0150	19.60	20.12	
15	175.6	.0287		141.6	.0234	15.87	16.36	
16	219.3	.0456		173.2	.0358	12.56	12.67	12.56
17	287.3	.0776		216.4	.0585	9.607	10.03	9.640
18	388.9	.1431		287.3	.1055	7.060	7.43	7.093
19	550.8	.290		384.6	.204	4.910	5.262	4.945
20	674.4	.440		452.8	.296	3.987	4.267	4.011
21	849.7	.705		541.0	.448	3.152	3.409	3.181
22	1,109	1.200		657.4	.710	2.419	2.649	2.446
23	1,513	2.23		864.9	1.26	1.779	1.918	1.807
24	1,789	3.14		1,220	1.71	1.498	1.667	1.305
25	2,162	4.58		1,460	2.35	1.241	1.392	1.247
26	2,663	6.95		1,760	3.33	1.008	1.152	1.013
27	3,192	10.05		2,080	4.51	.836	.977	.844
28	3,906	15.18		2,500	6.28	.683	.811	.689
29	4,570	20.9		2,870	8.23	.578	.699	.582
30	5,565	30.7	3,430	10.98	.478	.604	.486	
31	6,304	39.8	3,840	13.45	.419	.524	.428	
32	7,310	53.1	4,360	16.83	.364	.467	.371	
33	8,409	71.2	5,680	21.15	.313	.412	.329	
34	10,000	100.5	6,670	27.3	.264	.328	.271	
35	12,080	145	7,920	39.3	.221	.317	.228	
36	14,520	212	9,360	53.1	.181	.238	.188	
37	18,220	336	11,400	73.5	.146	.207	.151	
38	22,950	544	14,100	104.5	.114	.169	.119	
39	30,770	965	20,900	155.0	.0854	.138	.0868	
40	35,610	1,310	24,000	193.5	.0726	.123	.0791	
41	43,390	1,905	28,800		.0608		.0677	
42	51,620	2,740	33,700		.0505		.0571	
43	65,740	4,300	41,800		.0408		.0473	
44	81,620	6,760	50,800		.0324		.0386	
45	104,300	11,250			.0249		.0309	
46	142,100	21,000			.0182		.0231	
47	197,100	41,700			.0126		.0172	
48								

**RESISTANCE WIRE TABLE, B. & S.
20° C. (68° F.).**

B. & S. No.	Dia. mils.	Advance Wire				Nichrome Wire**		
		Ohms per 1,000 feet	Lbs. per 1,000 feet	Feet per Ohm	Current Milli Amps *	Ohms per 1,000 feet	Lbs. per 1,000 feet	Current Milli Amps :
8	128	17.9	50	55.9	—	40.8	45	—
9	114	22.6	39	44.2	—	51.9	36	—
10	102	28.0	32	35.7	—	64.9	29	—
11	91	35.5	25	28.2	—	81.5	23	—
12	81	44.8	20	22.3	—	102	18	—
13	72	56.7	15.7	17.6	—	130	14	—
14	64	71.7	12.4	13.9	—	164	11	—
15	57	90.4	9.8	11.1	—	207	9.2	—
16	51	113	7.8	8.85	—	259	7.2	—
17	45	145	6.2	6.90	—	333	5.6	—
18	40	181	4.9	5.44	800	421	4.42	—
19	36	226	3.9	4.43	650	520	3.58	—
20	32	287	3.1	3.48	522	659	2.83	—
21	28.5	362	2.5	2.76	420	831	2.24	—
22	25.3	460	1.9	2.17	335	1,055	1.77	—
23	22.6	575	1.5	1.74	273	1,321	1.41	—
24	20.1	728	1.2	1.37	220	1,670	1.12	460
25	17.9	919	.97	1.09	178	2,106	.89	390
26	15.9	1,162	.77	.861	144	2,669	.70	330
27	14.2	1,455	.61	.687	117	3,347	.56	278
28	12.6	1,850	.48	.541	95	4,251	.44	228
29	11.3	2,300	.38	.435	78	5,286	.35	196
30	10.0	2,940	.30	.340	63	6,750	.276	165
31	8.9	3,680	.24	.272	52	8,521	.199	158
32	8.0	4,600	.19	.217	43	10,546	.177	117
33	7.1	5,830	.15	.172	36	13,390	.139	97
34	6.3	7,400	.12	.135	29	17,006	.110	82
35	5.6	9,360	.095	.107	24	21,524	.087	69
36	5.0	11,760	.076	.085	20	27,000	.069	58
37	4.5	14,550	.060	.0687	17	33,333	.056	49
38	4.0	18,375	.047	.0544	14.5	42,187	.045	41
39	3.5	24,100	.038	.0415	12	55,102	.034	34
40	3.1	30,593	.028	.0327	10	70,239	.025	28
(41)	2.75	38,888	.0220	.0257	8.5	89,256	.0209	24
(42)	2.5	46,400	.0189	.0215	7.5	108,000	.0173	20.5
(43)	2.25	58,103	.0153	.0172	6.8	133,333	.0140	17.5
(44)	2.0	73,500	.0121	.0136	6.0	168,750	.0110	14.5
(45)	1.75	96,078	.0092	.0104	5.0	220,408	.0084	12.0
(46)	1.5	130,666	.0068	.0076	4.0	300,000	.0062	9.5

**Wire produced by some manufacturers differs considerably from the resistance values given.

*D.S.C. wound on spool.

†Bare wire on slab—well ventilated. Spacing between turns equal to wire diameter.

N.B.—To find current for Advance wire wound on slab, multiply Nichrome Current column by approx. 1.5.

RESISTANCE WIRE TABLE, S.W.G.

S.W.G. No.	Dia. mils.	Eureka Wire				Nichrome Wire**		
		Ohms per 1,000 feet	Lbs. per 1,000 feet	Feet per Ohm	Current Milli Amps *	Ohms per 1,000 feet	Lbs. per 1,000 feet	Current Milli Amps †
10	128	17.4	49.7	57.5	—	40.8	45	—
11	116	21.2	40.9	47.2	—	50.2	37.3	—
12	104	26.4	32.9	37.9	—	62.4	29.5	—
13	92	33.8	25.7	29.6	—	79.7	23.4	—
14	80	44.6	19.5	22.4	—	105.4	17.7	—
15	72	55.1	15.8	18.15	—	130	14.0	—
16	64	69.8	12.5	14.33	—	164	11.3	—
17	56	91.1	9.5	10.98	—	215	8.7	—
18	48	123.9	7.0	8.07	—	292	6.4	—
19	40	178.5	4.9	5.60	—	421	4.42	—
20	36	220.4	3.9	4.53	650	520	3.58	—
21	32	279.1	3.12	3.58	510	659	2.83	—
22	28	364	2.38	2.75	390	861	2.17	—
23	24	496	1.75	2.02	300	1,170	1.60	—
24	22	590	1.47	1.70	250	1,390	1.33	—
25	20	714	1.21	1.40	210	1,680	1.12	—
26	18	882	0.99	1.134	170	2,080	.897	400
27	16.4	1,062	.82	.942	140	2,510	.746	350
28	14.8	1,305	.67	.766	117	3,080	.607	300
29	13.6	1,545	.56	.647	101	3,650	.513	250
30	12.4	1,858	.47	.538	85	4,390	.427	230
31	11.6	2,123	.41	.471	75	5,010	.373	205
32	10.8	2,450	.35	.408	66	5,780	.324	185
33	10.0	2,857	.304	.350	57	6,750	.276	165
34	9.2	3,376	.257	.296	49	7,970	.235	145
35	8.4	4,049	.215	.247	41	9,560	.195	125
36	7.6	4,947	.175	.202	35	11,690	.160	110
37	6.8	6,179	.140	.1618	29	14,600	.128	91
38	6.0	7,936	.109	.1260	23	18,700	.100	76
39	5.2	10,565	.082	.0947	19	24,900	.075	62
40	4.8	12,395	.070	.0807	16	29,200	.064	55
41	4.4	14,756	.059	.0677	13	34,800	.0536	48
42	4.0	17,855	.049	.0560	11	42,180	.0450	41
43	3.6	22,045	.039	.0454	9.5	52,000	.0358	35
44	3.2	27,888	.031	.0359	8.0	65,900	.0283	30
45	2.8	36,216	.024	.0276	6.5	86,100	.0217	25
46	2.4	49,588	.018	.0202	5.0	117,000	.0160	20
47	2.0	71,428	.012	.0140	4.0	168,000	.0112	15
48	1.6	111,333	.008	.0090	3.0	263,600	.0071	—

**Wire produced by some manufacturers differs considerably from the resistance values given.

*D.S.C. wound on spool.

†Bare wire on slab—well ventilated. Spacing between turns equal to wire diameter.

N.B.—To find current for Eureka wire wound on slab, multiply Nichrome Current column by approx. 1.5.

Wavelength-Frequency Conversion Chart

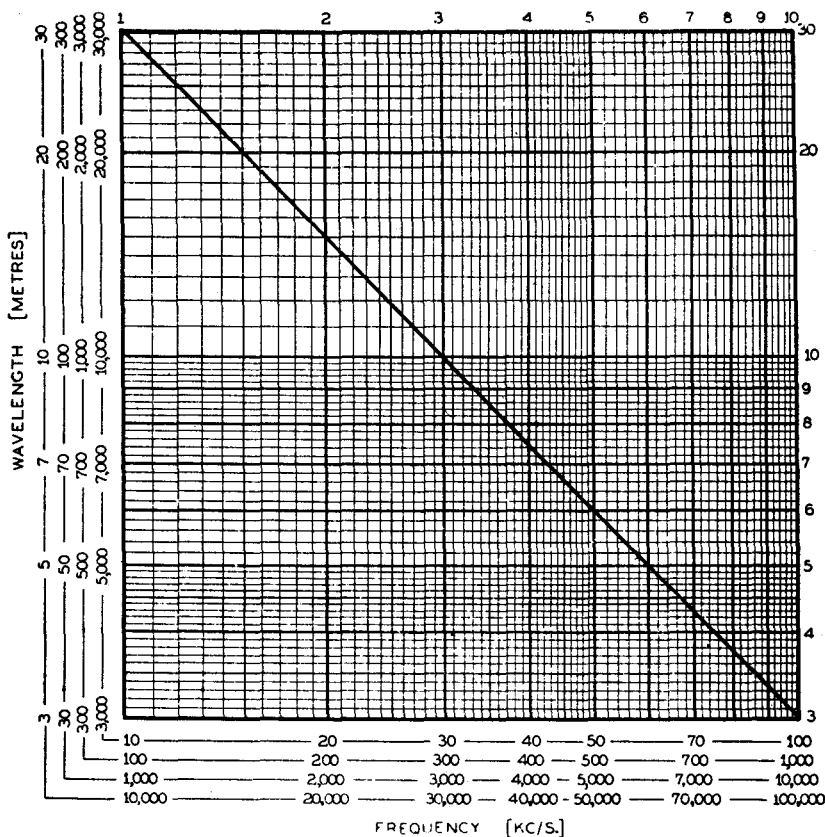

Wavelength-Frequency Conversion Table
 Convenient Points Selected for Rapid Reference.

Broadcast Band				Short Waves			
Fre- quency Kc/s.	Wave- length Metres	Fre- quency Kc/s.	Wave- length Metres	Fre- quency Mc/s.	Wave- length Metres	Fre- quency Mc/s.	Wave- length Metres
550	545	1050	286	1.5	200	11	27.3
600	500	1100	273	2	150	12	25.0
650	461	1150	261	3	100	13	23.1
700	429	1200	250	4	75.0	14	21.4
750	400	1250	240	5	60.0	15	20.0
800	375	1300	231	6	50.0	16	18.8
850	353	1350	222	7	42.9	17	17.6
900	333	1400	214	8	37.5	18	16.7
950	316	1450	207	9	33.3	19	15.8
1000	300	1500	200	10	30.0	20	15.0

Greek Symbols

Name.	Large.	Small.	English Equivalent.
alpha	Α	α	a
beta	Β	β	b
gamma	Γ	γ	g
delta	Δ	δ	d
epsilon	Ε	ε	e (short e as in "met")
zeta	Ζ	ζ	z
eta	Η	η	e (long e as in "meet")
theta	Θ	θ	th
iota	Ι	ι	i
kappa	Κ	κ	k
lambda	Λ	λ	l
mu	Μ	μ	m
nu	Ν	ν	n
xi	Ξ	ξ	x
omicron	Ο	ο	o (as in "olive")
pi	Π	π	p
rho	Ρ	ρ	r
sigma	Σ	σ	s
tau	Τ	τ	t
upsilon	Υ	υ	u
phi	Φ	φ	ph
chi	Χ	χ	ch (as in "school")
psi	Ψ	ψ	ps
omega	Ω	ω	o (as in "hole")

LOGARITHMS

										Differences.									
	0	1	2	3	4	5	6	7	8	9	1	2	3	4	5	6	7	8	9
10	0000	0043	0086	0128	0170	0212	0253	0294	0334	0374	4	8	12	17	21	25	29	33	37
11	0414	0453	0492	0531	0569	0607	0645	0682	0719	0755	4	8	11	15	19	23	26	30	34
12	0792	0828	0864	0899	0934	0969	1004	1038	1072	1106	3	7	10	14	17	21	24	28	31
13	1139	1173	1206	1239	1271	1303	1335	1367	1399	1430	3	6	10	13	16	19	23	26	29
14	1461	1492	1523	1553	1584	1614	1644	1673	1703	1732	3	6	9	12	15	18	21	24	27
15	1761	1790	1818	1847	1875	1903	1931	1959	1987	2014	3	6	8	11	14	17	20	22	25
16	2041	2068	2095	2122	2148	2175	2201	2227	2253	2279	3	5	8	11	13	16	18	21	24
17	2304	2330	2355	2380	2405	2430	2455	2480	2504	2529	2	5	7	10	12	15	17	20	22
18	2553	2577	2601	2625	2648	2672	2695	2718	2742	2765	2	5	7	9	12	14	16	19	21
19	2788	2810	2833	2856	2878	2900	2923	2945	2967	2989	2	4	7	9	11	13	16	18	20
20	3010	3032	3054	3075	3096	3118	3139	3160	3181	3201	2	4	6	8	11	13	15	17	19
21	3222	3243	3263	3284	3304	3324	3345	3365	3385	3404	2	4	6	8	10	12	14	16	18
22	3424	3444	3464	3483	3502	3522	3541	3560	3579	3598	2	4	6	8	10	12	14	15	17
23	3617	3636	3655	3674	3692	3711	3729	3747	3766	3784	2	4	6	7	9	11	13	15	17
24	3802	3820	3838	3856	3874	3892	3909	3927	3945	3962	2	4	5	7	9	11	12	14	16
25	3979	3997	4014	4031	4048	4065	4082	4099	4116	4133	2	3	5	7	9	10	12	14	15
26	4150	4166	4183	4200	4216	4232	4249	4265	4281	4298	2	3	5	7	8	10	11	13	15
27	4314	4330	4346	4362	4378	4393	4409	4425	4440	4456	2	3	5	6	8	9	11	13	14
28	4472	4487	4502	4518	4533	4548	4564	4579	4594	4609	2	3	5	6	8	9	11	12	14
29	4624	4639	4654	4669	4683	4698	4713	4728	4742	4757	1	3	4	6	7	9	10	12	13
30	4771	4786	4800	4814	4829	4843	4857	4871	4886	4900	1	3	4	6	7	9	10	11	13
31	4914	4928	4942	4955	4969	4983	4997	5011	5024	5038	1	3	4	6	7	8	10	11	12
32	5051	5065	5079	5092	5105	5119	5132	5145	5159	5172	1	3	4	5	7	8	9	11	12
33	5185	5198	5211	5224	5237	5250	5263	5276	5289	5302	1	3	4	5	6	8	9	10	12
34	5315	5328	5340	5353	5366	5378	5391	5403	5416	5428	1	3	4	5	6	8	9	10	11
35	5441	5453	5465	5478	5490	5502	5514	5527	5539	5551	1	2	4	5	6	7	9	10	11
36	5563	5575	5587	5599	5611	5623	5635	5647	5658	5670	1	2	4	5	6	7	8	10	11
37	5682	5694	5705	5717	5729	5740	5752	5763	5775	5786	1	2	3	5	6	7	8	9	10
38	5798	5809	5821	5832	5843	5855	5866	5877	5888	5899	1	2	3	5	6	7	8	9	10
39	5911	5922	5933	5944	5955	5966	5977	5988	5999	6010	1	2	3	4	5	7	8	9	10
40	6021	6031	6042	6053	6064	6075	6085	6096	6107	6117	1	2	3	4	5	6	8	9	10
41	6128	6138	6149	6160	6170	6180	6191	6201	6212	6222	1	2	3	4	5	6	7	8	9
42	6232	6243	6253	6263	6274	6284	6294	6304	6314	6325	1	2	3	4	5	6	7	8	9
43	6335	6345	6355	6365	6375	6385	6395	6405	6415	6425	1	2	3	4	5	6	7	8	9
44	6435	6444	6454	6464	6474	6484	6493	6503	6513	6522	1	2	3	4	5	6	7	8	9
45	6532	6542	6551	6561	6571	6580	6590	6599	6609	6618	1	2	3	4	5	6	7	8	9
46	6628	6637	6646	6656	6665	6675	6684	6693	6702	6712	1	2	3	4	5	6	7	7	8
47	6721	6730	6739	6749	6758	6767	6776	6785	6794	6803	1	2	3	4	5	5	6	7	8
48	6812	6821	6830	6839	6848	6857	6866	6875	6884	6893	1	2	3	4	4	5	6	7	8
49	6902	6911	6920	6928	6937	6946	6955	6964	6972	6981	1	2	3	4	4	5	6	7	8
50	6990	6998	7007	7016	7024	7033	7042	7050	7059	7067	1	2	3	3	4	5	6	7	8
51	7076	7084	7093	7101	7110	7118	7126	7135	7143	7152	1	2	3	3	4	5	6	7	8
52	7160	7168	7177	7185	7193	7202	7210	7218	7226	7235	1	2	2	3	4	5	6	7	7
53	7243	7251	7259	7267	7275	7284	7292	7300	7308	7316	1	2	2	3	4	5	6	6	7
54	7324	7332	7340	7348	7356	7364	7372	7380	7388	7396	1	2	2	3	4	5	6	6	7
	0	1	2	3	4	5	6	7	8	9	1	2	3	4	5	6	7	8	9

LOGARITHMS

										Differences.									
	0	1	2	3	4	5	6	7	8	9	1	2	3	4	5	6	7	8	9
55	7404	7412	7419	7427	7435	7443	7451	7459	7466	7474	1	2	2	3	4	5	5	6	7
56	7482	7490	7497	7505	7513	7520	7528	7536	7543	7551	1	2	2	3	4	5	5	6	7
57	7559	7566	7574	7582	7589	7597	7604	7612	7619	7627	1	2	2	3	4	5	5	6	7
58	7634	7642	7649	7657	7664	7672	7679	7686	7694	7701	1	1	2	3	4	4	5	6	7
59	7709	7716	7723	7731	7738	7745	7752	7760	7767	7774	1	1	2	3	4	4	5	6	7
60	7782	7789	7796	7803	7810	7818	7825	7832	7839	7846	1	1	2	3	4	4	5	6	6
61	7853	7860	7868	7875	7882	7889	7896	7903	7910	7917	1	1	2	3	4	4	5	6	6
62	7924	7931	7938	7945	7952	7959	7966	7973	7980	7987	1	1	2	3	3	4	5	6	6
63	7993	8000	8007	8014	8021	8028	8035	8041	8048	8055	1	1	2	3	3	4	5	5	6
64	8062	8069	8075	8082	8089	8096	8102	8109	8116	8122	1	1	2	3	3	4	5	5	6
65	8129	8136	8142	8149	8156	8162	8169	8176	8182	8189	1	1	2	3	3	4	5	5	6
66	8195	8202	8209	8215	8222	8228	8235	8241	8248	8254	1	1	2	3	3	4	5	5	6
67	8261	8267	8274	8280	8287	8293	8299	8306	8312	8319	1	1	2	3	3	4	5	5	6
68	8325	8331	8338	8344	8351	8357	8363	8370	8376	8382	1	1	2	3	3	4	4	5	6
69	8388	8395	8401	8407	8414	8420	8426	8432	8439	8445	1	1	2	2	3	3	4	4	5
70	8451	8457	8463	8470	8476	8482	8488	8494	8500	8506	1	1	2	2	3	3	4	4	5
71	8513	8519	8525	8531	8537	8543	8549	8555	8561	8567	1	1	2	2	3	3	4	4	5
72	8573	8579	8585	8591	8597	8603	8609	8615	8621	8627	1	1	2	2	3	3	4	4	5
73	8633	8639	8645	8651	8657	8663	8669	8675	8681	8686	1	1	2	2	3	3	4	4	5
74	8692	8698	8704	8710	8716	8722	8727	8733	8739	8745	1	1	2	2	3	3	4	4	5
75	8751	8756	8762	8768	8774	8779	8785	8791	8797	8802	1	1	2	2	3	3	4	4	5
76	8808	8814	8820	8825	8831	8837	8842	8848	8854	8859	1	1	2	2	3	3	4	4	5
77	8865	8871	8876	8882	8887	8893	8899	8904	8910	8915	1	1	2	2	3	3	4	4	5
78	8921	8927	8932	8938	8943	8949	8954	8960	8965	8971	1	1	2	2	3	3	4	4	5
79	8976	8982	8987	8993	8998	9004	9009	9015	9020	9025	1	1	2	2	3	3	4	4	5
80	9031	9036	9042	9047	9053	9058	9063	9069	9074	9079	1	1	2	2	3	3	4	4	5
81	9085	9090	9096	9101	9106	9112	9117	9122	9128	9133	1	1	2	2	3	3	4	4	5
82	9138	9143	9149	9154	9159	9165	9170	9175	9180	9186	1	1	2	2	3	3	4	4	5
83	9191	9196	9201	9206	9212	9217	9222	9227	9232	9238	1	1	2	2	3	3	4	4	5
84	9243	9248	9253	9258	9263	9269	9274	9279	9284	9289	1	1	2	2	3	3	4	4	5
85	9294	9299	9304	9309	9315	9320	9325	9330	9335	9340	1	1	2	2	3	3	4	4	5
86	9345	9350	9355	9360	9365	9370	9375	9380	9385	9390	1	1	2	2	3	3	4	4	5
87	9395	9400	9405	9410	9415	9420	9425	9430	9435	9440	0	1	1	2	2	3	3	4	4
88	9445	9450	9455	9460	9465	9469	9474	9479	9484	9489	0	1	1	2	2	3	3	4	4
89	9494	9499	9504	9509	9513	9518	9523	9528	9533	9538	0	1	1	2	2	3	3	4	4
90	9542	9547	9552	9557	9562	9566	9571	9576	9581	9586	0	1	1	2	2	3	3	4	4
91	9590	9595	9600	9605	9609	9614	9619	9624	9628	9633	0	1	1	2	2	3	3	4	4
92	9638	9643	9647	9652	9657	9661	9666	9671	9675	9680	0	1	1	2	2	3	3	4	4
93	9685	9689	9694	9699	9703	9708	9713	9717	9722	9727	0	1	1	2	2	3	3	4	4
94	9731	9736	9741	9745	9750	9754	9759	9763	9768	9773	0	1	1	2	2	3	3	4	4
95	9777	9782	9786	9791	9795	9800	9805	9809	9814	9818	0	1	1	2	2	3	3	4	4
96	9823	9827	9832	9836	9841	9845	9850	9854	9859	9863	0	1	1	2	2	3	3	4	4
97	9868	9872	9877	9881	9886	9890	9894	9899	9903	9908	0	1	1	2	2	3	3	4	4
98	9912	9917	9921	9926	9930	9934	9939	9943	9948	9952	0	1	1	2	2	3	3	4	4
99	9956	9961	9965	9969	9974	9978	9983	9987	9991	9996	0	1	1	2	2	3	3	4	4
0	1	2	3	4	5	6	7	8	9	1	2	3	4	5	6	7	8	9	

TRIGONOMETRICAL RELATIONSHIPS

Angle	Radians	Sine	Cosine	Tangent	Angle	Radians	Sine	Cosine	Tangent
0°	0000	·0000	1·000	·0000	45°	·7854	·7071	·7071	1·0000
1	·0175	·0175	·9998	·0175	46	·8029	·7193	·6947	1·0355
2	·0349	·0349	·9994	·0349	47	·8203	·7314	·6820	1·0724
3	·0524	·0523	·9986	·0524	48	·8378	·7431	·6691	1·1106
4	·0698	·0698	·9976	·0699	49	·8552	·7547	·6561	1·1504
5	·0873	·0872	·9962	·0875	50	·8727	·7660	·6428	1·1918
6	·1047	·1045	·9945	·1051	51	·8901	·7771	·6293	1·2349
7	·1222	·1219	·9925	·1228	52	·9076	·7880	·6157	1·2799
8	·1396	·1392	·9903	·1405	53	·9250	·7986	·6018	1·3270
9	·1571	·1564	·9877	·1584	54	·9425	·8090	·5878	1·3764
10	·1745	·1736	·9848	·1763	55	·9599	·8192	·5736	1·4281
11	·1920	·1908	·9816	·1944	56	·9774	·8290	·5592	1·4826
12	·2094	·2079	·9781	·2126	57	·9948	·8387	·5446	1·5399
13	·2269	·2250	·9744	·2309	58	1·0123	·8480	·5299	1·6003
14	·2443	·2419	·9703	·2493	59	1·0297	·8572	·5150	1·6643
15	·2618	·2588	·9659	·2679	60	1·0472	·8660	·5000	1·7321
16	·2793	·2756	·9613	·2867	61	1·0647	·8746	·4848	1·8040
17	·2967	·2924	·9563	·3057	62	1·0821	·8829	·4695	1·8807
18	·3142	·3090	·9511	·3249	63	1·0996	·8910	·4540	1·9626
19	·3316	·3256	·9455	·3443	64	1·1170	·8988	·4384	2·0503
20	·3491	·3420	·9397	·3640	65	1·1345	·9063	·4226	2·1445
21	·3665	·3584	·9336	·3839	66	1·1519	·9135	·4067	2·2460
22	·3840	·3746	·9272	·4040	67	1·1694	·9205	·3907	2·3559
23	·4014	·3907	·9205	·4245	68	1·1868	·9272	·3746	2·4751
24	·4189	·4067	·9135	·4452	69	1·2043	·9336	·3584	2·6051
25	·4363	·4226	·9063	·4663	70	1·2217	·9397	·3420	2·7475
26	·4538	·4384	·8988	·4877	71	1·2392	·9455	·3256	2·9042
27	·4712	·4540	·8910	·5095	72	1·2566	·9511	·3090	3·0777
28	·4887	·4695	·8829	·5317	73	1·2741	·9563	·2924	3·2709
29	·5061	·4848	·8746	·5543	74	1·2915	·9613	·2756	3·4874
30	·5236	·5000	·8660	·5774	75	1·3090	·9659	·2588	3·7321
31	·5411	·5150	·8572	·6009	76	1·3265	·9703	·2419	4·0108
32	·5585	·5299	·8480	·6249	77	1·3439	·9744	·2250	4·3315
33	·5760	·5446	·8387	·6494	78	1·3614	·9781	·2079	4·7046
34	·5934	·5592	·8290	·6745	79	1·3788	·9816	·1908	5·1446
35	·6109	·5736	·8192	·7002	80	1·3963	·9848	·1736	5·6713
36	·6283	·5878	·8090	·7265	81	1·4137	·9877	·1564	6·3138
37	·6458	·6018	·7986	·7536	82	1·4312	·9903	·1392	7·1154
38	·6632	·6157	·7880	·7813	83	1·4486	·9925	·1219	8·1443
39	·6807	·6293	·7771	·8098	84	1·4661	·9945	·1045	9·5144
40	·6981	·6428	·7660	·8391	85	1·4835	·9962	·0872	11·43
41	·7156	·6561	·7547	·8693	86	1·5010	·9976	·0698	14·30
42	·7330	·6691	·7431	·9004	87	1·5184	·9986	·0523	19·08
43	·7505	·6820	·7314	·9325	88	1·5359	·9994	·0349	28·64
44	·7679	·6947	·7193	·9657	89	1·5533	·9998	·0175	57·29

INDEX

- Admittance** 301-302, 308
- Air Cells, resistors for use with** . 321
- Amplification Factor (Valve)**
 definition of 264
 graphical determination of 270-271
- Amplifiers, A.F. Power (Chap. 2)** 13-19
 cost considerations 16
 damping on loudspeaker 15
 harmonic distortion in 14-15
 overload characteristic of . . 15-16
 parasitic oscillation in 16
 power efficiency of 13
 power output, measurement
 of 22, 228, 237-238
 power sensitivity of 14
 relationship with
 loudspeaker 20-23
 see also "Amplifiers, Audio, Design," "Valves, Pentode, Power Amplifier," "Valves, Tetrode, Beam Power," "Valves, Triode, Power Amplifier"
- Amplifiers, A.F. Voltage**
 (Chapter 1) 1-12
 choke capacitance coupled . . 6
 pentode valves,
 using 5-6, 28, 279-280
 resistance coupled, 3-6, 8, 57, 277-280
 see also "Amplifiers, Audio, Design," "Phase Splitting Methods"
 transformer coupled . . 1-2, 6-7, 272
 triode valves, using, 1-5, 6-12, 277-9
 wide band amplifiers 8
- Amplifiers, Audio, Design**
 (Chapter 8) 49-57
 equivalent circuits 57
 frequency response calculations . . 4-5, 27-28, 53-56, 61-63
 push-pull beam tetrode output 52-53
 push-pull pentode output . . . 51
 push-pull triode output 51
 ratings for amplifiers . . 49, 84-88
 see also chapter 34 268-294
 single beam tetrode output, 51-52
 single pentode output 50
 single triode output 49-50
- Amplifiers, Audio,**
Push-pull 9-12, 287-291
 composite characteristics . . 287-9
 harmonic distortion in 289
 plate current, average, 289-290, 291
 see also "Amplifiers, Class B Power"; also Chapter 8 . . 49-57
- Amplifiers, Class B Power**
 design procedure 17-19
 graphical treatment 287-291
- Amplifiers, D.C.** 8-9
- Amplifiers, I.F. (Chapter 17),** 157-160
 formulae, relevant 137-139
 screen grid supply for 204
 see also "Tuned Circuits"
 selectivity considerations . . 157-8
 valve input capacitance, 47, 96-8, 267
- Amplifiers, R.F. (Chapter 14)** . . 90-98
 advantages of 90
 formulae, relevant 91-2, 136-7
 gain of 90-1, 136-7
 screen grid, supply for 203-4
 see also "Tuned Circuits"
 valve input capacitance, 47, 96-8, 267
 valve input loading 92-6
- Automatic Frequency Control**
 (Chapter 20) 180-2
 definition of 180
 electronic reactances for . . 181-2
 Foster-Seeley discriminator for, 181
 frequency drift, correction of . 182
 Round (Travis) circuit for . 180-1
- Automatic Volume Control**
 (Chapter 19) 168-179
 amplified A.V.C. 174
 application of 173-4
 audio A.V.C. 174
 battery valves, with 175
 bibliography 179
 characteristics, plotting 175-8, 236-7
 definition of 168
 delayed A.V.C. 169-171
 differential distortion 170
 modulation rise, causing . . . 174-5
 simple A.V.C. 168-9, 175
 time constant of . . 168, 171-3, 178-9
 typical circuits 172-3
 voltage, methods of feeding . 171-2
- Band-Pass Circuits**
 formulae, summary of 138
- Bass Attenuation**
 cathode bypass, due to, 27-8, 55, 64
 grid coupling condenser,
 due to 4, 54-5, 63
 lateral cut recordings, in 75
 screen bypass, due to . 26, 28, 56, 64
 see also Chapter 9 58-73
 transformer, due to 211-5
- Bass Boosting**
 gramophone pick-up, for 71
 see also Chapter 9 58-73
 shunt fed transformers, with . . 7
 volume level, effect on 69-70
- Beis** 84
- Bias (Chapter 4)** 24-5
 back-bias 24-5
 cathode bias 24, 25, 272, 274
 graphical determination
 of see Chapter 34
 grid leak bias 5, 276
 optimum bias (for R.C. triodes) 3

- self bias — see under "Bias, Cathode"
- Blue Glow** (in valves) 246
- Bunet's Inductance Formula** . . . 148
- Bypassing** (see Chapter 4) 25-8
- cathode circuit 11, 25-8, 55, 64
- screen circuit 26, 28, 56, 64
- tone control, used for — see under "Tone Control"
- Capacitance**
- and inductance, circuits with, 300-2
- and resistance, circuits
- with 297-302, 315
- calculation of parallel plate condenser 299
- capacitances in parallel 296
- capacitances in series 297
- capacitive reactance 297, 313, 314
- imperfect capacitance 298
- Ohm's law for 297
- see also "Vectors" (Chapter 36) 303
- units of 298, 308
- valve input capacitance, see under "Input Capacitance, Valve"
- Cathode**
- cathode bias see "Bias"
- cathode bypass 11, 25-28, 55, 64
- cathode loading 39, 45
- Cathode Ray Tubes** (reference) . . 263
- Chokes, Power, design of**
- (Hanna's method) 219-220
- see under "Inductances, Iron Core"
- swinging chokes 196-7
- Coils, design considerations**
- (Chapter 16, Part 3) 152-6
- inductance calculations
- (Chapter 16, Part 2) 140-151
- see also "Inductances, Air Core"
- Colour Codes (R.M.A.)**
- A.F. transformers 320
- condensers 310-313
- I.F. transformers 320
- loudspeakers 321
- power transformers 321
- resistors 310-313
- Combination Tones** 23, 33
- Complex Algebra** (Chapter 37) . . 304-5
- absolute value and modulus . . . 304
- operator "j" 304
- Condensers, colour code for** . . 310-3
- see also "Capacitance"
- Conductance** 301-2, 308
- valve input 92-6, 105, 265
- valve plate 265
- Contact Potential** 275
- Converters, Conversion**
- see "Frequency Converters," etc.
- Coupled Circuits**
- coupled impedance 91, 137-8
- formulae 91, 136-9
- miscellaneous forms of
- coupling 125-7
- mutual inductance 149-150
- see also Chapter 16 (Part 1) 121-130
- Coupling Factor** 121
- critical 122, 123, 125, 137, 138
- transitional 123
- use of 121-130, 133, 137-9
- Cross Modulation**
- audio amplifiers, in 23, 33
- R.F., testing for 233-4
- Current Regulators** (Chapter 27) 223
- Decibels** (Chapter 13) 84-7
- definition of 84-5
- tables and curves 323-6
- Decimal-Fraction Equivalents** . . 316
- Decoupling** (Chapter 4) 28-30
- Detection** (Chapter 18) 161-7
- diode detection — see under "Diode Detectors"
- grid detection 163-4
- plate detection 164-5
- power grid detection 164
- reflex detection 165
- Dielectric Constants** 330
- Diode Detectors, A.C. shunting,**
- compensating for 162
- A.C. shunting, effect
- of 161-3, 166-7, 292-3
- A.F.C., for see "Automatic Frequency Control"
- A.V.C., for see "Automatic Volume Control"
- input voltage, optimum 161-2
- mathematical consideration . . 166-7
- testing 249
- Distortion** (Chapter 5) 31-3
- detectors, in 161-7, 292-3
- differential distortion 162, 170
- frequency distortion 32
- harmonic distortion see "Harmonic Distortion"
- modulation rise distortion 173, 174-5
- overload distortion 15-16
- phase distortion 32
- receiver, in 237-9
- scale distortion 33
- selective harmonic
- distortion 14, 21, 69
- transient distortion 33
- Distortion Factor Meter** 237
- Dropping Resistors** (Chapter 25) 203-4
- for air-cell receivers 321
- for 1.4 v. receivers 321
- see also "Resistors"
- Dummy Antennae, Standard** . . 228-9
- Durchgriff** 265
- Dynamic Resistance** 119
- coupled impedance 91, 137, 138
- formulae, summary 135
- Emission, testing for** 241-3
- Ensi, definition of** 235
- abac for calculation 326-7
- Esnault-Pelterie's Formula** . . . 144

- Farad** 298, 308
Fidelity (Chapter 7) 31-33
 measurement of 237-8
 see also "Distortion," "Harmonic Distortion"
Filters — Power Supply
 (Chapter 23) 191-8
 choke input 192-3, 195-6
 condenser input 191-3, 194
 design, examples of 194-7
 hum, see under "Hum"
 peak currents in 192, 193-4
 resistance-capacitance 197-8
 second section 194-8
 swinging choke 196-7
Fluorescence (in valves) 246
Fraction — Decimal Equivalents 316
Frequencies, Musical 322
Frequency Conversion
 (Chapter 19) 99-114
 converter valves, see "Frequency Converters"
 general principles 99-100
 oscillator circuit design 110-4
 typical circuits 107-9
Frequency Converters 100-9
 application of 107-9
 A.V.C., use with 106, 173
 characteristics, general 102-3
 constructional features of 100-2
 frequency drift, tests for 235-6
 gain in receiver 231
 grid current, measurement of 232
 special features of 103-7
 testing 247-8
 voltage supplies for 203-4
Frequency Drift 182
 bibliography 182
Frequency Response
 calculations for 53-56
 resistance coupled amplifier, in
 3-4, 5, 27-28, 54-6, 63, 64
 see also "Distortion," "Fidelity,"
 "Tone Control"
 transformer coupled amplifier,
 in 211-5
Frequency/Wavelength Chart 340
Fuse Wire Table 320
Greek Symbols 341
Grid Coupling Condenser
 bass attenuation of 4, 54-5, 63
 recommended value of 4
Grid Current 243, 275-7
 contact potential 275
 gas current 243, 275
 grid emission 275
 load lines, grid 276
 positive grid drive 17-9, 276, 290-3
Hanna's Method (for design of chokes) 219-220
Harmonic Distortion 31, 32
 detectors, in 161-7
 diode detectors, in 161-3, 166-7, 170, 292-3
 measurement of 237-9
 negative feedback, effect of
 11, 14, 22-3, 35-7, 43-5
 power amplifiers, in 14-5, 281-5, 289
 see also under "Distortion"
 selective harmonic distortion 14, 21, 69
Hayman's Inductance Formula 145
Heater-Cathode Leakage
 hum due to 200-1
 testing for 246
Hum (Chapter 24) 199-202
 causes of hum 199
 electromagnetic fields, from 200
 filter hum 199-200
 heater-cathode leakage, due
 to 200-1
 hum-bucking coil 200
 induction hum 200
 measurement of 239
 mercury vapour rectifiers, from 200
 microphone amplifiers, in 79
 miscellaneous cures for 201
 modulation hum 201
 neutralising hum 200
 phase splitters, in 11
 see also Chapter 23 191-8
 vibrators, from 202
I.F. Amplifiers, see "Amplifiers, I.F."
Inductance
 and capacitance, circuits with 300-2
 and resistance, circuits with 300-2
 inductances in parallel 299
 " in series 299
 kinetic energy in 300
 Ohm's law for 299
 reactance-frequency chart 313
 " table 314
 reactance, inductive 299, 313, 314
 see also "Inductances, Air-core"
 " "Inductances, Iron-core"
 " "Vectors" (Chapter 36) 303
Inductances, Air-Core
 (Chapter 16) 115-156
 bibliography 150-1, 155-6
 calculation of inductance 140-151
 current sheet inductance 140, 145-8
 design of 152-6
 general treatment of, in
 tuned circuits 115-139
 multilayer circular 148-9
 mutual inductance,
 calculation of 149-150
 see also "Coupled Circuits"
 " "Tuned Circuits"
 single layer spiral,
 inductance of 149

- solenoids, screened,
 inductance of 148
 solenoids, unscreened,
 inductance of 140-8
Inductances, Iron Core (low
 frequency)—Chapter 26 . 205-220
 core loss, calculation of 216
 direct current, with 218-9
 " " without 217-8
 filter chokes 219-220
 general transformer
 considerations 205-11
 Hanna's method of design 219-220
 inductance, calculation of 217-220
 " " measurement of 216-7
 see also "Transformers Audio"
 " " "Transformers Iron Core"
 " " "Transformers Power"
Input Capacitance, Valve
 change in 46-8, 96-7
 detuning, causing . . 96-8, 159-160
 mixing systems, in 81
 see also "Miller Effect"
 static and dynamic 267
 space charge, due to 48
Input Conductance, Valve . 92-6, 265
 frequency converter valves, in 105
Input Resistance, Valve
 Miller effect, due to 47
 phase splitter 11, 40, 45
 see also "Input Conductance"
Insulating Materials, properties of 330
Interference, R.F.
 blocking interference 234
 cross modulation 233-4
 mercury vapour rectifiers,
 due to 199-200
 vibrators, from (ref.) 202
"J", Operator 304-5
Kirchhoff's Laws 295-6
Logarithmic Decrement . . . 177, 135
Logarithms, Tables of 342-3
Loudspeakers
 acoustic output of 23
 characteristics of 20
 colour code for 321
 output stage, relationship
 with 15, 20-3, 211
Magic Eye Tuning Indicators . 224-6
 circuit considerations . . 162, 225-6
 null point indicator, for 226
 overlapping of image 226
 supply voltage for 204, 226
 wide-range indication 226
Measuring Instruments (Chap. 32) 263,
 bibliography 263
 cathode ray oscillographs
 (reference) 263
 electrostatic voltmeters 263
 hot wire instruments 263
 moving coil meters 263
 moving iron meters 263
 rectifier type instruments 263
 valve voltmeters 250-262, 263
 valve testers see "Testing
 Radio Valves"
Meters see Chapter 32 263
Microphone Amplifiers
 (Chapter 11) 50, 79-80
 mixing system, with 81-3
Microphones (Chapter 11) 77-9
 crystal microphones,
 coupling 78-9, 80
 decibel-voltage chart for 325
 microphone amplifiers . . 50, 79-80
 ratings of 78, 86, 87
Microphony, testing for 245-6
Miller Effect (Chapter 7) 46-8
 automatic frequency control, for 182
 automatic tone control, for . . 48
 definition of 46
 detuning due to 47-8, 159-160
 microphone amplifiers, in 79
 resistance coupled amplifier,
 in 3-4, 5
 see also "Input Capacitance"
Mixing Systems, A.F. 81-3
Multiples and Submultiples . . . 318
Musical Frequencies 322
Mutual Conductance 244, 264
 graphical determination of 270, 271
 testing for 244-5
Mutual Inductance 149-150
 see also "Coupled Circuits"
Nagaoka's Constant (K) . . 141-4, 148
 curves for determining 143
 for short solenoids 144-5
Natural Resonant Frequency . 115-6
 see also "Resonant Frequency"
 summary of formulae 133-4
Negative Feedback (Chapter 6) . 34-45
 affecting frequency response
 11, 23, 37
 " gain 10, 36, 39
 " generator impedance
 15, 37-38, 39
 " harmonic distortion
 11, 14, 22-3, 36-7, 39
 " input capacitance 47
 " input resistance 11, 40
 " noise 37
 " power output 13
 application methods 40-3, 51-3
 design data 43-5
 negative current feedback
 36, 39-40, 44-5
 negative voltage feedback
 36-8, 43-4
 over number of stages 34-5, 42, 52-3
 tone control, for 11, 68-9
 typical applications 51-3
Nepers (Chapter 13) 87

- Noise**
 effect of feedback on 37
 in frequency converters 106-7
 in receiver, testing for . . . 235, 326-7
 in valve, testing for 246
- Null Point Indicator**
 using magic eye 226
- Numerical Values of Mathematical Symbols** 328
- Ohm's Law**
 applied to capacitance 297
 " " inductance 299
 " " resistance 295
- Operator "j"** 304-5
- Oscillator, Superheterodyne**
 coil design, for 110-4
 see also "Frequency Conversion"
 " " "Frequency Converter"
- Oscillograph, Cathode Ray (ref.)** 263
- Overload Characteristic**
 A.F. power amplifier, in 15
- Palmermo's Formula** 141
- Parasitic Oscillation**
 in A.F. power amplifier 16
- Penetration Factor** 265
- Phase Angle**
 in capacitances 297-8, 300-2
 ,, inductances 299-302
 ,, tuned circuits 120
 see also "Complex Algebra" 304-5
 " " "Simple Trigonometry" 306
 " " "Vectors" 303
- Phase Splitter**
 application of 10-2, 51, 52-3
 gain with 10, 39, 44-5
 hum with 11
 input impedance of . . . 11, 40, 45
 output voltage capabilities of 11
 providing tone control 11
- Phase-Splitting Methods** 9-12
 centre-tapped choke 10
 centre tapped transformer 9
 simple transformer 9
 see also "Phase-Splitter"
 with resistance coupling 11-2
- Phon (Chapter 13)** 88-9
- Pickups, Gramophone**
 bass boosting for 71
 crystal, load requirements of . . . 80
 crystal, response curve of . . . 76
 desirable frequency response . . . 75-6
 general characteristics of . . . 75-6
 installation, notes on 77
 tracking and alignment of,
 (references to literature) 80
- Plate Conductance** 265
- Plate Resistance (valve)** 264
 graphical determination of . . . 270-2
- Power Efficiency**
 in A.F. power amplifier 13
- Power Factor** 297, 298, 300
- Power Output, note on** 13
 see also "Amplifiers, A.F. Power"
- Power Ratios in Decibels** 323-6
- Power Sensitivity**
 in A.F. power amplifier 14
- Power Supplies**
 importance of regulation in
 16, 186, 293
 see also Chapters 22, 23, 24, 25, 27
 " " "Transformers, Power"
- Q Factor (Chapter 16, Part 1)** 115-139
 definition of 117-8
 effective Q of coupled circuit
 91, 121-3, 137-8
 magnification by tuned circuit . 136
 summary of formulae 135-9
- R.F. Amplifiers**
 see under "Amplifiers R.F."
- Reactance-Frequency Chart** 313
- Receivers**
 receiver testing see under
 "Testing Receivers"
 see also under "Amplifiers A.F.
 Power; "Amplifiers A.F. Voltage;
 "Amplifiers I.F.; Amplifiers
 R.F.; Detection; Frequency Conversion;
 Power Supplies"; or
 under other specific items.
- Recording (Chapter 11)** 75
- Records, Gramophone** 75-7
 reproduction of 71, 75-7, 80
- Rectification (Chapter 22)** 185-190
 bibliography 190
 form factor, definition of 189
 rectifiers, application of 185-6
 ,, curves, use of 189-190
 ,, maximum ratings of 189
 ,, voltage and current
 relationships of 188-9
 regulation of power supply
 16, 186, 293
 ripple voltage 187-8, 191-8
 theory of 187-8
 transformer considerations
 190, 215-6
- Rectification Effect**
 in power amplifiers 285-6
- Reflex Amplifiers (Chapter 21)** 183-4
 distortion in 183
 minimum volume effect 183
 optimum operating conditions 184
 typical circuits 183
- Relative Humidity Chart** 331
- Resistance**
 and capacitance, circuits with
 297, 298, 300-2, 315
 ,, inductance, circuits with 300-2
 Kirchhoff's laws 295-6
 Ohm's law 295
 power in a 296

- relative resistance coefficients 318
 resistances in parallel 295
 " in series 295
 see also "Vectors" (Chapter 36) 303
 wire tables, copper wire, 332-3-6-7
 " " resistance wire . . 338-9
- Resistance Coupling**
 equivalent circuits for 57
 graphical analysis of 272-5, 277-280
 low impedance 8
 see "Amplifiers A.F., Voltage"
 wide band amplifiers 8
 with pentode valves 5-6, 28, 279-280
 " triode valves 3-5, 277-9
- Resistors**
 colour codes for 310-3
 dissipation of solenoids (chart) 319
 dropping resistors 203-4, 274-5, 321
 for use with air cells 321
 " " " 1.4V. receivers 321
 see also "Resistance"
- Resonant Frequency, definition of 116**
 relevant formulae 133-4
 universal resonance curves 129-130
- Screen Grid**
 bypassing of 26, 28, 56, 64
 voltage for optimum
 performance 6, 28, 273-5
- Screening**
 effect on inductance of coils . . 148
- Screw Threads, American 315**
Screw Threads, B.A. 316
Screw Threads, Whitworth 317
Screws, Wood 316
- Selectivity**
 graphical determination of . . 123-4
 maximum possible 125, 128
 of coupled circuit, untuned
 primary 121-2, 136-7
 " coupled tuned circuits
 122, 123-4, 137-8
 " over-coupled circuits
 123-8, 138, 158
 " parallel resonant circuit
 120, 135-6
 " series resonant circuit . . 136
 requirements in I.F. amplifiers 157-8
 summary of formulae 135-8
 tests for 233-4
 universal selectivity
 calculator 128-130
 variable selectivity . . 125-7, 158
- Self Bias . see under "Bias, Cathode"**
- Sensitivity, of power valve 14**
 of receiver, tests for 228-230
- Sensitivity, Absolute 230**
- Solenoid Coils**
 calculation of inductance . . 140-8
 effect of screening 148
 see also "Inductances, Air Core"
Solenoid Resistor Ratings (Chart) 319
- Spectral Energy Curves 322**
- Superheterodyne Receiver**
 general principles of 99-100
 see also "Frequency Conversion"
 " " "Receivers"
 tracking of coils in 110-4
- Susceptance 301-2, 308**
- Temperature**
 conversion of 330
 relative temperature coefficients 318
- Testing Audio Amplifiers**
 frequency response 237
 harmonic distortion 237, 238
 hum 239
 linearity 238
- Testing Radio Valves (Chap. 30) 240-9**
 class B valves 247
 diode detectors 249
 for emission 241-3
 " gas 243
 " heater-cathode leakage 246
 " microphony 245-6
 " mutual conductance 244-5
 " noise 246
 " plate current 243
 " screen current 243
 " shorts 240-1
 frequency converters 247-8
 gas-filled rectifiers 243
 vacuum rectifiers 249
 service emission tester 242-3
- Testing Receivers (Chapter 29) 227-39**
 A.V.C. characteristic . . 175-8, 236-7
 bandwidth 233
 bibliography 239
 blocking interference 234
 cross modulation 233-4
 definition of terms 227-9
 distortion, modulation 238-9
 distortion, overall 237
 dynamic tests 230-9
 fidelity 237-8
 gain, apparent, aerial coil 231
 gain of converter valve 231
 gain of single stage 231
 hum 239
 image ratio 234
 noise level 235, 326, 327
 oscillator frequency drift 235-6
 oscillator grid current 232
 selectivity 233-4
 sensitivity 230
 sensitivity, absolute 230
 static tests 230
 summary of tests 229-230
 tracking 232
- Thermometers, Wet & Dry Bulb 331**
- Time Constant**
 A.V.C. circuits . . 168, 171-3, 178-9
 resistor and condenser 298-9
 resistor and inductance 300
- Tone Compensation (Chapter 9) 58-73**

- Tone Control (Chapter 9)** 58-73
 automatic 48
 bibliography 72-3
 cathode bypass, effect of
 11, 25-28, 55, 64
 effect on volume level 69-70
 filter for constant current
 supply 67-8
 filter for constant voltage
 supply 64-7
 grid coupling condenser,
 effect of 4, 54, 55, 63
 negative feedback, by
 means of 11, 68-9
 non-resonant circuits 61-72
 phase splitter, with 11
 resonant circuits 68-61
 screen bypass, effect of 26, 28, 56, 64
 selective harmonic distortion 69
 shunt capacitance, effect of 61-2
 summary of general features 72
 tapping switch, using 69
- Transformers, Audio Frequency** 205-19
 application of 1-2
 auto-transformers 7, 205
 bibliography 215
 capacitances, effect of 212
 class B transformers 18, 213
 colour code for 320, 321
 inductance of primary 211-2, 213-5
 leakage inductance 212
 loaded transformers 2, 283
 output transformers 213-5
 parallel fed 6
 see "Transformers Iron Core"
 turns ratio of 2, 212-3
- Transformers, Iron Core**
 (Chapter 26) 205-220
 ideal transformers 205
 impedance calculations 205-7, 210-1
 losses, effect of 209-10, 211
 multiple secondaries, with 206-9
 practical transformers 209-11
 see also "Inductances, Iron Core"
 "Transformers, Audio"
 "Transformers, Power"
 voltage ratio of 210
- Transformers, Power**
 colour code for 321
 design of 215-6
- Treble Attenuation**
 see under "Tone Control" 58-73
- Treble Boosting**
 in phase splitter 11
 see also "Tone Control"
- Trigonometrical Relationships** 344
- Trigonometry, Simple (Chapter 38)** 306
- Tuned Circuits—General**
 (Chapter 16, Part 1) 115-139
 band pass circuits 138
 bibliography 130-133
 coupled impedance 91, 137, 138
 coupled circuits
 91, 121-130, 133-9, 149, 150
 coupling factor, see "Coupling
 Factor"
 damped train of waves 116-7, 135
 dynamic resistance
 91, 119, 135, 137, 138
 formulae, summary of 133-139
 gain in 91, 121, 122, 136-7
 logarithmic decrement 117, 135
 parallel resonance 118, 133-9
 phase angle 120
 Q factor 91, 117-9, 121-3, 135, 137-8
 resonant frequency 116, 133-4
 resonant frequency, natural
 115-6, 133-4
 see also "Inductance" and
 "Inductances, Air Core"
 Selectivity of "Selectivity"
 series and parallel resistance
 in 116-119, 135
 series resonant circuit 117, 136
 transformer, tuned primary and
 secondary 122-3, 137-8
 transformer, tuned secondary
 91, 121-2, 136-7
 wavelength 134
- Tuning Indicators (Chapter 28)** 224-6
 magic eye see "Magic Eye"
 milliammeter type 224
 saturated reactor 224
- Twist Drill Sizes** 317
- Units (Chapter 39)** 307-9
 electrical 308
 fundamental 307
 magnetic 309
 photometric 309
- Universal Resonance Curves** 129-130
- Universal Selectivity Calculator** 128-30
- Valve Characteristics**
 (Chapter 34) 268-294
 bibliography 293-4
 composite characteristics 287-290
 constant current curves 268, 277
 design purposes, for 277-291
 diode curves 292-3
 dynamic characteristic 269, 272-4
 grid current 275-7
 load lines 269-270, 276
 mutual characteristic 268, 271-2
 plate characteristic 268, 270-1
 screen current 292
- Valve Constants (Chapter 33)** 264-7
 amplification factor 264, 270, 271
 capacitances 267
 Durchgriff 265
 graphical representation of 268-294
 mutual conductance 264, 270-1
 penetration factor 265
 plate conductance 265

- plate resistance 264, 270-2
 see also "Valve Characteristics"
- Valve Conversion Factors** 328-9
- Valve Voltmeters (Chapter 31)** 250-262
 bibliography 261-2
 diode peak voltmeter 253
 loading effect of 250-1, 261
 mean reading 252-3
 peak reading 253-260
 practical designs 254-260
 probe construction 251, 259
 reflex peak voltmeter 253-4
 R.M.S. reading 251-2
 slide-back voltmeter 254
- Valves—Frequency Converters**
 see "Frequency Converters"
- Valves—Pentode Power Amplifier**
 application of 50-1
 damping factor of 15, 22
 design procedure with 283-4
 distortion in 14-5, 21, 22, 284
 negative feedback with .. see
 "Negative Feedback"
 overload performance of 15
 plate characteristics of 271
 power efficiency of 13
 power output of 13, 283, 284
 power sensitivity of 14
 rectification effects with .. 285-286
 see also "Amplifiers, Push-Pull"
 " " Chapters 2, 3, 8 and 34
 " " "Testing Radio Valves"
- Valves—Pentode Voltage Amplifier** 5-6
 application of .. 50, 51, 52, 53, 54
 design procedure 279-280
 dynamic characteristics of .. 273-4
 for microphone amplifiers .. 79-80
 operating conditions 6, 28
 plate characteristics of 271
 screen supply for 204, 274-5
 see also Chapters 1, 8 and 24
 " " "Testing Radio Valves"
- Valves—Rectifiers, High Vacuum**
 application of 185-186
 curves, use of 189-190
 maximum ratings of 189
 testing 249
 voltage and current
 relationships 188-9
 see also "Rectification"
- Valves—Rectifiers, Mercury Vapour**
 applications, typical 195-7
 end of life point 243
 interference due to 199, 200
 output voltage of 188
- peak currents, permissible 193-4
- Valves—Tetrode, Beam Power**
 application of 51-53
 damping factor of 15, 22
 design procedure with 285
 distortion in 15, 22, 284, 285
 negative feedback with .. see
 "Negative Feedback"
 overload performance of 15
 plate characteristics of 271
 power efficiency of 13
 power output of 13
 power sensitivity of 14
 see also "Testing Radio Valves"
 " " Chapters 2, 3 8 and 34
- Valves—Triode, Power Amplifier**
 application of 49-50, 51
 Class B 17-19, 290-291
 damping factor of 15, 22
 design procedure 280-283
 distortion in 14-5, 21, 281-3
 driver to class B 282-3
 overload performance of 15
 power efficiency of 13
 power output of 13
 power sensitivity of 14
 see also "Amplifiers, Push-Pull"
 " " "Testing Radio Valves"
 " " Chapters 2, 3, 8 and 34
- Valves—Triode, Voltage Amplifier**
 design procedure 277-279
 grid leak bias for 5
 resistance coupled 3-4
 see also Chapters 1, 8 and 34
 " " "Testing Radio Valves"
 transformer coupled 1-2
- Variable Selectivity** 123-129, 158
- Vectors (Chapter 36)** 303
- Vibrators**
 bibliography 202
- Visibility Curves, Eye** 322
- Voltage Dividers (Chapter 25)** 203-4
 current calculations for 296
- Voltage Ratios in Decibels** 324-6
- Voltage Regulators (Chapter 27)** 221-3
 gaseous 221-2
- Volume Compression (Chapter 10)** 74
- Volume Control**
 automatic .. see "Automatic
 Volume Control"
- Volume Expansion (Chapter 10)** .. 74
- Volume Units—V.U. (Chapter 13)** 88
 rating for microphones 78
- Wavelength/Frequency Table** .. 340