

Radio Amateur's Handbook

A Manual of Amateur Short-Wave
Radiotelegraphic Communication

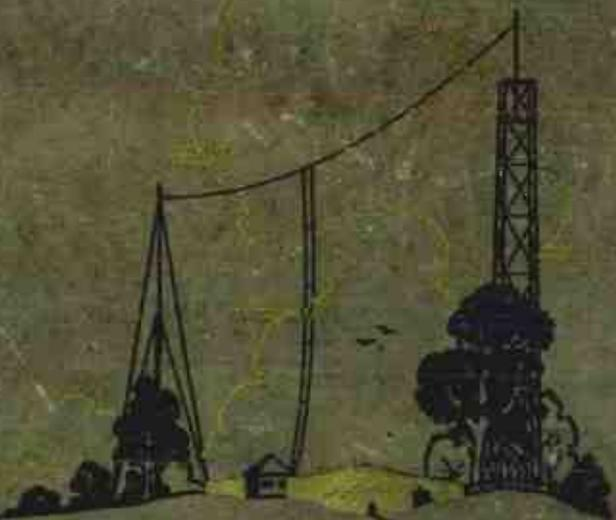

PRICE
ONE
DOLLAR



PUBLISHED BY THE AMERICAN RADIO RELAY LEAGUE • HARTFORD

The
RADIO AMATEUR'S HANDBOOK

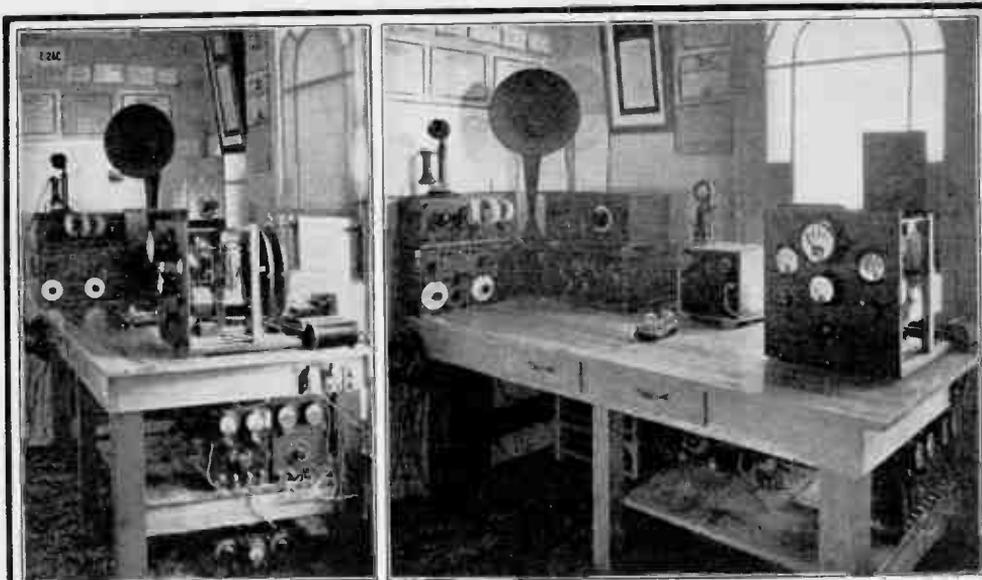

STATION ARRANGEMENT AT 6LJ, LOS ANGELES, CALIFORNIA

The apparatus is laid out on a large, substantial table in the most convenient way possible. Note the neatness, compactness, and accessibility of everything. The long-wave receivers are at the left; the amateur short-wave tuners are directly in front of the receiving operator; the transmitter is on the right with the wavemeter on top of it just above the fifty-watt tube. The keying relays, batteries, battery-charger and other power supply equipment are under the table. The message files and the station log book are kept in the drawers. There is sufficient room so the operator's feet may rest in a comfortable position under the table.

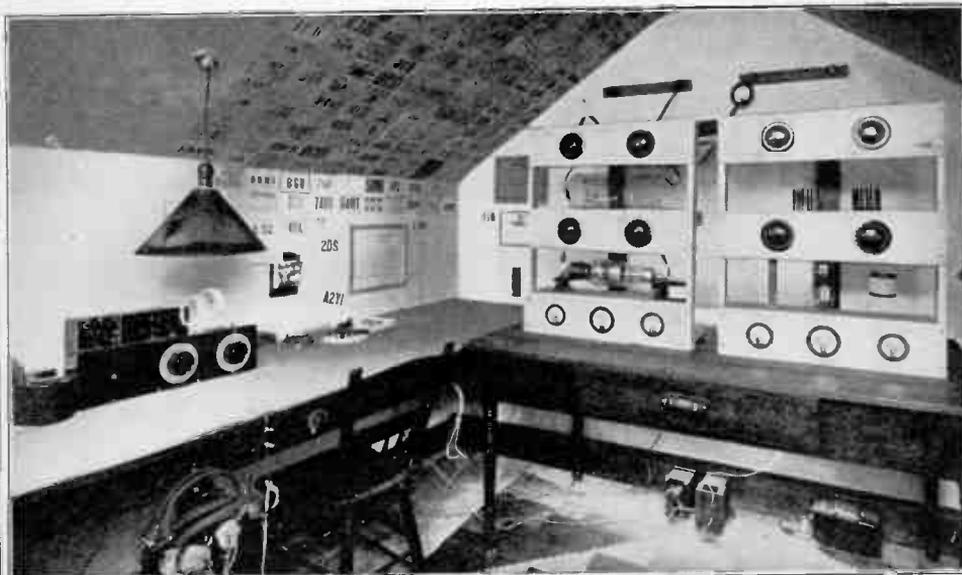

ANOTHER ARRANGEMENT USED AT 9CXX, CEDAR RAPIDS, IOWA

There is plenty of room here so things do not have to be so compact. Note the beautiful and simple panel mounting of the two transmitters. The power control switches are in easy reach at the right of the operator. The wavemeter is at the left of the receiver. A row of binding posts at the top edge of the panel makes it possible to change the Lorenz-wound coils quickly to cover different wavelength ranges. The construction of such coils and the use of space-wound plug-in coils are discussed in the Handbook.

The
RADIO AMATEUR'S HANDBOOK

A MANUAL *of* AMATEUR SHORT-WAVE
RADIOTELEGRAPHIC COMMUNICATION

BY
FRANCIS EDWARD HANDY
COMMUNICATIONS MANAGER, AMERICAN RADIO RELAY LEAGUE

SECOND EDITION



HARTFORD, CONN.
THE AMERICAN RADIO RELAY LEAGUE

1927

COPYRIGHT 1927, BY THE
AMERICAN RADIO RELAY LEAGUE, INC.

Phelps Printing and Publishing Co.
Springfield, - - Massachusetts

AUTHOR'S FOREWORD

THIS Handbook is written as a guide for member-operators of the League. It is also useful as a source of information to the man who wants to take part in amateur radio activity but who has no idea of how to get started. Written first of all for the beginner, such an amount of useful and up-to-date information has been added that the Handbook in its present form is equally valuable as a compendium of information for the experienced brass-pounder and the beginner alike.

The suggestions for building and using apparatus are based on experience. The printed matter included within these pages is not intended for use as a textbook but is rather to be used as a Handbook. Any theory discussed is as simple and fundamental as it can be made. The book is intended as a practical rather than as a theoretical work.

Every League member should be interested in some of the matter contained in these pages. Older members are of course more or less familiar with it all. Some of this information has appeared in past issues of *QST* in one form or another. We have tried to pick that material most useful to the people who will want it. In the appendix will be found some tables and information that should be useful to everyone.

Because of the limited size of this book it is impossible to include all desirable matter. However, we have tried to leave out nothing that the new amateur wants to know. The different subjects are handled as completely as space permits.

When any questions come up that are not answered in this book, look through all available back numbers of the magazine *QST* for the information. Many back numbers can be supplied by the *QST* Circulation Department. If you do not find what you want in that way, drop a line to A.R.R.L. Headquarters, 1711 Park St., Hartford, Conn., where someone will be glad to help out if the information is available.

The preparation of this Handbook has taken considerable time for the writing and arranging of the material. A great many photographs and diagrams have been included to make the text as clear as possible. It is of course realized that a more finished product would result by spending a great deal of additional work in preparation, although not a great deal more value to the reader could be added in that way and it would be impossible to distribute the Handbook at the present moderate cost. So

many people have been awaiting the appearance of the Handbook that it is only fair to them that it be presented without further delay. Before a revised edition is considered, it will be possible to look into some of the matters not covered with the thoroughness we wish was possible at this writing, giving to every single subject all the attention we think it deserves. The further investigation of the application of practical radio frequency choke coils to various amateur transmission problems is but one example of such a subject.

In the discussion of receiver and transmitter construction an effort has been made to simplify the work of getting a good and practical amateur station in operation at a minimum cost. Reliable circuits and apparatus of different cost and power have been suggested to make it possible for the constructor to build a station to fit his pocketbook, at the same time building a station which will work and produce the best results for the money invested.

Comments, suggestions, corrections, and questions on the matter contained in these pages are welcomed by the writer. If the first edition meets an enthusiastic reception a revised edition is contemplated and your comment will help the whole amateur fraternity by suggesting possible changes and additional matter for inclusion in the next edition.

The writer has had helpful suggestions from a great variety of sources. Indeed, there are so many, that it is hard to identify all of them. However, acknowledgment is chiefly due to Mr. K. B. Warner, Secretary of the American Radio Relay League and Editor-in-Chief of *QST*.

At this point, I wish to acknowledge and express my appreciation for the assistance and encouragement rendered me in the preparation of this Handbook. It is through the co-operation of every member of the staff of *QST* and through the courteous and considerate help of its Editor that this Handbook has been prepared. The use of some material and illustrations from *QST* has made it possible to bring the Handbook out at a much earlier date than otherwise would have been possible. For all the help received, I wish to express my sincere appreciation.

This book is made available by the American Radio Relay League, the radio amateur's own organization. Correspondence regarding any phase of amateur work is welcomed at League Headquarters. In-

quiries regarding membership should be addressed to the Secretary. Written by an amateur, for anyone and everyone who is interested in amateur work, we hope that this Handbook will be helpful to those who are active in amateur work and that it will be instrumental in helping beginning ama-

teurs and prospective brass-pounders to get into the game and get the most that there is in enjoyment of radio by directing their efforts along the lines that bring results most quickly, surely, and cheaply.

—*F. E. Handy*

CONTENTS

	PAGE
Author's Foreword	v
Chapter I—What Is An Amateur?	1
Chapter II—Getting Started	6
Chapter III—Fundamentals	19
Chapter IV—How Radio Signals Are Sent and Received	30
Chapter V—Building A Station	41
Chapter VI—The A.R.R.L. Communications Department	105
Chapter VII—Operating A Station	111
Chapter VIII—The Experimenter	126
Appendix	128
Membership Application Blank	177
O.R.S. Application Blank	178
Index	ix

The RADIO AMATEUR'S HANDBOOK

CHAPTER I

What Is An Amateur?

A FEW words at the beginning to tell the story of the present-day amateur to the uninitiated may be appropriate. Few hobbies can be compared to that of the amateur radio enthusiast. The experimenter, the man who enjoys communicating with distant lands and receiving cards and letters from foreign countries, and the operator who most enjoys talking with his fellow enthusiasts scattered all the way across the country—each does his part in amateur radio. Every individual is interested sooner or later in all three classes of operation.

A certain amount of skill is required. This makes amateur radio work the more attractive and interesting. There are adventures to be found in everyday two-way short-wave contact. Distant acquaintances will be made. Friendly chats with folks both far and near are possible. The relaying of citizen radio messages is worthwhile. The "kick" in snappy operating work gives pleasure. All these things are a part of our personal experience that defies duplication. The trout fisherman enjoys the pursuit of his hobby. The cross-word puzzle artist, the stamp collector and the Egyptologist all take pride in their special fields. There is no comparison that we can make that will give amateur radio its due. Personal contacts tie us together; personal experiences bond us in an organization without an equal anywhere.

There is untold pleasure in two-way amateur operating. The covering of hundreds of miles and the handling of friendly messages with low amounts of power lends an interest not found in any other pastime. Perhaps the relaying of messages has not been sufficiently mentioned. That is one of the amateurs' principal activities. Friendly messages are accepted at any amateur station. They are passed on toward their destination from one station to another. No charge is made for the service and of course no responsibility can be fixed for failure to perform. Usually messages are delivered by telephone or by the operator in person as soon as they reach the city of destination.

In many places it is possible to join a radio club and to enjoy active membership. The exchange of information between club members is valuable. By talks and demonstrations the club provides interesting winter activities. Through code classes, beginners are helped in getting started as "good" operators. A club library containing the books best suited to the members is an additional asset to the radio enthusiast who does not have too much money to spend on his hobby. In the summer, social activities of a different nature keep the members together for some enjoyable times. Picnics, demonstrations with portable equipment, and athletic contests keep up the interest then. Many such clubs are affiliated with the League and receive monthly bulletins from the League. On request, information on organizing a club and becoming affiliated is supplied from League Headquarters.

Amateur radio offers the *only* means of free communication with our fellows who are outside the range of the human voice. When we have become familiar with some of the simple facts about this fascinating hobby we will want to get on the air and talk by wireless with other men who have stations similar to ours. This we can do just as soon as our station is in actual operation. Cards will be received from many places where our signals have been heard. Correspondence with folks we have met by radio will result. New friendships will be made. We will take pride in our station and its records.

The "seven wonders of the world" were widely talked about in the days of our forebears. Today there are wonders that are not so well known. Amateur radio accomplishments are commonplace, but of the millions of people interested in radio relatively few even know that free citizen radio communication is possible. Perhaps amateur radio should be referred to as the "eighth wonder" of the world.

As a hobby radio has no equal. In every one of its phases it is well worth while. True enough not every amateur message

gets through to its destination. Our message handlers are not in the game for commercial benefit but for the pleasure that they get in doing something interesting and worth while. Amateur wireless messages do not always go from the sending station directly to their destination. They pass from one station to another until they eventually arrive, unless a special direct route has been pre-arranged. In the main, message delivery is surprisingly good.

There is a wholesome satisfaction in using something that our own hands have fashioned to accomplish the seemingly impossible of attainment right from our own homes. Besides the joys of actual communication there is pride in our work of construction. The whole amateur station can be built as cheaply and easily as a broadcast receiver. The advent of the short waves has added to our enjoyment. The sport in all its phases is splendidly worth while.

THE AMERICAN RADIO RELAY LEAGUE

The name *American Radio Relay League* and the words "amateur radio" are practically synonymous. Almost every good amateur in the world belongs to the A.R.R.L.

The League was organized in 1914 by a small enthusiastic group of earnest radio amateurs. Hiram Percy Maxim, now president of the League, was responsible for its formation. For two years he had wanted to band all amateurs together so that each amateur could talk to and know all other amateurs. By such an organization and by the ready exchange of ideas thus made possible, each member was able to get more enjoyment from amateur radio work.

For over eleven years the League has prospered and grown. It has had a history of glorious success as the spokesman in amateur affairs. During the Great War the League of course suspended activities. The Army and Navy enrolled some 3500 radio operators—well-trained by their amateur experience. Right after the war the League had to fight a threatened government monopoly. The League won the battle that makes amateur radio and broadcasting as well a part of our present-day life!

Throughout its whole life the story of the League has been a story of one achievement after another. In 1920 a message was sent from coast to coast and an answer returned to the starting point via several relay points, in six and a half minutes, at that time an unparalleled feat. In 1921 the League sent Paul F. Godley across the Atlantic to Scotland to listen for American amateurs. His success in hearing twenty-seven amateurs brought the amateur to the attention of the whole scientific world. What had been thought impossible was accomplished using short waves and low power. The At-

lantic conquered, amateur signals next spanned the Pacific ocean. Two-way communication followed right on the heels of tests showing that signals could be heard at great distances. In 1923 a message covered 10,000 miles in four minutes. A message was sent from the East Coast of the United States to Hawaii and the answer returned at once to the sender. One intermediate station "relayed" the message. To-day messages are handled *direct* over such distances nightly without causing any special excitement.

The League has not only done remarkable work right in its own field; it has helped many people in practical ways. The League has co-operated with the U. S. Army and Navy, with the U. S. Bureau of Standards, with the larger American radio engineering concerns, with the U. S. Department of Commerce and with foreign governments in collecting data and conducting tests of various sorts for the general advancement of the radio communication art.

In 1912 Radio Communication Laws were made allowing the amateur to use any wavelengths not in excess of 200 meters. Those who made the laws thought that the amateur had been successfully and forever disposed of! It was believed that wavelengths shorter than 200 meters were worthless for practical radio work. Amateurs proved the contrary! They perfected the equipment at their disposal. Through years of experimenting and by making one improvement after another, progress was made. Every bit of apparatus was tested and rebuilt after use had shown its weakness. Hard work brought increasingly greater results. In 1924 the short waves came into their own! World-wide communication on wavelengths below 100 meters opened the eyes of radio interests everywhere.

Members of the American Radio Relay League have proved their worth in many ways. In times of flood and disaster they have summoned help with their sending sets. Two MacMillian expeditions into the Arctic have kept in touch with loved ones at home reporting discoveries to the waiting world "via amateur radio". No commercial radio equipment, no power on earth, could have accomplished what amateur radio did in 1925 as an ordinary everyday service to this intrepid explorer. In 1925 an amateur short-wave station was installed aboard the flagship of the U. S. Battle Fleet, manned by F. H. Schnell, the then Traffic Manager of the League, himself a Naval Reserve officer. This station was with the Fleet throughout its long cruise to Australia and New Zealand. Its performance demonstrated to our Navy the usefulness of the amateur and his short-wave apparatus! At times when standard Navy equipment could not cover the required distance the

amateur-Navy short-wave station put messages halfway around the world to their destination.

Later in 1925 work was started on a plan of affiliation between the Signal Corps, U. S. Army, and the transmitting amateurs of the United States. Amateurs are to handle messages for National Guard and Reserve units when the plan is worked out more fully during 1926.

During the years that have gone by, the amateur has embraced every opportunity to be of service. He has "shown the world"; he has justified his existence!

To-day the American Radio Relay League is a great fraternity of amateur radio men. The League exists as a big organization with thousands and thousands of members, just because as individuals we can get more enjoyment from organized amateur radio than is possible for us to get as independent individuals. The League has a Headquarters divided into several departments. A whole staff of people render service of various kinds to the membership.

The League owns the magazine, *QST*, which goes to all members of the League each month. *QST* acts as a monthly bulletin of our organized activities. It serves as a medium for the exchange of ideas. It fosters amateur spirit. *QST* has grown until it is not only "the amateur's bible" but it is also one of the foremost radio magazines in the world. It is in such general demand that it is sold on news stands everywhere. The profits *QST* makes are used in supporting League activities and in serving the members. Membership dues to the League include a subscription to *QST*.

The American Radio Relay League is a non-commercial association of radio amateurs. The continent-wide organization is partitioned into Divisions. Its affairs are governed by a Board of Directors. Each one of the fourteen Directors is elected every two years by vote of the general membership in his territory. No one engaged commercially in making or selling radio apparatus can be a member of the Board of Directors or an officer of the League.

There are five officers of the League, elected or appointed by the Board. These officers constitute an Executive Committee which the Board has empowered to act in handling matters that come up between meetings of the Board, their authority, of course, subject to certain restrictions.

The American Radio Relay League is organized to represent the radio amateur in legislative matters. It is pledged to promote interest in two-way telegraphic communication and experimentation. It is interested in the relaying of messages by radio. It is concerned with the advancement of the radio art. It stands for the maintenance of fraternalism and a high standard of conduct. One purpose of the League is

to keep our activities so well-conducted that the amateur will continue to justify his existence and receive all that is his due just as he has in the past. The League champions the rights of the radio amateur before the whole world. Summarized, it exists that human enjoyment in amateur radio may be increased without measure.

LEAGUE SPIRIT

Ever since radio amateurs have been bonded together in a League, a spirit of fellowship has existed. Radio men everywhere have found pleasure in following friendly radio conversation by writing friendly cards and letters. Visits to neighboring amateur stations have cemented friendships. Little groups of amateurs have met informally; local clubs have formed similar in organization to the parent body; divisional and national conventions have been filled with pleasure by the meetings of radio acquaintances together. The League has been made possible by the loyalty of its members everywhere. The earnest work and ready co-operation of members has been responsible for the remarkable success of the League.

HEADQUARTERS

From the small group of enthusiastic radio amateurs who made up the League in 1914 we have grown to the present big organization. The first League Headquarters was in the attic of the home of our first Secretary, at that time a college lad who devoted himself to the work of the League after school hours with the help of several acquaintances. The early post-war offices of the League were in a couple of dingy and poorly lighted rooms in an old Hartford office building. Only one employee, the Secretary of the League and the Editor of *QST*, took care of every bit of League work. Soon a stenographer was needed to take care of the increasingly heavy correspondence. Then an Advertising Manager for the magazine was added. The activities of the members of the League took on more importance. The next addition to the Headquarters Staff was a Traffic Manager. Twice the headquarters office has been moved to larger and better quarters. More additions to the staff have been made to take care of the increased needs of a growing membership. Today the Headquarters is in a new office building, and the people are kept busy handling its each of the twenty thousand League's departments and its business quarters is divided into its business work.

manager, spends most of his time generally supervising League work. He handles personally many important League affairs, besides directing the work of his staff. An assistant helps in answering the somewhat bulky correspondence and seeing that the many details are properly carried out. The *Executive Office* takes care of the business management of the League. It watches the trend of amateur affairs. The relations of the League in co-operating with our government, with other national organizations or with expeditions are carefully considered by this office whenever any forward-looking steps are made.

The work on the magazine, *QST*, is carried out by several highly specialized departments. *Advertising, Circulation, Accounting, Editorial, and Technical Departments* take care of the different phases of work that go into the making of a first class magazine and distributing it to the readers.

In addition to the work of keeping records of changes in the membership up-to-date, and there are hundreds of them every day, the *Circulation Department* stocks message blanks, log sheets, and League emblems for the convenience of members who want them. Such supplies are sold at practically what it costs to place them in the hands of the members.

The *News Bureau* supplies amateur news direct to hundreds of newspapers, insuring that the amateur is understood and appreciated by the general public.

Several people are kept busy just helping members with their different problems. A *Communications Department* exists for the purpose of suggesting and supervising the operating activities of members. A large part of its work is "message-handling" work. The *Experimenters' Section* does for the hundreds of "experimenters" just what the *Communications Department* does for the "operators". The Headquarters office serves as the "go-between" for the exchange of ideas between the folks most interested in both fields of work. The *Information Service* is free to all League members. It is the "question and answer" department where beginners can write for advice and where more experienced amateurs write to get help in solving their technical problems. All questions are answered directly by letter. If

you don't find the information you need in this book, write the Information Service, telling all about your problem and all the needed information. The Service cannot compare different products but it answers the Office questions on the design of radio apparatus.

For all other matters it is not necessary to write the various Departments. Write to the Headquarters by mail each day to handle

your problem best. To get quick results when writing League Headquarters it is only necessary to write separate letters about separate subjects so each Department can serve you at the same time. "Calls Heard" should not be written into the letter to the *Communications Manager*. Technical questions should not be asked in a letter to the *Circulation Manager*. Just address letters to A.R.R.L. Headquarters, 1711 Park St., Hartford, Conn.

Members of the Headquarters staff are always hard at work. There are numberless details in our daily work. Getting two bags of letters to members in the mail each day keeps the stenographers busy. No matter how busy everyone is, though, the Headquarters fellows always have time to "rag-chew" with League members who visit "HQ". You will be interested in seeing where and how all the different kinds of work are handled. Someone will be glad to show you around the offices. The Headquarters station will be interesting to see, too. Visitors are always welcome at A.R.R.L. Headquarters.

TRADITIONS

As the League has come down through the years, certain traditions have become a part of amateur radio. Best known to a few old-time radio amateurs, the mysteries of the past lend an unmistakable flavor to our present-day League work.

Developments in radio have altered the apparatus used by amateurs a great deal in the last decade. Through all the changes some personalities have stood out above the rest, typifying the spirit of the amateur.

The Old Man with his humorous stories of "Rotten Radio" has done much from time to time to improve the morale of League members. T.O.M. is an odd radio character who puts into words things that we all feel at times but find difficult of expression. His pictures of radio and radio amateurs are characteristic and inimitable. His views are always refreshing. The Old Man sits in his "shack" and reflects on the "rotteness" of everything. He glares at "Kitty", spitting out his grouch on all who care to listen. At his right hand he keeps the sacred *Wouff Hong* to use in punishing those who commit offenses against the radio law. The *Rettynsnitch* is kept within easy reach to use in enforcing the principles of decency in operating work. Close by is *Old Betsy*, another ancient piece of radio apparatus (rotary gap), into which are fed the remains after the *Wouff Hong* and *Rettynsnitch* have done their work.

The Old Man visits the *Radio Club* and there we meet *Radical, Final Authority*, and other radio celebrities, all easily recognized in any gathering of amateurs. Back numbers of *QST* refer to these characters and

tell the story of their doings in a most interesting way. New members will profit by getting back *QST*'s and reading all about them. There is much speculation in amateur circles about the identity of T. O. M. When you read *QST* watch for references to him.

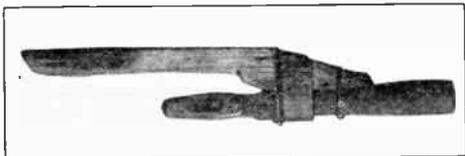

THE WOUFF-HONG AND THE RETTYSNITCH
(Photographs are not to the same scale)

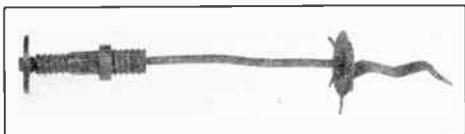

The Royal Order of the Wouff Hong is the rite administered at official conventions of the A.R.R.L. This mysterious order is open to all loyal "brass-pounders" of the League. One must be initiated to truly appreciate the honor.

Many of "the gang" who have twisted the dials and pounded the key all the night long have automatically become "Boiled Owls" with the rising of the sun.

The "Rag Chewers' Club" is another fra-

ternal society for members whose chief interest is in making friendly conversation by radio. The WAC Club is open to those who succeed in working all continents with their apparatus.

JOINING THE LEAGUE

We have briefly reviewed the story of the American Radio Relay League. Membership in the League brings you *QST* twelve times a year. The certificate of membership entitles you to partake in all the benefits of the organization. Amateur radio work brings its own reward. The thrill of actually talking with distant places, the fellowships made and enjoyed, are very much worthwhile. Pride in what we can do with the work of our hands and interest in comparing our records with those of other fellows, set amateur radio apart from other sports.

The best way to get into the spirit of things is to join the League and start reading *QST*. Follow the suggestions made in this book in getting started. Write the Information Service for help in any special problems that come up. An interest in amateur radio is the only essential qualification necessary in becoming a member of the League. Ownership of a station and knowledge of the code are *not* pre-requisites. They can come later.

Inquiries regarding membership should be addressed to the Secretary or you can use the convenient application blank on page 177.

CHAPTER II

Getting Started

THE story of amateur radio has been briefly told for the benefit of the newcomer. It gives to many people a new breadth of vision. Enjoyment from broadcast reception alone is soon exhausted. The thrill of hearing programs from distant stations soon gives place to a search for better quality in local programs. The novelty of listening to broadcast speeches and music wears off in a matter of months.

To understand and enjoy radio in the fullest sense we ought to listen to *all* that takes place. The broadcast listener has but skimmed the surface of radio fun. He has no conception of the joy that will be his, once he has put his finger on the throbbing pulse of two-way radio. Long waves, set up by frequencies below the broadcast band, bring us a horde of flute-like signals. Press messages, storm warnings, and weather reports from all over the world tell their story to whomever will listen. Some stations speak slowly and leisurely so that even the beginner can read. Others race along furiously so that whole sentences are meaningless buzzes. Countless ship stations work near the broadcast band. Ships report their position daily. Hundreds of interesting "human" messages are sent shore stations for delivery. Short waves, produced by frequencies above the broadcast band, are most interesting of all. Numberless amateurs, also transoceanic commercial radiotelegraphy, commercial re-broadcasting links, exploring expeditions and experimental stations are the attraction here.

These are the new fields for the broadcast listener to conquer. The greatest distances that have thrilled us with faint music are just beginning distances for our short-wave receivers. No continental limits confine the "DX" possibilities. Friendships in every corner of the world follow two-way communication. A short-wave receiver brings endless possibilities to light. A low-powered and inexpensive radio telephone may be built to use in talking with other stations over great distances. However, almost all amateurs prefer to learn and use the Continental telegraph code. Code signals will easily cover four or five times the distance possible for the same or more complicated radiophone equipment. The reliability is vastly better than that of any voice work.

There is nothing difficult about building

a receiver and transmitter. The parts are inexpensive; the construction is simple. In "getting started" the first step is to spend some evenings patiently learning the code. Before doing any operating it is necessary to obtain station and operator's licenses from the Department of Commerce. These are free of charge. Before we are ready to apply for licenses we must build the station, get the transmitter ready to operate, and learn the code.

MEMORIZING THE CODE

The easiest way to learn the code is for two or more people to practise together. As the writer learned by another method which is adaptable to a single person two methods will be outlined here.

In the appendix are the Continental Code characters. There are also phonetic symbols to help in learning quickly. The Continental Code is a dot and dash system used all over the world by radio operators and in Europe by wire telegraph operators as well.

In receiving code signals each letter must be associated *directly* with the *sound* heard. *The code must first be memorized.* Learn the code, pronouncing the symbols "dit darr" rather than "dot dash". Do not visualize the letter "A" as a dot and a dash. Recognize the *sound* "dit darr" as "A" directly. Learn a few letters every day until the alphabet and figures have been mastered. Have a friend ask you the letters in non-alphabetical order. Repeat them in terms of "dit-darr" language until familiar with them all. Practise until you know the *sounds* as *letters* without pausing to think of them in terms of dots and dashes. Don't expect to learn it all in a day. Take things easy. Learn a few symbols at a time. Review each day the letters learned the previous day. Be optimistic. You will be surprised at your progress.

Now for the two methods of obtaining code practise. Proficiency in code speed is gained as in other things, by constant practise. *Good* sending at moderate speeds is harder to learn than receiving. It is best not to use a key or to try to send much until ten or twelve words a minute can be read and copied.

PRACTISING WITH A BUZZER

A buzzer practise set is one aid to learning code, especially if someone who is a good

operator can help by sending to you. A buzzer, a telegraph key and a dry cell connected as shown in the diagram make a buzzer practise set. Using a head-set will

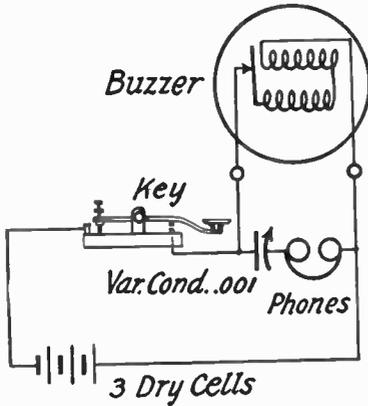

CONNECTIONS OF A BUZZER CODE PRACTISE SET WITH A TELEPHONE HEAD SET

The intensity of the signal can be varied by changing the setting of the variable condenser. Sometimes the phones and condenser are connected across the vibrator contacts but usually the circuit shown is best.

give more nearly the conditions that obtain in actual radio receiving. It will keep out outside noises. A condenser (about .002 μ fd.) will be needed if a headset is used. A variable condenser can control the audibility if desired. A high-pitched buzzer signal is helpful in learning the code. The small sum of money a buzzer set costs is a good investment.

In picking out a key for a practise set some care should be taken to get a well-balanced smooth-action key. A fairly "heavy" key with large contacts is best to use right from the start. It will save buying another key for the station later on. Good sending depends partly on the key.

USING A KEY

The correct way to grasp the key is important. The knob of the key should be

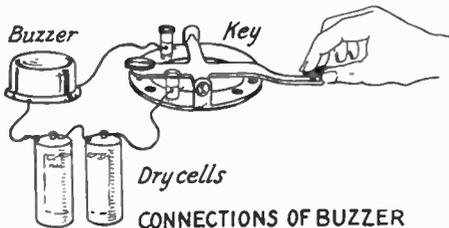

CONNECTIONS OF BUZZER KEY, BATTERIES AND THE CATLIN GRIP

about eighteen inches from the edge of the operating table and about on a line with the operator's right shoulder. A table of about thirty inches height is best. The

spring tension of the key varies with different operators. A fairly heavy spring at the start is desirable. The back adjustment of the key should be changed until there is a vertical movement of about one sixteenth inch at the knob.

Do not hold the key tightly. Let the hand rest lightly on the key. The thumb should be against the left side of the key. The first and second fingers should be bent a little. They should hold the middle and right sides of the knob respectively. The fingers are partly on top and partly over the side of the knob. The other two fingers should be free of the key. The sketch shows the correct way to hold a key.

A wrist motion should be used in sending. The whole arm should not be used. One should not send "nervously" but with a steady flexing of the wrist. The grasp on the key should be firm, not tight, or jerky sending will result. None of the muscles should be tense but they should all be under control. The arm should rest lightly on the operating table with the wrist held above the table. An up-and-down motion without any sideways action is best. The fingers should never leave the key knob.

A	N
B	O
C	P
D	Q
E	R
F	S
G	T
H	U
I	V
J	W
K	X
L	Y
M	Z
1	6
2	7
3	8
4	9
5	0

LETTERS AND FIGURES OF THE CONTINENTAL CODE

The code is made up of different combinations of dots and dashes. The sending of intelligible signals depends on proper keying by the transmitting operator. The dots and dashes must be of the proper relative length. Suitable spaces must be left between letters and words. A dash is equal in length to three dots. The space between parts of the same letter is equal to one dot. The space between two words is equal to five dots. The exact time intervals depend on the rate of sending. Beginners key a bit stiffly, making a C like two N's. Muscle control improves with a few hours daily practise.

RECEIVING

Now that we have *memorized* the code we must begin to practise sending and receiving using the buzzer practise set. Someone who is already a good operator should be enlisted to send the first signals.

Go over the code and name the different letters as they are sent on the buzzer. The letters should be sent while you name them. Don't try to compare different letters. Learn each by its own individual sound. Each letter combination should be sent in a snappy way. A slow rate of sending should be secured by leaving long spaces between letters, not by dragging out the signals. Practise on letters and then on groups of letters. Write down what you receive to better co-ordinate the process of receiving and recording signals. Do not try to write down the dots and dashes; *put down the letters*.

Code groups are more valuable for ordinary practise than straight English texts. The frequency with which certain letters appear in common writing gives more practise on some letters than on others. Concentrate on the practise work and be patient. All the effort you spend in learning the code will repay you fifty-fold.

Always have the letters sent you for practise a little faster than you can comfortably receive. When the sending is so fast that you can copy just two out of every three letters, your mind will be speeded up and you will try to get that other letter.

SENDING

When sending do not try to speed things up too soon. A slow, even rate of sending is the mark of a good operator. Speed will come with time alone. Leave freak keys alone until you have mastered the knack of properly handling the standard-type telegraph key. Because radio transmissions are seldom free from interference a "heavier" style of sending is best to develop for radio work. A rugged key of heavy construction will help in this.

When signals can be copied "solid" at a rate of ten words a minute it is time to start practising with a key in earnest. The paragraph on "using a key" and the diagram show just how to grasp a key. An experienced operator should be present right at the start to offer suggestions. Otherwise a wrong idea of spacing or of holding the key may develop into a habit that is hard to break. While learning to receive, you have become fairly familiar with good sending. Try to imitate the machine or tape sending that you have heard. This gives a good example of proper spacing values.

When beginning to handle a key do not try to send more than six or seven words a minute. A dot results from a short depression of the key. A dash comes from the same motion but the contact is held three

times as long as when making a dot. A common mistake of beginners is to make it several times too long. There is no great space between the parts of a letter. An "S" is made by three up-and-down motions of the key in regular sequence. The letter "G" is made by holding the first two contacts and making the third one without any pause at the contact. Key practise should not be extended over too-long periods at first. The control of the muscles in the wrist and forearm should be developed gradually for best results.

Individuality in sending should be suppressed rather than cultivated. Sending is something like writing, however. Individuality is bound to show in all hand-sending. Unless the spacing is even and regular, reception becomes guess-work. The operator who practises on a buzzer until he has developed a good "fist" is appreciated by everyone he "works". His sending is legible and gets favorable attention.

A good rule in sending is never to send faster than you can receive. Then you can tell what your signals sound like to the operator who must copy them. Speed needs to be held in check. "Copiability" is what we want. Repeats waste valuable time. When you find that you are sending too fast for the other fellow, slow down to his speed. Attempting to send dots nervously in as rapid succession as possible is the first step in acquiring a "glass arm".

A word may be said about the "Vibroplex" and "double-action" keys. The "Vibroplex" makes dots automatically. The rate of making dots is regulated by changing the position of a weight on a swinging armature. Dots are made by pressing a lever to the right. Dashes are made by holding it to the left for the proper interval. A side motion is used in both types of keys.

These keys are useful mainly for operators who have lots of traffic to handle in a short time and for operators who have ruined their sending arm. Such keys are motion savers. However a great deal of practise is necessary before readable code can be sent. The average novice who uses a "bug" tries to send too fast and ruins his sending altogether. The beginner should keep away from such keys. After he has become very good at handling a regulation telegraph key, he may practise on a "bug" to advantage.

LEARNING BY LISTENING.

Another method of learning the code will appeal to some individuals. We all want to try our skill on some real messages when we have progressed this far. The next step *after memorizing the letters* is to put into practise on an actual receiving set what we have learned.

A number of high-power stations can be

heard in every part of the world. Some commercial short-wave stations send on wavelengths below one hundred meters and can be copied with the receiver described on page 48. A one-tube or two-tube receiver can be quickly and cheaply put together for long-wave code practise. Powerful transatlantic commercial stations send on wavelengths between 5,000 and 20,000 meters. Many of them use tape transmission. The sending is perfectly regular. The stations send at speeds depending on the reception conditions at the time of transmission. It is usually possible to pick a station going at about the desired speed for code practise.

Right here we will list the materials that will be needed to construct a long-wave receiver for code-practise work:

- 1 1500-turn honeycomb coil (5000 to 15000 meters)
- 1 standard single coil mounting (not pivoted)
- 1 good variable condenser having a maximum capacity of .001 microfarads.
- 4 brass angles to support the condenser
- 1 good tube socket
- 1 30-ohm rheostat
- 1 .001-microfarad Sangamo mica by-pass condenser
- 1 .00025-microfarad mica grid condenser
- 1 2-megohm grid leak
- 10 feet of No. 14 tinned bus wire
- 1 single jack, open-circuit type
- 1 terminal block, 2" x 4 1/4" x 1/4", bakelite
- 1 wood base board, 1" x 7 1/2" x 12"
- 6 8-32 binding posts or machine screws with two hex nuts each.

The coil mounting and coil can be obtained from Sears-Roebuck and Co., Montgomery Ward and Co., Charles Branston,

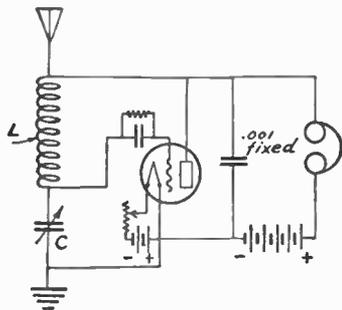

SCHEMATIC DIAGRAM OF A "SINGLE CIRCUIT" LONG-WAVE RECEIVER FOR CODE PRACTISE

Inc., Buffalo, N. Y., or the Remler Radio Manufacturing Company of San Francisco.

For the commercial ship and shore stations a 150-turn coil may be purchased. For the 1200 to 2000-meter wavelength band a

400-turn coil will be correct. A 750-turn coil will bridge the gap from 2600 to 5000 meters. These coils may be added as desired and by plugging them into the coil mounting the wavelength range of the set may be changed. You can then hear all the dif-

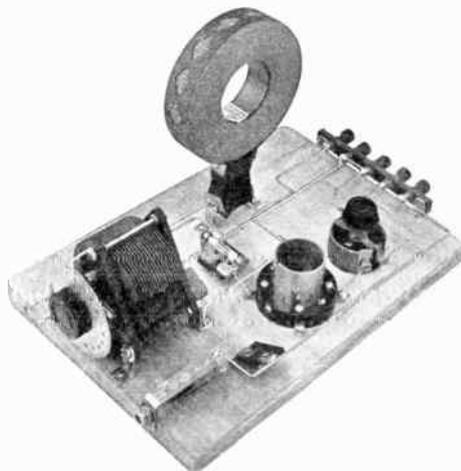

HOW THE SIMPLE LONG-WAVE RECEIVER LOOKS WHEN BUILT ON A "BREADBOARD"

ferent kinds of radio communication that we have mentioned in these bands.

The circuit and photograph of such a receiver are shown herewith. The parts may be connected as shown in the photograph.

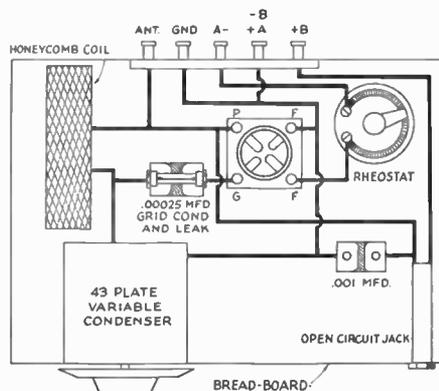

PICTURE DIAGRAM SHOWING HOW THE PARTS OF THE LONG-WAVE RECEIVER ARE CONNECTED

With the smaller coils we can hear Arlington's Navy Press as well as many low-powered ship and shore stations. We shall not want to listen to their high speed traffic handling at first. The longer wavelengths received with the large coil are most suitable for code practise.

Tuning is accomplished with the variable condenser. The use of but one con-

trol makes the tuning simple. The tone of the incoming signal can be varied to suit the operator. At first hunt for a station sending slowly. Listen for a letter. Use paper and pencil and write down the letters as you hear them. Try to copy as many letters as you can. Sometimes you will hear signals that you cannot interpret. Long-wave stations use keying systems that allow a signal to go out between the dots and dashes on a different wavelength. You will readily learn to distinguish between this "backlash", as it is called, and the actual



NOTE - Size of drill to agree with type of binding post used.

TERMINAL BLOCK SEEN FROM THE BACK OF SET

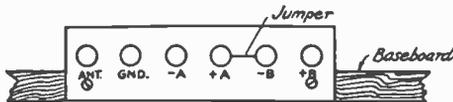

NOTE - Posts "+A" and "-B" are connected together as shown.

ARRANGEMENT OF COMPLETED TERMINAL BLOCK SEEN FROM THE BACK OF SET.

signals that you can copy. Whenever you hear a letter that you know, write it down. Keep everlastingly at it. Twenty minutes or half an hour is long enough for one session. This practise should be repeated three or four times a day. Don't become discouraged. Soon you will copy without missing so many letters. Then you will begin to get calls, which are repeated several times, and whole words like "and" and "the". After words will come sentences. You now know the code and your speed will improve slowly with practise. Learning by this method may seem harder to some folks than learning with the buzzer. It is the opinion of the writer, who learned in this way, that the practise in copying actual signals and having real difficulties with interference, static, and fading, is far superior to that obtained by routine buzzer practise. Of course that is of great value at first in getting familiar with the alphabet.

Many short cuts have been proposed for quickly memorizing the code for increasing speed of reception. Most of them have some good points. Learning the code is mostly a matter of getting practise, however. An omnigraph is of some assistance if a large number of records can be obtained. It is an expense that few can afford. Unless many different sets of "copy" are available one soon becomes familiar with the material and it is of no more

value. Phonograph records of code signals can be obtained but have similar drawbacks. Examinations for operator's licenses are conducted using an omnigraph. Therefore it is desirable to become familiar with tape or omnigraph sending to insure easily passing the examination. "Machine sending" on long or short waves is about as good as an omnigraph except that the speed cannot be controlled at will.

In "learning by listening" try to pick stations sending just a bit faster than your limit. In writing, try to make the separation between words definite. Try to copy the whole of short words before starting to write them down. Do the writing while listening to the first part of the next word. Practise and patience will soon make it easy to listen and write at the same time. Good operators can often copy several words "behind" the incoming signals.

AN ALL-WAVE RECEIVER

Under the heading "Learning by Listening" we have described the simplest and cheapest long-wave outfit that can be put together for getting code practise. The set is a "single circuit" affair and has the several advantages and disadvantages of all single circuit tuners.

For permanent use a somewhat better job can be made by purchasing another condenser, a 3-coil swivel mounting, and a few extra honey-comb coils wound on 2 1/2" forms. The "three circuit" regenerative (primary-secondary-tickler) circuit should be used,

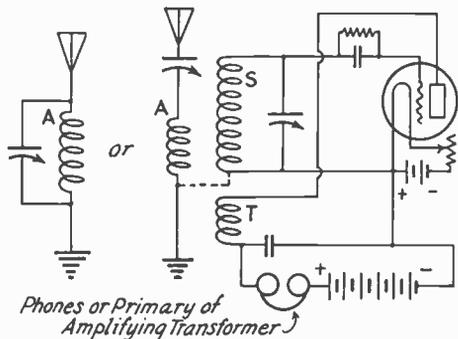

Phones or Primary of Amplifying Transformer
THREE CIRCUIT REGENERATIVE RECEIVER

giving more flexible and selective tuning with less trouble in getting it to work. Such an all-wave receiver will work efficiently on the long waves. It will be inferior to a special receiver for short-wave and broadcast work, however.

In the circuit shown, 1,000 micromicrofarad variable condensers are used in the antenna circuit and across the secondary coil. Smaller condensers will be best for getting good station distribution on the dial for amateur and broadcast wavelengths. This

outfit works best on wavelengths longer than 750 meters. When the tickler can be at the grounded end of the secondary coil, undesirable tuning effects are minimized.

All the parts are shown properly connected in the picture diagram. The an-

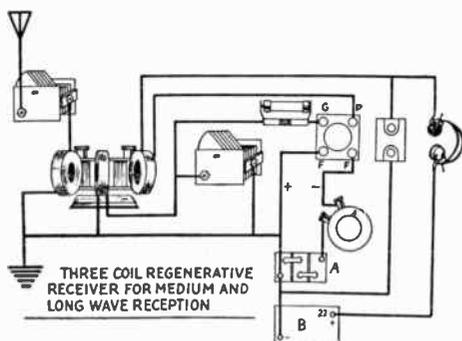

tenna coil (A) is the left-hand coil in the sketch while the secondary coil (S) is in the center of the coil mounting and the tickler (T) is on the right. A list of the proper number of turns for each coil to cover certain wavelengths is given below. The secondary coil is the one which really deter-

mines the wavelength band that can be covered with a certain size of secondary tuning condenser.

mines the wavelength band that can be covered with a certain size of secondary tuning condenser. The farther apart we move the antenna and secondary coils, the easier the set will oscillate and the "sharper" the tuning. Different stations can be separated more easily when the coils are not too close together. Varying the position of the coils changes the "coupling," as explained elsewhere. The tickler should be brought up toward the secondary coil until a light click is heard in the phones. Then the set is oscillating and stations may be tuned in by the process of turning the dial of the secondary tuning condenser (the one across S). When a station is found the tickler can be readjusted for loudest signal strength. Louder signals still can be obtained by bringing the antenna more nearly in tune by varying the setting of the antenna condenser which will also make a slight readjustment of the tickler coil position desirable.

READING DIAGRAMS

Schematic diagrams show the different parts of a circuit in skeleton form. Picture

Service	(Meters)	Turns Ant. Coil	Turns Sec. Coil	Turns Tic. Coil	Antenna coil connection for .001 mfd. var. condenser
Amateur and Broadcast	140-350	35	25	35	Series
Broadcast and Commercial	250-700	75	50	35	"
Comm'l Ship-Shore Tfc.	450-1500	150	100	75	"
Comm'l and Navy	700-2200	200	150	100	"
NAA Time	1100-4000	300	250	150	"
Arc Stations	2350-4800	200	300	150	Parallel
Arc Stations	2500-8500	500	500	200	"
Commercial, Foreign, and press	3100-15000	750	750	300	"
Same and NSS Time	6000-21000	750	1250	500	"

mines the wavelength band that can be covered with a certain size of secondary tuning condenser.

The dotted line means that equally good results may be expected with the filament circuit either grounded or ungrounded. The principle advantage in grounding the filament and connecting the movable plates of the variable condenser to this side of the circuit is that it minimizes the detuning effect of the hand when brought close to the condenser dial.

The schematic circuit diagram shows two methods of making the antenna coil connection. The "series" connection shown in both diagrams may be used for all wavelengths but with the "parallel" arrangement shown at the left it will be easiest to tune our antenna circuit clear up to the twenty thousand meter wavelengths which will result in the best signal strength. A

diagrams show the connections and apparatus as it actually appears in the station or laboratory. A little study of the symbols used in schematic diagrams will be helpful in understanding the circuits that appear in *QST* and in most of the radio books that we have mentioned. The diagrams are easy to understand once we have rubbed shoulders with some real apparatus and read about it. Schematic diagrams are used in all electrical work because they save so much space and time when discussing the various circuits. Picture diagrams are simpler to use but difficult to draw. Photographs of apparatus show the actual arrangement used better, but the wiring is not always as clear as in the picture diagrams. In building most apparatus a schematic diagram and a photograph will make everything clear. It is suggested that the beginner carefully compare a few picture and schematic dia-

grams if not entirely familiar with the latter.

We have not room in this book to include pages of pictures of apparatus giving the proper symbol for each device but a number of picture diagrams have been put in at different points so that a comparison of picture and schematic diagrams will enable one to understand what is intended in all the schematic diagrams here and elsewhere. In general, coils are indicated by a few loops of wire, resistances by a jagged line, and variable elements in the circuit by

arrowheads. If a device has an iron core it is usually shown by a few parallel lines opposite the loops indicating coils or windings.

When you can draw and talk about circuits in terms of the various conventional symbols you are on what is familiar ground to every amateur and experimenter. Then you can meet the dyed-in-the-wool expert and understand what he talks about.

You may find a correspondence school course of some help. It depends on the in-

STATIONS YOU WILL HEAR ON THE LONG WAVES

Call	Location	Wavelength	Time G.M.T.	Service
NSS	Annapolis, Md.	17,150 (17.5kc)	2200	Ice report
NAA	Arlington, Va.	2,677 (112.0kc)	1655-0255	Time Signals and Press
		4,409 (68.4kc)	1655-1530	Time Signals, Weather and Navy Press
NAR	Key West, Fla.	2,939-5,657	1655-0300	Time Signals and weather
NAT	New Orleans, La.	2,752 (107.0kc)	1655-1500	Time Signals
POZ	Nauen, Germany	18,075 (16.6kc)	1155	Time Signals
		3,900 (77.0kc)	2355-1155	Time Signals
LY	Bordeaux, France	18,940 (15.8kc)	0801	Time Signals
YN	Lyons, France	15,000 (20.0kc)	1700-1750	Wave calibration
		15,500 (19.4kc)	0818-0850	Time Signals
IDO	Rome, Italy	10,850 (27.6kc)	0850-1950	Coded report
NPG	San Francisco, Cal.	7,005 (28.6kc)	1700-0330	Weather bulletin
		4,836 (62.5kc)	0555-1955	Time Signals
NPL	San Diego, Cal.	9,798 (30.6kc)	1000-1655	Press and time
		2,939 (100.0kc)	1630-1655	Time Signals
UA	Nantes, France	9,000 (33.3kc)	1415	Wave calibration
FL	Paris (Eiffel Tower)	7,000 (42.8kc)	1640	Wave calibration
		6,000 (50.0kc)	1455	Coded synoptic report
		2,600 (115.0kc)	2244	Time Signals
NAD	Boston, Mass.	2,939 (102.1kc)	1600-2200	Weather bulletin
NAH	New York, N. Y.	2,776 (107.1kc)	1530-2200	Weather and navigation
XDA	Mexico City	5,800 (51.7kc)	0054-1856	Time Signals
NPM	Pearl Harbor, Honolulu	2,828 (107.0kc)	2355	Time Signals
		5,552 (52.3kc)	0630-1830	Weather
		11,490 (26.1kc)	2355	Time Signals
WQK	Rocky Point, L. I.	(Several waves)	Traffic	with different countries
WCC	Chatham, Mass.	2,150 (140.0kc)		Press
		2,200 (136.0kc)	2200-1400	Weather conditions
NBD	Bar Harbor, Maine	2,400 (125.0kc)	0800	Press
NAM	Norfolk, Va.	2,883 (107. kc)	1330-2100	Weather bulletin
GBL	Leafield, England	8750 (34.3kc)	0000-2000	Press
WSE	East Moriches, L. I., N. Y.	2,800 (107. kc)	0130	Press
NBA	Darien, Panama (Balboa, Canal Zone)	6,518 (46.0kc)	0900-1000	Time and Press
		6,518 (46.0kc)	1755-2755	Time Signals
OUI	Eilvese, Hanover, Ger.	9,600 (31.3kc)		Press
WAX	Miami (Heliah), Fla.	5,552 (54.0kc)	1130	Press
		600-1,599-2,175 (500-188-138kc)		
WNU	New Orleans, La.	3,331 (90.0kc)	0500-1700	Press
		600-1,700 (500-177kc)	1630	Weather
WSH	East Moriches, L. I., N. Y.	2,400 (125.0kc)	0315	Press
WSA	East Hapton, L. I., N. Y.	650 (462.0kc)	0315	Press
WRQ	East Hampton, L.I., N.Y.	13,500 (22.2kc)	0518	Press
WBF	Boston, Mass.	600-690-2,025-2,350		
WNN	Mobile, Ala.	600-680-1,713		
UQ	Bluefields, Nicaragua	1,850-2,100		
UW	Cape Gracias, Nicaragua	650-2,000		
UL	Managua, Nicaragua	600-1,800-2,400-4,600		
UG	Tegucigalpa, Honduras	600-1,950-4,330		

dividual's ability to absorb by mail. In any event, though, study things out from the information available in this book—then jump in and enjoy the experience. Learn by doing!

third word in the text of Bordeaux's number 271 addressed to the cable address Irvingbank?"

The answer to an "RQ" is a "BQ". If the

Some active and regular traffic-handling circuits are:

Carnarvon, Wales MUU, and New Brunswick, N. J., WII
Bordeaux, France, LY, and Marion, Mass., WSO
Stavanger, Norway LCM, and Tuckerton, N. J., WGG
Nauen, Germany POZ, and Rocky Point, L. I., WQK
Elvесе, Germany OUI, and Marion, Mass., WSO

Regular operators handle these circuits in some cases; in others "tape" or "machine" transmission and reception is used to speed up traffic handling to the limit fixed by relays and atmospheric conditions.

Most beginners are puzzled by certain abbreviations which are used right along on long waves. Many code groups are sent by different commercial organizations to shorten the messages and to reduce the expense of sending messages which often runs as high as 25 cents a word. Unless one has a code book it is impossible to interpret such messages. Five and ten-letter cypher groups are quite common and make excellent practise signals. Occasionally, when receiving conditions are fine, a blur of code will be heard which results when tape is speeded up to 100 words per minute and photographic means are used to record the signals.

A prefix is often used to show the class of traffic and the station to whom the message is going. The long-wave commercial stations number their messages periodically. Ship and shore stations start a new series of message numbers each day and with each new station worked. Naval stations use "v" for an intermediate. The commercial stations use "de" for an intermediate. Thus Tuckerton sending the 86th message for a certain period sends, "86 LCM de WGG." In case Bordeaux is sending, the prefix reads "F 86" or if the operator is just starting his evening's work, "Hr tfc F 86", meaning "Here traffic Bordeaux, France, number 86". Stavanger, Norway, uses the prefix "NW"; POZ uses "PR" and OUI uses "OPR".

Traffic is classed as "ordinary"; "deferred"; "urgent"; and "rush". "Ordinary" messages have a straight prefix as we have mentioned above. "Deferred" messages have "K" added to the prefix of a given station. "Urgent" messages have "D" added to the prefix. An "R" stands for rush.

When the receiving operator is uncertain of a word or part of a message, he asks a repeat from the transmitting station at the first opportunity. "RQ" is the prefix that tells what is meant. "RQ" is used when the receiver questions the message. "RQ F 271 irvingbank third" means, "What is the

third word of number 271 was "membership", LY will answer the "RQ" by sending, "BQ F 271 third membership."

When the public asks for information about a message, a service message is sent. The prefix "SG" is used for this. If the reply comes back with the prefix "SVC" (service), "SG", or in the form of a "BQ" showing the company to be at fault, the company does not charge for the service message. If "ST" is added to "BQ" the message in question was clear of errors the first time transmitted. Then the service message is paid for by the inquirer.

A time conversion chart is printed elsewhere in this booklet. Most schedules of high power stations are kept on Greenwich time (five hours later than Eastern Standard Time).

LCO and LCD in the prefix refer to the text as being "Language of country of origin" or "Language of country of delivery". RP means "reply prepaid".

It should perhaps be emphasized that the procedure described in the foregoing paragraphs is that of commercial usage, not amateur. Amateurs use a less complex procedure of their own, as will be explained later.

UNDERSTANDING TIME SIGNALS AND WEATHER REPORTS

Amateurs in the United States will probably find the time signals, weather and press reports from Arlington, Va., (NAA, 2650 meters) and Annapolis, Md., (NSS, 16,000 meters) sent at noon and 10 p.m., E.S.T., most useful and interesting in learning the code. Sometimes before sending the press NAA will request listeners to stand by (QRX) for a certain time while ship traffic is cleared. That gives us a chance to see how traffic is handled. Then the "U.S. Navy Press" will follow with interesting worldwide news items. A 12-to-15-word code speed is employed.

The time signals start at 11:55 a.m. and 9:55 p.m., E.S.T., daily. Every tick of the standard clock at the Naval Observatory is sent as a dot. The 29th second of each minute is omitted as well as the last five seconds of the first four minutes of time

signals. The last ten seconds before the hour are omitted. The beginning of the dash which is sent at noon and ten p.m. is exactly the hour.

Weather reports go something like this: "QST de NAA USWB T02081 DB01251 H00442 P99265," etc. This introduction means, "General call to all stations from Arlington, Va., United States Weather Bureau." The report gives conditions at various points two hours previous to the time of transmission. The key-letters refer to the different observation points. A few of the commoner ones follow:

T—Nantucket, R. I.	K—Key West, Fla.
DB—Delaware Breakwater.	DU—Duluth, Minn.
H—Cape Hatteras, N. C.	G—Green Bay, Wis.
P—Pensacola, Fla.	D—Detroit, Mich.
B—Bermuda.	M—Marquette, Mich.
C—Charleston, S. C.	CH—Chicago, Ill.
S—Sydney, Nova Scotia.	V—Cleveland, O.
SF—San Francisco, Cal.	DI—San Diego, Cal.
SE—Seattle, Wash.	

The first three figures give the barometer reading. "P992" shows that the barometer at Pensacola reads 29.92 inches. "6" shows the direction of the wind:

1—North	5—South
2—Northeast	6—Southwest
3—East	7—West
4—Southeast	8—Northwest

The last figure gives the velocity of the wind in statute miles per hour. 1.15 nautical miles equal 1 statute mile. "5", for example, indicates "fresh breeze" according to the table below:

Figure	Air	Statute M.P.H.
0	Calm	0-3
1	Light air	3
2	Light breezes	13
3	Gentle breezes	18
4	Moderate breezes	23
5	Fresh breezes	28
6	Strong breezes	34
7	Moderate gale	40
8	Fresh gale	48
9	Strong gale	56
10	Whole gale	65
11	Storm	75
12	Hurricane	90

When several 5-unit groups of figures are given, the first two groups are surface observations at stations indicated by the key letters. Additional groups contain *upper air data* which can be interpreted in the customary way.

The Radio Service Bulletin which is issued monthly by the Department of Commerce may be obtained from the Superintendent of Documents, Government Printing Office, Washington, D. C., for 25c a year. This gives the up-to-date details about such stations.

Official Broadcasting Stations of the A.R.R.L. send the latest Headquarters' news on *amateur wavelengths*. The messages are often interesting and they are sent slowly enough for code practise between 15 and 20 words a minute. Lists and schedules appear frequently in the membership copies of *QST*.

A word of caution: The U.S. radio communication laws prescribe heavy penalties for divulging the contents of any radiogram to other than the addressee. You may copy anything you hear for practise or for your own information but you must preserve its secrecy.

SHIP-SHORE STATIONS

After a little proficiency in code speed has been developed it is interesting to become familiar with other radio services than the long-wave commercial stations that are so useful in giving regular code practise. Cables cross the oceans: telegraph and telephone circuits span the continents. The minute we set foot on a ship and get away from the offices and residences where our everyday life is spent, we are cut off from quick and easy two-way communication by telegraph, telephone and mail. Everything now depends on wireless telegraphy. The very ship on which we travel is protected by radio beacons. Warnings and weather reports are received every few hours. If we have important business to transact it must be done by radiogram.

So the business handled from ship to shore is always varied and interesting. Its importance can hardly be sufficiently stressed in a few words. Steamers many days at sea keep in touch with the stock market quotations, and receive news of world-wide significance. They receive individual messages for their passengers. When storms are encountered, machinery becomes damaged, fires break out, or when there is trouble aboard ship, a simple SOS call brings assistance from the nearest point within just a few hours, depending on the nearness of assistance. The safety and confidence of everyone in the ocean travel of to-day depends in a large measure on the ship-shore telegraphic communication.

At one end of the broadcast band of wavelengths lies the amateur telegraph field and a number of experimental services. At the other end of the broadcast band lies the ship-shore communication channels. Hundreds of ships have traffic to clear to shore daily. Often foreign ships sending in the broadcast band cause interference for which the amateur is unjustly blamed. Ship and shore station operators have highly developed time-saving procedure in order to handle many varied messages with a minimum of interference (QRM) with each other. So that the listener will know what to expect and so that he can understand what he hears we will give a few of the commoner abbreviations and their uses right here.

Using the 150-turn coil to listen to the ship-shore traffic between 500 and 1200 meters wavelength we may hear both "spark" and "tube" transmitters. The

communication laws specify that a call shall be made by sending the "attention sign" once, the call letters of the station called three times, the intermediate "de" (meaning from) once, and following this with the call letters of the calling station three times. The full form of a call is like the following, "—.—.— WSA WSA WSA de ITF ITF ITF." The answer, "—.—.— ITF ITF ITF de WSA K", signifies that WSA is ready for traffic. Usually the note of WSA or any of the shore stations is quite distinctive. To save time he may say nothing but "ITF K". When the ship station is near the shore station, he shortens his call to "WSA ITF". If WSA is busy taking traffic from someone else he will ask ITF to "stand by", this way: "ITF QRX". Still shorter is "ITF .—.—." which means the same thing.

On long waves some of the commercial stations use the Navy intermediate "v" instead of "de". For ship-shore work the "de" is most common. A 600-meter wavelength is used for *calling*, and 700 to 850 meters is used for *working*. 952 meters is used for naval radio compass work.

When ITF says, "WSA ITF P" he means, "I have a *paid* message for you. The reply from WSA is usually, "ITF K 700". The operator at WSA then proceeds to listen on 700 meters or thereabouts and to copy the message. The prefix "P" in the message shows that it is a "paid" message. "TR" is the prefix to a position report which is sent daily showing the position of various ships for the information of owners and the public who await ship movements anxiously. "SVC" indicates that a service message is coming. The letters "GOVT" indicate that a government message will be sent.

"W", "WDS", or "CK" refer to the number of words or the check of the message. "RC" usually refers to the Radio Corporation of America who control some of the large traffic-handling commercial stations. A short commercial message with a "radio" check might be sent from WLC to ITF as follows: "ITF WLC R HR P 1 W 11 CONEY ISLAND NY 217P 14 to WILLIAM RICHARDSON SS GENUARO RCNEWLONDON —.—.— ADVISE WHAT NEW MACHINERY NECESSARY —.—.— TOMPKINS AR WSA K".

The time and date precede the address. Suppose the operator of ITF misses a few words; he may ask WLC to repeat: "QTA TEXT". He may use ".—.—.—." for the missed portions as described elsewhere in this book. To ask for missing words, "WA" and "WB" refer to the "word after" and "word before" a specified word.

POSITION REPORTS

Ship stations send a "position report" daily or when requested by the coast sta-

tion. The letters "TR" precede the report, which includes the distance from ship to the shore station in nautical miles, the position as briefly as possible, the next port of call and the number of radiograms or words handled. The speed of the ship is sometimes included. A sample report: "—.—.— TR 150 OFF CAPE HATTERAS BOSTON 5 —.—.— ITF".

The presence of unnecessary capital letters, periods, commas or other marks of punctuation may alter the meaning of a text. For this reason commercial communication companies use a shiftless typewriter (capitals only). The texts of messages are typed in solid block letters (all capitals) devoid of punctuation, underlining and paragraphing except where expressed in words.

Code speed depends mostly on the amount of practise one gets. Anyone can learn the code. A desire to learn, plus determination and persistence at the start are the prime requisites a beginner should have.

As soon as the scattered letters begin to make words and sentences, the beginner is repaid a thousand-fold for his time and trouble. Long wave (5,000-15,000-meter) flute-like signals have a charm all their own; medium wavelength (500-5,000-meter) signals are filled with throbbing "human-interest stuff"; the broadcast band (200-500 meters) brings us music that entertains; the amateur short-wave signals (15-200 meters) give us the thrills of world-wide two-way contacts with others just like ourselves. Each wavelength has its particular characteristics and the whole spectrum of radio activities is a field where we can explore and enjoy the findings when we will, not forgetting to keep the contents of messages secret as required by law.

OBTAINING A GOVERNMENT LICENSE

Before one can operate ANY form of transmitter he *must* have two government licenses. A license is required for the *station* and another license is required for each *operator* of the station. Happily, neither of the licenses costs anything to obtain.

The station license allows the station to be operated. The man who holds the license is responsible for the proper operation of the station under the terms of the license. The operator's license is proof of the ability of the operator. Some knowledge of the code and operation of the apparatus are necessary to get this license. There is information enough right in this book to enable anyone to get an amateur operator's license. No license whatsoever is necessary for the operation of any kind of receiving station. Operation of a transmitter of ANY SORT without a license is unlawful and a heavy penalty is imposed for such operation.

There are several grades of station licenses. The Provisional license is a

temporary license given an uninspected station. The Supervisor of Radio cannot visit and inspect every station as soon as application has been made so Provisional licenses are issued. The Restricted license is necessary when a station operates near a government station. If you live within five miles of a military or naval station there are restrictions in power or wavelength necessary to prevent interference to such services. Usually there are no restrictions of this sort that affect amateur operation materially. The General license replaces the Provisional license when a station has been inspected and approved by the Radio Supervisor. The Experimental ("X") license is given to stations having a definite object in view that justifies the granting of special wavelength and power privileges. Individuals engaged in research or engineering work frequently can get Experimental licenses but the Government has been generous in giving amateurs plenty of wavelengths and a great deal of valuable work can be done with the ordinary grades of station licenses. Long experience and proof that the work cannot be done with a "dummy" antenna are necessary to get an "X" license.

Most amateurs hold the Provisional or General grade of license which is not hard to obtain. All ordinary citizen radio work can be carried on under such a license.

Amateur operators are licensed in three grades. The Second Grade, First Grade and Extra First Grade are the names by which they are known. The Second Grade license is given amateurs who do not live near the Supervisor's office, who have to take a brief examination by mail. Anyone can get application blanks for operator's and station licenses from the nearest Supervisor by asking for them. Provisional and Second Grade operators' licenses are issued to be effective until the applicant can be examined in person and the station inspected. When you are qualified, two licensed men in your vicinity will gladly make affidavit to the fact that you can send and receive at 10 words per minute.

The First Grade amateur operator's license is issued when the Supervisor has given the examination in person. A ten-word speed is all that is necessary for the code part of this examination.

The Extra First grade of license requires a code speed of 20 words per minute and a very good understanding of the technical points of the game.

Either a first or second grade amateur operator's license is sufficient, although a Commercial "ticket" is proudly displayed in many a "ham shack".

The requirements for passing the amateur examination are not difficult. Information on all amateur stations and operating rulings of the Department of Commerce may

be obtained on application to the Supervisors. The applicant must be able to send and receive 10 words a minute, 5 letters to the word of the Continental code. He must be familiar with the "Radio Communication Laws and Regulations of the United States," available from Superintendent of Documents, Government Printing Office, Washington, D. C., for 15c (not stamps). Special attention should be given to the part of the pamphlet which mentions amateur stations. Applicants are expected to be familiar with amateur receiving and transmitting equipment. The construction and function of each part of the apparatus should be studied. You should be able to explain the operation and elementary theory quite thoroughly.

In the examination the applicant is required to tell what apparatus he expects to use, to draw a simple diagram of connections, and to explain the operation. The diagram should show the switches and ground connections just as they are in the station. Applicants must be able to identify a distress signal (SOS) and to understand the signal used telling him to stop sending (QRT) when he is causing interference (QRM).

Tube sets for CW and ICW telegraph work or for radiophone communication on certain amateur bands are readily licensed. Spark sets are no longer licensed to operate on amateur wavelengths. If an applicant lives near the Supervisor of his district it is only necessary for him to get in touch with the Supervisor. The necessary arrangements for taking the examination and getting a station license can be made in person or by mail.

The Department of Commerce licenses amateur telegraph stations to work in *any* or *all* of several wavelength bands. If voice is to be used, the station must be built to work in either the 83.28-85.66 (3600-3500 kcs.) or the 170-180 (1765-1667 kcs.) meter wavelength band. Amateur transmission when using wavelengths above 85.6 meters is prohibited in the United States between the hours of 8:00 and 10:30 P. M. local standard time, and on Sundays during local church services. Radiophone stations using the 80-meter band are also required to observe the prescribed quiet hours. Interference to other services cannot be permitted and quiet hours are prescribed when readjustments of the transmitter or alterations of a non-selective receiver will not do away with the trouble.

A.R.R.L. "Vigilance Committees" have been organized in a number of communities. Amateurs, broadcast listeners, and representatives of the local newspapers make up the committees. They investigate reports of amateur interference, put the interested parties in touch with each other, suggest ways of reducing or getting rid of

the interference and see that the blame is placed where it belongs. When quiet hours are necessary, they are recommended. In cases where suggestions are disregarded, the interference is reported in detail to League Headquarters. In extreme cases the matter has to be turned over to the Department of Commerce. 98% of the interference experienced by broadcast listeners comes from power leaks and foreign ships who transmit in the broadcast band when near our shores. The Vigilance Committees have done much to educate the broadcast listener regarding the sources of interference and they have reduced what little amateur interference there has been to a negligible quantity.

To-day there is no excuse for amateur interference. The broadcast listener who uses a non-selective receiver (there are some such still on the market) has only himself to blame if he takes no steps to improve it and increase its selectivity. The amateur who interferes can always reduce his wavelength, loosen the antenna coupling and improve the plate supply. The addition of a "key thump filter" will often be sufficient to permit non-interfering operation. Close proximity to a transmitting station often results in the setting up of forced oscillations in near-by receiving circuits. Placing antennas at right angles and using good "shielding" will eliminate even such troubles.

There should not be the slightest hesitation in constructing a station on the grounds that it will "interfere" or "draw lightning". The use of short wavelengths has solved the interference problem for good, as far as the situation between these different services is concerned. A receiving or transmitting antenna properly grounded will "leak" off a charge gradually to ground, preventing the accumulation of voltage that might cause a disruptive discharge with danger to life and property. An antenna is a protection, not a hazard.

You may construct your station for telegraph work in any of the following wavelength bands:

Amateur Wavelengths for telegraphy	Corresponding frequencies (Kilocycles)	Kilocycles width of each band
.7477— .7496	401,000—400,000	1,000
4.69 — 5.35	64,000— 56,000	8,000
18.7 — 21.4	16,000— 14,000	2,000
37.5 — 42.8	8,000— 7,000	1,000
75.0 — 85.7	4,000— 3,500	500
150.0 —200.0	2,000— 1,500	500

The four last mentioned wavelength bands have proved most useful in carrying on actual communication over great distances. The purpose of the Government in assigning many wavelength bands to amateurs is to give the amateur the freedom which

has always been his due. Thus the knowledge of the behavior of the shorter wavelengths incidental to actual communication can be developed most fully. The *experimenter* is most interested in the two first mentioned wavelength bands about which least is known.

The five-meter band is the "widest" as shown in the above table. From the standpoint of interference between short-wave stations, most stations should be operating on the lower wavelengths.

The different degrees of usefulness of the different bands cause the distribution of operating stations to vary widely from the ideal case from the interference standpoint. The 20-meter and 40-meter wavelengths have proved most useful for daylight work over long distances. At night many records have been made using 80-meter and 150-meter wavelengths. Using the shorter waves, there is often difficulty in talking with stations within three or four hundred miles while greater distances than this and also very short distances of ten or twelve miles can be covered with ease. In summer, transcontinental and foreign daylight work is best accomplished using 20 meters; 40 meters seems best for the same purpose at night. In winter 80 meters is usually used at night for such distances. 150-meter and 200-meter wavelengths are good at night for almost any distance up to 3000 miles. They also have the advantage of being best for working with stations one or two hundred miles away. Probably the 75-85 meter band is best to use in transmitting when getting started, although there are lots of good things to listen to on other wavelengths.

Request application blanks (Form 756 and 757) and information from the nearest Supervisor of Radio. The country is divided by the Department of Commerce into nine Inspection Districts. The addresses and territories of the different Supervisors follow:

First District: Maine, New Hampshire, Vermont, Massachusetts, Rhode Island and Connecticut. Address, Supervisor of Radio, Customhouse, Boston, Mass.

Second District: New York (county of New York, Staten Island, Long Island, and the counties on the Hudson River to and including Schenectady, Albany, and Rensselaer) and New Jersey (counties of Bergen, Passaic, Essex, Union, Middlesex, Monmouth, Hudson and Ocean). Address Supervisor of Radio, Customhouse, Federal Building, Wall, Pine and Nassau Sts., New York City.

Third District: New Jersey (all counties not included in second district), Pennsylvania (counties of Philadelphia, Delaware, all counties south of the Blue Mountains, and Franklin County), Delaware, Maryland, Virginia, and the District of

Columbia. Address Supervisor of Radio, Customhouse, Baltimore, Maryland.

Fourth District: Tennessee, North Carolina, South Carolina, Georgia, Florida and the Territory of Porto Rico. Address Supervisor of Radio, Room 524, Post Office Bldg., Atlanta, Georgia.

Fifth District: Alabama, Mississippi, Louisiana, Texas, Arkansas, Oklahoma and New Mexico. Address Supervisor of Radio, Customhouse, New Orleans, La.

Sixth District: California, Nevada, Utah, Arizona and the Territory of Hawaii. Address Supervisor of Radio, Customhouse, San Francisco, Cal.

Seventh District: Oregon, Washington, Idaho, Montana, Wyoming and the Territory of Alaska. Address Supervisor of Radio, Room 2301, L. C. Smith Bldg., Seattle, Washington.

Eighth District: New York (all coun-

ties not included in the second district). Pennsylvania (all counties not included in the third district), West Virginia, Ohio and Lower Peninsula of Michigan. Address Radio Supervisor, Room 405, Federal Building, Detroit, Mich.

Ninth District: Indiana, Illinois, Wisconsin, Michigan (upper peninsula), Minnesota, Kentucky, Missouri, Kansas, Colorado, Iowa, Nebraska, South Dakota and North Dakota. Address Supervisor of Radio, Federal Building, Chicago, Ill.

When you receive the application blanks fill them out completely, answer all the questions and return the papers to the Radio Supervisor. If you pass the examination you will receive your license *unsigned*. Then take the license to a Notary Public. Execute the oath of secrecy of messages and return the licenses to the Supervisor, who will send them back to you after signing them.

CHAPTER III

Fundamentals

BEFORE we go on to study the problem of economically building a station and getting it working we should step aside just a moment to get some idea of how radio signals can be sent and received.

To understand fully all the things that happen in the process of sending and receiving radio impulses we ought to know something about electricity and the physical laws of electricity and magnetism that determine its behavior as we understand it. The books described and recommended in the appendix will cover the ground very well on this subject. However, we are going to mention some elementary principles that will help in getting a picture of what happens. A thorough groundwork of fundamental knowledge can be gained through consistent reading and through experience in handling apparatus.

ELECTRICITY

Almost everyone has rubbed a cat's fur and noticed the little sparks in it that can be seen in the dark. "Frictional" electricity is present. Sometimes lightning discharges take place between two clouds or between clouds and earth. This is another example of the liberation of "static" electricity which is manufactured by wind friction under certain temperature conditions.

We use electric lights, electric heaters, telephones, flashlights, street cars and motors and know that the mysterious agent that has been harnessed is "electricity." Sometimes we call this "current" electricity, as distinct from the other kind of electricity. Current electricity always manifests itself by heating effects and magnetic effects. All that is known about electricity is known by its effect when it is used in certain ways.

Every substance is made of mixtures or chemical combinations of different elements. Any chemical combination can be divided and redivided into smaller particles of the same chemical make-up. The chemist calls the smallest possible piece of any one such substance a "molecule". Molecules are in turn made of atoms of chemical elements. The atom of hydrogen, copper or carbon, combines with atoms of sulphur or chlorine to make "molecules" of different compounds which the chemist names appropriately. These atoms themselves are made of still smaller particles called electrons, which are of exceedingly small mass and size. The

electron is negative electricity. A positive nucleus (center), surrounded by a group of electrons, makes up the "atom" or smallest particle of every element. So every substance is made up of millions on millions of electrons. The electron itself can be considered the smallest possible quantity of negative electricity.

THE ELECTRIC CURRENT

The everyday uses of "current electricity" we have mentioned. A free flow of electrons in any body constitutes an electric current. When the electrons in a body flow readily we say the body is a "conductor." If they do not flow quite so readily we say that the substance offers more "resistance" to the electric current. If the electrons hardly flow at all we say the body is an "insulator."

The "resistance" of most substances varies somewhat with temperature. Sometimes the variation is so great that a body ordinarily considered an insulator becomes a conductor at high temperatures. The "resistance" of metals usually increases with temperature. The resistance of liquids and of carbon is decreased with increasing temperature. Copper, silver and most metals are relatively good conductors of electricity while such substances as dry glass, mica, rubber, dry wood, porcelain, shellac and gutta percha are good insulators.

MAKING CURRENT ELECTRICITY

The ordinary electric cell and the electric generator are the sources of all our electric current. The electric cell may take the form of a so-called dry cell; it may be a wet cell; it may be a storage cell. In any case the source of current is a chemical source. In the first two forms mentioned the chemical action of the fluid (there is such a fluid in even the "dry" cell) tears down the structure of one of the elements or "poles" of the cell to supply the electric energy current. In the storage cell the chemical change is reversible and the cell can be "recharged." The heating, chemical and magnetic effects of the electric current have been briefly mentioned. These effects are reversible ones, too. The electric generator has wires moving through a magnetic field which can generate the electric current that we are talking about.

SERIES AND PARALLEL CONNECTIONS, E.M.F., CURRENT FLOW

A number of cells or generators grouped together as a source are termed a "battery." By connecting a number of cells together a more powerful current source is obtained than can be made by a single cell. Any high school physics book will explain about the different kinds of electric batteries. Certain chemical solutions and elements are

tive terminal of the battery. The electric current is a "current flow" away from the positive terminal. The diagram shows what is intended. Only because the electron theory had not been advanced when the conventional definition of positive and negative was made do we need to make this distinction. The current flows in the same direction through every part of the circuit. If we examine conditions *inside* the dry

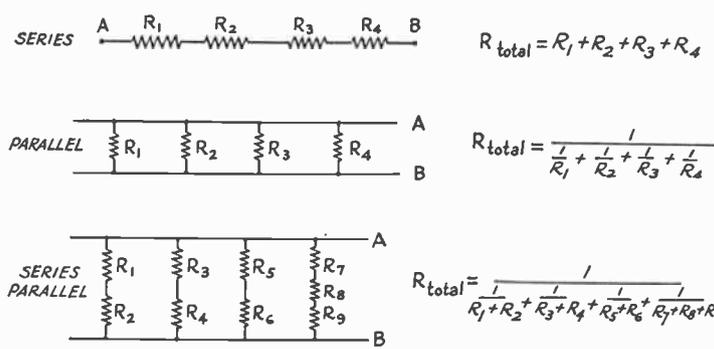

RESISTANCES CONNECTED IN SERIES, PARALLEL, AND SERIES-PARALLEL

best suited for making cells for certain jobs. Electric cells and in fact all pieces of electrical apparatus may be connected in "series" or "parallel" or "series-parallel" depending on which way is best for a given purpose.

In any electric cell, there are two different chemical elements in a solution. Depending on the choice of elements and solution a certain *electromotive force* will be developed and maintained. One terminal will always be *positive* (+) while the other terminal will always be *negative* (-) with respect to it. When the two terminals are connected by a wire or conductor an electric current flows.

In the circuit *external* to a battery the "current" is said to flow from positive to negative. The electrons on the other hand

cells shown in the diagram we find the flow just opposite from the directions indicated for the external circuit. When the key is closed the electric current flows around the external circuit from positive to negative. When the key is open there is an insulating medium or non-conductor between its contacts. No current of any consequence can flow. We speak of the conditions with the key closed as "closed circuit" conditions. When the key or any part of the circuit is open or broken we speak of the conditions as "open circuit" conditions.

When a steady current flows in any electric circuit, the size or amplitude of the current is determined by the *electromotive force* in the circuit and the *resistance* of the circuit. The relations that determine just what current flows are known as Ohm's Law. In order that we may speak conveniently of electrical pressure, current and resistance, certain units of measure are used. The commonly accepted *unit of current* is the ampere. The *unit of electromotive force* or electrical pressure is the volt. The *unit of resistance* is the ohm. When one volt (e.m.f.) is applied in a circuit having one ohm resistance, a current of one ampere will flow.

When I is the current in amperes, E is the electromotive force in volts and R is the circuit resistance in ohms. A simple formula expresses Ohm's law:

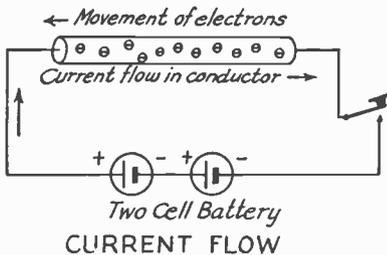

are said to flow from the negative pole of the battery to the positive. Thus we must always think of the flow of negatively charged particles as an "electron flow" toward the posi-

$$R = \frac{E}{I} \quad I = \frac{E}{R} \quad E = RI$$

The resistance of the whole circuit can be found by dividing the voltage by the current. The current can be found by dividing the voltage by the resistance. The e.m.f. is equal to the product of the resistance and current flowing. It is at once evident that if any two of the quantities are known, the other may be found by applying the formula.

A good analogy can be made by considering for a moment some fluid acting in a

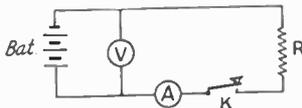

A - SCHEMATIC DIAGRAM

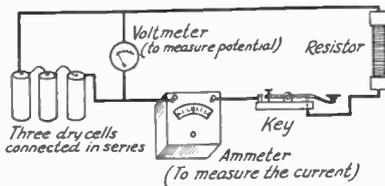

B - PICTURE DIAGRAM

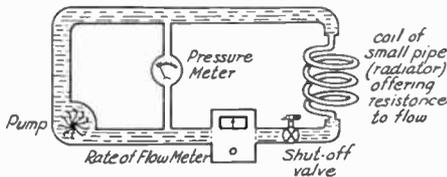

C - MECHANICAL ANALOGY

THE ELECTRIC CIRCUIT AND MEASURING INSTRUMENTS

mechanical circuit. In Figure 1C the pump has a similar function to that of the battery.

A shut-off valve controls the current flow in the pipe similarly to that of the key in the electric circuit. The walls of the pipe offer "resistance" to the flow of fluid just as the atomic structure of the connecting wires and resistor hold back the flow of electric current in the electric circuit. A water pressure meter and a "rate-of-flow" meter have the same uses in such a circuit that the voltmeter and ammeter have in measuring the electrical pressure and rate of current flow in the electric circuit.

The higher the "pressure" the more fluid will flow around the pipe. The smaller the pipe the greater its "resistance" and the less current will be permitted to flow.

USING OHM'S LAW

Every part of an electric circuit has some resistance. We have shown how cells can be connected in series, how resistances can be connected in series. Different electrical instruments can be connected in series in the electric circuit. In the diagram on the next page, the tubes, the rheostat, and the three cells of the storage battery make up the series circuit. The two vacuum tubes are connected in parallel, but they are in series with respect to the rest of the circuit. The rheostat is a variable resistance and is used to change the current flowing in the circuit by changing a part of the resistance of the whole circuit and therefore in effect changing the whole resistance which is the sum of all the parts. The rheostat has part of the circuit resistance, the exact value depending on the position of the rheostat arm and the amount of resistance wire that it includes in the circuit. The storage cells themselves have some "internal" resistance, depending on their condition. The filaments have a resistance depending on the temperature. This in turn depends on the current through the tubes. The lead wires in the circuit also have resistance. Sometimes certain resistances are so small that they can be neglected for practical computations. If the lead wires are of copper and have a large cross-sectional area (the kind of wire and the size wire used determine the "conductivity" [mhos] which is the reciprocal of the resistance in such a circuit) their resistance is so small that we need not consider it. If dry cells are used, their resistance may be neglected if they are new. Storage cells always have a very low internal resistance if they are cared for and kept charged.

VOLTAGE DROPS

When current flows through a resistance we have what is called a "voltage drop" across the resistance. The voltage drop is always equal to the voltage which causes the current to flow through the resistance. The voltage drop across the filament of a vacuum tube can always be found by Ohm's Law and is the "resistance" (of the filament) times the current flowing through it. The sum of all the voltage drops across the various pieces of apparatus in a series circuit is always equal to the voltage of the source (or the sum of the voltages in the circuit if there be more than one source). This law is known as Kirchoff's Law. So the combined voltage drop across the rheostat and the paralleled filaments will be always equal to the voltage of the storage battery (six volts).

Keeping these relations in mind we can find the resistance of any part of the circuit. For example, we have a detector and one

stage audio amplifier (standard equipment for amateur code work) using two UX-201-A tubes. What resistance (Rx) should we connect in the circuit to use a six-volt battery with this outfit?

On the box in which the tube came we find that the manufacturers specify a terminal voltage of 5 volts and a filament current of .25 (¼) ampere for each tube. This then will be the voltage drop or terminal voltage of the tube under operating con-

ditions. When two tubes are connected in parallel the resistance of the combination is:

$$R = \frac{1}{\frac{1}{R_1} + \frac{1}{R_2}} = \frac{R_1 R_2}{R_1 + R_2} = \frac{20 \times 20}{20 + 20} = 10 \text{ ohms}$$

Now we can check the accuracy of our problem solution by using our answers and the e.m.f. in the circuit and solving for the current.

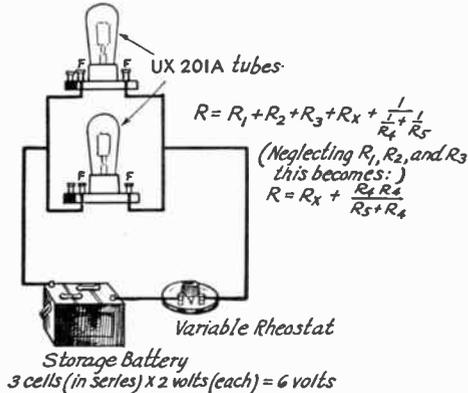
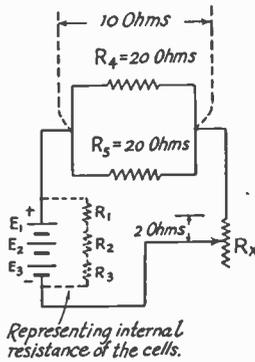

SERIES-PARALLEL CONNECTION SHOWING HOW TO SOLVE FOR THE TOTAL RESISTANCE IN THE CIRCUIT

ditions. We have two tubes each requiring .25 amperes so our storage battery will have to supply 2 x .25 or .5 (½) ampere. If possible, always find the current and voltage (or the effective resistance) of the portions of the circuit in parallel before trying to find out about the series branches of the circuit.

Because the summation of the voltage drops equals the voltage of the source, the drop across the rheostat equals 6 volts minus 5 volts or 1 volt. We have assumed that the drops in the battery and leads are negligible, which is nearly true.

Now we know two things about the rheostat. The voltage drop across it must be 1 volt. The current through it is .5 ampere. By Ohm's Law the resistance is:

$$R = \frac{E}{I} = \frac{1}{\frac{1}{2}} = 2 \text{ ohms.}$$

The usual 0-6 ohm rheostat will give ample variation and should be chosen for this purpose.

The resistance of the filament under any operating conditions can be determined by Ohm's Law or from facts about the tube supplied by the manufacturer. A five-volt tube which takes a filament current of one-fourth ampere has a resistance of 5 di-

$$I = \frac{E}{R} = \frac{6 \text{ volts}}{10 \text{ ohms} + 2 \text{ ohms}} = \frac{1}{2} \text{ ampere}$$

R = combined resistance of tubes plus resistance of rheostat at proper setting

The heating effect of the electric current is caused by the friction of the electricity flowing through the wire. The higher the resistance the more heat will be generated for a given length of time (seconds) and for a given amount of current and the greater will be the power loss or power spent in making heat.

$$\text{Power (watts)} = I^2 R = EI = \frac{E^2}{R}$$

$$\text{Heat (British Thermal Units)} = I^2 RT \text{ (9.5 x 10}^4 \text{)}$$

If the current in a resistor and the resistance value is known we can readily find the power that is used. If the voltage drop across a resistance and the current through it are known we can determine the resistance value and also the power used, which is always equal to the product of volts and amperes.

Maximum power is spent in heating when

the load resistance equals the internal resistance of battery or generator.

pending on length, area and material acts similarly in the magnetic circuit.

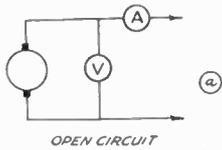

OPEN CIRCUIT
Full voltage at terminals but no current, therefore no output

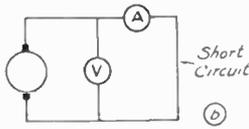

SHORT CIRCUIT
Very large current but no voltage at machine terminals therefore no output, altho much power is being used up inside the machine

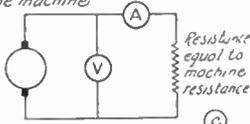

LOAD FOR MOST OUTPUT
Half the generated voltage at machine terminals, heavy current, large output.

NOTE: Conditions (b & c) shown above are impractical for generator operation, however for vacuum tubes we want largest possible output

VARIATION OF OUTPUT AS LOAD RESISTANCE IS CHANGED

$$I = \frac{E}{R} \text{ in the electric circuit so}$$

$$\Phi = \frac{\text{mmf.}}{\mu} \text{ in the magnetic circuit.}$$

The magnetic field about wires and coils may be traced with a compass needle or by sprinkling iron filings on a sheet of paper held about the coil through which current is passing. When there is an iron core the increased magnetic force and the concentration of the field about the iron is readily discernible.

Permeability is the ratio between the flux density produced by a certain m.m.f. and the flux density that the same m.m.f. will produce in air. Iron and nickel have higher permeability than air. Iron has quite high permeability and is comparatively inexpensive and is therefore very commonly used in magnetic circuits of electrical devices.

The permeability of iron varies a lot depending on the treatment it is given during manufacture. Soft iron has low permeability. The molecules readily turn end to end when current flows around a soft iron bar and we have a *magnet*. When the circuit is broken and the current does not flow, the molecules again assume their hit-

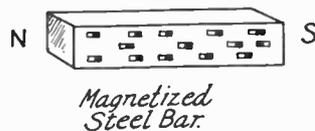
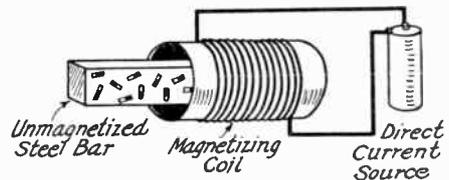

HOW PERMANENT MAGNETS ARE MADE

Magnetic effects are always present when a current flows in a circuit. Lines of magnetic force or influence surround the current carrying conductors. When a conductor is wound into a coil of many turns the magnetic field becomes stronger because there are more lines. The laws of the magnetic circuit are similar to those of the electric circuit but we do not use them as often in elementary work. The magnetic force is spoken of in terms of magnetomotive force (m.m.f.) which depends on the number of turns of wire, the size of the coil, and the amount of current flowing in the coil. If ten amperes flow in one turn of wire the magnetizing effect is 10 *ampere-turns*. If one ampere flows in ten turns of wire the magnetizing effect is also 10 *ampere-turns*

The length of the magnetic circuit, the material of which it is made and the cross-sectional area, determine what "magnetic" current or flux (Φ) will be present. Just as the resistance of the wire determines what current will flow in the electric circuit, the *reluctance* (μ) of the magnetic circuit de-

or-miss positions. Little or no magnetic effect remains. When a steel bar is subjected to the same magneto motive force in the same way, it has less magnetic effect. However, when the current is removed, the molecules tend to hold their end-to-end positions and we have produced a *permanent magnet*. Compass needles are made in this way. Permanent magnets lose their magnetism only when subjected to a reversed m.m.f., when heated very hot or when jarred violently.

The direction of the magnetic field can be found by what is called the right-hand rule. Grasp the wire in the right hand with the fingers around it and the thumb pointing along the conductor in the direction in which

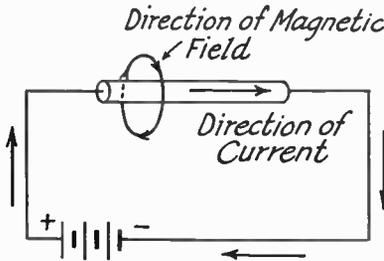

the current is flowing. The fingers then point in the direction of the magnetic field.

ALTERNATING CURRENT

Thus far we have considered current electricity as a flow of electrons in one direction around a circuit. This sort of a current is known as "direct" current (D. C.). In many applications to-day we have to think about "alternating" current (A. C.). Instead of a unidirectional current in the circuit, the current that flows goes first in one direction and then in the other. Instead of having a pump (dynamo with commutator) to make the water flow in one direction in a pipe, we now have a double-acting pump and the water (electrons) flow first in one direction and then in the other. The speed of the reversals depends on the time in which the pump acts in each direction before reversing. In an alternating current generator the number of field poles and the speed of rotation determine the number of alternations or reversals in current that take place in one second. A complete cycle has two alternations or reversals of current. The diagram shows the way in which a rotating coil cuts a magnetic field, and the changes in the direction of the current with time are indicated by the second part of the diagram, as well as the amplitude or size of current flow during different parts of the cycle.

We shall be much concerned with alternating currents, as all radio work is based on them. The number of cycles that takes place each second is called the "frequency" of an alternating current. Power circuits ordinarily use 25-cycle current. Electric lighting circuits are usually 60-cycle circuits. Ship radio generators are often wound for 500-cycle operation. Radio transmission circuits require energy at frequencies of 15,000 to several millions of cycles per second. These higher frequencies can be produced in several ways. We are concerned with the equipment that is necessary. High frequency alternators and

"arc" sets can best be used to produce the lower radio frequencies. "Spark" transmitters have been in use for years for ship-shore communication. "Vacuum tube" transmitters are most efficient and inexpensive of all. They are widely used today for all sorts of radio services. The older equipment is interesting but we shall study the tube transmitter mainly.

INDUCTION

When current passes through a coil it sets up a magnetic field around the coil. The strength of this field varies as the current varies. Conversely, if a field of varying strength passes through a coil an electromotive force is induced in the coil. If a permanent magnet is thrust in and out of a coil a voltage is induced in the coil. The time rate of cutting flux determines the value of the induced voltage.

This principle is utilized in large direct-current and alternating-current generators,

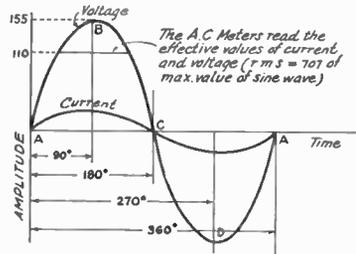
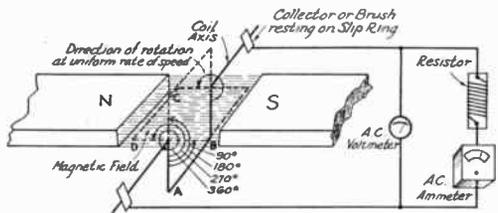

SIMPLE ALTERNATOR CIRCUIT

Diagram shows instantaneous values of current and voltage with electrical degrees of coil rotation - there are 360 electrical degrees for every pair of poles so that one complete mechanical revolution may correspond to more than one electrical revolution.

in transformers and in all sorts of electric motors and rotating electrical machinery. In generators and motors, magnets (or field poles) set up an electrical field which links conductors (armature coils). The relative motion of the field poles and the armature determines the rate of cutting flux and the voltage that is induced. In transformers the parts are stationary but the flux is alternating or changing in value and direction. The value of the induced voltage depends on the rate at which the magnetic field changes and on the number

of turns in the coils. Changes in flux follow changes in current directly. All coils have that property known as "self-inductance", or electrical inertia. A decreasing current causes a decreasing flux. The decreasing flux induces an E.M.F. in the coil which tends to prevent any further decrease in current. The direction of the induced voltage always tends to prevent the change of current which makes the induced voltage. When changing flux links other coils which are near the coil in which a varying current flows, a voltage is set up in each coil, the value depending on the rate of change of the flux linking each coil and on the turns in the respective coils. The induction between coils is known as "mutual" induction.

Energy is stored in the magnetic field which surrounds a current-carrying coil.

Inductance is measured in "henries". This property of a coil depends on its number of turns, the diameter of the coil, and on the permeability of the magnetic material of the core. In 25-cycle and 60-cycle work an iron path is usually provided for the flux. The permeability of iron is much greater than that of air at these frequencies. All iron and steel shows a "magnetic lag". The flux in the iron lags somewhat behind the current producing it. This phenomenon is known as "magnetic hysteresis". When the magnetizing force (H) is increased, the flux density (B) increases very rapidly at first if an iron core is used. However, for large values of magnetizing force, the intensity of magnetization becomes constant and the magnetic substance is said to have become "saturated". A further increase in flux density (B) can only be made by a disproportionate increase in magnetizing force (H). In radio-frequency circuits, iron introduces a hysteresis loss. The higher the frequency the lower the permissible flux density. The iron cannot follow the rapid changes in flux. It is worthless at the higher radio frequencies.

FIXED AND VARIABLE INDUCTANCE

Coils used in radio circuits are made having either fixed or variable inductance values. Fixed coils have a fixed self-inductance (L). Sometimes two coils are arranged in series so that they may be rotated with respect to each other. When the fields add, the mutual inductance of the combination (2M) can be added to the self-inductance of each of the coils. When the fields are opposed, the mutual inductance (2M) is subtracted from the self-inductance of the two coils. When the fields of the coils are at right angles, the mutual inductance is zero and the inductance of the combination is the sum of the inductances of the two coils. This arrangement is commonly known as a variometer.

CAPACITANCE AND CONDENSERS

The property of a dielectric between two conductors that makes it possible for the combination to become charged is known as capacitance. Coils have inductance; condensers have capacitance. Usually a number of metal plates of large area are separated by air, mica, glass or some other dielectric. The capacitance of a condenser depends on the number of the plates, the area of the plates, the distance by which they are separated and the material of the dielectric.

The "electric field", sometimes called the "electrostatic" field of the condenser, is con-

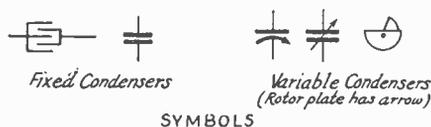

SYMBOLS



FORMS OF CONDENSERS

centrated mostly in the space between the plates. When the plates are connected to a direct current source, a heavy current flows for an instant, and decreases to zero. The condenser is said to be "charged" and if the dielectric is good, it will hold the charge for some time. If the current source is taken away and a wire connected across the plates, the condenser will discharge through the wire. A large condenser charged with several hundred volts will give a visible spark and discharge with a crash. It will also cruelly "jolt" one who plays thoughtlessly with its terminals.

Energy is stored in the electric field of a condenser just as it is stored in the magnetic field of a coil. The energy in the field of a coil or condenser is potential energy. Water stored in a tank high above the earth has potential energy due to its position with respect to the center of the earth.

Capacitances can be connected in series or in parallel like resistances or inductances. However, connecting condensers in parallel makes the total capacitance greater. In the case of resistance and inductance, the value is lessened by making a parallel connection.

DISTRIBUTED INDUCTANCE, CAPACITANCE AND RESISTANCE

Thus far, we have considered three properties of electrical circuits and apparatus. Coils, condensers and resistors

are all built to have as much of one of these properties as possible without having a great deal of the other two. These "lumped" properties can be connected in a circuit to produce a certain effect on the current and voltage distribution. Condensers will not permit the passage of a steady direct current. Radio frequency impulses act readily through a condenser, however. Choke coils and large inductance coils tend to prevent rapid changes in current. Radio frequency impulses do not act through properly built coils. Direct or continuous current, however, flows unhindered by the inductance of coils.

In every sort of coil or condenser and in every electrical circuit, we find not the one property for which the instrument was built but a combination of all the electrical properties we have mentioned. Most design work is a compromise, to approach nearest the ideal results we have in mind. Every coil and transformer winding has resistance and distributed capacitance between the turns as well as the inductance that makes it a useful device. Every condenser has resistance losses also. Power lines, telephone circuits, cables and radio antennas all have distributed inductance, capacitance, and resistance throughout their entire length. Lumped values are introduced at intervals and at the terminals to produce certain effects. The distributed properties have to be carefully considered also.

OHM'S LAW FOR ALTERNATING CURRENT

Alternating current behaves much the same way as direct current in circuits that contain resistance only. However, its behavior is somewhat changed by the addition of capacitance and inductance to a circuit.

We have mentioned the fact that the rise of current in a circuit containing inductance was somewhat delayed, that the inductance had the effect of electrical inertia. The effect of a lot of inductance is to tend to prevent any increase or decrease of current in the circuit. It is also true that current must flow into the plates of a condenser before any potential difference can exist between its plates. Because of these facts, we say that the current "lags" behind the voltage in a circuit which has much inductance and that the current "leads" the voltage in a circuit where capacitance predominates.

In a direct current circuit, containing either inductance or capacitance, the current increases to a maximum value or decreases to zero as the case may be, coming to a constant rate of flow after a few moments. In an alternating current circuit, the voltage is alternating in character

as we have seen and the instantaneous values of current and voltage are constantly changing. Some curves show the am-

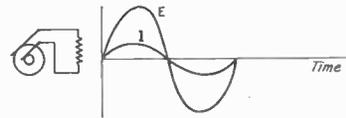

(a) Current and Voltage "in phase" with Pure Resistance in circuit

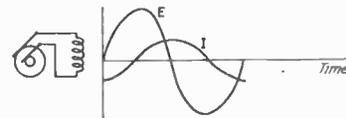

(b) Current "lagging" Voltage with Pure Inductance in circuit

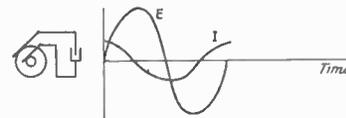

(c) Current "leading" Voltage with Pure Capacitance in circuit

SHOWING AMPLITUDE-TIME RELATIONS OF CURRENT AND VOLTAGE FOR A COMPLETE CYCLE (360 Electrical Degrees)

plitude-time relations of current and voltage in circuits where there is (a) resistance (b) inductance (c) capacitance.

Ohm's Law for alternating currents:

$$E = IZ \quad I = \frac{E}{Z} \quad Z = \frac{E}{I}$$

In an alternating current circuit, the current flow is determined by the voltage of the source and by the resistance (R) and re-

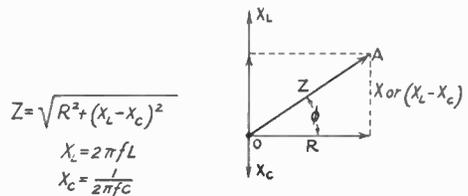

$$Z = \sqrt{R^2 + (X_L - X_C)^2}$$

$$X_L = 2\pi fL$$

$$X_C = \frac{1}{2\pi fC}$$

THE IMPEDANCE TRIANGLE

(showing relations between impedance and its components, reactance and resistance)

actance (X) of the different parts (i.e., the impedance Z) of the circuit. R, X, and Z are expressed in ohms.

Sometimes it is useful to show the relations between R, X and Z in a vector diagram. The length of the lines in such a diagram can be made to represent the size or magnitude of the electrical quantities while the angles between the lines can show "lead" and "lag" in the circuit. In the impedance triangle shown, OA can be taken as unit radius of a circle drawn about the center O. Distances upward represent inductive reactance while distances downward from O

show capacitive reactance. Either may predominate and govern the conditions in a circuit. X_L and X_C are always opposite in their effects and therefore can be subtracted directly if the values are plotted to scale.

Reactance is a property which we have not discussed before. Reactance is a property of a coil or condenser. It is that property depending on the frequency and inductance (or capacity) which determines the behavior of the coil (or condenser) in limiting the current that flows when an alternating voltage is applied. The reactance is but one component of the impedance. The inductive reactance of a coil is meant by the symbol X_L ; the capacitive reactance of a condenser is meant by the symbol X_C . Some resistance is also always present in electrical circuits and must be taken into consideration.

We have spoken of "lead" and "lag". The relations of the voltage drops caused by resistance, inductive or capacitive reactance, and impedance can be shown in a diagram and will help in understanding these terms better.

Alternating voltages and currents have thus far been shown on a magnitude-time chart. The values of amplitude are shown from instant to instant throughout the whole cycle (a complete cycle is 360 electrical degrees of rotation). A vector diagram can be used to show the angular relations and magnitudes at a given instant. In a series circuit, the current is the same through each piece of apparatus. In a parallel circuit the voltage of the source is common to each bit of apparatus connected in the circuit. Either a current vector or a voltage vector may be taken as a reference vector, depending on the particular circuit we are talking about.

The diagram shows a circuit containing resistance, inductance and capacitance in series. The vector (I) is the reference vector showing the current flowing in such a circuit. There is a "voltage drop" across each part of the circuit just as in the case of a direct current circuit. The algebraic sum of all the voltage drops around the circuit is equal to the voltage of the source. In an alternating current circuit some of the voltage drops may be positive and others may be negative. The voltage ($E=RI$) is effective in causing current to flow through the resistance of the circuit. It is "in phase" with the current. The voltage ($E_L=IX_L$) is effective in overcoming the inductance of the coil. It is 90° ahead of the current vector, for the current in a coil lags the voltage, and when the coil has pure inductance the angle is 90° . The voltage ($E_C=-IX_C$) causes current to flow in and out of the condenser plates. It is 90° behind the current vector, for the current in a condenser leads the voltage. Right away one

can see that voltages across coils and condenser in the circuit are about 180° out of phase. When they are equal in amplitude and exactly opposite in phase, the condition known as electrical "resonance" obtains. The current in the circuit is "in

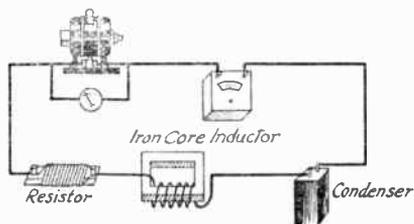

PICTURE DIAGRAM

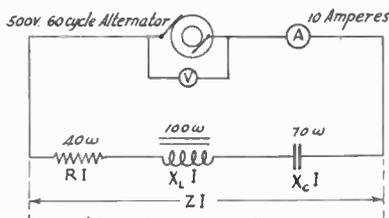

Voltage Drops $\left\{ \begin{array}{l} E_R = RI = 400 \text{ volts} \\ E_L = X_L I = 1000 \text{ volts} \\ E_C = X_C I = 700 \text{ volts} \\ E_{alt} = ZI = 500 \text{ volts} \end{array} \right.$

SCHEMATIC DIAGRAM

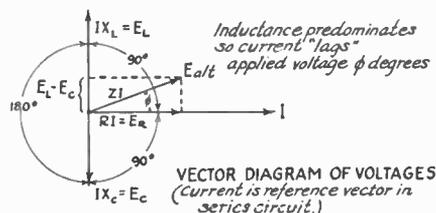

VECTOR DIAGRAM OF VOLTAGES (Current is reference vector in series circuit.)

SERIES ALTERNATING CURRENT CIRCUIT

phase" with the voltage. Its value is determined only by the resistance of the circuit. This is called "series resonance" or "voltage resonance". Sometimes the voltages across the condenser and coil in a circuit like this build up to values much higher than that of the voltage source. Then they become dangerous to both life and equipment. In a vector diagram where size and angle are correctly shown, the "in-phase", "leading" and "lagging" components of the voltage can be separated. The leading and lagging components are 180° apart. Subtraction gives the "effective" reaction vector. Combining this with the "in-phase" vector by the old law of triangles that "the square of the hypotenuse equals the sum of the squares of the other two sides" we can find the "impedance drop" which is the diagonal of the impedance triangle.

In the second diagram a circuit with resistors, coils, and condensers in parallel is shown. The voltage impressed on each device is common to all devices in the circuit. The current in each of the three paths is

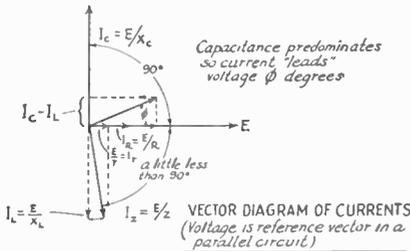
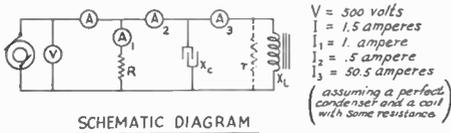
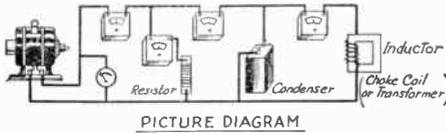

PARALLEL ALTERNATING CURRENT CIRCUIT

determined by the applied voltage and the "resistance" or "reactance" of the path we are considering. In the condenser branch, the current will "lead" the applied voltage; in the coil branch, the current will "lag" the applied voltage; and in the resistance the current will be in phase with the applied voltage. If the current in the coil and that in the condenser happen to be of the same value, the current supplied by the alternator will be the same as that taken by the resistance alone. A much higher current will be present in the leads between the condenser and coil. This condition is known as "parallel" or "current" resonance.

If we know the values of inductance, capacitance and the frequency, we can always figure out the "reactance" and find the current that will flow in the coil or condenser when a certain voltage is applied. If resistance, inductance and capacity are all present, they must all be considered in the proper relation. Complicated net works are hard to solve but usually we can divide the circuit into sections and treat each one independently.

When the resistance of a device is small in proportion to its inductance we can neglect the resistance and simplify calculation. Suppose we want to connect some con-

densers across a high-voltage plate transformer to protect the transformer winding from voltages that might build up if high frequency currents leaked back thru the R. F. choke and filter (unlikely but possible). The higher the frequency is, the lower the "reactance" of any condenser. We know that a small condenser will probably do. We find that a 2000-volt 2-microfarad filter condenser is available. The transformer is a small one and it is possible that the secondary cannot even furnish the current that this condenser will take without overheating.

The plate transformer has a ratio of 10:1 and delivers 1100 volts (effective value) when run normally.

$$X^{\circ} = 1 \div 2 \pi f C = 1/6.28 \times 60 \times 2 \times 10^{-8} = 132800 \text{ ohms at } 60 \text{ cycles.}$$

$$I = \frac{E}{X^{\circ}} = \frac{1100}{132,800} = .0083 \text{ amperes} = 8.3 \text{ m.a.}$$

The transformer is rated at 100 watts (VA) which means that it will deliver

$$I = \frac{W}{E} = \frac{100}{1100} = 91.1 \text{ m. a.}$$

The transformer output goes to a tube rectifier thru a filter which has a 70-henry choke in one lead. After keying in the negative lead the current passes through a 3-henry "keying" filter choke to the plates of two UX-210 tubes. There is a considerable voltage drop in the rectifier tubes and in the resistance of the two choke-coil windings. In addition to this, a resistor may be added in series with the keying choke winding to further drop the voltage so our tube will operate normally with about 400 D.C. volts in its plate circuit.

Each tube takes 45 milliamperes. 2 x 45 = 90 M.A. which the set takes when correctly adjusted. The 2-mfd condenser across our transformer takes a "leading" 60-cycle

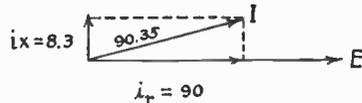

current of 8.3 M.A. (assuming a perfect condenser with no losses). There are filter condensers across the high voltage line but they are across RECTIFIED D.C., and do not affect the transformer current in quite the same way. Assuming that the transmitter operates at nearly unity power factor (current in phase with the voltage)

the resultant current taken by the transmitter AND condenser will be 90.35 M.A.

$$I = \sqrt{(I_r)^2 + (I_x)^2} = \sqrt{90^2 + 8.3^2} = \sqrt{8169} = 90.35 \text{ m.a.}$$

So our transformer will operate at about full load with the condenser and transmitter load connected continuously. Transformers can be operated *intermittently* at 150% of rated load without much danger. Before connecting many different kinds of loads to a transformer we should figure out about what is going to happen. Suitable protective fuses should be installed.

POWER AND POWER FACTOR

In a direct current circuit the power equals the product of volts and amperes. (P=EI) In an A.C. circuit the instantaneous power equals the voltage times the "in-phase" current. P=E (I cos Φ).

We have mentioned the "leading" and "lagging" currents that flow electrically "ahead" of or "behind" the voltage. The

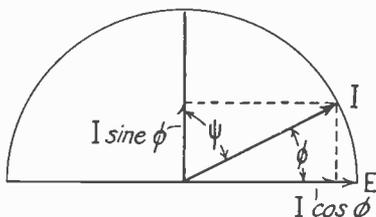

IN THE VECTOR DIAGRAM I COS Φ IS THE "IN PHASE" COMPONENT AND I SIN Φ IS THE "QUADRATURE" COMPONENT

The origin of vectors should be labelled O. Current and voltage vectors are shown with a full arrowhead while the components of the current have the half arrowhead.

angle between the current and voltage is called the "phase" angle (Φ). The cosine of this angle is the "power factor". In the diagram the current (OI) is shown leading the voltage (OE) by the angle (Φ). The cosine (in-phase component of the current) is OI_c. The sine or 90° out-of-phase com-

ponent of the current is I sine Φ in the diagram. This is sometimes known as the quadrature or the "wattless" component of the current. I cos Φ = I_c. Any trigonometry text has tables of sines and cosines of different angles. Strictly speaking the

cosine is the ratio $\frac{OI_c}{OI}$. OI is taken as unity

radius for the semicircle so the cosine can be expressed as OI_c, some fraction of unity. The power factor is the ratio of the actual power dissipated in a circuit (watts) to the volt-amperes (combined power and wattless power.) The volt-ampere rating of a circuit is often known as the "apparent" power.

PHASE DIFFERENCE OF A CONDENSER

The angle between voltage and current in a good condenser is nearly 90°. The power factor of such a circuit (cos Φ or cos 90°) is almost zero.

$$\psi = 90^\circ - \Phi$$

$$\cos \Phi = \sin \psi$$

$$\psi = \sin \psi \text{ approximately (when the angle is nearly } 90^\circ)$$

$$\text{P.F.} = \cos \Phi = \sin \psi = \psi$$

ψ is the angle of *phase difference*. It is the angle expressing best the amount by which the condenser falls short of being a perfect condenser. The power losses in a condenser are:

$$W = E I \cos \Phi = E I \psi = 2 \pi f C E^2 \psi.$$

The better the dielectric of a condenser the lower the phase difference. The power factor of a condenser is the ratio of its

$$\text{resistance to its reactance. P.F.} = \frac{R}{X} = 2 \pi f C R.$$

A condenser with imperfect dielectric behaves like a perfect condenser having a *low* series or a *high* parallel resistance.

CHAPTER IV

How Radio Signals Are Sent and Received

WHEN a pebble is thrown into a still pond, water waves are created which travel outward in circles from a common point. When a clothes line fastened to a post is shaken vertically, waves are set up which travel to the post and are reflected back to the hand.

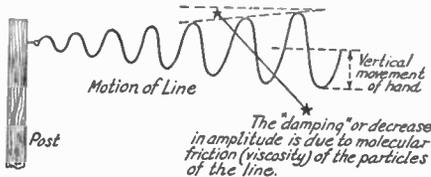

WAVE MOTION

The waves are recurring displacements having amplitude, length, and frequency. They carry energy and spread outward from the source with a definite speed. Light waves and sound waves represent other forms of wave-motion. Radio waves are similar to water waves. They differ in velocity and frequency from other forms of wave-motion.

The velocity of radio waves is about 300,000,000 meters (186,000 miles) per second. There is a fixed relation between the velocity, frequency and length of radio waves. The velocity is constant and the frequency or wavelength may readily be found if either one is known.

$$f = \frac{v}{\lambda}$$

Where
f is frequency (cycles)
v is velocity of propagation (meters/sec.)
λ is the wavelength (meters)

Suppose we know the wavelength is 200 meters.

Then the frequency is $\frac{300,000,000}{200} = 1,500,000$ cycles per second.

A radio wave consists of magnetic and electric lines of force. To create a water wave we can mechanically agitate the water. If we simply throw a pebble into the water, the wave will soon decrease in height, lose energy and be damped out. If we regularly hit the water at suitable intervals we can keep the wave going out continuously from

the central point. To create a radio wave we must disturb the medium in which lines of force or radio waves can be set up. This hypothetical medium is usually referred to as the ether. A high-frequency electric current (radio frequency to-and-fro movement of electrons) is necessary for the production of radio waves. If this current is damped out, the radio wave will also diminish to zero value. Magnetic and electric lines of force go through the same variations as the current that sets them up. If we continually supply energy to keep the electrons in motion, a continuous wave (CW) will be sent out.

We are concerned with the manner of creating this high frequency energy. The apparatus used is of particular interest to us. The lower radio frequencies can be produced by rotating machinery (Alexander-son alternator). Resonant circuits having a natural period or frequency are made use of in converting ordinary direct current to high frequency current. In practice, the electric arc, the spark gap and the vacuum tube have all been used with resonant circuits for this purpose.

OSCILLATIONS

If we put a weight on a spring and release it, the weight bobs up and down for several minutes. The weight has inertia; the spring has elasticity. Coils have inductance or "electrical inertia". Condensers have capacitance or "electrical elasticity". Mechanical and electrical oscillations are very similar in most respects.

When a high voltage is free to act in a circuit containing inductance and capacity, the current surges back and forth in a transient oscillatory way, just as the displaced weight bobs up and down on the spring.

TUNED CIRCUITS

In all radio work tuned circuits are used a great deal. Radio receivers and transmitters alike make use of tuned circuits. "Tuning" a transmitter simply means changing the values of inductance and capacitance so that the "resonant" frequency of the circuit is the desired value. A transmitter is usually tuned to one wavelength (frequency) and the circuit adjusted for maximum effectiveness. If more than one wavelength is used, the adjusting is carefully done for each. The position of clips and condensers should be marked so that a change can be quickly made.

"Tuning" a receiver simply refers to the changing of the variable element (usually capacitance, but which may be either inductance or capacitance) to change the received wavelength.

A tube circuit may be adjusted for either maximum effectiveness or maximum efficiency or both if the controls of power supply and coil adjustment are flexible enough.

$$\lambda = 1885\sqrt{LC}$$

When L is the inductance in microhenries
 C is the capacitance in microfarads
 λ is the wavelength in meters

Simple calculations can be made directly from the formula. Knowing that inductance usually varies as the square of the number of "turns" (n) and as the square of the diameter of coils (d), suppose we wish to tap a coil to receive 40-meter signals, instead of 80 meters which a circuit happens to be working on. The coil is a Bremer-Tully space-wound affair and we will neglect the distributed capacitance, which is otherwise important.

$$\lambda \propto \sqrt{LC} \text{ (from above)}$$

$$\frac{\lambda}{2} \propto \frac{\sqrt{L}}{2} \propto \frac{\sqrt{n^2}}{2} \propto \frac{n}{2}$$

or

$$\frac{\lambda}{2} \propto \frac{\sqrt{L}}{2} \propto \frac{\sqrt{d^2}}{2} \propto \frac{d}{2}$$

Then neglecting distributed capacity, if we tap the coil in the center, the half-wavelength signals will be received. We might also build a coil of half the diameter, having the same number of turns as the original coil. The same variable condenser can be used successfully for tuning.

DAMPING, RESISTANCE, SHARPNESS OF TUNING

We can compare our electrical oscillations to the mechanical oscillations of a pendulum. Given one impulse, the number of times the pendulum swings back and forth depends on the medium around it. It will swing longer in a vacuum than in air. If it is placed in water, it will stop quickly. The work done in overcoming molecular friction slows it to a standstill. The "viscosity" of the water or air is the measure of this sort of friction. For a given impulse, the amplitude of swing will not be so great if the motion is hindered by some sort of friction. Loss of energy causes "damping". In an electrical circuit we meet "resistance" which has much the same effect on electrical oscillations as the "viscosity" of the medium has on mechanical

oscillations. The "sharpness" of tuning and the "amplitude" of electrical oscillations are greatest when the "resistance" of a circuit containing a condenser and coil is lowest.

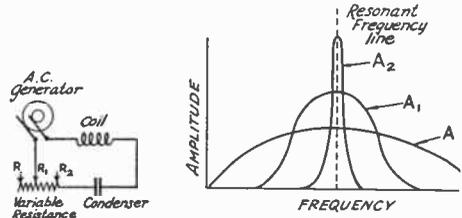

HOW RESISTANCE IN A CIRCUIT BROADENS TUNING

The diagram shows a tuned circuit which has a variable resistance as well as a certain amount of inductance and capacity. The high-frequency generator G impresses a constant voltage in the circuit. The currents that flow vary in broadness and amplitude depending on the amount of resistance in the circuit.

We get the loudest signals with a receiver having low resistance circuits. If we are talking with a station whose note is very sharp and a trifle "wobbly" or if we are tuning for someone near a certain wavelength we can advantageously use a lumped variable non-inductive resistance in our tuned circuits. The note can be broadened and made more readable without materially decreasing its high intensity. Of course, our circuit does not tune as "sharply"; more interference from other stations may be noticed; a certain station will be heard, however, even if the set is de-tuned a trifle. The value of this arrangement depends altogether on the conditions for a given case. Add forty or fifty ohms to one of your tuning circuits and observe the action we have mentioned.

DAMPED AND UNDAMPED WAVES

When our pendulum receives but one impulse to set it in vibration, the oscillations soon die out due to damping. In radio this damping means that the current or oscillation gradually decreases in amplitude. After a few swings thru positive and negative values, the circuit is electrically in a state of rest. Then another discharge across our spark gap will set up another group of damped oscillations.

If energy is supplied in a series of "timed pushes" the oscillations will rise to a maximum value and hold that value continuously. There will be no groups of damped oscillations. The wave will be a continuous wave (CW). The damping effect of the circuit will influence the decaying of oscillations when the circuit is broken as by keying. The energy supplied by each "push" will just make up for the amount lost thru friction (damping) and the amplitude of oscilla-

tions will be constant. The vacuum tube is the most common generator of continuous oscillations.

The spark transmitter creates such a highly damped wave as we have discussed in the second above paragraph. A con-

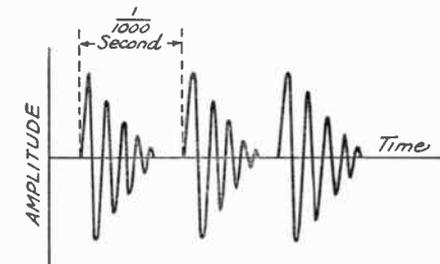

GROUPS OF DAMPED RADIO FREQUENCY OSCILLATIONS

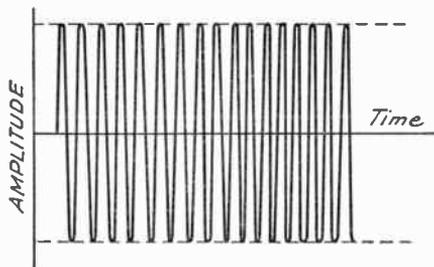

CONTINUOUS R.F. OSCILLATIONS

denser is charged to a high potential. It (C) stores energy. When charged, the condenser voltage breaks down gap (G) and oscillations take place in the LC (inductance-capacitance) circuit. These are coupled into the antenna thru the "oscillation" or "R.F." transformer (LL₁). The resulting electrical surges take place at the natural frequency determined by the values of in-

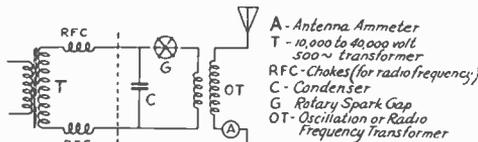

CIRCUIT USED IN A "SPARK" TRANSMITTER

ductance and capacity in the circuit. Just as a pendulum has a natural rate of swinging back and forth determined by its length and weight, every circuit has such an "electrical" period which depends on its inductance and capacity. Unless energy is supplied to electrical circuits to keep them "oscillating", the high-frequency currents are soon damped out by the resistance of

the circuit just as molecular friction of the air stops the action of the pendulum. The escapement of a clock supplies energy from the spring to keep the pendulum in motion. In tube sets, the vacuum tube (like the escapement) provides energy from the plate supply source at the proper time intervals if the transmitting circuits are correctly adjusted.

THE ANTENNA

High frequency currents can produce radio waves. If these currents are confined to circuits containing lumped inductance and capacitance, they are not very effective in producing radio waves, however. An antenna-ground or antenna-counterpoise circuit has distributed inductance, distributed capacitance, and also a comparatively high "radiation" loss. Such a circuit is often referred to as a "radiator" or "radiating system". The physical dimensions are quite large and the lower the frequency the larger they have to be to "radiate" successfully.

The antenna or "radiator" is built expressly for the purpose of setting up the radio waves. Antennas have a number of shapes. The T, the inverted L, the V, the umbrella, and the coil or loop antenna are common types. The last named is very poor for most transmitting purposes but can be used effectively with the very short waves. Directional transmission is effected by building antennas of certain shapes. A loop radiates most energy in both directions along the plane of the loop. The inverted L transmits best in the direction opposite from that in which the horizontal part points. Radio waves like other kinds of waves can be reflected and refracted. Suitable reflectors make a "beam" transmitter that has marked directional characteristics. The short antennas used for high-frequency short-wave transmission do not have any marked directional effects and we do not have to worry about these.

COUPLING

How do we get the radio frequency energy into our antenna, does someone ask? The energy transfer is accomplished by the use of coupled and tuned circuits. A pendulum has a certain natural period of swinging back and forth. We can move the pendulum back and forth at any rate we wish by applying enough force. By far the greatest response is shown when we pay attention to the natural rate of swing and time our application of force accordingly. If one of two pendulums of the same natural period is set in motion and there is a common link between them that transmits even a very tiny bit of energy, the other pendulum will gradually get in motion. Mechanical resonance exists when the two pendulums are tuned to the same natural rate of vibration. The pendulums are "coupled" by the com-

mon link which makes the energy transfer possible.

(A) When the common link in two electrical circuits is a condenser, we refer to the coupling as "capacitive" coupling. (B) When a resistor is used, we speak of "re-

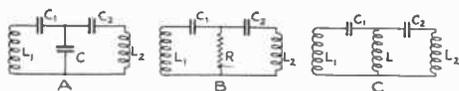

Direct coupling with condenser, resistor, or coil.

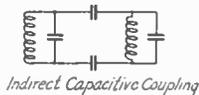

Indirect Capacitive Coupling

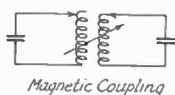

Magnetic Coupling

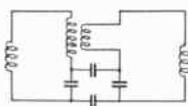

Magnetic and indirect Capacitive Coupling

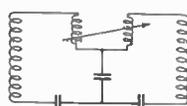

Magnetic and Direct Capacitive Coupling

TYPES OF COMPLEX COUPLING

sistance" coupling. (C) When a coil is used, the coupling is "inductive" coupling. These three types of direct coupling are sometimes called "conductive", as shown in the diagram.

The "voltage drop" across the common link (C, R, or L) caused by current circulating in $L_1 C_1$ (C, R or L) is effective in producing currents in the $L_2 C_2$ (C, R or L) circuit. The $L_1 C_1$ current and the value of C, R, or L determine what takes place in the $C_2 L_2$ circuit.

The circuits may also be coupled less directly as shown in the second diagram.

These methods of coupling are known as indirect capacitive coupling and magnetic coupling, respectively.

Most amateur stations using short wavelengths use "magnetic" coupling. In such an arrangement the coupling value may be changed by changing the number of active turns in either coil or by changing the relative position of the coils (distance or angle between them).

The value of the condensers and coils used for coupling and the value of high frequency currents (causing a voltage drop across the first circuit) determine the power transfer between the two circuits. Whether the coupling is "inductive" or "capacitive" is determined by whether the two circuits are linked by a magnetic or an electrostatic field. Sometimes both kinds of coupling exist and this is known as complex coupling.

All of the above coupling schemes may be classified as either tight or loose. Coupling cannot, as is commonly supposed, be

measured in "inches" separation of coils. The separation between the coils (distance and angle between axes) and the number of turns in each determines the coefficient of coupling. Many turns in two coils very close together give us tight coupling and a big transfer of power. Few turns at right angles or far apart give us loose coupling with little actual energy transfer.

When the coupling between two circuits is very small the two circuits can be readily tuned to be resonant to the same frequency. As we increase or "tighten" the coupling, the mutual inductance increases. The circuits are no longer resonant to the same frequency but the combination is resonant

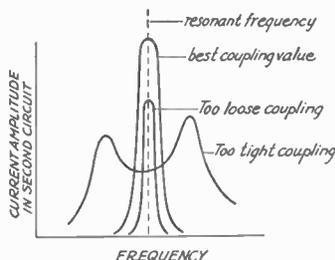
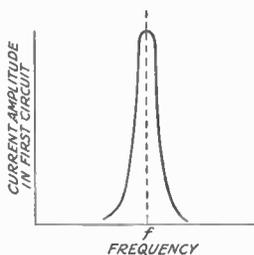

SHOWING CURRENT VALUES IN PRIMARY AND SECONDARY FOR DIFFERENT VALUES OF COUPLING

to two frequencies, one higher and one lower than the first frequency. The quantity of power transferred is greater and greater as the coupling gets tighter and tighter. However, the power transferred on the one frequency that we are interested in, increases to a maximum and then begins to decrease. The peak values of the two frequencies are never quite as high as the one peak. We have a broader wave that creates interference. The range is somewhat decreased. With most transmitters there is a certain critical value of coupling that gives best results. With a tube set, too close (tight) coupling causes instability. The transmitting wavelength flops from one wavelength to another and the signals cannot be easily copied. With a "quenched" spark transmitter and with an "arc" set the best coupling value is somewhat critical. Too close coupling gives a big reading on

the antenna ammeter but the wave is "broad" and the signals do not "reach out".

SENDING AND RECEIVING (DAMPED WAVES)

In transmitting, then, we use apparatus that generates radio-frequency alternating currents from a high-voltage commercial source. The radio-frequency energy is coupled into an antenna or radiating system. Here it sets up magnetic and electric lines of force that radiate in all directions.

In receiving radio signals we may use apparatus similar to the sending equipment and reverse the procedure. Magnetic and

radio waves of long and short length. The biggest tubes handle many kilowatts of energy. They sometimes have water jackets for cooling the plates which waste some power as heat. Any three-element vacuum tube can perform all three kinds of action if we use it properly.

All substances are made of electrons. When most metals are heated some of the electrons in their make-up "boil" off. The purpose of the *filament* in our vacuum tube is to give off electrons. Any light that it gives is simply incidental to the heating process. A tungsten filament has to be

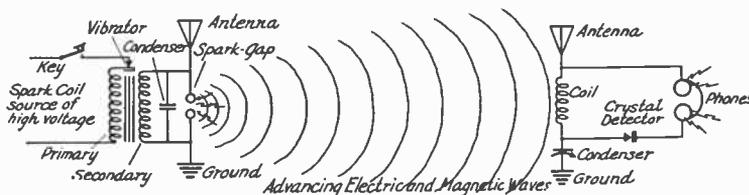

SENDING AND RECEIVING (damped waves) This sending arrangement causes interference and cannot be used by amateurs.

electric lines from the radiator sweep across an antenna which we erect for the purpose. Radio-frequency potentials are induced in it. Our antenna has distributed inductance and capacitance. It therefore tunes to a certain frequency. We can add lumped inductance and capacitance if we please. The maximum response occurs when the antenna circuit is tuned to the incoming frequency. The small potential induced by the advancing electric waves causes oscillations to take place in the antenna circuit. The radio-frequency voltages in this circuit can be applied directly or indirectly to the grid of a vacuum tube or to a crystal detector. These devices have the property of conducting current better in one direction than in the other. Rectification takes place and the damped impulses from a spark transmitter or the modulated voice frequencies from a radiophone may be received. Continuous waves cannot be quite so simply received, however.

THE VACUUM TUBE

The usefulness of the vacuum tube is known to most of us. Its action as a rectifier or detector, as an amplifier, and as an oscillator is known but not so well understood.

A vacuum tube is familiar to most folks as an evacuated glass vessel containing three elements, filament, plate and grid. Small vacuum tubes are used for radio reception. Larger tubes are used as amplifiers of speech or of weak radio-frequency signals. Every time we make a long distance telephone call hundreds of V.T. amplifiers are put into use for our benefit. Still larger tubes are used in making powerful radio-frequency currents for sending out

heated very hot before it gives up its electrons. It takes lots of energy to do this and much light is given off in the process. Thoriated filaments are used in most modern tubes. A coating of barium and strontium oxides on a filament also parts readily with electrons. Such tubes do not take so much power for filament heating. Plenty of electrons are available and but little light is thrown off, as the temperature is not very high.

Electrons are negative particles of electricity. In a tube full of some fluid like air, electrons given off will fall back into the filament. When there is a vacuum around the filament the heated parts are protected from oxidation and the electrons easily boil out and fill this tube. The grid is next to the filament and if it is well insulated so the electrons cannot leak away it will collect electrons until it is negatively charged. Like charges repel and most of the new electrons coming off the filament will then fall back into it. Out beyond the grid is the *plate*. If we connect a battery between the filament and plate with the positive terminal next the plate, the positive plate will attract the negative electrons. As fast as the electrons come off the filament they fly over to the plate. Electrons in motion make an electric current. The amount of current depends on the size and temperature of the filament, the voltage of the battery and the resistance in the different parts of the circuit. The potential of the grid has a marked influence on the current, too. An ammeter or milliammeter anywhere in the circuit will measure the current that flows. A change in the voltage of the plate battery does not change the plate current according to

Ohm's Law. The temperature of the filament plays a part in limiting the electron emission and possible current flow. The electrons come from the heated filament. The grid and plate are seldom hot enough to give off electrons under normal conditions. The current can only flow one way through the tube. If alternating current is applied in the place of our direct current B-battery, the electrons will only be attracted to the plate during the parts of an alternating current cycle when the plate is positive. The tube is acting as a "rectifier". This

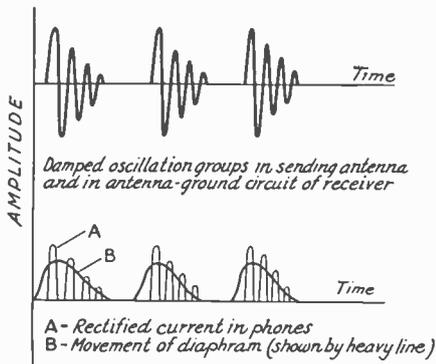

action is similar to that of the "crystal" detector in receiving "spark" and "voice".

The *grid* is the controlling element of the vacuum tube. A two-element vacuum tube is a good rectifier. It can act as a "valve" in the circuit allowing the current to flow in but one direction. It is good for little else, however. The grid is of open construction and it is placed near the filament. A battery (C) can be connected in the grid circuit (between the grid and filament) which makes the grid either positive with respect to the filament or negative with respect to the filament.

When the grid is positive, the negative electrons are attracted more and they get started away from the filament with more velocity so that more of them reach the plate. A plate current meter shows that the plate current has increased. When the grid is negative, the negative electrons are repelled and the plate current is decreased. The grid is near the filament and any change in grid potential has a large effect on the plate current. If the grid potential is varied while the filament current and plate voltage remain constant, the effect on the plate current varies as shown in the diagram. The filament temperature limits the emission of electrons causing the bend at the top of the curves, as saturation is approached. The bends in the curve (A B C D) can be used for detection. The straight section of the characteristic curve is useful for non-distorted amplification.

HOW A VACUUM TUBE "DETECTS"

For simple detection the circuit shown is usually used. A tuned circuit is coupled to the antenna and connected through a small condenser which is shunted by a high resistance to the grid and filament of a vacuum tube. This whole connection is called the *input* circuit to our tube. The filament current is provided by a low voltage battery (the A-battery). The head phones and a higher voltage battery are connected between the filament and plate of the vacuum tube. This is the *output* circuit of our tube. The B-battery, as it is called, usually has a voltage between 15 and 25 volts.

The electric and magnetic field from a sending station set up voltages in the antenna causing oscillating high frequency currents in the antenna coil. The resulting field about this coil links the coil in the input circuit to our tube. This circuit is tuned to resonance at which point there is a maximum voltage across the condenser and coil. One of the terminals of the grid condenser connects to one side of the condenser and coil. This point becomes first positive and then negative at radio frequency. At a given instant let us say that this terminal of the grid condenser is positive. The other plate of the condenser takes on a negative

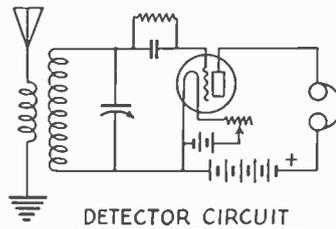

charge of equal value by robbing the grid of some of its electrons. This leaves the grid itself positive with respect to filament. The *resistance* of the grid leak is so high that practically no charge is lost through leakage in the very small time required for a half-oscillation. The positive grid attracts more electrons from the filament through a momentary increase in the plate current. As soon as the negative half of the radio frequency cycle comes along, the other plate of the grid condenser becomes positive and the grid itself has a charge of electrons. The negative grid repels further electrons but *holds all that it has received*. It continues to gain electrons during each positive part of the radio frequency cycles that occur. The result of a continued damped or modulated group of oscillations is to make the grid more or less negative. This causes a dip in the plate current. Between every group of oscillations the negative charge has time to "leak" off the grid through the high

resistance, allowing the plate current to increase again. When receiving modulated speech the process becomes continuous and the variations in telephone current are therefore at speech frequencies.

A tube can detect without the grid condenser and leak by adjusting it to work on the "bend" in the curve. Radio-frequency

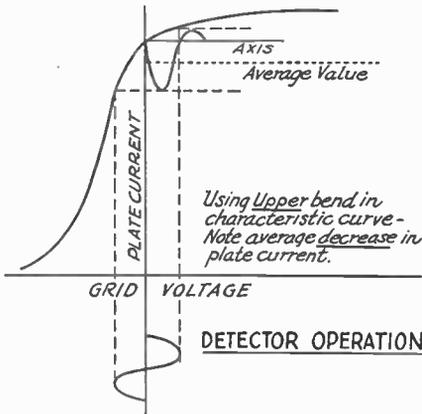

changes in grid potential will make radio-frequency changes in plate current. The decrease in plate current when the grid is negative will be greater than the increase in plate current when the grid is positive (at that "bend" in the plate-current grid-voltage curve which comes just before saturation).

If we wish, we can leave out the grid leak and grid condenser, substituting a C-battery to put a negative bias on the grid of our detector tube. Just the right bias must be used so that the tube will detect on the lower bend of the plate-current grid-voltage characteristic curve. The set recovers quickly from static crashes when this is done. It is quieter in operation than a set with a poor grid leak can ever be. Slightly superior sensitivity on weak signals is claimed, due to the increased quietness.

HOW A VACUUM TUBE "AMPLIFIES"

A small change in grid potential always makes quite a large change in plate current. This makes it possible to apply currents of any frequency to our grid and to use the effect of the varying plate current in a transformer or "coupler" of some sort to produce greater voltages and currents at the same frequency. The power of course comes from the local B-batteries and the grid simply controls that local power supply.

Several tubes can be used one after another in an amplifier. They are coupled by any of the methods we mentioned under the subject of coupling. Magnetic coupling is perhaps most commonly used. Radio and audio frequency transformers are the

simplest examples of magnetic coupling for amplifying voltages of different frequencies.

The action of amplification is quite similar to detector action. No grid condenser or leak is necessary. To give undistorted amplification the tube must be connected in a circuit so that it operates on the straight portion of its plate-current grid-voltage curve. The grid voltage must be kept down below certain limits, and a C-battery or bias potential to shift the axis of the input voltages will often prevent distortion and save battery consumption, although not necessarily giving more amplification. The figure shows how undistorted amplification is secured.

Maximum voltage amplification is desired between tubes. Between the last step of an amplifier and phones or loud speaker we

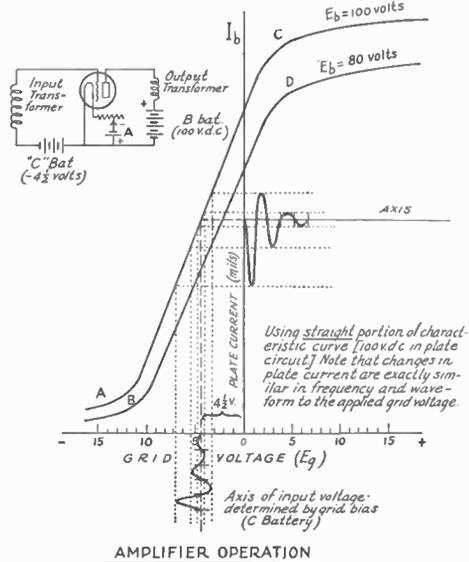

want maximum power transfer. This is obtained by matching the tube impedance to the primary impedance of the output transformer. The secondary impedance of the output transformer is made equal to the

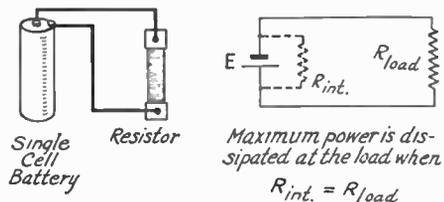

CONDITION FOR MAXIMUM POWER IN A CIRCUIT

impedance of the winding on phones or speaker to give best results. Just as in the case of the dry cell or generator, the maximum power is transferred when the load

and internal impedance characteristics are matched.

HOW A VACUUM TUBE "OSCILLATES"

We have mentioned that vacuum tubes can and are used to generate undamped high-frequency currents. The production of undamped oscillations is accomplished by adding energy in "timed pushes" to each oscillation. A tube can be made to oscillate by coupling the input and output (grid and plate) circuits. The inductance and capacitance in the grid circuit usually determine the frequency of oscillation, although the values of inductance and capacitance in other parts of the circuit may control this. A coil in the plate circuit (tickler coil) sometimes couples a part of the plate circuit energy magnetically to the grid circuit, thus keeping the amplitude of oscillations unchanged despite the losses that tend to make them decrease. Every tube has some capacitance between the elements. When there is a coil in the plate circuit there is bound to be a "reactance voltage drop" across this coil. This voltage couples some energy back to the grid circuit through the grid-plate capacitance of the tube. Often a tube which refuses to oscillate can be brought into oscillation by adding a small condenser between the grid and plate. A few inches of insulated wire connected to each and twisted together will serve this purpose. Increasing the size of the coil in the plate circuit will do the same thing.

REGENERATION

There is always some feed-back through the tube inter-electrode capacity. Usually detection and amplification are accomplished in one tube. Oscillation takes place only

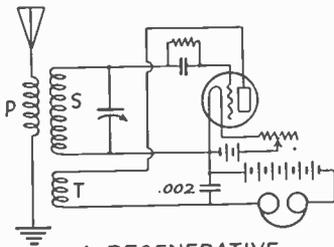

A REGENERATIVE
DETECTOR CIRCUIT

when there is enough feed-back from the output to the input circuits so that the action is continuous as long as power is supplied and the coupling is sufficient, and where the feed-back is sufficient to compensate for the losses in the circuit. Whenever any energy is "fed back" to the input of the tube we refer to the process as "regeneration". A signal impressed in the grid circuit (S) produces changes in the plate circuit (T) at

the same frequency. These changes have greater magnitude than the impressed signal because they take power from the plate battery. Whenever some of the energy is led back to the grid circuit (or made to react on the grid circuit) we have "regeneration". The response to weak signals is greatly increased by using regeneration because the original voltage impressed on the grid is much increased by the feed-back. When there is sufficient "regeneration" we have "oscillation". By varying the tickler coupling, the capacitance across grid and plate, or the turns in any coils that may be in the plate circuit, we can control the amount of regeneration and the ease with which the set goes in and out of oscillation. In receiving "spark" and "phone" signals we want our tube to be adjusted for maximum regeneration WITHOUT oscillation. To receive a continuous wave (CW) signal we want the set to just oscillate.

In a radiophone receiver we always want to prevent oscillation. "Neutralization" refers to any of the various methods by which oscillation is prevented. The coupling between grid and plate through the inter-electrode capacity of the tube always feeds back some high frequency (h.f.) voltage to the grid circuit. To neutralize the effect of this we adopt some method to feed back another equal and opposite voltage (a voltage equal and 180° out of phase) to our input circuit. To get some regeneration is desirable, so we usually do not neutralize completely—the neutralizing voltage is opposite but not quite equal.

If a continuous wave is impressed on a detector tube having unilateral conductivity, rectification takes place. Since the waves are not modulated or damped, a change in the average value of the plate current takes place when we start to receive the continuous wave and no further change occurs until the continuous wave stops coming in. In our phones there is merely a click at the start and end, but no evidence of a signal being received as long as the amplitude of the incoming signal is constant. The impulses received change their direction at radio frequency and as such frequencies are inaudible we must look to other means to receive continuous wave telegraph signals.

HETERODYNE AND AUTODYNE CW RECEPTION

The best and most common way to receive continuous waves is to use a vacuum tube to produce weak oscillations of *nearly* the same frequency as the incoming continuous wave (CW). The local oscillations and the incoming oscillations are added together in the input circuit to one vacuum tube.

Two tuning forks of slightly different frequency "beat" upon each other, alternately adding to and neutralizing each other in

effect. The "beats" are of low frequency (the difference of the frequencies of each tuning fork) and the amplitudes of the two forks add so that the beat has first the sum of the amplitudes, then the difference (zero).

In radio work, continuous waves are ordinarily received by the "beat" method. Inaudible high frequencies are combined to produce an audible beat note. Millions of cycles can be generated locally in a small vacuum-tube oscillator. This oscillator is coupled to the grid circuit of a vacuum tube. The incoming oscillations are also coupled to this same circuit. The beats between the two frequencies are present in the output. The beat frequency equals the difference of the two frequencies. "Heterodyne" comes from two Greek words meaning "other-force". When a tube is used especially to generate the local frequency, serving no other purpose but this, we have the heterodyne method of CW reception.

"Auto-dyne" means "self-force". The standard amateur regenerative tuner employs the autodyne method of reception. One vacuum tube generates oscillations. Incoming signals are coupled into the grid circuit of this same tube. A single tube thus acts as oscillator, detector, and amplifier.

RECEPTION—GENERAL

In all radio work, whether the apparatus is for sending out radio-frequency energy or whether it is for receiving weak impulses to amplify and convert into understandable characters, the business of tuning is important. Tuning is the process of adjusting the coils or condensers so that the circuit will respond to certain frequencies (wavelengths) which correspond to certain stations that we want to receive. When signals are to be received, the sending and receiving stations must have their apparatus and circuits tuned to the same frequency (wavelength).

Usually sending stations use some fixed wavelength while receiving stations "tune" for the station that is wanted. Either the condenser or the coil may be the variable element in the receiving circuit. Sometimes both are made variable. The proper ratio of capacitance to inductance in a circuit has long been the subject of controversy. Good receiving results are obtained over quite wide limits. Therefore, for simplicity of control just the coil or just the condenser is made adjustable.

Using a coil with a small variable condenser and a number of fixed condensers makes it possible to cover a wide range of wavelengths (frequencies) with the desired nicety of adjustment. When a big condenser is used a vernier knob or dial helps to give easy control. By using one small variable condenser and a number of removable coils

it is possible to design a practical and efficient "tuner" that will cover any or all the frequencies (wavelengths) used by amateurs today.

Tuning controls should be few in number and easy to operate. Adjustments should stay put and body capacity effects must be avoided, especially so in a high-frequency (short-wave) receiver.

Almost everyone who reads this Handbook has seen, used, and perhaps constructed a receiver of some sort for broadcast or amateur wavelengths. There is little difference in the procedure followed in making a one or two-tube broadcast receiver and in building a good short-wave tuner. In fact the fundamental change that must be made is simply to reduce the size of both the coils and condensers used.

In broadcast reception we are careful to use amplifying transformers that do not amplify certain frequencies in the musical scale much more than others. In code reception we can use the same instruments if we please or we can pick out some so-called "distortion" transformers to give us more amplification on some one frequency. By heterodyning or autodyning the incoming signal to give a beat note of the desired frequency we can readily get maximum amplification from such a transformer. Static and signals of different frequency from that of the transformer "peak" will not be amplified to the same extent as the signal we want to read. The signal will stand out clearly against a background of little noise.

Most of the stations we hear will be continuous-wave stations. Our reception is accomplished by the autodyne method. Our local receiver oscillates. Our adjustment of the condenser coil circuit determines the frequency of oscillation. The antenna circuit is coupled to the condenser-coil circuit. Oscillations are set up in the antenna circuit by the changing field from the transmitter. The field about the antenna coupling coil (if one is used) *links the coil in the tube circuit. The grid of the vacuum tube has impressed on it voltages of two frequencies. The output circuit of the vacuum tube contains the *difference* between these two grid-circuit frequencies. When the two frequencies (one from the antenna circuit and one locally generated) are exactly the same, we have "zero beat" and no sound in the phones *unless* the incoming signal is modulated.

In receiving code signals the regeneration control is set so that the receiver oscillates over the whole range of frequencies that

* When the antenna is connected directly to the grid end of the condenser-coil circuit thru a small fixed condenser, the oscillations of the antenna circuit take place as usual and the voltage drop across the coil and condenser is applied directly to the grid of the detector tube.

can be covered by the set. The tuning dial of the condenser-coil circuit is turned slowly while the regeneration control is moved just the little bit necessary to keep the tuner *on the edge of oscillation*. When the amplitude of the local oscillations is just equal to that of the incoming signals, the beat note will be strongest. In receiving signals the energy from the antenna circuit is always very weak. The best results (maximum sensitivity) are obtained with the regeneration control not beyond the point where oscillations begin in the local circuit.

Most vacuum tube receivers to-day utilize the principle of regeneration. Part of the energy in the output circuit (plate circuit) of the detector tube is coupled back to the input circuit (grid circuit). The feed-back

microphone. This is a crude arrangement. The variation in antenna current is usually small, the modulation incomplete, the power loss considerable, the current a microphone will handle limited, the interference produced illegal.

The absorption method (B) of modulating a continuous wave ("carrier" wave) is something of an improvement. A microphone is connected in an absorbing circuit coupled to the antenna. The amount of energy absorbed varies with the resistance in the absorbing circuit and the coupling used.

"Grid" modulation and "plate" modulation are accomplished by introducing the speech frequencies into the input or output vacuum tube circuits through suitable transformers (to isolate the high voltages and to match the impedance of the circuits).

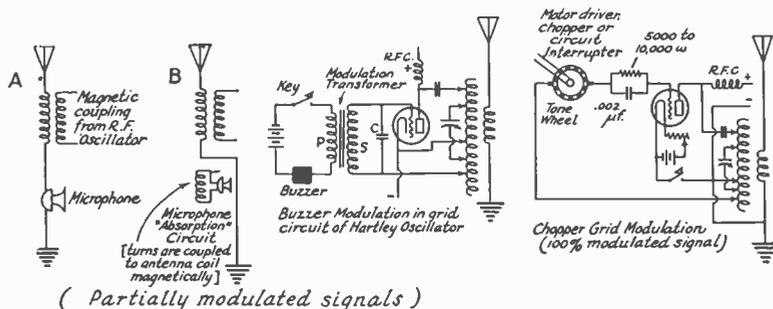

SOME MODULATION METHODS

voltage may be applied to the grid either through the plate-grid intra-tube capacity or by an inductive feedback obtained by using a "tickler" coil.

MODULATION

When something that we do varies the amplitude of the current in a circuit, we have modulated the current. Speech modulation is usually accomplished by speaking into a microphone. Microphones for speech only are quite satisfactory when made of a stretched metal diaphragm in front of some carbon granules whose resistance varies, depending on the position of the diaphragm. For musical reproduction the condenser microphone and the Pallophotophone are quite useful even though they must work through a large amplifier before there is energy enough to control large amounts of power. The glow microphone gives uniform modulation over a wide band of audio frequencies.

Microphones and modulators vary currents by varying the resistance or impedance of the circuits of which they are a part.

Perhaps the simplest way to modulate a continuous wave is to put a microphone in the antenna circuit (A). The antenna resistance can be varied by speaking into the

In modern radiophone transmitters the microphone works into a number of amplifiers, cascaded and coupled together to produce uniform amplification over the desired audio range. Sometimes part of the amplifiers are right at the microphone. The speech or music goes over telephone lines for some distance to the point where the station is located and there more amplifiers are used to get power enough successfully to "modulate" the strong "carrier" radio-frequency current which is used to set up the radio waves.

The system of modulation most widely used in radiotelephone practice to-day is known as the Heising method. In such a transmitter we have two vacuum tubes. One is used to generate radio-frequency power to apply to the antenna. This is connected as an oscillator. The other tube is of equal size to the oscillator but is employed as a modulator tube. Both tubes are fed from a common plate supply source thru a large iron-core coil. The reactance of the choke coil (X) is so great that the current through it is practically constant and cannot vary at speech frequencies or higher frequencies. Thus when the transmitter is working the current from the source is constant. For this reason the Heising system is sometimes known as the "constant current"

modulation system. The designer should allow about five times as much reactance in the choke coil as there is in the combined (joint) impedance of the paralleled modu-

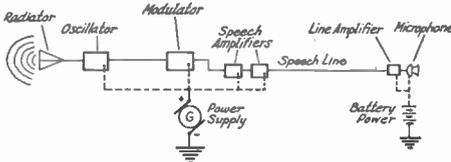
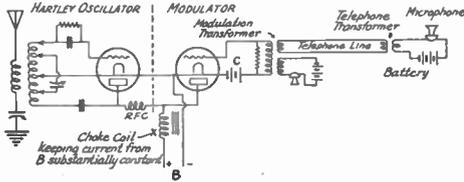

A SIMPLE RADIOPHONE CIRCUIT
(with Heising Modulation)

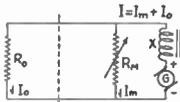

HEISING MODULATION SCHEME

lator and oscillator tubes. The average speech frequency (about 800 cycles) is usually taken as a working value in designing this choke. The best practice is to use large tubes and amplifying transformers in the speech amplifier that can always operate underloaded giving practically no distortion—equal amplification at all frequencies.

The oscillator works steadily and the radio frequency is coupled into the antenna circuit. A radio-frequency choke coil keeps H. F. current from leaking back into the modulator and supply circuits. The load which the modulator tube takes varies. As the grid voltage of the modulator tube is changed at speech frequencies, its plate current is made larger and smaller accordingly. The microphone and its amplifiers have complete control over the plate current of the modulator tube. The plate currents of the modulator and oscil-

lator normally are about the same. When the microphone is spoken into, the modulator plate current can vary from nearly zero to about twice its average value. The reactance coil (X) keeps the current from the source and the voltage across both tubes practically constant. Therefore while the modulator plate current is varying from zero to twice its average value, the oscillator plate current must vary inversely from twice its normal value to about zero. The high-frequency output of the oscillator varies directly with its input. Thus we have a high-frequency carrier wave completely modulated with a speech "envelope".

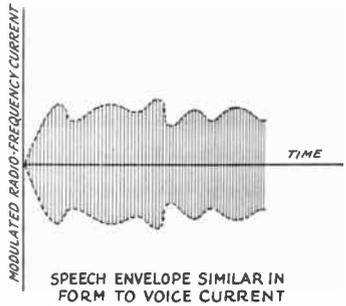
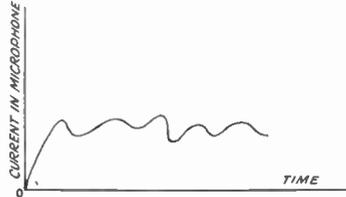

When we have a buzzer or a "chopper" connected in place of the microphone, we get "buzzer modulation" or "ICW" (interrupted continuous waves). For modulated telegraphy, however, the "constant current" system of modulation is not important. "Grid" modulation is less complicated and expensive, and perfect reproduction of the wave-form is not as necessary as when voice communication is intended.

IN GENERAL

The idea to be kept in mind when building a station is not "How *quickly* can I build my station?" but "How *well* can I build my station?" Every bit of station apparatus must be just as good as we can make it.

SOLDERING AND WIRING

In wiring the different pieces of apparatus a neatly soldered job will repay the builder in good appearance and reliable operation. Good connections may be made without solder but a well-soldered job has low contact resistances. A soldered outfit works quietly and uniformly over long periods of time. Soldering is worthwhile when properly done.

Making soldered joints is quite a simple matter. A few points should be kept in mind for best results. A hot well-tinned soldering copper, clean, bright surfaces, a *small* amount of rosin and a small amount of "half-and-half" soft solder will do the trick.

Soldering flux keeps the clean surface from becoming oxidized when heat is applied. Acid fluxes or soldering pastes made by the action of hydrochloric acid on zinc and supported in a low-melting base should especially be avoided. They are good for mending tin pans and gutter pipes. They cause corrosion of electrical connections. The melted "paste" can cause a set to operate poorly or to become inoperative by adding leakage paths across coils and condensers. Use lump or powdered rosin that can be obtained for a dime from any drug store.

"Half-and-half" simply means that the solder is an alloy, half tin and half lead. "Tinning" the soldering copper is done by filing the point bright and clean and rubbing it in hot solder with a little flux until

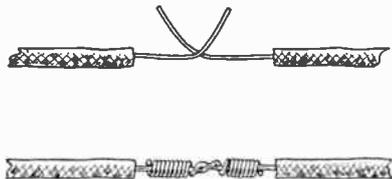

THE WESTERN UNION SPLICE

the point is covered with clean solder. Scrape connections with a knife and file before soldering, to save time and make a joint good electrically and mechanically. The soldering copper must be re-tinned occasionally if it becomes overheated. It should always be used when very hot but

not allowed to become "red hot." A hot copper makes soldering easy.

Bus wiring is neat and effective. The wires are laid out in straight lines running straight back, horizontally and vertically. The corners are made square. Hold bus wires firmly with pliers while a little solder "runs" into the joint.

Splicing wires is best done as shown in the diagram. A little care makes a permanent and strong splice of low resistance. In a twisted pair, "stagger" the splices. Tape all splices carefully to avoid trouble.

Battery leads to the receiver may be bunched to good advantage. Radio-frequency circuits should have the leads well spaced. Wires should cross at right angles when crossing is necessary. Connections between coils and condensers should be as short as possible. However, coils and condensers must not be jammed together too much as this increases the effective resistance and lowers the sensitivity. The antenna lead and the connection from the condenser and coil should be kept away from other wiring. The wiring in the audio amplifier can be spaced, and short leads are good, but they are not nearly as important here as in the detector and antenna circuits. To avoid undesirable feed-backs the plate and grid leads should be kept well separated.

The transmitter should be wired neatly in such a way that it will be electrically efficient. At the same time, the power supply and high voltages must be taken care of in a way that insures safety to life and property. The insulation of lead-in and high voltage conductors should comply with underwriters' rules.

In the pages that follow we are going to describe in detail a conventional short-wave tuner. Constructional "dope" for a moderately-priced transmitter with a world-wide range is also given. We have discussed some fundamentals of electricity. The diagrams and constructional information are quite complete. We suggest that the constructor study the books mentioned in the Appendix for more complete theory and general information. The "Station Descriptions" department of *QST* gives good ideas of various station arrangements. *QST* itself keeps us informed about new developments that are useful and noteworthy. The writer believes that knowledge of why a certain thing is done in a certain way is desirable before any work on a station is done. For that reason a number of pages have been given over to simple explanations of some of the things that happen in radio circuits.

DESIGNING THE RECEIVER

The first apparatus built for our station should be a receiving set. It is impracti-

cal to build one fixed receiver that will work at maximum effectiveness over all the wavelength ranges in use by amateurs. By using removable coils it is possible to design a practical and efficient receiver that will readily cover the wavelength bands in actual use today. We must use a mounting for our coils that makes it easy to change them. The contacts must be positive and the losses must be kept low to make our receiver efficient. The tuning controls must be easy to operate. Body capacitance effects must be avoided.

The simplest and most stable circuit is the best one to use. One regenerative cir-

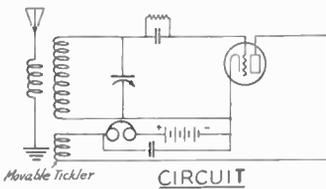

CIRCUIT

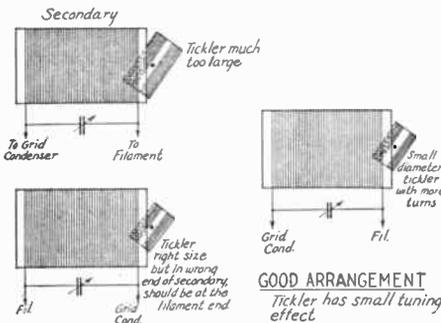

BAD ARRANGEMENTS
Tickler has large tuning effect

ORDINARY TICKLER-SERIES FEED

FEED BACK CONTROLLED BY MOVING THE TICKLER

cuit will give us as loud signals as another. However, rotating-tickler feedbacks and tuned-plate circuits affect the tuning as the regeneration is changed, which makes these methods undesirable. This effect can be minimized by putting the tickler at the filament (ground) end of the secondary coil but it cannot be eliminated. A fixed tickler with a 250-micromicrofarad variable condenser (throttle) regeneration control is probably the best that has been devised. It does not matter whether this condenser is straight-line frequency, wavelength, or capacitance. By properly proportioning the parts of the circuit and putting the fixed tickler at the ground end of the secondary, one setting of the throttle condenser will enable us to tune over quite a wide frequency band.

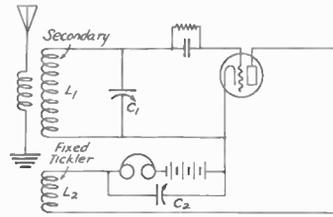

Normal Throttling Condenser System

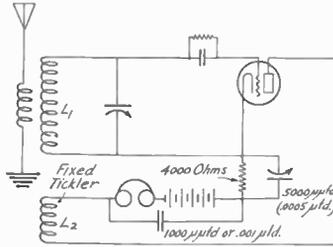

Throttling Condenser System Suggested by IAEI

THROTTLING CONDENSER SYSTEMS

Fixed tickler, series feed. Feed-back controlled by variable feed-back condenser. Coil arrangements same as for Weagant-Reinartz.

The secondary or grid circuit is the tuned circuit. The size of the variable condenser and the different coils used will determine the wavelengths covered. A

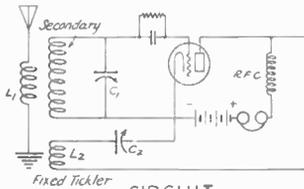

CIRCUIT

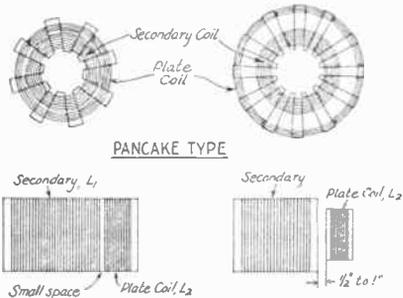

TUBE TYPE

ORDINARY ARRANGEMENTS
Feed-back condenser has some tuning effect

ARRANGEMENT
in which feed-back condenser has little tuning effect

THE WEAGANT-REINARTZ ARRANGEMENT

Fixed tickler-shunt feed. Feed-back controlled by variable feed-back condenser.

big variable condenser will enable us to cover many different frequencies with just one coil. The tuning with such an arrangement would be very critical and the important amateur bands would correspond to only a very small number of graduations of the dial. Such a receiver would be of no use to any radio operator. The smaller the variable capacitance, the more secondary coils will be necessary to cover the amateur wavelengths. The happy medium which is best for all-around work makes our choice of a secondary tuning condenser one with a maximum capacitance of between 90 and 120 micromicrofarads. A very low minimum capacitance will be helpful. The plates should be shaped so that the change in the frequency to which the circuit will tune will be directly proportional to the angle through which the dial is rotated (such a device is commonly called a "straight-line frequency" condenser). A condenser of good mechanical features with low electrical losses will be best. The plates should be soldered together. The insulation should be of hard rubber, Pyrex or quartz, and the path along the insulation between stator and rotor should be long.

Coming to the coils, they should be space-wound and supported as nearly as possible by nothing at all. Stray capacitances and resistances should be avoided by properly spacing the different parts.

The antenna can be coupled to the set through a little fixed condenser between the antenna lead and the grid end of the secondary coil. A very small variable condenser will be an improvement here, enabling us to have some control over the selectivity by loosening the lumped capacitance part of the coupling as much as necessary (by reducing the value of this capacitance). The figure shows the throttle-control circuit with this arrangement. To get good energy transfer it is necessary to ground the filament. When we do this we bring in a lot of unnecessary noises picked up from the local street car lines, lighting circuits and so on. During summer electrical storms and when snow is falling in the winter, trouble from periodic sparking over of the micro-condenser (or perhaps the lightning arrester) will make the combined electrostatic magnetic coupling directly to grid undesirable. The series of clicks will disappear when straight magnetic antenna coupling is used under such conditions. The charge will leak off to ground as fast as it collects. However, when using a condenser as above, antenna harmonics do not affect the required regeneration as much as when magnetic coupling is used.

For most short-wave work the antenna can advantageously be coupled to the set

magnetically. A fixed coil of eight or ten turns, two inches in diameter, placed in the filament end of the grid coil to reduce tuning effects, will give sufficient coupling. This is known as a "fixed tune" primary. It should be held on an adjustable hinge so that the coupling angle can be changed to the best value for the antenna one is using. By sufficiently loosening the antenna coupling there will be but a very slight tuning effect, making a calibrated receiver possible. With sufficiently loose coupling we will have no trouble with "dead spots", points at which the antenna circuit and secondary circuit are in tune and at which the set will not oscillate. The shorter the wavelength the further away from the secondary the antenna coil should be placed.

A regenerative-detector circuit and one stage of audio amplification is practically standard for short-wave work. A couple of UX-201-A (C-301-A) tubes make the best set. UV-199's can be used if no 6 v. storage battery is available for running the filaments. A "soft" (low-vacuum) tube that will oscillate on a low voltage on short wavelengths will make a sensitive detector if the hissing is not objectionable. The new UX200-A is excellent as a sensitive detector for weak signals. Use the lowest plate voltage possible to get the greatest response from weak signals.

Whatever tube is used, a few trials in adjusting the values of grid condenser and grid leak to fit the particular tube will be well worth while. The smallest capacitance and the highest resistance grid leak possible should give best results. The tube should go into oscillation easily and gradually. It should not "howl" or become unstable in the process. An audio howl is usually caused by instability. The set does *not* oscillate at audio frequency. It starts and stops oscillating rapidly, making clicks in the phones at audio frequency (howling) as it does so. Usually the grid return is made from the secondary coil to the positive of the A battery. A 150-micromicrofarad grid condenser and a 7-or 8-megohm leak will be about right for the average tubes. Above all things we want a "quiet" receiver. A metallized filament grid leak will give superior results in this respect. A good fixed mica grid condenser, a friction-type slow-motion dial with a high ratio and no backlash, good condensers, and solid connections will all help in making a smooth-running, quiet set. In special cases the set can be shielded in a copper box with a metal panel to prevent pick-ups of signals and noise by the receiver coils and wiring.

The coils should be placed clear of large solid bodies by $1\frac{1}{2}$ to 2 inches. They should be far from the baseboard, the cabinet,

the panel and a respectable distance from the tuning condenser, though we want the leads to that fairly short.

Use the smallest tickler that will work with a low detector plate voltage. Too large a tickler or a poor B-battery will often cause howling. A large tickler makes the set go into oscillation with a "bang" and the tuning effect is bad. The proper way to build a tickler for a given secondary coil is to adjust the number of turns and the diameter of the tickler with the set operating. With the throttle control set at maximum capacitance and the tuning condenser also adjusted for maximum capacitance, the size of the tickler should be reduced until the set will just barely oscillate. Tickler coils for C.W. reception should be wound with heavier wire than that used in broadcast receivers which work just *below* oscillation. The diameter of tickler coils should be smaller than the secondary. This reduces capacitive coupling between the turns of the two coils and cuts down the tuning effect. The rotary condenser plates should connect to the filament side of the circuit to cut down body tuning effects. Grounding the filament is necessary in extreme cases.

Either a pointer moving over a scale or a dial with indicator may be used. The pointer is the most reasonable but hardest to obtain. Our tuning condenser should have an easy-reading scale. The feedback control does not need to have anything but an indicator showing the relative setting as its position will vary with filament temperature and "B" potential.

A rheostat for the detector and one for the amplifier is convenient. Often the detector will work best at a lower temperature than the amplifier filaments.

The amplifying transformers selected for this receiver are not necessarily ones suitable for broadcast reception. A high ratio of transformation and a high primary impedance are desirable. The transformer should be selected that gives most amplification on frequencies between 500 and 1000 cycles. Varying the tuning control to make the received beat note lie between these values will give the best amplification. Lower-toned atmospherics and ground noises will be lost in the background. The quality will be actually atrocious when receiving modulated signals. We are building this set for the best results in telegraph communication rather than for radiophone reception. We should not use a C-battery in our relay receiver if we desire the best signals. A C-battery will cut down the plate current (providing it is properly installed) and the plate battery will last longer but the signals will not be as loud as if no C-battery is used. We want as widely variable an

audio-frequency current as possible in the phone circuit rather than a current that varies directly in accordance with the impressed signal on the grid of the tube. The latter condition is desirable in a broadcast receiver but we want to work our tube above the straight line portion of the grid-voltage plate-current characteristic curve in order to get as loud signals as possible. If a movable tickler is used, a .002 phone by-pass condenser is built into the set to make it oscillate easily. It should be across the B-battery and primary of the amplifying transformer. A condenser with good insulation should be used because leakage will ruin the B-battery.

Fairly good plug-in coils are manufactured in the Lorenz or basket weave type of winding or in the space-wound skeleton-form type. The best mechanically and electrically balanced job can be done by the individual builder, however. Lorenz coils have low distributed capacitance and they are mechanically pretty good. A winding jig can be made by driving 14 pins or nails in a 3½-inch circle. No. 16 cotton-enamel-insulated wire will avoid corrosion and needs no protection from dampness. Skip every two pins after starting the winding.

WINDING COILS

Space-wound coils should be wound on skeleton or notched ribbed forms. Hard rubber is fine electrically but it "flows" after the wire has been tightly wound and

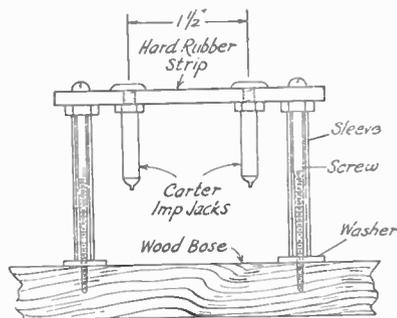

DETAIL OF COIL MOUNTING

the coils eventually loosen. Micarta tubing with projecting ribs is best. In an emergency the "Quaker Oats" box or cardboard tubing will be best to use after baking it in shellac to exclude moisture. The coils can have terminals brought out to fit into binding posts on the baseboard for interchangeability. Straight wire ends will slip into binding posts neatly. A

better arrangement is to build them with little bakelite or hard rubber strip bases and to use General Radio plugs. Phone

that are available. The principle advantages of the Lorenz coil are low distributed capacitance (because the turns cross each other at an angle instead of lying side by side) and good mechanical strength when strong binding cord and sufficiently heavy wire are used. Perfectly round turns of cylindrical coils have the greatest inductance per turn, however, Therefore, a coil having better electrical properties can be made by winding the coils on a round form and spacing the turns to reduce the distributed capacitance. If we use a solid tube for a form we run into difficulties again by introducing additional dielectric losses which add to the effective resistance of our coil. By adopting a skeleton notched form or by spacing the turns by knots (as shown) we can improve the coil electrically but before long we find that our coil is mechanically weak making a carefully balanced compromise necessary to achieve the "best" practical coil. For making transmitting coils, glass or porcelain beads can be substituted for the knotted cord separating the turns of space-wound coils. Always use waxed or paraffined cord in supporting coils to make them moisture proof. Sealing wax or paraffin is good for supporting and stiffening coil ends. Avoid shellac and "dope" on receiving coils. Anything of this nature between turns will raise the distributed capacitance of the coil because it has a dielectric constant greater than that of air. To get as great a tuning range as possible with a given coil it is desirable to have the capacity lumped in the condenser used across the coil. The coil itself should have minimum distributed capacitance and the condenser should have a low capacity at the "zero" dial setting.

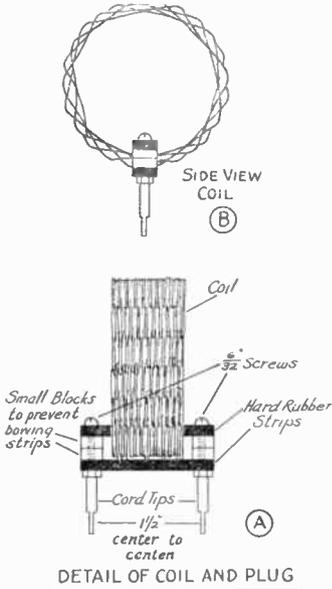

cord-tip terminals and Carter jacks make a fairly good wiping contact, however. The coil terminals are made by slipping a phone cord-tip over a 6:32 machine screw and soldering it in place.

The diagram shows easy ways of making receiving coils that will compare very favorably with any manufactured products

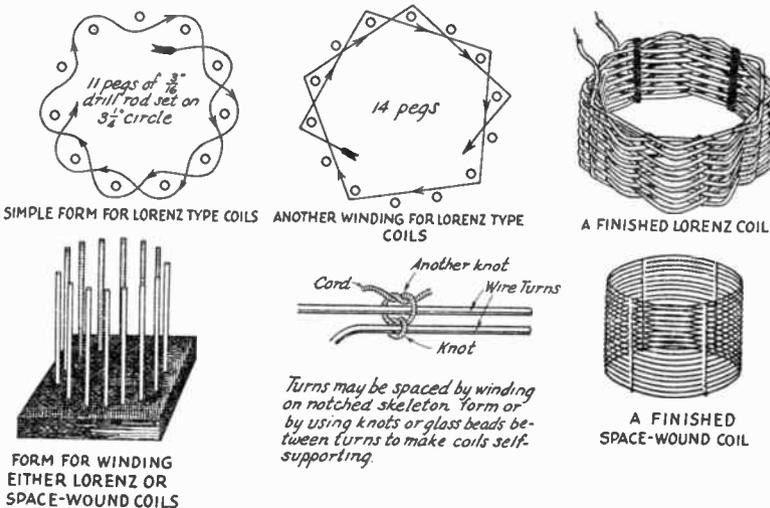

All distributed capacity in coils does not come from the capacity between turns. Running leads through the finished coil adds to the distributed capacitance, especially if the lead happens to be one of the coil leads itself. If a lead *must* be run through a coil by all means run it through the center as this adds least distributed capacitance. Running the lead near one side of the coil raises the effective resistance of the coil considerably especially at the shorter wavelengths.

A simple way of making quite good space-wound coils is to wind the wire on a cardboard form, spacing it with a thread, string, or another wire which is taken off after the winding is completed. Cardboard tubing should be first prepared by waterproofing with a celluloid varnish and binder. Wire should never be wound on the form until the varnish is dry. This prevents the varnish from soaking into the insulation which raises the dielectric constant making a poorer coil with higher effective resistance and distributed capacitance. A "Quaker Oats box" form is as good as they come electrically. Don't think that all coils must be of three inch diameter just because those mentioned here and all those you have seen are of that diameter. This is just a convenient size and good short-wave coils performing beautifully can be made 1½ and 2 inches in diameter. A thick form should be provided with longitudinal supporting strips to keep the wire off the form to reduce dielectric losses.

Here is a table showing the wavelength ranges that can be covered using 3½" diameter Lorenz coils of the following numbers of turns and a tuning condenser having the maximum and minimum capacity values specified. The wavelength ranges were determined by means of an oscillator (described in the appendix) and wavemeter (the next instrument we will build for the station after our receiver is in operation).

Tuning condenser capacity range: 20 to 380 micromicrofarads. A smaller maximum capacity (150 μμf) is recommended to give less crowding on the amateur ranges.

Turns	Wavelength meters
55	200 to 625
24	85 to 273
10	40 to 126
5	24 to 70
2	11 to 35

Some space wound coils checked by the writer were three inches in diameter, wound on skeleton forms, of No. 18 B. and S. wire spaced the width of the wire itself. The tuning condenser had a range of from 15 to 100 micromicrofarads.

Turns	Wavelength (meters)
19	58 to 115
8	30 to 62
3	11 to 31

Although not allowing much overlap these ranges cover the three lower amateur bands nicely in the center of the dial. The confirmed traffic man will wish to use a still smaller condenser with a much larger number of coils (eight or ten) so that the tuning will not be critical and so that all stations will be spread out well over the dial.

BUILDING THE RECEIVER

A receiver built on a "breadboard" is very effective but picks up dust and dirt after a while and gets noisy. A panel-mounted set is about as cheap. The cabinet can be added later to protect the parts. Photographs show both "breadboard" and panel layouts. The sets can be wired from the photographs and the diagram.

Select every part carefully if you would make your receiver a permanent invest-

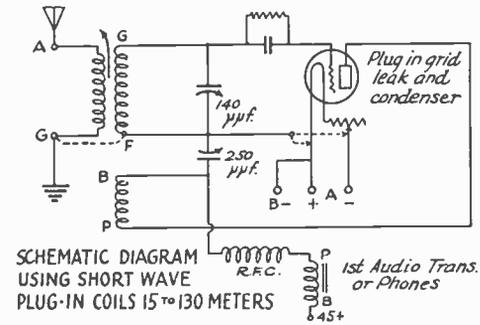

SCHMATIC DIAGRAM USING SHORT WAVE PLUG-IN COILS 15 TO 130 METERS

THE CIRCUIT

Chosen from the several possible circuits, a fixed tickler and a "throttle" condenser for regeneration control are used. Smooth regeneration control is effected with this arrangement, while at the same time the tuning is but slightly changed by movements of the regeneration condenser.

ment. Do not patronize the local cut price or "gyp" store if you are after the best results obtainable for your money. "Bootleg" parts are cheap it is true—but standard parts and tubes from reputable manufacturers are not so likely to prove defective after a few weeks of use. Buy well and your set will still be giving satisfaction when the friend who was taken in by a misguided idea of saving is paying for expensive replacements.

In putting the "breadboard" receiver together lay out the apparatus as it is shown

in the photograph marking the places that should be drilled for screws with a pencil point. Now take off the parts and pick out the proper size drills for the various wood screws that will be used. Make the holes with the hand drill right at the beginning

and you will avoid splitting the baseboard and making an unsightly job. If the wood is soft you can use a gimlet, punch or a nail of the right size in making a hole for starting the wood screws.

Fasten down the apparatus securely, supporting the variable condensers on strong metal brackets obtained from the local hardware store. Some condensers are easier to mount on "breadboards" than others. If a "breadboard" set is planned be sure to buy condensers that can be readily supported on angle brackets and that have suitable provision for securing the vernier dials. Next, wire the set according to circuit diagram or photograph running the wires from one instrument to the next and soldering each connection as it is made. Bus wiring is best looking but flexible rubber-covered wire is just as useful and practical. Most of the parts manufactured today have binding posts conveniently arranged so it is a short job to put together a workable set simply by running wires from binding post to bind-

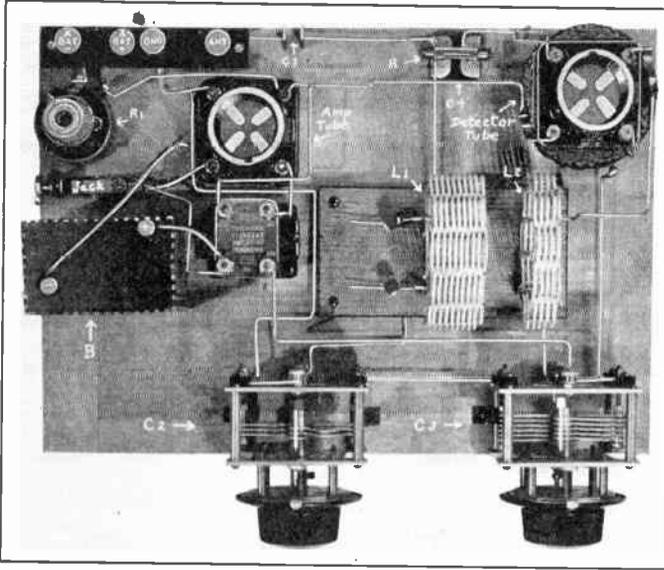

A BREADBOARD RECEIVING SET SHOWING THE LAYOUT AND WIRING OF ALL EQUIPMENT NECESSARY FOR BRINGING IN GOOD SIGNALS FROM ALL OVER THE WORLD

But one stage of audio amplification is necessary or desirable. Home-made Lorenz-wound coils are mounted in binding posts. The antenna is coupled directly to the grid end of the secondary through two one-half-inch-square brass angles. Note the rubber cushion placed under the detector socket to prevent microphonic noises. Velvet Vernier dials are used on variable condensers of 100 $\mu\text{f.}$ and 250 $\mu\text{f.}$ maximum capacitance.

List of Material Required for a Breadboard Receiver

Wooden baseboard, $\frac{1}{2}$ " x 10" x 14"	\$0.50
100-micromicrofarad S. L. F. variable condenser	4.00
250-micromicrofarad variable condenser	4.00
2 UX tube sockets	1.00
Soft rubber sponge (5 and 10c store) to mount detector socket, preventing microphonic noise	0.10
1 30-ohm rheostat	0.75
1 150- $\mu\text{f.}$ fixed mica condenser	0.50
1 7-meg. metallized-filament grid resistor	0.50
1 single jack, open circuit type	0.50
Brandes phones	5.00
Phone plug	1.00
2 High-ratio (20:1) dials	3.00
1 audio-frequency amplifying transformer: GE UV712 9:1 ratio (without * beside style number), Thordarson 6:1, General Radio 6:1, or Western Electric 29:1; say	5.00
1 2 $\frac{1}{2}$ volt block B-battery	2.00
Material for Lorenz coils:	
4 Eby binding posts
1 pound No. 18 or No. 20 Contenamel wire	1.00
For each secondary coil:	
2 hard rubber strips $\frac{1}{4}$ " x $\frac{3}{4}$ " x 2"
2 cord tips (unless coil ends are inserted right in binding posts)
2 6:32 brass machine screws 1" long, and brass washers
Coil mounting:	
1 bakelite micarta strip $\frac{1}{4}$ " x 1" x 2 $\frac{3}{4}$ "
2 large washers

2 2" lengths of $\frac{3}{16}$ " I. D. hard rubber or bakelite sleeving
2 Carter Imp. jacks (or substitute General Radio plugs and jacks in the set)
2 2 $\frac{3}{4}$ " blued round head wood screws
Terminal Board for Antenna, Ground and A-battery connections:
1 $\frac{1}{4}$ " x 1" x 6" bakelite strip
4 Binding Posts
Miscellaneous:
24 wood screws to hold things down, 1 ft. of $\frac{3}{8}$ " copper strap to fasten down B-battery, 2 copper angles constituting antenna coupling condenser, 4 ft. No. 12 bus wire, 6 brass angles to support condensers, strong light cord to bind Lorenz coils, wooden block $\frac{1}{4}$ " x 4" x 7" for mounting coils (unless plug mounting is built). A paper clip or piece of tinned bus wire attached to the frame of the condenser and bent over the top of the dial will make a good indicator lacking a better one. If the particular condensers you get do not permit of mounting the back plate for the vernier dials, some flat 90° angle pieces from the 10c store or the local hardware store will hold them so that the smooth vernier action can be used in tuning. The cost of these miscellaneous items should not greatly exceed	\$1.50

Estimated cost of a practical and excellent short wave receiver

\$32.00

ing post. For a set that is permanently quiet in operation, the connections should be soldered when the outfit is assembled, but a laboratory set-up or a set to be used for but a few weeks and then torn apart can be conveniently made without any soldering.

When the wiring has been completed, check it over carefully before connecting the batteries or trying it out. Be sure the connections are right before going ahead. Before connecting the B-battery, hook up the A-battery and see that the filaments can all be turned on and off and controlled by the rheostat. If all the tubes do not light, find the trouble in the wiring before going any farther. Then, and not until then, complete the plate circuit by connecting the B-battery. Plug in the phones and listen to the set as you operate the different controls. There should be a strong click in the phones when the B-battery connection is made and broken. The regeneration control should be gradually worked up from zero until a slight click and a "live" sound shows that the detector tube is oscillating.

The first thing to do in building the panel mounted set is to lay out the panel. The arrangement should be symmetrical, balanced for appearance and utility. Thought must be given the proper spacing of parts to insure an efficient set that will handle easily. The clearance of instruments mounted at the top and sides of the panel must be sufficient so that the set can be readily put in and taken out of the cabinet.

Use the templates that are provided with most variable condensers for locating the holes to be drilled for mounting the variable condensers. A scribe will mark through the paper template. A sharp point of any substance that is considerably harder than the panel to be scratched may be used. A very small drill is probably best of all. After the surface has been marked, drill the small hole all the way through the panel and follow it up with the larger drill that makes the full size hole. If large drills are not available, a reamer will often increase the hole to the necessary diameter without undue labor and without spoiling the panel.

A grounded metal panel helps to shield the set from body capacity effects. An aluminum or brass panel will drill easily and can be given a crystalline finish at a nominal sum by some of the larger radio manufacturing concerns that do such work for themselves.

Bakelite-micarta panels are most often used for home-built sets as they are stocked in a variety of sizes by most dealers and cost about the same amount as the metal panels mentioned. A fine satin finish may be put on bakelite panels by rubbing them with three or four sizes of fine sandpaper. Start the rubbing with the coarsest sandpaper, ending with the very finest variety known as

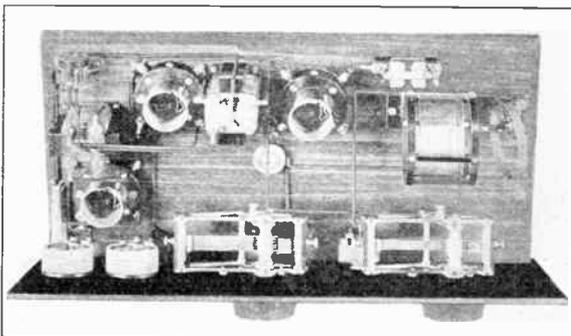

PHOTOGRAPH SHOWING THE ARRANGEMENT OF PARTS ON PANEL AND BASEBOARD AND ALSO THE WIRING

Note the plug-in grid leak and condenser and the cushioned detector socket. The small disk in the center of the set is the small coil used as R. F. Choke.

"double naught". Use nothing coarser than No. 1 sandpaper on the panel or you may scratch the panel. Always rub in the direction of the length of the panel. Use a little 3-in-1 oil as lubricant and finally clean off the panel with a soft cloth putting on the finishing touches by hand rubbing.

A convenient list of parts for the construction of a panel-mounted amateur plug-in-coil tuner is given. Besides the parts in the list, two vacuum tubes and a filament battery are needed. The filament battery or A-battery will depend somewhat on the number and type of tubes used. Two five volt, $\frac{1}{4}$ ampere tubes (UX201A or C201A), can be most economically supplied by a six volt storage battery of between sixty and one hundred ampere-hours capacity. Of course, the bigger the battery is, the less frequently it will be in need of charging. UV199, CX199, UX199, WD11 and WD12 tubes may be run from a filament battery made up of dry cells. The greater the number of cells used in parallel, the longer they will operate the set and the better the economy. Dry cells are fairly good for supplying current intermittently and often old cells will depolarize or recuperate by standing without use so that they can again be used for short intervals.

There are now several varieties of plug-in coils on the market for building short-

wave receivers. Anyone can make a selection depending on the mechanical and electrical goodness of the coils under consideration as compared with the other types

advertisements if you do not care to build up either the space wound or the Lorenz type coils yourself.

The next step after drilling and finishing the panel is to mount the parts on it. Then the panel should be fastened to the baseboard by strong brackets and wood screws. The parts to be mounted permanently on the baseboard are now put in place and fastened down in the same way that was described in the building of the "breadboard" set. After wiring the outfit and putting on the dials we are ready to connect the batteries and operate providing the final check of the wiring shows everything to be all right.

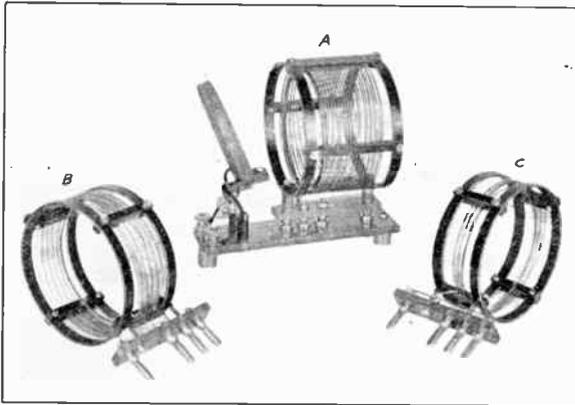

THREE MANUFACTURED PLUG-IN COILS
The base holds the swivel-mounted primary for adjustable magnetic coupling. The secondary coil is a typical space-wound coil using General Radio plugs for easy interchangeability. Small tickler coils are wound inside the main coils.

A picture diagram shows exactly how to wire the panel-mounted tuner. A two-tube receiver (detector and one stage audio) is standard for amateur relay work but three tubes and two stages of audio amplification are described here for the

available. Space-wound coils should be chosen for a short-wave tuner. A set of coils and a mounting for the type used may be bought direct from QST or Handbook

benefit of the chap who likes to have a signal at loudspeaker strength occasionally. If you are going in for amateur relay work you can build this outfit and use just the

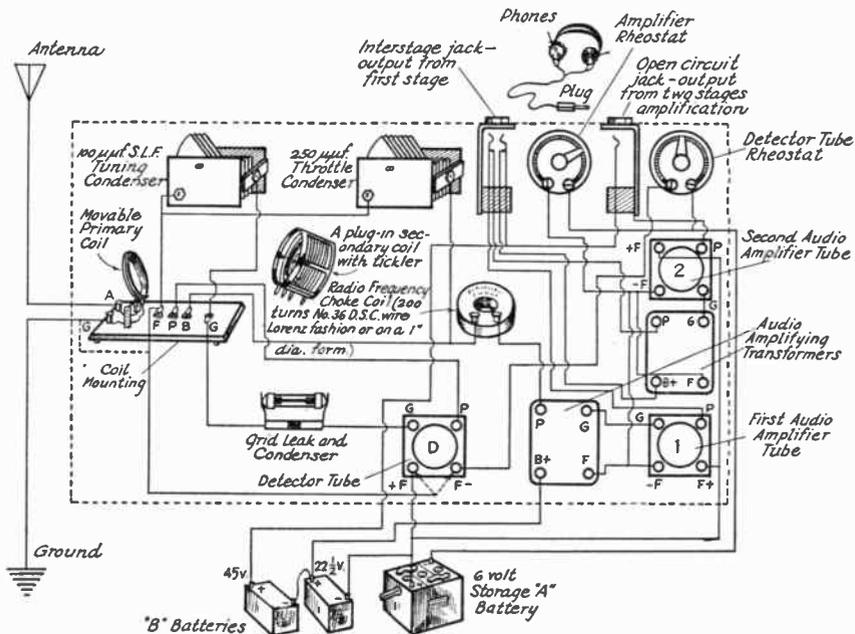

SHORT WAVE PLUG-IN-COIL RECEIVER - PICTURE DIAGRAM SHOWING WIRING OF DETECTOR AND TWO STEP AUDIO AMPLIFIER

first stage for most listening or you can drop one amplifying transformer, one socket, the interstage jack, and one vacuum tube from the list of parts and reduce the cost below the amount estimated for a complete set. Although the signals will not be so terribly loud with the one stage of amplification, they will satisfy everybody but the chap with the "tin ear" for use with a telephone head set. The signal to static ratio is the same with one stage of audio amplification as with a dozen, meaning that we can bring in just as many stations and get as good DX without the use of more than two tubes. Perhaps we ought to say that we can do better work, because of the decreased tube noises which are always to be considered in multi-stage amplifiers.

A panel set with detector and one step of amplification is built and wired exactly like the outfit shown in the picture diagram by leaving out the parts mentioned for the second stage and by substituting the open circuit output jack for the interstage jack shown.

List of Parts for Panel-Mounted Tuner

Bakelite-micarta panel 3/16" x 7" x 8"	\$1.00
Wooden baseboard 1/2" x 8" x 17 1/4"25
100-micromicrofarad straight-line-frequency variable condenser	4.00
250-micromicrofarad variable condenser of any type mechanically good	4.00
3 UX tube sockets	1.50
1 150- μ f fixed mica condenser	0.50
1 7-megohm metallized-filament grid leak	0.50
1 jack, open circuit type	0.70
1 jack, interstage type	0.80
2 30-ohm filament rheostats	1.50
2 audio-frequency amplifying transformers	10.00
Complete set of shortwave plug-in coils and mounting	\$4.00 to 12.50
(These can be purchased from any one of several reputable manufacturers or you can use home built Lorenz coils, etc. A space-wound movable-tickler unit can be used instead, in which case the 250- μ f. condenser will not be needed at all. If such an arrangement is used, the circuit given for movable-tickler outfits on page 43 must be followed.)	
2 C or UX201A tubes	6.00
1 C or UX200A detector tube	3.00
1 telephone head-set	5.00
1 45-volt block B-battery	4.00
1 ready-built cabinet, walnut finish	4.00
6 ft. of No. 12 or No. 14 tinned bus wire, material for R.F. choke, assortment of wood screws50
6 volt 60 to 100 ampere-hour capacity lead storage battery of standard make	18.00
Battery Charger	

OPERATING THE RECEIVER

In operating the receiver the batteries are connected to the set as shown in the diagram and the phones are plugged into the jack. After the antenna and ground have been connected, the filaments are

lighted to a dull red by turning the rheostat knob. The throttle condenser or tickler coil control knob) is turned so that the feedback to the secondary is increased. A slight click is heard after which a "live" or faint hissing sound can be heard. The set is now in an oscillating condition. The detector tube is generating radio-frequency oscillations. When the tuning condenser knob is turned the capacitance of the variable condenser is changed and this changes the frequency of the generated oscillations. Oscillations are present in the antenna circuit which is coupled to the secondary circuit (where the local oscillations are generated).

Coupling the antenna circuit to the tube circuit causes the incoming frequency and the local frequency to be impressed on the grid of the detector tube, so that in the output of the tube we hear the resultant or beat frequency. Two radio frequencies of millions of cycles per second will beat together so that the audio note of but several hundreds of cycles per second can be heard. By moving the dial of the tuning condenser we change the local frequency and the beat note. Different transmitting stations use different transmitting frequencies (each uses a certain definite frequency) and by changing the period of the local circuit (tuning with the variable condenser) we may listen to any one of the stations we wish. The amplitude of the grid voltage caused by the local oscillations should be nearly the same as that caused by the incoming oscillations in order to obtain the loudest signal. After "picking up" our station, we reduce the feedback (amplitude of the local oscillations) until the loudest signals are obtained.

MAKING IT WORK

In winding coils for our receiver it makes no difference which way they are wound. After the set is assembled the wiring can be properly made to give the best operation. The tickler and antenna coils should both be at one end of the secondary coil. The filament return should be made from this end of the secondary. The set may refuse to oscillate, in which case the first thing to do is to REVERSE the tickler leads. Next test the B-battery and plate circuit connections. Be sure B+ connects to the plate. There should be a click in the phones when they are plugged in with the tubes turned on.

A pair of phones, a dry cell, and a D.C. voltmeter are the most useful instruments for locating faults in the set. If the tube does not light, it should be tested for an open filament. Then the filament-circuit wiring should be traced carefully. The rheostat should be examined for an open

wire, the socket for a sprung prong. With the B-batteries disconnected trace the filament wiring from the A-battery to the socket using either the click in the phones or the voltmeter across the 6-volt

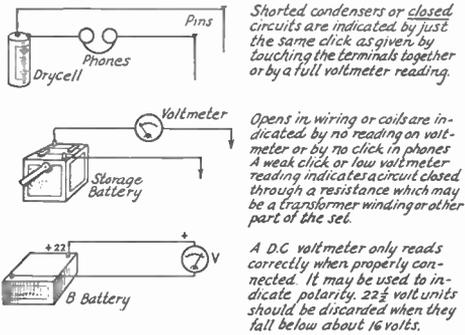

LOCATING FAULTS

line. A couple of pins on the end of the voltmeter terminals will make it possible to pierce the insulation for testing purposes.

If a regular clicking sound is heard in the phones when they are connected to the set as in regular operation, it probably means that the grid leak is open or of too high a value. A lower-resistance leak will remedy this condition. A pencil mark between grid and filament terminals on the bottom of the tube (or a line of carbonized India ink) will serve in an emergency. Two brass machine screws in a small piece of hard rubber or bakelite with the "leak" drawn between terminals will be a better arrangement.

If the filament lights but there is no sound in the phones, trace the plate circuit wiring carefully, paying attention to the jack to see that the phones are not shorted there. If there is a by-pass condenser across the phones, this should be checked with phones or voltmeter and battery to see that it is not shorted inside or by some solder across the terminals. The grid and plate terminals of the socket may be bent.

An open secondary coil or grid circuit lead may cause a clicking similar to that when there is no grid leak. The winding may be tested with the voltmeter or phones for an open circuit. If no signals come through and there is no "tuning", probably the variable condenser is not solidly connected across the secondary coil. Decreased signal strength may indicate that the antenna coil is open or that the antenna or ground are off. A shorted grid condenser may give the same effect. If no "clicking" is heard with the grid leak removed from the set there may be a shorted grid condenser,

a soldering paste "leak" within the socket or across the grid condenser, or a poor tube (open grid). Try a new tube, test the grid condenser with the phones or voltmeter, or clean up any leaky paths that are found between grid and filament.

An audio howl in the phones indicates that the set does not slide into oscillation quietly and stably as it ought. Change the grid leak resistance. Test the B battery to make sure it is new and fresh (shunting it with a .002 mfd. bypass condenser will sometimes help).

We frequently hear the complaint that a tuner will not work at one particular wavelength altho it works well above and below that wavelength. The reason for this almost always is that the dead wavelength is the wavelength of the antenna circuit. By loosening the coupling to the antenna or by changing the antenna "fixed" tune we can get rid of the trouble. If the coupling is fixed we can cut a small fixed condenser into the antenna circuit. A "postage stamp" condenser will do. The right value of capacitance depends on the particular antenna. 150-200 micromicrofarads is about right for the average short-wave rig. The effect is simply to shift the dead wavelength to some other point where it does not give trouble for a short time. Our condenser can be placed across a single-pole single-throw (SPST) knife switch in the antenna circuit. A small

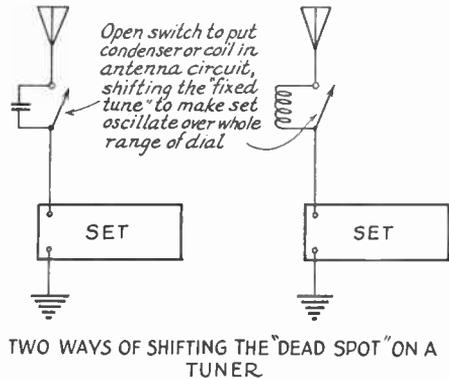

coil will have the same effect as a small condenser but shifts the "tune" in the other direction. Opening the switch will cut it in when we want it there.

Now that we have a receiver working smoothly and well we can listen to different amateurs at will. We can practise reading the code. Next we will wish to be in a position to talk with other fellows by radio. Sometimes we wonder what wavelength the stations we hear are using.

BUILDING A WAVEMETER THE BASIC RADIO MEASURING INSTRUMENT

Before we can tell what wavelength a station is using and before we can adjust our set to comply with government regulations we must have a wavemeter or frequency standard. Such an instrument can be purchased outright to good advantage from any of several companies. We can save a lot of money and build a simple wavemeter that will answer our purposes better than the boughten one, however.

A wavemeter is simply a calibrated tuned resonant circuit. A variable and fixed element are used with some sort of resonance indicator. A coil, variable condenser, and flashlamp in series constitute a wavemeter. Sometimes a coil, condenser and neon tube in parallel are used. As neon tubes are not uniform and have a critical break-down voltage we will discuss the first kind of instrument.

Either the coil or condenser is made variable. The shaft of the variable element is brought out of the case and a dial attached which may be calibrated directly in wavelength or frequency. In the simplest meter the standard 100° dial is used with a hair-line indicator. The frequency or wavelength is read from a calibration chart made up for the meter.

In our meter we shall use a variable capacitance. The variable condenser must be well-built. The plates should be heavy, well and *permanently* spaced. They should be firmly bound together with large-surfaced separators and husky supporting rods. The bearings must be metal, should have no play in any direction, and should be substantial and smooth-running. Cone bearings are good. A geared vernier becomes a necessity on the shorter waves with condensers of high capacitance.

The coil must be non-changing in its properties of inductance, resistance, and distributed capacitance. The last two named should be kept low. To accomplish these things the coil form should be strongly built, the coil tightly wound, and the wire bound so that the position of the turns cannot vary. The coil terminals should be firm and unchanging in their relation to each other.

Since our wavemeter is to be built to use more than one coil, all wavelengths from about 15 meters to 500 meters can be covered. It is ruggedly built to withstand ordinary use without injuring its calibration.

The tuning condenser used in the meter shown in the photograph is a General Radio type 239 (1000 micromicrofarads original maximum capacitance). Half the plates have been removed and the others put back double-spaced so that the capacitance is now about 175 micromicrofarads.

This arrangement spreads out our wavelengths on the dial so several coils are necessary. Every amateur wavelength can be accurately determined, which is the reason for our meter after all. Slight mechanical changes in the position of the plates cannot greatly affect our calibration

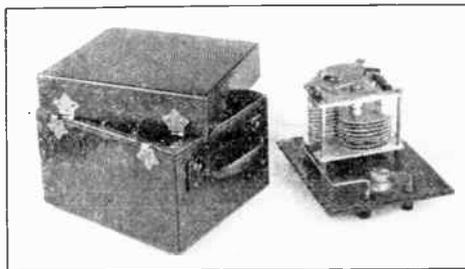

INSIDE VIEW OF WAVEMETER

Note the back-of-panel shield, the rebuilt removable butterfly hinges, the rugged double-spaced condenser. The wiring is partly supplied by the shield itself.

with a rugged double-spaced condenser. This means that our calibration will be PERMANENT which is of more importance than extreme accuracy in an amateur wavemeter. A geared vernier makes the adjustment less critical.

A General Radio dial and hair-line indicator makes close readings possible. A back-of-panel white dial with several wavelength scales for direct reading would be good but special work and design are necessary. Our meter is made of standard parts as far as possible and anyone can assemble a good wavemeter in a few hours which will be serviceable for many years.

For accuracy of measurements, shielding the inside of the wavemeter box and the back of the supporting panel is practically a necessity. The amount of detuning which will occur on short wavelengths through body capacity if the meter is not shielded carefully is surprising. The shielding is of No. 30 gauge sheet copper in the form of a box with soldered seams for the inside of the case of the wavemeter. A flat sheet of heavier material is used back of the panel. The panel shielding is held on by the mounting screws of the condenser. The edges of the copper box are bent over the shoulder to which the panel is screwed, and with these edges the panel shielding makes contact when the panel is in place. The cleats to which the panel is screwed are fastened to the side of the box at such a height that the panel is flush with the edge when the shielding is in place. A hole is drilled through the shielding on the cleats so that the screws holding the panel may be readily put in or taken out. These screws clamp the panel shield and the

box shield firmly together. The shielding is connected to the rotor plates and to one binding post on the panel. Thus the meter is completely shielded so that there is no capacity effect to the hand, and no pickup of energy by the wiring or instruments of the meter. It is a simple matter to line a box with standard width shielding material fastening it in place with little copper tacks and then soldering the seams.

A 100-milliampere full-scale reading hot-wire galvanometer or a sensitive thermo-



ANOTHER WAVEMETER

Showing hot-wire meter as resonance indicator and giving another suggestion for building and supporting wavemeter coils. This meter, built by 9DBF, won a wavemeter contest conducted by the Chicago Radio Traffic Association.

galvanometer can be used as an indicator if money is no object.

A small flash-light bulb is the best low-cost resonance-indicating device to use. When the transmitter must have its wavelength measured we can use the wavemeter as an absorbing circuit. We can watch the plate milliammeter "flop" upward when we cross resonance or use the flash-lamp to glow at the resonant wavelength. For checking the meter or finding out the wavelength of different stations on the receiver, the "click" method is used. A low-resistance flash-lamp is the best. To get best results from the "click" method we will take out the flash-lamp and screw a short-circuiting plug (burned out lamp filled with solder) in its place. Our meter was calibrated under these conditions. It is "sharpest" tuning with no resistance in series or parallel with the condenser-coil circuit.

To avoid the use of a short-circuiting plug for reducing the resistance of our wavemeter when using it with a weak oscillator or a receiving set, a pickup lamp may be connected into a single turn loop of No. 14 or No. 16 wire about three inches diameter. When the single turn is held

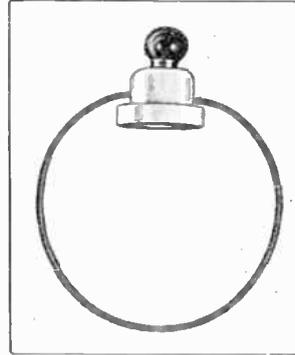

THE PICK-UP LAMP TO BE PROVIDED WHEN A WAVEMETER HAS NO RESONANCE INDICATOR

Having the lamp independent reduces the resistance of the meter, makes it sharper tuning, and makes changes in calibration less likely.

about two inches from the wavemeter coil the lamp will light when the wavemeter is in resonance with the transmitter. If such a pickup indicator is used we keep away from every chance of slight changes in the calibration of the meter due to small variations in the circuit of the meter itself. The separate resonance indicator gives a

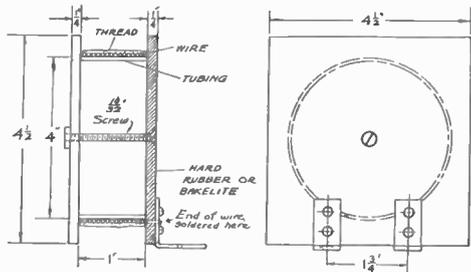

Dowels could be used instead of tubing for coil support

DETAILS OF COILS FOR WAVEMETER

very sharp response but it matters little whether an amateur station wavemeter is made to use a short-circuiting plug or the pickup loop—both methods are good. If

you have a wavemeter without an indicator you can use the click method, watch the plate current meter "flop" when you cross resonance, note the point where the antenna current changes or drops, or add a small loop with a pick-up lamp like the one shown in the photograph.

The coils for this meter are made as shown in the diagram. A six-inch diameter coil would be better because of the larger field of that size of coil which permits one to get a greater distance from the oscillator or other source of energy whose wavelength is being measured. A plug mounting on the coil will permit of coil rotation without the necessity of having to move the entire wavemeter. A Weston phone plug can be used for this. The position of the wavemeter coil in relation to the source to which it is coupled has a direct bearing on the energy picked up.

The winding of the coils themselves may be done easily and conveniently by using wire of a size to fill the form width completely with the number of turns to be used. After the wire is wound on the coil form it should be covered with a thick layer of waxed shoemakers's thread to exclude moisture and to make a permanent coil.

The coils used with this meter are as follows: A single turn of 3/8 inch brass tubing eight inches in diameter, gives a wavelength range of 16 to 43 meters; a coil of 5 turns of No. 12 D. C. wire with a range of 33 to 92 meters; a coil of 13 turns of No. 14 D.C.C. wire with a range of 70 to 210 meters; a coil of 31 turns of No. 22 D.C.C. with a range of 170 to 650 meters. Smaller coils must be built to cover the band from four to twenty meters. You can easily juggle the number of turns to make the "overlaps" and ranges just what you want them.

On a 100-degree condenser scale, the useful portion is from 10 to 90, and on a 180-degree scale, from 15 to 165.

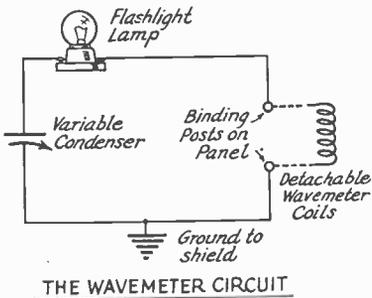

You will notice from the wiring diagram that any instrument in the meter can be taken off from some pair of binding posts, independent of the other instruments. You

should preserve this feature as a matter of convenience in the wavemeter you build.

A cabinet 4 1/2 inches deep taking a 6 1/2" x 8 1/2" panel was necessary to hold the G. R. 239 condenser. Such cabinets can be obtained for about \$1.00 from some of the radio cabinet manufacturers. The butterfly hinges can be removed and some hinges of the type with removable pins substituted.

The calibration curve is often put in the cover and it is convenient to take the cover off for use in taking down

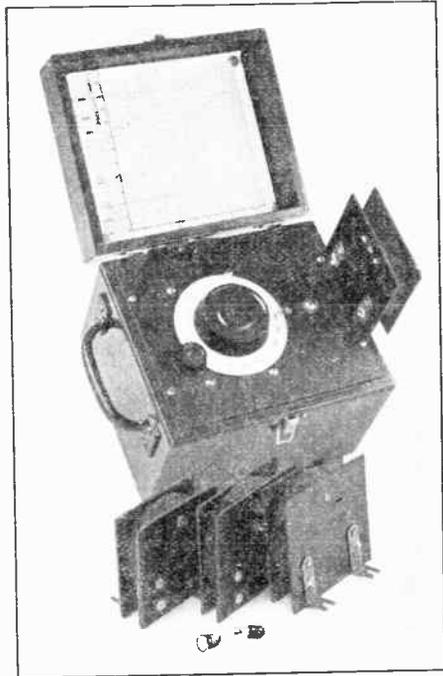

TYPICAL AMATEUR WAVEMETER

Note the calibration curve in the cover, the carrying handle, extra coils, flash-lamp and short-circuiting plug to use when the "click" method is followed with a receiving set.

the readings. A sheet of transparent celluloid placed in front of the calibration curve protects it from moisture, dirt, or mechanical injury. A curve supported between a sheet of cardboard and such a sheet of celluloid by strips of photographers' adhesive binding tape will be portable and useful.

In the meter shown one-half the butterfly hinge was cut off, the pins were taken out and cut, then put back and soldered into the part of the hinge integral with the cover. A slightly weaker hinge resulted but the job was highly satisfactorily to the builder who wanted the convenient removable cover.

The diagrams show the circuit and the photograph shows the assembly of the condenser, flash-lamp, and binding posts.

A diagram also shows the coil construction rather well. Brass angles are slotted to fit into the binding posts and the end of the coil windings are soldered to the brass angles. The micarta sides of the coils protect them from mechanical injury and make them easy to handle.

Here is a list of parts:

1 General Radio type 239, 1000- μ f. variable condenser with geared vernier	\$18.00
Cabinet, 5" x 9" x 9" outside dimensions	1.00
Micarta panel, 6 $\frac{3}{4}$ " x 8 $\frac{1}{2}$ "	1.00
Copper shielding to line box and go under panel	0.50
Flash-light bulb	0.10
Miniature lamp base mounted behind panel	0.10
Box copper tacks from local hardware store ..	
2 binding posts (the huskier the better).....	0.30
4" dial and indicator	1.50
Brass angles, 1/16" material for square coil sides	
bus wire, 8-32 brass machine screws, Mi-	
carta tubing 4" diameter, 1" to 4" lengths,	
for coil winding	1.00
Total	\$18.50

ceiver are of just the same frequency as the incoming oscillations. Now it will be observed that the beat note will reappear if the condenser dial is moved at all in either direction. Leaving the receiver adjusted for zero-beat reception turn the wavemeter knob slowly. At some point (resonance) there will be a click in the receivers. The wavemeter circuit now has the same (or nearly the same) period as the receiving circuit. If there are two clicks at slightly different points on the dial it indicates that the wavemeter is coupled too closely to the receiver. Pull the wavemeter away until only one click is heard. If no click can be obtained the coupling is too loose or there is an open in the wavemeter circuit. Sometimes a single turn in series with the secondary of the receiver may be coupled to the wave-

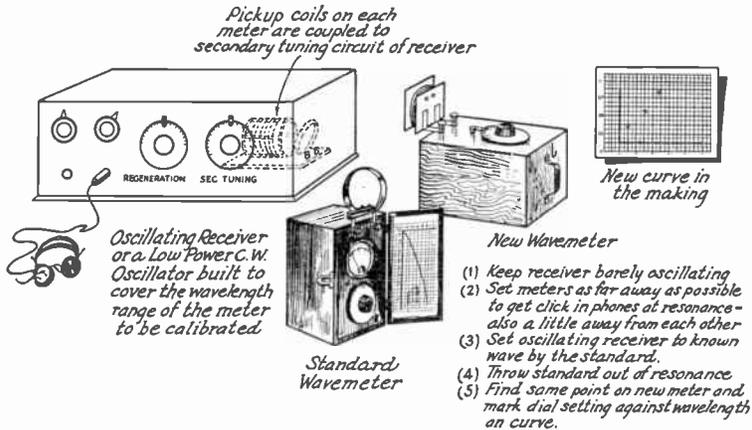

CALIBRATING BY THE CLICK METHOD AND BY COMPARISON WITH A STANDARD

By calibration is meant the job of finding out just what wavelengths are shown by different readings of the condenser scale. Before any wavelengths can be put down on a dial or chart we must "know" them. The best standard of comparison for our new wavemeter is the "Standard Frequency" transmissions from WWV (the Bureau of Standards at Washington), 9XI, 1XM and 6XBM. These stations may be picked up sending with extreme accuracy and on schedule. A very accurate wavemeter will be obtained by properly using the "resonance click" method of calibrating.

Start by putting the wavemeter coil very near the tuner secondary. Tune in a C.W. signal and turn the secondary condenser knob until the pitch drops lower and lower and finally disappears altogether. This is the point that is called "zero-beat." At zero-beat our local oscillations in the re-

meter or wound directly around the wavemeter coil.

In addition to the four stations mentioned above the A.R.R.L. now has appointed some thirty "Official Wavelength Stations" who regularly announce their wavelength correct (within 1%) at the close of each transmission and many of whom use crystal-controlled transmitters. For a list of these stations see the latest QST.

In case it is found impossible to check our wavemeter by the "click" method the next best thing is to calibrate it by comparison with a "standard" wavemeter. An oscillator may be used with both the new meter and the standard, finding the wavelength in the same way as when using the wavemeter on a transmitter. Any oscillating receiver may be used to calibrate a wavemeter. The "click" method will not only indicate resonance with the "funda-

mental" frequency of an oscillator but it will also indicate resonance with the harmonics of the oscillator if we use somewhat closer coupling than when investigating the fundamental. The oscillator will have prominent harmonics if its plate voltage is above normal. The second harmonic is at double frequency (half the wavelength). The third harmonic is at three times the frequency of the circuit (one-third wavelength). If possible, compare your wavemeter with a standard wavemeter all the way, using the fundamental frequency of the oscillator and the click

rather close to the top of the helix and hold down the key while slowly turning the wavemeter condenser. When you run into the working wave the plate current of the set will go up and the antenna current will change. Sometimes the resonance point can be spotted by the changing hum of the plate transformer. This stunt can best be used with large sets by putting them on low power.

USING THE WAVEMETER ON THE RECEIVING SET

The way to use a wavemeter with a receiving set is very simple. Make the receiving set oscillate. Put the wavemeter coil close to the secondary. Turn the wavemeter condenser until there is a click in the phones, showing that the wavemeter has "run into" the secondary tune and stopped oscillation. Note the wavemeter reading. Then turn the wavemeter knob until there is another click and the tuner starts oscillating again. Unless the tuner oscillates on both sides of the resonant point, readings are no good. Now move the wavemeter away from the tuner until the two clicks are very close together, perhaps 3 divisions on the wavemeter dial. The correct reading is half way between. By working carefully the clicks can be made to run together so that a single click is gotten right at the resonance point.

Working in this way it is a matter of only ten minutes work to tell exactly what range of wavelengths an oscillating tuner will cover.

The measurement of received C.W. signals is very simple. When the signal has been tuned in (tuner oscillating, of course) bring the wavemeter up and use the "click" method as above. If the signal happens to be coming in while you are measuring, a reading can be gotten by noticing the "tweet" when the wavemeter is run thru the tune.

In all this work use loose coupling—the very loosest that will give results.

A calibrated receiving set can be constructed though it is better to keep the wavemeter at hand and to check the wavelength with that directly when desired. The apparatus may be arranged so that the wavemeter may be used with the receiver where it rests on the table at any time. Before a receiving set is calibrated we must make *sure* that the antenna coupling is loose and that the tickler is not going to have any tuning effect on the circuit. It is easy to check this with the wavemeter. Remember that the wavemeter is right always—the calibrated receiver sometimes.

WAVEMETER TRAPS

Any wavemeter may be coupled to a few turns in series with the antenna. It will

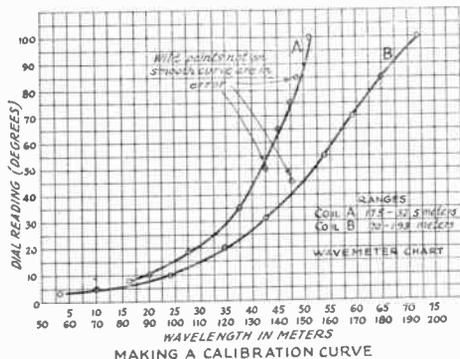

MAKING A CALIBRATION CURVE

method. Find the period of the receiving circuit with the standard meter. Then take the new wavemeter and find the resonant click. Leave the receiving set strictly alone while changing wavemeters. Record the dial reading of the new wavemeter opposite the wavelength of the oscillator which was found using the standard meter. Plot the points you have recorded on cross section paper as shown in the diagram. Errors will show up as wild points. Draw a smooth curve thru all the good points you find and go by that.

USING THE WAVEMETER ON THE SENDING SET

In measuring the wavelength of a sending set it is very important to use loose coupling between the wavemeter and the sending set. If you do not, you are likely to burn out the lamp (or thermo-galvanometer) in the wavemeter and in addition to get wrong wavelength readings. Start out with the wavemeter a yard or so from the helix and work forward gradually until you get an indication when turning the condenser very slowly. When the coupling is loose you will get a dull red glow from the lamp at the very best setting. If the lamp lights brightly you are much too near the set.

A low power set will sometimes fail to light the wavemeter lamp. Another stunt may then be used; bring the wavemeter

act as an infinite impedance in the antenna circuit at the wavelength to which it is set. Signals of that wavelength will be excluded. Our wavemeter thus makes an excellent wavetrapp.

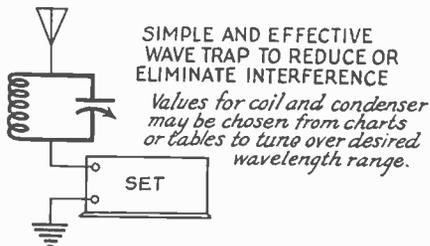

A handy way to use a wavemeter on a receiving set is that built into the General Radio 247-W meter. A tapped primary coil is wound over the wavemeter coil and connected to a switch so that 0, 1, 3, 5 or 8 turns can be cut into the antenna circuit. When the wavelength of a received signal is wanted the switch is set on the point giving 1 primary turn and the wavemeter condenser turned until the "tweet" is heard as the wavemeter "wipes across" the signal. More than one turn changes the tune of the wavemeter noticeably. More than three should not be used.

If a wavemeter is to be used as a trap it is necessary to wind on the tapped primary coil before the wavemeter is calibrated. Such a combination is accurate enough for most amateur work and can be used as a receiving wavemeter, as a trap for undesired signals, as a neutrodyne transformer, and as a "tuned impedance" for that type of R.F. amplifier.

A simple wavetrapp is shown in the diagram. It can be connected as shown or the coil can be connected across the condenser terminals and coupled to one or two turns in the antenna circuit. Such a wavetrapp will help to separate interfering broadcasting stations. It will also help materially in reducing amateur interference to a broadcast receiver when it is properly constructed. If a very poor "single circuit" broadcast receiver is encountered the wavetrapp can be used. In addition, the antenna and ground should be coupled to the main coil by an "antenna coupling coil" which can be readily made of several turns of wire added to the original faulty broadcast receiver without much trouble. The looser this coupling the less the danger of interference.

No station should be without a reliable wavemeter. It is the most useful instrument for making many radio measurements. Every cent spent for a "good" meter is well invested.

THE TRANSMITTER

The transmitter is the heart of the station. We have learned the code and built a receiver and wavemeter. Before we begin on the transmitter we should remember all that was said about doing a "good" job. The transmitter is that piece of equipment which is going to represent our station on the air. Whoever hears us is going to form some opinion of our station from the signals he hears. It is most important that the transmitter be built substantially and so constructed that it does not interfere with neighboring listeners. It is entirely possible to build a set which will accomplish all the wonders of distant communication without interfering with the pleasures of our friends who listen to the broadcast programs.

Any vacuum tube transmitter may be divided into several sections. A typical circuit separated into five parts by vertical lines is shown. The power supply, usually 110 volts, 60 cycles, enters on the right. The voltage is first stepped up to 500 to 2500 volts by the plate transformer. This transformer supplies current to the plate circuit of the tube. Next is the rectifier which changes the alternating current to pulsating direct current. To the left of this is the filter. The filter smooths out the pulses in the current from the rectifier. The oscillator tube delivers radio frequency alternating current to the antenna circuit.

The transformer, rectifier, filter, and antenna systems in use are more or less standardized.

Fundamentally there are only two general divisions of oscillating circuits; those employing capacitive coupling (condensers) to feed back energy from the plate to the grid circuit, and those using inductive

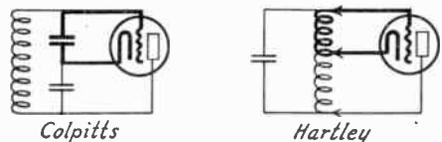

CLASSES OF OSCILLATING CIRCUITS

coupling (coils). All others are modifications of these two general classes.

For a general discussion we may divide the transmitter into power supply apparatus, control apparatus, and radiating apparatus. The purpose, construction, and adjustment of each part of the transmitter will then be mentioned.

In the beginning it is well to think of the transmitter as just an overgrown receiver. Every oscillating receiver is really a miniature transmitter. We want to use a little bigger equipment and more vol-

tage. We want to maintain better adjustment and get higher output efficiency from our circuits than is ordinarily obtained in oscillating receivers.

Power supply equipment necessarily varies somewhat with local conditions. Usually sixty-cycle lighting current is available. Therefore we will not need to consider the purchase of dynamotors, motor-generators, or high-voltage storage cells for our power supply. Such equipment is often desirable in isolated cases but it is expensive both to buy and to maintain. We can more economically use the supply current at hand.

tube can supply. Connecting tubes in parallel means connecting grid to grid, plate to plate and filament to filament. The efficiency of one tube is better than that of several, however. On the shorter wavelengths particularly it is better to use a single tube. With more than one tube we may get into difficulties with "parasitic" oscillations in the inductance of leads and the inter-electrode capacities of the tubes. The use of one tube results in more certain operating, cooler tubes, and a steadier wave with fewer harmonics. The simpler our oscillator circuit, the easier it will be for us to get it working and to get the

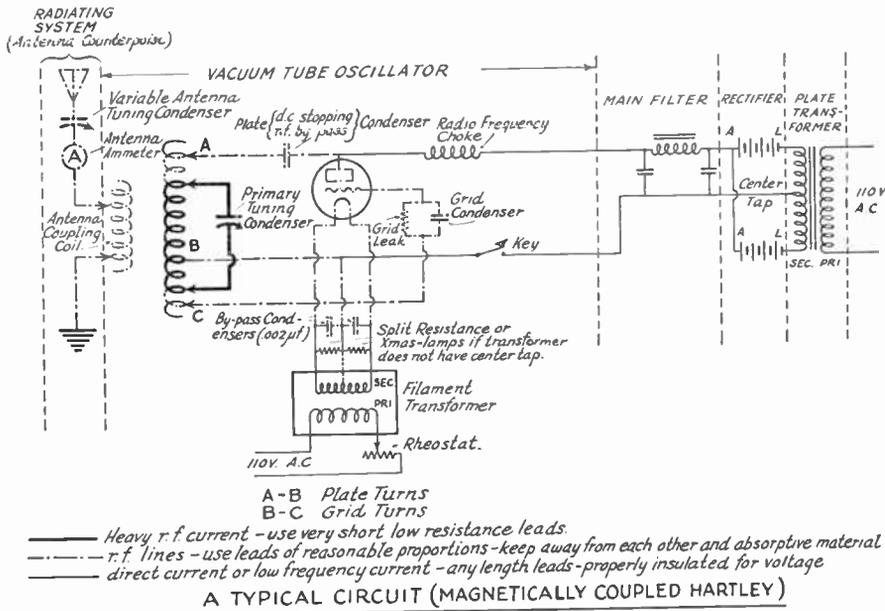

The filament of our transmitting tubes may be heated by alternating current or by storage cells. Alternating current is universally used for the purpose as it insures low operating cost, long filament life, and is convenient. No large and messy storage batteries are needed. A small transformer may be built using the information supplied in the appendix. Filament and plate transformers may also be purchased for very reasonable amounts. The cost will depend somewhat on the size of the transformer and that is determined by the current it must deliver and the voltage it must maintain across the filament terminals.

One vacuum tube is shown in all the circuits we have drawn. This does not mean that only one tube can be used. Two or three tubes may be used in parallel to obtain greater power outputs than one

"bugs" out of it. By all means let us use one tube. For relay work probably two UX-210's or one vacuum tube rated at fifty watts (UV-203-A) plate dissipation will be best.

Tubes are usually rated at the amount of power they will dissipate in heating at the plates without damaging the tube itself or shortening its life.

The tubes available to amateurs are rated at "five", "fifty", "one hundred" and "two hundred fifty" watts maximum plate dissipation.

The filament transformer should have a continuous rating equal to the sum of the power required by each filament (and to this should be added line and rheostatic losses if there are long leads and if a rheostat is used in the low voltage circuit from the transformer). The rated terminal voltage of the transmitting tube multiplied

by the normal filament current of the tube will give the power taken by a filament in watts.

There are two methods of supplying plate current to a vacuum tube transmitter. In the parallel supply method a radio-frequency choke coil is connected in the positive lead of the high voltage supply, next to the plate. This choke coil permits the direct current to flow to the plate but prevents the radio frequency energy from flowing back to the supply source and damaging supply equipment. Radio frequency power is relatively expensive and we cannot afford to waste a bit of it.

The negative power lead is connected directly to the filament of the tube. To prevent the coil A from being a short circuit on the high voltage supply a condenser is put in the lead from the plate to the coil. This is called either a blocking condenser or a radio frequency by-pass condenser. It has a low reactance at high frequencies and permits the radio frequency component of the plate potential to be applied to the condenser-coil circuit (shown by heavy lines) without much drop in voltage. The condenser has almost infinite impedance to direct current and prevents short circuiting of the high voltage supply.

The series plate supply method consists of opening the plate circuit at some point and inserting the supply source. "B" batteries are commonly connected to receiving

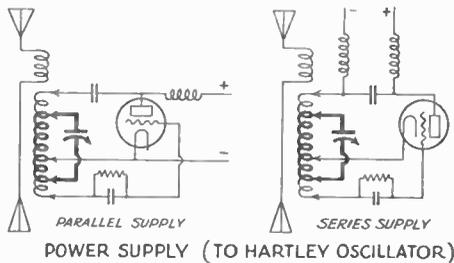

sets in this way. A by-pass condenser is connected as shown where the high voltage is brought to the set in order to complete the radio-frequency circuit without going back to the source of supply. Two chokes are used in the plate power leads to keep the radio-frequency currents "where they belong."

Of the two methods, the parallel supply method is generally the one to be preferred. When using the series method be sure that the positive side of the high-voltage supply is not grounded, for if it is, the full plate potential will be impressed between the secondary and primary windings of the filament transformer with probably disastrous results.

The "center tap" on the filament transformer should be exactly located in order that the plate current divides equally between the two branches of the filament. Equal current division will lengthen the

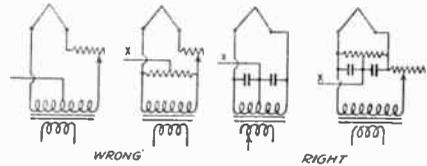

METHODS OF CONNECTING TO THE "ELECTRICAL CENTER" OF THE FILAMENT CIRCUIT

life of the tubes. It is usually most economical to light the filaments with alternating current. To give a good unmodulated signal we must have the center tap just where it belongs to prevent A. C. voltage from getting on the grid of the tube. In transmitting circuits, the resistance shown across the winding in the diagram may be replaced by two condensers of equal capacity, usually in the neighborhood of .002 microfarads each. Correct and incorrect methods of making a center tap to the filament are shown.

In the diagram showing the different types of plate supply the heavy radio-frequency currents circulate in the condenser coil circuit where the heavy lines are drawn. Radio-frequency voltages are present in both the grid and plate circuits of the tube. The filament is at ground potential and the plate power leads are isolated from the radio-frequency voltages by the choke coils.

The plate transformer supplies the high-voltage alternating current to the rectifier. An electrolytic or tube rectifier may be used to change the alternating current to direct current. A rectifier passes the current in one direction only. During part of the alternating-current cycle the rectifier acts like a very high resistance and allows no current to pass. By using a multi-jar electrolytic rectifier or two or more tubes in a rectifying circuit, a practically continuous current at high voltage is delivered by the rectifier. Some of the peaks of the waves of the supply current are still in the output of the rectifier. Therefore we have an output from the rectifier modulated at the supply frequency. A signal with 15 or 20% modulation is very readable and more pleasant to copy for a long time than the perfect D.C. note. As it is slightly "broader" it is easier to pick up and hold than the D.C. note.

To make the transmitter quiet and non-interfering it is necessary that the plate supply be as nearly pure direct current as we can make it. We must keep

the center tap where it belongs; we must keep the sixty-cycle modulated voltages out of both our plate and grid circuits. Some additional precautions will be necessary in making our keying arrangements. A filter is necessary to take the ripple out of our plate supply voltage. A good filter will do this well and efficiently. A filter consists of one or more groups or sections of condensers and coils (capacitances and inductances) arranged between the rectifier and the tube. A tube rectifier is best for a portable outfit. For a permanent installation we are going to recommend the much-maligned electrolytic rectifier. The cost is as low as that of a tube rectifier, the maintenance is as low, and the electrolytic rectifier requires less filter to give the same results that a tube rectifier will give.

The oscillator circuit may be any one of the fundamental circuits. The tube should be connected to the transmitting coil or condenser by short leads. The leads in the coil-condenser circuit should be kept as short as possible as there is a lot of circulating current there and the resistance losses mount rapidly with long leads. The oscillator MUST be loosely coupled to the antenna circuit, or radiating system as it is sometimes called.

Meters are not shown in the diagrams that we have discussed so far, but meters are really necessary to adjust the circuit properly for best efficiency. After the set is once adjusted and in operation, meters are useful but not necessary. We should have as many meters in the set as we feel we can afford. A filament voltmeter is necessary for tungsten-filament tubes. A filament ammeter (a voltmeter will do) for "XL" filament tubes is of first importance. If we do not use a filament voltmeter or some indication of the operating temperature of the filament, the life of the tube may be much shortened by improper operation. An indicating device for the filament is, therefore, a matter of economy. Next we need an antenna ammeter. The antenna ammeter should be placed at the point in the antenna circuit where the antenna current is greatest (the nodal point) but its indication will be useful wherever it is and the exact location is not extremely important. If we can afford it we should have a plate milliammeter of the proper range. All meters should be selected with regard to the tubes employed and the current and voltage that we may expect in the different circuits of the transmitter. With these three meters we can get along very well indeed in operating our transmitter. A plate voltmeter can be used if it is available but is not very useful after the circuit is once adjusted. Another milliammeter for the grid-leak circuit may be purchased after all the above have been obtained. Only by the

use of indicating instruments can we tell what is going on in the circuit.

The variable condenser, the transmitting coil, and the tube socket should be as fine pieces of apparatus as we can build or purchase. Good meters will be worth while. Buy only a few things. Make the rest of the parts yourself. Connect them in a simple circuit such as the Hartley or the Colpitts. You will have good results and the set will be relatively inexpensive.

HOW A TUBE OSCILLATES

Let us review briefly the production of oscillations by the vacuum tube in a typical circuit. When the plate voltage is applied to the circuit the sudden shock causes some current to circulate in the condenser-coil circuit. The currents that flow are at the natural period of this circuit. The current flows in and out of the condenser plates at millions of cycles per second and there is a voltage drop across each of the turns of the coil due to the "reactance" of the coil. Reactance is a property of coils due to their inductance and depending on the frequency applied to the coil also. This current sets up a field linking all the turns of the inductance coil. Radio-frequency potentials exist between each of the turns of the coil.

The grid potential controls the flow of plate current within the tube. The D. C. plate potential is constant. There are two or three turns between the grid and filament clips (Hartley circuit). The radio frequency voltage across these turns is applied to the grid. The rapidly changing grid potential tends to cause changes to take place in the plate current at radio-frequency. While the plate current remains substantially constant, the internal impedance of our vacuum tube is changed at radio frequency (in effect). Changing plate impedance establishes a radio-frequency voltage between the filament and plate of the tube. The plate coil circuit is part of the condenser-coil circuit. Therefore the condenser-coil circuit receives more "timed shocks" which keep it oscillating at its natural period.

This voltage cannot cause the flow of radio-frequency currents back through the plate transformer, for the radio-frequency choke coils offer a very high impedance to high frequency currents. This radio frequency voltage is impressed across the condenser-coil circuit and causes high currents to flow in this circuit. The energy in this circuit is "stored" first in the electric, then in the magnetic field. Sometimes this circuit is called a "tank" circuit because of that fact. The current which flows in this circuit sets up a field about the inductance

which embraces all the turns of the inductance. This field causes a voltage to be induced in the grid turns; this is applied to the grid circuit of the tube. As long as a sufficiently large "feedback" voltage is supplied to the grid there are continuous oscillations.

The tube is really a "converter" of direct current energy from your battery or other plate supply source to radio frequency energy which you want in the antenna. The clips are placed on the split coil in the same relative positions shown in our diagrams. The filament clip is that one in the center of the coil while the plate and grid clips are on either end. More turns are usually needed between the filament clip and the plate clip than between the filament and grid clips. The position of the clips from the variable condensers determines the wavelength. The higher the capacitance and the larger the inductance coil in the "condenser-coil" circuit the greater will be the wavelength (the wavelength varies as the square root of the product of inductance and capacity).

The portion of the coil between the filament clip and the plate clip may be referred to as the "plate" coil. The part between the filament clip and the grid clip is usually called the "grid coil".

When the filament is heated, electrons, negative particles of electricity, are boiled away from the filament. The plate of the tube is positively charged and the negative electrons from the filament are attracted to it. The grid is nearer to the filament than the plate and if a positive charge is put on the grid, it accelerates or speeds up the motion of the electrons from the filament to the plate and increase the flow of plate current. If a negative charge is placed on the grid it retards or repels the electrons so that most of them fall back into the filament and the plate current is small.

When the key is pressed and the tube is oscillating we have seen that there is a radio-frequency current in the condenser-coil circuit. This current sets up a magnetic field about the coil in which it circulates (the primary coil). Transformer action takes place and radio frequency *voltage* is induced in the antenna coupling coil (the secondary coil). This induced voltage is of course of the same frequency as that supplied by the tube circuit. The greatest current flows in the antenna when the antenna circuit is tuned to have the same period as that of the coil circuit—and a maximum reading on the antenna ammeter shows when this condition obtains. The coupling between the two coils depends both on the number of useful turns in primary and secondary and also on the relative position of the two coils. Coupling can be

loosened by cutting down on the number of turns (of either coil), by drawing the coils farther apart, or by leaning one coil over at an angle with respect to the other.

Energy stored in the tube circuits may be likened to the energy stored in the fly-wheel of a gas engine. Circuits having less than twice the amount of energy stored that is wasted or lost tend to be erratic in action. On the other hand if too much circulating current is present in the condenser-coil circuit the "copper losses" will be high. Most of the stored energy should be in the plate circuit of the tube.

ADVANTAGES OF LOOSE MAGNETIC COUPLING

Loosely coupled circuits are justly required by law. Only by the use of a well-filtered plate supply, by the use of a suitable keying filer and by the use of a loosely-coupled circuit we can make a station that will work thru the evenings without causing interference with our neighboring listeners-in. Some advantages of loose magnetic coupling to the antenna system follow:

Sharpens the wave both locally and at a distance.

Materially reduces key thumps, and harmonics from the oscillator circuit.

Almost entirely eliminates series condensers, which are needed only when working below the antenna fundamental.

Increases efficiency of transmitter in many cases.

Allows rapid changes of wavelength without need for locating the nodal point (center of oscillating radiator system where the current is maximum and R. F. voltage is zero) at the filament clip or grounded point.

Removes danger of tubes "going up" when antenna changes or drops, inasmuch as tubes draw normal load only when the condenser-coil circuit is in tune with the antenna.

Removing aerial and counterpoise leads from the inductance removes the plate voltage from the radiating system and makes it possible to use series feed with safety.

By sharpening the wave, absorption losses are reduced and more energy is concentrated on the desired wavelength.

The Hartley and Colpitts circuits are inherently more stable than the Meissner, for they have plenty of stored energy in the tuned condenser-coil circuit. Any of the fundamental circuits can be adapted to any of the amateur wave-bands, possibly excepting the $\frac{3}{2}$ -meter band. On the shorter wavelengths one will often find that with certain coils no tuning condenser will be necessary. Coils of large edgewise-wound copper strip have considerable distributed

capacitance (between turns) and no lumped capacity may be required. The trouble with this sort of thing is that when trying to adjust the set it is impossible to change one thing at a time as we desire—the controls are interlocking. The plate turns and the wavelength will be changed at the same time. Considerable inconvenience will result. Sometimes coils or parts of a circuit will give trouble by putting oscillations in the circuit at their natural period. Certain adjustments will appear to be stable but the tube later will “flop over” to another frequency of some particular part of the circuit. This emphasizes the desirability of using one tube rather than several in parallel on the short waves, as we thus get rid of troubles that may occur from “parasitic” oscillations between the different tubes and their leads. On the ultra-high frequencies we can make use of these oscillations in actual transmission but they are not well suited to practical communication and we will not spend any time on them.

PLANNING THE TRANSMITTER

To design and build a tube set for transmitting on short waves is quite simple. The choice of apparatus to fit the pocket-book is probably the most difficult task. Tube transmission and the use of shorter and shorter wavelengths have simplified this problem. The more powerful the set built, the more consistent the results obtained with least effort and care. The range of the transmitter in miles will not differ greatly with the power used. Low-powered transmitters using receiving tubes often give as good results in “DX” as more powerful sets. The atmospheric conditions, the wavelength used and the time of day all have greater effects on the “DX” worked than the power input.

Our transmitter may be built “bread-board” style or the apparatus can be mounted on a panel. To keep the expense down, a wooden panel or baseboard should be used. Dry oak or maple are as good as anything else we can buy for this.

Contrary to the general superstition, a panel-mounted set with the parts spaced sensibly and wired correctly will give much superior results to the hit-or-miss layout frequently seen with leads running helter-skelter over everything in sight. The apparatus can be neatly arranged in either style of mounting.

CIRCUITS

The choice of a transmitting circuit is not of great importance. There is no excuse for most of the variations from the standard and simple circuits that are used. The principle of feeding back r.f. voltage

from the plate to the grid circuit to produce continuous oscillations is the same in all vacuum-tube oscillator circuits. The fundamental circuits are the Hartley and Colpitts circuits, named for the prominent investigators who first used them. In both circuits an inductance and capacitance determine the wavelength. In the Hartley circuit the filament of the tube is connected to the middle of the coil and the

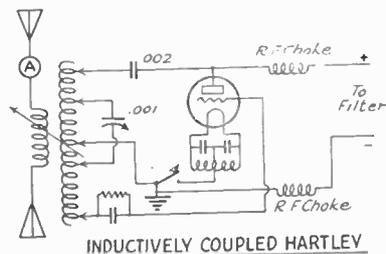

INDUCTIVELY COUPLED HARTLEY

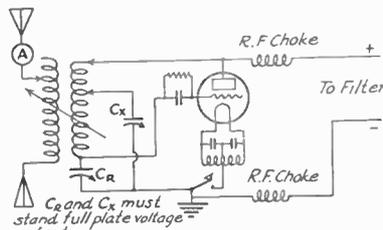

INDUCTIVELY COUPLED COLPITTS

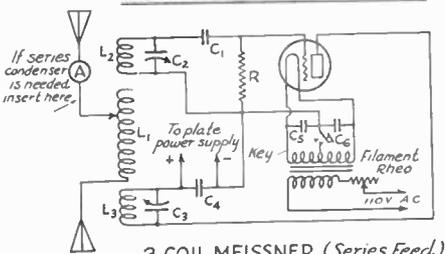

3 COIL MEISSNER (Series Feed)
COMMONLY USED CIRCUITS

plate and grid connections are made to the extreme ends of the coil. In the Colpitts circuit the filament of the tube is connected between two condensers and the plate and grid connections are made to the other condenser terminals. In one arrangement the tube gets its feedback inductively, in the other the capacitive voltage drops take care of the feedback.

The Hartley circuit has the tuning condenser across some of the turns both in the grid and in the plate part of the coil. When the condenser is entirely across plate turns, the circuit is a “tuned plate” circuit. When it is across the grid turns we have a “tuned grid” circuit.

The Meissner circuit is flexible, having grid, plate and antenna circuits magnetically coupled together. All the circuits we have mentioned are usually magnetically coupled to the antenna circuit nowadays. If the transmitting coil is properly built to have low distributed capacitance, either the Hartley or Colpitts circuits will give good results. Coils of edgewise-wound copper strip and closely wound pancake coils have high distributed capacitance which results in interlocking controls. Such coils are of little value in working below 100 meters wavelength.

The Master Oscillator circuit is really not a separate circuit to be considered by itself. A tube is used as oscillator with either the Hartley or Colpitts arrangement.

The output of this is used to control the grid circuit of a second tube which acts as a power amplifier. The output coil (plate coil) of the amplifier is coupled to the antenna. The advantage of this system is the constancy of the oscillation frequency that can be obtained.

CHOICE OF TUBES

Most important at first is the selection of vacuum tubes. Low powered transmitters using receiving tubes with a "B" battery plate supply are easy to construct. Larger transmitters use larger tubes which require higher voltages and a greater expenditure of money. They are about as easily built, however.

For all practical purposes we will not need to remove the bases from any tubes. In experimenting with 5 meters and shorter wavelengths it is sometimes helpful to take off the tube bases to reduce the capacitance between tube leads. This was especially true of the old metal-based tubes. The new "UX" bases have much reduced the between-lead capacitance, however.

Most amateurs use one or two UX-210 tubes or one UV-203-A tube for transmitting. Either larger or smaller tubes can be used. The cost of the transmitter varies depending on the tubes used. We recommend that the new station-builder start in with ONE UX-210 (7½ watter) or possibly with a couple of UX-201-A's (5-volt receiving tubes). The set can be built of standard receiving parts with a few exceptions. Supposing that UX-201-A's are used with a "B" plate supply of 200 volts, later on the power can be increased without throwing away the original equipment just by buying some UX-210's and additional plate supply equipment. The same sockets, coils, and parts will serve.

Sangamo fixed receiving condensers will stand up very well for grid and plate con-

densers if UX-210's or smaller tubes are used with not over 500 volts on the plate. Bigger tubes will require condensers having a higher voltage breakdown. The UC-1015 condenser or other mica-insulated product (see *QST* advertisements) will be suitable for this. Bigger tubes and higher voltages will require variable condensers with widely spaced plates. Receiving condensers will do for antenna and primary tuning condensers for the UX210 tubes. Several well-known manufacturers make good transmitting condensers.

Any well built condenser of the right capacitance will serve. Built-up condensers can have every other plate removed to increase the spacing and voltage breakdown. Remember that the capacitance decreases rapidly (doubling the spacing gives one-fourth the capacitance) as the spacing increases. Taking out plates decreases the total area and results in a further decrease in capacitance. In making transmitting condensers by this method we must start with a large receiving condenser.

The DeForest H tube gives best results when used with a high grid bias. While tubes with a low plate impedance will work well with a grid leak of about 5,000 ohms (2,500 ohms when two tubes are used in parallel), the output and efficiency of the H tube drops rapidly when the grid resistance is less than 15,000 ohms. A grid bias resistance as high as 20,000 ohms can be used advantageously. The leads of the H tube are brought out through the glass at different points which makes the interelement capacity low so this tube is especially useful for five meter experimental work.

A list of some of the tubes that can be used for transmitting follows. Radio Corporation tubes can be obtained through local dealers and when there is none who handles the desired article, you may order direct from the Sales Department of that company, Woolworth Building, 233 Broadway, New York City. The same tubes are furnished under C and CX numbers by E. T. Cunningham, Inc., through distributors in all parts of the country. Western Electric tubes can usually be obtained in Canada from the Northern Electric Co.

The higher the plate voltage applied to the tubes the lower the internal plate impedance of the tubes. The ratings are those given the tubes by the manufacturers. The figures for plate impedance are made from measurements at the rated plate voltage with zero grid voltage. The plate current which the tube will safely stand *when oscillating* is that given in the table. The stated voltages that can be used in the plate circuit are conservative. When adjustments of the set are made,

use low applied voltages for safety, increasing the value as the best adjustment is found.

High impedance tubes need many helix turns in the plate circuit to work efficiently. When tubes are connected in parallel the external plate impedance for best working conditions will be lower (less turns) than when a single tube is used. Tubes having widely differing plate impedances will not work well together (in parallel) as oscillators in ordinary circuits.

need to worry us for the short waves will get out fine from even a wire clothes line. If an indoor antenna is all that is possible use it, but if there is a way to get a wire out in the open by all means take advantage of it. A Hertz antenna on the roof with a long feeder will have to take the place of simpler systems if you live at the bottom of an air shaft but most of us are not that unfortunate. Your results will depend on the way your transmitter is adjusted, the amount of time and skill you use in

Tube	Rating Watts	Plate Impedance	Plate Volts	Plate M.A.	Fil. Volts	Fil. Amps
UV-201	—	18,000	100	8	5.0	1.00
UX-201-A	—	8,000	120	10	5.0	0.25
UV-202	5	4,000	350	45	7.5	2.35
UX-210	7½	3,500	350	60	6.0-7.5	1.1-1.25
UV-203	50	3,300	1,000	150	10.0	6.50
UV-203-A	50	5,000	1,000	125	10.0	3.25
UV-204	250	3,000	2,000	250	11.0	14.75
UV-204-A	250	5,000	2,000	250	11.0	3.85
UV-206	1000	225,000	15,000	135	11.0	14.75
UV-851	1000	900	2,000	875	11.0	15.50
DeForest "H"	—	High	3,000	50	10.0	2.35
W. E. 205D	—	3,500	350	40	4.5	1.60
W. E. 216A	—	4,000	150	9	6.0	1.00
W. E. VT-2 (E)	5	4,000	350	40	7.0	1.35
W. E. 211A (G)	50	4,000	750	—	8.7-10.	3.40
W. E. 211D	50	3,500	1,000	85	10.0	3.00
W. E. 212A (I)	250	2,000	1,500	175	10.5-12.	6.25
W. E. 212D	250	2,000	1,500	150	14.0	6.00

BUILDING THE TRANSMITTER

Here is a transmitter that can be put together for a cost less than that of a standard broadcast receiver! Although many amateurs have communicated over thousands of miles using a single receiving tube (UV199 or UX201A) we are not going to regard that as satisfactory equipment for a real transmitter. With the right location, favorable conditions, and operated by some one with experience, it is perfectly possible to duplicate low-power records. The outfits we are going to describe for everyday work can be used with receiving tubes—but their effectiveness will be more than doubled by using one so-called 7½ watter, two of 'em if you can afford and want to put out a signal with a good wallop.

It would be foolish to specify the "range" of the Transmitter—there are too many variable quantities. The Hartley, Colpitts, Tuned-grid and Tuned-plate, in fact any of the fundamental circuits will serve nicely. Your location has nothing to do with the "best" circuit to use. The best antenna will depend somewhat on the location and the limitations it imposes—but it will not really

"pounding brass" and operating the receiver. You can duplicate with fair regularity all your work except the very most distant. Keep at the set long enough and you can pile up records over distances as great as those any station has ever covered regardless of power. Stations owned by amateurs like yourself living in every civilized country in the world will be at your finger tips. Besides talking with friends in different parts of this country you can readily get in touch with foreign amateurs after you have had a little experience in operating the set.

The Hartley circuit using coils of the right size for each wavelength band is simple, flexible, and easy to understand. The performance of one UX-210 with a few hundred volts on the plate will give us most for our money from the standpoint of results and satisfaction. By careful construction, loose coupling to the antenna, and a fairly high ratio of capacitance to inductance in the primary tuning circuit, we can secure the desired steadiness of note. Crystal control will give the ultimate in steadiness, but the additional ap-

paratus necessary makes crystal control impractical for the first transmitter.

A "breadboard" mounting of the apparatus can be made by getting a base 15" x 32" x $\frac{3}{4}$ ", laying out the different parts neatly, supporting condensers and meters on brass angles, and screwing everything down firmly before wiring it. A few Fahstock clips will serve for making connections. A terminal board with bracket supports and 8:32 or 10:32 brass machine screws for connections will be good if a permanent "breadboard" layout is planned.

amateurs the world over use the English language for their conversations by radio and are at your command. Less than one out of every hundred stations on the amateur bands is interested in two-way voice transmission. It follows that the set we are now going to show is a telegraph set, completely practical and inexpensive. The total cost will be only about \$25.00 though of course key, filament-heating and plate supply transformers, electrolytic rectifier and filter will add a little to this. It makes little difference whether you buy all the ma-

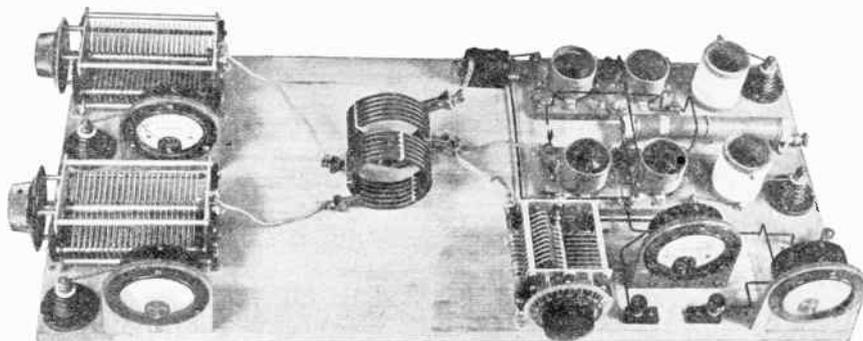

SHORT-WAVE "BREADBOARD" TRANSMITTER ARRANGEMENT

Condensers—Special National with Velvet Vernier dials. 250 μf . max. capacity.
 Plate blocking condenser—Mica and copper of about 1800 μf . (fixed).
 Gridleak—1,500 to 5,000 ohms. An R.C.A. leak is shown but a Lavite non-inductive leak will be excellent for the purpose. A single UV203A tube usually requires a 10,000-ohm leak. Two tubes paralleled need but 5,000 ohms leak resistance to give the same bias voltage. Tubes with very high plate impedance require much higher values of grid bias resistance. See the table giving vacuum tube impedances elsewhere in this Handbook.
 A large space has been left for different types of helices, the base being 15" x 32" x $\frac{3}{4}$ ". The plate supply for the tube comes in from the right through the radio-frequency chokes which are clearly shown. The filament supply source connects to the two binding posts at the front of the set while the antenna and counterpoise connect at the left. Although two antenna and counterpoise series condensers and meters are shown, but one 250-micromicrofarad variable condenser and one 0-2 ampere meter are necessary in the antenna circuit. One, two, or four UV-203-A tubes can be used, wiring the set so that they are in parallel or using two tubes on each half of the cycle with 60 or 500-cycle A. C. plate supply. The set is wired with No. 10 enameled wire. Plate current, filament voltage and antenna current are measured with Jewell meters. The coils shown are of edgewise-wound copper strip, spaced with porcelain beads. You can use the flatwise-wound coils described elsewhere and the regular Hartley circuit, giving the wavelength ranges shown in the curves. Note the ready accessibility of every piece of equipment.

The sets we show here are for telegraph work. A radiophone transmitter is not nearly as practical and useful. A telephone set will be more expensive, it will create interference, it will take more power to cover any distance, static will interfere more with reception, the power supply equipment and circuits must be more complex in order that our radiophone be decently good. If you *must* experiment with voice work, you can use any of the sets described with a few changes to give a pure direct current plate supply and a means for voice modulation. However, why turn a good telegraph set with a range of one to ten thousand miles into a mediocre radiophone outfit which will seldom reach points more distant than fifty miles? Telegraphing

material from the list or get a whole transmitter kit at once.

List of Material

- Hardwood baseboard $\frac{1}{2}$ " x 8" x 18".
- 1 Hardwood, hard rubber or bakelite panel $\frac{1}{4}$ " x 6" x 18".
- 2 250 μf . (.00025 mfd.) variable receiving condensers.
- 1 1000 μf . (.001 mfd.) fixed receiving grid condenser (Sangamo).
- 1 2000 μf . (.002 mfd.) fixed receiving plate condenser (Sangamo).
- 1 5000 ohm Lavite grid leak (receiving leaks not suitable).
- 1 Standard base tube socket for either UV or UX base tubes.
- 1 2 ohm rheostat with carrying capacity of about 2 amperes.
- 2 Xmas-tree lamps with sockets (8 volt auto or flash-lamps will also do).
- 1 $3\frac{1}{2}$ volt flashlight lamp with miniature base.
- 1 Bakelite (or hard rubber) terminal strip $\frac{1}{4}$ " x $\frac{1}{2}$ " x 6".

- 1 Bakelite (or hard rubber) terminal strip $\frac{1}{4}$ " x $\frac{1}{2}$ " x 3".
- 6 Binding posts or Fahnestock clips.
- $\frac{1}{4}$ lb. No. 28 or No. 30 double cotton covered (D.C.C.) magnet wire.
- 1 cardboard (or wood) form 1" diameter and 3" long for R.F. choke.
- 8 ft. No. 12 enameled hard drawn copper wire (for ant. coupling coil).
- 3 Hardwood strips $\frac{1}{2}$ " x $\frac{3}{4}$ " x 4" (drill holes and push wire through for coupling coil spacers, clamping one end of one strip to baseboard for swivel mounting to adjust coupling—see photograph).
- 2 pointers or dials for adjusting the variable condensers.
- 7 8" lengths of No. 12 flexible lamp cord.
- 3 3 foot lengths of No. 12 or No. 14 tinned bus wire.
- 5 Mueller test clips (get the nickled variety instead of the lead coated).
- 2 brass angles $\frac{1}{2}$ " x 2" for supporting panel on base.
- 2 brass angles $\frac{1}{4}$ " x $\frac{3}{4}$ " for supporting coil.
- 10 No. 6 $\frac{3}{4}$ " round head brass wood screws.
- 1 UX210 vacuum tube.
- Hardwood (maple) strips $\frac{1}{2}$ " x $\frac{3}{4}$ " x 10 $\frac{1}{2}$ " (notched per specifications given later).
- 2 pieces $\frac{1}{8}$ " wall 3" outside diameter 1" long Bakelite or Hard Rubber tubing.

If a set using receiving tubes is planned, we can get along without a filament voltmeter. A UX-210 run from a storage battery without a voltmeter will be quite satisfactory. A voltmeter is mainly useful with a variable alternating current supply for filament heating. The bigger the tubes used the more important it is for protecting the filaments and insuring long tube life. With the tubes we mention the investment is not very great and the use of such an instrument can be regarded as optional; it is convenient but not necessary.

A good 0-150-m.a. milliammeter costs about \$8.00. Such an instrument is desirable in a set using large vacuum tubes. Meters are almost a necessity to insure that tubes are operating under the best adjustments. A milliammeter can be used in the negative lead from the high voltage source to the tubes to show the plate current value. Placed there it is very nearly at ground potential and can be handled safely without danger.

A small but fairly good outfit can be built using no meters at all. A 2-volt flashlight bulb with a wire of variable length shunting it to prevent burn-out will do for a resonance indicator in the antenna circuit in place of an antenna ammeter. Using receiving tubes, no shunt will be needed.

TRANSMITTING COILS

The best coils to use in your transmitter will be of small enough diameter so that clips can be adjusted for "plate turns" and

"grid turns" without running leads around to the other side of the coil. From a theoretical standpoint, coils have simply inductance. Practically we meet a somewhat different situation that gets serious on the shorter wavelengths. All coils have some distributed capacitance between the different turns. They have resistance dependent on the material, size, spacing of the wire and frequency. The current distribution in each turn of wire depends on the frequency. High-frequency currents travel the surface of conductors, not on the interior. Our coil must be decently proportioned so that the field about the coil is confined to the neighborhood of the coil.

The ideal coil is probably made of flatwise-wound metal strip on notched Pyrex glass forms. Edgewise-wound coils, sometimes used, are quite unsuitable for use in a Hartley circuit for shorter wavelengths than 100 meters. They have high distributed capacitance unless the turns are spaced far-apart. When used for high frequency work the Hartley circuit degenerates into an arrangement having the tuning adjustment interlocking with the impedance adjustment. No primary condenser is necessary, for the outfit works on the

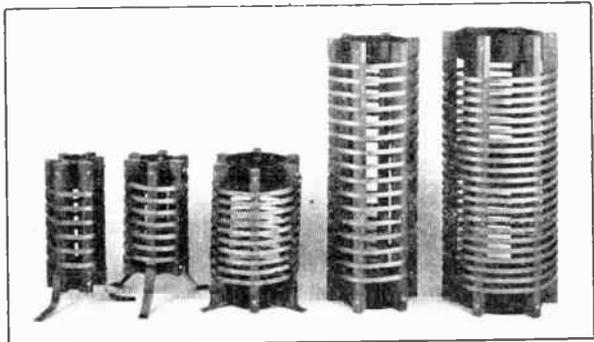

A COMPLETE SET OF FLATWISE-WOUND COILS
 The three coils at the left are interchangeable in the transmitter for which they were built. Note that the brass legs supporting them are bent so that each coil is the same height and the feet of each coil rest in the same places, being clamped between two wood screws which are loosened slightly when changing coils. The two coils on the right are antenna loading coils.

distributed coil capacitance. If we adjust our coil so that the tube works into the right impedance (plate turns) for greatest power transfer, we are operating off-wavelength. Shifting the wavelength within the amateur band, our efficiency is lost. Flatwise-wound coils have lower distributed capacitance than edgewise-wound or pancake coils. A practical and inexpensive coil construction is shown.

Your local carpenter can notch the six wooden strips for you or you can do the

whole job yourself. As the local wood-working shop only asks about fifty cents for such a job it is scarcely worth the effort on your part.

On two short pieces of hard rubber tubing (or wooden ends) are bolted six oak strips which have been notched and boiled in paraffin to keep out moisture. One 6:32 brass machine screw will hold them firmly in place. Cut a string which will just go around the rubber tube. Divide it into six parts while it lies flat on the table. Then wrap the string around the tube again and drill holes where the marks appear on the string.

Computing the inductance of the coils shown in the photograph gives us the following inductance values for each. Left to right:

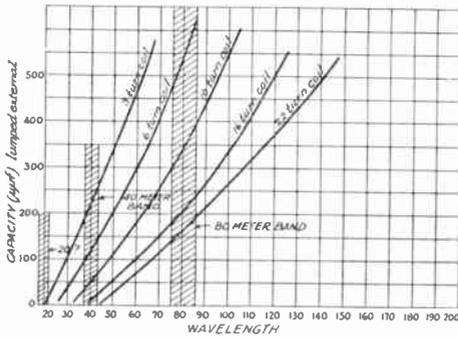

TUNING CURVES FOR 3½-INCH COILS

These are wound of ¼" brass strip spaced ¼" between turns (i. e., pitch ½"). Wavelengths given are for condenser across entire coil.

1.39 µh, 2.53 µh, 8.64 µh, 11.2 µh, 31.8 µh. Actual measurements made on the seven and ten turn coils using a known capacitance and a wavemeter and solving in the formula (Wavelength equals 1885 times the square root of inductance times capacitance, where the quantities are in meters, microhenries, and microfarads respectively) for the inductance gave 3.3µh and 9.3µh instead of 2.53µh and 8.64µh, the difference of course being due to the fact that the presence of some distributed capacitance raised the wavelength measured. Nevertheless, these values are surprisingly close showing that the flatwise wound coils have successfully reduced the distributed capacitance to a minimum. As would be expected, the apparent difference in values is greatest on the smaller coils because the leads between coil and condenser make up a larger part of the circuit with the small coils and the distributed capacitance of leads amounts to more on the shorter wavelengths.

80 meters is best for the beginner to use and a very useful wavelength for all-around amateur communication. The

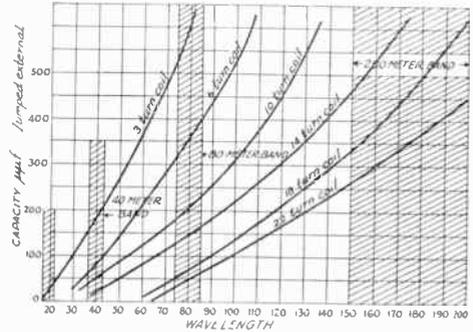

TUNING CURVES FOR 5" DIAMETER COILS WITH ¼" SPACING BETWEEN THE TURNS

150-200 meter wavelength is also good to use. There is less likelihood of interference with neighboring broadcast listeners if we use the shorter wavelengths.

For building a transmitter using a couple of UV-203-A's, or a UV-204-A, flatwise-wound strip ⅜" or ½" wide, spaced the width of the strip, will be useful. Our receiving tube transmitter can use a coil of wire on a cardboard form if necessary. The best thing to build for all-around use, however,

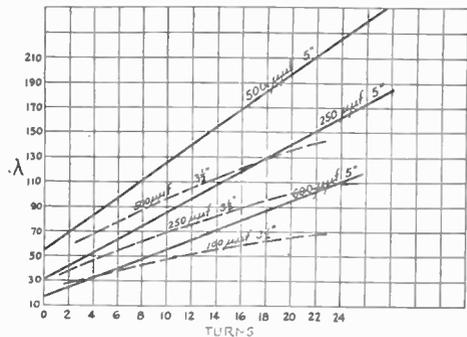

CURVES FOR 3½" AND 5" COILS OF ¼" STRIP WITH ½" SPACING BETWEEN TURNS

will be a group of interchangeable coils of ¼" brass or copper strip. A good coil will improve the receiving-tube transmitter and will be useful when we increase power to a couple of UX-210's. Here are the dimensions for three coils that will cover four amateur bands when the right tuning condenser arrangement is used.

Wave Band, Meters	Coil Diameter	Max. Cap. of Variable Tuning Condenser $\mu\text{f.}$	Turns, flatwise-wound $\frac{1}{4}$ " strip	Spacing between turns
150-200	5"	.0005 (or a .00025 shunted with a fixed .00025 condenser)	10 $\frac{1}{2}$	$\frac{1}{4}$ "
75-85.7	5"	.00025	10-12	$\frac{1}{4}$ "
37.5-42.8	3 $\frac{1}{2}$ "	.00025	7	$\frac{3}{8}$ "
18-22	2"	.00025	6	$\frac{1}{2}$ "

The cut shows how the notched strips are laid out. All six oak strips can be sawed straight across in a miter-box to a depth of 1/16". Then they can be staggered the right amount and the ends sawed off. The staggering will make the winding progress ahead the right amount from turn to turn. If a miter-box is not available

screw or a brass machine screw as shown in the diagram. If one long strip is not available it will be necessary to solder shorter lengths together before starting the winding on the form. After the winding is completed, the small brass angles can be attached to hold the coil off the base in a horizontal position.

The antenna coil is simpler. Although you can make a similar coil of fewer turns, such good and heavy construction is less necessary. Smaller wire can be used in the antenna coil because we plan to work into a high resistance antenna and the resistance of any ordinary size of wire in the antenna coil will be negligible compared to the total resistance of the antenna worked at or below its fundamental wavelength. The secondary or antenna coil consists of five turns of wire threaded through some hard wood strips with the turns spaced one-fourth inch apart or a little less. This coil is made nearly six inches in diameter—large enough so that it may be moved over the main coil if necessary.

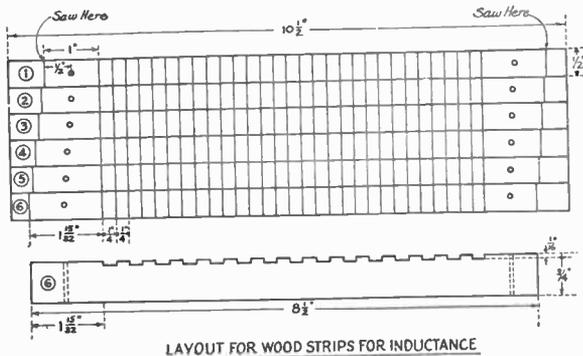

each strip can be notched separately in a vice. Be sure to leave room on the ends for the mounting bolt and so that the ends can be sawed off the necessary amount. The notches should be sawed a few thousandths of an inch wide so the strip will slip into place easily. When the strips are staggered the right amount strip number 1 can be placed next strip number 6 and the grooves will progress uniformly as shown by the dotted line.

The staggering is necessary in order to give the proper pitch to the winding that will be put on later. A hole is drilled one-half inch from the ends of each strip using a No. 27 drill. After soaking the strips in boiling paraffin for at least an hour they can be removed. Despite the fact that the paraffin is not visible on the surface of the wood, the wood is impervious to moisture and full of paraffin. Now you can bolt the wooden strips to the end rings which were previously drilled taking care to see that they are put on in the correct order and that none of them is reversed in the process. It is a good idea to number the ends of the strips when they are first sawed to avoid trouble.

The brass (or copper) strip is next wound on after anchoring the end with a wood

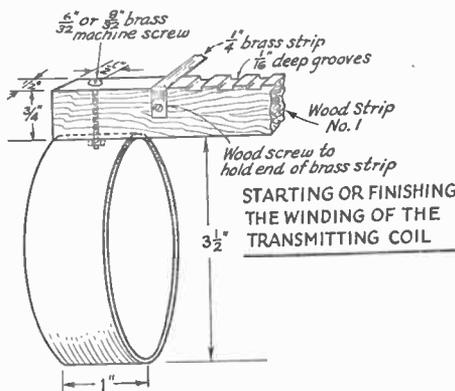

The photograph of this low-power transmitter shows the complete assembly. The radio frequency choke coil is wound of about 150 turns of No. 30 D.C.C. magnet wire on the cardboard form and held in place by the

connecting bus wiring. It is kept as far from the large coil as possible and at right angles to it. To the right of the UX210 (attached to the plate terminal of the socket) is the .002 mfd. plate blocking condenser. To the left of the tube is the .001

schematic diagram—and in the illustration. The photograph shows the general arrangement of parts as well as a clear picture of the wiring. The setting of the left-hand condenser and the number of turns between the two uppermost clips, determines the

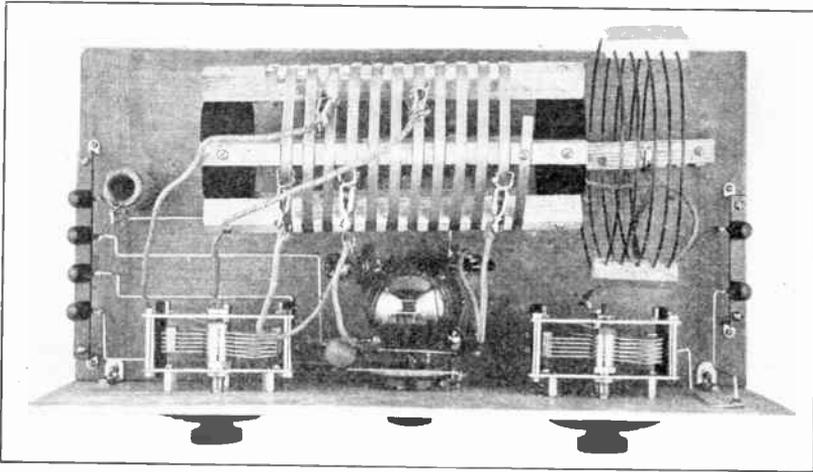

SIMPLE AND INEXPENSIVE LOW-POWER SENDING SET
Note carefully the position of the five clips on the coil.

mfd. Sangamo fixed condenser used as a grid condenser. Soldered to the terminals of this condenser is the Lavite grid leak. Both grid and plate condensers are mounted vertically to shorten the leads from the condensers to the coil. The main coil is $\frac{3}{4}$ inch above the baseboard, one of the supporting brackets being at the center instead of at the end so the coupling coil can be slid over the end of the main coil if necessary. No detailed panel or baseboard layouts are given as it is not necessary to follow any plan to such extremes to get good results. It is well for you to follow the general plan shown in the photographs as the important leads are of minimum length when these layouts are duplicated.

A little study of "Ham-Ads" in the latest *QST* often will show where good apparatus may be picked up at a saving. Make out a list of the apparatus that you will need. Check over the items, marking the parts that you already have. Look over the remaining items. Go thru *QST* and order apparatus or send for catalogs and information from the dealers who advertise there. Be sure to get parts that are good mechanically and electrically. No new or fancily gotten up "fixings" are needed. We cannot afford to pay for "frills". Standard fittings from reputable manufacturers are best.

The transmitter is wired as shown in the

wavelength. The antenna coupling coil and the series condenser are on the right, the UX-210 and filament rheostat in the center. The three lower clips from left to right are

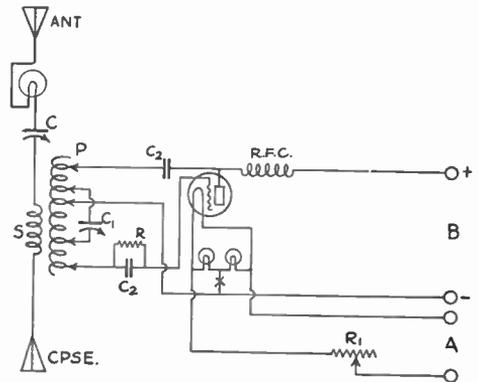

THE INDUCTIVELY COUPLED HARTLEY CIRCUIT

SCHEMATIC DIAGRAM FOR SIMPLE LOW-POWER TRANSMITTER

the grid, filament and plate circuit clips. The power input terminals are on the extreme left while the R.F. output to the antenna is on the extreme right. A flashlight lamp in the upper right hand corner of the panel

shows when the antenna circuit is in resonance. Xmas tree lamps on either side of the filament rheostat enable us to connect to the "electrical center" of the filament circuit. The R.F. choke is wound on the 1" form supported at right angles to the main coil and shown on the left side of the photograph.

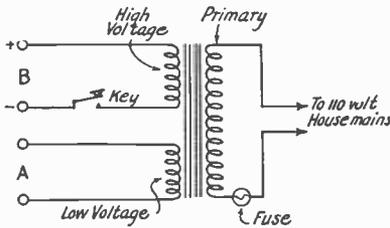

THE SIMPLEST POWER SUPPLY CIRCUIT FOR A TRANSMITTER

A three-winding transformer or separate filament and plate transformers may be used. The signal put out by a transmitter with such a power supply is known as ACCW.

Two automobile lamps and some .02µf. fixed condensers across them make a good center-tap arrangement if there is no center-tap available on the filament transformer. Instead of using automobile or Xmas tree lamps, we can make a 50-ohm resistor, wound non-inductively on both sides of the center-tap if we wish. Each 25-ohm section can be wound half in one direction, half in the other, on a one-inch form, or the wire can be doubled in the middle and wound in two sections. The center tap of course comes from the point where the two sections meet. It is a good idea to use a center tap arrangement as shown anyway as few of the boughten transformers really provide a tap at the electrical center.

If insulated resistance wire is not available it will be necessary to notch, groove, or thread the form in the proper direction so that the turns will not touch. The wire cannot be space wound on a smooth form as it is liable to expand and come off when connected in the circuit due to the heating that takes place, however slight. Resistance wires go by various trade names such as Nichrome, Advance, German Silver, Ideal, Constantin, Climax and Manganin. The last named is an alloy of copper, nickel, and manganese which is used in measuring instruments where constant resistance at different temperatures is important. The resistance of the various alloys varies with the composition and tempering process used. (See wire table in appendix for some values). Ideal, Constantin, and Advance are nickel-copper alloys, non-magnetic and non-corrosive. Having about 28 times the resistivity of copper, they can be used in

air to about 500° Centigrade. German-Silver and Climax are cheap nickle-steel alloys, useful like iron wire, when they can be protected from oxidation. Nichrome (nickle-chromium) is best of all and you can sometimes make a good center tap from an old electric stove or toaster element. Nichrome will stand temperatures of 1,000° C. continuously without corrosion. Whatever you use, be sure to tap the exact center of your resistance if you use A.C. for filament heating and if you expect to have a good D.C. note. The photograph shows two center-tapped resistances. The large one on the one inch form is wound non-inductively as described. The other shows two Ward Leonard impregnated resistors of about 25 ohms each.

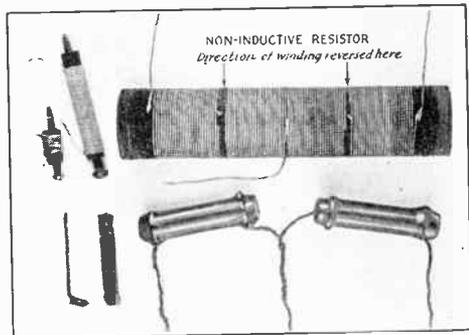

TWO SIZES OF GRID CHOKES FOR PREVENTING PARASITIC OSCILLATIONS—TWO VIEWS OF BRASS CLIP FOR TRANSMITTING COILS—TWO CENTER-TAPPED RESISTORS

Note the two points on the home-made resistor where the winding changes direction one-fourth the distance from the end, also the method of connecting the different sections of the winding together, which can be readily duplicated for bringing out taps from single-layer coils. Three holes are drilled in the form, the ends of each winding go inside the form and are pulled out and twisted together through the center hole. Using insulated resistance wire, it is not necessary to thread the form and non-inductive resistors can easily be made up to have any desired resistance value. The construction of grid chokes and the shape of the brass clips is clearly shown.

Clips to go on the flatwise wound coils may be made of the same material as the coil winding itself if brass ribbon is used. Some amateurs use the ¼" copper ribbon from a Ford magneto for both purposes. The photograph shows how the clip is bent with pliers to make it fit the coil neatly and to make it go on and off readily. But five clips are necessary and they can be made in as many minutes. Flexible lamp-cord leads are soldered to the clips and they go to the grid-filament-plate tube connections as well as to the variable tuning condenser. The two condenser leads are made as short as possible, while allowing the coil to be a couple of inches away from the condenser.

Little grid chokes are used directly in series with the grid of each tube (if more than one tube is used) to cut down inter-tube H.F. currents and prevent loss of energy through parasitic oscillations. A resistance of about 100 ohms will do as well. Both are occasionally necessary. A few dozen turns of fine wire wound over and over on a 1/4" dia. tube fastened down by a screw through it into the baseboard, will be effective. These chokes or resistors are in series with respect to the parasitic oscillations that we want to prevent between tubes. With respect to the main oscillating circuit the chokes are in parallel and have little effect. The grid chokes in the photograph are most effective of all as a coil of resistance wire is used. The longer coil shown contains four feet of No. 35 Ideal resistance wire (about 10 ohms per foot). The combination of both resistance and inductance is very effective in limiting parasitic oscillations to a negligible value of current.

The main radio-frequency choke coil is constructed to work best on the particular wavelength to which the transmitter is tuned. Often one choke will work in the set for more than one waveband, but in this case it may not be "right" for either one.

Every radio-frequency choke coil has a natural period of its own due to its inductance and distributed capacitance. When connected in a tube circuit the choke-period is changed. For every apparatus layout and tube equipment there will be a "best" choke. The best we can do is to specify what works best for our particular set. Mount the choke at right angles to the main coil and at a distance from it and everything else. Keeping coils away from each other and isolated as much as possible makes their losses lower and keeps induced voltages out of the argument.

Good chokes can be wound of No. 30 D.C.C. wire on a 3" coil form. Closely wound coils of the smallest wire that will pass the plate current will be satisfactory.

Best choke for	Turns
150-200 meters	250
75- 85 meters	150
40 meters	100
20 meters	50

ANOTHER HOMEMADE ARRANGEMENT

Some Handbook readers will not wish to follow the specifications given for a single UX210 transmitter so exactly. They can branch out with ideas of their own, installing equipment for a starter that will work nicely with receiving tubes or UX210's for the present but which will not need to be entirely rebuilt when going to two UX-

210's, one or two UV203's (fifty watters), or which can even be adapted to a UV204A (250 watter) if occasion demands. For their benefit we will show photographs of another homebuilt set wired up for two standard base tubes, but with a base and framework heavy enough and large enough to support larger tubes and equipment of any of the types mentioned.

This set will have some meters to help in keeping the correct adjustments. A filament voltmeter will be put on the panel to be connected across the filament circuit of whatever tube or tubes are used. By keeping the filament voltage down to the proper value (using filament rheostat in primary or secondary of the filament transformer) the life of the tubes will be lengthened. An antenna ammeter can now be afforded for indicating resonance. Perhaps it will be wise to connect a plate current meter in series with the supply circuit to help in obtaining the best adjustment. A grid current meter may be connected right in series with the grid leak if one wishes to add to the array and to have one more indication of what is going on in the set at different adjustments. However, most of us who feel the strain on our pocketbook will have to forego the last mentioned.

The base and frame can be obtained from the local wood working shop. Wood is better than metal for these parts as there is no loss due to induced eddy currents in the metal which gets in a high-frequency magnetic field. If metal was used it would be necessary to cut the frame open at some points and to insert a hardwood strip across these to prevent absorption of energy. In the photograph, the frame, base and panel are of oak. The panel is 12" x 14" by 1/4". The frame is 16" deep, constructed of 1" square stock with doweled joints. The base is 1" thick. The material and labor charge amounted to five dollars. A substantial arrangement is worthwhile. Some saving can be made by getting a base and panel of the sizes mentioned and putting them together with some strong brackets from the local dime store.

Here are the parts and the approximate list price of each:

- 1 UX-210 power tube\$9.00
 - 2 250-µf. variable condensers 8.50
(any type—S.L.C., S.L.W., or S.L.F.)
 - 1 Antenna ammeter, 0-1.5 amps. 5.00
 - 2 UC-1015 Faradon (grid and plate) condensers 2.00
 - 1 Standard-base socket 1.00
 - 1 5000-ohm Crescent Lavite grid-leak 1.50
 - 1 Filament-heating transformer (110-7.5v.)
(Acme, Thor, RCA, Hughes, Amertran) ... 5.00
 - 1 Plate transformer, 110-550 v., 100 watts10.00
(Or 350-volt "B" battery—cost about \$30)
 - 1 Filament voltmeter 0-15 a. c. volts 7.50
 - 2 4-inch dials with markers 3.00
 - 1 Telegraph key 2.00
- Materials for coil and coil mountings:
 50 ft. No. 18 Brass strip 1/4" wide 2.00
 5 cakes Paraffin (1 box "Parowax") 0.10

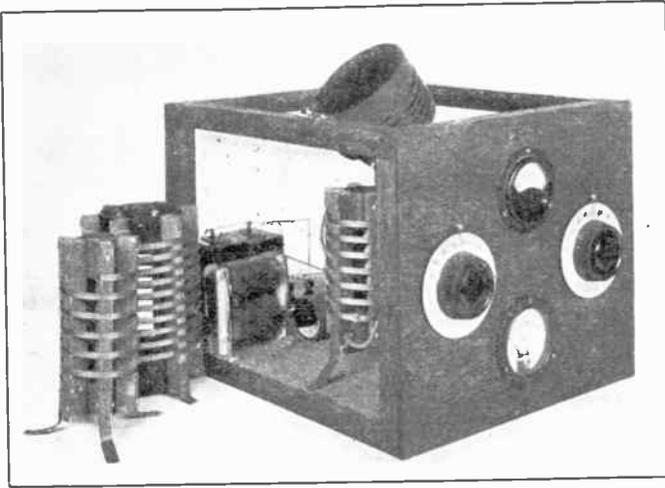

ANOTHER TRANSMITTER ARRANGEMENT

UX-210's or one or two receiving tubes may be used. By substituting large sockets for the standard sizes, keeping all other parts the same, and using higher plate and filament voltages, 50-watters can be used. Note the Acme choke and the fixed condensers constituting the thump filter—also the hinged antenna coupling coil and the interchangeable coils.

6 notched Oak Strips $\frac{1}{2}$ " x $\frac{3}{4}$ " x 10" (from local wood-working shop)	0.50
2 pcs. Hard Rubber Tubing $\frac{1}{8}$ " wall, $1\frac{1}{2}$ " long, $3\frac{1}{2}$ " diam.	0.60
(Or wooden discs of right size)	
Miscellaneous: 25 ft. No. 12 B & S tinned bus wire; 24 $\frac{7}{8}$ " round-head nickeled wood screws; 1 doz. Fahnestock clips or 8-32 brass machine screws with hex. nuts; 10c worth of rosin; stick of half and half solder; brass strip for mounting the coils	1.30
Total	\$59.00

A stiff hinge arrangement makes it possible to move the antenna coil to any position desired to vary the coupling. The coil in this instance is made by winding a few turns of wire on a bakelite form so tightly that they remain in place after the ends of the coil have been soldered to the terminal bolts. One connection of this coil is fastened to the hinge itself which is bolted to the forms by three brass machine screws.

It is a good scheme to build a mounting for the radio frequency choke coil using a strip of bakelite and two General Radio plugs and jacks. Then the "best" choke for

a given wavelength can be plugged in at the same time the coils are changed in the main part of the Hartley circuit. The different chokes should be labelled plainly and the positions for each clip on the interchangeable coils should be indicated by tags or colored markers tied permanently in place after the best adjustments have been found.

This particular transmitter uses interchangeable coils to make it possible to work on any of the amateur wavelength bands at short notice. The fixed condensers are of mica and copper and will stand much higher voltages safely than those shown in the low power set described first. Spaced variable condensers for transmitting purposes can be mounted on the panel when the set is first built — but receiving condensers can be used successfully until we use upwards of 1,000 volts on the plate of a fifty watter at which point the Hartley circuit tuning condenser is apt to begin sparking across if the antenna gets out of tune. This transmitter shows another possible arrangement for the antenna coupling coil on any set you build.

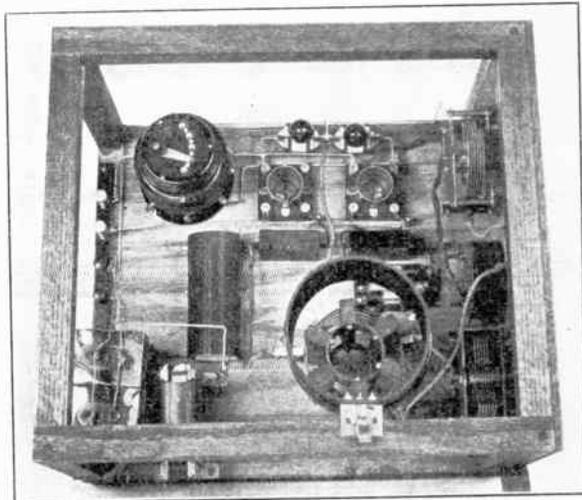

THIS VIEW OF THE TRANSMITTER SHOWS THE WIRING OF THE SOCKETS AND TERMINAL BOARD
The automobile lamp center-tap is clearly shown, the lamps being painted black to keep the light from escaping while not preventing heat radiation. Note the brass clips in their proper positions on the coil.

Several ideas for mounting plug-in chokes will suggest themselves to the builder. The R.F. chokes can be wound on wooden dowels, each end of the winding being connected to some short right-angle brass pieces fastened to each end of the dowel.

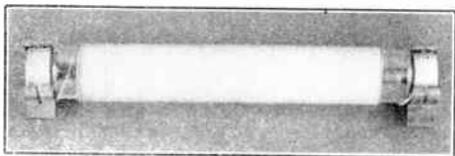

EASILY MADE PLUG-IN R.F. CHOKES FOR OPERATION AT DIFFERENT WAVELENGTHS

Materials: 2 large cartridge fuse clips
"5 and 10" glass toothbrush holders
Small spool No. 28 to No. 32 D.C.C. wire
The threaded aluminum caps clamp the end of the wire, making good connection and holding the wire in place without the use of dope.

These brass angles should be mounted so that the projecting portions on each end are in the same plane. They will plug into the jaws taken from a discarded knife switch. Some glass toothbrush holders from the "5 & 10" make even better forms that will mount nicely in large cartridge fuse clips. The aluminum caps clamp the wire and make good contact with the clips which should be mounted near the back of the transmitter frame where the chokes will be readily accessible when changing wavelength.

The complete wiring of this outfit is shown quite clearly in one of the photographs. Right beside the sockets you will see the grid chokes built exactly like the ones shown for preventing inter-tube parasitic oscillations. As the eye looks down vertically on the chokes about all that can be seen is the head of the screw and the first turn of the winding. Whenever more than one tube is used in parallel, such chokes will probably be needed. If the tubes heat unduly and the output is low you can be sure that something is wrong. In extreme cases a radio frequency ammeter placed in the grid condenser lead will indicate an ampere or more of R.F. current circulating between tubes. The addition of a resistance in the lead from the grid of each tube will reduce the value of this current—the choke will tend to prevent it altogether. Too large a choke will of course have an effect on the main oscillating circuit and this condition should be avoided.

It is a good idea to mount the interchangeable transmitting coils on plugs so that we can change from one wavelength-band to another quickly but the mounting of the three coils on brass feet is easier and

cheaper which is the reason we decided to present it here.

KEYING THE SET

If your set uses "raw" A.C. in the plate circuit, the keying can conveniently be done in the primary of the plate (high voltage) transformer. The inductance of the transformer windings and the sinusoidal character of the alternating voltage itself prevent the sudden application of voltage to the plate and the keying is very satisfactory.

With a battery or D.C. generator supplying the plate, we have a different condition. Keying should be in the negative lead to the high voltage and the arm of the key should be grounded for safety. As soon as we press the key the voltage is applied to the plate. The oscillations rise quickly to their maximum value (with the ordinary short-wave antenna) and sets listening on almost any wavelength are "shocked". Something must be done to make the tube start and stop oscillating more gradually, yet not too gradually or there will be no clean-cut keying.

The keying thump is cured by putting a small keying "filter" between the key and the set. A 3-henry choke and a 2-or 3-

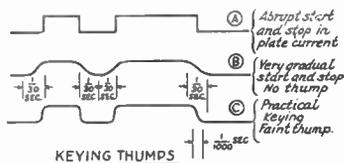

CONDITIONS AT POINTS IN THE PLATE SUPPLY CIRCUIT

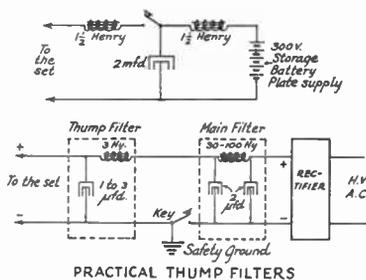

microfarad condenser will do the trick. They are connected as shown in the diagram. If we want a decent note and have only alternating current available we must step up the voltage to the desired value and then pass the current through a rectifier. "S tubes", mechanical synchronous

rectifiers, Kenotron or Rectron tube rectifiers, mercury arc rectifiers and electrolytic rectifiers are all used for changing our high voltage alternating current to pulsating direct current. After the current has gone through the rectifier it must be filtered to take out the pulsating A.C. modulation. A "brute-force" filter will be best for this.

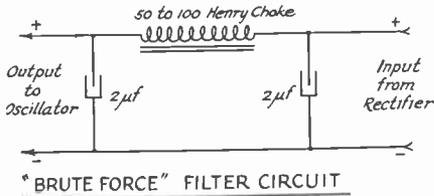

A 50-to-100-henry choke coil with several microfarads connected across the supply line will do the business here.

When a filter of this sort is used the key must always be placed between the filter and the set. The filter tends to smooth out all irregularities in the supply and it will put "tails" on the dots and dashes in an attempt to smooth out the keying if the key is put on the power-supply side of the main filter.

Keying in the center tap is quite common in some parts of the country. This arrangement positively cuts off the supply voltage and the R. F. current in the condenser-coil circuit and is productive of key thumps. The best place to key is in the negative lead from the high voltage source—and don't forget the "thump" filter between the key and the set.

THE ELECTROLYTIC RECTIFIER

For a permanent station the electrolytic rectifier is one of the best. It is bulky and sloppy but works well. Chemically pure aluminum is hard to obtain, while the lead or iron element is plentiful and cheap.

In designing a chemical rectifier be

FORMING

Special care must be used in first forming an electrolytic rectifier, especially if the cells are formed in series across a high voltage transformer. When the circuit is closed it is almost a dead short circuit across the transformer secondary, and the current will be quite high until the film is partially formed. Use lamps or resistors in series, closing the circuit for a few seconds at a time until the current drawn from the transformer is not above its rated capacity. The maximum current density should not exceed the normal operating density. The jars must not be allowed to heat as the film on the aluminum plates begins to break down about 120° F. If there is sparking the rate must be reduced, as the film on the aluminum will be destroyed as fast as it is made. A well formed aluminum electrode will be smooth and have a thin dull white surface.

SOLUTIONS

A dilute solution of sodium bicarbonate (baking soda) gives good results with low cost. A layer of transformer oil on top can be used to reduce evaporation and creeping will not be as troublesome as when borax is used. Sodium-ammonium phosphate and sodium-potassium tartrate are good but more expensive. The use of borax requires a saturated solution. If baking soda is used there will be a heavy white precipitate formed at the aluminum electrode which will settle to the bottom. As this does not appear after the aluminum is formed, an old solution can be used for forming and the electrodes put into a clean solution after they are formed. Lead and iron are not satisfactory for use as auxiliary electrodes in an aluminum rectifier that has an organic solution but they work well with a borax solution or with the dilute baking soda solution. A carbon auxiliary electrode will be satis-

Tube	Plate volts (r.m.s.)	Plate mil-amps.	Submerged alu-minum plate area, per cell	Jars required for Bridge or center tap connection	"Voltage Doubling" connection
UV-202	350	40	1 sq. in.	20	10
2 UX-210's	1000	120	2½ sq. in.	28	14
UV-203-A	550	90	3 sq. in.	50	25

sure to use sufficiently large jars to prevent undue heating of the solution. Allow 40 or 50 volts to a jar and a current density of not over 40 milliamperes per square inch of aluminum sheet. Chemical rectifiers are cheapest and easiest of any to filter.

factory if an organic rectifier solution such as a citrate, acetate, or tartrate is used.

When a good large filter is used there is a "back-voltage" or counter electromotive force from the charge left in the filter condensers which has an effect in the rectifier

circuit as soon as the key is up. This voltage is applied to the rectifier at the same time the transformer is applying high voltage alternating current to it. This may make the voltage-per-jar too high so that some of the aluminum films break down, sparking and making a "noise" that does not filter out easily. A few more jars added to a rectifier will usually cure this trouble permanently. The transformer voltage that causes break-down is always the "peak" of the A.C. cycle, which is nearly one and one-half times the effective value of voltage at which A.C. circuits are rated.

Diagrams of connections are shown. An example may help. We have 2 UX-210's that normally take 45 M.A. each of the

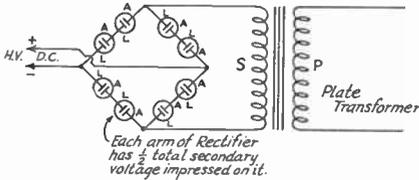

BRIDGE-CONNECTED LEAD-ALUMINUM RECTIFIER

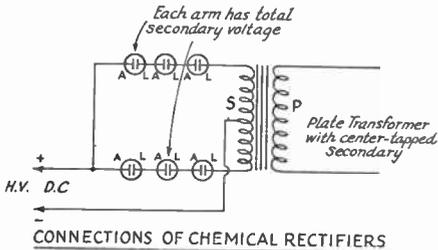

CONNECTIONS OF CHEMICAL RECTIFIERS

plate current. That makes 90 M.A. the set uses. Our transformer gives us 550 volts on each side of the center tap. Assuming 100 M.A. maximum load, 100 divided by 40 gives us $2\frac{1}{2}$ sq. in. of aluminum that must be immersed in each jar to carry the current. $550/50$ makes 11 jars necessary for each leg of the rectifier. We should use 12 jars to give the necessary 10% factor of safety. Some jelly tumblers may be pressed into service to hold the solution. A small rack and some wooden pieces holding the aluminum and lead strips will complete the outfit.

In forming aluminum rectifiers a resistance or bank of lamps should be placed in series with the input to the plate transformer. The unformed jars are not able to rectify effectively and act as a short circuit across the high voltage winding. If fuses do not blow, the transformer probably will burn up. Putting lamps in series limits the transformer load to one it can stand. As the rectifier begins to form, the series lamps get dimmer and larger lamps or more of

them can be used until the rectifier will withstand the full voltage. After several hours of forming the rectifier will keep in condition with occasional use. An aluminum oxide film and a gas film as well are re-

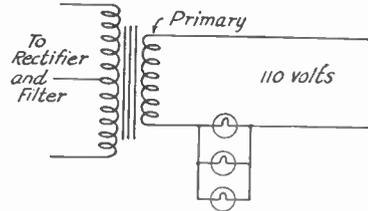

FORMING THE ELECTROLYTIC RECTIFIER

More lamps are screwed in as rectifier forms. When nearly formed, the lamp bank may be bridged by a wire. If there is appreciable heating, cut off the forming current until rectifier is again cool.

sponsible for its functioning, and the gaseous film forms as soon as the jars are connected to the source. There should be no fireworks or scintillating sparks on the plates. That is sign of too much voltage per jar and means that some other "dead" cells are not working. Each plate should have a uniform phosphorescent glow. A dark cell may be working. If there is enough voltage the phosphorescence will prove it is working. The current carrying capacity of electrolytic rectifiers seems to be limited mainly by the heating in the cells. Quite high instantaneous currents can be rectified but unless artificial cooling of the aluminum electrode is possible it is necessary to follow the prescribed current density of 40 M.A. per square inch.

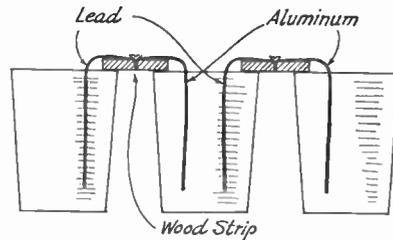

SIMPLY MADE ELECTROLYTIC RECTIFIER FOR LOW-POWER SET

The rectifier must be allowed to form gradually. If the voltage is raised too quickly the cells will heat and operations should be suspended until they are cool again. Impure aluminum contains carbon, zinc or iron. Such plates will show brown spots. Cells containing poor aluminum will not form and new aluminum should be used. White petrolatum can be used for sealing the cells if desired. Lye can be used to clean the

plates when it is necessary. A little ammonia can be added often to replace that lost by evaporation. Old aluminum lightning arrestor cones are a good source of pure aluminum. Sheet aluminum from the Aluminum Company of America and its agencies is satisfactory.

Test tubes, jelly tumblers, drinking glasses, and small and large preserve jars can be used to hold the different sized plates.

FIGURING THE COST OF A RECTIFIER

Two UX-210's will need a rectifier with the following parts:

28 Aluminum strips, 5" x 1" x 1/32" thick\$3.00
28 Lead strips, 5" x 1" x 1/16" thick 2.00
28 Glass tumblers, 2 for 5c,70
4 2" x 1" wooden strips (7 jars long)30
1 gross 5/8" blued round-head wood screws20
2 packages "20 Mule Team" borax20
Total	\$6.40

TUBE RECTIFIERS

A vacuum tube rectifier has a somewhat greater first cost and maintenance than an electrolytic rectifier. It is convenient, portable and neat, however. It can be filtered with the usual 50-henry to 100-henry choke coil and 4 to 8 mfd. shunt capacity. Electrolytic rectifiers have "condenser" characteristics and are easiest to filter successfully. Tube rectifiers come next in ease of filtering. They are silent in operation and not as costly as motor generator supply.

The two-element vacuum tubes for rectifying are now known as Rectrons (formerly Kenotrons). The filaments give off electrons when heated and current can only flow through the tubes in one direction. The rectifying circuit is similar to that used with the aluminum-lead cell. The filaments are always at "plate" potential and the low-voltage winding of the filament transformer must be insulated for the high voltage. Separate filament transformers should be used for the rectifier and oscillator. The tubes are manufactured in appropriate sizes for use with the corresponding oscillator tubes, and the two-element "Rectrons" cost about three-fourths as much as the same sized 3-element oscillators. The efficiency of the

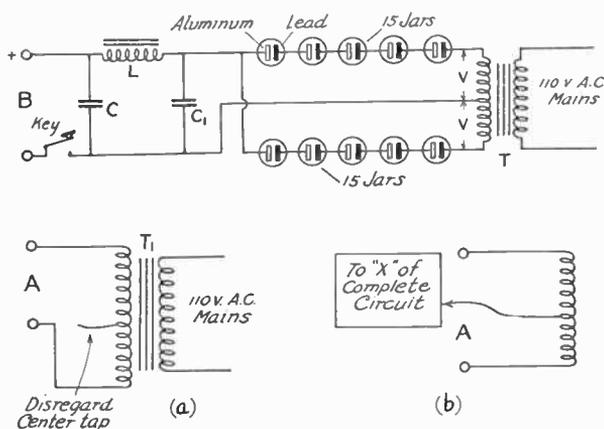

FILTER AND RECTIFIER CIRCUIT
L is a 30-henry to 100-henry choke, C and C1 are each 2 microfarads or more, T is the plate transformer, T1 is the filament transformer.

electrolytic and tube rectifiers is rather low. The loss in heating the rectifier solution, the plate of the Rectrons, and power consumed by the filament of rectifying tubes is responsible. Tube rectifiers have a larger voltage drop across the rectifier unit than chemical rectifiers have.

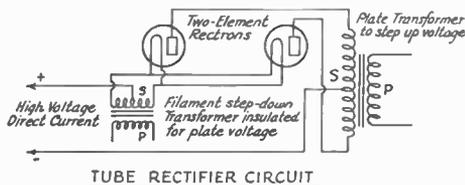

Most of the first cost in connection with a tube rectifier goes into the extra filament-heating equipment. For a sending set using one or even two UX210's a couple of old style tungsten filament UV216 tubes will be an excellent investment. Since tubes requiring less filament current have come on the market, all types of tungsten filament tubes have taken a drop in price—but they work beautifully and require less attention than the electrolytic rectifier. The UV216's will handle up to 750 volts A.C. without flashing in the base and require 7.5 volts from a separate filament heating transformer. Use two tubes in the circuit shown for the UX210 transmitter. Four tubes (two in series for each one shown in the diagram) will stand twice the plate voltage and successfully run a fifty watt (UV 203A).

GASEOUS CONDUCTION TUBES

"S" tubes or "gaseous conduction" tubes operate on the "short path" principle. A rarefied gas is a good insulator between

two points that are near each other. Two metal plates are separated by a gas in the "S" tube. No filament is required at all. When there is a potential difference between the plates, the few free electrons in the gas move toward the positive electrode (anode), their speed depending on the volts per inch across the gap and on the collisions that take place with neutral atoms and molecules. The electron flow is so small that it can be neglected. The effect of the movement of electrons in the gas is to "bump" the molecules hard enough to break up the gas into a great number of positive ions and negative particles. We say that the gas has become "ionized" and that gaseous conduction takes place. The "Tungar" and "Rectigon" are examples of low voltage rectifiers depending on this principle. They use Argon gas and a special thoriated filament, the filament being necessary for stable operation because of the very low voltage at which they work. Under the right conditions, these tubes can be used for battery-charging with the filaments unlighted.

The size, material and spacing of the two elements is important as well as the gas and gas pressure used. One of the hardest things is to prevent a change in characteristics of the rectifier tube during its life. "S" tubes are connected just like the aluminum rectifier cells. Each tube will handle a certain voltage. Two tubes may be used in series to take care of twice that voltage. Tubes placed in parallel will increase the current-carrying capacity proportionately.

"S" tubes will handle between 750 and 1000 volts per tube. As there is no filament to burn out or to require a filament-heating source, the cost of operation is somewhat less than a similar rectifier using two-element vacuum tubes. The "S" tubes are hard to obtain but we hope their manufacture will be resumed soon. The new type "S" tubes have the higher voltage break down value. These rectifier tubes can be connected similarly to the vacuum tube rectifier just described.

B-BATTERY ELIMINATORS

In the last few years a number of substitutes for A and B-batteries have been advanced. Of course these devices were made to use with vacuum tube receiving sets but they enter the picture here because they can be used with transmitters that you build using receiving tubes.

These battery eliminators of course are designed to plug into your local 110-volt alternating current circuit and there are several types on the market, all containing a step-up transformer, rectifier, and filter and differing from one another principally in the type of rectifier used and the means

for determining and regulating the output voltages. As far as using such arrangements with a receiver are concerned we are perhaps unduly pessimistic and expect to stick right by the usual form of A and B-batteries for a long time in the future. Battery current is 100% quiet and under no circumstances do we get into trouble with fluctuating voltages, noises brought in from leaky power lines, and the like. Under certain conditions a B-eliminator will be satisfactory but seldom will reception be quiet over the whole wavelength range of an *oscillating* receiver such as that used in receiving code from continuous-wave stations.

A few of the B-eliminators give a good direct current output at between three and four hundred volts. Using one on a small receiving tube *transmitter* gives excellent results after boosting the voltage as high as it will go and connecting the B-eliminator in place of a transformer or other high voltage plate supply.

MERCURY ARC RECTIFIERS

Mercury arc rectifiers operate similarly to the gaseous conduction tubes previously described, the operation depending on mercury vapor. A cold mercury arc tube is quite highly evacuated. The arc in mercury vapor takes place between a cold positive upper electrode (anode) and a pool of mercury constituting the lower negative electrode (cathode). This mercury pool is incandescent where the arc strikes and the tube is usually tilted to start the arc. The load of the rectifier usually keeps the mercury pool at a high temperature which is very necessary to keep the arc properly rectifying as if the "hot spot" on the pool is allowed to cool off the arc will go out.

The mercury arc rectifier will handle over six thousand volts and in commercial use mercury arcs are sometimes built to handle much greater potentials. The life of a mercury arc tube is about the same as that of kenotrons—sometimes much greater. At a number of amateur stations tubes have been installed, obtained for little or nothing from the local electric light company that discard them after they begin to operate unsteadily in a series street lighting system. Such tubes will still serve as rectifiers for an amateur plate supply source for UV203A's or for a UV204A for years providing they are once installed correctly at a "ham" station. The efficiency of such rectifiers is very high, there being a negligible drop in plate potential within the tube. The overall efficiency of course is lowered an amount depending on the "keep-alive" circuit used and the instantaneous load values on the tube. Mercury arc rectifiers are easy to filter, too. The device used for keeping the hot-spot

on the mercury pool and the inductance for keeping the tube operating stably will be most of interest to Handbook readers.

The "keep-alive" circuit is necessary for

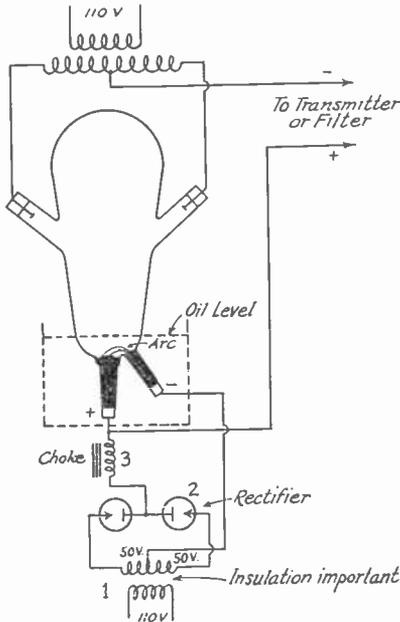

SIMPLEST FORM OF "KEEP-ALIVE" SYSTEM FOR MERCURY ARC RECTIFIERS

using the mercury arc rectifier with amateur transmitting sets for telegraph work. An auxiliary electrode near the base of the tube is ordinarily provided for use in starting the arc by an initial flash on the main pool—and this starting arc is kept in operation continuously by our "keep-alive" circuits so that the tube will be kept filled with mercury vapor even when the key is up as in intermittent telegraph work. The auxiliary and main mercury pools are connected through an inductance coil (to steady the keep-alive arc and prevent it from going out) and rectifier to a source of low voltage alternating current (about 50 volts on either side of the center tap). Tungar or Rectigon tubes such as used in low voltage battery chargers can be used or lacking these an electrolytic rectifier made up in two half-gallon battery jars will prove very satisfactory. In operating the tube the glass next the keep-alive arc gets so hot that you should take the precaution to mount the mercury arc tube in an oil bath to a level

somewhat above the mercury pools to protect the glass. Use light gas engine oil of any kind convenient for cooling purposes.

The transformer supplying the "keep-alive" circuit must be well insulated because just as in the case of the filament heating transformer for kenotron rectifiers, the filament circuit of the rectifier is at plate potential above ground. If no one-to-one ratio transformer with a center tapped secondary is available for the keep-alive circuit, a 50-volt supply can be used with four large rectifier jars connected in a bridge arrangement (shown previously).

The choke can be easily built if a spare transformer winding of the necessary inductance is not available. Some resistance in series with the choke will help in limiting the current used in the "keep-alive" circuit to a value which will just keep the arc operating stably, preventing the wasting of power and getting away from the danger of overheating the glass at the auxiliary electrode. The primary of an R. C. A. 75-watt filament heating transformer makes a good choke in an emergency. One amateur used a choke having about 800 turns of No. 18 or No. 20 wire wound on a closed core 1 1/4" square (cross-section). The primary of some transformer in almost every experimenter's "junk box" will be found to serve in an emergency. The voltage used and the necessary adjustments are not critical.

The connections of the mercury arc rectifier in transmitting circuits are just the same as those of any of the other rectifier types we have discussed. Keying in the primary of the plate transformer is very satisfactory although the key may be placed as in any of the other circuits described. The output can be very successfully filtered. We are showing diagrams and photographs

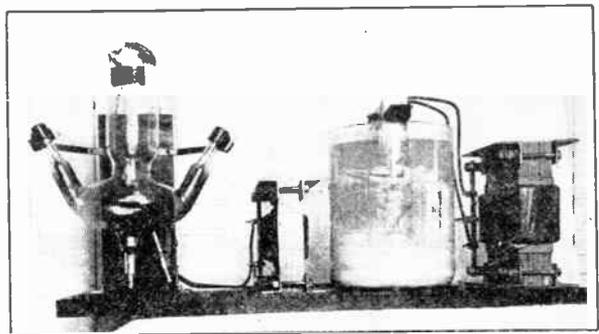

ELECTROLYTIC "KEEP-ALIVE" ARRANGEMENT AT 3CDQ

of some rectifiers actually in use at amateur stations employing different "keep-alive" rigs. One man who did not have a 30 to 55 volt alternating current supply available

from transformers, used a 1½" spark coil fed by a step-down transformer. This is quite all right if the noise of the vibrator is not objectionable and if the spark coil is husky enough to vaporize mercury. Us-

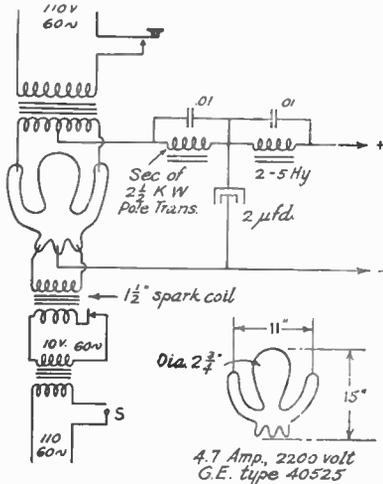

"KEEP-ALIVE" CIRCUIT USING SPARK COIL AND SHOWING PERMISSIBLE METHOD OF KEYING CONVENIENTLY IF A RELATIVELY SMALL FILTER IS USED

ually it takes a transformer of nearly 200 watts capacity to supply power for vaporizing the mercury and to supply the losses in the low-voltage rectifying device, the voltage drop in the choke and so on. Most of the stations use the small 220 volt 110 ampere tubes successfully. So many styles and varieties of tubes are available that we cannot be too specific regarding any particular rectifier tube. In general, the tubes are not critical and a little careful experimenting will enable you to get one going at your station. At least one fellow

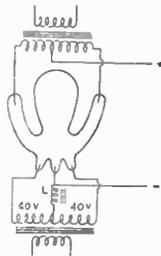

CIRCUIT THAT CAN BE USED WHEN THERE ARE TWO AUXILIARY ELECTRODES (THREE MERCURY POOLS)

Note that no low-voltage rectifier is necessary for maintaining the "keep-alive" arc.

has successfully operated one of the G. E. 10 kilowatt street lighting rectifier tubes (Type 40525) without the low voltage rectifier for the keep-alive circuit. Nevertheless, it will sometimes be desirable to have the rectifier with such a tube as low voltage direct current makes an arc stable.

Some of the rectifier tubes that have been used by lighting companies until unsteady operation was observed have a deposit of mercury inside the glass arms. It may be possible to improve the operation by holding the tube rightside up in water and boiling for several minutes to evaporate the deposit getting it back in the main pool where it belongs. Several amateurs have also suggested that a wrapping of tinfoil or wire about these glass arms, being careful not to get the wrapping down too near the main mercury pool, will help to steady operation in old lamps. In handling the tubes remember that mercury is heavy and it must be poured carefully to prevent cracking the tube. If a tube is defective due to a poor vacuum it will not operate. A tube having a good vacuum will give out a clicking sound when the mercury is shaken about carefully so that it splashes a little. If there is much

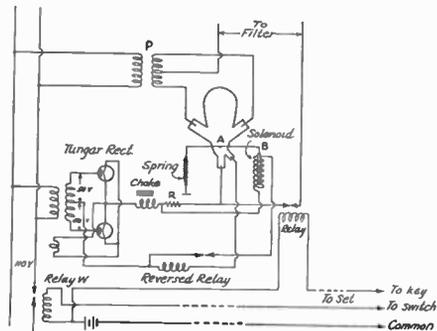

COMPLETE RECTIFIER CIRCUIT AT 3AB Also showing Remote Control System.

air in a tube the mercury will oxidize on trying to start the arc. In mounting the rectifier tubes the glass should not be clamped so that there is any strain on it as it is almost sure to fracture after a few hours of operation if there is a strain on some part of the glass.

At the station owned by Mr. A. B. Goodall (3AB) of Washington, D. C., the mercury arc rectifier tube is mounted with the oil jar in a wooden frame and remote controlled by the arrangement shown in the photograph and diagram of 3AB. The tube with its frame is pivoted on a line through the center of gravity (point A in the circuit diagram) in a second larger wooden support. A rod B is fastened to the frame

of the tube as shown, a coiled spring pulling down on one end of the rod and an iron solenoid armature of cylindrical shape arranged on the other end of the rod so mounted that when the coil of wire (solenoid) around the armature is energized by the closing of the proper relay, the magnetic pull will tilt the tube. The low voltage rectifier circuit supplies the current for operating the solenoid. In the "keep-alive" circuit is a reverse-connected relay, the contacts of which are held closed whenever there is no current in the circuit leading to the auxiliary electrode. A storage battery controls the power and keying relays. When the switch closes the circuit to relay W, the power transformer P and the Tungar rectifier are connected to the 110-volt mains. The circuit through the solenoid being closed, the current goes through the solenoid windings, pulling down one end of the rod and tipping the tube. The mercury flows over, covering both lower electrodes and allowing current to flow in the "keep-alive" circuit. This energizes the reversed relay, breaking the solenoid circuit so the spring can pull the tube into an upright position striking an arc as it does it. The arrangement is much simpler than the somewhat drawn-out explanation would indicate and 3AB tells us that the outfit has not given the slightest trouble in over a year of use.

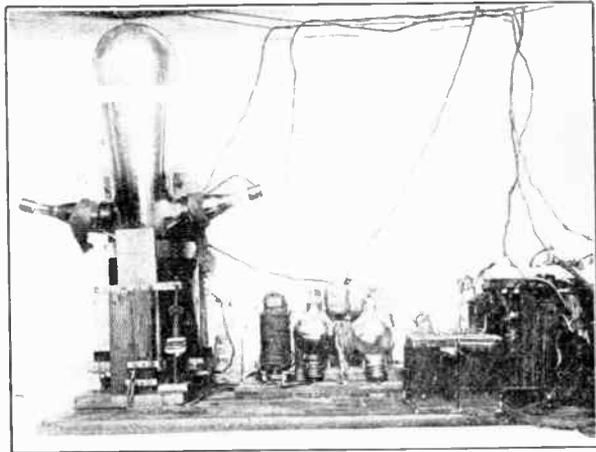

TUNGAR OR RECTIGON "KEEP-ALIVE" ARRANGEMENT AT 3AB
 Note the framework supporting the tube and the solenoid used for tilting it by remote control.

reed was magnetized permanently to be a North pole it will of course be repelled by the adjacent North pole and attracted toward the South pole and it will move toward the

SYNCHRONOUS VIBRATING RECTIFIERS

The reader will be familiar with the several makes of vibrating rectifiers sold for boosting the automobile battery. All of these rectifiers have a vibrating reed, usually a steel reed which has been magnetized and which is definitely polarized. Let us assume that the free end is a north pole. This steel reed is mounted at the central point of a W while the arms of the W are made of soft iron on which are mounted coils energized by the alternating current supply source. Before the current is turned on, the soft iron core is not definitely polarized and the pull exerted by the magnetized reed itself is not quite enough to make it move closing the contacts connected to it, especially in view of the fact that it is attracted by each arm of the W equally and in opposite directions. If a current is run through the winding on the core, the core becomes magnetized and one extremity of the W becomes a North pole while the other becomes a South pole. As the free end of our

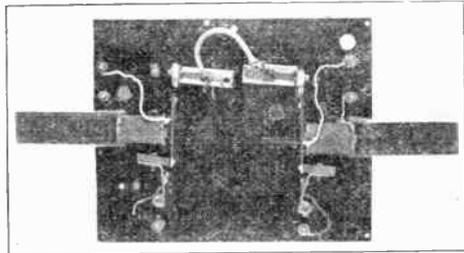

THE UPPER PHOTOGRAPH
 Showing a half-wave rectifier of the vibrating type. This rectifier made by 9BRI will handle 2,000 volts. Operating in series, the vibrators will handle higher voltages than a single-break contact will handle.

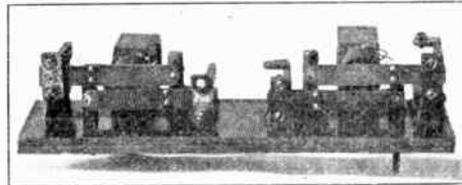

THE LOWER PHOTOGRAPH
 Showing a similarly built full-wave rectifier.

South pole closing a set of contacts. If the current is reversed, the reed will move in the opposite direction closing the other contacts. If alternating current is run through the windings of the soft iron core, the polarity

of the core will be reversed at the frequency of the A. C. and the reed will be moved back and forth operating the contacts mechanically so that one lead of the output is always positive with respect to the other lead. The armature must be of the proper size and stiffness and the contacts (usually of carbon and copper to prevent sticking) must be carefully adjusted to give good results.

The vibrating reed and iron core may be used as the basis for a high voltage rectifier if the insulation of a Homcharger, Valley, F F Battery Booster, or the like is replaced with a well insulated mounting making use

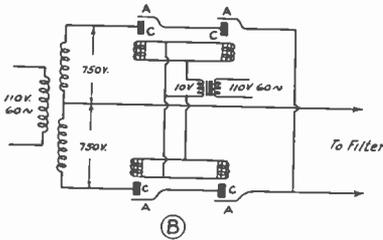
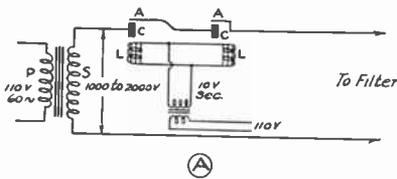

FULL AND HALF WAVE VIBRATING RECTIFIER CIRCUITS

A is a half-wave rectifier for voltages up to 2,000. B is a full-wave rectifier for voltages to 750 or 1,000.

of the old windings merely to energize the vibrating reed. The photograph shows both a half-way rectifier of the vibrating type which will handle up to 2,000 volts and a full-wave rectifier similarly constructed. The vibrators are not polarized as suggested by our general explanation of operation but depend on the changes in total magnetic pull to operate them. In the circuit diagram A shows the connections of the half-wave rectifier while B shows the full-wave rectifier which will handle voltages as high as 750 without bad sparking. Note the difference in the connections of the magnet windings. For the sake of clearness the U magnets are not shown. However, each vibrator (A) is mounted on one end of a U magnet, the other end of which carries the iron-cored spool (L). In both diagrams the armatures (A) carry silver contacts working with carbon contacts (C). A study of the photographs will give some idea of the construction.

SYNCHRONOUS ROTARY RECTIFIERS

While both vibrating and rotary rectifiers are more or less noisy they have quite high efficiency as there is almost no voltage drop through the rectifier. The plate transformer used with a rotary synchronous rectifier does not need a center tap. It amounts to a double-pole double-throw (D. P. D. T.) polarity reversing switch operated at synchronous speed. Rotary rectifiers must be driven by a synchronous motor, that is, by one which keeps right in step with the supply frequency, in effect throwing a reversing switch every time the polarity changes between the supply wires. The diagram explains the operation quite clearly. All the loss in mechanical rectifiers is due to brush contact resistance and to the mechanical power required for driving. It varies with the particular motor and brush rigging used. No rotary "sync" starts "right side up"

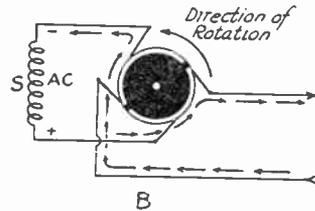
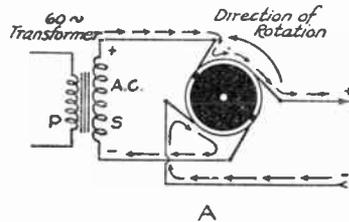

OPERATION OF A ROTARY SYNCHRONOUS RECTIFIER

A—Wheel in first position.
 B—Now the wheel has made one-quarter turn and reversed the connections but the polarity of the transformer has also reversed so the output is unidirectional. If the supply current is 60-cycle then B is 1/120 second after A.

more than half the time. The other half of the time the rectifier starts reversed, putting the positive side of the line on the filament center tap and connecting the negative to the plate of our oscillator. A hand reversing switch or a polarized relay will quickly correct the connections or one can turn off the motor and allow it to "slip a pole." If a hand switch is used it should be put behind a panel or boxed up for safety to life. A high voltage transformer plus a big filter is a mighty dangerous thing so don't touch the switch! The safe and sensible thing to do is to put the reversing switch

in the *primary* side of the high voltage plate transformer.

The difficulty with most synchronous rectifiers is in the "hash" that is sent out locally. While the "keep-alive" circuit of a mercury arc is perfectly quiet and reasonable, the synchronous rectifier makes such a racket that it sometimes is unpleasant to have it within the station—and when the key is depressed the sparking makes an electrical noise than can be picked up on all sorts of receivers for many blocks away from the station. However one only needs to stop the sparking to have a really good rectifier. The synchronous rectifiers of either the rotary or vibrating type are excellent except for the first trouble in stopping the sparking. Though we cannot get as enthusiastic over them as over some of the other types, we can at least discuss the troubles in filtering the output of a "sync" and mention some of the remedies.

An unfiltered synchronous rectifier sparks very little, but as might be expected with any circuit which is mechanically made and broken many times a second, it produces a noise instead of a musical tone which makes us think of a good filter as an appropriate remedy. The alternating current is fed into the revolving disk by two brushes—pulsating direct current comes out of the two others. The brush rig can be unclamped and moved backward or forward with the set running until with no filter the operation is practically sparkless. As long as the contacts open and close at the time when the voltage of the transformer secondary is zero, there will be no sparking. It is at once evident that as the contacts do not open and close at *quite* the same time, we are bound to have some voltage across the contacts *either* at the time of making or breaking the circuit. The airgap in the wheel can be made small or the wheel can be made of large diameter to get a long gap while making the breaking time short. To prevent burning the insulation some rectifiers are made with air gaps in the wheel but unfortunately this is bound to make the brushes chatter at high speed which burns the wheel where the brush hits after climbing onto the next segment and which manufactures an intolerable noise for non-oscillating receivers miles around. Gauze brushes help some but they must be kept very carefully trimmed.

As soon as a filter is connected, the sparking gets rapidly worse in direct proportion to the goodness of the filter. If a condenser is across the line next the disk, there are blue sparks which jump just before the "make." This is because the transformer voltage is not yet equal to the voltage left in the filter from the last half-cycle. If there is a coil next the wheel there will be a flaming arc at the "break." It is impossible to adjust things so that we can "make"

and "break" the circuit when the filter and transformer voltages are the same. Just as long as there is a difference in voltage there will be sparking *unless* some kind of an electrical shock absorber is provided ahead of the filter.

Resistances in both the positive and negative leads and right next the wheel (between the wheel and either coil or condenser) will help. They are very wasteful of power and

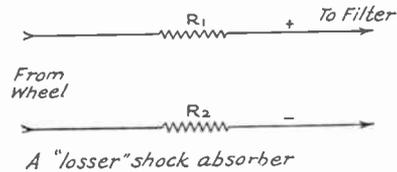

make the voltage regulation of the rectifier poor because they should have about the same resistance as the plate circuit resistance of the tube. Another method is to provide each brush holder with three brushes, a brush a little ahead of and behind the main brush but connected to it through about 5,000 ohms resistance. This will re-

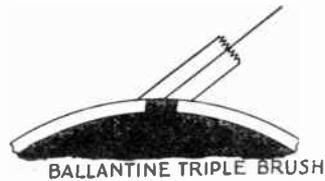

duce sparking but the eight extra brushes put a drag on the motor and tend to make it get out of synchronism. If some gauze brushes are used with little pressure the scheme is good to use with one of the filter circuits we will now show.

As mentioned previously, it is possible to shift the brushes so that there will be no sparking at all at "break" but this will tend to make the sparking worse at the instant of making contact. The best way to stop any backfire was first used at 2CQZ and is beautifully simple. An S tube, kenotron or four or five jars of electrolytic rectifier can be placed between the wheel and the filter. This auxiliary rectifier does not need to stand the full voltage—merely the difference voltage between filter condenser C1 and the transformer at "make." At high voltages the S tube is very satisfactory and at lower voltages a single rectron (or a tube that doesn't oscillate well any more) can be used. The filament heating transformer must of course have ample insulation between primary and secondary as it must hold up under the full plate voltage. The electrolytic rectifier will probably be

easiest for most of us to build. With such a device we can use a good large filter and obtain a good note getting rid of trouble with poor notes and from neighboring listeners-in who might be bothered with the terrible "hash" from an unfiltered "sync."

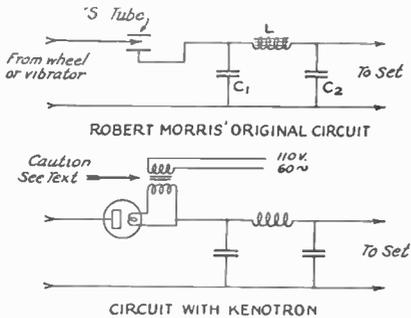

SPARKLESS FILTER CIRCUIT CONNECTIONS
An S-tube, rectron, or electrolytic rectifier may be used.

The size of condenser C1 largely determines the regulation. If it is made too small, the output voltage will depend on the load too much. A big filter fully charged is a dangerous thing. Such filters should be kept out of easy reach with the live parts well protected by insulation to prevent accidental

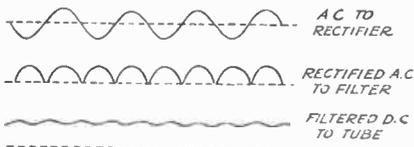
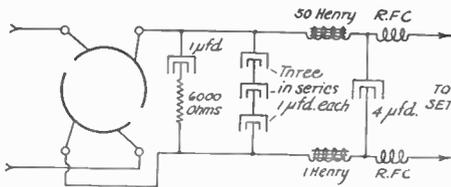

Dotted lines are zero lines

SPARKLESS FILTER CIRCUIT USING SMALL INPUT-TO-FILTER CONDENSER WITH HIGH SERIES RESISTANCE

The best spark prevention is obtained by omitting the 3-in-series condenser arrangement, using the circuit otherwise just as shown.

contact. Good filter condensers hold a charge for a long time and a 250,000 ohm resistance or a high voltage voltmeter with multiplier placed across the output of the filter will be useful in discharging it quickly after use. Don't forget to watch for key thump trou-

bles. These may be cured if you are keying in the high voltage line by putting a one microfarad condenser across the key contacts and inserting a two or three henry choke in the line between the key and the set.

A very simple method of helping sparking troubles is to use a fairly small input condenser to the filter, putting about 6,000 ohms in series with it to prevent heavy quick surges at "make" and "break." The circuit used is shown and gives good performance except for somewhat poorer regulation.

A number of good rotary synchronous rectifiers are available from different manufacturers. The Advance rectifier shown in the photo has a brush rig which can be clamped by turning the handle making it easy to shift and adjust the brushes while

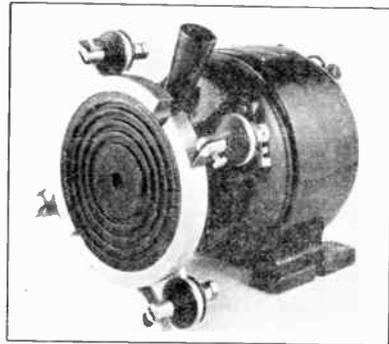

A TYPICAL SYNCHRONOUS RECTIFIER
The brush holders are clamped by turning the handle which can be operated while the motor is running. The wheel is of bakelite with the segments moulded in.

operating. The Stahl rectifier has a smooth brush path, the gaps being filled with compressed mica to resist injury from flashover. The Marlo has segments on each side of an insulating ridge making it possible to use segments of nearly a half-circle in length and a smooth path without danger of flashover or burning.

REGULATION

When we speak of the voltage regulation of a transformer, generator, rectifier, filter, or rectifier-filter combination we are talking about the variation in the voltage the device delivers with the "load" that it handles.

A rectifier-filter delivers 350 volts, 45 m.a., to a UX-210 with the key pressed. We lift the key and the voltage at the output terminals of the filter rises to 500 volts. The regulation from full-load to no-load is the difference or 150 volts. Regulation is often expressed as a percentage. Voltage

regulation is the ratio of the difference in full-load and no-load voltage to the rated load voltage.

$$\frac{150}{350} = 42.8\% \text{ regulation (rather poor)}$$

The tube load is not necessarily *full* load for this rectifier. If we design our rectifier-filter to give an output of 350 volts, 100 m.a., (35 volt-amperes or watts), and happen to be using it under-loaded, we have 42.8% as a value of regulation for about half-load. A regulation curve for the outfit can be plotted showing what the percentage regulation of volts delivered will be for different loads.

The regulation of mercury-arc and synchronous rectifiers is very good. Big filters and transformers having lots of resistance and reactance have notably poor regulation. Tube rectifiers and electrolytic rectifiers have quite poor regulation which has to be taken into account in building transmitters. The condensers across the high-voltage line must always have a voltage breakdown high enough for safety under no-load conditions.

MOTOR-GENERATORS

A direct current motor-generator is an excellent source of plate power for any station. The rated output of the generator (watts) should be equal to the product of the plate voltage (volts) and plate current (amperes). The terminal voltage must match the rated plate voltage of the transmitting tubes. It is convenient but not necessary to have a "field" rheostat in the field of the generator to regulate the terminal voltage. The regulation of most of the motor-generators on the market is good. By using a series field winding or "compounding" a machine, an increase in load current makes the field in which the armature rotates stronger, which compensates for the several factors causing a drop in voltage. A machine having the same full-load and no-load voltages is known as "flat" compounded. If the full-load voltage is greater than the no-load voltage, the machine is "over-compounded." A motor generator set is the simplest plate supply source but it is also probably the most expensive.

The motor that drives the generator can be direct connected or belted. In any case it should drive the generator at about its rated speed. It should be rated at about $1\frac{1}{4}$ to $1\frac{1}{2}$ times the generator capacity as it has to take care of its own and the generator's losses.

Motor-generators for radio work can be obtained from the Electrical Specialty Company of Stamford, Conn., who will supply

information on their products on request. Motor generators are expensive. An A.C. supply with a filter is cheaper. However, a motor-generator of the right size will save bother with big filters and rectifiers. A little filter to take out the commutator ripple may be necessary. A many-segment commutator will have little ripple and will not need to be filtered except for voice work (radio telephony). The motor-generator set is noisy which makes it impossible for some jobs. However, it is usually very convenient if one has the ready money to spend on power supply equipment.

Dynamotors, gasoline-engine-driven generators, storage cells or dry-cell "B" batteries are necessary for isolated lay-outs or semi-portable motor-truck outfits. Emergency communication must always depend on a local source of power, for commercial lighting and power are cut off in times of emergency.

A dynamotor is simply a two-winding machine, running on one winding as a motor driven from a six or twelve-volt storage battery. The high-voltage winding delivers several hundred volts to the plates of our transmitting tubes.

Storage cells are expensive and many of them are necessary to give us high-voltage power. Either Edison alkaline batteries or lead cells can be used. Equipment must be provided for charging them. Distilled water has to be added to replace that lost from evaporation. In cold climates they must be kept fully charged to prevent freezing of the electrolyte. After a few years the storage cells must be rebuilt or replaced and so the up-keep is also quite high.

CARE OF LEAD STORAGE CELLS

A transformer and rectifier can be used for recharging storage cells. A high-voltage generator is equally good. Storage cells can take a small charge continuously when not in use. This is called a "trickle" charge and keeps them in excellent condition. It is almost as good to charge batteries at an 8-hour rate, however. In the 8-hour rate 40% of the charge is completed in the first 2 hours, 30% in the second 2 hours, 20% in the third two hours, and 10% in the last two hours. A tapering charge is best. A good overcharge should be given once a month. The lead cells will gas on becoming nearly charged. In overcharging cells, discontinue the charge after the gassing has taken place for about an hour. Use only distilled water when it is necessary to add water.

Lead cells normally give about 2.2 volts each. When the cells are discharged the terminal voltage is about 2 to 1.8 and the specific gravity of the electrolyte is 1.150. On completing a charge the terminal, volt-

age may be as high as 2.7 or 2.8 per cell, which falls rapidly to 2.2 when the charging is discontinued. A charged cell has a specific gravity of 1280 to 1300. A good hydrometer costs 50c and is the surest indicator of battery conditions that we can use.

The safe charging rate depends on the size of the plates (ampere-hours capacity of the battery). The lower the charging rate the less the likelihood that we dislodge active material from the positive plates, reducing the capacity of our battery. A 150-A.H. battery can be charged at as high a rate as 12 amperes at start and 6 amperes at finish, without danger of materially decreasing its life. A 100-A.H. battery should be started at about 8.5 amperes and tapered off to 4 amperes. A 1200-m.a.-hour storage "B" battery can be charged at a 100-m.a. rate.

Connections to batteries should be kept clean and tight. Corrosion can be prevented by applying vaseline or grease to the terminals. Spilled acid can be neutralized by applying baking or washing soda, or household ammonia.

Batteries should not be allowed to stand in a discharged condition. Overdischarge causes sulphation. The reddish-brown positive plates turn darker, the negatives take on a light reddish hue, the density of the acid in sulphated cells is lower than in others. Keeping the cells well-charged, overcharging at a high rate to reduce sulphate, keeping deposits from under the plates, and charging individual sickly cells will prevent early sulphation of a lead cell. Storage cells should *never* be discharged until they are absolutely dead.

One of the most important things to observe in the care of storage batteries is to use the correct connections when charging. Connect the *positive* terminal of the charger to the *positive* terminal of the battery, and the negative charging line to the other terminal. A red terminal, POS, or + usually marks the positive leads. A D.C. voltmeter can be used as a polarity indicator. If the wires are dipped in a conducting solution, hydrogen bubbles will rise from the negative terminal. A salt-water solution or one made by putting a little hydrochloric or nitric acid in water can be used. If sulphuric acid is used add small quantities of strong acid to the water carefully to avoid trouble from the hot solution. Most of the corrosion will appear at the positive terminal of the battery. Sometimes this can be used as an indicator, though it is not as reliable as others mentioned.

Keep open flame away from gassing batteries. The hydrogen given off may cause an explosion that damages the battery or blows acid into your face. Add acid electrolyte only when electrolyte has been

spilled. Charging batteries in the wrong direction will reverse the negative plates. Reconnecting correctly and giving a good charge will correct the situation. Bad plates which have lost most of the active material should be replaced. New separators are occasionally necessary after a couple of years of service.

DRY CELLS AS PLATE SUPPLY

Dry cell batteries usually can be obtained in 22½ or 45-volt units for plate supply work. They are made in odd sizes for use in flashlights. The No. 6 dry cell (1½ volts) is familiar to all of us for gas engine ignition or to light the filaments of our "peanut" tubes.

The 22½-volt batteries (4" x 4¼" x 8") usually have about 5700 milliamperere hours capacity when discharged intermittently at rates not in excess of 30 milliamperes. 200 hours of operating use can be expected when using such batteries with a UX-210 transmitting tube. With 201-A tubes even longer life can be expected. Of course the thickness of the zinc shell, the sealing to prevent evaporation, the composition and disposition of the electrolyte, and the depolarizing elements used will have a great deal to do with this life. Our figures are merely representative of some of the batteries available from reputable manufacturers.

Battery capacity will be reduced if batteries are kept in too dry a place, especially if they are not sealed well, as the electrolyte will dry out. In damp climates there is apt to be leakage between the cells of high voltage batteries if precautions are not taken. In cold climates batteries keep very well but may show a temporary loss of voltage as the activity of the chemicals is decreased by cold. In this case the voltage will rise as current is drawn from the batteries due to the heat generated on the inside.

The life and capacity depend on the size, weight, construction, on the adaptability to service and on care in installation and use. The ampere hour capacity given above is representative of the average medium sized 22½-volt, 15-cell, 5-pound B-battery. Of course the figures would be the same for a 45-volt, 30-cell, 10-pound battery made by the same firm. The exact battery dimensions are bound to vary somewhat, as these batteries have been manufactured in a variety of sizes and shapes to suit the many kinds of broadcast receivers brought out in the last few years. In general one can go best by the weight—the larger and heavier the battery for a given voltage, the longer it can be depended on to last if it is made

by a well-known manufacturer instead of by some fly-by-night concern.

Dry cell batteries are not suited for use with larger sets than those using one UX-210. The economy is rather poor beyond a 50-milliampere discharge rate. Such batteries are comparatively light. They are ever-ready to use, and they have done notable work in short-wave transmitters used by explorers in the far North on several occasions.

transmitting coils and chokes can be the same as those described under "Building the Transmitter." Two plate by-pass condensers and two radio-frequency choke coils in the positive leads will be needed. The other details remain the same.

ADJUSTING THE TRANSMITTER

Getting on to the actual adjustments of the transmitter let's first see just how to go about it. Remember that if things go

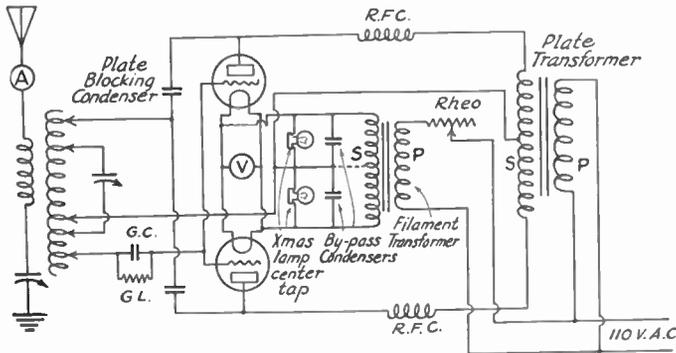

FULL-WAVE SELF-RECTIFYING HARTLEY CIRCUIT

The beginning amateur will have no trouble in starting off with a set using small tubes with a dry cell battery of two or three hundred volts for plate supply. A high-voltage step-up transformer with a cheap electrolytic rectifier will perhaps be more economical than this. A good filter should

wrong we may lose some expensive equipment. First reduce the voltage applied to the set. Run the filament a volt (or at least half a volt) below normal filament voltage. Cut down the plate voltage by using low voltage taps of the plate transformer or by putting some series resistances in the plate supply circuit. Always change *one* adjustment at a time and observe the results by the meters in the circuit. If more than one change is made at a time nothing will be accomplished. Don't expect that the adjustment will be a matter of good luck. Real results will come from systematic work with the circuit. The adjustments are very simple and but a very short time will suffice to make one well acquainted with them.

Assume that we have a magnetically coupled Hartley circuit. That is most common and easiest to adjust. First of all place the clips in the relative positions shown in the diagrams and photographs of the transmitters shown in this Handbook. The filament clip is somewhere near the center of the coil while the plate and grid clips are on either end of the coil. More turns will be needed between the filament clip and the plate clip (plate coil) than between the filament clip and the grid clip (grid coil). The plate current to our tube is largely dependent on the ratio of "plate turns" to "grid turns"—the more grid turns used, the more feedback voltage and the higher the plate current. However, enough grid turns must be used to give you the

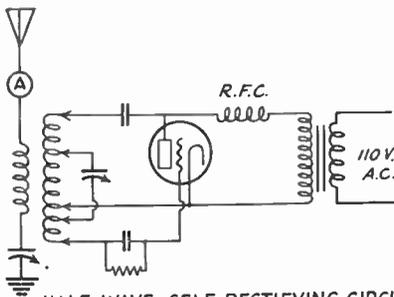

HALF-WAVE SELF-RECTIFYING CIRCUIT

be added to take out the A. C. ripple with the transformer arrangement. A keying filter is necessary with the battery plate supply to keep key-clicks from making the set a local nuisance. Using the tubes with a self-rectifying circuit is most economical of all, but the broad and poor note makes the dry cell or transformer-rectifier-filter combination better. A self-rectifying circuit using full wave rectification is shown. The

necessary feedback voltage or the set will refuse to oscillate. The wavelength will be practically independent of the adjustments of plate and grid clips (using our *flatwise* wound coils). The higher the wavelength the more nearly this statement will be absolutely true.

You must have two objects in mind when tuning your set. You want the maximum obtainable *steady* output from the tube and the highest possible efficiency, the highest ratio between antenna input and the electrical input to the plate circuit of the tube. The greatest output will be indicated by the highest antenna current at a particular wavelength but the antenna ammeter cannot be trusted to tell the whole story—it does *not* show antenna power. More antenna current at a higher wavelength does NOT mean that you are radiating more energy. In general, when you are working at or near the natural period of an antenna system, the antenna resistance is higher as the wavelength is reduced causing the antenna current to drop off as the wavelength used is cut down but not necessarily indicating less power output. (Ant. power = $R_{\text{total}} I^2$). As R gets greater, I is necessarily less if the power is constant.

If you have never before had anything to do with transmitters, it is a good idea to enlist the help of a neighboring amateur in tuning the set for the first time. However, if this is inconvenient be sure to operate at reduced voltages, and proceed by yourself. You will find out a number of interesting things and be able to do the job more intelligently next time.

With the clips on the coil in what you think are the proper positions depress the key. If you have a plate milliammeter note the reading of it. If not watch the tube to see that the plate doesn't get red hot indicating that something is wrong with your clip positions. If everything seems all right, tune your *receiver* to some point in the amateur band where you intend to transmit and adjust it so that it oscillates. Disconnect antenna and counterpoise leads from the transmitter and keeping the phones on, adjust the variable condenser which is in the condenser-coil circuit (the left hand dial of our low-power transmitter described in this Handbook). If the transmitting tube is oscillating as it should be, you will hear the whistle (beat note) and buzz when you swing the variable condenser through the wavelength to which the receiver is tuned. If you have the wavemeter handy, you can couple it to the big coil in the transmitter and watch the resonance indicator of the wavemeter or the plate current meter of the set for an indication as resonance is crossed.

Lacking any indication that the set is oscillating, add a few turns to the grid side

of the circuit after shutting down. Again vary the condenser and try to find out if the set is perking. When the whistle has been located, check the wavelength by the wavemeter (or by the oscillating receiver) until it is WITHIN an amateur band by an ample margin. Then connect the antenna and counterpoise leads to the set and move the antenna coupling coil toward the main coil far enough so it can pick up some energy. Holding down the key, vary the antenna series condenser watching the antenna ammeter (or flash-lamp) in the antenna circuit. If a resonant point is found and the lamp shows signs of getting too bright and perhaps burning out, shut down again long enough to put a short piece of wire directly across the terminals of the lamp to protect it from burn-out. Any piece of magnet wire will do. Use a piece about ten inches long and move it up and down leaving it at an adjustment where you can just see the lamp glow. If at any time the tube gets any hotter than a cherry red, add some turns in the plate circuit readjusting the tuning condenser if it was necessary to change the filament clip in finding a better ratio of grid and plate turns. After the antenna lamp has been made to burn as brightly as it will you can try changing the value of coupling by moving the antenna coupling coil or by changing the active number of turns in it noting the adjustments with pencil and paper opposite readings of plate input. If there is no plate current meter you should try to make the lamp glow brightest on a given wavelength with the plate of the tube barely showing any color at all. When you change the coupling, don't forget to change the antenna tuning condenser a little to re-tune to resonance.

If there are meters in both plate and grid circuits it will be possible to use them as an indication of what is going on. The grid current meter should never read over about one-fifth as much as the plate current meter. It will be instructive when the rough adjustments have been made to put meters in the different parts of the circuit, noting the reading of all meters as one clip at a time is changed a turn at a time.

Without the antenna connected, the plate current meter should read less than normal for the tube. If the set persistently refuses to oscillate the wiring should be checked and the tube carefully examined. A radio frequency ammeter in the condenser-coil circuit will tell you right away if the set will oscillate. Be sure to shunt the meter with a piece of wire, though, as there is a lot of current in this circuit and the meter may easily jump to an off-scale deflection if only a small meter is available and no protective means are observed. If there is a low input and the R.F. meter shows no current in the output circuit of the tube it will be necessary to change the clip adjust-

ments, using more turns in the grid circuit. Usually, the fewest turns that can be used in the grid circuit while maintaining steady oscillations will give good output and run your tube cool. If possible raise the plate voltage when this adjustment has been found as high plate voltage makes for high efficiency. It is possible to increase both the input and output just by adding on more grid turns—but this will probably give a marked decrease in efficiency if this adjustment is carried too far.

The more turns used in the plate circuit the higher the external plate impedance and the lower the plate current. You will remember that the greatest power output available from a dry cell was when the load resistance and the internal resistance were equal. A similar condition obtains with a vacuum tube oscillator. For a given wavelength you are working on there will always be a "best" number of turns to use in the plate circuit. By changing the number of turns in the plate coil we can change the efficiency of the outfit.

We really ought to hold the plate power input and the grid excitation constant and find the best number of plate turns to use to give maximum current in our output circuit at the wavelength we wish to use in transmitting. Usually, though, we have neither a widely variable plate voltage or a (plate) high-voltage voltmeter and sometimes not even the milliammeter. If we have these instruments we can vary the plate voltage enough to keep the POWER input constant and make this adjustment. Otherwise we must get along without it. Adjust the plate turns with the antenna tuned so that we can work the tube at its rated dissipation. Use loose coupling to the antenna and a sufficient number of grid turns so that the set will oscillate STABLY. Most amateurs in the United States try to overload filament and plate, tighten coupling and do anything that will get a reading of an extra tenth of an ampere in the antenna—but they are all wrong. The *most effective signal is your goal*. Try to push a nice, steady, clear-cut signal out. Even if the audibility isn't quite so striking you can work rings around the fellows with floppy signals that it takes a mind reader to copy. The most effective signal is seldom the *loudest* one in these days of shorter wavelengths and higher frequencies. It is the clear, *steady* note that gets through.

If you are unfortunate enough to have a set with too large coils, you will find that there are some turns left over on your main inductance coil. Try to avoid unused turns

or dead ends if possible. When there are dead ends, keep them all in one end of the primary coil. If there are unused turns in both the primary and antenna (secondary) coils, keep the dead ends away from each other rather than towards each other, thus keeping capacitive coupling between coils low and making it easy to determine and vary the magnetic coupling. Cutting off dead end turns will raise the efficiency, *raising* the antenna current and *lowering* the input.

Using flatwise wound coils having low distributed capacitance, you can use a shunt primary tuning condenser even when working on 20 meters. If edgewise wound strip is used in coils, the set will work on the distributed capacitance for wavelengths below fifty meters unless abnormal spacing is used between turns. Below 20 meters wavelength, the effect of distributed capacitance will be rather great whatever coils are used, part of it being the inter-turn capacitance of the coils, the rest being due to the capacity between leads. The use of some lumped capacitance is highly recommended when possible as it prevents the interlocking of different adjustments and makes the circuits both flexible and stable. A large value of capacity and a small number of turns in the condenser-coil circuit always makes for a *steady* signal.

When working with edgewise wound coils on very short wavelengths it is impossible to adjust things separately—the amount of regeneration and the wavelength are both changed together each time we change an adjustment. It helps some at five meters to use a variable plate bypass and a variable grid condenser to make the total effective capacities in the circuit as low as possible and to afford a means of adjustment.

When two tubes are used in parallel the grid leak needs but half the resistance value to give the same grid bias effects. As the input to the tubes is increased, reduce the grid leak resistance in steps. On most wavelengths the grid leak may be connected right across the grid condenser. For shorter wavelength operation, however, it is desirable to keep less material at grid voltage to minimize the capacity effect. For twenty meter sets (and lower wavelengths) run the grid leak from the grid directly to filament with a radio frequency choke (20 turns magnet wire space-wound on a 1/2" wooden dowel) in series. In a circuit where the controls interlock, changing the grid and plate clips will also change the wavelength appreciably. Allowance must be made for this in juggling the clips. Usually the farther from the center of the coil the clips are moved, the higher the wavelength.

If the antenna is tuned to exact resonance with the primary and the coupling is very close, the low power set may stop oscillating or oscillate unstably. The coupling can be loosened or either one of the circuits may be detuned a trifle. With the antenna detuned so the antenna current is about nine-tenths of its maximum value most anything can happen and the set will still oscillate on the proper wavelength. It is often better to operate slightly detuned than to operate with fairly tight coupling and very close to resonance where anything that happens can throw the signals out.

Parasitic oscillations can be prevented by the use of grid resistances and grid chokes of the proper sizes. They usually occur when there is more than one tube operating in parallel or on very high frequencies where there are leads and distributed capacities in the circuit with a strong natural period of their own. The construction of grid chokes has been mentioned before. Heating of the grid and plate leads inside the base is almost a sure sign of parasitic oscillations. A large input and low available output also lead one to suspect trouble of this sort. The current at ultra-high frequencies may not show up on any meters at all but if it is there it is robbing the antenna of useful power. An R.F. ammeter placed in the grid lead may show a high reading—if parasitic oscillations are present.

When a circuit has both high distributed capacitance and a lumped capacity across it there may be two resonant frequencies in the circuit, one due to the lumped value, the other to the distributed values acting in conjunction with the inductance of the faulty coil. At certain adjustments the set is liable to become unstable, flopping over to the "other" frequency which is apparently not affected much by varying the tuning condenser between certain limits. If the natural period of a coil happens to be in the tuning range, care must be taken not to operate on this wavelength. If the grid circuit happens to have a natural wavelength near that of the secondary circuit the tube is liable to want to oscillate at this frequency. By building good coils of low distributed capacitance and by putting in grid chokes whenever we parallel tubes we have minimized the chances of getting into trouble from these causes.

When a UX210, UV203A, UV211, UV204A or UV851 is used for work below 50 meters special precautions should be taken to protect the tube against abnormal conditions. Besides the burnout of grid or plate leads from excessive R. F. currents at ultra-high frequencies, there is danger of insulation breakdown or puncture of the glass stem. The plate and grid leads will handle from five to ten amperes safely (depending on the size of the tube) and a fuse placed close to

the grid or plate terminal rated at a little less than five amperes will often save a tube. Never operate a tube when plate or grid leads show color. It is best to reduce plate voltage or plate current if necessary to avoid brushing or overheating, applying all the remedies mentioned for reducing or avoiding parasitic oscillations.

Sometimes trouble will be found with the radio frequency choke coil or coils. When working below 20 meters wavelength, chokes in series with the filament leads will help to get more antenna output. Often chokes in the 110 volt power supply leads to the station will be helpful in preventing loss of radio frequency energy. R.F. chokes so used give the high frequency impulses a backstop "on which to get their feet placed". Chokes in the set should be mounted at right angles to the main coil to avoid harmful coupling effects. There is bound to be some coupling if the coils are near together even if they are located at right angles. A greater distance will aid materially in improving the operation or if this is impossible, the position may be changed until the right point of *lowest* coupling is found. A "different" choke may often make an improvement when all other adjustments have been repeatedly made without much success.

The point of lowest coupling can be found most easily by experiment. Alternating current can be run through one coil while a pair of sensitive phones is connected to the other coil. One coil is then varied until there is minimum pick-up as indicated by the weakest sound in the telephone receivers.

FILTERS

With all the rectifier arrangements that have been described a filter is essential to improve the note and to suppress any A.C. hum that may get through from the supply source. Even with a motor generator set a filter may be necessary to take the commutator ripple or "burr" out of the note unless the motor generator happens to be supplying a crystal controlled set. In some cases a suitable filter has been mentioned when discussing or diagramming a particular rectifier system. The construction of choke coils of different sizes is given in detail in the appendix to this Handbook. Diagrams of different sorts of filters, methods of measuring the inductance of the filter choke, and ways of testing a filter system by listening to it are given there, too.

A filter of the so-called "brute force" type using a 30-henry to 50-henry choke coil in series with the high voltage leads from rectifier to set, and having a two-microfarad (or larger) condenser across the high voltage line on each side of the choke will be satisfactory for filtering the output of

almost any rectifier of the electrolytic, mercury-arc, rectron (vacuum tube), or gaseous conduction tube types. With the addition of the devices mentioned in connection with the synchronous rectifier, such a filter of the "brute force" type should also give a fairly good note from a "sync" which is well known as a hard subject to filter.

One of the best ways of improving the note obtained from any rectifier and filter is to "float" a high voltage storage battery or dry cell battery right across the output to the filter (or across the rectifier itself if no filter is used). An emergency power supply can be combined readily with the usual commercial source of power in this fashion to good advantage. Suitable relays for protective purposes should be installed to disconnect the battery from the line every time when power is cut off—otherwise it will become discharged through the rectifier and transformer winding. The best sort of a relay to use is one that uses power from the local mains (or from the rectifier itself) to close the connections between battery and high voltage line when the power is put on. A spring pulls the contacts open whenever the power goes off if a good sounder-relay such as described in the appendix is used. A light "trickle charge" during the periods when the set is in operation will keep the storage battery charged. If a bunch of dry cell batteries are "floated" in this fashion with a reverse current of several milliamperes, the depolarizing effect will prolong the useful life of the batteries to much beyond the ordinary liberal shelf life. Any sort of high voltage battery will greatly improve the note. In fact, a battery is superior to any kind of filter for most purposes. Any high voltage battery should be sectionalized by suitable switches to prevent leakage currents and to make it convenient and safe to handle. In some broadcasting stations where D.C. generators supply hundreds of amperes for heating the filaments of 10-kilowatt water-cooled tubes, a relatively small lead storage battery is similarly used to suppress commutator ripple.

STATION ARRANGEMENT

A complete station consists of a receiver, wavemeter, transmitter and suitable antennas for picking up and sending out the signals. So far as possible we can build from *standard* parts, which are sold at the local radio shop. This makes our station inexpensive and easy to install quickly. Although there are no complete inexpensive outfits manufactured, there are plenty of "parts" and "kits" containing all the parts necessary for a transmitter assembly. Ready-built apparatus is advertised in

QST's Ham-ads. Some local amateur will always be glad to assemble and build stuff to order if a beginner does not wish to attempt the construction himself.

The arrangement of a station should be made with careful thought. Convenience, electrical efficiency, and simplicity should govern here. The frontispiece to this Handbook shows a station arranged with these points in mind. The key should be well back on the table so the operator's arm can be well-supported. The tuning controls should

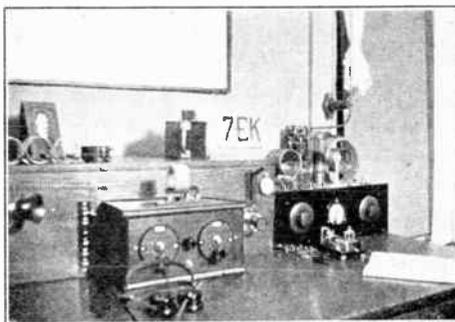

A COMPACT ARRANGEMENT AT 7EK
All controls are in easy reach of the operator.

be in easy reach of the operator. The power control switch to the transmitter should also be close by. A minimum number of controls makes operation quick and reliable. The storage battery should connect to the center of a double-pole double-throw switch so it can be thrown to the receiver or to the charger at will. It should be accessible for taking hydrometer readings and placed where any acid drippings or leakage will do no harm. High-voltage leads should be run directly from the power source to the tubes, insulated and kept out of the way where no one can suffer injury by accidental contact. The antenna lead-ins should be kept well away from grounded metal lath or plaster supports. They should run to the set in the most direct way. All the wiring should be done in accordance with the National Electric Code. Good arrangements will be suggested by looking through the Station Descriptions department of a few back numbers of *QST*.

UNDERWRITER'S RULES

The specific rules covering radio equipment are given in Article 37 of the National Electric Code, under the heading of Radio Equipment. Some states have adopted this code or a more strict version of it. Certain cities have adopted it, too, and they enforce their regulations through municipal

inspectors. Before making an installation it is well to find out if the apparatus and wiring are subject to a state and city inspection as well as by insurance interests.

The following cities have adopted wiring codes of their own and, therefore, installations in these cities should be made in accordance with their special rules: New York City, Chicago, St. Louis, Denver, Portland, Ore.; Memphis, Tenn.; Macon, Georgia; Kansas City, Mo.; Jamestown, N. Y.; Newark, N. J.; Camden, N. J.; Sioux City, Iowa; San Diego, Cal.; Little Rock, Ark.; Hot Springs, Ark.; San Francisco; Gary, Ind.; Atlanta, Ga.; New Haven, Conn.; Chattanooga, Tenn.; Madison, Wis.; Wilkes Barre, Pa.; Moline, Ill.; Rock Island, Ill.; Peoria, Ill.; Detroit, Mich., and Louisville, Ky.

Electrical wiring in Maryland, the District of Columbia, Louisiana, Tennessee, Ohio, Minnesota, and North Carolina is subject to the approval of a state inspector.

"Approved" refers to a device designed for the purpose used in accord with recognized practice. The device must be acceptable to the Inspection Department having jurisdiction (there may be a City or State inspector in addition to the Insurance Rating or Inspection Bureau.) When there is no inspector for the city or state, insurance interests inspect through their rating organizations, one of which covers each part of the United States. Your local insurance agent can advise you in whose territory you are located so you can get in touch with the proper authority.

A conference with the Inspection Department *before* making an installation or change will save inconvenience and expense later. Your own interests and those of fellow citizens will be best protected from an insurance and fire hazard standpoint by having such a conference.

The wiring must follow the requirements observed in your particular community. In some instances a separate power line must be run directly to the watt-hour meter. A few feet of "BX" from the nearest outlet to a "Square-D" switch box, properly fused at the switch, will usually be satisfactory. The installation of high-voltage apparatus and wiring must be done in approved fashion. High-tension cable, supported on porcelain pillar insulators, keeping the high voltage away from all wood-work and neighboring conductors, is a safe type of construction.

A receiving antenna can be connected to ground before it gets to the set through either in-door or out-door type of lightning arrester. Several approved types are sold by local dealers with complete instructions for installation. These arresters are simply spark-gaps sealed in a vacuum to lower the voltage break-down. The ground can be made by scraping a water pipe or ground

rod clean and bright with a file. A 10c ground-clamp will make a good connection to the pipe. A yearly inspection will insure a good ground. An approved lightning arrester operating at a potential of 500 volts or less is required for *each* lead-in conductor of a receiving station. There are no requirements for indoor antennas, however.

Part 5 of the Fourth Edition, National Electrical Safety Code, classifies transmitting stations as those of low, medium, and high power. A low power station is one to which the power supplied is less than 100 watts and where the voltage supplied is less than 400 volts. A high power station is one requiring over 1,000 watts power supply or a supply voltage of over 2,000 volts. Medium power stations are classified as those not falling into either the low or the high power class. Most amateur radio stations fall into the low or medium power class, unless a voltage in excess of 2,000 volts is used.

The same requirements apply to both antenna and counterpoise wires. Antennas for receiving and low-power transmitting stations should be supported and insulated

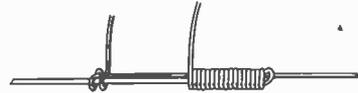

ANOTHER METHOD OF SPLICING WIRES



SUPPORTING A WIRE AT INSULATORS



A RIGHT-ANGLE SPLICE

similarly to public service communication lines while for medium and high-power stations the requirements for constructing supply lines for transmitting electrical energy in like situations shall be met. Antennas should not cross over or under supply lines or telephone and telegraph wires nor should they run above and parallel to them in such a way that a falling antenna might come in contact with a live wire. Antennas should not cross railroad tracks or public thoroughfares. They should not be attached to poles owned and maintained by local public utilities for supporting power lines or communication cables or wires. In

most cases local ordinances forbid such construction as a menace to the public welfare. When antennas are put up in such hazardous locations special precautions should be taken to have ample strength in the antenna wire and its support and ample clearances.

Antennas should not be supported on chimneys. When a tree is used there should be some provision for keeping the antenna from snapping when the tree sways in the wind. Any size of wire can be used for a receiving antenna. Probably No. 14 B. & S. (American Wire Gauge) hard-drawn copper wire, enameled to prevent corrosion, will have the best balance of electrical conductivity and mechanical strength for that purpose. Sending antenna and counterpoise wires for medium or high power stations should have a strength of not less than No. 10 hard-drawn copper wire and should be insulated with insulators having a minimum creepage distance of 10 inches or more. A clearance above ground of 10 feet is prescribed for receiving and low-power antennas where they cross foot paths and entrances to private garages. Above streets a clearance of 15 to 18 feet is required and this must be increased to 28 feet when an antenna or counterpoise for a medium or high-power sending station is contemplated. For spans over 150-feet in length these clearances must be increased. There must always be at least 10 inches clearance between antennas of such stations and the nearest combustible material. There should be at least a 10 foot clearance when the antenna or counterpoise of a medium or high-power station crosses under other conductors. The clearance required is less for receiving antennas and those of low-power stations and is specified as 2, 4 and 6 feet depending on whether communication lines, low-voltage or high-voltage (above 750 volts) conductors are crossed.

Transmitting antennas and counterpoises must be *grounded* by means of lightning switches. The switch shall be of the single-pole double-throw type having a minimum break distance of 4 inches and a blade of at least .0625 sq. in. cross-section. The switch should be in the most direct line between lead-in and ground but can be located either outside or inside the station. Live parts of the switch must clear the wall (or other conductors) by 3 inches for a C. W. installation (5 inches for a damped-wave set). The switches must be connected so that the antenna and counterpoise leads can be disconnected from the set and connected to the ground wire.

The lead-ins must be made through approved lead-in bushings. A good but cheap way to bring in the antenna lead is to drill a hole in the center of a large window-pane. A brass machine screw with

rubber gaskets will go through this and make an excellent lead-in. The lead-in insulator must have a 3-inch clearance beyond the wall of the structure. Antenna leads must never come within 5 inches of supply wires. A wooden board at the top or bottom of a window will make a good support for lead-in bushings under most circumstances. Pyrex bowls make good bushings. M. M. Fleron & Son, Trenton, N. J., manufacture an "approved" bushing of adjustable length. A "drip loop" prevents water from following the antenna wire into the station. Lead-in bushings or tubes must be rigid, noncombustible, nonabsorptive, and have good insulating properties.

An outside ground is recommended but not absolutely necessary for a transmitting antenna. The ground lead should be made of No. 14 hard-drawn copper wire or of wire having greater strength and conductivity. Its cross-section should not be less than that of the lead-in wires. The ground wire should be run in as direct a line as possible from the switch to a good permanent ground. A driven or buried ground or a waterpipe ground is satisfactory. Never ground to a gas pipe, though. For ground wires no insulating supports or insulation is necessary. The ground switch should have husky blades and jaws. They may be mounted on pillar-type insulators, on marble or water-proof bases. Slate bases and absorptive composition bases will leak electrically and decrease the effective output of the set. "Mud" lead-in insulators will act similarly.

Everyone who owns an amateur station or who plans to have one should send ten cents (not in stamps) to Superintendent of Documents, Government Printing Office, Washington, D. C., for the booklet, *Safety Rules for Radio Installations*, Handbook of the Bureau of Standards No. 9. This gives a great number of rules for installing amateur radio equipment. In addition to this, *Safety Rules for Installation and Maintenance of Electrical Supply Stations*, Handbook No. 6, covering the installation and maintenance of electrical supply stations may be useful as it treats of generating apparatus and the installation of conductors for various applications, covering the subject of power supply to amateur radio stations indirectly as coming under the larger subject. This can be obtained for the same price from the same source. Both publications are a part of the National Electrical Safety Code.

ANTENNAS

A receiving antenna should have low total resistance over the desired tuning range. A single-wire antenna is usually considered

best for reception as it will not collect atmospheric charges to the same extent as a multi-wire antenna. The total resistance of an antenna depends on the "losses" in near-by objects as well as on the frequency of the incoming oscillations and the physical properties of the wire itself. An antenna is well worth while. The energy pick-up from a good antenna will give as good response as may be obtained from several tubes with a coil antenna. The coil or loop aerial has directional characteristics and may be used to improve selectivity or for direction-finding work, however. 20, 40, and 80-meter signals pound in nicely with an indoor antenna of almost any sort.

A very long wire (several hundred feet) will bring in signals with increased energy but with decreased selectivity because of the high resistance. Short waves become reflected, refracted, and polarized in transmission. A horizontal 30-foot wire with a coupling coil to a receiver in the center of it brings in stations 200 miles away with several times the intensity possible with a vertical wire of the same dimensions. The improvement over a vertical wire is about twice as great at 40 meters as at 80 meters. Reception with the horizontal wire for more distant stations (1,000 miles) does not show so great an improvement over the straight vertical wire.

Receiving antennas (and sending antennas too) usually have both a horizontal and a vertical part (the lead-in). A "regular

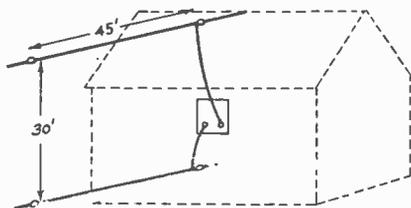

REGULAR COLLECTOR

collector" is shown and is, perhaps, the best for average work. It is interesting and profitable to compare results obtained with vertical and horizontal antennas, especially if you are so situated that you can put up good ones of both types in the open (away from house wiring and buildings that tend to shield an antenna). If a third antenna having both horizontal and vertical characteristics can be used at the same time, some interesting things will be found out. Connect two antennas to be compared to the extremities of a double pole double throw switch so that the receiver can be thrown from one to the other quickly and it will

be easy to compare signals received from any distance or direction. The distance, the time of day, and the wavelength used will all have an effect on the conclusions you draw from the data collected. A true "horizontal collector" is shown in one of the

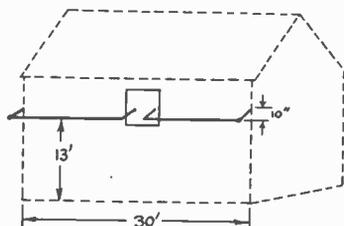

HORIZONTAL COLLECTOR

diagrams. Good and poor arrangements for the antenna and lead-in are also sketched. For receiving work the length of the antenna wire is not at all critical. For all practical purposes a high antenna wire of the length given in the table can be put up working "against ground" instead of with another lower wire which is usually called the counterpoise and which comprises part of most antenna systems used by amateurs for sending.

Changing reflecting and refracting properties of the Heaviside layer* are sometimes supposed to account for the minute-to-minute changes in the intensities of received signals (fading). Changes in the strength of vertical and horizontal components of radio waves due to varying polarization* also account for fading.

The following dimensions for receiving antennas will prove satisfactory:

Received Wavelength	Length of Single wire
20 to 50 meters	15 feet
50 to 100 meters	25 feet
100 to 150 meters	40 feet
150 to 200 meters	60 feet (best for general amateur use)
200 to 600 meters	120 feet (best for broadcast reception)
600 to 2400 meters	500 feet

* The Heaviside layer or Kennelly-Heaviside layer is so named for the investigators who first suggested the existence of an ionized region above the earth's surface which might have an influence on the propagation of radio waves. It can be shown mathematically that such ionized layers can transmit an electromagnetic wave with a higher velocity than it would have when travelling through un-ionized space. There is a more or less increasing state of ionization in the higher levels of the earth's atmosphere. Explaining ionization we might say that it must be thought of as the breaking up of neutral gas molecules into positive and negative constituents by ultraviolet light from the sun and by direct bombardment of the outer layers of the earth's atmosphere by electrons thrown off from the sun—notably from sun spots.

Polarization refers to a change produced by the
(Concluded at bottom of next column.)

A high wire in the open is best. A sixty-foot antenna will bring in good signals at ALL wavelengths used by amateurs. It can be used against ground or with a counterpoise of equal length. A couple of small glass insulators or porcelain cleats should be used at the points of support.

The sending antenna or "radiator" is of greatest importance in connection with the range of the station. The antenna must always be built to fit the space we have for it. Only the exceptional amateur station can put up the "ideal" radiator.

Height is probably more useful than length. In any case get the antenna in the clear. It should not come near houses, guy wires or trees. The insulation should be

the space where the antenna must go, and the arrangement for mechanical support are the factors to be considered. The antenna dimensions given are for use on all amateur wavelengths. The natural period of the unloaded antenna described will vary a bit with height and length and surrounding objects, but it will probably be about 90 meters. (Add length of lead-in and see chart.)

A small coupling coil on the transmitter frame picks up the R.F. voltage for antenna excitation magnetically. This loads the antenna to perhaps 95 meters wavelength. The series antenna condenser tunes the antenna, pulling the wavelength down to the 80-meter band. For 80-meter

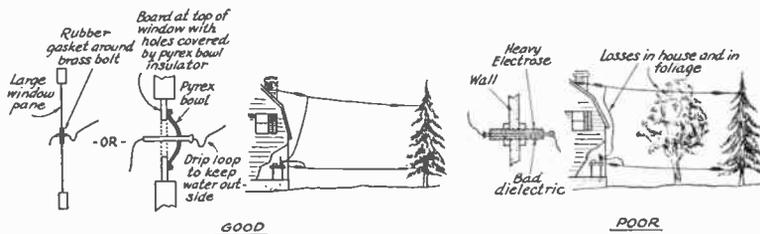

LEAD-IN AND ANTENNA

of the best, as transmitting antennas have high voltage at the far end. Some Pyrex glass insulators will be best.

A single-wire antenna and counterpoise is as good as any if used rightly. The antenna can be about 40 to 50 feet long and should be 40 feet high if possible. The counterpoise should have the same length and be about 10 feet above the ground. When there is a good ground it can be used with as good results as the counterpoise will give. A water-pipe ground may or may not be good. Buried metal or ground rods in moist earth or charcoal will make a fairly good ground. The counterpoise has no particular advantage over a ground when using a series antenna condenser and a small coupling coil and working on or above the *fundamental frequency* of the antenna circuit. No. 12 or 14 enamel insulated wire will be good to use in the antenna and counterpoise. The counterpoise is not necessarily directly under the antenna. It should be kept in the open, however.

The size power tubes used has nothing to do with the choice of our antenna. The choice of wavelength for normal working,

medium through which the radio waves travel by which the transverse vibrations in the medium are limited to a single plane. Near any transmitter the vibrations take place more or less indifferently in any plane about the line of propagation depending on the type of radiator used to some extent.

work the primary circuit is tuned to this wavelength also. Leaving the antenna tuning the same we can shift the condenser-coil circuit tuning to the 40-meter band and operate our antenna on its second harmonic. Taking out the antenna series condenser (shorting it with a wire) and putting ten or fifteen turns of inductive loading in series with the antenna we can tune the radiating circuit to 100 meters. With the condenser-coil circuit operating at 20 meters, the antenna will be excited at its 5th harmonic. Perhaps we will get better results by adding turns enough to tune the antenna to 120 meters. 40-meter transmission will then be effective using the third harmonic of the antenna. Further loading will get the antenna up on the 150-200 meter wavelength for work up to 1,000 miles. Working with inductive loading (below the fundamental frequency of the antenna) we have high values of antenna current, for the total resistance of our antenna is lower at these lower frequencies. The proportion of radiated energy to energy accounted for in other losses is not so great with inductive loading. It is probably more efficient to work an antenna somewhat below its natural wavelength (above its natural frequency). An antenna of rather large physical dimensions with a series tuning condenser seems to bring best results. For regular 200-meter operation, a longer an-

tenna should be put up. Make any antenna as high as possible. Keep it in the open.

BUILDING SINGLE WIRE ANTENNAS TO HAVE A CERTAIN NATURAL PERIOD

Circumstances alter cases. Our antenna system will always differ from a similar antenna that we could put up under ideal conditions. A chart is shown from which the wavelength can be predicted very nearly if the lengths of the wires are carefully observed. The best way to do is to build a good antenna and measure its period by closing the circuit (tying antenna lead to counterpoise lead) and bringing a sensitive

Lifting the single wire up and down above the counterpoise makes little difference in the fundamental. The distributed capacitance is low but the inductance is high. As the wires approach each other the capacitance is increased slightly. The inductance is increased and the percentage change in natural frequency is not very great. The "effective" height is what is changed widely and the radiating powers are best with good separation between antenna and counterpoise.

In multi-wire antennas, the flat-top portions act like plates in a condenser and we have a great increase in capacitance as the plates are allowed to approach each other.

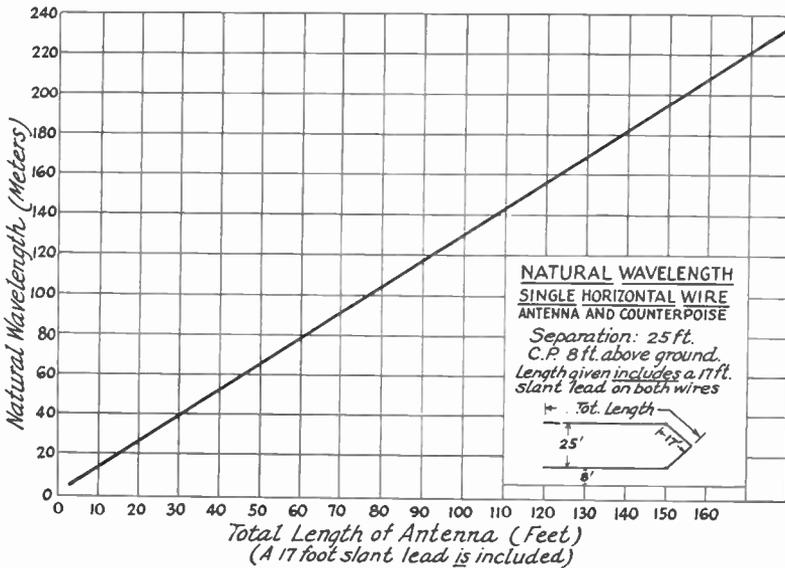

oscillator near the lead with a milliammeter in the grid circuit. Varying the oscillator frequency, the reading on the 0-1 or 0-5 meter will drop sharply as the antenna "tune" is found. The wavelength of the oscillator at this adjustment can now be measured.

Suppose we happen to want to build an antenna for 80-meter work. To make the antenna current low, the radiation losses high, and the antenna tuning convenient, it will be desirable to put up an antenna having a natural wavelength of nearly 90 meters. Referring to the chart we find that the length of the antenna and counterpoise from the set should be 70 feet. If we use 20-foot leads our flat-top portions will be 50 feet long. The coupling coil will "load" the antenna to perhaps 93 or 95 meters wavelength. The series variable condenser will enable us to tune down to 80 or 85 meters without difficulty, however.

The best rule to follow for ANY antenna is to get the wires in the OPEN making the SEPARATION as much as is conveniently possible.

To use a single antenna for transmitting on ALL the useful amateur bands it is only necessary (if antenna and counterpoise leads come into the operating room) to tune the oscillator tube's condenser-coil circuit to the particular wavelength desired and to couple this circuit to the antenna at a current node (see page 99) of the antenna circuit. The antenna may be loaded inductively or capacitively so that the operation is at its loaded period or so that it is excited at one of the several possible combinations of harmonics. The process of loading an antenna to raise or lower its period of response is similar to that of lengthening or shortening a pendulum (or changing the weights) to change its period. A suitable coil to serve as antenna loading coil can readily be constructed

from the description of making flatwise wound coils and the photograph in another part of the Handbook.

A loop or coil antenna is of little practical use for amateur transmission over long distances. It is a good directional radiator when the length of one side of the loop (in meters) is equal or nearly equal to one-half the transmitting wavelength to be used. A loop for 5-meter work does not have unduly large physical dimensions. It will be about 7½ feet long on each of its four sides. For longer wavelengths the use of a loop is impractical because of the size required to transmit efficiently. The use of a loop lies in the reception and direction-finding fields. Any sort of a loop can be used for hunting down power leaks—not so particularly because of its directional characteristics as because of its portability. When nearest the power leak, reception of the noise will be loudest and often a power line can be followed with a loop receiver in an automobile until the defective point in the circuit is reached. For broadcast reception many tubes in a loop receiver will be required to give equal results to those that may be obtained with two or three tubes working on a single wire antenna such as has been described. In direction finding, the setting of the loop for maximum and minimum signal is found by rotating the loop. Unless the wave front is distorted, the distant station will lie in the plane of the loop when it is adjusted for maximum signal. Direction determinations are always made from the *minimum* signal setting as the human ear can detect changes in the intensity of *weak* signals best.

THE HERTZ ANTENNA

For transmitting most amateurs use what is commonly known as the Hertz antenna. The diagram shows various forms of Hertz antennas which differ principally from the type of antenna used first by Marconi and known generally as the Marconi type in that

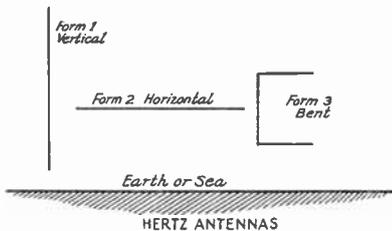

no ground connection is used. If an antenna is used against ground (Marconi type) it is usually coupled to the oscillator magnetically by a coupling coil in the ground lead.

It is safe to say that three-fourths of the amateurs transmitting today use an antenna and counterpoise—the bent form of the Hertz. Although the electric and magnetic field about the different forms of the Hertz antenna varies so that the three types of antenna shown radiate in different ways, all three types are useful. If you are blessed with a good location so that you can put up a good antenna and counterpoise almost entirely in the open, you will find the bent form of antenna simple to put up and use. The field about the bent antenna is mostly concentrated between the upper and lower parts when working at the natural period.

A vertical single wire or copper pipe is very useful for transmitting on short

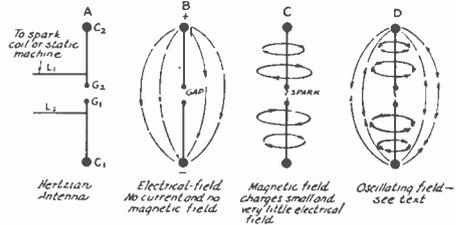

THE HIGH FREQUENCY VOLTAGES AND CURRENTS IN A HERTZ ANTENNA SET UP ELECTRICAL AND MAGNETIC FIELDS WHICH ARE AT RIGHT ANGLES IN SPACE

The antenna first used by Hertz was like the one shown in this diagram. Both fields exist at the same time about an antenna, one increasing as the other decreases.

waves. It may be supported rigidly on pillar-type insulators or stood on a Pyrex bowl insulator well off the ground. The vertical form was the kind of antenna originally used by Hertz, and the other types (horizontal and bent) are merely adaptations. The electrical field (often spoken of as the static field) exists as a stress between two bodies charged by opposite voltages. The flow of current is always accompanied by a magnetic field around the current-carrying wire. How the two kinds of fields are present and at right angles in space is shown in the sketch of the original Hertz antenna.

The vertical antenna has distributed inductance throughout its length. Each foot has distributed capacitance to every other foot and to ground. At the lower end, the capacitance to ground per unit length is greatest. The vertical aerial has a natural period due to these distributed values. Because the capacitance is highest at its ground end the point of highest current (nodal point) in such a system is about 1/3 the distance from the foot of the aerial to the top.

The horizontal antenna of course has distributed inductance and capacitance the same as the other types, but as the capaci-

tance to ground per unit length is the same throughout the entire radiating system, the node or point of highest current will be right at the center when we are working at the natural period of the antenna.

While the Marconi-type antenna can be energized most easily by using a coil coupled to some point in the ground lead, there are many convenient and practical ways of operating the Hertz antenna forms mentioned. If you live in an apartment house looking out on only an air shaft, you need not despair of putting up an antenna that will get out. Instead of trying to put up a makeshift antenna and counterpoise, your space limitations will make it desirable for you to put up a vertical antenna on the roof, or a horizontal form of the Hertz antenna suspended on bamboo rods in a nearby tree top. Such an antenna can be energized by a voltage feed line as will be explained. The losses in a radio frequency transmission line are much lower and of less importance than the very important losses of an antenna surrounded by brick walls and steel girders.

HARMONIC OPERATION AND NODAL POINTS

There are several ways of operating an antenna. Either the fundamental period (first), second or third harmonic can be used. An antenna can be worked at any harmonic if it is built to have the right natural period. To use *one* antenna at *several* of its harmonics it is only necessary to use inductive or capacitive loading (series coils or condensers) to change the period of greatest response to the desired value. This process corresponds closely to the changing of weights or length of a pendulum to change the period at which it will swing back and forth most readily. Loading coils will raise the wavelength of greatest response (fundamental) while series condensers will lower the wavelength. In the discussion of building transmitting coils we showed two loading coils made especially for this purpose. Any coil built of antenna wire (or larger) on a skeleton form will answer the purpose but the inductance of the coils shown is about right.

On any Hertz antenna we can have $\frac{1}{2}$, $\frac{2}{2}$, $\frac{3}{2}$, $\frac{4}{2}$, $\frac{5}{2}$, etc., wavelengths—*always* a number of half waves. We cannot have a quarter wave or three quarters of a wave as with a Marconi antenna, because we have a radiating system of perfectly definite dimensions instead of a ground of somewhat indeterminate length. With a Hertz antenna there is always a high radio frequency voltage at the end of the antenna and counterpoise. When operating at the fundamental, the current is highest at the electrical center of the radiating system, and as we go along over the antenna there

is less and less current and more and more voltage. The voltage drops over the distributed inductance of each portion of the antenna build up to a high voltage at the end. The current flows in and out of the distributed capacities all along the antenna. There is zero current at the end of the antenna because we have come to the end of the wire and there isn't anything farther on for a current to flow into—the wire with its distributed properties has come to an end. When operating at the different harmonics of an antenna, there are several nodes or maximum current points along the antenna system. It is easy to see where these will be on a simple horizontal or

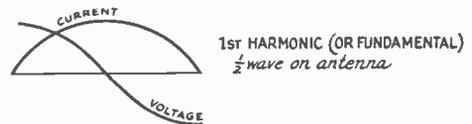

VOLTAGE AND CURRENT DISTRIBUTION OF ANTENNAS OPERATING AT HARMONICS

vertical antenna, but on the bent antennas it will take some thought to figure it out. Voltage distribution on an antenna can be readily investigated by using a Westinghouse Spark C (or other neon tube) as in testing spark plugs, moving it along the antenna and observing the glow at points of highest voltage. Lacking a neon tube, you can try for sparks with a screwdriver blade. If you are using a UV204A you had better be careful. The output will be hot stuff, and although radio frequency currents travel on the surface of the wires and the outside of the skin and are not dangerous to life, one can get a bad burn. A well-insulated metal rod will fill the bill. It is difficult to show how the voltage and current is distributed over an antenna of the bent form without using valuable space, so we will show diagrams of a horizontal antenna and you can apply the diagrams to the vertical and bent antennas which will probably be used in your location by bending

the diagrams yourself, making the voltage and current lines cross the axis at the right points.

CURRENT AND VOLTAGE FEEDS

Hertz antennas can be energized either by feeding a large current (at low voltage) to a point where we can have current in the antenna or by feeding a fairly high voltage (at low current) to a place where the antenna is supposed to have a current node. A typical current feed system is shown as used by the majority of amateurs at the present writing. At a gap (X) in the center

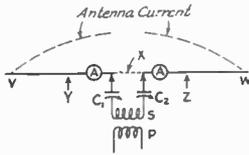

TYPICAL CURRENT-FEED SYSTEM

of the antenna system is coupled a coil to transfer energy magnetically to the antenna. The coils enable transformer action to take place and the voltage induced in the secondary (S) or antenna coil by the primary (P) causes current to flow in the antenna at its natural period. A series condenser is used to keep S from loading the antenna to a higher wavelength. Besides acting as coupling coil it has a loading effect which must be nullified to work on the fundamental where radiating conditions are somewhat better than on a higher wavelength. A current feed can be cut in at Y or Z, though X is the best place for it. It will not work well at V or W.

A voltage feed can be arranged in a number of ways. A tuned intermediate circuit can be used between the set and the antenna. One side of this circuit can be connected at V or W. It will work moderately well at Y or Z, but should not work at X. The antenna ammeter will still need to be located at (X) the current node. Note

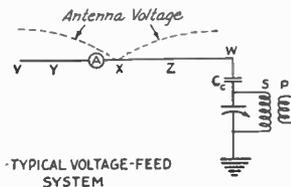

TYPICAL VOLTAGE-FEED SYSTEM

that the voltage-feed system connects to the antenna at only one place, while the current-feed system is connected at two points. In the voltage-feed arrangement there is little current in the line connecting to the antenna at W but quite a high voltage. A

coupling condenser C or coil L_c with variable taps (see the diagram "Hints on Voltage Feed") is usually used to give an independent coupling adjustment. Coupling may also be varied by changing the tap along the antenna or by connecting the feed line to some point on S or P. It is always best to use a coil, L_c, as a coupling condenser tends to emphasize harmonics (high frequencies get thru a condenser easily because the reactance is lower at H.F.), while a coil suppresses harmonics. A coil of 20 turns of No. 14 wire with 1/8" spacing between wires on a 4 1/2 inch form will work well for 80-meter operation. Too many turns at L_c will make the antenna current drop and the primary current go up because of the too-loose coupling. Too few turns will make the antenna oscillations unsteady or uncertain and give a "floppy" note. There is some possibility that the feed line will want to act as part of the antenna system. To prevent this it should be kept as low as possible when feeding a vertical antenna. The current in the feedline measured on an R.F. ammeter probably will be between 4 and 10 per cent of the antenna current. If it is more than this there is some chance that the feeder is trying to act as part of the antenna. If the feeder happens to tune to some harmonic of the antenna there

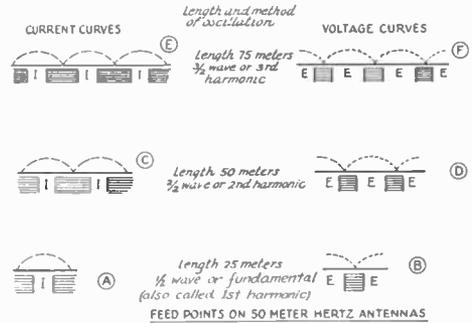

is bound to be trouble and a readjustment of the coil (L_c) will be necessary. The beginner should not attempt to tackle anything as complicated as the adjustment of a voltage-fed Hertz antenna at first without assistance, as there are so many troubles to avoid that cannot be found right away unless some one with experience is around to help. One diagram shows where the maximum currents and voltages will be on an antenna operating at different harmonics and adjusted in each case for 50-meter operation. The shaded points are no good for making connections, while the points marked "I" and "E" are the ones where current feeders and voltage feeders (respectively) can be connected to best advantage. The antenna ammeter should in

any case be inserted at one of the current nodes (I).

ADJUSTING CURRENT-FEED SYSTEMS

At A in the current-feed diagram we have a horizontal Hertz antenna with a fundamental of 40 meters. At B we have done the usual thing—cut the antenna near the center and put the antenna coupling coil and two series condensers in the circuit. The coil alone might increase the wavelength eight or ten meters, but the addition of one

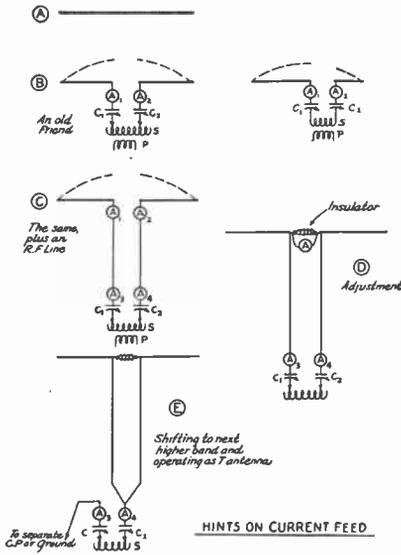

HINTS ON CURRENT FEED

or more series condensers enables us to counteract the inductive loading. If this system alone is used, the antenna circuit is tuned by C1 and C2 so we can work from about 35 meters up without trouble, which is an advantage over some of the voltage-feed systems. To gain ease in adjustment C1 and C2 are right in the station which is impossible for some locations on account of the waste of R.F. energy by absorption in surrounding objects from the too-long antenna leads. Before telling how to get around the difficulty please note that it is not necessary that A₁ and A₂ read the same to have this simple and ordinary current-feed system working well. If the coupling device is put at the exact electrical center of the radiating system the meters will read alike. If not, as is shown on the right of B, the meters are sure to read differently, but this doesn't matter. It needs an antenna made of R.F. ammeters connected together to show best where the current node is located. One meter and ONE series condenser will answer the purpose for most of

us. If the current at a point off the exact center of the antenna system is *maximum*, the greater current at the node will also be maximum—the condition for best operation that you want.

If your location is ideal, the arrangement at B will be quite satisfactory and there is no reason for changing it. If your antenna is inconveniently located around the corner of the house or on the roof, a current-feed system can still be used and the antenna made tunable from the operating room by putting up a 2-wire R.F. line that will not radiate. The only thing to look out for is to see that the line does not have too-high resistance and that it does not get in tune with anything.

Suppose you have put up an antenna of about the right dimensions for 40-meter work and have constructed an R.F. line to take energy to it. First connect a meter across the end of the R.F. line as in D. Then tune the primary and secondary to find what wavelength gives most current through this meter. As you are operating a "half-wave" antenna, the wavelength will of course be nearly twice the length of the wire of which the antenna system is made (in meters), but it will not be exactly this amount because the antenna is not in free space. Now leaving the R.F. line "as is", you should prune pieces off the end of the antenna until the best reading on A is obtained when tuned just a very little above 37.5 meters wavelength. The meter out in the antenna can next be removed altogether using a meter or meters (A3 and A4) at the station end of things for keeping track of what is going on in the antenna as reflected by the input to the R.F. line.

To shift higher in the 40-meter band tune the primary circuit to the desired wavelength, bringing the antenna into resonance with C1 and C2 and this time keeping their capacity settings as well as the current in A3 and A4 about the same. Using the R.F. line current-feed system it is not possible to put a loading coil in the antenna to operate at eighty meters. However, if the antenna happens to be of the horizontal Hertz type, the scheme used in E will work well. The two parts of the 40-meter antenna can be operated against ground or against a separate counterpoise as a T-antenna with a double-wire lead-in.

In building an antenna to be fed by a two-wire R.F. line make the antenna of such size that it has a natural wavelength 5% below the wavelength where you plan to work. Attach the feed line near the center after cutting the antenna in two. If it doesn't go all right, it is probably because the feed line is unduly long. Just as in the case of the voltage feeder, when there is trouble of this sort it will be helpful to detune the feed line. Try adding some series condensers used in pairs and spaced along the line at

regular intervals. In the case of a two-wire feed line it is necessary to treat the two sides of the line similarly, for otherwise the fields about the two wires will not cancel and we will run into radiation troubles. The feed line will not radiate unless we give it a chance by doing something to just one side of it, however.

BUILDING A RADIO FREQUENCY TRANSMISSION LINE

The currents in R.F. transmission lines are smaller than the antenna currents and so the size wire used can be selected from a consideration of the strength necessary for mechanical support. In 2-wire lines the voltage is fairly low too, and so you do not need to worry much about losses. The two

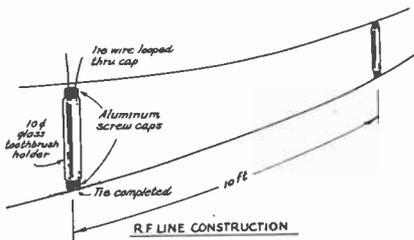

wires cancel each other's effect so there can be very little radiation. Even some swinging of the line wires will not vary the wavelength much. A good way of spacing the wires of an R.F. 2-wire line is suggested by the diagram. In single-wire voltage-feed systems there are higher voltages on the line and losses and insulation should be considered when it is put up.

ADJUSTING VOLTAGE-FEED SYSTEMS

As two-wire R.F. lines operate so nicely without high losses without trying to

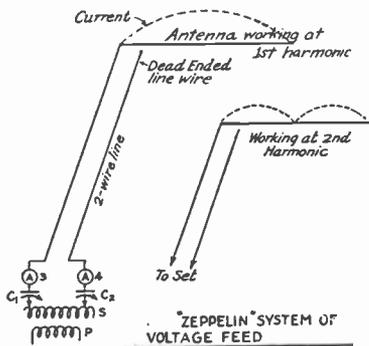

radiate and become part of the antenna when they begin to get long, you had best stick to the two-wire line even if you prefer

voltage-feed to current-feed. The "Zeppelin" voltage-feed system is shown in one of our sketches and is most simple to erect and adjust. It is flexible, too, and can be worked on any harmonic we wish without difficulty just by tuning the primary circuit of the oscillator to the desired wavelength. The "Zeppelin" arrangement has one of the line wires dead-ended, the other one connecting to the very end of the antenna which is always a voltage node, no matter what harmonic you are working on with a Hertz antenna. The system is very flexible and has the great advantage that the wire acting as antenna can be entirely in the open, getting rid of troublesome absorption losses that often keep an otherwise good station from reaching out.

A two-wire line and a one-wire voltage-feeder may be combined. The greatest trouble with most one-wire feeds you will find is that the wavelength cannot be changed without a trip into the next lot or up on the roof or wherever the antenna happens to be. Although you cannot get rid of this trouble by combining the one-wire feed with a two-wire line, you can avoid the danger of radiation from a long or high one-wire line and also avoid some of the losses and insulation troubles of the long one-wire system. The 1-wire part of the system can

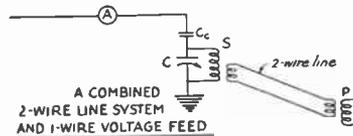

be made very short. If you wish you can tune the R.F. line by adding condensers, but the untuned circuit shown is the best.

Using a one-wire voltage-feed system, some idea of what is going on in the antenna after the initial adjustments have been made can be obtained by observing readings of the plate milliammeter with the feeder on and off. In fact the difference of the readings multiplied by the plate voltage gives a pretty good idea of the power you are actually putting into the antenna. (Note: This is not radiated power but radiated power plus all the several antenna and feeder losses.) A further check on adjustments can be made by observing the current on an R.F. ammeter at the node of the antenna or by noting the increase in the circulating current in the primary condenser circuit when the feeder is disconnected if a large R.F. meter is available. If the supply of meters is limited a 12-volt automobile lamp will make a good current indicator for the antenna after it has been

shunted. Put the lamp near the center of the antenna system about where you think the maximum current will be at the fundamental. Other lamps can be located as shown in the diagram if you expect to operate the antenna at harmonics. Several feet of magnet wire can be connected around the resonance-indicating lamp if a UX210 is used, but only a few inches or a foot of larger wire will be necessary if more

desirable, it is simpler to explain the adjustments by tapping the feed wire directly off the transmitting coil—so that is what we have shown in the "hints on voltage feed" diagram. First connect the feeder to the coil on the transmitter about one turn above the filament clip (between the filament and plate clips). Put the other end of the feeder wire a little way off "center" of the radiating system and have but two or three turns of L_c in the circuit. Now tune the primary circuit until you get best antenna current. Put the feeder wire further off center. It will be best to move it out about a foot each time, tuning the primary circuit for best antenna current and writing down values of antenna current, wavelength, and feeder current if possible. There will be one feeder position that will give the very best antenna current and somewhere near the smallest feeder current. If there are plenty of meters the readings can be taken and plotted as at D in the figure. If the wavelength where best results are obtained is too high start taking off wire at each end of the antenna, taking about an equal amount from each end and taking less than half what seems to be the desired drop. By repeating the first process, another set of curves similar to those in D can be plotted and the proper antenna length and feeder position can be easily found. The points of highest antenna current and lowest feeder current will not be exactly at the same wavelength, so split the difference for practical results.

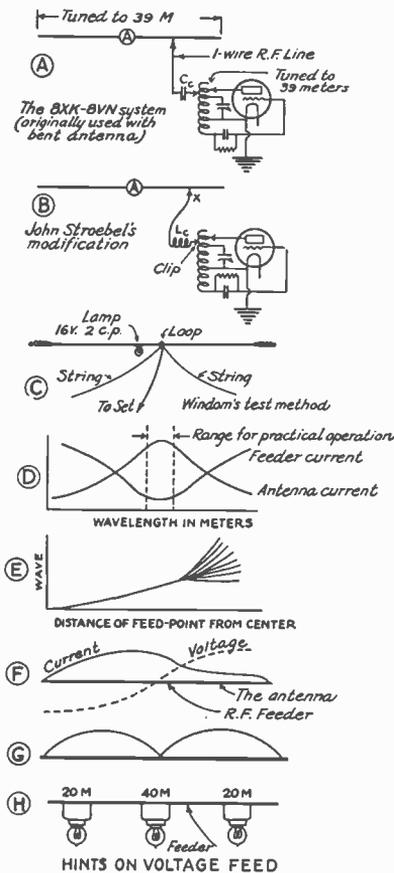

When we move the feeder away from the "center" of the antenna we increase the coupling which makes the wave broader. Beyond a certain point there is apt to be local interference. The same effects will be noted by cutting down on the number of turns in L_c or by changing the feeder clip farther toward the plate clip. The coupling coil or condenser helps to keep the one-wire R.F. feeder from changing the voltage and current distribution in the antenna and also helps to keep the apparent natural period of the antenna from being changed by the addition of the feeder.

After the antenna and feeder are adjusted so the set is working properly on the wavelength originally decided upon within the amateur band, the ground should be taken off the filaments of the transmitting tubes. Nothing should change very much. If there is a change in antenna current there is nothing but a poor antenna-ground system with direct coupling and it will be necessary to start over again.

Working at harmonics with a single-wire voltage-feed line, the current curve is shown in G and the location of current indicators is given at H. It will be possible to vary the wavelength over a band about two meters wide on either the fundamental or

or bigger tubes are used in the transmitter.

In putting up an antenna it is always safe to cut the wire for a vertical or horizontal Hertz antenna about equal to half the wavelength you wish to use, shortening it a little as the best adjustments for a certain wavelength are made. If the bent form of Hertz antenna is put up, you can use the chart shown elsewhere to get an idea of how long to make the antenna.

Assuming that the antenna is up and the set installed, the only remaining thing to do is to adjust the voltage-feed system. Although the use of an intermediate circuit is

when using harmonic transmission but the set is not nearly as flexible as when using current-feed. Changing the primary tune is all that is necessary to change wavelength. If the very highest efficiency is desired on each wavelength, a loading coil such as described under the subject of "coils" can be built and left in the center of the antenna with one adjustable clip to change when moving up or down within the band. In fact such a coil will make it simpler to get the outfit right where it is wanted in a hurry at any time. Remember that it is always best to operate *detuned* six to ten percent to avoid instability. With several turns of

in the feeder to make the coupling loose and to avoid the possibility of the feeder getting tuned to harmonics of the working wavelength you will have little trouble in getting a voltage-feed system on the air. The ground may or may not be used when the tuned-intermediate circuit is tried. The ground should have no effect except to keep the filament circuit at low voltage where it belongs and the test of proper operation will still be operation **WITHOUT** the ground connection.

ANTENNA TYPES

The T, inverted L, umbrella, fan and cage are all named for their physical shapes. Each type has resulted from attempts to get lots of capacitance at the end, high in the air. The cage spacing of wires is useful for getting a maximum of capacitance in a limited space. The current distribution in spaced wires is better than in bunched leads, reducing the loss-resistance. The day of the high-capacity antenna is over as far as short-wave work is concerned. Single wire antennas of the inverted L type, with a small coupling coil and a variable antenna condenser are just as effective. Cage construction is unwieldy, expensive, and cumbersome. Cage leads to a flat-top of three or four wires is the best possible construction if we must work with heavy inductive loading. The cages should change to bunched leads 10 feet before we pass through the station wall, however. A bunched lead is best to keep the field confined to the lead as we pass by the edges of buildings, trees, masts or other poor dielectric that will introduce losses.

Steel buildings, metal stacks, and wires all have a natural period of oscillation of their own depending upon their size. If it should accidentally happen that you try to operate your transmitter near the natural wavelength of a nearby mass of metal or wire, that object will absorb an unusually large amount of power. This will be shown by a large amount of antenna current at the transmitter on certain wave-

lengths. In some cases it is possible to remedy the difficulties by going out with a wavemeter and a pair of phones and picking up the re-radiation from these wires, and then connecting inductances and capacities to them in such a way as to shift the natural period of the object out of the way.

ANTENNA POINTERS

Receiving antennas should be worked at **LOWER** frequencies than their natural period to give decent selectivity. This means that a short antenna is desirable. The natural frequency of a receiving antenna should be 150% the working frequency (two-thirds the working wavelength).

Transmitting antennas should be worked at **HIGHER** frequencies than their natural period to get best radiation of energy. A fairly long antenna is best. The natural period of a transmitting antenna should be about 90% the working frequency (110% the working wavelength) or the antenna can be worked nicely at one of its harmonics.

HIGH wires in the **OPEN** are always best.

Nearby guys should be broken up into short lengths by porcelain or wooden insulators. This prevents absorption of power and added losses.

Halyards can be made of *tarred* hemp rope which will not rot or contract in wet weather.

One-piece antennas are best. Any joints made should be soldered. Wires break after constant motion in the wind unless the joints are good mechanically.

Pyrex insulators are better than those of ordinary glass which look much the same. Glazed "wet-process" porcelain is acceptable.

Bare copper wires soon collect an oxide coating (black) which materially raises the skin resistance of the wire. Enamel-insulated wire wastes less energy in losses and is best for a permanent job.

In some locations it is necessary to clean the soot deposits off the insulators once in a while.

Hard-drawn copper is more brittle than soft copper wire. Its tensile strength makes it best to use in long spans. Aluminum wire is hard to solder and the thin oxide on the surface makes it undesirable.

Antenna and counterpoise (or ground) leads should be bunched and supported away from all solid materials. There should be free space between antenna and counterpoise.

In putting up a multi-wire antenna first hoist a single wire and vary the length be-

tween insulators until the correct length is found. Then in an open space measure the lengths approximately. Build the "far" end permanently. Attach insulators in SERIES at the juncture of the bridle and supporting rope. Parallel insulators offer parallel leakage paths and are ineffective. The far end of flat-top or cage can be supported rigidly while the wires at the near end are adjusted and bound to the "near-end"

spreader or hoop and the joints and lead-in connections soldered.

Single wire antennas are easy to build and actually best for short wave work.

While extra-long antennas seem to bring in good signals (with some loss in selectivity) no one has yet proved that they give a better signal-to-static ratio than a shorter wire. This ratio is most important in determining the readability of signals.

CHAPTER VI

The A.R.R.L. Communications Department

THE Communications Department is concerned with the practical operation of the stations of League members. The work of the department includes arranging amateur operating activities, establishing standard operating procedure, encouraging good operating, improving message relaying, and conducting tests to these ends.

The aim of the Communications Department is to keep in existence a network of League stations made entirely of privately-owned radio stations covering the entire continent of North America. One of its objectives is to create a body of skilled operators whose services and abilities will further the general knowledge of the art of radio communication. The relaying of friendly messages between different parts of the country without charge is one of the most important phases of the work coming under the supervision of the Communications Department. Amateur operators have also always been of great assistance to our country in times of any sort of emergency in which quick communication to a distant point has been a factor, especially when other methods of communication have failed.

These objects of our organization must be borne in mind at the same time we, as individuals, are getting the most enjoyment from the pursuit of our chosen hobby. Only by operating our stations with some useful end in view can we improve the service which we give others and increase the pleasure we get from amateur radio communication, at the same time justifying our existence.

The activities of the Communications Department are arranged and recorded through *QST* and by special correspondence. Tests and relays are arranged from time to time to develop new routes for traffic handling, to prepare ourselves to render emergency service in time of need, and to bring to light additional general radio information. In this way all members of the League benefit from the experience of certain individuals who excel along specified lines of work.

The policies of the Communications Department are those urging members to adopt uniform operating procedure and to use system in their station operating. The Communications Department con-

stantly tries to make our communication system just as efficient as a non-commercial message-handling organization can be made. Compliance with government regulations, orderly operating, and co-operation with each other and with outside interests for the advancement of the art, are a part of the policies of the Communications Department. The first duty of the department to member-stations is to supervise operating work so well that the amateur will continue to justify his existence in the eyes of his Government. Then he will be allowed a continuance of the privileges which he has received as his due in the past.

Records of the worth-while traffic handling, of message routing, and of specific tests conducted between the different stations are kept in the files of the Communications Department and recorded in the Official Organ of the League, *QST*.

It is obviously impossible to distribute up-to-the-minute information in a monthly periodical. Therefore mimeographed circular letters are used. The active stations are thus kept informed of the developments in such a rapidly progressing system. Through such letters, through *QST* and through a large volume of routine correspondence with individual members, the contact is kept good and the activities we have outlined are effectively carried out by the interested member-stations.

Official Broadcasting Stations have been appointed to improve on even the arrangement we have just outlined. Every day of the week at certain hours about one hundred stations send a telegraph broadcast that is copied by hundreds of members. The broadcasts carry the very latest information that is available from League Headquarters.

Official Wavelength Stations, many of them crystal-controlled, have been selected to aid in maintaining the orderly and law-abiding operation which is in accordance with the policies of the League and of the Communications Department. The up-to-date list of calls and wavelengths is printed in one of the recent numbers of *QST* for your benefit. The official Wavelength Stations are not appointed by A.R.R.L. Section Communications Managers as are all the other appointees. They are selected by the official Wavelength Committee. Communications should be addressed to the

Committee Chairman, Mr. D. C. Wallace, 109 West Third St., Long Beach, California.

In these pages we are going to explain the organization of the Communications Department, the proper message forms to use, and some special practices which experience has proven best. We urge that you help strengthen amateur radio by studying the operating practise suggested and by adopting uniform operating procedure. Keep this book in your station for ready reference.

Everyone at League Headquarters welcomes criticism that is accompanied by constructive suggestions. In fact it is only through the boosts and suggestions which come from every member and operator that we can improve our service to others, thereby increasing the pleasure we ourselves get from our chosen hobby.

ORGANIZATION

The affairs of the Communications Department in each Division are supervised by one or more Section Communications Manager each of whom has jurisdiction over his section of a Division.

For the purpose of organization, the A.R.R.L. divides the United States and Canada into Divisions as follows:

ATLANTIC DIVISION: Delaware, District of Columbia, Maryland, Pennsylvania, that section of New Jersey within the Third Federal Inspection District, and that section of New York within the Eighth Federal Inspection District.

CENTRAL DIVISION: Illinois, Indiana, Kentucky, Michigan, Ohio and Wisconsin.

DAKOTA DIVISION: Minnesota, North Dakota and South Dakota.

DELTA DIVISION: Arkansas, Louisiana, Mississippi and Tennessee.

HUDSON DIVISION: The entire Second Federal Inspection District, consisting of certain counties of New Jersey and New York States.

MIDWEST DIVISION: Iowa, Kansas, Missouri and Nebraska.

NEW ENGLAND DIVISION: Connecticut, Maine, Massachusetts, New Hampshire, Rhode Island and Vermont.

NORTHWESTERN DIVISION: Idaho, Montana, Oregon, Washington and the Territory of Alaska.

PACIFIC DIVISION: Arizona, California, Nevada and the Territory of Hawaii.

ROANOKE DIVISION: North Carolina, Virginia and West Virginia.

ROCKY MOUNTAIN DIVISION: Colorado, Utah and Wyoming.

SOUTHEASTERN DIVISION: Alabama, Florida, Georgia, South Carolina and the Island of Porto Rico, the Republic of Cuba, and the Isle of Pines.

WEST GULF DIVISION: New Mexico, Oklahoma and Texas.

MARITIME DIVISION: Newfoundland, Labrador, and the provinces of New Brunswick, Nova Scotia, and Prince Edward Island.

ONTARIO DIVISION: Province of Ontario.

QUEBEC DIVISION: Province of Quebec.

VANALTA DIVISION: Provinces of Alberta and British Columbia and Yukon Territory.

PRAIRIE DIVISION: Provinces of Manitoba and Saskatchewan, and the Northwest Territories.

Each United States Division elects a Director to represent it on the A.R.R.L. Board of Directors and the Canadian Divisions elect a Canadian General Manager who is also a Director. The Board determines the policies of the League which are carried out by paid officers at League Headquarters acting according to the instructions of the Board. When the Board is not in session, the officers of the League, constituting an Executive Committee, can act for the Board, subject to certain limitations.

The Communications Department has a field organization made of officials elected by the membership in a way similar to the Directors. Each Director and the Communications Manager at League Headquarters decide the proper sectionalizing of each Division, after which each Section holds an election for Section Communications Manager. These field officials are listed on page 3, while the names and addresses of the Directors are printed on page 6, of each *QST*.

It is for more efficiently collecting reports from the active stations and supervising the activities of the Communications Department that the operating territory is divided into Sections. In each Section there is a Section Communications Manager, who under the direction of the Communications Manager, has authority over the Communications Department within his Section. He is responsible to, and report to the Communications Manager, except in Canada where he reports to the Canadian General Manager.

Whenever a vacancy occurs in the position of Section Communications Manager in any section of the United States, its island possessions or territories, or the Republic of Cuba, the Communications Manager announces such vacancy and calls for nominating petitions signed by five or more members of the Section in which the vacancy exists, and naming a member of the Section as candidate for Section Communications Manager. The closing date for receipt of such petitions is announced.

After the closing date, the Communications Manager arranges for an election by mail. Ballots are sent to every member of the League residing in the Section concerned, listing candidates in the order of the number of nominations received. The closing date for receiving ballots is announced. Immediately after this date, the Communications Manager counts the votes. The candidate receiving a plurality of votes becomes Section Communications Manager. The Canadian General Manager similarly manages such an election for a Section Communications Manager whenever a vacancy occurs in any section of the Dominion of Canada, Newfoundland or Labrador.

Section Communications Managers are elected for a two-year term of office.

The office of any Section Communications Manager may be declared vacant by the Executive Committee upon recommendation of the Communications Manager, with the advice and consent of the Director, whenever it appears to them to be in the best interests of the membership so to act, and they may thereupon cause the election of a new Section Communications Manager.

COMMUNICATIONS DEPARTMENT OFFICIALS AND APPOINTMENTS

The following portions, relating to Section Communications Managers, Official Relay Stations, and Reports, are reprinted from the "Rules and Regulations of the Communications Department" and set forth the regulations which govern these matters within the department.

SECTION COMMUNICATIONS MANAGER

1. The Section Communications Manager is responsible to the Communications Manager at League Headquarters for the efficiency and co-operation of his personnel. His policies are the democratic policies of the League itself.

2. His territorial limitations are determined by the Division Director and the Communications Manager.

3. He recommends the appointment or cancellation of Official Relay Stations in accordance with the rules pertaining to the Official Relay Station Appointment.

The Section Communications Manager examines application and question forms, signing the prescribed certificate of appointment and forwarding it to the station owner when the appointment can be properly made. Form 4 appointment card bearing the certificate number is forwarded to League Headquarters with the questionnaire forms properly filled out by the applicant. Cancellations (Form 4C) are made for inactivity or for violations of any of the rules or provisions of the Rules and

Regulations or of the Official Relay Station Certificate.

An applicant who fails to qualify may again apply for appointment after 3 months have elapsed.

4. He shall be responsible for the maintenance of the Official Broadcasting Station System within his Section, recommending such appointments or cancellations as may be necessary. Due consideration shall be given the distribution of stations on the different wavelengths. There shall be enough stations on each, to cover the Section.

5. He is responsible for the traffic activities of his Section. He shall appoint such assistants for specific work as may be deemed necessary by the Communication Manager, such as Route Managers, Official Observers, and the like. These officials will have full authority within the Section over the activities indicated by their titles. They will report and be responsible to the Section Communications Manager for their work. With the consent of the Communications Manager he may, if necessary, designate a competent Official Relay Station or League member to act for him in a particular matter in any part of his territory. He shall be careful to instruct such an appointee properly in the duties he is to execute while acting for the S.C.M.

6. He shall conduct investigations of radio societies and other organizations which are referred to him by the Communications Manager. He shall recommend affiliation only when well satisfied that such organizations are worthy of affiliation with the League.

7. He shall appoint Vigilance Committees in the centers of activity where amateur interference conditions appear to make such committees desirable in helping to lighten the load of complaints received by the Supervisors of Radio. (See April 1925 *QST*).

8. He shall have referred to him by his various appointees any correspondence that may relate to matters of general policy, or suggestions for improvements in conducting the affairs of the League.

9. He may requisition necessary Communications Department supplies provided for making appointments and supervising the work in his Section. He may render an itemized postage expense account monthly.

10. He shall render a monthly report to Headquarters, consolidating all the reports by subjects into a comprehensive summary. This report shall reach Headquarters on or before the fifth of each calendar month. It shall be made up from all reports from O.R.S. and other active stations together

with the reports from special appointees (5) and as mentioned under the subject of reporting.

THE ROUTE MANAGER

While the Section Communications Manager is the traffic executive of the Section, the Route Manager has the principal traffic station of his particular locality. There is generally one Route Manager to every twenty or twenty-five Official Relay Stations, depending on the radio population of the Section concerned and the amount of organized activity. Route Managers maintain good local radio contacts regularly so that stations can be lined up and routes developed and operated BY RADIO. Route Managers co-operate actively with all active stations in their districts, so that each Route Manager is the nucleus of a communication net which he organizes himself, and for which he is responsible at all times to his Section Communications Manager. Route Managers arrange schedules for local traffic handling between the different towns and cities in their territory as well as keeping many schedules at their own station and keeping track of between-Section schedules, reporting monthly to the S.C.M. who in turn reports to A.R.R.L. Headquarters where work in all parts of the country is co-ordinated monthly.

OFFICIAL OBSERVERS

Each S. C. M. recommends for appointment a suitable number of Observers who report regularly to the S.C.M. on the off-wavelength operation noticed, sending out notification forms to help amateurs in keeping within the assigned wavelength bands. When not too busy with this work, the Official Observers make general observations on operating conditions taking the proper action to bring about improvement, always reporting the action taken to the Section Communications Manager.

THE OFFICIAL RELAY STATION

The Section Communications Manager shall recommend for appointment as Official Relay Station such stations of League members as apply for and merit such appointment. The recommendation shall be based on the ability of the applicants to come up to a specified set of qualifications. The applicant shall have a loyal, co-operative attitude; he shall follow standard A.R.R.L. operating practices (understanding and using the proper message form, finish signals, service message, cable-count check on important messages, and so on); he shall have a transmitter and receiver capable of operation at any time; and he must be able to

send and receive Continental code at a rate of at least 15 words per minute.

1. It shall be the duty of the owner of each duly appointed Official Relay Station to report monthly to his Section Communications Manager, to keep the station in readiness to operate, to use A.R.R.L. operating practices exclusively, and to take part in the activities of the League whenever possible.

2. Each Official Relay Station shall receive an Appointment Certificate to be displayed prominently in the station, a monthly bulletin newsletter from Headquarters, and a Form 1 reporting card on which to turn in the regular monthly report to the Section Communications Manager.

3. When a station is of necessity inoperative for four months or less, the appointment may be held on an inactive list by the Section Communications Manager, providing the station owner has reported the facts of the case and requested that he be excused from active operating and reporting during this time. Inactive lists shall be turned in to Headquarters by the Section Communications Manager with his monthly report. O.R.S. appointments shall be transferable from one Section to another, with the consent of the Section Communications Managers concerned who must alter their records and notify Headquarters of such changes. Such appointments shall not be transferable from one station-owner to another.

4. The violation of the provisions made above for operating and reporting shall be sufficient reason for the Section Communications Manager to recommend cancellation of the appointment. The Section Communications Manager shall notify the Official Relay Station that this action is pending when the first and the second report has been missed. The appointment shall be cancelled automatically when the third consecutive report fails to come through on time.

REPORTS

Each Official Relay Station report shall include the number of messages originated, delivered, relayed, and the total. The Form No. 1 reporting card furnished monthly by the A.R.R.L. shall be used when it is available but the non-arrival of this form shall not constitute an excuse for not reporting.

The Section Communications Manager shall condense all reports received, leaving out any "negative" information. His report shall not mention inactivity or non-reporting. Traffic figures shall be separately listed at the end of the report and shall not be included in the body of the report. The most consistent traffic stations and the

ones doing most experimental and other useful work are the ones deserving credit and to whom space shall be given. When possible, the Section Communications Manager shall send in his report *typewritten and double-spaced*. Section Communications Managers shall not transmit the reports received by them to Headquarters except on a request to do so, but shall consider the reports as for their information and from them prepare a condensed report of the month's activities and the status of amateur affairs in the territory under their jurisdiction.

The Official Relay Station appointment of the Communications Department deserves some further explanation. Telegraphing members who hold amateur licenses are most interested in this work.

Before the war our League was a much smaller organization that it is to-day. What traffic handling was done was performed in a very easy-going manner. Messages were not taken seriously by those who sent them or by those who handled them. Because there were fewer stations operating, it was harder to relay messages to their destinations. Deliveries were the exception rather than the rule.

As the League expanded more stations came on the air. It became increasingly possible to land messages right at the city of destination. More messages came our way from the public who began to realize that messages were actually being delivered and handled in good time. As the service improved, more people availed themselves of its use. Regular trunk and branch traffic routes were arranged so that messages could be handled reliably in almost any direction. However, with the advent of the war, this organization became inoperative with the closing down of all stations by the government.

After the war, the new organization went through some violent changes. New developments were principally along the lines of tube transmission. Next came the shorter wavelengths, making a complete revamping of our communication system necessary. The granting of appointments right and left, the increase in numbers of inexperienced operators, the new conditions under which we were operating (on several wavelength bands), each left its mark on our communication system. Once a man could handle a certain number of messages a month, he was granted an appointment without much questioning. Before the war newcomers automatically got operating experience by listening to commercial and government long-wave stations. By the time their stations were in workable shape to handle relay traffic, the necessary operating experience had been gained. After the war, newcomers threw

sets together from the information then made available. Stations capable of communicating over thousands of miles on short waves were operated by operators whose tuners no longer reached wavelengths where good commercial traffic was being efficiently handled. Lack of this preliminary training was responsible for poor operators. Unreliable stations and operators slowed up traffic. Complaints were received on the unreliability of operators and on the poor delivery of messages everywhere.

Finally, it was decided to abandon the old system and to start fresh. The need of placing a greater responsibility on the traffic handling of stations was felt keenly. A class of stations that could be depended upon should be created! An iron-bound set of qualifications and a set of Rules and Regulations for Official Relay Stations were drawn up as a standard and a foundation for the present traffic-handling organization was built. Appointments under the new system of things are no longer given without investigation. A set of questions to be answered for Communications Department files and recommendations to the Section Communications Manager are necessary. The present system of Official Relay Stations, which has been in successful operation for over two years, is the result.

WHY YOUR STATION SHOULD BE AN OFFICIAL RELAY STATION

Official Relay Stations are the best regulated and the most active stations in League operating work to-day. Every Official Relay Station has a good-sized certificate of appointment. The certificate is a mark of distinction putting the operator in a class above the average "ham". The operators of Official Relay Stations are well-known as "reliable" operators and amateurs of good standing. The badge of honor carries some weight with everyone who visits the station, including the Radio Supervisor. Vacancies in the ranks of the League officials are filled from the ranks of the Official Relay Stations. Every owner of an Official Relay Station receives a bulletin letter from A.R.R.L. Headquarters each month with the latest schedules, news, and procedure hints and helps. A special form reporting card is also enclosed for the convenience of the Official Relay Station operators in reporting their traffic-handling work and records.

HOW TO BECOME AN O. R. S.

To secure an appointment as Official Relay Station is quite a simple matter. After building the station and gaining some code speed, get in touch with your Section Communications Manager. Arrange some schedules for traffic-handling by writing a

few letters to the best stations you hear consistently in different directions from your own station. Collect and handle some traffic regularly and don't forget to report your work to him on time each month for a few months. Then ask your local traffic official to furnish you with an application blank to become an Official Relay Station (or use the one printed for your convenience in the rear of this book). Fill out the application blank and send it to Headquarters.

You will get some question blanks to be filled out and returned to the S.C.M. If you have the necessary knowledge and qualifications the S.C.M. will be able to follow his instructions and make the appointment. In this event the information you have sent him will be turned over to Headquarters for Headquarters files. If you cannot answer all the questions correctly or are not quite able to make the grade, your application may be tabled for two or three months in which time you can study and practise operating until you can make the grade. It may be that you miss out on some of the questions but get a nice letter from the Sections Communications Manager ex-

plaining the answers and notifying you what action can or cannot be taken regarding an appointment.

Being recognized as an Official Relay Station is very much worth while. It is not difficult to obtain an appointment but certain requirements must be met and lived up to if the appointment is to be kept valid. Otherwise it would *not* be worth while. Cancellations of appointment follow failure to report for two successive months, continued failure to operate according to A.R.R.L. practices, failure to observe government regulations, failure to keep a receiver and transmitter in commission, and failure to comply with the spirit of the rules on the application form or certificate.

When a station is inoperative of necessity and the Section Communications Manager has been duly notified, the appointment is gladly held on an inactive list over a certain period of time. New operators are needed among the "reliables" every day. The appointment is one made with mutual advantage to yourself and to our Communications Department. Fill out the application form as soon as you can qualify!

CHAPTER VII

Operating A Station

THE enjoyment of our hobby usually comes from the operation of our station once we have finished its construction. Upon the *station* and its *operation* depend the traffic report and the communication records that are made. We have taken every bit of care that was possible in constructing our transmitter, our receiver, and in erecting a suitable antenna system. Unless we make ourselves familiar with some uniform operating procedure, unless we use good judgment and care in operating our stations, we will fall far short of realizing the utmost in results achieved. More than this, we will make ourselves notorious unless we do the right thing, because we have the power to interfere with other stations if we operate improperly.

After a bit of listening-in experience you will hear both kinds of operators and realize the contrast that exists between the operation of the good man and that of "lids" and "punks" who have never taken the trouble to familiarize themselves with good practise. Occasionally you will pick up an amateur whose method of operating is so clean cut, so devoid of useless effort, so snappy and systematic, that your respect is gained and it is a pleasure to listen and work with him.

For efficient traffic handling, the transmitter should be adjusted for most efficient operation on two or three known lawful wavelengths. Marked or tagged points on the coil with known condenser settings for definite wavelengths will enable the operator quickly to change wavelengths (QSY) at any time.

The operator and his methods have much to do with limiting the range of the station. The operator must have a good "fist". He must have patience and judgment. Some of these qualities in operating will make more station records than many kilowatts of power. Engineering or applied common sense is as essential to the radio operator as to the experimenter. Don't make several changes in the set hoping for better results. Make one change at a time until the basic trouble is found.

An operator with a clean-cut, slow, steady method of sending has a big advantage over the poor operator. Good sending is partly a matter of practise but patience and judgment are just as important qualities of an operator as a good "fist".

The good operator sends signals which are not of the "ten words per minute" variety, but they are slow enough so that there is no mistaking what he says. The *good* operator does not sit down and send a long call when he wants to work someone. He puts on the phones and *listens in*. He goes over the dial thoroughly for some time. The fellow that is admired for his good operating is the one who is always calling some particular station instead of using the "inquiry signal". Because he *listens* until he hears someone to work and *then* goes after him, our good operator gets his man nearly every time. A good operator chooses the proper time to call, he makes plain signals, and he doesn't call too long. A short call is sufficient because if a station does not get the call it is likely that he is listening to another station. A long call makes the receiving operator lose patience and look for someone else.

The adjustment of the receiver has much to do with successful operation, too. The good receiving operator notes the dial setting and when he has completed calling in proper fashion, he waits a moment and then tunes above or below the logged dial setting just in case something has shifted a bit in the receiver or transmitter. The best operator has patience and waits a few minutes in case of delay at the transmitter or in case fading signals make a second answer necessary.

COMMUNICATION

After all, communication has as its object the exchange of thought between two minds. Sometimes those minds are near together and it is possible for the individuals concerned to converse at length and exchange their thoughts freely. At other times and this is when radio communication is involved, the individuals are miles apart and the thoughts to be transmitted must be condensed to just a few words. Then these words must be relayed or passed on from mind to mind or operator to operator. When they reach their ultimate destination someone can interpret them fully if they have been properly and carefully handled by the intermediate operators.

Time is involved in making any exchange of thought. Because every man's life and experience is measured by time, this factor

becomes important in everything we do or say. The number of messages handled, the number of distant stations worked, the number of records made at our station, all depend in some degree on the time available for our hobby. The more time we spend at the set, the more well-known we become and the greater the summation of our accomplishments.

As time is a factor, uniform practises in operating have become necessary to insure a ready understanding of what is going on in the minds of each operator. "Q" signals and abbreviations of various sorts have been devised and are in general use today just because of the time element involved, to enable every operator to exchange intelligible thoughts with as little waste effort as possible. So proficiency in the commonly-used abbreviations and in knowledge of uniform operating practises is to be desired. Proficiency comes with practise. In the latter part of this booklet we have included the "Q signals" and some common abbreviations used by amateur operators. We will mention some of the time-saving things that have become standard practise among good operators and following that a few words about relay procedure will show how a station is operated to best advantage.

MESSAGE TRAFFIC

Amateur operators can engage in friendly conversation and talk about their stations and apparatus to their heart's content. Commercial operators are required to devote all their time to the handling of business. Amateur operators usually use abbreviations and short-cut methods of stating things so that a lot can be said in just a little while. When two operators are in touch, it is easy for them to understand each other or to ask for more complete wording if there occurs a failure to interpret all the abbreviations used.

One activity of the League that is quite important is the accepting and relaying of messages. Station owners may originate traffic going to any part of the United States or to such foreign countries as permit the handling of citizen messages by amateur operators. Messages may be accepted from friends or acquaintances for sending by amateur radio. Such messages should be put in as complete form as possible before transmitting them, and incomplete messages should not be accepted. As messages are often relayed through several stations before arriving at their destination, no abbreviations should be used in the text as mistakes are bound to happen when the text is shortened in this manner. To people not acquainted with radio abbreviations, messages written in shortened form are meaningless. Delivering stations must

be careful to see that messages are written out fully.

In handling messages we are doing something really worth-while. We want to start only good worth-while messages from our stations. Our efforts should be directed to making the quality of our message service high. The number of messages we handle is of secondary importance. The *kind* of messages we originate or start from our stations and the *speed* with which the messages pass through our station and the *reliability* or *accuracy* with which the messages are handled are the things of paramount importance.

A few years ago many of our stations got into the bad habit of originating hundreds and hundreds of station-to-station messages of the "rubber stamp" type. The text of these messages usually ran "Ur crd recd wl QSL", and so many of these useless messages were sent that our whole communication machine got clogged and refused to function. A very small number of the messages handled were delivered, simply because none of the messages meant anything, and because no one could waste time in handling them.

To-day we are getting 80% of our messages delivered. Each reader of these pages is asked to *assume personal responsibility* for the accuracy and speed of each message handled so that we can each have reason to take personal pride in our operating work and so that we will have just cause for pride in our League as a whole. Do *your* part and we will yet reach the 100% figure.

Each message originated and handled should contain the following component parts in the order given:

- (a) City of origin
- (b) Station of origin
- (c) Number
- (d) Date
- (e) Check (optional)
- (f) Address
- (g) Text
- (h) Signature

(a) The "city of origin" refers to the name of the city from which the message was started. If a message is filed at League Headquarters by someone in Hartford, Conn., the preamble reads, "*Hr msg fm Hartford Conn 1MK Nr 456*", etc.

If a message is sent to your radio station by mail the preamble reads a little differently to show where the message came from and from what city and station it originated as well. If a message was filed at A.R.R.L. Headquarters and if it came by mail from Wiscasset, Maine, the preamble would run

like this to avoid confusion, "Hr msg fm Wiscasset Maine via Hartford Conn 1MK Nr 457 April 9", etc.

(b) The "station of origin" refers to the call of the station at which the message was filed and this should always be included

THE AMERICAN RADIO RELAY LEAGUE HARTFORD, CONN., U. S. A. RADIOGRAM					
CITY OF ORIGIN (2R MRB PR) HARTFORD CONN	OFFICE OF ORIGIN 1MK	NUMBER 581	DATE MAY 24	CLASS 4B	
TO: F B BERRY 3208 NORTH BIRMINGHAM ST. OKLAHOMA CITY OKLA (Name and address)					
COMMUNICATIONS DEPARTMENT SUPPLIES AND RELAY STATIONS LIST HERE HALLS LAMP BURNER FLARES READ YOUR COMMENTS BY LETTER OR TRIP ASKING ABOUT TERMS BOOK AS INFORMATION AVAILABLE					
FROM: F B BERRY AMEL COMMUNICATIONS MANAGER					
Rec'd	FROM STATION	LOCATION	DATE	TIME	REMARKS
Sent	TO STATION OK	CARLEAD OK	5/24/24	5:45	7E-9
THIS MESSAGE WAS RECEIVED AT THE STATION STATION WHOSE ADDRESS APPEARS ON THE REVERSE SIDE (PLEASE TURN THIS OVER-IMPORTANT)					

To emphasize properly the standard message form used by the A.R.R.L., we are illustrating a sample message herewith. It is a simple matter to record the date and time of receiving and sending a message if a calendar and clock are kept handy in the station. If these data and the calls of the stations concerned are placed right on the message blank itself, there is never any question about the routing or speed of handling messages that cannot be answered at once by reference to the message file.

so that a "service" message may be sent back to the originating station if something interferes with the prompt handling or delivery of a message. In the example of preambles just given "1MK" is the station of origin, that call being the one assigned the League Headquarters Station by the Department of Commerce.

(c) Every message transmitted should bear a "number". Beginning on the first day of each calendar year, each transmitting station establishes a new series of numbers, beginning at Nr. 1. Keep a short with a consecutive list of numbers handy; file all messages without numbers; and when you send the messages, assign numbers to them from the "number sheet", scratching off the numbers on that list as you do so. Such a system will keep things straight and be very convenient for reference to messages originated.

The original number supplied each message by the operator at the originating station is transmitted by each station handling the message. No new numbers shall be given the message by intermediate stations. If a message is filed at 1MK on April 9 and when sent is given the number "nr 458" this same call and number is used by all stations handling this

message. The number and date become a part of the city-and-station-of-origin identification used for the purpose of tracing.

The message started from 1MK reads, "Hr msg fm Hartford Conn 1MK Nr 458 April 9". No matter what station handles this message, the city and station of origin, the number and the date, remain exactly the same as in the original and should reach the addressee in that form. Only at stations where a message originates or is filed can a number be assigned to a message. Intermediate relaying stations neither change numbers nor supply new ones to messages.

(d) Every message shall bear a "date" and this date is transmitted by each station handling the message. The date is the "day filed" at the originating station unless otherwise specified by the sender.

(e) Every word in the address, text, and signature of a message counts in the check using radio cable-count. Words and abbreviations in the preamble are not counted.

In the address, the names of cities, states, countries or other divisions of territory each count as one word regardless of the number of letters they contain. Proper names in the address and signature are counted at the rate of one word for each 15 letters or fraction thereof. The words "street", "avenue", "square" or "road" are always to be counted each as one word separately from the name of the street, etc., whether written with it or separately. Names of ships are counted as one word irrespective of the number of letters they contain. When there are two ships of the same name, the name and the call letters of the ship are together counted as one word. The name of the state is always counted as one word in addition to the name of the city. Initials in the address are counted each as one word. Each group of house or street numbers is allowed to pass as one word, however.

It is customary to omit the count of the name of a state in the check when it is written and sent in parentheses in the address.

If a telephone number is included in the address, the word "telephone" or "phone" counts as one word. The name of the exchange is an additional word in the check. Each group of five figures or fraction thereof counts as one word. A hyphen indicating the word "ring" may be substituted for one figure in a telephone number without increasing the check. "PHONE CHARTER 328-5" counts as 3 in the check. "26039" counts as 1 in the check. "2603-9" is a six character group and accordingly counts as 2 in the check.

Radio calls are often included in the address to make proper routing easy.

"5XAY" counts as one word in the address but as four words when it appears in the body or signature of the message.

In the *text* words are counted for every fifteen characters or fraction thereof if the message is a *plain language* message. A word containing from 16 to 30 letters counts "2" in the check. As English is the business language of the world, most messages are sent in English. Messages can be sent in any languages made up of the Arabic (26-letter) alphabet.

Names of cities in the address count always as one word while in the text they may count as more than one word depending on how written and transmitted. NEW YORK CITY counts as *one* word in the address but three words wherever it appears in the body of the message. NEWYORKCITY is counted as one word when written and sent *without* spacing between the parts.

Isolated characters each count as one word. Five figures or less in a group count as one word. Words joined by a hyphen or apostrophe count as separate words. A hyphen or apostrophe each counts as one word. However, they are seldom transmitted. Two quotation marks or parenthesis signs count as one word. Punctuation is *never* sent in radio messages except at the express command of the sender. Even then it is preferably spelled out. In the text of messages, the names of ships are counted at the rate of 15 letters to a word if the names are written out separately. If all parts are joined to form one word each 10 letters or fractional part counts as one word.

Messages may be classed as *plain language* messages, *coded* messages or *cipher* messages. A plain-language message bears the same thought indicated by the dictionary meaning of the words used in the text. All ordinary messages are plain-language messages. Every 15 characters or fraction thereof counts as one word. Numerals are counted in groups of five or less.

Examples:
 ARRANGEMENT 1 word 2961 1 word
 UNCONSTITUTIONAL 2 words 85772 1 word
 X-RAY 2 words 171186 2 words
 (the hyphen is not transmitted)

In coded messages the words are all pronounceable but their arrangement is not necessarily in sentences to express the thought. Several selected words or word groups express more extensive thoughts.

In code messages every ten characters or less count as one word. Either dictionary or artificial words may be used but all words must be pronounceable to take the ten-letter count. Words containing 11 to 20 letters count "2" in the check. When

one has a copy of the simple and commonly used codes the business of coding and decoding is easy.

Examples:
 CAUSTIC 1 word AVIABLOSKI 1 word
 COMBINZUBIOUS 2 words HOOTBAFF 1 word

In cipher messages the letters or figures in each uninterrupted series are counted at the rate of 5 (or fraction thereof) per word. Groups of letters are checked at the same rate as groups of figures. Mixed letters and figure combinations must be counted differently. "R4TG" counts as four words unless it is an *established* trade mark or trade name. Radio calls are always counted as cipher. "1MK" counts as *three* words in the text or signature of a message. For accuracy it should be written "one mike king." Abbreviated or misspelled words are counted at the "5-letter" rate in any message where they accidentally appear.

Examples:
 XYPPQ 1 word
 D6W 3 words
 CXQPWL 2 words

If a message is written partly in plain language, partly in cipher, and partly coded, the words in plain language and code are counted at the "10-letter" rate while the other parts of the messages are checked at the "5-letter" rate.

When messages are written in plain language and cipher, the passages in plain language take the fifteen letter count and the passages in cipher take the five letter count.

Messages in plain language and code take the ten letter count.

When the letters "ch" come together in the make-up of a dictionary word, they are counted as one letter.

Either whole or fractional numbers spelled out so each group forms a continuous word may be checked at the "15-letter" rate. "FOB," "COD," "SS," "ARRL," "QST," and such expressions in current use, are counted five letters to a word wherever they appear. Groups of letters are not acceptable in the address but must be separated and checked as one word *each*.

Here is an example of a "plain-language" message in correct A.R.R.L. form and carrying the "cable-count" check:

(HR MSG FM HARTFORD CONN 1MK
 NR 83-217p MAY 3 CK 51)
 (to) H. W. DENSHAM
 140 WASHINGTON ST
 COLLINGSWOOD NEWJERSEY
 PLEASE COMMENT ON PROPOSED
 OLD TIMERS WEEK USING 75 METER
 WAVELENGTH STOP BACK NUMBER
 OF QST YOU WANTED WAS FORWARD-

ED MONDAY STOP WHAT WAVE-LENGTH IS MOST IN USE AT 3EH QUESTION 73 TO YOU AND NEW JERSEY GANG

(sig) ARRL COMMUNICATIONS MANAGER

The count on each part of the message is added to give the "check" shown. Address: 8. Text: 40. Signature: 3. The check is the sum of these three or 51 words. The parts of the message in parentheses are always transmitted but do not count in the check.

The following words that give most trouble in counting this message add into the "check" as follows:

H	1
W	1
140	1
St	1
NEWJERSEY	1
175	1
QST	1
3EH	3
73	1
NEW JERSEY	2
ARRL	1

The use of a check on amateur messages is optional. Where employed, however, it is a matter of courtesy to see that the check is correct and is handed on along with the rest of the message. Very important messages should be checked carefully to insure accuracy, and if an important message is received with no check, a check should be added.

(f) The "address" refers to the name, street and number, city, state, and telephone number of the party to whom the message is being sent. A "sufficiently complete" address should always be given to insure delivery. When accepting messages this point should be stressed. In transmitting the message the address is followed by a double dash or break sign (---) and it always precedes the text.

(g) The "text" consists of the words in the body of the message. No abbreviations should ever be substituted for the words in the text of the message. The text follows the address and is set off from the signature by another break (---).

(h) The "signature" is usually the name of the person sending the message. When no signature is given it is customary to include the words "no sig" at the end of the message to avoid confusion and misunderstanding.

ORIGINATING TRAFFIC

Every message has to start from some place and unless some of us solicit some

good traffic from friends and acquaintances there will be no messages to relay. A number of League members have made a special study of different simple methods of collecting messages and we want to mention those that have proved worthy and worked out well in practise. Of course the simplest way to get messages is to offer to send a few for friends, always reminding them that the message service does not cost them a penny and that no one can be held responsible in case a friendly message does not arrive at its destination or if it arrives after some delay, but that, after all, most messages do get through in good season so that sending them is really worth while.

A number of our most enthusiastic traffic handlers who are interested in handling messages in quantities have taken more aggressive steps to secure results. One man at least has advertised in the local papers that messages may be phoned him for transmission via A. R. R. L. radio stations. Another fellow we know has made arrangements to handle a daily report on livestock and butter-and-egg market conditions. Radio stations at Madison and Milwaukee, Wisconsin, are responsible for conducting the first daily and speedy market service of its kind. A number of the amateur fraternity have distributed pads of message blanks to a number of local stores and business houses. A neatly typed card is displayed near-by explaining the workings of our A. R. R. L. traffic organization, and listing the points to which the best possible service can be given.

The time of collecting messages and the list of schedules kept may also be posted for the benefit of those interested. Wide-awake amateurs have always distributed message blanks to the nearest tourist camps during the summer seasons of recent years and lots of good traffic has been collected through a system of message-collection boxes placed in public buildings and hospitals. A sign prominently displayed outside the radio station has in some instances proved a good source of obtaining worth-while messages. Other similar ways of obtaining message traffic will occur to the station operator when he is ready to go out after something to do. When conventions or exhibitions come to a city there are always opportunities for getting a lot of real messages to send. Some hotels are glad to accept messages from guests to be sent through near-by amateur stations as a special free service to their patrons.

NUMBERING MESSAGES

The keeping of a station logbook is important in making our station excel in every respect. That subject is treated in the operating appendix in the back part of this Handbook. The "log" is written up, right at the time the station is in operation. Properly kept it, it becomes a detailed and interesting history of station accomplishments and is frequently of great value in proving or disproving transmissions.

Reference to a well-kept log will usually disclose the number of the last message that was sent, so that we can quickly find the next number to use. The log will give us the whole story of the "where" and the "when" of every message that has passed through the station.

Often an additional "number sheet" posted on the wall of the station or kept attached to the log sheet that is in use, will help in keeping the records straight and in avoiding possible duplication of numbers on messages. Guess work and confusion are eliminated in a station of either one or several operators if a "number sheet" is used. A "number sheet" system enables any operator *quickly* to tell just what number is next; it helps the operator in counting the number of messages *originated* in a given month; and it may also give a convenient check with the log in showing to whom each message was sent.

Take a blank sheet of paper and put a consecutive list of numbers on it starting with the current message number. Run the numbers in columns, ten numbers to each group or column, and allow sufficient space between columns for entering station calls.

File the messages in complete form except for the number and when you have a station ready to take a message, consult the number sheet, assign the next available number to the message, and when the station acknowledges the message, cross off the number used, putting the station call after this number and writing the number on the message blank.

A new number sheet can be made as often as necessary. A sheet that is in use looks something like the illustration.

Number 16 will be the next number originated at the station using this number sheet.

COUNTING MESSAGES

So that we can readily keep run of our messages and compare the number of messages originated and delivered each month to learn some facts about the "efficiency" of our work in handling messages, a method of counting messages is used that

gives the desired information. Each time a message is handled by radio it counts one in the total.

A message received in person, by telephone, by telegraph, or by mail, *filed at the station and transmitted by radio* in proper form, counts as one message *originated*.

A message *received by radio and delivered* in person, by telephone, telegraph, or mail, counts as one message *delivered*.

A message *received by radio and sent forward by radio* counts as *two* messages *re-layed*.

All messages counted must be handled within a 48-hour (maximum) delay period

Message Numbers	Sent to Station	Date	Message Numbers	Sent to Station	Date
1	8CWK	6/10/26	31		
2	SAGN	6/10/26	32		
3	4OA	6/11/26	33		
4	1BTG	6/12/26	34		
5	6BUR	6/12/26	35		
6	3BZ	6/13/26	36		
7	7LR	6/14/26	37		
8	8ASV	6/14/26	38		
9	6CGO	6/15/26	39		
10	8ADG	6/16/26	40		
11	8EU	6/17/26	41		
12	1BIG	6/18/26	42		
13	98PY	6/20/26	43		
14	8ASV	6/21/26	44		
15	9ET	6/22/26	45		
16			46		
17			47		
18			48		
19			49		
20			50		
21			51		
22			52		
23			53		
24			54		
25			55		
26			56		
27			57		
28			58		
29			59		
30			60		

to count as "messages handled" under one of the three classes mentioned. A "service" message counts as a message handled just the same as any other type of amateur radio message.

The message *total* is the sum of the messages *originated*, *delivered*, and *re-layed*.

EXAMPLES OF COUNTING

During the "message month" messages can be easily counted by following the italicized rules. A monthly report is sent to the local traffic official of the A. R. R. L. as mentioned under the subject of "Reporting." The closing date of the "message month" is the 26th of each month, (the 18th in Hawaii). On the 26th of the month one operator of a large amateur station re-

ceives several messages from another station. (a) Some of these messages are for relaying forward by radio. (b) Some of them are for local delivery. (c) There are still other messages the disposal of which cannot be accurately predicted. They are for the immediate neighborhood but can be either mailed or forwarded to another amateur by radio. A short-haul toll telephone call will deliver them but the chances of landing them nearer the destination by radio are pretty good. This operator's "trick" ends at midnight on the 26th and he must make out the report with some messages "on the hook" to be carried over for the next month's report.

(a) The messages on the hook that are to be relayed have been received and *are to be sent*. They count as "1 relayed" in the report that is made out now, and they will also count as "1 relayed" in the next month's report (the month during which they were forwarded by radio).

(b) By mailing the messages or phoning them at once, they can count as "1 delivered" for the current month's report. By holding them until the next day they will count in the *next* report as "1 delivered."

(c) The messages in this class should be carried forward into the next month. If they have to be mailed they will count in the next report as "1 delivered." If they are relayed, we count them as "2 relayed," "1" received in the preceding month being carried forward and added to "1" sent makes the "2 relayed." If the operator wishes to count this message at once (for the current month) it must be mailed promptly and counted as "1 delivered."

Some examples of particular counting problems follow:

The operator of Station A gets a message by radio from Station B addressed to himself. This counts as "1 delivered" by himself and by Station A.

The operator of Station A takes a verbal message from a friend for relaying. He gives it to Station B over the telephone. Operator A does not handle the message by radio. Station B and operator B count the message as "1 originated." A cannot count the message as he did not start it on the air.

The operator and owner of Station A visits Station B and while operating there takes a message for relaying. The operator and owner of B cannot operate for a day or two so the message is carried back to Station A by operator A who relays it along within a few hours. The traffic report of *both* Station A and Station B shows "1 relayed" for this work. Operator A gets credit for "2 relayed" if he is entered in a message-handling contest and gives de-

tails of his work at both stations specially for the contest.

Messages originating at any station count only in the "originated" column. Messages received by radio and delivered, count only in the "delivered" column. The relayed column can contain either an odd or even number of messages, depending on the messages left over for next month, the circumstances in a given case, and so on. The *total* is the sum of the figures in originated, delivered, and relayed columns.

DELIVERING MESSAGES

The only service that we can render anyone by handling a message comes through "delivery." Every action of ours in sending and relaying messages leads up to this most important duty. Unless a message is delivered, it might as well never have been sent. Sure enough, we have had a lot of pleasure in sending it and many stations have been glad to acknowledge receipt and to forward it by radio, but without a delivery nothing has really been accomplished.

Right now, delivery conditions are pretty good. Periodically, however, we have an influx of new operators who are willing to get all the fun out of handling messages by radio and who are not willing to give anything in return. If a message comes their way, it gets filed or thrown in the waste basket. Often the man who sent the message expects an answer. Sometimes he writes to confirm his message or to inquire if his friendly message was received. It is then that our League gets a black eye because of the unreliability of some individual who has allowed a message to die at his station or who has been too lazy to deliver a message after it has been received and acknowledged.

There is no reason for anyone to accept a message if he has no intention of relaying it or delivering it promptly. It is not at all discourteous to refuse politely to handle a message when it will be impossible for you to forward it to its destination.

Occasionally message delivery can be made through a third party not able to acknowledge the radiogram he overhears. When a third party happens to be in direct contact with the person addressed in the message he is able to hand him an unofficial confirmation copy and thus to make a delivery much sooner than a delivery could be made otherwise. It is *not* good radio etiquette to deliver such messages without explaining the circumstances under which they were copied, as a direct delivery discredits the operator who acknowledged the message but who through no fault of his own was not able to deliver so promptly. With a suitable note of explanation, such

deliveries can often improve A.R.R.L. service and win public commendation. An operator's oath of secrecy prevents him from giving out information of any sort to any person *except* the addressee of a message. It is in no manner unethical to deliver an unofficial copy of a radiogram, if you do it to improve the speed of handling a message or to insure certain and prompt delivery. Don't forget that there are heavy fines prescribed by Federal laws for divulging the contents of messages to anyone except the person addressed in a message.

There are several ways of delivering messages. When it is possible to deliver them in person, that is usually the most effective way. The telephone is the most serviceable instrument in getting messages delivered without undue labor. When the telephone does not prove instrumental in locating the party addressed in the message, it is usually quickest to mail the message.

To help in securing deliveries and making the relay game very much worthwhile to everyone concerned, here are some good rules to follow:

Messages received by stations shall be delivered immediately.

Every message shall be relayed within forty-eight (48) hours after receipt, or if it cannot be relayed within this time, shall be mailed to the addressee.

We are primarily a radio organization, and the bulk of our messages should go by radio, not by mail. The point is that messages should not be allowed to fall by the way, and that they should be sent on or delivered just as quickly as possible. When a message cannot be delivered, or if it is unduly delayed, a "service" message should be written and started back to the "office of origin."

THE SERVICE MESSAGE

A service message is a message sent by one station to another station relating to the "service" which we are or are not able to give in message handling. The service message may refer to non-deliveries, to delayed transmission, or to any phase of message handling activity.

Whenever a message is received which has insufficient address for delivery and no information can be obtained from the telephone book or the city directory, a service message should be written asking for a better address. While it is not proper to abbreviate words in the texts of regular messages, it is quite desirable and correct to use abbreviations in these "station-to-station" messages relating to traffic-handling work.

The prefix "svc" in place of the usual "msg" shows the class of the message and

indicates at once that a station-to-station message is coming through. Service messages should be handled with the same care and speed that is given other messages.

Suppose a regulation message is received by 3CA for someone in Roanoke, Va. Suppose that the message cannot be delivered because of insufficient address. The city and station of origin of the message are given as "Pasco Washn 7GE." In line with the practise outlined above 3CA makes up a service message asking 7GE to "give better address," of course obtaining the address from the party that gave him the message. 3CA will give the message to anyone in the west, of course trying to give it to the station nearest Pasco, Washington, and sending it over the greatest distance permitting reliable communication. The message looks something like this:

```
"HR SVC FM ROANOKE VA 3CA NR
291 Aug 19
TO RADIO 7GE
L C MAYBEE
110 SOUTH SEVENTH AVE
PASCO WASHN ---
UR NR 87 AUG 17 TO CUSHING SIG
GICK HELD HR UNDL D PSE GBA---
(sig) WOHLFORD 3CA"
```

ROUTING MESSAGES

Messages can usually be placed near their destination. In any case they should be relayed to the station nearest the location of the addressee and over the greatest distance which allows reliable contact.

OPERATING ON SCHEDULES

Traffic handling work can very advantageously be carried on by arranging and keeping a few schedules. By arranging schedules and operating the station in a business-like way, using an accurate wavemeter and a clock, it has been proven many times that a maximum amount of business can be moved in a minimum of time and effort. The message "hook" can be cleared in a few minutes of work on schedule and the station will be free for "DX" or "experimental" work.

Every brass-pounder is urged to write letters to some of the reliable and regular stations heard, asking if some schedules cannot be kept a few times a week especially for traffic handling. With reliable schedules in operation it is possible to advertise the fact that messages for certain points can be put through with speed and accuracy, and the traffic problem will take care of itself.

THE FIVE POINT SYSTEM

To make our relaying more systematic the "five-point system" of arranging

schedules was proposed and has worked out very nicely in many cases. After getting the station in good operating condition, each station's operator arranges to work four stations, one north, one east, one south, and one west. These directions are not exact but general. The distances are not too great but they must be distances that can be worked with absolute certainty under any conditions.

A good way to select the four stations is to listen-in and to pick out the stations heard most regularly, operating most consistently, and in the right direction. It is a good scheme to "work" these stations a few times. Write them letters and get acquainted; then try to arrange some schedules. Short schedules are the best. A half or quarter hour each day is enough. Using our twenty and forty meter channels we can work right through the broadcast period.

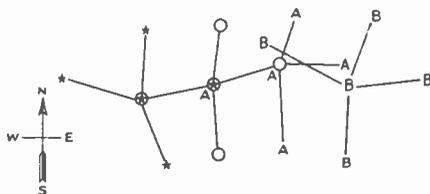

There is no excuse for failure to keep a schedule. After a little while, keeping it will be a part of the daily routine, and when the arrangement has been made after careful consideration by the fellows involved it will prove no hardship but rather a source of pleasure. In an hour one can call the four stations, clear traffic, and be free to work other groups of "five-pointers" or to spend the time otherwise.

By referring to the sketch the idea may be seen at a glance. Five stars work together, five circles, five A's, and so on, all over the country.

The system depends on the use of an accurate clock, wavemeter and log. When things stay the same from day to day the dial settings become memorized like telephone numbers and the importance of the three items named is not so great.

When there is no traffic, a few pleasures are in order during the scheduled time of working. Several advantages of handling messages on schedule are evident from whatever angle the situation is approached. The use of several separate wavelength bands for amateurs has more or less divided us. By arranging schedules and working in a business-like way we can make full use of all our wavelengths.

ACCEPTING AND TRACING MESSAGES

Messages that are not complete in every respect shall not be accepted for relaying. The city of origin, station of origin, number, date, address, text, and signature constitute a complete message. The fundamental parts of the message are regarded as the CITY and STATION of origin, a SUFFICIENT ADDRESS to insure delivery, a TEXT, and a SIGNATURE. All these parts are necessary to make a message of value to the recipient, to make it possible to deliver the message and to route an answer back to the sender. The city and station of origin make it possible to send a service message back to the starting point in case of delay or trouble in making a delivery. The date and number are useful as the inclusion of a date speeds up the message and the number makes it possible to trace the messages easily.

Tracing messages is sometimes necessary when it is desired to follow the route of a message or to find where it was held up or delayed. Tracing is usually accomplished by sending a copy of the message and a letter requesting that the time, date, and station calls of the stations from whom the message was received and to whom the message was given, be noted in the proper place on an enclosed sheet. The letter asks that the sheet and message be forwarded in rotation to all the stations handling the message until it has overtaken the message, when the tracer is mailed back to its starting point with the information collected from all the logs along the route.

REPORTING

Whether the principal accomplishments of the station are in traffic handling work or along other lines, what you are doing is always of interest to A. R. R. L. headquarters. Our magazine, *QST*, covers the entire amateur field, keeping a record of all the messages handled in different sections of the country, giving mention of the outstanding work that is done in communicating over great distances using small amounts of power, and summarizing all the worthwhile activities in the sections of the magazine devoted to those particular activities.

We have mentioned the Official Relay Stations and the Communications Department organization. A special section of *QST* is devoted to the Communications Department. Each month a special form postal is sent the active stations in the relay system for reporting purposes. Blanks on the card are provided so that the number of messages *originated*, the number *delivered*, and the number *relayed* can be inserted, together with the message *total*.

There is also space to tell about the most important traffic handled, the wavelength used during the reporting month, the "DX" worked, and other station records and activities, together with a list of the stations with whom schedules are kept. Items of general interest, changes in the set, and addresses of new amateurs also come in on this card.

This information is wanted from every operator of an active amateur station in the United States. Each month on the 26th (the 18th in Hawaii) the active stations send reports to their local officials. These officials forward all the reports sent them to Headquarters. They are next prepared for the magazine. Only representative space can be given each section of the country and almost every report received has to be squeezed in order to get it in. Reports must have the dead material edited out of them to allow room for as much *active* and *interesting* news as can be gotten in. Sometimes paragraphs have to be cut down or left out altogether to make the material fit the space it is allowed. Reports about what someone is "going to do next month" and about "burnt out tubes," "no traffic" or "non-operation" get deleted. The more worth-while a report is, the more of it gets in print. If something comes in that is worth special mention, it gets more space in another part of the magazine. Traffic figures and calls of active stations always get full space. The readers of this Handbook are cordially invited to send in their reports to the local traffic official just as soon as they have a station in operation. Write the nearest traffic official whose name appears on page 3 of each *QST*. *Make your report as informative and interesting as possible.*

Especially important work that has a news value should be sent direct to League Headquarters at Hartford. Get in touch with your local man soon, and ask him just when he must get a report from you, so that he can include it with other reports on the day he makes up his official report. Be sure to make your report as full of information as possible, including some of the things we mentioned if possible.

Contributions to *QST* are welcomed by the Editors! Authors must remember that only a small percent of the received material can be printed and that it is impossible for an organization like ours to pay for articles. By carefully selecting material the members get the best magazine that can be made. *QST* is noted for its technical accuracy. Getting into the reading pages of *QST* is an honor worth working for.

TROUBLES WITH OUR TRAFFIC HANDLING AND THEIR REMEDIES

Incomplete preambles seem to be the most common fault in our message-handling work.

The city of origin, the station of origin, the number, the date, and the check are all a part of the preamble which goes at the beginning of every message. The *city and station of origin* are most essential. Without them it is impossible to notify the sender that his message could not be delivered and without this information it is not possible to route the reply speedily. All Official Relay Stations are instructed to refuse to accept messages without this essential information. Every station should demand an "office of origin" from stations who have messages, and traffic may be rightly cancelled (QSK) on failure to include it. Thus messages will never get on the air without a starting place.

Many messages carry an *insufficient address* and cannot be delivered. Originating stations should refuse to accept messages to transmit when it is apparent that the address is *too meagre*.

Improper calling is a hindrance to the rapid dispatch of traffic. Long calls after communication has been established are unnecessary and inexcusable. Some stations are slow to reply to a call. However, the day of the station with dozens of switches to throw is past. Controls for both receivers and transmitters are simpler, fewer in number, and more effective. The up-to-date amateur station uses a "break-in" system of operation* and just *one* switch controlling the power supply to the transmitter.

Poor sending takes the joy out of operating. There are stations whose operators are not able to send better and those who can send better but do not. The latter class believe that their "swing" is pretty. Some of them use a key with which they are not familiar.

Beginners deserve help and sympathetic understanding. Practise will develop them into good operators. The best sending speed is a *medium* speed with the letters quickly formed and sent evenly with proper spacing. The standard type telegraph key is best for all-around use. Before any freak keys are used a few months should be spent in practising with a buzzer.

No excuse can be made for a "garbled" text. Operators should copy what is sent and refuse to acknowledge messages until every word has been received correctly. Good operators never "guess" at anything. When not sure of part of a message they ask for a repeat (QTA). The "lid" operator can be told very quickly when he makes a mistake. He does not use a definite "error" signal and go on with his message but he usually betrays himself by sending a long string of dots and nervously increasing his rate of sending. The good operator sends "?" after his mistakes and starts

* See pages 123 and 156.

sending again with the last word sent correctly. Unusual words are often sent twice. After the first transmission "I?" is sent and then the word is repeated for verification.

The A.R.R.L. system of getting "fills" on incomplete message is a good one. The last word received correctly is sent followed by the interrogation and the first word received after the communication was again good. Everyone knows the fellow who sends the whole message over to fill in one word. Nothing is quite so exasperating. When there is a check, reference to it reveals missing or superfluous words. The necessity for accuracy is really the reason for a check. Almost as aggravating as the repeating of a whole message unnecessarily to fill in a word is the sending of "words twice" when reception is perfect. Words should be sent more than once *only* when necessary and at the request of the receiving operator.

The law concerning *superfluous signals* is totally disregarded by some amateurs. Certain operators hold the key down for long periods of time when testing or thinking of something to send. Whenever this is done during operating hours, someone is bothered. Unnecessary interference prevents someone from getting in contact with (QSO) someone else, and if messages are being handled the copy is ruined. If you must test, disconnect the antenna system and use an equivalent "dummy" antenna (made of lumped resistance, capacity and inductance). Always send your call occasionally when operating with the antenna. You may be heard in Africa. If it is code practise that you must have, by all means use a buzzer or an omnigraph. Pick a time for adjusting the station apparatus when few stations will be bothered.

Some stations lose track of the messages which they accept for delivery or transmission. They use scratch pads to copy signals on and they never clean up the operating table or have a place for things. The remedy is to adopt a few of the principles of neatness and to spend about two minutes each time you are through operating to put things in order. Write messages on message blanks of a uniform size when they arrive at the station. Keep the messages to be sent together. A good system to use is to mark the state of destination in the upper right hand corner of each message, arranging the messages in a heavy clip so that the names of the states are in easy view. A file box may be similarly arranged. A simple log book, a good filing system, an accurate wavemeter and clock, are sure signs of a well-operated station. The apparatus on the operating table will tell a story without words.

OPERATING RULES AND REGULATIONS

The Official Relay Stations follow some general requirements for law-abiding operation which are mentioned on the appointment certificate. Some specific rules and regulations have been made to raise the standard of amateur operating. Official Relay Stations observe these rules carefully. They may be regarded as "standard practice."

Any actively-operating stations will do well to copy these rules, to post them conspicuously in the station, and to follow them when operating.

Here are the rules with an example of the use of each in actual operating:

1. Use "CQ" as adopted by the A.R.R.L., calling three times, signing three times, and repeating three times. "CQ" is not to be used in testing or when the sender is not expecting or looking for an answer. After a "CQ" cover the dial *thoroughly* looking for replies.

Example: —.—.— CQ CQ CQ U 8ASV
8ASV 8ASV CQ CQ CQ U 8ASV 8ASV
8ASV CQ CQ CQ U 8ASV 8ASV 8ASV
.—.—.

2. When you have traffic, send a directional "CQ" (call followed by direction, district, or state for which you have traffic) or send a "QST" listing the states for which you have traffic. A plain "CQ" always indicates that you have no traffic to send but are open for traffic.

Examples: —.—.— CQ WEST CQ
WEST CQ WEST u 9RR 9RR 9RR (repeated three times) —.—.—.

—.—.— CQ MASS CQ MASS CQ MASS
u 6BUR 6BUR 6BUR (repeated three times) —.—.—.

—.—.— QST QST QST u 1ARE 1ARE
1ARE —.—.— HR MSGS FOR MICH,
CONN, TENN, FLA, TEXAS —.—.—
QST QST QST u 1ARE 1ARE 1ARE
.—.—.—.

3. Answering a call: Call three times (or less); sign three times (or less); and after communication (QSO) is established decrease this to once or twice.

Example: —.—.— 1BIG u 1MK GE OM
QRV K (meaning, "Good evening, old man, I am ready to take your messages, go ahead.")

4. Signing off: When through working a station send "AR SK" followed by YOUR OWN CALL sent once. "SK" indicates to others that you are through with the station which you have been working and that you will now listen for whoever wishes to call. Never "CQ" after "SK" until you have covered the dial thoroughly looking for stations calling you.

Example: R CU AGN 73 etc. AR . . . —.— 2BBX (meaning, "your last transmission understood, all right, I'll see you again, best regards, I am through now and will listen for whoever wishes to call. This is 2BBX signing off.")

5. The proper use of "AR", "K", and "SK" signals is required for uniformity in understanding what the other operator intends to do. Use "AR" at the end of a call or between messages (it stands for the end of message or transmission); use "K" at the end of each transmission when answering or working someone (it means "go ahead"); use "SK" only when signing off (it means, "I am absolutely through working you for this time and am now going to listen for other stations who call me.")

Examples: (AR) —.—.— 2SZ gu 1DQ —.—.— (showing that 1DQ has *not* yet gotten in touch with 2SZ but has called and is now listening for his reply). Used after the signature between messages, it indicates the end of one message. There may be a slight pause before starting the second of the series of messages. If —.— (K) is added it means that the operator wishes his first message acknowledged before going on with the second message. If no "K" is heard, preparations should be made for copying the second message.

(K) —.—.— 2NM gu 1BDI R K. (This arrangement is very often used for the acknowledgment of a transmission. When anyone overhears this he at once knows that the two stations *are* in touch, communicating with each other, that 2NM's transmission was all understood by 1BDI, and that 1BDI is telling 2NM to *go ahead* with more of what he has to say.) —.—.— 9CNP u1YB NR 23 R K. (Evidently 9CNP is sending messages to 1YB. The contact is good. The message was all received correctly. 1YB tells 9CNP to *go ahead* with more.)

(SK) R NM NW CUL VY 73 AR . . . —.—.— 7NT (7NT says "I understand OK, no more now, see you later, very best regards, I am through with you for now and will listen for whomever wishes to call. 7NT signing off.")

6. Acknowledging messages or conversation: NEVER SEND A SINGLE ACKNOWLEDGE UNTIL the transmission has been SUCCESSFULLY RECEIVED. "R" means "All right, OK, I understand completely". When a poor operator, commonly called a "lid", has only received part of a message he answers, "R R R R R R R R R R, sorry, missed address and text, pse repeat" (QTA) and every *good* operator who hears, raves inwardly. The string of acknowledgments leads one to believe that the message has been correctly received and that it can be duly filed away. By the time

this much is clear it is discovered that most of the message did not get through after all but must be repeated. Perhaps something happens that the part after the string of R's is lost due to fading or interference, and it is assumed that the message was correctly received. The message is then filed and never arrives at its destination.

Here is the proper procedure to follow when a message has been sent and an acknowledgment is requested. When ALL the message has been received correctly a short call followed by "NR 155 R R K" is sufficient. When most of the message was lost the call should be followed by "PSE QTA ADDRESS AND TEXT K". When but a word was lost the last word received correctly is given followed by (. . . —.—.)? and the first word received correctly after the break in the transmission. "—.—.— 1XM u 9XBP —.—.— CHRISTMAS?? BY —.—.— REST R —.—.—" asks for a fill in the text "Christmas greetings by amateur radio".

7. Do not send words twice (QSZ) unless it is requested. SEND SINGLE unless otherwise instructed by the receiving operator. When reception is very poor, a QSZ can be requested to help make better copy. When conditions are even moderately fair, a QSZ is unnecessary. Few things are as aggravating as perfect transmission with every word coming twice. Develop self-confidence in yourself by not asking others to "QSZ" to you unless conditions are rather impossible. Do not fall into the bad habit of sending double without a definite request from the fellows you work.

8. Be sure the transmitter is adjusted to give a *steady* signal that is copiable. Floppy wabby notes are due to poor mechanical construction, improper circuit adjustments, or too close coupling to the antenna. See that the transmitter is built substantially. The apparatus should not move around or vibrate as you operate. Use few turns in the antenna coupling coil and keep it at a good distance from or at an angle with the coil which is in the "condenser-coil" circuit containing the oscillator tube.

9. Do not accept or start incomplete messages. Omission of the fundamental parts of a message often keeps a message from getting through to its destination. Official Relay Station appointments are subject to cancellation for failure to make messages complete enough.

10. A file of messages handled should be kept. Only messages that can be produced shall count in monthly reports. In the case of A.R.R.L. stations the message file is subject to call by local or state traffic officials at any time.

CALLING PRACTICE

The 18.7—21.4 meter wavelength band is 2,000 kilocycles wide. The 37.5—42.8 meter band is 1,000 kilocycles wide. The 75—85.7 meter band and the 150—200 meter band are but 500 kilocycles wide. It has been pointed out by some active members that the width of these bands should determine the length of the call. When all amateurs operated mostly on 200 meters, a two-minute call was quite common to enable an operator who had sent "CQ" to cover the band thoroughly in his search for stations calling him. Because our eighty-meter band is also a narrow one, it is evident that a two-minute reply should suffice here. However, the forty and twenty-meter bands are wider. Because there is "more room" on these short waves (higher frequencies) it is reasonable to conclude that if an operator is hunting for stations calling him with the thorough and systematic methods of a good operator, a longer period of time must be allowed to enable him to use the same care in covering the dial that he used on the upper wavelength amateur bands. Thus a four-minute call on forty, and an eight-minute call on twenty meters at first seem to be justified to give us the same chance of raising a station that we call that we had when only a 200-meter wavelength was used.

These are the facts in the case. It does not follow that a blanket practise of making long calls should be adopted. We think that a modified practise, adopted with this situation in mind, will produce the best results in raising stations. Assuming that it always does take two minutes to cover 500 kilocycles of territory when thoroughly hunting for stations calling us, we still must observe that if the receiving operator starts from one side of a 500-kilocycle band, changing his tuning at a rate that completely covers the band in two minutes, he will run across the station calling him in something less than two minutes unless the most unfavorable condition exists and our station is on the edge of the band while the receiving "op" is on the other edge when he starts to tune. So it is seldom necessary to call for the full two minutes to raise a station if we use our best judgment and refrain from doing any calling until we know that the receiving operator is "doing his stuff" and that our chances of raising him are best.

The League has never attempted to lay down any rules regarding the length of a call. The problem must be solved by the individual operators to fit the length of a call to the individual case under consideration.

We believe that the use of a "break-in" system at most of our stations will do much to obviate the necessity for long calls. We think that in any case where it is imperative that we raise a certain station, a long call is

justified. We are strongly of the opinion that a one-minute call with a break in the sending long enough to listen for a reply from the station called, followed by more one-minute calls is much better than a long unbroken call. Such a calling scheme will eliminate much unnecessary transmission and result in raising a station as quickly as calls of great length.

In calling you should always send the call of the station wanted several times (not more than 10 times under any circumstances). Follow this with the intermediate sent carefully. Then send your own station call three times. This combination can be repeated as many times as necessary. Such a procedure allows many stations to log our station without turning away in disgust at a too-long call.

The operators who seem to be most successful in raising the stations they want are *not* the ones who use the longest calls. They are the operators who use the best judgment in selecting the time to call, and in deciding on the number of calls that will give the best results in the calling periods.

USING A BREAK-IN SYSTEM

A break-in system of operation makes it possible for us to talk back and forth with fellows we work just as one talks back and forth over a telephone circuit or telegraph system. Using a "break-in" we can interrupt the other fellow if we miss a word or do not understand him. With a telephone we stop talking as soon as the distant party speaks and interrupts us. In a telegraph office the operator who misses a word opens his key so that the sending is interrupted and cannot go on until the receiving operator has had his say and again closed the circuit. In a radio system using a break-in the receiving operator presses the key and makes some long dashes for the transmitting operator to hear. As soon as he does get the signal he stops transmitting and listens to what the receiving operator says, after which the sending is resumed.

A separate receiving antenna put up at right angles to the transmitting antenna makes it possible to listen to most stations while the transmitting tubes are lighted. It is usually necessary to pause just a moment occasionally when the key is up to listen for the other station.

Much useless calling and unnecessary transmission is prevented if a break-in is used. Two stations can use the system to mutual advantage. When messages are being handled, if some interference comes in or if a word is missed due to swinging signals, a few taps of the key will set things straight in a jiffy. "BK BK GA ROAN-OKE" (or whatever was the last word received correctly) will save time and unnecessary sending. If the trouble con-

tinues, the sending station can "stand by" (QRX) or it can take traffic until the reception conditions at the distant point are again good.

For example, suppose 8SF has a message for New York City. He calls, "CQ NY u 8SF ar," repeating the call three times. 2PF hears him, answering "8SF u 2PF bk me bk me." When 8SF hears 2PF, 8SF immediately holds his key down and makes some long dashes. 2PF, who is, of course, receiving "break-in" while he calls, stops sending when he hears the dash. 8SF then starts to call in the regular manner saying, "2PF u 8SF ge hr msg QRV?" Then 2PF gives him a "ga OM" and the message is sent without further preliminaries. Since both stations are using "break-in", they can interrupt each other at any time when something goes wrong or a letter is dropped, and traffic can be handled in half the usual time. There is a real "kick" that comes from working a "break-in" arrangement. After the fun is over, there is a wholesome satisfaction in the knowledge of a job well done. Swift, clean-cut operation brings its own reward.

In calling, the transmitting operator sends the letters "bk", "bk in" or "bk me" at frequent intervals during his call so that stations hearing the call may know that a break-in is in use and take advantage of the fact. He pauses at intervals during his call, to listen for a moment for a reply from the station being called. If the station being called does not answer, the call can be continued. If the station called answers someone else, he will be heard and the calling can be broken off until he has finished his business and is again listening for more stations to work.

GETTING FILLS

Sometimes parts of a message are not received correctly. In that case the interrogation (..—..) is used between the last word received correctly and the first word received after the interruption. There is seldom any excuse for repeating the whole message to get a few lost words. The good operator will ask for what fills he needs, separating the different sections of the message having missing words by using the break signal (—...—) between parts.

Messages are often transmitted as many as three times at the request of the receiving operator. Failing to make a complete copy after three attempts, the receiving operator cancels the message (QSK) and the transmitting operator tries to relay the message through another station.

QTA MSG should not be sent unless nearly all the message is lost. QTA FROM TO..... is a long way of asking for fills sometimes heard in commercial

usage. The "interrogation" method is always the best especially when only a few characters were missed.

RELAY PROCEDURE

Let us assume that a station in Hartford, Conn., receives a message whose destination is Dallas, Texas. The message is at once written out on a message blank, filling in the city and station of origin, leaving only the "number", "rec'd", and "sent" spaces vacant.

The operator is anxious to get the message started. He sits down in front of the set and listens. He does not hear any western stations so he decides to give a directional "CQ" as per A.R.R.L. practise. He calls, "CQ DALLAS CQ DALLAS CQ DALLAS u 1MK 1MK 1MK", repeating the combination three times and ending with only ..—..

He listens and hears 9CXX in Cedar Rapids calling him, "1MK 1MK 1MK u 9CXX 9CXX 9CXX ..—.."

Then he answers 9CXX indicating that he wishes him to take the message for Dallas. 1MK says, "9CXX 9CXX u 1MK R QSR DALLAS? QRV? K"

After 9CXX has given him the signal to go ahead the message is transmitted, inserting the "number" in its proper place, and assigning the next number indicated on the "number sheet". The message is sent in A.R.R.L. sequence.

"Hr msg fm Hartford Conn 1MK nr 247 Nov 11 ck 24 To Mr Frank M Corlett Radio 5ZC 2515 Catherine Street Dallas Texas —...—Communications Department supplies and membership list are going forward today please send your reaction to general number 372 our army file —...— sig Houghton ..—.. 1MK ..—.."

9CXX acknowledges the message like this: "1MK u 9CXX Nr 247 R K". Never should a single "R" be sent unless the whole message has been correctly received.

The operator at 1MK now writes in the number of the message, scratches off number 247 on the "number sheet", putting "9CXX" after that number, and in the "sent" space at the bottom of the message blank he notes the call of the Cedar Rapids station, the date, time, and his own personal "sine". At the same time he concludes with 9CXX something like this: "R QRU 73 ES GB ..—..— 1MK" meaning, "All received OK, I have nothing more for you, see you again, no more now, best regards and good-bye, I am through with you and shall at once listen for other stations who may wish to call me. 1MK is now signing off."

9CXX will come back with "I R GB AR ..—..— 9CXX", meaning "I understand, re-

ceived you OK, good-bye, I am through". Then he will listen a few minutes to see if anyone is calling him. He will listen particularly for the Texas stations and try to put the message through to 5ZC or a neighboring station. If he does not hear someone calling him, he will listen for Texas stations and call them.

OPERATING HINTS

Listen carefully for several minutes before you use the transmitter to get an idea of what stations are working. This will help in placing messages where they belong.

Use abbreviations in operating conversations. This saves time and cuts down unnecessary interference.

Stand by (QRX) when asked to by another station who is having difficulty working through your interference. It is equally courteous to shift wavelength (QSY) to a point where no interference will be caused. Sometimes a change in wavelength will help the station you are working to get your message through interference. Accurate wavemeters at both stations will make this change speedy and the contact sure.

Report your messages to the local traffic official every month ON TIME. Otherwise you cannot expect a report to reach QST. Reports sent to Headquarters are routed back to the local officials who make up the monthly report.

Don't tell a fellow his signals are R8 when you can just hear him.

Don't say "QRM" or "QRN" when you mean "QRS".

Don't acknowledge any message until you have received it COMPLETELY.

Don't CQ unless there is definite reason for so doing. When sending CQ, use judgment. Sign your call three times for each three CQs.

Abbreviated standard procedure deserves a word in the interest of brevity on

the air. If you hear some old timers using it you will understand what is meant by reading the following paragraph. In handling lots of messages with a number of scheduled stations, most traffic can be cleared by holding all stations to 15-minute schedules. Several schedules should be arranged in consecutive order. To get several messages through in 15 minutes isn't an easy job but abbreviated practises help to cut down unnecessary transmission.

1AUF u1BMS P meaning paid, personal, or private message (adopted from commercial procedure) is much quicker than HR MSG added to a call. N QSU is shorter than QRU CU NEXT SKED. Instead of using the completely spelled out preamble HR MSG FM AUGUSTA MAINE 1BIG NR 156 OCTOBER 13 CK 14 TO etc. transmission can be saved by using RDO AUGUSTA ME 1BIG 156 OCT 13 14 TO etc. Still one more thing that conserves operating time is the cultivation of the operating practise of writing down 156 1UE 615P 11/13/26 with the free hand *during the sending* of the next message. It is hard to do at first, but all these little points added together make the total time saved on a message mean something. Of course only stations handling many messages regularly need to think of abbreviations to this extent. If one follows standard practises, he is most sure of being understood and it is *not* necessary to waste time in explaining too-abbreviated messages in detail. Make it a rule not to abbreviate unnecessarily when working an altogether unknown station.

Be courteous over the air. Offer suggestions for improving the other fellow's note or operating methods. Expect and ask for similar suggestions *without* expecting any praise. Constructive things can be said without being disagreeable or setting one's self up as a paragon. Be truthful but tactful.

CHAPTER VIII

The Experimenter

WE HAVE mentioned the experimenter briefly. When the station is first built it may be desirable to make some simple experiments or to do a bit of systematic adjusting. This is so that our transmitter can operate at greatest efficiency and effectiveness. Sometimes after the station has been built new ideas will need to be worked out experimentally. Many new and valuable discoveries have been made by the experimenter. It is this energetic individual who has advanced the radio game to the stage where we find it today.

For most of us constant experimenting is out of the question. We can build a good station at a very reasonable cost. There is nothing expensive or complicated about our undertaking. Only those of us fortunately endowed with wealth can purchase all the instruments we would like to have for advanced experimenting. Not all of us have either time or money to spend in a laboratory, let alone both. Some of us can learn valuable things from making the most of the experimental facilities at hand. These men belong to the "Experimenter's Section."

Radio measurements are very interesting to the experimenter. Only by comparing a large number of measurements on a certain general problem can certain conclusions and predictions be made. A set of figures about a certain antenna proves nothing in general about antennas. Measurements made on hundreds of antennas which show similarities make it possible to make useful deductions from the evidence.

In changing things experimentally one must always be sure to make just *one* change at a time. A careful record of the changes and the results of each change should be kept if our "experimenting" is to be good for anything. The most common mistake of the beginner is to draw conclusions from insufficient evidence.

Just as certain tools are needed for station-building, the experimenter must have a few good instruments. Pencil and paper, a decently accurate wavemeter, some fixed condensers of known capacity, a variable calibrated condenser, some fixed *known* resistances, some resistance wire, a resistance box if it can be afforded, a sensitive galvanometer, D. C. milliammeter, voltmeter with ammeter shunts, and a thermocouple

sensitive to small radio-frequency currents make a pretty complete outfit. The first items in the list are most important. As many good meters should be added as one can afford.

OUTLINES

Before tackling any problem, it should be outlined on paper. The experimenter always works from what is known to what is unknown. The outline should give (1) a statement of the problem, (2) a suggestion of all possible solutions, (3) the logical and most probable solution in detail, and (4) the procedure for trial and solution of the problem.

Analysis of a problem is simply the dividing of it into a number of pieces so small that we can grasp and handle each one without difficulty. In mapping out the attack on something we want to find out, it is well to split it into a number of sections that can be considered separately.

Next to outlines, records of what is done are most important. Readings of the meters should be recorded for each change that is made.

REPORTS

After the problem has been investigated, a few notes on the results can be made. If we are going to present the results to someone else for discussion or information, they should be written up more fully. A complete report may have several parts: (1) introduction stating the problem; (2) summary of the work of others; (3) description of apparatus used; (4) the method of investigation; (5) data taken; (6) results shown by data; (7) conclusions that can be made; (8) summary, (if the report is a long one).

The Experimenter and The "X" Section

By Robert S. Kruse, Technical Editor of QST

Did you ever get sick of some radio question and say "By George, I am going to hunt up someone that will work with me and find out the truth about this thing!"?

If so, then you are the sort of man the

"X" Section was made for. There are many others like you and it is the business of the Section to bring you together, to suggest things that need doing, to help you with your own problems and finally to turn the results over to the Radio Amateur thru the columns of our magazine.

THE TINKERER

Of course, all that is true only if you don't happen to prefer tinkering to experimenting.

To show just what I mean by that, let us suppose that a tinkerer and an experimenter start out to test two antennas for 40-meter work at a certain station.

The tinkerer works the first antenna for three nights, calling different people and asking them "How do I come in?" He may even disgrace himself by long "CQ" calls. Every once in a while he monkey with the adjustments of the sending set. On the fourth day he changes antennas—and at about the same time the weather changes. He gets back on the same wavelength (almost) and gets something like the same power into the tubes but makes a careless job of the adjustments and runs his tubes a bit hotter than before. Then he starts in working stations and it is almost certain that he doesn't work the same ones as before. The whole mess does not work out well and he is sure that the new antenna is "the bunk." When his report cards come along he cannot for the life of him remember which adjustment he was using on the 13th when he happened to be heard by that African station.

THE EXPERIMENTER

Now the experimenter starts out by making careful notes on his original adjustments before he changes a single thing. If possible he measures the antenna resistance to make sure that he knows what power is going into it. Then he picks a few reliable stations and arranges to have them test with him now—and again a bit later when he changes antennas. Then he changes to the new antenna—adjusts *carefully* to the same wavelength, makes careful adjustment of the sending set with about the same power into the antenna (*not the same current but the same power*) and puts down every clip position and every meter reading. He tries this new combination on his stations and finds that the results are very much poorer.

Does that settle it? I should say not! You see, the weather has changed *and he has noticed it*. Therefore he tries antenna No. 1 again and finally tries antenna No. 2

again. In the end he finds that antenna No. 2 is much the better—and then he starts in to find out WHY.

IS IT WORTH WHILE?

Is experimenting worth while? That depends entirely on you. If you *want to find out for yourself*, then the only possible thing you can do is to experiment. Of course if you are satisfied with an opinion it is all right to guess at it—or to ask *QST* if anyone else has done the job.

Naturally you can't try everything for yourself—one does not have all the money in the world and one does not live forever. Besides that, some things can be decided best by scientists and engineers—not by amateurs. On the other hand the engineers are sometimes wrong. Besides that there are some things that are *not* yet decided and that amateurs can *help* to find out. Of course one man seldom settles anything, but it is enough satisfaction to help start the thing off. That is the only way humanity ever gets ahead—each man builds on the work of the last man.

Many things can be done by one man alone—but it is lonesome business. Other jobs cannot be done at all without help or without checking with someone else's results. As often as not the results do *not* agree and then one starts out to find still more new things by finding out why things didn't check.

Very well, that is what the Experimenter's Section is for—to help you with your problem if we can or to find someone else who may be able to help you or at least to work with you. If something good comes out of the work we are certainly going to want a chance to consider it for *QST*, but that is *NOT* the main idea.

There are no membership requirements except interest in experimental radio. There is a problem list but it is only a suggestion and anyone is more than welcome to work on other things too. Every man enrolled gets a list of the other men working at the same thing so that he can write them.

Among the things that are now being done is the writing of outlines for doing all the problems which are on the regular list. In addition to this the Information Service helps the Experimenter when possible.

To join the Experimenter's Section is simple enough—just send a letter (please not a postal card) to "Experimenter's Section, American Radio Relay League, 1711 Park Street, Hartford, Conn., and say "I wish to join the X Section." The blanks will then be sent, together with the problem lists.

Appendix

THE SHORT WAVE TUNER CHART

Coils and condensers can be adjusted to tune to certain wavelength ranges by the "cut-and-try" method. However, a little planning with formulas or charts brings quicker and better results than this. The chart is simplest to use and easiest to understand.

A number of scales given on the chart

each bear definite relation to others. A straight-edge is the only tool required in solving problems.

When the capacity and wavelength are known, lay the ruler to touch these two values. The value of inductance is shown where the ruler crosses the inductance scale. From two known values the unknown one can be found on the chart. 3-inch coils are a common size for short wave

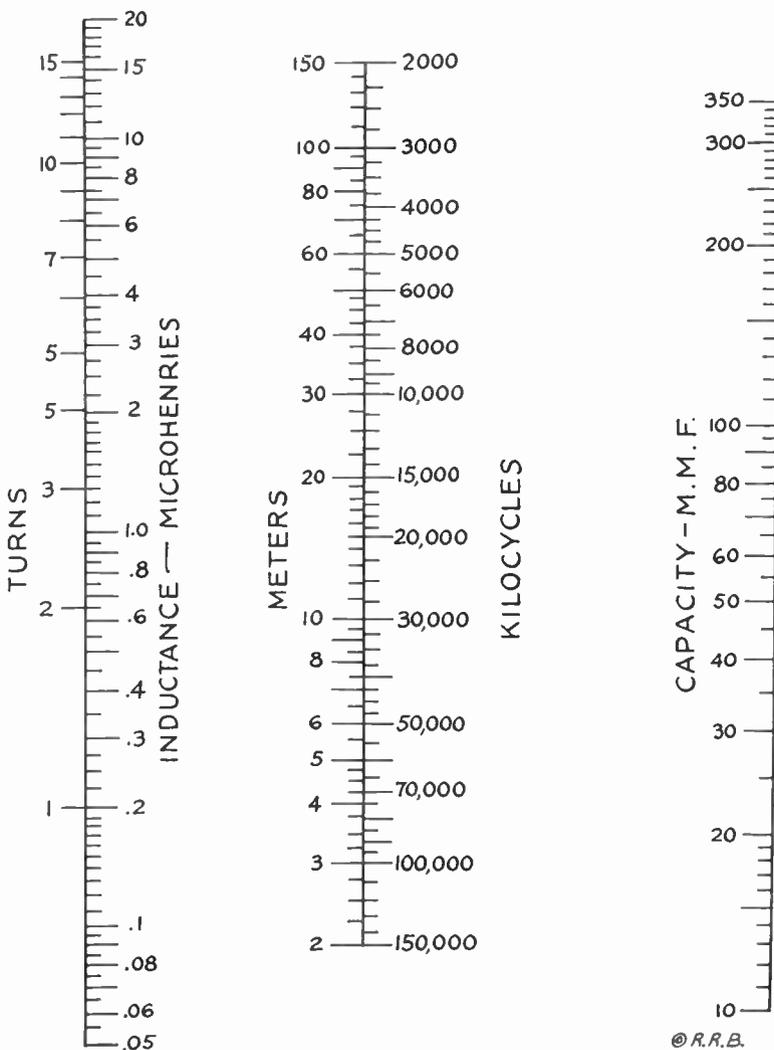

© R.R.B.

THE SHORT-WAVE TUNER CHART

work. Wind the turns, 8 to an inch, with No. 16 or No. 18 B. & S. wire and the turns will be the same as given at the extreme left of the chart. The inductance of only 3-inch coils can be directly found from the chart.

THE INDUCTANCE CHART

A special inductance-turns chart is given for some other coils which do not fit the special scale on the left of the tuning chart.

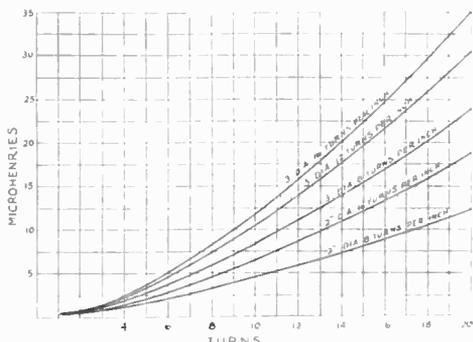

THE INDUCTANCE CHART

Given the maximum and minimum capacitance of our variable tuning condenser and a coil of given inductance we can readily find the upper and lower wavelength ranges to which the set will tune, with a straight-edge. Space-wound coils have lowest distributed capacity and are best for short-wave tuner construction.

The resistance of coils wound with various sizes of wire and spacings has been quite thoroughly investigated. Most of the condensers on the market are well designed and the "losses" that they introduce in the circuit can be neglected. A good condenser with decent electrical and mechanical features, used with a well-built coil, will give the results that we want. In general, some fine wire, space-wound, gives a better coil than heavier wire, tightly wound.

A skeleton coil form is electrically "best". Coils wound on solid tubing have increased loss-resistance over self-supporting coils. Shellac should be avoided. It causes increased distributed capacitance. Collodion dissolved in amyl acetate is the best coil "dope" to use for protection against moisture. Receiving coils of No. 26 or No. 28 wire, space-wound on skeleton forms, are best for the higher frequencies.

An article on "Designing the Secondary Coil" in September 1925 *QST* gave a simple chart for determining the sizes of coils for the broadcast wavelengths. This chart is good only for coils of tightly-wound double-cotton-covered wire of different sizes and coil diameters.

INDUCTANCE CALCULATION

The lumped inductance of coils for transmitting and receiving is fairly easy to calculate. Using a *wavemeter* and a *known capacitance* we can easily measure the inductance of various coils to check on our calculations

$$L = \frac{.0395 a^2 n^2}{b} K$$

(for single layer solenoids)

Where L is the inductance in microhenries
 n is the number of turns
 a is the mean radius of the coil (cm.)
 b is the length of coil (cm.) = nD
 D is distance between the centers of two adjacent turns
 K is the coil shape factor depending on the ratio 2a/b (see chart)

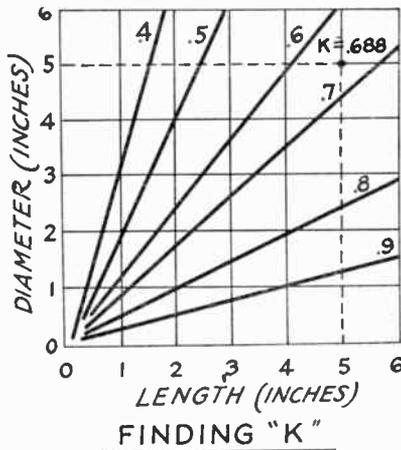

Start with the given coil diameter. Using the overall length of the coil find a value for "K". If the diameter is 5" and the length 5" go to the right from "5" on the diameter scale. At the same time go "up" from "5" on the length scale. Notice where the two lines meet. They meet at "X" between the lines "6" and "7". We estimate the value of "K" at .688 and proceed.

Assume a transmitting coil having 10 turns of 1/4" brass strip, flatwise wound, 5" diameter (6.35 cm. radius), and spaced 1/4" between turns, making the overall length (nD) 12.7 cm.

a = 6.35 2a
 n = 10. — = 1
 b = 12.7 b

K is about .688 (from chart)
 (Dia. and length each arc 5")

$$L = \frac{.0395 (6.35)^2 (10)^2}{12.7} .688 = 8.64 \text{ microhenries.}$$

SMALL TRANSFORMERS

A transformer is an electrical device for changing electric power at one voltage and current to power at another voltage and current. A step-down transformer takes its power at a high voltage and small current, delivering a lower voltage and more current. A step-up transformer delivers higher voltage than it takes at its input.

Filament-heating, bell-ringing, distribution and welding transformers are examples of step-down transformers. Plate-supply voltage and high-voltage transmission lines between cities are fed from step-up transformers.

The input winding connects to the source of supply and is called the *primary* winding. The output connects to the load and is called the *secondary* winding. Any transformer may be used for either step-up or step-down work. To avoid confusion it is always best to refer to transformer windings as high-voltage and low-voltage windings.

Most transformers that amateurs build are for use on 110-volt 60-cycle supply. The number of turns necessary on the 110-volt winding depends on the goodness of the iron core used and on the cross-section thru the core. Silicon steel is best and a flux density of about 50,000 lines per square inch can be used. That is the basis of the table of cross-sections given in this article.

The size wire used depends on the current expected. This will vary with the load on the transformer. A circular mil is the area of the cross-section of a wire one thousandth of an inch in diameter. When a small transformer is built to handle a continuous load, the copper wire in the windings should have an area of 1500 circular mils for each ampere to be carried. For intermittent use, 1000 circular mils per ampere is permissible.

Let us review the theory of transformer operation briefly. A small magnetizing current will flow in the primary winding at no load. This sets up a magneto-motive force (m.m.f.) and flux lines go around the magnetic circuit or core. The flux links both low-voltage and high-voltage windings. This flux induces a counter electromotive force in the primary winding just opposite to the applied e.m.f., which prevents much current from rushing into the primary. The flux induces a secondary voltage depending on the turns per volt and the number of turns in the secondary winding. When the secondary is connected to a load, the induced voltage makes current flow in the load. The m.m.f. produced by this secondary current opposes the primary m.m.f. and tends

to reduce the flux in the core. This results in lessened counter-e.m.f. in the primary. More current is taken from the supply line

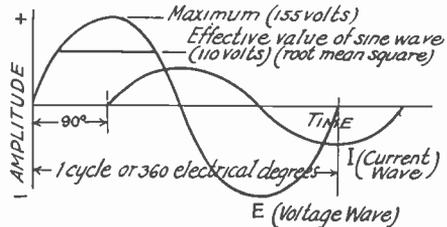

ALTERNATING CURRENT IN A COIL
(Current lagging voltage 90°)

to keep up the flux value and maintain the secondary voltage under load.

The transformer uses a little energy to supply losses in the core and windings. Due to the resistance of the windings and to mag-

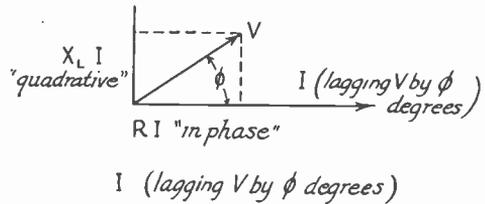

IN THE PRIMARY OF A TRANSFORMER THE CURRENT AT NO LOAD (MAGNETIZING CURRENT) LAGS THE APPLIED VOLTAGE BY NEARLY 90°. AS THE LOAD COMES ON, VOLTAGE AND CURRENT ARE MORE NEARLY "IN PHASE." THE POWER IS ALWAYS $V(\cos) \phi$. THE POWER IS ALSO $R I^2$ FOR $V(\cos) \phi = R I$. THE QUADRATURE COMPONENT OF THE CURRENT TIMES THE APPLIED VOLTAGE GIVES THE "WATTESS" POWER.

netic leakage paths, the voltage of the secondary may drop materially under load. Poor regulation, as this is called, is sometimes useful in a special transformer. In our filament-heating and plate-supply transformers we can arrange the windings compactly, make good solid joints in the core, use large low-resistance wire in the windings, and keep the length of the magnetic path fairly short and of good cross-section. This will keep the secondary voltage quite constant under load.

A table is given showing the best size wire and core to use for particular transformers. The figures in the table refer to 60-cycle transformers. The design of 25-cycle transformers is much similar. A slightly higher flux density is permissible. Because the frequency is much lower the cross-sectional area of the iron must be greater

Input (Watts)	Full-load Efficiency	Size of Primary Wire	No. of Primary Turns	Turns Per Volts	Cross-Section Through Core
50	75%	23	528	4.80	1 1/4" x 1 1/4"
75	85%	21	437	3.95	1 3/8" x 1 3/8"
100	90%	20	367	3.33	1 1/2" x 1 1/2"
150	90%	18	313	2.84	1 5/8" x 1 5/8"
200	90%	17	270	2.45	1 3/4" x 1 3/4"
250	90%	16	248	2.25	1 7/8" x 1 7/8"
300	90%	15	248	2.25	1 7/8" x 1 7/8"
400	90%	14	206	1.87	2" x 2"
500	95%	13	183	1.66	2 1/8" x 2 1/8"
750	95%	11	146	1.33	2 3/8" x 2 3/8"
1000	95%	10	132	1.20	2 1/2" x 2 1/2"
1500	95%	9	109	.99	2 3/4" x 2 3/4"

(or the number of turns per volt correspondingly larger). Otherwise the inductance of a certain number of turns will be too low to give the required "reactance" at the reduced frequency ($X_L = 2\pi f L$). If one builds the core so that its cross-section is 2.1 to 2.2 times the value of area worked out from the table, the same number turns of wire may be used in a primary coil for 25-cycle operation. If the same core and more turns of wire are used a larger "window" will be needed for the extra wire and insulation. Increasing both the number of turns per volt and the cross-section of the core gives the best balanced design.

Most 60-cycle transformers will behave nicely on a 25-cycle supply if the applied voltage is sufficiently reduced. Up to 52 volts 25 cycles may be applied to a 110-volt 60-cycle winding without harm. Knowing the transformer voltage ratio the output voltage will be known. The current-carrying capacity will be the same as at 60 cycles. The KVA (kilovolt ampere) rating will be about half the 60-cycle value.

Suppose we want to build a plate transformer for 2 UX-210 (7 1/2 watt) tubes. General amateur practise is to supply two of these tubes with about 100 milliamperes at 500 volts. Allowing 250 volts drop in the rectifier (not unusual) we will need 750 volts at the secondary. A transformer built for this voltage can be used with a resistor to make additional voltage drops if it is necessary to work with just one tube or lower voltages to prevent heating. With one tube the current required will be less and the regulation will be better. A 4,000-ohm resistor carrying 50 mils (.05 ampere) to one UX-210 will have 200 volts drop (RI), compensating for greatly improved regulation.

750 volts x .100 amperes = 75 watts transformer output.

The table gives us a probable efficiency of about 85 or 90% for small transformers of this size.

The number of turns in the secondary winding is governed by the number of turns

in the primary and the desired secondary voltage (in this case 750). Before the number of secondary turns can be found out we must know how many turns per volt there are in the primary. This can be found by

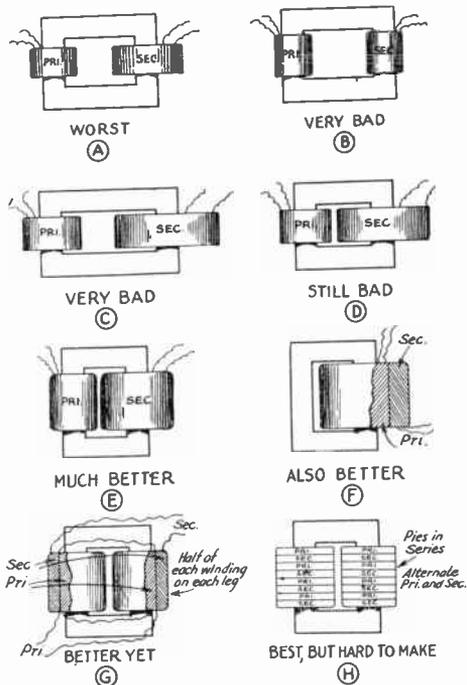

HOW THE ARRANGEMENT OF THE CORE AND WINDINGS AFFECTS THE VOLTAGE REGULATION OF CORE TYPE TRANSFORMERS

dividing the number of primary turns by the primary voltage and is given directly in the table. The number of turns for the secondary can now be found by multiplying this figure by the desired secondary voltage. As we have decided to build the 75 watt transformer (the one nearest the require-

ments of our problem) the number of secondary turns can now be easily found ($750 \times 3.95 = 2963$ turns) The size of wire to be used for the secondary depends on the secondary current and the allowable current density and can be found in the same way as for the primary wire from the wire table included in this Handbook. For this layout of equipment, look for a size of wire for the secondary that will safely carry 100 milliamperes (.1 amp). This is given in the wire table as No. 30 B. & S. It is a good idea to add 3% to 5% of the number of secondary turns to the winding to make up for the voltage drop that will occur at full load due to the transformer losses and regulation. ($105\% \times 2963 = 3110$ turns)

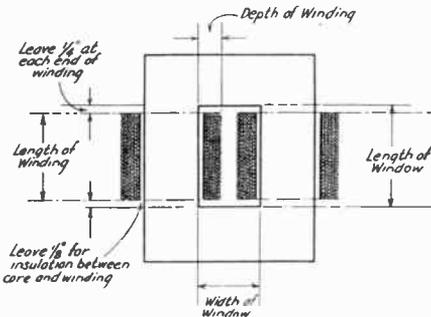

A FULL SIZE DRAWING OF THE TRANSFORMER SHOULD BE MADE SHOWING THE SPACE TO BE OCCUPIED BY THE WINDINGS AND INSULATION. BE SURE THE WINDOW IS LARGE ENOUGH TO GET THE WINDINGS ON BUT DO NOT MAKE IT A BIT LARGER THAN NECESSARY OR THE REGULATION WILL BE IMPAIRED

Usually an electrolytic rectifier is used that rectifies both halves of the cycle using a separate secondary winding for each half cycle. This means that unless the bridge rectifier connection is used, two 3110 turn secondaries will be required. It is possible to use smaller wire in the secondary in view of the fact that each winding is passing current but half the time but it is better to stick to 1,000 circular mils per ampere and be safe. Using good sized wire will help to improve the regulation. The core specifications and the number of turns to use in the primary are given in the table. Before we go ahead with the construction it is necessary to figure out the opening or window size that will be necessary in the core of proper cross-section in order to just get the windings on without wasting any space.

The best thing to do is to decide on a tentative length of winding making a full size drawing of the transformer on a sheet of paper. From the wire table find out how

many turns of wire per layer can be obtained in the primary winding. Leave at least $\frac{1}{4}$ " between the end of the winding itself and the adjacent leg of the core. Divide the total number of turns that will be needed in the winding by the number of turns per layer to find out how many layers will be needed to get the required number of turns on. The depth of the winding can next be ascertained. Be sure to allow $\frac{1}{8}$ " between the core and the inside layer of wire for insulation. Allow for insulation between layers if there is to be any, too. Having finished these computations, you can draw the outline of the winding in, just as it is going to look as it is shown in the diagram. The depth of the secondary winding can be figured in just the same fashion, using the same length of winding as was used in the primary. If enameled wire is used allow for a layer of thin paper between each layer of wire. Although enamel-insulated wire has the best space factor, single cotton covered enamel is best to use. Double cotton covered wire can be used but is not so economical of space.

When the depth of both primary and secondary windings has been computed, their sum plus $\frac{1}{4}$ " (for a factor of safety) will give the width of the window in the core. If the drawing begins to look like D instead of E (see the sketch showing different arrangements of core and windings), it will be necessary to try a different value for the length of the winding, figuring the size of the window out all over again. A transformer with a large core and a relatively small amount of wire is best from the standpoint of the amateur builder because wire in the smaller sizes is expensive while transformer iron is cheap. It is hard for most amateurs to wind many turns by hand unless a convenient winding jig is available, too.

After a little juggling with pencil and paper, the design of the transformer will be complete. The next step will be to obtain the materials and start the process of construction.

Any kind of transformer iron or silicon steel will make a good core. Sometimes an old power transformer from the local junk yard or from the electric light company can be torn down to get good and cheap core materials. The writer used the wire thus obtained from a wrecked compensator to put up a complete multi-wire antenna and counterpoise in the good old times when lots of wires were considered essential in an antenna system, making a transmitting coil and giving away a lot of wire besides, so there are other uses for junked transformers if you can get hold of one. It is not worthwhile to try to cut out core materials yourself or to use ordinary stovepipe iron as it

WIRE TABLE

Gauge No. B.&S.	Diam. in mils*	Diam. in mm.	Cross-sectional area			Turns per linear inch		Feet per pound (copper)		Bare	Resistance of wires (ohms per 1000 ft.)		Copper wire carrying capacity at 1000 C.M. at 1500 C.M.	
			Cir. mils	Sq. inches	Sq. mm.	D.C.C.	S.C.C. Enamel	D.C.C.	S.C.C.		Copper**	Advance (approx)	per amp.	per amp.
0000	460.0	11.68	211600	.1662	107.2	1.561	.0499	211.6	140.7
000	409.6	10.40	167800	.1318	85.03	1.968	.0629	167.8	111.3
00	364.8	9.266	133100	.1045	67.43	2.482	.0793	133.1	88.9
0	324.9	8.252	105500	.08289	53.48	3.130	.1000	105.5	70.3
1	289.3	7.348	83690	.06573	42.41	3.947	.1260	83.7	55.7
2	257.6	6.544	66370	.05213	33.63	4.977	.1592	66.4	44.1
3	229.4	5.827	52640	.04134	26.67	6.276	.2004	52.6	35.0
4	204.3	5.189	41740	.03278	21.15	7.914	.2536	41.7	27.7
5	181.9	4.621	33100	.02600	16.77	9.980	.3192	8.88	33.1	22.0
6	162.0	4.115	26250	.02062	13.3	5.44	5.60	12.58	.4028	11.21	26.3	17.5
7	144.3	3.665	20820	.01635	10.55	6.08	6.23	15.87	.5080	14.19	20.8	13.8
8	128.5	3.264	16510	.01297	8.36	6.80	6.94	19.6	.6405	17.9	16.5	11.0
9	114.4	2.906	13090	.01028	6.63	7.64	7.68	24.6	.8077	22.6	13.1	8.7
10	101.9	2.588	10380	.008155	5.26	8.51	8.55	30.9	1.018	28.0	10.4	6.9
11	90.74	2.305	8234	.006467	4.17	9.58	9.60	38.8	1.284	35.5	8.2	5.5
12	80.81	2.053	6530	.005129	3.31	10.62	10.80	48.9	1.619	44.8	6.5	4.4
13	71.96	1.828	5178	.004067	2.62	11.88	12.06	61.5	2.042	56.7	5.2	3.5
14	64.08	1.628	4107	.003225	2.08	13.10	13.45	14.	77.3	2.575	71.7	4.1	2.7
15	57.07	1.450	3257	.002558	1.65	14.68	14.90	16.	97.3	3.247	90.4	3.3	2.2
16	50.82	1.291	2583	.002028	1.31	16.08	16.60	18.	119	4.094	113.0	2.6	1.7
17	45.26	1.150	2048	.001609	1.04	18.80	18.20	21.	188	5.163	145.0	2.0	1.3
18	40.30	1.024	1624	.001276	.82	19.90	20.20	23.	237	6.510	184.0	1.6	1.1
19	35.89	.9116	1288	.001012	.65	21.83	22.60	27.	298	8.210	226.0	1.3	.86
20	31.96	.8118	1022	.0008023	.52	23.91	25.30	29.	370	10.35	287.0	1.0	.68
21	28.46	.7230	810.1	.0006363	.41	26.20	28.60	32.	461	13.05	362.0	.81	.54
22	25.35	.6438	642.4	.0005046	.33	28.58	31.00	36.	584	16.46	460.0	.64	.43
23	22.57	.5733	509.5	.0004002	.26	31.12	34.30	40.	745	20.76	575.0	.51	.34
24	20.10	.5106	404.0	.0003173	.20	33.60	37.70	45.	903	26.17	725.0	.41	.27
25	17.90	.4547	320.4	.0002517	.16	36.20	41.50	50.	1118	33.00	919.0	.32	.21
25	15.94	.4049	254.1	.0001996	.13	39.90	45.30	57.	1422	41.62	1162	.25	.17
27	14.20	.3606	201.5	.0001583	.10	42.60	49.40	64.	1759	52.48	1455	.20	.13
28	12.64	.3211	159.8	.0001255	.08	45.50	54.00	71.	2207	66.17	1850	.16	.11
29	11.26	.2859	126.7	.00009953	.064	48.00	58.00	81.	2534	83.44	2300	.13	.084
30	10.03	.2546	100.5	.00007894	.051	51.10	64.40	88.	2768	105.20	2940	.10	.067
31	8.928	.2268	79.70	.00006260	.040	56.80	69.00	104.	3137	132.70	3680	.079	.053
32	7.950	.2019	63.21	.00004964	.032	60.20	75.00	120.	4607	167.30	4600	.063	.042
33	7.080	.1798	50.13	.00003937	.0254	64.30	81.00	130.	6168	211.00	5830	.050	.033
34	6.305	.1601	39.75	.00003122	.0201	68.60	87.60	140.	8310	266.00	7400	.039	.026
35	5.615	.1426	31.52	.00002476	.0159	73.00	94.20	160.	10480	335.00	9360	.032	.021
36	5.000	.1270	25.00	.00001964	.0127	78.50	101.00	190.	13210	423.00	11760	.025	.017
37	4.453	.1131	19.83	.00001557	.0100	84.00	108.00	205.	16660	533.40	14550	.020	.013
38	3.965	.1007	15.72	.00001235	.0079	89.10	115.00	205.	21010	672.60	18395	.016	.010
39	3.531	.0897	12.47	.000009793	.0063	95.00	122.50	215.	26500	848.10	24100	.012	.008
40	3.134	.0799	9.888	.000007766	.0050	102.50	130.00	230.	33410	1069.00	32660	.009	.006
410711	7.841	.000006160	.0040	112.00	153.00	240.	42130	1323.00008	.005
420633	6.220	.000004885	.0032	124.00	168.00	250.	53100	1667.00006	.004
430564	4.933	.000003873	.0025	140.00	192.00	265.	66970	2105.00005	.003
440502	3.910	.000003073	.0020	153.00	210.00	275.	84460	2655.00004	.0025

*A mil is 1/1000 of an inch **For hard drawn copper, increase resistance values 2%.

will not lie flat. Laminations of about 28 gauge thickness should be used as thicker iron pieces will give a large loss from eddy currents in the core and the heating in the core will be objectionable. The iron must be carefully cut so that good joints in the core can be made if the transformer is to have passably good regulation. L-shaped laminations are convenient to use in building a transformer but separate pieces for the four sides can be used if they are more readily obtained. The method of assembling a transformer core is shown in one diagram.

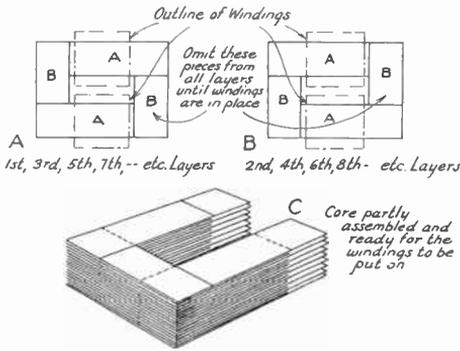

HOW TO PUT A TRANSFORMER CORE TOGETHER

Three sides of the core can be built up, the windings put on, and then the fourth leg of the core put in place one lamination at a time. All laminations should be insulated from each other to prevent eddy currents flowing in the core. If there is iron rust or a scale on the core material you have, that will serve the purpose very well—otherwise one side of each piece can be coated with thin shellac. It is essential that the joints in the core be well-made, that the joints be square and even. After the transformer is assembled, the joints can be hammered up tight using a block of wood between the hammer and the core to prevent damaging the edges of the laminations. A cigar box with two adjacent sides knocked out and the cover removed will be helpful in building up the core evenly. When three legs are completed, the whole can be tied with string, clamped in a vise, and the legs on which the windings are to be slipped, wound with friction tape to hold them firmly in place and to keep the iron from damaging windings and insulation.

It is convenient to wind the coils on varnished fullerboard. At any rate the coils should be wound on a wooden form and if some fullerboard or pliable cardboard can be put over this it will make it easy to slip the finished coils from the form to the core with-

out mechanical injury. The wires cannot get out of place when so wound and they are well-insulated from the core besides. The wooden block should be slightly larger than the leg of the core on which the winding is to be put and it should be a few inches longer than the winding. The block must be smooth and of just the right size. Several pieces fastened together with small

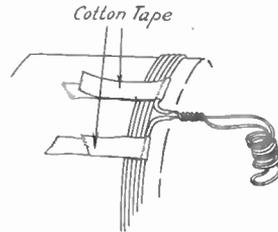

BRINGING OUT A TAP

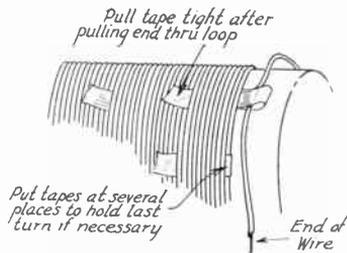

FINISHING OFF THE WINDING

screws at the ends will make a form of the right size which can be easily taken apart when the winding is finished.

Diagrams suggesting ways of starting the winding, finishing the winding and bringing out taps are shown to suggest the best procedure. If a lathe is not available for holding and rotating the form during winding, a bicycle, grinder, sewing machine or hand drill clamped in a vise can be adapted for the purpose. For secondary windings of many turns of wire a revolution counter should be used to make the work easy and to insure that the right number of turns are put on each coil. It is certainly exasperating to lose track of the number of turns when a winding is nearly finished.

If a solid block is used for a winding form, a layer of string should be wound over the form before the wire is put on. The ends of the string are fastened to tacks and this string can be removed as soon as the winding is finished, to leave room for slipping the winding off the form. The fullerboard, some

thin fibre, or heavy fish paper goes over this string serving as a permanent support for the winding and as insulation from the core. In high voltage windings, some layers of Empire cloth (varnished cambric) should be included in addition and if a transformer to give very high voltage is built a micarta barrier will be necessary.

The winding itself is quite simple. The wire is wound on in layers as it takes least space when wound that way. Strips of paper between layers of small enameled wire are necessary to keep the turns of each layer even and to give added insulation. Too thick paper must be avoided as it keeps the heat generated in the winding at full load inside so that the temperature may become dangerously high for the insulating materials resulting in breakdown.

It is advisable to impregnate transformer coils after driving the moisture out to make them permanently good. Manufacturers do this by putting the coils in a partial vacuum, heating, and then forcing insulating compound under pressure into the coils. Transformers built by the amateur for filament and plate voltage supply can be painted with insulating varnish or waxed to make them rigid and moisture proof. A mixture of melted beeswax and rosin makes a good impregnating mixture. Melted paraffin can be used but it has too low a melting point. When possible, the transformer can be suspended in a tank of cooling and insulating oil though this is not good for indoor use as the fire hazard must be considered. Double cotton covered wire can be coated with shellac as each layer is put on. However, enameled wire should never be treated with shellac as it may dissolve the enamel and hurt the insulation and it will not dry because the moisture in the shellac will not be absorbed by the insulation. Small transformers can be treated with battery-compound after they are wound and assembled. Usually, a home made transformer that is varnished or protected from moisture by shellac can be mounted as shown in one diagram and will stand up indefinitely under the intermittent service of amateur radio work. Therefore, a can of insulating varnish or shellac and a small brush with which to apply it will be made part of our transformer building equipment.

In starting the winding, hold the loose end on each side of the winding form by folding a two inch piece of cotton tape around the first turn in such a way that the following turns hold the first one in place. Coil up enough wire on the end to provide a lead from the inside of the coil to the terminal board after the transformer has been mounted. After making a good start, the winding process can be speeded up. In winding the coil, feed the wire with a

cloth over your hand about two or three feet away from the rotating form. Keep the wire as tight as possible without danger of breaking it. Wind the wire in even layers

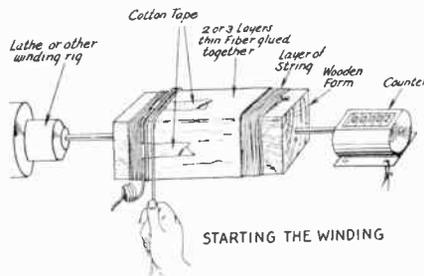

with no turns directly on top of each other to take best advantage of the available space.

When about half an inch from the end of the first layer, lay on some more pieces of cotton tape to bend back under the second layer, thus holding the end turns securely in place. If very thin paper or no paper at all is used between layers the same thing can be done at the end of each layer. Using very fine wire with paper between layers no additional support for the end turns will be necessary, especially if the precaution of ending the layers about one eighth inch from the edge of the paper is observed. Where no paper is used, run the layers as near to the end of the form as possible, keeping the wire as tight as possible.

Keep watch for shorted turns and layers. If just one turn should become shorted in the entire winding, the low voltage induced in it would cause a heavy current to flow which would burn it up, making the whole transformer useless.

Taps can be taken off as the windings are made if it is desired to have a transformer giving several voltages. The diagram plainly shows the method to be used in making taps and in finishing the winding. The more taps there are, the more difficult becomes the problem of avoiding weakened insulation at the points where the taps are made. Taps should be arranged so that they come at the end of the layers whenever possible. If the wire is very small, the ends of the winding and any taps that are made should be of heavier wire to provide a stronger lead. Unless the finished winding is well taped, a piece of fullerboard or heavy paper should be put over it to prevent the winding from mechanical injury as well as to improve its appearance.

High voltage coils should be taped with varnished cambric tape. Low voltage coils

can be taped with friction tape or with untreated cotton tape and varnished later. Always lay the tape on smoothly so that each turn advances half the width of the preceding one. Pull the tape tight but not so tight as to pull the winding out of shape.

The leads should be well insulated. High voltage leads can be run through varnished cambric tubing or the "spaghetti" that is on sale at the local radio store. Pieces of flat tubular shoe lacing are good enough to cover the low voltage leads.

When slipping the coils on the partially assembled core, be sure that the leads do not touch the core. If the windings fit loosely some small wooden wedges should be driven in place at each end. Last of all, the other leg of the core is put in place and driven up tight. If the coils are wedged firmly and wound tightly and the core is taped, clamped or bolted between some strips of wood or bakelite, the transformer will not hum. It will operate with very little noise anyway if these precautions are observed. Last of all the transformer should be mounted. After leaving the primary winding connected to the line for several hours it should be only slightly warm. If it draws much current or gets hot there is something wrong and some short-circuited turns are probably responsible which will continue to cause overheating and fireworks later.

Some $\frac{1}{8}$ " x 1" angle iron or pieces of iron strap of the right size, make an excellent mounting. The core is clamped tightly by

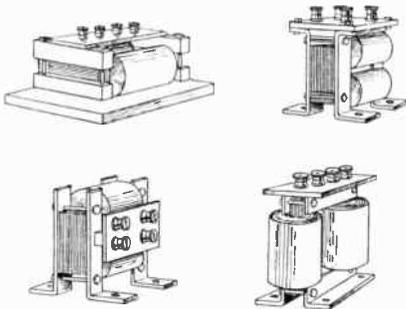

WAYS OF MOUNTING TRANSFORMERS

several bolts at the corners. The terminal board should be of bakelite and situated so that there is plenty of room for the leads to come up under it from the windings below. Several ways of mounting transformers and putting on the terminal board are shown in one drawing. Be sure to separate the terminals from the different windings as much as possible so that there is no danger

of their becoming crossed. Ordinary binding posts, 8-32 or 10-32 brass or nickled brass machine screws, or even Fahnstock clips can be used on the terminal board for making the connections.

DESIGNING AND BUILDING CHOKE COILS FOR THE FILTER

The design and construction of choke coils to use in filtering the plate supply of an amateur transmitter can be carried out in the same way that the building of a transformer was developed. The basic design principles are the same and the building of a choke coil is even simpler because no taps are necessary and only one coil is required on the core.

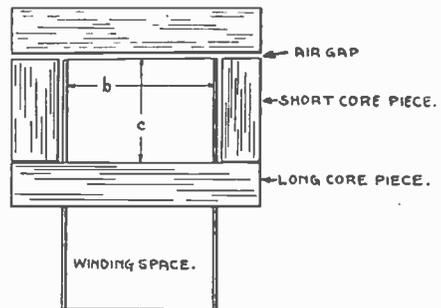

ARRANGMENT OF INDUCTANCE COILS.

A full page chart, reproduced from *QST*, shows the dimensions for building chokes that will meet most needs of the amateur for removing the commutator ripple from a D.C. generator or smoothing out the ripple in rectified 25-cycle and 60-cycle plate supplies. Of course the chokes must be used with suitable capacities to make an effective filter. Though it is usually best to make chokes, the filter condensers can be purchased ready-made from any of the reputable condenser manufacturers. As this is a practical rather than a theoretical book, it is not possible to discuss the theory of high-pass and low-pass filters. Some good books on telephone transmission from the nearest public library will cover this theory for readers who want it. Chokes of inductances between the values given in the table can be made by using less turns of wire in the winding. Inductance varies about as the square of the number of turns so that using half the number of turns specified gives one fourth the inductance. More turns than those specified in the table must not be used as the core will become saturated. Dimensions *b* and *c* given in the table can be understood by reference to the diagram. The ar-

DESIGN DATA FOR INDUCTANCE COILS WITH IRON CORES. *Weight of Steel taken as 480 $\frac{lbs}{cu. ft.} = 0.28 \frac{pounds}{cubic\ inches}$*

CORE SIZE	INDUCTANCE	EQUIV GAP	% ACTUAL	GAP	NO TURNS	FLUX DENS.		WINDING FORM	MEAN TURN	FEET OF WIRE	RESISTANCE (D C)	WEIGHT OF COPPER	CORE DIMENSIONS		POUNDS STEEL	
						(A)	(B)						Long Piece	Short Piece		
Cross Section	HENRYS	(G)	Decimals	Nearest Fraction	(N)	(A)	(B)	b	c	inches	WIRE	(D C)	COPPER	Long Piece	Short Piece	STEEL
1/2 x 1/2	0.5	.040"	.017"	1/64"	1600	6500	0.42"	0.28"	3.0	400	82.5	1.00z	1/2 x 1.6"	1/2 x .50"	0.30	
	1.0	.041	.019		2300	9000	0.50	0.33	3.2	615	127.0	1.5"	1/2 x 1.7	1/2 x .55"	0.31	
	5.0	.043	.023		5200	20000	0.75	0.50	3.8	1670	345.0	4.0"	1/2 x 1.92	1/2 x .75"	0.37	
	10.0	.046	.030	1/32"	7600	27000	0.90	0.60	4.2	2640	545.0	6.5"	1/2 x 2.1	1/2 x .85"	0.41	
	15.0	.048	.035		9500	32000	1.00	0.68	4.5	3510	725.0	8.5"	1/2 x 2.2	1/2 x .85"	0.43	
3/4 x 3/4	5.0	.043"	.023		3500	13000	0.62"	0.42"	4.5	1310	271	3.25oz	3/4 x 2.4	3/4 x .75	1.0	
	10.0	.046	.030		5000	18000	0.73	0.49	4.75	2000	411	5.0"	3/4 x 2.5	3/4 x .75	1.0	
	15.0	.048	.035		6300	21000	0.82	0.55	5.0	2630	544	6.5"	3/4 x 2.6	3/4 x .75	1.05	
	20.0	.052	.044	3/64"	7600	24000	0.91	0.60	5.2	3280	678	8.0"	3/4 x 2.7	3/4 x .85	1.1	
	50.0	.070	.100	1/64"	14000	33000	1.25	0.83	6.0	7000	1445	1lb 1"	3/4 x 3.0	3/4 x 1.0	1.25	
1 x 1	10.0	.046"	.030	1/32"	3800	14000	0.64"	0.43"	5.6	1760	364	4.25oz	1 x 3.0	1 x .75	2.1	
	15.0	.048	.035		4800	16000	0.69	0.49	5.8	2310	478	5.5"	1 x 3.0	1 x .75	2.1	
	20.0	.052	.044	3/64"	5700	18000	0.78	0.52	5.9	2800	580	6.75"	1 x 3.1	1 x .75	2.2	
	50.0	.070	.100	1/64"	11000	25000	1.10	0.75	6.7	6130	1270	15.0"	1 x 3.5	1 x 1.0	2.5	
	100.0	.100	.250	1/4"	18000	29000	1.40	0.93	7.4	11000	2280	1lb 10"	1 x 3.8	1 x 1.1	2.75	
2 x 2	100.0	.100"	.250	1/4"	8900	14000	0.97"	0.65"	10.4	7700	1590	1lb 3oz	2 x 5.5	2 x 1.0	14.5	
1/2 x 1/2	0.5	.040"	.017	1/64"	1600	13000	0.55"	0.38"	3.4	450	46	2.20z	1/2 x 1.6	1/2 x 0.63	0.31	
	1.0	.041	.019		2300	18000	0.66	0.45	3.6	700	72	3.5"	1/2 x 1.75	1/2 x 0.70	0.35	
	5.0	.043	.023		5200	39000	1.00	0.68	4.5	1950	200	9.5"	1/2 x 2.10	1/2 x 0.95	0.43	
	1.0	.041"	.019		1500	12000	0.53"	0.37"	4.3	540	56	2.70z	3/4 x 2.10	3/4 x 0.63	0.87	
	5.0	.043	.023		3500	26000	0.83	0.56	5.0	1470	151	7.2"	3/4 x 2.5	3/4 x 0.80	1.05	
1 x 1	10.0	.046	.030	1/32"	2600	20000	0.71"	0.49"	5.8	1250	130	6.10z	1 x 2.8	1 x 0.75	2.0	
	15.0	.048	.035		3800	27000	0.86	0.58	6.1	1940	200	9.5"	1 x 3.0	1 x 0.85	2.2	
	50.0	.070	.100	1/4"	11000	32000	1.40	0.93	7.4	11000	2280	12.5"	1 x 3.1	1 x 0.90	2.25	
	10.0	.046"	.030	1/32"	1900	13000	0.60"	0.42"	9.5	1500	160	7.5oz	2 x 4.6	2 x 0.60	11.5	
	15.0	.048	.035		2400	16000	0.68	0.46	9.7	1900	200	9.5"	2 x 4.75	2 x 0.66	12.3	
2 x 2	20.0	.052	.044	3/64"	2900	18000	0.75	0.51	9.8	2400	250	11.5"	2 x 4.85	2 x 0.75	12.5	
	50.0	.070	.100	1/4"	5300	24000	1.00	0.70	10.5	4600	480	18.65"	2 x 5.50	2 x 0.95	14.0	
	100.0	.100	.250	1/4"	8900	28000	1.33	0.90	11.2	8300	860	2lb 8"	2 x 5.90	2 x 1.15	16.0	
	0.5	.040"	.017	1/64"	1600	32000	0.90"	0.60"	4.2	550	22.5	7oz	1/2 x 2	1/2 x .85	0.40	
	1.0	.082	.120	1/8"	3200	32000	1.30	0.85	5.1	1350	55	1lb 1"	1/2 x 2.5	1/2 x 1.10	0.50	
3/4 x 3/4	0.5	.040"	.017	1/64"	1000	21000	0.72"	0.46"	4.7	390	16	5oz	3/4 x 2.3	3/4 x 0.71	0.96	
	1.0	.041	.019		1500	30000	0.90	0.58	5.1	640	26	8"	3/4 x 2.5	3/4 x 0.83	1.05	
	1.0	.041"	.019	1/64"	1100	22000	0.75"	0.50"	5.8	530	22	6.5oz	1 x 2.9	1 x 0.75	2.10	
	5.0	.086	.170	1/64"	3700	35000	1.40	0.92	7.3	2260	92	1lb 12"	1 x 3.6	1 x 1.20	2.7	
	5.0	.043"	.023	1/32"	1300	23000	0.82"	0.53"	9.7	1050	43	13oz	2 x 4.9	2 x 0.80	12.7	
2 x 2	10.0	.050	.040	1/64"	2000	32000	1.05	0.68	10.5	1750	71	1lb 6"	2 x 5.2	2 x 1.0	13.8	
	15.0	.096	.200	13/64"	3300	28000	1.35	0.86	11.1	3060	125	2 lb 6"	2 x 5.5	2 x 1.1	14.7	
	20.0	.140	.280	9/32"	4000	32000	1.43	0.95	11.5	3820	156	2 lb 15"	2 x 5.6	2 x 1.2	15.2	
	10.0	.046"	.030		1300	22000	0.81"	0.53"	14.0	1510	62	1lb 3oz	3 x 6.9	3 x 0.8	39	
	15.0	.048	.035		1600	26000	0.90	0.60	14.2	1900	77	1 lb 7"	3 x 7.0	3 x 0.85	40	
3 x 3	20.0	.052	.044	3/64"	1900	30000	1.00	0.65	14.4	2300	93	1 lb 12"	3 x 7.1	3 x 0.9	41	
	50.0	.140	.330	1/32"	5000	28000	1.60	1.10	15.9	6600	270	5 lb 2"	3 x 7.8	3 x 1.35	46	
	100.0	.200	.600	19/32"	8400	34000	2.10	1.40	17.0	12000	485	9 lb 3"	3 x 8.3	3 x 1.65	50	
	0.5	.016"	.35	1/32"	3200	32000	1.80"	1.20"	6.4	1700	35	2lb 10oz	1/2 x 3	1/2 x 1.45	0.62	
	0.5	0.08"	.170	1/64"	1480	30000	1.25"	.83"	6.0	735	15	1lb 2oz	3/4 x 2.9	3/4 x 1.1	1.26	
1 x 1	1.0	0.16	.35	1/32"	3000	30000	1.75"	1.20"	7.2	1800	37	2 lb 13"	3/4 x 3.5	3/4 x 1.5	1.6	
	0.5	0.04"	.02	1/64"	800	32000	0.90"	0.60"	6.2	410	85	0lb 10oz	1 x 3.0	1 x 0.85	2.2	
	1.0	0.082	.17	1/64"	1600	31000	1.30	0.85	7.1	945	19	1 lb 8"	1 x 3.5	1 x 1.0	2.5	
	5.0	0.367	.75	3/4"	7800	32000	2.90	1.90	11.0	7000	143	10 lb 14"	1 x 5.2	1 x 2.2	4.2	
	1.0	0.041"	.019		560	22000	0.75"	0.50"	9.8	460	94	0lb 12oz	2 x 4.9	2 x 0.75	12.7	
2 x 2	5.0	0.086	.17	1/64"	1800	32000	1.35	0.90	11.3	1700	35	2 lb 10"	2 x 5.5	2 x 1.15	15.0	
	10.0	0.184	.40	13/32"	3800	33000	2.00	1.30	12.8	4100	83	6 lb 6"	2 x 6.2	2 x 1.5	17.3	
	5.0	0.043"	.023		860	30000	1.00"	0.60"	14.2	1000	21	1lb 10oz	3 x 7.1	3 x 0.85	40.0	
	10.0	0.092	.20	13/64"	1840	31500	1.40	0.92	15.3	2350	48	3 lb 10"	3 x 7.5	3 x 1.15	43.5	
	15.0	0.130	.30	19/64"	2620	32000	1.65	1.10	16.0	3500	71	5 lb 7"	3 x 7.8	3 x 1.4	46.0	
3 x 3	20.0	0.175	.38	3/8"	3500	32000	1.90	1.25	16.6	4850	99	7 lb 8"	3 x 8.1	3 x 1.5	48.0	
	50.0	0.432	.80	13/16"	8700	32000	3.00	2.00	19.2	14000	282	2 lb 8"	3 x 9.3	3 x 2.3	58.0	
	100.0	0.900	1.50	1/2"	16700	31500	4.10	2.80	22.0	31000	620	4 lb 5"	3 x 10.5	3 x 3.1	68.0	

* The Actual Gap can only be an approximation owing to the many factors which may effect fringing of flux, permeability of core, etc. It must be adjusted by trial until the proper value of inductance is obtained or better yet, until the set up operates at the best point.
 * The values of (B), the flux density, are those obtained with all D.C. & a.c. or the effective B if all A.C. The maximum value in the latter case will be 1.41 x B as given in the case of rectified A.C. applied to coil with no previous smoothing the maximum B may be 1.57 times the values given

angement of core and winding is supposed to be that of the diagram, also.

The best core material is the same as that specified for building transformers—silicon

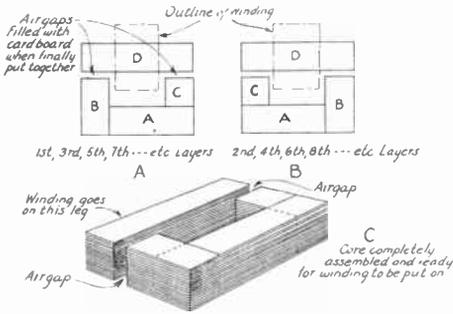

HOW TO PUT A CHOKO COIL CORE TOGETHER.



ANOTHER METHOD OF BUILDING A CORE FOR A CHOKO COIL

sheet steel. The laminations should be .014" (or less) thick covered with shellac or rust to reduce eddy current losses. Fine iron wire is excellent as a core material, also. While interleaved corners are almost a necessity for a good transformer core, the core of your choke coil should be made with a butt joint. An air gap is needed in any case to prevent saturation of the core and to offer a means for adjustment of the inductance. After the gap is adjusted the core should be clamped firmly so that the magnetic pull will not change the adjustment and to insure quiet operation. Besides clamping the core, a substantial "brass" air gap can be used or a wooden or cloth wedge inserted in the air gap to prevent vibration and make the adjustment permanent. The total air gap, if there is more than one, will of course be the sum of the length of the separate air gaps.

Wire with thin insulation should be used to make an economical design. Large wire uses up a great deal of space without giving much inductance. It is best to wind directly on the core with just a single layer of tape between if possible. More insulation will be required for chokes that are to be placed in high voltage plate supply lines but this should not be any thicker than is absolutely necessary. Before starting the winding on the core, put some cotton strips along it and fasten some heavy cardboard or thin micarta end flanges in place. After winding the coil, the tape can be tied over the coil to keep the wire from spreading. Too much tape

should not be put on or the choke will not keep cool under load conditions. The wire sizes in the table are conservative and 10% more current can be carried continuously and even more than this intermittently. If the winding is very deep, the cooling will be better if the coil is split into two sections to slip on each long core piece. 10% more turns will need to be added to each coil to make up for the magnetic leakage between coils which is increased by splitting the winding. Heavy flexible leads should be soldered to the ends of the coil and taped down to prevent their breaking off.

The action of a filter may be likened to that of a big flywheel that stores energy in the magnetic field of the choke and in the electro-static field of the condensers placed

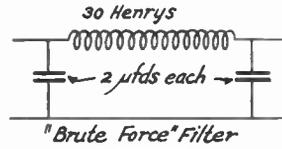

"Brute Force" Filter

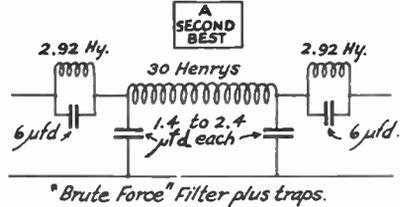

"Brute Force" Filter plus traps.

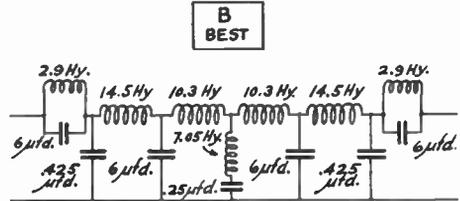

B BEST

C GOOD

THREE GOOD FILTERS FOR RECTIFIED 60~ A.C.

across the line. The filter absorbs energy during the "peak" output periods of the rectifier, giving out this energy during the "zero" part of the A.C. cycle to keep the supply voltage substantially constant (unvarying). A large paralleled condenser alone (75 µfd.) helps a great deal. A large series choke with condensers across the line at either end seems to work best and this is commonly referred to as the "brute force" type of filter. The choke should be over 30 henries but it does not have to be adjusted to any particular value of inductance. Several parallel resonant circuits effectively eliminate one frequency.

By means of a carefully designed filter having high impedance to certain frequencies, the several fundamental and harmonic frequencies from the A.C. supply that are present in the output of a rectifier can be suppressed. Three good filter circuits for 60-cycle supply are shown in one of the diagrams.

Windings from spark coils, amplifying transformers, or any old coils of many turns of small wire can sometimes be pressed into use to use with the plate supply equip-

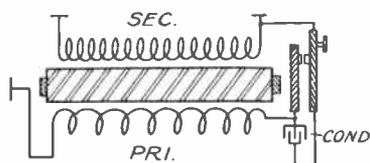

FORD COIL HOOKUP

ment for a low-power transmitter. All that is necessary is to mount them on the right sort of a core and to adjust the air gap. Any transmitter using a UX210 or larger tubes should be provided with a good rectifier and filter using one of the choke coils whose dimensions are given in the table. Sets of lower power using receiving tubes can sometimes be filtered by making use of some old spark coils such as find their way into every experimenter's "junk" box.

In using a spark coil, the D.C. resistance of the many turns of small wire is rather high and so the secondaries of two spark coils should be connected in parallel as shown in one of the diagrams to secure best results. The primary winding does not have much inductance and is of little value. The

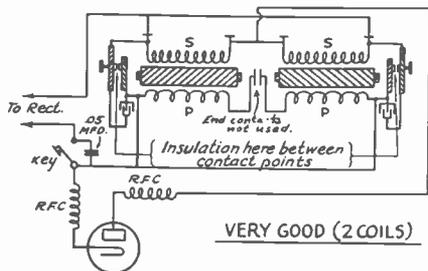

VERY GOOD (2 COILS)

secondary of a Ford coil has a resistance of about 5,000 ohms which will reduce the plate voltage a good bit if used by itself. There is a condenser shunted across the vibrator contacts which has a capacity of about 1 micro-farad and which will easily stand four or five hundred volts and this should be connected so it is across the output

of the rectifier—it will *not* be as effective if placed next the tube. A thin piece of insulating material must be placed between the contact points of the coil and between the lower contact arm and the core but it is not necessary to tear the coils down to make use of them. The connections of a Ford coil and the method of connecting two coils with their condensers as a filter are shown in the sketches. Such a filter as that described can

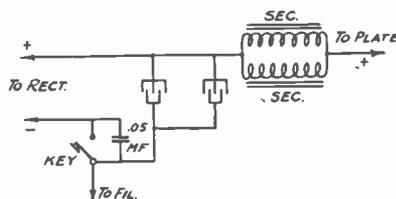

be made from discarded coils obtained for almost nothing from local automobile repairmen. One coil will cut down the ripple somewhat and two of them connected as shown still have sufficient inductance to improve the tone greatly without reducing the plate voltage more than 20%.

ADJUSTING THE AIR GAP AND TESTING FILTER ACTION

The simplest way to adjust the air gap is to connect the filter to the load with which it is to work, changing the air gap until the best filter action is observed. A too-large air gap will reduce the inductance and the choke will be ineffective. A too-small gap will allow the core to become saturated, and the choke will be just as ineffective.

The right value for the air gap is one that uses up about nine tenths of the ampere turns of the coil to maintain flux in the air gap. The rest of the magnetomotive force magnetizes the core. As the permeability of air is unity and that for sheet steel is about 3,000 (average), the ratio of air to iron can be determined approximately but the iron varies so much that the exact value must always be decided by trial. For a core of 10" total length, an air gap of about .05" or a little less will meet average requirements.

Any one of the circuits shown for testing filter action can be used. **DON'T LEAVE OFF THE GROUND. DON'T TOUCH OR WEAR THE PHONES.** High voltage direct current is dangerous and contact with any part of the circuit may cause a severe burn or even death. You can listen to the output of the filter without touching the phones. After each test, turn off the power, unclamp the core of the choke, set the air gap to a different value and try again. When things

are properly adjusted the sound in the phones should be very weak. *Keep the telephone headset on the table with one side grounded.*

lem has been worked out to show how it is done. If the alternating current supply voltage and frequency are accurately known, the values can be substituted if no meters can be obtained for the purpose. A dry

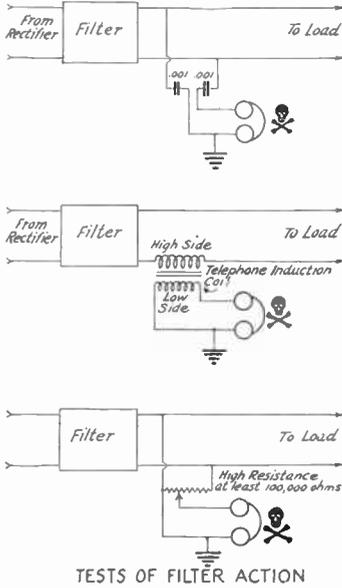

(A.) $R = \frac{E}{I}$
 (B.) $Z = \frac{E}{I}$
 (C.) $Z = \sqrt{R^2 + (2\pi fL)^2}$

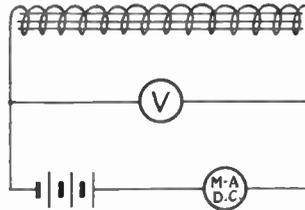

(A.) $R = \frac{E}{I}$; $E = 6 \text{ volts}$; $I = .150 \text{ Amp.}$
 1. $R = \frac{6}{.150} = 40 \text{ ohms}$

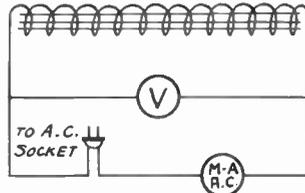

(B.) $Z = \frac{E}{I}$; $E = 110 \text{ V.}$ $I = .13 \text{ Amp.}$
 2 $Z = \frac{110}{.13} = 846 \text{ ohms}$
 (C) $Z = \sqrt{R^2 + (2\pi fL)^2}$
 3 $Z = \sqrt{(40)^2 + (2 \times 3.1416 \times 60 \times L)^2}$
 4 $Z = \sqrt{1600 + 142,129 \times L^2}$
 5 $Z^2 = 1600 + 142,129 \times L^2$
 6 $Z^2 - 1600 = 142,129 \times L^2$
 7 $(846)^2 - 1600 = 142,129 \times L^2$
 8 $715,716 - 1600 = 142,129 \times L^2$
 9 $142,129 \times L^2 = 714,116$
 10 $L^2 = \frac{714,116}{142,129} = 5.02$
 11 $L = \sqrt{5.02} = 2.24 \text{ Henries}$

MEASURING FILTER CHOKE COIL INDUCTANCE

The approximate inductance of different choke coils at 60 cycles is given in the table. However, the inductance of choke coils is a variable quantity depending on the grade of iron used in the core and on the length of the air gap. When the core becomes saturated or the frequency varies, the inductance value will change somewhat, too. For all practical purposes a measurement of the inductance can be made that will be much better than the approximate figures of the table and closely approaching the inductance actually obtained under working conditions.

Two things about the coil must first be determined—the resistance and the impedance at a known frequency. Then the inductance can be found by solving a few formulas or by the still simpler process of referring to the chart reproduced in these columns.

Formula A (Ohm's Law) can be used to get the resistance. Formula B will give the impedance. Substituting these values in formula C and solving for L will give the inductance in henries.

Four meters should be used for making the measurements if you can get them. The connections for making the measurements are shown in the diagram and a sample prob-

FORMULAS USED IN FINDING CHOKE COIL INDUCTANCE AND THE CIRCUITS FOR MAKING THE NECESSARY MEASUREMENTS

The problem can be worked out mathematically like the sample shown or the inductance can be more readily found by referring to the chart.

cell or storage battery can be connected to the choke to be measured through a D.C. milliammeter using only sufficient voltage to get a reading in the middle of the scale of the meter. The voltage across the coil should

next be read. Dividing the voltage by the current (changed to amperes) gives the D.C. resistance in ohms.

Next, the local A.C. supply is taken as a source of voltage and the same procedure is repeated—this time using *alternating* current meters. The result is the impedance in ohms at the frequency used. Now both the reactance and resistance of the coil come into play so that the current that flows into the choke does not increase as much as might be expected in view of the greater ap-

lowing the directions under the curve after R and Z have been found. If the number ($Z^2 - R^2$) obtained lies between 1,421 and 142,100, the inductance will be in tenths of henries. If it is between 142,100 and 14,210,000 the middle lines of figures on the axes of the curves should be used. If the difference of the squares is between 14,210,000 and 1,421,000,000 the inductance will be found on the scale of 10 to 100 henries. If you wish to use the curve, it is of course necessary to measure the choke coil at one

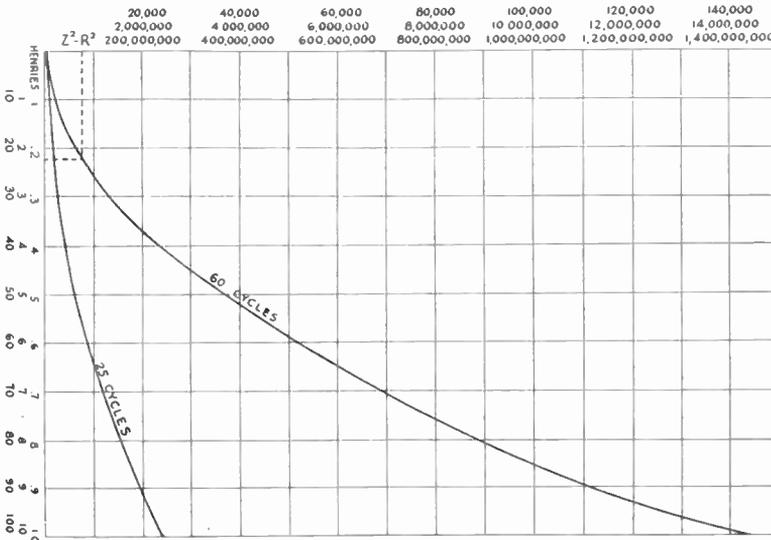

CHART FOR FINDING INDUCTANCE OF FILTER CHOKES

- 1—Find the resistance of the coil (R) by using Formula A.
- 2—Find the impedance of the coil (Z) by using Formula B.
- 3—Find $Z^2 - R^2$ by multiplying Z by Z and R by R and subtracting.
- 4—Using the value found for $Z^2 - R^2$, refer to the 60-cycle or 25-cycle curve and find the inductance at the frequency you are interested in at the left given in henries.

Note: If the choke has too small a core or too small an air gap it may become saturated when carrying rectified alternating current, somewhat lowering the effective inductance. A very "skimpily designed" choke will lose nearly three-fourths of its inductance under such conditions.

plied voltage. Usually the frequency is accurate to within a part of a cycle and anyone can find out what it is quickly enough by telephoning the local power house for information. Unless the coil was found to have a resistance of 20 ohms or more from the first set of measurements, it is not safe to connect it directly across the 110 volt mains. In any case it will be wise to put a small fuse in the circuit to protect the meters, the circuit and the choke itself. Suitable A.C. meters can be obtained from the high school laboratory or perhaps from the local electrician.

Now substitute the values in formula C. The result can be obtained by working down through the eleven steps shown or by fol-

lowing the directions under the curve after the frequencies shown on the curve. The 25-cycle and 60-cycle curves are most convenient and the inaccuracy of the meters themselves will often result in a greater degree of error than that derived from use of the curves.

In the example worked out we got the values of R and Z as 40 and 846 ohms respectively. $Z^2 - R^2 = 714,116$. On the curves this number is in the middle row of figures. Following the dotted line from this point gives the inductance as 2.25 henries. The accuracy of measurement will depend mostly on the accuracy of the meters used and on the care in taking readings. The average of several readings can be used if especially accurate measurements are

necessary. A D.C. milliammeter can be borrowed from the transmitter for taking the measurements necessary. Most hot-wire and thermocoupled ammeters are calibrated on commercial frequencies and can be used for finding the impedance if they happen to be available in the right scale ranges. A moving-coil electro-dynamometer type ammeter is best of all if it can be borrowed from some laboratory.

THE CONTINENTAL CODE

Letter or Figure	Symbol	Phonetic
A	.-	Dit darr
B	—...	Darr dit dit dit
C	—...—	Darr dit darr dit
D	—..	Darr dit dit
E	.	Dit
F	..—	Dit dit darr dit
G	—	Darr darr dit
H	Dit dit dit dit
I	..	Dit dit
J	.—	Dit darr darr darr
K	—.	Darr dit darr
L	..—	Dit darr dit dit
M	—	Darr darr
N	—.	Darr dit
O	—	Darr darr darr
P	..—	Dit darr darr dit
Q	—...—	Darr darr dit darr
R	..—	Dit darr dit
S	...	Dit dit dit
T	—	Darr
U	..—	Dit dit darr
V	Dit dit dit darr
W	—...—	Dit darr darr
X	—...—	Darr dit dit darr
Y	—...—	Darr dit darr darr
Z	—...—	Darr darr dit dit
1	.—	Dit darr darr darr darr
2	..—	Dit dit darr darr darr
3	...—	Dit dit dit darr darr
4—	Dit dit dit dit darr
5	Dit dit dit dit dit
6	—....	Darr dit dit dit dit
7	—...—	Darr darr dit dit dit
8	—...—	Darr darr darr dit dit
9	—...—	Darr darr darr darr dit
0	—...—	Darr darr darr darr darr
Period (.)		
.. . . .		Dit dit dit dit dit dit
Question (?)		
..—...—		Dit dit darr darr dit dit
Break (double dash) (=)		
—...—		Darr dit dit dit darr
Exclamation (!)		
—...—		Darr darr dit dit darr darr
Received (O.K.)		
.-.		Dit darr dit

Bar Indicating Fraction (Oblique stroke)		
—...—		Darr dit dit darr dit
Wait	..—	Dit darr dit dit dit
Comma (,)	..—	Dit darr dit darr dit darr
Colon (:)	—...—	Darr darr darr dit dit dit
Semicolon (;)	—...—	Darr dit darr dit darr dit
Quotes (" ")	..—	Dit darr dit dit darr dit
Parenthesis ()	..—	Darr dit darr darr dit darr
Attention Call to precede every transmission		
—...—		Darr dit darr dit darr
End of each message (cross)		
..—		Dit darr dit darr dit
Transmission finished (end of work)		
...—		Dit dit dit darr dit darr
Invitation to transmit (go ahead)		
—		Darr dit darr

A dash is equal to three dots.
 The space between parts of the same letter is equal to one dot.
 The space between two letters is equal to three dots.
 The space between two words is equal to five dots.

HAM ABBREVIATIONS

ABL	Able
ABT	About
AC	Alternating Current
ACCT	Account
ACCW	Alternating current C.W. (Not rectified before application to plate circuit of transmitting tubes)
ADS-ADSD	Address-addressed
AER	Aerial
AGN	Again
AHD	Ahead
AMP	Ampere
AMT	Amount
ANI	Any
ANT	Antenna
ARL	Aerial
AST	Atlantic Standard Time (1 hour later than E.S.T.)
AUD	Audible, audibility
AUSSIE	Australian amateur
B	Be

B4	Before	GM	Good morning
BCL	Broadcast listener	GMT	Greenwich Mean Time
BD	Bad	GN	Gone, good night
BI	By	GND	Ground
BK	Break, back	GQA	Get quick answer
BKG	Bookkeeping, breaking	GSA	Give some address
BLV	Believe	GUD	Good
BN	Been	GV-GVG	Give-giving
BND	Bound	HA	Hurry answer
BPL	Brass Pounders' League	HAM	Amateur, brass-pounder
BTR	Better	HD	Had, head
BUG	Vibroplex key, amateur radio "fever"	HI	Laughter, high
		HR	Here, hear
C	See	HRD	Heard
CANS	Phones	HV	Have
CHGS	Charges	HVY	Heavy
CK	Check	HW	How, hot wire, herewith
CKS	Chokes, circuits	HWM	Hot wire meter
CKT	Circuit	ICW	Interrupted continuous wave
CL-CLG-CLD	Call-calling-called	INPT	Input
CM	Communications Manager	IMPT	Important
CN	Can	KNW	Know
CNT	Can't, cannot	LD	"Lid", a poor operator, long distance
COND	Condenser, condition	LITE	Light
CONGRATS	Congratulations	LTR	Later, letter
CP-CPSE	Counterpoise	LW	Low
CRD	Card	MA	Milliampere
CST	Central Standard Time	MANI	Many
CUD-CD	Could	MG	Motor-generator
CUL	See you later	MGR	Manager
CUM	Come	MILS	Milli-amperes
CW	Continuous wave	MI	My
CY	Copy	MIN	Minute
DA	Day	MIM	Exclamation
DC	Direct current	MITY	Mighty
DFS	Disregard former service	MK	Make
DH	Dead head, service message	MO	Month, master oscillator
DL-DLVD	Delivered	MSG	Message
DLY	Delivery	MSGS	Messages
DN	Done, down	MST	Mountain Standard Time
DNT	Do not, don't	MTR	Meter
DPR	Day Press Rate	ND	Nothing doing
DSTN	Destination	NG	No good
DSTC	Delivered subject to correc- tion	NIL	Nothing
		NITE	Night
DUPE	Duplicate	NM	No more
DX	Distance	NO	Know
ERE	Here	NPR	Night Press Rate
EM	Them	NR	Number, near, no record
ES	And	NSA	No such address
EST	Eastern Standard Time	NT	Not
EVBDI	Everybody	NTG	Nothing
Evy	Every	NW	Now
EZ	Easy	NZ	New Zealand
FB	Fine business, excellent	OB	Old Boy, Official Broadcast
FIL	Filament	OFS	Office
FLD-FLT	Filed, filing time	OM	Old man
FM	From	OO	Official Observer
FONES	Telephones	OPN	Operation
FR	For	OP-OPR	Operator
FREQ	Frequency-frequently	ORS	Official Relay Station
GA	Go ahead	OSC	Oscillate, oscillations
GB	Good-bye	OT	Oscillation transformer, old timer
GBA	Give better address		
GE	Good evening	OW	Old woman
GEN	Generator	PRI	Primary
GES	Guess	PSE	Please
GG	Going		

PST	Pacific Standard Time	WO	Who
PT	Point	WT	What, wait, watt
PUNK	Poor operator, lid	WUD	Would
PUR	Poor	WV-WL	Wave, wavelength
PWR	Power	WX	Weather
PX	Press (news)	XMTR	Transmitter
R	Are, all right, O.K.	XCUSE	Excuse
RAC	Rectified alternating current	XPLN	Explain
RCD	Received	XTRA	Extra
RCVR	Receiver	YL	Young lady
RDO	Radio	YR	Your
RDS	Reads	ZEDDER	New Zealander
RES	Resistance	73	Best regards
RHEO	Rheostat	88	Love and kisses
RI	Radio Inspector	99	Keep out
RITE	Write, right	2	Two, to, too
RM	Route Manager	2DA	To-day
RPT	Repeat, report	4	For, four
RUF	Rough	8	Eight, ate
SA	Say		
SCM	Section Communications Manager		
SEC	Second		
SED	Said		
SEZ	Says		
SHUD	Should		
SIG-SG	Signature		
SIGS	Signals		
SINE	Sign, personal initials, signature		
SINK	Synchronous		
SITE	Sight		
SKED	Schedule		
SORRI-SRI	Sorry		
SPK	Spark, speak		
SUM	Some		
SVC	Service message		
TC	Thermo couple		
TFC	Traffic		
TKS-TNX	Thanks		
TNG	Thing		
TMW	Tomorrow		
TR	There, their, position report		
TRI	Try		
TRUB	Trouble		
TS	This		
T	The		
TT	That		
U	You		
UNDLD	Undelivered		
UNKN	Unknown		
UR	Your, you're		
URS	Yours		
V	Volt		
VAR	Variable		
VC	Variable condenser		
VT	Vacuum tube		
VY	Very		
WD	Word, would		
WDS	Words		
WN-WEN	When		
WI-WID	With		
WK	Work, weak, week, well-known		
WKD	Worked		
WKG	Working		
WL	Will		
WN	When		

INTERNATIONAL INTERMEDIATES

Amateurs in many foreign lands are transmitting. To identify the nationality of the sending station, certain intermediate signals were devised by the International Amateur Radio Union and are in general use throughout the world. These intermediates replace the usual "de" which was formerly placed between the call of the calling station and the call of the called station. The international intermediate as now used consists of, first, the intermediate of the *called* country, and second, the intermediate of the *calling* country.

Example: Brazilian 1AC is calling United States 6CGW. The call is sent like this: 6CGW 6CGW 6CGW nusb 1AC 1AC 1AC. In answering 6CGW sends: 1AC 1AC 1AC sbnu 6CGW 6CGW 6CGW.

When two stations in the same country are calling or working together, the intermediate is given only once. U.S. 2DD calls U.S. 5AKP like this: 5AKP 5AKP 5AKP nu 2DD 2DD 2DD.

New intermediates effective at 0000 G.M.T., Feb. 1, 1927, follow:

EUROPE

EA	Austria
EB	Belgium
EC	Czechoslovakia
ED	Denmark and Faroe Ids.
EE	Spain and Andorra
EF	France and Monaco
EG	Great Britain and Northern Ireland
EH	Switzerland
EL	Italy
EJ	Jugo-Slavia
EK	Germany
EL	Norway, Spitzbergen and Franz Josef Land
EM	Sweden
EN	The Netherlands
EO	Irish Free State
EP	Portugal, Madeira Ids., and the Azores
EQ	Bulgaria
ER	Rumania
ES	Suomi (Finland)
ET	Poland, Esthonia, Latvia, Courland and Lithuania
EU	U. S. S. R. ("Russia"), including Ukraine

EV—Albania
 FW—Hungary
 EX—Luxemburg
 EY—Greece
 EZ—Zone of the Straits

ASIA

AA—Arabia
 AB—Afghanistan
 AC—China (including Treaty Ports), including Manchuria, Mongolia, and Tibet.
 AD—Aden
 AE—Siam
 AF—French Indo-China
 AG—Georgia, Armenia and Azerbaijan
 AH—Hedjaz
 AI—India (and Baluchistan) and Goa
 AJ—Japan and Chosen (Korea)
 AK—(Unassigned)
 AL—(Unassigned)
 AM—Federated Malay States (with Straits Settlements)
 AN—Nepal
 AO—Oman
 AP—Palestine
 AQ—Iraq (Mesopotamia)
 AR—Syria
 AS—Siberia, including "Central Asia"
 AT—Turkey
 AU—(Unassigned)
 AV—(Unassigned)
 AW—(Unassigned)
 AX—(Unassigned)
 AY—Cyprus
 AZ—Persia

NORTH AMERICA

NA—Alaska
 NB—Bermuda Id.
 NC—Canada, Newfoundland and Labrador
 ND—Dominican Republic
 NE—(Unassigned)
 NF—Bahama Ids.
 NG—Guatemala
 NH—Honduras
 NI—Iceland
 NJ—Jamaica
 NK—(Unassigned)
 NL—Lesser Antilles
 NM—Mexico
 NN—Nicaragua
 NO—British Honduras
 NP—Porto Rico and Virgin Ids.
 NQ—Cuba and Isle of Pines
 NR—Costa Rica
 NS—Salvador
 NT—Haiti
 NU—United States of America
 NV—(Unassigned)
 NW—(Unassigned)
 NX—Greenland
 NY—Panama
 NZ—Canal Zone

SOUTH AMERICA

SA—Argentina
 SB—Brazil, Trinidad Id., and St. Paul Id.
 SC—Chile
 SD—Dutch Guiana
 SE—Ecuador and Galapagos Archipelago
 SF—French Guiana
 SG—Paraguay
 SH—British Guiana
 SI—(Unassigned)
 SJ—(Unassigned)
 SK—Falkland Ids. and Falkland Dependencies
 SL—Colombia
 SM—(Unassigned)
 SN—Ascension Id.
 SO—Bolivia
 SP—Peru
 SQ—(Unassigned)
 SR—(Unassigned)
 SS—(Unassigned)

ST—(Unassigned)
 SU—Uruguay
 SV—Venezuela and Trinidad
 SW—(Unassigned)
 SX—(Unassigned)
 SY—(Unassigned)
 SZ—(Unassigned)

AFRICA

FA—Abyssinia
 FB—Madagascar, Reunion Id., Comoro Id., etc.
 FC—Belgian Congo, Ruanda, Urundi
 FD—Angola and Kabinda
 FE—Egypt
 FF—French West Africa, including French Sudan, Mauritania, Senegal, French Guinea, Ivory Coast, Upper Volta, Dahomey, Civil Ter. of the Niger, French Togoland, etc.
 FG—Gambia
 FH—Italian Somaliland
 FI—Italian Libya (Tripolitania and Cyrenaica)
 FJ—Somaliland Protectorate and Socotra
 FK—Kenya, Zanzibar Protectorate, Uganda, Anglo-Egyptian Sudan, and Tanganyika Territory.
 FL—Liberia
 FM—Tunisia, Algeria, Morocco (including the Spanish Zone), Tangier
 FN—Nigeria
 FO—Union of South Africa, Northern and Southern Rhodesia, Bechuanaland Protectorate, and Southwest Africa
 FP—Portuguese Guinea and Cape Verde Ids.
 FQ—French Equatorial Africa and Cameroons
 FR—Rio de Oro and adjacent Spanish Zones, Ifni, and Canary Ids.
 FS—Sierra Leone
 FT—Eritrea
 FU—Rio Muni (Spanish Guinea) and Fernando Po
 FV—French Somaliland
 FW—Gold Coast Colony, Ashanti, Northern Territories and British Togoland
 FX—Seychelle Dependencies
 FY—(Unassigned)
 FZ—Mozambique

OCEANIA

OA—Australia (and Tasmania)
 OD—Dutch East Indies*
 OE—Melanesia*
 OH—Hawaiian Ids.
 OI—Micronesia*
 OO—Polynesia*
 OP—Philippine Ids.
 OZ—New Zealand
 *To be further partitioned when activity warrants.

SHIP STATIONS

Ship stations with amateur calls will place an X before their usual intermediate. E. g., Australian 3AA at sea, calling U. S. 1AW, would send "1AW NUXOA 3AA." The reply would be "3AA XOANU 1AW."

"Q" SIGNALS

Our list of "Q" signals conforms in the main to the official international list. The common usage of a signal in the amateur fraternity sometimes differs slightly from the official definition. When this occurs, the official definition is given first, and then a second definition follows and is preceded by "(A.R.*)" to indicate that this definition is the "amateur radio" definition.

To indicate which of the "Q" signals the amateur telegrapher should learn first, the most used are indicated by asterisks (**). Signals not preceded by asterisks are rarely or never used by amateurs.

**QRA?	What station is that? (A.R.) What is your address?
**QRA	This is. (A.R.) My address is
QRAR?	(A.R.) Is your call-book address correct?
QRAR	(A.R.) My call-book address is correct.
QRB?	What is your distance?
QRB	My distance is
QRC?	What is your true bearing?
QRC	My true bearing is
QRD?	Where are you bound for?
QRD	I am bound for
QRDD?	(A.R.) In what direction are your messages going?
QRDD	(A.R.) My messages are going (north, east, south, or west).
QRF?	Where are you bound from?
QRF	I am bound from
QRFF?	(A.R.) From what station did you receive message Nr
QRFF	(A.R.) Message Nr. was received from
QRG?	What line do you belong to?
QRG	I belong to the line.
**QRH?	What is your wavelength in meters?
**QRH	My wavelength is meters.
QRHH?	(A.R.) What tune shall I adjust for?
QRHH	(A.R.) Adjust to receive on meters.
QRJ?	How many words have you to send?
QRJ	I have words to send.
**QRK?	How do you receive me? (A.R.) How are my signals?
**QRK	I am receiving well. (A.R.) Your signals are good.
*QRL?	Are you receiving badly? Shall I send ...- . 20 times for adjustment?
*QRL	I am receiving badly. Please send ...- . 20 times for adjustment.
QRLL?	(A.R.) May I test for minutes?
QRLL	(A.R.) Permission to test granted.
**QRM?	Are you being interfered with?
**QRM	I am being interfered with.
**QRN?	Are atmospherics (static) strong?
**QRN	Atmospherics are very strong.
QRO?	Shall I increase power?
QRO	Increase power.
QRP?	Shall I decrease power?
QRP	Decrease power.
*QRQ?	Shall I send faster?
*QRQ	Send faster.
*QRR	Official A.R.R.L. "land SOS" for emergency use only.
*QRS?	Shall I send slower?
*QRS	Send slower.
**QRT?	Shall I stop sending?
**QRT	Stop sending.
**QRU	I have nothing for you.
**QRV?	Are you ready?
**QRV	I am ready. All right now.
*QRW?	Are you busy?
*QRW	I am busy. Please do not interfere.
**QRX?	Shall I stand by?
**QRX	Stand by, I will call you when required. (A.R.) Stand by for..... Example: "QRX 3 min" meaning "Stand by for 3 minutes."
QRY?	When will be my turn?
QRY	Your turn will be No.
**QRZ?	Are my signals weak?
**QRZ	Your signals are weak.
**QSA?	Are my signals strong?
**QSA	Your signals are strong.
**QSB?	Is my tone bad? (A.R.) How is my tone?
**QSB	Your tone is bad. (A.R.) Your tone is
**QSC?	Is my spacing bad? (A.R.) Is my Morse (sending) bad?
**QSC	Your spacing is bad. (A.R.) Your Morse is bad.
QSD?	What is your time?
QSD	My time is

QSF?	Is transmission to be in alternate order or in series?
QSF	Transmission will be in alternate order.
QSG	Transmission will be in series of 5 messages. (A.R., followed by a number.) Transmission will be in series of messages.
QSH	Transmission will be in series of 10 messages.
QSJ?	What rate shall I collect for?
QSJ	Collect for
**QSK?	Is the last radiogram cancelled?
**QSK	The last radiogram is cancelled.
**QSL?	Did you get my receipt? (A.R.) Will you acknowledge?
**QSL	Please acknowledge. (A.R.) Please mail me confirmation of this transmission.
*QSLL	(A.R.) Please acknowledge my signals by card. I will return the favor.
QSM?	What is your true course?
QSM	My true course is degrees.
QSN?	Are you in communication with land?
QSN	I am not in communication with land.
**QSO?	Are you in communication with any ship or station? (A.R.) Can you get in communication with soon?
**QSO	I am in communication with through (A.R.) I am in communication with
*QSP?	Shall I inform that you are calling him?
*QSP	Inform that I am calling him.
*QSQ?	Is calling me?
*QSQ	You are being called by
**QSR?	Will you forward the radiogram?
**QSR	I will forward the radiogram.
*QSRM?	(A.R.) Will you forward message Nr. by mail if you cannot relay by radio at once?
*QSRM	(A.R.) I will forward message Nr. by mail if I fail to relay by radio within 12 hours.
**QSS?	(A.R.) Are my signals fading?
**QSS	(A.R.) Your signals are fading.
**QSSS?	(A.R.) Are my signals swinging?
**QSSS	(A.R.) Your signals are swinging.
**QST?	Have you received the general call?
**QST	General call to all stations.
*QSU?	Please call me when you have finished (or at o'clock).
*QSU	I will call you when I have finished (or at o'clock).
*QSUF	(A.R.) Please call me by wire telephone at once.
QSV?	Is public correspondence being handled?
QSV	Public correspondence is being handled.
QSW?	Shall I increase my spark frequency?
QSW	Increase your spark frequency.
QSX?	Shall I decrease my spark frequency?
QSX	Decrease your spark frequency.
**QSY?	Shall I send on a wavelength of meters?
**QSY	Let us change to the wavelength of meters.
QSYI	(A.R.) I shall shift my transmitting wavelength to meters.
QSYU	(A.R.) Please shift your transmitting wave to meters.
**QSZ?	Do you wish me to send each word twice?
**QSZ	Send each word twice. I have difficulty in receiving you.
*QSZ MSG	(A.R.) Please send each <i>message</i> twice, "words once," as I have difficulty in receiving you.
**QTA	Repeat the last radiogram.
*QTB?	Are you in accord with my check? Please repeat first letter or figure of each counted word.
*QTB	I am not in accord with you in your statement of the number of words. I repeat the first letter or figure of each counted word.
**QTC?	Have you anything to transmit? (A.R.) Have you anything for me?
**QTC	I have something to transmit. (A.R.) I have something for you.
QTE?	What is my true bearing?
QTE	Your true bearing is degrees from
QTF?	What is my position?
QTF	Your position is latitude and longitude.

AUDIBILITY

The adoption of the British "R" system of indicating audibility was suggested some time ago by a number of correspondents. It was printed in May 1925 *QST* and in a very short time it came into general use. The meanings of the several "R" signals are as follows:

- R1—Faint signals, just audible.
- R2—Weak signals, barely readable.
- R3—Weak signals, but readable.
- R4—Fair signals, easily readable.
- R5—Moderately strong signals.
- R6—Strong signals.
- R7—Good strong signals, readable through lots of interference.
- R8—Very strong signals, several-feet-from-phones stuff.
- R9—Extremely strong signals.

READABILITY

Readability is really very important to the traffic man. A signal may be audible all over the station, but if there is any great amount of interference (QRM) or if atmospherics (QRN) are present, or if the note is poor (QSB), the *readability* may be away down. A second figure may be added to the above to indicate "readability." The following table explains a method used to indicate percentage copy or percentage readability.

- 9—100% readable.
- 8— 80% readable.
- 7— 70% readable.
- 6— 60% readable.
- 5— 50% readable.
- 4— 40% readable.
- 3— 30% readable.
- 2— 20% readable.
- 1— 10% readable.

A few examples of what may be expected, showing how audibility and readability signals may be interpreted, may help. If one is told that signals are "R99" it means that the signals are "extremely strong" and can be copied "100%." It certainly is not necessary to send "words twice" (QSZ) to that operator. When told that your signals are "R29" you know that signals are "barely readable" but can be copied "100%" despite the fact that they are "weak." It is not necessary or desirable to send "words twice" to him either. A report of "R66" indicates "strong" signals, only "60%" copiable due to disturbing noises present in the receivers in addition to the useful signals.

CALL BOOKS

One useful addition to every station is a good call book. When stations are heard

or worked, the first thing that interests us is the location. If we have messages to be handled, it is absolutely necessary that we know the location of stations that we hear so that we may route our messages correctly.

Several call books are available for small sums of money. However, no call books are ever quite up-to-date because new stations are continually coming on the air and old stations occasionally drop out of existence and some changes have taken place in just the short time while an up-to-date list of calls is being set in type by the printer.

"Amateur Radio Stations of the United States" contains a list of the licensed amateur radio stations of this country. Experimental station or "X" calls are also listed. This may be obtained for 25c (not in stamps) from Superintendent of Documents, Government Printing Office, Washington, D. C. The yearly June edition is usually available about October first.

"Commercial Radio Stations of the United States" gives lists of the various commercial stations together with naval and government licensed calls. This publication may be obtained for 25c, (not in stamps) from Superintendent of Documents, Government Printing Office, Washington, D. C.

"The International Amateur Radio Call Book" contains up-to-date lists of amateur calls, both official and un-official, for all countries except the United States. Nearly 4000 calls in 36 different countries are listed. This book may be obtained from the International Call Book Company, Drawer 205, Station "A," Hartford, Conn., for 50c.

A complete list of Canadian amateur station calls can be obtained for twenty-five cents from the Department of Marine and Fisheries, Ottawa, Canada.

"The Citizens' Radio Call Book" (Amateur Edition) may be obtained for 75c from The Citizens' Radio Service Bureau, Chicago, Ill. It contains the calls and addresses of many high-power long-wave foreign and U. S. commercial stations who handle trans-ocean traffic. In addition it lists some amateurs, ship calls, and shore stations handling ship traffic. This publication is for sale on many newsstands also.

KEEPING A LOG

Every operator of an amateur station should keep a log of the operating work that is done as well as of the tests of an experimental nature that are carried out with the transmitter or receiver. A log makes it possible to verify transmissions whenever reports are received. A log assures that there will be a complete record

of the message handling that takes place, especially if the log is faithfully kept. A log gives absolute proof of the transmitting work that has been carried on and makes the history of the station always available, up-to-date, and complete. Every commercial and government station keeps a log because it is a necessity. Amateurs keep a log because of the ready-reference value in proving records and because of the pleasant recollections and associations that come from reviewing the history of friendly radio contacts and from displaying the record of the accomplishments of the station to interested visitors and friends. So by all means plan to start a log at the same time you start operating the station.

There are as many different kinds of logs as there are stations. Station owners all have opinions on the form that the log should take. The more elaborate the log is, the more time, care, and pains are required in keeping it. The value of the log does not increase as rapidly as the work of entering details mounts. Therefore, the simple log is best as we will get the biggest return from the time spent in keeping it up-to-date.

A loose-leaf notebook often proves useful in making our log. The sheets can be renewed each month and those used can be taken out and filed away with the cards and station records. A stenographer's ordinary notebook costing from ten to thirty cents and about 4½" by 8½", takes little space on the operating table and also makes a good log book.

4-2-26					
P.M.	11:25	(5IN)	39.5	R-5	QRN
	11:50	CQ	Nil	QRN	GN
4-8-26					
P.M.	8:00	CQ u 6CGW	40	R-4	
4-13-26					
A.M.	12:06	CQ	40		
	2:10	(1BAN)	42		
	2:55	(8PL)	CW Hl	QSS	40
P.M.	1:20	(1AID)	40	fair	NIL

Fig. 1

Figure 1 shows a sample page in such a log book. A dozen pages may be ruled in advance with vertical lines. In the first column the DATE and TIME are noted. In the second column the calls of stations worked, heard, and called are put down. A circle, parentheses, or a line drawn under the call can indicate whether a station was worked, heard or called, or simply heard. A special designating sign or abbreviations

before or after the call letters can show this information.

DATE: APRIL 10, 1927			ANS X
E.S. TIME	CALLED	CALLED BY	WKD (X)
3:25 P.M.	CQ	8BRC	X

Fig. 2

Figure 2 shows a more standardized form of log. The date is usually placed at the top in the center; the time is put in the first column at the left; the next two columns show the called and calling stations. In an additional column is placed an "X" when a station is called. If communication is established, a circle is placed around the "X."

Still another column may be added for "Remarks". A, B, C, or D are often used to indicate the 150-200, 75-85, 40, or 20 meter band. The letter can show which wavelength band or secondary coil was used. After this letter follows the condenser setting, "B-28" showing that 8BRC was using the 80 meter wavelength-band and that the tuner condenser setting was on 28 degrees. At the end of the line the time of transmission may be noted. "1s, 2s" can be used to mean that one message was sent and two received from 8BRC.

Figure 3 shows a very detailed log which really gives a lot of information but which is somewhat harder to keep in good shape. W, H and C are used for "worked," "heard" and "called." A bar under the "R" in "RAC" may show that the note is well-rectified and fairly smooth. A line under the 'AC' can indicate that the ripple is pronounced. Plenty of information will be available for stations wanting information when such a log is kept, no matter how late a date the request for information is received.

AMERICAN RADIO RELAY LEAGUE
LOG SHEET

PERSONAL RECORD OF COMMUNICATION

DATE	TEMPERATURE	BAROMETER						REMARKS
CALL LETTERS	TIME	W	H	C	R	RE	REMARKS	

FIGURE 4

In Figures 4 and 5 are shown some printed log sheets that are ready for use and in quite convenient form. The log sheet shown in Fig. 5 is stocked at A.R.R.L. Headquarters simply for the convenience of League members.

DATE	TIME	CALL	W	H	C	R	RE	REMARKS
Oct. 10	0310	7ABB						Cig CQ es 8AWJ
11	0120	g2NM						He faded—swings too

Fig. 3

A log is of great value in a number of ways. A comparison of the operating results obtained with different apparatus in use at different times is valuable. The "DX" or traffic-handling value of the various wavelengths over varying distances may be readily found from the log. The effect of weather or time of day may also be quickly found. *Every change made in either the transmitter or antenna system should be noted down in the log*, so that results may be compared for dates before and after the date when a change was made, no matter how trivial the change, **PUT IT DOWN IN THE LOG.** Remember that

FIGURE 5

A simple form of log is shown above. What is worth doing is worth recording. The simpler the form is the more of us can use it advantageously. We simply offer this form as a suggestion, hoping that you will find it worthy of adoption. Every station should keep a log of transmissions and stations worked so that reports received can be verified from the log and so that the record of message-handling will be a complete one.

only *one* change at a time should be made if the changed results are to be attributed to ONE definite cause.

We have shown several types of log sheets in these pages. There are advantages and disadvantages to each. Perhaps certain ideas from different log sheets can be embodied in your own station log. Perhaps some printed log sheets will be best for your work. Every reader will wish to start his station right by making up an individual station log. The simpler the form of the log is, the more of us can use it advantageously. We offer these forms of logs as suggestions, hoping that you will find them worthy of adoption. **KEEP A STATION LOG!!!**

MEASURING DISTANCES ACCURATELY

Oftentimes it is interesting to know just how far away some station is located. In measuring distances it is customary to measure along the shortest path on the surface of the earth. This distance is along the arc of a Great Circle and for very short distances it is practically a straight line.

To find the distance of a foreign station, or to most accurately find distances in the United States, the following formula from spherical trigonometry is convenient and easy to apply.

$$\cos a = \cos b \cos c + \sin b \sin c \cos A.$$

a is the distance in which we are interested.

b and *c* are the co-latitudes (90° minus the latitude) of the two stations.

A is the difference in longitude.

This formula gives the distance in degrees of arc. One minute of arc equals one nautical mile or 1.15 statute miles. One degree of arc equals 69. statute miles.

EXAMPLE: What is the distance between Hartford, Conn., and Honolulu, Hawaii?

Hartford's latitude, from a map, is found to be 41° 47'N., its co-latitude 48° 13', its longitude, from the map, 72° 40'W. Similarly Honolulu's latitude is 21° 15'N., its co-latitude 68° 45', and its longitude 157° 50'W.

Using a set of trigonometric tables (any library or school has them) we find that

$$\cos b = \cos 48^\circ 13' = .66632$$

$$\sin b = .74567$$

$$\cos c = \cos 68^\circ 45' = .36244$$

$$\sin c = .93201$$

$$157^\circ 50' - 72^\circ 40' = 85^\circ 10' = A.$$

$$\cos A = .08426$$

Substituting these values in the formula we have:

$$\cos a = (.666) (.362) + (.746) (.932) (.84) = .2405 + .0584 = .2989.$$

From the "trig" tables we find *a* = 72° 36' of arc.

$$72 \times 69 \text{ (miles per degree)}$$

$$36 \times 1.15 \text{ (miles per min. arc)}$$

$$= 4968 \text{ statute miles}$$

$$= \underline{41} \text{ statute miles}$$

$$\text{Total} = 5009 \text{ statute miles}$$

which is the distance between Hartford and Honolulu along the surface of the earth.

Good maps are convenient for measuring distances quickly and with a fair degree of accuracy. A large map with circles drawn having radii suitable to the scale of the map and your own station as a center, is the best to use. When another station is located on the map, the distance can be estimated at once by noting just which circles it lies between.

A "parcel post" map made for the use of the Post Office Department is useful for the traffic handlers. It is cross-ruled with horizontal and perpendicular lines. The squares are numbered. In the Postal Guide there is a complete list of postoffices in the U.S.A. and provinces. These offices are numbered and the numbers correspond to the squares on the maps. To find the location of a station refer to the call-book, to the Postal Guide, and to the numbered square on the map.

Having a message, it is easy to pick a big city near the ultimate destination of a message. The distance in miles may be figured easily by subtracting the numbers appearing at the top of the map on the perpendicular line above your own "location" square, from those above the station you have worked.

TIME CONVERSION

From time to time we become interested in making and keeping schedules for tests or traffic handling with foreign amateurs, or with stations in some other part of our own great country. Test schedules are often printed or distributed in mimeographed form and the time specified is usually that

ly refer tests to a specified time by using a "zone" system. Each 15° of longitude constitutes a "zone" starting with the "zero" meridian (Greenwich) as Zone 0. Eastern Standard Time is referred to as ZONE PLUS 5 time. Pacific Standard Time is ZONE PLUS 8 time and so on. In the Western hemisphere time zones are "plus". In the Eastern hemisphere time zones are "minus". For convenience and to avoid confusion tests are sometimes specified on the basis of numbering the hours like the dial of an Italian clock, from "1" to "24". The day starts with midnight which is "the zero", 0000. One o'clock in the morning Eastern Standard Time (75th meridian time) is 0100 E.S.T. and 11:30 p.m. E.S.T. is 2330 E.S.T. by the same

Longitude	Place	TODAY												TOMORROW											
		12	13	14	15	16	17	18	19	20	21	22	23	24	1	2	3	4	5	6	7	8	9	10	11
EAST 180	Fiji Islands	12	13	14	15	16	17	18	19	20	21	22	23	24	1	2	3	4	5	6	7	8	9	10	11
165	New Zealand (*)	11	12	13	14	15	16	17	18	19	20	21	22	23	1	2	3	4	5	6	7	8	9	10	11
150	Australia, east	10	11	12	13	14	15	16	17	18	19	20	21	22	1	2	3	4	5	6	7	8	9	10	11
135	Japan	9	10	11	12	13	14	15	16	17	18	19	20	21	1	2	3	4	5	6	7	8	9	10	11
120	China, Philippines	8	9	10	11	12	13	14	15	16	17	18	19	20	1	2	3	4	5	6	7	8	9	10	11
105	Indo China, Straits Settlements	7	8	9	10	11	12	13	14	15	16	17	18	19	1	2	3	4	5	6	7	8	9	10	11
90	Calcutta (**)	6	7	8	9	10	11	12	13	14	15	16	17	18	1	2	3	4	5	6	7	8	9	10	11
75	Mauritius, Seychelles	5	6	7	8	9	10	11	12	13	14	15	16	17	1	2	3	4	5	6	7	8	9	10	11
60	Aden, Somaliland, Madagascar	4	5	6	7	8	9	10	11	12	13	14	15	16	1	2	3	4	5	6	7	8	9	10	11
45	South Africa	3	4	5	6	7	8	9	10	11	12	13	14	15	1	2	3	4	5	6	7	8	9	10	11
30	Germany, Italy, Norway, Sweden	2	3	4	5	6	7	8	9	10	11	12	13	14	1	2	3	4	5	6	7	8	9	10	11
15	England, France, G.M.T.	1	2	3	4	5	6	7	8	9	10	11	12	13	1	2	3	4	5	6	7	8	9	10	11
0		12	13	14	15	16	17	18	19	20	21	22	23	1	2	3	4	5	6	7	8	9	10	11	
WEST 15		11	12	13	14	15	16	17	18	19	20	21	22	1	2	3	4	5	6	7	8	9	10	11	
30	Brasil, east	10	11	12	13	14	15	16	17	18	19	20	21	1	2	3	4	5	6	7	8	9	10	11	
45	Argentina, Porto Rico	9	10	11	12	13	14	15	16	17	18	19	20	1	2	3	4	5	6	7	8	9	10	11	
60	Washington, D. C., E.S.T.	8	9	10	11	12	13	14	15	16	17	18	19	1	2	3	4	5	6	7	8	9	10	11	
75	Chicago, C.S.T.	7	8	9	10	11	12	13	14	15	16	17	18	1	2	3	4	5	6	7	8	9	10	11	
90	Denver, M.S.T.	6	7	8	9	10	11	12	13	14	15	16	17	1	2	3	4	5	6	7	8	9	10	11	
105	San Francisco, P.S.T.	5	6	7	8	9	10	11	12	13	14	15	16	1	2	3	4	5	6	7	8	9	10	11	
120		4	5	6	7	8	9	10	11	12	13	14	15	1	2	3	4	5	6	7	8	9	10	11	
135		3	4	5	6	7	8	9	10	11	12	13	14	1	2	3	4	5	6	7	8	9	10	11	
150	Alaska	2	3	4	5	6	7	8	9	10	11	12	13	1	2	3	4	5	6	7	8	9	10	11	
165	Samoa, Hawaii (***)	1	2	3	4	5	6	7	8	9	10	11	12	1	2	3	4	5	6	7	8	9	10	11	
180		12	13	14	15	16	17	18	19	20	21	22	23	1	2	3	4	5	6	7	8	9	10	11	

NOTES:—(*) Add one-half hour for New Zealand Time.
 (**) Calcutta local time Subtract one-half hour for India Standard Time.
 (***) Subtract one-half hour for Hawaiian Standard Time.

NOTES:—0 is midnight, 1 is 1.00 A.M., etc. 12 is noon, 13 is 1.00 P.M., 15 is 3.00 P.M., etc.
 Read the figure columns vertically, thus:—when it is 12, noon on Monday in New York E.S.T., it is 3.00 A.M. on Tuesday in Melbourne, Australia.
 Or again: 11.00 P.M. on Sunday in San Francisco is 6.30 P.M. on Monday in New Zealand and 5.00 P.M. in Australia.
 The hours of darkness—8 P.M. to 5 A.M. are shaded

of the place where the station doing the testing is located. Occasionally the time is changed to Greenwich Mean Time. Perhaps it is stated in 75th Meridian Time. When we are listening to some of the long-wave arc and alternator stations we often pick up time signals sent on local standard time. So whatever we do, sooner or later we will need to convert schedules to or from our local time to take advantage of them.

For your use we are including a convenient conversion table which shows the time in different parts of the world. Every fifteen degrees of longitude corresponds to one hour time difference. The use of the table is self-explanatory.

Time is usually reckoned by the nearest meridian of longitude. Every 15° of longitude corresponds to one hour of time. The "zero" meridian passes through the Greenwich (England) Observatory and international time is usually in terms of "Greenwich Mean Time". Government departments concerned with time designation usual-

ly refer tests to a specified time by using a "zone" system. Each 15° of longitude constitutes a "zone" starting with the "zero" meridian (Greenwich) as Zone 0. Eastern Standard Time is referred to as ZONE PLUS 5 time. Pacific Standard Time is ZONE PLUS 8 time and so on. In the Western hemisphere time zones are "plus". In the Eastern hemisphere time zones are "minus". For convenience and to avoid confusion tests are sometimes specified on the basis of numbering the hours like the dial of an Italian clock, from "1" to "24". The day starts with midnight which is "the zero", 0000. One o'clock in the morning Eastern Standard Time (75th meridian time) is 0100 E.S.T. and 11:30 p.m. E.S.T. is 2330 E.S.T. by the same

TUBE REACTIVATION

When excessive plate voltage has been applied to "XL" filament tubes or high plate currents have been run through the tube due to a misadjustment of the transmitter, the filament emission is somewhat decreased. Overworked transmitting tubes will have a gradually decreasing plate current. Reduced output results from such a condition.

Running the tubes at a slightly higher filament voltage than normal for a considerable time with the plate voltage OFF will bring active thorium to the surface and renew the available electron supply.

Tube	Flashing Volts	Method Time	Ageing Volts	Method Time
UX-210	15	30 sec.	9	2 min. plus
UV-203-A	20	30 sec.	12	2 min. plus
UV-199	10	30 sec.	4.5	8 to 10 min.
UX-201-A	15	1 min.	7.5	10 min.
UX-120	10	1 min.	4.5	10 min.

FIGURING THE CAPACITANCE OF A CONDENSER

$$C = \frac{kA (n-1)}{4\pi d \times 9 \times 10^9}$$

$$= .0088 \frac{kA}{d} (n - 1) 10^{-5} \text{ mfd.}$$

where A = area of one side of one plate (sq. cm.)
 n = total number of plates
 d = separation of plates (cm.)
 k = specific inductive capacity of dielectric.

The Specific Inductive Capacity (k) is a property of the dielectric used in a condenser. It determines the quantity of charge which a given separation and area of plates will accumulate for a given applied voltage. The "inductivity" of the dielectric varies as in the following table. "k" is the ratio of the capacitance of a condenser with a given dielectric to the capacitance of the same instrument with air dielectric.

Dielectric	"K"	Kilovolts per cm. to puncture
Air (Normal pressure)	1.00	7.8-9.0
Flint Glass	6.6 to 10	900
Mica	4.6 to 8	1500
Paraffin Wax (solid)	2.0 to 2.5	400
Sulphur	3.9 to 4.2	—
Castor Oil	4.7	150
Porcelain	4.4	—
Quartz	4.5	—
Resin	2.5	—
Olive Oil	3.1	120
Gutta Percha	3.3 to 4.9	80-200
Shellac	3.1	—
Common Glass	3.1 to 4.0	300-1500
Turpentine	2.23	110-160
Dry Oak Wood	2.5 to 6.8	—
Formica, Bakelite, etc	5 to 6	—

When the air dielectric in a variable condenser is replaced with some other fluid dielectric its maximum and minimum capacitance values are multiplied by "k" and the "sparking" potential is increased.

Fluid dielectrics repair themselves after a break-down unless an arc is maintained

that carbonizes the oil. Dry oil is a good dielectric with quite low losses. When solid dielectric is used it should be borne in mind that dielectric strength (break-down voltage) becomes lower as temperature rises. Breakdown is a function of time as well as voltage. A condenser that stands up under several thousand volts for a few seconds might break down when connected to a 2000-volt line for a half-hour.

Example of finding condenser capacitance: We have 3 plates, 3" x 5", in air. The plates are separated 1/8". 1" = 2.54 centimeters. k = 1. A = 7.62 x 12.70 = 96.8 sq. cm. d = .3175 cm. n - 1 = 2.

$$C = .0088 \frac{1 \times 96.8}{.32} 2 \times 10^{-5} = .00005325 \text{ mfd.}$$

or 53 1/4 micromicrofarads.

If we put this in castor oil the increase in capacitance will make our condenser have a capacitance of

$$53 \frac{1}{4} \times 4.7 = 250 \text{ micromicrofarads.}$$

The air condenser might spark over at about

$$7.8 \times .3175 \text{ c.m.} = 2.475 \text{ kv. (2,475 volts)}$$

In oil (castor oil) it would have 150/7.8 times the breakdown voltage of air.

$$\frac{150}{7.8} = 19.25$$

$$19 \frac{1}{4} \times 2475 = 47,600 \text{ volts}$$

We can find the same value directly:

$$150 \times .3175 \text{ cm.} = 47,600 \text{ volts (peak).}$$

Using the formulas for "reactance" we can find what the voltage drop across this condenser will be when carrying current at a specified high frequency.

$$E_x = X_c I \quad X_c = \frac{1}{2\pi f c}$$

Where Ex is the reactance voltage drop. C is the capacitance of the condenser (farads)

f is the frequency (cycles per second)
 Xc is the reactance of the condenser in ohms.

Suppose we are using the 3-plate fixed air condenser in our antenna circuit, that a radio frequency ammeter is in series with it. We are operating on an 80-meter wavelength (3,750,000 cycles) and the meter right next the condenser reads 1.3 amperes. What is the voltage drop across the air condenser?

$$X_c = \frac{1}{2 (3.1416) (3750000) (53.25) 10^{-12}}$$

$$= \frac{1}{1257 \times 10^{-6}}$$

$$= \frac{10^9}{1257} = 797. \text{ ohms}$$

$E_x = (797) (1.3) = 1034$ volts (root mean square value)

If the wave is a sine wave, this value multiplied by 1.414 will give the "peak" or maximum value.

$1034 \times 1.414 = 1462$ volts (peak)

Our radio frequency ammeter measures the heating effect of all the instantaneous values of current during the radio-frequency cycle. The direct current, the square of which equals the average of the squares of all the values of alternating current over a whole cycle, produces the same heat as the alternating current. Alternating current meters generally used for A.C. switchboard work read the *effective* or *root mean square values* which we mention above.

DRILLING GLASS

An ordinary Red Devil glass cutter will do for cutting glass panels and strips of glass to be used as insulators. Long skinny glass towel bars often make excellent antenna insulators. A trip to the ten cent store will procure such apparatus.

Plate glass is the best kind of glass for panels. After it has been cut to the exact size it may ground on the flat face of a grindstone wheel with a rocking motion to avoid chipping. Plenty of water must be used to lubricate and cool the surfaces in contact. Thin glass can be worked but cracks rather easily. A rotating wooden wheel and a mixture of valve grinding compound and water can be used for polishing glass using powdered pumice stone for finishing the job.

In drilling glass panels or in drilling a large pane of window glass for the lead-in use a bit brace, a sharp twist drill and some turpentine for lubrication. First lay the glass carefully on a flat surface—if the glass is less than $\frac{1}{4}$ " thick you will have to be especially careful to avoid cracking it. A paper template should be placed under the glass if there is to be more than one hole drilled in it. With hammer and center punch and very light but sharp blows mark the points where holes are to be drilled directly on the glass itself. Turn the glass over and mark each hole on both sides.

Place the panel over a flat surface in which there is a rounded bolt head protruding slightly above the surface. Move it so that the bolt head is exactly below one of the punch marks. Now put a small drill in the bit brace, dip it in turpentine and drill right into the glass. *Do not drill too far* as the glass will split out on the other side if you do. Be careful to keep the drill directly above the bolt head so that the pressure is all squarely under the point of

the drill. Go about half way through the panel. Then turn the panel over and drill from the other side drilling so that all the holes will meet in the middle and not using any great pressure after the holes have started to come together. Always turn the drill *slowly*. Keep the head of the brace *moving* in different directions so the axis of the drill is ever changing. Wear glasses to protect the eyes from flying particles and lubricate well with turpentine. Sometimes revolving the drill backwards will help in getting out little pieces of glass.

A three-cornered file or a rat-tail file may be used for reaming out the holes and enlarging them to the desired size for the lead-in wire. Two rubber washers holding a 10:32 machine screw should be useful to make a weather tight job. The files must be turned in the opposite direction from that in which you would turn a drill or the files will screw right into the glass and split it. If a three-cornered file is used it should be ground on all three sides for an inch from the point so it is absolutely smooth and the point should then be ground at an oblique angle with one cutting edge which will cut when the file is turned backward. Holes may even be countersunk with the point of a very large drill if very great care and slowness in turning are observed.

EXPERIMENTAL LAYOUTS

In building apparatus for experimental purposes and for temporary use it is just as desirable to use system in laying out the apparatus and in wiring up as when the more permanent panel job is built. Some spare "breadboards", a bunch of General Radio plugs and jacks, Fahnstock clips, some scrap bakelite pieces for building terminal boards, angles for supports and a bunch of different sized brass machine screws, wood screws, nuts, and washers will make it easy to build up and try out new circuits or to wire up auxiliary apparatus to go with the transmitter. It is a good idea to keep some bus wire on hand and various sized spools of magnet wire will prove useful in doing temporary wiring if you are an experimenter.

A table of drill sizes giving the proper numbered drill to use for passing a screw through a panel or for tapping to take a certain size of machine screw is included for the convenience of League members who are continually building and who like to have such information in convenient form. Only the sizes most used in radio constructional work are given as too many tap sizes that are seldom of use might prove confusing. Wood screws also come in various sizes and lengths. Usually the numbers correspond to the drill-size numbers, the diameter given being that of the screw just below the head. The lengths of wood

screws are stocked by most hardware stores to the nearest quarter inch of what you want. Round-head screws look best. Whether blued or nickled screws are used is mainly a matter of choice with the individual builder.

A small tap holder, a die holder and three or four taps and dies covering the 8-32, 6-32, and 10-32 sizes used most of all can be obtained from a hardware store at a reasonable cost. Sometimes the local 5-and-10-cent store will have these tools at a dime each. With the dies you can thread brass rod and run over threads that become "bunged-up" on machine screws. With the taps you can thread the holes that you drill so that they will take machine screws to hold the apparatus that you wish to mount.

NUMBERED DRILL SIZES

Number	Diameter (mils)	Will clear screw	Drilled for tapping iron, steel or brass*
1	2280	—	—
2	2210	12-24	—
3	2130	—	14-24
4	2093	12-20	—
5	2055	—	—
6	2040	—	—
7	2010	—	—
8	1990	—	—
9	1960	—	—
10	1935	10-32	—
11	1910	10-24	—
12	1890	—	—
13	1850	—	—
14	1820	—	—
15	1800	—	—
16	1770	—	12-24
17	1730	—	—
18	1695	8-32	—
19	1660	—	12-20
20	1610	—	—
21	1590	—	10-32
22	1570	—	—
23	1540	—	—
24	1520	—	—
25	1495	—	10-24
26	1470	—	—
27	1440	—	—
28	1405	6-32	—
29	1360	—	8-32
30	1235	—	—
31	1300	—	—
32	1160	—	—
33	1130	4-36 4-40	—
34	1110	—	—
35	1100	—	6-32
36	1065	—	—
37	1040	—	—
38	1015	—	—
39	0995	3-48	—
40	0980	—	—
41	0960	—	—
42	0935	—	4-36 4-40
43	0890	2-56	—
44	0860	—	—
45	0820	—	3-48
46	0810	—	—
47	0785	—	—
48	0760	—	—
49	0730	—	2-56
50	0700	—	—
51	0670	—	—
52	0635	—	—
53	0595	—	—
54	0550	—	—

* Use one size larger drill for tapping bakelite and hard rubber.

GOOD BOOKS

For extended information on station building and for advanced theory we suggest reference to some good books that will be both helpful and interesting. *Radio Telephony for Amateurs* by Stuart Ballantine is the best help to you in understanding short wave transmitters and receivers using vacuum tubes. The price is \$2.00. *Robinson's Manual of Radio Telegraphy and Telephony* contains more advanced information and data on tube transmission and reception than any other two books that we know. It is both an exhaustive and an authoritative work. While not dealing specifically with station-building or with the shorter wavelengths, it does treat thoroughly the principles that underlie radio communication. This book contains some good operating data and useful tables for the radio man. It is chiefly useful in studying the technical aspects of amateur radio work. It is well worth the \$3.00 at which it is sold. *The Principles of Radio Communication*, by J. H. Morecroft, is much the same sort of a book. It sells for \$7.50. These books find a place in the library of every radio amateur and engineer. The last two are more expensive than Ballantine. They are very complex and worthy of intensive study.

Ballantine's book is the best for amateurs who do not care to purchase several texts. The new and revised edition is handled by the QST Book Department. Beginners should send 10c (not stamps) to the Superintendent of Documents, Government Printing Office, Washington, D. C. for *Elementary Principles of Radio Telegraphy and Telephony* (Radio Communication Pamphlet No. 1). It is just what its name implies, a valuable elementary treatise on principles. *The Principles Underlying Radio Communication* can be obtained from the same address for \$1.00. This gives good general background information in non-technical fashion. *Radio Simplified*, by Kendall and Koehler, edited by John M. Clayton, contains elementary receiving information. The would-be commercial operator should obtain A. R. Nilson's *Radio Questions and Answers on the Government Examination for Operators* (\$1.00) or E. E. Bucher's *How to Pass the U. S. Government Radio Examination* (60c) before attempting to take the examination for a commercial "ticket". Every experimenter will want *Experimental Radio* (\$2.00) by R. R. Ramsey of Indiana University. It gives a wealth of information on making various sorts of radio measurements with many references to the other books that are worthwhile which we have recommended. *Prepared Radio Measurements* by R. R. Batcher is also quite useful. When certain quantities are known from the measurements that are briefly explained, the solution to the problem can usually be quickly found by using a straightedge to-

gether with one of the many charts given in the book. Van der Bijl's *Thermionic Vacuum Tube* is the best text available for studying the theory of operation of vacuum tubes in various circuits. It is written for the advanced experimenter rather than the beginner, however. *Radio Instruments and Measurements*, Circular of the Bureau of Standards No. 74, is a valuable reference on the subject of making radio measurements. It can be purchased for 60c (not in stamps) from Superintendent of Documents, Government Printing office, Washington, D. C.

QST is the Official Organ of the American Radio Relay League. It appears

ing that one of them will hear your call. In general, just hearing an occasional foreign station does not mean that that country can be worked at your own pleasure.

A common fault among amateurs that do not get in touch with DX stations readily is that their calls are too short. Often they do not send enough *short* CQ's indicating the country or place desired even when the receiver is sensitive enough to bring in several stations located at the desired spot. Of course the type of radiator can always be blamed or the antenna location but usually the operator has only himself to blame.



THE AMATEUR'S BOOKSHELF

monthly, containing up-to-date information and telling about all the latest developments in amateur radio. *QST* is a magazine devoted exclusively to the radio amateur. Written by and for the amateur, it contains knowledge supplementary to the books we have mentioned. *QST* is found on the bookshelves of earnest amateurs and experimenters everywhere. Some good books are a worthwhile investment. A subscription to *QST* is equally valuable.

OPERATING NOTES

A real sensitive receiver is often more important than the power input to the transmitter in working foreigners. There is not much difference in results with the different powers used, though a 250-watt will probably give 10% better signal strength at the distant point than a UV203A or two UX210's, other factors being the same for the purposes of comparison. It will not do much better than this because the field strength drops so rapidly as we get away from the antenna of a transmitting station. In working foreign countries and DX stations you should be able to hear ten or a dozen stations before expect-

Sometimes when you are listening you will hear a long succession of dots sent with perfect regularity for six or seven minutes at a time. Usually these dots come from commercial "machine" or "tape" transmitters. When there is no tape with code characters going through the machine, the mechanical key automatically makes dots, the purpose being to enable the receiving station to keep tuned to the proper wavelength and to adjust his receiver for maximum sensitivity of reception. Such interruptions occur when the tape breaks, when it has to be taken out in order to repeat part of a message, or when there is no more traffic to be sent for the moment.

The signal "... " (V) or most often "... ." is sometimes sent for two to five minutes for the purpose of testing. When one station has trouble in receiving, the operator asks the transmitting station to "QRL" while he tries to adjust his receiving set for better reception.

WORD LIST FOR ACCURATE TRANSMISSION OF SEPARATE CHARACTERS

When sending messages containing radio calls or initials that are likely to be con-

fused and where errors must be avoided, the calls or initials should be thrown into the following code words:

A	ABLE	N	NAN
B	BOY	O	OBOE
C	CAST	P	PUP
D	DOG	Q	QUACK
E	EASY	R	ROT
F	FOX	S	SAIL
H	HAVE	T	TARE
I	ITEM	U	UNIT
G	GEORGE	V	VICE
J	JIG	W	WATCH
K	KING	X	XRAY
L	LOVE	Y	YOKE
M	MIKE	Z	ZED

EXAMPLE: 1BCG is sent as "ONE BOY CAST GEORGE" but put back into the first form by the operator who delivers the message.

A somewhat different list can be obtained from the local Western Union telegraph office and posted beside the telephone to use when telephoning messages containing initials and difficult words. The above list was made up of short words to save time in radio transmission while insuring accuracy. The W. U. list is best for voice work (radiophone, telephone or dictaphone) as the words are selected to carry the proper sounds best while delivering messages by phone.

BREAK-IN OPERATION

In the chapter on operating practices, break-in was discussed. There are many advantages of such operation. "BK" sent once between short CQ calls invites anyone listening to answer immediately. While the transmitter is giving the CQ, the operator is carefully tuning over the band to listen for stations calling him. With break-in operation it is not necessary to wait until the end of a transmission to ask for repeats. A long dash will stop the other operator and you can ask him what you please. Commercial stations use break-in when working ships at sea by controlling transmitters many miles away over land lines using relays to start, stop, and key the sending set. It is not necessary even that the transmitter be very far away to take advantage of break-in work, though generally the more distant it is, the better the break-in system.

Listening on the receiver while sending constitutes the basis of every break-in system. A short antenna for the receiver may be put up at right angles to the sending antenna. Some magnet wire strung across the room or put behind the picture moulding will bring in the short-wave signals in fine shape and avoid the difficulties of changing over

the antenna from the sending to receiving set. Often, the signals can be picked up without any antenna at all if the receiver is unshielded or if there is some coupling to the transmitter due to its adjacent location. In this case there will be trouble in working break-in on wavelengths close to that on which the sending set operates. If the transmitter is close and you key in the negative high voltage lead, you may not be able to copy stations sending on your own

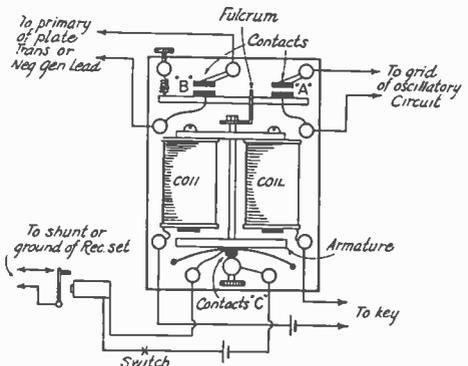

DIAGRAM OF A LEACH RELAY

Contacts at A close first before those at B close applying the plate power. The contacts at B open first (a few thousandths of a second before those at A). As both sets of contacts open positively there is dead silence in the phones because all oscillations are positively stopped. The auxiliary contacts at C open a trifle before those at A and B close, making it possible to use a 50-cent pony relay with reversed contacts to shunt or ground the secondary circuit of the receiver, keeping a high-powered outfit from burning out coils or condensers or making the grid leak noisy and positively preventing the receiver tubes from blocking. The switch should be opened when listening for any length of time.

wavelength. There may be trouble even when the key is up from oscillations of the transmitting tubes caused by voltages from the filament transformer which come from an unbalanced center-tap arrangement. If this cannot be cured by putting in a true center-tap, it will be best to locate the transmitter farther away from the receiver and to use remote control.

A satisfactory method is to break the grid circuit to stop oscillation. This can cause bad key thumps and give the operator some bad radio frequency burns, too, if a relay is not used. Best of all is the use of a relay that breaks both plate and grid circuits in proper sequence absolutely preventing oscillation, and eliminating key clicks due to the fact that the oscillating circuit is not broken abruptly as in "grid" keying, but the plate voltage is first cut off through a suitable "thump" filter so that the oscillations die out more gradually. Any relay having two sets of insulated contacts and suitable ad-

justments will do. The Leach relay diagrammed is well-suited for this use as it is so arranged that the grid circuit is closed first, the power being applied to the plate circuit through the other set of contacts a fraction of a second later. The process is reversed when the key is opened, the plate supply being cut off first. Keying the plate supply in the primary of the plate transformer is possible when the set is arranged for A.C. C.W. operation without a big filter and rectifier. The primary is always the best place to key when possible as the inductance of the transformer windings cushions the putting on and off of plate voltage, preventing the likelihood of troublesome key thumps. A really good filter will wipe out the keying, putting long tails on the dots and dashes due to the stored energy given up by the filter after the key is opened. Sets operating from rectifier and filter should be keyed in the plate circuit between filter and set. They often require the addition of a separate "thump" filter between the key and the oscillator to get rid of key thump. The compensating method of keying consists of keying in a loop of wire coupled to the coil of the oscillator thus shifting the wavelength and amount of absorbed energy at the same time. The key even can be connected in the antenna circuit to shift the tune by shunting a small coil or condenser in the antenna circuit. However, compensating methods of keying are not permissible at amateur stations because they create undue and needless interference from the "back lash" which is sent out with the key open.

We highly recommend keying with a Leach type of relay in plate and grid circuits. In an A.C.C.W. transmitter, a single-

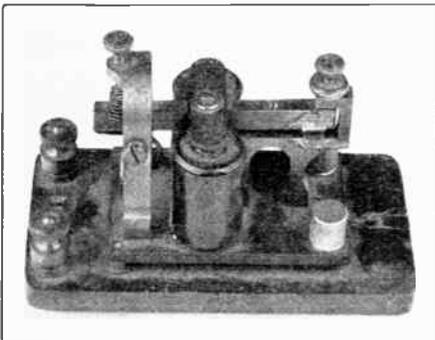

A GOOD SINGLE-CONTACT RELAY MADE FROM A TELEGRAPH SOUNDER

contact relay connected in the primary of the transformer feeding the plates from the 60-cycle or 500-cycle A. C. source will work very well indeed. If rectified D.C. is used, keying in the negative lead of the high

voltage source will sometimes fill the bill. A double contact relay with one set of contacts in the plate and one in the grid circuit is guaranteed to give satisfaction.

MAKING A SUITABLE RELAY

A keying relay can be made easily of an old telegraph sounder. The photograph shows a single contact relay made from a sounder. The brass sub-base should be removed and a piece of bakelite of the same size substituted. This can be drilled using the brass base as a template. Two additional binding posts should be added to the device to make it easy to connect to the contacts. $\frac{1}{4}$ " x $\frac{1}{4}$ " silver slugs $\frac{1}{16}$ " thick obtained from a jeweler make dependable contacts. These can be fitted into notches filed in the armature and frame of the sounder and soldered in place. A piece of copper braid or a thin brass spring should be connected between the U-shaped part of the frame and the armature so that the pivots do not carry any current. In addition, it will be necessary to fasten a bit of insula-

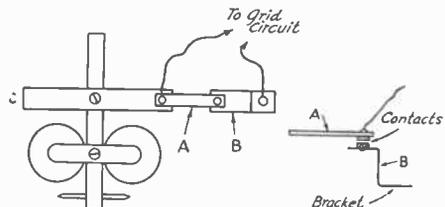

ADDING CONTACTS TO A TELEGRAPH-SOUNDER RELAY

tion between the armature and the back-stop screw to keep the armature from closing the circuit when the key is open. This can be threaded and glued to the back-stop screw itself or made a part of the armature. Such contacts are heavy enough to break the primary circuit of almost any amateur's plate transformer. The relay will operate from the same storage battery that heats the filaments of the receiving tubes or from a separate battery. It can be adjusted to work well at almost any desired speed without bad sparking or sticking.

The diagram shows how a set of contacts can be added to the sounder-relay to break the grid circuit. Remember that anything added to the armature must be as light as possible or the relay will be sluggish. The screw that holds the two parts of the armature together (also acting as a downward stop for the armature) can be taken out and a thin bakelite strip inserted just above the crossed metal pieces. Contacts for the grid circuit obtained from an old spark coil vibrator can be riveted to the

end of a thin spring (A) which is fastened in turn to the bakelite arm. A small bracket bearing the lower contact and two flexible leads to suitable binding posts will complete the layout.

The spring (A) should be bent so that the A-B contacts close just before the main power contacts close and so that they open only after the power is off.

REMOTE CONTROL

If you are one of those unfortunates who live in apartment houses, you can dispense with the troubles of getting a one-wire or two-wire R.F. feed line in operation by putting the sending set right at the center of the antenna system on the roof. This will make it very easy to use break-in and save you from worrying about losses in poor dielectrics which are certain to be in the field of the lead-in if it is brought right down to the operating room.

In a remotely controlled arrangement, relays can be installed in any one of several ways depending on the distance and on the combinations most desirable to fit the individual application. The problem is merely one of turning on and off the filament heating and plate supply power with a switch and a key, using a minimum number of relays and as small an amount of wire as possible to give results.

For installations up to 100 feet distant it is probably best to use no special relays at all—but to run the power leads through switch and key to the points desired. Three wires will be necessary unless wires from the same power source can be tapped at a point near the sending set to obtain a common lead for filament and plate transformers, in which case, but two wires will be required.

All relay contacts should be large enough to avoid the possibility of sticking if the set is remote controlled. The outfit must be built substantially and adjusted to operate stably, too. There is a lot of pleasure in operating a set some distance away and the improved break-in work makes it well worth considering, especially if your radio shack is going to be a small one. A number of good relays can be purchased if you do not wish to fix them up yourself but usually it is necessary to substitute larger contacts than generally provided for handling large amounts of current. If a motor generator is used an automatic starting compensator operated by a suitable relay will be necessary for starting up the set. If a synchronous rectifier is remote controlled, a polarized reversing relay will be necessary to reverse the connections to the primary of the plate

transformer each time it starts with the wrong polarity at the output. Simple relays can be built as suggested or made from spare bell and buzzer magnet windings using a soft iron core and a pivoted soft iron armature carrying the movable contact or contacts. The generator cut-out on a Ford can be made into a good relay using the fine winding in the keying circuits.

The beginner should limit his efforts to building a simple and inexpensive low power sending set and a good receiver and not attempt to start off with a remote controlled transmitter. The numerous "kits" of transmitting and receiving parts on the market make it especially easy to get started right at low cost. Remote control is not absolutely necessary to break-in work and it can always be added easily after the elements of a station have been built and are in operation. Remote control is the best possible thing for the fellow with the cold out-door shack or the radio room in the attic where the temperature hits the 100° mark in summer.

THE MASTER OSCILLATOR CIRCUIT

The importance of having a *steady* note has been emphasized several times in the preceding pages. While the ordinary arrangement of apparatus gives a reasonably steady signal, the addition of a master oscillator tube with an oscillating circuit of its own will insure a note that is steadier than usual with respect to antenna changes. By adding a quartz crystal to the layout, constant frequency transmission can be obtained under *all* conditions—more of that later.

The master oscillator circuit is so named because its output is used to control the frequency of the set instead of using it to feed the antenna directly as usual. The master oscillator can be crystal controlled or not; it can employ any of the commonly used vacuum tube circuits; the principle is the same in any event. The R.F. output of the master oscillator is all used for controlling the grid circuit of a radio-frequency amplifier, commonly known as the power amplifier.

The power amplifier grids are controlled by energy from the master oscillator. Therefore, a larger amount of the amplifier's plate power is available for the antenna than normally the case. (Of course the economy of the extra tube required as master oscillator is poor). The frequency of the output is the same as the frequency of the master oscillator's resonant circuit. The output of the power amplifier is fed to the antenna either directly through an output transformer or by means of an intermediate circuit to make the problem of

steadiness easier in the case of a highly tuned antenna. Too many amplifier tubes in parallel or too large a tube cannot be fed by one small master oscillator. The oscillator should always be large enough to supply the grid losses of all amplifier tubes. Under certain conditions, the power amplifier must be neutralized like the R.F. amplifiers used in so many broadcast receivers and for the same reason. With a master oscillator power amplifier arrangement a swinging antenna has less tendency to change the wavelength than is experienced with an oscillator coupled directly to the antenna.

The plate power supply for both oscillator and amplifier can be from the same source irrespective of tube sizes. The plate voltage for the smaller master oscillator tube must be cut down by putting a series resistance in the master oscillator plate lead. The proper size of resistor can be calculated easily knowing the plate current and the voltage rating of the master oscillator tube. The amount of voltage which must be absorbed by the resistor divided by the plate current will give the resistance value—just a simple application of Ohm's Law.

The filaments of both the master oscillator and power amplifier tubes can also be heated from the same source. Once again, a special resistance probably will be needed in series with the master oscillator filaments to drop the filament voltage to the right value for smaller tubes.

The exciting voltage for the power amplifier is obtained by taking the reactive drop across part of the plate coil (Hartley) or plate condenser (Colpitts). The filament circuit is common to both master oscillator and power amplifier. The connection to the power amplifier grids from the plate circuit of the master oscillator can be made through a variable condenser for the purpose of varying the amount of excitation. It is just as well instead to adjust the clip to use more or less turns of the Hartley plate coil if that circuit is used. Adjusting the master oscillator is carried out just as discussed elsewhere in this book for any transmitter. R.F. chokes must be placed in the plate supply leads of both master oscillator and lower amplifier. When tubes are paralleled in the power amplifier small chokes or resistances, perhaps both, will be needed in the grid and plate leads of each one to reduce loss from parasitic oscillations (especially when high-frequency operation is intended). These are placed in each lead so that they have little effect on the main circuit but they are in series with respect to the paralleled tubes to give the desired results. The choice of condensers and coils in either Hartley or Colpitts cir-

uits will of course, depend on what wavelength band you are designing the set to work in. The blocking condensers and R.F. chokes may be chosen just as for any outfit, from a consideration of the voltage breakdown and the working wavelength. Don't forget that if a Colpitts circuit is used, the condenser between grid and filament should have twice the capacitance of the one between plate and filament if the grid excitation is to be of the proper value.

An output transformer can be used to couple the power amplifier to the antenna circuit. It should be built and adjusted so that when the antenna is disconnected and out of tune, the plate current of the amplifier drops to a low value. The primary should be made of large wire if it is tuned with a condenser—otherwise, small wire can be used (for the radio frequency component of the plate current is no larger than the direct current component). The primary should be wound and connected in the plate circuit of the amplifier and tested with the master oscillator without at first attempting to transfer any power into the antenna. The number of turns in the primary should be adjusted so that the plate current is 15% its normal value (or less) under operating conditions. No. 24 or No. 26 wire on a 3-inch diameter form will make a good primary for an output transformer. Use about 15, 25 or 40 turns for a set that is going to work on 40, 80 or 175 meters respectively. Try different numbers of turns until the best adjustment is located—then remove most of the dead-end turns. The secondary (antenna) coil should fit closely over (or into) the primary. This winding will depend altogether on the particular antenna to be used. The reactance of the secondary of the output transformer and the reactance of the primary should be in the same ratio as the antenna reactance to the plate impedance of the amplifier. When the secondary is working nicely, a final adjustment of the primary turns will be needed to compensate for the effect of the added mutual inductance.

Keying in such a circuit must be accomplished in the power amplifier. The master oscillator is allowed to oscillate steadily and the key is usually placed in series with the power amplifier's grid leak so that the amplifier blocks whenever the key is opened and the plate current falls to zero. The Leach-type of relay opening both plate and grid circuits can be used to key the power amplifier to good advantage. In modulating such a circuit as this, the regular Heising system should be used with the modulator tube capacity the same as that of the power amplifier. If a high grid bias is used on the modulator even a greater number of tubes

may be desirable. It is *not* satisfactory to attempt to modulate the power supply of the master oscillator circuit.

PROPER TUBE COMBINATIONS

Master Oscillator	Power Amplifier
1 UX201A, UX112 or UX171	1 UX 210
1 UX210	2 UX210s or 1 UV203A
1 UV203A	2 UV203As or 1 UV204A

In building a crystal controlled outfit or using a master oscillator circuit, the apparatus should first be set up on a board where everything is accessible and where all the parts can be observed carefully and changed if found defective. After the breadboard outfit is working correctly, the parts are easily mounted in panel form if this is desired.

CRYSTAL CONTROL

Another interesting development until recently beyond the means of most beginners is the use of quartz crystals for controlling the frequency of the transmitter. The main advantage is an absolutely *steady* note whose pitch *never* varies or swings due to movements of the antenna or to slight changes in the constants of the tube circuit. A crystal properly used provides wavelength control not approached in any other form of transmitter.

Although an oscillator whose frequency is determined by a quartz crystal of the proper size in its grid circuit can be coupled directly to an antenna, the energy that can be directly controlled by a crystal is so limited that the crystal is usually placed in a master oscillator circuit and a power amplifier used to put more constant frequency energy in the antenna. The right tubes to give ample grid control of certain sized power amplifiers were listed in tabular form. The voltage and plate current ratings of these tubes may be found in another chapter. Other combinations such as a VT2 master oscillator controlling an H tube power amplifier may suggest themselves—our table is not a complete one.

Most amateurs purchase their quartz crystals cut, ground, and guaranteed to oscillate in one of the amateur bands. As good crystals are available for fair prices, there is no particular reason for mentioning the laborious process of making crystal oscillators from the rough quartz crystals here. A method for testing crystals and some notes on operating with crystal control are quite in order, however.

Quartz crystals are useful in radio work chiefly because of their piezo-electric properties. Many other kinds of crystals act in the same way but they are not as suitable mechanically or do not have as marked electrical properties as quartz.

Crystal action can be understood best by considering what happens when a crystal is supported between two metal plates to which a voltage is applied. As indicated by the diagram, the crystal becomes shorter along the lines A-B and C-D and longer along the lines A-C and B-D. It acts as though it were being squeezed by the two

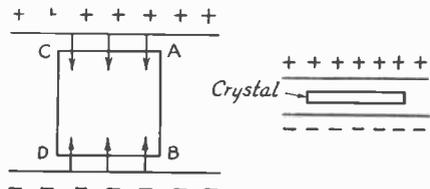

CRYSTAL ACTION

metal plates. If the polarity is reversed, the mechanical strain is reversed, also. The changes in dimensions are very, very small but they are there just the same. If mechanical pressure is applied to a crystal, the opposite action takes place and its surfaces become electrically charged. Just as in the case of a pendulum displaced from its normal position, a crystal whose shape has been changed by mechanical or electrical means will immediately return to its original dimensions. In doing so, it swings through the "zero" position and oscillates backward and forward—at radio frequency. A crystal can be made to oscillate at two definite frequencies determined by its thickness in the usual position or when supported endwise.

A crystal should be ground with absolutely flat and parallel surfaces. If the thickness is not uniform it may not oscillate. The shape of the crystal is not important. It is convenient to have it rectangular or circular but an irregularly shaped crystal will be just as satisfactory if it is of uniform thickness and has no scratches on the flat surfaces. The thinner the crystal, the lower its fundamental wavelength. Grinding to reduce the fundamental can be undertaken with a mixture of No. 301 powdered emery and kerosene, pushing the crystal in circles on a flat glass or steel plate. The final grinding should be done with No. 100 carborundum and oil. The crystal should be cleaned frequently with carbona or carbon tetrachloride from a pyrene fire extinguisher and tested for wavelength. If the crystal was cut with its length parallel to the optical (Z) axis which runs vertically through the crystal parallel to the sides, its thickness parallel to the X axis (which may bisect any of the angles of the crystal) and its width parallel to the Y axis (which is perpendicular to any of the sides of the crystal), it should oscillate at a wavelength proportional to

the thickness (about 105 meters wavelength per millimeter thickness of the crystal).

TESTING THE CRYSTAL

A receiving tube can be connected in the elementary crystal circuit shown to test crystals. A fairly high plate voltage and a

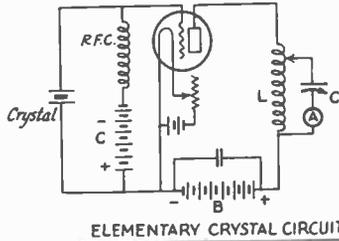

ELEMENTARY CRYSTAL CIRCUIT

C-battery of -1.5 to -10 volts should be used. The coil L and condenser C should be chosen to tune over the wavelength range in which the crystal is expected to oscillate. The hot-wire or thermo-coupled ammeter (A) shows a deflection only when the crystal is oscillating. For a test circuit, using a receiving tube a 0-100 milliamperere hot-wire meter will be plenty big enough.

As the condenser and coil are tuned to approach the natural frequency of the crystal, the hot-wire meter will start to read. The nearer the condenser-coil circuit is tuned to the frequency of the crystal, the greater will be the deflection until at resonance, the tube will stop oscillating because the tuned choke reaches an extremely high value of impedance at the working frequency. In a transmitter, this circuit is always tuned to a wavelength a little less than the natural wavelength of the crystal. The L-C circuit can be varied within quite large limits without changing the beat note that the crystal controlled tube gives when loosely coupled to

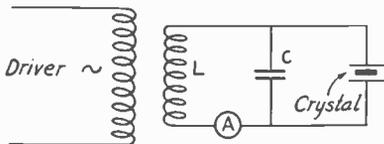

CIRCUIT USED TO SHOW CRYSTAL ACTION

an oscillating receiver. Meters in the grid and plate leads of the crystal testing circuit will give a positive indication of oscillation if one does not happen to have an R. F. meter of the right scale size. Any meter put directly in the grid lead should have an R.F. choke in series with it to protect the meter and the combination of meter and choke should be shunted with a large R.F. bypass condenser to make the test outfit work rightly.

Crystals also can be tested by setting up a circuit such as diagrammed to show crystal action. A coil (L), condenser (C), and R. F. ammeter (A) are connected in series. Across the condenser-coil circuit is the quartz crystal to be tested, mounted between two flat metal plates. A high frequency driver is coupled to the coil so that the current indicated on A can be plotted for different frequencies of the driver. If the crystal is a good oscillator, a point will be found where the current in the L-C circuit drops sharply. If C is variable, the setting can be changed so that the L-C circuit resonates at the same frequency as the crystal at which setting the dip on A will be more pronounced as the crystal absorbs power from the driver. This frequency is bound to be either the fundamental or a harmonic frequency of the crystal. A sketch of the resonance curve of the crystal and condenser-coil circuit is shown to illustrate better what happens in testing

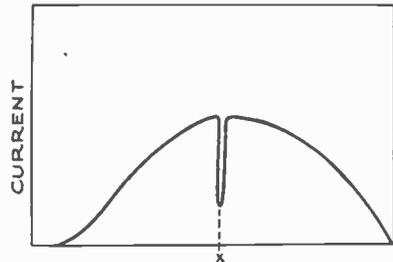

RESONANCE CURVE OF CRYSTAL AND TUNED CIRCUIT

crystals. If a grid-current or plate-current meter is used in the driver, a change in the deflection of the meter will show both the resonant point of the L-C circuit and the natural frequency of the crystal if it is a good one.

If you come across a crystal that refuses to oscillate even after repeated grinding and cleaning and a careful inspection to see that there are no scratches to be ground out, it still may be possible to get some results from it by means of a little regeneration in the crystal controlled circuit. Increase the number of turns in the plate coil a little. If this does not do the trick by increasing the feed-back through the tube capacity, add a small coil (L_1) in the grid circuit. If the crystal has any oscillating properties at all it will pick up and determine the frequency of oscillation when the rest of the circuit is tuned to nearly the right frequency. For 80-meters the grid coil should have about 15 turns of wire 2 inches in diameter. The right combination is not critical and can easily be found by trial. Don't add any grid coils if you have

a crystal that *does* oscillate satisfactorily. Crystals always crack if vibrated too-hard and not a thing will be added in the way of control by using regeneration with a *good* crystal. Sometimes a poor crystal can be

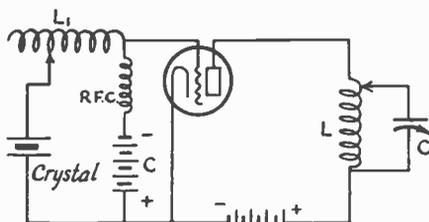

ADDING REGENERATION
WHEN THE CRYSTAL WON'T OSCILLATE

made to work with a small coil in series to bring joy to some amateur's heart and that is the sole reason for this paragraph.

MOUNTING

The simplest way to mount a crystal is between two absolutely flat smooth metal plates. Brass plates which have been turned in a lathe and ground flat with fine emery have been successfully used in a number of installations. The plates must be kept clean, free from both moisture and finger marks. The vibrations of the crystal can take place when the crystal is mounted loosely between the plates or even when the plates are pressed quite tightly together as is usually the case. Anyone can build a good mounting similar to the one used at 4XE. Make the plates at least an inch

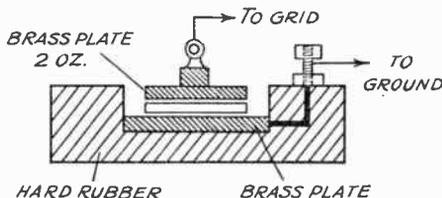

THE 4XE CRYSTAL HOLDER

square and about 1/8" thick. The plates may be held together either by gravity alone, or by a light spring pushing down on the upper plate. The crystal always starts oscillating by itself every time the plate power is applied as by keying provided the circuit is properly adjusted. A little pressure is probably best to hold the crystal firmly in place and to insure good contact with its surfaces which will mean good output and frequency control. The top plate should float free on top of the crystal.

In putting the crystal into the mount-

ing do not handle it with greasy fingers. This will positively prevent oscillation. Crystals can be cleaned as often as necessary in carbon tetrachloride or in most any other similar grease solvent. It does not matter whether the surface of the crystal is highly polished or not. Crystals with a frosted finish appear to make just as good oscillators as those with a clear polished surface.

OPERATION

The elementary circuit that was shown in one diagram is the basis of most all the circuits using a crystal to give a steady note. A UX210 is probably the largest tube that can be *directly* crystal controlled. If a UX210 tube is used instead of a receiving tube and the plate voltage raised to about 350 volts (with $-22\frac{1}{2}$ to -45 volt C-battery), the plate coil (L) can be coupled directly to the tuned antenna circuit making a very good constant frequency transmitter. The grid choke (RFC) should be wound with fine wire and made as small as possible. As soon as the antenna is tuned to the wavelength of the crystal (or even to one of its harmonics) some power will be absorbed and radiated. The amount of power from a UX210 is limited and if more output is desired, the same circuit and tube can be used as *master oscillator* and a larger amount of antenna power obtained from the *power amplifier*. Be careful *never* to overload the UX210 crystal controlled circuit. About 350 D. C. volts and 50 milliamperes plate input is all that most crystals will stand without overheating and cracking. Some will not even stand as much as this without shattering into fragments from the intense inter-molecular strains of oscillation.

It is best not to attempt to use a crystal that is too thin. Although it is possible to grind crystals to work on the forty meter wavelength band that oscillate very decently, they will not handle very much power without overheating, cracking and shattering. It is far better to use crystals ground for wavelength *longer* than 75 meters. The additional thickness is a factor of safety on your investment. If the crystal has a natural wavelength of just two or three times the wavelength on which you wish to operate, you can operate the antenna by tuning it to one of the harmonics. Better still, you can build a transmitter using the crystal in the master oscillator circuit, tuning the output circuit of the power amplifier so that it amplifies the proper harmonic—a dodge that saves neutralizing the power amplifier which ordinarily is necessary when amplifying the fundamental of a crystal. The power amplifier can always be depended on as a reliable frequency doubling circuit not requiring neutralization when so operated.

ADJUSTMENTS

Before mentioning various combinations of tuned input and output circuits that will enable us to operate in any wavelength band using a 160-meter crystal we are going to explain the adjustments of a crystal controlled set such as shown in the diagram assuming that we want to operate on the fundamental of the crystal. The master oscillator is shown at the right having the tuned circuit L-C. The power amplifier (shown neutralized for fundamental operation) is at the left. Its tuned output circuit is L_1-C_1 . The master oscillator adjustments are carried out like those of any simple transmitting circuit. The condenser C is adjusted for maximum current in the L-C circuit with a minimum reading of plate milliammeter (MA): Listen to the beat note in an oscillating receiver on 20 or 40 meters (double-harmonic) and make sure that it is strong and steady. Couple L_2 to L for the time being in order to tune the antenna to resonance by noting the proper adjustments of C_2 and L_2 to give the maximum deflection on A_1 . When this has been done, L_2 is coupled to L_1 , leaving the antenna tuning the same. Next the power amplifier grid clip is connected to some point on the plate end of coil L—a few turns inside of the plate clip of the master oscillator will be about right. You are now ready to neutralize the amplifier circuit by adjusting condenser C_4 . This will be possible *only* if the oscillator and amplifier circuits are properly isolated or shielded.

There is usually some regeneration present in an amplifier circuit all the time due to the tube inter-electrode capacities and to the disposition of coils in the circuit. If the feed-back reaches a large enough value, the crystal will become shattered. If operation on the fundamental is intended, the master oscillator should be built in a completely shielded metal box. Each stage of power amplification (if there is more than one) must also be similarly shielded to make complete neutralizing possible.

In neutralizing the power amplifier start by turning on the filament supply for both the master oscillator and the power amplifier tubes. Connect the plate supply to the master oscillator but *not* to the power amplifier tube. Now adjust C_4 until

there is a *minimum* change in the deflection of MA when tuning condenser C_1 in the amplifier circuit is varied. If the master oscillator is well-shielded so that complete neutralization is possible there will be little or no change in the plate current of the master oscillator if C_4 is adjusted after the proper setting of C_1 is found.

Next it will be necessary to readjust the master oscillator tuning condenser C for a maximum reading on A with minimum plate

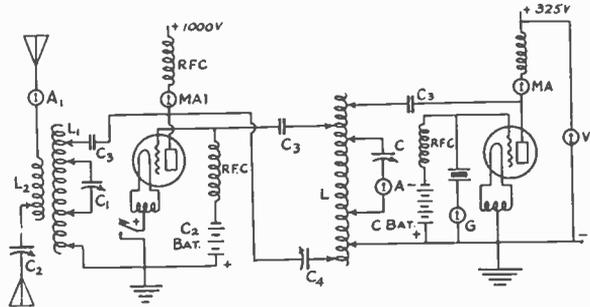

CRYSTAL-CONTROLLED CIRCUIT USED AT MANY AMATEUR STATIONS FOR THE 80-METER BAND

A single UX-210 is used as the crystal-controlled master oscillator. One or two UV-203A's can be used in the power-amplifier which is neutralized by C_4 to prevent too much regeneration in the amplifier circuit, which may feed back into the crystal circuit causing the crystal to crack.

L and L_1 —10 turns R.C.A. coil.

L_2 —4 turns of the same.

RFC—200 turns No. 36 D.C.C. wire wound on a $\frac{1}{4}$ " dia. wooden form.

C—500 μ f. variable condenser.

C_1 —250 μ f. variable condenser.

C_2 —430 μ f. variable condenser.

C_3 —2,000 μ f. fixed condenser.

V—0-15 volt A.C. meter.

X—Key.

C_4 —A 250 μ f. variable condenser which has been double spaced.

This can be made from a receiving condenser.

G—0-100 milliamperes thermo-galvanometer.

A and A_1 —0-3 ampere thermo-ammeter.

MA—0-100 milliamperes scale D.C. ammeter for the UX-210 plate supply circuit.

MA1—0-500 milliamperes scale D.C. ammeter for the power amplifier.

C—BAT—22½ to 30 volts.

C_2 —BAT—90 volts.

current. Then further adjustment of neutralizing condenser C_4 will be required. The two adjustments should be repeated until there is maximum R. F. current in the master oscillator L-C circuit with minimum plate current and at the same time very little *change* in plate current (MA) when C_1 is varied.

Now somewhat reduced plate voltage (as always in testing and adjusting) can be applied to the power amplifier. L_1 and C_1 are adjusted until the circuit hits resonance with the master oscillator frequency. A_1 now shows a reading because the antenna circuit was previously tuned to the right wavelength and is now coupled to L_1 . C_1 and C_2 are now adjusted for maximum antenna

current. If MA₁ reads too much or the power amplifier shows undue heating, the bias voltage on the amplifier can be increased (it is usually about 10% of the amplifier plate voltage). Another remedy is to loosen the antenna coupling or to add turns in L₁ to raise the external plate impedance.

With full voltage on the amplifier it may be advisable to change the grid clip position on the master oscillator plate coil to get more input to the amplifier grids. If so, move it toward the plate clip of the oscillator. Changes in grid clip position will necessitate a slight readjustment of neutralization (and probably of the oscillator too). When everything is working nicely note the setting of C and then change it until maximum antenna current is obtained. Make any other slight readjustments that seem necessary from the looks of the tubes or readings of the meters before starting to operate.

Listen to the beat note of the oscillator on a receiver. When the amplifier is keyed, the tone should stay the same with an increase in audibility. If the note changes it indicates that the circuits are not well-tuned or that there is quite an amount of feedback. Feedback always is indicated by an increasing current in the L-C circuit or by an increasing deflection of the thermo-couple galvanometer G in series with the crystal. The antennt and amplifier must be kept carefully in tune or the amplifier tube or tubes will overheat. On the other hand, if the crystal stops oscillating or if the master oscillator tube is removed from its socket, the power amplifier operates quietly at no load.

AMPLIFYING HARMONICS OF A CRYSTAL

An extra-high bias voltage on the grid of the crystal oscillator tube tends to make the harmonics in the output of the oscillator more pronounced. This is desirable when one wants to pick off a particular harmonic for exciting the grids of the power amplifier tubes. When the power amplifier is depended on to act also as a frequency doubler it is desirable that this, too, have an unusually high grid bias and for the same reason, to emphasize the higher frequencies and obtain more output on the shorter wavelengths than would otherwise be possible. Grid bias is best provided by a large C-battery. Though it can be taken from the drop across a resistor in the negative plate lead, this varies when the power amplifier is keyed which makes the C-battery the more suitable of the two methods. It will seldom be necessary to use over 50 volts bias on a UX210 or 100 volts bias on a UV203A, as most crystals are rich in harmonics.

Usually a crystal controlled set is built to operate on some wavelength within one amateur band which is a comparatively simple job. The easiest arrangement, permitting the use of a fairly thick crystal and avoiding neutralizing, employs a master oscillator adjusted for 160-meter operation, with the power amplifier output circuit and antenna both tuned to 80 meters when it is desired to send on that wavelength. The use of high grid bias on both oscillator and amplifier helps the output considerably. Of course an 80-meter crystal will easily produce a good 40-meter signal by tuning the power amplifier output circuit and antenna to the second harmonic of the crystal in similar fashion.

A somewhat more flexible crystal controlled set can be built, however. With a 160-meter crystal it is possible to operate without neutralizing on either 20, 40, or 80 meters. As usual the power amplifier is depended on for frequency doubling. A carefully arranged input circuit to the power amplifier picks the desired harmonic. Twice the input frequency is obtained from the output.

A coil of 40 turns of No. 20 wire on a 2½" diameter form should be connected between the plate of the master oscillator and the usual L-C output circuit with a 160-meter crystal. A different coil will be needed for a crystal of different wavelength, the coil to be so designed that the crystal operates properly without a tuning condenser across this coil. The best way to design such a coil is to put a ½-ampere R. F. ammeter in the L-C circuit. Try removing turns from the special coil taking one off at a time. If there are too many turns, the L-C current will rise gradually as each turn is taken off. After the proper inductance is passed the L-C current will fall off quickly.

The grid circuit of the master oscillator contains the 160-meter crystal. The L-C output circuit of the master oscillator resonates at 80 meters, however. In the lead from the master oscillator plate to the L-C 80-meter-tuned circuit is the special coil mentioned to enable the master oscillator to operate under such conditions. The clip to the power amplifier grids is taken off the L-C coil outside the connection which goes (through the special coil) to the master oscillator plate instead of being connected between the plate and filament clips as usual. The output of the power amplifier is tuned to 40 meters (slightly retuning the 80-meter resonant P. A. input circuit if necessary).

With this arrangement the special coil in the oscillator plate circuit can be shorted out, L-C tuned to 160 meters, and the amplifier output and antenna tuned to 80 meters for 80-meter work. 40-meter operation was explained in the paragraph

above and requires amplifier output and antenna tuned to 40-meters. For 20 meters the 40-meter system is used except that the output circuit of the amplifier and the antenna are now tuned to 20 meters. It is well to remember the thump filter when transmitting with the amplified harmonics of a crystal. The filter should go between the key and the plate input to the power amplifier. A 150,000-ohm resistor across the key helps materially in reducing troubles from thump by keeping oscillations at a very low value with the key open.

prettilly modulated indeed, broader than the usual crystal controlled note but much sharper than any signal from an ordinary set employing a so-called self-rectifying circuit with A.C. on the plate. The crystal tends to continue in oscillation even during the "zero" part of the A.C. cycle which gives a clear rattling note with a 60-cycle supply and a piercing whine if a 500-cycle supply is used.

Although a crystal will not successfully control more than one UX210 with D.C. plate supply, two UX210s may be used in

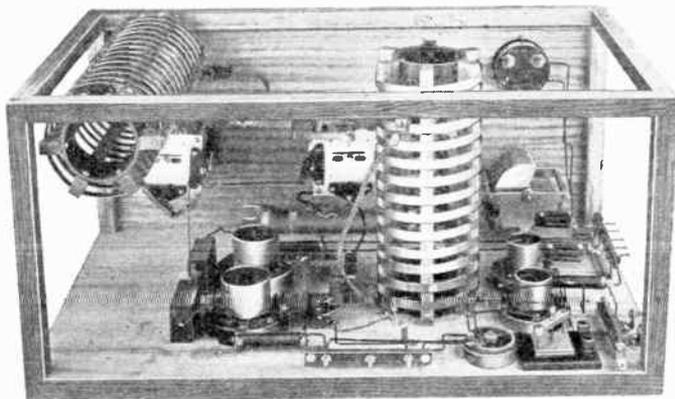

REAR VIEW OF AN A.C. CRYSTAL-CONTROLLED TRANSMITTER USING TWO UX-210'S AND TWO UV-203-A'S

Note that the coils in the master oscillator and power amplifier circuits are at a distance and at right angles to make the coupling between them as low as possible. The crystal is mounted between the two brass plates and the output is greatest when there is a little pressure exerted on the top plate by an adjustment of the spring. The hinged antenna coupling coil can be mounted on the rear left corner of the frame work and the series condenser and antenna ammeter will go on the panel in front. They are omitted from the photograph for clearness.

A.C. OPERATION WITH CRYSTALS

Another advantage of crystal control (besides absolute steadiness) is that a rather poor source of plate voltage may sound very well indeed if a crystal is used. A crystal controlled set will readily suppress a bad commutator ripple from a motor generator. No matter what sort of a poorly-filtered plate supply you have, crystal control will always steady and *improve* the note. Although a slightly modulated note is more pleasant to copy for hours at a stretch than even a crystal controlled one there is no doubt that quartz crystal control is worthy of more general adoption. Its several advantages seem to outweigh the disadvantages in most instances.

Crystal control can be applied to almost any arrangement of apparatus and plate supply. If D.C. is not available, A.C. can be used. The note will be very clearly and

the usual push-pull self-rectifying circuit for A.C. work. Between 350 and 400 volts A.C. may be successfully applied to such an arrangement. Two tubes can be used in this fashion working right into the antenna or if more output is required a power amplifier can be added. The connections of a crystal controlled push-pull A.C. master oscillator are shown on the right of our diagram. The left hand tubes are those of the power amplifier. Both sets of tubes can be fed from one tapped high voltage transformer as shown or a transformer with but one voltage can be used with the proper resistances in the plate leads to give the necessary voltage drop for the smaller tubes in the master oscillator. In this instance the antenna is working against ground instead of with a counterpoise as usual.

The photograph shows how the parts are conveniently mounted. The coils are spaced far apart and at right angles when the

master oscillator is not shielded to keep the coupling between them low so that there will be little feedback to endanger the crystal. The chokes are wound on small dowels using fine wire. The sockets shown are provided for two UX210s and two UV203As. A good mounting for the crystal is shown in the photograph. When a set is shielded, it is important that the coils be

Electrical measurements are based on the use of one or more calibrated instruments especially made for their application. These instruments vary in construction depending on whether they are for use with direct current, alternating current at commercial frequencies (25 or 60 cycles), or for radio measurements where you are dealing with frequencies of millions of cycles.

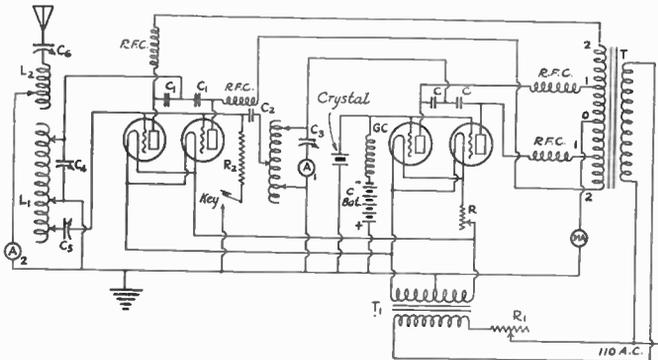

COMPLETE CIRCUIT OF A 40-METER A.C. CRYSTAL-CONTROLLED SENDING SET

- T—Tapped plate transformer. 400 volts between 0 and 1. 1500 volts between 0 and 2.
- T1—250-watt filament transformer with a 12-volt secondary.
- R—2-ohm rheostat to adjust filaments of crystal tubes.
- R1—Primary rheostat to adjust all filaments to supply voltage conditions.
- RFC—200 turns No. 30 D.C.C. on half-inch wooden dowels.
- GC—140 turns No. 26 D.C.C. on half-inch dowel, tapped every 20th turn after the 80th so that the "best" adjustment can be used.
- C—2,000 μ f. Sangamo blocking condensers.
- C1—2,000 μ f. mica blocking condensers (7500 volt breakdown).
- C2—400 μ f. fixed mica grid condenser (4,000 volt breakdown).
- C3—Double-spaced Cardwell receiving condenser, resultant max. capacity 250 μ f.
- C4, C5, and C6—National or Cardwell 100- μ f. transmitting condensers.
- C—BAT—40 volts.
- MA—0-500 milliamperes D.C. ammeter.
- A1-A2—0-5 ampere scale thermo-ammeter.
- L-L1—14 turns flatwise-wound $\frac{3}{8}$ " brass strip spaced $\frac{3}{8}$ ". Diameter $4\frac{1}{2}$ inches.
- L2—6 turns No. 12 wire hinged on hard rubber form.

small to keep the magnetic field from spreading out and inducing heavy R.F. currents in the shielding. Such eddy currents will cause a serious power loss if the set is not very carefully planned and constructed. An un-neutralized set working on amplified harmonics of the crystal is best for the inexperienced builder to attempt.

ELECTRICAL MEASUREMENTS

The simple measurements of resistance (D.C.) and impedance (A.C.) have been described in the explanation of how to find the inductance of the filter choke. The proper use of voltmeter and ammeter followed by a substitution of the scale readings in Ohm's Law makes the determining of many circuit constants possible.

Two of the most important quantities to be measured are *current* and *voltage*. The instrument for measuring the rate of current flow is called an *ammeter* because the unit of current is taken as the "ampere". The unit of potential difference is the "volt" from which we name the instrument for measuring electrical pressure a *voltmeter*. Some instruments may be used for one kind of current only; others are suitable for both D.C. and A.C. Meters are built on various principles, each of which has a field of application and certain advantages and disadvantages. Most commercial instruments are built ruggedly and compactly. A pivoted movement carries a pointer moving over a scale which is calibrated directly in terms of volts, amperes, watts and so on, depending on the construction and circuit of

the instrument. In most indicating instruments a fine spiral spring holds the pointer in its zero position when no current is flowing.

Many direct current instruments make use of a moving coil pivoted between two permanent magnetic poles. This type of instrument is known as the d'Arsonval type, taking the name of the physicist who first made use of the principle. The deflection depends on the current through the moving coil which is connected to the terminals of the instrument. When heavy currents are to be measured, metal shunts are connected across the terminals of the meter to pass some of the current. The scale of the meter can be calibrated to read the current directly when the shunt is built into the instrument. However, a sensitive voltmeter is often used for measuring current when a set of shunts of known resistance is available. The current value is figured out by knowing the resistance of the shunt, measuring the voltage drop across it when current flows, and applying Ohm's law.

Voltmeters are made by connecting a high resistance in series with the d'Arsonval movement to limit the current flow and power consumption of the instrument to a small amount. The resistance is usually placed right within the instrument itself. The value of resistance, the size of the spring, the number of turns in the coil, and the strength of the magnetic field (which determines the torque for a given current) all have an effect on the range of the meter. Any low-reading D.C. milliammeter will make a good D.C. voltmeter when calibrated with a suitable external resistor.

If you have an instrument of the d'Arsonval type it can be used either as voltmeter or ammeter if separate calibrations are made with various external shunt and series resistances. An external resistor or "multiplier" placed in series with any voltmeter will increase the range of the meter so it may be used to measure higher voltages than given on the scale of the meter. The internal resistance of the voltmeter must first be found using Ohm's law. Substitute the values for the current the meter takes (measured on a milliammeter) and voltage applied to the meter in Ohm's law to get the resistance of the movement and series resistor. A fresh 22½-volt block B-battery will do for a source of voltage if only a rough calibration is necessary. If the total resistance in the circuit of the meter is doubled, the deflection will be just half the value for a given voltage that was obtained before adding the external resistor, so that the scale readings can be multiplied by two—which is the reason such an external resistor is called a multiplier. If it is desired to increase the useful scale of a volt-

meter by adding resistors of unknown value, take two meter readings, one with the voltmeter "as is" and the other with the external multiplier in series with the meter and the same applied voltage. The ratio of the two readings is the figure by which any and all scale readings of the meter can be multiplied to give the correct results.

Any pocket voltmeter can be used as a milliammeter in connection with circuits whose resistance is comparatively high (compared to that of the meter). As the plate impedance of small vacuum tubes is high, such a meter can be connected right in series with the negative lead from the high voltage plate supply to a vacuum tube circuit. If one cares to alter the connections inside the voltmeter, bringing out an extra lead so that the movement can be used without any resistance in series with it, the meter will have less effect on the external circuit. One should take precautions never to overload the meter. A calibration curve may be made for the meter or the current figured out by writing Ohm's law:

$$\text{Milliamperes} = \frac{(1000) (\text{reading in volts})}{(\text{resistance between meter terminals})}$$

Direct current instruments such as described using permanent magnets must never be connected in A.C. circuits. The permanent magnets will be weakened, ruining the calibration. The pointer will tend to vibrate but cannot follow the alterations. Direct current meters of the type described measure the *average* value of the current passing. This must be considered when a D.C. meter is used to measure fluctuating current such as that supplied to a self-rectifying vacuum tube oscillator. The average value of a complete A.C. cycle is zero.

The value of an alternating current ampere is based on its heating effect which varies as the square of the current. The square root of the average of the squares of all the instantaneous values of an alternating current over a half-cycle is called the *effective* or *root-mean-square* value which is a true measure of the heating effect. Taking the peak value of sine wave alternating current as unity, the *average* value (sum of all the instantaneous values divided by the number of values) is .637 while the *effective* value is .707. Thus the plate input to a self-rectifying circuit as measured on a D.C. meter does not give a true indication of the heating effect. Its readings are *average* readings and they

must be multiplied by about $\frac{.707}{.637}$ or 1.11 to give the *effective value*.

Both alternating and direct current can be measured by instruments of the electro-dynamometer type. Such instruments contain both a fixed and a movable coil, the fixed coil taking the place of permanent magnets. The calibration is in terms of the torque or force between the two coils through which the current is passed. As the fixed and moving coils are in series, the current reverses at the same time in both and the force of attraction between coils is always in the same direction. This instrument reads *effective* values of fluctuating current and voltage. Such meters are usually calibrated on steady direct current, but they are very accurate at all commercial frequencies as usually manufactured.

A third type of instrument has a moving iron plunger which is drawn into a solenoid by the current. If the soft iron plunger is well-laminated such instruments read equally well on A.C. or D.C. The better class of instrument utilizes a soft-iron vane mounted on the shaft in an inclined position. The vane tends to become parallel to the lines of force from the stationary coil which is inclined about 45° with the shaft. This instrument also reads *effective* values and the type is quite commonly used for pocket meters and switchboard instruments.

Induction-type instruments work by means of a split-phase alternating field. Indicating and recording ammeters, voltmeters, watt and watt-hour meters, power factor meters and so on base their use on this principle which is discussed in any good electrical engineering text book. It should not be necessary to add that they will work correctly only on alternating current of certain specified commercial frequencies.

Electrostatic voltmeters depend on the mechanical attraction between two charged surfaces at a difference of potential. They can be used for either A.C. or D.C. but are unduly bulky for use below 3,000 volts. For high voltage work they are quite accurate and they sometimes can be used in amateur work for measuring plate supply voltage. Condensers answer the same purpose for electrostatic voltmeters as do multiplier resistances for ordinary A.C. and D.C. voltmeters.

Hot-wire instruments are familiar to every amateur. The current to be measured heats a wire and the scale of the meter is calibrated to read amperes from the change in the length of the wire. Such instruments can be used with equal facility for direct current, low-frequency alternating current, and radio-frequency alternat-

ing current measurements. A hot-wire instrument calibrated with direct current will read true effective values of alternating current with the possibility of slight errors creeping in at radio frequencies due to the capacity between terminals and to the fact that radio-frequencies travel on the surface of wires rather than on the inside, thus raising the effective resistance of the meter.

Another meter familiar to the amateur is the thermo-coupled type. The current to be measured is sent through a small resistance or "heater" strip which warms a thermo-junction. This is connected to a sensitive galvanometer of the d'Arsonval type which is calibrated directly in amperes at 60 cycles for commercial purposes. For laboratory measurements a sensitive D.C. meter is used with several thermo-couples and thermo-couple bulbs to cover different ranges. The couples are often sealed in a bulb full of dry hydrogen which protects the junctions from atmospheric changes and movements of the air, dissipating the generated heat at a constant rate. Properly constructed and calibrated, this sort of instrument will read *effective* values of alternating current at both radio and commercial frequencies. If the couple is separate from the heater the instrument will read equally well on D.C. However, the usual thermo-coupled meter sold for radio work contains a copper-Advance couple spot-welded to a manganin heater strip and unless the weld covers a very small area there is some likelihood that the direct current being measured will get through to the galvanometer causing its readings to vary from the correct ones. Unless the couple and the heater are intimately related, there is danger that much of the heat will be lost before it reaches the couple. Hot-wire and thermo-coupled meters can be calibrated in either terms of current or current-squared, so it is well to note the type of calibration before making any measurements. Current-squared instruments are usually called thermo-galvanometers.

There are certain qualifications of all meters that should be considered by the prospective purchaser. For most work at an amateur station, precision equipment is neither necessary nor desirable. Meters should be rugged, fairly accurate and not unduly expensive. *Permanency of calibration* is always the first requirement; extreme accuracy is secondary and dependent on permanency. A wavemeter that does not hold its calibration well is practically useless. No matter how accurately it was calibrated, its correctness cannot be depended on. Indicating meters should be shielded from stray magnetic fields, should have a suitable and legible scale, high sensitivity (low friction), and they should be

dead-beat (the pointer should come to rest quickly). The springs and magnets should have as permanent qualities as good manufacturing conditions and processes can insure. Instead of using a large multiplying resistance with A.C. voltmeters, it is most economical to use an "instrument" transformer, to step-down the high voltage. By knowing the ratio of the transformer, the proper multiplying factor can be used. The scale may be calibrated directly in terms of the higher voltage if necessary. The resistance method is necessary for measuring high D.C. voltages though it is wasteful of power.

In applying meters to radio circuits, it is best to get meters which have a full-scale deflection at about double the value at which you will ordinarily work. This brings the reading in the center of the scale and makes it possible to use the meters for lower or higher ranges. Always put plate ammeters in the *negative* high voltage leads when possible. This will keep them at low voltage (nearly ground potential) which makes them safe to handle and protects them from insulation breakdown as well. A meter to measure the D.C. component of the grid current should be placed in series with the grid leak resistor and a small radio-frequency choke coil (to protect the windings from radio-frequency voltages that may otherwise build up across them). A low-reading hot-wire or thermo-coupled meter in series with the grid condenser will show that the radio frequency component of the grid current of an oscillator is about proportional to the R.F. values elsewhere in the circuit. If it is necessary to put a D.C. meter in a radio frequency lead, be sure to protect it with a radio frequency choke of the right size and to by-pass high-frequency currents around the meter and its choke coil by shunting them with a condenser of ample capacitance. A radio-frequency meter placed in a lead carrying a current with both a D.C. and an A.C. component will indicate both and the effect of the direct current must be subtracted out of the scale reading to give the value of radio frequency current. It is well to see that a small D.C. and A.C. current give the same (or proper) deflection on the meter, too, as a little D.C. getting through to the d'Arsonval movement may throw the reading away off. Multipliers for high voltage D.C. meters should be mounted where the live parts are out of reach, preferably in a grounded metal-incased box. The measurement of direct current quantities and even of alternating currents at commercial frequencies is comparatively simple compared to some of the measurements made at radio frequencies. About all anyone needs to know to measure direct current quantities is how to apply Ohm's law and how to connect the meters so they have little effect on the measure-

ments themselves. The measurements of radio-frequencies should be thought of as simply an advanced application of ordinary alternating current laws, however. The construction and use of a wavemeter (or radio frequency meter) has already been described and now we are going to touch on some of the more common and useful measurements that anyone can make at a radio station.

ANSWERS TO SOME COMMONLY-ASKED QUESTIONS

How can plate input power be measured?

Plate input power can be measured with a plate ammeter and voltmeter (D.C. instruments). A watt-meter may also be used if the proper voltage multiplier is available. If an electro-dynamometer type watt-meter is used to measure power in the low voltage side of the plate transformer, the transformer, rectifier, and filter losses must be subtracted from the reading to give the plate dissipation.

What does "reactance" mean?

Reactance is the *property* of a coil or condenser. It is that property depending on the frequency and inductance (or capacity) which determines the behavior of the coil (or condenser) in limiting the current that flows when an alternating current voltage is applied. Reactance is one component of the "impedance". Resistance, the other component, is always present in coils and condensers and must also be taken into consideration.

In how many ways may the coupling between two tapped hinged coils be changed?

The coupling in such an arrangement may be changed by changing the number of active turns in either coil or by changing the relative position of the coils (distance or angle between them).

What is the difference between inductive and capacitive coupling?

Whether the coupling is inductive or capacitive is determined by whether the two circuits are linked by a *magnetic* or an *electro-static* field, in short by whether the link common to both parts of the system is a *coil* or a *condenser*.

What does an antenna ammeter measure?

An antenna ammeter measures *current* in the antenna at the point where it is located—nothing more. It does NOT measure set efficiency, radiation, or energy directly.

How can the power in the antenna be calculated?

Antenna power may be considered as the input to the set minus the losses in the set. If a resistance curve of the antenna is available, antenna power is (RI^2) where R is the resistance at the wavelength under consideration and I is the current at the center of the radiating system.

Here is another way of calculating antenna power. The plate voltage times the plate current (D.C. values) gives the plate power. The input power times the efficiency of the set (known or estimated as 50 to 60%) gives the output power from the transmitter or power in the antenna circuit. Substituting the value of antenna current (at node) in the formula $(P=RI^2)$ gives a value of antenna resistance at the wavelength in use.

RADIO MEASUREMENTS

Many pieces of apparatus can be constructed from specifications or by using various curves to show the combinations of capacity and inductance necessary to cover a certain range of wavelengths. However, there are many things that can be found out only by making actual measurements of apparatus. The calibration of a wavemeter requires the use of a radio frequency driver as has been described. The measurement of the fundamental and harmonic frequencies of antennas, coils, and of circuits containing various combinations of capacity and inductance can be carried out most conveniently by using a radio frequency driver. Such a driver is almost a necessity for measuring inductance and capacitance, determining the high frequency resistance of an antenna system at different radio frequencies, and so on.

A GRID-METER OSCILLATOR

Although a radio frequency driver for any wavelength range can be thrown together on a small "breadboard" at short notice, it is so useful an instrument that an oscillator more permanently constructed with plug-in coils to cover different wavelengths is desirable. The oscillator should cover all wavelengths at which measurements will ordinarily be made and it should oscillate strongly at all possible adjustments. It is most convenient to have a low reading milliammeter in series with the grid leak in the oscillator circuit for use as a resonance indicator between the circuit driver and other tuned circuits. The grid current of an oscillator drops sharply at resonance with another circuit, giving a positive resonance indication. All that is necessary to put such a driver in operation is to

connect A-batteries and B-batteries to the proper binding posts and to plug-in the proper coil for the wavelength range desired. A metal box made of brass or sheet aluminum can be bolted together on brass angles though it is usually simpler and easier to mount the apparatus in a small wooden box. Shielding is not necessary or desirable.

All the parts of a grid-meter driver can be mounted on a standard 3/16" panel 6" x 10". Photographs show the appearance of

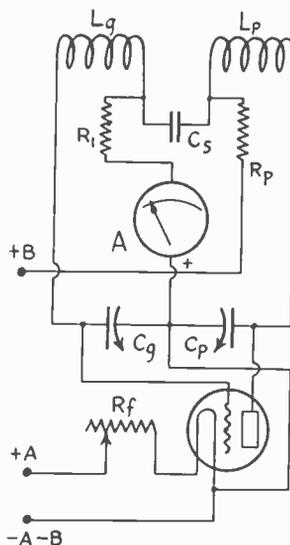

THE SCHEMATIC CIRCUIT OF THE GRID-METER DRIVER (COLPITTS)

List of Parts:

- Tube—UV-199, UX-201-A, UX-210, depending on output power desired. Larger tubes are necessary for measuring antenna constants. Those suggested are excellent for making measurements of natural wavelength, and determining capacitance and inductance values by comparison with known capacity and wavelength standards.
- Socket—Any standard base for the type of tube used.
- Panel—6" x 10" x 3/16" bakelite.
- Metal box or metal-lined box 6" x 4½" x 10".
- Dial—National Velvet-vernier.
- Rf—Filament rheostat to fit tube used.
- Rp—Plate supply resistor—100 to 500 ohms.
- Ri—5,000 ohm grid leak.
- Cs—6,000 µf. fixed Sangamo or Micadon condenser.
- Cg-Cp—Cardwell double unit condenser, 350 µf. each part.
- A—0.5 or 0-10 milliamperage range ammeter.
- Lg and Lp—Coils wound on 3" diameter, 4½" long, mica tubes as below:

Winding of each section	Wavelength range
2 turns of No. 16 D.C.C.	12 to 32 meters
5 turns of No. 16 D.C.C.	25 to 67 meters
13 turns of No. 16 D.C.C.	54 to 150 meters
33 turns of No. 22 D.C.C.	135 to 370 meters
74 turns of No. 22 D.C.C.	310 to 800 meters

an oscillator built to cover 12 to 800 meters, the five plug-in coils and the appearance of the inside of the oscillator. The schematic diagram shows the Colpitts circuit adapted for use in the driver. The specifications

for winding the different coils and list of parts required for putting such a driver together are given below the diagram. 3" diameter micarta tubing is used for winding the coils and each coil is provided with four General Radio 247-P plugs which slip into the binding posts on the end of the oscillator panel. A double unit condenser is used so that plate and grid circuits are tuned at

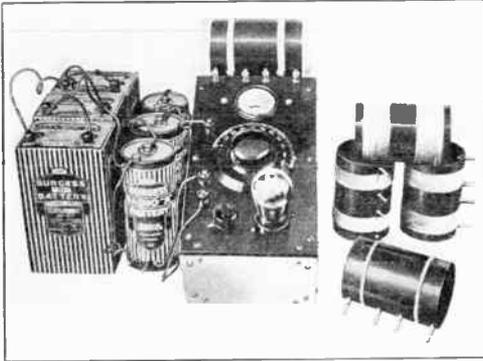

12 TO 800 METER OSCILLATOR-DRIVER AND ALL COILS

the same time. This gives strong oscillations over the whole range of the driver. No radio frequency choke coils are required with the circuit arrangement shown. A cabinet or box 4½" deep is required for the double-unit Cardwell condenser. The point of minimum deflection of the grid-meter indicates resonance with any circuit or combination of capacity and inductance to which the driver is coupled, with an extremely high

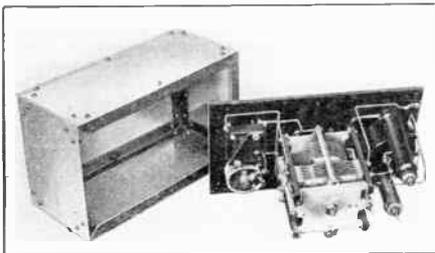

THE INSIDE OF OSCILLATOR AND CASE

degree of accuracy. It is not necessary to use a resonance indicator in the coupled circuit. Such an instrument is most useful around an amateur station.

FINDING THE NATURAL PERIOD OF ANTENNA SYSTEMS

Usually the fundamental of the antenna circuit can be found by connecting antenna directly to counterpoise (with no inductive

or capacitive loading at all) and bringing the driver (into which has been plugged the proper coil) near the antenna lead. The dip on the grid-meter will occur at the fundamental or there may be a less pronounced dip at a harmonic of the antenna system. Noting the dial setting at which the grid-meter changed its deflection and leaving that setting as it is, the driver is next coupled loosely to a wavemeter. The wavemeter setting is changed until another dip of the grid-meter indicates the point at which the fundamental wavelength of the radiating system can be read directly from the wavemeter calibration curves. Coils may be suspended in front of the driver in free space and their natural periods measured similarly.

If a sensitive resonance indicator is *not* incorporated in a driver, the arrangement shown in the diagram may be used for get-

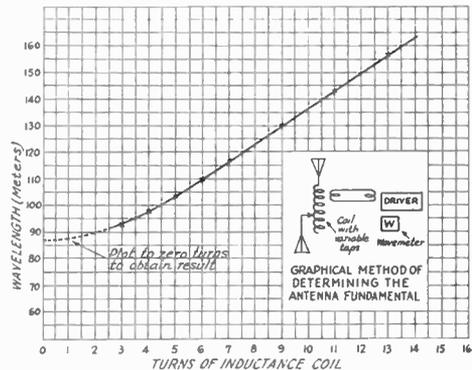

ting at the antenna fundamental by graphical means. Several different amounts of inductive loading are used. A low-reading hot-wire meter or flash-lamp in the antenna circuit is used as a resonance indicator. The driver (which may be your transmitter) is coupled to the antenna through a link circuit constructed of 15 or 20 feet of twisted lamp cord. The driver is adjusted to resonance with the antenna for each different load employed and its wavelength plotted against the number of turns of the loading coil used. When this curve is extended to "zero" turns it gives the antenna fundamental quite accurately.

MEASURING HIGH FREQUENCY RESISTANCE

The resistance of circuits and conductors to direct current and to high frequency current is quite different. At high frequencies, current tends to crowd to the outer layers of a conductor, a condition which is known as "skin effect" caused by the field due to the current itself, which is most dense at the center of the conductor, setting up a

counter E.M.F. within the wire itself so that most current flows on the surface of the wire making a tubular conductor as effective as a solid wire for working with radio frequencies. Any distribution of current in coils and wires other than a uniform current density throughout each part results in increasing the effective resistance of the coil or conductor materially over the D.C. value of resistance. Another factor raising the resistance of coils is that the inside of the turns has less inductance than the outside so that the current crowds to the inside due to the lower reactance there. Every stray field tends to cause some sort of redistribution of current in the conductor which raises the resistance. The "copper loss" resistance due to the area and conductivity of the wire itself, the losses due to poor dielectrics, corona, radiation of energy, and the resistance coupled in from adjacent circuits, all add to give the *total* conductor or circuit resistance which is the high frequency resistance that we can measure.

It matters little whether we are measuring the resistance of resonant circuits containing lumped inductance and capacitance or whether we are measuring the total resistance of a radiating circuit made up of distributed values of inductance and capacitance throughout its length—the methods that can be followed are the same. The two most common and practical methods are shown in the diagram and will be discussed briefly. With either the variation or the substitution method of finding circuit resistance, a radio frequency driver such as described is necessary and a wavemeter will also be needed to check the wavelength as each measurement is made. A link coupling circuit consisting of two or three turns of wire at each extremity and connected by a twisted flexible pair is also necessary to isolate the driver and make accurate measurements possible. The total length of wire used in the link circuit should be less than a half-wavelength of the circuit being measured. Meter (M) should be bridged with a piece of No. 14 B. & S. (A. W. G.) wire to protect it from the high current that obtains in the artificial load circuit of the oscillator.

THE SUBSTITUTION METHOD

In the *substitution* method of determining resistance a variable non-inductive resistance and a variable condenser are connected as shown. A loading coil is brought into play to load the circuit to the uppermost wavelength it is desired to reach in making measurements. A single-pole double-throw switch is used to make it possible to substitute the "dummy" circuit (variable condenser, resistor and inductance of loading coil) for the actual circuit under measurement at a moment's notice. A thermo-

couple bulb with a sensitive milliammeter is used at A to indicate the amount of current flowing in either the circuit being measured or in the artificial circuit. In using the substitution method, the antenna (or circuit under measurement) is connected to the driver coupling coil by throwing the switch to the left. The driver is adjusted to resonance at which point the wavelength and the reading of A are carefully noted. Then the switch is thrown to the right and C varied until resonance obtains again. R is now varied until the same current is indicated on A as was previously

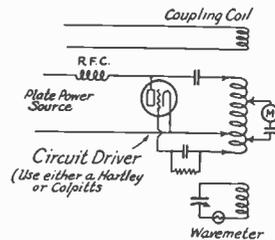
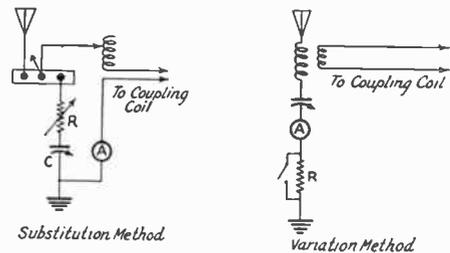

MEASURING ANTENNA RESISTANCE AND EFFECTIVE CAPACITY

noted. It may be necessary to re-tune C for resonance at the same time the final adjustments of R are made. The value of R is the resistance at a particular wavelength; the value of C at the condenser setting is the equivalent antenna (or circuit) capacity. The true capacity differs from the equivalent capacity, as this method neglects the inductance of the antenna. The equivalent approaches the true at higher wavelengths, so the true antenna capacity can be obtained by plotting the equivalent capacity against the wavelength until the curve flattens out. The substitution method is very accurate, for the loading coil and the thermo-couple are in the circuit for both positions of the switch so that the losses in these pieces of apparatus cancel out and the loss in R is very closely the same as in the circuit under measurement. The driver should be of ample power and the reading of meter M should not change more than 5% when the switch is opened. M must read the same with the switch closed in either position or the results are liable to be in

error. A steady driver is absolutely necessary. The method is particularly applicable to antennas but the results will be valueless if the coupling changes, if the driver output varies, if the driver is too close so that there is magnetic or capacitive coupling between loading coil and driver, if there is too much reaction between loading coil and driver, if there is too much reaction between the driver and circuit under measurement (more than 5% change in M), or if the readings are not taken when tuned to exactly the resonance peak. The readings should be taken from about four times the natural wavelength of the antenna to as low a wavelength as possible. Make measurements every ten meters or so over the whole range and draw a smooth curve through all the points on the resistance-wavelength or resistance-frequency curve and it will be possible to determine the power in the antenna (output of the transmitter) and the efficiency of the transmitter by knowing the resistance at the working wavelength and making proper substitutions in the RI^2 formula for power.

MAKING H.F. RESISTANCE STANDARDS

A decade resistance box is useful for making measurements at the longer wavelengths but some No. 30 or No. 35 B. & S. Advance or Ideal resistance wire stretched out straight on a board with an adjustable clip is acceptable as a substitute. The resistance used must be large in proportion to the condenser resistance to give accurate results. This means that a condenser of very low equivalent resistance is necessary and that its resistance must be found and added to the resistance determinations at different frequencies for extreme accuracy.

Some specially built resistance units are recommended for the experimenter who wants to make a large number of accurate measurements. Ordinary resistance boxes contain wire-wound units satisfactory for D.C. or low frequency work but useless at very high frequencies on account of distributed inductance and capacitance. Good resistance units are made up of short pieces of Managanin or Advance wire (which also has a low temperate coefficient) sealed into small glass tubes of uniform length and diameter. Pyrex tubes 8 cm. long with an outside diameter of 8 mm. and a wall thickness of 2 mm. can be purchased from the Corning Glass Works, Corning, N. Y. About thirty of these tubes are required to make a complete set of resistances. The values of resistance should range from one-tenth to one ohm in tenth-ohm steps, then in steps of one to three ohms up to about thirty ohms resistance. Some No. 38, 40, and 44 B. & S. (A.W.G.) Manganin wire should be obtained from the Driver Harris

Co. or from Baker & Co., both of Newark N. J. The diagram shows how each resistance unit is constructed. The length of resistance wire in each unit will vary from about $\frac{1}{4}$ " to 2". It is first soldered to two lead wires (No. 14 copper) using resin as flux and just as little solder as possible. The lower values of resistance will be made up of the larger wire. The ends of the No. 14 lead wires are filed to a 45° angle, then tinned and clamped firmly while the fine resistance wire is soldered to the center of the filed surfaces. As soon as a long piece of resistance wire has been soldered to the terminals it is tested in an accurate Wheatstone bridge, adjusted, readjusted and marked with the correct resistance value as soon as the final soldering job and measurement has been made.

Small corks that fit tightly into the glass tubes are drilled to take the No. 14 lead wire and the completed resistance is carefully mounted as shown in the sketch. The

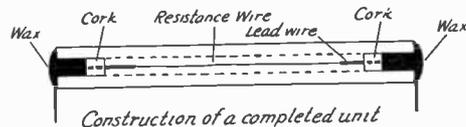

terminals are bent over at right angles after which some good sealing wax is melted and poured into the end of the tube and over the lead wire to hold it firmly in place and to make a permanent seal. Care must be taken not to get the tubes so hot that the resistance wire becomes unsoldered. The leads should be cut off to a uniform length and the resistance values rechecked carefully after which a tag or sticker on each unit will keep the different values from getting mixed up. A micarta panel on which has been mounted some small blocks of copper in which $\frac{1}{8}$ " holes have been drilled to hold mercury, will make a fine resistance board. Many blocks spaced so that the resistance units fit nicely between any pair will make it possible to get almost any combination desired. Great care should be taken never to let more than a tenth ampere flow through the resistances as the fine wire will be melted off by too much current. With some very sensitive instruments very accurate resistance measurements can be made at wavelengths below 100 meters using either the substitution or the variation method that will be next described.

THE VARIATION METHOD

In using the resistance variation method which is perhaps easier to use in finding resistance values below the fundamental wavelength of an antenna and which is one of

the best methods to apply to any closed R.F. circuit, the current is first read in the circuit to be measured when it is tuned to resonance with the driver circuit, then a known resistance (such as one of those just described) is put in series with the circuit and the current again read. The connections for measuring antenna resistance are shown on the right of the "measuring antenna resistance" diagram. The unknown circuit resistance is found by substituting in a simple formula:

$$R_x = \frac{R_s}{\frac{I}{I_s} - 1}$$

Where:

R_x is the unknown circuit resistance.
 R_s is the known resistance added to the circuit.

I is the current before R_s was added.
 I_s is the current after adding R_s .

The resistance obtained is that of the entire radiating system, and includes thermo-couple resistance, antenna resistance, and loading coil resistance. The resistance of devices connected in the antenna circuit must be found at the frequencies of the measurements and subtracted out of the results to give the true antenna (or circuit) resistance desired.

If a suitable variety of resistance is available (or a continuously variable resistance), it may be possible to add a value of resistance to the circuit so that the current (I_s) will be just half its previous value (I). In this case, the formula will be simplified and the answer may be read directly from the resistance unit used or from the readings of the decade box. The denominator of the right hand side of the fraction will be equal to unity. Remember that if a thermo-galvanometer is used it probably reads current-squared and the deflection for half-current will be $\frac{1}{4}$ the initial value instead of $\frac{1}{2}$ as in the case of meters giving scale readings of current directly (ammeters and milliammeters).

Just as in making measurements by the substitution method, the circuit driver used must be of ample size. A tube at least as large as the UV-203A should be employed in most instances. Two UX-210s will work in a pinch. The transmitter itself can often be utilized to save the expense and trouble of building a separate powerful oscillator. The driver must be some distance away and very loosely coupled if accurate results are desired.

Resistance curves of condenser-coil circuits will usually be uniform and smooth unless other resonant circuits or other sources of

loss at certain frequencies are coupled into the circuit under measurement. In general the measurements made with the highest frequencies will give the highest values of resistance. It must be remembered that there are several different kinds of "losses" that are represented in the total resistance as found. "Humps" in antenna resistance curves may be caused by neighboring guy wires, resonant lighting circuits in the field of the antenna, metal roofs and so on and the poorer the antenna location the more irregularities there are apt to be in resistance curves. Sometimes radio frequency energy from a transmitter will cause lamps across different parts of the house-lighting circuit to light dimly, a condition which can be checked when measuring the high frequency resistance by making measurements with the lamps in and out of the sockets. Connecting condensers or loading coils in the circuits in question will often alter their period to some point outside the amateur bands of wavelengths, after which the amateur station in question will be able to get much better results from the hours spent in operating the set.

The graphical separation of total antenna resistance into curves of "copper loss" resistance, dielectric loss resistance, and radiation resistance is quite simple. The curve of total resistance plotted for different wavelengths should be equal to the sum of these three components or different types of losses. A straight line drawn through several points on the total resistance curve at three or four times the fundamental wavelength may be extended to the resistance axis. The point where the extended line cuts the resistance axis may be taken as the "copper loss" resistance. The dielectric loss will be represented by a straight line drawn from the origin parallel to the first line drawn. By subtracting the sum of these two losses at every point along the curve from the line representing the total resistance loss, the approximate value for radiation resistance can be found. This should be a smooth uniform curve which rises rapidly as the frequency goes up. It may be interesting to compare the radiation resistance found with a curve constructed from the best theoretical considerations in which case reference should be made to pages 476 to 483 of the book "Electric Oscillations and Electric Waves" by G. W. Pierce.

MOTOR-STARTING COMPENSATORS

When large alternating current motors such as used in driving a synchronous rectifier are thrown directly across the line, a large amount of starting current is drawn from the mains causing a "dip" in line

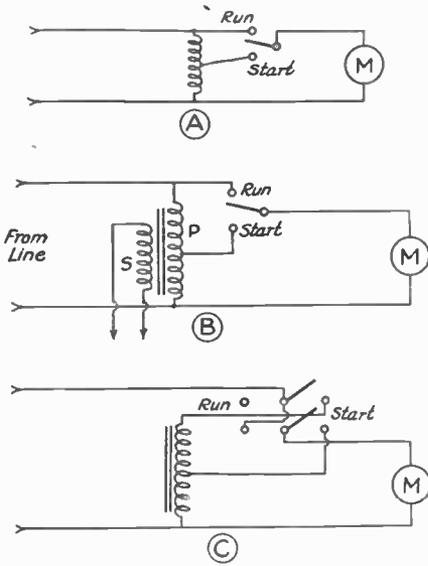

MOTOR-STARTING COMPENSATORS GIVE A MOTOR LOW VOLTAGE AND HIGH CURRENT AT START, PROTECTING THE MOTOR ITSELF AS WELL AS THE SUPPLY CIRCUIT FROM OVERLOAD

- A—Simple compensator circuit.
- B—Using one winding of a plate supply transformer as a compensator.
- C—Another compensator circuit using a D.P.D.T. switch to take the compensator off the line after the motor starts. This allows one to use smaller windings, as the service is intermittent.

voltage which blinks any lights connected to the circuit. This rush of current may injure the motor itself unless the coils are very firmly braced and it may cause heating as well as mechanical injury to the motor and disk.

The diagram suggests simple methods that may be used in motor-starting work. A plate-supply transformer primary winding can be used as a motor starter as shown. It acts as an auto-transformer. The efficiency is high as part of the power is "transformed" while some is taken directly from the line (the amount of power supplied by each method depending on the ratio of the auto-transformer). Auto-transformers are chiefly useful when the ratio is very nearly "one-to-one".

WAVELENGTH CHART

A Wavelength Chart will be found very useful for the determination of wavelength, inductance or capacity, when any two values are known. But one operation is necessary. No mathematics are needed. Both micromicrofarads and microfarads are used in the capacity scale and both microhenries and millihenries in the inductance scale. Be sure you are using the right units.

The chart is used as follows:

A—For wavelength determinations.

For wavelengths from 10 meters to

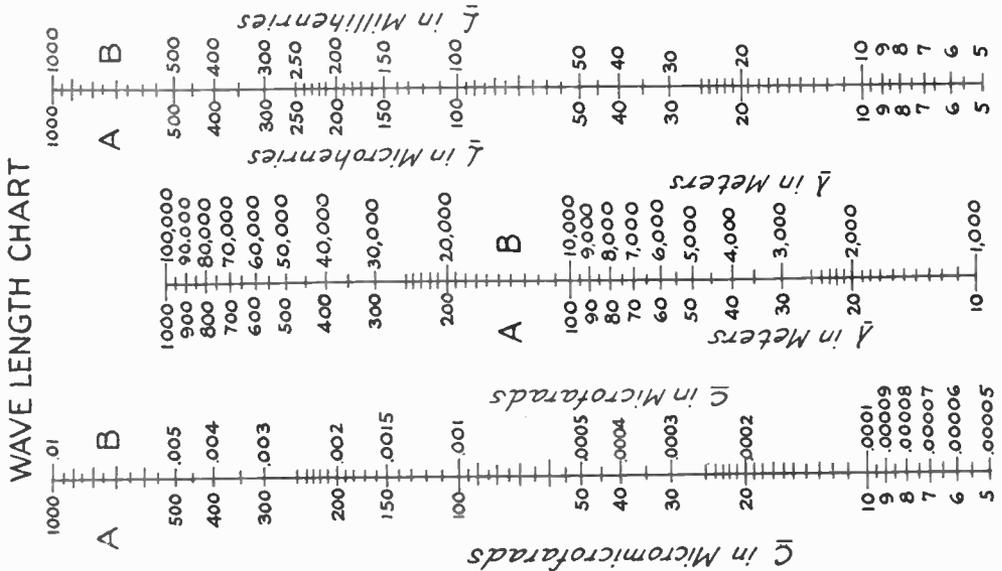

1000 meters align A.A.A. For from 1000 to 100,000 align B.B.B.

Take a straight edge such as a rule or piece of paper and simply lay it across the three scales so that it intersects with the two outer scales at known values of inductance and capacity. It will then cut the wavelength scale at the correct answer.

Example: A circuit has an inductance of 250 microhenries and a capacity of 50 micromicrofarads. The circuit will then oscillate at app. 210 meters.

B—Determination of inductance if capacity and wavelength are known.

Example: The capacity used is .0005 microfarads and the circuit is to oscillate at 300 meters. The inductance is then found to be 500 microhenries.

C—Determination of capacity if the inductance and wavelength are known.

Example: A coil has an inductance of 450 microhenries and it is to be used in a closed tuned circuit which is to oscillate at 400 meters. The capacity is then found to be 97 micromicrofarads.

FOREIGN LETTERS

Ä (German)	Dit darr dit darr
Á or Å (Spanish-Scandinavian)	./	Dit darr darr dit darr
CH (German-Spanish)	./	Darr darr darr darr
É (French)	Dit dit darr dit dit
Ñ (Spanish)	Darr darr dit darr darr
Ö (German)	Darr darr darr dit
Ü (German)	Dit dit darr darr

DEFINITION AND CONVERSION OF RADIO TERMS

While a complete glossary of quantities and units, with conversion tables, is outside the main purpose of this handbook, the writer feels that some of the more commonly used terms and symbols encountered require definition, especially as they may have been mentioned hastily in some of the preceding chapters. For complete and reliable information covering both terms and graphical symbols the reader is referred to "The Report of the Committee on Standardization" published by the Institute of Radio Engineers (New York), and to the "Standard Handbook for Electrical Engineers".

Metric Prefixes Often Used With Radio Quantities

	1		
μ	$\frac{1}{1,000,000}$	One-millionth	micro-
m	$\frac{1}{1,000}$	One-thousandth	milli-
c	$\frac{1}{100}$	One-hundredth	centi-
d	$\frac{1}{10}$	One-tenth	deci-
dk	1	One	uni-
h	10	Ten	deka-
k	100	One hundred	hekto-
	1,000	One thousand	kilo-
	10,000	Ten thousand	myria-
	1,000,000	One million	mega-

The practical unit of capacity is the farad. The ability of the dielectric between the plates of a condenser to become charged electrically determines the permittance or capacitance of a given condenser. A capacity of one farad is defined as that capacity which will have its plates charged to a potential difference of one volt when that quantity of electricity known as one coulomb (one ampere flowing for one second) flows into it. In radio engineering the farad is much too large for practical work so that sub-multiples are commonly used. The microfarad (μf) and micromicrofarad (μμf) are units used in common radio practise. The micromicrofarad (μμf) is sometimes referred to as a picofarad (pf), which is a simpler expression standing for the same electrical quantity. The centimeter is taken as the electrostatic unit of capacity (esu) in the C. G. S. (centimeter-gram-second) system and can be readily used by applying the conversion factor given below:

1 farad (f)	= 1,000,000 microfarads (μf)
1 microfarad (μf)	= 1,000,000 micromicrofarads (μμf) or picofarads (pf)
1 centimeter (cm) (esu)	= 1.11 micromicrofarads (μμf)

The practical unit of inductance is the henry, defined as that inductance which will produce a reactance voltage drop of one volt when the rate of current change is one ampere per second. The millihenry and microhenry occur most often when discussing radio circuits. The centimeter is likewise taken as the electromagnetic unit of inductance (emu) in the C.G.S. system, and is used by applying another conversion factor:

1 henry (h) = 1,000 millihenries (mh) or
1,000,000 microhenries (μ h)

1 microhenry (μ h) = 1,000 centimeters (cm) (emu)

The practical unit of electric pressure and potential difference is the *volt*. The electromotive force (E.M.F.) or voltage in a circuit is what causes the flow of current, just as pressure in fluids causes the flow of water or gas in pipes. Current always tends to flow from a point of higher to a point of lower potential. The C.G.S. units which equal one volt are the abvolt (10^{-8} emu) and the statvolt (300 esu).

The practical unit of the rate of current flow is the *ampere*, determined by a fixed

rate of the electro-deposition of silver under specified conditions.

1 ampere = 10 absamperes (emu) = 3.33×10^{-10} statamperes (esu).

The practical unit of resistance is the *ohm*, defined as the resistance of a mercury column of certain dimensions under specified conditions. 1 ohm = 10^9 abohms (emu) = 9×10^{11} stathms (esu). An E.M.F. of 1 volt is required to produce a current of 1 ampere in a resistance of 1 ohm.

Energy and power should be carefully differentiated. Energy is simply the capacity for doing work. Power represents the expenditure of energy and is a measure of the rate at which work is done. Power is measured in watts; work done is measured in watt-hours. Most electrical devices are rated by their power consumption in watts. One horse power (H.P.) = 746 watts.

FINIS

INDEX

Abbreviations	Page	Choice of Tubes	64, 65
Accented Letters	142-147	Choke Coils	72, 137
Accepting Messages	176	Choosing the Antenna	96
Acknowledging Messages	119, 64	Cipher Messages	114
Additional Information	132	Circuit-Drive Specifications	170, 171
Adjusting the Transmitter	87	Circular Mill	130
Adjusting a Neutralized Master Oscillator Power Amplifier Set	163	Clearance of Antenna (Requirements)	93
Address	115	"Click" Method	86
Address of Magnetic Coupling	17	Code (Continental)	8, 142, 176
Advantages	62	Coded Messages	114
All Wave Receiver	10	Coils, Receiving	46
Alternating Current	24	Coils, Transmitting	-67, 68
Amateur	1	Diameter vs Wavelength	31
Amateur Radio	1	Inductance Formula	129
As a Hobby	1	Tapping	131, 71
American Radio Relay League	2, 3, 4, 5	Turns vs. Wavelength	31
Accomplishments	2	Coil Forms	46
Board of Directors	3	Coil Winding Forms	46
Conception in 1914	3	Communication	111
Executive Committee, The	2	Communications Department	105
Fraternity Today, The	3	Activities	105
Headquarters	3	Appointments	107
Headquarters' Departments	3	Official Broadcasting Station	108, 109
History	2, 3	Official Relay Station	108, 109
Joining the League	5	Assistants	108, 109
League Spirit	3	Official Observers	108
Purposes and Ideals	3	Route Managers	108
Traditions	3	Duties	107, 108
Visiting Headquarters	4	Field Officials	106
Writing to Headquarters	4	Objective, Its	105
Ammeter Shunts	167	Organization	106
Amplification	36	Policies	105
Amplifying Harmonics of a Crystal	162, 164	Section Communications Manager	105
Amplifying Transformers	45	Territorial Limitations	105
Analysis	126	Work, Its	105
Analogy of Electric Current	121	Component Parts of a Message	112
Answering a Call	121	City of Origin	112
Antennas	93-103	Check	113
Ammeter (what it measures)	169	Date	113
Counterpoise or Ground	94, 95	Number	113
Current Feed	99, 100	Station of Origin	113
Adjustments	100	Conclusions vs Evidence	128
Height	95	Condensers	25
Hertz	97	Condenser for Wavemeter	53
Harmonic Operation	98, 99, 97	Condenser Reactance vs Frequency (problem)	28
Nodal Points	98	Connections for Charging	86
Insulating the Receiving Antenna	95	Contacts for Relays	158, 137
Receiving Dimensions	94	Continental Code	8
E. F. Transmission Lines	101	Contributions to QST	120
Sending Antenna, The	96	Conversion of Radio Terms	176
Voltage Feed	102, 101, 99	Correcting reading of plate current of self-rectified circuits	167
Adjustments	101, 102	Correcting Mistakes in Transmission	120, 121
Antenna for Inductive Loading	95	Counterpoise	94, 95
Antenna Pointers	103	Counting Messages	116, 117
Antenna Power	170	Counting Words in Messages	113, 114
Antenna, Radiator (General)	32	Coupling	32
Antenna Types	103	Capacitive, Magnetic and Complex	35, 169
Application for League Membership	177	Direct and Indirect	33
Application for Official Relay Station Appointment	178	Loose and Tight	33
Applying for a License	17	Ways of Changing	169
Audibility	148	Coupling the Antenna to our Receiver	44
Author's Foreword	V	Crystal Control	160
B-Battery Eliminators (as Power source)	78	A. C. Operation	165
Best Circuit, The	43	Amplifying Crystal Harmonics	164
Best Sending Speed, The	120	Circuits	161-166
Best Wavelength	17	Crystal Action	160
Blocking Condenser	60	M. O.—P. A. Circuit	158, 159
Books, Recommended	154, 155	Mounting Crystals	162
Box for Wavemeter (Removable Cover)	33	CV Reception	37
Breadboard and Panel Receivers	48	Theory of Autodyne	38
Break-down Voltage	152	Current Flow	19
Break-in Operation	124, 156, 123	Current Lag	27
Brute Force Filters	85, 138	Current Lead	27
Building a Transformer	130, 131, 132, 134, 135, 136	Damped and Undamped Waves	32
Building Single Wire Antennas for a Certain Natural Period	96	Damping	30
Building the Transmitter	65-73	Parasol-Type Meters	167
Building Transmitting Coils	67	Date to Send your Report	120
Building a Wavemeter	53	Definition of Radio Terms	176
Building Your Station	41	Delivered Messages	117
Cable Count Check Explained	114, 115, 113	Delivering Messages	117
Calculating Inductance	129	Designing the Receiver	43
Calibrating the Wavemeter	56, 57	Detection	35
Call Books	148	Detection without Grid Leak	36
Calling and Working Wavelengths	15	Diagrams, Reading	11
Calling Practice	123	Dielectrics	152
Calling Practice and Break-in	123	Direction of Current	20
Capacitance	25	Resistance	20
Care of Storage Cells	85	Directional CQ	121
Catlin Grip, The	7	Distributed Inductance, Capacitance and Resistance	5
Center Tap for Filaments	60, 71	Doping Coils against Moisture	135
Center Tapped Resistances	71	Drilling Glass	153
Charging Rate	85	Drill Sizes for Clearing Tap	154
Chart for determining Capacitance, Inductance and Wavelength	175	Drill Sizes for Tapping	154
Choice of Circuits	63	Dry Cells as Plate Supply	86
		Dry Cell Battery of High Voltage to Improve Note	81
		Economically	96
		Effective Height	96

Effective Value	153.	167	Kirchoff's Law	21				
Electrical Inertia	19	26	Law Concerning Superfluous Signals	121				
Electricity	19	19	Leach Relay	156				
Chemical and Magnetic Effects	19	19	Lead-in Bushings	93				
Current Electricity	19	19	Lead-in Drilling Glass for	153				
Electrons	20	20	Learning the Code	92				
Series Parallel Connection	20	20	Lightning Arrestor	8				
Electrolytic Rectifier, The	75.	76	Lightning Hazard	17				
Diagram of Connections	76.	77	Lines of Force (Magnetic and Electric)	30				
Estimating the Cost	77	77	Loading the Antenna	95.	67			
Figuring the Size	75	75	Log Books	149				
Forming the Rectifier	20	20	Long Wave Stations (List)	12				
Electromotive Force	30	30	Lorenz Coils	46				
Electron Motor	20.	34	Low, Medium and High Power Stations Defined	92				
Electrons	19	19	Low Power Transmitter	23				
Elementary Principles	17.	74.	Magnetic Effects	23.	24			
Eliminating Interference and Key Thumps	17.	74.	Magnetic Field	45.	46.	47.	67	
Emergency Power Supply	121.	124	Making Coils	150				
Error Signal	121.	114	Marking Messages	158				
Example of Cable Count Check	153	153	Master Oscillator Circuit	23				
Experimental Layouts	126	126	Matching Impedances for Power Transfer	36				
The	126	126	Material for Short-Wave Receiver	48.	51			
Experimenters' Section	126	126	Maximum Power (Circuit Conditions for)	150				
Fading	94	99	Measuring Distances Accurately	140.	141			
Feeding the Antenna	99	99	Measuring Inductances at Commercial Frequencies	140.	141			
Figuring Condenser Capacitance	152	152	Measurements	166				
Figuring Voltage Drop across Condensers	34	34	Electrical	166				
Filaments	90.	91.	Radio	170				
Filter, The	138.	139.	High Frequency Resistance	171-174				
Adjusting the Air Gap	139.	140	By Substitution Method	172				
Building Filters	136-140	136-140	By Variation Method	177				
Designing Filters	136-140	140	Membership Blank in A. R. R. L.	78				
Measuring Filter Choke Coil Inductance	140	75	Mercury Arc Rectifiers	113				
Shown with Synchronous and Mercury Arc Rectifiers	140	140	Message Blanks	115				
Testing Filter Action	171	171	Message Collection Boxes	115				
Finding Natural Period of an Antenna System	22	22	Message File, The	123				
Finding Proper Resistance Values	51.	52	Message Total, The	120				
Finding Trouble in the Receiver	119	119	Message Traffic	112				
Five Point System, The	23	23	Meters	61.	166.	167.	168.	169
Flux	130	130	Method of Making Abbreviations	144				
Flux Density in Small Transformers	130	139	Methods of Keying	157				
Ford Coil Filters	148.	148	Mill	133				
Form of Log	148.	113	Modulation	39				
Friendly Conversation	119	119	Modulation Methods	39.	40			
Fundamental Parts of a Message	77	77	Most Used Q Signals	145				
Gaseous Conduction Rectifiers	123.	124	Motor-generator	87				
Getting Bills	41	41	Motor-Starting Compensators	174				
Getting Materials	6	6	Mounting Crystals	162				
Getting Started	7	7	New Field for the Broadcast Listener	6				
Continental Code, The	7	7	Neutralization	37.	163			
Learning by Listening	8	8	Neutralizing the Power Amplifier	163				
Memorizing the Code	6-7	6-7	Neutralizing Spilled Acid	85				
Practicing with Buzzer	7	7	Numbered Drill Sizes for Drilling and Tapping	154				
Receiving Code	7	7	Numbering Messages	116				
Sending	7	7	Number Sheet	116				
Using a Key	152.	153	Obtaining a Government License	15-17				
Glass	152.	153	Official Observers	108				
Grades of Amateur Station License	16	16	Official Relay Station Appointment, The	108				
Grid	35	35	Duties	108				
Grid Chokes	44	44	Qualifications Necessary	108				
Grid Leak	34	34	Official Wavelength Stations	56				
Grid Leak Action	170.	171	Ohm's Law	20-21				
Grid-Meter Oscillator-Driven	170.	171	Ohm's Law for A. C.	25				
Grid Potential	35	35	Operating Hints	125				
Grid Voltage—Plate Current	36	36	Operating Notes	155				
Ground Connection	93	93	Operating on Schedules	118				
Ground Switches	93	93	Operating Rules and Regulations	121				
Grounding Antennas for Lightning Protection	112-144	112-144	Operating the Receiver	51				
Ham Abbreviations	99	99	Operating Tubes in Parallel	59				
Harmonic Operation of Antennas	95	95	Operating your Station	111				
Heaviside Layer	39.	40	Originated Messages	112.	115			
Height of Antenna	39.	40	Originating Traffic	178				
Heising Modulation	94	94	O. R. S. Application Blank	37				
Hertz Antenna, The—Harmonics, Loading	97.	99	Oscillation	37				
High-Frequency Resistance and Measurements	2.	3	Aching Oscillation by twisting wires to grid and plate	37				
History of American Radio Relay League	100	100	leads	61				
History of Official Relay Station Appointment	91	91	How a Tube Oscillates	37.	37			
Horizontal Antennas	61.	37	Oscillations	126				
How a Tube Oscillates	109	109	Outlines	159				
How to Become an Official Relay Station	145	145	Output Transformer for Master Oscillator	28				
How to send Intermediates	40	40	Parallel Alternating Current Circuit	60				
ICW (Interrupted Continuous Wave)	25	25	Parallel Plate	59.	71			
Impedance	120	120	Parasitic Frequencies	59.	71			
Improper Calling	120	120	Parts for the Wavemeter (List)	55				
Incomplete Preambles	120	120	"Peak" Value of sine wave A. C.	153				
Improving Selectivity of a Receiver by Reducing Coupling	58	58	Permanent Magnets	23				
to Antennas	92	92	Permeability	112				
Insurance Rating Bureau, etc.	25	25	Personal Responsibility Necessary in Message Handling	29				
Inductance	129	129	Phase Difference	114				
Inductance Chart, The	24	24	Plain Language Messages	63				
Induction	93	93	Planning the Transmitter	34				
Installing Antennas for Sending and Receiving	92.	93	Plate Current	169				
Instruments	167	167	Plate Power (Measurements of)	65				
Electro-dynamometer type	169	169	Plate Impedance	65				
Electro-static type	169	169	Plate Supply—Series and Parallel	60				
Hot-wire and thermo-coupled Instruments	169	169	Plate Transformer	45				
Induction type	169	169	Plug-in Coils	95				
Iron-vane type	169	167	Polarization of Radio Waves	44				
Moving Coil (d'Arsonval)	167	167	Policy in Delivering Messages	117				
Voltmeters and Ammeters	167	120	Poor Sending	120				
Insufficient Address	144	144	Position Reports	15				
International Intermediates	127	127	Positive and Negative Terminals	20				
Joining the Experimenters' Section	78-81	78-81	Power Amplifier	158				
Keep-Alive Circuits for Mercury Arc Rectifier	148-149	148-149	Power and Power Factor	29				
Keeping a Log	74.	165	Power Supply Sources	59				
Keying Filter	74.	157	B-eliminators	78				
Keying the Set	74.	157	Dry Cell	86				
Keying in Master Oscillator—Power Amplifier Circuits	159	159						

Dynamotor	85	Skeleton Coil Form Best	129
Motor-generator	85	Soldering	42
Transformer and Electrolytic Rectifier	70	Space Wound Coils	46
Power Classification of Stations	92	Spacing of Coils	46
Prefix to Service Message	118	Spark Transmitter	82
Preventing Corrosion	86	Specific Inductive Capacity	92
Primary	130	Splicing Wires	42
Privileges of Official Relay Stations	109	Standardized Log	148-150
Procedure, Long Wave Commercial	13	Station Arrangement	81
Procedure, Ship-Shore Operating	14-15	Steady Signals	122
Purchasing Reliable Equipment	70	Storage Battery (High Voltage) Used to Improve Note from a Rectifier	91
QST	V. 3, 155	Storage Coils	85
Q Signals	145-147	Substitution Method of Measuring Antenna Resistance and Capacity	172
Qualifications of Good Operators	111	Supervisors of Radio	17
Qualifications of Meters	168	Supporting Wires at Insulators	22
Quantity vs Quality of Messages	180	Synchronous Rectifiers	82-84
Quartz Crystals	160	Test Letter	165
Quiet Hours (Regulations)	16	Testing Filter Action	140
Radio Frequency by-pass Condenser	60	Text of Message	115
Radio Inspection Districts	17	Thump Filters	74, 185
Radio Service Bulletin, The	14	Time Conversion	151
Rating Power Tubes	59	Time for Adjustment	121
Reactance	169, 27	Time Signals	13
Inductive and Capacitive	151	Thinker vs Experimenter	127
Reactivation of Vacuum Tubes with Thoriated Filaments	148	Tools	41
Readability	11	Tools for the Experimenter	126
Reading Diagrams	121	Transformers	119
Reason for Check	44-46	Bringing out Taps	130-136
Receiving Coils	38	Core Material	132
Reception—general	109	Design	130, 131
Recognition as ORS	126	Efficiency	131
Records (Keeping them Important)	35	Impregnating	135
Rectification	61	Mounting	136
Rectifiers	75	Putting the Core together	134
Electrolytic	81-84	Regulation	130, 131
Synchronous	82	Starting & Finishing the Winding	134-138
Rotary	81	Taping the Coils	136
Vibrating	77	Theory of Operation	130
Tube	78	Wedging the Coils	136
Mercury Arc	77	Transmitter, The	59
Rectron	78	Power Supply	59
S	78	Typical Circuit	59
R. F. Choke, The	72, 74	Transmitting Coils	67
R. F. Transmission Lines	101	Transmitting Condensers	64
Reducing Absorption Losses at the lead-in, in dielectrics and guys	103	Transmitting Clips	71
Regeneration	37	Transmitting Parts (List)	66, 72
Regeneration Methods	43	Transmitting Tubes (table)	65
Regulation	85	Transmitting Vacuum Tubes	64, 65
Relation between Velocity, Wavelength and Frequency	80	Transmitting Wiring Diagram	70
Relays	156	Troubles with our Traffic Handling	120
Adding contacts to sounder-relay	157	Tube Reactivation	151
Leach	156	Tube Combinations to use in M. O. P. A. Circuits	150
Making Suitable Relay for Keying and Other Purposes	157	Tube Rectifiers	77
Relay Procedure	124	Gaseous	77
Reluctance	23	Mercury Arc	78
Remedies for our Traffic Troubles	120	Vacuum (Rectron type)	77
Remote Control	158	Tuned Circuits	30
Reports	108	Tuning	31
Reporting	119	Tuning Ranges of Coils with Certain Condensers	47
Reports on Experiments	126	Type Key to Use	120
Requirements for passing the Amateur Examination	16	Type of News to Report	120
Resistance	20	Typical Circuit (showing name and connections of each part)	59
Resistance Units	173	Underwriters' Rules	91-93
Resistance Wires	71	Units	20
Resistors, Center Tapped	71	Using Break-In	123
Resonance	27	Use of Check	113
Current	27	Use of CO	122
Voltage	27	Use of Finish Signals	122
Resonance Indicator, The	53	Using Ohm's Law	21
Route Managers	108	Using one Antenna for Sending on Several Wavebands	95, 100, 96, 164
Root Mean Square Value	153	Using the Wavemeter	57
Routing Messages	118	Vacuum Tubes	34
Rules and Regulations	11, 15, 91, 110, 121	List of Different Tubes	65
Operating	121	Vacuum Tube Rectifiers	77
Amateur	11	Variation Method of Measuring Antenna Resistance	173
Commercial	11	Vibrating Rectifiers	8
Government	15, 16	Vigilance Committees	21
O. R. S.	109, 112	Voltage Drops	98
Underwriters	91, 92	Voltage Regulation of Rectifiers	84
Secondary	130	Voltmeter Multipliers	167
Secretary of Messages	14	Voltmeter Used as Milliammeter	167
Self-rectifying Circuits	87	Wave Motion	30
Sending Antennas, The	95, 96, 97, 98	Wavelengths Chart	175
Sending and Receiving Signals	34	Wavelengths Available for Amateur Radiophonic Work	17
Sending Words Twice	122	For Amateur Telephony	17
Series and Parallel Plate Supply	60	Wavemeters for the Amateur	53-55
Series Alternating Current Circuit	27	Wavemeter Traps	13-14
Series and Parallel Connections	20	Weather Reports	74
Series Antenna Condenser, The	95	Western Union Splice	118
Service Message, The	118	When to Send a Service Message	118
Serving Tourist Camps, Conventions, Exhibitions, Hotels, etc.	115	Where to Report	120
Sharpness of Tuning	31	Winding Jig (Home-Made)	46
Shall be to be Avoided	135	Wire Table	133
Shielding Necessary	53, 54	Wiring Requirements	92
Ship-Shore Station	14	Wiring the Receiver	42
Short Leads	60	Wiring the Transmitter	42
Short Wave Tuner Chart, The	128	Wood Screw Sizes	163
Signature	115	Word Lists for Accurate Code Transmission (and voice work)	155, 156
Signing Off	121	Writing Reports of Experimental Investigations	126
Simple Long Wave Receiver	9		
Size of Condenser	41, 47		
Sizes, Drills and Wood Screws	153, 154		
Size of Ticker	45		
Size Wire	129, 133		
Solutions to use in Aluminum-Lead Rectifier	75		

To Handbook Readers Who Are Not A. R. R. L. Members

Wouldn't you like to become a member of the American Radio Relay League? We need you in this big organization of radio amateurs, the only amateur association that does things. From your reading of this Handbook you have gained a knowledge of the nature of the League and what it does, and of its purposes. We would like to have you become a full-fledged member and add your strength to ours in the things we are undertaking for Amateur Radio, and incidentally you will have the membership edition of *QST* delivered at your door each month. A convenient application form is printed below—clip it out and mail it today.

.....1926

American Radio Relay League,
Hartford, Conn.

Being genuinely interested in Amateur Radio, I hereby apply for membership in the American Radio Relay League, and enclose \$2.50 (\$3.00 in foreign countries) in payment of one year's dues. This entitles me to receive *QST* for the same period. Please begin my subscription with theissue. Mail my Certificate of Membership and send *QST* to the following name and address.

.....
.....
.....

Station call, if any

Grade Operator's license, if any

Radio Clubs of which a member

Do you know a friend who is also interested in Amateur Radio, whose name you might give us so we may write him about the League?

..... Thanks!

TO HANDBOOK READERS WHO ARE ALREADY A. R. R. L. MEMBERS

For telegraphing members, who hold amateur licenses, and who are interested in Communications Department work, here is an application blank for an appointment as Official Relay Station. Copy this, or cut and fill it out, and send it to A.R.R.L. Headquarters for routing to the proper Section Communications Manager, if you are really interested.

AMERICAN RADIO RELAY LEAGUE, INC.

1711 Park St., Hartford, Conn., U. S. A.

APPLICATION FOR APPOINTMENT AS

OFFICIAL RELAY STATION

Name Call.....
Street & Number
City County
State
Transmitting wave-lengths specified on my license from meters,
to.....meters. Actual wave-length in use.....meters.

In making application for appointment as Official Relay Station, I understand that this appointment may be suspended or cancelled, at the discretion of the Section Communications Manager for any of the following:

—Violation of the radio communication laws of the country under which this station is licensed, particularly with respect to the regulations governing quiet hours and wave-lengths.

—Failure to send monthly reports of this station to the officer of the Communications Department under whose jurisdiction this station comes.

—Failure to deliver messages within forty-eight (48) hours either by relay to the next station in line or by mail to their destination. In other words, "Clear the hook within 48 hours."

My membership in the A.R.R.L. expires.....
Month Year

Signed.....

THE AMATEUR'S BOOKSHELF

Readers of this Handbook appreciate the need for good radio books. A number of good books that should find a place on the amateur's bookshelf are handled at A.R.R.L. Headquarters by the QST Book Department. Some of these are described in more detail in the Handbook Appendix; many have been reviewed in QST. Prices include postage.

Radio Telephony For Amateurs, by Stuart Ballantine. The most valuable single book that we know of for the amateur. Theory, construction, practice. <i>Not</i> particularly about telephony. Heartily recommended for every amateur. 296 pp., 5½ x 8¼	\$2.00
Manual of Radio Telegraphy and Telephony, by Commander (now Admiral) S. S. Robinson, U. S. N., published by the Naval Institute. "Ranks with the very best of all published radio matter . . . Not only worth its cost but is perhaps the best radio book that ever came to this desk."—QST Book Review. 895 pp., 6¾ x 10	8.00
Experimental Radio, by Prof. R. R. Ramsey. <i>The</i> book for the experimenter. A laboratory manual, describing 85 excellent experiments that help in understanding radio work.	2.00
Principles of Radio Communication, by Prof. J. H. Morecroft. An elaborate general textbook. 935 pp., 5¾ x 9.	7.50
Radio Engineering Principles, by Lauer & Brown. An excellent general textbook.	3.50
Radio For Everybody, by A. C. Lescarboursa.	1.50
Radio Simplified, by Kendall & Koehler, revised by J. M. Clayton.	1.00
Prepared Radio Measurements, by R. R. Batcher.	2.00
Elements of Radio Communication, by Ellery W. Stone	3.00
Radio Questions and Answers, on Government Examination for Operators, by A. R. Nilson.	1.00
How To Pass The U. S. Government Wireless Examination, by E. E. Bucher60
Ideas For The Radio Experimenter's Laboratory, by M. B. Sleeper.25
Henley's 222 Radio Circuit Designs, by Anderson, Lewis and Mills	1.00
Henley's Workable Receivers, by Anderson and Lewis	1.00

Read 'em and learn!

**QST BOOK DEPT., 1711 PARK STREET
HARTFORD, CONN.**

NOTES

NOTES

NOTES

NOTES

NOTES

NOTES

NOTES

Learn to Send the *Easy* Way



Reg. Trade Marks
Vibroplex
Bug
Lightning Bug

With the Genuine Martin

VIBROPLEX

Improved Radio Transmitter

For
Continental
Morse or
Navy
Code

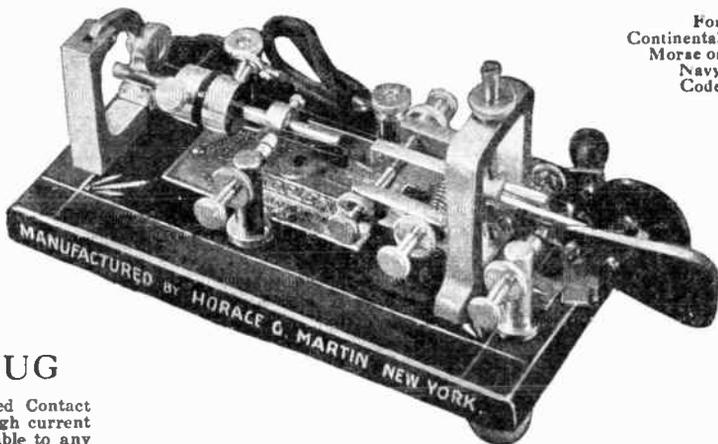

Japaned Base, \$17
Nickel-Plated, 19
Carrying Case, 3

Improved Radio BUG

Equipped with Specially Constructed Contact Points 3/16" in diameter to break high current without the use of a relay. Adjustable to any desired speed. The choice of radio operators everywhere. **\$25**

Simply Press the Lever—The Vibroplex Does the Rest

What Users Say

From Station 4UA
Dundee, Fla.

"I am a constant user of the Vibroplex, and my signals are always clear and readable at audibility R5 in England, France, Italy, Argentina and Alaska according to reports received on QSL cards. Have had many a compliment on my sending 'good fist' but I attribute it to my faithful Vibroplex."

From Station u2EV
New York City

"I wouldn't be without a Vibroplex. I use it continuously at my station and on ships at sea and results have been more than I anticipated. Its speed and accuracy is marvelous, and makes one's sending far more readable than when using the ordinary key. What a blessing it would be if all amateurs used the Vibroplex thereby improving those 'bum fists' you hear so much."

No operator—no matter how skilled can send Continental or Morse code on an ordinary key with the *EASE* and *PERFECTION* of the Vibroplex.

Signals that will be heard and easily read thousands of miles away are transmitted at any desired speed, simply by pressing the lever—the *Vibroplex does the rest*.

More than 100,000 Wireless and Morse operators use the Vibroplex in preference to the key, because the sending is more uniform, the signals easier to read and the effort of sending is reduced to the minimum.

Learn to send the *EASY* way—with the Improved Vibroplex. It saves the arm, prevents cramp and enables you to send with the skill of an expert.

Insist on the Genuine Martin Vibroplex. See that the *VIBROPLEX Nameplate* is on the *BUG* you buy. Accept no substitute. When you buy a Vibroplex you buy complete satisfaction. Sent anywhere on receipt of price. Money order or registered mail. Liberal allowance on your old Vibroplex—any model.

Write for Catalog

THE VIBROPLEX COMPANY, Inc., 825 Broadway, NEW YORK

J. E. Albright, President
Telephones: Stuyvesant 6094, 4828, 4829

xxii

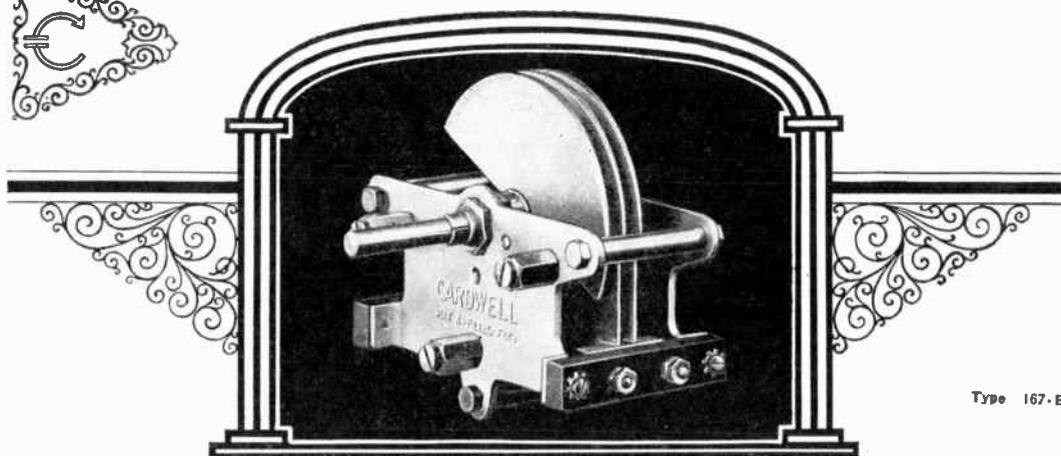

Type 167-E

THE BACKGROUND

TO THE "OLD TIMERS"—by whose unswerving efforts present day radio has been made possible, little of the contribution of Cardwell to the science of radio needs to be told.

For others, we mention just a few things, designed so far in advance of their general adoption that many have no idea of the date of their original inception.

The first sub-panelled receiver! The first single control receiver! The first shelf brackets! The first cabled wiring! The first symmetrical panels! The first commercial Neutrodyne! The first Toroid, "Binocular", "Figure 8" and "Self Supporting" coils! The first equalizing vernier dial!

In the variable condenser field, the "Low-Loss" Condenser. The "grounded rotor". The first "straight line" Condenser. The first condensers with tuning characteristics arranged for special purposes, culminating in the Taper Plate, with the *Ideal Tuning Curve*, midway between straight frequency and straight wavelength.

Send twenty-five cents for our thirty-six page booklet. It is an education in low-loss design.

The Allen D. Cardwell Manufacturing Corp.
81 PROSPECT STREET BROOKLYN, N. Y.

Cardwell

"THE STANDARD

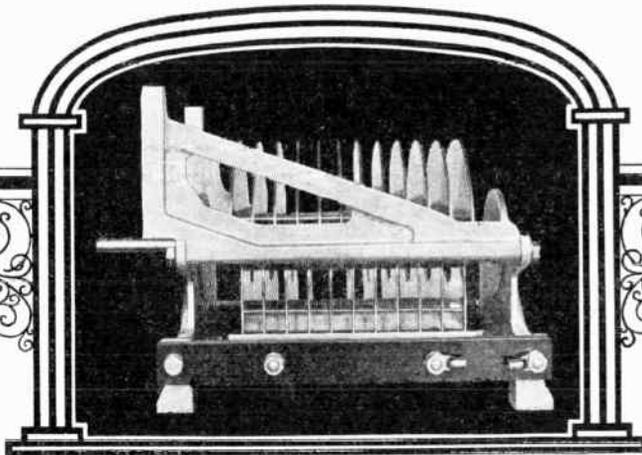

Type 166-11

Catalogue

The thirty-six page booklet, profusely illustrated, mentioned on the opposite page, contains our complete line.

RECEIVING CONDENSERS

Type	Taper Plate Capacity Mmfd.s.	Price
191E	.000075	\$4.00
167E	.00015	4.00
168E	.00025	4.25
169E	.00035	4.75
192E	.0005	5.00

TYPE "C"

(Particularly adaptable for Broadcast Receivers where dual or single control is desired)

Capacity	Type	Price
.00035	171C Single	\$ 4.75
	217C Dual	8.00
	317C Triple	12.00

"BALANCET"



SINGLE

Type	Capacity	Price
605-A	.000015	\$1.25
607-A	.000025	1.25
609-A	.000035	1.25
611-A	.000040	1.50
613-A	.000050	1.50

DUAL

Type	Capacity*	Price
610-A	.000015	\$2.00
614-A	.000025	2.25
618-A	.000035	2.25
622-A	.000040	2.50
626-A	.000050	2.50

*Each Side



INDUCTORS (Receiving)

Type 196-A (Single)	- - -	\$1.50
196-A-2 (Set of two)	- - -	2.75
196-A-3 (Set of three)	- - -	4.00
198-C R. F. Choke	- - -	1.50

TRANSMITTING CONDENSERS

Variable

Capacity Mmfd.s.	Type No.	Breakdown Voltage†	Price
250	164-B	3000	\$ 7.00
440	147-B	3000	10.00
80*	197-B	3000	8.50
217*	157-B	3000	12.00
156	183-B	5250	15.00
297	166-B	7600	70.00
480	123-B	1400	5.00
480*	156-B	1400	7.00
980	137-B	1400	7.00

FIXED

250	501	3000	\$4.50
440	502	3000	7.00
966	503	3000	10.00
250	504	5250	15.00

*Has two insulated stators-capacity of each.

†R. M. S. pure sinusoidal A.C. Plate Voltage should not exceed 60% of this value.

INDUCTORS (Transmitting)
Edgewise Wound Copper Ribbon
5 1/4 Outside Diameter, per turn, \$.10
9 1/4 Outside Diameter, per turn, \$.15

R. F. Chokes, complete with tips and jacks

198 A up to 100 meters - - \$3.00
198-B above 100 meters - - 4.50

SUB-PANEL BRACKETS
Type 195 Per pair - - - \$.75

MOUNTING FEET
Adapting Condensers for sub-panel or baseboard mounting.

Per pair - - - - - \$.25

FLAT COPPER RIBBON
Per foot - - - - - \$.08

The Allen D. Cardwell Manufacturing Corp.
81 PROSPECT STREET
BROOKLYN, N. Y.

Condensers

of "COMPARISON"



Technical Apparatus for RADIO

Tobe Transmitting Condensers

The TOBE Transmitting Condensers are made with the same care and scrupulous attention to detail as the TOBE Bi-Pass, filter and high-voltage power pack type condensers. Each transmitting condenser is tested and labeled with date of test and initials of tester. Capacities are guaranteed within 5% of ratings.

1,000-volt condensers are fitted with heavy brass binding posts. 2,000-volt condensers have heavy brass binding posts with petticoat insulators. Each condenser is cased in a heavy silvered finish metal case.

The ideal condenser for transmitting plate-supply use. Packed singly.

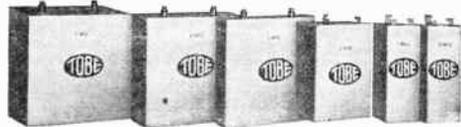

		PRICES		
Capacity Mfds.	Type No.	1,000 Volts	Type No.	2,000 Volts
.1	1001	\$1.50	2001	\$2.50
.25	1002	\$2.00
.5	1005	\$3.00	2005	\$4.00
1.0	1010	\$4.00	2010	\$4.75
2.0	1020	\$6.00	2020	\$8.00

Tobe Bi-Pass and Filter Condensers

TOBE Bi-Pass and Filter Condensers are designed for all ordinary by-passing work around Radio sets and for filter use where working voltages do not exceed 300.

List of Prices Bi-Pass Condensers		
.1 Mfd. 60c.	1.0 Mfd. 90c.	2.0 Mfd. \$1.75
List Prices — Filter Condensers		
0.1 Mfd. 70c.	0.5 Mfd. 90c.	1.0 Mfd. \$1.25.
		2.0 Mfd. \$1.75



Tinytobes

A new TOBE product making the TOBE line complete, from the smallest to the largest fixed condensers required in Radio.

TINYTOBES are specified in the Lincoln Superhet., Victoreen, Sampson T. C., and many other leading circuits.

It would be hard to find a more efficient, compact and generally advantageous small fixed condenser than the TINYTOBE.

PRICES	
.0001 Mfd., .00025 Mfd., .0005 Mfd.	35c
.001 Mfd. and .002 Mfd.	40c
.005 and .006 Mfd.	45c
.01 Mfd.	55c
.02 Mfd.	60c



Tobe Veritas Hi-Current Resistors

The heavy duty resistor that radiates 5 watts. For plate-supply voltage-control and transmitting grid-leaks.

PRICES:	
2000 ohms to 10,000 ohms	\$1.10.
50,000 ohms	\$0.90
100,000 ohms	\$0.80.
1/4 meg., 1/2 meg., and 1 meg.,	\$0.75



Tobe Transmitting Tubes

The TOBE Transmitting Tubes are made in four sizes: 8, 30, 250 and 500 watts. They are of exceptionally rugged construction and are designed primarily for short-wave work. The larger tubes have the plate connection at the top and the grid connection brought out at one side.

PRICES:					
8 watts	\$6.00	250 watts	\$95.00
30 watts	\$15.00	500 watts	\$140.00

Send for pamphlet fully describing these tubes.

If you are unable to secure TOBE technical apparatus at your dealers, we will be glad to forward your order on receipt of check or money order.

Tobe Deutschmann Co.

Engineers and Manufacturers of Technical Apparatus
Cambridge, - Mass.

PYREX RADIO INSULATORS

T. M. REG. U. S. PAT. OFF.

PYREX indicates special glasses and products manufactured by Corning Glass Works, and radio products bearing the trade-mark PYREX are the ideal equipment where permanent high insulating values are desired.

PYREX Radio Insulators are homogeneous and of a continuous uniform construction and do not depend on surface glaze for their insulating properties.

PYREX Insulators do not absorb water or attract moisture. Their smooth, permanent surface prevents

the collection of dust. They are mechanically strong and light in weight, thus enabling even high power transmitting insulators to be made with reasonable dimensions.

The electrical properties of PYREX Radio Insulators are as follows:

Phase Angle Difference, 0.25° Di-electric Constant, 4.5

Surface Resistivity, 34% Humidity, 10.14 ohms.

Surface Resistivity, 84% Humidity, 14x10.8 ohms.



Small Lead-in Insulator

No. 67009 Size 1-K.W.

12 Pieces in Case

Factory List Each \$1.50

Height 4 3/8 inches, Width at bottom 6 1/16 inches, Weight 1 lb. 11 1/2 oz. Suitable for use on receiving and transmitting antennas, powers up to 2 K. W.



Amateur Transmission Insulator

No. 67017. Size 7 1/2 in. Factory List Each \$1.50

Packed one in Carton

36 Cartons in Case

Developed Leakage Path 6 ins., Strength approximately 1000 lbs., Weight 13 1/2 oz. Suitable for use on transmitting antennas, powers up to 250 watts.



Broadcast Reception Insulator

No. 67007 Size 3 1/2 in.

Factory List Each \$.45

Packed one in Carton

12 in Display Box

12 Display Boxes in Case
Developed Leakage Path 3 9/16 inches, Strength in excess of 450 lbs., Weight 3 oz. For use on broadcast receiving set antennas.



Stand-off Insulator

No. 67018. Size 3 in.

Factory List Each \$2.75

12 Pieces in Case

Length of base 3 1/16 inches, Width of base 1 1/8 inches, Weight 10 oz., 3/8"-16 Hole tapped in top brass cap. Used for insulating lead wire of receiving and transmitting sets.

Stand-off Insulator

No. 67019. Size 7 in.

Factory List Each \$3.00

12 Pieces in Case

Length of base 3 1/16 inches, Width of base 1 1/8 inches, Weight, 17 oz., 3/8"-16 Hole tapped in top brass cap. Suitable for use on powers up to 1 K. W. Used for insulating lead wire of receiving and transmitting sets.

Strain Insulator

Size 12 1/4 in.

12 Pieces in Case

Factory List Each \$3.50

Developed Leakage Path 11 3/16 inches, Strength approximately 1000 lbs., Weight 1 lb. 14 oz. Suitable for use on transmitting antennas, powers up to 1 1/2 K. W.

Note: Prices slightly higher in the West.

What is Dependable?



THATS the question the experimenter faces in buying his apparatus, particularly in buying by mail. The only solution is to purchase known parts, from dependable sources.

The E. F. JOHNSON COMPANY, (9ALD), Waseca, Minnesota, is such a source. Our earnest endeavor is to handle only such merchandise as we can highly recommend and guarantee, and the number of extremely complimentary reports we continually receive bears witness to our success in fulfilling this desire.

In addition to certain items we manufacture, the following are some of the well known manufacturers we represent directly:

Acme Apparatus Co.
Allen-Bradley Co.
Belden Mfg. Co.
Corning Glass Works
Tobe Deutchmann Co.
Electrad, Inc.
M. M. Fleron & Son

B. F. Goodrich Rubber Co.
Jewell Electrical Inst. Co.
National Company, Inc.
Signal Electric Mfg. Co.
Thordarson Elec. Mfg. Co.
Ward Leonard Electric Co.
Wireless Specialty App. Co.

If you haven't our HAMALOG, the latest copy of which is illustrated, by all means ask for it at once—it's free. It is the original "Ham Catalog", and still the best although copied.

To bona-fide RADIO DEALERS, we offer the usual trade discounts—also to broadcasters, educational institutions, etc., a large number of whom are now our regular customers.

E. F. JOHNSON COMPANY

Waseca

Minnesota

9 ALD

AMATEURS

Standardize on

GENERAL RADIO

Apparatus in Your Short-Wave Receivers and Transmitters

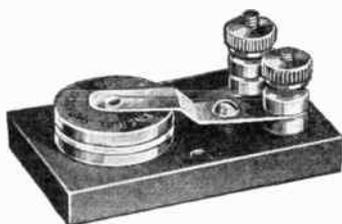

Type 276-A—Quartz Plates

Quartz plates for crystal controlled transmitters are available at random frequencies in the 150-170 meter band. These plates provide harmonics in the 20, 40, and 80 meter bands, and may be used for transmitters on these wavelengths. Calibration is to 0.25%. All plates are guaranteed to oscillate when used as directed. The only licensed plates available to amateurs.

Type 276-A Amateur Quartz Plate, unmounted,	\$15.00
Type 356 Crystal Mounting,	1.00

Type 358—Amateur Wave Meter

This instrument is particularly designed for amateur use in checking wavelengths. Consists of a coil mounting directly on the binding posts of a shielded condenser of 125 MMF capacity. A small lamp serves as a resonance indicator.

The 358 wavemeter is supplied with 4 coils, a calibration chart and wooden carrying case.

The coil ranges are as follows:

Coil A	14 to 28
Coil B	26 to 56
Coil C	54 to 114
Coil D	105 to 224

Wavemeter complete Price \$22.00

Type 349—UX-CX Tube Socket

This socket is made of moulded Bakelite and designed for UX and CX base tubes. Positive contacts are made with double gripping springs of Phosphorus bronze to the sides of the tube prongs.

Type 349 Socket Price \$5.00

Type 334—Transmitting Condensers

The types 334-T and V condensers are similar in appearance and assembly to all other Type 334 condensers except that they have double spacing for use in short wave transmitting on voltages up to 2000. They have metal end plates with shielded rotor. Plates of the rotor and stator groups are soldered to insure perfect electrical contact. The type 334 transmitting condensers are supplied with counter weights only.

Type 334-T Capacity 100 ⁰ MMF	Price \$4.25
Type 334-V Capacity 50 MMF	" 3.75

Type 277—Low Loss Coils

The type 277 coils are wound on moulded Bakelite forms, and the ratio of diameter to length so proportioned that they have very low losses. They are available in various ranges of wavelengths from 50 to 900 meters, and are supplied with single winding and with primary and secondary windings closely coupled. For ranges and prices, see Bulletin No. 925.

Write for Folder 276-A on Quartz Plates and Parts Bulletin 925-A

GENERAL RADIO CO. :: CAMBRIDGE, MASS.



Here's the most economical "B" battery —not only for receivers but for low power short wave Transmitters

IN the production of the Eveready Layerbilt "B" Battery No. 486 we have made a great advance in radio economy not only for the BCL but for the transmitting amateur. Here is what we tell the BCL, and it is just as true for you as for him:

Eveready Heavy Duty 45-volt "B" Batteries will outlast any lighter duty 45-volt "B" two to one regardless of the number and kind of tubes used! Moreover—though lasting twice as long, they cost only one third more!

Exactly the same unequalled endurance and dependability that make

this battery the world's best buy for broadcast receivers, make it the best power source you can buy for short wave receivers—and low power transmitters.

Hook a set of Eveready Layerbilts to an oscillator tube and you'll be known on the air for the prettiest, cleanest pure DC note that it is possible to produce. There is nothing like battery power. And we'll back the Eveready Layerbilt to the limit as offering the most suitable plate supply for low power, and as giving you that supply at the least operating expense. There is an Eveready dealer nearby.

Manufactured and guaranteed by

NATIONAL CARBON COMPANY, Inc.

New York

San Francisco

Canadian National Carbon Co., Limited, Toronto, Ontario

EVEREADY

Radio Batteries

—they last longer

Never Before At This Sacrifice Price



HIGH VOLTAGE KENOTRON RECTIFYING TUBES MODEL U. V. 217



A. C. Plate Voltage 1500 volts. Filament Voltage 10 volts.

Used with U. P. 1016 Power Transformer or similar Transformer.

These Genuine R.C.A. U. V. 217 Tubes are very efficient Rectifiers and they will pass plenty of current and voltage for 50 watters and H Tubes and also can be used for 250 watters. **Every tube is brand new and packed in original carton.**

List Price \$26.50 ea. **EXTRA SPECIAL, \$12.50 EA.**



POWER RHEOSTATS

Model PR-535



For controlling filaments of U. V. 202, 216, U. X. 210 and 216 B. Tubes.

Each Rheostat has two windings giving four different resistance values from 1.5 to 6 ohms, and has a large rated current carrying capacity up to 2.5 amps.

LIST PRICE \$2.75 Ea. **SPECIAL PRICE, 65c Ea.**

GENUINE BAKELITE PANELS 1/4" THICK

First Grade. Highly Polished on Both Sides.

Size	Regular Price	SPECIAL PRICE
9 1/2 x 11 1/8"	\$2.63 ea.	\$1.00 ea.
10 1/16 x 14 1/16"	3.63 ea.	1.50 ea.
14 9/16 x 17 15/32"	6.38 ea.	2.50 ea.
15 1/8 x 16 13/16"	6.38 ea.	2.50 ea.



Make your TRANSMITTER and RECEIVER efficient and neat with these High Grade Panels.



MICA TRANSMITTING CONDENSERS

.002 MFD. 6000 VOLTS

Manufactured by Connecticut Telephone & Electric Co.
Used As Grid, Radio Frequency By-Pass
and Plate Blocking Condenser

EXTRA SPECIAL PRICE \$2.00 Each

RADIO SPARK TRANSMITTERS (75 WATT PORTABLE)

Made for U. S. Army Aeroplanes

This is a tuned spark coil transmitter, with a wave length of 100-300 meters. The set is made of the finest of materials and the essential parts are the spiral tuning inductance, the induction coil, sending condenser and spark gap. Average range about 25 miles more or less. Just what you want for making a Spark Coil—C.W. transmitter.

Brand new, in original cartons.

ORIGINAL GOVERNMENT COST, \$47 EACH

OUR PRICE \$4.75 EACH

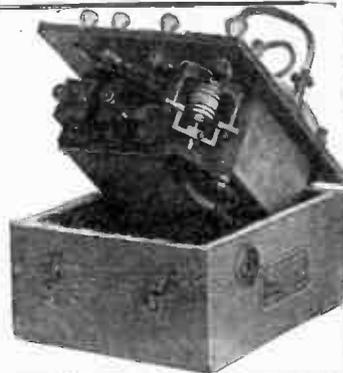

U. V. 216, R.C.A. Kenotron Rectifying Tubes. A. C. input 550 Volts, Filament 7 1/2 Volts.
Brand New, List \$7.50, SPECIAL \$1.85 Each

AMERICAN SALES CO., 21 Warren St., New York City

THE SUPER SYNC RECTIFIER

The Synchronous Rectifier that can be Filtered

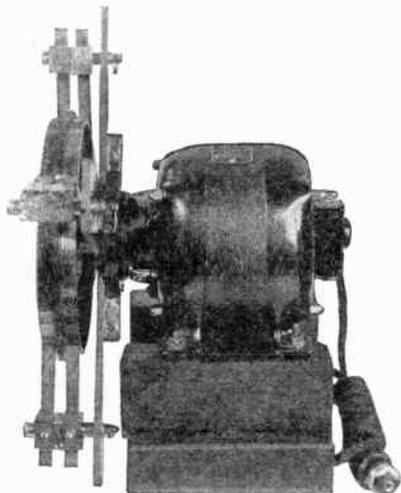

PAT. PENDING

The Super Sync is designed to rectify alternating current to direct current at any voltage up to 4000 volts for use as plate current for radio transmitters.

The fact that the Super Sync rectifies practically 99% of the full wave makes it casier and requires much less apparatus for filtering out the A.C. hum than when using any other type of mechanical rectifier.

The tone delivered by this rectifier when filtered properly is pure D.C. and in many instances we have reports on file which state that it is as good a tone as

delivered by stations using battery plate supplies. It has been proven that the current delivered by this rectifier can be used on broadcast stations and is much more efficient than any other type of plate supply.

The insulating ridge between the conducting segments prevents any breakdown between these two points. This is not true of any other synchronous rectifier on the market.

The commutator on the Super is eight inches in diameter and is turned at a synchronous speed by a $\frac{1}{4}$ H.P. synchronous motor. This motor can be supplied for either 110 or 220 volts, 50 or 60 cy. Motors with other ratings can be supplied, but will require a slight delay in shipment.

Further information will be supplied if you will write to the address stated below.

MARLO ELECTRIC CO.

5241 Botanical Ave., St. Louis, Mo., U.S.A.

HALCO

DALLIN HALCO SUPER

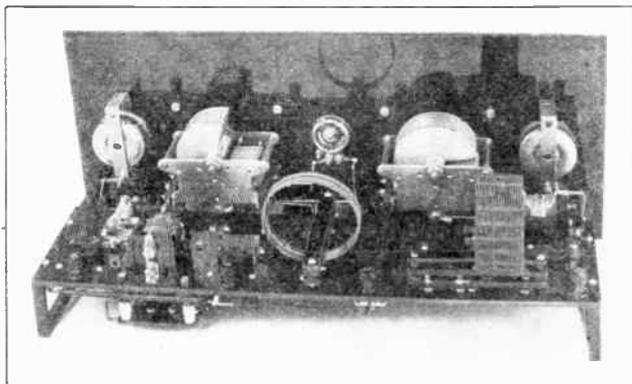

THIS new short-wave receiver developed by Edwin B. Dallin, Cruft Laboratory, Harvard University, Cambridge, Mass., employs a Super-Regenerative circuit which is, unlike most of its predecessors, extremely easy and uncritical to operate. (1) The tuning control has no effect on the beat-note. (2) The beat-note has no effect on the tuning or sensitivity. (3) The variation frequency is super-audible and does not disturb the listener.

The detector never really oscillates so that a third heterodyne tube is required for receiving C. W. This heterodyne oscillator circuit employs an extremely weak harmonic, as high as the fiftieth, for best reception of extremely distant signals.

PERFORMANCE

The performance of the set is remarkable. Mr. Dallin, using an experimental model, heard signals from all over the world, including voice and music from Nauen, Germany, on 30

meters. A number of other foreign stations on short waves are readily picked up with the Dallin-Halco Super. Whenever pure C. W. is to be received it is simply necessary to switch on the filament of the oscillator tube.

DALLIN--HALCO KIT

The Dallin-Halco Super is available in complete kit form with nothing else to buy. The price is \$47.00 (Send for new descriptive folder giving circuit diagram, stations heard, and harmonic heterodyne chart.)



HALCO MAIL ORDER SERVICE

32 HANOVER STREET

BOSTON, MASS



SHORT WAVE PRODUCTS



“BREAKING IN” *with* QST's LOW POWER TRANSMITTER

Built in Accordance to Specifications Given in the A.R.R.L. Handbook

COMPLETE KIT INCLUDES:

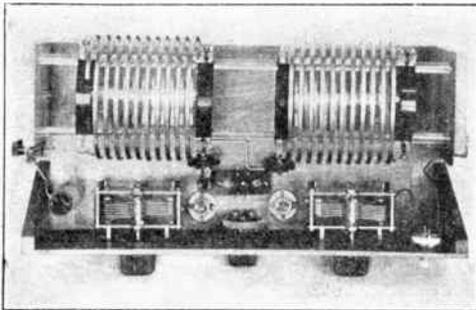

7½ Watt Transmitter for 20, 40 and 80 Meters

- | | |
|--|--------------------------------------|
| 1—Maple Front Panel—drilled and engraved | 1—REL Radio Frequency Choke Coil |
| 2—Maple Panel supports | 1—REL UX Base Socket |
| 2—Maple Inductance supports | 1—4 Post engraved Binding Post Strip |
| 1—Maple Baseboard with grooved end pieces | 1—2 Post engraved Binding Post Strip |
| 1—REL Inductance—flatwise wound on glass. One primary and one secondary coil with two glass rods | 1—5000 Ohm Lavite Grid Leak |
| 2—Cardwell .0025 Mfd Variable Condensers | 1—.001 Sangamo Condenser |
| 2—3 Inch Dials | 1—.002 Sangamo Condenser |
| 1—2 ohm Amsco Power Rheostat | 3—Porcelain Miniature Lamp Sockets |
| | 1—3.5 volt Lamp |
| | 2—6 volt Lamps |
| | 2—Lengths of Bus Bar |
| | 5—feet flexible rubber covered wire |
| | All necessary mounting screws |

The Inductance You Will Eventually Use Is Included in This Popular Set

Regular Price on These Parts When Purchased Individually \$35.00

Specially priced for sale to the amateurs **\$24.50**

The complete REL line comprises of

Receiving :::—Plug-in Coils, R.F. Chokes, Short Wave Receiving Kits.
Transmitting :::—Complete Kits for all Circuits.

Power Supply. 50 and 250 watt REL Sockets, Power Rheostats, Inductances, Condensers, Chokes, Panels and Frames.

These are all described in our Catalogue. Write us your problems.

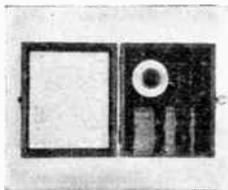

REL Wave Meter—Suitable for general usage. Wave length range 17-560 meters, with Neon tube indicator. Type “A” complete is \$22.00.

The New REL Catalogue Is Here!

Complete, comprehensive, invaluable information that is kept absolutely up to the minute by our sending you, from time to time, the latest data sheets “hot off the press.”

The only cost to you is the initial payment of twenty-five cents.

We have pages on Tuned Grid, Master Oscillator, Crystal Control and a number of other subjects ready to send to every devotee of Short Wave Radio.

First come, first served. Send for yours today. Remit P. O. money order or U. S. currency.

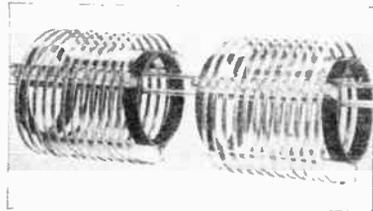

REL Transmitting Inductances—Flatwise wound on glass. The inductance that you must eventually use.

Type L—(40, 80, 150 meters wavelengths)

Type S—(20 meters and less)

Single Unit, either type, with three clips \$5.50

Double Unit, either type, with six clips \$11.00

REL OWNS AND OPERATES EXPERIMENTAL STATION 2XV ON
15.1 METERS, 19867 KILOCYCLES, CRYSTAL CONTROLLED



Radio Engineering Laboratories

27 Thames Street, N. Y., N. Y.



DODGE RADIO SHORTKUT

WHAT WE THINK

Once mastered our way Code signals never forgotten.

Code often learned with "exceptions."

Few "exceptions" mean very slow speed.

Many who think know Code fall down on official test.

Shortcut users pass exam first time trying.

To fail in exam means call again after three months.

Shortcut users have made world records mastering Code.

Boy Scouts using Shortcut say makes them think quick.

Shortcut as well adapted to Hams who need more speed as to those learning the Code.

If anchored at 20 or less, just "get" code our way and speed up to 25 per.

If intend to learn Code use Shortcut, save months in time possibly avoid total failure.

"Grandpa" has used Shortcut with fine success; now has license.

Hundreds of BCL'S read Code. Studied Shortcut few evenings only.

As all we say may be doubted give once over to right hand column where users talk.

KILLS HESITATION. Fixes Signals in Mind to Stay Put. Now offered in combination with APPENDIX which makes rapid progress more certain. Also Helpful Hints for BETTER KEY WORK which cultivates legible transmission. Code mastered our way is foundation for quick advance to limit of individual capacity.

MEMORIZE CODE OUR WAY. No instruments of any kind required. **FIX SIGNALS IN MIND TO STICK.** Task has been finished by many in 15 to 45 minutes.

GAIN ABILITY TO READ CODE WHEN HEARD. By listening in as instructed ten word speed has been developed in few days utilizing odd moments only.

LEARN TO TRANSMIT LEGIBLE CODE. The easiest part of the job and often carelessly done. To be copied Code must be fairly legible as sent. Cannot be studied and compared as written text. Use of key should be taken up after can copy ten per.

RAW BEGINNERS USING RADIO SHORTKUT have mastered Code; developed receiving speed; learned use of key and to send and passed exam all in ten days.

RAISE RECEIVING SPEED TO 20 PER. Make yourself a regular Ham. Apply for ORS or OBS A.R.R.L. appointment. Mind the rules. Push traffic. Qualify for Commercial Ticket. Spend many pleasant vacations on board ship at good pay. Briefly this is history of several who used Radio Shortcut to master the Code.

STRUGGLING BEGINNERS STUCK AT 4 TO 8 say as result of using our method increased speed to 20-25 per by attention four to six evenings.

LICENSED HAMS WHO USED OTHER METHODS for learning and found themselves anchored at about 15 per and could not budge until tried Shortcut report have raised receiving speed from 15 to 25 in ten days — from 15 to 30 in one evening — 12 to 20 by practice at spare moments during few days, etc., etc. Several easily made themselves Commercial First because as foundation they had mastered Code our way.

PLAY SAFE — INVESTIGATE before investing. Only one true test as to merit of any method for self instruction — results obtained by users.

REPORTS FROM TWO HUNDRED LICENSED USERS telling the story of rapid progress and quick results, mailed for 25 cents. Quarter coupon enclosed for use when ordering Shortcut.

INFORMATION AND REPORTS EACH RADIO District mailed on request.

Shortcut with Appendix and Better Key Work, \$3.50 U. S. and Canada. Elsewhere \$4.00. Registered Mail. Money Order only. None C. O. D.

WHAT USERS SAY

1COB Damon; Learned Code your way in 15 min. Now First Class Commercial.

2CPQ Phipps; Helped me so much qualified in 3 days.

3RD Galbraith; Thought I never would learn Code. Mastered same in 30 min.

4QY Grogan; Doubled receiving speed in just five hours.

5AHM Wilkens; Speed was 6. In few weeks 18. Now 27.

6BFA Murphy; Before using knew nothing of Code; Passed in 10 days.

7EI Doty; Anchored at 6. In 2 weeks copied 15 per.

8AND Fallain; For teaching found Shortcut the thing for code.

9ML Hull; Stuck at ten per. Now copy 20 per easily.

c3ADY Brien; Attention six evngs raised speed 6 to 20 per.

g6ZX Field; Method quite wonderful. Quick results.

z2AI Harrison; Mastered Code quickly; passed exam easily.

z4AZ Sidey; Method was invaluable. Quick results.

srFMH Mejia; Mastered Code easily, quickly your way. Wonderful method.

DODGE RADIO SHORTKUT, Mamaroneck, New York

Faradon

Capacitors for Every Need



To help iron out that 60 cycle A. C. power line hum a Faradon Filter Capacitor Block is most convenient for use in connection with the generally used Battery Eliminator circuits. Outside dimensions of casing are $3\frac{1}{4}$ " x $4\frac{1}{2}$ " x 5" (high).

Where required for replacements or to meet any unusual conditions, we are prepared to furnish special units or blocks. In such cases full data is requested.

Wherever a reliable fixed condenser is required there is a Faradon to meet the exact need. Finest materials and workmanship maintained by numerous rigid inspections and tests during production insure satisfactory operation. It always pays to specify Faradons.



Model WS Filter Units



Model WS By-Pass Unit

Faradon Units are available for application at the source of interference resulting from sparking commutators or similar causes. Special units can be furnished where potential exceeds 220 volts A. C.



Model T

All Metal Mica Condenser
(Showing Type 1 Terminals)

This high grade mica condenser furnishes precise capacity values in least space with minimum weight. It fits in wherever wanted

Manufactured by

The Wireless Specialty Apparatus Company

Jamaica Plain, Boston, Mass., U. S. A.

Established in 1907

Specialists in Electrostatic Condensers for All Purposes

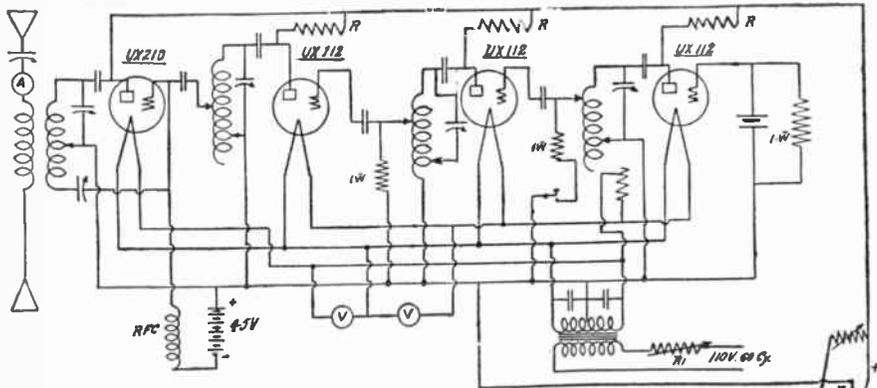

THIS is the third of a series of five "hook-ups" for crystal control transmitters using "ESCO" Maximum miles per watt Power Supply. The crystal oscillator is a UX112 controlled by a 320 meter crystal for 80 meter operation or 160 meter crystal for 40 meter operation. A 320 meter crystal can be used for both 80 and 40 meters, with slightly reduced output in the 40 meter band. Assuming a 320 meter crystal—the first UX112 oscillates at 320 meters. The second UX112 has its plate circuit tuned to the second harmonic of the crystal tube—160 meters. It amplifies at this wave length. The third UX112 has its plate tuned to the second harmonic of the preceding tube or 80 meters. The last amplifier is a UX210 which is tuned to the wave of the last UX112. Neutralization in the last stage is then necessary, as is shown. Plate supply comes from Item 8 operating from DC or AC supply. The filaments are heated by a 110 volt 60 cycle transformer. Plate circuits of all tubes except the 210 have resistance [R] to drop the plate voltage to not over 250 volts. The 210 has the full 500 volts from Item 8.

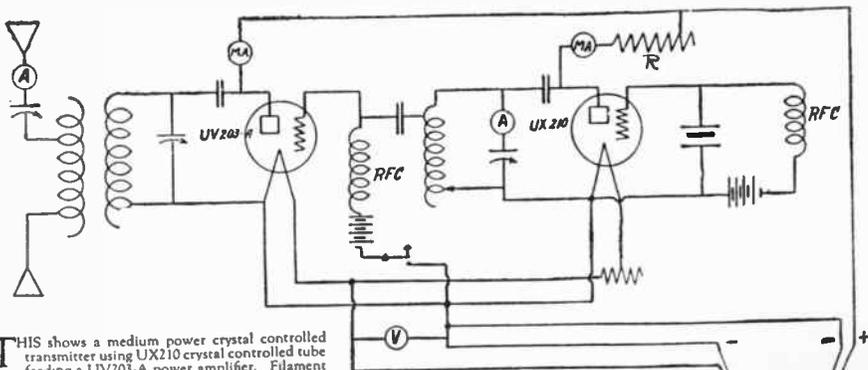
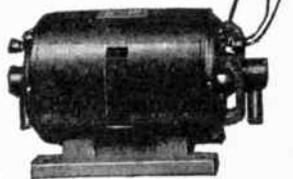

THIS shows a medium power crystal controlled transmitter using UX210 crystal controlled tube feeding a UV203-A power amplifier. Filament and plate voltages are to be obtained from Item 34, operating from either DC or AC house mains. The voltage to the filament generator of the tubes is variable, either by the field reostat in the filament generator circuit (not shown) or by the resistance in the filament circuit of the UX210 tube. Keying is done in the bias circuit of the 203-A power amplifier. As the amplifier is NOT neutralized, the power amplifier must work on some harmonic of the crystal tube [preferably the second], for all operations in the 20, 40 or 80 meter bands. A crystal having a fundamental of 160 meters will allow operation in all bands with best output in the 80 meter one. An 80 meter crystal is best for 40 meter operation and in like manner the 40 meter crystal would be best for 20 meter operation. Forty meter crystals are hard to get and blow up easily, so for 20 meters the 80 meter crystal is used again. Both tubes obtain plate supply from the plate end of Item 34, the UX210 being supplied with not over 350 volts through resistance R, and the 203-A taking the full 1000 volts.

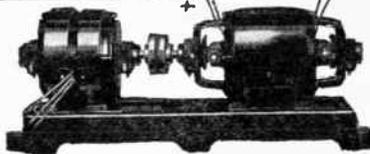

ELECTRIC SPECIALTY COMPANY

150 South Street

TRADE "ESCO" MARK

Stamford, Conn., U.S.A.

Manufacturers of Motors, Generators, Motor-Generators,
Dynamotors and Rotary Converters for Radio and other purposes

This Series of five "hook ups" will soon be available in pamphlet form. Write for your copy.

NATIONAL

in name **NATIONAL** *in fact*

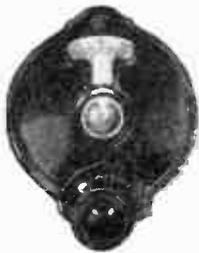

The new NATIONAL Velvet-Vernier, Type C ILLUMINATED Dial has every famous feature of the Type B, including variable ratio with a concealed lamp added. Easily installed without special tools.

Price \$3.00

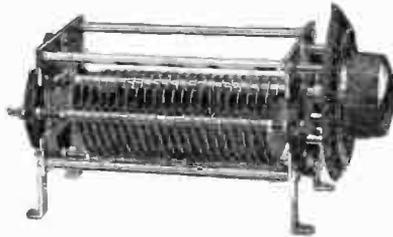

[National Transmitting Condensers used and approved by Lieut. Fred H. Schnell, Don. C. Wallace, A. A. Hebert, Gerald M. Best, L. W. Hatry, Lieut. Lowell Cooper, and countless other members of the A.R.R.L.]

Supplied with 3/16 inch and 3/8 inch spacing on stator plates,—four sizes:— .0001—\$12.50 (3/8" spacing),
 .00023—\$11.50, .00045—\$16.50
 .00015—\$7.50 (3/16" spacing),
 .00023—\$11.00
 .00045—\$16.50

Price includes Type "A" Velvet-Vernier Dial. Type "B" supplied without extra charge. Add fifty cents for Type C Illuminated Dial.

If not stocked by your dealer, we will gladly ship orders for direct shipment on receipt of check or money order, plus transportation charges.



The NATIONAL Impedance Transformer, Type B, includes in one case audio choke coil, .1 Mfd. TOBE Condenser, mounted Lynch Resistor. Three to a set—for modern audio amplification. The first stage contains an R. F. Choke.

Price \$5.50 each

NATIONAL Radio products need no introduction to A.R.R.L. members. In proper combination they form a lasting foundation for modern broadcasting receiving sets, too. Literature covering any or all of these items gladly sent on request,—if A.R.R.L. ANNUAL is mentioned.

Be sure you get genuine NATIONAL products.



The NATIONAL Tuning Unit BD-1B combines a Browning-Drake spaced-wound inductance coil, .0005 NATIONAL "Equicycle" Condenser in a four-inch, Type B NATIONAL Velvet-Vernier Dial.

Price \$10.25
 Add fifty cents for Type C Dial.

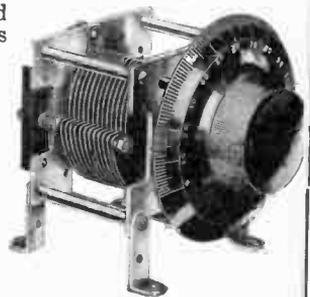

NATIONAL "Equimeter" Condensers with Velvet-Vernier Type A Dials, exceptionally adapted to shortwave receiving sets. In capacities from 50 to 1,000 Mmf.

Prices \$5.00 to \$8.00

NATIONAL COMPANY INCORPORATED

ENGINEERS AND MANUFACTURERS
 110 BROOKLINE STREET

W. A. READY, President
 CAMBRIDGE

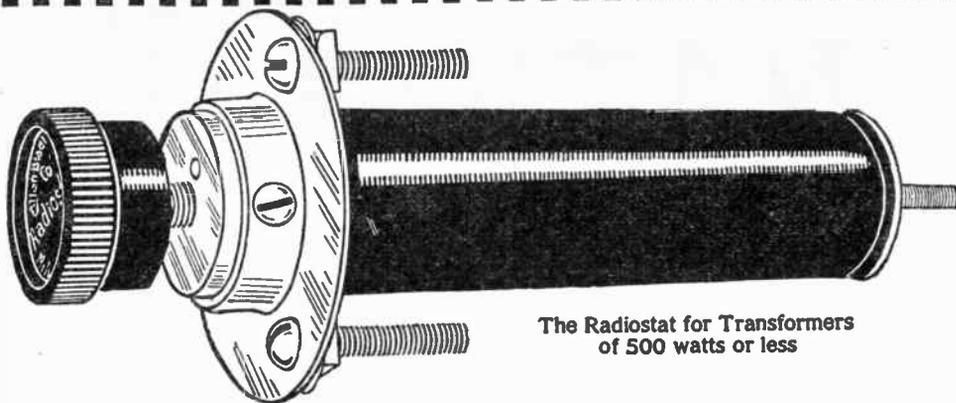

The Radiostat for Transformers
of 500 watts or less

Two Filament Control Rheostats that improve every amateur transmitter

THE RADIOSTAT is an Allen-Bradley graphite-disc rheostat to be used in the primary side of your filament supply transformer. It will easily handle transformers up to 500 watts. It is poor practice to put filament rheostats in the secondary side of the transmitter, because it throws the center tap off. The highly polished mounting plate and dandy knob improve any set, and its smooth, noiseless operation is a distinct surprise. J. D. Slaughter, 5AMF, says "One of the most wonderful instruments manufactured since introduction of tube transmitters."

A. H. Buch, 8AMS, "One knob brings center tap where it should be for efficient operation."

BRADLEYSTAT E-210 is a compact graphite-disc rheostat for two 5-watt tubes. By using it in the primary side of the transformer, the center tap is not displaced, and the transmitter efficiency is greatly improved. Like the Radiostat, one knob provides noiseless, stepless control. Panel mounting is easily made, or table mounting can be used.

F. D. Fallain, 8ZH, 8AND, WGF, WEAA, says, "It appears to me to be the best obtainable. No jerky reading on meter. It is the smoothest ever."

J. C. Lisk, 8CCI, says, "If I could not replace, would not sell for several times original cost."

Use ALLEN-BRADLEY Radio Devices for Better DX Efficiency

Mail the Coupon for Prices and Data

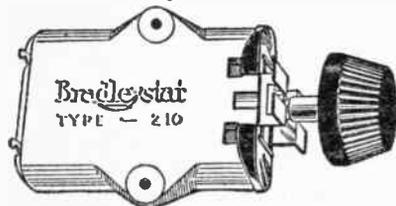

Bradleystat E-210 for
10 watts or less

Allen-Bradley Co.
277 Greenfield Ave., Milwaukee, Wis.
Gud news, OM, abt ur DX rheos. Send me by
return mail, prices and blue prints on

- Radiostat [500 watts]
 Bradleystat E-210 [10 watts]

Name.....

Address.....

The TRANSMITTER and RECEIVER

built by the BURGESS LABORATORIES and used by

HOWARD F. MASON

Chief Radio Operator for the Detroit Arctic Expeditions

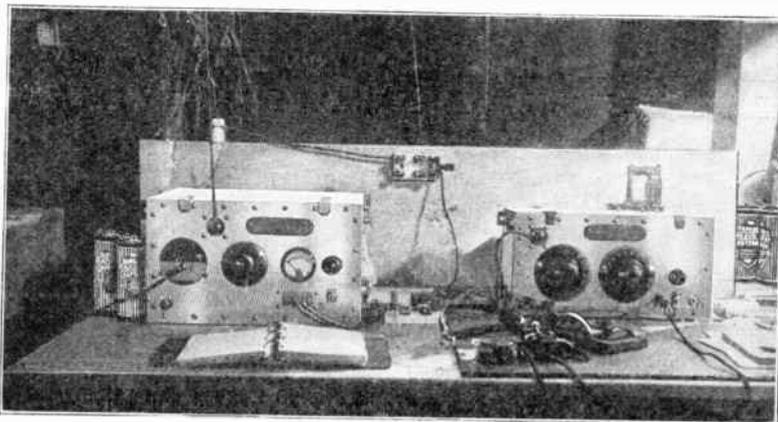

VIEW of portable transmitter and receiver built in the Burgess plant and being used at Fairbanks and Point Barrow, Alaska. The transmitter has a wavelength range of 24 to 80 meters, over which operator Robert Waskey at KFZH (Point Barrow) flashed all reports of the expedition. Both transmitter and receiver are operated by Burgess "A" and "B" dry batteries.

It was Waskey who scored a news beat which scooped the entire world when he saw and reported the first view of the dirigible Norge after it had passed over the top of the world and was seen at point Barrow May 12, 1926. A complete description of the radio equipment of this expedition is contained in the Burgess Engineering Circular No. 10, and you are invited to ask for a copy.



First Landing at Point Barrow of the Alaskan, the Fokker Monoplane used to transport supplies from Fairbanks. The Alaskan was later wrecked in taking off.

BURGESS BATTERY COMPANY

GENERAL SALES OFFICE: CHICAGO

CANADIAN FACTORIES AND OFFICES: NIAGARA FALLS AND WINNIPEG

In United States: Offices and Warehouses in Principal Cities

Don't Guess—push the button and see!

The Sterling Line of Meters

is complete for measuring the charging rate of battery chargers, for amateur transmitting sets and for special testing devices of commercial manufacture or home design.

These include *Ammeters* in several ranges for measuring rates of filament current consumption in tubes; *Milliammeters* for measuring plate current in tubes or in experimental work; *Voltmeters* to indicate correct rheostat adjustment to control voltage of filaments and to measure A and B battery voltages; *Combination Panel Voltmeters* for showing A battery or filament voltage and B battery voltage.



No. R-1626—Milliammeter Push Button Type

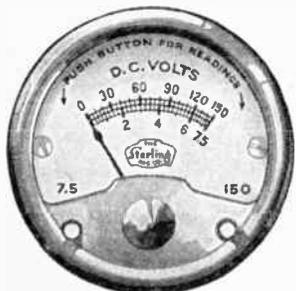

No. R-1647—Combination Voltmeter. Push Button Type



No. 1632. "A" Battery Charge Indicator

STERLING Panel Meters have silver etched dials and nickel or black rims optional. Diameter of body 2"; of rim 2 1/8". Furnished with back clamp for mounting.

Panel D. C. Ammeters

Number of Meter	Capacity of Scale	Scale Divisions	List Price
R-621	0-1 1/2 amps.	1/20 amp.	\$3.00
R-622	0-3 amps.	1/10 amp.	\$3.00

Panel D. C. Milliammeters

R-623	0-10 M.A.	1/2 M.A.	\$3.00
R-625	0-15 M.A.	1/2 M.A.	\$3.00
R-624	0-30 M.A.	1 M.A.	\$3.00
R-1626	0-50 M.A.	2 M.A.	\$3.50

Push Button Type

Panel D. C. Voltmeters

R-640	0-6 volts	1/5 volt	\$3.00
R-641	0-8 volts	1/4 volt	\$3.00
R-642	0-120 volts	5 volt	\$3.50
R-646	0-150 volts	5 volt	\$3.50
R-643	{ 0-4 volts	1/2 volt	\$3.50
	{ 0-720 volts	5 volt	
R-647	{ 0-150 volts	5 volt	\$4.00
	{ 0-7 1/2 volts	1/4 volt	

Panel D. C. Voltmeters With Push Button Built In

R-1640	0-6 volts	1/5 volt	\$3.50
R-1641	0-8 volts	1/4 volt	\$3.50
R-1647	{ 0-7 1/2 volts	1/4 volt	\$5.00
	{ 0-150 volts	5 volt	

Panel A. C. Voltmeter

Invaluable for mounting in equipment used by transmitting amateurs, also for devices for treating tubes.

R-644	0-15 volts	1/2 volt	\$6.00
-------	------------	----------	--------

Panel 6 Volt A Charge Indicator

Shows when the A battery needs charging and when A battery on charge has been charged enough.

R-1632	Nickel finish, Black Dial		\$3.00
--------	---------------------------	--	--------

Sterling

Radio Meters

Send for booklet "S" giving complete information on all necessary caretakers and inspectors of radio

THE STERLING MANUFACTURING CO.
2831 Prospect Ave. - - Cleveland, Ohio

CARTER

Radio Products

CARTER Parts respond to the call of every circuit. Carter has designed and manufactures the largest line of radio parts—and year after year a greater number are preferring them above all others. From those who know, the word has gone forth—You can't beat Carter Parts. *Your dealer will gladly show you why.*



"MIDGET" Rheostat with Filament Switch Complete with Pointer Knob \$1.00



"HOLD-TITE" Jack Seven Different Spring Combinations 70c to \$1.30



Quarter Size Receptacle Jack with Volume Control \$2.75



"ONE-WAY" Plug 50c

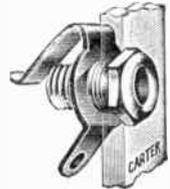

(Full Size) Tip Jack 10c



Half Size "MIDGET" Rheostat All resistances 50c



Half Size "IMP" Pilot Switch Complete with 6 volt lamp \$1.50



Half Size "SHORT" Jacks Open Circuit 25c each Closed Circuit 30c each



Half Size New Fixed Resistance Unit 3, 4, 6, 10, 15, 20, 25 ohms 15c ea.



Half Size "IMP" Battery Switch 65c



Half Size "IMP" Inductance Switches \$1.00 to \$1.25



"IMP" Plug 15c



Half Size "IMP" Lock Switch 75c

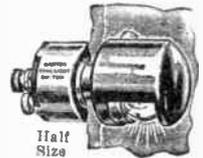

Half Size DIAL LIGHT \$1.75



Half Size "IMP" Rheostat All Resistances 3 to 50 ohms \$1.00



Half Size "IMP" Potentiometer 200 or 400 ohms \$1.25



Half Size "HI-OHM" 500,000 ohms \$2.00



Half Size "Flat" Plug 75c



Half Size "HI-POT" Potentiometer type 500,000 ohms \$2.25

In Canada—Carter Radio Co., Limited, Toronto

Offices in Principal Cities of the World



Radio Operators Wanted

POSITIONS GUARANTEED

BY

Eastern Radio Institute

Modern and Efficient Methods of Instruction. Completely Equipped Laboratory. Up-To-Date Apparatus including Crystal Controlled Short Wave Transmitter. Special Code Classes. Fourteen Years a Radio School. Day or Evening Classes Start Every Monday.

Write for Illustrated Prospectus

EASTERN RADIO INSTITUTE

899 BOYLSTON STREET

BOSTON, MASS.

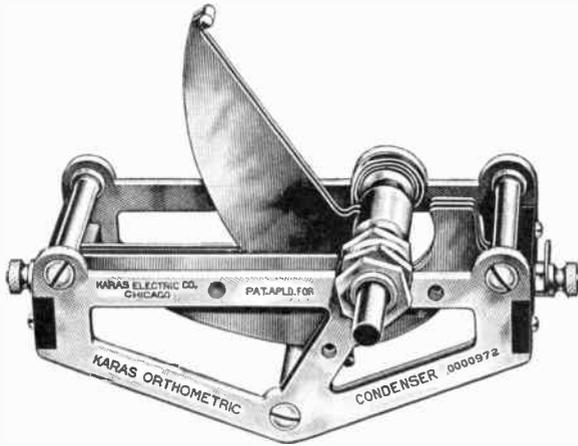

Build it with Karas Orthometric Condensers

YOUR short wave receiver will give better results if built with Karas Orthometric Variable Condensers. You want as close to 100% perfect reception as possible, and these remarkably fine condensers will enable you to have it. Be sure to use them in your next short wave receiver. In addition to having the lowest losses known, Orthometrics are absolutely straight frequency line. They are built for the man who knows the best when he sees it and is not going to be satisfied with anything less than the best. Orthometrics are built of brass throughout, with rotor and stator plates soldered at every point of contact. (Illustrated above is our 5-plate short wave .0001 mfd. Orthometric, price \$6.50.)

Your dealer can supply you with Karas Orthometrics for your short wave requirements, or can secure them for you. If you are in a hurry you can order direct from us at the prices listed below. If you send cash with order we will ship postpaid. However, if you prefer, you need send no money, simply paying the postman the price of the condensers plus a few cents postage. Just tell us which Orthometrics you require and we will forward them by return mail.

Orthometric 5-plate .0001 mfd., \$6.50;
 7-plate .00014 mfd., \$6.50; 11-plate
 .00025 mfd., \$6.50; 17-plate .00037
 mfd., \$6.75; 23-plate .0005 mfd., \$7.00;
 17-plate .00037 mfd. with extended
 shaft for Equamatic System, \$7.00.

KARAS ELECTRIC CO.

1001 Association Bldg.

Chicago



Karas Micrometric Vernier Dials
 Have 63 to 1 ratio and tune to within 1-1000th of an inch. Price each\$3.50.

Here is a dial that makes a hard to tune oscillating circuit or any short wave set do things that no other dial can accomplish. It brings in stations you never heard before, because of its 63 to 1 vernier ratio. Has absolutely non-slip vernier action, with no backlash. Turns with velvety smoothness. Supplied in 100 division 180 degree right or left hand markings, and in 200 division 360 degree right hand marking. Order a set from your dealer today.



Karas Harmonik Audio Transformers
 Great volume, unparalleled clearness and freedom from distortion make Karas Harmoniks best for all audio amplification. Price\$7.00

Karas Harmoniks have extremely high impedance and high inductance with low distributed capacity, insuring full amplification of high audio frequency harmoniks and pure, full, sweet, mellow amplification of all musical sounds. There are no finer audio transformers made, nor any which deliver greater volume minus all distortion.

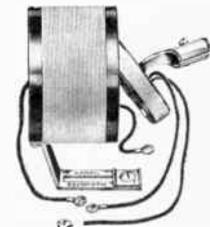

Karas Equamatic Inductance Coils
 If you'd like to own the newest, most efficient radio frequency receiver ever designed, secure three of these coils from your dealer and build the Karas Equamatic 5 Tube Sensation. Full instructions and complete manual is packed with each set of 3 coils. Price, set of 3 coils, \$12.00.

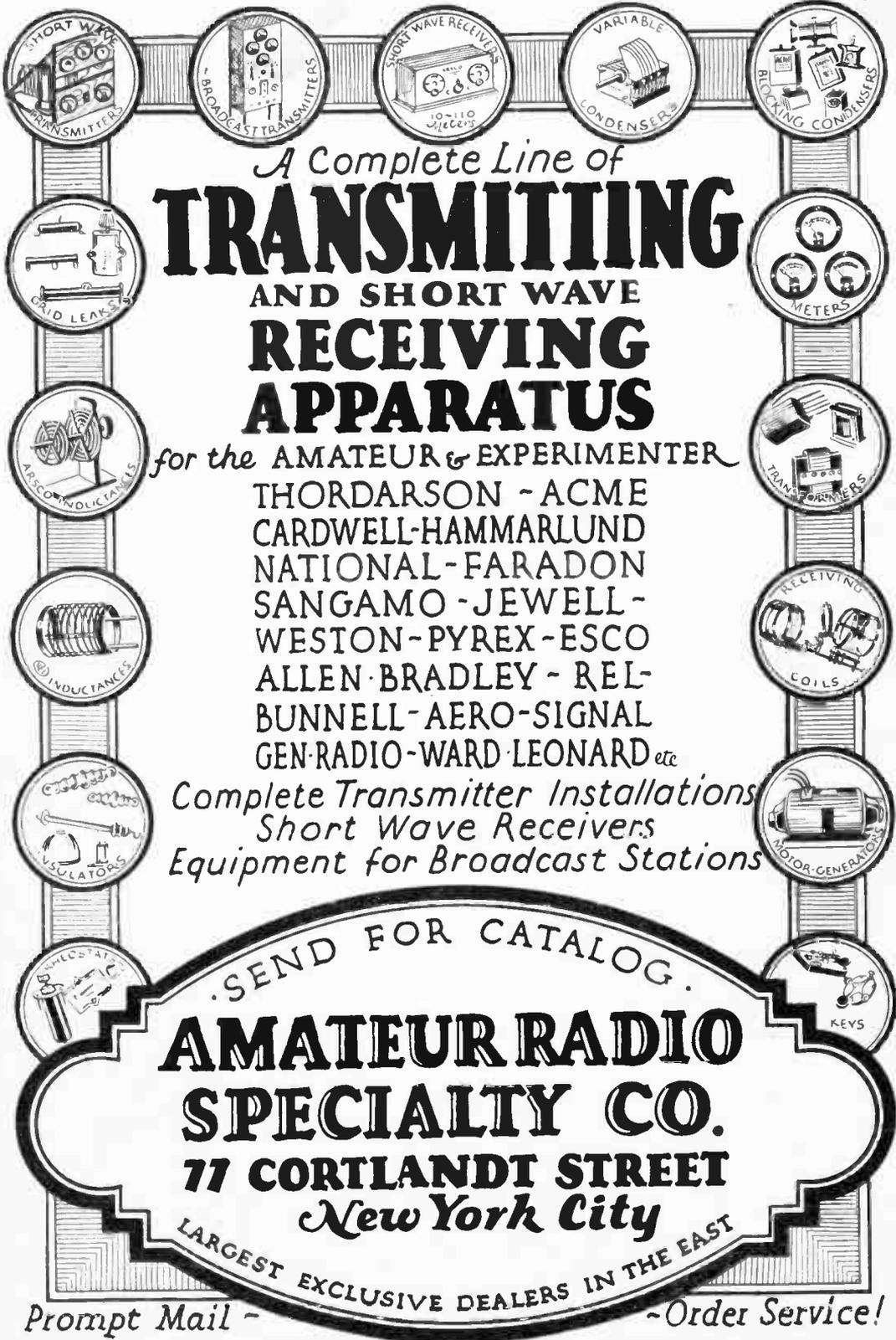

A Complete Line of
**TRANSMITTING
 AND SHORT WAVE
 RECEIVING
 APPARATUS**

for the AMATEUR & EXPERIMENTER
 THORDARSON - ACME
 CARDWELL-HAMMARLUND
 NATIONAL-FARADON
 SANGAMO - JEWELL -
 WESTON-PYREX-ESCO
 ALLEN-BRADLEY - REL-
 BUNNELL-AERO-SIGNAL
 GEN-RADIO-WARD-LEONARD etc

Complete Transmitter Installations
 Short Wave Receivers
 Equipment for Broadcast Stations

SEND FOR CATALOG.

**AMATEUR RADIO
 SPECIALTY CO.**
 77 CORTLANDT STREET
 New York City

LARGEST EXCLUSIVE DEALERS IN THE EAST

Prompt Mail -

-Order Service!

Hammarlund Condensers and Coils are Ideal for Amateur Work

Every Ham who "knows his stuff" ranks Hammarlund Condensers and Coils the finest available. He knows that Hammarlund understands his problems.

For the beginner, no sounder advice could be given than that he use Hammarlund Products for *real results*.

Low-Wave Receiving Condensers

Soldered brass plates with tie-bars. Spaced $2\frac{1}{2}$ times greater than standard. Sturdy, non-warping frame. Minimum dielectric. Maximum capacity 100 mmfd; minimum 3 mmfd. Straight frequency line. Price \$4.50. Also standard-spaced low-wave condensers in other sizes.

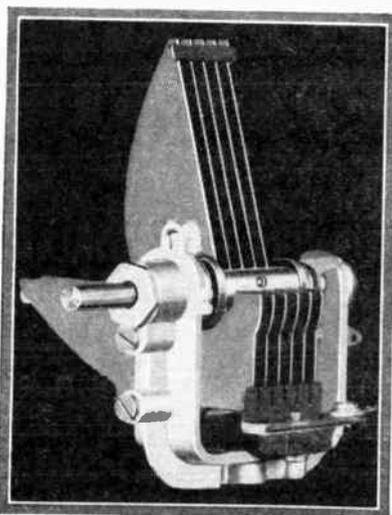

Low-Wave Transmitting Condensers

Low losses and high quality are emphasized in Hammarlund Transmitting Condensers. Straight line capacity, with double spacing between plates. Tested to withstand high potentials. Three sizes:—Maximum Capacity .0001, .0002 and .0004 mfd. \$6, \$7 and \$10, respectively.

Low-Wave Receiving Coils

Space-wound on dielectric of very high quality, only $\frac{5}{1000}$ in. thick. Losses are extremely low. Wire firmly anchored to the dielectric.

3 inches in diameter, wound with No. 16, green silk over cotton covered wire. 10 turns per inch.

Coils average 20 inches long and are cut to any desired length.

Price 40 cents per inch.

Broadcast Receiving Coils

Hammarlund Broadcast Band Receiving Coils have the same characteristics as the low-wave coils described opposite. Two sizes:—

3 in. diameter, green single silk covered No. 22 wire, wound 29 turns per inch.

2 in. diameter, wound with No. 24 single silk covered wire—43 turns per inch.

Primary coils for the above, wound 15 turns per inch.

Technical Assistance will be gladly given in designing special coils.

HAMMARLUND MANUFACTURING CO.

424-438 W. 33rd Street, New York City

For Better Radio
Hammarlund
PRECISION
PRODUCTS



AERO COIL

SUPER-SENSITIVE

INDUCTANCE UNITS

The most important factors in perfect set performance:

Aero Coils are the perfect supersensitive inductance units! Due to their special patented construction, high frequency resistance is reduced to a minimum. Hence Aero Coils are capable of greater volume, and are sensitive to all the radio frequencies, thereby correcting the real cause of distortion, impossible to correct with other types of coils. But more! No dope is used. So if you are interested in better performance from any set, be sure to build with Aero Coils.

Tuned Radio Frequency Kit



PRICE \$12.00

The Aero Coil Tuned Radio Frequency Kit illustrated above will positively improve the performance of any receiver. Patented Aero Coil Construction eliminates radio frequency losses and brings tremendous improvement to volume, tone and selectivity.

Kit consists of three matched units. The antenna coupler has variable primary. Uses .00035 condenser. 8 page color circuit layout and instruction sheet for building the supersensitive 5 tube Aero-Dyne receiver packed with each kit. Extra copies, 75c each.

Low Wave Tuner Kit

Completely interchangeable. Adopted by experts and amateurs. Range 15 to 130 meters. Includes three coils and base mounting, covering U. S. bands 20, 40 and 80 meters. You can increase the range of this short wave tuner by securing coils No. 4 and 5. Combined range of 15 to 550 meters. Both interchangeable coils fit same base supplied with short wave kit and use the same condensers. Coil No. 4 price \$4.00; Coil No. 5 price \$4.00.

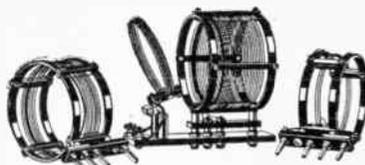

PRICE \$12.50

Aero Interchangeable Coils No. 4 and 5



Increase range of your short wave tuner by securing coil No. 4 and coil No. 5, combined range 125 to 550 meters. Both interchangeable coils fit the same Aero base supplied with the short wave kit, and use the same condensers.

Coil No. 4 — Range 125 to 250 meters — \$4.00
Coil No. 5 — Range 235 to 550 meters — \$4.00



Other Supersensitive AERO Inductance Coils

There is an Aero Coil for every inductance requirement. In addition to these described above we make the following coils: Aero 3 Circuit Tuner, \$6.50. Aero Radio Frequency Regenerative kit, \$10.00. Aero Low-Loss Antenna Coupler, \$4.50. Aero Oscillator (for Superheterodynes), \$5.50. Aero Wave Trap Unit, \$4.00.

You can get any or all of these coils from your nearest dealer. See him TODAY.

AERO PRODUCTS, INC., Dept. 116, 1772 Wilson Ave., Chicago, Ill.

HENGER-SELTZER (Pacific Coast Representatives)

1111 Wall St., Los Angeles, Calif.—337 Brannan St., San Francisco Calif.

GREETINGS

from "EX9ME"

MANY MEMBERS OF THE LEAGUE have heard and answered the old call "9ME" and though the station is temporarily inactive, my interest in the League and its work is as keen as ever. My enthusiasm for radio now is centered on building top notch receivers for those who do not care to build their own, and I shall gladly send material illustrating my [2]- and [3]-dial sets to A. R. R. L. members or their friends on request. With every good wish,

L. S. SLAGLE, *President*

SLAGLE RADIO COMPANY

FORT WAYNE, INDIANA

Now Operating U9ii

Slagle Radio

