



---

COYNE  
ELECTRICAL TRAINING  
SCHOOL

---



---

PUBLISHED BY  
MCGRAW-HILL

---

NEW YORK, CHICAGO, AND LONDON

## How to Use This Reference Set

This Electrical Reference Encyclopedia will be of use and value to you in exact proportion to the time and energy you spend in studying and using it.

A Reference Set of this kind is used in two distinct ways.

**FIRST**, by the fellow who wishes to make Electricity his trade and uses this Reference Set as a home training course.

**SECOND**, for the man who wishes to use this Encyclopedia strictly as a Reference Set. This includes anyone working at any trade who wishes to have a set of books so that he can refer to them for information in Electrical problems at any time.

You, of course, know into which group you fall and it is my purpose in this article to explain how to properly use this Reference Set to get the most out of it for your own particular purpose.

### HOW TO USE THE ENCYCLOPEDIA AS A HOME TRAINING COURSE IN ELECTRICITY

The most important advice I can give for the fellow who wishes to study our Encyclopedia as a home training course in Electricity is to start from the beginning in Volume 1, and continue in order to Volume 2 and 3. Don't make the mistake of jumping from one subject to another or taking a portion of Volume 3 and then reverting back to Volume 2, etc. Study the set as it has been written and you'll get the most out of it.

Volume 1 is one of the most important of the entire Reference Set. Every good course of training must have a good foundation. Our first volume is the foundation of our course and is designed to explain the simple terms and expressions, laws and rules of Electricity, upon which any of the big installations, maintenance and service jobs are based. So, become thoroughly familiar with the subjects covered in this first volume and you will be able to master each additional subject as you proceed.

Here's the way you study this set. You take one section at a time and study it carefully. Then go back for a re-check and see whether you fully understand this section. The best way to do this is to have some scratch paper handy and put down the

heading of each of the subjects covered in the section. Then under this heading write these words:

WHAT—

WHERE—

HOW—

Then answer these questions on each of the articles. As an example, paragraph 8 on page 29 of Volume 1 is given to an explanation of Condensers. After you have finished this entire section, you would ask yourself, first—**WHAT** are Condensers, second—**WHERE** are they used, third—**HOW** are they used. You see in this way, you have a constant check on your knowledge of the subject, and the same procedure should be followed in checking on every subject covered in our home training course.

Above all, do not rush through any part of the home training course in order to cover a large amount at one time. You should, read it slowly and in this way you will gain a thorough understanding as you read and think it out.

For the especial benefit of the fellow trying to learn Electricity at home, we have prepared a great number of diagrams and illustrations. These will help you get a better understanding of certain devices and principles. These are numbered and arranged as conveniently as possible so that it will be easy to refer to as you study the individual subjects. Remember, the old adage, "One Picture tells the story of ten thousand words," and refer to these pictures, diagrams in our Reference Encyclopedia regularly.

Now let me repeat again, if you are using this Reference Encyclopedia to learn Electricity, remember these important things. **ONE**—start at the beginning and continue through the reference set as it has been written. **TWO**—read it slowly and make constant use of the diagrams and illustrations. **THREE**—refer back after completing each section for a re-check, answering the questions—**WHAT—WHERE—AND HOW** is the equipment used.

### HOW TO USE THE COYNE ELECTRICAL ENCYCLOPEDIA STRICTLY AS A REFERENCE SET

The man who is interested in using the Reference Encyclopedia simply for reference purposes will use it in a little different way than the fellow who is trying to learn Electricity as a trade by home

study. Some of the types of fellows who use this set strictly for reference purposes are: home owners, electricians or mechanics, garage owners or workers, hardware store owners, farmers or anyone who has an occasional use for electrical knowledge. Those types of fellows should use the Reference Encyclopedia in the following manner.

#### USE THE MASTER INDEX IN VOLUME 1 TO LOCATE ELECTRICAL SUBJECTS

If some particular type of electrical problem presents itself, refer immediately to Master Index in Volume 1. Find out where the instruction on this subject of electricity is covered in the Reference Encyclopedia. Then, turn to that section and carefully read the instructions outlined. Also read any other sections of the set mentioned in the article especially devoted to these subjects. As an example, in checking over some information on electric motors, some reference might be made to an electrical law of principles contained in Volume 1 of the Reference Set. In order to thoroughly understand the procedure to follow in working out the electrical problem, you should refer to Volume 1 and get a thorough understanding of the electrical law of principles referred to. The purpose in doing this is to get as much information as possible concerning the electrical problem at hand.

The man who uses the Coyne Encyclopedia strictly as a Reference Set should also make constant use of the diagrams and illustrations. Another part that we would like to call to your attention is the fact that in the Reference Set we use many sub-headings and article numbers so that the reader can find what he is after quickly. Certain important words, common terms and rules are also set out in larger type. This is for the benefit of the reader in getting the highlights of each subject and

is particularly valuable on emergency repair jobs where speed is an important factor.

Thousands of men use this Reference Encyclopedia in their daily problems, both on the job and around the home as well. If you follow the instructions outlined you will be able to locate any information you may want at anytime on your own electrical problems.

#### TRY TO READ THE ENTIRE REFERENCE ENCYCLOPEDIA IF AT ALL POSSIBLE

Of course, even though you may use the reference Encyclopedia strictly for reference purposes; it would be a good idea to try to go through the entire set to improve your knowledge of all branches of electricity. Naturally, the more you read about electricity, the more you will learn. If you can set aside a few hours each week to go through the Encyclopedia systematically from one end to the other it will certainly be time well spent. The way the material is presented makes it extremely interesting, and even though it may cover some subjects upon which you are already well versed, nevertheless the Reference Encyclopedia should give you some additional ideas on these subjects which is bound to help you.

In the above explanations we have given you a general idea of the correct way to use this Reference Set for your own personal benefit. Every person has a different way of studying and we merely submit these suggestions because they have been found to prove most helpful to many thousands of men in the past. If used properly and regularly, this Encyclopedia can be one of the most valuable sets of books you've ever purchased in your life. It will save money for you and make money for you directly in proportion to the amount of time you spend in studying it and using it in the future.

*The material in this Electrical Encyclopedia represents 43 years of actual experience in teaching the subject of Electricity.*

*It is built around, and duplicates, as near as possible to duplicate in printed form, the actual "Learn by Doing" shop training course taught at the Coyne Electrical School.*

*Should you or any friend desire any further information about our school and our method of training I will be very glad to send it to you if you will write me or drop me a card.*

H. C. LEWIS  
500 SOUTH PAULINA ST.,  
CHICAGO, ILLINOIS  
Dept. R. S.

## INDEX

	Page		Page
Air-Break Switches, A.C.....	739	Alternating Current	
Air Circuit Breakers, D.C.....	382	" Parallel Circuits .....	466
Air Conditioning.....	1029 to 1047	" Phase Relations of Voltage and Current .....	456
" Air Circulation .....	1038	" Polyphase and Single-Phase Currents.....	456
" Attic Ventilators .....	1038	" Power Calculations .....	472
" Blowers and Ducts .....	1039	" " Equipment, Installation of.....	745
" Building Insulation .....	1044	" " Factor (See also Power Factor).....	469
" Cooling of Air .....	1031	" " Measurement .....	473
" Dehumidifying Air .....	1033	" " Plants .....	660
" Filtering Air .....	1037	" " Problems .....	479
" Heat Load Calculation .....	1042	" " Rectifiers, (See also Rectifiers).....	612
" Principles .....	1030	" Reactance, Capacity .....	463
" Problems .....	1045	" Relays (Also see Relays A.C. and D.C.) .....	742
" Proper Air Temperatures .....	1032	" Resistance and Inductive Reactance	
" Psychrometers .....	1035	in Series, Graphic Solution for.....	465
" Psychrometric Charts .....	1036	" " Capacity and Inductance in	
" Size of Units Required .....	1041	Series .....	466
" Systems and Units .....	1030	" " and Capacity in Series.....	466
Air Gaps in Magnetic Circuit.....	66	" " and Capacity in Parallel.....	467
Air Gaps in Motors and Machines.....	760	" " Inductance and Capacity in	
Alarms, (See Signals).....	109	Parallel .....	468
Alternating Current .....	450	" " and Inductance in Parallel.....	467
" Ammeters and Voltmeters.....	482	" Self Induction .....	459
" Capacity, Reactance .....	458	" Sine Curves, Voltage .....	454
" Central Stations .....	660	" Single-Phase Currents .....	310
" Circuits .....	457	" Single-Phase and Polyphase Currents.....	456
" Circuits, Calculation of Impedance in		" Starters (See Starters A.C. Motors).....	636
Series .....	464	" Starters Maintenance .....	768
" Compensators, Motor Controllers.....	644	" Static Condensers (See also Condensers,	
" Condensers, Synchronous Motors.....	599	Static) .....	600
" Converter Stations .....	721	" Stators, Alternators, Revolving Field.....	309
" Converters, (See Converters Synchron-		" Substations (See also Substations).....	720
ous) .....	626	" Switches, High-Tension Air-Break .....	739
" Distribution Stations .....	720	" " Oil .....	735
" Frequency .....	454	" Switchgear .....	729
" Generating Stations .....	660	" Three-Phase Currents .....	311
" Generators (See Generators, A.C.).....	502	" Three-Phase Motors, Operating	
" Impedance .....	458	Principles .....	317
" Inductance .....	458	" Transformers (See also Transformers).....	522
" Inductance and Capacity in A.C.		" Transmission Lines (See also Trans-	
Circuits .....	453	mission Lines) .....	675
" Induction Voltage-Regulators .....	548	" Transmission Lines, Lightning	
" Inductive Reactance, Capacity Reac-		Arresters (See also Lightning	
tance and Impedance.....	458	Arrestors) .....	703
" Instrument Transformers .....	550	" Two-Phase Currents .....	311
" Kilovolt Amperes .....	470	" Two-Phase Motors, Operating	
" Machines, Winding .....	308	Principles .....	316
" Maximum and Effective Values.....	455	" Values of .....	455
" Measurements .....	475	" Voltage, Generation of.....	453
" Meters, (Also see Meters A.C.).....	482	" " " .....	308
" Meter Tests and Power Problems.....	478	" Voltage Regulators .....	548
" Motors, (See also Motors A.C.).....	566	" Voltmeters and Ammeters.....	482
" " Controllers .....	636	" Wattmeters .....	484
" " Starters (See also Starters, A.C.		Alternation, A.C. Current.....	454
Motor) .....	636	Alternators, Types and Construction.....	308
" " Synchronous, Starting Compen-		Alternators, Types and Construction.....	502
sators and Protective Devices.....	590	Aluminum Cell Lightning Arrestors.....	708
" " Three-Phase .....	577	Aluminum Conductors, Line Transmission.....	676
" Motors, Windings, (See also Stator		Amalgamate Cell Elements.....	58
Windings) .....	313	Ammeter .....	388
" Ohm's Law Applied.....	458	Ammeters, A.C. ....	482
		Ammeters, D.C. ....	390

	Page		Page
Ampere-Turns .....	72	Armature Reaction, D.C. Generator.....	354
Annunciators, Signal .....	99	" Resistance and I.R. Loss, D.C. Generator .....	355
Anode or Positive Pole.....	57	Artificial Magnets .....	63
Arc Light and Heat.....	38	Auto Valve Lightning Arresters.....	706
Arc-Over Values, Lightning Arresters.....	713	Automatic Induction Regulators.....	549
Arc Transmitter .....	1059	" Telephones .....	142
Armature, A.C., Construction of.....	504	" Voltage Regulation of Alternators.....	510
" D.C. ....	280	Automotive Electricity .....	813
" Banding .....	299	" Batteries, Storage .....	773 & 826
" Coil and Slot Insulation.....	287	" Bendix Drive for Starters.....	856
" Coil Span of.....	291	" Carburetion .....	817
" Coil Turns .....	285	" Distributors .....	833
" Coil, Types of.....	287	" Distributors, Spark Advance.....	834
" Coil Winding .....	288	" Double or "Dual" Ignition.....	836
" Collecting and Recording Winding Data .....	299	" Effects of Self-Induction in Coils.....	828
" Commutator Pitch .....	295	" Eight-Cylinder Engines .....	823
" Connecting Coils .....	293	" Eight-Cylinder Engines, Distributors.....	837
" Construction .....	280	" Electric Starter .....	854
" Cutting Out Faulty Coils.....	304	" Engines, Firing Order.....	821
" Eddy Currents .....	280	" Four-Cylinder Engines .....	821
" Emergency Repairs .....	304	" Fuel Combustion .....	819
" Flux .....	284	" Generators .....	861
" Galvanometer Tests on.....	303	" , Adjust Charging Rates.....	863
" Generators .....	348	" Cut-Outs .....	864
" Governor Effect of Counter E.M.F. ....	285	" Troubles .....	868
" Grounded Coils .....	303	" Voltage Regulation .....	867
" Grounded Commutator Segments.....	303	" Headlights .....	870
" Growler Tests .....	300	" High Speed Distributors.....	836
" Inserting Coils for Lap Winding.....	292	" High Speed Engine Ignition.....	836
" Inserting Coils of Wave Winding.....	294	" High-Tension Magnetos .....	846
" Insulations, Coil and Slot.....	287	" Horns .....	876
" Lap Winding .....	290	" Ignition Coils .....	826
" Lap Windings, Inserting Coils.....	292	" Ignition Coil Resistance .....	828
" Loose Coil Leads.....	302	" Condensers .....	827
" Magnet Wire .....	286	" Locks .....	838
" Multiple Windings .....	297	" Systems .....	825
" Open Circuit .....	302	" Timing .....	835
" Repairs, Emergency .....	304	" Trouble Shooting .....	839
" Reversed Coil .....	303	" Lighting Equipment .....	869
" Reversed Loops .....	303	" Switches .....	872
" Rewinding, Old .....	297	" Troubles .....	873
" Short Circuits .....	302	" Magneto Breakers .....	849
" Shorted Commutator Segments.....	303	" Distributor .....	849
" Shorts Between Coils.....	303	" Ground Brush and Ignition Switch.....	848
" Slots .....	281	" Safety Gaps .....	848
" Spider .....	280	" Timing .....	851
" Symmetrical and Non-Symmetrical Connections .....	298	" Troubles .....	852
" Taping and Shaping of Coils.....	289	" Six-Cylinder Engines .....	822
" Testing .....	300	" Spark Advance and Retard.....	819
" Troubles .....	301	" Spark Plugs .....	830
" Voltage Changes .....	297	" Special Ignition Systems .....	836
" Wave Winding .....	293	" Starter Troubles .....	859
" Winding .....	278	" Valve Arrangement .....	819
" Winding Coils .....	288	" Valves .....	816
" Winding Element .....	295	" Vibrating Type Ignition Coil.....	829
" Winding Large Armatures .....	296	" Wiring Systems .....	877
" Winding, Preparing for.....	292	" Wiring Troubles .....	873
" Winding Progressive and Retrospective .....	294	Aviation Lighting (See Illumination).....	261
" Winding Small Armatures.....	296	Baking Temperature and Ventilation for Insulating Varnish .....	332
" Winding Tools .....	300	Balanced System, D.C.....	367
" Wire Insulation .....	286	Balancer, Three-Wire Generator, D.C.....	368
" Elementary .....	36	Bar Magnet .....	64
" Oscillator, Synchronous Converter.....	634		

	Page		Page
Batteries .....	35	Brushes, Carbon, D.C. ....	435
“ .....	56	“ “ “ Adjustments on Interpole	
“ Automotive Storage .....	773 & 826	“ “ “ Machines .....	373
“ Radio, grid bias .....	1090	“ “ “ Adjustments .....	441
“ Signal .....	82	“ “ “ Leads or Shunts.....	437
“ Storage .....	773	“ “ “ Materials .....	435
“ “ Buckled Plates .....	796	“ “ “ Pressure or Tension.....	437
“ “ Charging New Batteries.....	805	“ “ “ Requirements .....	435
“ “ Cadmium Test .....	785	“ “ “ Resistance .....	436
“ “ Capacity .....	788	“ “ “ Duplicating and Ordering.....	438
“ “ Capacity Tests .....	789	“ “ “ Fitting to Commutator.....	439
“ “ Care .....	797	“ “ “ Graphite .....	436
“ “ Care of Edison Batteries.....	809	“ “ “ Severe Service .....	436
“ “ Cell Containers and Cases.....	779	“ “ “ Special .....	436
“ “ Charging .....	790	“ “ “ Hammer .....	350
“ “ Charging, Constant Potential.....	792	“ “ “ Holder .....	349
“ “ Charging from D.C. Lines with		“ “ “ Setting for Neutral Plane.....	371
Rheostats .....	794	“ “ “ Shifting, with Varying Load	
“ “ Charging Edison Cells.....	809	on Machines without	
“ “ Charging Rate .....	791	Interpoles .....	371
“ “ Chemical Action, Charge and		“ D.C. Generators .....	348
Discharge .....	782	BTA Variable-Speed A.C. Motors.....	594
“ “ Construction .....	776	Burglar Alarm (See Signals).....	107
“ “ Cycling .....	789	Buzzers, Signal.....	92
“ “ Edison Nickel-Iron .....	807	Cable, Transmission Lines.....	674
“ “ Electrolyte .....	780	Cadmium Test, Storage Batteries.....	785
“ “ Electron Bulb Chargers .....	791	Calculations of Electro-Magnetic Forces.....	72
“ “ Hydrometers .....	780	Call System, (See Signal).....	81
“ “ Hy-Rate Discharge Test .....	787	Capacity of A.C. Circuit.....	462
“ “ Lead-Acid Cells .....	774	Carbon Pile Starters, A.C. ....	640
“ “ Lead Burning .....	800	Carbon Pile Starters, D.C.....	421
“ “ Molding Straps and Posts.....	803	Cathode or Negative Pole.....	57
“ “ Opening and Disassembling.....	798	Cell .....	35
“ “ Pasted Plates .....	774	“ Care .....	59
“ “ Placing in Storage .....	804	“ Current and Life.....	57
“ “ Planté Plates .....	774	“ Lead Plate Storage.....	774
“ “ Plate Paste Formula .....	775	“ Voltage .....	57
“ “ Reassembling .....	800	Central Stations (See A.C.).....	660
“ “ Repairs and Shop Methods.....	798	Centrifugal Switches.....	315
“ “ Replacing Defective Plates and		“ Switches, A.C. Motors.....	337
Separators .....	799	“ Switches, Defective.....	337
“ “ Retainers and Isolators.....	778	“ Switches for Single-Phase Motors.....	315
“ “ Separators .....	777	C.G.S. Units.....	73
“ “ Shop Equipment .....	805	Charging Rate Adjusted, Automotive	
“ “ Specific Gravity .....	780	Generators .....	863
“ “ Tests .....	783	Charging Storage Batteries.....	790
“ “ Troubles and Remedies.....	795	Chemical Effects of Electricity.....	39
“ “ Voltage Tests .....	784	Chemical Method of Producing Current.....	35
“ Telephone .....	129	“Choke-Bars” of Double-Squirrel-Cage	
Bearing Currents .....	635	Motors .....	593
Bearings, D.C. Generator .....	351	Choke Coils.....	460
“ Lubrication, A.C. Maintenance.....	756	Choke Coils, Line Protection.....	704
“ Maintenance .....	752	Circuit-Breakers, A.C. ....	735
“ Tight or Worn.....	336	“ “ D.C. ....	382
Bell Transformers, Signal.....	83	“ “ “ Air .....	382
Bells and Buzzers .....	92	“ “ “ Care and Mounting .....	384
Bent Shaft and Bearings Out of Line, A.C.		“ “ “ Oil .....	382
Machines .....	337	“ “ “ Overload Release.....	383
Blow Torches, Operation and Care of.....	448	“ “ “ Series Type Overload	
Boilers .....	662	Release Coils .....	383
Brake Horsepower Tests.....	413	“ “ “ Trip Coils .....	383
Branch Circuits (See Wiring).....	208	“ “ “ Trip Coils or Overload	
Brush Adjustments on Interpole D.C.		Release .....	383
Machines .....	373		
Brush Lifting Mechanism, Synchronous			
Converter .....	633		

	Page		Page
Closed Circuit Cells.....	58	Controllers, D.C., Overload Protecting	
Cobalt, Steel .....	68	Devices, Care of.....	442
Coil and Slot Insulation, D.C. Armatures.....	287	"    Remote Control .....	422
Coil Span, D.C. Armature.....	291	"    Reversing Drum.....	429
Combination of Series and Parallel Circuits.....	54	"    Shunt Trip Coils and Overload.....	383
Commutation and Interpoles, D.C.		"    Speed Regulating .....	420
Generators .....	370	"    Starters, Automatic.....	422
Commutator .....	78	"    Starters, "Blow-Out" Coil.....	427
" D.C. Action .....	283	"    Starters, Carbon Pile .....	420
"    Generators .....	348	"    Starters, Magnetic.....	424
"    Maintenance and Resurfacing.....	441	"    Starters, Terminals and Con-	
"    Mica Undercutting .....	441	nections .....	419
"    Pitch, D.C. Armature.....	295	"    Starters, Three & Four Point D.C.....	418
Compass Test of Magnets.....	67	"    Starters, Time Element on.....	423
Compound Generators, D.C.....	358	"    Starting Drum Control.....	431
Compound Magnet .....	67	"    Starting Rheostats .....	416
Compound Motors D.C.....	412	"    Switches, Reversing Drum.....	429
Condenser Charging Current.....	462	Converter, A.C. Synchronous.....	626
Condensers, Location of.....	601	Converter Stations .....	721
" Radio .....	1078	Converters, Synchronous, Arc Chutes and	
" Static .....	600	Barriers .....	634
" Static, Electricity .....	29	"    Armature Connections .....	628
" Static, Operation of.....	601	"    Armature Oscillator .....	634
" Static, Size Required for P.F. Correc-		"    Auxiliaries .....	633
tion .....	604	"    Auxiliary Brush for Bearing	
" Steam .....	663	Currents .....	635
" Telephone .....	134	"    Brush Lifting Mechanism .....	633
Conductance, The MHO .....	43	"    Building up D.C. Voltage.....	632
" Method (Resistance Calculation).....	51	"    Characteristics and Connections.....	628
Conductor Spacing, Transmission.....	689	"    Connections to Transformer.....	630
Conductors .....	36	"    Correcting Polarity .....	633
Conduit (See also Wiring).....	170	"    Field Connections .....	629
Consequent Poles (Magnetic).....	67	"    Field Excitation .....	629
Constant Potential (Chargers), Storage Battery.....	792	"    Flash Over Relays and Temper-	
Construction of D.C. Machines.....	279	ature Relays .....	635
" Electrical (See Wiring).....	154	"    Overspeed Device .....	634
Control of Electricity.....	45	"    Power Factor, of.....	630
Controllers, A.C.....	636	"    Starting .....	631
"    Drum .....	650	"    Voltage Control .....	630
"    Drum Connections .....	652	"    Voltage Ratios .....	630
"    Drum Starting, Reversing and		Cooling of A.C. Generators.....	506
Speed Control .....	651	Cooling of Transformers.....	526
"    Full Voltage or Across-the-Line		Copper Conductors, Line Transmission.....	676
Starting .....	637	Copper Oxide Rectifiers.....	616
"    Installation Care and Main-		Corona, Transmission Line.....	694
tenance .....	654	Coulomb .....	40
"    Maintenance .....	768	Counter E.M.F. in D.C. Motors.....	408
"    Motor .....	636	Counter E.M.F. in Motors.....	284
"    Motor Overload, Time Delay and		Counter-Voltage of A.C. Motor.....	638
No-Voltage Devices.....	636	Counter-Voltage of Self Induction.....	459
"    Printing Press .....	649	"Creeping" A.C. Watthour Meters.....	490
"    Protective Features .....	645	Creeping of D.C. Meters.....	396
"    and Switching, Equipment,		Cross Arms, Transmission Pole.....	687
Installation .....	745	Current Flow .....	34
"    Voltage Reducing.....	639	Current Transformers .....	550
" D.C., Care of.....	442	Cycle, A.C. Current .....	454
"    Dash Pots for Time Delay.....	424	Cycles and Alternations.....	309
"    Drum .....	428	Cycling Storage Batteries .....	789
"    Drum, Construction of.....	431	Damping of A.C. Meters.....	483
"    Drum Control for Reversing and		Daniel Cell .....	58
Speed Control .....	431	Decomposition by Electrolysis.....	39
"    Economy Coil, Remote Control.....	423	Deion Arc Quenchers, A.C.....	650
"    Motor .....	418	Deion Circuit Breakers .....	739
"    "No Voltage" and "No Field"		Delta-Star Connections .....	541
Release Coil .....	419	De-Magnetizing .....	66
		Dielectric .....	29

	Page		Page
Diesel Engines.....	881 to 952	Electrical Degrees .....	309
" Construction and operating principles.....	833	" Maintenance, A.C. ....	749
" Cooling Systems .....	926	" Power Plants .....	660
" Exhaust Systems .....	921	" Power Transmission and Distribution.....	671
" Fuel Combustion Systems.....	906	" Resistance-The Ohm .....	41
" Fuel Oils .....	909	Electro Magnet .....	38
" Fuel Pumps .....	892	" Magnetic Calculations .....	72
" Inspection .....	943	" Magnetic Induction .....	76
" Lubrication and Lub. oil requirements.....	932	" Magnetism .....	68
" Maintenance .....	944	" Magnets .....	70
" Operating Procedure .....	941	" Motive-Force .....	41
" Starting Systems .....	914	" Plating .....	39
" Timing of Injection .....	900	Electrolysis .....	39
Direct Current .....	77	Electrolyte .....	57
" Circuit Breakers .....	382	" Storage Batteries .....	780
" Generators (See also Generators D.C.) .....	347	Electrolytic Rectifiers .....	613
" Meters, (See also Meters D.C.).....	388	Electrolytic Solution .....	39
D.C. Motors, (See also Motors D.C.).....	406	Element Winding for D.C. Armatures.....	296
" Motor Controllers .....	415	Elementary Electricity .....	27
" Power and Machines.....	377	End Shields, A.C. Maintenance.....	759
" Resistance Measurement .....	401	Energy, Forms of .....	27
" Switchboards .....	378	Equalizer Connections, D.C. Generators.....	365
Direction of Flux Rule.....	69	Estimating Wiring Jobs.....	220
Distribution, Grounded Systems.....	715	Excitation of Alternator Fields.....	507
" Lines .....	714	Exciter Anodes, Mercury Arc Rectifier.....	620
" Substations .....	720	Exhaust Steam Condensers.....	663
" System, Feeders and Mains.....	714	External Cell Circuit .....	62
Door Bell .....	82	Factory Lighting .....	248
Door Opener, Magnetic .....	93	Failure to Build up Voltage in D.C. Generator .....	353
Drum Controllers, A.C. Motor (See also Controllers A.C.) .....	650	Farad, Unit of Capacity A.C.....	462
Drum Controllers D.C. Reversing.....	429	Faraday, Michael .....	36
Dry Cells .....	60	Feeders and Mains, Distribution System.....	714
Dynamic Braking .....	433	Field Excitation of Alternators.....	507
" Electricity .....	27	" Excitation, D.C. Generator.....	352
" Electricity Effects of.....	37	" Discharge Switch .....	508
" Electricity Production of.....	34	" Poles, Direct Current .....	279
Dynamo (See Generators A.C. and D.C.).....	34	" Poles, Direct Current .....	347
Earth's Magnetism .....	63	" Problems .....	47
Edison Primary Cell .....	59	Filters, Radio .....	1137
Edison Nickel-Iron Storage Batteries.....	807	Fire Alarms .....	111
Efficiency and Power Factor of A.C. Motor.....	569	Fire Protection, A.C. Maintenance.....	770
Efficiency of D.C. Motors.....	414	Fixtures, Home Lighting .....	272
Electric Arc .....	38	Flemings Right Hand Rule.....	351
" Battery .....	35	Flood Lighting .....	257
" Cells and Batteries .....	56	Formulas, Ohm's Law .....	46
" Circuits .....	37	Four-Wire Systems .....	545
" Current, Ampere .....	40	Franklin's Discovery .....	31
" Current Flow .....	34	Frequency, A.C. ....	454
" Doorbell .....	82	" of A.C. Circuits .....	309
" Furnace .....	39	" Changer Substation .....	725
" Generator .....	34	" Meters .....	493
" Light, and Incandescent Lamps.....	38	Frozen Bearings, A. C. Maintenance.....	758
" Power Units .....	43	Fuses High-Tension .....	741
" Pressure .....	76	" and Switches .....	194
" Pressure E.M.F. ....	41	" Cartridge .....	194
" Quantity-The Coulomb .....	40	" Knife Blade .....	195
" Refrigerators .....	953	" Lead Link .....	194
" Signal Systems and Circuits.....	80	" National Code Rules on.....	195
" Signs and Billboards.....	253	" Plug .....	195
" Storage Batteries .....	744	" Troubles .....	228
" Units and Symbols.....	40	Fynn-Weichsel, A.C. Motors.....	595
Electrical Construction and Wiring for Light and Power.....	154	Galvanometer .....	43
		Gears, A.C. Maintenance .....	759
		Generating Electric Pressure by Induction.....	76
		Generating Stations .....	660



	Page		Page
Generator Charging Rate Adjusting,		Generators, D.C., Correct'g Wrong Polarity .....	363
Automotive .....	863	D.C., Cumulative and Differential	
" Cut-Outs, Automotive .....	864	Compound Generators .....	359
" Electric .....	36	" Drives for .....	346
" and Motor Installation, A.C.....	745	" Equalizer Connections .....	365
" Principles .....	67	" Equalizer Switches .....	365
" Troubles, Automotive .....	868	" Failure to Build up Voltage.....	253
Generators, A.C. ....	502	" Failure to Build up Voltage.....	444
" " Adjusting and Transferring		" Field Excitation .....	252
Load on .....	515	" Field Frames .....	247
" " Armature, Construction .....	504	" Field Poles .....	247
" " Arrangement of Instruments		" Flat Compound Generators	
and Connections .....	516	Voltage Characteristics .....	359
" " Construction .....	308	" Flemings Right Hand Rule.....	351
" " Cooling of .....	506	" General Types of.....	355
" " Engine Type .....	503	" Horse Power Calculations .....	361
" " Exciter and Alternator Field		" Instrument Connections with	
Circuit Connections .....	507	Parallel Generators .....	366
" " Exciter and Alternator Rheostats.....	508	" Interpoles, Polarity and Adjust-	
" " Field Construction .....	505	ment .....	372
" " Field Control Circuits .....	508	" Lubrication .....	376
" " Field Discharge Switch .....	508	" Magnetic Circuit in.....	351
" " Field Excitation .....	507	" Maintenance .....	439
" " Frequency and Voltage of.....	508	" Mechanical Construction .....	347
" " Installation .....	745	" Neutral Plane .....	354
" " Lamp-Bank Method of Phasing		" Neutral Plane .....	298
Out .....	511	" Neutral Wire, Three-Wire System .....	366
" " Motor Method of Phasing Out.....	512	" Noises, Unusual .....	444
" " Reassembling .....	755	" Operating Principles .....	282
" " Operation of .....	511	" Operating Principles .....	351
" " Paralleling of .....	511	" Operating Temperature .....	345
" " Principles .....	308	" Operating Temperature .....	440
" " Radio, Inductor Type.....	1056	" Operation of .....	361
" " Revolving Field .....	502	" Over Compound Generators,	
" " Shutting Down .....	516	Voltage Characteristics .....	359
" " Starting Up .....	515	" Overheating of .....	443
" " Synchronizing with Lamps.....	513	" Parallel, Instrument Connections.....	366
" " Synchronizing with Sychrosopes.....	514	" Parallel Operation .....	363
" " Turbine Type .....	503	" Peripheral Speed .....	346
" " Types of .....	503	" Polarity, Correcting Wrong.....	363
" " Vertical Type .....	503	" Pole Shoes or Faces.....	347
" " Voltage Control .....	508	" Poor Voltage Regulation.....	444
" " Voltage and Frequency of.....	508	" Ratings .....	345
" " Voltage Adjustment .....	509	" Rocker Ring .....	350
" " Voltage Regulators, Automatic.....	510	" Self Induction in Coils Shorted	
Automotive .....	861	by Brushes .....	370
D.C., Armatures .....	348	" Series Wound .....	357
" " Armature Reaction .....	354	" Series Field Shunts .....	357
" " Armature Resistance and I.R.		" Shunt Wound .....	356
Loss .....	355	" Speeds .....	346
" " Balance Coil, Principle of.....	367	" Starting .....	362
" " Balanced System .....	368	" Test Equipment for Locating	
" " Balancer Generators .....	368	Faults .....	445
" " Bearings .....	351	" Testing for Troubles.....	444
" " Brushes .....	348	" Three-Wire, and Balancers .....	367
" " Care of During Operation.....	362	" Voltage Adjustment and	
" " Commutating Field Strength		Regulation .....	354
Varies with Load .....	372	" Voltage, Building up.....	353
" " Commutating Poles to Prevent		" Curves .....	283
Sparking .....	372	" " Drop in Brushes and Lines.....	355
" " Commutation and Interpoles.....	370	" " Regulation, Poor .....	444
" " Commutators .....	348	" " Will Not Operate in Parallel.....	444
" " Compound Wound .....	358	" " Winding Temperature .....	440
" " Compound, Best for General		" and Motors, D.C. ....	279
Service .....	364	Gilbert, Unit of Magnetic Force.....	73
" " Compound, Testing and Adjusting.....	364	Graded Shunt Lightning Arresters.....	705

	Page		Page
Graphite Brushes, D.C. ....	436	<b>Illumination, Lamps, Mercury Vapor Lamp</b>	
Gravity Cells .....	58	Circuit and Operation.....	268
Ground Detectors, A.C.....	751	" Lamps, Mercury Vapor Lamp Mech.....	268
Grounded Circuits .....	74	" " Mercury Vapor, Operating	
Grounding Transformers .....	544	Voltage .....	269
Growler, Armature Testing .....	300	" " Mercury Vapor Tubes.....	267
Guard Rings and Horns, Lightning		" Light, Coefficient of Utilization.....	244
Protection .....	711	" " Colors, Wave Frequencies .....	233
Heat Energy of Coal.....	28	" " Controlling and Directing with	
Heating Effect of Electric Current.....	38	Reflectors .....	240
Heavy-Duty Oil Switches, A.C.....	737	" " Diffusing Bowls .....	242
Helix .....	70	" " Distribution .....	237
High-Frequency Alternators .....	1056	" " Inverse Square Law for.....	239
High-Frequency Energy, Sources of.....	1055	" " Measurement, Units of.....	236
High-Tension Air-Break Switches, A.C.....	40	" " Measuring Devices .....	236
" " Fuses, A.C. ....	741	" " , Nature of .....	233
" " Insulators .....	677	" " Quantity, Unit of.....	237
" " Magnetos, Automotive .....	846	" " Reflection .....	239
High Voltage Power Measurement.....	477	" " Spot and Color Flood.....	252
" " Spark Coils .....	79	" " Standard Intensities in	
Home Lighting .....	271	Foot-Candles .....	247
Horn and Sphere Gaps, Line Protection.....	703	" Lighting, Bays .....	246
Horse Power .....	44	" " Counter .....	252
" " Brake Tests .....	413	" " Factory .....	245
" " Calculations for Prime Movers.....	361	" " Factory Problem .....	248
" " Rating of D.C. Motors.....	407	" " Fixtures, Depreciation Factor.....	243
Horseshoe Magnet .....	63	" " Fixtures, Mounting Height of.....	245
"Hot" Line Work & Protective Equipment.....	700	" " Flood .....	257
"Hunting" of Synchronous Motors.....	588	" " Home .....	271
Hydro Electric Plants .....	666	" " Motion Picture .....	261
Hydrometers, Storage Battery.....	780	" " Office Problem .....	249
Hy-Rate Discharge Test, Storage Batteries.....	787	" " Outlets, Spacing Distance between .....	245
Hysteresis Loss .....	66	" " Practical Problem .....	246
Ice and Wind Stress, Transmission Line.....	696	" " Projectors .....	257
Ignition Systems, Automotive .....	825	" " Show Window .....	251
<b>Illumination</b> .....	231	" " Signs and Billboards.....	253
" Airplane Lights .....	266	" " Store .....	246
" Airport, Approach and Obstruction		" " Street .....	258
Lights .....	264	" " Units .....	242
" Airport Beacons .....	262	" " Working Plane .....	245
" " Boundary Lights .....	264	" Lights, Number and Location of.....	245
" " "Ceiling" Projectors .....	264	" Lumens, Unit of Light Quantity.....	237
" " Hangar and Shop Lighting.....	265	" Mazda Lamp .....	234
" " Illuminated Wind Direction		" Mean Spherical Candle Power.....	237
Indicators .....	264	" Photometer .....	237
" " Landing Field Flood Lights.....	262	" Principles of .....	232
" " Lighting Equipment .....	261	" Reflectors, Light .....	234
" Airway Lighting or Route Beacons.....	265	" Reflectors, Types of.....	240
" Aviation Lighting .....	261	" Signs Construction and Operation.....	254
" Candle Power and Light Measuring		" " Flasher Circuits .....	254
Devices .....	236	" " Neon Tube .....	256
" Counter Lighting .....	252	" " Wiring & Constructing Small Signs .....	257
" Flood Lighting .....	257	" Voltages of Lamps .....	235
" Foot Candle Meter.....	237	<b>Impedance</b> .....	464
" Foot Candles, Unit of Intensity.....	238	<b>Incandescent Lamp</b> .....	38 & 232
" Home Lighting .....	271	" Lamps (See also Illumination, Lamps) .....	234
" Home Lighting Fixtures .....	274	<b>Induced Magnetism</b> .....	63
" Incandescent Lamps, Edison.....	232	" Pressure and Current, Direction of.....	76
" Lamp Life and Rated Voltages.....	235	" Pressure Generated, Amount of.....	76
" Lamps, Efficiency of .....	235	<b>Inductance</b> .....	38
" " Incandescent Types of.....	234	<b>Inductance in A.C. Circuits</b> .....	458
" " Mazda .....	234	<b>Induction Coils</b> .....	78
" " Mercury Vapor .....	267	" Coils, Telephone .....	129
" " Mercury Vapor, Care and		" Electro Magnetic .....	76
Maintenance .....	270	" Lenz's Law .....	459
" " Mercury Vapor Installation.....	269	" Method of Producing Current.....	36

	Page		Page
Induction Motor Controllers.....	636	Line Conductor Arrangement and Spacing.....	689
" Motors (see Motors A.C.).....	566	" Conductor Copper, Aluminum.....	676
" " Change Poles and Speed.....	330	" Costs, Transmission .....	697
" " Change Voltage .....	326	" Drop, Voltage .....	48
" " Construction and Principles of.....	312	" Erection, Transmission .....	698
" " Efficiency and Power Factor.....	569	" Fittings, Transmission .....	688
" " Horsepower, Voltage and Frequency Ratings .....	570	" Ice and Wind Stress.....	696
" Regulators .....	548	" Insulators .....	677
" " , Operating Principles .....	548	" Interference with Signal Lines.....	691
" Frequency Meters .....	494	" Loss .....	49
Inductive Reactance .....	458	" Pole Climbing, Transmission.....	699
Inductor Type Alternators.....	1056	" Protectors and Lightning Arresters.....	703
Industrial Signal Systems.....	113	" Reactance and Capacity.....	693
Inspection Records, A.C.....	750	" Sag and Tension, Transmission.....	694
Installation and Maintenance, A.C.....	745	" "Sagging Tees" and "Pulling Grips".....	699
" and Maintenance, D.C. ....	439	" Skin Effect and Corona .....	694
" Signal Systems .....	115	" Steel Towers .....	687
" Wiring for Light and Power.....	216	" Supporting Structures .....	685
" of Transformers .....	747	" Ties, Transmission .....	680
Insulated Wires .....	37	" Transmission .....	675
Insulating Varnish, A.C. Stator.....	331	" Transposition .....	690
Insulation Tests, with Megger.....	765	Lines of Magnetic Force.....	72
Insulations, Armature, D.C.....	286	Live Line Work and Tools.....	700
Insulators .....	36	Load Demand Indicators, D.C.....	399
" Bushing .....	684	Loadstone .....	62
" High Tension .....	677	Local Action in Cells.....	58
" Pin Type .....	678	Lubrication, A.C. Bearing Maintenance.....	756
" Strain .....	682	Magnet .....	38
" Transmission Line .....	677	Magnet .....	62
" Wall Bushing .....	684	" Plunger Type .....	75
Interference, Radio .....	1211	" Shell Types .....	75
Internal Cell Circuit.....	62	" Winding and Repairing.....	73
Interpoles .....	373	" Wires, Armature, D.C.....	286
Kilowatt, Unit of Electric Power.....	53	Magnetic Alloys .....	68
Kilowatt Hour Meters, D.C.....	397	" Circuit .....	64
Kenotron Rectifiers .....	616	" Circuit in D.C. Generator.....	351
Keys, Keyways, Pulleys and Gears		" Effect .....	37
A.C. Maintenance .....	759	" Field .....	36
Knife Switches .....	380	" Field .....	64
Lagging Current, Caused by Inductance.....	460	" Field Around Wires Carrying Current.....	68
Lap Winding, A.C. Machines.....	318	" Flux .....	64
Lap Winding, D.C. Armature Coils.....	290	" Flux .....	72
Lead-Acid Cells, Storage Batteries.....	774	" Forces between Parallel Wires.....	69
Leading Current .....	470	" Lifting Power .....	73
Lenz's Law of Induction.....	459	" Lines of Force .....	64
Leyden Jar Condenser .....	29	" Materials .....	65
Lifting Power of Magnets.....	73	" Polarity .....	71
Lighting (see Illumination) .....	231	" Poles .....	63
Lighting System Troubles, Automotive.....	873	" Shields .....	67
Lightning .....	30	" Starter, D.C. ....	424
" Arresters .....	703	" Strength .....	66
" " Aluminum Cell .....	708	" Yoke or Keeper.....	66
" " Arc-Over Values .....	713	Magnetism .....	62
" " Auto Valve .....	706	Magneto Breakers, Automotive.....	849
" " Connections and Operation.....	709	" High-Tension, Automotive .....	846
" " Graded Shunt .....	705	" Motive-Force .....	72
" " Guard Rings and Horns.....	711	" Safety Gaps, Automotive.....	848
" " Horn and Sphere Gaps.....	703	" Telephone .....	131
" " and Line Protection.....	703	" Timing, Automotive .....	851
" " Overhead Ground Wires.....	711	" Troubles, Automotive .....	852
" " Oxide Film .....	707	Maintenance, A.C. Machines.....	745
" " Surge Absorbers .....	712	" Air Gap Measurements.....	756
" Rods .....	31	" Air Gaps .....	766
Line Calculation, Transmission.....	692	" A.C., Bearings .....	752
" Charging Current, Transmission.....	694	" " " "Frozen" .....	758
		" " " Lubrication .....	756

	Page		Page
Maintenance A.C., Controllers.....	768	Meters D.C. Operating Principles.....	388
" A.C., Fire Protection.....	770	" D.C. Potential and Current Coils.....	394
" " Inspection Records .....	749	" " Recording .....	397
" " Insulation Tests, Megger.....	765	" " Relay Type Recording.....	398
" " Motors Over-Heating .....	765	" " Shunts and Resistances .....	391
" " Overload and Single-Phasing.....	764	" " Types of .....	388
" " Safety Precautions .....	751	" " Voltmeters .....	389
" " Secondary Resistance .....	761	" " Watthour .....	393
" " Shafts .....	759	" " Watt-Hour Constant and Time Element .....	395
" " Single-Phase Motor Troubles.....	766	" " Wattmeters .....	392
" " Squirrel-Cage Rotor Troubles.....	760	Microhms .....	42
" " Slip-Ring Rotor Troubles.....	761	Motor Commutator, Mica Undercutting.....	441
" " Spare Parts, Stocking of.....	769	Motor and Generator, A.C. Installation.....	745
" " Starters .....	768	Motor-Generator for Signal System.....	83
" " Starting New Machines.....	767	" Substation .....	724
" " Stator Troubles .....	763	" Principles, D.C. ....	284
" " Tools and Instruments.....	751	" Troubles (See Maintenance D.C. for List) .....	442
" D.C. Machines .....	439	Motors, A.C. ....	566
" " Bearing Lubrication .....	440	" A.C. Applications on Ships.....	598
" " Brushes and Commutators.....	441	" " B T A Variable-Speed .....	594
" " Controllers .....	442	" " Characteristics .....	567
" " Motor Troubles, List of.....	442	" " "Choke-Bars" .....	593
" " Resistance Tests .....	446	" " Compensating Windings, Repulsion .....	574
" " Test Equipment .....	445	" " Condenser Table .....	609
" " Tools for D.C. Maintenance.....	446	" " Condenser Type Split-Phase.....	572
Maximum Demand Indicators D.C.....	399	" " Construction .....	312
Maxwell Unit of Force.....	73	" " Controllers, Reducing Voltage in.....	639
Mechanical Degrees .....	309	" " Double Squirrel-Cage .....	592
Mechanical Method of Producing Electricity.....	36	" " Double Squirrel-Cage, Operating Principles of .....	593
Meggers .....	401	" " Efficiency and Power Factor.....	569
Mercury Arc Power Rectifiers.....	620	" " Enclosed-Type .....	597
" Arc Substation .....	726	" " Fynn Weichsel .....	595
" Vapor Lamps (see also Illumination Lamps) .....	267	" " and Generator Installation.....	745
" Vapor Lamps, Maintenance.....	271	" " Horsepower, Voltage and Frequency Ratings .....	570
Meters, A.C. ....	482	" " Internal Resistance .....	583
" A.C. Adjustment of Watthour.....	491	" " Operating Principles of Synchronous Motors .....	586
" " Ammeters .....	482	" " Over-Heating .....	765
" " Connections .....	474	" " Overload and Single-Phasing.....	764
" " Creeping of, Watthour.....	490	" " Phase-Wound .....	581
" " Damping of .....	483	" " Polyphase .....	577
" " Demand Indicators .....	492	" " Portable .....	597
" " Dynamometer Type Instruments.....	483	" " Power Factor of.....	569
" " Electro-Static Voltmeters .....	488	" " Power Factor Correction.....	599
" " Frequency .....	493	" " Rotor Construction .....	572
" " Hot Wire Instruments.....	487	" " Rotor Troubles .....	760
" " Induction Type, Frequency.....	494	" " Secondary Resistance .....	761
" " Induction Type Instruments.....	485	" " Series or Universal.....	575
" " Moving Iron Type Instruments.....	482	" " Shaded-Pole .....	573
" " Shaded Pole Induction.....	487	" " Single-Phase .....	571
" " Test .....	491	" " " (see A.C. Stator).....	313
" " Thompson Inclined Coil.....	483	" " " Trouble .....	766
" " Pollyphase Watthour .....	491	" " Slip .....	568
" " Power Factor .....	492	" " Slip-Ring .....	581
" " Vibrating-Reed Type Instrument.....	493	" " Applications .....	585
" " Voltmeters .....	482	" " " Characteristics .....	583
" " Watthour .....	489	" " " Speed Control .....	582
" D.C. ....	388	" " " Starting Current .....	584
" " Care and Adjustment.....	389	" " " " and Speed Control with External Resistance.....	582
" " Compensating Coil .....	395	" " Special .....	592
" " "Creeping" .....	396		
" " Damping Disk and Magnets.....	394		
" " Direct Acting Recording.....	397		
" " Indicating Wattmeters .....	392		
" " Kilowatt-Hour .....	397		
" " Maximum Demand Indicators.....	399		



	Page		Page
Parallel Circuits .....	52	<b>Radio, Automatic Frequency Control</b> .....	1154
Parallel-Series .....	55	" Automatic Tuning .....	1152
Paralleling of Alternators.....	511	" Automatic Volume Control .....	1147
Paralleling D.C. Generators.....	363	" Cathode Ray Power Supply .....	1200
Pasted Plates, Storage Batteries.....	774	" Cathode Ray Tubes .....	1196
Permanent Magnets .....	65	" Circuit Disturbance Tests .....	1164
Permeability and Reluctance .....	66	" Condensers and Color Code .....	1141
Phasing Out Alternators.....	511	" Condenser Testers .....	1171
Physiological Effect of Electricity.....	39	" Continuity Tests .....	1165
Plan Reading, Circuit Prints.....	102	" Diode Detectors .....	1147
Planté Plates, Storage Batteries.....	774	" Fault Localizing .....	1163
Plunger Type Magnet .....	75	" Head Phones and Speakers .....	1127
Polarity of Converters.....	633	" Interference Elimination .....	1211
Polarity of D. C. Generators.....	363	" Microphones .....	1193
" of Dry Cells .....	62	" Modulated Oscillator .....	1169
" of Electro-Magnets .....	71	" Multiple Band Receivers .....	1156
Polarization of Cells.....	57	" Neutrodynes and Neutralizing .....	1126
Pole Climbing, Transmission.....	699	" Power Amplification .....	1121
" Cross Arms, Transmission.....	687	" Power Supply Filters .....	1137
" Sizes, Transmission .....	686	" Power Supply Troubles .....	1168
" Spacing, Transmission .....	686	" Power Supply Units .....	1136
Polyphase Transformers .....	525	" Public Address, Accoustical Treat- ment .....	1188
Porus Cup Cells .....	59	" Public Address Systems .....	1186
Portable A.C. Motors.....	597	" Principles .....	1053
Positive Charge .....	27	" Push Pull Amplification .....	1120
Positive Element or Pole.....	57	" Receiver Circuits .....	1114
Potential .....	41	" Receiver Construction .....	1158
" Transformers .....	552	" Receiver Tuning .....	1075
<b>Power Calculations, A.C.</b> .....	471	" Receiving Antennas .....	1067
" Calculations for Prime Movers.....	361	" Reflex Circuits .....	1117
" Equipment Installation .....	746	" R. F. Amplification .....	1118
" Factor, A.C. .....	469	<b>Radio, RF and AF Stage Troubles</b> .....	1167
" " Correction .....	599	" Resistance Analysis .....	1174
" " Definition and Formula.....	470	" Resistors and Color Code .....	1139
" " Meters, A.C. .....	492	" Service Inspection, Troubles.....	1162
" " Problems and Graphic Solution.....	604	" Servicing with Oscilloscope .....	1200
" " Synchronous Converters for Correcting .....	630	" Servicing and Troubles .....	1162
" Measurement, A.C. .....	473	" Signal Modulation .....	1060
" Plant, Auxiliary Equipment .....	670	" Speaker Baffles .....	1129
" " Hydraulic .....	667	" Speaker Coupling .....	1123
" " Rules .....	671	" Speaker Phasing .....	1192
" " Location .....	660	" Speaker Troubles .....	1168
" " Steam .....	662	" Superheterodyne Receivers .....	1143
" Transmission, Electrical .....	671	" Tone Control .....	1156
Primary Cells .....	35	" Tube and Voltage Troubles .....	1166
Primary Cells .....	56	" Tuning and Resonance .....	1062
Primary Induction Coil .....	79	" Types of Antennas .....	1062
Prime Mover .....	361	" Vacuum Tubes .....	1084
Prime Movers, Starting and Control of.....	669	" Vacuum Tubes, Amplifiers .....	1093
Printing Press Controllers, A.C.....	649	" Vacuum Tubes, A. C. Type .....	1098
Problems (Ohm's and Watt's Laws).....	47	" Vacuum Tubes, Beam Power .....	1102
Pyrometer .....	35	" Vacuum Tubes, Cathode Ray Tun- ing Indicators .....	1104
<b>Radio</b> .....	1049 to 1212	" Vacuum Tubes, Charts .....	1107 to 1112
" A. C. Receivers .....	1133	" Vacuum Tubes, Grid Action .....	1087
" Aligning Superhets .....	1148	" Vacuum Tubes, Grid Bias .....	1090
" A. F. Amplification .....	1119	" Vacuum Tubes, Numbering System .....	1101
" Amplification Factor .....	1095	" Vacuum Tube Oscillators .....	1057
" Analyzers .....	1170	" Vacuum Tubes, Rectifiers .....	1103
" Antenna Circuit .....	1061	" Vacuum Tube, Screen Grids .....	1097
" Antenna Inductance and Capacity .....	1072	" Vacuum Tube Selection .....	1105
<b>Auto Radio, Antennas</b> .....	1179	" Vacuum Tubes, Types .....	1100
" Interference and Suppressors .....	1182	" Variable Condensers .....	1078
" Receiver Installation .....	1181	" Voice Coils and Hum Bucking Coils .....	1130
" Vibrator Rectifiers .....	1184	" Voltage Analysis .....	1172
		" Volume Control .....	1122
		" Wave Length .....	1054
		" Wiring Symbols .....	1082
		<b>Sound Picture Units</b> .....	1191

	Page		Page
Reactance and Capacity.....	458	Relays, A.C. ....	742
Reassembling A.C. Motors and Generators.....	755	" A.C. Magnetic Overload.....	637
Reciprocal Rule for Resistance Calculation.....	51	" " Motor Controllers .....	636
Recording Instruments, D.C. Meters.....	397	" " Overload, Construction .....	643
Records, A.C. Inspection (Maintenance).....	750	" " Thermal and Magnetic Overload.....	637
Rectifiers and Converters.....	612	" D.C. Protective .....	384
" Copper Oxide .....	616	" D.C. Reverse Current.....	384
" Electrolytic .....	613	" Flashover .....	635
" Full-Wave Bulb-Type.....	615	" Signal .....	94
" Gaseous .....	1104	" Telephone .....	138
" Kenotron .....	616	" Temperature .....	635
" Mercury Arc .....	617	Reluctance in Magnetic Circuit.....	72
" Radio .....	1104	Reluctance and Permeability .....	66
" Vibrating .....	612	Remote Control, D.C. Motors.....	418
Reflectors, Illumination .....	234	Repairing Magnets .....	73
Reflectors, Illumination .....	240	Repulsion Motors .....	574
Refrigeration .....	953 to 1028	Residual Magnetism .....	70
" Absorption Type .....	984	Resistance .....	41
" Adding Oil Charge .....	1013	" of A.C. Circuits, Determining.....	475
" Cabinets .....	978	" of Conductors (Table) .....	211
" Cabinet Repairs .....	1017	" of Conductors (Table) .....	215
" Calculating Service Loads .....	1026	" Measurement, D.C. ....	401
" Common Troubles .....	994 to 1003	" of Parallel Circuits .....	50
" Compressors .....	968	Reversing Drum Controllers, D.C. Motors.....	429
" Compressor Efficiency Tests .....	1004	Reversing Drum Switches, D.C. Motors.....	429
" Condensers .....	970	Revolving Field Alternator.....	309
" Control Switches .....	975	Rewinding Old Armatures, D.C.....	297
" Control Valves .....	973	Rheostats, Alternator .....	508
" Cycle Diagrams .....	964	Rheostats, D.C. Motor Starting.....	416
" Dehydration .....	1012	Right Hand Rule for Direction of Flux.....	69
" Discharging of Units .....	1011	Rotor, A.C. ....	312
" Evaporation Temperatures and Pressures .....	959	" A.C. ....	326
" Evaporators .....	972	" Phase-Wound .....	312
Refrigeration, Expansion Valves.....	974	" Squirrel-Cage .....	312
" Heat, Latent and Sensible .....	958	" Troubles, Slip-Ring .....	761
" Ice Cream Freezers .....	1025	" Troubles, Squirrel-Cage .....	760
" Installation .....	986	" Windings, A.C. ....	326
" Lubrication .....	983	Sag and Tension of Transmission Lines.....	694
" Motors .....	977	"Sagging Tees" and "Pulling Grips".....	699
" Multiple Systems .....	967	Salesmanship .....	219
" Parts and Construction .....	968	Saturation, Units and Strength of Electro Magnets .....	72
" Principles .....	955 to 960	Scott Transformers .....	546
" Purging of Air .....	1013	Secondary Cells .....	56
" Recharging Unit .....	1011	" Induction Coil .....	79
" Refrigerant Chemicals (Refriger- ants) .....	979	" Resistance Troubles .....	761
" Refrigerant Leak Tests .....	981	Self-Induction, Automotive Ignition.....	828
" Rotary Compressor Repairs .....	1007	Self-Induction in D.C. Circuits.....	461
" Safety Codes .....	1023	Separators, Storage Battery.....	777
" Service Gauges .....	993	Series Circuits .....	49
" Service Methods .....	933 to 1003	" Circuits .....	52
" Service Tools .....	1018	" " A.C. Impedance of.....	464
" Service Valves .....	994	" Generators, D.C. ....	357
" Servicing Multiple Units .....	1019	" Motors, D.C. ....	411
" Soldered Connections .....	990	" Parallel, Circuits .....	55
" Solenoid Valves .....	1021	" and Parallel Connection of Generators and Batteries .....	52
" Systems and Cycles .....	962	" or Universal A.C. Motors.....	575
" Thermostats .....	977	Shaded-Pole Motors .....	573
" Troubles and Symptoms .....	994 to 1003	Shafts, A.C. Maintenance.....	759
" Tubing Flares .....	989	Shell Type Magnet .....	75
Regenerative Braking .....	434	Short Circuits .....	74
Regulators, Induction .....	548	" Circuits, D.C. Armature.....	302
		" " and Grounds, Wiring.....	229
		" " Induction Motors .....	337
		Shunt Wound D.C. Generators.....	356

	Page		Page
Shunt Wound D.C. Motors.....	410	Signal, Putting Your Training into Practice.....	119
Shutting Down an Alternator.....	516	“ Recorders .....	112
Signal, Advertising, Value of.....	120	“ Relay Terminal Tests.....	98
“ Annunciators, Connections and Tests.....	99	“ Relay Terminals and Connections.....	95
“ Annunciators, Locating Faults in.....	101	“ Relays .....	94
“ Apartment Door Bell and Opener		“ “ Adjustment and Care of.....	98
System .....	106	“ “ in Burglar Alarms.....	96
“ Automatic Signaling Machine.....	114	“ “ Open Circuit Stick.....	108
“ Balanced Alarm Systems.....	110	“ “ in Telegraph Systems, Ground	
“ Barn or Garage Alarm.....	105	Circuits .....	97
“ Batteries .....	82	“ Reset Switch .....	109
“ Bells and Buzzers, Care and Test of.....	92	“ Return Call Systems.....	103
“ Bells and Lamps.....	89	“ Running Signal Wires.....	116
“ Bells, Muffling of.....	92	“ Saving Wires by Use of Double	
“ Bells, Transformer .....	83	Circuit Switches or Grounds.....	104
“ Bells, Troubles .....	89	“ Saving Wires by Special Group Con-	
“ Benjamin Signals .....	115	nection and Separate Batteries.....	107
“ Burglar Alarm, Closed Circuit,		“ Selective and Master Calls.....	104
Two Flat .....	107	“ Silent .....	92
“ Burglar Alarm Foil for Window		“ Special Arrangement of Vibrating Bell	
Protection .....	110	for Constant Ringing.....	107
“ Buzzer .....	92	“ Starting a Business of Your Own.....	120
“ and Call Systems.....	81	“ Stick Relay Circuits.....	108
“ Call System without Switches.....	104	“ Switches .....	84
“ Closed Circuit System.....	82	“ “ Burglar Alarm .....	86
“ Combination Bells .....	91	“ “ Closed Circuit and Double Circuit.....	85
“ “ Closed and Open Circuit Alarms.....	109	“ Symbols Used in Signal Diagrams.....	102
“ Common Devices .....	82	“ Telephones (see Telephones).....	124
“ Connecting Vibrating Bells for		“ Testing to Locate Proper Wires for	
Series Operation .....	105	Connections .....	117
“ Current Supply Troubles.....	84	“ Thermostatic Switch .....	88
“ Door and Window Springs.....	86	“ Three Section Alarm System.....	109
“ Doorbell .....	82	“ Tools and Materials Necessary.....	121
“ Double Circuit Stick Relay.....	109	“ Tracing Circuits, Methods of.....	102
“ Drop Relays for Constant Ringing		“ Traps .....	87
of Signals .....	93	“ Trouble Shooting .....	119
“ Emergency Wires, and Pulling-in		“ “ and Tests .....	88
Replacements .....	117	“ “ Tests .....	117
“ Estimating Job Costs.....	120	“ Types of Circuits.....	102
“ Fire Alarm Devices and Circuits.....	111	“ Vibrating Bells .....	89
“ “Fishing in” Wires, “Mouse” and		“ Wiring, Caution Necessary for Safe	
“Fish Tape” .....	116	and Reliable .....	108
“ Floor Switches .....	87	“ Wiring Materials .....	108
“ Fusible Links for Fire Alarms.....	113	Single-Phase Current .....	310
“ Horns or “Howlers”.....	113	“ Motor (see also Motors A.C.).....	571
“ Hotel or Office Call System with		“ Motor Troubles .....	766
Annunciator .....	106	Slip of A.C. Motors.....	568
“ Industrial Signals & Heavy Duty Bells.....	113	Slip-Ring Motors (see also Motors, A.C.).....	581
“ Installation of Call and Signal System.....	115	Slip-Ring Rotor Troubles.....	761
“ Key or Lock Switches.....	87	Solenoids .....	70
“ Layout or Location of Parts in the		Sound Waves .....	124
Building .....	115	Spark Advance, Automotive Distributors.....	819
“ Lock Switch Connections.....	111	“ Coils, High Voltage.....	79
“ Magnetic Door Openers.....	93	“ Plugs, Automotive .....	830
“ Magnetically Operated Switch (Relay).....	95	Sparking at Brushes, D.C.....	443
“ Motor-Generator (Power Supply).....	83	Specific Gravity, Storage Battery.....	780
“ Office or Shop Call System.....	106	Specific Resistance of Materials .....	42
“ Open Circuit Systems.....	103	Speed Control, D.C. Motors.....	416
“ Open Circuit Systems .....	82	“ Indicators .....	446
“ Open, Closed & Double Circuit Relays.....	96	“ Regulation, D.C. Motors.....	407
“ Plan Reading .....	102	Spider, D.C. Armature.....	280
“ Plans and Symbols .....	82	Split Phase, Single-Phase Motors.....	571
“ Proper Location of Parts for Closed		Squirrel-Cage Rotor Troubles.....	760
Circuit System .....	96	Squirrel-Cage Rotors .....	312
“ Pull Boxes and Code Call Devices.....	111	Stalling Torque of Series Motors, D.C.....	411
“ Push Buttons .....	85	Star and Delta Starters, A.C. Motors.....	653



	Page		Page
<b>Starters, A.C. Motor</b> .....	636	<b>Stator Windings, Open Coils</b> .....	335
" A.C. Motor Across-the-Line, or Full Voltage .....	637	" Windings Pitch and Coil Span.....	317
" " " Auto Transformer or Compensator .....	644	" " Polarity, Correct Test for.....	327
" " " Automatic Carbon Pile.....	642	" " Pole Group Connections.....	326
" " " Remote Controlled .....	646	" " Poles and Speed Change.....	330
" " " Carbon Pile .....	640	" " Principles of A.C. Generators.....	308
" " " Compensators, Starting Voltage Adjustment .....	646	" " Reversed Coil Groups .....	336
" " " Printing Press .....	649	" " " Connections .....	335
" " " Remote Cont'ld Automatic.....	646	" " " Connections and Grounds.....	337
" " " Resistance Type .....	639	" " " Phase .....	336
" " " Star-Delta .....	653	" " Revolving Field Alternators.....	309
" A.C. Maintenance .....	768	" " Short Circuits .....	337
" Automotive .....	854	" " Shorted Coil Groups, A.C. Wind.....	335
" D.C. Motor (See also Controllers D.C.).....	415	" " Shorted Turns .....	334
" Magnetic D.C. ....	424	" " Single-Phase .....	313
" Troubles, Automotive .....	859	" " Skein Windings .....	313
<b>Starting Alternators</b> .....	515	" " Speed Change .....	330
" A.C. Motor with a Compensator.....	644	" " Star and Delta Connections.....	323
" and Control of Prime Movers.....	669	" " Terms and Definitions.....	317
" Current of Slip-Ring Motors.....	584	" " Testing Split-Phase Motor .....	336
" D.C. Generators .....	262	" " Three-Phase, Marking and Connecting Coil Leads.....	321
" Mercury Arc Rectifiers.....	618	" " Three-Phase Winding, Procedure.....	319
" New Machines, A.C.....	767	" " Troubles .....	333
" Own Business .....	120	" " Two-Phase Winding Example.....	318
" Single-Phase Motors .....	576	" " Types of .....	313
" Synchronous Converters .....	631	" " Types of Coils .....	319
" Synchronous Motors .....	589	" " Varnishes, Air Dry and Baking.....	331
" Torque of Series Motors, D.C.....	411	" " Voltage Change in Motors.....	326
<b>Static on Belts</b> .....	30	" " Voltage Change Effect on Current, Induction Motors .....	327
" Condensers .....	600	<b>Stopping, D.C. Motors</b> .....	423
" Control and Protection.....	30	<b>Storage Batteries, (see Batteries)</b> .....	773
" Electricity .....	27	" Batteries Automotive .....	763 & 826
" Electricity Condenser .....	29	" Cell or Battery .....	57
" Experiments .....	27	<b>Store Lighting</b> .....	251
" Explosions .....	30	<b>Steam Cycle, Power Plants</b> .....	664
" Machine .....	28	" Power Plants .....	662
<b>Stator</b> .....	310	" Turbine .....	665
" Troubles .....	763	<b>Steel Towers, Transmission</b> .....	687
" Winding Connections .....	322	<b>Street Lighting</b> .....	258
" " Fractional Pitch Windings.....	325	<b>Strength of Electro Magnets</b> .....	72
" " Terms and Definitions.....	317	<b>Substations</b> .....	720
" " Test for Correct Polarity.....	327	" Combination .....	727
" " Troubles .....	333	" Converter .....	721
" " Types of .....	313	" Distribution .....	720
" " Types of Coils.....	319	" Frequency-Changer .....	725
" " A.C. ....	313	" Mercury-Arc .....	726
" " A.C. ....	319	" Motor-Generator .....	724
" " Changing Number of Poles and Speed .....	330	" Switchboards (see also Switchboards).....	728
" " Coil Group, Winding.....	317	<b>Surge Absorbers, Lightning Arresters</b> .....	712
" " Coil Polarity .....	317	<b>Switch Gear, A.C.</b> .....	729
" " Construction of A.C. Motors.....	312	<b>Switchboard, A.C.</b> .....	728
" " Electrical Degrees .....	309	" A.C. Circuits and Wiring.....	733
" " Fractional Pitch Windings.....	325	" " Layouts .....	730
" " Frequency, Changes in.....	329	" " Operation .....	733
" " Grounded Coils .....	334	" " Substation .....	728
" " Induction Motor .....	313	" " Switch Gear .....	729
" " Insulating Varnish and Com- pounds on A.C. Windings.....	331	" D.C. ....	379
" " Lap Winding for A.C. Machines.....	318	" " Bus Bars .....	385
" " Mechanical Degrees .....	309	" " Feeder Panels .....	378
" " Open Circuits and Defective Centrifugal Switches .....	337	" " Frames .....	379
		" " Generator and Feeder Panels.....	378
		" " Knife Switches .....	380
		" " Layout and Circuits.....	386
		" " Panel Materials .....	378

	Page		Page
Switchboards, D.C., Pipe Frames.....	380	" Complete, Circuits .....	132
" D.C. Switch Mounting and Current		" Condenser .....	134
Rating .....	381	" Dials, Construction and Operation.....	142
" Types of .....	378	" Exchange .....	134
" Wiring .....	386	" Ground Circuits, Cables .....	149
" Telephone .....	135	" Important Parts and Devices.....	126
Switches and Fuses.....	194	" Induction Coil .....	129
" for Call and Signal Systems.....	85	" Jacks and Drops .....	137
" Centrifugal, Induction Motors.....	315	" Key Switches .....	136
" D.C. Field Discharge.....	382	" Lightning Protection and Transposition .....	150
" Generator Equalizer .....	365	" Line Banks and "Wiper" Contacts.....	143
" Instrument .....	384	" Lines .....	149
" Knife .....	380	" Magnetos .....	131
" Switchboard .....	380	" Phantom Circuits .....	150
" High-Tension Air-Break .....	739	" Principles of Operation .....	124
" Oil, A.C. ....	735	" Receiver .....	127
Symbols .....	44	" Receiver Hook Switch .....	128
Symbols of Electrical Units.....	40	" Relays .....	138
Synchronizing of Alternators.....	513	" Relays Slow Acting.....	148
Synchronous Converter, Starting .....	631	" Simplified Circuit of Important Parts.....	145
" Motors (See also A.C. Motors, Synchr.) .....	585	" Sound Waves .....	124
" Motors Starting Compensators.....	590	" Sound Waves Transmitting and	
" Speed Motors .....	567	Reproducing Electrically .....	125
Synchrosopes .....	496	Switchboard Connections, Simple.....	137
Synchrosopes .....	514	" Switchboard Lamps .....	136
Tables, Aluminum Cable, Size, Weight,		" Switchboard for Manual Operation.....	135
Strength, and Resistance.....	678	" Transmitter .....	126
" Battery Electrolyte Mixtures .....	781	" Troubles .....	151
" Conductor Sag and Tension (Trans.).....	695	" Wiper Shaft and Selector Mechanism.....	144
" Conductor Spacing (Transmission).....	689	Television .....	1203
" Conduit Sizes, for Number of Wires.....	183	" Cathode Ray Iconoscope .....	1208
" Currents Required by Squirrel		" Cathode Ray Kinescope .....	1207
Cage Motors .....	571	" Image Scanning .....	1204
" Current Carrying Capacity of R.C. Wires .....	158	" Interlaced Scanning .....	1207
" Current Carrying Capacity of R.C.		" Pick-up Camera .....	1205
and Varnish Cambric Cov. Wires.....	212	" Projectors .....	1206
" Inductive Reactance of Lines per		" Receivers .....	1209
1000 feet .....	693	" Receivers, Phasing .....	1210
" Insulator Arc-Over Voltages.....	713	" Sweep Circuit Oscillators .....	1199
" Lighting Intensities in Foot Candles.....	247	" Video Amplifier .....	1210
" Line Transposition Practice .....	690	Testing, D.C. ....	444
" Magnet Wire, Sizes, Weights		Testing Magnetic Coils .....	74
and Resistance .....	215	Thermal Method of (Producing Current).....	35
" Pole Heights and Settings		Thermo Couples .....	35
(Transmission Line) .....	686	Thermostats, Switches .....	88
" Power Factor, Condenser Sizes.....	609	Thompson Inclined Coil Instruments, A.C.....	483
" Sparking Distance of Air Gaps,		Three-Wire D.C. Systems .....	366
High Voltage .....	704	Three-Phase Current .....	311
" Specific Resistance of Materials.....	42	Timing Ignition, Automotive .....	835
" Starting Torque of Induction Motors.....	579	Tools for Maintenance Work.....	446
" Temperature Conversion, Fahrenheit		Torque, Squirrel-Cage Motors .....	579
and Centigrade .....	530	Tracing Circuits .....	102
" Transmission Cable Strength, Size,		Transformers .....	79
Weight, and Resistance .....	676	Transformers .....	522
" Transmission Voltages .....	675	" Air Blast Cooling of.....	526
" Wire Dimensions, Rubber Covered.....	182	" Auto .....	547
" Wire, Sizes, Weights and Resistance.....	215	" Auxiliary Oil Tanks and	
" Wires in Conduit, Number of.....	181	Breather Ports .....	528
" Vacuum Tube Characteristics .....	1107	" Bell, Signal .....	83
" Voltage Drop per Ampere, in Wires.....	214	" Connecting Primaries in Series.....	538
Telephones (See Signal) .....	124	" Connections .....	536
" Automatic .....	142	" Connections to Converter.....	630
" Batteries and Current Supply.....	129	" Construction .....	523
" Bells .....	130	" Cooling .....	526
Telephone, Cables and Terminals.....	138	" Current .....	550
" Central Energy Systems and Phones.....	134	" Delta-Star Connections .....	541

	Page		Page
Transformers Drying Out .....	555	<b>Transmission Lines Structures</b> .....	685
" Effect of Secondary Load Current on Primary Current .....	533	" Lines Supports .....	685
" Effect of Water on Oil .....	556	" " Ties .....	680
" Field Problems .....	554	" " Transposition .....	690
" Grounding .....	544	" " Underground .....	672
" Installation .....	747	" " Underground Cables .....	673
" Instrument .....	550	" " Voltages .....	675
" Insulating Bushings .....	530	" " Line Work and Tools.....	700
" Leads, Polarity of .....	534	" "Sagging Tees" and "Pulling Grips".....	699
" Loading .....	534	" Voltages and System Layout.....	672
" Losses .....	526	Transposition of Line Wires.....	690
" Maintenance and Care.....	555	Trouble shooting, A.C. Motors.....	333
" Oil, Cleaning of.....	557	" Shooting, A.C. Motors.....	760
" Oil Testing .....	556	" " Automotive Ignition .....	839
" Oil-Cooled .....	527	" " D.C. Armatures .....	301
" Open-Delta Connections .....	543	" " D.C. Generators .....	444
" Operating Temperatures .....	529	" " D.C. Motors .....	442
" Paralleling Single-Phase .....	537	" " Radio .....	1163
" Paralleling Three-Phase .....	544	" " Refrigeration .....	993 & 1003
" Polarity of Leads .....	534	" " Telephones .....	151
" Polyphase .....	525	" " Signal System .....	99
" Potential .....	552	" " Signal System .....	119
" Power Output of.....	533	" " Storage Batteries .....	795
" Principles .....	532	" " Wiring .....	228
" Ratios and Secondary Voltages.....	532	True Power and Apparent Power.....	470
" Scott .....	546	Turbines, Hydraulic .....	667
" Single-Phase .....	525	Turbines, Steam .....	665
" Star and Delta Connections.....	539	Two-Phase Current .....	311
" Tap-Changing .....	546	Unbalanced Load on Three Wire D.C. Gen.....	368
" Temperature & Load Indicating Device .....	530	Underground Transmission .....	672
" Tertiary Windings .....	535	Unit of Capacity, A.C. Circuits.....	462
" Testing Split-Secondary Leads.....	537	Units of Electricity .....	40
" Tests .....	553	Units of Magnetic Force.....	73
" Three-Phase Connections .....	538	Universal or Series A.C. Motors.....	575
" Voltmeter Test for Polarity.....	535	Vacuum Tubes, Radio (See also Radio Vacuum Tubes) .....	1084
" Water Cooled .....	528	Varnishes, A.C. Stator .....	331
" Windings .....	524	Vibrating-Type Ignition Coil Automotive.....	829
<b>Transmission and Distribution,(see Distrib.)</b> .....	714	Volt, Unit of Electro-Motive-Force.....	41
" Electrical Power .....	671	Voltage Adjustment and Regulation, D.C. Generator .....	354
" "Hot" Line Work and Protective Equipment .....	700	" Build up in D.C. Generator.....	353
" Lines .....	671	" Changes, D.C. Armatures .....	297
" Cable .....	674	" Changes in Induction Motors.....	326
" Cable Handling and Splicing.....	675	" Curves, D.C. Armatures .....	283
" Calculations .....	692	" Drop in Brushes and Lines, D.C. Gen.....	355
" Charging Current .....	694	" Generation of Alternating.....	453
" Conductors .....	676	" Generating of, D.C.....	282
" Conductor Spacing .....	689	" Measurements on Three-Phase Circuits .....	475
" Corona .....	694	" Regulation, Alternator .....	509
" Costs .....	697	" Regulation Automotive Generators.....	867
" Electrical .....	671	Voltage Test, Storage Batteries.....	784
" Erection .....	698	Voltaic Cell .....	57
" Fittings .....	688	Voltmeter .....	40
" Ice and Wind Stress.....	696	Voltmeter A.C. .....	482
" Insulators (See also Insulators).....	677	Voltmeter D.C. .....	389
" Interference with Signal Lines.....	691	Water Cooled Transformers .....	528
" Pole Climbing .....	699	Water Wheels .....	667
" Pole Cross Arms .....	687	Watt (Unit of Electric Power).....	43
" Pole Sizes .....	686	Watt's Law .....	47
" Pole Spacing .....	686	Wattour Meters, A.C.....	489
" Protection .....	703	Wattour Meters, D.C.....	393
" Reactance and Capacity.....	693	Wattmeters, D.C. .....	392
" Sag and Tension.....	694	Wave Winding, D.C. Armature.....	293
" Skin Effect and Corona.....	694	Wet Cell or Battery.....	57
" Steel Towers .....	687	Wheatstone Bridge .....	400

	Page		Page
Winding Armature Coils (See Arm., D.C.).....	288	Wiring, Fuses, (see also Fuses and Switches) .....	194
“ Element of D.C. Armature.....	295	“ Gauge Equivalents Copper Wire.....	215
“ Magnets .....	73	“ Getting New Contracts .....	222
Wire Calculations .....	209	“ Ground Wires and Fittings.....	195
“ Insulation (Magnet Wire).....	286	“ Important Points in .....	154
“ Insulated .....	37	“ Inspection—An Advantage to the	
“ Resistance, Weight and Size (Table).....	215	Trained Man .....	155
Wiring, Always First-Class Work.....	221	“ Installation Methods .....	216
“ Armoured Cable .....	186	“ Insulation .....	156
“ Armoured Cable (B.X.).....	170	“ Knob and Tube Installation .....	216
“ Armoured Cable, Advantage of.....	186	“ Knob and Tube Work.....	169
“ Attaching and Soldering Lugs to Cable .....	167	“ Knobs and Tubes, Porcelain.....	170
“ Attachment Plugs .....	203	“ Layouts and Plans .....	216
“ Blow Torches .....	166	“ for Light and Power.....	154
“ Branch Circuits .....	208	“ Loads on Wiring Systems and	
“ “ Circuits Appliance .....	208	Size of Service Wires.....	208
“ “ “ Combination Lighting and		“ “Loom” Tubing .....	171
Appliance .....	208	“ Maintenance Work, Good Knowledge	
“ “ “ Lighting .....	208	of Wiring Needed in.....	154
“ “ “ Types of .....	208	“ Materials, Conductors .....	156
“ Business Methods and Estimating.....	219	“ Maximum Connected Load .....	208
“ B & S Gauge Wire Table.....	211	“ Maximum Demand Factor.....	205
“ BX & Non-Metallic Cable Installation.....	216	“ Metal Raceways or Moulding.....	187
“ BX Cutting and Stripping.....	187	“ Metal Systems .....	170
“ BXL, Use of .....	187	“ Metallic Tubing, Electrical .....	184
“ Cable Lugs .....	166	“ Modern Methods and Instruments to	
“ Capital Required to Start.....	219	Secure Interest and Confidence of	
“ Circular Mil .....	159	Customers .....	220
“ “ Mil Conversion of Square Mils to.....	210	“ National Electric Code.....	155
“ “ Mil Unit of Conductor Area.....	210	“ Neat Appearance .....	189
“ Cleaning and Tinning .....	164	“ New House Plan .....	216
“ Cleat Work .....	169	“ Non-Metal Systems .....	169
“ Cleat Work .....	173	“ Non-Metallic Sheathed Cable .....	174
“ Concealed .....	169	“ Open Neutral and Unbalanced Load,	
“ Conduit, Advantages of.....	177	Effects of .....	205
“ “ in Concrete Buildings, Special		“ Open Systems .....	169
Precautions for .....	218	“ Outlet Boxes .....	172
“ “ Fittings .....	179	“ “ Cost per .....	220
“ “ Fittings and Methods of Installing .....	177	“ “ Location of Light and Switch.....	216
“ “ Flexible .....	170	“ “ Locating and Cutting, Box Open.....	217
“ “ Flexible .....	185	“ “ and Receptacles, Convenience.....	202
“ “ Installation .....	217	“ Panel Boards and Fuse Cabinets.....	196
“ “ Number of Circuits and Wires		“ Plans and Layouts .....	222
Allowed in One .....	182	“ Polarized System, Advantages of.....	206
“ “ Pulling Wires into .....	181	“ Polarized System, Grounding Neutral	
“ “ Reaming Cutting and Bending of.....	178	Wire of .....	207
“ “ Rigid .....	170	“ Pull Boxes and Junction Boxes.....	179
“ “ Rigid .....	177	“ Pulling in the Wires.....	218
“ “ Sizes and Dimension of.....	182	“ Raceways, Underfloor .....	170
“ “ Sizes and Types of Bends and		“ Raceways, Underfloor .....	190
Number Allowed .....	178	“ Radio .....	1160
“ “ Supports for .....	180	“ Resistance of Conductors.....	211
“ “ Systems, Grounding .....	183	“ “ of Copper per Mil Foot.....	212
“ Connections to Switches and Fixtures.....	216	“ Rigid Conduit .....	177
“ Copper Oxide and Its Effect on		“ Romex, Installing .....	175
Joint Resistance .....	163	“ Running the Wires .....	172
“ Cut-Out Blocks .....	195	“ Running Wires and BX into	
“ Demand Factor .....	208	Difficult Places .....	217
“ Drip Loop .....	207	“ Service Wires .....	207
“ Edison Three-Wire System.....	203	“ Short Circuits, and Grounds, Causes,	
“ Estimate, Method of Figuring		Locating .....	229
Overhead and Profit .....	221	“ Simple Formula for Conductor Area.....	213
“ Estimate Practical Problems.....	222	“ Soldering, Solder, Flux, Methods.....	163
“ Estimating, Time and Materials Basis.....	220	“ Solderless Connections .....	167
“ Exposed .....	169	“ Splice, Stranded Cable .....	162
“ Feeders .....	208	“ Splice, Taping of .....	168

	Page		Page
Wiring Splice, Western Union.....	160	Wiring Systems, Types of.....	169
“ Splicing and Types of Splices.....	159	“ Tests, Final .....	219
“ Splicing Lead Covered Cable.....	167	“ Tools .....	227
“ State and Local Code Rules.....	155	“ Trouble Shooting .....	228
“ Stripping and Cleaning Wires.....	159	“ Two-Wire System .....	156
“ Switches, Snap, Various Types.....	198	“ Unbalanced System .....	204
“ “ Knife .....	197	“ Value of General Knowledge of.....	154
“ “ Substituting Various .....	201	“ Voltage Drop .....	209
“ “ Symbols for Types of.....	199	“ Voltage Drop Allowable, Formula.....	213
“ “ Three-Way and Four-Way.....	199	“ Weather Cap .....	207
“ Symbols .....	225	“ Wires, Allowable Current Carrying	
“ Systems, Automotive .....	877	Capacity of .....	212
“ “ Classes of .....	155	“ “ Calculations .....	209
“ “ Parts of .....	207	“ “ Gauge Numbers Based on Resist.....	210
“ “ Three-Wire .....	156	“ “ Size and Dimensions of	
“ “ Three-Wire .....	203	Rubber Covered .....	182
“ “ Three-Wire .....	205	“ “ Size Very Important.....	157
“ “ Three-Wire, Saving of Copper		“ Wood Moulding .....	169
by Use of .....	204	“ Wood Moulding .....	176
“ “ Three-Wire, “Solid Neutral” for.....	205	Yoke (Magnetic) .....	66



# THE ELECTRICAL FIELD

---

## USES AND APPLICATIONS OF ELECTRICITY GREAT OPPORTUNITIES FOR TRAINED MEN

The electrical industry is one of the greatest in the world today. It is a comparatively young industry, and it was only about 55 years ago that we commenced to use electricity to any great extent. Yet today there are many billions of dollars worth of electrical machinery and equipment in use in this country alone, and new electrical equipment is being manufactured at a rate of over \$1,000,000,000.00 worth per year.

In practically every country in the world, electricity is coming into greater use, at a rate so tremendously fast, that it is impossible to predict the extent and size of this great industry for even a few years ahead.

Every student of electricity should be vitally interested in the great size of this industry, and the many thousands of uses to which electricity is being put today. It gives him certain assurance that he has plenty of opportunities to "cash in" on every bit of training he can obtain.

There are so many different branches of electrical work today, that the trained man can choose almost any kind he desires.

### INDUSTRIAL POWER AND LIGHT

Industrial plants and factories all over the country use electric power by the millions of horse power, and are over three-fourths electrified at present. Electric motors, ranging from a small fraction of one horse-power to many thousands of horse-power each, turn the wheels of these great factories and mills.

Almost every new plant that is built is completely equipped with electric power machinery because it is so much cleaner, quieter, safer, and more efficient than any other power.

Electric lights by the millions brighten the modern factory to speed up the work, and make safer and better conditions for employees.

Electric furnaces melt our finest steels and metals. Electric arc welders, spot welders and butt welders replace riveting and bolting in the faster and better construction of our manufactured metal products today. Electric enameling ovens and heat treating furnaces are also coming more and more into use, by the thousands of kilowatts each year.

Many thousands of men are required to install, operate and maintain this power, lighting, and heating equipment in these shops and factories.

### TRANSPORTATION

In transportation we find electricity used on a vast scale. Electric street cars, elevated and subway trains in our cities, and electric interurban lines between towns are common. And the great railway lines are electrifying more every year. Powerful, silent, electric locomotives and motors, pull many trains over hundreds of miles of the most difficult mountain railways, as well as the level runs.

Then there are the electric block signals on every principal railway in the country, and the automatic electric train control equipment installed on many lines, to say nothing of the train lighting and many other uses. Even on the seas, we have great battle ships using as much as 180,000 horse-power of electric energy each, just to drive their propellers. Merchant marine ships also use hundreds of thousands of horse-power of electrical machinery.

### COMMUNICATION

Electricity operates our many millions of telephones, making it possible to talk to our friends, or conduct our business over a few miles, or across the ocean, as we please. These and our vast telegraph systems require many thousands of electrical men in pleasant, fascinating work, to install and maintain them.

Then we have the radio industry, just another branch of electricity, and while it is only a few years old, we have many millions of radio sets bringing education and entertainment to our homes throughout the country today.

And now the newer fields of auto radio, sound amplification and television

There is a genuine need for many trained electrical men in these branches.

Many streets in the larger cities are electrically lighted at night, almost as bright as day light. Special electric lighting beautifies the outside of the great skyscraper buildings. Electric signs with thousands of lamps in each of the larger ones, flash their advertisements in all colors.

## ENTERTAINMENT

Our marvelous motion pictures of today, with their great entertainment and educational value, are made possible by electricity. Great electric lamps of from 1,000 to 50,000 watts each, light the studios for the photography. Electric projector machines reproduce pictures in the theatres, and the beautiful stage and theatre lighting effects add their part electrically.

The talking movies are also electrical devices which are simple enough to those who have a practical training in electricity and radio.

## AUTOMOTIVE AND AVIATION ELECTRICITY

Every one of our many millions of gasoline automobiles, trucks and tractors, use electricity. It ignites the gasoline, starts our cars, provides the lights, horn, and other conveniences on the modern motor cars. Electrical experts who can repair the trouble of these electrical systems and their electrical units, including the storage batteries, can draw good pay or run a very profitable business of their own.

Aviation is another great field, requiring many more trained electrical men each year, to take care of the ignition equipment of these great airplane engines. The landing and flying lights and electrical instruments on the plane, the radio beacon and communication equipment, air port lights and route beacon lights, all require trained electrical men in the finest kind of work.

## HOME LIGHTING AND CONVENIENCE DEVICES

In our homes electricity gives us plenty of clean, convenient light, beautifying the home, and saving our eyes when we read and study, and actually giving us many more useful hours each day.

Then there are the electric fans, toasters, heaters, vacuum cleaners, washers and ironers, refrigerators, kitchen utensils, and dozens of other electrical convenience devices saving time and eliminating drudgery in the home.

These things are no longer limited to the city homes alone. Farm and rural electrification is one of the fastest growing branches of this indus-

try. Hundreds of thousands of farms are electrified today, with their own private plants, or from lines of the power companies. The modern farmer is beginning to use electricity to save time and earn money for him, just as the business man or factory owner does in the cities.

So we see that electricity is rapidly becoming a great part of our entire life and civilization. And it is literally true as the late Dr. Steinmetz said, "that if we were to remove the electric wires from the world today, our civilization would look like a sieve."

Now, this brief review of some of the most important uses of electricity serves to show us what a great industry it is, and what a variety of different branches the trained man has to choose from.

## GREAT OPPORTUNITIES FOR TRAINED MEN

The field and uses of electricity increase at such a rapid rate each year, that it requires many more trained men yearly, to install, operate and maintain all this equipment.

Thousands of additional trained men are required each year to replace those who retire from this great field. Employers require more than ever before, men with practical training to install and operate their expensive electrical equipment.

So if you have carefully read and thought over this brief description of the electrical industry, I am sure you can see that there is no field of greater opportunity for fascinating, steady work at good pay, and with real opportunities for advancement. Electricity offers all these to the ambitious man, who will study and train to become a qualified and efficient electrical worker.

The following material in this reference set, has been prepared in simple practical form, to make easy the things about electricity that remain so mysterious to the ordinary untrained man.

We believe that every ambitious student who is not afraid to study and do his part, and who takes pleasure in adding to his practical knowledge of electricity, will enjoy his study of every page of this set.

# ELEMENTARY ELECTRICITY

## ARTICLE 1.

The very important purpose of this section is to acquaint you with the general nature of electricity, how electrical energy may be produced in commercial form, and the fundamental laws and rules by which we control electricity and its various useful effects.

It is not necessary for the practical man to try to obtain an exact definition of electricity, or exactly what it is in terms of detailed scientific theory. But is well to understand that we consider electricity to be in and throughout everything. In fact all matter is considered to be made up of electricity, or electrons in continuous whirling motion. These electrons compose the very atoms of matter, which themselves are so small that we cannot see them even with the most powerful microscopes.

So we find that electricity is a natural force or element, present in all things, and we do not create or produce it, but instead we have merely learned how to generate electrical pressure to set the electricity in motion.

## 2. FORMS OF ENERGY

In this way we transform some of our various forms of energy into electrical activity or energy, and use this electricity to carry and give up or reproduce its energy wherever we want it in useful forms, such as light, heat or power.

For example in Figure 1, we have the latent energy of coal, which was stored in it ages ago by the sun, given up by burning or combustion. This burning of the coal produces heat energy. The heat boils the water and changes it into steam under pressure in the boiler, and from here we pipe it to an engine.

Under control of proper valves, the steam expands in the engine cylinder pushing the piston, turning the wheel and giving up its energy in the form of useful mechanical power.

Then we use this power by means of a belt, to drive a dynamo which generates electrical pressure and sets electricity in motion in commercial form. This electricity flows silently and incredibly swift through little wires to the lamp, where it is again changed into glowing incandescent heat or light.

So you see it is simply a cycle of transformation of one kind of energy to another. And electricity being so much cleaner, more convenient and efficient is why it is preferred to all other forms of heat, light or power. We can, of course, use water power, wind power, and gas or oil engines as well as steam, to drive our electric generators, and we will take these up later.

## 3. STATIC AND DYNAMIC ELECTRICITY

Now before we go further in this phase or part of our work, let us consider the two different forms or conditions of electricity we have to deal with.

These two kinds of electricity as they are often called, are **Static** and **Dynamic** electricity.

**Static Electricity** refers to electricity at rest, in the form of charges, or not flowing in the usual commercial form.

**Dynamic Electricity** is electricity in motion, or flowing through wires and devices in our usual commercial form. This is by far the most common in the work of the average electrical man, and will be the kind the greater part of this reference set deals with. But **Static Electricity** is quite often encountered in our work also, and every thoroughly trained man should have a general knowledge of its nature, how it is produced, and how to control it.

## 4. STATIC EXPERIMENTS

One of the simplest examples of static electricity, is the rubbing of amber with wool flannel, which causes it to become charged and attract small bits of paper, wood or pith.

This was discovered about 600 B. C. by a Greek. The Greek word for amber being *Elektron*, and the Latin word *Electrum*, the name **Electricity** was given to this charged effect.

It was about 22 centuries later, in 1600 A. D. that Dr. Gilbert, an English physicist, discovered that other materials such as glass, hard rubber, wax, etc., would become charged by rubbing with silk, wool or fur. These will also attract bits of paper, string, etc.

Try this by rubbing your comb or fountain pen briskly on your coat sleeve, and then bring it near to very small bits of thin dry paper.

## 5. POSITIVE AND NEGATIVE CHARGES

We can probably best understand how this occurs, if we refer briefly to the electron theory of matter again. All matter is supposed to be made up of atoms, consisting of a **Positive** nucleus or center, and negative electrons whirling around this positive nucleus.

In normal uncharged bodies of matter, these positive and negative forces are equal or balanced. And when we briskly rub two unlike bodies together, the theory is that some of the free electrons of the surface of one body are removed to the other. This creates an unbalanced condition, with one body having a shortage of negative electrons, and the other an excess. The body with the shortage of negative electrons, is said to be **Positively** charged, and the



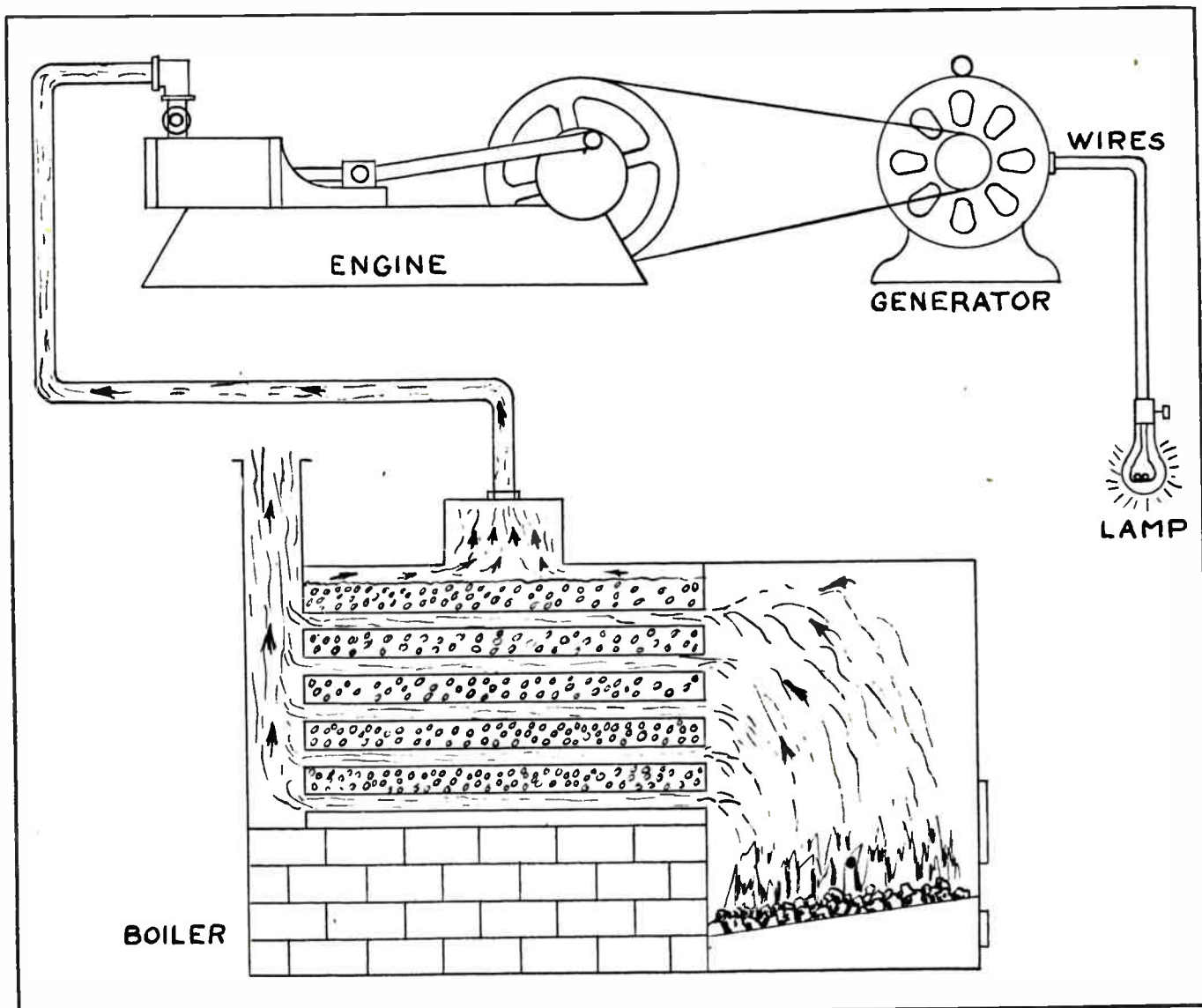

Fig. 1. Sketch showing how heat energy of coal is changed into mechanical energy by the engine, then to electrical energy by the generator, and into heat and light again by the lamp.

one with the excess of negative electrons is **Negatively** charged. So much for the theory by which static charges occur or are produced.

We now see that we can set up opposite conditions of charge on different bodies, and we call them **Positive** and **Negative**. When we set up such a condition, we say there is a difference of potential or electrical pressure between them, and this pressure tends to cause electricity to flow and balance them up again.

Now, if we take a piece of amber which has been negatively charged, and bring it into contact with two suspended pith balls, as in Figure 2A, the pith balls will both take on or absorb negative charges. Objects of this nature will often take on a charge from a short distance. This is called an **Induced** charge.

## 6. STATIC REPULSION AND ATTRACTION

Now, as soon as the two pith balls have been given like charges, we note that they immediately

push apart or repel each other. And they will also repel each other if both are positively charged, as we can prove by giving them a positive charge from a glass rod which has been rubbed with silk. But if we charge one pith ball negatively from the amber, and one positively from the glass, they will at once draw together or attract each other. (See Fig. 2B.)

This proves one of our most important electrical laws, as follows: **Like Charges repel each other and Unlike Charges attract.**

This law of electricity should be memorized, as it is very important, and many electrical devices have their operating principles based on it.

## 7. STATIC MACHINE

A number of very interesting and valuable demonstrations of this law, and the nature and effects of static electricity, can be made with a static machine such as used in the elementary department of your shop course.

The static machine is shown in Figure 3. It is simply a device to produce strong charges of static

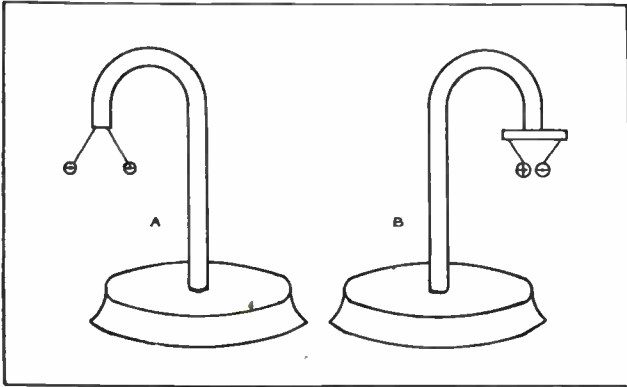

Fig. 2-A. Pith balls with like static charges repel each other.  
Fig. 2-B. Two balls with unlike charges attract each other.

electricity, for various experiments and tests. With it we can produce charges many times stronger than by rubbing the amber, glass, or hard rubber rods.

As you will note in Figure 3, the static machine consists of one stationary glass disk, on the back of which are fastened some tinfoil strips. To these foil strips are attached little wire brushes, extended around to touch a row of metal buttons, which are placed around the edge of a rotating glass disk, which is revolved close to the stationary one.

These little metal buttons or carriers, convey the little charges collected, to the metal system of the machine. When the rotating disk is driven at high speed by means of a hand crank, belt and pulleys, a charge is gradually built up by what is called induction, as the metal buttons are whirled rapidly by the foil plates and little wire brushes. This gradually builds up a positive charge on one of the metal spheres or electrodes and a negative charge on the other.

It is possible to build up charges of such high pressure or voltage, that a discharge in the form of a spark will take place between the two electrodes.

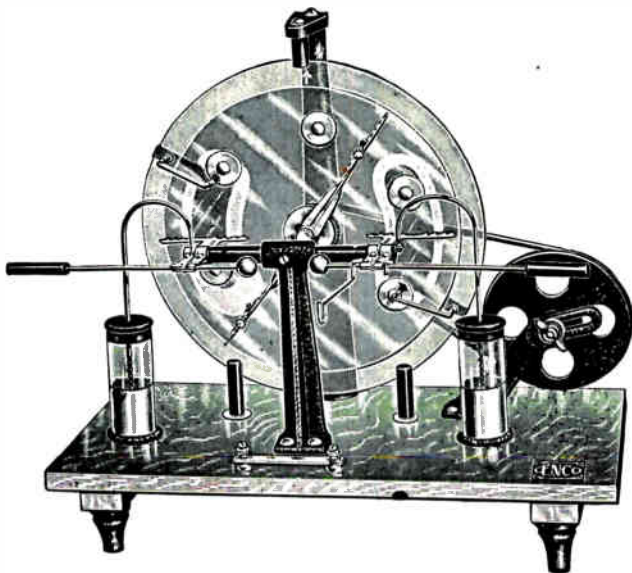

Fig. 3. Static machine, for producing strong charges of static electricity. When the disks are rotated rapidly a spark an inch or more in length can be produced.

This discharge tends to equalize or again balance the positive and negative charges.

Sometimes these machines can be made to produce sparks an inch or more in length, which represent charges of several thousand volts. But these charges are not dangerous, because they are of such small quantity, or actual amounts of electricity.

If we attach simple Leyden jar condensers to each of the electrodes of the static machine, we can get it to store up or accumulate in them, much larger amounts of electricity. Then when the discharge occurs it will be a very hot snappy spark, and will give quite a shock to anyone touching the terminals.

## 8. CONDENSERS

These condensers, which are used to store up electricity in the form of static charges, are made in many different shapes and sizes, but all on the same principle. The Leyden jar type consists of an inner and outer metal jar or cylinder of thin copper, brass, or foil, separated by a glass jar. (See Figure 4.)

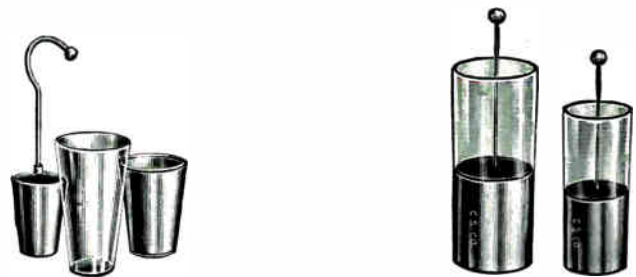

Fig. 4. Two types of Leyden jar condensers.

This provides two conducting surfaces of metal, separated by an Insulator or Dielectric, in the form of glass. (An insulator or dielectric is any material which prevents the flow of electricity. These will be explained later.)

When the terminals of a static machine or source of electric charge are connected to the two metal jars or elements, these will distribute a charge over the surface area of the glass which they cover. Then after the condenser has been so charged, we can discharge it by connecting a wire from one metal element to the other.

Condensers are often made with flat plates of foil or metal, stacked and separated by flat plates of glass, rubber or mica. Others are made of strips of metal foil and paper rolled together.

The area of the active or charged surfaces of the condenser, and the quality and thickness of the glass or insulation, determines the amount or quantity of charge it will take, or the volume of the spark when it discharges. A good thing to remember about any condenser is that the charge resides on the surfaces of the glass or dielectric, while it is charged. The metal elements simply act as conductors to distribute the charge over the surface of the glass while charging, and to collect it when discharging.

This can be proved by charging a Leyden jar condenser of the type with separable jars. Then carefully remove the metal jars with one hand only, and by inserting one hand inside the glass jar, and drawing the other over its outer surface you can get a discharge to your hand, in the form of small sparks.

Condensers of other types and their uses for power, radio and other purposes will be discussed later.

## 9. METHODS OF STATIC CONTROL AND PROTECTION

Now that we have an idea of the general nature of static electricity it will be well to consider some of the forms in which it is often encountered in every day life outside the laboratory. Also some of the methods of controlling, or protecting against it, because in some of the forms in which it is produced by nature, and in our industries, it can be very harmful if not guarded against.

For example, one of the most common occurrences of static in the home, is when we walk across a heavy carpet, and by rubbing or scuffing action of our feet we collect a strong charge on our bodies, from the rug. Then when we come near to a grounded radiator, or water pipe, or large metal object, a discharge takes place from our body to it, in the form of a hot spark, sometimes from half inch to an inch in length.

In many cases the only effects of this are the surprising little shocks or rather humorous incidents caused by it. But in some cases it becomes so bad it is very objectionable, and even dangerous. For example a person's body so charged can unexpectedly ignite a gas flame, or vapor over some explosive cleaning fluid.

Where rugs are the source of objectionable static it is sometimes necessary to weave a few fine wires into the rug, or provide a metal strip at its edges, and ground these by connecting them to a water or steam pipe. Or it may be reduced by occasionally dampening the rug a little.

## 10. EXPLOSIONS FROM STATIC

When handling any cleaning fluids of an explosive nature, one should be very careful not to rub the cloth too briskly, as this may produce sparks and ignite the vapors. In dry cleaning plants the various pots and machines should have all parts connected together electrically, and thoroughly grounded with a ground wire.

Another common occurrence of static in a dangerous place is on large oil trucks. These trucks running on rubber tires over pavements on dry hot days, collect surprising charges. To prevent the danger of this accumulated charge sparking to the operator's hand or a can near a gasoline faucet, and causing an explosion, these trucks should all carry a grounding chain with one end attached to the metal frame of the truck, and the other end dragging on the ground or pavement. This equalizes the

charges, or lets them flow back to earth before they build up to dangerous values.

Passenger busses are also equipped with such ground chains or wires sometimes, to prevent the passengers receiving a shock from static charges, when stepping on or off the bus.

## 11. STATIC ON BELTS

High speed belts in factories and industrial plants are often sources of surprising static charges. The rapid movement of the belt through the air and over the pulleys, will often build up charges that are very likely to be harmful if not eliminated. In some cases these charges from the belts will flash over to electric motors or generators on which the belts are running, and puncture the insulation of the windings of these machines, causing leaks of the power current through this damaged insulation, which may burn out the machine.

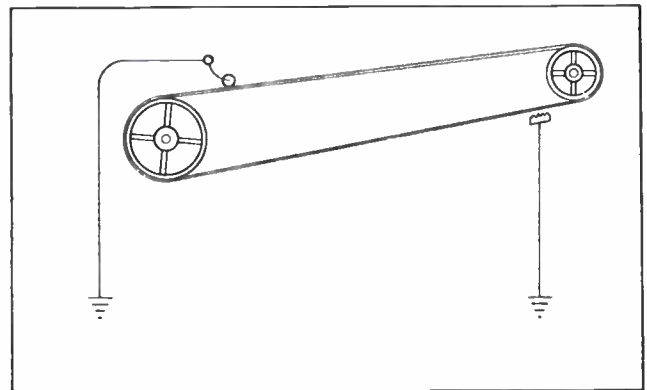

Fig. 5. Sketch showing how static can be removed from a belt by use of either a metal comb or roller, and ground wire.

A workman around such belts may get such a shock from the static, that it will cause him to fall off a ladder, or to jump against some running machinery and be injured. These dangers can be eliminated by placing a metal roller on the belt, or a metal comb with sharp points near the belt, and then connecting these combs or rollers to earth, or a grounded pipe or metal framework, to carry away the charges before they become so large. The combs should be located from  $\frac{1}{4}$  to  $\frac{1}{2}$  inch from the belt. The closer the better, as long as its teeth do not touch the belt. (See Figure 5 which shows both methods in use on a belt.)

Many serious fires and explosions of mysterious source in various plants, could have been prevented by a trained electrician with a knowledge of how static is formed and how to guard against it.

So you see, even in this first little section on static electricity alone, you are learning something which may be of great value to you on the job.

## 12. LIGHTNING

Lightning is probably the most sensational manifestation of static electricity that we know of.

Lightning is the discharge of enormous charges of static electricity accumulated on clouds. These charges are formed by the air currents striking the face of the clouds and causing condensation of the

vapor or moisture in them. Then these small particles of moisture are blown upward, carrying negative charges to the top of the cloud, and leaving the bottom positively charged. (See Figure 6.)

Or the reverse action may take place by heavy condensation causing large drops of rain to fall through part of a cloud. Thus one side of a cloud may be charged positively and the other side negatively, to enormous pressures of many millions of volts difference in potential.

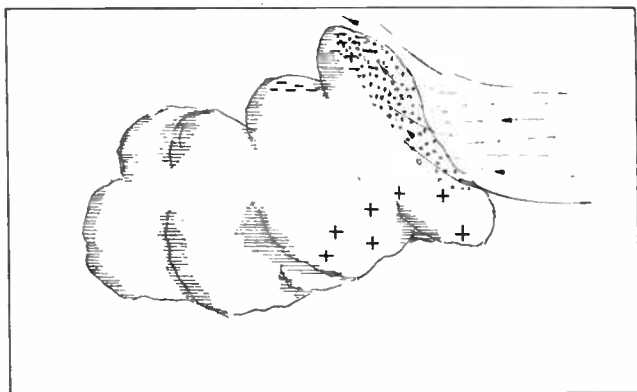

Fig. 6. Wind striking the face of a cloud, carries vapor and electrical charges to top of it.

When such a cloud comes near enough to earth, and its charge accumulates high enough, it will discharge to earth with explosive violence. (See Figure 7.)

The earth is assumed to be at zero potential. So any cloud that becomes strongly charged will discharge to earth if close enough. It is important to remember that whenever one body is charged to a higher potential or pressure than another, electricity tends to flow from the point of high potential to the low. The direction of this flow is usually assumed to be from positive to negative. It takes place very easily through wires when they are provided. But it is hard for it to flow through air, and requires very high pressure to force it to flash through air, in the case of sparks or lightning.



Fig. 7. Photo of a brilliant lightning flash at night.

Very often a side of one cloud will carry a negative charge, and the nearest side of another cloud a positive charge. When these charges become high enough a discharge will take place between the two clouds. (See Figure 8.)

### 13. FRANKLIN'S DISCOVERY

Benjamin Franklin with his kite and key experiment, about 1752, discovered that lightning was electricity, and would tend to follow the easiest path, or over any conducting material to earth.

He actually obtained sparks from a key on his kite line, to his fingers, and to ground. This led to the invention of the lightning rod, as a protection against lightning damage.

We say lightning "strikes" various objects such as trees, buildings, etc., because in its tendency to follow the easiest path to ground it makes use of such objects projecting upwards from the earth, as part of its discharge circuit or path.

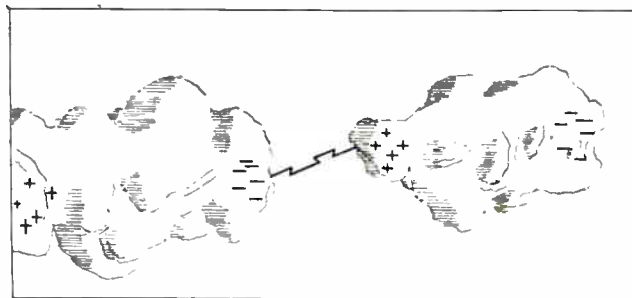

Fig. 8. Lightning flashing from one cloud to another, when clouds carry unlike charges.

Rain soaked trees, or trees with the natural sap in them are of lower electrical resistance than air and so are buildings of damp wood or masonry, or of metal. And the taller these objects are above the ground, the more likely they are to be struck by lightning.

When lightning does strike such objects, its intense heat vaporizes their moisture into steam, and causes other gases of combustion that produce explosive force. And this along with an electrostatic stress set up between the molecules of the material itself, causes the destructive action of lightning. This can be quite effectively prevented by use of properly installed lightning rods. (See Figure 10.)

### 14. LIGHTNING RODS

These rods are made of copper or material that is a good conductor of electricity. They should be installed on the tops, or very highest points of buildings or objects to be protected, and on all of the various corners or projections that are separated to any extent. These several rods are all connected together by a heavy copper cable, and then one or more ground cables of the same size, run from this to the ground by the most direct path. In running this ground cable, it should be as straight as possible, and if any turns or bends are made, they should be rounded or gradual bends.

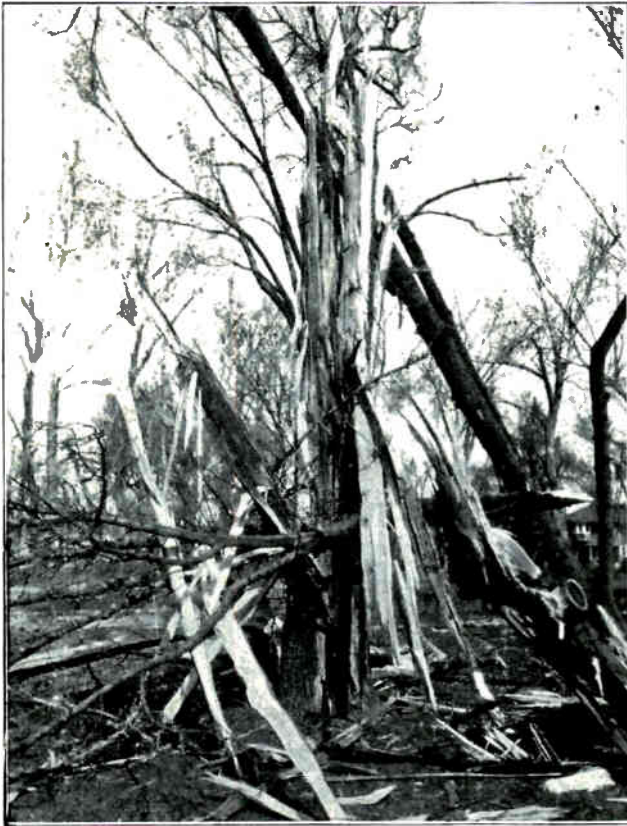

Fig. 9. Large tree shattered by lightning, showing the force and power of heavy lightning discharge.

The grounded end should be buried several feet in moist earth, or securely attached to a driven ground rod or pipe, or buried metal plate. The tips of lightning rods are usually sharply pointed, because it is easier for electricity to discharge to or from a pointed electrode, than a blunt one. These pointed rods, and heavy conductors of copper, form a much easier path to ground for electricity than the ordinary non-metal building does, and in some cases actually drain the atmosphere of small charges, before they become dangerously large. When a direct bolt of lightning does strike a rod, it usually flows through the cable to ground, doing a little or no damage to the building, because the heavy charge of electricity flows through the good metal conductor without causing the terrific heat that it does in passing through air, wood, and other higher resistance materials.

Such rod systems have been proven to be a great protection, both by data collected on rodded and unrodded buildings in different parts of the country, and by actual tests in laboratories where several million volts of artificial lightning have been produced and used on miniature buildings.

Tests also prove that rods of a given height, protect a certain cone shaped area around them as shown in Figure 11. The diameter of this area at the base, is about three to four times the rod height. Many of the large oil reservoirs in western states are protected from lightning fires by installing tall

masts around their edges, and sometimes with cables strung between the masts.

Electric power lines are often protected from lightning by running an extra wire above them on the peaks of the towers, and grounding it through each tower. (See Figure 12.)

More about protection of lines from lightning will be covered later under lightning arresters.

But in this section we have covered ordinary lightning protection, the general nature of static, and the methods of controlling it, in the places where it is most commonly found, in our homes and factories.

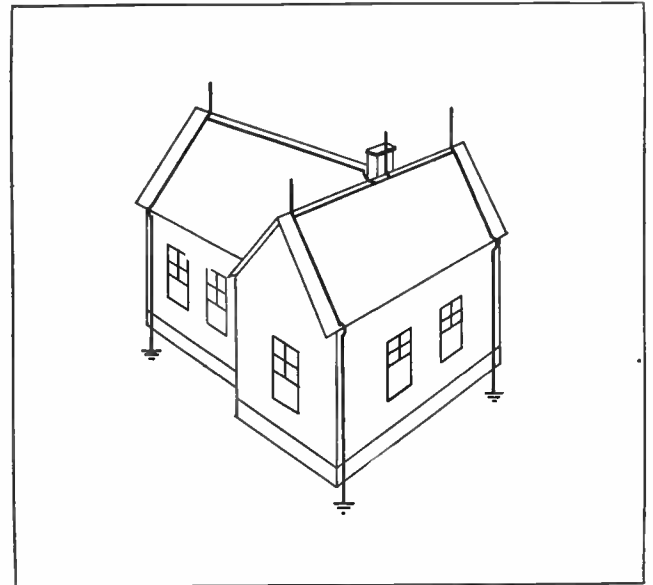

Fig. 10. Sketch of house equipped with lightning rods, to carry static and lightning safely to earth.

You will have many uses for the principles covered in this section, and they will help you to better understand certain things that will come up in your work in the field. Many of the hardest problems in "trouble shooting" on electrical systems, are easily solved by the trained man who knows these fundamental principles.

In the next section we will find out more about **Dynamic Electricity**, or the kind of "juice" that operates our motors, lights, etc.

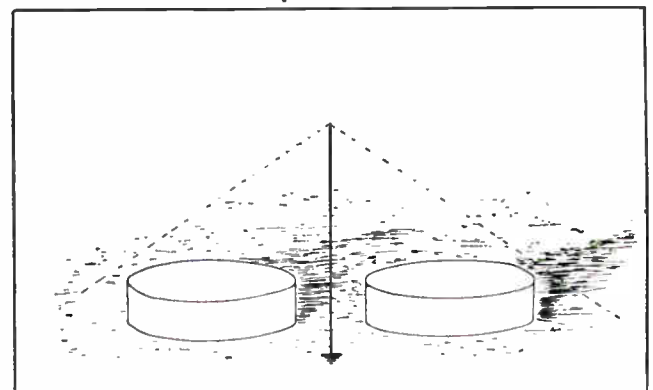

Fig. 11. Tall lightning rod used to protect oil tanks from lightning fires. The dotted lines show the area protected, and within which lightning will not strike.

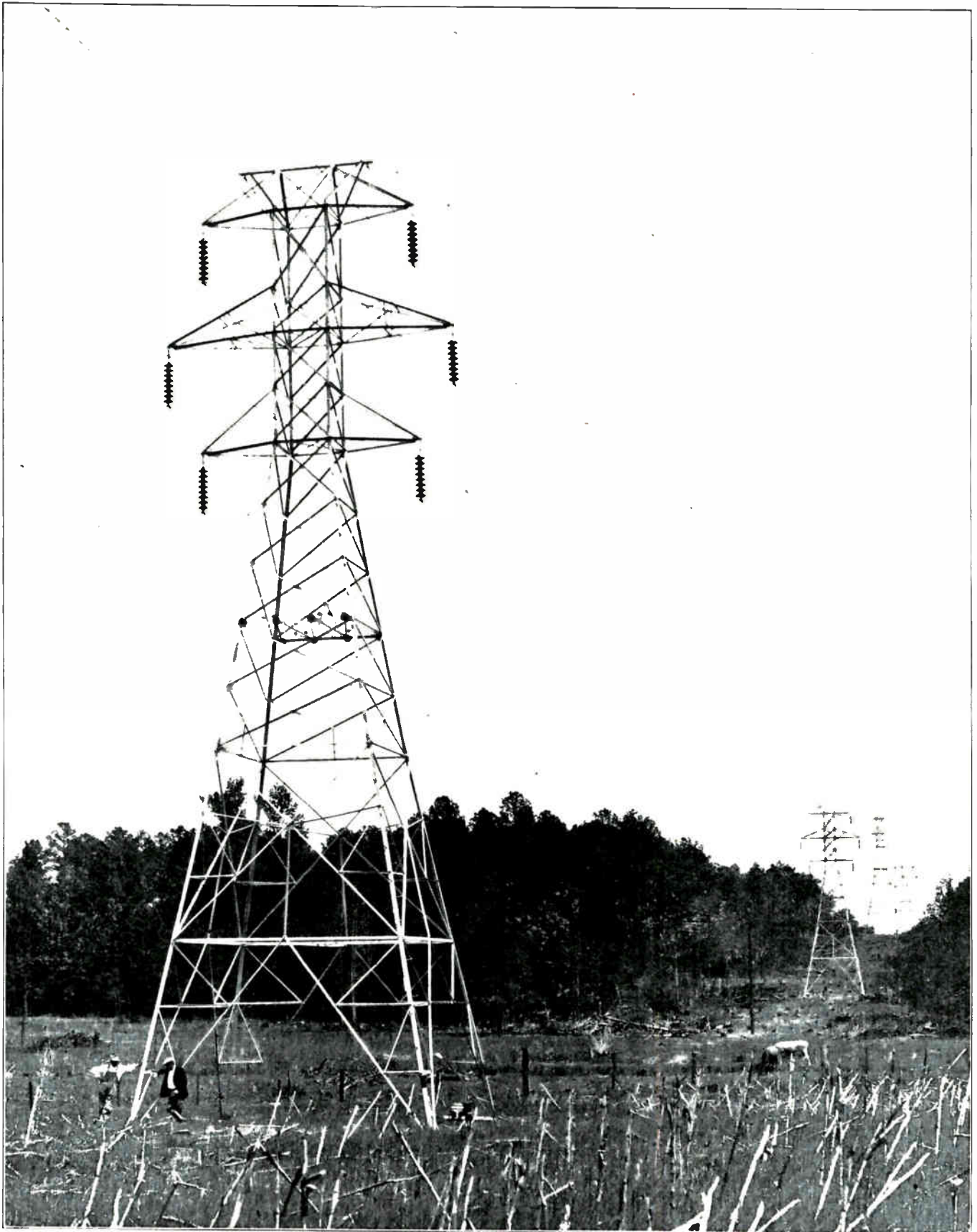

Fig. 12. High voltage transmission line. Note the two smaller wires on the very top of the tower. These are to protect the line from lightning, and are "grounded" through the tower.

*Photo, courtesy of Walter Bates Steel Corp.*

## DYNAMIC ELECTRICITY

As we have said before, Dynamic Electricity is electricity in motion, or the kind that flows through wires, lines, motors, lamps, etc. This is the kind, or rather the condition of electricity we find most useful, and from which we get our heat, light and power.

So it is very important that we have a good understanding of dynamic electricity, and how it is produced, controlled and used.

We found that static electricity could be produced by rubbing or friction of certain materials, and that it could be accumulated or stored up in condensers or on certain surfaces or bodies. Also that when it discharges it usually takes the form of an arc or spark. Although in some cases we caused these discharges to flow to earth through wires.

So for the very short period during which an accumulation of static is discharging or flowing, it could be said to be dynamic.

But sources of static do not supply enough electricity or furnish it for long enough periods to be of much use to us, so we do not produce dynamic electricity in this manner.

### 15. ELECTRIC CURRENT FLOW

Remember we do not **Create** electricity at all, but merely **set** it in motion. When we say a generator produces a flow of current in a wire, it is assumed that it simply sets in motion some of the free electrons already in the wire.

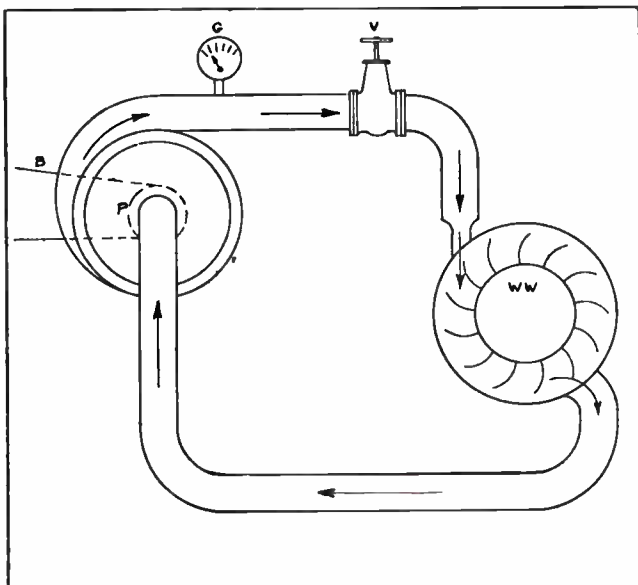

Fig. 1. Water pump supplying pressure to cause water to flow through pipe and operate water wheel. The purpose of the pump here is similar to that of a battery or generator in an electrical circuit.

It is well to consider dynamic electricity as very similar in many ways to water in a pipe line. For example, we can have water in a closed pipe line, and this water will have no movement, force or power, unless a pump is used to set up the pressure. (See Fig. 1.) In this illustration the pump (P) is the source of pressure to set the water in motion, and cause current to flow. The pump is driven by belt (B) and develops pressure to force the water through the pipe to the water wheel (WW). The gauge (G) indicates the amount of pressure developed by the pump, and the valve (V) will start, stop, and control the water flow.

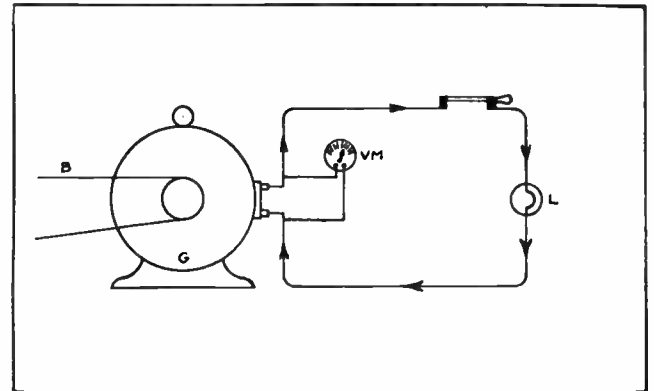

Fig. 2. Dynamo supplying electric pressure to force current to flow through the wires and lamp. No current will flow without a source of pressure or voltage.

In Fig. 2 an electric generator or dynamo (G) is shown producing electrical pressure to force current to flow through the wires to operate the lamp (L).

Here the volt meter (V.M.) indicates the amount of pressure set up by the generator, and the switch will start or stop, the flow of current.

### 16. PRODUCING DYNAMIC ELECTRICITY

One of our first problems is to find out how to develop electrical pressure to set electricity in motion.

There are three methods of doing this, which are all common, and should be kept in mind. They are called the **thermal method**, **chemical method**, and **induction or mechanical method**.

The induction method is the basis of all our modern generators, and converts mechanical power into electrical energy. This method is by far the most commonly used of the three, but as both of the others also have many practical uses, we will cover them briefly first.

17. THERMAL METHOD

To generate electricity by the Thermal Method, we simply join the ends of two pieces of unlike metal together and heat them at the joint. (See Fig. 3.)

The heat acts differently on the different metals, and the activity it sets up within them will actually cause a small current of electricity to flow through the wires and meter attached, as shown in the figure.

We can use a piece of copper and one of iron for this device, or better still a rod of bismuth, and one of antimony.

These devices are called **Thermo Couples**. As they are only capable of producing very small amounts of electric current, and at very low pressures, we do not use this method for generating electricity for light or power.

However as the amount of electric pressure produced by a certain thermocouple is proportional to the amount of heat applied, these devices are very useful for measuring temperatures of ovens, furnaces, etc.

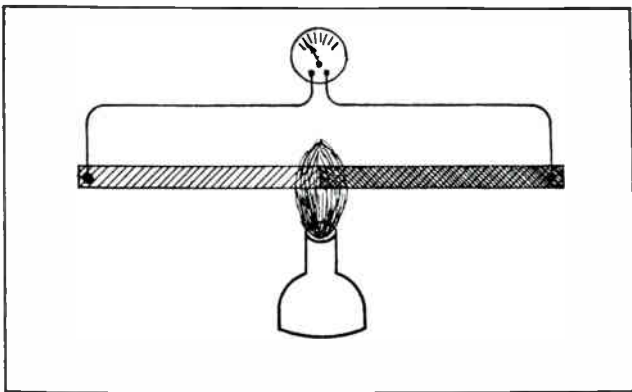

Fig. 3. Heating the joint of two unlike metals, produces a small amount of electric pressure and current flow through the meter in the circuit.

For this purpose a proper element or "couple" is enclosed in a non-combustible tube, so it can be inserted right into the flames or heat of a furnace.

Wires connected to the "couple" are brought out of the tube to a meter which can be adjusted and marked to read the temperature direct, in degrees. (See Fig. 4.)

18. CHEMICAL METHOD

The chemical method of producing electricity, is one with which you are probably more familiar, as this is the principle of our electric cells and batteries.

This source of electric supply is also very simple. It is based on the action of chemical solutions on various metals.

If we fill a jar with an acid solution, and immerse in it a piece of zinc and one of copper, the acid will immediately commence to act on these metals. And because the intensity and nature of its action is different on the two unlike metals, we again have a difference of electric pressure set up between the copper and zinc elements. If we connect them together with wires, and place a meter or lamp in this circuit, current will start to flow at once. (See Figure 5.)

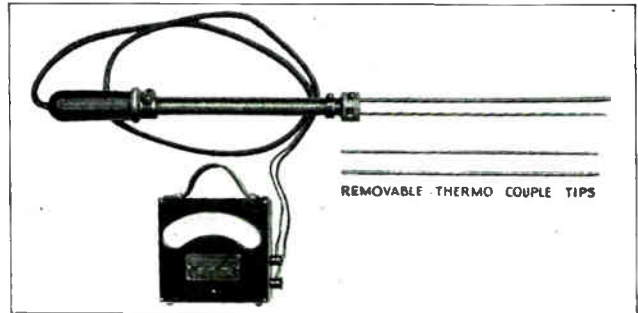

Fig. 4. Portable pyrometer for measuring high temperatures in ovens or furnaces, by use of "thermo couples."

Various kinds of metals and acids can be used. Even strong salt water will do with certain metals. But a solution of sulphuric acid, and the copper and zinc elements produce higher electric pressures than many other combinations, and are more commonly used.

Such devices are called **Primary Cells**, and a group of them connected together is called an **Electric Battery**.

It is interesting to know how the discovery of this form of electric source came about.

In the 17th Century, an Italian scientist named Galvani, discovered that frog legs would twitch and react to sparks of static electricity.

In 1779 Alessandro Volta in performing some experiments, accidentally discovered that pieces of metal with an acid soaked cloth between them would produce an electric spark.

He stacked up piles of metal disks, spaced with wet pieces of cloth, and developed our first known electric battery, from which he obtained quite strong currents and small arcs. And we find that many of our most important electrical devices of today, were discovered or developed from some such simple experiments.

Nowadays we have not only the wet primary cell, but also convenient dry cells, and large storage batteries, using this principle.

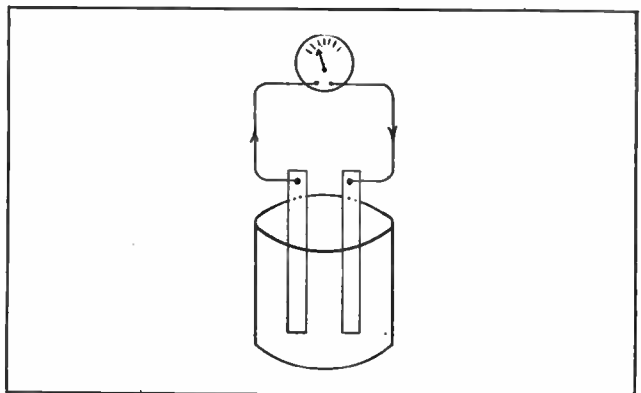

Fig. 5. Simple electric cell. Chemical action on the copper and zinc strips produces electric pressure.

These devices are used by the millions, to supply small amounts of electricity for various uses today.

Each type will be taken up thoroughly in a later section on cells and batteries.



## 19. MECHANICAL OR INDUCTION METHOD

The **Mechanical Method** of producing electricity is also very simple in principle, and it is this method that is used in all our great power plants today.

If we simply take a magnet as in Fig. 6, and quickly move a piece of wire between its poles, the wire will have an electric pressure induced in it.

Any magnet has between its poles a field of invisible lines of force. These are shown by the dotted lines in the Figure.

Only about one hundred years ago, a man named Michael Faraday, discovered that moving a wire rapidly through these lines of force in a position to cut across their path, would generate electricity in the wire.

This can be proven by connecting a meter to the ends of the moving wire, by means of other wires as shown in Figure 6.

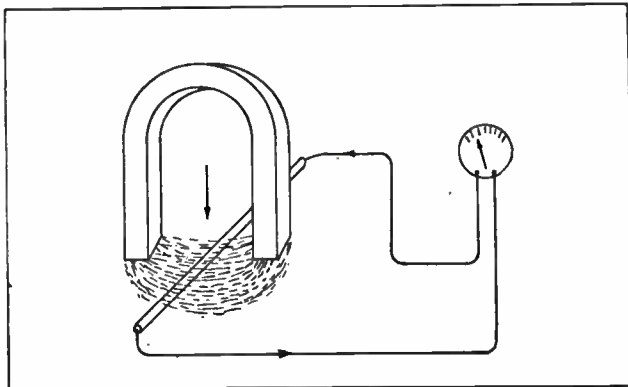

Fig. 6. Moving a wire through a magnet field induces pressure in the wire, and causes current to flow in the meter circuit.

Every time the wire (A) is moved up or down, through the magnetic field, the meter needle will indicate a flow of current.

The **direction** of this induced current changes, as we change the **direction** of movement of the wire. The **amount** of electric pressure set up by this type of device depends on the **strength** or **density** of the magnetic lines of force, and the **speed** with which the wire is moved through them.

Now if we were to mount a number of wires on a revolving armature, and spin them rapidly, between powerful magnets, we can produce consider-

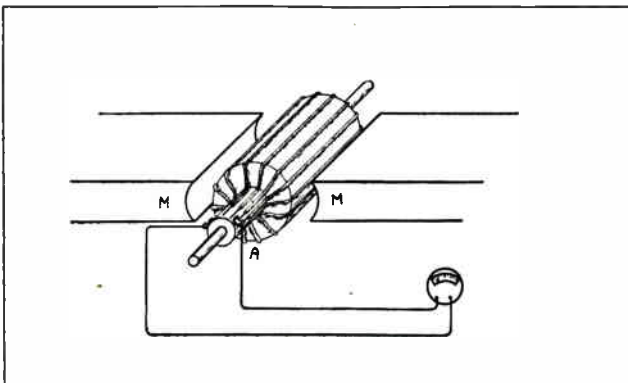

Fig. 7. Elementary type of armature A, with wires mounted on it to revolve in a strong magnetic field from magnets M, M.

able amounts of dynamic electricity by this method. (See Fig. 7.)

It is in just this manner that our great power plant generators of thousands of horse power are made.

We will take up in detail their principles of operation and construction in a later section.

## 20. CONDUCTORS

Now that we know how electricity can be produced, we must consider how to get it from the generators or source of supply to the places and devices where we wish to use it.

To do this we use proper electrical **Conductors** or wires.

We have found that electricity will pass or flow through some materials very easily while with others it is very difficult to get electricity through them at all. And we have good use for both.

In order to use electricity, we must be able to provide a good easy path for it to flow from the generators, to our lamps and motors which it is to operate. We must also be able to confine it to these proper paths, and prevent its wasteful or harmful leakage where materials or persons might come in contact with the wires.

The materials that carry electricity easily, we call **Conductors** and use the best of them to carry it where we want it to go.

## 21. INSULATORS

Those materials that tend to prevent the flow of electricity or not allow it to pass through them, we call **Insulators**, and use them to confine electricity to the proper conductors, and to prevent it leaking or flowing to other objects or places where we do not want it.

No material that we know of is a perfect conductor or insulator of electricity, but some are much better than others. Both are so necessary and important in the use and control of electricity that a few of the best of each are given in the following lists:—

### CONDUCTORS

Silver  
Copper  
Gold  
Aluminum  
Zinc  
Bronze  
Platinum  
Nickel  
Steel  
Iron  
Lead  
German Silver  
Mercury  
Water (ordinary)  
Carbon  
Acids

### INSULATORS

Glass  
Mica  
Porcelain  
Enamel  
Rubber  
Wood (dry or oiled)  
Bakelite  
Fibre  
Paper (dry or oiled)  
Oil  
Waxes  
Air

The conductors and insulators in this list are all used to some extent in electrical machines and devices.

Silver is one of the best conductors known, but because of its very high cost, and certain mechanical properties, it is not much used.

Copper is also an excellent conductor, and is by far the most commonly used in all electric lines and machines.

You will note that most of the conductors are metals, although ordinary water with its usual impurities is a fair conductor, and acids are also.

All the insulators are non-metallic. Glass and Mica are two of the best insulators, and rubber is also excellent. Rubber is most commonly used in insulating electric wires, because of its flexibility, allowing them to bend freely without damaging the insulation.

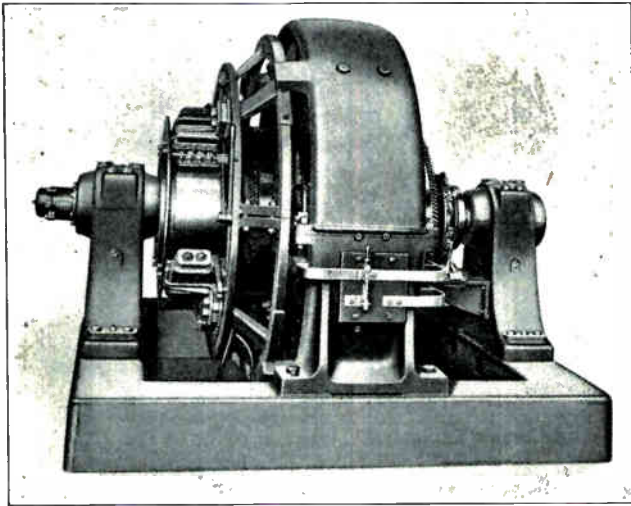

Fig. 8. Photo of a large generator, which produces its voltage by induction.

## 22. INSULATED WIRES

A good example of a conductor and insulator properly used together is the common rubber covered copper wire. The copper providing an excellent path for the electric current to flow through, and the rubber an excellent insulator to confine it to the wire, and prevent its escape where the wire might otherwise touch metal objects or earth. (See Fig. 9.)

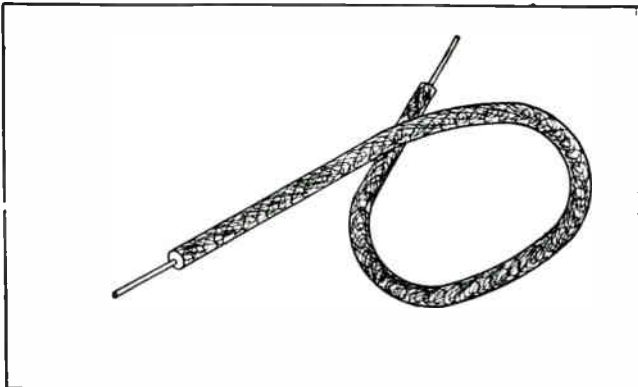

Fig. 9. Sketch of insulated wire. The copper wire is covered with rubber, and cotton braid.

## 23. ELECTRIC CIRCUITS

In order to use electricity with any device, we must always provide a complete Circuit or path, for the current to flow from the generator or source, to the device using it, and then back again to the generator. (See Fig. 10.)

This endless path or circuit includes the coils or windings inside the generator, the line wires from the generator to the lamp, motor or other device, and any switches or instruments that may be in the circuit anywhere.

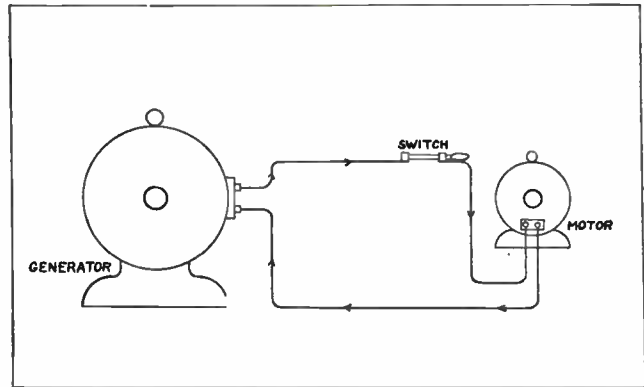

Fig. 10. Complete electric circuit. The current flows over the top wire from the generator to the motor, then back along the lower wire to the generator.

Current will only flow when all parts of this circuit are complete, all switches closed, and all wires connected. To start or stop the flow of electricity and the operation of the devices, we only need to close or open the switches provided the generator is running.

All line wires and switches as well as the coils within the machines are made of conducting material, usually copper.

All these wires, coils, etc. must be insulated, usually with rubber, cotton or oil, and sometimes with air only, on certain parts.

So we can readily see the importance of a knowledge of common conductors, insulators and circuits, in the use and handling of electricity.

In later sections we will take up more of the exact properties of various conductors and insulators, and various types of circuits.

## 24. EFFECTS OF DYNAMIC ELECTRICITY

How are we going to make use of this electricity which we have learned how to produce and convey from the generators to our electrical devices?

First we must know something about the useful effects of electricity and how to obtain them.

Dynamic electricity flowing through a circuit from any generator or source, can produce four valuable effects, if we know how to obtain them.

These are called the magnetic, heating, chemical and physiological effects.

## 25. MAGNETIC EFFECT

Whenever electricity flows through any wire or conductor, it sets up around that conductor a field of whirling magnetic lines of force. These lines are invisible and we cannot feel them. But we can prove

they exist by placing a magnetic compass needle near the wire. (See Fig. 11.)

As soon as current is started in the wire, the needle will be deflected from its true North and South position.

The direction and amount of movement of the needle will depend on the direction and the amount of current flowing.

For example, if we reverse the direction of current in the wire, the compass will deflect in the opposite direction. If the current is increased or decreased in the wire, the needle will increase or decrease its amount of deflection accordingly.

This magnetic effect of dynamic electricity is of the greatest importance, as it is the one that we use in all generators, motors, and electro-magnets.

If we wind a coil of insulated wire around a core of soft iron and pass an electric current through the coil, the iron will become strongly magnetized at once, from the magnetic lines set up around the turns of wire.

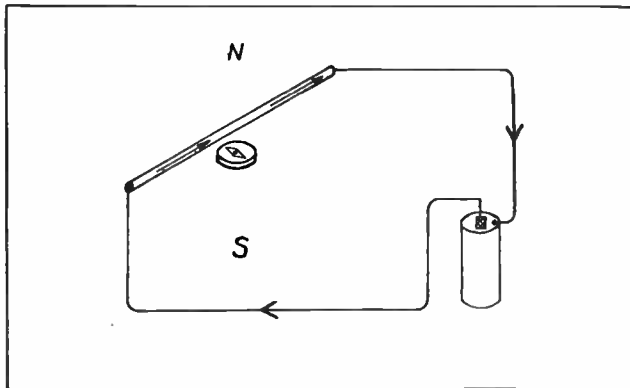

Fig. 11. Showing a compass needle deflected from its north and south position, by the magnetic flux around a wire carrying current.

These electro magnets have thousands of uses in electric lifting magnets, relays, bells, controllers, motors, generators, etc. We will make a very thorough study of them and this magnetic effect of electricity a little later.

A good demonstration that you can easily make of this useful effect of electricity, is to wind a few turns of insulated wire around a nail, bolt, or screwdriver, and connect the coil ends to a dry cell.

As soon as the circuit is closed the iron will become magnetized and attract other nails, tacks, etc. But as soon as the wire is disconnected from the cell, the iron loses most of its magnetism.

The practical man can often find many handy uses for this knowledge in his daily work.

## 26. HEATING EFFECT

Electric current flowing through a wire always produces a certain amount of heat in that wire.

In copper wires of low resistance this heat may not be noticeable, but if we overload them or cause too much current to flow, even copper wires will become hot and burn their insulation or possibly melt.

When we want to create heat from electricity, we apply high enough pressure to cause current to flow through high resistance wires or coils, such as iron

or German silver wire. And because of their high resistance, a moderate amount of current will cause them to become red hot, or even white hot in some cases.

Our electric toasters, flat irons, waffle irons, table grills, portable heaters, electric ranges, ironers, soldering irons, etc. are all examples of this method of producing electric heat.

Large baking and enameling ovens, heat treating furnaces, etc., in industrial plants, use this principle.

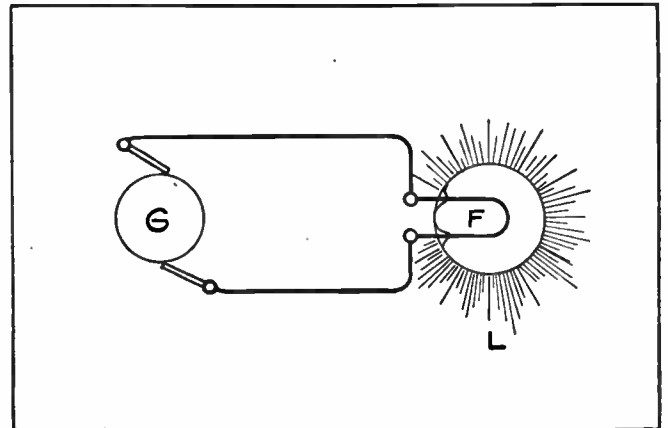

Fig. 12. Electric current flowing through filament wire in the lamp, produces intense heat and light.

## 27. ELECTRIC LIGHT

The incandescent lamp operates on the same principle.

Here we have a wire of tungsten metal, which is high resistance, and will not melt at white heat. This filament wire is enclosed in a glass bulb from which the air has been drawn to prevent it burning. Then current is forced through it in the right amount to bring it to white hot or incandescent heat, so it radiates light. (See Fig. 12.)

An electric arc produces heat and light on about the same principle. In this case instead of using a high resistance wire, we use voltage high enough to force current through air and the gases formed by

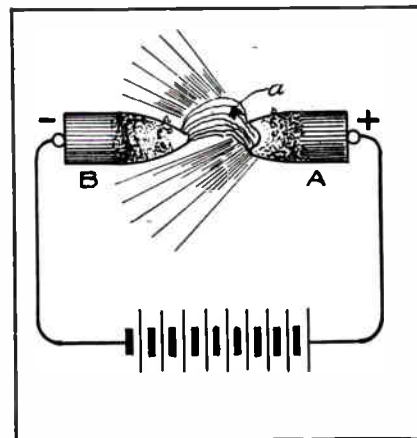

Fig. 13. Electric Arc formed by current between carbon electrodes.

the arc. This mixture of air and gas is very high resistance, and the current flowing in the form of an arc produces the highest temperatures made by man. (See Fig. 13.)

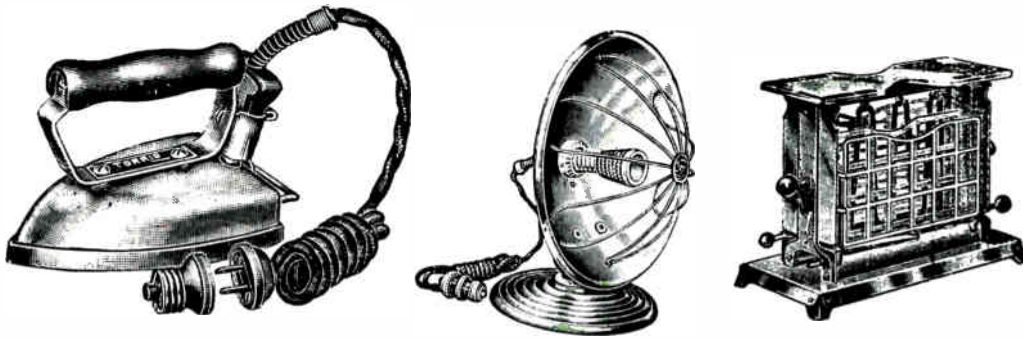

Fig. 14. Ordinary electric flat iron, glow heater, and toaster, all devices using the heating effect of electricity.

Great furnaces of this type using carbon electrodes from 12 inches to 30 inches in diameter, and 6 to 12 feet long, and thousands of amperes of electric current, melt tons of steel in our steel mills.

The arc was one of the first forms of electric light. And many large arc lamps are in use today, for street lights, flood lights, search lights, etc.

So we see that the heating effect of electricity is also very important to know how to use.

Fig. 14 shows several devices which use electric heat, produced by current flowing through high resistance wires.

## 28. CHEMICAL EFFECT

When electricity is passed through various chemical solutions it has the power to decompose them. And if we immerse two pieces of metal in an acid solution, and allow current to flow from one to the other through the solution, it will carry away particles of the metal at which it enters the liquid and

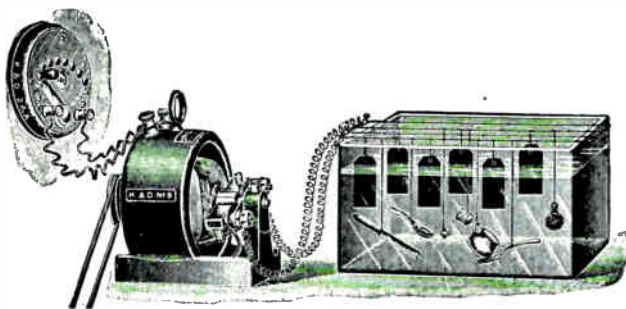

Fig. 15. Small electro-plating outfit, consisting of generator, rheostat and plating vat.

deposit them on the other metal. This is the method and effect used in electro-plating, and is used very extensively in covering cheaper metal objects with gold, silver, chromium, nickel, etc. (See Fig. 15.)

This action is also called **Electrolytic action**, and is used in the refining and purifying of some of our metals.

Another example of the chemical effect of electricity is in the charging and discharging of our storage batteries.

## 29. PHYSIOLOGICAL EFFECT

This effect of electricity is less commonly used than those above mentioned, and it usually refers to the effect of electricity on the human body.

We all know that if we touch live electric wires we feel a shock, or the effect of electricity on our nerves and muscles. If the voltage is low, this may be only a mild and somewhat pleasant sensation. If the voltage is high and from a heavy power wire, the shock may be injurious or even fatal. So it is best to always be very careful in handling electric wires and equipment.

Doctors and hospitals use the shocking effects of electricity, properly controlled, for very beneficial treatments of certain body disorders and diseases.

They also use the heating effect and chemical effect of electricity, by applying metal plates or electrodes to various parts of the body, and passing carefully controlled currents of either direct or alternating current, through affected parts of the body.

So this physiological effect of electricity is also very important in its modern and proper use.

## ELECTRIC UNITS AND SYMBOLS

In dealing with electricity, we must have definite units to measure it and express it in certain quantities.

We have units of measurement for water, steam, coal, money, groceries, etc. and we need them for electricity, as it is as common and necessary today as many of these other items.

We speak of water in pints, quarts, or gallons, all of which are units of different sizes, and which we easily understand because we are familiar with the size and amount of each.

We speak of steam in pounds pressure, and degrees of heat. Coal is measured by the pound, or the larger unit called the ton, money in dollars and cents, groceries by the pound or dozen, etc.

So we can see that we need to have these definite units of measurement to deal with all the things we use in our daily life. And the man who intends to use electricity, should know the units for its measurement, those which measure its effects, and the important factors in electrical circuits.

There are only a few of the more common units needed by the practical man in ordinary work, and they are easy and simple to use.

With these units you can determine the amount of current flowing in a line, or through a motor or lamp. Also the amount required to operate a given machine or device, and its cost of operation as well.

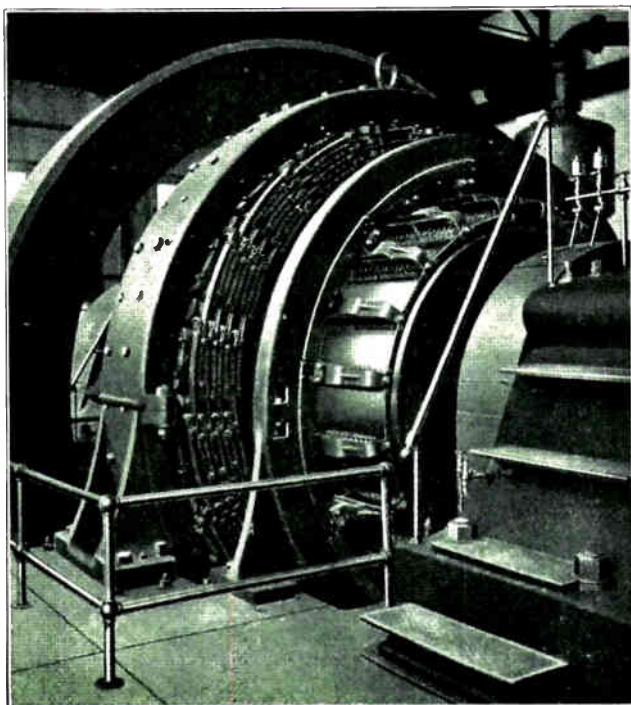

Fig. 1. Large D. C. generator. It is rated as follows, 2000 Kw., 750 V., 8000 I. After carefully reading the pages on units and symbols, you should easily understand this rating.

It is not necessary to memorize all these units at once, but you should study them carefully, to get a good understanding of the meaning and use of each. Then by practicing their use you will soon have them fixed in your memory.

Of course we know that we cannot weigh or measure electricity as we do coal or water. So we measure its effects, and establish our units in this manner.

### 30. ELECTRIC QUANTITY

The Coulomb is the practical small unit of electrical quantity. We determine this quantity by the chemical effect of electricity flowing through a device called a "voltmeter." (See Fig. 2.)

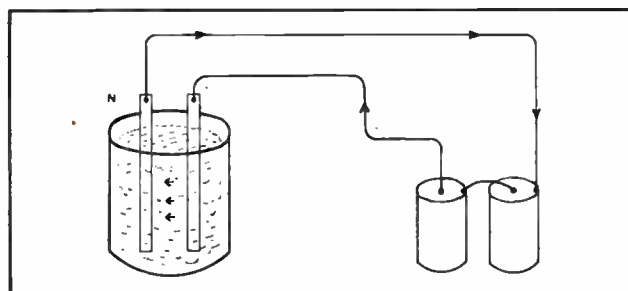

Fig. 2. Sketch of a "voltmeter," or device for measuring electric quantity by work done on a plating principle.

Here we have two pieces of copper immersed in a solution of copper sulphate, and a battery connected to them and passing current through the solution from one electrode to the other. As you have already learned, this will cause some copper to leave the positive plate and deposit on the negative plate.

Of course the more electricity we pass through this device, the more copper it will deposit, or the more work it will do. So by carefully weighing the amount of copper transferred, we can set a certain unit of electric quantity. This unit of one Coulomb is the amount required to deposit .0003293 gram of copper from one plate to the other. Or with silver, to deposit .001118 gram, from a standard solution of silver nitrate.

These are very small amounts and are odd figures, and need not be remembered. But it serves to illustrate the method of measuring electrical quantity by its effect or work done.

### 31. ELECTRIC CURRENT

The Ampere is our unit of electric current or rate of flow. It is a unit you will use much more often than the Coulomb.

An electric current of one ampere is flowing when electricity passes through a circuit at the rate of one Coulomb per second. So we see this unit considers both quantity and time, and tells us just how fast the current flows. Knowing the amount of current in amperes gives us some idea how much work we could expect it to do in a given time.

For example we say a gallon of water is a unit of quantity, and compares to a Coulomb of electricity. But if we say water is flowing at the rate of so many gallons per minute or per second, then we can get an idea how much work it would do, or how much we would get in an hour or a day at that rate.

We say a certain lamp uses  $\frac{1}{2}$  ampere, or that a motor uses 50 amperes, which means that they require a continual rate of flow of those amounts of current to operate them.

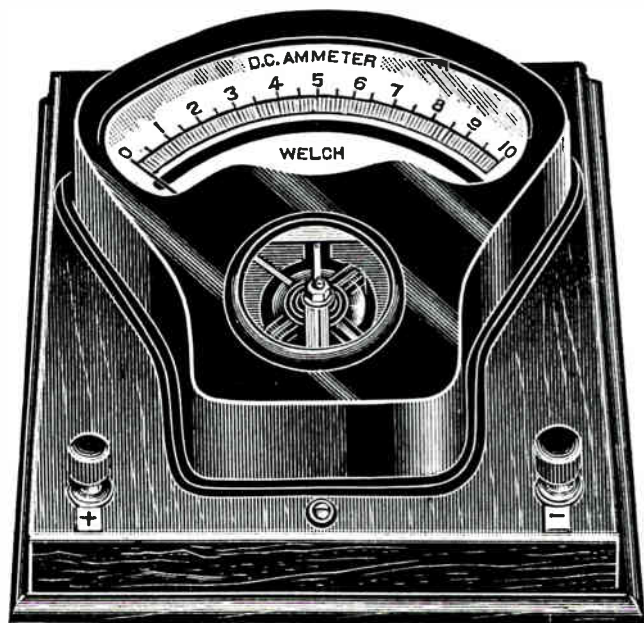

Fig. 3. Portable ammeter, used to measure electric currents.

The current of any circuit or device can be measured with an ammeter such as shown in Fig. 3. The practical man will have many occasions to use this device and the unit Ampere in his electrical work.

### 32. ELECTRIC PRESSURE

The volt is our unit of electric pressure, and is used to measure or express the amount of pressure required to force a given current to flow.

As we have already learned, all electric wires or conductors offer some resistance to the flow of current. So we must have electric pressure to cause current to flow in any circuit or device.

This pressure is often called **Electro-Motive-Force** (Abbreviated E. M. F.), and meaning the force that moves electricity. It is also sometimes called **Potential**.

So we say a certain battery produces 6 volts pressure, or a generator produces 110 or 440 volts pressure. Or that a power line has 220,000 volts potential or pressure. This gives us an idea of the amount of electro-motive-force available, the same as if we said a boiler produces 300 pounds of steam pressure, or a pump 100 pounds of water pressure.

One volt is the exact amount of pressure required to force one ampere of current through one Ohm of resistance. The voltage of any machine or circuit can be measured with a voltmeter. See Fig. 4, which shows a photo cut of a voltmeter.

### 33. ELECTRICAL RESISTANCE

The Ohm is the standard unit of electrical resistance, by which we measure or compare the resistance of any electrical circuit or device.

Remember every wire and device has some resistance to current flow, as we have no perfect conductors. Naturally this resistance limits or controls the flow of current, the same as friction in a pipe or a partly closed valve, would limit and control water or steam flow.

So it is very important that we know the unit to measure and determine the resistance of electrical circuits and machines.

The standard Ohm, is the resistance of a column of mercury, 106.3 centimeters long and 1 square Millimeter in cross sectional area. Or this is 41.85 inches long and about 1/25th inch in diameter. This standard resistance is taken always at 32 degrees Fahrenheit, or Zero degrees centigrade, because the resistance is not the same at all temperatures.

### 34. FACTORS GOVERNING RESISTANCE

It is important to remember that the resistance of any conductor depends on the kind of material, its length, area, and temperature.

For example we know that copper wires are of much lower resistance than iron or steel wires. And the longer a wire is, the greater will be its resistance. The larger it is in cross section or area the lower will be its resistance. And with all of our common metals the resistance will increase slightly as their temperature increases. Carbon and certain liquids are exceptions to this rule, and their resistance gets less as their temperature increases.

It is interesting and convenient to know that a piece of No. 10 copper wire 1000 feet long has a resistance of about one ohm. A No. 10 wire is about 1/10th of an inch in diameter.

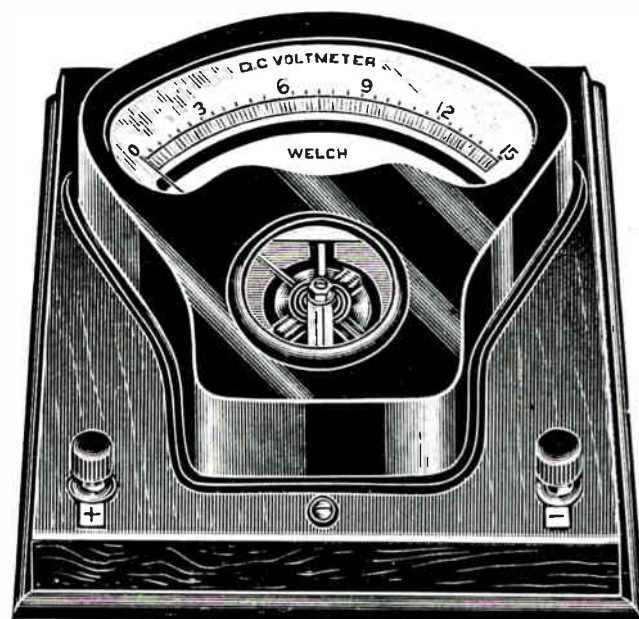

Fig. 4. Portable voltmeter used to measure electric pressures or voltages.

Number 14 wire such as commonly used in house wiring, has about 2.5 ohms resistance per thousand feet.

A piece of No. 30 copper wire 10 feet long has about one ohm resistance, while a piece of No. 30 German Silver wire only 6.2 inches long will have about one ohm resistance. Note carefully the difference in resistance of these various wires according to their size, length and material, and it will help you get a better understanding of how the wires and their resistance will tend to control the current flow.

A little later we will give a definite law or rule explaining this relation between current and resistance.

The resistance of wires and materials can be measured with an ohmmeter, and other instruments which will be explained later.

**35. SPECIFIC RESISTANCE** is a term we use to express and compare the resistance of various materials. To do this we of course take pieces of the same size of each material. Usually this piece is one cubic centimeter in size, or sometimes one cubic inch. The centimeter is about .4 of an inch.

The specific resistance of any metal or material means the resistance to flow of electricity through a centimeter cube of this material, from one side to the opposite side.

The resistance of a piece of ordinary metal of this size is usually a small fraction of one ohm, so is expressed in Microhms, meaning millionths of an ohm. One million microhms equal one ohm.

The following table gives the specific resistance of some of our common materials. It is not necessary to memorize these, but is well to observe and compare the specific resistance of several of the mate-

rials familiar to you, such as copper, aluminum, iron, mercury, etc.

In this manner you can get an idea of their comparative values as electrical conductors, and you can always refer back to this table whenever you need to know or use any of these values.

Specific resistance of various common materials, at 0 degrees centigrade:

MATERIALS	Specific resistance in Microhms.	
	Centimeter cube	Inch cube
Silver (Annealed) .....	1.49	.587
Copper (Annealed) .....	1.59	.627
Copper (Hard) .....	1.62	.638
Gold .....	2.20	
Aluminum .....	2.61	
Zinc .....	5.38	
Phosphor Bronze (Commercial) .....	8.48	3.34
Bronze .....	17.80	
Platinum (Annealed) .....	8.98	3.54
Nickel (Commercial) .....	9.90	
Steel (Soft) .....	11.80	
Steel (Wire) .....	13.50	
Steel (Hard) .....	45.60	
Iron (Pure) .....	8.85	
Iron (Wrought) .....	13.80	5.45
Iron (Cast-soft) .....	74.40	
Lead .....	19.80	
German Silver .....	33.10	
German Silver Wire.....	20.90	8.24
Mercury .....	94.07	
Water (Ordinary) .....	1200. to 12,000.	
Carbon .....	400. to 1150.00	
Carbon (Arc) .....	5100. to 7600.00	

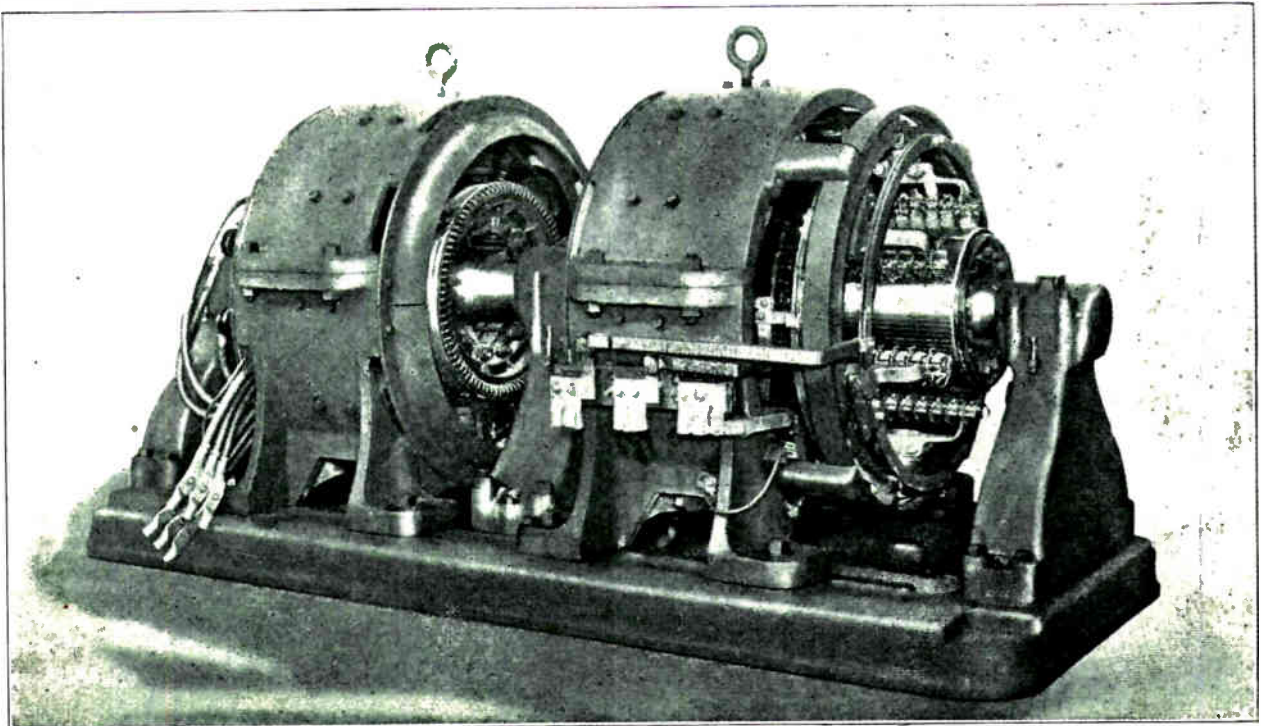

Fig. 5. If this machine is rated at 500 Kw., how many horse power is this equal to?

36. THE MHO is the unit of conductance, and expresses the conductivity of a wire, or the exact opposite of resistance. Its use will be explained later.

37. ELECTRIC POWER UNITS

The Watt is our unit of electric power. And this is the unit by which we determine the amount of heat, light, or power we can get from electricity. It is also the unit by which we rate the power produced or consumed by many small electrical devices.

One Watt is the amount of power produced by one ampere flowing under a pressure of one volt.

It requires 746 watts to make one horse power. So we can see that the watt is too small a unit to deal with our larger amounts of electric power. For this use we have the Kilowatt, or 1000 watts. The prefix "Kilo," is used with many electric units at times, and always means 1000.

One Kilowatt is equal to approximately 1.34 H. P.

One horse power is the power required to lift 33,000 pounds, one foot in one minute, or 550 pounds, 1 foot in one second. It is often referred to as 33,000 foot pounds per minute.

The Watt Hour is a commonly used unit, and means the power used at the rate of one watt, for one hour continuously.

The Kilowatt Hour is the larger and more common unit, and means the power used at the rate of one kilowatt, for one hour. The kilowatt hour is the unit used to buy and sell electric power, and electricity is commonly sold for a few cents per kilowatt hour.

For example, suppose you were asked to find the cost of operation of a 10 H. P. motor for 50 hours, with electricity costing 3 cents per kilowatt hour.

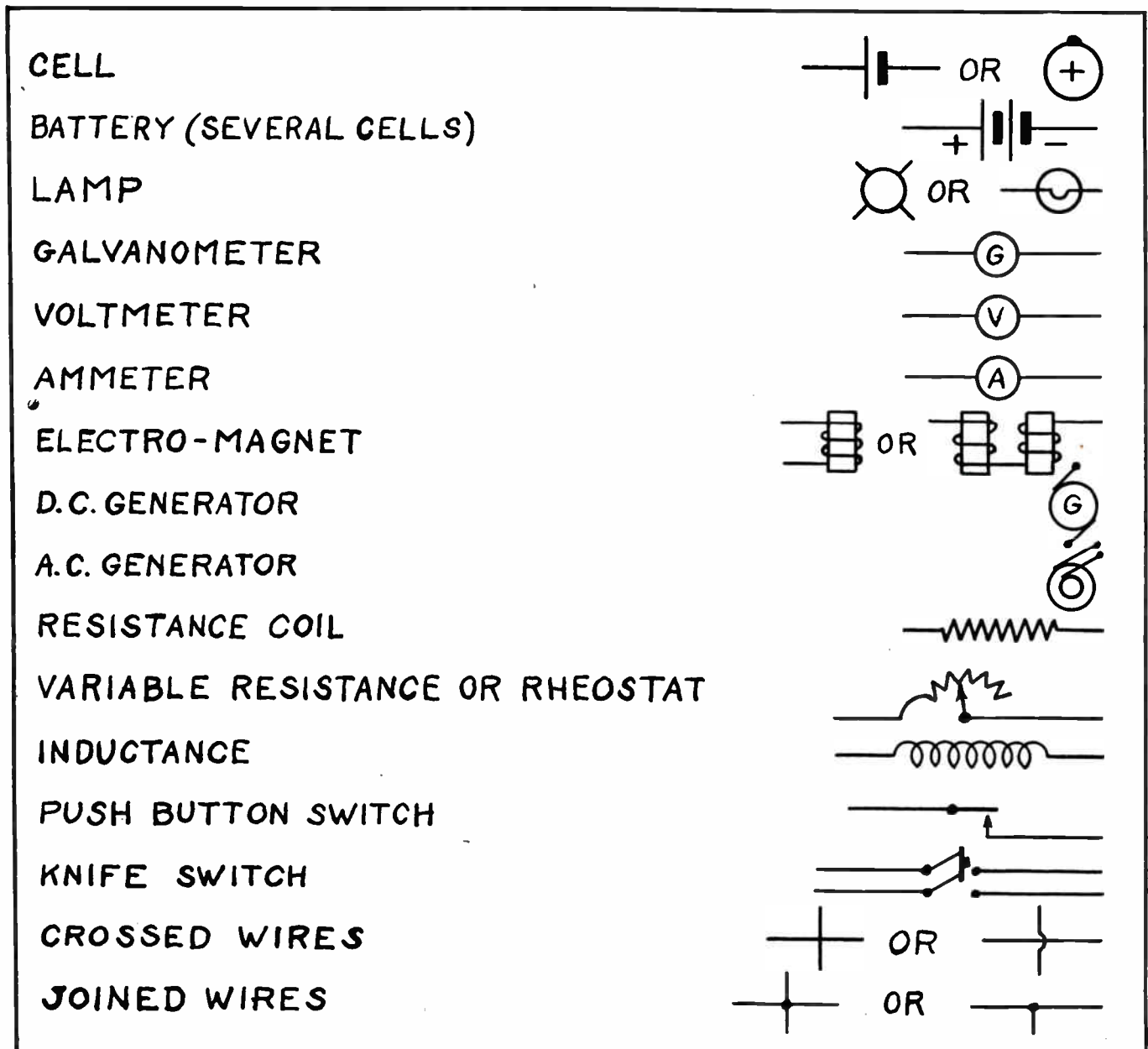

Fig. 5B. Some of the most common symbols used in electrical diagrams.



If one H. P. is equal to 746 watts, then a 10 H. P. motor will use  $10 \times 746$  or 7460 watts. Then to change this to kilowatts, we divide 7460 by 1000, or 7460 divided by 1000 equals 7.46 kilowatts.

For a period of 50 hours this would use a total of  $50 \times 7.46$  or 373 kilowatt hours.

Then  $373 \times .03$  equals \$11.19 total cost.

We have not considered the efficiency of the motor in this problem as this will be taken up later.

### 38. SYMBOLS

For each of these units, we have just learned, we have a symbol or abbreviation which we use in writing them in problems or specifications on the job. These symbols are very easily learned and remembered with a little practice in using them, and will save a great amount of time for the practical electrician, the same as our abbreviations for other commonly used terms, such as lb., oz., ft., in., qt., Jan., Feb., Mar., etc.

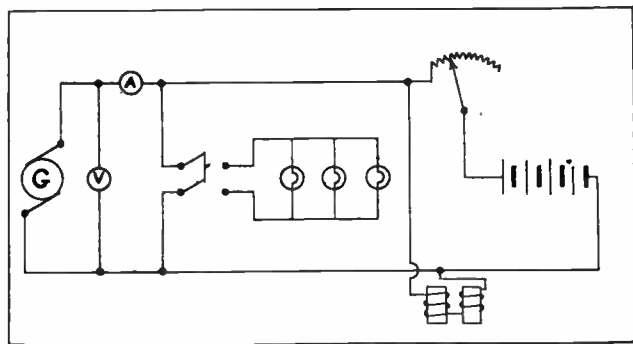

Fig. 6. This diagram shows the use of some of the symbols given in Fig 5B. How many can you recognize?

To make it more convenient to remember the names of these important electrical units and their symbols and also easy to refer to them for reminders, we have arranged them all together in the following group.

Read them over several times to help fix them in your memory ;

Symbols	Units	Use
Q	Coulomb	Unit of electrical quantity.
I	Ampere	Unit of current flow.
E	Volt	Unit of electrical pressure.
R	Ohm	Unit of electrical resistance.
G	Mho	Unit of electrical conductance.
W	Watt	Unit of electrical power.
KW	Kilowatt	Larger unit of electrical power.
Kw.Hr.	Kilowatt-Hour	Unit of electrical power for a given time or unit of electrical work.
H. P.	Horsepower	Unit of mechanical power.
		746 W. equals 1 H. P.
		1 KW. equals 1.34 H. P.

A few other common symbols used to represent electrical devices in circuit diagrams, are shown in Figure 5-B, so you will be able to recognize and understand them in the sketches used from now on.

The units and symbols covered in this section may seem somewhat dry at first, and are probably less interesting than the work on machinery will be. Remember, however, you will understand the machines much better if you know these few practical units and symbols well.

## OHMS LAW

Ohms Law is one of the most important laws of electricity that the practical man can know, and yet it is very simple. This law is named after a German scientist, George Ohm, who in his experiments discovered the definite relation between pressure, current, and resistance in electrical circuits, and put it in the form of a simple statement or rule.

When you obtain a thorough understanding of Ohms Law, it will be much easier to understand the operation of all electrical machines, and circuits.

You have already learned that in order to use electricity in any way we must have circuits, to carry it from the generators to the machines or devices, and also through the devices themselves.

In every live electrical circuit there are always present the above mentioned three factors, pressure, current and resistance. All circuits have some re-

sistance, and therefore, to cause current to flow through them we must have pressure or electro-motive-force.

### 38-A. EXPLANATION AND APPLICATION OF OHMS LAW

According to Ohms Law the current in any D. C. circuit is always directly proportional to the pressure, and inversely proportional to the resistance.

The first part of this rule means that if we increase or decrease the voltage or pressure applied, the current will increase or decrease the same amount, if the resistance remains constant.

For example if 100 volts will force 10 amperes through the resistance of a certain circuit, 200 volts would send 20 amperes through it, or 50 volts, 5 amperes, etc.

The second part of the law means that if we increase the resistance of a circuit, the current decreases, or if we decrease the resistance the current will increase, if the voltage remains constant. Thus the term "inversely proportional."

For example, if we have a current of 10 amperes flowing through a circuit of 30 ohms resistance, and change the resistance to 60 ohms, then 5 amperes will flow. Or if we change the resistance to 15 ohms, 20 amperes will flow.

### 39. CONTROL OF ELECTRICITY

The above shows us how to obtain any desired current for a certain device or work, by regulating the voltage of our generators, or the resistance of the windings of the device.

On this law or principle are based the majority of ordinary electrical calculations made by the practical man, so it is well worth a little reviewing to get it thoroughly understood.

If we compare Ohms Law for electricity with the principles of water flow in pipes, and use just common reasoning with it, as we do with other things we are more familiar with, it should be easily understood. (See Fig. 1.)

Here we have a pump driven by an engine, and producing pressure which causes the water to flow. The friction of the water moving through the pipe, and the smaller section of pipe (A), and partly closed valve (B), all offer resistance or opposition to the flow of water. And the more we increase this resistance by reducing the size of the pipe or valve opening, the less water will flow. But if we increase the pressure supplied by the pump, then more water will flow.

Electrical circuits operate similarly. (See Fig. 2.)

Here we have a generator driven by an engine, and producing electrical pressure or voltage which causes the current to flow. The resistance of the wires, the rheostat and lamp, all tend to oppose the flow of current, and if we use smaller wires or a higher resistance lamp the current will decrease.

But if we speed up the generator and increase its voltage the current would increase.

The voltmeter (V) and ammeter (A), in the electrical circuit measure and show the pressure and the current in volts and amperes, just as the pressure gauge and flow meter in the water circuit measure the pressure in pounds, and the flow in gallons per minute.

### 40. CONVENIENT SIZE OF ELECTRIC UNITS

Another very interesting fact is that one volt pressure is just exactly enough to cause one ampere of current to flow through one ohm of resistance.

This of course is not accidental, but is the way those who developed these standard units made them of convenient relative sizes. This greatly simplifies all electrical work and calculations.

For example if one volt will force one ampere through one ohm, then it is easy to see that two volts would force two amperes through the same resistance of one ohm. Or  $\frac{1}{2}$  volt would only force  $\frac{1}{2}$  ampere to flow through one ohm.

If one volt will force one ampere through one ohm, then if we increase the resistance to two ohms a volt could only force  $\frac{1}{2}$  ampere to flow. If we reduce

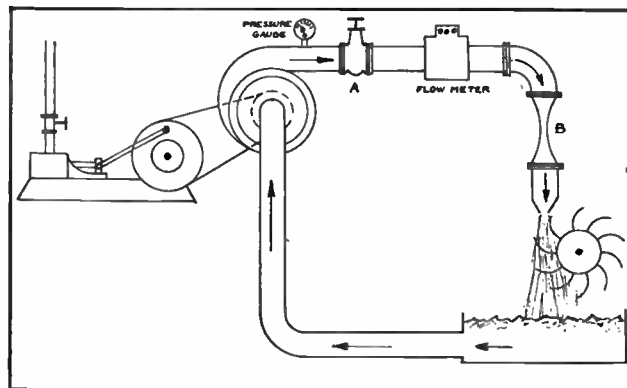

Fig. 1. The amount of water flow in this system can be increased by increasing the pump pressure. But it will decrease if we increase the opposition of the valve, or small section of pipe.

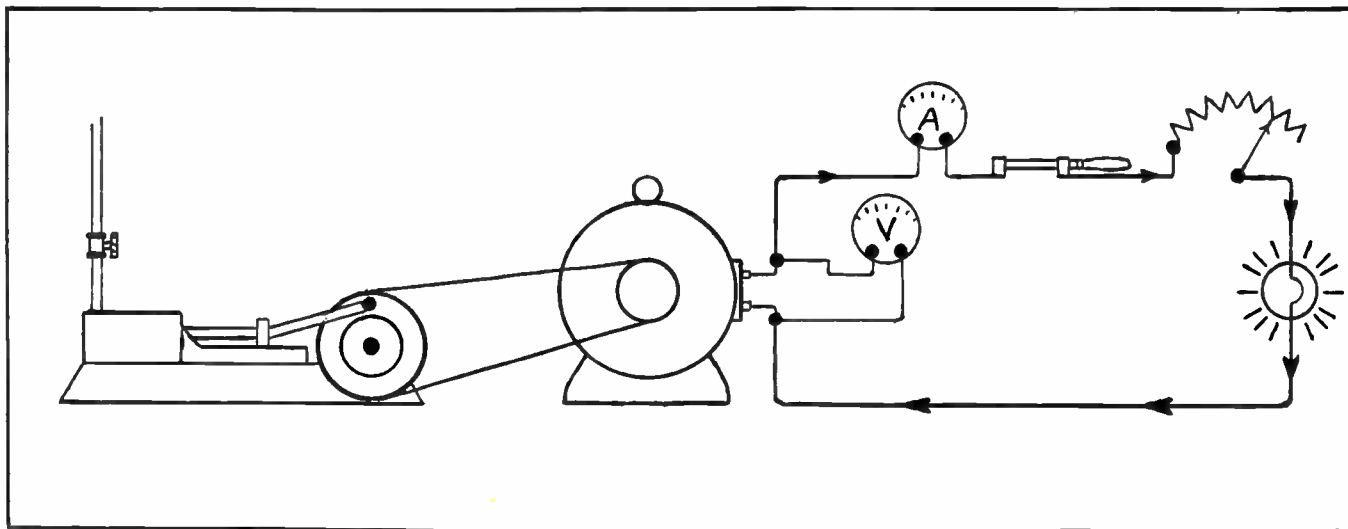

Fig. 2. The electric current flow in this circuit will be increased if we increase the generator voltage, or decreased if we increase the resistance of the wires, rheostat, or lamp.

the resistance to  $\frac{1}{2}$  ohm, the one volt could force two amperes to flow.

#### 41. OHMS LAW FORMULAS

From this simple relationship between the size of these units and the discovery of the effect of pressure and resistance, we obtain the following formulas called Ohms Law Formulas.

$$I = \frac{E}{R}, \quad E = I \times R, \quad R = \frac{E}{I}$$

In which:

I=current in amperes.

E=pressure in volts.

R=resistance in ohms.

These are simply little abbreviated sets of instructions which tell us exactly how to proceed with certain electrical problems.

Remember that when any two factors are placed one above the other and a line between, it means to divide the upper one by the lower.

For example suppose you have to find the amount of current that would flow through a lamp of 5 ohms resistance when a pressure of ten volts is applied to it. (See Fig. 3.)

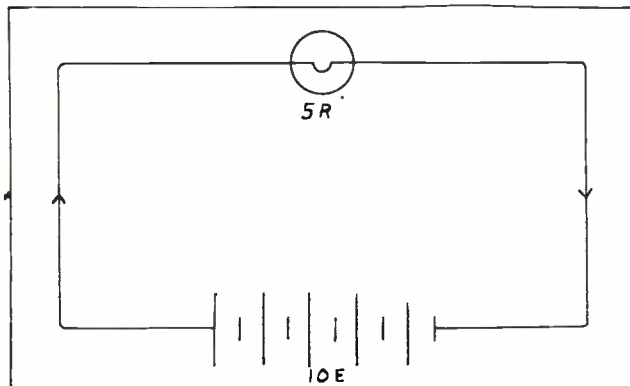

Fig. 3. Ten volt battery supplying current to a 5 ohm lamp. Can you find how much current would flow, without an ammeter?

If you have an ammeter handy to connect in the circuit you can measure this current. But if no ammeter is available you can calculate the current in even less time, by the use of the first formula.

$$I = \frac{E}{R}, \text{ or } I = \frac{10}{5} \text{ or } 2 \text{ amperes.}$$

This would apply equally well to a motor or de-

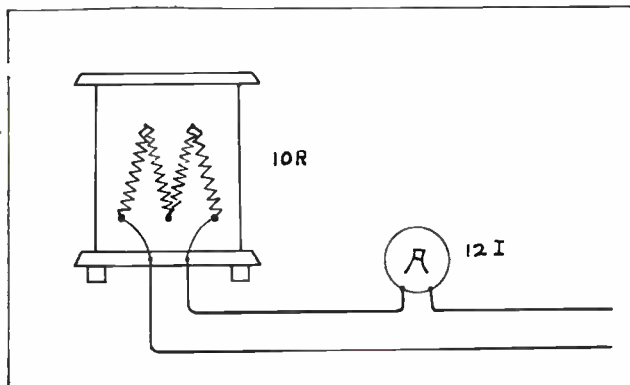

Fig. 4. Electric heater of 10 ohms resistance draws 12 amperes. Can you tell the voltage of the line?

vice of higher resistance and on higher voltage circuits. Whenever you know the voltage applied and the resistance of a device, you can quickly determine the amount of current that will flow through it.

Then suppose you were told that a certain electric heater, as in Fig. 4, had a resistance of 10 ohms and required 12 amperes to operate it. What voltage should this device be operated on? This can be determined by the use of the 2nd formula,  $E=I \times R$ , or  $E=12 \times 10$  or 120 volts.

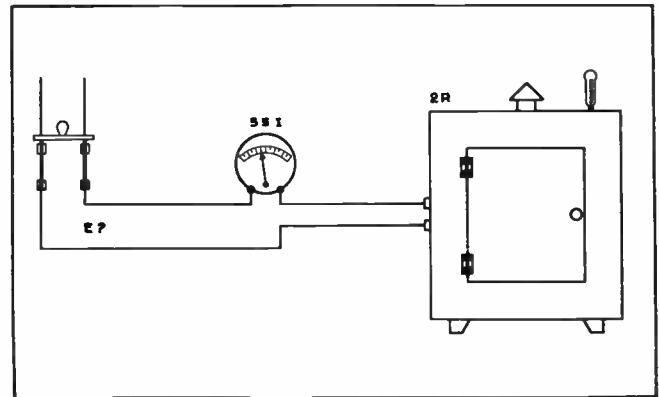

Fig. 5. The ammeter shows 55 amperes flowing through an oven of 2 ohms resistance. Ohms Law formula makes it easy to determine the voltage of the line.

Or in another case, you have an electric oven operating as in Fig. 5, and its resistance is known to be 2 ohms. An ammeter in its circuit shows that a current of 55 amperes is flowing. But you have no voltmeter. The voltage of this circuit can be determined by the same formula as used in the heater,  $E=I \times R$ , or  $E=55 \times 2$  or 110 volts.

Now let us say you have a powerful electro magnet operating as in Fig. 6. A voltmeter shows 80 volts applied to it, and an ammeter shows 20 amperes flowing. How could you determine the resistance of the magnet coils? The 3rd formula shows exactly how to do this, as it says resistance can be found by dividing the volts by amperes, or

$$R = \frac{E}{I} \text{ or } R = \frac{80}{20} \text{ or } 4 \text{ ohms}$$

resistance in the coils.

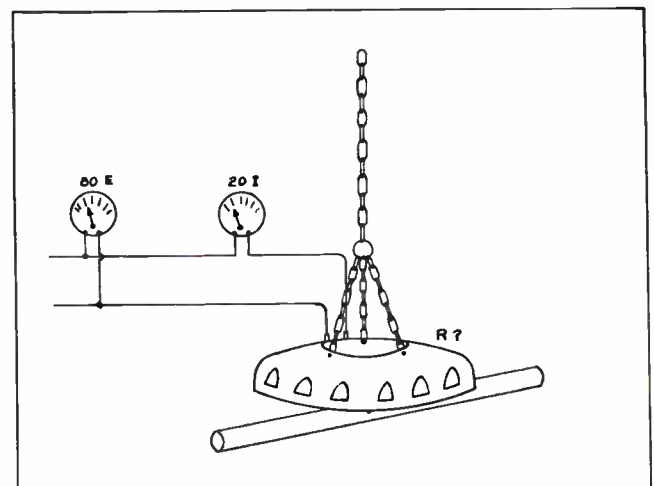

Fig. 6. Electro-magnet and meters, showing voltage and current supplied to operate it.

So we see that whenever we know any two of the three factors of an electrical circuit, we can easily determine the other one, even without instruments, by the use of these simple formulas.

**42. SIMPLIFIED OHMS LAW FORMULA**

A very simple way to remember all three of these formulas in one is shown by the following figure:

$$\frac{E}{I \times R}$$

All that is necessary is to cover the one you wish to find and the remaining 2 factors show you what to do, if you know their values. For example if you know the current and resistance of a circuit and wish to find the voltage, cover E and the parts still shown indicate to multiply  $I \times R$ . Or if you know the voltage and resistance and wish to find the current, cover I and do as indicated by the remaining two or divide E by R.

**WATTS LAW**

**43.** We also need a law and formula to calculate the amount of power of electrical circuits or devices.

You will recall that the watt is the unit of electrical power.

To produce power we must have current flowing under pressure. One ampere flowing under a pressure of one volt, will produce one watt of power.

From this relationship we get Watts Law or, the power in watts in any D. C. circuit is equal to the pressure in volts multiplied by the current in amperes.

And from this law we obtain the very useful formulas:

$$\begin{aligned} I \times E &= W \\ W \div E &= I \\ W \div I &= E \end{aligned}$$

In which:—

- I=current in amperes.
- E=pressure in volts.
- W=power in watts.

So if we want to determine the amount of power used in a circuit in which we know the current and pressure, we simply use the first formula.

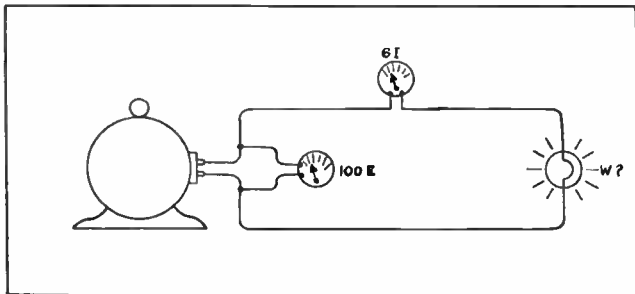

Fig. 7. How many watts does the lamp in this circuit use, according to the simple rule on this page?

In Fig. 7 we have a generator producing 100 E and supplying current to a lamp. An ammeter in the circuit shows a current flow of 6 amperes. Find the power used by the lamp.

$$I \times E = W, \text{ or } 6 \times 100 = 600 \text{ watts.}$$

Many electrical devices have their rated power in watts and their operating voltage marked on them.

And in such cases if you wish to determine the current such a device will use, apply the second formula.

$$W \div E = I.$$

**44. FIELD PROBLEMS**

Suppose on some future job you have a case as in Fig. 8. Your generator supplies 200 volts to a 4000 watt machine. How much current will the machine use, or what should an ammeter read, if connected in this circuit?

$$W \div E = I, \text{ or } 4000 \div 200 = 20 \text{ amperes.}$$



Fig. 8. Using meters right on the job to test a motor. When you know the rating of a machine in volts and amperes, it is easy to determine with meters whether the machine is properly loaded or not.

The next day you have another problem as in Fig. 9. You have a special lamp of 600 watts, and an ammeter in its circuit shows the lamp is using 5 amperes. What is the voltage of the circuit to which the lamp is connected?

Here we use the third formula.

$$W \div I = E, \text{ or } 600 \div 5 = 120 \text{ volts.}$$

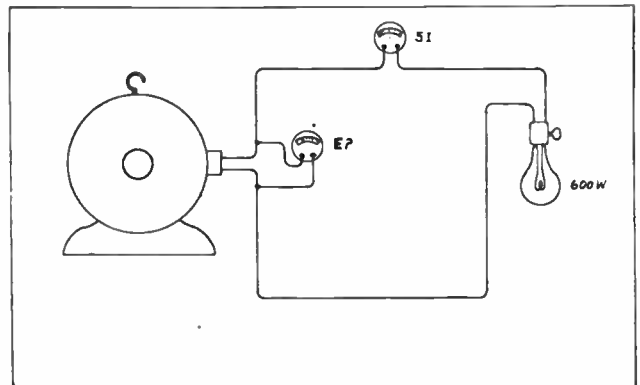

Fig. 9. Generator supplying 5 amps to a 600 watt lamp. What is the generator voltage?

The three watts law formulas can also be simplified for use in the following manner:

$$\frac{W}{I \times E}$$

Then by covering the one you wish to find the value of, the remaining ones indicate what to do,

There are also two other very convenient formulas for finding the power in watts, when we do not know both the amperes and volts, but may know either the amperes and ohms, or the volts and ohms of the circuit or device. They are as follows:

$$I^2 \times R = W$$

$$E^2 \div R = W$$

In which:—

- $I^2$  equals amperes squared, or multiplied by itself.
- $E^2$  equals volts squared, or multiplied by itself.
- R equals resistance in ohms.

In the first case if we have a circuit of 5 ohms resistance and in which a current of 10 amperes is flowing, we square the current first and then multiply by resistance, or  $10 \times 10 = 100$ , and  $100 \times 5 = 500$  watts.

Or if in another circuit you found a device of 20 ohms resistance connected to a line of 200 volts. You could very easily find its power in watts by using the formula  $E^2 \div R = W$ , or  $200 \times 200 = 40,000$ , and  $40,000 \div 20 = 2000$  W or 2 KW.

To prove that all three of the formulas for finding power in watts are always dependable, try them all on the same circuit, where current pressure and resistance are all known.

In Fig. 10, a generator of 440 volts supplies 22 amperes of current to a device of 20 ohms resistance.

Using the first formula, or  $I \times E = W$ , we find that  $I \times E$  is  $22 \times 440$  or 9680 watts.

Using the second formula or  $I^2 \times R = W$ , we find that  $I^2 \times R$  is  $22 \times 22 \times 20$  or 9680 watts.

Using the third formula or  $E^2 \div R = W$ , we find that  $E^2 \div R = \frac{440 \times 440}{20}$  or 9680 watts.

20

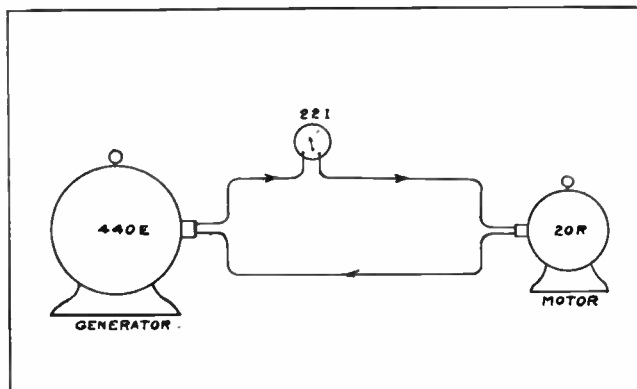

Fig. 10. 440 volt motor supplying 22 amperes to a device of 20 ohms resistance. Check all three of watts law formulas carefully on this circuit.

So we see that we can depend on any one of these formulas that is most convenient to use for any problem.

You are not expected to memorize all these formulas at once. But practice using them frequently, on every practical electrical problem you can find, and soon they will be easy to use and remember.

**45. LINE DROP**

In electrical work we often hear the term Line Drop used. This refers to the voltage used or re-

quired, just to force the current load through the line resistance alone. This becomes a very important item to consider on long transmission lines, or feeders of considerable length to lights and motors. If we have too much voltage drop in the line, we of course will not get enough pressure at the device operating at the end of the line.

The line drop in volts is proportional to the load carried, in amperes, and to the resistance of the wires, or

$$Ed. = I \times R.$$

In which:—

- Ed. equals line drop in volts.
- I equals current in amperes, flowing through line.
- R equals line resistance.

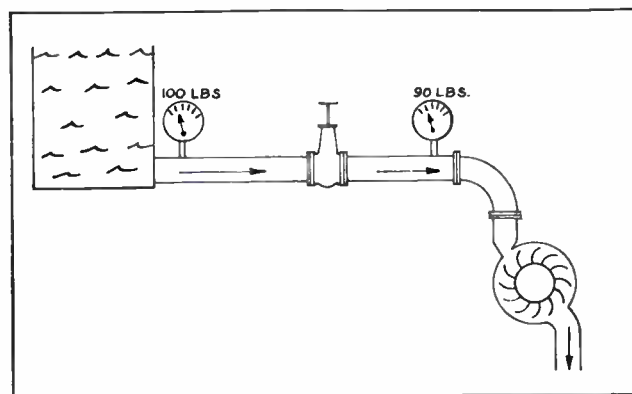

Fig. 11. Water pressure tank and pipe line to water turbine. Note drop in pressure in the pipe line, by readings of the two gauges.

In Fig. 11, we have a water pressure tank, and pipe line. While the water is flowing through the pipe, it creates friction or resistance. Some pressure is required to overcome this resistance in the pipe and maintain a given flow.

The gauge on the pipe near the tank, shows 100 lbs. pressure, but the one at the end of the pipe only shows 90 lbs. pressure. So 10 lbs. pressure was used to force the water through the pipe resistance, and 90 lbs. used to force it through the water wheel.

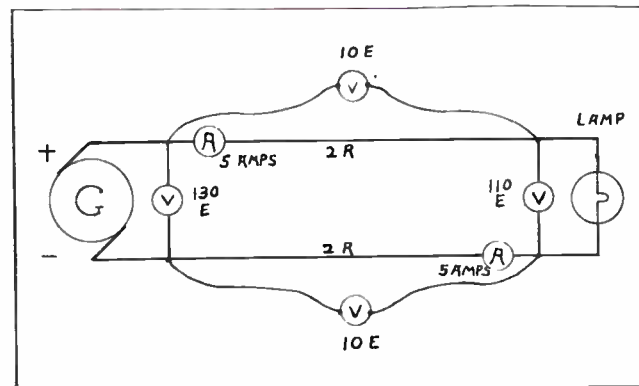

Fig. 12. Generator, lamp and meters connected for testing "voltage drop" and proving Ohms Law Formulas. This is typical of problems encountered by the head electrician in the field.

In Fig. 12, is shown a generator producing 130 volts pressure, and sending current of 5 amperes over a line of 4 ohms total resistance, to a lamp which requires 5 amperes at 110 volts to operate it.

You will note there is a difference of 20 volts between the reading of the voltmeter at the generator and the one at the lamp. This shows a line drop of 20 volts.

An ammeter near the generator shows five amperes flow to the lamp, and one at the lamp shows 5 amperes flow from the lamp back to the generator.

So if there are 5 amperes flowing through each side of the line, and each line wire has 2 ohms resistance, then by using the formula  $I \times R = Ed$ , we have  $5 \times 2$  or 10 volts drop in each wire, or 20 volts total line drop.

Voltmeters connected as at (A) and (B) would each show 10 volts drop.

So in this case we have 20 volts used to force the 5 amperes of load current through the line resistance, and 110 volts used to force the current through the

lamp resistance. Or a total of 130 volts required at the generator.

#### 46. LINE LOSS

This term refers to the power consumed by the line, and which goes into heat along the line. It is usually expressed in watts.

This is found with our regular Watts Law formulas, but using only the voltage drop in the line itself, to multiply by the current.

In the problem shown in Fig. 12, the line loss is  $I \times Ed = W$ , or  $5 \times 20 = 100$  watts.

Such problems as this are frequently encountered by the practical man when installing or inspecting wires feeding lamps or motors. And the man who knows these simple rules and formulas, is the man who is most valuable to his employer, and bound to advance most rapidly to the better jobs and salaries.

## SERIES AND PARALLEL CIRCUITS

As we have already learned, in order to use electricity in any device, we must have a complete path or circuit for the current to flow from the generator or source of supply, to the device, through it, and back again to the source.

We call this a complete electrical circuit.

Where two or more devices are connected to the same line or source of supply, there are different methods of connecting them. They can be arranged to form a **Series** circuit or a **Parallel** circuit, or in a combination of series and parallel.

If you understand series and parallel circuits, it will be easy to understand most any combination of circuits.

#### 47. A SERIES CIRCUIT IS ONE IN WHICH THE CURRENT HAS ONLY ONE PATH

(See Fig. 1). Here is shown a generator and 4 lamps connected in series. The devices are connected one after the other along the wire or line, and the same current must pass through them all. So the current will be the same in all parts of a series circuit. This current is of course governed by the total resistance of all the devices in the circuit, as well as the voltage applied:

Suppose you wish to find the total resistance in a series circuit such as Fig. 1. It is very simple. To find the total resistance of a series circuit, add the resistances of all the devices in the circuit.

In the case of Fig. 1, where there are 4 lamps of 40 ohms each, the total is 160 ohms.

So we can easily see that the greater number of lamps or devices we put in a series circuit, the greater the total resistance becomes, and the higher the voltage which will be required to force a given current through it.

Or if we do not increase the voltage, the current will decrease for every additional lamp or device that is added, because each one tends to make the circuit or path longer, and resistance higher.

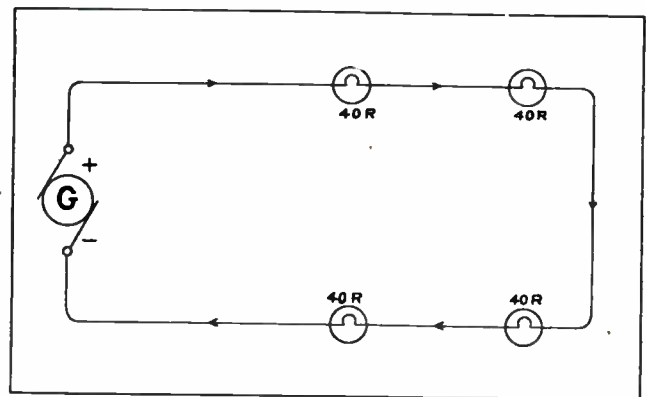

Fig. 1. Four lamps connected in series to a generator. Total resistance of lamp circuit 160 ohms.

#### 48. APPLICATIONS OF SERIES CIRCUITS

Series circuits are often used for street lighting, and such applications where a number of lamps or devices of the same current requirements, are operated a considerable distance apart, and away from the source of supply.

This effects quite a saving in copper and line costs, as the total current flow is only that of any one device. Thus the wires can be kept smaller than with parallel circuits. And only one continuous wire is needed, instead of two to each device, as required with a parallel system. (See Fig. 2A and Fig. 2B.)

One of the disadvantages of series circuits is that we cannot conveniently control the devices separately.

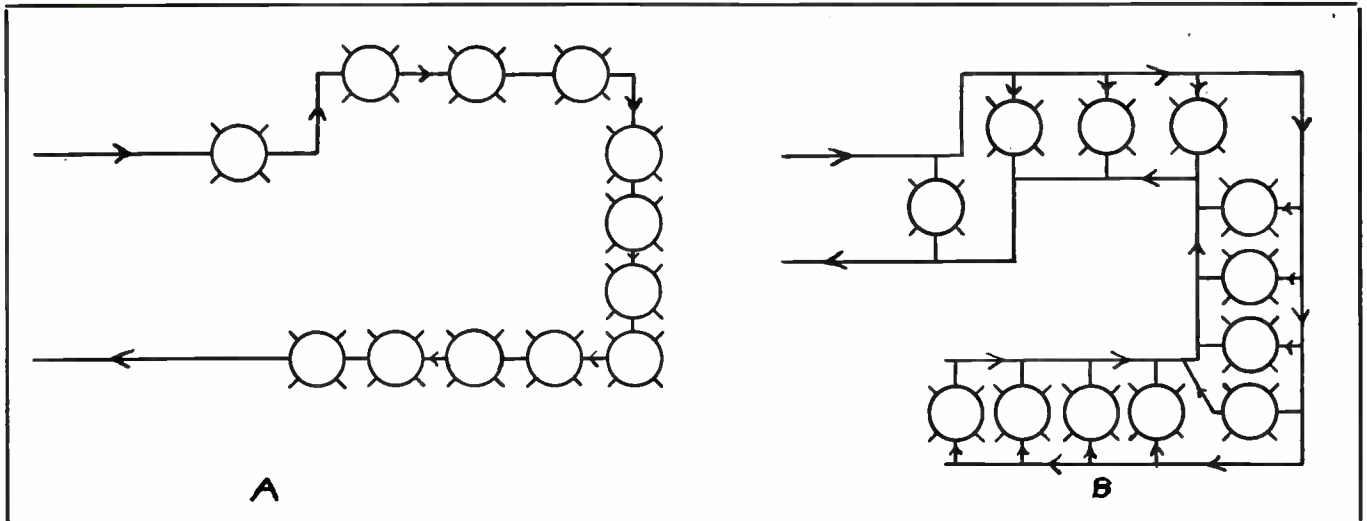

Fig. 2-A. Twelve lamps connected in series. Note that only one main wire is needed.

Fig. 2-B. Twelve lamps connected in parallel. Two main wires are needed for this circuit.

In a series circuit the voltage applied to any device, is the same as the voltage drop across this device. And it will be a fraction of the total line voltage, and proportional to the resistance of the device, also the total number of devices in the line. (See Fig. 3.)

A voltmeter connected across the terminals of any one of the lamps in this circuit will show 50 volts drop.

The sum of the voltages of all lamps will be that of the generator. Assuming of course that the line resistance is not enough to be considered.

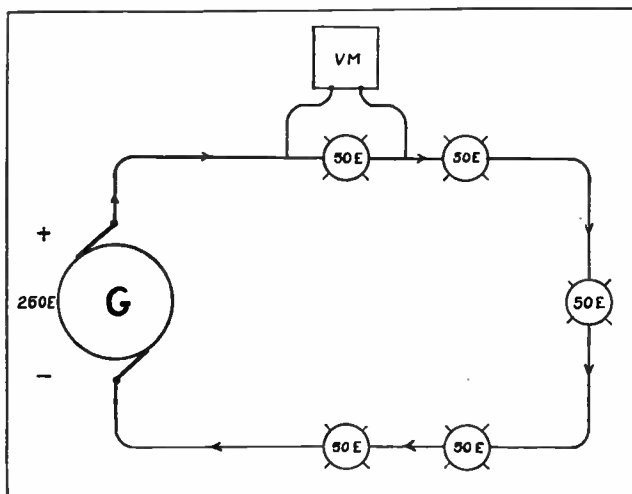

Fig. 3. Five 50 volt lamps in series. Voltmeter will show 50 volts drop through any lamp, or 250 volts total.

#### 49. A PARALLEL CIRCUIT IS ONE IN WHICH THE CURRENT HAS TWO OR MORE PATHS THROUGH WHICH IT CAN FLOW

In such circuits the current from the generator or source divides, and part flows through each of the branches of the circuit according to their resistances. (See Fig. 4.)

Here is shown a generator and four lamps connected in parallel. Sometimes such a circuit is called a multiple circuit.

So if you hear a circuit called multiple or parallel, remember they both mean the same.

In this circuit shown, the resistance of all lamps is equal or 40 ohms each, so the current will divide equally through them. Note how the arrows show by their direction and size, the division and amounts of current in the various parts of this circuit.

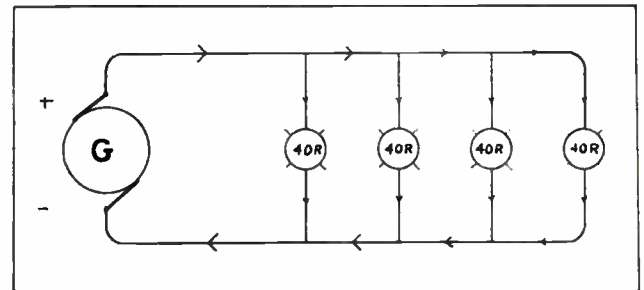

Fig. 4. Four lamps in parallel. Note how the current divides through each path.

The current tends to flow from the positive or top wire to the negative or bottom wire, through every path we give it. It is easy to see that as we connect more devices in a parallel circuit, it makes more paths or a larger total path of lower resistance, for current to flow through. So every device added in parallel causes more current to flow. If we were to connect too many devices on such a circuit, the amount of current required would be an overload on the wires or generator. It is very important therefore that we know how to calculate the total resistance of parallel circuits, so we can properly regulate the current load by having the proper resistance.

#### 50. RESISTANCE OF PARALLEL CIRCUITS

If the total resistance of a parallel connection gets less as we add more paths, then we see we cannot get the correct total resistance of all paths, by adding their separate resistances.

To find the total resistance of a parallel circuit, where all paths are of equal resistance, we divide the resistance of one path by the number of paths.

This is a very simple method but applies only to paths of equal resistance.

To get the total resistance of the circuit in Fig. 4, we divide 40 by 4, and our answer is 10 ohms.

Suppose you have a circuit with 10 lamps of 20 ohms each, connected in parallel. What is the total resistance? The resistance of one path divided by

$$\text{the number of paths, or } \frac{20}{10} \text{ equals 2 ohms.}$$

Many parallel circuits have devices of unequal resistance, and to find the total resistance of such a circuit we must use a different method, known as the "Reciprocal" or conductance method.

This method uses the reciprocal of the resistance values, which is the conductance of the path. You will recall the term conductance and its unit "Mho," explained on earlier pages.

Adding more paths or devices to a parallel circuit decreases the total resistance, but it increases the conductance. So if we find the reciprocal of the resistance, which is the conductance of each path, and add them all to get total conductance, then change this back to its reciprocal, we will have the total resistance.

The important thing to remember is that conductance and resistance are opposite, and the reciprocals of each other. As one increases in any circuit the other decreases.

To find the total resistance of a parallel circuit, with paths of unequal resistance, get the reciprocal of each resistance and add them to get their sum or the total conductance. Then take the reciprocal of this which is the total resistance.

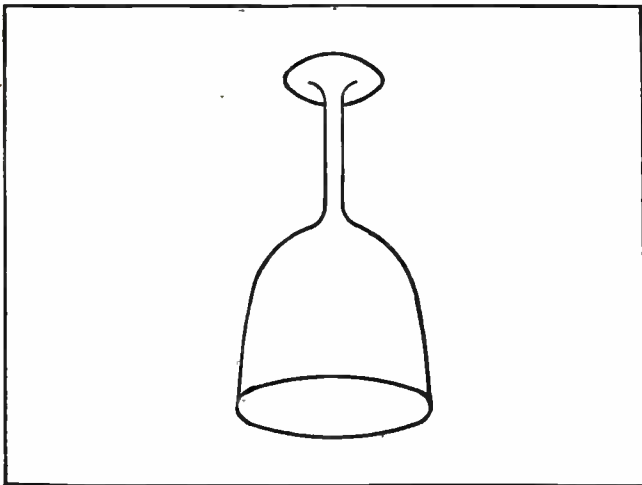

Fig. 5. What is this? Invert or turn it up-side-down and see. When we invert a fraction we get its reciprocal. Now it is a tumbler. Before it was a reciprocal of a tumbler, so to speak.

To find the reciprocal of any whole number we place the figure "one" above it with a line between to make a fraction. For example, the reciprocal of

$$2 \text{ is } \frac{1}{2} \text{ that of } 12 \text{ is } \frac{1}{12} \text{ that of } 25 \text{ is } \frac{1}{25} \text{ etc.}$$

To find the reciprocal of a fraction, we simply invert it. For example the reciprocal of  $\frac{1}{2}$  equals

$$\frac{2}{1} \text{ or } 2, \text{ that of } \frac{1}{5} \text{ equals } \frac{5}{1} \text{ or } 5, \text{ that of } \frac{2}{6} \text{ equals } \frac{6}{2} \text{ or } 3, \text{ that of } \frac{5}{20} \text{ equals } \frac{20}{5} \text{ or } 4, \text{ etc.}$$

51.—FIELD PROBLEMS

Now suppose you have a circuit with 3 lamps in parallel as in Fig. 6.

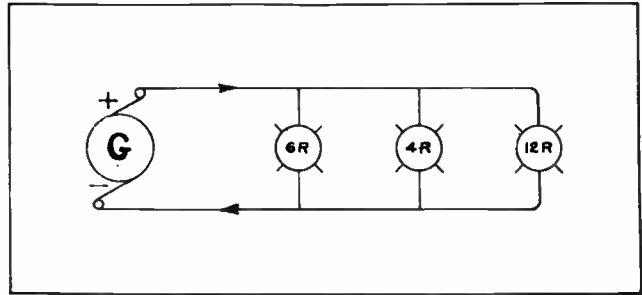

Fig. 6. Three lamps of unequal resistance, in parallel. Use the "reciprocal" method to find total resistance.

One lamp is 6 ohms, one 4 ohms, and one 12 ohms. How will you find the total resistance? According to our rule we first get the reciprocals of each resistance.

$$\text{The reciprocal of } 6 \text{ equals } \frac{1}{6}$$

$$\text{The reciprocal of } 4 \text{ equals } \frac{1}{4}$$

$$\text{The reciprocal of } 12 \text{ equals } \frac{1}{12}$$

Then we add these to get the total conductance in Mhos.

$$\text{Before we can add } \frac{1}{6}, \frac{1}{4}, \text{ and } \frac{1}{12} \text{ we must}$$

get common denominators for them to make them "like fractions." Twelve is common to all, so

$$\frac{1}{6} \text{ equals } \frac{2}{12}$$

$$\frac{1}{4} \text{ equals } \frac{3}{12}$$

$$\frac{1}{12} \text{ equals } \frac{1}{12}$$

$$\text{Then } \frac{2}{12} \text{ plus } \frac{3}{12} \text{ plus } \frac{1}{12} \text{ equals } \frac{6}{12} \text{ Mho.}$$

Then its reciprocal equals  $\frac{12}{6}$  or 2 Ohms, which is the total resistance.



An interesting and valuable rule to remember, and with which to check such calculations, is that the total resistance of any parallel group, is always lower than the lowest resistance in the group.

Note how this proves out with the problem just finished.

This method of finding the total resistance is important enough to be worth a little practice on any problem you can find or think up, and this is one of the best ways to fix it in your memory.

In a parallel circuit having resistances as in Fig. 7. What is the total resistance?

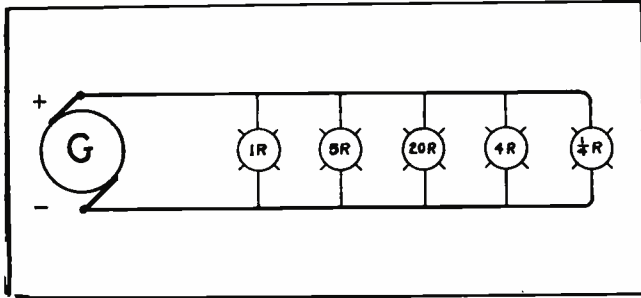

Fig. 7. Could you find the total resistance of a circuit like this, if you were asked to by your employer? See the example given.

$$\begin{aligned} \text{Reciprocal of } 1 \text{ equals } & \frac{1}{1} \\ \text{Reciprocal of } 5 \text{ equals } & \frac{1}{5} \\ \text{Reciprocal of } 20 \text{ equals } & \frac{1}{20} \\ \text{Reciprocal of } 4 \text{ equals } & \frac{1}{4} \\ \text{Reciprocal of } \frac{1}{4} \text{ equals } & \frac{4}{1} \end{aligned}$$

20 is common to all so:—

$$\begin{aligned} \frac{1}{1} \text{ equals } & \frac{20}{20} \\ \frac{1}{5} \text{ equals } & \frac{4}{20} \\ \frac{1}{20} \text{ equals } & \frac{1}{20} \\ \frac{1}{4} \text{ equals } & \frac{5}{20} \\ \frac{4}{1} \text{ equals } & \frac{80}{20} \end{aligned}$$

$$\begin{aligned} \text{Then: } & \frac{20}{20} \text{ plus } \frac{4}{20} \text{ plus } \frac{1}{20} \text{ plus } \frac{5}{20} \text{ plus } \frac{80}{20} \\ \text{equals } & \frac{110}{20} \text{ Mho.} \end{aligned}$$

$$\begin{aligned} \text{And the reciprocal of } \frac{110}{20} \text{ Mho equals } & \frac{20}{110} \text{ or} \\ & \frac{2}{11} \text{ ohm, total resistance.} \end{aligned}$$

### 52. IMPORTANT FACTS ABOUT SERIES AND PARALLEL CIRCUITS

Advantages of parallel circuits are, that all devices receive equal voltage, or the voltage of the main wires, and any device can be controlled separately, without affecting the others. If the wires and generator are large enough, we can connect any desired number of devices in such a circuit. Lamps, motors and most electrical devices are usually connected in parallel.

The important things to remember about series and parallel circuits are the effects they produce on resistance, current, and pressure, when different devices are connected one way or the other.

We have seen that a series connection of lamps or current consuming devices, increases the resistance to the sum of all their resistances. This tends to reduce the current flow, or requires higher voltage to maintain a certain current. Series circuits also effect economy of copper or wire size in certain systems.

We have also shown how current consuming devices connected in parallel, reduce the total resistance by making the path larger in effect, and increasing the current required. Parallel circuits provide independent control and give all devices full line voltage.

### 53. SERIES AND PARALLEL CONNECTIONS OF GENERATORS AND BATTERIES

We have so far only considered the effects of series and parallel connections on current consuming devices. It is also very important to know the results that can be obtained by use of series and parallel connections on sources of electrical supply, such as batteries or generators.

Suppose you have a device which you want to operate with dry cells, and one cell will not furnish high enough pressure to force the required current through the resistance of the device.

By connecting cells together in series, that is positive of one to the negative of the next as in Fig. 8, the voltage may be increased to almost any desired amount.

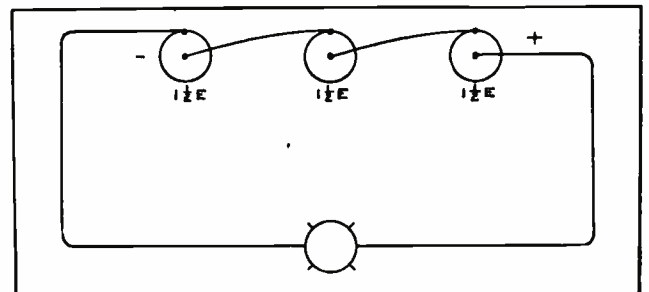

Fig. 8. Connecting dry cells in series will give the sum of their voltages at the lamp.

In Fig. 8, 3 dry cells are shown connected in series to increase the voltage they can supply. If each cell has 1½ volts, this connection will give 4½ volts.

The current that flows through the lamp must also flow through each cell because it has only one path. Therefore the current flow will not be increased, but will be just that of one cell.

Such series connections of cells are commonly used. A good example is in radio "B" batteries, where a number of very small cells are connected in series, to get up to 45 volts from one battery.

The current required from these batteries is very small, so a straight series connection can be used.

**54. EFFECT OF SERIES CONNECTION ON GENERATOR VOLTAGE**

Electric generators can also be connected in series to obtain higher voltages than one machine alone can produce. (See Fig 9.)

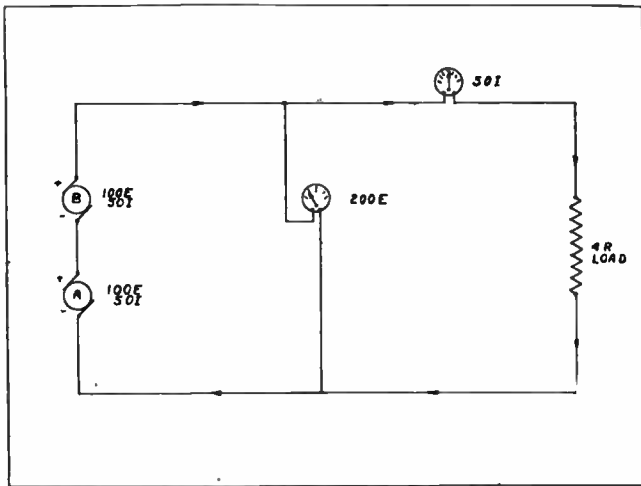

Fig. 9. Two 110 volt generators connected in series. Compare carefully the readings of the voltmeter and ammeter with the generator ratings.

Here are two generators properly connected positive to negative, so their voltages add together. But the current that can be supplied by these two machines in this connection, is only the same as the capacity of one.

This circuit is easily compared and illustrated with a water system in Fig. 10.

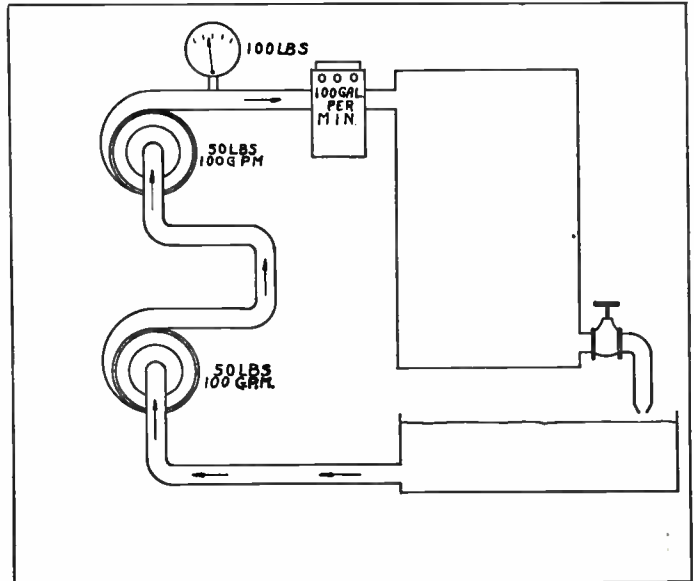

Fig. 10. Two water pumps in series, each producing 50 pounds pressure, and pumping 100 gallons per minute. The total pressure will be 100 pounds, and total flow 100 gallons per minute.

Here we have two water pumps also connected in series. They can supply double the pressure produced by one pump, as their pressures add together. But the current they supply is only the same as passes through one pump.

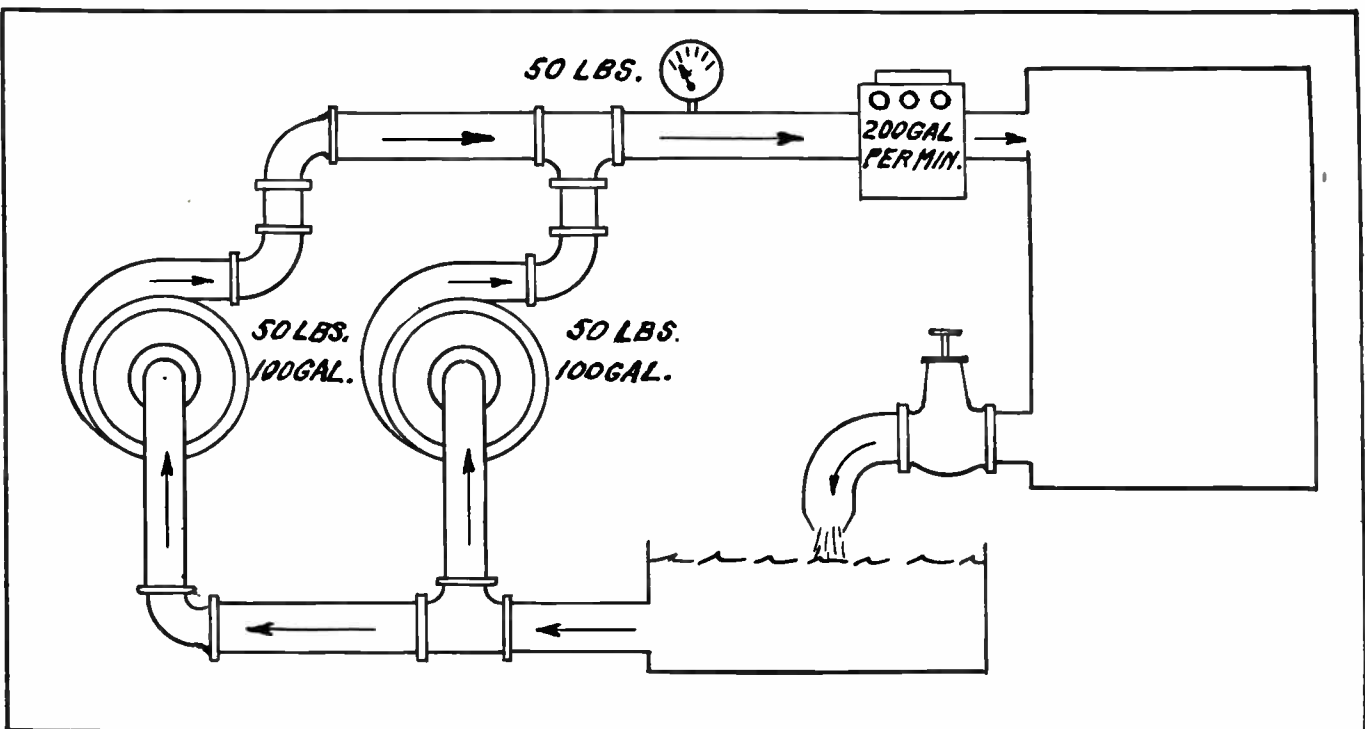

Fig. 11. Two 50 lb., 100 gal. per minute pumps operating in parallel. They develop 50 lbs. total pressure and pump 200 gallons per minute.

Now if we wish to get a greater current or volume of water at lower pressure, we can arrange the pumps as in Fig. 11. Here the pressure on the mains will be the same as that of one pump, but their current flow will add together, and be twice that of one pump.

Similarly in Fig. 12, we have two generators connected in parallel. The voltage across the main wires is only equal to that of one machine, but their currents will add, and the total current flowing will be twice that of one machine.

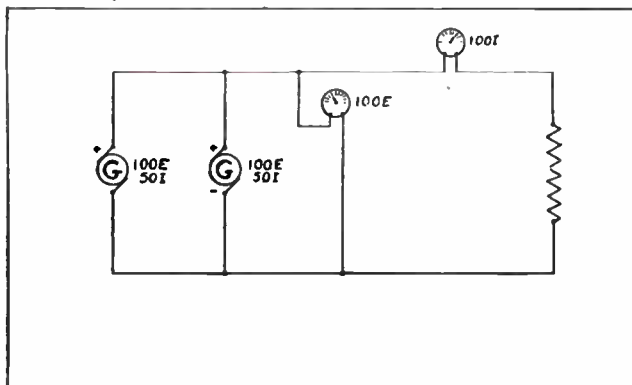

Fig. 12. Two 100 volt, 50 amp generators in parallel. The line pressure is 100 volts, and full load current is 100 amperes.

In large power plants, generators are commonly connected in this way, and we often find from 2 to 10 or more, all operating in parallel, and each supplying its share of the total load current. (See Fig. 13.)

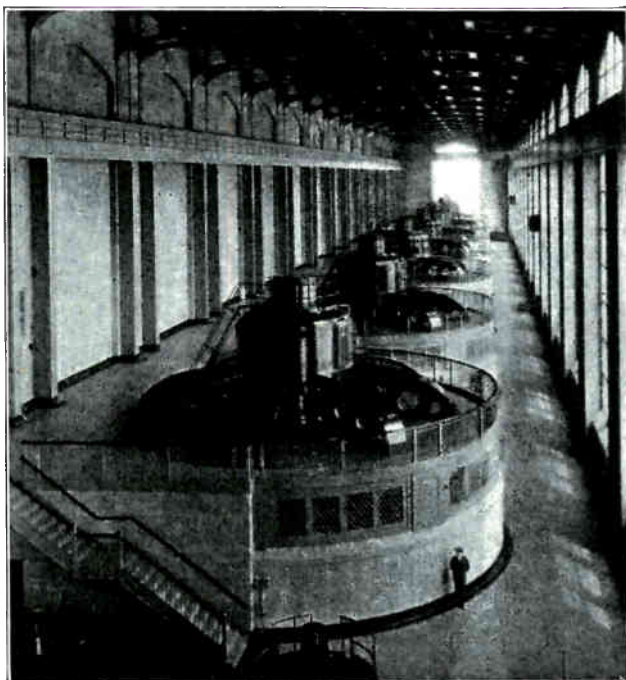

Fig. 13. Row of generators in a modern power plant. These machines are operated in parallel, each one supplying its share of the total load.

On small requirements where batteries or cells are used we can connect them in parallel to increase the current supply. (See Fig. 14.)

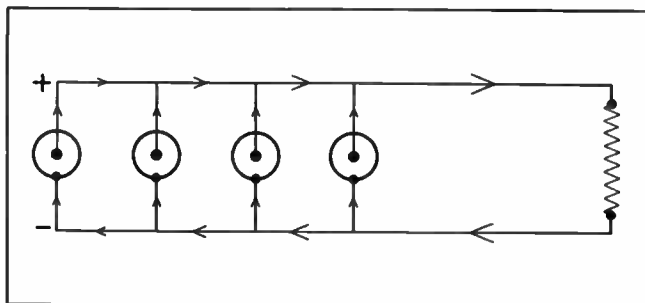

Fig. 14. Four dry cells connected parallel to obtain more current than one could supply.

Here are 4 dry cells connected in parallel, or all positives to one wire, and all negatives to the other. The voltage on the main wires will only be  $1\frac{1}{2}$  or the same as one cell. But the available current will be the sum of that of all 4 cells. Or they will furnish a given current four times as long as one cell.

**55. COMBINATION OF SERIES AND PARALLEL CIRCUITS**

If we wish to obtain both higher voltage and more current than one cell can produce, we can combine the series and parallel connections, in a series-parallel system as in Fig. 15.

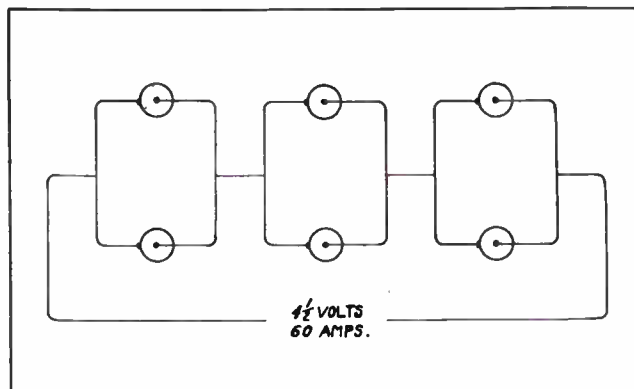

Fig. 15. Six cells connected series-parallel. Note voltage and amperage obtained by this connection.

Here are 3 groups of 2 cells each. The two cells in each group are connected in parallel to add or double their current. Then all 3 groups are connected in series to add their voltages. So at the main wires we can obtain 3 times the voltage of one cell, and twice the current.

The same effect would be obtained if they were connected parallel-series as in Fig. 16.

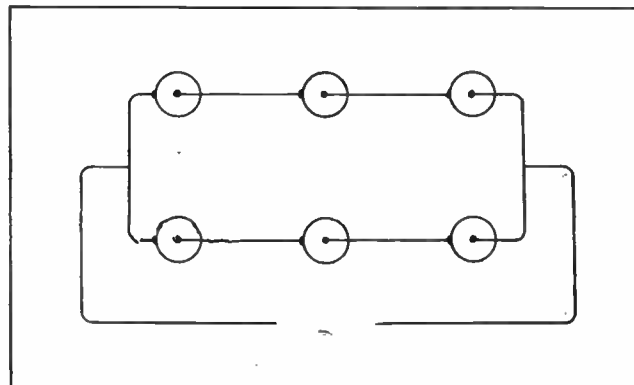

Fig. 16. Parallel-series connection of six cells.

So it makes no difference in the voltage obtained, whether we connect cells in **series-parallel** or **parallel-series**, as long as we keep the same number in series and the same number in parallel.

There is often some argument as to whether a certain circuit should be called **series-parallel**, or **parallel-series**.

This is easy to determine if you just call the name of the external or main wires first, or note what kind of a connection is made **Of** the groups. Note the emphasis on the word **Of**.

Thus in Fig. 15 we say we have a series connection **Of** parallel groups, or series-parallel. In Fig. 16 we have a parallel connection **Of** series groups, or parallel-series.

In connecting such combination circuits we should see that all groups are equal. Do not connect a group of 2 cells in series with a group of 4. And do not connect a series group of 3 cells in parallel with a group of 6. Their voltages would be unequal, and the group of six would discharge through the 3, even with no load attached to the main wires. (See Fig. 17.)

A general rule is, when we wish to obtain high pressures and moderate current, we connect batteries or generators in series. And when we need large amounts of current at moderate voltage, we connect them in parallel.

This is one of the most important rules to remember about series and parallel connections.

As you progress into the later sections on electric systems and machines you will more fully appreciate the importance of this knowledge of series and parallel circuits. You will also find it much easier to make certain installations, and locate troubles in your future work in the field, now that you know these principles.

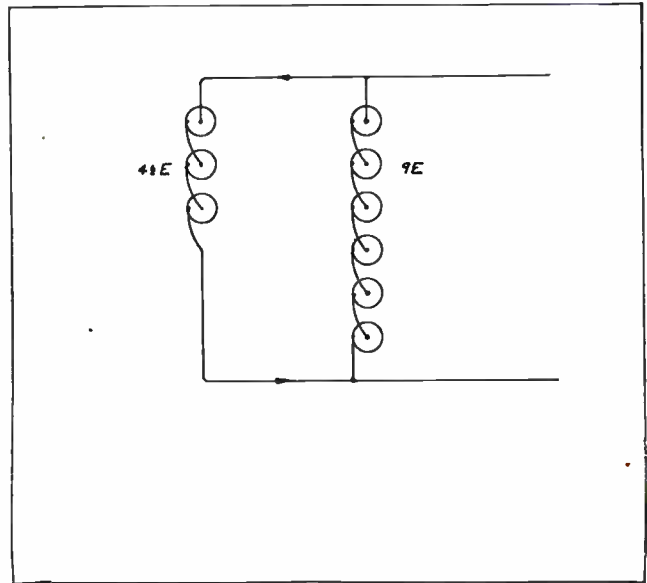

Fig. 17. Wrong connection of unequal numbers of cells in parallel-series. This connection would discharge the cells, even without any load connected.

## ELECTRIC CELLS AND BATTERIES

56. Electric batteries are commonly used to supply current in small amounts, and particularly to portable equipment.

It is cheaper to produce electricity from large generators in power plants than from batteries. But where no generators or power lines are available, and where only very small amounts of power are needed for small or portable devices, the convenience of electric batteries offsets their higher cost of current.

There are many millions of them in use in automobiles, electric trucks, radios, airplanes, electric lanterns, flashlights, and in telephone, burglar alarm and signal systems. In some power plants big groups of large batteries are used for emergency service, in case of shut down of the generators, and in such cases they may supply thousands of amperes for short periods.

The term "Battery" applies to 2 or more cells grouped together in series or parallel. As you have

already learned such a group will supply more voltage or current than one cell, according to the way they are connected. But where only very small amounts of current are needed, at low voltage, one cell may be used alone, as in small flashlights or door bell systems, etc. Fig. 1 shows a large battery for telephone operation.

As we said in a previous section, batteries are devices to convert chemical energy into electrical energy, or they use the chemical method of producing dynamic electricity.

All batteries consist of some chemical solution or paste, and metal elements to be acted upon or consumed by the acid or solution.

### 57. PRIMARY AND SECONDARY CELLS

Batteries or cells are divided into two classes, called "Primary" and "Secondary." The Primary

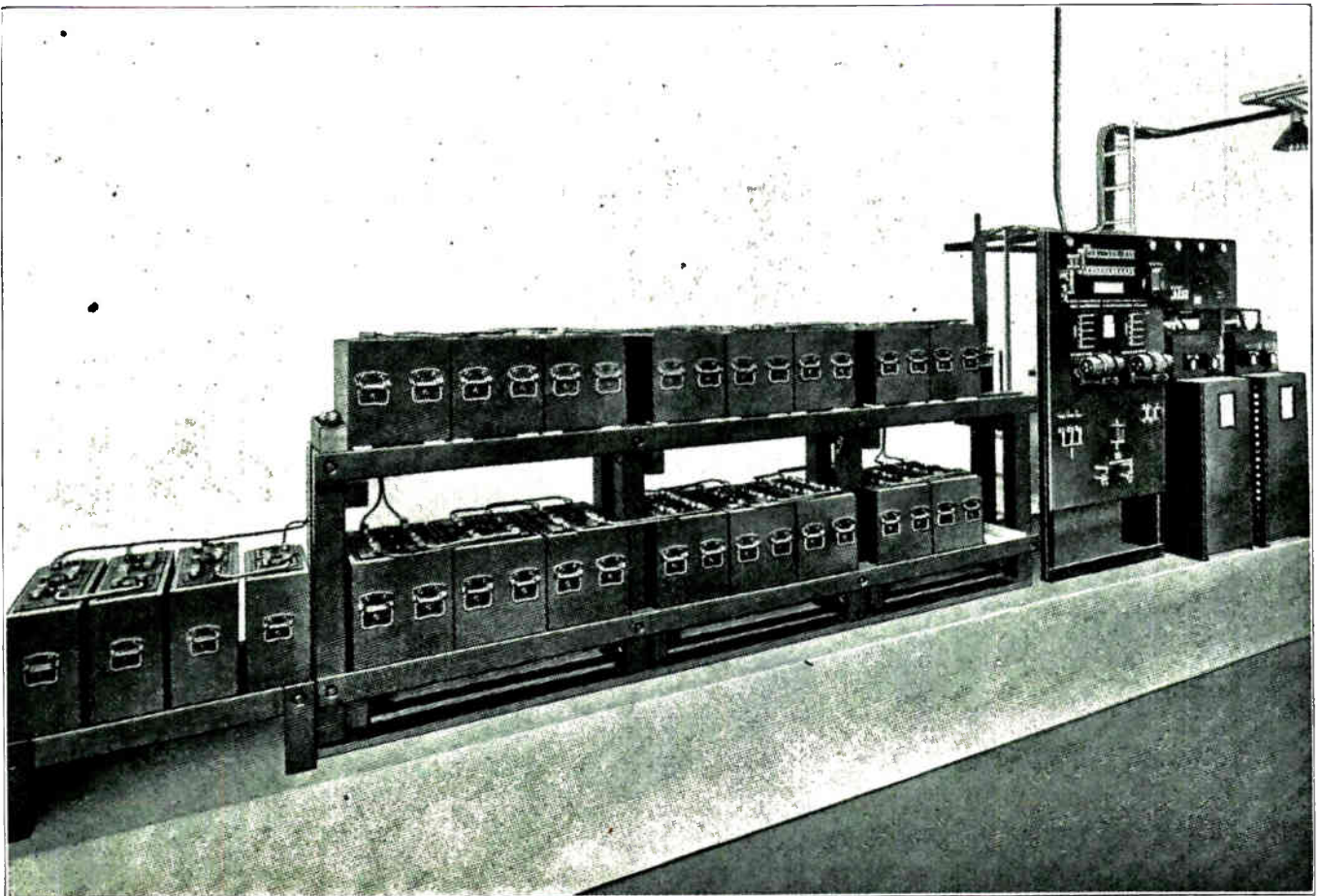

Fig. 1. Photo of group of storage batteries used for telephone work.

Cell is one that is made of such materials that it will supply electric pressure as soon as it is assembled, without first receiving any electrical charge. In these cells part of the unlike metal elements are consumed by the chemical action during their use and when the materials are used up or destroyed, they must be renewed before the cell can deliver current again.

A Secondary Cell is one that uses metal elements of similar nature when first constructed, and will not deliver current, until it has first been charged by passing electric current through it.

This charging or flow of current through the cell sets up one form of chemical action, and changes the nature of the material in the metal plates. Then when the cell is being used or discharged, a reverse chemical action is taking place.

When such a secondary cell is discharged the metal elements are not destroyed, and it can be again charged by passing current from a generator or other source, through it in the opposite direction to its flow during use. These cells can be charged and discharged many times before their metal elements need renewing. So they are often called storage cells or batteries. But remember they do not store electricity, instead they simply store a form of chemical energy, set up by the charging current flow.

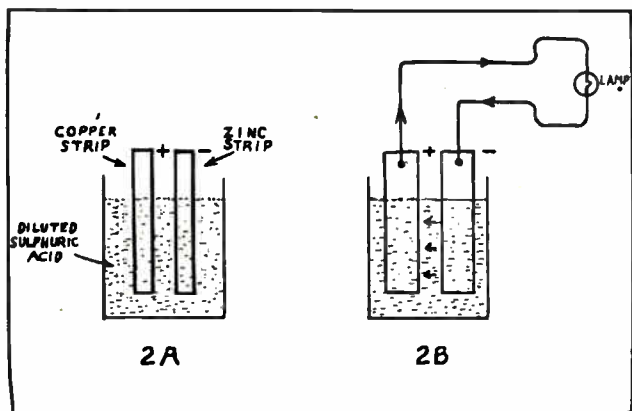

Fig. 2-A. Simple primary cell.  
Fig. 2-B. Primary cell connected to a lamp. This cell has larger metal strips than the one in Fig. 2-A.

## 58. CONSTRUCTION OF PRIMARY CELLS

Primary cells are made of positive and negative elements of different kinds of material, immersed in the acid or chemical solution, and all in some suitable container.

The acid solution is called the "Electrolyte."

Cells which have the electrolyte in liquid form are called "Wet cells." Those having the electrolyte in a moist paste form are called "dry cells." These are not really dry, but because there is no loose liquid to spill, and the manner in which they are sealed, they can be placed in any position and treated as a dry cell.

A simple form of wet primary cell is shown in Fig. 2A. This is known as a "Voltaic cell."

Here we have a strip of copper and one of zinc, immersed in an electrolyte of sulphuric acid that has been diluted or weakened with water.

## 59. CELL VOLTAGE

The action of the acid on the zinc causes a difference of potential between it and the copper. So if we connect a voltmeter to the top ends of the copper and zinc elements, it will show a pressure of about one volt.

The amount of voltage we can obtain from a cell depends on the kind of materials used, and not on their size. Thus copper and zinc used with sulphuric acid electrolyte give about 1 volt, while carbon and zinc used with an electrolyte of ammonium chloride will give about 1.5 volts. Or carbon and zinc with sulphuric acid and a little bichromate of potassium will give about 2 volts.

If we connect a lamp to the terminals of this simple cell as in Fig. 2B, a current will flow from the positive terminal on the copper, through the lamp to the negative terminal on the zinc, and also inside the cell from the zinc through the electrolyte to the copper. This shows the complete circuit or path of current in both the external and internal parts of the circuit.

As long as the external circuit is closed and current allowed to flow, the chemical action decomposes and consumes the zinc plate. The copper, however, is not destroyed. When the zinc element is practically all destroyed, the cell will not furnish any more current and is said to be dead.

By replacing the zinc with a new piece it will again deliver the current.

In referring to the terminals and external circuit of a battery the element at which the current leaves the cell is commonly called the positive element or pole, and the one at which current enters the cell is called the negative element or pole.

Inside the cell however, the current flows from zinc to copper, so in the internal circuit the element at which current enters the electrolyte is the positive or anode, while the one at which current leaves the electrolyte is the negative or cathode.

## 60. CELL CURRENT AND LIFE

From the above we can see that the amount of current we can obtain from such a cell, as well as the life of the cell, will depend on the size of the elements.

The cell in Fig. 2B, having elements twice as large as in Fig. 2A, will furnish current twice as long at the same rate, or would deliver more current on a low resistance circuit than the smaller cell.

A cell such as in Fig. 2A, or 2B, is sometimes called a one fluid cell, as the electrolyte is just diluted sulphuric acid.

## 61. POLARIZATION

Such one fluid cells are not used much except for experimental purposes, because if we leave some device connected in the circuit to operate continuously, we find that the current flow will very rapidly decrease to almost nothing.

This is caused by what is called Polarization. As the acid attacks the zinc element hydrogen gas is created and has a tendency to collect on the copper plate in the form of little bubbles. If the current

continues to flow at a very heavy rate, the copper plate soon becomes so coated with a layer of these bubbles that they shut off the current flow, as the gas is an insulator of very high resistance, and reduces the active area of copper in contact with the electrolyte.

When the copper is thus coated with bubbles, if it is taken out and wiped off or dried, then put back, the cell again delivers current a short time until it becomes polarized once more.

Such a cell can only be used for short periods, or on circuits that are normally open, and just closed intermittently. So they are called open circuit cells.

In primary cells we sometimes have "Local Action" at the zinc element, caused by impurities in its surface. The action of the acid on these particles of other metals is different than on zinc, and sets up a difference of potential, and little short circuited local currents at these spots. This consumes the zinc even when the cell is not in use. To help prevent it, we sometimes amalgamate or coat the zinc with mercury.

## 62. CLOSED CIRCUIT CELLS, AND PREVENTION OF POLARIZATION

For many uses we need cells that will furnish current continually or at least for reasonable periods, without polarizing.

There are several ways of constructing such cells to prevent polarization. In Fig. 3, is shown a cell using two solutions for the electrolyte, copper sulphate in the bottom, and sulphuric acid and zinc sulphate in the top. These two liquids stay separate because the copper sulphate is heavier than sulphuric acid or zinc sulphate. The lighter liquid floats on the copper sulphate, as oil will float on water.

In the bottom of the jar, and immersed in the copper sulphate solution, we place the copper element which is usually several strips of thin copper fastened together in the center, and the ends spread out fanwise. From this a rubber insulated wire leads up through the solution to the top of the jar.

In the top of the jar and in the sulphuric acid solution we place a zinc element, that consists of several heavy bars cast together to a vertical stem, in the shape of a "Crowfoot".

The stem has a hook shaped extension at the top to hang it on the rim of the glass jar and hold it up in place, also a terminal nut for connecting wires to it.

When this cell is in operation, the acid acts on the zinc the same as in our first simple cell, and hydrogen gas is again set free. But before it can reach the copper element it must pass through the copper sulphate solution in the bottom of the jar.

When the gas reaches this solution it combines with part of the copper sulphate, forming sulphuric acid which stays in the top, and metallic copper collects on the copper element, instead of hydrogen bubbles.

Thus polarization is prevented. The copper deposited on the copper element of course does no harm as it is a conductor, instead of high resistance like the gas bubbles.

This type of cell is called a **Closed Circuit Cell** because it can be used to supply small currents continually, to closed circuit electrical systems.

They are also called "Gravity Cells" because of the manner in which the two solutions are kept separated by their different gravities. They are one form of **Daniel Cell** and often called by this name. Fig. 4 shows two such cells connected to telegraph instruments.

They are used for telegraph and telephone work, and in some types of signal and alarm systems.

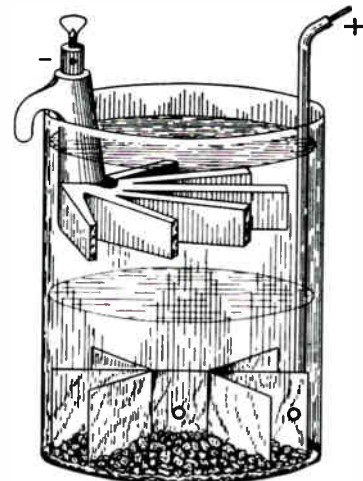

Fig. 3. "Two Fluid" Gravity Cell. These cells do not polarize as the one fluid type do.

## 63. ASSEMBLY AND PREPARATION OF GRAVITY CELLS

In preparing such a cell for use we place the copper element in the bottom of the jar, with its "lead in" wire brought to the top, then sprinkle the bottom of the glass jar evenly and about  $\frac{1}{2}$

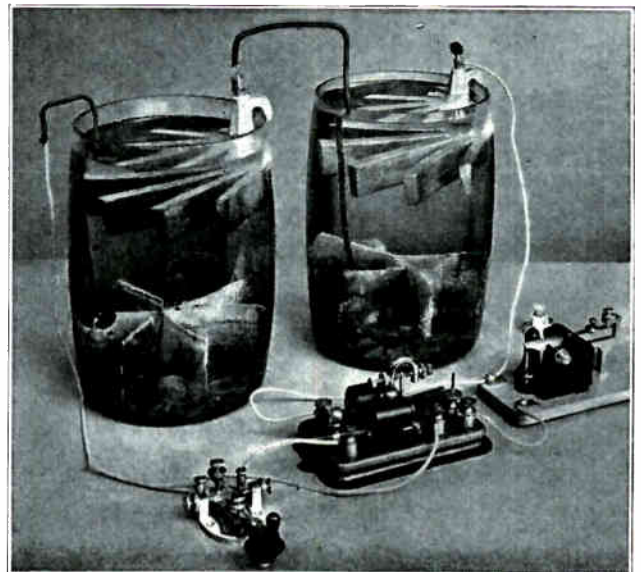

Fig. 4. Photo of two gravity cells, showing their parts and construction.

inch thick with copper sulphate crystals. Then hang the zinc element in the top and fill the jar with water (preferably distilled) to within about 2 inches of the top, or well over the zinc.

If the cell is to be used at once it may be necessary to add about a tablespoon full of sulphuric acid. But if it can be allowed to stand a few days on short circuit, a chemical action takes place which soon forms enough zinc sulphate to start operation.

After quite a period of use the zinc element becomes practically destroyed and must be renewed. The electrolyte and copper sulphate crystals must also be renewed occasionally to keep the cell up to good strength.

The copper element becomes heavily coated with metallic copper from the solution, after long periods of operation.

It is well to cover the top of the electrolyte in these cells with a thin film of oil to prevent evaporation.

#### 64. CARE OF CELLS

They should not be left on open circuit long, as they will deteriorate if no current is flowing. The acids tend to mix when the cell is idle. When standing idle and not in use in a regular circuit, it is best to connect a wire or coil of about 30 or 40 ohms resistance across them.

There is a noticeable difference in the color of the two solutions. The lower solution or copper sulphate should show a blue color when in good condition. When it shows a brown color it indicates that the zinc is deteriorating.

The line of separation of the two liquids should be about half way between the copper and zinc elements. If too low, it can be raised by adding some copper sulphate crystals and water. If too high, a little can be siphoned out with a small rubber tube. Then short circuit the cell awhile to create more zinc sulphate.

#### 65. POROUS CUP CELLS

Another form of primary cell, also one of the Daniel type, uses a porous cup or cylinder between the positive and negative elements to separate the solutions. (See Fig. 5).

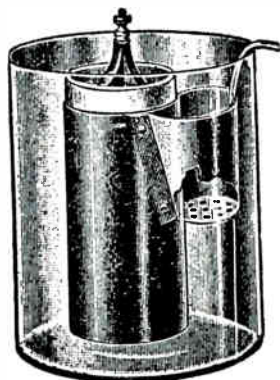

Fig. 5. Daniel Cell, in which the liquids are kept separated by a porous cup.

This cell has a porous cup to keep the two liquids separated. Inside this cup is placed a saturate

solution of zinc sulphate, and the zinc electrode. Outside the cup the jar is filled with copper sulphate solution or dilute sulphuric acid, in which the copper electrode in the form of a cylinder is placed. The copper sulphate solution is kept renewed by the dissolving of copper sulphate crystals in a little perforated copper container shown in Fig. 5.

In this cell the porous cup keeps the liquids separate, and thereby prevents polarization, but does not prevent the proper chemical action, or prevent the current flow in the cell. They are better for portable use than the gravity type, as their solutions cannot mix so easily by motion or jarring.

#### 66. EDISON PRIMARY CELL

The Edison cell is quite commonly used in railway signal work, and many other places. These cells use an alkaline solution such as caustic soda or caustic potash, and a positive element of copper oxide, and negative of zinc. (See Fig. 6.) They supply a low voltage of about .7 volt, but their internal resistance is very low, and they will deliver from 1.5 to 7.5 amperes according to the size of the cell. If short circuited their current will range from 7 amperes with the small cells to 33 amperes for the largest, but this rate of course cannot be maintained long.

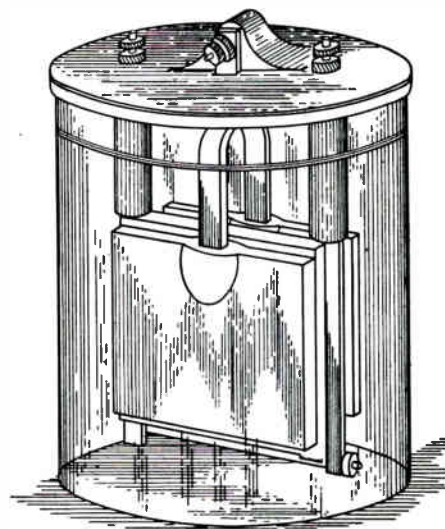

Fig. 6. Edison Primary Cell.

The negative zinc element is amalgamated throughout by adding mercury to it while it is being cast. The positive element consists of a mass of copper oxide mixed with metallic particles coated with copper, to decrease its resistance.

After considerable use the hydrogen bubbles reduce the copper oxide to metallic copper, and it must then be replaced like the zinc.

These cells are very rugged in construction and will stand quite cold weather without freezing, so they are often used for railway signal batteries, and other outdoor work.

The electrolyte should be covered with a thin layer of paraffin oil to prevent evaporation, and to stop the salts from "creeping" over the sides of the jar.



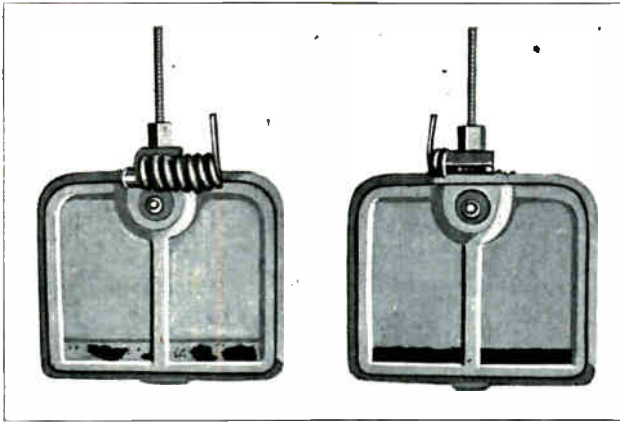

Fig. 7. Zinc elements of an Edison Primary cell, with "indicator panels" which show their condition.

The zinc plates of these cells are made with special sections or panels at the bottom edges, which become eaten away first, as the cell is used and exhausted.

This is called an indicator panel, and is very useful in determining when the cells should be renewed.

Fig. 7 shows two plates at different stages of exhaustion. The one at the left with the panel partly eaten away is about 85% exhausted, and the one at the right with the panels eaten out entirely is almost completely exhausted. They should be replaced at once when this condition is noted.

Fig. 8 shows the renewal parts for one of these cells. This consists of the new zinc element, a can of caustic soda, and the bottle of oil to cover the electrolyte surface. The soda and oil supplied are in just the right amounts for the one cell, and the entire contents should be used when renewing a cell.

In maintaining these cells and making renewals, clean water should be used, and the soda should be poured slowly into the water while it is being stirred constantly, with a clean wood stick or glass rod.

This caustic soda should be handled very carefully, as it will burn the flesh and destroy clothing if spilled on them.

The element should hang vertically when im-



Fig. 8. Renewal parts for Edison Primary cell, consisting of zinc, caustic soda and oil.

mersed in the solution. If the cell is to be used on open circuit work the element should be short circuited with a piece of wire before inserting it in the hot solution, and the "short" left on a couple of minutes after the element is immersed, and then remove the wire.

The electrolyte should be kept up to within  $\frac{3}{4}$ " of the top of the jar at all times, and should always be stirred after adding water.

Fig. 9 shows a group of this type of primary cells in use in a railway signal tower.

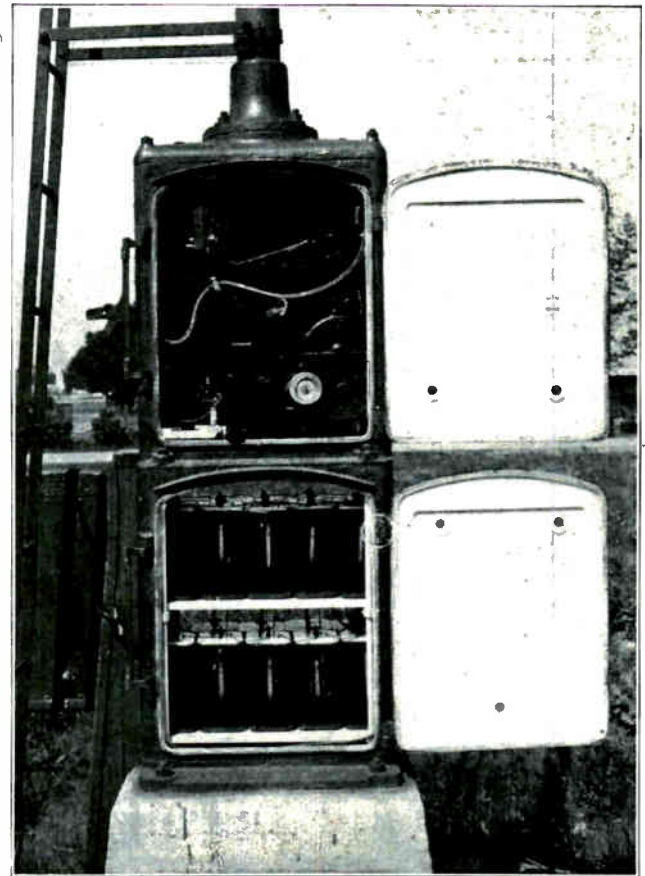

Fig. 9. Edison cells in railway signal tower.

They are located in a weather proof iron box in the lower section of the tower. Many times they are located in concrete pits or "battery wells" along the tracks.

## 67. DRY CELLS

Dry Cells are probably the most universally used of any type, because of their great convenience and portability.

Practically every one has seen and used them in some device or other, such as flashlights, lanterns, door bells, electric clocks, electric toys, gas engine ignition systems, rural telephones, radios, etc.

Their construction is shown in Fig. 10.

The zinc element is in the form of a cylinder and serves as the container for the rest. The other element is a carbon rod in the center, and around it is packed a pasty mass of granulated carbon and manganese dioxide, saturated with ammonium chloride (Salammoniac) as the electrolyte.

The manganese dioxide acts as a depolarizer and helps prevent the formation of hydrogen gas bubbles. Other ingredients are added by various manufacturers in their patented processes.

Between the wet mass and the zinc container there is a porous paper separator which allows the chemical action to take place, but prevents a short circuit between the carbon and zinc.

The tops of these cells are sealed with compound that makes it possible to handle or place them in any position. This compound will melt if the cell is over heated.

The whole cell is placed in a paper container to prevent the zinc from coming in contact with other metal objects, and to serve as a protector and insulator.

### 68. USE AND CARE OF DRY CELLS

Dry cells are designed to operate on open circuit systems, where current is only used occasionally for short periods. But they are sometimes used on

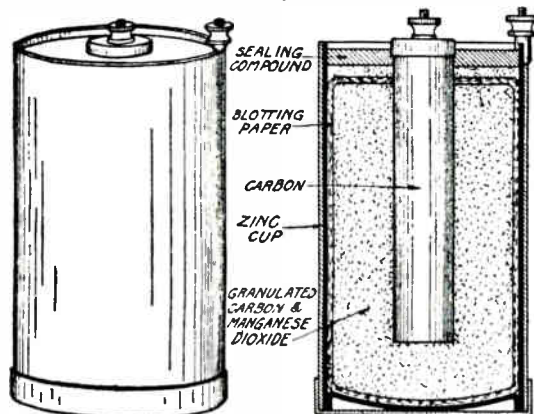

Fig. 10. Typical dry cell, with sectional view showing parts and construction.

closed circuit systems where only very small amounts of current are required.

If used on a circuit or device requiring heavy current, or if short circuited, the rate of current flow at first may be 30 amperes or more, but will fall off very rapidly. This is because their depolarizing material is not strong enough to prevent the formation of hydrogen gas at higher rates of current flow.

If a cell which has been shorted briefly or used on a heavy load, is allowed to stand a while, it will often recuperate or supply nearly normal current again, as it has been given time to break up the gas formation with its depolarizer chemical.

The life of a dry cell will be much greater if used as intended, to supply small currents for short periods with intervals of rest between.

Dry cells are made in different sizes, but perhaps the most commonly used is the number 6 size, about 2½ inches in diameter and 6 inches high. This cell when new should test 1½ volts with a battery voltmeter, and 30 to 35 amperes on short circuit with a battery ammeter.

Then there are the very small sizes used in pocket flashlights, etc. As before mentioned, radio "B" batteries are a group of these little cells connected in series and sealed in a paper box.

Some dry batteries for radio and test work requiring high voltages, are built of little flat cells stacked together. These use flat plates, of zinc and carbon with a layer of the acid paste in between, for each cell. When a number of these are stacked they are more compact and eliminate a lot of connecting wires. See Fig. 11, which shows a comparison of the old type, and the new type "layer built" B batteries.

Dry cells should not be stored or located in damp places, or they will quickly deteriorate or lose their strength.

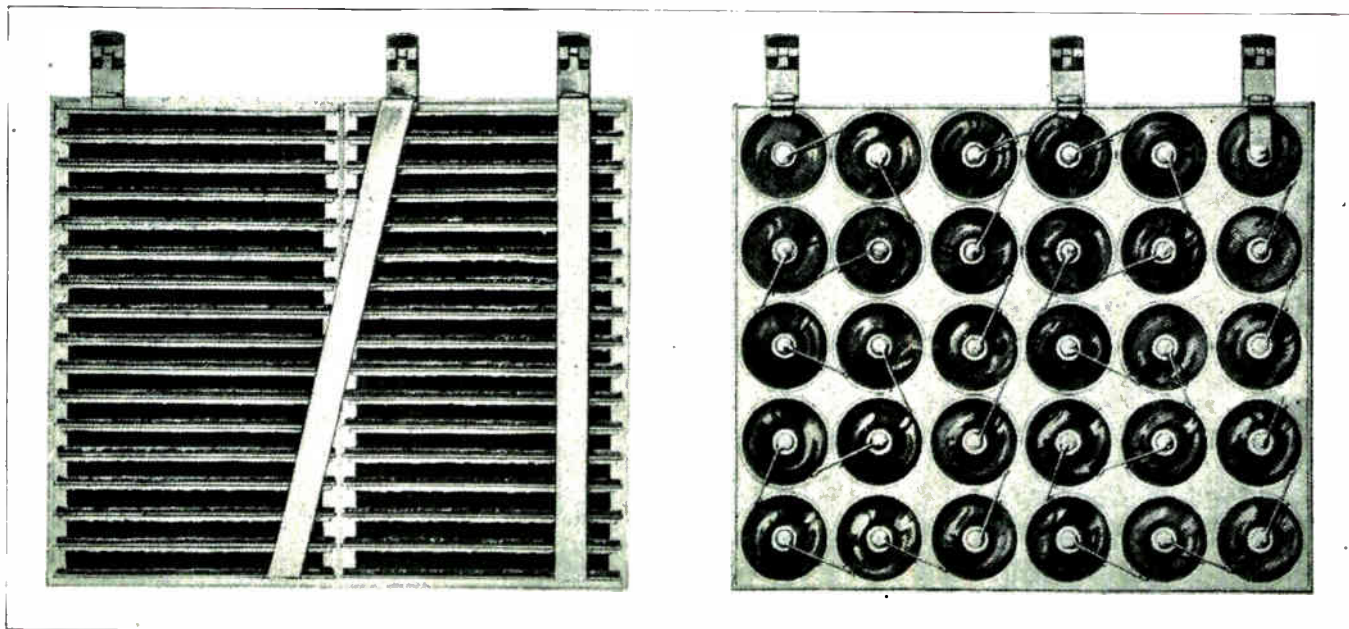

Fig. 11. Views showing inside construction of radio "B" batteries. Compare the new "layer built" type on the left, with the series grouped cells on the right.

Their tops and terminals should be kept clean of dirt and dampness, and terminals also kept tight.

The terminal nuts provided for easy connection of wires are very convenient, and are sometimes called binding posts.

### 69. POLARITY

The center terminal on the carbon electrode is always positive and the one on the zinc shell is negative. Current flows from positive to negative outside the cell, and from zinc or negative through the paste to carbon or positive, in the internal circuit.

These cells will often decrease in strength if stored too long on shelves before being sold, and therefore should be tested when buying.

When the paper covering of a dry cell shows damp or greasy appearing spots, or if when the paper is removed, the zinc shows bulges and holes eaten through it, this shows the cell is dead or used up, and should be replaced.

It is not practical to try to recharge dry cells, except in rare emergencies.

Dry cells can be adapted to many uses, and made to supply a wide variety of voltages or current capacity, by proper connection in series or parallel as covered in the previous section on series and parallel circuits. Fig. 12 shows a group of six dry cells connected parallel-series, and ready for use in a burglar alarm system.

In dealing with any cells it is well to remember that the copper or carbon electrode at which current leaves the cell is called the **Cathode**, and has the positive terminal attached to its top or pole. The zinc electrode at which current enters the cell from



Fig. 12. Six dry cells connected parallel-series, for use in an alarm system.

the external circuit, is called the **Anode**, and has the negative terminal attached to its top.

The Internal circuit of a cell includes the electrodes and electrolyte. The External circuit refers to the wires and devices connected to its terminals.

The practical man will often have many uses for various types of batteries in his work, and this general knowledge of their operation and care should be of great value to him.

When you have carefully studied this material you should feel confident of your ability to install, care for, test and renew any of the common primary cells.

Remember you are not expected to memorize all of the material or data, but should use this set for reference any time necessary, when you have such problems or work ahead to do, and until practice fixes them in your mind.

This section has dealt only with various types of primary cells, as storage batteries of the lead plate and acid type, and also the nickle-iron alkaline type, will be covered thoroughly in a later section.

## MAGNETISM

**70. MAGNETS AND MAGNETISM** play such an important part in the operation of many electrical devices and machines, that every electrical man should have a good understanding of them.

Magnetism is also an extremely interesting subject, and you will really enjoy the following practical material.

You have probably seen magnets in use in some form or other, such as magnetic tack hammers or toy horseshoe magnets, with their mysterious power to attract tacks, nails, and other iron and steel objects.

Then there are the common magnetic compass, magnetized pocket knives and screw drivers, as well as magnets of another type in bells, buzzers, etc. But most people without electrical training do not realize that magnets form a large part of every electric motor and generator, and thousands of other devices such as telephone and a radio receivers, tele-

graph instruments, power and telephone relays, magnetic tools, etc.

**71. NATURAL MAGNETS** were first found in Magnesia, a country in Asia Minor, about 600 B. C., and for this reason were called magnetite or magnets. (See Fig. 1.)

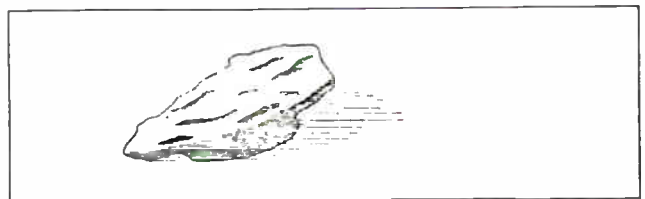

Fig. 1. Sketch of natural magnet or lodestone.

These first magnets were just lumps of iron ore or oxide, which were found to have the power of attracting small pieces of iron. Later it was also discovered that if an oblong piece of this material

was suspended by a thread, it would always turn to a position with its length north and south. If moved or turned, the same end would always go back to point north. So its end which pointed north was called the North seeking or North end, and the other end the south seeking or south end. It was used in this manner as a crude compass and often called "Lodestone," meaning leading stone.

Our compasses today are simply small steel needles that have been permanently and strongly magnetized, and mounted on jeweled pivots so they are free to turn easily. They are made by the thousands in many styles and sizes from the pocket variety used by hunters and explorers to keep their directions, to the big elaborate ones used to guide our steamships and airplanes.

## 72. EARTH'S MAGNETISM

The earth is also a natural magnet on a huge scale, with centers of magnetic force or attraction on its north and south sides. (See Fig. 2.)

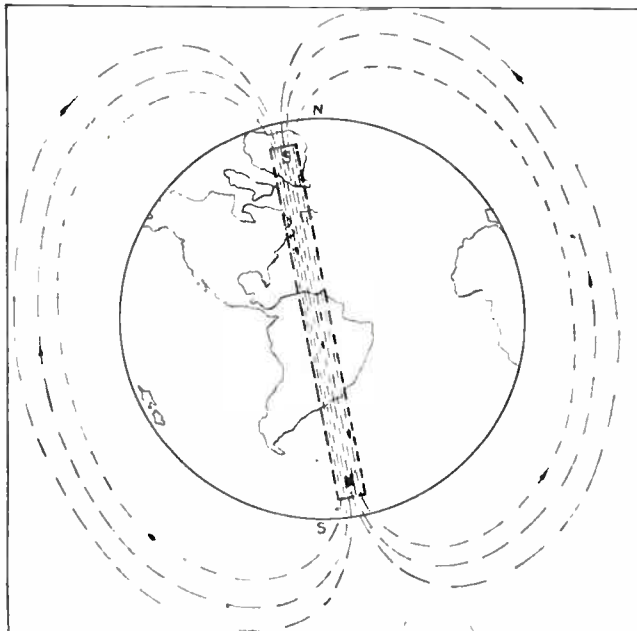

Fig. 2. Sketch showing earth's magnetic field and poles. Note that the magnetic poles do not exactly align with the geographical poles.

This is the reason for the attraction of the ends of the compass needle to a north and south position. But a compass does not point exactly true north, because the earth's magnetic centers are not exactly at its true north and south geographical poles, or ends of its axis.

In using a compass for accurate work, mariners, aviators, and surveyors allow a certain number of degrees for correction of this error, at various places on the earth.

You will note in Fig. 2, the earth's magnetic poles are opposite to its geographical poles. This will be explained later.

**73. ARTIFICIAL MAGNETS** are made of steel and iron, in various forms. Common types are the straight bar and horseshoe forms. (See Fig. 3A and 3B.) These are usually much more powerful than the natural magnets or lodestones.

Artificial magnets can be made by properly stroking a bar of steel with a lodestone or some other magnet, or by passing electric current through a coil around the bar. In fact we find that a piece of iron often becomes magnetized, just lying near a strong magnet. This last method is called **Induced Magnetism**.

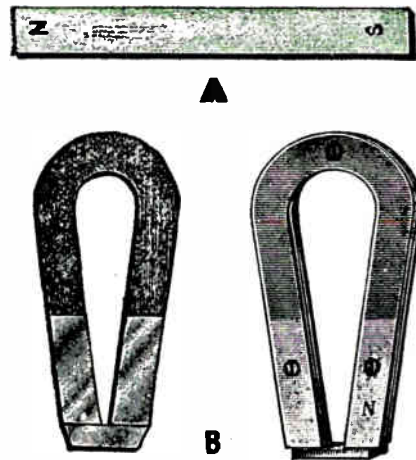

Fig. 3-A. Common bar magnet.  
Fig. 3-B. Horseshoe magnets with "keepers" across poles.

If a small bar of soft iron is held near to, but not touching a strong magnet, as in Fig. 4, the small bar will be found to have magnetism also, and attract nails or other iron objects. But as soon as it is taken away from the permanent magnet, it will lose its charge. This is an example of induced magnetism.

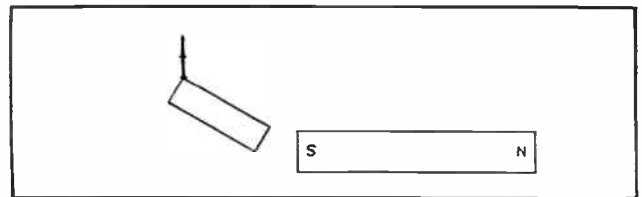

Fig. 4. The small bar of iron attracting the nails, obtains its magnetism by induction from being near the large magnet.

## 74. MAGNET POLES

All magnets whether natural or artificial, usually have their strongest pull or effects at their ends. These ends or points of stronger attraction are called **Poles**.

Ordinary magnets usually have at least two poles, called north and south, because of their attraction for the north and south poles of the earth.

If we dip a bar magnet in a pile of iron filings or tacks, we find it will attract them most at its ends, and not much in the middle. (See Fig. 5.)

## 75. ATTRACTION AND REPULSION

If we take two magnets and suspend them so they can turn freely until they come to rest with their north poles pointing north, and south poles pointing south, then we know that their ends which point north are alike, as well as the two which point south.

Now if we mark these magnets and bring the two north poles together, we find they will try to push

apart, or repel each other. The two south poles will do the same if we bring them near each other. But if we bring a north pole of one magnet near the south pole of the other they will try to draw together or attract each other.

This proves one of the most important principles or rules of magnetism often called the first law of magnetism, as follows: **Like Poles Always Repel and Unlike Poles Attract Each Other.** This law should be remembered as it is the basis of operation of many electrical machines and devices.

Prove it for yourself with magnets, at your first opportunity, so you will remember it better.

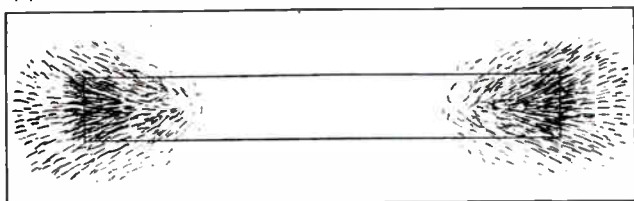

Fig. 5. Sketch of bar magnet showing how iron filings are attracted almost entirely at its ends or poles.

Refer back to Fig. 2, showing the earth's magnetic poles and you will now understand how we know that the magnetic pole in the north must be unlike the north pole of our compass, and why we assume that the earth's magnetic poles are opposite to its geographical poles.

#### 76. LINES OF FORCE

Magnets do not have to be touching each other, but will exert their force of attraction or repulsion through a distance of several inches of air in many experiments.

If we place a magnet under a piece of glass or paper which is covered with iron filings, and tap or jar it, the filings will arrange themselves as shown in Fig. 6A and 6B.

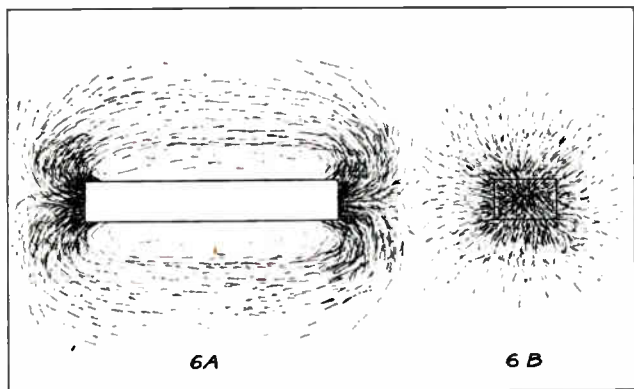

Fig. 6-A. Iron filings on a paper over a bar magnet, show shape of lines of force around the magnet.

Fig. 6-B. Filings over end of magnet.

This gives us some idea of the shape and direction of the lines of force acting around a magnet.

For practical purposes it is assumed that all magnets have what are called Lines of Force acting around and through them,<sup>1</sup> and in the direction indicated in Fig. 7.

These magnetic lines are of course invisible to the eye, and cannot be felt, but we can easily prove that the force is there by its effect on a compass

needle. By moving a small compass around a large magnet we can determine the direction of the lines of force at various points. They always travel through the compass needle from its south to north pole, so it will always turn to such a position that its north pole indicates the direction the lines are traveling. It is well to remember this, as a compass can often be used to determine the direction of magnetic lines of force in testing various electrical machines.

#### 77. MAGNETIC FIELD AND CIRCUIT

The lines of force around a magnet are called **Magnetic Flux**, and the area they occupy is called the **Field** of the magnet.

The strong, useful field of an ordinary magnet may extend from a few inches to several feet around it, but with sensitive instruments we find this field extends great distances, almost indefinitely, but becomes rapidly weaker as we go farther from the magnet.

In Fig. 7, note that the lines of force through the bar or **Internal path**, are from the south to north pole, and outside the magnet through the **External path**, are from the north to south pole. This is a very important fact to remember.

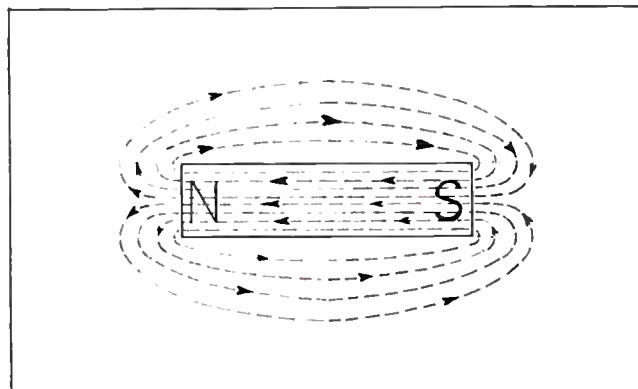

Fig. 7. Sketch of magnetic field, showing direction of lines, inside and outside the magnet.

We can also get further proof of the shape of this magnetic field by floating a magnetized needle in a cork, over a bar magnet as in Fig. 8.

If started at various points in the field the needle will travel the lines as indicated.

The path of lines of force around and through a magnet is often called the **Magnetic Circuit**.

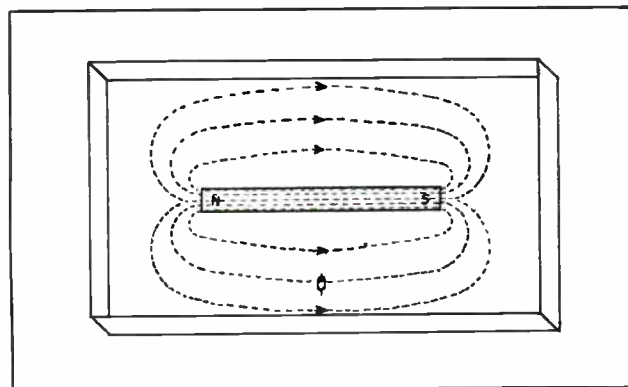

Fig. 8. Floating a needle in a cork, in water over a magnet, to show shape of lines of force.

## 78. ACTION OF MAGNETIC FIELDS

When two magnets are placed with unlike poles near each other as in Fig. 9, we find that their lines of force combine in one common path through them both as shown by the dotted lines.

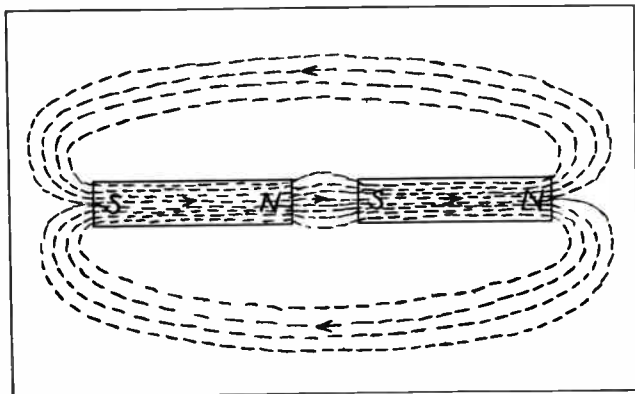

Fig. 9. Two bar magnets with unlike poles near each other, and attracting. Note how their fields join.

These lines then seem to try to shorten their path still more by drawing the magnets together, thus their attraction for each other.

It may be well to consider magnetic lines of force as similar in some ways to stretched rubber bands, revolving like endless belts, and continually trying to contract or shorten themselves.

This will help to get a practical understanding of many important effects and principles of magnetism, without going into lengthy and detailed theory.

If we place two magnets with their like poles near each other as in Fig. 10, we find their fields will not join, as the lines of force are coming in opposite directions. Therefore they crowd apart in separate paths between the ends of the poles, and the magnets push apart or repel each other to avoid this conflict or crowding of the opposing fields.

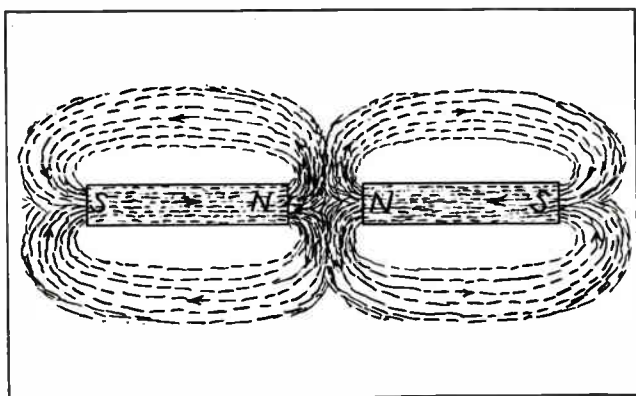

Fig. 10. Two bar magnets with like poles near each other and repelling. Note how their fields oppose.

## 79. MAGNETIC AND NON-MAGNETIC MATERIALS

In our experiments with magnets we find that only certain materials can be magnetized or attracted by magnets, while others cannot.

Those that can be magnetized we call **Magnetic**

**Materials**, and those that cannot be magnetized we call **Non-Magnetic Materials**.

Iron and steel are good magnetic materials, and most magnets are made from them. Nickel and cobalt are somewhat magnetic. Brass, copper, gold, silver, lead, wood, glass, air, etc., are all non-magnetic materials.

## 80. PROPERTIES OF MAGNETIC MATERIALS

Soft iron is very easily magnetized, but does not hold its charge long. In fact it loses most of its magnetism as soon as the magnetizing force is removed.

Hard steel is much more difficult to magnetize, but when once charged it holds its magnetism much longer.

A good steel magnet may hold a strong charge for many years. Such magnets are called **Permanent Magnets**.

Materials that hold a charge well are said to have high **Retentivity**, meaning retaining power.

Therefore steel has high retentivity and soft iron is low in retentivity. In order to understand how magnets become charged, and why some will hold a charge better than others, let us briefly consider the molecular theory of magnetism. We know that all matter is made up of very small particles called molecules, and these molecules consist of atoms and electrons.

Each molecule has a polarity of its own, or might be considered as a tiny magnet. In a bar of iron or steel that is not magnetized, it seems that these molecules arrange themselves in little groups with their unlike poles together, forming little closed magnetic circuits as in Fig. 11.

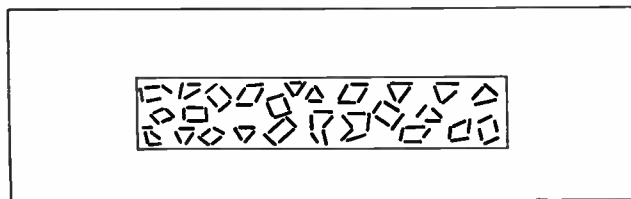

Fig. 11. Simple sketch showing the supposed arrangement of molecules in an unmagnetized bar of iron.

This view, of course, shows the molecules many times larger in proportion to the bar, than they really are.

Now when lines of force are passed through the bar, from some other strong magnet, causing it to become magnetized, the little molecules seem to line up with this flux, so their north poles all point one way and all south poles the other way. (See Fig. 12.)

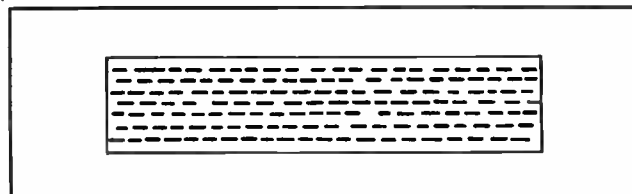

Fig. 12. Molecules lined up, in a fully magnetized bar.

In soft iron this change is effected very easily, and as we have already said it can be easily magnetized. But the molecules of iron also shift back to their natural position easily, so it quickly loses its magnetism.

With hard steel the molecules do not shift so easily, so it is harder to magnetize, but once charged the molecules do not shift back to their normal position so easily, and it holds its magnetism much better, as stated before.

When charging or making permanent steel magnets, tapping or vibrating the bar slightly seems to help speed the process. On the other hand if a permanent magnet that has been charged, is struck or bumped about roughly it will lose a lot of its strength, as the jarring seems to shift the molecules. Therefore, permanent magnets should be handled carefully.

The magnetism of a bar can also be destroyed by heating it to a cherry red. This is called **De-Magnetizing**.

If a magnet is placed in a reversing flux or field from some source, so its charge or polarity is rapidly reversed, the rapid shifting of the molecules sets up heat. This is called **Hysteresis loss**. Naturally this effect is much less noticeable in soft iron than in hard steel, as the molecules shift easier and with less friction and heat, in the soft iron.

### 81. PERMEABILITY AND RELUCTANCE

Experiments prove that magnetic lines of force will pass through iron and steel, or magnetic materials much easier than through air, wood and brass, or non-magnetic materials of any kind. So iron and steel form a good path for magnetic flux, and are said to have high **Permeability**, and low **Reluctance**. The term reluctance means the same to magnetic flux as resistance means to electric current.

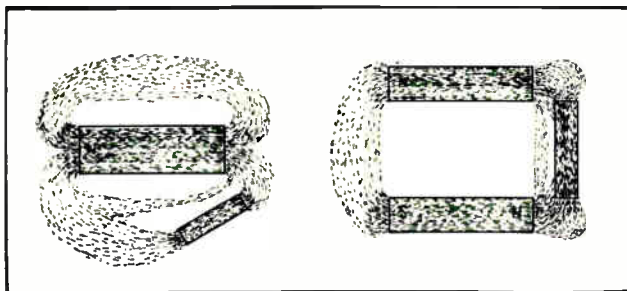

Fig. 13-A. & B. Sketches showing how lines of force can be distorted and made to follow the easier path through the small iron bars.

If we place a small bar of soft-iron in the field of a larger magnet as in Fig. 13A or near the ends of two magnets as in Fig. 13B, in both cases the lines of force will largely choose the easier path through the iron as shown. This can be proven by sprinkling iron filings on a glass over such a group of magnets and iron. This not only proves that iron is of lower reluctance than air, but also that magnetic flux will choose the easiest path available.

Good soft iron is only about 1/2000th part as high reluctance as air. For this reason we construct

many magnets in the form of a horseshoe, which brings the poles closer together, greatly reducing the air gap reluctance and increasing the strength and life of the magnet. (See Fig. 14A and 14B.)

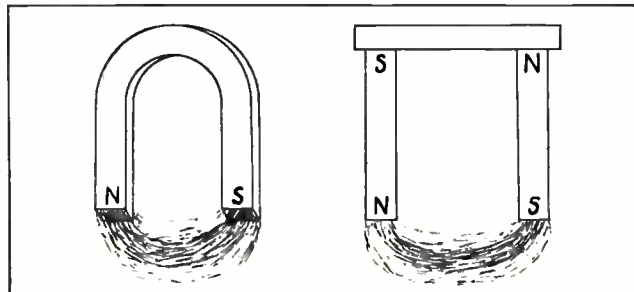

Fig. 14-A. Horseshoe magnets have a much shorter flux path through air from pole to pole.  
Fig. 14-B. Double magnet constructed in horseshoe shape, also to shorten its air gap.

In Fig. 14B, the bar joining the two magnets together is called a **yoke**. We often place a soft iron "keeper" across the ends of horseshoe magnets as in Fig. 15, when they are not in use, to provide a complete closed circuit of magnetic material and eliminate the air gap reluctance. This will greatly increase the life of the magnet.

### 82. PULLING STRENGTH

Horse shoe shaped magnets having unlike poles near each other, have a much greater lifting power when in contact with an iron surface, than the one end of a bar magnet does. This is because the horseshoe type has so much better complete path of low reluctance for its lines of force, and the field will be much more dense, and stronger. (Compare Fig. 15 and 16.)

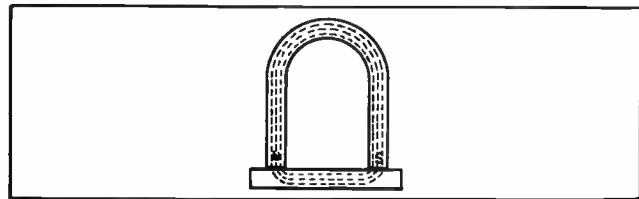

Fig. 15. Horseshoe magnet with keeper bar across its poles to decrease air gap when not in use.

In Fig. 16, the lines must pass a considerable distance through air, which greatly weakens them. In Fig. 15, the lines can travel entirely within a closed iron path or circuit of much lower reluctance, and give a much stronger pull.

A good horseshoe magnet weighing one pound, should lift about 25 pounds of soft iron.

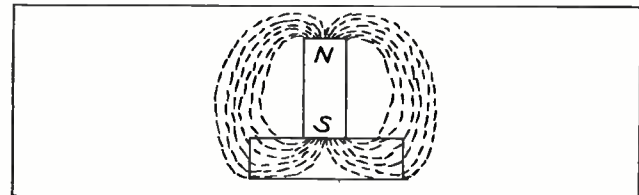

Fig. 16. Bar magnet attracting a piece of iron. Note the long path through air, which the lines of force must take.

### 83. EFFECT OF AIR GAPS

As air is of such high reluctance it is very important to reduce the air gaps as much as possible in all magnetic circuits where we wish to obtain the greatest possible strength of flux or pull.

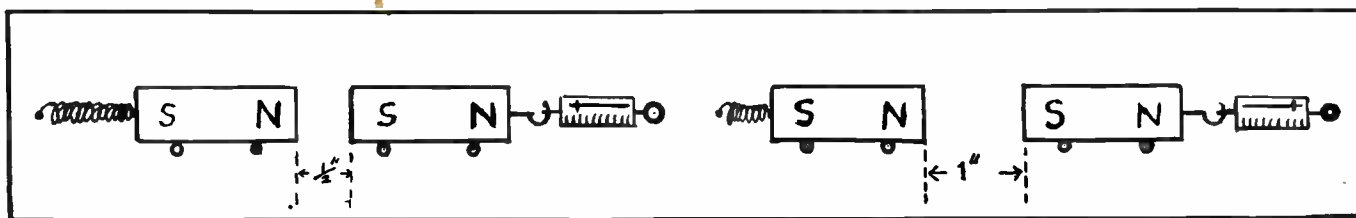

Fig. 17-A. & B. Doubling the distance between two magnets, decreases their pull to  $\frac{1}{4}$  of what it was.

If two magnets are placed as in Fig. 17A, and their pull measured, and then they are moved farther apart as in Fig. 17B, we find that the small increase in the distance or air gap makes a great reduction in their pull. If the distance is doubled, the pull is decreased to about  $\frac{1}{4}$  of what it was.

If the distance is tripled, the pull decreases to about  $\frac{1}{9}$  of what it was.

If on the other hand we reduce the distance to  $\frac{1}{2}$  its original amount, the pull will increase to 4 times the original pull.

So we get another very important law of magnetism as follows:

The force exerted between two magnets varies inversely with the square of the distance between them.

If we change the strength of the magnets we find their combined pull will vary with the Product of Their Separate Strengths.

#### 84. MAGNETIC SHIELDS

While iron is a good conductor of magnetic flux, and air is a very poor one, we do not have any known material that will insulate or stop magnetic lines of force. They will pass through any material. But we can shield magnetic flux from certain spaces or objects, by leading it around through an easier path. As before mentioned the line of force will largely choose the easiest path. So if we arrange a shield of iron around a device as in Fig. 18, we can distort the flux around, and prevent most of it from entering the shielded area.

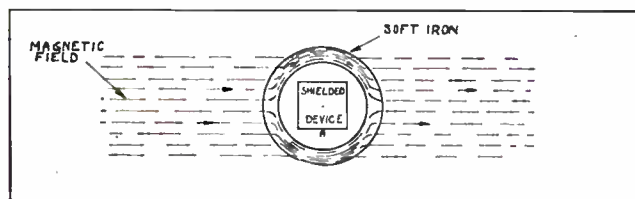

Fig. 18. Iron shield to deflect lines of force away from instrument or device (A).

Quite often the magnetic field of some large generator or electric machine may affect the operation of a meter or some delicate device located near it. So you should remember how to shield such instruments. Many meters are equipped with iron cases to shield their working parts in this manner.

Sometimes in our work with magnets we find evidence of more than two poles, or points of attraction at other places along the magnet besides at its main poles. Such poles are called Consequent Poles, and are formed by adjoining sections being

oppositely magnetized so the fluxes oppose. Very weak magnets may sometimes develop consequent poles. (See Fig. 19.)

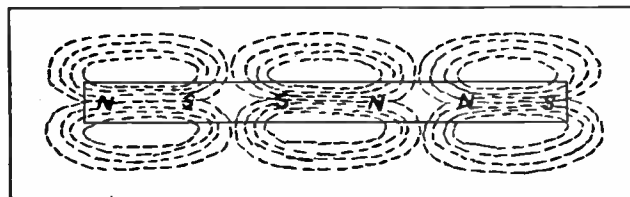

Fig. 19. Consequent poles in a bar magnet.

If a long magnetized bar is broken into several pieces, each piece will take on separate north and south poles. (See Fig. 20.)

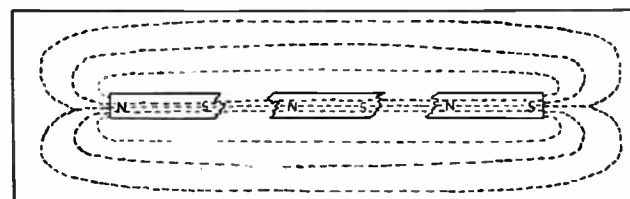

Fig. 20. Bar magnet broken into several pieces. Note each piece takes on separate poles in this case.

Two or more separate magnets with their like poles grouped together will in many cases give more strength than a single magnet the size of the group. Such a magnet is called a Compound Magnet. (See Fig. 21A and 21B.)

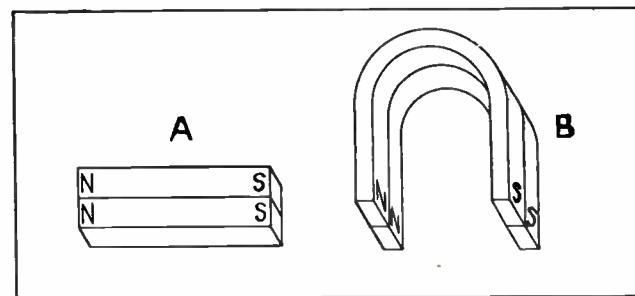

Fig. 21-A. Compound bar magnet.  
Fig. 21-B. Compound horseshoe magnet.

#### 85. COMPASS TEST

When using a compass to test the polarity of magnets, or the direction of flux on motors or generators, it is well to first test the compass by letting it come to rest in the earth's magnetism, away from the device to be tested. Compass needles sometimes have their polarity reversed by the influence of strong magnets around which they are used. But the end of the needle that points north is always the north pole, and the one which will point in the direction of flux travel.



This may seem confusing because we know unlike poles attract, and might wonder how the north pole of the compass would point to the north pole of the earth. But remember that the magnetic pole of the earth which is near its north geographical pole, is in reality a south magnetic pole. This was illustrated in Fig. 2, and explained in Articles 72 and 75.

### 86. SPECIAL MAGNETIC ALLOYS

There are certain patented alloys of iron and steel mixed with other metals, which have very good magnetic properties. Some of these have higher permeability than soft iron, and others have higher retentivity than hard steel.

**Cobalt Steel** is one of these improved alloys, especially good for strong, permanent magnets.

**Permalloy** is another, of very low reluctance, used in thin ribbon form for wrapping telephone and telegraph cables.

We find a few materials that show slight properties of repulsion to either pole of a magnet. These are called **Diamagnetic**.

Some of the uses of permanent magnets were mentioned in the first part of this subject. They are also used for fields of magnetos, in electric meters, for surgical instruments, and many other things.

Before proceeding farther, be sure you have a good understanding of these important principles of magnets and magnetism, as it will be of great value to you in all electrical work. It will also make it easy for you to understand the very interesting section on **Electro-Magnetism** which follows.

## ELECTRO-MAGNETISM

You will recall that in an earlier section we found that one of the very important effects of dynamic electricity, was its magnetic effect.

We learned that whenever a current is passed through a wire, it sets up whirling lines of force around the wire. This is called **Electro-Magnetism**.

### 87. MAGNETIC FIELD AROUND WIRES CARRYING CURRENT

The strength of this magnetic field around a wire depends on the amount of current flowing, and can be varied at will by controlling the current flow.

The direction of the line's rotation depends on the direction of current through the wire; reversing if we reverse the current.

If we pass a stiff wire which is carrying current, vertically through a piece of paper, as in Fig. 1, and sprinkle iron filings on the paper, they will arrange themselves in a pattern as shown.

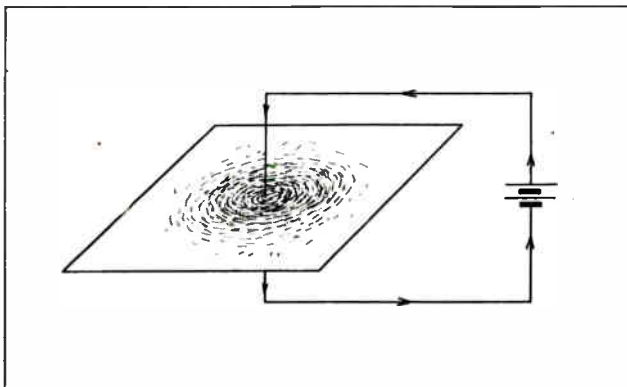

Fig. 1. Electro magnetic lines shown by iron filings around a conductor.

If we remove the filings and place several small compass needles on a cardboard around the wire,

they will point in a circle as shown in Fig. 2. These experiments prove the existence of this invisible magnetic force, and also show the circular shape of the field around the wire. The north poles (black ends) of the compass needles also show the direction the lines of force travel. If the current flow is stopped, the needles will all point north, but as soon as current is again started they will point in a circle once more.

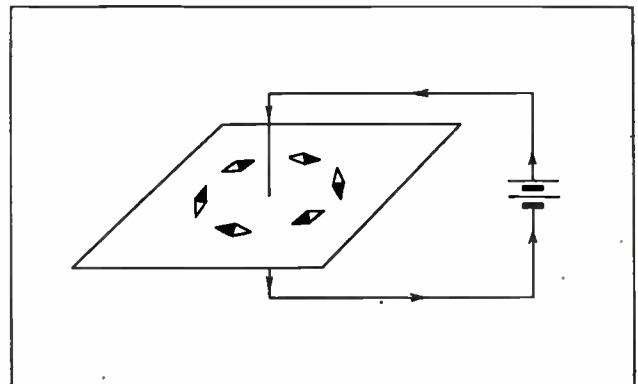

Fig. 2. Small compass needles showing shape and direction of lines around a conductor.

### 88. DIRECTION OF LINES AROUND CONDUCTORS

Note the direction of current in the wire in Fig. 2, and the direction the needles point. If we change the leads at the battery, and thereby reverse the direction of current through the wire, the needles will at once reverse their direction also. This proves that the field reverses with the current.

We can see from this that if we know the direction of current in any wire, we can determine the

direction of the lines of force around it. Or if we know the direction of flux, we can find the direction of current.

A single compass needle is all that is required to tell the direction of flux. See Fig. 3.

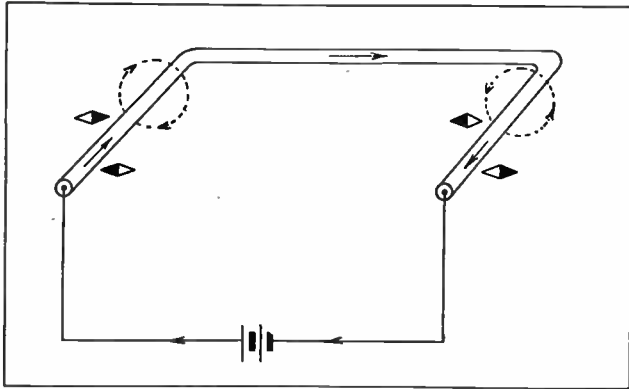

Fig. 3. Convenient compass test for direction of flux around conductors. Note carefully the direction of current and flux of each end of the wire.

Here we have a bent piece of stiff wire connected to a battery by other wires. The current in the left end is flowing away from us, and if we place a compass under the wire it points to the left. If we move the compass above the wire it points to the right.

This proves that when current is flowing away from you in a wire, the lines of force are revolving Clockwise, as the hands of a clock turn.

When we try the compass on the right end of the loop where the current flows toward us, we find it points opposite to what it did on the left end.

This proves that when current flows toward you in a wire, the lines of force revolve counter clockwise. See the lines of force indicated by the dotted lines. Study this rule over carefully and start practising it at every opportunity on actual electric circuits, because it will be very useful later in your work on power machines and circuits.

**89. RIGHT HAND RULE FOR DIRECTION OF FLUX**

Another simple rule by which you can determine the direction of current, or flux of wires, is called the "Right hand rule". Grasp the wire with the right hand, with thumb pointing in the direction of current flow, and your fingers will point in direction of flux around the wire. (See Fig. 4-A and 4-B.)

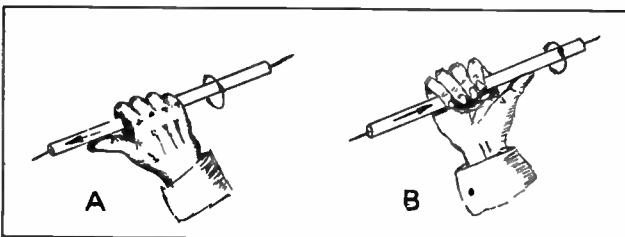

Fig. 4. "Right hand rule" for direction of flux around conductors.

This rule should be memorized by practice.

Of course in the case of a bare, uninsulated wire it is not necessary to touch or actually grasp it to use this rule. After a little practice you can use

it very well by just holding your hand near the wire in a position to grasp it, and with thumb in direction of current, your finger tips will indicate the direction of flux.

**90. MAGNETIC FORCES BETWEEN PARALLEL WIRES**

If we run two wires parallel to each other, close together, and both carrying current in opposite directions, we find their lines of force being in opposite directions tend to crowd apart, and actually make the wires repel each other. See Fig. 5-A.

In Fig. 5-B, are shown two flexible wires suspended close together, yet loosely and free to move. When a rather heavy current is passed through them in the direction shown by the arrows, they will crowd apart quite noticeably. The dotted lines show where they would hang normally when no current is flowing.

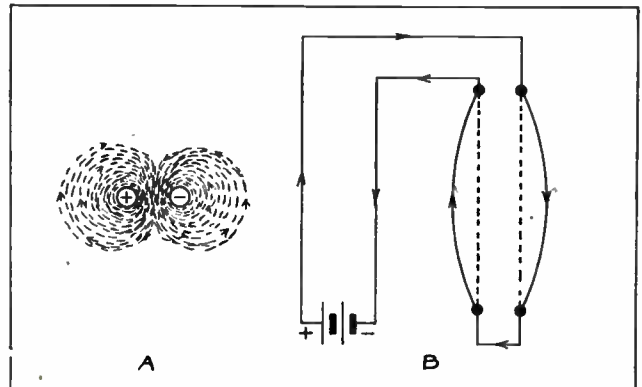

Fig. 5. This sketch shows the repulsion of parallel wires, carrying current in opposite directions.

If we run two wires parallel to each other, close together, and both carrying current in the same direction, we find that their lines of force tend to join together in one common field around both wires, as in Fig. 6-A and 6-B.

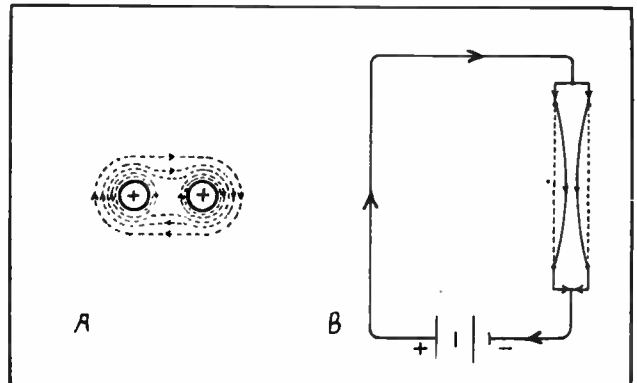

Fig. 6. When parallel wires carry current in the same direction, their flux tends to draw them together.

When wires are close together in this manner, the combined path around the two is shorter than the two separate path around each. Then by joining each other, the lines avoid going in opposite directions in the small space between the wires. This flux around the two wires tends to pull them together, as the lines of force are always trying to shorten their path, as we learned before.

In Fig. 6-B, we again have the two suspended parallel wires, this time carrying current in the same direction, and we find they now draw toward each other.

This magnetic force exerted between wires often becomes very great in the heavy windings of large power machinery, especially in case of excessive currents during overloads or short circuits. So we find their coils are often specially braced to prevent them moving due to this stress.

### 91. STRONG FIELDS AROUND COILS

We can make excellent use of this tendency of magnetic flux, to join in a stronger common field around two or more wires, to create some very powerful electro-magnetic fields.

One of the best ways to do this is to wind a coil of insulated wire as shown in Fig. 7-A.

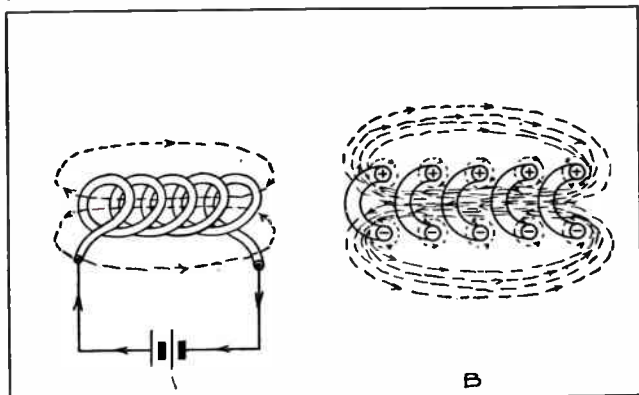

Fig. 7-A. The lines of force around the turns of a coil join together, in one very strong field.

Fig. 7-B. Sectional view, note how the lines join around all turns, and the dense flux set up in the center of the coil.

We can easily see that all turns of such a coil are carrying current in the same direction on all sides of the coil. If we split such a coil from end to end, as shown in Fig. 7-B, we can then see how the flux of all the turns will unite in a common field through the center of the coil and back around the outside.

### 92. SOLENOIDS

Such a coil of a single layer is called a **Helix**. Coils for creating strong electro-magnetic fields, are often wound with many layers of insulated wire on a spool of brass or fibre, or some other non-magnetic material. Such coils are called **Solenoids**. See Fig. 8.

By referring to both Figs. 7 and 8, we see that all the lines of force travel one way through the center of the coils in a very dense field, and back the other way outside the coil. Thus a solenoid has north and south poles just as a bar magnet does.

Now if we place an iron core inside of a solenoid the field will at once become much stronger, as the iron offers a much better path for the lines of force than air does. When we start to insert the core in a solenoid that has current flowing in it, we find it exerts a strong pull on the core, tending to draw it into the coil. This seems to be an effort of the lines of force to draw the iron into the most dense flux, which is inside the coil.

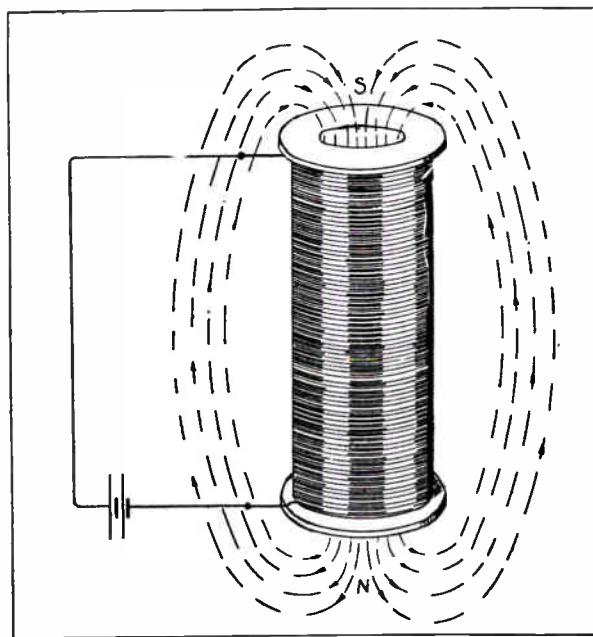

Fig. 8. Solenoid, or coil wound on a non-magnetic tube. Note the direction of the lines, and polarity of this solenoid.

A solenoid will give a strong and fairly uniform pull for about half its own length. This is the most effective distance. Solenoids with movable cores attached to levers, or handles of switches and controllers, are used considerably on electrical equipment.

### 93. ELECTRO-MAGNETS

While an iron core is inside a coil and current is flowing, we find the iron becomes strongly magnetized due to the very dense field in which it is located. But if the core is soft it loses practically all its magnetism as soon as the current is turned off.

Such a coil and core are called an **Electro-Magnet**. Or in other words an **Electro-Magnet** is a core of soft iron, wound with a coil of insulated wire.

Electro-magnets are the ones used in bells, buzzers, relays, lifting magnets, and electric motors and generators. They can be made extremely powerful, and have the advantage of being magnetized or demagnetized at will, by turning the coil current on or off.

The lifting magnet in Fig. 9, is an example of a huge electro-magnet. With the current turned on it is lowered to the iron it is to lift, often raising tons of metal at one time. Then when we want it to drop the iron the current is simply turned off.

### 94. CONSTRUCTION OF SIMPLE ELECTRO-MAGNETS. RESIDUAL MAGNETISM.

Electro-magnets for various tests or handy uses, can be easily made by winding a few turns of insulated wire around any soft iron core, and connecting the coil ends to a dry cell or storage battery. Even a nail or small bolt will do, and will prove quite a strong magnet when wound with 50 to 100 turns of No. 24 to 30 wire, and used with a dry cell. But you will note that as soon as the coil is disconnected, or the battery current turned off, the core will lose practically all its noticeable magnetic strength, as

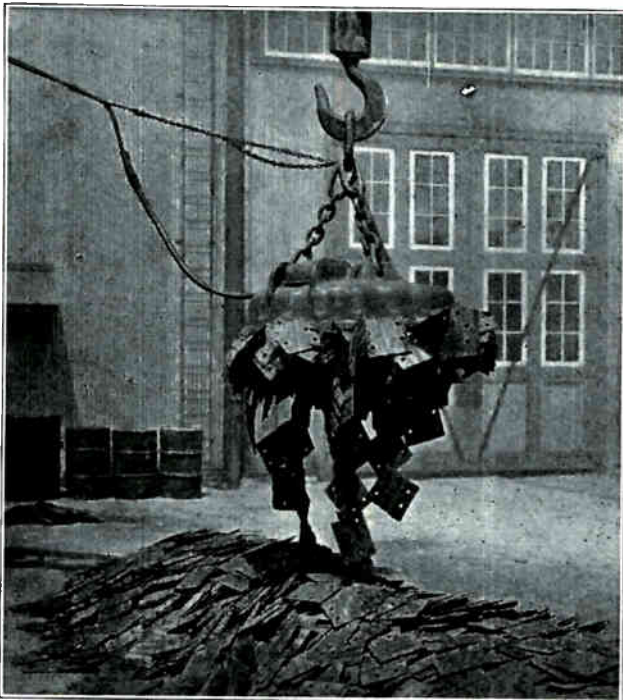

Fig. 9. Electro-magnet used for handling iron and steel. This magnet has a number of coils inside its frame or cover.

far as any attraction is concerned. However, in reality there is almost always a very feeble charge left in the core for a while after the current stops flowing. This charge remaining or residing in the core is called **Residual Magnetism**. The softer iron the core is made of, the less residual magnetism it will retain. Residual magnetism plays a very important part in the operation of many electric generators, as will be found later.

Permanent magnets can be made by placing a piece of hard steel in a coil for a time, with the current turned on. Then when the current is turned off, the hard steel being of higher retentivity than iron, retains considerable of its charge as residual magnetism.

Powerful electro-magnets are often used to charge permanent magnets, by holding or rubbing the magnet to be charged on the poles of the electro-magnet. See Fig. 10.

A good charging magnet of this type for charging

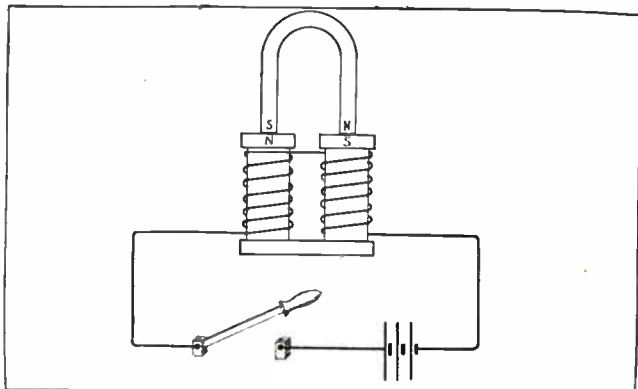

Fig. 10. Powerful electro-magnet for charging permanent magnets. The horseshoe magnet is in position to be charged and its poles will be as shown.

magneto magnets, can be made of two round cores of soft iron about 3x6 inches, wound with 500 turns of No. 14 wire on each. They should have a soft iron bar 1x3x8 inches bolted to their bottom ends, and square pieces 1x3x3 inches on their top ends. Such a magnet can be used on a 6-volt storage battery, and is often very handy in a garage or electrical repair shop.

### 95. POLARITY OF ELECTRO-MAGNETS

It is very important to be able to determine the polarity of solenoids and electro-magnets. A compass will, of course, show the north pole by the attraction of its tail or south pole. But if we know the direction of winding of a coil, and the direction current passes through it, we can quickly find the correct polarity with a simple rule. This rule is called the **Right Hand Rule for Electro-Magnets**.

Grasp the coil with your right hand, with the fingers pointing around the coil in the same direction current is flowing in the wire, and your thumb will point to the north pole of the magnet. See Fig. 11.

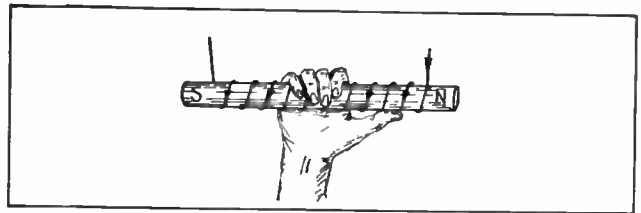

Fig. 11. Right hand rule for determining polarity of electro-magnet.

Every electrical man should know this rule, as there are many uses for it in practical work. Practice it until you can use it easily.

It can also be used to find the direction of current flow if you know the polarity of the magnet. In such a case we again grasp the coil with the right hand, thumb pointing to north pole, and the fingers will point in direction of current flow around the coil.

We already know that the flux around a wire will reverse if we reverse the current flow. This is equally true then of the flux around a coil or group of wires. So we can reverse the polarity of a solenoid or electro-magnet at will, merely by reversing the current supply wires to it.

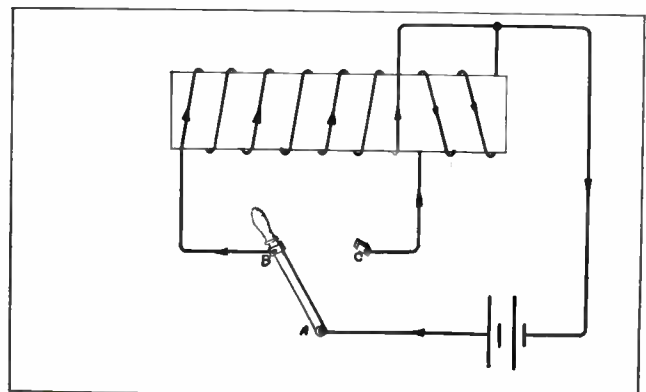

Fig. 12. Electro-magnet with demagnetizing coil for destroying residual magnetism.

Some special electro-magnets are wound with a separate demagnetizing coil, in addition to the main coil.

This may be a smaller coil, wound in the reverse direction to the main coil, so if connected just for an instant, after main coil is turned off, it will just destroy the residual magnetism that might otherwise remain. See Fig. 12.

If when switch (A) opens the main circuit at (B), it is momentarily closed to (C), it will create a reverse flux to more quickly demagnetize the core.

It is also possible to wind a coil on a core so it will create no magnetism in the core. See Fig. 13.

Here the coil has been wound with two wires, and their ends connected together. The current flows through an equal number of turns in each direction, so practically no magnetism will be set up in the core. Non-magnetic coils of this type are often used in meter construction.

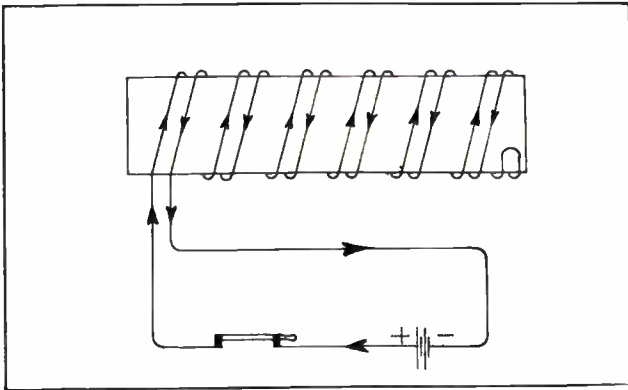

Fig. 13. Non-magnetic winding. One half of the turns oppose the other half, so the core does not become magnetized.

## 96. UNITS, SATURATION AND STRENGTH OF ELECTRO-MAGNETS

The strength of an electro-magnet depends on the number of turns in its coil, and the amperes or amount of current flowing through them, or as we say the **Ampere-Turns**.

The **Ampere-Turns** are the product obtained, when the amperes are multiplied by the number of turns.

A coil of 100 turns, carrying 2 amperes, has 200 ampere-turns. (Abbreviated I.N.)

Another coil of 400 turns carrying  $\frac{1}{2}$  ampere, has 200 ampere-turns.

We say therefore that the number of ampere turns, determines the **Magneto-Motive-Force**. (Abbreviated M.M.F.) and meaning magnetizing force.

The greater the M.M.F. or number of ampere-turns we apply to a given core, the stronger magnet it becomes, up to certain limits.

As we go on increasing the ampere-turns and strength of a magnet, the lines of force in its core become more and more dense and numerous. After we reach a certain point in flux density, we find a further considerable increase of ampere turns of the coil, does not cause much increase of flux in the core, as we have apparently reached its practical limit in the number of lines it can carry. This is called the **Saturation-Point**.

Good magnetic iron or steel can carry about 100,000 lines per square inch, before reaching the practical saturation point. Therefore, if we wish to make electro-magnets requiring more than 100,000 lines of force, we should use a core larger than 1 square inch cross sectional area. Fifteen ampere-turns per inch of core length, on a closed core of 1 square inch area, will produce approximately 100,000 lines of force.

The chart in Fig. 14, showing the lines of force per square inch, produced in soft iron by various numbers of ampere-turns, may often be very useful to you.

To read the chart select any number of ampere turns at the bottom line and run up the vertical lines to the curve, then to the left edge, and read number of lines. Thus 5 ampere turns gives about 67,000 lines per square inch. 10 ampere turns gives 90,000 lines. 12 ampere turns about 95,000 lines, etc.

It is interesting to note how the factors in a magnetic circuit can be closely compared to those of an electric circuit. In the electric circuit, we have pressure or **Electro-Motive-Force**, **Current** and **Resistance**. In the magnetic circuit we have **Magneto-Motive-Force**, **Flux** and **Reluctance**. And in the electric circuit we have the units volt, ampere and ohm, while in the magnetic circuit we have the **Ampere-Turn**, **Lines of Force**, and **Rel**.

The **Rel** is a name often used for the unit of reluctance. Its symbol is R.

One rel is the amount of reluctance offered by a prism of air or non-magnetic material, 1 inch square and 3.19 inches long. We know that iron is much lower reluctance than air, and it takes a bar of mild steel or wrought iron 1 inch square and 460 feet long to have a reluctance of 1 rel. Cast iron is somewhat higher reluctance, and a bar 1 inch square and 50.7 feet long has 1 rel reluctance.

One ampere turn can set up one line of force in a reluctance of 1 rel.

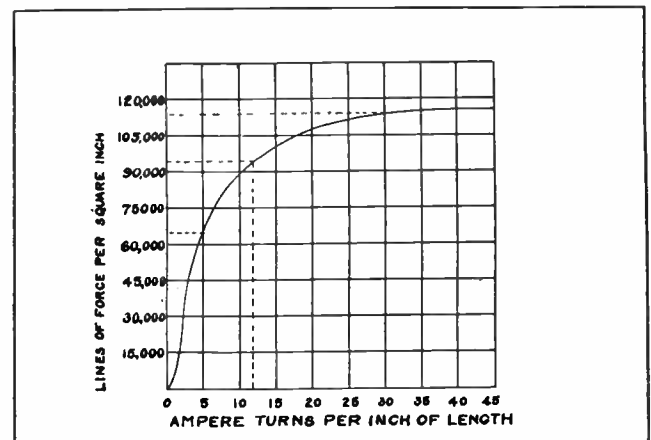

Fig. 14. Curve showing number of lines of force that can be set up in soft sheet iron, with various numbers of ampere turns.

## 97. PRACTICAL ELECTRO-MAGNET CALCULATIONS

To calculate the total flux or lines of force in a magnetic circuit we can use the following formulas:

$$\phi = \frac{M}{R}$$

In which:

- $\phi$  equals flux in lines of force.
- M equals MMF in ampere turns.
- R equals reluctance in rels.

For example, if we have 1200 ampere turns M.M.F., on a magnetic circuit of .03 rel, what would be the total flux?

$$\phi = \frac{M}{R}, \text{ or Flux} = \frac{1200}{.03} \text{ or } 40,000 \text{ lines.}$$

In order to be able to calculate the reluctance of a magnetic circuit, we must know the Reluctivities of common magnetic and non-magnetic materials.

Non-magnetic materials all have a reluctivity of about .313 rel, per inch cube.

Mild steel or wrought iron usually has a reluctivity of about .00018 rel, per inch cube, and cast iron .00164 rel per inch cube, under favorable conditions. But of course, the values vary somewhat with the density of the flux used in the metals.

Knowing these values, the reluctance of a core can be found as follows:—

$$R = \frac{\nu \times L}{A}$$

In which:

- R equals rels.
- $\nu$  equals reluctivity of core per inch cube.
- L equals length of core in inches.
- A equals cross sectional area of core in square inches.

If you wish to make a magnet using a wrought iron core 2x2x8 inches, what would the core reluctance be?

$$R = \frac{\nu \times L}{A}, \text{ or } R = \frac{.00018 \times 8}{4} \text{ or } .00036 \text{ rel.}$$

If the same magnet has an air gap of about 2x2x1 inches, what would the total reluctance of the circuit be, including the core and air?

$$R = \frac{\nu \times L}{A}, \text{ or } R = \frac{.313 \times 1''}{4} = .07825 \text{ rel.}$$

reluctance of air core.

Then .00036 plus .07825 = .07861 rel reluctance of total circuit.

If you wind 1000 turns of wire on this core, and pass 5 amperes of current through the coil, how much flux will be set up?

5 amps  $\times$  1000 turns equals 5000 ampere turns or I.N., and I.N. also equals M or MMF.

Then from our formula for determining flux:

$$\phi = \frac{M}{R}, \text{ or flux} = \frac{5000}{.07861} \text{ or } 63,605 \text{ lines.}$$

### 98. LIFTING POWER

The pulling or lifting power of a magnet depends on the flux density in lines per square inch, and the area of the poles in square inches. Then to determine the actual lift in pounds we use the

figure 72,134,000, which is a "constant," determined by test of the ratio of lines to lbs.

From this we get the very useful formula:

$$\text{Pounds Pull} = \frac{\text{Area} \times (\text{Flux Density})^2}{72,134,000}$$

(Note, the flux density is to be squared or multiplied by itself.)

If a magnet has a pole area of 4 square inches and a flux density of 100,000 lines per square inch, what would be its lifting power?

$$\text{Lbs.} = \frac{4 \times 100,000^2}{72,134,000} \text{ or } 554.5 + \text{ pounds.}$$

So we find that a good magnet should lift over 138 pounds per square inch of pole surface.

We can usually depend on a lift of over 100 pounds per square inch even though the magnet is only working at a density of 90,000 lines per square inch. This, of course, means the lift obtainable when both poles of the magnet are actually in good contact with the iron to be lifted.

You have now learned how to use the units Ampere-turn, lines of force, and rel, to calculate flux and pull of magnets by simplified formulas.

### 99. C. G. S. UNITS

It may be well to mention here another set of units used in some cases instead of those above mentioned.

These are the Gilbert, Maxwell, and Oersted.

The Gilbert is a unit of M.M.F., similar to the ampere-turn, but one ampere-turn is larger, and equal to 1.257 Gilbert.

The Maxwell is a unit of flux, or the same as one line of force.

The Oersted is a unit of reluctance, and is the reluctance of 1 cubic centimeter of air or non-magnetic material.

This second set of magnetic units are from the C.G.S. (Centimeter, gram, second) system of units, and can be used for practically the same purpose as the ampere-turn, line of force, and rel. They merely differ slightly in size, the same as the centimeter and the inch are both units of measurement, only of different sizes.

The practical man will probably find the ampere-turn, lines of force, and rel, much easier units to use, because they deal with square inches instead of centimeters, and the ampere-turn is so easily understood, as a unit of M.M.F. The other units are merely mentioned and explained here, so if you see or hear them used from time to time you will understand their meaning.

Direct current is best for operation of Electro-magnets, as its steady flow gives a much stronger pull per ampere-turn, than alternating current.

However, many A. C. magnets are used on motor controllers, relays, circuit breakers, etc.

### 100. MAGNET WINDING AND REPAIRS

In making electro-magnets the core should be of good soft iron, and covered with one or more layers of oiled paper or varnished cloth insulation.

This will prevent the wires of the first layer of winding from becoming grounded or shorted to the core, if their insulation should become damaged.

Some sort of end rings should be provided to hold the ends of the winding layers in place. Hard fibre is commonly used for this purpose. See Fig. 15, which shows a sectional view of an electro-magnet.

Some magnet coils are wound with thin insulation between each layer of wire, and some are wound without it. It is not absolutely necessary to have the turns of each layer perfectly flat and even, as they are in machine wound coils, to make a good magnet. But they should be wound as smooth and compact as possible.

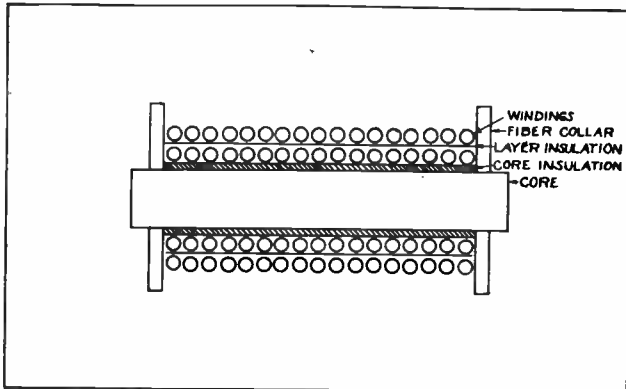

Fig. 15. Sectional view of electro-magnet, showing core, insulation and winding.

Magnet wires, with insulation of cotton, silk, enamel, or combinations of cotton-enamel or silk-enamel, are used for winding electro-magnets. Enamel is excellent electrical insulation, takes up the least space in the coil, and carries heat to the outside of coil very well. Therefore it is ideal for many forms of compact coils, of fine wires. But the cotton or silk covered wires are easier to handle and wind, as they stand the mechanical abuse better.

When winding a magnet coil with very fine wires which are easily broken, it is well to splice a piece of heavy flexible wire to the fine wire, for both starting and finishing leads of the coil. The piece of heavier wire used in starting the coil should be long enough to make several turns around the core, to take all strain off the fine wire in case of a pull on this end wire. Then wind the fine wire over the "lead in" wire, and when the coil is finished attach another piece of heavy wire, and wrap it several times around the coil, to take any possible strain on this outer "lead" wire. Any splices made in the coil should be carefully done, well cleaned, and soldered, so they will not heat up, arc or burn open, after the coil is finished and in service. A layer of tape or varnished cloth should be put over the outside of the coil to protect the wires from damage.

When repairing and rewinding magnet coils from motors, controllers, relays, or any electrical equipment, be careful to replace the same number of

turns and same size of wire as you remove. Otherwise the repaired coil may overheat or not have the proper strength.

If the wire removed is coarse, the turns can usually be carefully counted. If it is very fine and perhaps many thousands of turns, it can be accurately weighed, and the same amount by weight, replaced.

The size of the wire used for the repair should be carefully compared with that removed, by use of a wire gauge or micrometer.

The same grade of insulation should be used also, because if thicker insulation is used it may be difficult to get the full number of turns back on the coil, or it may overheat, due to the different heat carrying ability of the changed insulation.

### 101. TESTING COILS FOR FAULTS

It is very simple to test any ordinary magnet coil for "open circuits," "grounded circuits" or "short circuits," commonly referred to as opens, shorts, and grounds.

A test lamp or battery and buzzer can be used for most of these tests.

See Figs. 16-A, B and C.

In Fig. 16-A, the coil has a break or "open," and a battery and test lamp or buzzer connected to its ends, will not operate, as current cannot pass through. If the coil was good and not of too high resistance, the lamp or buzzer should operate. In testing coils of very high resistance, a high voltage magneto and bell are often used instead of the battery and lamp.

In Fig. 16-B, the insulation of one turn of the coil has become damaged, and allows the wire to touch the core. This is called a "ground."

With one wire of the lamp and battery circuit connected to the core, and the other connected to either coil wire, the lamp will light, showing that some part of the coil touches the core and completes the circuit. If there were no grounds and the insulation of the entire coil was good, no light could be obtained with this connection, to one coil lead and the core.

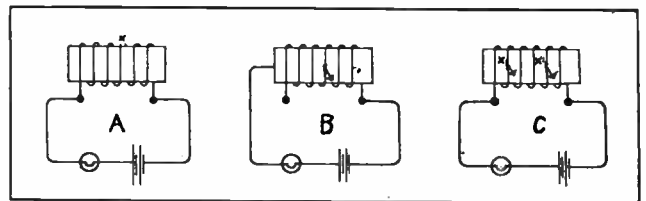

Fig. 16. Methods of testing coils for faults.

In Fig. 16-C, the coil has developed two grounds at different places, thus "shorting" out part of the turns, as the current will flow from X to X1 through the core, instead of around the turns of wire. With the battery and lamp connected as shown this would usually cause the lamp to burn a little brighter than when connected to a good coil. If a good coil of the same type and size is available, a comparative test should be made.

Some of the turns being cut out by the "short"

reduces the coils resistance, and more current will flow through the lamp. In some cases a low reading ammeter is used instead of the lamp, to make a more accurate test.

Short circuits may also occur by defective insulation between two or more layers of winding, allowing the turns to come together and possibly shorting out two or more layers, thus greatly weakening the coil and causing overheating.

Figs. 17, 18, 19 and 20, show several types of electro-magnets.

Note carefully the windings and direction of current flow in each of these magnets, and check the polarity of each with your right hand rule. This will be excellent practice and help you to remember this valuable rule.

The two coils on the double magnet in Fig. 17, are wound in opposite directions to create unlike poles together at the lifting ends. This is very important and necessary, or otherwise the magnet would have like poles, and not nearly as strong attraction or pull. The coils of the telephone receiver and bell, in Fig. 19, are also wound oppositely for the same reason.

Those in the motors in Fig. 20 are wound

opposite to create unlike poles adjacent, to allow a complete magnetic circuit from one to the other. Note carefully the path of the flux in each case.

If you have carefully studied this section on magnetism and electro-magnetism, you have gained some very valuable knowledge of one of the most important subjects of electricity.

You will undoubtedly find many definite uses for this knowledge from now on, and it will be a great help in understanding electrical machines of practically all kinds.

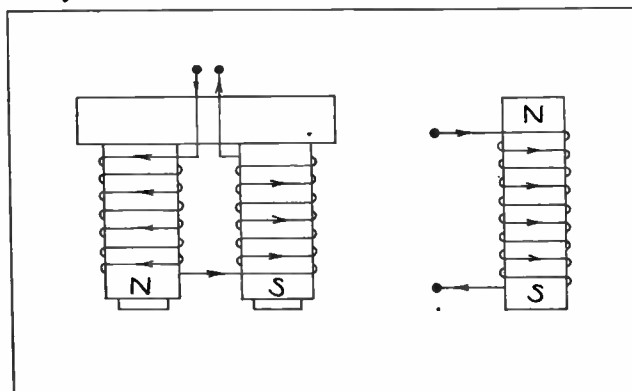

Fig. 17. Double and single electro-magnets.

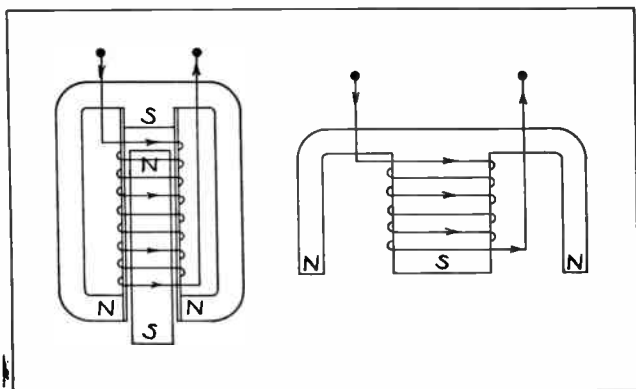

Fig. 18. Plunger type magnet at left. Shell type magnet at right.

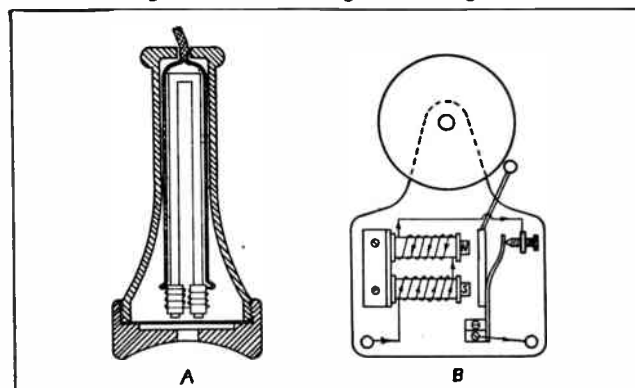

Fig. 19. Sketches showing use of electro-magnets in telephone receiver and door bell.

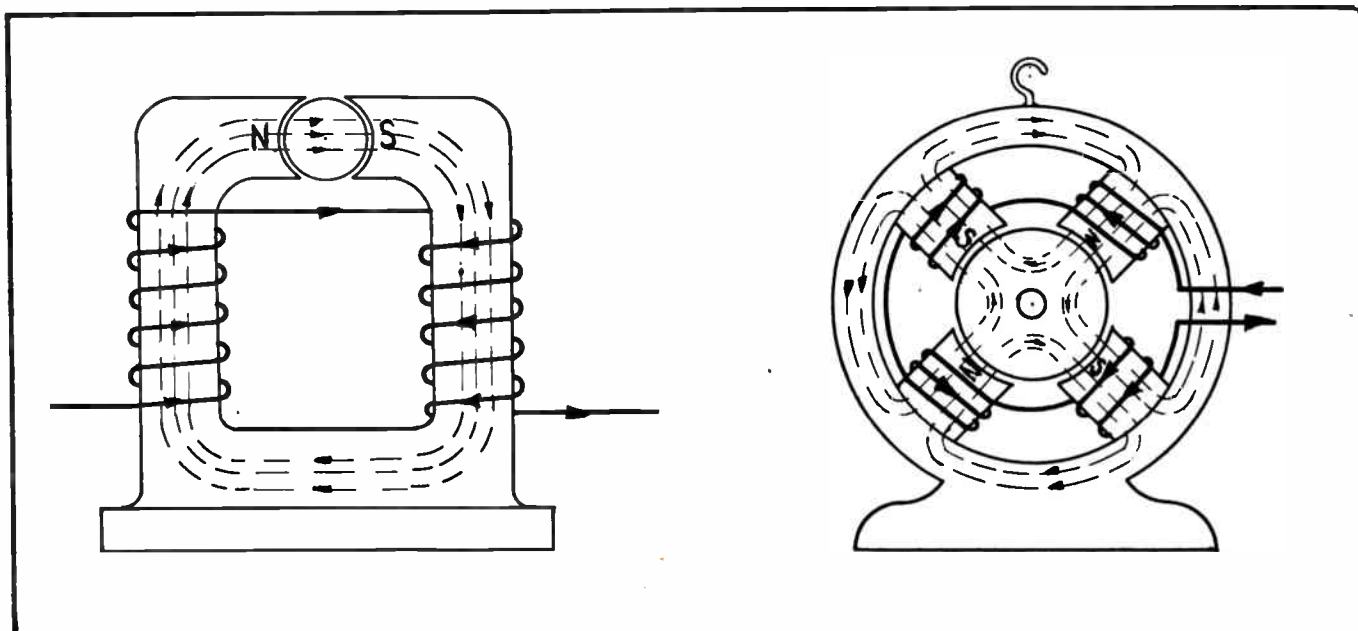

Fig. 20-A. Flux path in a simple early type of motor. Fig. 20-B. Note the several flux paths in this modern 4 pole motor frame and poles.



## ELECTRO-MAGNETIC INDUCTION

Electro-magnetic induction is another very interesting and important subject. This is the principle used in all of our power plant generators, motors, transformers and many other electrical machines.

### 102. GENERATING ELECTRIC PRESSURE BY INDUCTION

If we move a piece of wire through magnetic lines of force as in Fig. 1, so the wire cuts across the path of the flux, a voltage will be induced in this wire. Faraday first made this discovery in 1831.

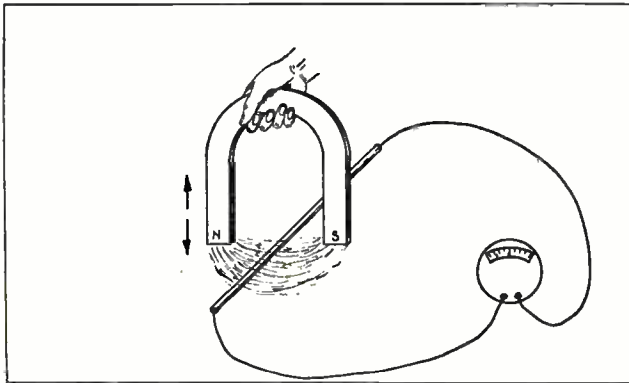

Fig. 1. When a wire is moved through magnetic flux, voltage is generated in the wire.

If we connect a sensitive voltmeter to this wire, thus completing the circuit, the needle will indicate a flow of current every time the wire is moved across the lines of force. This induction, of course, only generates electrical pressure or voltage in the wire, and no current will flow unless the circuit is complete as shown in Fig. 1. So it is possible to generate voltage in a wire, without producing any current, if the circuit is open.

In fact we never do generate current, but instead we generate or set up the pressure, and the pressure causes current flow if the circuit is completed. But it is quite common to use either the term induced voltage, or induced current. This is all right and sometimes simpler to state, if we simply remember that current always results from the production of pressure first, and only when the circuit is closed.

### 103. DIRECTION OF INDUCED PRESSURE AND CURRENT

Referring again to our experiment in Fig. 1, if we move the wire up through the flux the meter needle reads to the left of zero, which is in the center of the scale. If we move the wire down through the flux, the needle reads to the right. If we move the wire rapidly up and down, the needle will swing back and forth, to left and right of the zero mark. This proves that the direction of the induced pressure and resulting current flow, depends on the direction of movement through the magnetic field, and that we can reverse the voltage

and current, merely by reversing the direction of movement of the wire.

A simple rule to determine the direction of the voltage induced, when the direction of the lines of force and movement of the conductor are known, is as follows:

Consider the lines of force as similar to moving rubber belts, and the wire as a pulley free to revolve when it is pushed against the belts. (See Fig. 2.)

Assume (A) and (B) to be the ends of wires to be moved. (A) is moving upwards against lines of force traveling to the right. Then its imaginary rotation would be clockwise as indicated by the arrows around it, and this will be the direction the lines of force will revolve around the conductor from its own induced current. Then remembering our rule from the section on electro-magnetism, we know that clockwise flux indicates current flowing away from us.

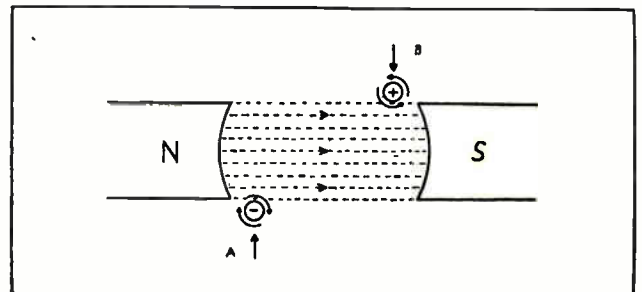

Fig. 2. Sketch of conductors moving through flux, as in a simple generator. Note direction of induced pressure.

Wire (B) is moving down against the lines of force, so if it were to be revolved by them it would turn counter clockwise. As this would be the direction of flux around the wire from its induced current, it indicates current would flow toward us.

Another rule that is very convenient, is the right hand rule for induced voltage, as follows:

Hold the thumb, forefinger and remaining fingers of the right hand, at right angles to each other. Then let the forefinger point in the direction of flux travel, the thumb in direction of movement of the wire, and remaining fingers will point in the direction of the induced pressure. (See Fig. 3.)

In the illustration the flux moves to the left, the wire moves up, and the current in the wire would be flowing toward you, as indicated by the three remaining fingers.

Practice this rule, as you will find a great deal of use for it on the job, in working with motors, generators, etc.

### 104. AMOUNT OF PRESSURE GENERATED DEPENDS ON SPEED AT WHICH LINES ARE CUT

Referring back again to Fig. 1, if we hold the wire still, even though in the magnetic field, no

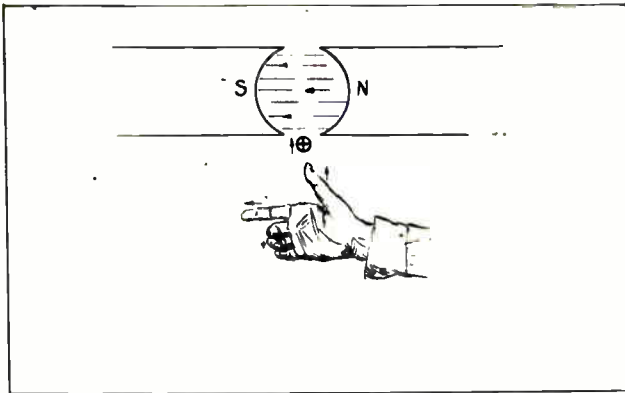

Fig. 3. Right hand rule for direction of induced voltage. Compare position of fingers with direction of flux and wire movement.

pressure will be generated. Or if we move the wire to right or left, parallel to the path of the flux, no pressure will be produced. So we find that the wire must cut across the flux path to generate voltage, or as we often say it must be "Cutting" the lines of force.

The faster we move the wire through the magnetic field, or the stronger the field and greater the number of lines of force, the farther the meter needle moves.

So the amount of pressure or voltage produced by electro-magnetic induction, depends on the speed with which lines of force are cut, or the number of lines cut per second.

A very important rule to remember is that one conductor cutting 100,000,000 lines of force per second will produce 1 volt pressure.

This probably seems to be an enormous number of lines to cut to produce one volt, but we do not actually have to use one magnet with that many lines of force, as we can speed up the movement of the conductor in an actual generator, so fast that it will pass many magnet poles per second.

We can also add the voltage of several wires together by connecting them in series in the form of coils. (See Fig. 4A and 4B.)

Here we have three separate wires all of which are moved upwards through the flux at once, and we find an equal amount of pressure is induced in each, all in the same direction. Then when we connect them all in series as shown, so their voltages will all add up in the same direction in the circuit, our meter reads three times as much voltage as it did with one wire. Generator coils are often made with many hundreds of turns so connected, thus obtaining very high voltage.

### 105. SIMPLE GENERATOR PRINCIPLES

In Fig. 5A and Fig. 5B, are shown single turn coils A, B, C, D, arranged to be revolved in the field of permanent magnets. The ends of the coils are attached to metal slip rings which are fastened to the shaft, and revolving with it. This gives a connection from the moving coils to the lamp circuits by means of metal or carbon brushes rubbing on the slip rings.

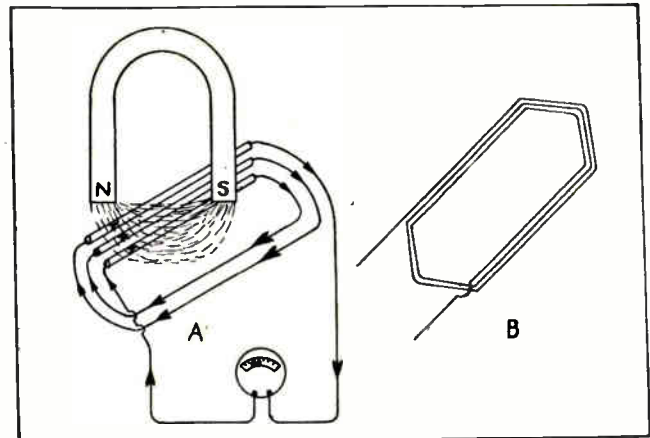

Fig. 4-A. Using several wires connected in series to obtain higher induced voltage.

Fig. 4-B. Coil of several turns, as used in generators.

Assume that the coil A, B, C, D in Fig. 5A, revolves to the right, or clockwise. The wire A, B, will be moving upward through the flux, and the induced pressure will be in the direction indicated by the arrow on it.

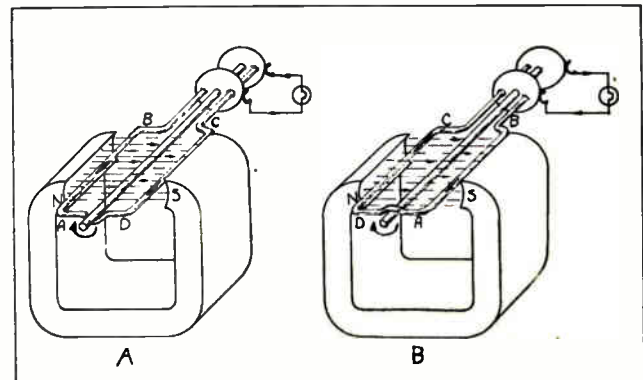

Fig. 5-A. Simple electric generator of one single wire loop, in the flux of a strong permanent magnet.

Fig. 5-B. Here the coil has revolved one-half turn farther than in (A).

Wire C, D, is moving downward, and its induced pressure will be in the reverse direction, but will join with, and add to that of wire A, B, as they are connected in series in the loop. Note that the current flows to the nearest collector ring, and out along the lower wire to the lamp, returning on the upper wire to the farthest collector ring and the coil.

In Fig. 5B, is shown the same coil after it has turned one-half revolution farther, and now wire A, B, is moving downward instead of up as before. Therefore, its pressure and current are reversed. The wire C, D, is now in position where A, B was before, and its pressure is also reversed. This time we find that the current flows out to the farthest collector ring, and over the top wire to the lamp, returning on the lower wire.

### 106. ALTERNATING CURRENT AND DIRECT CURRENT

So we see that as the conductors of such a simple generator revolve, passing first a north pole and then a south, their current is rapidly reversed.

Therefore we call the current it produces **alternating current**, abbreviated A. C.

If we wish to obtain **direct current** (D. C.), we must use a **commutator** or sort of rotary switch, to reverse the coil leads to the brushes as the coil moves around. All common generators produce A. C. in their windings, so we must convert it in this manner if we wish to have D. C. in the external circuit. (See Fig. 6A and 6B.)

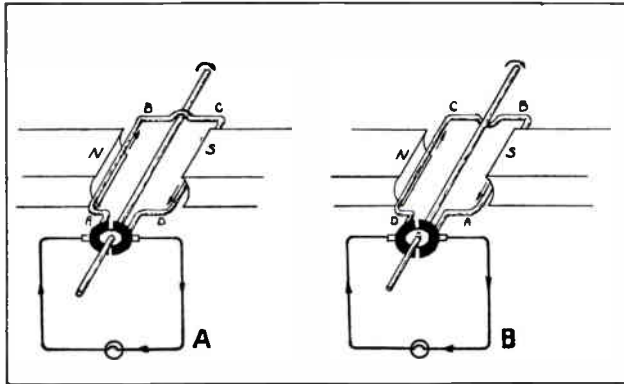

Fig. 6-A and B. Single loop generators with simple commutators, for producing direct current. Note how current continues in same direction through the lamp, at both positions of the coil.

Here again we have a revolving loop. In Fig. 6A, the wire A, B is moving up, and its current is flowing away from us, and that of C, D. toward us. The coil ends are connected to two bars or segments of a simple commutator, each wire to its own separate bar. With the coil in this position, the current flows out at the right hand brush, through the lamp to the left, and re-enters the coil at the left brush.

In Fig. 6B, the coil has moved one-half turn to the right, and wire A, B is now moving down, and its current is reversed. However, the commutator bar to which it is connected has also moved around with the wire, so we find the current still flows in the same direction in the external circuit through the lamp.

## 107. INDUCTION COILS

Now did you think of this?

If moving a wire through lines of force will induce pressure in the wire, why wouldn't it also generate pressure if the wire was stationary, and the flux moved back and forth across it?

That is exactly what will happen. ( See Fig. 7.)

Here we move the magnet up and down, causing the lines of force to cut across the wire which is stationary, and again we find that the meter needle swings back and forth. This proves that pressure is generated whenever lines of force are cut by a wire, no matter which one it is that moves.

You also know that every wire carrying current has flux around it.

Now if we place one wire which is carrying current, parallel and near to another wire, its flux will encircle the wire that has no current. (See Fig. 8A and 8B.)

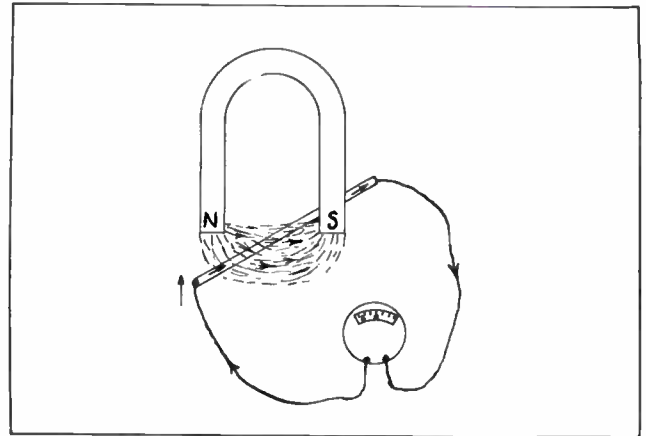

Fig. 7. Induction experiment, moving the magnet and its field instead of the wire.

When we close the switch the current starts to flow in wire "B," building up its magnetic field around it. In building up, these lines seem to expand outward from the wire, cutting across wire "C," and the meter will show a momentary deflection when the switch is closed.

After the flux has been established the meter needle drops back to zero, and remains there as long as the current in wire "B" does not change. This shows that no induction takes place unless the current is changing, causing the flux to expand or contract and cut across the wire.

When we open the switch interrupting the current flow, and allowing the flux to collapse around wire "B," the meter needle reads in the opposite direction to what it did before. Then it drops back to zero once more after the flux has died down.

If we open and close the switch rapidly, causing a continual variation in current and flux of wire "B," the meter needle will swing back and forth, showing that we are inducing alternating current in wire "C." This is the principle on which induction coils and power transformers operate.

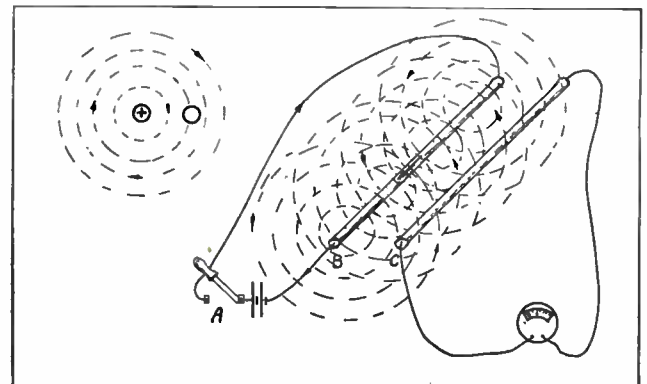

Fig. 8-A and B. Sketch showing how induction takes place between two wires, when current and flux are varied.

If we arrange two coils as in Fig. 9, we find the induction between them much greater than with the single straight wires, because of the stronger field set up around coil A, and the greater number of turns in coil "B" which are cut by the flux. The

meter will now give a much stronger reading when the switch is opened and closed.

In Fig. 9, coil A, which is said to be excited or energized by the battery, is called the "Primary." Coil "B," in which the voltage is induced by the flux of the primary, is called the "Secondary."

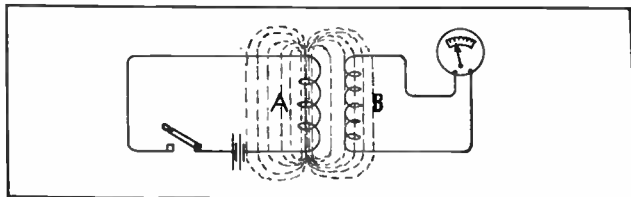

Fig. 9. Induction between two coils. A is the "primary coil" in which exciting current flows. B is the "secondary coil" in which current is being induced.

### 108. HIGH VOLTAGE SPARK COILS

The greater number of turns we use in the secondary coil, the higher will be the induced voltage. This is due to the fact that all the turns are affected by the flux, and all are in series, so the voltages induced in each turn are added, giving a pressure equal to their sum at the coil ends.

In this manner we can get very high voltages by winding the primaries and secondaries of induction coils or transformers with proper ratios, or numbers of turns. This is called stepping up the voltage. Of course when we increase the voltage in this manner, the current in the secondary decreases proportionately, or by the same proportion as the voltage is increased. Thus the watts remain the same except for slight losses in the coils.

In Fig. 10, is shown the construction of a simple type of spark coil. The iron core (A) is made of soft iron strips called Laminations, or sometimes of iron wires bundled tightly. The primary coil which is a few turns of rather heavy wire, is wound over the insulated core. Then after a layer of good insulation is placed over the primary, the secondary coil is wound over it all. This secondary usually consists of several thousand turns of very fine wire, and may have a pressure of several thousand volts induced in it.

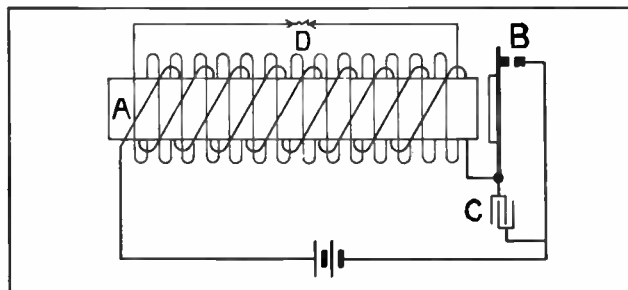

Fig. 10. Diagram of a spark coil, showing primary and secondary coils and make and break contacts.

Such high voltages will cause a hot spark through an air gap, as at "D."

An interrupter to make and break the circuit rapidly, is shown at "B." This interrupter is operated or kept vibrating by the magnetism set up in the iron core. It serves to keep the current and flux of the primary continually changing, to accomplish induction.

A condenser is shown at "C." Its purpose is to reduce sparking at the interrupter contacts, and cause a quicker collapse of primary flux when the current is interrupted. The action of such condensers will be more fully explained later.

109. TRANSFORMERS, also operate on this principle of electro-magnetic induction. Transformers are used to increase or decrease the pressure or voltage of electric circuits, for many purposes. They range in size from the little bell ringing type, to those of several kilowatts capacity, located on the poles and supplying power and light current to our homes; and on up to those of many thousands of kilowatts, for the high voltages of our great power transmission lines.

In Fig. 11, is shown a simple transformer illustrating in general the construction and principle of all common types. Here the primary and secondary coils are wound on opposite legs of a closed iron core. This core serves to carry the flux of the primary, over to the secondary coil. Such transformers operate on alternating current, so they do not need an interrupter, as alternating current is continually reversing in direction, and varying in amount. As the current in the primary coil reverses, and increases and decreases, its flux whips back and forth across the turns of the secondary, inducing alternating current in them.

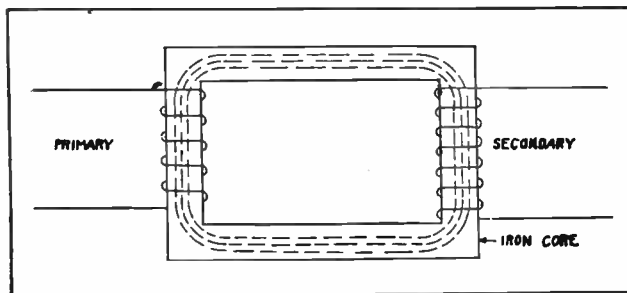

Fig. 11. Core and windings of a simple transformer.

Transformers of various types will be covered thoroughly in a later section, but be sure to obtain a good knowledge of this principle of electro-magnetic induction, as you will use it in many ways in your work from now on.

Now if you have studied carefully and thoroughly each part of this elementary section, you can feel that your time has been very well spent. Nothing is so essential to the practical man as a good general knowledge of the fundamental and important principles of electricity, covered in this section.

With a good understanding of these things you can proceed into the following sections and easily understand them. You will also find that some of these same simple principles will clear up many trouble shooting and operating problems in the field, that would otherwise be very mysterious and difficult. This is where the trained man has the advantage, and is well repaid for all his efforts and study, by being able to solve the problems that stick many an "old timer."

# SIGNAL SYSTEMS AND CIRCUIT WORK

## Great Opportunities In Signal Field

The field of electric signalling is a very broad one, covering everything from simple door bells and call systems to elaborate burglar alarm, telephone and railway signal systems.

Every year many millions of dollars are spent in new installations and expansion in these branches, creating new jobs for many more trained men yearly.

There are millions of homes with their door bell systems and some of them with burglar alarm equipment to be maintained, and thousands of new homes being built each year.

Hotels, office buildings, department stores, theatres and hospitals have elaborate signal systems. Banks, stores, and offices have their burglar alarm systems. Fire and police departments also have special signal networks.

Then there are the railroads with their block signals, crossing alarms and automatic train control equipment, to provide greater safety in the operation of trains.

The telephone and telegraph field is one of the largest branches of the electrical industry and employs many thousands of trained electrical men. So you see the general field of signal work is far greater than many people realize, and offers interesting work at good pay in all parts of the country, and also splendid opportunities for a business of your own.

Many men entering electrical work overlook this branch, thinking it is of small importance because of the small size of the equipment, and the low voltage it uses.

This however is a great mistake, and signal wiring and maintenance should not be overlooked just because one may be interested in wiring or power work.

You may plan or hope to have a business of your own some day. It requires but very little capital to start a business in this line, and many of our graduates are making good money specializing in this work in a business of their own. Others, who are working at some other line of electricity, do alarm and bell wiring jobs as a side line, and make extra money. Often in this way they gradually build up a full time business of their own.

Signal work of any kind requires a good knowledge of blue print reading and circuit tracing and testing, and needs men who know definite methods of wiring equipment from a print, and how to systematically "shoot trouble."

Even though you may not specialize in signal work, and no matter what line of electrical work you follow, the principles of these **signal systems** and the knowledge of circuit tracing and testing this section gives you will be very necessary and valuable.

The general electrician or foreman often encounters a job of installation or repair on some signal system, even though his principal work is on power equipment.

So make a very careful study of every part of this section if you wish to qualify for success in this branch of Electricity.

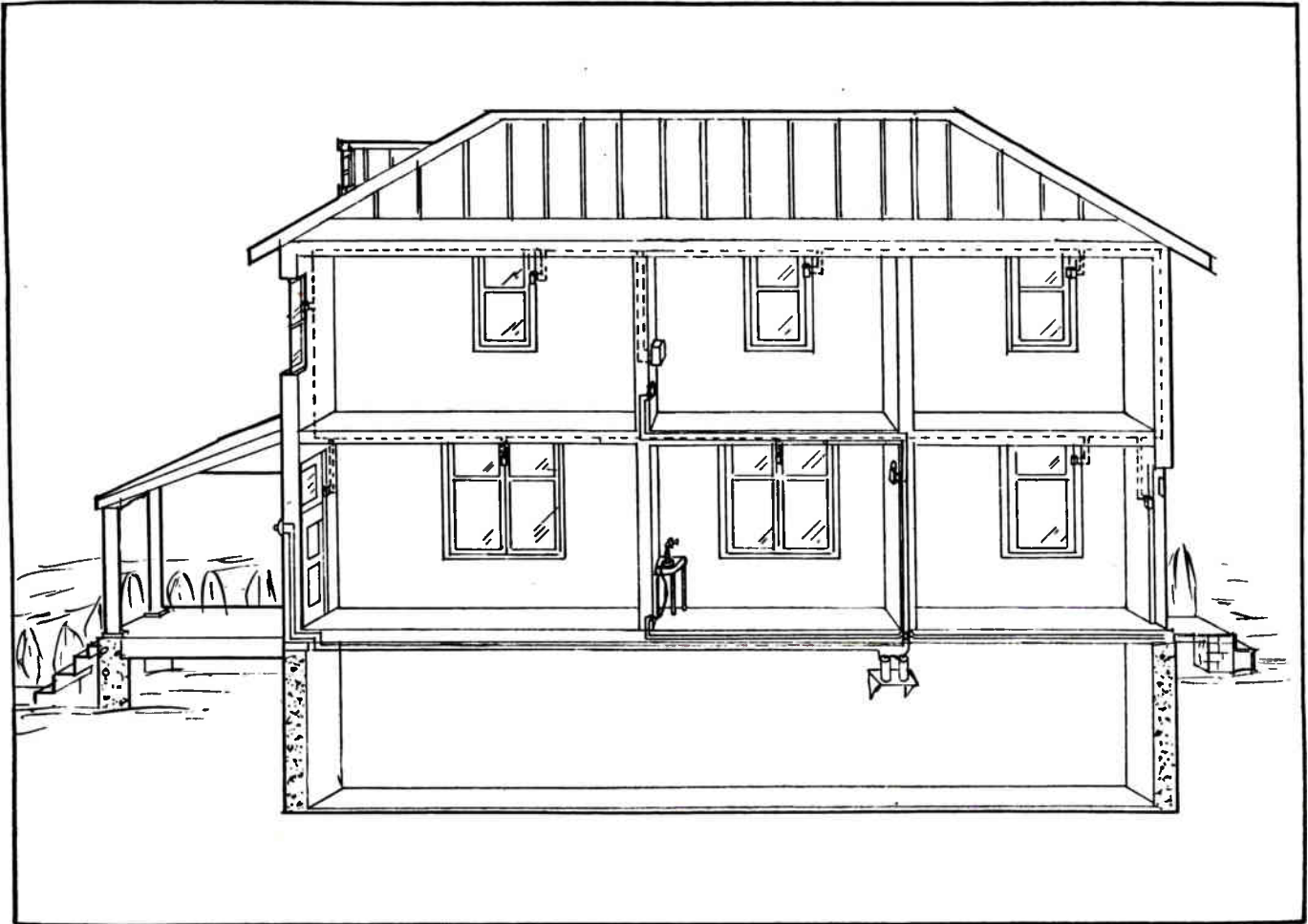

Sectional view of a house showing the wiring for doorbells, burglar alarm and telephone. These are three of the most common signal conveniences in the home.

## CALL AND SIGNAL SYSTEMS

In obtaining a knowledge of signal systems, we have to deal with the equipment or devices used, and also the circuits or methods of connection.

There are a number of very interesting devices used in this work and you should become thoroughly acquainted with the operation, care, and purpose of each. With this knowledge and a good understanding of fundamental circuits you can lay out and install most any common signal system.

The more common pieces of equipment are batteries or transformers, switches of various types, bells, buzzers, relays, drop relays, annunciators, etc.

The circuits are series or parallel, which you already know something about, and "closed" and "open" circuits, which will be explained later.

### 1. SIMPLE CALL BELL

One of the simplest of all signal systems, is the ordinary door bell or call bell.

Such an installation requires an ordinary bell, a dry cell, a switch, and a few pieces of wire as shown in Figure 1.

Note how the three devices are connected together in a simple series circuit. One wire leads from the positive terminal of the cell to the right-hand bell terminal, one from the left bell terminal to the switch, and one returning from the switch to the negative cell terminal, thus completing the electrical circuit when the switch is closed.

In an actual installation, of course, these wires would be much longer, as the button would be located at the door, and the dry cell and bell probably near together somewhere in a rear room of the house.

Or this same system can be used for an office call with the button located on a certain desk, and the bell at another desk or office where a party is to be called. The battery can be located at either end of the circuit, equally well.

This circuit can also be used for a shop call, or a burglar alarm or fire alarm, by replacing the push button switch with a special door or window switch, or thermal switch, all of which will be explained later.

So we find that this very simple system has a variety of valuable uses.



Fig. 1. Materials and parts for a simple doorbell or call system. Note how the dry cell, bell and button are connected.

## 2. USE OF PLANS AND SYMBOLS

When the equipment for any signal system is pictured as in Fig. 1, it is of course easy to recognize each part, and also to connect the wires as shown. But we must have some form of plan or sketch to do such work from, that can be made quicker and cheaper than photographs. So we have certain little marks or signs which we use to indicate the different pieces of equipment in blue prints or job plans and sketches. These marks are called **Symbols**.

As practically all new electrical installations now-a-days are made from prints or plans, the man who knows these symbols and can read prints has a great advantage over the untrained man who cannot.

In Figure 2 is shown a simple sketch of the same door bell system as in Figure 1.

This sketch uses the symbols for the various parts, and can be quickly and easily made, and also easily understood, with a little practice.

The part marked "A" is the symbol for a cell, the long line representing the positive terminal at which the current leaves, and the short line the negative terminal. "B" is the symbol for the bell, and "C" for the switch.

The heavy top line of the switch represents the movable contact. The arrow underneath represents the stationary contact. Note that the arrow does not touch the upper part, showing that the switch is open as it should be normally. Imagine that you were to press down on this top part causing it to touch the arrow and close the circuit. Current would immediately start to flow from the positive

cell terminal to the bell, and back through the switch to the negative side of the cell. The arrows along the straight lines, representing wires, show the direction of current flow.

In **Reading** any electrical diagram from now on, practice **Tracing Out** the current flow in this manner. First locate and recognize all the parts by their symbols, and if there are any open switches, imagine that you close them. Then starting at the battery, trace the current flow along the wires and through the devices, always returning to the opposite side of the battery from the one at which you started. Remember that unless you have such a complete circuit no current will flow.

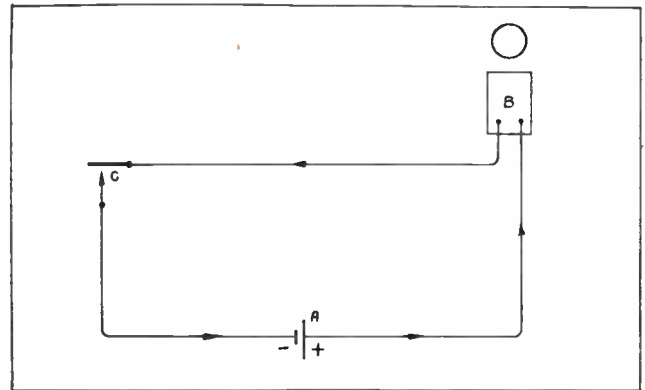

Fig. 2. Sketch showing the connections and circuit of simple doorbell system.

## 3. COMMON DEVICES IN SIGNAL CIRCUITS

Now let's find out more about each of the devices used in this simple system just covered, and also others.

We can readily see that the principal parts which we must have for any electric signal system are a source of current supply, a means of control, and a device to transform the electric energy into a signal.

## 4. BATTERIES FOR CURRENT SUPPLY

Dry cells are very commonly used to supply current to ordinary door bell and call systems of the "open circuit" type, where current is only required for occasional short intervals. Figure 3 shows two dry cells. You are already familiar with the care and operation of these cells from a previous section. (Elementary Section 6, Article 68.) When two or more cells are used they can be connected series or parallel according to the voltage and current requirements of the signal device. These connections were also covered in a previous section on Series and Parallel Circuits. Figure 4, however, shows two groups of three cells each, one group connected series, and the other parallel.

Dry cells should not be used in closed circuit systems, except where the current requirements are exceedingly small.

Primary cells of the "gravity" type or the "Edison" type are often used in closed circuit systems

because they will stand the continuous current requirements much better than dry cells. The operation and care of these cells were also covered in a previous section. (Elementary Section 6.)



Fig. 3. Two common dry cells such as used extensively in signal systems. One is cut away to show terminal strip attached to the zinc.

Storage batteries are often used in signal systems where the current requirements are quite heavy. Their care and charging will be covered later.

### 5. MOTOR GENERATORS FOR SIGNAL SYSTEMS

In very large signal systems Motor-Generator sets are often used to supply the necessary current.

These consist of a motor operated from the usual 110 or 220 volt current supply in a building, and driving a generator which supplies from 2 to 30 volts D.C. to operate the signals. (See Figure 5.)

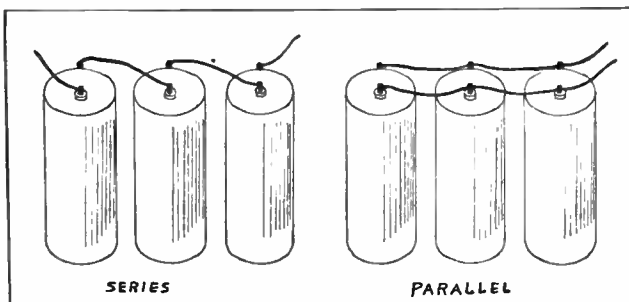

Fig. 4. Sketch showing method of connecting groups of dry cells in series or parallel, to obtain proper voltage or current for various signals.

Storage batteries are often used with motor generators, to supply current for short periods when the motor-generator might be shut down.

Figure 6 shows a storage battery connected in parallel with a D.C. generator so that the generator, while operating, will keep the battery fully charged. Then, when the generator is stopped for any reason, the battery supplies the current to the signals. The generator should be disconnected from the battery when it is stopped, so the battery will not discharge through the generator winding.

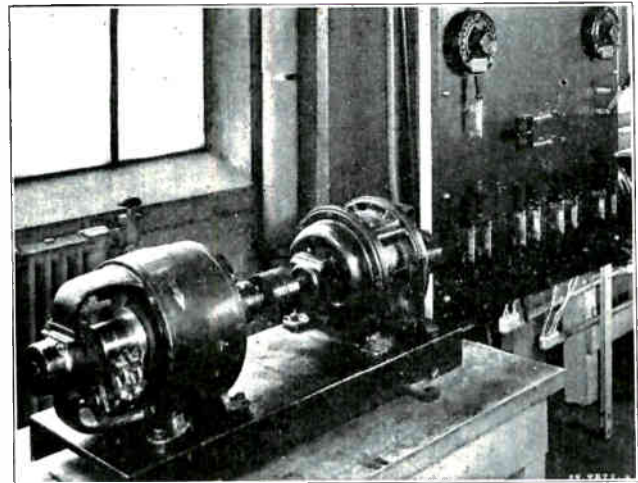

Fig. 5. Photo of low voltage motor generator set and switchboard, used for supplying energy to large signal systems.

### 6. BELL TRANSFORMERS

Bell Transformers are very commonly used to supply current to ordinary door bell and simple call systems. These transformers operate from the 110 volt A.C. lighting circuits and reduce the voltage to that required for the signal bells or lamps.

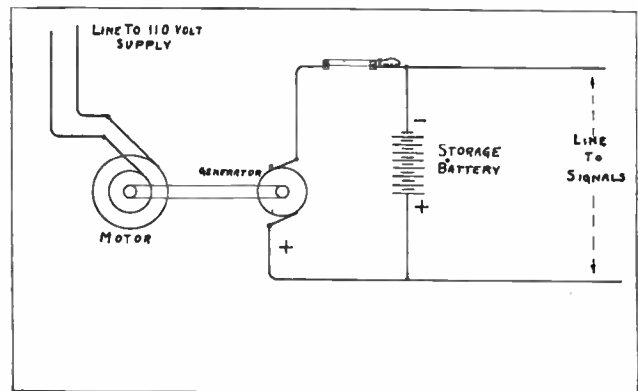

Fig. 6. Diagram of motor generator and storage battery connected together for dependable energy supply to large signal systems.

Figure 7 shows two common types of door bell transformers.

A number of these transformers have three secondary wires, or "leads," giving 6, 8, or 14 volts with different connections. Others give still higher voltages. Where higher voltage bells or lamps are used, or where the line is long, the higher voltage "leads" on the transformer should be used.

In Figure 8 is shown a sketch of the windings and connections of a very common type of bell transformer. The primary winding "P" consists of about 1800 turns of No. 36 wire. The secondary winding consists of 235 turns of No. 26 wire, and has a "tap" or connection at the 100th turn. The core legs are about 1/2 in. x 3/4 in. in size and 2 1/4 in. long.

Transformers can only be used where there is electric supply in the building, and only on A.C.



They will not operate on direct current supply, and in fact, will "burn out" quickly if connected to a D.C. line.

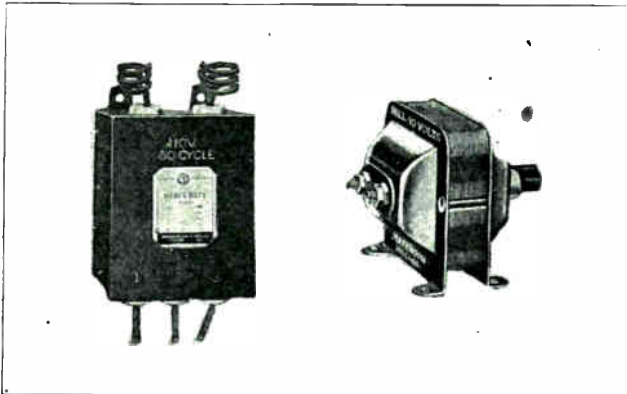

Fig. 7. Two different types of low voltage bell transformers. These reduce the voltage of an A. C. lighting circuit to 6, 8, and 14 volts for operation of bells.

For special uses transformers are obtainable with taps and a switch to vary the voltage in a number of steps. One of this type is shown in Figure 9.

Several other types are shown in Figure 10. Two of these, on the left, are mounted right on covers of "outlet boxes" for convenience in installing and attaching them to the lighting circuits, which are run in conduit, or protective iron piping. The other is built in a box with fuses.



Fig. 9. Low voltage transformer with "taps" for obtaining various voltages.

A transformer can be tested with a bell, buzzer or low voltage test lamp for the secondary test, or a 110 volt test lamp for the primary test.

When "shooting" trouble on any defective signal system, you should never fail to check the source of current supply first of all.

8. SIGNAL SWITCHES

Now that we know something of the different sources of current supply for signal systems, let us consider the means of control or switches used.

Referring again to Figure 2, the purpose of the switch, as we have already mentioned, is to close and open the circuit, and start or stop the current flow, thus causing the bell to ring when desired.

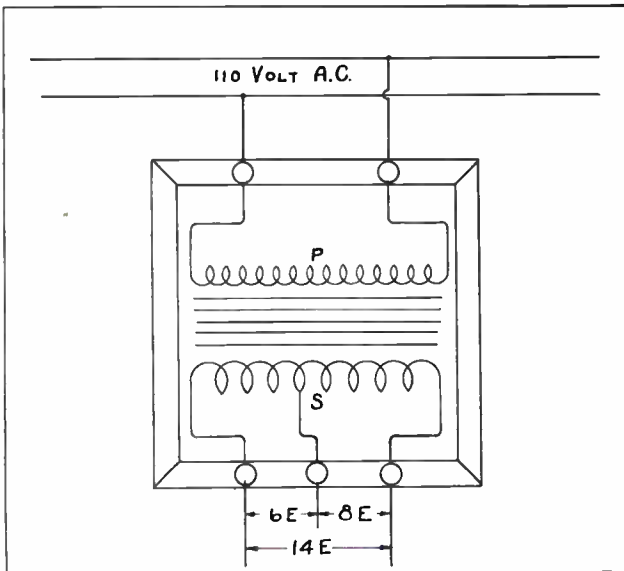

Fig. 8. Sketch showing windings and connections of a bell transformer.

All of the various sources of current supply above mentioned are low voltage devices, usually furnishing from 6 to 20 volts, as most bells and signal lamps are made to operate at these low voltages. Special bells are made, however, for 110 volt operation. But a low voltage bell should never be connected directly to a lighting circuit, as it will immediately burn out, and possibly blow the fuses or do other damage.

Certain types of signal systems using relays can-

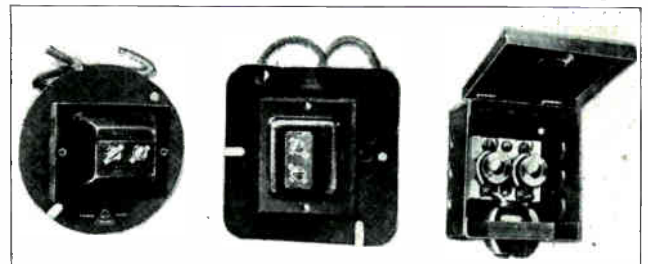

Fig. 10. Three types of bell transformers which are built in the covers of standard outlet boxes for conduit wiring.

This type of switch is called a Push Button switch. Figure 11 shows the operating parts of such a switch with the cover removed, and also the assembled switch. The upper left part shows the contact springs, mounted on an insulating base of hard fibre. The short lower contact is called the stationary one, and the longer upper spring is called the movable contact.

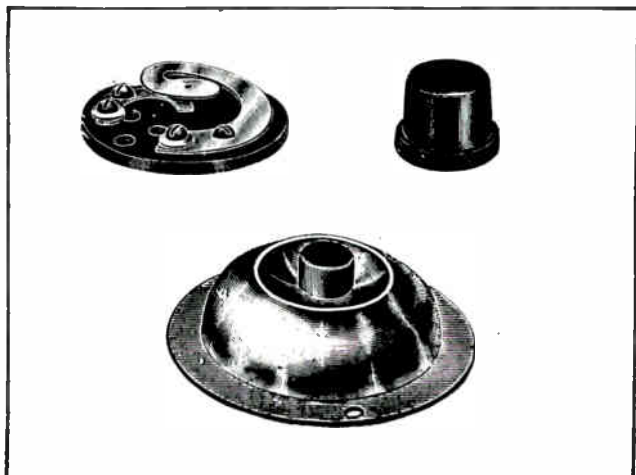

Fig. 11. View showing parts of a push button switch; also completely assembled button below.

When assembled, the button, which is also of insulating material, rests on the large spring and is held in place by the cover, as shown in the lower part of the figure. The springs are so shaped that they normally remain separated from  $\frac{1}{8}$  in. to  $\frac{1}{4}$  in., thus keeping the circuit open. But when the button is pressed it forces the movable spring down onto the stationary one, closing the circuit and allowing current to flow through the switch.

This type of push button switch is called an **Open Circuit Switch**, because it is normally open.

These switches are made for low voltages only, and should never be used for high voltage lighting circuits, or heavy currents, as they may arc and overheat badly.

When connecting such a switch in a circuit, one wire is attached to each of the screws which have the washers under their heads. This fastens one wire to each switch contact.

The two holes in the fibre base are for the wires to pass through, and the switch is held in place by the cover. The button is slipped in the hole in the cover before placing the cover on the switch. Some switches have metal covers that snap on, while others have wood covers that screw on. In addition to this common open circuit switch, we have "closed circuit" and "double circuit" push button switches.

A **Closed Circuit** switch is one that has its contacts normally closed, and some current flowing through it all the time except when it is pressed open.

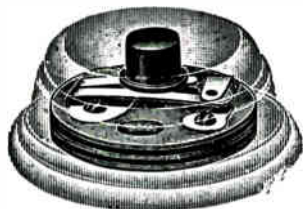

Fig. 12. Double circuit push button switch, showing clearly the arrangement of contacts and parts with respect to base and cover.

## 9. DOUBLE CIRCUIT SWITCHES

A **Double Circuit** switch is one that has both a closed contact and an open contact, and when

pressed it breaks the closed circuit and closes the open circuit.

In Figure 12 is shown a double circuit switch. This switch is used in certain types of signal and alarm systems, where we wish to open one circuit and close another at the same time.

Referring to the figure, you will see that it has a large movable contact, and one open contact underneath, and also a closed contact above the movable spring.

The top spring is called the closed contact because it is normally touching the movable strip, keeping a circuit closed through them until the button is pressed. Then the movable spring leaves the top one and touches the bottom one, opening one circuit and closing the other.

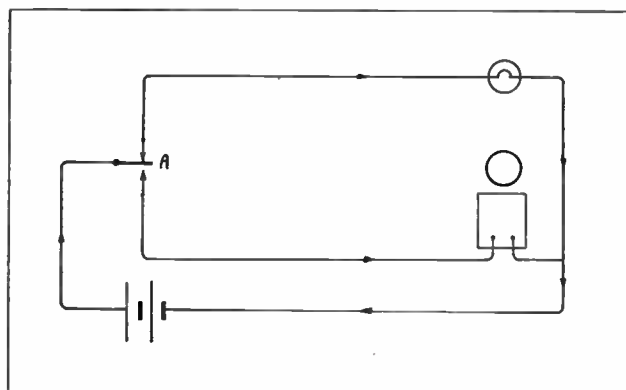

Fig. 13. Connections for a double circuit switch to operate a signal lamp and bell.

Figure 13 shows a double contact switch in use in a signal circuit. Normally the lamp burns continually and the bell is silent until the switch is pressed. Then the lamp goes out and the bell rings. Trace the circuit to note carefully this operation, and notice the symbol used to represent the double circuit switch at "A".

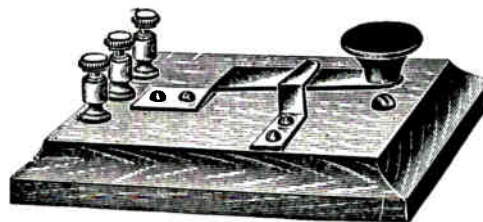

Fig. 14. Different type of double circuit switch, very convenient for code signalling because of its "key-like" construction.

It is quite important, in making a drawing of these switches, to have the top contact closed or touching the movable strip, and the bottom contact or arrow should not be touching, in normal position.

Also remember that in all these switches the movable part is a spring, so it goes back to normal as soon as released.

In Figure 14 is another type of double circuit switch, that has no cover, and is used for indoor work such as desk call systems.

Because of the shape of its spring and button, it is very convenient to use as a signalling key for certain code calls.

With either of the double contact buttons shown, we can remove the bottom contact or leave it unused, and then this switch will serve as a closed circuit switch.

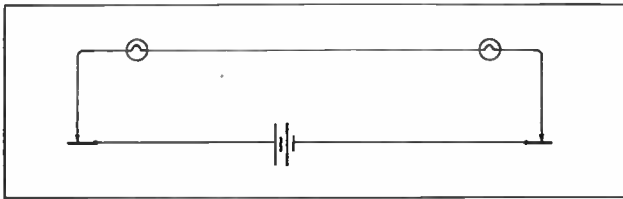

Fig. 15. Two closed circuit switches connected with lamps for a return call signal.

Figure 15 shows a sketch of two such switches used with two lamps, as a signal system for two parties to signal each other at a distance, by blinking the lamps.

Such a circuit should use a transformer, storage battery or gravity battery, because the continual current flow through the lamps would soon exhaust a dry cell.

One definite advantage of such a closed circuit signal system is the fact that any failure or defect, due to a dead battery or broken wire, is more likely to be noticed at once, than it is with an open circuit system. This is often of great enough importance to more than make up for the slight extra current cost.

Push button switches can be obtained with ornamental covers as shown in Figure 16.

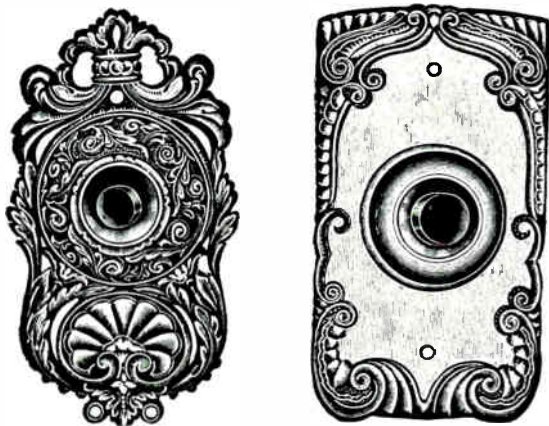

Fig. 16. Two types of ornamental covers for use with push button switches.

### 10. DESK BLOCKS AND SPECIAL PUSH BUTTON SWITCHES

For desk call systems a smaller push button switch is often required, so a number of them can be located in one small block or panel.

Figure 17-A shows a desk block with five of these small buttons, and marker plates to indicate which call each button operates. Figure 17-B shows a metal panel assembly of 10 switches, such as quite commonly used in office call systems.

In Figure 18 are shown several types of small

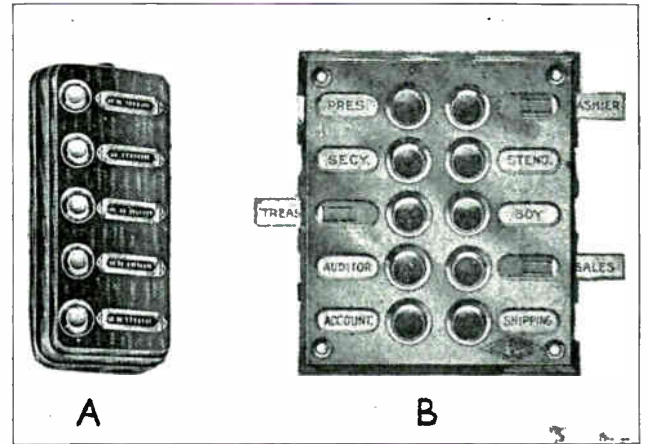

Fig. 17-A. Push buttons arranged in a desk block for office signal systems.

Fig. 17-B. Ten small push buttons with indicator tags, on a panel that can be used for wall or desk mounting.

push buttons that can be mounted in desk blocks, or in round holes drilled in a board or desk.

For hospitals, and certain other uses, a very convenient push button can be arranged on the end of a flexible wire, so it can be laid on the pillow, or moved around somewhat. A button of this type, and also one to be clamped onto a bed or chair are shown in Figure 19.

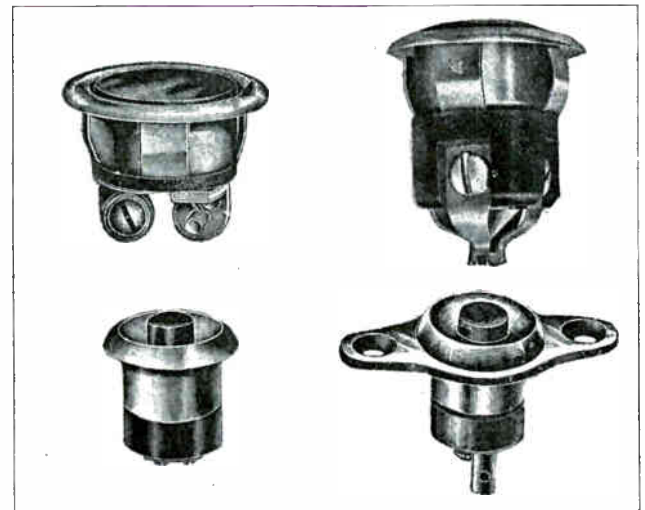

Fig. 18. Four different types of small push buttons for use in desk blocks or panels.

### 11. BURGLAR ALARM SWITCHES. DOOR AND WINDOW SPRINGS

In burglar alarm work we have special types of switches called "Window Springs" and "Door Springs." Figure 20 shows three views of common types of window springs which are made to fit in the window casing. These switches can be obtained in either open circuit or closed circuit types. They are mounted in the window casing in such a manner that when the window is closed, its frame rubs on the projecting slide of the switch and holds the switch open, so the bell does not operate. When the window is opened and its frame slides off the switch, the spring closes the circuit and causes the bell to operate. Or the

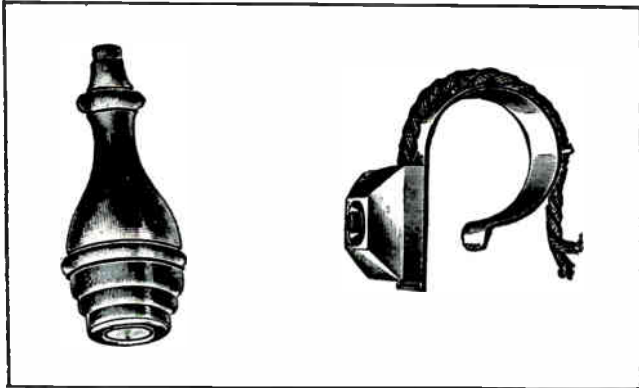

Fig. 19. Two types of push buttons commonly used in hospitals. The one on the left for attachment to pillow cord; the one on the right to be clamped to bed rail or chair arm.

reverse operation takes place where open circuit switches are used.

Figure 21 shows two door spring switches. The one at the left is a closed circuit switch, and the one at the right is an open circuit type.

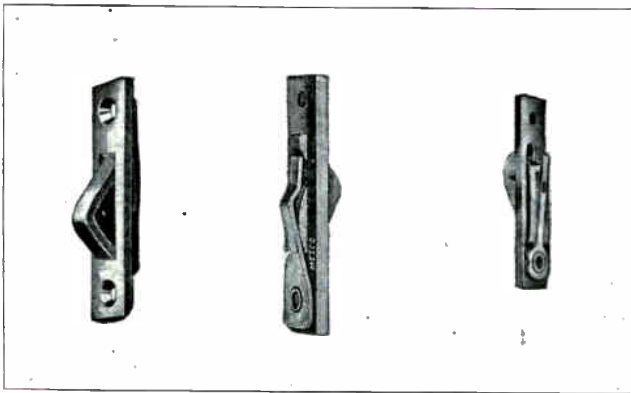

Fig. 20. Three different views of open and closed circuit window springs used in burglar alarm systems.

These switches are installed in the door casing, so that when the door is closed it holds the button compressed, and when the door is opened, the spring pushes the button out and closes or opens the circuit as desired, causing alarm to operate. Window and door springs can be obtained in both closed and open circuit types.

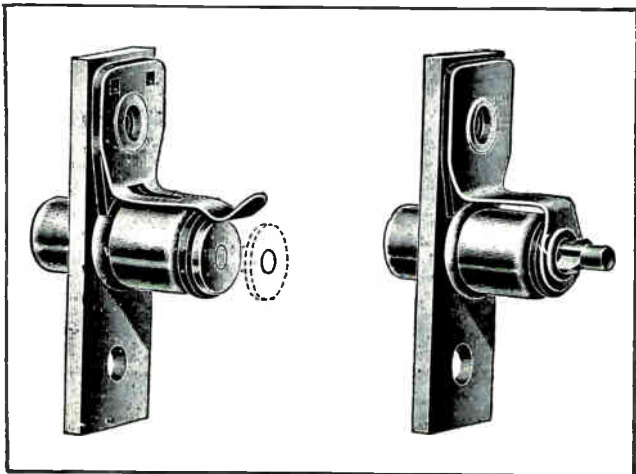

Fig. 21. Door springs of open circuit and closed circuit types to be mounted in door casings for burglar alarms.

Two types of Door Trips are shown in Figure 22. This type of switch is to be mounted above the door so that as it opens, the top of the door will strike the suspended lever, causing the bell to operate momentarily.

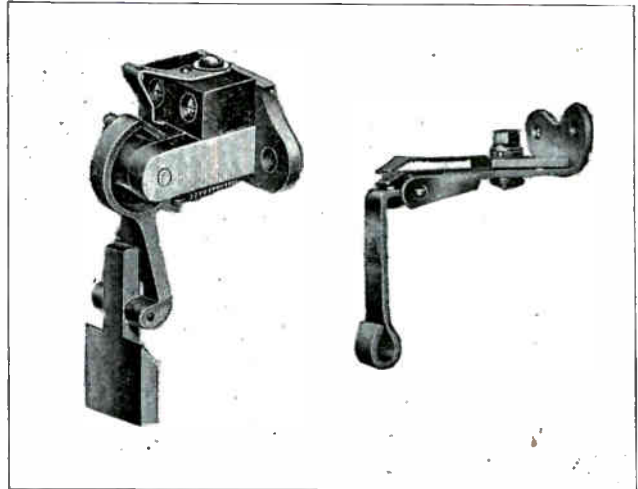

Fig. 22. Door trips to be mounted above a door, and ring a bell as the door is opened.

## 12. KEY OR LOCK SWITCHES

In burglar alarm systems a lock switch is often used so the owner can turn the system on at night and off during the day, or enter the building without tripping the alarm if he desires. These switches can only be operated with a special key. Figure 23 shows two switches of this type.

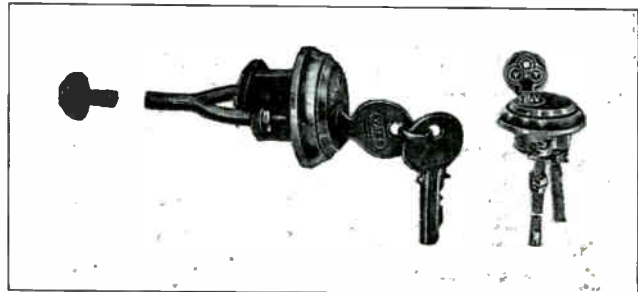

Fig. 23. Burglar alarm lock switches, used to turn the system off during the day, or when the owner wishes to enter the building without sounding alarm.

## 13. BURGLAR ALARM "TRAPS"

Another type of switch, often called a burglar alarm "Trap" is shown in Figure 24. This switch is arranged to be operated by a string attached to the door, window, or device to be protected.

Some of these "traps" will cause the alarm to operate if the lever is moved in either direction from the "set" position.

If the string is pulled it moves the lever in one direction, making contact on that side. If the string is cut, it releases the lever and a spring moves it in the opposite direction, making a contact on that side.

## 14. FLOOR SWITCHES

Often it is desired to have a signal system that can be operated from a concealed floor switch, under

a carpet or rug. A switch of this type is shown in Figure 25-A. Pressure on any part of this switch will close a circuit through it, and operate a bell or other signal. Figure 25-B shows a special burglar alarm matting which is equipped with wires and contacts, to cause a bell to ring when the mat is stepped on.

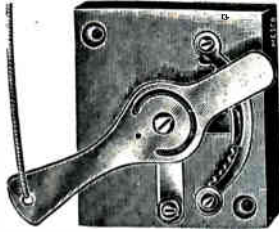

Fig. 24. Burglar alarm trap or switch to be operated by a string attached to door, window, or other object.

### 15. THERMAL OR HEAT SWITCHES

Another very interesting type of switch is the Thermostat type. One of these is shown in Figure 26. This switch is caused to operate by changes in temperature, and makes use of the different rates of expansion of different materials when they are heated. In the type shown here a strip of brass and one of hard rubber or composition are riveted together. When heated, the rubber or composition strip expands much faster than the brass, causing the whole strip to warp or bend downwards and close a circuit with the lower adjustable contact. When the strip is allowed to cool the contraction of the top strip causes the whole element to bend upwards again, and break the connection with the lower contact. If cooled beyond a certain point, it will bend upward still farther and close another circuit with the top adjustable contact.

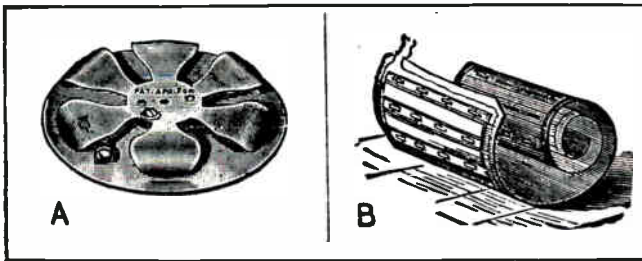

Fig. 25-A. Floor switch for use under carpets, near tables or desks.  
Fig. 25-B. Burglar alarm mat to be placed under door mats or rugs, to close a circuit when stepped upon.

These thermostatic switches are made in several different styles, and are used in fire alarm systems, or to indicate high or low temperature in ovens, refrigerators, storage rooms and various places, by operating a bell or signal when certain temperatures are reached. Some of their applications will be more fully described later.

So you see there are switches for almost every need in signal work, but all are simply devices to open or close a circuit.

Switches for special alarm or signal needs can often be easily and quickly made from two or more strips of light spring brass mounted on a piece of wood or other insulation, and bent to the proper shapes.

A few other types of switches are shown in Figure 27. Snap switches of the type used in lighting circuits are sometimes used in signal circuits also.

### 16. SWITCH TROUBLES AND TESTS.

Some of the mysterious little troubles that cause failure of signal systems are often right at the switches, and nothing more than a loose connection, or dirty or burned contacts. Or possibly some small piece of insulating material such as a bit of string or fuzz from the wire insulation, or a bit of wood or sand, stuck to one of the contacts. A sure way to test any switch is to connect a dry cell and buzzer, or low voltage lamp, directly across its terminals; and then press the switch a number of times. If it does not operate the lamp or buzzer every time it is pressed, its contacts should be thoroughly cleaned with sandpaper, knife, or fine file, and its terminals carefully tightened. Remember a very small object or amount of dirt offers enough resistance to prevent current flow in low voltage circuits.

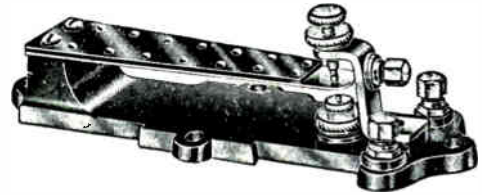

Fig. 26. Thermostatic switch which closes its contacts when heated, and is used in fire alarm systems.

We have seen many an "old timer" or electrician with considerable experience sweat and worry over something of this same nature. But with a knowledge of circuit principles, Ohms Law, and these simple definite tests, such troubles can be "cornered" and need not be so mysterious to the man with training.

Now that you understand the common types of switches or devices for controlling signal circuits, we will take up the bells and devices for producing the call or alarm.

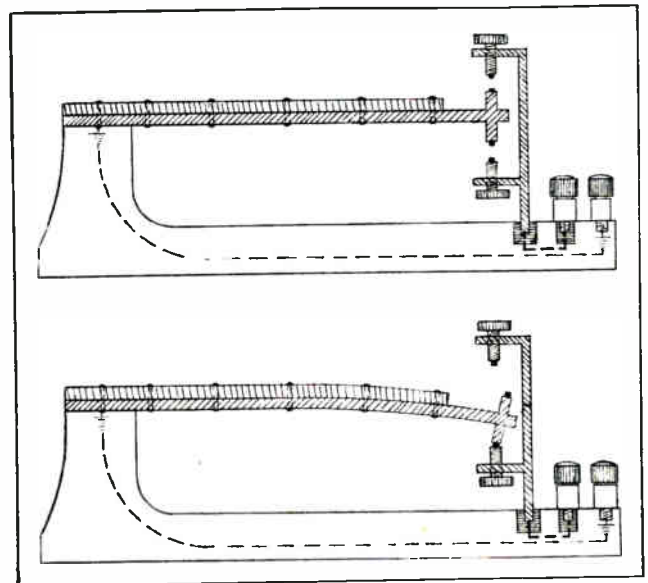

Fig. 26-B. Two sketches of thermostatic switch, showing the strip in normal position in the upper view, and warped to close the contacts in the lower view. Note how the circuit is completed through the metal frame of this device.

## 17. SIGNAL BELLS AND LAMPS

The purpose of any signal or alarm system, is to call the attention of someone. To do this we can use either an "audible" or "visible" signal, or quite often a combination of both. By an audible signal, we mean one that creates sound loud enough to be heard by those whose attention is desired. Bells, buzzers, and horns are used for this purpose. Visible signals are those that are to attract the eye, such as lamps, or semaphores. The term "semaphore" means a sort of moving flag or shutter.



Fig. 27. Several different types of switches used in signal work. The two above are called Lever Switches. In the center on the left is a Multiple Key Switch; at the right double circuit Lever Switch. Below are two Knife Blade Switches.

Visible signals as a rule can only be used where they are in front of, or in line with the vision of those whose attention is desired, and are most commonly used where an operator or attendant is watching for them continually.

Electric bells are very commonly used in all types of signal systems.

Their construction and operation is quite simple and yet very interesting, and important to know.

## 18. VIBRATING BELLS.

There are several different types of bells, but the Series Vibrating Bell is the most commonly used of any. Figure 28 shows a good view of such a bell with the cover removed, showing the coils and parts.

Examine this carefully and compare it with Figure 29, which is a sketch of the same type of bell, and shows the electrical circuit and operating principle clearly. Note how easy it is to recognize each part in the photo, from the simple symbols in the sketch, and how the sketch really shows some

things more clearly than the actual photograph. "A" and "A" are the bell terminals to which the wires are fastened. "B" "B" are the cores and coils or electro-magnets, which attract or operate the armature "C". "D" is a spring which supports the armature and also pulls it back every time the magnets release it. "E" is the end of the same spring, on which is mounted a piece of special alloy metal, which serves as a contact to close a circuit with the adjustable screw contact "F". These form the Make and Break Contacts, and are very necessary in the operation of the bell. "G" is the frame of the bell, "H" is the hammer which is attached to the armature, and strikes the gong "I", when the magnets attract the armature.

When a battery is connected to terminals "A", "A", current at once starts to flow through the bell. If the positive battery wire was attached to the left terminal, current would flow up through the armature, which, of course, is insulated from the frame, then through the "make and break" contacts, through the coils and back to the right hand terminal and the battery. As soon as current flows through the coils, the magnets attract the armature,

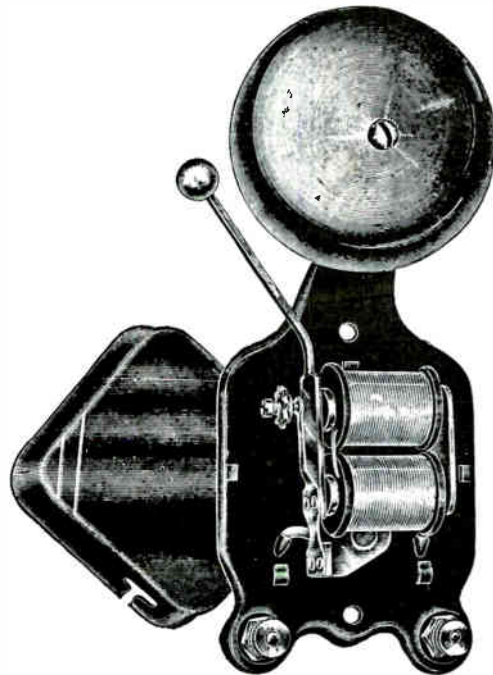

Fig. 28. View showing common vibrating bell with cover removed. Note carefully the construction and arrangement of coils, armature, and contacts.

causing the hammer to strike the gong, and also opening the "make and break" contacts. This stops the flow of current, demagnetizing the coils and releasing the armature. As soon as the armature falls back and closes the contacts, the magnets pull it away again. This is repeated rapidly as long as current is supplied to the bell; thus it is called a Vibrating Bell.

## 19. BELL TROUBLES

Most of these bells have their coils wound for 6 to 10 volts, and should not be operated on much

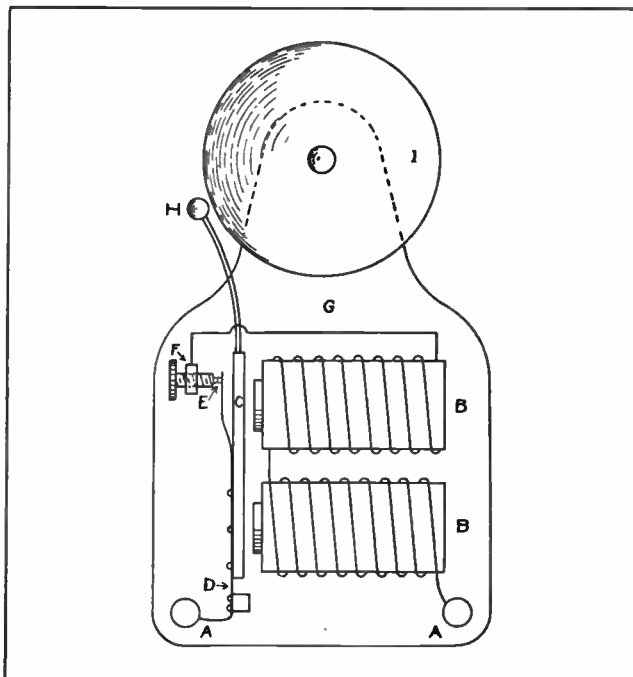

Fig. 29. Sketch showing electrical circuit and connections of common vibrating bell. Observe very carefully the parts of this diagram, and the explanation given.

higher voltage or the coils will overheat and burn their insulation off, which destroys them.

Most vibrating bells are made for short periods of operation only, and should not be allowed to operate continuously for long periods, or the arc at the contacts will heat and burn them. If these contacts become badly burned or dirty, they should be cleaned and brightened with a thin file. When a vibrating bell refuses to operate the trouble can usually be found at the contacts, or a loose terminal nut, or poorly adjusted armature spring.

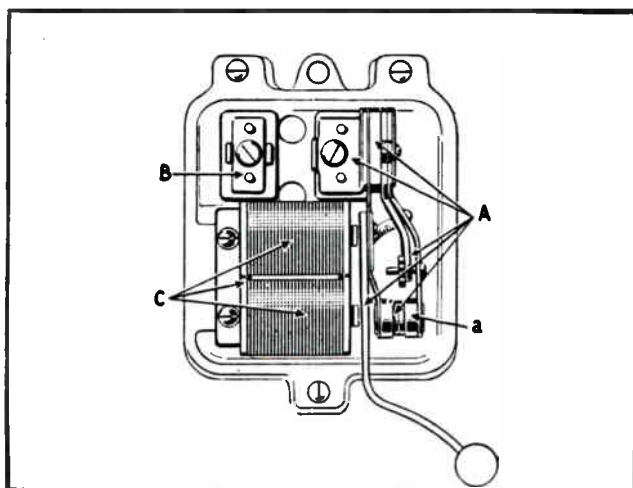

Fig. 30. Heavy duty bell frame and parts. Note the extra heavy carbon contacts for making and breaking the circuit at "A."

When the contacts are worn out, they can be replaced on the more expensive bells, but on the cheaper bells it is difficult to remove them and the bells can be discarded more economically, because of their very low cost.

In the more expensive bells, the contact points are faced with platinum, silver or special alloys that resist corrosion and burning, as even a very small amount of burned metal or dirt in these contacts will prevent the operation of the bell.

In some vibrating bells both terminals are insulated from the frame by little fibre sleeves and washers, and must be kept so.

If this insulation becomes defective the current is shorted through the frame and the bell will not operate. Other bells have only one terminal insulated, and the other is intentionally grounded to the frame, passing the current through the frame to the armature, which in this case is also grounded to the bell frame.

Sometimes the hammer of a bell becomes bent so it will not touch the gong, or rests too tightly against it, stopping the proper operation of the bell.

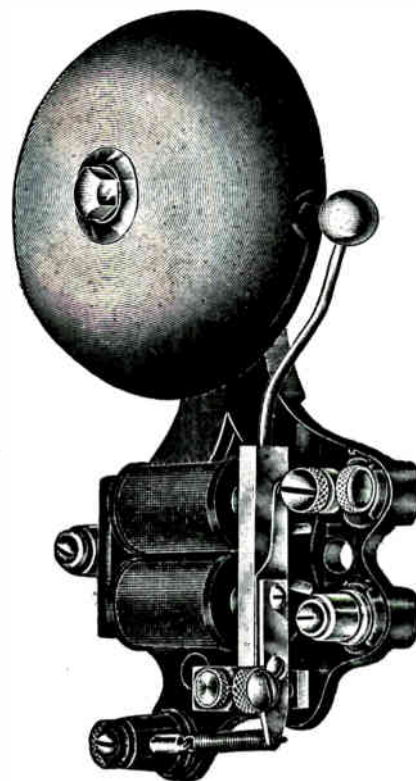

Fig. 31. Ruggedly constructed heavy duty bell. Bells of this type are often wound for 110-volt operation, and used where a very loud signal is desired.

A good understanding of the parts and operation of these bells will enable anyone with a little mechanical ability, to easily locate and repair their most common troubles.

In Figure 31, is shown one of the larger types of vibrating bells which are often wound for 110 volt operation.

Series vibrating bells will operate on either D. C. or A. C. as it does not matter which way current flows through them; the magnets will attract the armature just the same. For this same reason, it makes no difference which way a battery is connected to these bells, as far as polarity is concerned.

**20. SINGLE STROKE BELLS**

Sometimes it is desired to have a bell that will give single taps each time the button is pressed, instead of the continuous vibration.

Such a bell is called a Single Stroke Bell. Figure 32 shows a sketch of a bell of this type. The only difference between this and a vibrating bell is that it has no make and break contacts, and therefore cannot vibrate. Each time the button is pressed and current supplied to this bell, its hammer strikes one tap on the gong. As long as the switch is kept closed the magnets hold the hammer quietly against the gong, after the first tap. When the switch is opened the hammer drops back ready for the next stroke.

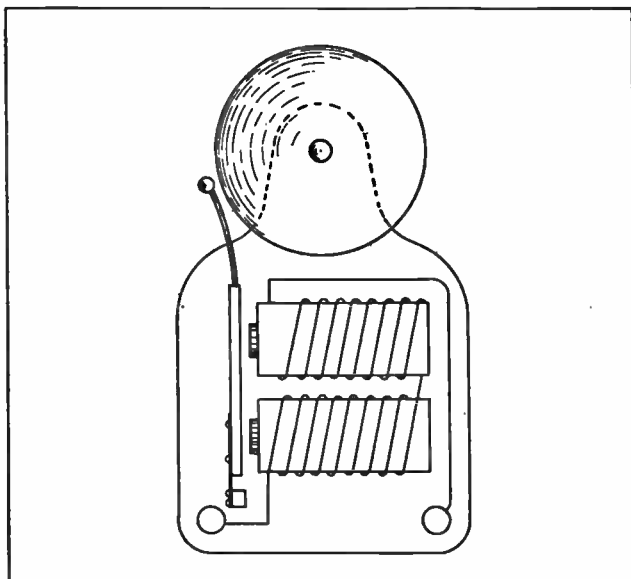

Fig. 32. Circuit diagram of a single stroke bell. Note that it does not have any "make and break" contacts.

These bells are very good for code calling, where a certain number of distinct strokes are used for each different call. They should be operated on D. C., as alternating current will cause the hammer to chatter slightly if held against the gong. This is due to the regular variations in value of alternating current.

**21. COMBINATION BELLS**

There are also combination bells which are arranged to be used either vibrating or single stroke.

Figure 33 shows a sketch of such a bell connected to a battery and two switches, to be operated either as a single stroke or vibrating bell as desired. If button "A" is pressed, the current will flow directly through the coils without having to pass through the make and break contacts at "C", and the bell will operate single stroke. The arrows show the path of current flow, during single stroke operation. If button "B" is pressed the current will flow through the armature and make and break contacts, and then to the coils, and the bell will vibrate because the magnets can now break the circuit rapidly as they pull the contacts apart at "C".

In emergencies or when a combination bell of this

type cannot be obtained conveniently, you can easily convert an ordinary vibrating bell to single stroke or combination operation, by attaching an extra wire to the stationary contact of the breaker. See Figure 34, and the extra wire "A".

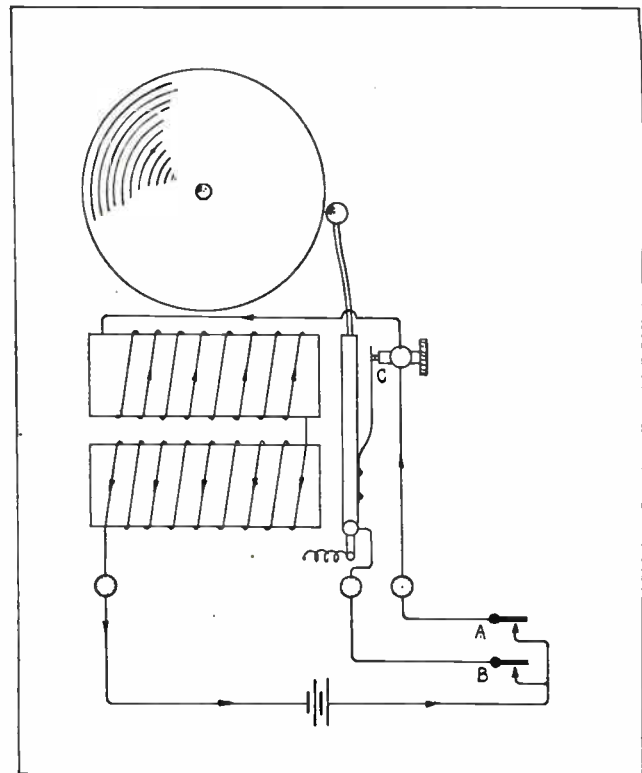

Fig. 33. Connections for a combination bell to be used either single stroke or vibrating. Trace this circuit carefully.

There are several other types of bells that are slightly different from the series vibrating type with principles very similar, but they are little used and can be easily understood with a little close observation and a knowledge of general principles covered here.

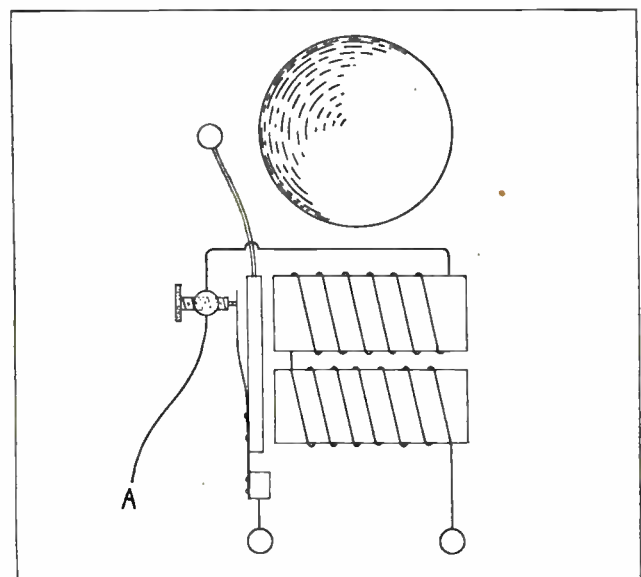

Fig. 34. Sketch showing method of attaching an extra wire to the stationary contact to convert an ordinary vibrating bell for single stroke or combination operation.



Another type of bell used extensively in telephone work, and operated on alternating current, will be taken up in a later section.

## 22. SIGNAL BUZZERS

In certain places such as hospitals and offices where noise is undesirable, a bell is too loud, and some device to give a softer note is needed.

For this purpose we have buzzers. These buzzers are almost exactly the same in construction and operation as the bells, except that the hammer and gong are left off entirely. The vibration of the smaller and lighter armature makes a sort of low buzzing sound which is sufficient to attract the attention of anyone near it. Figure 35 shows a common type of office buzzer enclosed in its metal case, and Figure 36 shows a sketch of the electrical circuit and parts of this buzzer. Buzzers can be obtained in different sizes, and some have an adjustment screw on them to change the tone and volume of sound. Figure 37 shows four buzzers of different sizes.



Fig. 35. Common office type buzzer, very similar to a vibrating bell, except that it has no hammer or gong.

## 23. "MUFFLING" OF BELLS

Sometimes when a buzzer is not available it is desirable to partly silence a bell, without putting it out of service entirely. This can be done by plugging the back of the gong with paper, or by removing the hammer ball, or bending it back so it does not strike the gong.

## 24. CARE AND TESTS OF BELLS AND BUZZERS

When any bell or buzzer fails to operate, a quick test to find out whether the trouble is in the bell or some other part of the circuit, can be made by connecting a cell or battery of proper voltage directly to the bell terminals.

If the bell does not operate then, be sure its terminals are tight, and its armature free to move. Clean the make and break contacts carefully with a thin file, or fine sand paper, and you will probably cure the trouble. If it still does not operate, examine the coils and the wires leading to them and, if necessary, test the coils as explained in previous sections. Usually the trouble will be found

at the contacts, loose terminals, or armature adjustment.

## 25. SILENT SIGNALS

In some places an entirely silent signal is desired, and a visual indication is used instead of a bell or buzzer.

For this purpose we have low voltage signal lamps of various types. These can be obtained in voltages from two to twenty, and with colored bulbs, in white, red, blue, green, amber, etc. The different colors can be used to indicate different signals or to call different parties.

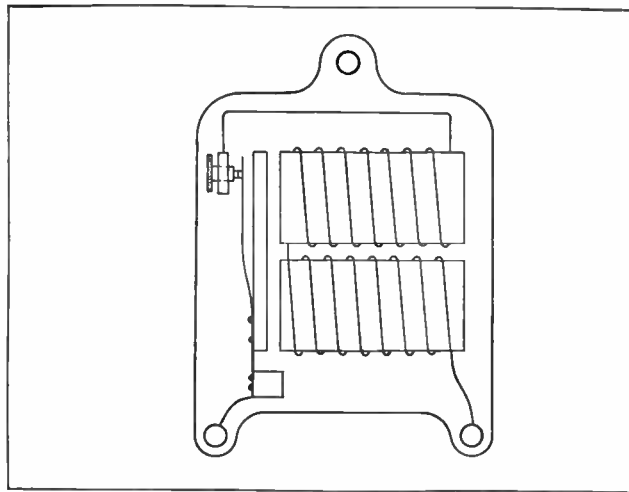

Fig. 36. Sketch showing coils and circuit of a buzzer of the type shown in Fig. 35.

Some of these lamps can be obtained with miniature threaded bases, to screw into small porcelain sockets, and can be conveniently located most anywhere desired. Others are made in special sizes and types, such as those used in telephone switchboards, etc.

When regular signal lamps are not available, automobile lamps and flashlight lamps can often be used to good advantage.

In many cases both a lamp and bell are used, or a lamp in the daytime, and a bell at night to arouse a sleeping person.

Danger signals often use both a red lamp and a bell. Railway crossing alarms are good examples of this.

Lamps of proper size and voltage rating can often be connected in parallel with a bell as in Figure 39-A, or in series as in Figure 39-B.

Figure 40 shows a circuit which enables the caller to use either the lamp or bell as desired.

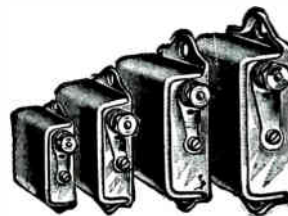

Fig. 37. Four office buzzers of different sizes. Each size gives a signal of a different tone and volume.

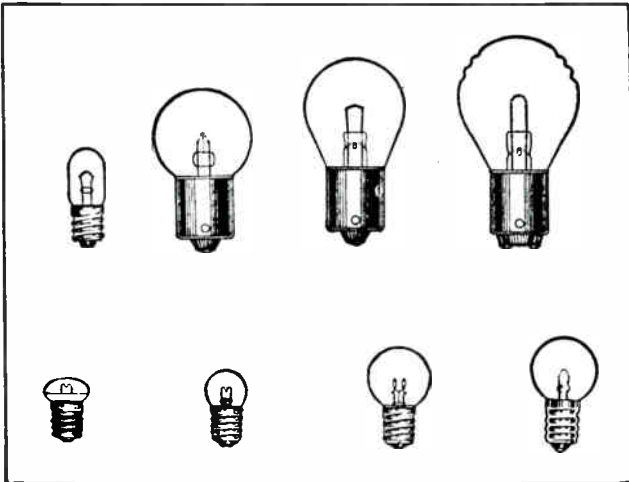

Fig. 38. Several types of low voltage lamps which can be used for signal circuits.

**26. MAGNETIC DOOR OPENERS**

A device quite commonly used in connection with door bells is a Magnetic Door Opener, shown in Figure 41. These devices will unlock the door by use of magnets, when a button inside is pressed. They are particularly popular and useful in apartment buildings where the door bell may call someone several floors above. Such buildings usually have speaking tubes or telephones in connection with the door bells, and after the bell is rung and the party in the house finds out who is calling, they can unlock the door if they wish to by merely pressing a button in their apartment. Thus they are a

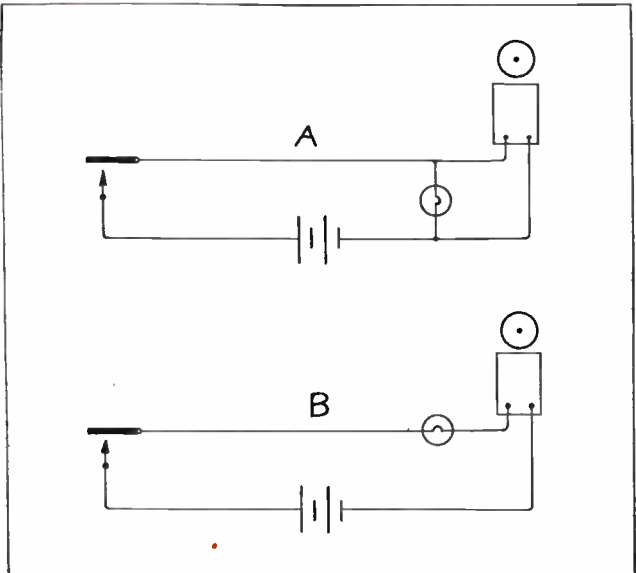

Fig. 39-A. Signal lamp connected in parallel with a bell so they both operate at once.

Fig. 39-B. Signal lamps can also be connected in series with bells if they are of the proper resistance.

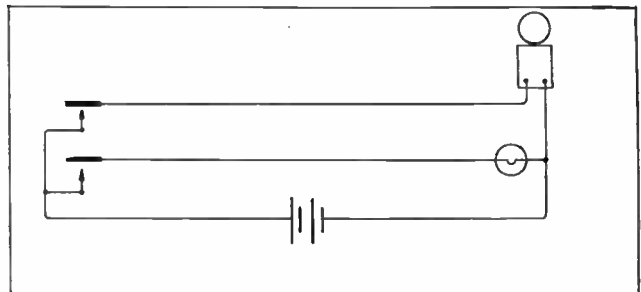

Fig. 40. Connections for operating either a bell call or silent lamp signal, as desired.

an advantage to have the bell continue to ring until it is shut off by the person it is to call. For example a burglar alarm in order to give a sure warning, should not stop ringing if the burglar stepped in through the window and then closed it quickly. To provide continuous ringing of a bell once the switch is closed, we use a device called a drop relay. Figure 43 shows one of these devices, and Figure 44 shows a sketch of the connections of a drop

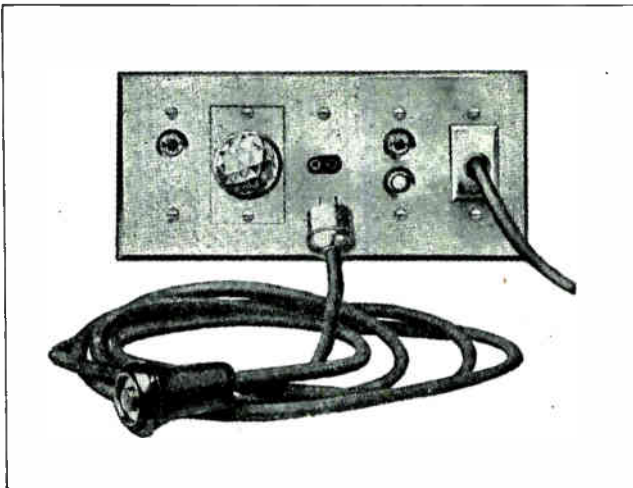

Fig. 38-A. Panel and cord for silent hospital signal. The lamp is located behind the glass "bulls-eye" at the left.

great convenience and time saver. Figure 42 shows a sketch of a magnetic door lock in connection with a door bell system. Note how the same battery and the center wire are used for both circuits. Many worth while economies can be effected in wiring signal systems, by such simple combinations of circuits. A number of these will be shown a little later in this section.

**27. DROP RELAYS FOR CONSTANT RINGING SIGNALS**

In certain alarm and signal systems it is often

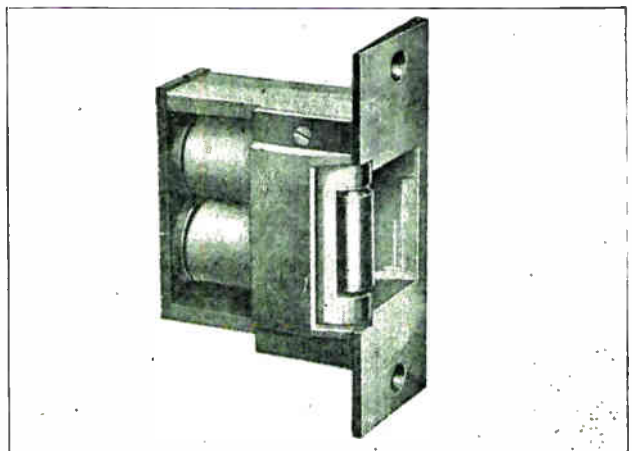

Fig. 41. Magnetic door opener, used to unlock doors in apartment houses or buildings from a distance, by the use of a push button and low voltage circuit.

relay with a bell, battery, and switch, ready to operate. Trace each part of this circuit and examine the parts of the device carefully, and its operation will be easily understood.

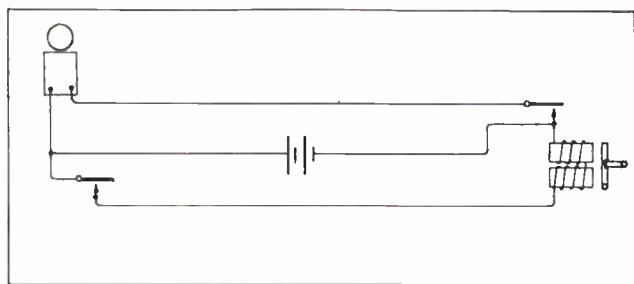

Fig. 42. Sketch showing connections for a door bell and magnetic door opener.

When the switch is closed, current first flows through the circuit as shown by the small arrows, causing the coils to become magnetized and attract the armature. This releases the contact spring which flies up and closes the circuit with the stationary contact to the bell. Before being tripped, the contact spring is held down by a hook on the armature, which projects through a slot in the spring. The button "B" extends through the cover of the relay, and is used to push the contact spring back in place, or reset it, and stop the bell ringing.

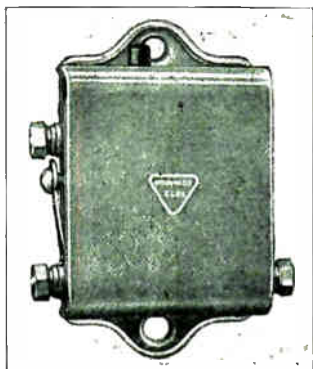

Fig. 43. Common type of drop-relay to provide constant ringing in alarm or signal circuits.

In tracing the bell operating circuit shown by the large black arrows, we find the current flows through the frame of the device from "C" to "D." The marks or little group of tapered lines at "C" and "D" are symbols for Ground connections. From this we see that a ground connection as used in electrical work does not always have to be to the earth. But instead a wire can be Grounded to the metal frame of any electrical device, allowing the current to flow through the frame, saving one or more pieces of wire and simplifying connections in many cases. It is a very common practice in low voltage systems, and extensively used in telephone and automobile wiring. So remember what that symbol means whenever you see it from now on. Another type of drop relay is shown in Figure 45, and its circuit and connections with a bell and battery are shown in Fig. 46.

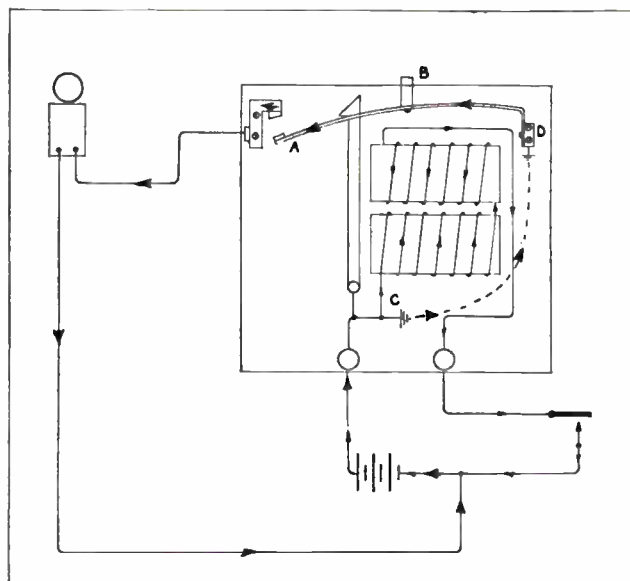

Fig. 44. Sketch showing complete circuit and connections of drop-relay of the type shown in Fig. 43. Examine this sketch and trace the circuit very carefully.

This relay is a little different in construction than the one in Figure 43, but it performs the same function of causing the bell to ring constantly when the relay is tripped. Trace this circuit carefully and compare the terminals "C," "D" and "E" with their position on the relay in Figure 45, and this will show you how to properly connect the device in a circuit.

Drop relays are used very extensively in burglar alarms, and also in other forms of signals. Some special bells are made with an extra release spring and switch to make them ring constantly until reset. This is a sort of drop relay built right into the bell.

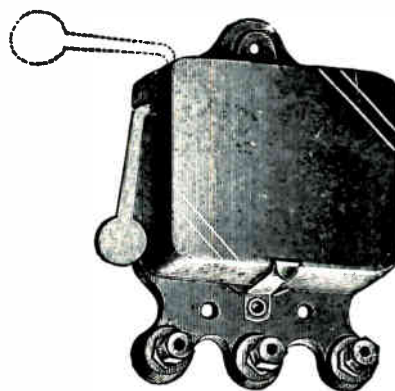

Fig. 45. Another type of drop-relay of slightly different construction, but also providing constant ringing.

## 28. RELAYS

Earlier in this section it was mentioned that a closed circuit system is much more reliable than an open circuit system, because any fault such as a broken wire or dead battery would make itself known at once by causing the signal to operate. So closed circuit systems are much better for burglar alarms, fire alarms, etc., where it is very important

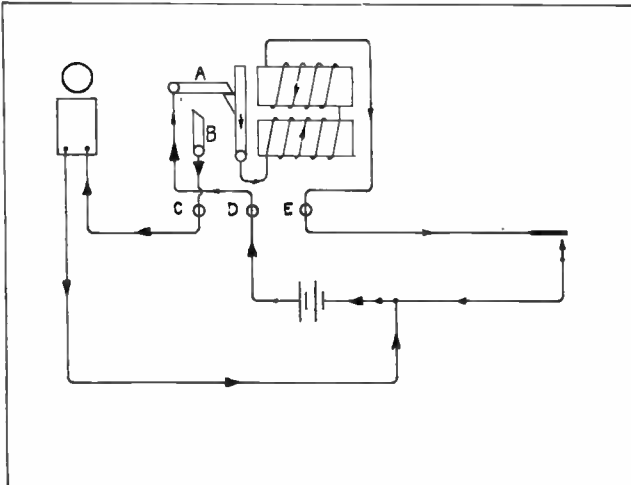

Fig. 46. This sketch shows the method of connecting a drop-relay such as shown in Fig. 45 to a bell battery and push button for constant ringing signals.

not to have a fault in the system go unnoticed until just when the signal is most needed.

We cannot, of course, connect a bell directly in a closed circuit, or it would ring continually. So we have an interesting device which can be connected in the closed circuit, using very little current, and making no noise until its circuit is disturbed. Then it immediately gets busy and closes a second circuit to the bell, causing it to ring.

This device is called a Relay. Its name gives a good idea of its function. When it receives an impulse or has its current interrupted, it passes on an impulse of current to a bell or other device, similar to the man in a relay race who passes his stick to the next man to carry on.

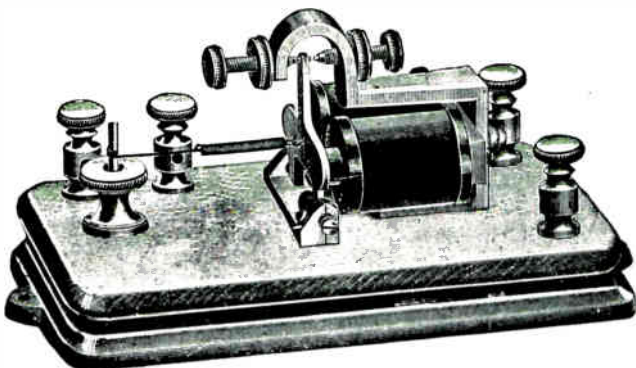

Fig. 47. Common Pony Relay such as used in burglar alarm and telegraph systems. Examine the construction and parts, and compare with description given.

A relay is in reality a Magnetically Operated Switch. Figure 47 shows a common type of Pony Relay, which is used extensively in alarm, signal, and telegraph work.

Examine this relay very closely. You will note the Coils or electro magnets, which are to attract the Armature or movable part of the switch. The armature is the vertical metal piece set in pivot hinges at the left end of the magnets. Then there is a coil spring attached to it and having its other end fastened to an adjusting screw to vary the

spring tension on the armature. This spring is to pull the armature back each time the magnets release it. The large piece of brass with the curved arch above the armature is called the Bridge, and supports two adjustable bridge contacts. These screw contacts have hollow tips, in which we can place plugs of metal, hard rubber, or wood, according to which contact we wish to use in the circuit. Note that the armature tip also has small points of good contact metal on each side where it touches the bridge contacts.

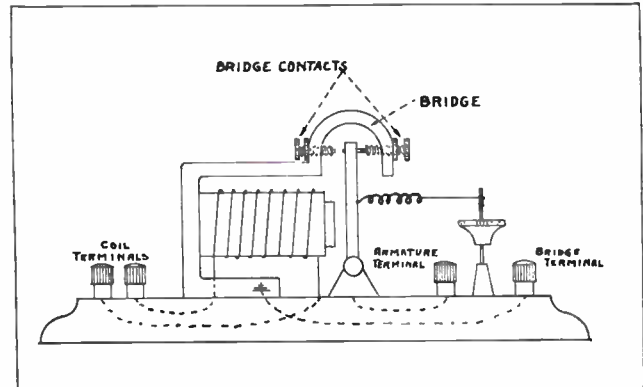

Fig. 48. Diagram showing the arrangement of the electrical circuits and terminals of a Pony Relay.

## 29. RELAY TERMINALS AND CONNECTIONS

The two connection posts or terminals on the right end of the base in Fig. 47 connect to the coils. And of the two on the upper left corner, the right-hand one nearest the armature is connected to the armature, and the left one connects to the bridge. These connections are made under the relay base. It is very important to remember which of these terminals are for the coils, armature, and bridge.

Figure 48 is a sketch of this relay showing its electrical parts and circuits from the opposite side to the one shown in Figure 47. Compare this very closely with the picture in Figure 47, and locate the coils, armature, bridge, contacts, and terminals, so you know the location of each and the operating principle of the relay. Figure 49 shows another relay of slightly different construction but same general principle as Figure 47.

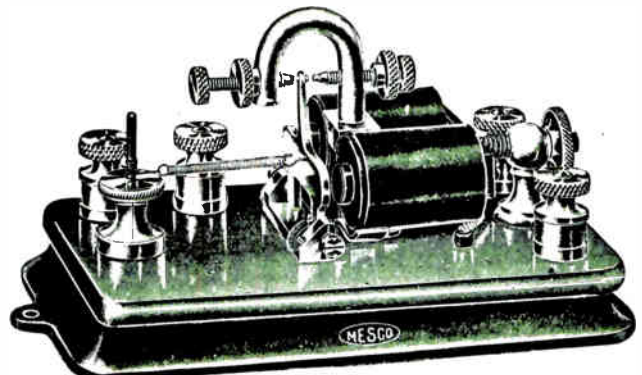

Fig. 49. Another type of Pony Relay similar to the one in Fig. 47, but of slightly different mechanical construction.

### 30. OPEN, CLOSED, AND DOUBLE CIRCUIT RELAYS

Relays can be used in several different ways in circuits, and according to their use they are called Open Circuit, Closed Circuit, and Double Circuit Relays.

To use a relay as an open circuit device, we place the metal tipped bridge contact screw on the left side of the bridge arch, and the insulated contact on the right, or the side away from the coils, as in Fig. 50-A.

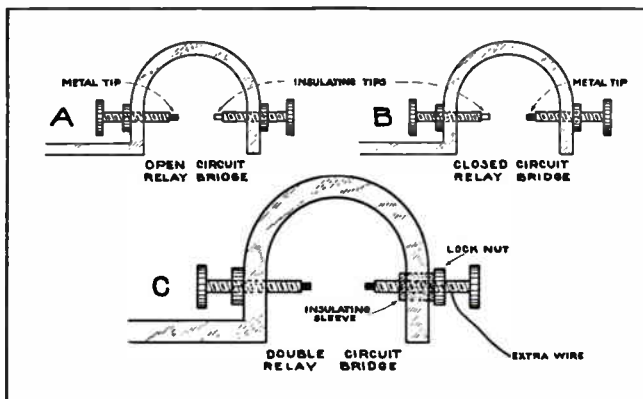

Fig. 50. This sketch shows in detail the manner of arranging and insulating relay bridges for open circuit, closed circuit, and double circuit operation.

For closed circuit operation we reverse them. For double circuit use we fit both bridge screws with metal tips, but remove one screw and insulate it from the bridge arch, by enlarging the hole and fitting it with an insulating sleeve, then replacing the screw in this sleeve. Then we attach an extra wire to this screw for the extra circuit. See Figs. 50-A, B, and C. With a drill to enlarge the hole in the bridge, and piece of fibre or hard rubber, or even hard wood, for the insulating sleeve, any ordinary pony relay can be easily changed to a double circuit relay in this manner in a few minutes. This is a very important thing to remember, because some time you may not be able to get a double circuit relay, and it may be very handy to know how to change over a single circuit relay in this manner.

### 31. RELAYS USED IN BURGLAR ALARMS

Figure 51 shows a closed circuit relay connected up for operating a simple closed circuit burglar alarm. Here we have used just the symbol for the relay instead of a complete sketch. Note what a time saver this symbol is, and practice making a sketch of it until you are sure you can make it any time, when laying out a plan for a system using relays.

Trace out the circuit in Figure 51 until you understand its operation thoroughly. Note that current will normally be flowing all the time in the closed circuit "A". For this reason most relays of this type have high resistance coils, wound with many turns of very fine wire, so they will not use much current from the battery. Many of these

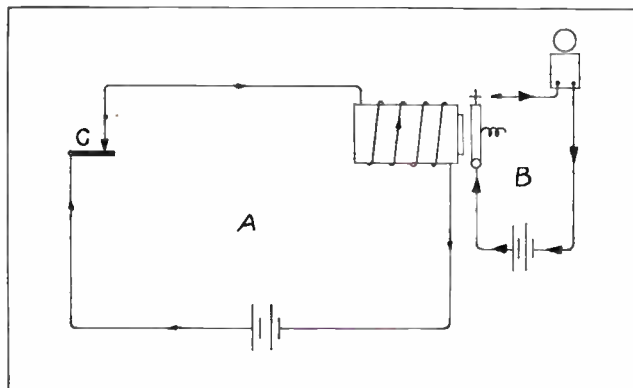

Fig. 51. Connections for a closed circuit relay used to operate a bell in a simple burglar alarm system.

common relays have coils of 75 ohms, and they can be obtained with higher or lower resistance for various uses. Recalling the use of Ohms law formula, we find that if a 75 ohm relay is used in a circuit with a 3 volt battery, only .04 ampere will flow. Or as  $E \div R = I$ , then  $3 \div 75 = .04$ .

Many relays are made so sensitive and with such high resistance coils, that .001 ampere or less will operate them. But even with the small current flow of .04 ampere, it will be best to use a gravity cell, Edison cell, or storage battery, for the closed circuit "A", so the continuous current flow will not exhaust it quickly.

As long as this system is not disturbed, the current flowing in the closed circuit "A" and through the relay coils, will hold the armature away from the bridge contact, and the bell will remain silent.

But if a burglar disturbs the window or door to which the closed circuit switch "C" is attached, this will open the circuit and stop the current through the relay coils, and they will release the armature. Its spring will pull it against the bridge contact and close the circuit to the bell giving the alarm.

### 32. PROPER LOCATIONS OF PARTS FOR DEPENDABLE CLOSED CIRCUIT SYSTEMS

In installing such a system, the relay, bell, and batteries would usually all be grouped close together, possibly all on one shelf, so the wires between them and in circuit "B," would be short and have little chance of being damaged. The wires of circuit "A" would be the long ones running through the building to the part to be protected.

If these wires should be cut or damaged, or this battery go dead, the relay would immediately cause the bell to operate, calling attention to the fault. While with an open circuit system the wire could be cut, or the battery dead, and the system out of order, without any one knowing it, and thus fail to operate when needed the most.

The battery in circuit "B" is not likely to go dead so often, as there is very seldom any current required from it. But it should be tested occasionally to make sure it is in good condition. Any

important alarm system should be tested daily, or every evening, before being switched on for the night.

In Figure 51, in the relay symbol, we only show the one bridge contact which is in use.

When we desire to operate a bell or signal sounder at a considerable distance, an open circuit relay can be used to good advantage to save sending the heavier current required by the bell over the long line.

If we were to send the heavy current over the long line, it would cause considerable voltage drop and we would have to use larger, more expensive wires, or higher voltage supply. But the relay current being very small can be sent over the line more economically, and the relay will act as a switch at the far end of the line, to close a Local circuit to the bell. See Figure 52.

This circuit uses an open circuit relay, and the bridge contact on the side opposite to the one used in Figure 51. This method of using a relay to operate on a feeble impulse of current, and close a circuit to a larger device requiring more current, is one of their most common applications.

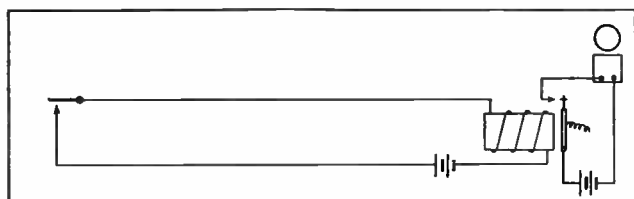

Fig. 52. Connection diagram for an open circuit relay used to operate a bell at a considerable distance from the push button.

### 33. USE OF RELAYS IN TELEGRAPH SYSTEMS. GROUND CIRCUITS

Figure 53 shows two relays at opposite ends of a line, and operating Sounders in local circuits, in a simple telegraph system. The primary circuit includes two line batteries, two key switches, and two high resistance relay coils. The secondary circuits each consist of a local battery and sounder, and include the relay armature and bridge contacts as their switches. You will note that only one line wire is used in the primary circuit, and the earth is used for the other side of the circuit, by grounding the batteries at each end as shown. This saves considerable expense in line wire, and is quite commonly done in telegraph, telephone, and certain classes of signal work.

If the ground connections are well made of buried metal plates, or rods driven deep into moist soil, the resistance of the earth is low enough so the losses are not very high with such small currents.

Such ground circuits are not used to transmit electric power in large amounts, however.

Both of the telegraph keys in this system have extra switches that are normally kept closed when the keys are idle. This allows a very small amount of current to flow through the line and relay coils continually, when the system is not in use.

This keeps the relays energized, and the local sounder circuits closed also, through the relay armatures and bridges. This may seem like a waste of current, but the batteries, being of the closed circuit type, stand this current drain very well and do not cost much to renew when exhausted.

When an operator wishes to send a message, he opens the auxiliary switch on his key, thus opening all circuits. Then each tap of his key sends a feeble impulse or very small current over the line, causing the relays to operate and give similar impulses, but of much heavier current, to the sounders from their own local batteries.

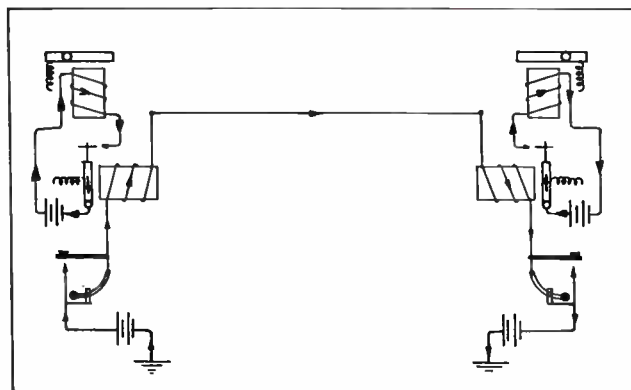

Fig. 53. Sketch of simple telegraph system showing line and ground circuit for the relays and keys, and local battery circuits for the sounders.

The operator at the other end of course hears the signals from his sounder. When the sending operator finishes, he closes his key switch, and waits for an answer. Then the other operator opens his switch and uses his key to signal back. Sometimes a number of such relays at various stations are all connected to one line, so they all operate at once, when any key is used.

Figure 54 shows a double circuit relay. In this system, as long as the switch "A" is closed the relay armature is attracted and closes a circuit through the lamp, showing that the circuit is in normal condition. But when switch "A" is opened the relay armature is released, allowing the lamp to go out and causing the bell to ring.

These double circuit relays have many uses, some of which will be shown a little later.

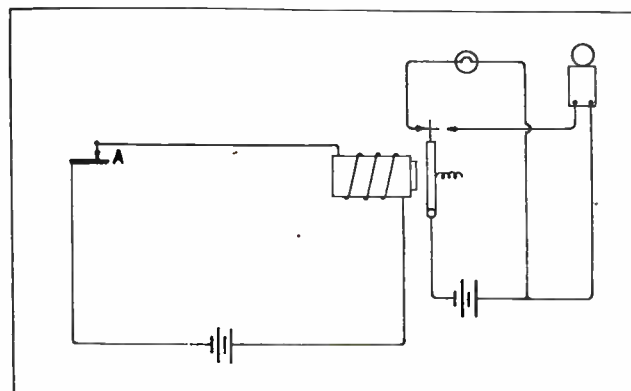

Fig. 54. Diagram and connections for a double circuit relay to operate a lamp when the system is undisturbed, and to ring a bell when the closed circuit is molested in any way.

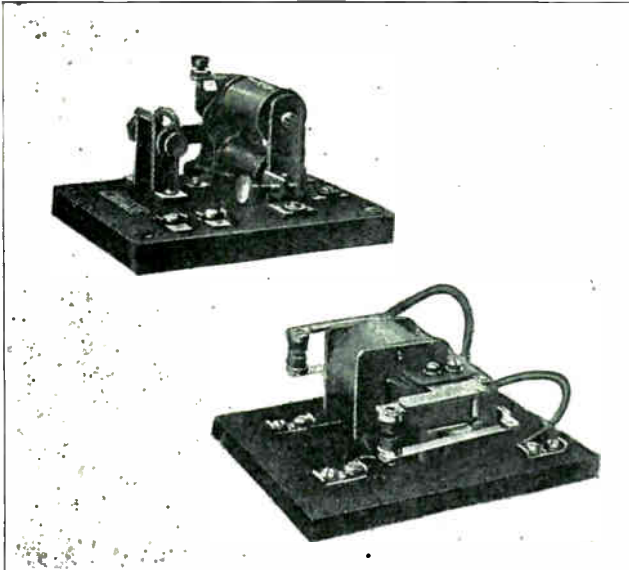

Fig. 54-B. Two additional types of relays used in various classes of signal circuits.

### 34. RELAY TERMINAL TESTS

If you are ever in doubt as to the correct terminals on a relay, a quick test with a dry cell and two test wires will soon locate the coil terminals. When the cell is connected to the coil wires the armature will snap over toward the magnets. Connecting a cell and buzzer or small low voltage test lamp, to the armature and bridge terminals, and then moving the armature back and forth by hand, will soon show which terminal connects to the closed bridge contact and which to the open one.

### 35. ADJUSTMENT AND CARE OF RELAYS

Relays require careful adjustment to secure good operation. The pivot screws supporting the armature and acting as its hinges, should be tight enough to prevent excessive side play of the armature, but not too tight or they will interfere with its free movement. By turning one of these screws in, and the other one out, the contact points on the armature can be properly lined up with the bridge contacts. The bridge contacts should be adjusted to act also as stops for the armature. The contact on the magnet side should be adjusted to allow the armature to come very close to the core ends, to reduce the air gap and strengthen the pull as much as possible. It should not, however, allow the armature to touch either core end, or it is likely to stick, due to slight residual magnetism, even after the coil current is turned off. Some relays have thin brass or copper caps over the iron core ends of the magnets, to prevent any possibility of this sticking. The contact on the side away from the magnets should be adjusted to allow the armature just enough swing to effectively break the circuit at the other contact; but not too far, or it will be very hard for the magnets to pull it back, due to the increased air gap between the armature and cores.

This would require more current to operate the relay. Usually the gap or travel of the armature contacts should be from  $1/32$  in. for breaking circuits at very low voltage and small currents, to  $1/8$  in. or  $1/4$  in. for slightly higher voltages and heavier currents; as these have a tendency to arc more, when the circuit is opened and the points must separate farther to extinguish the arc quickly.

The armature spring should be adjusted just tight enough to pull the armature away from the magnets quickly when it is released, but not too tight, or the magnet will not be able to pull up the armature.

The contacts on both the armature and bridge should be kept clean and occasionally polished with a thin file or fine sandpaper, as the slight arcing often burns and blackens them, greatly increasing their resistance.

When contacts become too badly burned or damaged to repair, they can easily be replaced with new ones, obtained from the relay manufacturers.

Dust and dirt should be kept off from all parts, and all terminal nuts should be kept tight. Cores of magnets should be kept tight on keeper bar support.

Occasionally, but not often, a relay coil may become open, grounded, or shorted, or completely burned out. Simple tests as given in the elementary section on electro-magnets will locate any such faults. (See Article 101.) In addition to these pony relays, there are numerous other types used in telephones, railway signals, power plants, etc. Some of these differ in mechanical construction and shape, from the ones just described, but their general purpose and principle are very much the same. So if you have a good understanding of the relays in this section and always remember that **any relay is simply a magnetically operated switch**, you should be able to easily understand most any type. Some of the others will be explained in later sections.

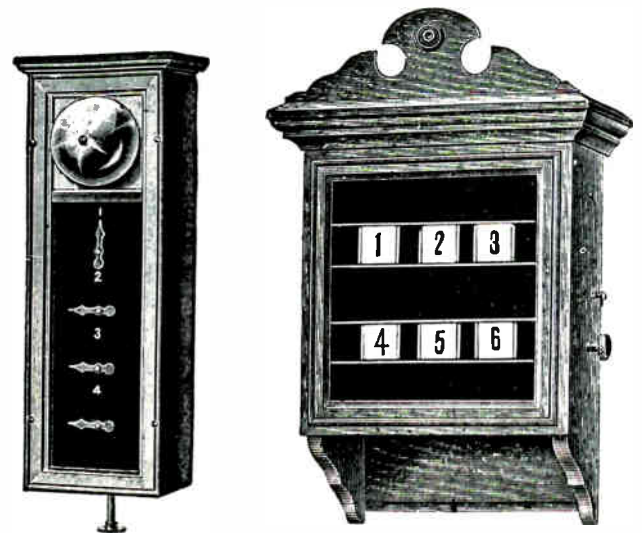

Fig. 55. Annunciators of these types are used to indicate where various calls on signal circuits come from.

### 36. ANNUNCIATORS

In alarm or signal systems where calls may come from several different points, it is often necessary to have some device to indicate which place the signal comes from. For this purpose we use an Annunciator. These devices indicate which circuit is operated, by arrows or numbers which are dropped into view by electro-magnets. Figure 55 shows two types of annunciators, and Figure 56 shows the electrical circuit of a 4 point annunciator.

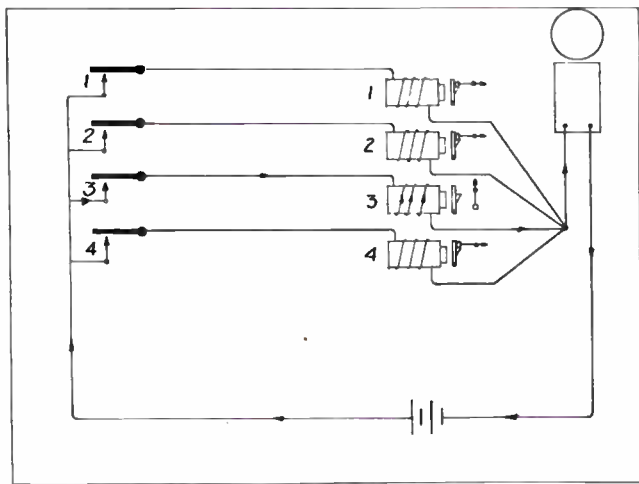

Fig. 56. Circuit diagram of the connections for a four-drop annunciator. Note that the drop number 3 has been operated.

Here for example we have four switches that may be used for office calls, burglar alarms, or hotel room calls. When any one of the switches is closed current will flow through the respective annunciator magnet, and on through the bell. When a magnet is energized the armature is attracted, allowing the weighted end of the arrow to fall off the catch, and the arrow to fly up, as on magnet 3.

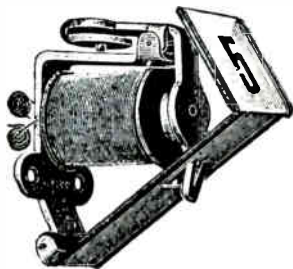

Fig. 57. This view shows the mechanical construction of one type of annunciator drop. Note how the drop is held up by a small hook on the end of the armature.

In Figure 57 are shown one of the magnets and "number drops" of an annunciator. When this magnet is energized, the armature is attracted and releases the catch from the slot in the drop arm. Gravity then causes the drop number to fall. Annunciators usually have a system of rods and hooks, all attached to one lever, to push the drops back in place after any of them are tripped. Some are equipped with a strong electro-magnet to operate

this "reset" lever, from a switch on the annunciator case, or a short distance away.

Figure 58 shows a back view of an annunciator, and the magnets and reset mechanism.

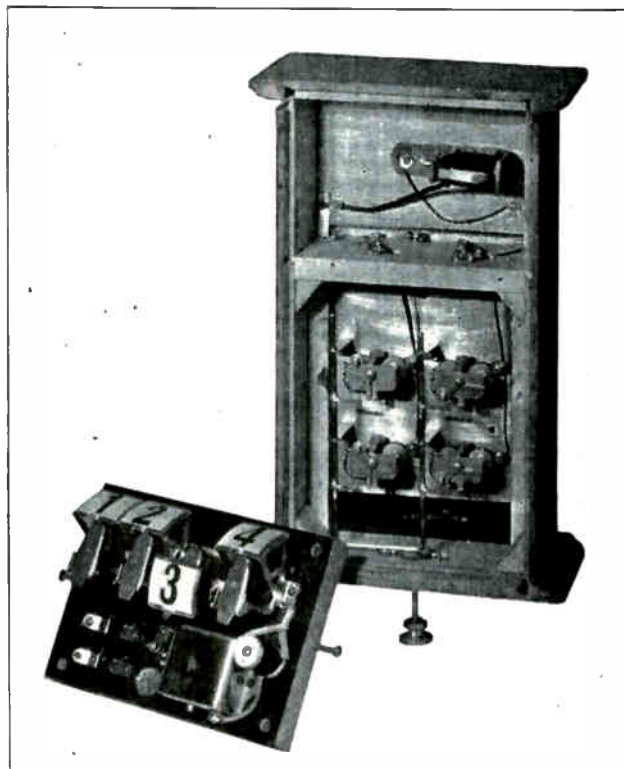

Fig. 58. Photograph showing the inside parts and construction of two common types of annunciators.

Referring to Figure 56 again, note how one wire from each magnet attaches to a common terminal or wire leading to the bell. This is called a **Common Return Wire**, as it makes a common path for current from any magnet to return to the battery. This is the wire that should go to the bell, so all coil circuits will operate the bell when they are tripped. Some annunciators have the bell built in them, and others do not.

### 37. ANNUNCIATOR CONNECTIONS AND TERMINAL TESTS

When installing annunciators it is very important to connect the proper wires to the separate circuits, and to the bell. Sometimes the terminals are marked with numbers on the box where they enter, but when they are not marked, they can be found by a simple test. Using a dry cell or some other source of current supply, and two test wires, as in Figure 59-A, place one wire on one of the annunciator terminals at the end of the row or group, and hold it there while touching the other wire to the remaining terminals in rotation. If this causes the drops to operate in proper rotation then mark the wire to which your stationary test lead was connected, as the common lead, and the rest according to the numbers of the drops they each operate.



If touching the free test lead to certain terminals causes two or more drops to trip at once, the stationary lead is not on the common wire, and should be tried on the terminal at the opposite end of the row, because the common lead is usually at one end or the other. Sometimes, however, it may be somewhere else in the group.

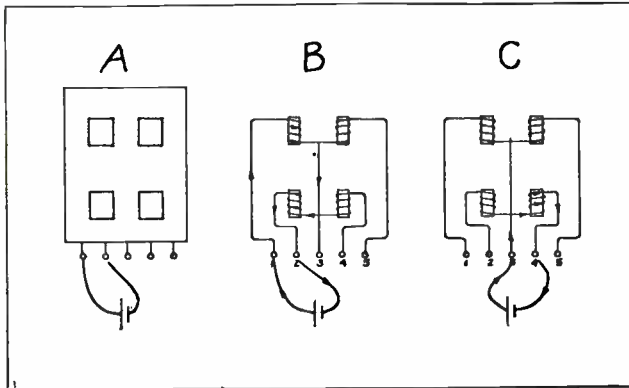

Fig. 59. Observe these test diagrams very carefully with the instructions given for locating annunciator terminals.

By touching the test wires to adjacent terminals two at a time, when two are found that cause only one drop to operate, one of these leads should be the common return. In Figure 59-B, with the stationary test lead on wire No. 1, touching the other test lead to wires No. 2, 4, and 5, should cause two drops to fall each time, if they are reset before each test. But when No. 3 is touched only one drop should fall, as No. 3 is the common terminal. Then when the stationary lead is placed on wire No. 3, and the free lead touched to the others, each one should cause one drop to operate.

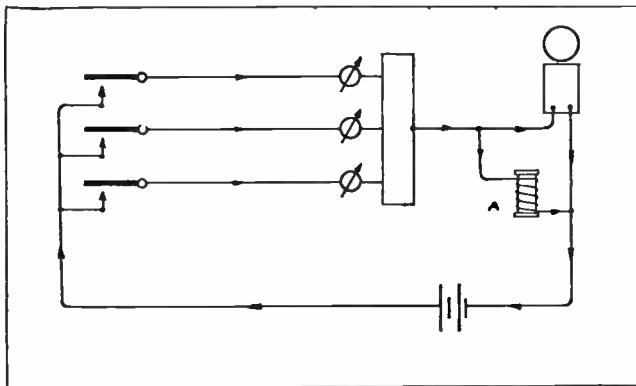

Fig. 60. Diagram showing connections of a three-drop annunciator in an open circuit, signal system. This annunciator uses a ballast coil shown at "A," and connected in parallel with the bell to allow the proper amount of current to flow to operate the drops.

With annunciators that are equipped with a bell or buzzer permanently connected, it is easier to locate the common wire, as it is the only one that will cause the bell to operate when the test battery is applied. For example, when the test wires touch two terminals and cause the bell to ring, one of these terminals must be the common return lead. Trying each one with another wire will quickly show which one operates the bell.

Some annunciators have a ballast coil connected in parallel with the bell, as at "A" in Figure 60. This coil carries part of the current when the bell is of high resistance and not able to carry quite all the current required to operate the drop magnets. Figure 60 also shows a different symbol which is often used for the annunciator in plans or diagrams.

Some large annunciators have a separate reset magnet for each drop magnet, as in Figure 61-A and B. In Figure "A" the reset coil has been operated, and has drawn the armature toward it, carrying the number on the disk out of view from the annunciator window. In Figure 61-B the trip coil has operated, drawing the armature toward it and bringing the number on the disk into view, in vertical position in the annunciator window. (Window and case not shown in this sketch.)

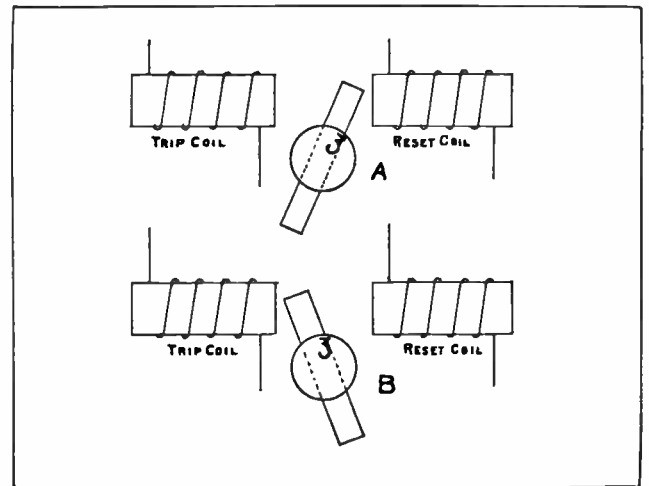

Fig. 61. Sketch illustrating arrangement of coils and number disks on an "electrical reset" annunciator.

Figure 62 shows both sets of coils for a four point annunciator and their connections. Each trip coil can of course be operated separately, but when the reset button is pressed all reset coils operate at once, resetting all numbers that have been tripped.

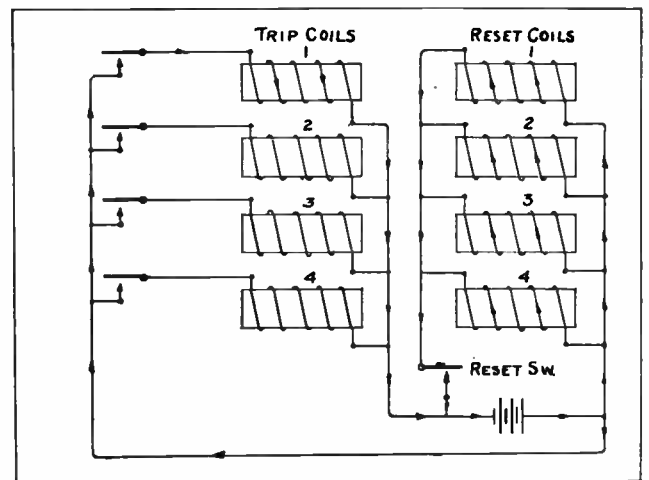

Fig. 62. Complete diagram of a four-drop annunciator using "electrical reset" magnets.

Hotels, hospitals, and steamships often have annunciators with several hundred numbers each. Elevators also use thousands of these devices.

### 38. LOCATING FAULTS IN ANNUNCIATORS

When annunciators fail to operate, careful checking and tightening of all terminals will usually locate the trouble. If none of the drops operate, and the supply battery to the system has been

tested and found O. K., and all circuits are good up to the annunciator, then the trouble is almost sure to be in the common return wire, bell, or ballast coil, if one is used. If only one drop fails, then its own wire, coil, or mechanism is at fault, and careful checking and testing with a dry cell and buzzer should locate it. Here again the rules for testing electro-magnets, given in Section 1, Article 101, should be useful.

# PLAN READING AND VARIOUS TYPES OF SIGNAL CIRCUITS

Now that you understand some of the more common devices used in signal circuits, you will want to learn how they are arranged and connected in the larger and more complete systems.

But first, in order to be able to more easily understand and trace out these advanced circuits, we will cover some of the more definite methods of plan reading and circuit tracing.

Remember this is one of the most valuable things any electrical man can know, and nothing will give you any more confidence, or be of greater help to your success on the job, than a good knowledge of plan reading and circuit tracing. Once you have learned the real system or "trick" of this, it is really very enjoyable and satisfying to trace out almost every circuit or blue print you come across, and you will be surprised how much better understanding you can get of any device or system in this way.

### 39. SYMBOLS USED IN SIGNAL DIAGRAMS.

The chart in Fig. 62-A gives a review of the most common symbols used in the following diagrams and signal systems, and you should study these carefully, so you will be able to recognize them quickly when tracing any circuit. You will also want to be able to quickly select and use the proper symbol for any device, when laying out a plan for a job.

### 40. METHOD OF TRACING CIRCUITS, OR READING PRINTS.

In each of the following systems shown, make a practice of first examining the plan in general, locating and recognizing all of the devices by their symbols. Then get a general idea of the layout, number and arrangement of separate circuits which may be combined in the one system. Next start with the primary or first operating circuit, and trace it out carefully until you can imagine every step of its operation clearly, then the next circuit, or the one which is operated by the first, tracing its operation and so on until you are sure you thoroughly understand the entire system.

At first this may seem like quite a job, but after a little persistent practice you get the trick or method of it, and then you can read most any plan almost at a glance. The ability to do this will be

worth more in the field than any beginner can realize, until he finds out what a great help it is on the job, in any kind of electrical construction work or "trouble shooting" and maintenance.

Don't forget that every principle and bit of practice you get in tracing signal circuits will also apply to practically any other kind of electrical work.

Also remember that most electrical wiring nowadays is done from plans, and not by guesswork. And when we have a difficult trouble shooting problem in a large machine or system, looking over the plan furnished, or making a sketch of the wiring, will often speed up the location of the trouble more than anything else. The man who can do this and save the most time is the man who gets the best jobs.

Then too, as you carefully trace out and study each of the following systems you will also be gaining a knowledge of the principles and operation of common signal, alarm, and call systems.

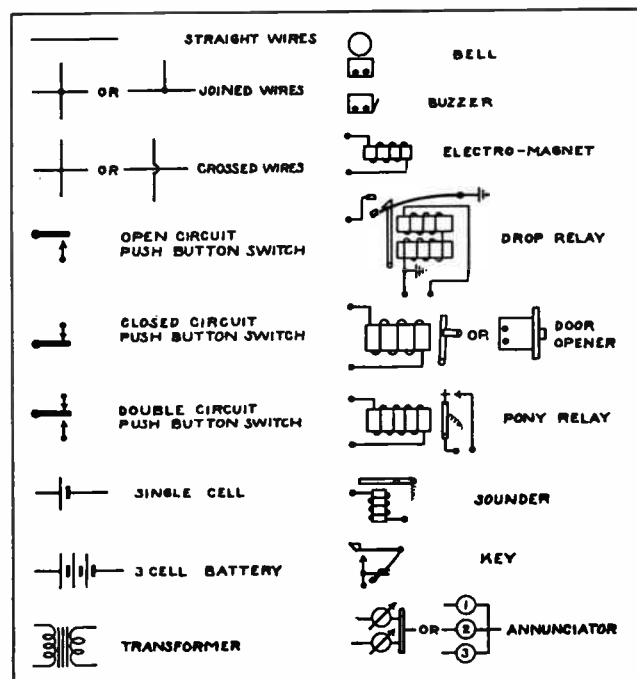

Fig. 62-A. These are some of the most important symbols used in signal diagrams and circuits. They should be memorized so you can easily recognize them when tracing any diagram in the future.

41. OPEN CIRCUIT SYSTEMS.

Fig. 63 shows an open circuit call or signal system, in which any one of three switches will operate the bell. Note that the switches are all connected in parallel. **Open Circuit Switches must always be connected in parallel, if each one is to be able to close the circuit.**

If open circuit switches were connected in series they would all have to be closed at once, in order to close the circuit. Make a sketch of this same circuit, but with the switches in series, and prove this out for yourself, because it is very important, and making a sketch will help you remember it.

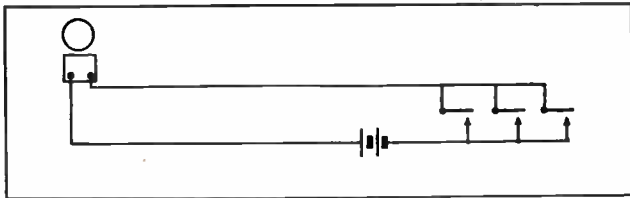

Fig. 63. Simple signal system using three buttons in parallel, any one of which will ring the bell.

Fig. 63 shows only three buttons in use, but any number can be connected in this manner to operate the same device. Such a circuit can be used for the signals on street cars or busses, for an office call where several different parties are to be able to call one person, or for a simple burglar alarm system, by connecting the window and door contacts of open circuit type, to the bell and battery as shown.

42. SELECTIVE CALL CIRCUIT.

Fig. 64 shows a selective call system, in which switch number 1 rings bells 1 and 2, and switches 2 and 3 both operate bell number 3.

Bells 1 and 2 are connected in parallel and both controlled by button 1. Buttons 2 and 3 are connected in parallel, and either one will operate bell number 3.

The lower wire leading from the positive terminal of the battery to the stationary contacts of the switches, can be called a **Common Feeder Wire**, as it carries current to any of the buttons as they are closed.

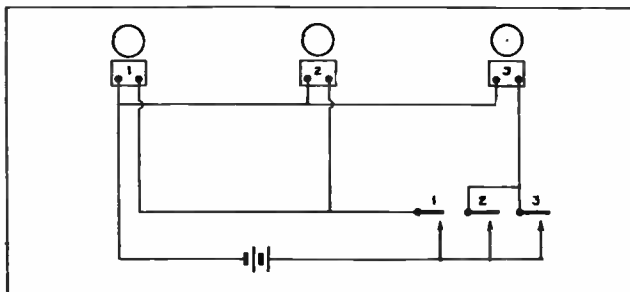

Fig. 64. Selective call system. Button No. 1 will ring bells 1 and 2; buttons Nos. 2 and 3 will ring bell No. 3.

Trace this circuit carefully. When switch number 1 is closed, current will flow from the battery through the switch, and then divide, part of it flow-

ing through each bell. A good rule to remember in tracing such circuits is as follows: **Electric current will flow through all paths provided from positive to negative of the source of pressure. It also tends to follow the easiest path, or the greater amounts of current will flow over the lower resistance paths.**

In the case of Fig. 64, both bells being of equal resistance, and the circuits to them about the same length, the current will divide about equally.

The wire which leads from the left terminal of all three bells, back to the negative battery terminal, can be called a **common return wire**, as it serves to carry the current back to the battery, from any or all of the bells.

43. RETURN CALL SYSTEMS.

Fig. 65 shows a return call system using two bells and two single contact buttons. This is called a return call system because either party can signal the other, or can answer a call by a return signal if desired.

Button number 1 rings bell number 2, and button number 2 rings bell number 1. When button number 1 is closed current flows as shown by the small arrows, and the large arrows show the path of current when button number 2 is pressed.

Note that three main wires or long wires are used in this system.

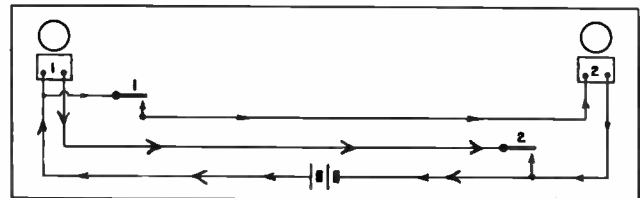

Fig. 65. Return call system. Button No. 1 will ring bell No. 2; button No. 2 rings bell No. 1.

In Fig. 66 is shown another method of connecting a return call system, which causes both bells to ring when either button is pressed.

This system uses two batteries, one at each end, but it saves one main wire, using only two instead of three, as in Fig. 65.

When button number 1 is pressed current flows from battery number 1 as shown by the small arrows, dividing through both bells. When button number 2 is pressed, the current flows from battery number 2 as shown by the large arrows, also operating both bells.

In this system, if the line is very long the bell nearest the button pressed, may ring a little the

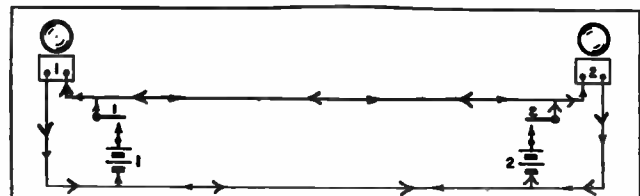

Fig. 66. Return call system using two batteries, thereby saving one wire.

loudest, because its circuit is shorter and lower resistance. Trace this carefully in the sketch.

If the far bell does not ring loud enough, then higher voltage batteries, or larger wires should be used.

Fig. 67 shows a return call system, using double circuit switches.

Here also, button number 1 rings bell number 2, and button number 2 rings bell number 1.

When button number 1 is pressed the current flow is shown by the small arrows, and the large arrows show the path of current when number 2 is pressed. If both buttons should be pressed at once neither bell would ring. Check this on the diagram.

This system also uses three main wires.

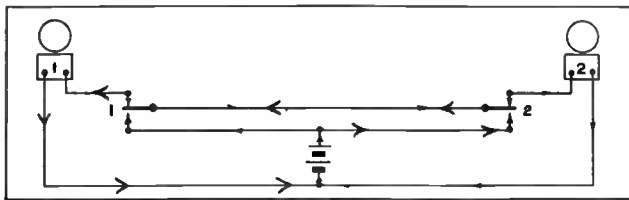

Fig. 67. Return call system using double circuit switches. Trace this circuit carefully.

44. SAVING WIRES BY USE OF DOUBLE CIRCUIT SWITCHES OR "GROUNDS".

Fig. 68 shows how double circuit switches can be used to save considerable wire in connecting a return call system.

By using two separate batteries and the double circuit switches, one main wire can be eliminated and the system operated with only two as shown.

When button number 1 is pressed, current (shown by small arrows) flows from battery number 1, and operates bell number 2. When button number 2 is pressed, current (shown by large arrows) flows from battery number 2, and operates bell number 1.

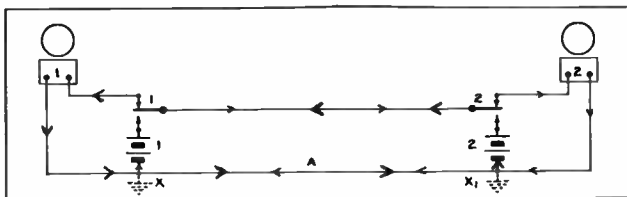

Fig. 68. Return call system showing how wires can be saved by the use of double circuit switches, two separate batteries, and a ground circuit.

When such a return call system is to be installed where the bells are a long distance apart and it is convenient to make good ground connections at each end, we can eliminate still another wire, by the use of ground connections as shown by dotted lines at "X" and "X1," in Fig. 68. Then we do not need wire "A", current flowing through the ground instead. Sometimes a piping system can be used for these grounds, and no connection to earth is needed.

Trace this circuit over very carefully, and be sure you understand its operation, as it is often very important to be able to save these extra wires, where the line between bells is long.

45. CALL SYSTEM WITHOUT SWITCHES.

Fig. 69 shows a system of signaling that is often very convenient for use on temporary construction jobs, where workmen need to signal each other; or in mines or mine shafts.

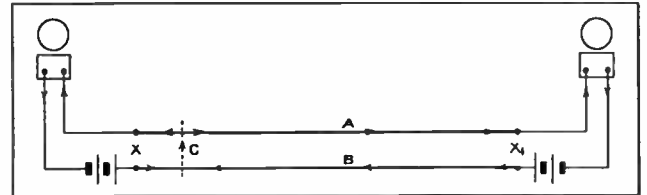

Fig. 69. Mine signal or alarm circuit which uses no switches. The bells are caused to ring by short circuiting wires "A" and "B".

No switches are used in this system, and instead wires "A" and "B" are bare or uninsulated, so any metal object can be used to "short" them or connect them together as shown by the dotted line at "C." Then if the wires "A" and "B" are strung tight and parallel to each other, a few inches apart and supported on insulators, a shovel, pick or piece of wire or metal touching both wires anywhere between points "X" and "X1", will cause both bells to ring.

You may wonder at first why current does not flow all the time in this circuit, as it is always closed. Note how the batteries are connected positive to positive, or opposing each other, so if they are of equal voltage no current can flow normally. Of course if one battery was dead the other would cause both bells to ring continuously.

When a circuit is made between the two wires as at "C" the current starts to flow from both batteries as shown by the arrows, up through the connection "C" and then dividing through both bells, and returning to both battery negatives.

Such a system as this can also be operated from moving cars or elevators, by running the bare wires along close to the track or in the shaft.

46. SELECTIVE AND MASTER CALLS.

Fig. 70 shows a selective call system, with a master control, using one battery, three bells, and three single circuit switches.

Button number 1 operates bell number 1. Button number 2 operates bells number 2 and 3 in series. And button number 3, which is called the master button, operates all three bells in series. Trace each circuit carefully.

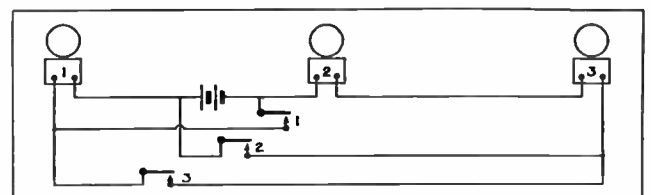

Fig. 70. Selective signal circuit. Check its operation carefully with the instructions.

Another method of arranging a selective call system with a Master Switch, is shown in Fig. 71. In this system any one of the double circuit switches 1, 2, 3 or 4, will operate its respective bell of the same number only, but the single circuit switch number 5, will operate all bells when all the other switches are in normal position.

When any one of the double switches is pressed, its movable contact is disconnected from the upper, or normally closed contact, so when the movable contact touches the lower one, current can only flow through its own bell, and not to any of the others.

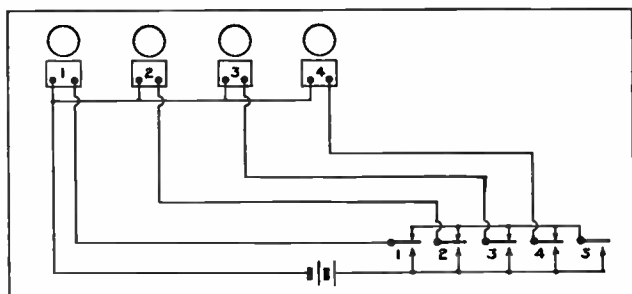

Fig. 71. Selective call system with Master Switch. This is a type of system very often used in executives' offices.

When button number 5 is pressed current flows from the positive of the battery through this button, then divides through the closed contacts of all the other switches and to all bells. Trace this on the sketch until you can clearly imagine this operation.

Note how the wire from the positive of the battery is again used as a Common Feeder for all switches, and also the common return wire used for all bells. Of course one separate wire is required feeding from each switch to its bell, if we are to operate them separately at times, but a great amount of wire can be saved by proper use of Common Feeder and Common Return wires.

This is where a sketch or plan laid out in advance helps to save materials.

#### 47. CONNECTING VIBRATING BELLS FOR SERIES OPERATION.

When several bells are to be operated in series as in Fig. 70, or other systems for which they are connected this way, they will usually not operate very loudly or steadily without a special connection. This is because they do not all vibrate evenly or in synchronism, and the make and break contacts of one bell will open the circuit just as another closes for its power impulse. This results in rather irregular and weak operation, and the greater the number of bells in series, the worse it usually is.

This can be overcome by arranging one bell only as a vibrator, and all the rest as single stroke bells. This is done by shunting out the make and break contacts of all bells except the one, as in Fig. 72. Here the current will flow through the make and break contacts of bell number 1 only, and on the others it flows directly through the coils. Number

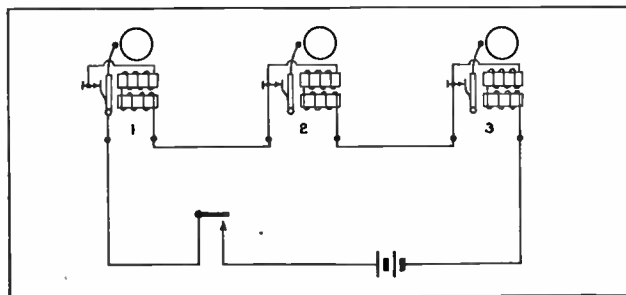

Fig. 72. This sketch shows the proper method of connecting vibrating bells in series, to secure best results.

1 bell then acts as a Master Vibrator, making and breaking the circuits for all the others, preventing them from interrupting the circuit, and forcing them to operate in synchronism.

A series connection of bells is often desirable where they are all to be rung at once and are located a long distance apart, as it saves considerable wire in many cases.

#### 48. ECONOMICAL BARN OR GARAGE ALARM.

Fig. 73 shows a method of connecting a bell as a combination single stroke and vibrator, and obtaining a closed circuit call or alarm system.

When we recall that a closed circuit system usually requires a relay to operate the bell, we find that this connection effects quite an economy by saving the cost of a relay.

Tracing the circuits we find that as long as the switches are all closed, the current will flow continuously as shown by the small arrows, through the bell coils, then through the switches and back to the battery. This keeps the coils energized and holds the hammer quietly against the gong, after the first single stroke when it is connected.

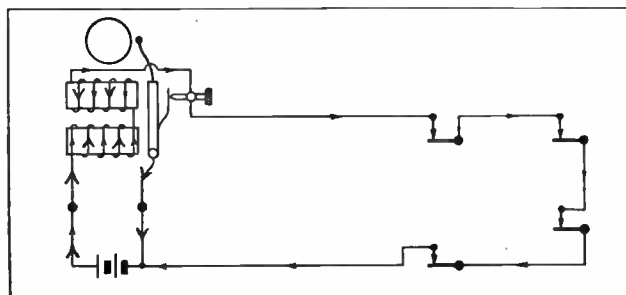

Fig. 73. Simple and economical barn or garage alarm of closed circuit type.

Then when any one of the switches is opened, the circuit is momentarily broken, allowing the hammer to fall back and close the circuit again at the make and break contacts of the bell.

The bell will then continue to vibrate, current flowing as shown by the large arrows, until the switch in the line is again closed. This is a very good circuit to keep in mind when the dependability of a closed circuit system is desired, but must be had at low cost.

A bell with high resistance coils should be used, to keep the amount of current flow small. A closed circuit battery should also be used, as dry cells would soon be exhausted by the constant current flow.

This system makes a very good barn or garage alarm, where long wires are to be run in the open, between the protected buildings and the house. Then if anyone attempts to cut these wires, the alarm will operate just as though the window or door switches of the building were disturbed and opened.

#### 49. OFFICE OR SHOP CALL SYSTEM.

Fig. 74 shows a selective master control call system that would be very convenient for an office executive or shop or power plant superintendent, to signal their various foremen or workmen. Any one at a time can be called, by pressing the proper double circuit switch, or all can be called at once by pressing the single master switch.

The small arrows show the path of current flow when one of the double switches is operated, and the large ones show the current flow to all bells when the master switch is operated.

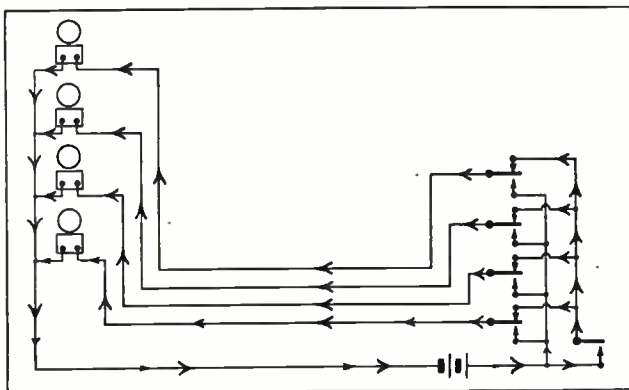

Fig. 74. Another type of selective call system with Master Control.

At first glance this circuit does not look much like the one in Fig. 71, does it? But look at it again and compare the two closely, and you will find they are exactly the same as far as parts and operation are concerned. The only difference is in the position or arrangement of these parts.

This comparison is made to show you that it does not matter how or where the bells or switches are to be located, as long as certain general principles of connection are followed.

Note that in each of these sketches a common feeder runs from the positive of the battery to all the lower or open contacts of the switches. Another common wire leads from the top or closed contacts of all double circuit switches. Then the individual bell wires are each attached to the movable contacts of the double switches in each case, and a common return from the bells back to the battery.

These are the principle points to note and follow in connecting up any such selective, master, call system.

#### 50. APARTMENT DOOR BELL AND OPENER SYSTEMS.

Fig. 75 shows a door bell and magnetic door opener system for a three apartment building.

This sketch is arranged a little differently to show how the wires running up to the various floors can all be grouped together and run in one conduit or cable, and then branches taken off to each bell and switch.

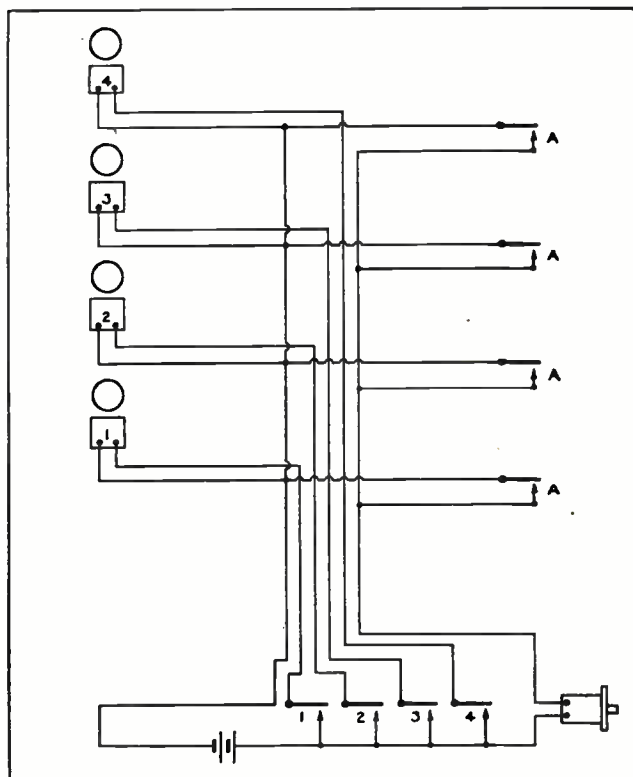

Fig. 75. Combination doorbell and magnetic door-opener system. Note the use of certain wires as common "Feeder" and "Return" wires.

Such a system is commonly used in connection with speaking tubes and telephones in apartment buildings, and could be extended to take in as many more floors or apartments as desired, just following the same scheme of connection as shown.

Any one of the buttons in the lower hall will ring its own bell of the same number. Then if the party is at home and wishes to admit the caller, any one of the apartment buttons marked "A" will operate the door lock.

Fig. 76 shows a similar system of apartment building calls and door opener, including also a buzzer at each apartment door, for parties within the building to use when calling at any other apartment, and without going down to the front door buttons. Trace the circuit and operation carefully.

#### 51. HOTEL OR OFFICE CALL SYSTEM WITH ANNUNCIATOR.

Fig. 77 shows a selective, master call system that could be used very well in an office or hotel and many other places.

With this system a party at "A" can call any one of the parties "B", "C", or "D", by pressing

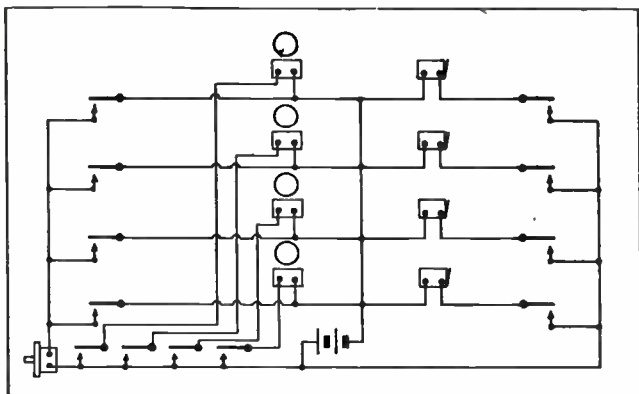

Fig. 76. Doorbell and door-opener system, including separate local buzzer circuits.

the proper buttons; or he can call them all at once by pressing the master button.

The party called can also answer back or acknowledge the call with their button, and the annunciator and buzzer show the response to party "A".

Or if "B", "C", or "D", wish to signal "A" at any time, the annunciator shows which one is calling.

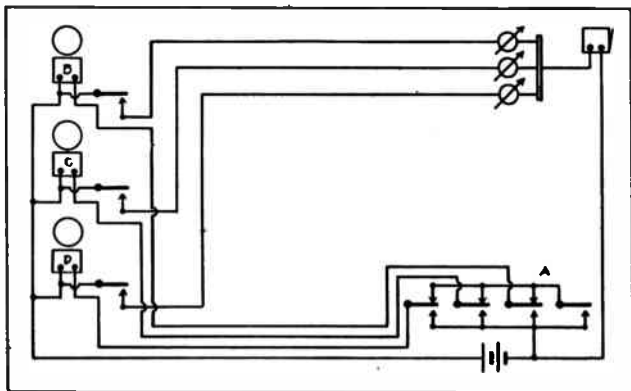

Fig. 77. Selective signal circuit with Master Control, return call and annunciator features. This is a very popular form of signal system.

## 52. SAVING WIRES BY SPECIAL GROUP CONNECTION, and SEPARATE BATTERIES.

Fig. 78 shows a method of connecting a large number of bells and switches in an extensive call system, and using separate batteries and a grouping system to reduce the number of main wires.

Any one of the buttons will ring its corresponding bell of the same letter. By the use of the three separate batteries and Cross Grouping connection of the bells and switches, this can be done with seven vertical line wires, while with one battery it would require thirteen wires.

## 53. CLOSED CIRCUIT BURGLAR ALARM FOR TWO FLOORS OR APARTMENTS.

Fig. 79 shows a closed circuit burglar alarm system for two apartments or floors of a building, using an annunciator to indicate which floor the intruder has entered, and also a drop relay to keep

the bell ringing constantly until some one is aroused and shuts it off.

Normally, when the system is in operation, current flows continually in the two relay circuits as shown by the small arrows. This keeps both relay armatures attracted, and no current flows in the annunciator, drop relay, or bell circuits.

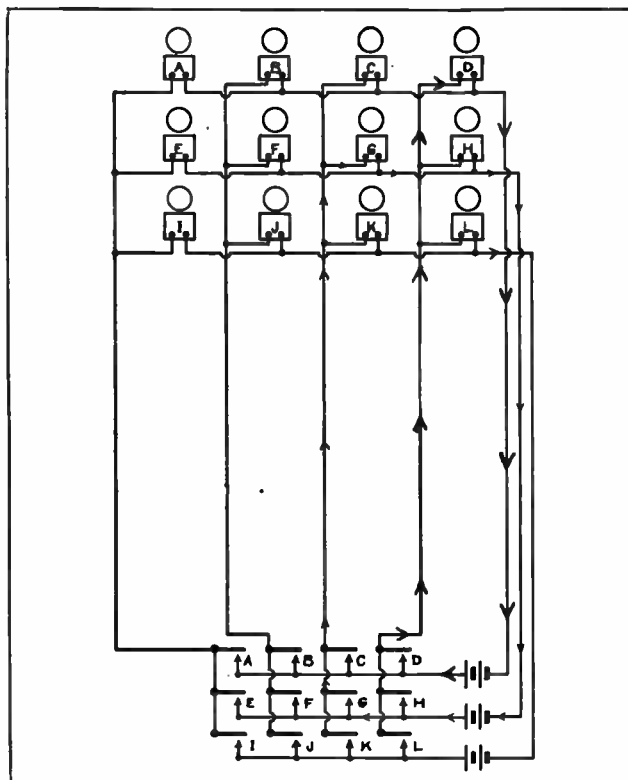

Fig. 78. "Group" method of connecting a large number of bells and switches to secure independent operation of each, with the least number of wires.

But as soon as any switch in either circuit "A" or "B", is disturbed, the relay current stops flowing, releasing the armature, and closing a circuit to the drop relay as shown by the dotted arrows. This trips the drop relay, starting the bell in operation. The bell circuit is shown with large arrows.

A system of this type using several separate circuits gives one an excellent chance to practice step by step tracing of each circuit, and the operation of all parts of the system. Trace it carefully.

## 54. SPECIAL ARRANGEMENT OF VIBRATING BELL FOR CONSTANT RINGING.

Fig. 80 shows a rather novel method of arranging a vibrating bell for a constant ringing alarm, without the use of a drop switch or relay. This is done by placing a piece of hard cardboard, fibre or hard rubber, between the make and break contacts of the bell. The spring tension of the armature should hold it there normally, but if cardboard is used it should not be too soft, or it may stick in place when it is released.



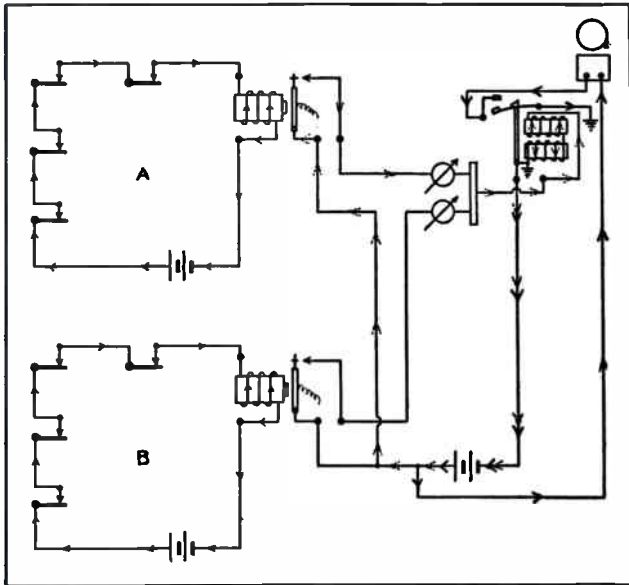

Fig. 79. Two section alarm system using a drop relay for constant ringing, also an annunciator to show which section of the building the alarm was disturbed in.

When one of the three open circuit alarm switches is closed, current will flow directly through the coils of the bell, attracting the armature and releasing the cardboard.

This starts the bell ringing until the switch "A" is opened. Switch "A" should be a lever switch or snap switch.

This system of course does not give the positive protection of a closed circuit system, or of one using a relay, but is very good for an emergency job, or one where the cost must be kept very low.

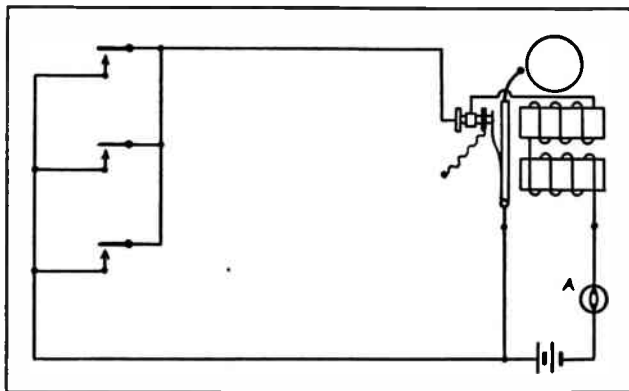

Fig. 80. Simple method of arranging an ordinary vibrating bell to secure constant ringing feature.

**55. STICK RELAY CIRCUITS.**

It is possible to connect an ordinary pony relay in an alarm circuit, so that it will provide the advantage of constant ringing of the bell, without the use of a drop relay. This is done by connecting the relay to operate as a Stick Relay.

This term comes from the manner in which the relay armature closes a circuit to the coil, and causes the armature to stick and continue to feed the coil until it is forced away, or its circuit broken by another switch. (See Figure 81.)

This relay has its armature and bridge connected in series with its coil and the battery. Imagine you were to push the armature to the left with your finger, until it touched the bridge contact. What would happen? The armature would stick there, because as soon as it touches the bridge contact, it closes a circuit for current to flow through the coil, which then becomes magnetized and holds the armature.

Then to get the armature to go back to its normal position it would be necessary to force it away, in spite of the pull of the magnets, or to open the closed circuit switch at "A". This would stop the current flow through the coils, and allow the armature to release.

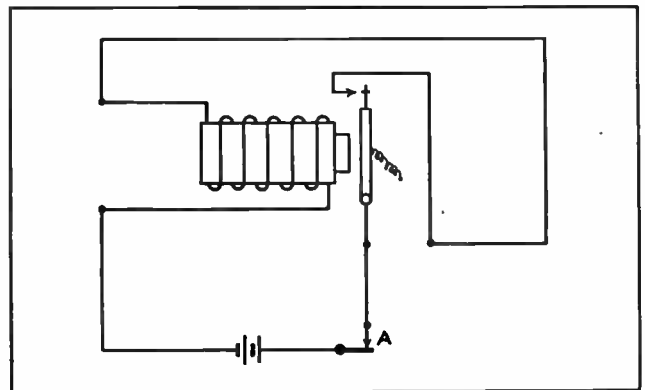

Fig. 81. Diagram illustrating the principle of a closed circuit stick relay.

Remember that to connect up a "stick relay," its armature and bridge must be connected so they will close and hold a circuit through the coils when the armature is attracted.

**56. OPEN CIRCUIT STICK RELAYS.**

Now let's see how we connect this stick relay in a simple open circuit, constant ringing alarm or call system, as in Fig. 82.

Here again we notice that the armature and bridge are in Series with the coils, and the bell is connected in Parallel with the coils. These are the

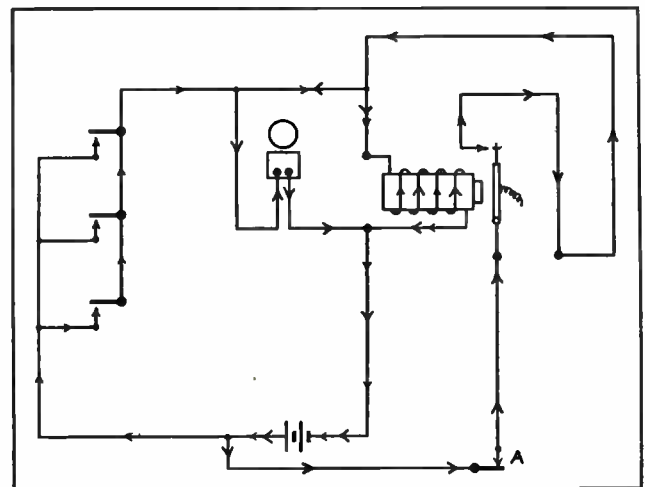

Fig. 82. Open circuit alarm system using a stick relay for constant ringing when alarm is tripped.

two principle rules to follow in arranging such a system.

The parallel group of open circuit switches is connected in series with the battery and relay coil.

Normally there is no current flowing in any part of this system, and the relay armature is not touching the bridge until the switches are disturbed. If any one of the open circuit switches is closed even for an instant, current will start to flow through the relay coils and bell in parallel, as shown by the small arrows.

This causes the armature to be attracted, and then it feeds current to both the coil and bell, even though the first switch is opened in case the burglar closes the window quickly.

The larger arrows show the path of current which keeps the relay coil energized and the bell ringing, after the system is tripped.

To stop the ringing of the bell and restore the system to normal "set" condition, we press the Reset Switch "A".

This stops the current flow through the coils long enough to release the armature; then we allow switch "A" to close again, and if the open circuit switches are again normal or open, the system remains quiet until again tripped.

#### 57. DOUBLE CIRCUIT STICK RELAY.

In Fig. 83 is shown a double circuit "stick relay" system, which gives both the advantages of constant ringing and closed circuit reliability.

Here we have the relay armature, bridge, coils, closed circuit alarm switches and battery, all connected in series. An open circuit reset switch at "A" is used in this system. To set the system in order, this switch is pressed and current starts to flow at once, as shown by the dotted arrows. This energizes the relay coil and attracts the armature. Then the reset switch can be released, and the armature will stick in place, as it now feeds the coils, and a small current will flow continually as shown by the small solid arrows.

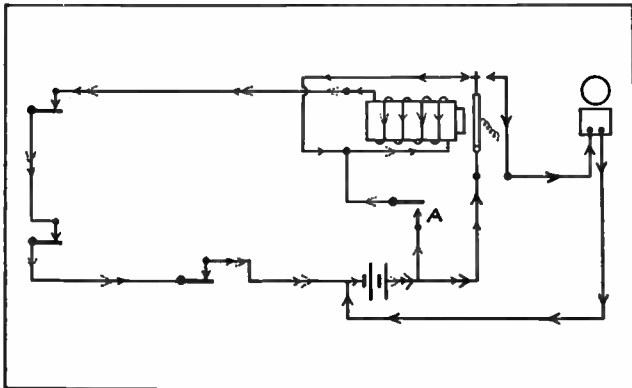

Fig. 83. Double circuit stick relay used in a closed circuit burglar alarm system. This is a very simple and efficient alarm circuit.

Now if any one of the closed circuit alarm switches is opened, the current stops flowing through the coil, releasing the armature, which closes a circuit to the bell, as shown by the large arrows.

This is a very simple and dependable alarm system, and one you may often have use for.

#### 58. THREE SECTION ALARM SYSTEM.

Fig. 84 shows a system of this same type, with three separate sections for three different floors or apartments, and an annunciator to indicate which section is disturbed.

When an alarm switch in any one of the sections is opened, the relay sends current through the proper annunciator coil and keeps the bell ringing constantly until the reset button is pressed.

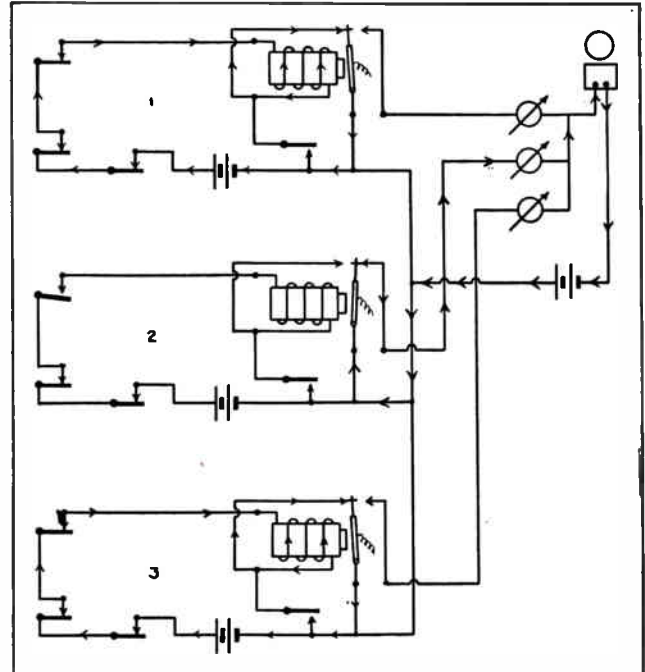

Fig. 84. Closed circuit burglar alarm system of three sections, each using stick relays for constant ringing; and an annunciator to indicate point of disturbance.

The relay armatures in this Figure and also the arrows, are shown as the system would be if sections 1 and 3 were normal, but section 2 has been disturbed causing the alarm to operate. Observe the armatures and arrows, and trace all circuits carefully to be sure you understand them.

At first glance such a diagram as Fig. 84 looks quite complicated and appears hard to understand, but you have probably found by now, that taking one section at a time, it can be traced out quite easily. This is true of even the largest circuit plans of telephone or power plant systems, and if you practice tracing each of these diagrams carefully, you will soon have confidence and ability to read any circuit plan.

#### 59. COMBINATION CLOSED AND OPEN CIRCUIT ALARMS.

Fig. 85 shows a method of using double circuit switches to operate both the relay and annunciator in a closed circuit constant ringing system.

When any one of the alarm switches is pressed, it opens the relay coil circuit and closes the annunciator circuit at the same time.

In this system the annunciator shows exactly which window or door is disturbed.

A number of such circuits could be arranged to protect separate floors or apartments in a building, and then all connected together through one annunciator and alarm bell as in Fig. 84. The additional annunciator would then indicate to the watchman, janitor or owner, which floor or apartment the alarm came from.

The small arrows in Fig. 85 show where current will normally flow when the system is "set". The large arrows show where current would flow through both the annunciator and bell circuits, if switch number 2 was disturbed.

After this system is tripped and the bell is ringing what would you do to stop the bell and reset the alarm?

### 60. BURGLAR ALARM FOIL FOR WINDOW PROTECTION.

In addition to window and door contacts, switches and alarm traps, some alarm systems use tinfoil strips for the protection of glass windows or thin wood panels that could be easily broken.

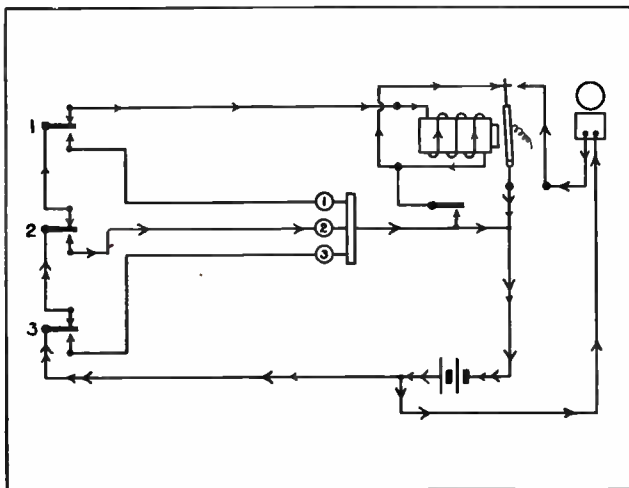

Fig. 85. Combination alarm system using double circuit switches to operate both the stick relay and the annunciator.

Tinfoil for this purpose can be bought in rolls, prepared for cementing to the inner surface of the glass or panel to be protected. It is then connected into the regular alarm circuit by attaching wires to its ends.

If the glass is broken it will crack the tinfoil and open the circuit, causing the alarm to operate.

Fig. 86 shows a large show window and small window above the door protected by burglar alarm foil, and the door and two small windows by door and window springs. All are connected in series to form the closed circuit for the relay coil.

Disturbance of any one will cause the bell to ring.

### 61. BALANCED ALARM SYSTEMS.

Burglar alarms can be arranged so that it is nearly impossible for even an expert to disturb or tamper with them without giving the alarm.

Fig. 87 shows a system using circuits of balanced resistance and a specially wound relay.

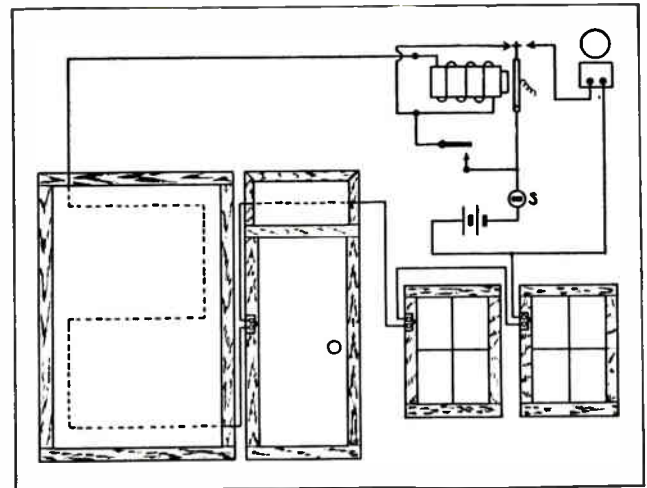

Fig. 86. This diagram shows the use and application of burglar alarm foil for the protection of glass windows and doors.

This relay has two coils wound in opposite directions on each core, so when current flows through them equally they create opposing magnetic flux and do not attract the armature.

The variable resistance at "A" is used to balance the current flow through coil "R", with that of coil "L", by being adjusted so that its resistance is equal to that of the entire alarm circuit. The alarm circuit includes the wire, switches, and the resistance unit "B" which is in series with the closed circuit switches.

As long as the alarm circuit remains of equal resistance to that of the balancing circuit, the current from the battery divides evenly through coils "L" and "R". But if any switch is opened or closed, or the wires are changed, the resistance of the alarm circuit will be changed and more current will flow through one coil or the other, and magnetize the relay core.

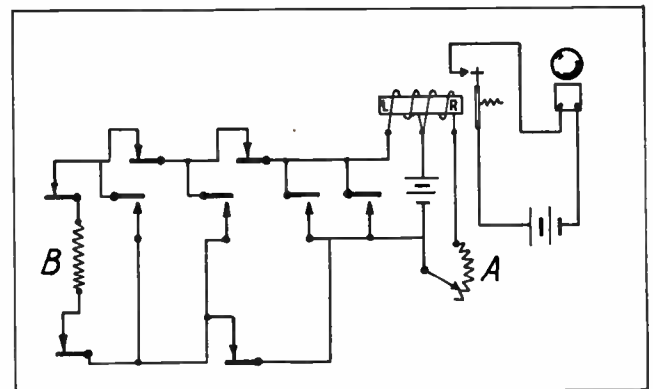

Fig. 87. Balanced resistance alarm circuit. This is a very dependable alarm system, as it is almost impossible to tamper with it without causing the alarm to sound.

For example, if any closed circuit switch is opened, the current through coil "L" stops flowing, leaving the flux of coil "R" unopposed and strong enough to attract the armature and cause the bell to ring. Or, if any open circuit switch is closed, it affords a much easier path than the normal one

through resistance "B", and more current at once flows through coil "L", overcoming the opposing flux of coil "R", and again attracting the armature and ringing the bell.

Variations of this principle can be used in several ways in different types of alarm circuits, making them very dependable and safe from intentional or accidental damage.

## 62. LOCK SWITCH CONNECTIONS.

Fig. 88-A shows how a lock switch can be connected in a burglar alarm system, to allow the owner or watchman to enter the building without sounding the alarm, and also to turn off the system during the day.

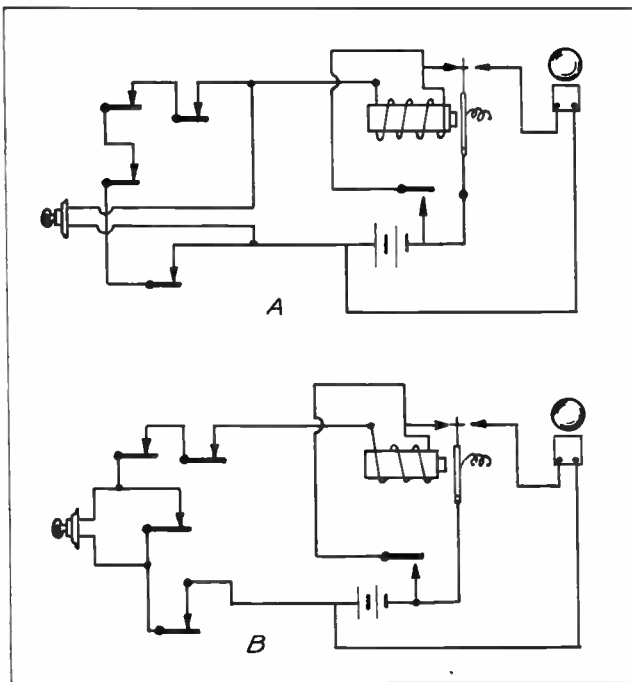

Fig. 88. These circuits "A" and "B" show two different methods of connecting a lock switch to a burglar alarm circuit.

This switch is connected in parallel with the entire line of switches here, and when it is locked closed, any of the others can be opened without tripping the alarm.

Or we can connect it to one switch only as in Fig. 88-B. In this case only the one door and switch can be opened. Then when the lock switch is again locked open, the alarm will operate if any other switch is opened.

## 63. FIRE ALARM DEVICES AND CIRCUITS.

Fire alarms are very similar in many ways to burglar alarms, using many of the same parts such as relays and bells; and also many of the same types of circuits.

The principle difference is in the types of switches used.

There are manually operated fire alarms and automatic ones; the manual alarms being merely a signal system by which someone sends a warning of fire

when he sees it. The automatic alarms are those that are operated by the heat of the fire, and send in the alarm without the aid of any person.

One simple type of manual fire alarm switch is the "break glass" type, in which the switch is held in a closed normal position by a small pane or window of glass. In case of fire the person sending the alarm merely breaks the glass, which allows the switch to open by spring action and give the alarm.

One of these devices is shown in Fig. 89. The illustration at the left, with the box closed, shows clearly how the glass holds the switch button compressed against a spring, and also the small iron hammer provided for convenience in breaking the glass. At the right the box is shown open and the switch button can be seen in the center.



Fig. 89. Fire alarm box of the "break glass" type. Note the hammer used for breaking the glass, and the location of the push button in the box which has the cover open.

## 64. PULL BOXES AND CODE CALL DEVICES

Figs. 90 and 91 show two different types of fire alarm "pull boxes". To send an alarm from this type of box, the operator opens the door and pulls the hook or crank down as far as it will go and then releases it.

When it is pulled down it winds a spring inside, and when released the spring operates a wheel or notched cam that opens and closes a switch several times very rapidly. These notches or cams can be arranged to send a certain number of impulses in the form of dots and dashes, or numbered groups of dots, to indicate the location of any particular pull box.



Fig. 90. This is a fire alarm "pull box" which sends in numerical or code signals to indicate its location.

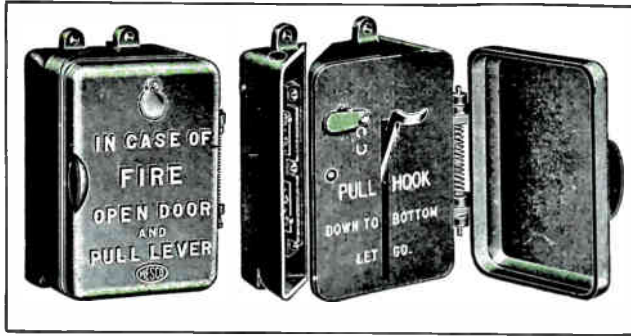

Fig. 91. Another type of fire alarm pull box which also sends code signals.

This enables the fire department crews to proceed direct to the location of the fire.

Fig. 92-A shows how a notched wheel can be arranged to open the contacts of a closed circuit fire alarm, giving a series of short signals and sounding the number 241. Fig. 92-B shows a cam wheel arranged to close the contacts of an open circuit system and send call number 123.

From this we see that such boxes are merely mechanically operated switches or sending keys.

Certain types of industrial or shop "code call" systems use a mechanism similar to these to send number calls for different parties in the plant. These will be explained later.

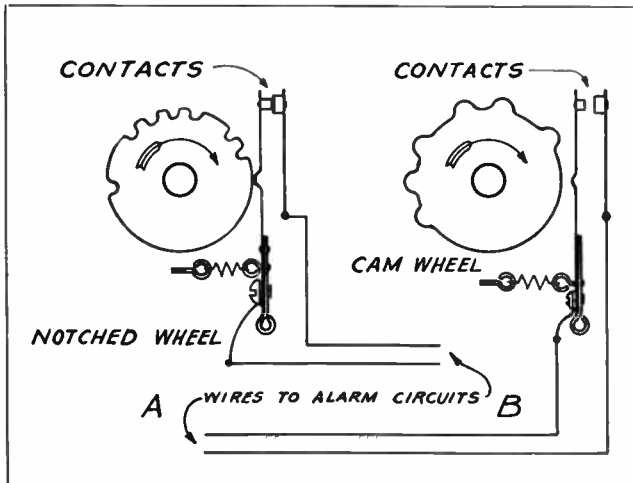

Fig. 92. This sketch shows the arrangement of the code wheel and contacts of closed and open circuit code call systems.

Fig. 93 shows a fire alarm control cabinet, which is used to control and check the condition of such systems. These cabinets are equipped with relays which receive the small impulses of current from the alarm box lines, and in turn close circuits sending heavier currents to the gongs or horns located near the cabinets.

Meters are also often provided for indicating the amount of current flow through closed circuit systems, and thereby show the condition of the circuits.

Note the diagram of connections which is in the cover of this cabinet, and is usually furnished by

the manufacturer of such devices. So you can readily see what an advantage it is to know how to read these diagrams.

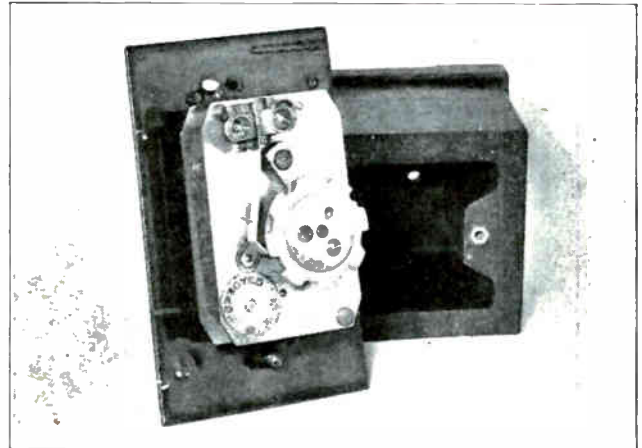

Fig. 92-C signal or alarm box of the code calling type, showing code wheel and contact springs.

## 65. SIGNAL RECORDERS

In fire alarm, bank burglar alarm, and police call systems, it is often desired to keep a record of the numerical code call sent in by the signal box, in addition to hearing the call sounded on the bell or horn. This helps to prevent mistakes in determining where the call comes from.

For this purpose we have recording machines which mark or punch the call on a moving paper tape as the signal comes in, thus giving an accurate and permanent record of it. Such a device is shown in Fig. 94.



Fig. 93. Fire alarm control cabinet, showing relays, test meter, and connection diagram.

There is a spring and clockwork mechanism kept wound and ready to pull the tape through, at a definite speed. The first impulse of the signal operates a relay or magnetic trip that releases or starts the spring and tape.

Then another magnet operates a small pen arm, shown on the outside of the box in this case, and

marks every impulse on the tape in the form of dots and dashes.

Automatic fire alarms use thermostatic switches or fusible links, to open or close circuits and send an alarm as soon as a certain temperature is reached. This type of system is very valuable in warehouses and buildings where no people or watchman are about to notice a fire immediately.

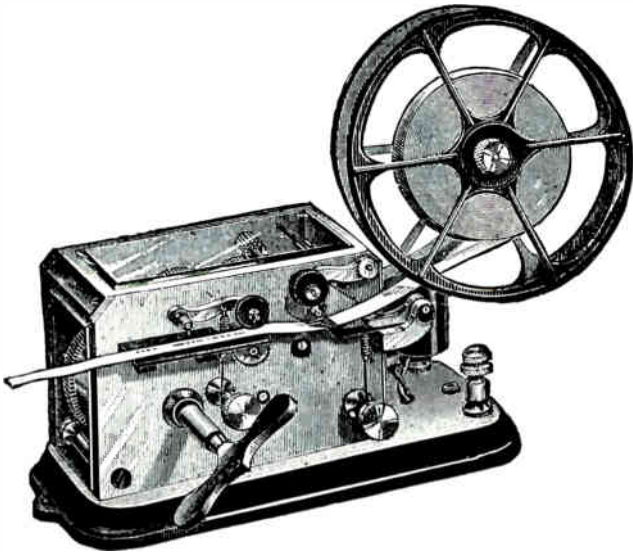

Fig. 94. Recording device for receiving code calls on paper tape. Fire and police departments use such recorders.

Thermostatic switches can be set or adjusted so a rise of even a few degrees above normal temperature will cause them to close a circuit almost immediately.

One switch of this type was explained in Art. 15 of this section. Another type is shown in Fig. 95. There are various types in use but all are quite simple and merely use the expansion of metals when heated, to close or open the contacts.

Any number of such thermostats can be connected on a fire alarm circuit to operate one general alarm, through the proper relays.

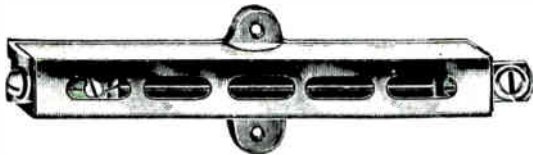

Fig. 95. One type of thermostatic fire alarm switch, that can be adjusted to open or close an alarm circuit by expansion at temperatures above normal.

## 66. FUSIBLE LINKS FOR FIRE ALARMS

The fusible link fire alarm is made of a soft metal alloy something like electrical fuse material. Some of these metals are made which will actually melt in warm water, or at temperatures of 125 degrees and up. Such fusible links can be located at various points where fire might occur, and all connected in series in the alarm circuit. If any one is melted by

fire or excessive heat near it, the circuit will be broken and the alarm operated.

Fig. 96 shows a fire alarm system in which all three types of switches are used. The "break glass" switches can be located where they are easily accessible to persons who might observe the fire, and the thermostats and links installed in other places in the building where no one is likely to be.

In this sketch, "A" and "A-1" are fusible link switches. "B" and "B-1" are "break glass" switches, and "C" and "C-1" are thermostatic switches. All of these are of the closed circuit type. In addition to these, an open circuit thermostat switch is shown at "D" to operate the bell direct in case of fire near the relay and alarm equipment. Fig. 96-A shows a fire alarm fuse or link.

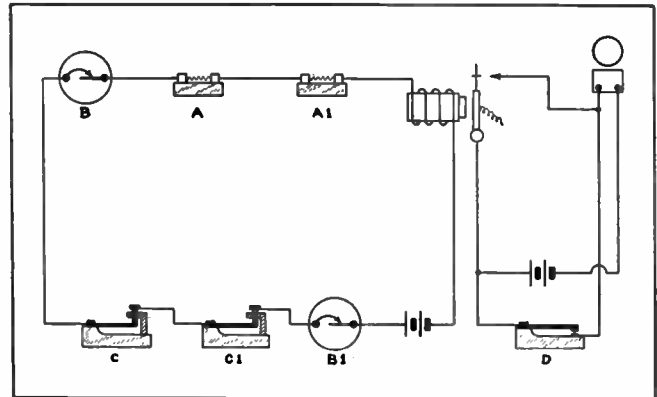

Fig. 96. This sketch shows the connection of several different types of fire alarm switches in one system.

## 67. INDUSTRIAL SIGNALS AND HEAVY DUTY BELLS

In factories, industrial plants and power plants, where signals are used to call department foremen and various employees, and where the noise would make ordinary small bells difficult to hear, large heavy duty bells or horns are used.

The bells used for such work are very similar to the smaller ones, but are much larger and are usually wound to operate on 110 volts. Instead of using the vibrating armature pivoted on one end, they often use a rod for the hammer. This rod is operated by the magnets in the case. Two bells of this type are shown in Fig. 97, and the hammer rod can be seen under the gong of the larger bell.

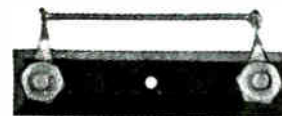

Fig. 96-A. Fire alarm fuse which melts when heated above normal temperature, opening the circuit and causing alarm to sound.

## 68. SIGNAL HORNS OR "HOWLERS"

Horns have a very penetrating note and for very noisy places are often preferred to bells. They are made to operate on either D. C. or A. C., and at

110 volts, or can be obtained for any voltage from 6 to 250.

Some such horns are made with a vibrator which strikes a thin metal diaphragm at the inner end of the horn. Others have small electric motors which rotate a notched wheel against a hard metal cam on the diaphragm, causing it to vibrate or "howl" loudly. Many of these horns are called "howlers".

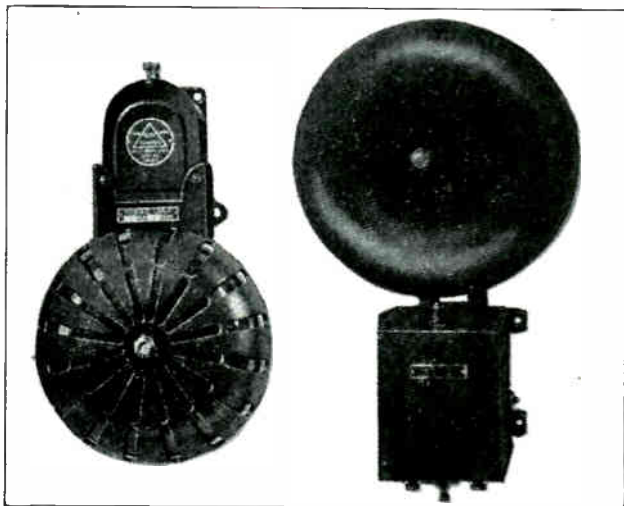

Fig. 97. Two types of large heavy duty bells for use in industrial plants or noisy places.

Fig. 98 shows two horns of the vibrator type, and Fig. 99 shows one of the motor operated type.

Fig. 100 is a sectional view of a motor horn, showing all its parts.

Heavy duty bells and horns require more current to operate them, than can be handled by the ordinary small push button, and these low voltage push buttons should not be used on 110 volts.



Fig. 98. Two styles of signal horns using magnetic vibrators to produce a loud note.

So we usually connect the switches to a special relay which has heavy carbon contacts, to close the high voltage and heavier current circuit to the bells or horns.

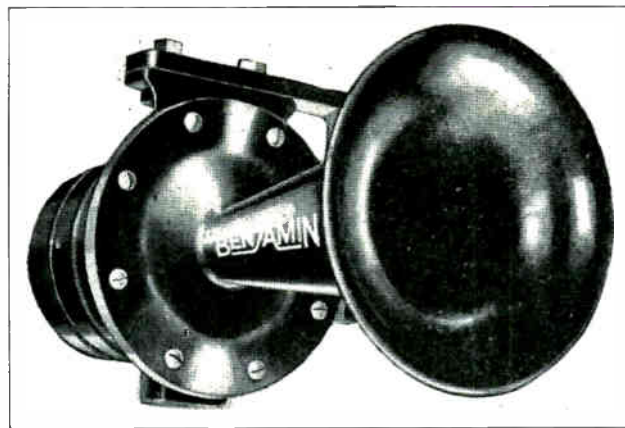

Fig. 99. Motor operated signal horn which produces a very penetrating note, and is excellent for industrial and power-plant use. (Photo courtesy of Benjamin Electric Company.)

Fig. 101 shows the connection diagram for a group of horns with such a relay.

### 69. AUTOMATIC SIGNALING MACHINES

In large plants where a great number of different numerical or code calls are used for signaling different parties, an automatic signaling machine is often used. With this device, the operator simply pushes a button for a certain call, and this releases or starts a spring or motor operated disk or code wheel, which sends the proper signal or number of impulses properly timed, in a manner similar to the fire alarm already explained.

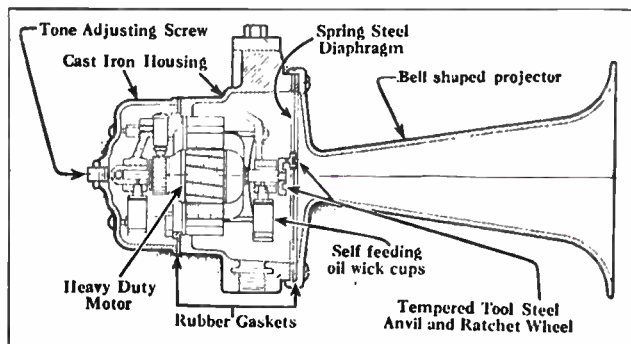

Fig. 100. Sectional view showing parts and construction of motor operated horn. (Sketch courtesy of Benjamin Electric Company.)

A box with a number of these buttons and wheels can be used to conveniently call any one of a number of parties, by just pressing the proper button once, and this does not require the operator to remember a number of code calls.

A diagram for connecting such a device to signal horns operated from a transformer is shown in Fig. 102.

Extra push buttons are also shown for sending special calls not included on the automatic signal box.

A time clock is also connected in this system to sound the horns at starting and quitting periods for the employees.

These clocks have two program wheels, one of which revolves with the hour hand, and one with

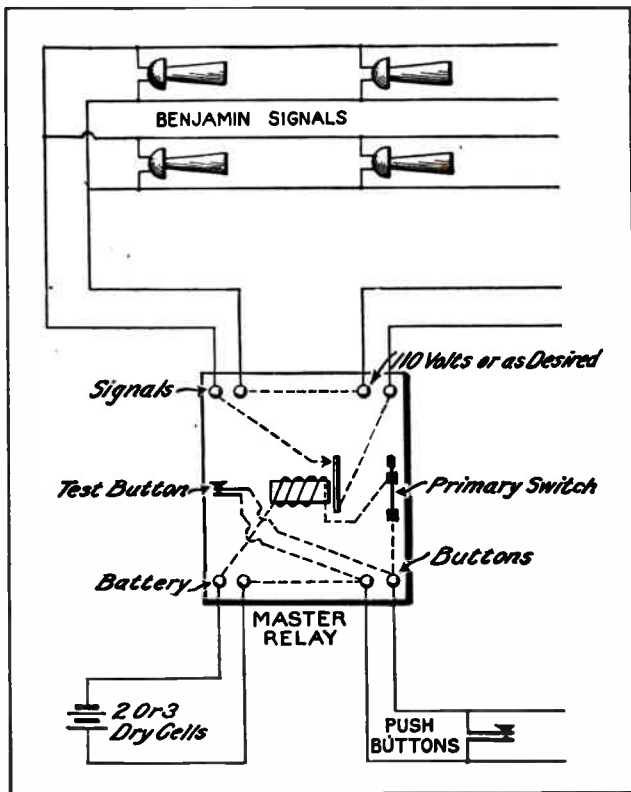

Fig. 101. Connection diagram for signal horns and Master relay. This relay operates on low voltage and very small current, and closes a high voltage, heavy current, circuit to the horns. (Courtesy Benjamin Electric Company.)

the minute hand. These wheels carry adjustable lugs or projections which open or close electrical contacts as they come around.

Schools often use these program clocks with signal systems, to start and dismiss various classes.

## 70. INSTALLATION OF CALL AND SIGNAL SYSTEMS

Now that you have learned the operating principles of these signal devices and circuits, and know how to trace and understand the diagrams and plans, you will want to know more about how to install them.

In making any electrical installation, the first thing should be the plan or layout, and circuit diagram. So as soon as we have decided upon the type of system desired and how it should operate to give best service, we should decide on the location of the various parts, and then lay out the circuits accordingly.

Of course in many cases a complete plan is furnished for new installations, by the architects in case of new buildings, or by the engineering or construction departments of large power or industrial plants. But if such plans are not furnished, you should at least make up a rough layout before any work is started.

This can be drawn approximately to scale for the various distances between devices, or length of wire runs, and this will enable you to estimate and select the required materials with best economy.

Then, by following a circuit diagram, many mistakes and time losses can be avoided in making the final connections.

In drawing up plans, or in copying them from other prints, it is usually much easier to sketch the parts and devices on the paper first, in about the same location and proportional spacing as in the original plan, or as they are to be installed in the building. Then draw in the wires and circuits one at a time, keeping them as straight and simple as possible. Lay out the wires and connections first to get the desired operation and results. Then go over the plan again, and possibly redraw it to simplify it and shorten wires, making use of "common wires" eliminating unnecessary crossed wires, etc.

## 71. LAYOUT OR LOCATION OF PARTS IN THE BUILDING

By going carefully over the building with the plans, and using good common sense in choosing the location for the various devices and wire runs, you can make a more satisfactory job and save additional time and labor on the installation.

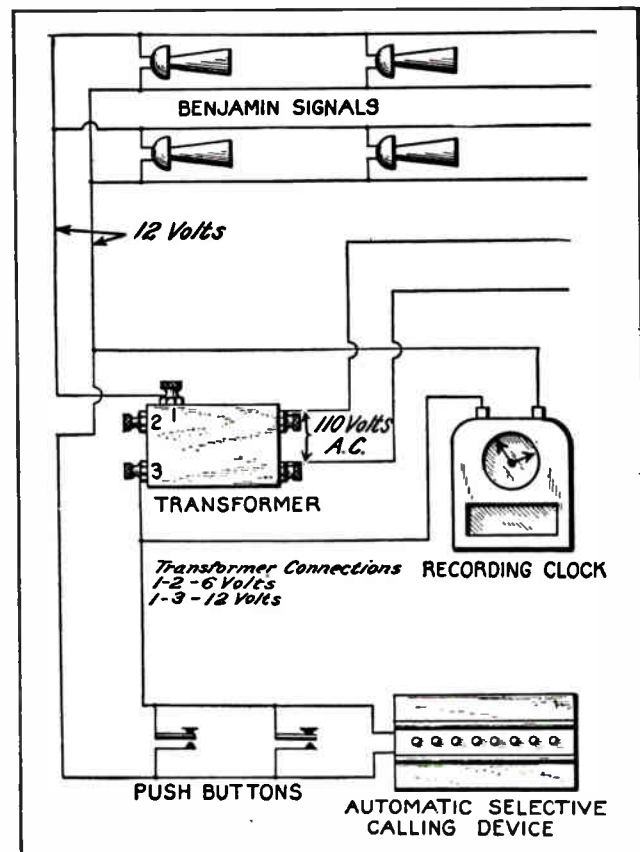

Fig. 102. This diagram shows the connections for signal horns operated from a transformer, and controlled either by a time clock or automatic signal device. (Courtesy Benjamin Electric Company.)

For example, when installing a simple door bell system in a home, the bell should be located in a rear room, probably the kitchen, because both its noise and appearance would probably be objectionable in the parlor or dining room. Usually some



"out of the way" place can be found in a corner or hall or behind a door, and preferably quite high from the floor, so it is out of reach of children and safe from accidental damage. By considering where the wires can best enter the room and placing the bell on this side if possible, time and material may be saved.

The battery or transformer should usually be located in the basement or attic near to the bell or wires. However, the battery or transformer can sometimes be located on a small shelf or attached to the wall right with the bell, or in a small box.

The buttons of course must be located at the proper doors, and preferably on the door casing. Their height should be carefully chosen to be within convenient reach of grown-ups, but usually not low enough for small children to reach, unless a lower mounting is requested by the owner.

## 72. RUNNING THE WIRES

All wires should be run concealed whenever possible. Very often it is possible to drill two small holes in the door casing strip directly beneath the button and, by loosening the strip, run the wires under it to the basement or attic.

If it is not possible to get behind the strip, perhaps the holes can be drilled at an angle to get the wires into the edge of a hollow wall. Or, if necessary, they can be run in the corner at the edge of the door casing and covered with a strip of wood or metal moulding.

Where wires can be run through the basement or attic they can usually be stapled along the basement ceiling or attic floor. Care should be taken to run wires where they will be least likely to receive injury, and they should always be run as straight and neatly as possible.

Sometimes it is advisable to lay a narrow board to run the wires on across ceiling or floor joists in unfinished basements or attics.

When making long runs of wire always keep in mind the saving of time and material that can be made by using a common feeder wire to a number of switches, or a common return wire from bells to battery. This should also be carefully considered when laying out the diagram and plans.

Where it is desired to run wires vertically through walls, they can be "Fished" through by dropping a weight on a string from the upper opening to the lower one. This device is often called a "Mouse". If the weight or "mouse" does not fall out of the lower hole, the string can be caught with a stiff wire hook and pulled out of the hole.

Then the wires can be pulled through with this string, or if necessary another heavier cord can be pulled through first, if the wires are too long and numerous to be drawn in by the light cord on the "mouse".

In horizontal runs through walls a steel "Fish Tape" (spring steel wire) can be pushed through

first, and hooked or snared at the outlet opening, then drawn through with the signal wires attached.

A little "kink" that often comes in very handy in either signal or light wiring is as follows:

When you desire to locate the exact spot to drill up or make the hole in the basement ceiling, so that it will come directly under the center of the partition above, or some other certain spot, stick the point of a magnetized file in the floor above or ceiling below, and then use a pocket compass to locate this spot on the other side.

The compass needle will be attracted by the file tip. Moving the compass around will locate the center of attraction, which should be the point directly opposite the file tip. Then measure the distance between the spot located by the compass and to the edge of the partition, and add one-half the thickness of the partition. Measure off this distance in the same direction from the file and you should have a point about in the center of the partition.

In other cases measurements in two directions from certain outside walls may be accurate enough.

Sometimes an exact spot can be located best by drilling through the wall or floor with a long thin feeler drill, 1/8 or 3/16 in diameter.

If the hole does not come near the exact spot desired, it will serve as an accurate point to measure from, and can be easily plugged and concealed afterward.

Fig. 103-A shows how to use the magnetized file and compass and make the measurements to locate the center of partition. Fig. 103-B shows by the dotted lines how the small "feeler" holes can be drilled for the same purpose. The first hole should be drilled down at the proper angle and the second one drilled up, to try to strike the center of the

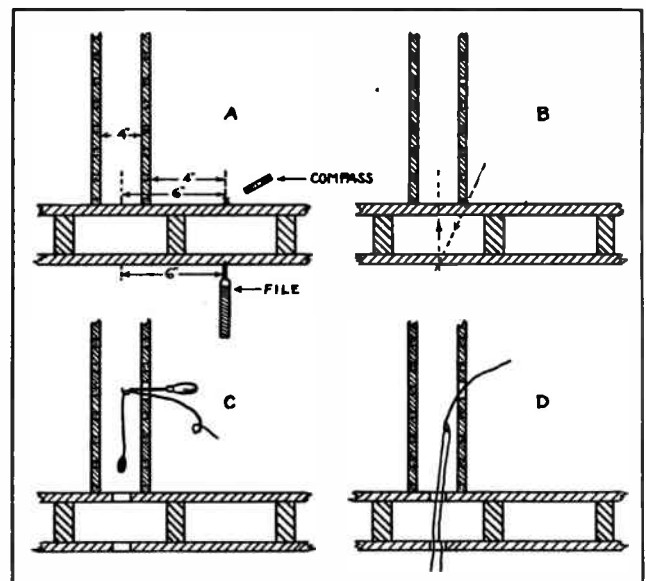

Fig. 103-A. Sketch showing uses of magnetized file and compass to locate spot to drill for wires. "B," dotted lines show how the "feeler drill" can be used. "C," dropping a "mouse" on a string, through holes in wall and floor. "D," pulling the wires in with the cord which was attached to the "mouse."

partition. Or, the first one can be drilled straight down and then the proper distance measured over to partition.

Figs. 103-C and 103-D show the method of dropping a "mouse" through the holes and pulling the wires in.

### 73. RUNNING SIGNAL WIRES IN CONDUIT

In some cases, especially in modern fireproof office or factory buildings, signal wires are run in conduit. Conduit, as previously mentioned, is iron pipe in which the wires are run for protection from injury and to provide greater safety.

Signal wires should always be run in separate conduits of their own, and never with wires of the higher voltage lighting system.

A fish tape is usually pushed through the conduit first, and used to pull the wires in.

### 74. TESTING TO LOCATE PROPER WIRES FOR CONNECTIONS

When a number of wires all alike and without color markings are run in one conduit, cable or group, it is easy to find the two ends of each wire by a simple test with a battery and bell, or test lamp.

Simply connect one wire to the conduit at one end, and then attach the bell and battery to the conduit at the other end, and try each of the wires on the bell, until the one that rings it is found. This is the same wire attached to the conduit at the other end. (See Fig. 104-A.) Mark or tag these ends both No. 1 or both "A", and proceed to locate and mark the others in the same manner.

When testing or "ringing out" wires in a cable or open group with no conduit in use, very often some other ground to earth or some piping system, can be obtained at each end, making it easy to test the wires. (See Fig. 104-B.)

### 75. TROUBLE TESTS

When troubles such as grounds, opens or shorts occur in wires in conduit, the fault can be located as follows:

Suppose one wire is suspected of being broken or "open." Connect all the wire ends to the conduit at one end of the line, as in Fig. 104-C. Then test with the bell and battery at the other end, from the conduit to each wire. The good wires will each cause the bell to ring, but No. 2, which is broken at "X" will not cause the bell to ring, unless its broken end happens to touch the conduit.

When testing for short-circuits between wires, disconnect all wires from the devices at each end of the line and test as in Fig. 104-D.

When the bell is connected to wires Nos. 1 and 2 it will ring, as they are shorted or touching each other at "X", through damaged insulation. Connecting the bell to any other pair will not cause it to ring.

Sometimes one wire becomes grounded to the

conduit because of defective insulation as in Fig. 104-E.

For this test we again disconnect the devices from the wires, and connect the test bell and battery as shown.

With one test lead on the conduit, try the other lead on each wire. It will not ring on Nos. 1, 2, or 3, but will ring on No. 4 which is touching the pipe at "X", thus making a closed circuit for the test bell.

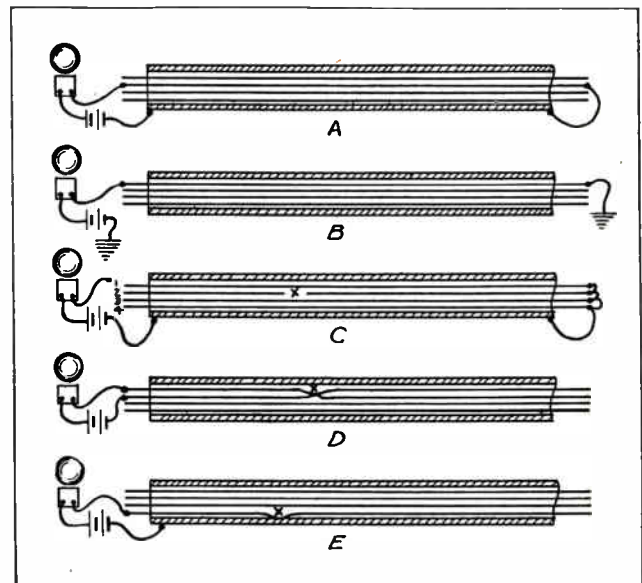

Fig. 104. Sketches showing methods of testing for various faults in wires run in conduit. Compare carefully with test instructions given.

### 76. EMERGENCY WIRES, AND PULLING-IN REPLACEMENTS

Where long runs of wires are installed in conduit or signal cables, it is common practice to include one or more extra wires for use in case any of the others become damaged.

This is especially good practice with cables, because it is difficult to remove or repair the broken wire. In a conduit system, where no extra wires are provided and a new wire must be run in to replace a broken or grounded one, it is sometimes easier to pull out all wires, and pull a new one back in with them.

Where this is not practical or possible, it sometimes saves time and money to pull out the broken or bad wire, and then attach two good wires to the end of one of the remaining wires, and pull it out, pulling in the two good ones with it. This replaces both the bad wire and the one good wire pulled out.

If the bad wire was not broken but only grounded, it can be used to pull in the new wire; but, of course, a broken wire cannot be used for this purpose. Therefore, it is often advisable to sacrifice one good wire, to pull in two new ones.

The several tests and methods just explained are very valuable and should be thoroughly understood, for use on other wiring systems as well as signal wiring.

While some of these tests were explained for wires in conduit, they can be also used on groups of open wires or cabled wires, by using in place of the conduit, some other ground or an extra wire, run temporarily for the tests.

### 77. SIGNAL WIRING MATERIALS

Now for the materials. In addition to the bell, battery or transformer, and push button switches, we will need the proper amount of wire, and in case of open wiring, staples to fasten the wire in place.

Ordinary bell or annunciator wire as it is called, is usually No. 16 or No. 18, B. & S. gauge, and is insulated with waxed cotton covering. It can be bought in small rolls of  $\frac{1}{2}$  lb. and up, or on spools of 1 lb., 5 lbs. or more. It can also be bought in single wires, or twisted pairs, and with various colored insulation.

Where several wires are to be run together, the use of different colors helps to easily locate the proper ends for final connection.

For damp locations, where the cotton insulation might not be sufficient, wire can be obtained with a light rubber insulation and cotton braid over it.

As ordinary door bells use only very low voltage, it is not necessary that the wires be so heavily insulated. In many cases they can be run with no other protection, such as conduit or mouldings.

To fasten the wires we use staples which have paper insulation to prevent them from cutting into insulation of the wire. However, these staples should not be driven too tightly down on the wires, and never over crossed wires, or they may cut through the insulation, causing a short circuit. Such a "short" under a staple is often hard to locate, and great care should always be used in placing and driving the staples.

Small cleats with grooves for each wire, and holes for screws to fasten them, are sometimes used. In other cases where twisted pairs of wires are run, a small nail with a broad insulating head is driven between the two wires, so the head holds them both. Fig. 105 shows several sizes of insulated staples, and Fig. 106 shows the nail and cleats mentioned.

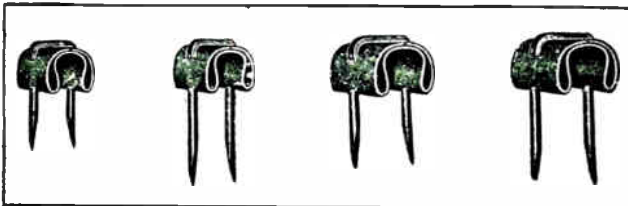

Fig. 105. Several different sizes and styles of insulated staples used in bell wiring.

On installations where a large number of wires are to be run in a group, cables with the desired number of wires can be obtained. These wires are usually marked by different colored insulation, so that the ends of any certain wire can be quickly

and easily located at each end of the cable. Such cables simplify the running of the wires, save space and time, and make a much neater job in offices and places where numerous separate wires would be undesirable.

In large signal installations terminal blocks are used on some of the equipment, and all wires are brought to numbered terminals on these blocks. Then with the plans, on which the wires can also be numbered, it is very simple to make proper connections of cables with dozens or even hundreds of wires.

This is common practice with telephone installations and elevator signals, and also on modern radio sets, as well as for office and industrial call systems.

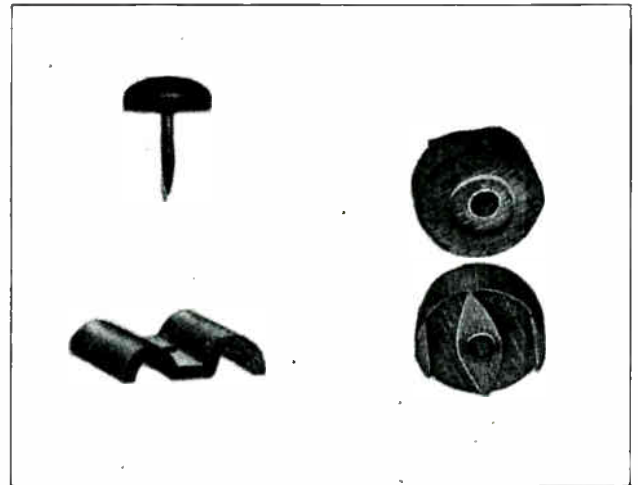

Fig. 106. Bell wires can also be fastened with the large headed nails and cleats shown here.

### 78. CAUTION NECESSARY FOR SAFE AND RELIABLE WIRING

Considerable care should be used when drawing bell wires through holes and openings, or the insulation may be damaged. Where the wires are left against the edge of a hole they should be protected from damage by vibration and wear, by means of a piece of hollow "loom" or insulating tubing slipped over the wires and taped in place. Also, where wires cross pipes or other wires, they should be well protected with such extra insulation.

Even though signal and bell wires carry low voltage and small current, they are capable of creating sparks and starting fires if carelessly installed.

So, for this reason and also that the finished system will give good service, all signal work should be done with proper care.

Low voltage signal wires must never be run in the same conduits with higher voltage lighting or power wires as it is very dangerous, and is also a violation of the National Electric Code, which will be explained in later sections.

If such wires were run with high voltage ones, and a defect should occur in the high voltage wires and allow them to touch the signal wires with their

thinner insulation, it would create a serious fire and shock hazard.

When installing bell transformers, the wires from the lighting circuit to the transformer primary must be regular No. 14 rubber covered lighting wire, and must run in conduit, B X, or approved fashion for 110 volt wiring, according to the code of that particular town or territory.

When making splices or connections to devices all wires should be well cleaned of insulation and all connections carefully made and well tightened. Splices in wires should be carefully soldered and well taped, to make secure and well insulated joints.

Any bell or signal system should be thoroughly tested before leaving it as a finished job. Pride in your work and neatness and thoroughness in every job should be your rule in all electrical work. That will be the surest way to make satisfied customers and success, in your job or business.

## 79. TROUBLE SHOOTING

In each section of this work on signal devices and circuits, common troubles and methods of locating them have been covered. In order to apply your knowledge of these things to solve any troubles in signal systems, your first step should be to get a good mental picture of the system, either from the plan or by looking over the system and making a rough sketch of the devices and connections.

Then go over it one part at a time **Coolly and Carefully**, and try to determine from the faulty action or symptoms of the system where the trouble may be.

## 80. KEEP COOL AND USE A PLAN AND A SYSTEM

A great mistake made by many untrained men in trouble shooting, is that they get rattled and worried as soon as they encounter a difficult problem of this nature. They forget that a plan or rough sketch of the wiring will usually be of the greatest help, and they make a few wild guesses as to what the trouble is. If these don't hit it, they often get still more rattled and indefinite in their efforts, and as a result sometimes mess up the system making it worse instead of improving it.

Remember that **Every Trouble Can Be Found, and Someone Is Going to Find It**. If you can do it, it will be to your credit and often put money in your pocket, or get you a promotion.

You can find any fault, by thoughtful systematic testing of each circuit and device and applying the knowledge you have of this work.

In general, a good rule to follow is to **first test the source of current supply**. See that it is alive and at proper voltage. A test lamp or voltmeter will do this nicely.

**Then test the devices that fail to operate**, using a portable battery and test wires to make sure the device itself is not at fault, or has no loose terminals.

If the power supply and all bells, relays, and switches are tested and O. K., then start testing the main wires and circuits with the proper switches closed to energize them. Use a test lamp of the proper voltage, or a voltmeter, to make sure the current can get through the lines.

Any time you are not sure just how to test the wires, just refer back to Article 75 of this section and refresh your memory on the various steps.

No one can remember all these things perfectly the first time, but referring back to them and trying them out on the job at every opportunity is the quickest and surest way to fix them in your mind.

Never be ashamed to refer to a plan or notes when you have a problem of connection or other trouble. The most successful electricians and engineers always follow plans.

When a system has several separate circuits, test them one at a time and mark them off on the plan or sketch as each is proven O. K. In this manner you know at all times how far you have gone, and where to look next, and can feel sure of cornering the trouble in one of the circuits or devices.

Remember a portable battery and bell, buzzer, or test lamp, and a few pieces of test wire, used with a knowledge of the purpose and principles of the circuits and devices, and plain common sense, will locate almost any signal trouble.

When any certain device is found to be out of order, you also have its troubles and repairs covered in the section on that device, in this Reference Set. Refer to it if you need to.

Welcome every "trouble shooting" job as a chance to get some excellent experience.

## 81. PUTTING YOUR TRAINING INTO PRACTICE

Now, if you have made a careful study of this section so far, you should be able to install almost any ordinary call or signal system.

You may doubt your ability to do this, but that is natural at first, as most of us have felt this way on our first jobs. But the thing to do is to get out and try it the first time you have an opportunity after graduation.

Start with a small job if you wish, and you will quickly find that you can apply every principle covered in this Set and in your shop work. After the first job or two, your confidence will grow and you will be ready to tackle any work of this nature.

Many hundreds of our graduates have started their present successful contracting businesses by a few bell wiring jobs at first.

Fig. 107 shows a floor plan of a house equipped with a modern bell call system, that affords great convenience in any home. Here are shown front and back door buttons, and buttons to call a maid from the parlor, bedroom, or dining room. An annunciator indicates which door or which room any call comes from. The switch in the dining

room can be a floor switch under the table for foot operation, while those in the other rooms can be neat push buttons in convenient locations on the walls.

In homes where no maid is kept, several of these buttons may not be necessary, but practically every home should have a door bell.

They are becoming quite popular in many rural and farm homes. And in these homes a call bell from the house to the barn or garage is often a great convenience.

In Fig. 107 the wires are shown in a simple layout to be easily traced, but they should be run through the basement or attic, or through the walls where necessary.

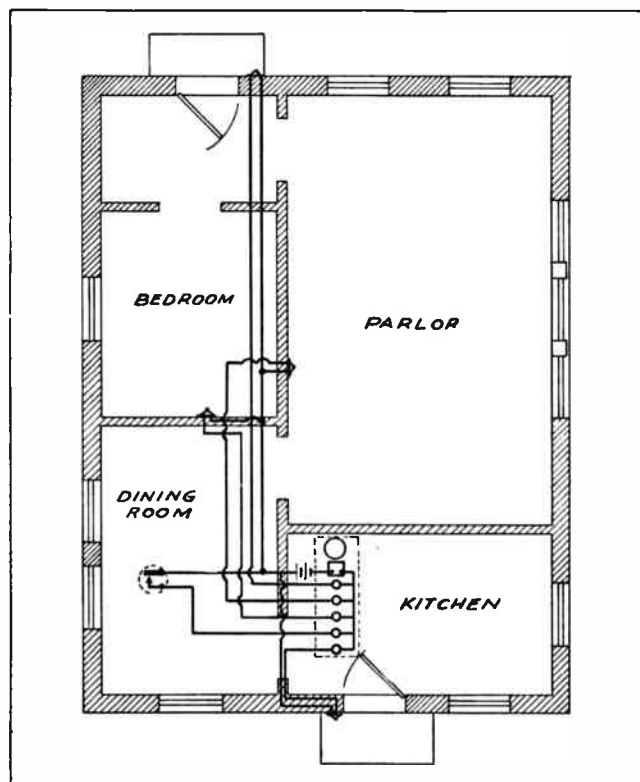

Fig. 107. Diagram showing layout of wiring for doorbell and convenience call system with annunciator. Such systems are commonly used in modern homes and are very well worth their cost of installation.

## 82. STARTING A BUSINESS OF YOUR OWN

To start a business of your own or side line jobs for extra money in bell and signal wiring, as mentioned before, very little capital or material is required.

Many men have started big businesses with only a few pounds of annunciator wire, a box of staples, a few push button switches, and a couple of bells and buzzers, along with a few tools, such as pliers, knife, screw driver, hammer, brace and bit, key-hole saw, star drill for brick walls, etc.

You may not even need to buy any materials, and only a few tools, until you get your first jobs lined up.

A little salesmanship will often convince the owner of a home, shop, or store that a door bell or

signal system would be a great improvement and convenience, and well worth the very small expense, or that a burglar alarm system would be excellent protection for their property, or perhaps fire alarms from shops, garages, barns, etc., to the houses.

Both practice in salesmanship, and electrical practice are extremely valuable to every beginner.

## 83. GOOD WORKMANSHIP IMPORTANT

In every job you do, from the smallest door bell system to the most elaborate burglar or fire alarm system, make a practice of doing nothing but first class work—work that will be a credit to your profession, your school, and yourself.

Whether working for a customer or an employer, start building your reputation with your first job, and keep this thought in mind on all the rest.

## 84. ESTIMATING JOB COSTS

Try to do all work at a fair price to the customer, and a fair wage, plus a reasonable profit for yourself.

A good plan on the first job or two, is to do them on a "time and material" basis. After determining the type of system desired and parts and materials needed, let the customer buy them, and then charge for your time on installing them by the hour.

Keep a record of your time, wages, materials, and costs, and these will help you estimate future jobs quite accurately. Then you can buy your own materials, and charge 25 per cent or more for handling them and for overhead or miscellaneous expense; in addition to a good wage for your time, all in the estimate figure.

In many cases, time and money can be saved on alarm installations by arranging the relays, bells, batteries, and reset switch all on one panel or shelf board, in advance at your home or shop. Then when you go to the job, it is only necessary to mount this assembled unit and install the wires and proper switches.

And again let us emphasize the value of doing all work neatly and with good workmanship, both for the appearance of the job, and for its quality and dependability of operation.

A customer is usually better satisfied in the end, to have a first class job done at a fair price, than to have a poor job at a cheap price.

## 85. VALUE OF ADVERTISING

Don't hesitate to let the people in your neighborhood know of your training and ability. With just a little confidence and real ambition you can do these things you want to. Prove it to them and to yourself, and be proud of your training, and every job well done.

Very often the repair of bell and signal systems already installed, will bring you some extra money.

After completing your entire course you will be able to do repair and installation work, not only on signal and alarm systems, but also on radios, lighting systems, electric motors, appliances, etc.

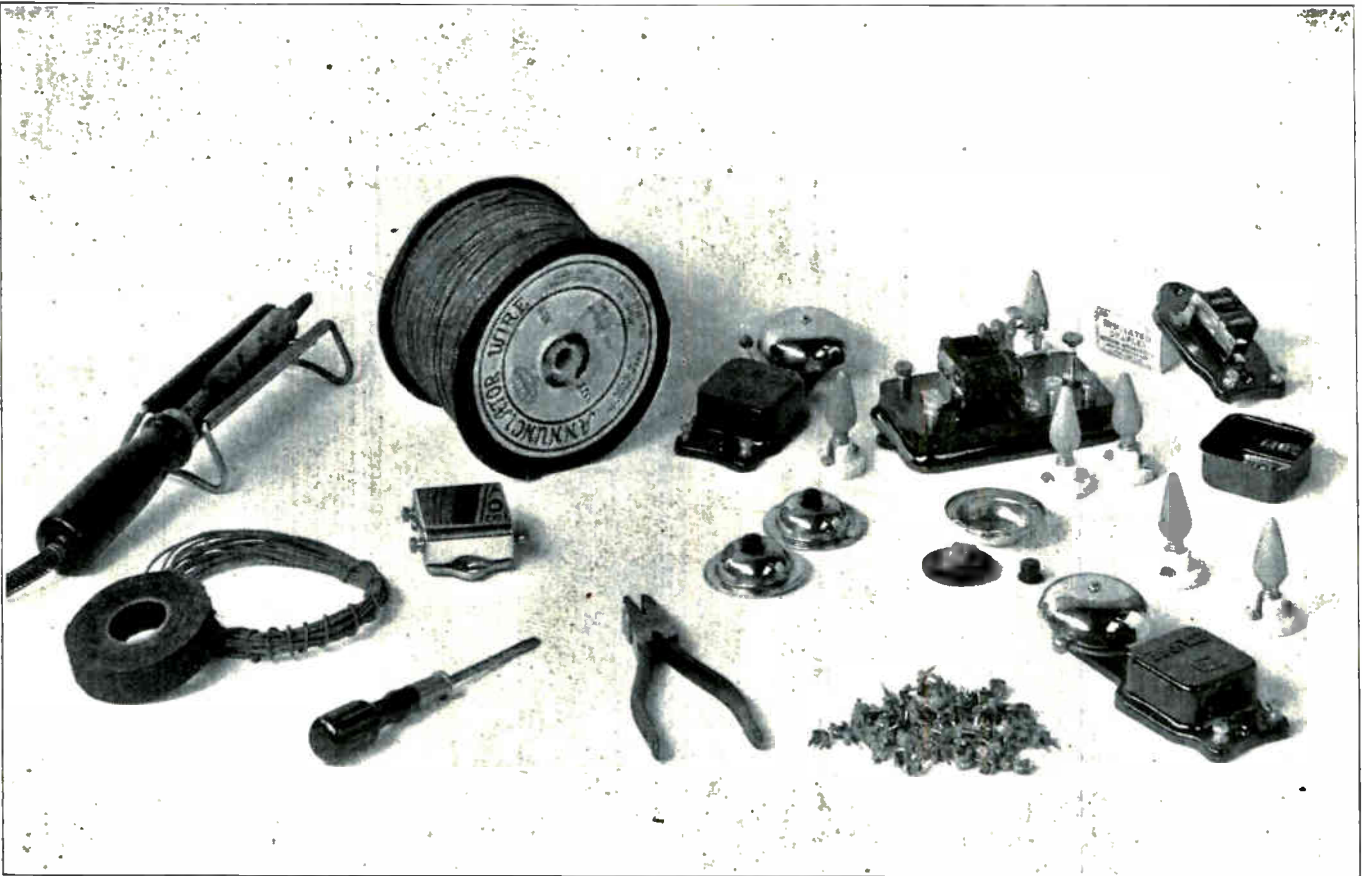

Fig. 107-B This photo shows a view of the more common parts and materials used in signal and alarm wiring.

If you have spare time evenings and week ends, and wish to do such work aside from your regular job, or to make a business and specialty of it, it will usually pay to do a little advertising. An advertisement in your local newspaper, and printed cards left at houses and shops will call attention of people to yourself, as a trained man available to install or service such equipment for them. In many cases this will bring all the work of this kind that you can handle, especially after you have done some work and have a few satisfied customers boosting for you.

Small advertisements and a few hundred cards of the type mentioned can often be gotten out at as low a cost as five to ten dollars.

If you should make a specialty of this line of work, and build up quite an active shop and business, then you can add to your tools and materials to make a more complete equipment for greatest time saving and convenience.

For a more complete list of tools and materials in case you want them later, see the following list.

Remember, however, that you can make a good start in this work with probably no more than one tenth of this amount.

- 1 2" screw driver for bell adjustments.
- 1 4" screw driver for small screws.
- 1 6" screw driver for small screws.
- 1 ratchet for wood bits.
- 6 assorted wood bits.

- 3 long electrician's bits, 24" to 36", for long holes through walls and floors, and through mortar joints in brick walls.
- 1 pair side cutter pliers.
- 1 pair long nose pliers.
- 1 pair diagonal pliers.
- 1 claw hammer.
- 1 light machine hammer.
- 1 staple driver.
- 1 compass saw.
- 1 hack saw.
- 1 carpenter's saw.
- 1 small pipe wrench.
- 1 small set of socket wrenches.
- 2 small star drills.
- 1 Yankee drill.
- 2 ignition point files, for bell contacts.
- 20-ft. of steel fish tape.
- 1 wood chisel.
- 1 cold chisel.
- 1 doz. assorted push button switches.
- 3 to 6 vibrating bells.
- 3 to 6 vibrating buzzers.
- 3 drop relays.
- 3 bell transformers.
- 12 dry cells, No. 6.
- 5 lbs. No. 18 annunciator wire.
- 3 boxes insulated staples.
- 1 electric or gasoline soldering iron.
- 3 rolls friction tape.
- 1 lb. solder.

After getting a start in this work so you are buying considerable of materials and parts, you can get discounts or wholesale prices from your dealer, or by sending to some mail order house, and in this manner make still more profit on your jobs.

Now, whether you choose to follow bell and alarm

wiring or not, every bit of the knowledge of these circuits and devices that you have gained in this section will be of great help to you in any line of electrical work, and particularly if you should enter any of the other great fields of a similar nature, such as railway signal, telephone, or radio work.



## NOTES

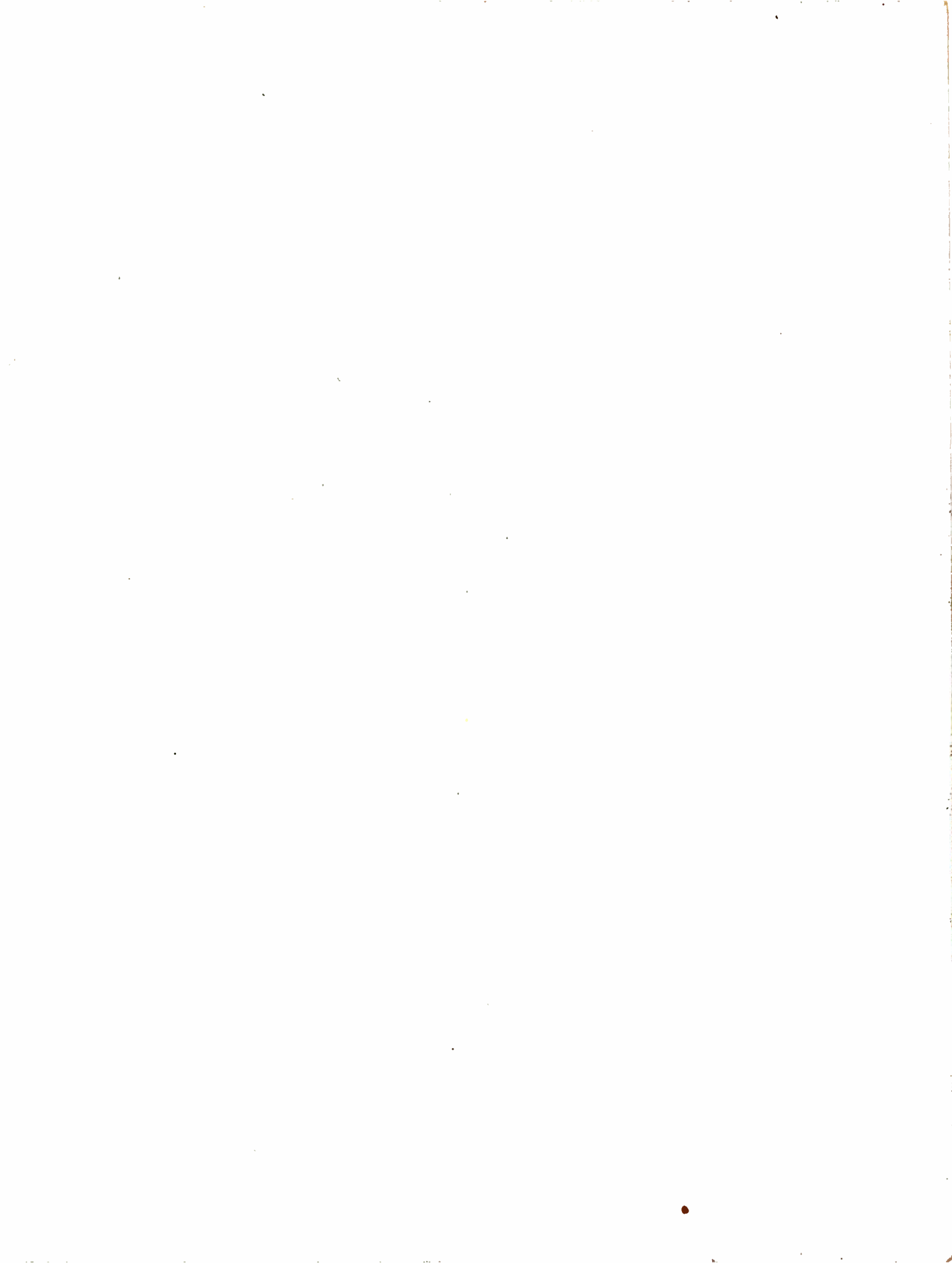



## TELEPHONES

The telephone industry today is one of the greatest branches or fields of electrical work, and is rapidly expanding year by year.

Tens of thousands of trained electrical men are kept constantly employed in the fascinating work of this field, and its continuous rapid development creates new jobs for many more yearly.

The modern telephone is a form of electrical signalling device of the most refined type. It has become one of the greatest factors in our present civilization and is an absolute necessity in modern business.

Important business transactions are carried on over the vast telephone network of this country every minute of the day and night, saving vast amounts of time and making distances seem very small.

Today a farmer can talk to his neighbor a few miles away, or call the nearest town for groceries, machinery repairs, or the doctor—all for a few cents cost.

A resident of any large city can call any individual, one of the thousands or millions of people who may live in that town, or in any town in the country.

In a few minutes a connection can be established from New York to Los Angeles, or from New Orleans to Duluth, and a business or social conversation can be carried on for a few dollars.

We can also talk to people across the ocean, through undersea cables, or by means of the combination telephone and radio connections now in common use.

### 86. GREAT FIELD FOR MEN WITH ELECTRICAL TRAINING

To keep all this vast and marvelous system of telephones functioning perfectly requires thousands of well trained electrical men who are familiar with circuit tracing, trouble shooting, and care and adjustment of the relays, bells, coils, etc. Many more men are required to install the thousands of new telephones constantly being added to this vast system.

### 87. TELEPHONE KNOWLEDGE VALUABLE IN ANY LINE OF ELECTRICAL WORK

The telephone field is one in which you can use many of the principles that have been covered so far in this signal section, and in the sections which follow there will be much information applying to telephones in particular. And even though you may not desire to specialize in or follow telephone work, you should at least have an understanding of the fundamental principles of telephone equipment. Many power plants, factories, shops and offices have

their own private telephone systems, and in any line of electrical maintenance work you are likely to find good use for this knowledge.

### 88. PRINCIPLES OF OPERATION

The telephone is an instrument for transmitting sounds and voice from one point to another. Telephones do not actually carry the sound itself, but instead reproduce it by means of electric current impulses.

In order to understand how this is done, we should first know something of the nature of sound. Most everyone knows that any sound is transmitted by means of waves in the air. These air waves may be set up by one's voice, clapping of hands, firing a gun, or anything that causes a disturbance of the air.

Different sounds have waves of different volume and frequency. A loud sound has waves of greater volume or energy, and a low or feeble sound has waves of less volume or energy. A high pitched sound has waves of high frequency, and a low note has waves of lower frequency.

These little puffs or waves of air strike our ear drums and cause them to vibrate and transmit impressions of various sounds to our nerves and brain, thus enabling us to hear them. Figs. 108 and 109 show several different forms of sound waves, represented by curves showing their volume and frequency.

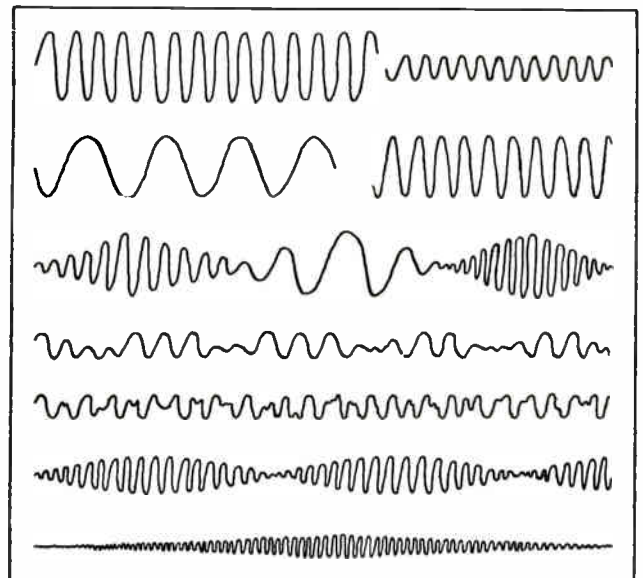

Fig. 108. This sketch shows a number of different forms of sound waves represented by curves. The upper line shows two groups of waves, both of about the same frequency, but the first group of considerably greater volume than the second. The second line shows two groups of about the same volume, but the first is of much lower frequency than the second. The third line shows waves of varying volume and varying frequency.

In order to be heard by the ordinary human ear, sound waves must be between 16 per second and 15,000 per second, in frequency. These are called Audible sounds. Many people cannot hear sounds of higher pitch or frequency than 8,000 to 9,000 waves per second, and it is only the highest of musical or whistling notes that reach a frequency of 10,000 or more per second.

Sound waves travel about 1,100 feet per second in air, and about 4,700 feet per second in water.

Ordinary sounds can only be heard at distances from a few feet to a few hundred feet, and the loudest sounds only a few miles.

This is, because the actual amount of energy in the sound waves is very small and is quickly lost in traveling through air.

Electricity travels at the rate of 186,000 miles per second, and can be transmitted over hundreds of miles of wire without much loss. So if we change sound wave energy into electrical impulses and then use these impulses to reproduce the sounds at a distance, we can greatly increase both the speed and the distance sounds can be transmitted.

This is exactly what the telephone does.

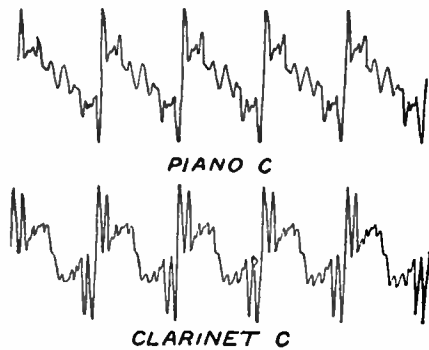

Fig. 109. These waves are typical of various musical notes, having the small variations in frequency and volume occurring at regular intervals, forming groups or large variations in the general note.

### 89. TRANSMITTING AND REPRODUCING SOUND WAVES ELECTRICALLY

In Fig. 110-A is shown a sketch of a simple form of telephone. Sound waves striking the Transmitter at the left, cause it to vary the amount of current flowing from the battery through the transmitter, and also through the Receiver at the right. These varying impulses of current through the receiver magnet vibrate a thin diaphragm or disk and set up new air waves with the same frequency and variations as those which operated the transmitter. Thus the original sound is reproduced quite faithfully.

This illustration of the telephone principle shows that the actual sound does not travel over the wires, but that the wires merely carry the electrical impulses.

Figs. 110-B and 110-C show the same circuit with different amounts of current flowing in each case, as they would be at the time different sound waves strike the transmitter.

This simple telephone would serve to transmit the sound only in one direction, but would not permit return conversation. For two-way conversation we can connect a transmitter and receiver at each end of the line, all in series with a battery, as shown in Fig. 111.

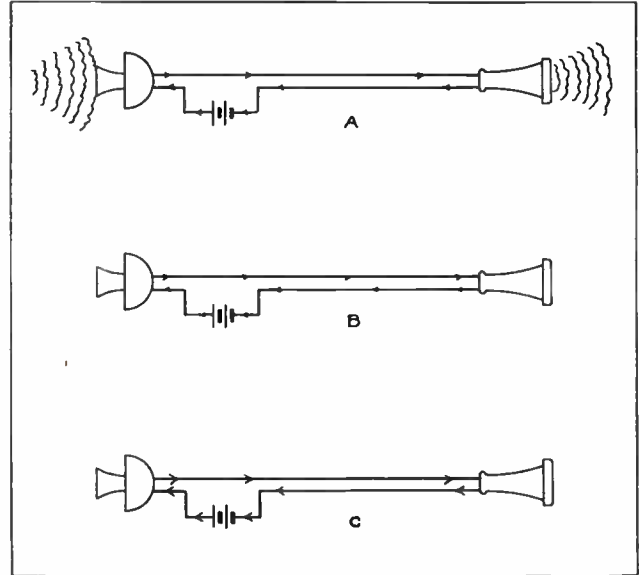

Fig. 110-A. Sound waves striking the transmitter are reproduced electrically by the magnets in the receiver.  
B. When feeble waves strike the transmitter only small currents flow in the circuit.  
C. When stronger waves strike it heavier currents flow.

When sound waves enter either transmitter, both receivers are caused to operate, so this system can be used to carry on conversation both ways.

However, we still do not have any means to call the distant party to the telephone.

This can be arranged very easily, as in Fig. 112, by simply attaching a return call bell and push button system. In this circuit we have made use of one of the talking circuit wires, and a ground path for the bell circuit, but it still requires an extra wire for the signals. This wire can be eliminated by the use of a Receiver Hook Switch, to separate the talking and ringing circuits when the receiver is up or down.

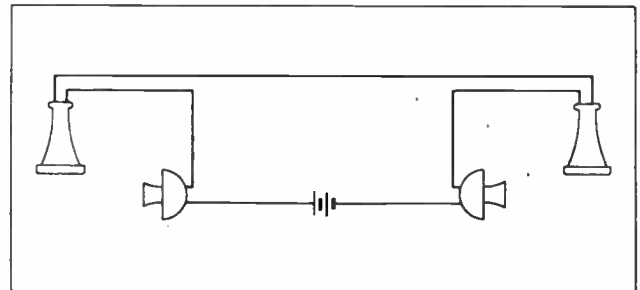

Fig. 111. Two transmitters and two receivers connected in series to form a simple two-way telephone circuit.

The circuit shown in Fig. 112 can be used for a very practical telephone for short distances, such as between a house and barn, or in a large shop

or office building. But for longer distances we should also have the hook switch to save the extra wire, and an **Induction Coil** to increase the voltage for the long line. The bells should also be of a special high resistance type, so they will operate on less current and maintain better line economy.

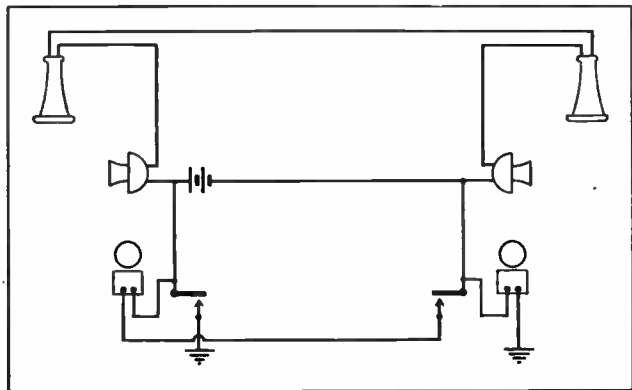

Fig. 112. Simple telephone system for two-way conversations, and including bells and buttons for calling the parties to the telephone.

### 90. IMPORTANT PARTS AND DEVICES

Now we have found that the more important parts of a telephone are the **Transmitter, Receiver, Bell, Hook Switch, Induction Coil, and Battery**, or source of current supply. Some types of telephones also require a special **Magneto** to operate the high resistance bells.

In order to more thoroughly understand the operation of various types of telephones, and also their care and repair, we should now find out more about each of these important parts mentioned.

Although there are many styles of telephones and various circuits and systems, they all use these same fundamental parts, and if you get a good general knowledge of these parts it should be much easier for you to understand any ordinary telephone installation.

### 91. TRANSMITTER

The transmitter, as was mentioned before, acts as a valve to release from the battery, electric current impulses in synchronism with the sound waves which operate the transmitter. This is done by the use of a variable resistance in the form of carbon granules (particles) in a small cup-like container.

This cup has a loose cover or front end, which is attached to the thin disk or diaphragm directly in front of the mouthpiece.

The mouthpiece acts as a sort of funnel, to concentrate the sound waves on this disk. As the waves strike the disk, they cause it to vibrate slightly and this moves the loose end of the carbon container and compresses and releases the carbon grains or granules. See Fig. 113, which shows these parts in detail.

The transmitter circuit is arranged so the current from the battery must flow through the carbon granules from one end of the cup to the other. When the carbon particles are compressed tightly the contacts between them are better, their electrical resistance is lower, and they allow a strong current to flow. When they are released and their contacts loosened, the resistance increases and less current will flow.

So, as the various sounds strike the transmitter and cause the disk and button to vibrate rapidly, it controls or liberates from the battery corresponding impulses of current. Fig. 114 is a sketch showing the connections and electrical circuit through a transmitter.

Fig. 115 shows several different forms of electric current represented by curves. The straight lines are base or zero lines, and are considered as points of no current value. When the curve goes above the line it represents positive or current in one direction; and when it goes below it means negative or current in the opposite direction. Fig. 115-A shows a steady or continuous flow of direct

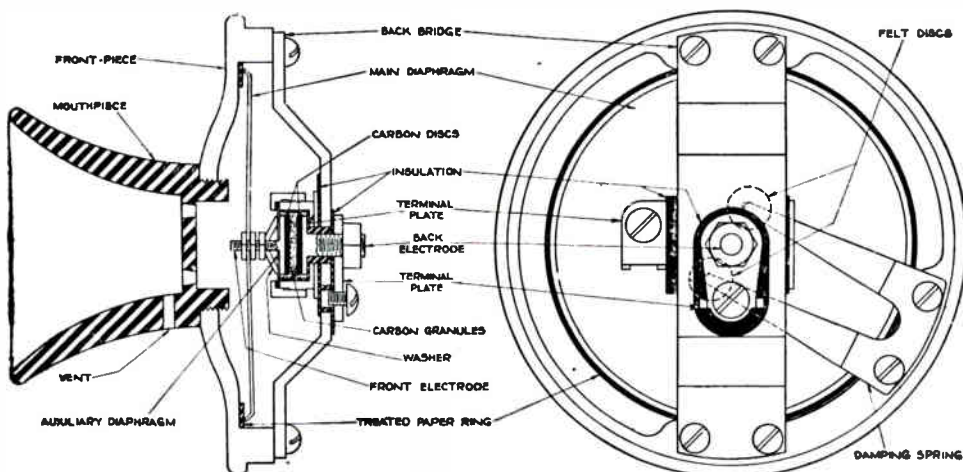

Fig. 113. This diagram shows two different views of a telephone transmitter and its parts. Examine each very closely, and note the names of each part.

current, such as the battery would ordinarily supply. Fig. 115-B shows pulsating direct current such as the transmitter would produce. The height of the curve above the line indicates the value of the various current impulses. While this current varies in amount, it is still flowing all in one direction.

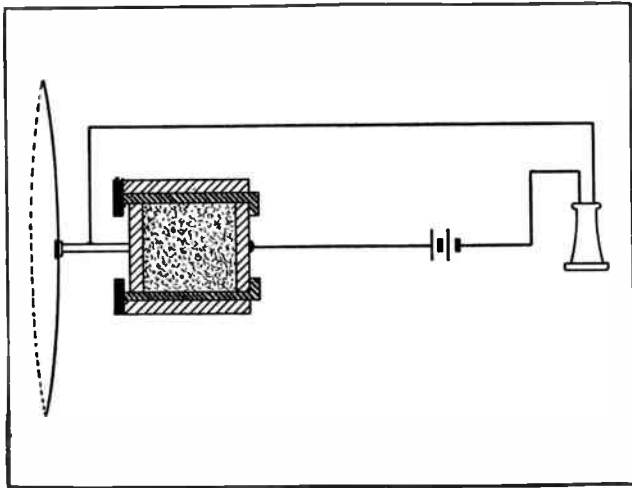

Fig. 114. Simple sketch showing principle of telephone transmitter button, and how the varying pressure on the carbon granules varies the resistance and current flow in the circuit.

Fig. 115-C shows ordinary alternating current, such as a magneto or A. C. generator would produce. This current continually varies in amount and regularly reverses in direction. Fig. 115-D shows alternating current of irregular frequency and varying volume, such as produced by a telephone induction coil, which will be explained a little later.

Fig. 116 shows another type of transmitter of slightly different construction, but similar in oper-

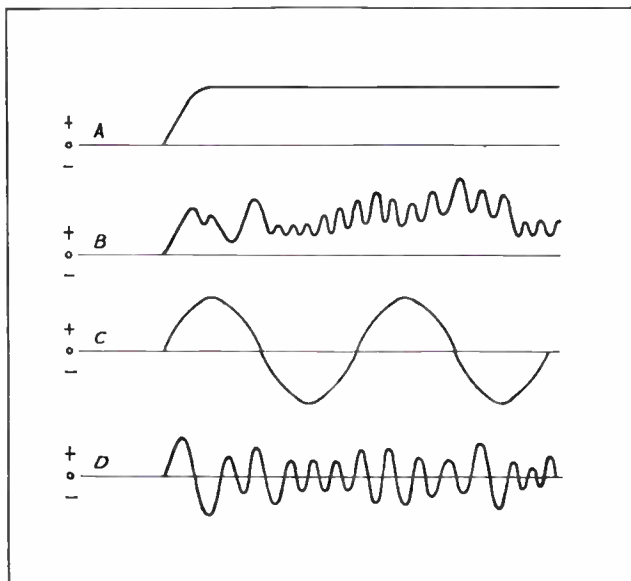

Fig. 115. Various kinds of electrical current represented by curves. Examine each curve very closely and compare with the explanations given.

ating principle to the one in Fig. 113. This transmitter has the disk or diaphragm mounted in a soft rubber ring, to allow it free movement without rattling or chattering.

Sometimes the carbon granules in a transmitter become packed or worn and need to be removed. In many transmitters the entire cup can be easily removed and exchanged. Loose terminals, broken connections, or dirt around the diaphragm also cause occasional trouble.

## 92. RECEIVER

The ordinary telephone receiver consists of a strong permanent magnet of horseshoe shape, a pair of electro-magnet coils at the ends of the permanent magnet poles, a thin disk or diaphragm, and the shell and cap in which these parts are enclosed.

See Fig. 117. The receiver at the left shows the parts named, while the one at the right shows a slightly different type which does not use the large permanent magnet, but just a strong electro-magnet instead.

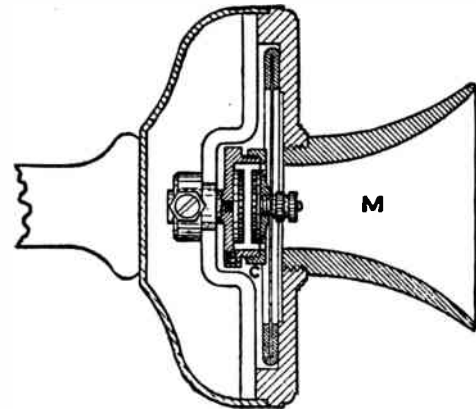

Fig. 116. Sectional view of a common type of telephone transmitter. The carbon cup is here shown empty or without any carbon granules in it.

The permanent magnet normally holds the iron disk attracted when the receiver is not in use. When "talking current," or current from the talking circuit, passes through the coils of the electro-magnets, its current variations strengthen and weaken the pull of the permanent magnet on the diaphragm, causing it to vibrate.

Telephones using induction coils have alternating current in the line and receiver circuits. This current reverses rapidly, and the reversals or alternations are of the same corresponding frequency and volume as the sound waves which caused them.

Some of these impulses were shown in Fig. 115-D. As these impulses pass through the receiver coils, they not only vary the magnetic strength of the coils, but also actually reverse their polarity. This causes the electro-magnets to strengthen the polarity and aid the pull of the permanent magnets on the diaphragm while the current flows in one

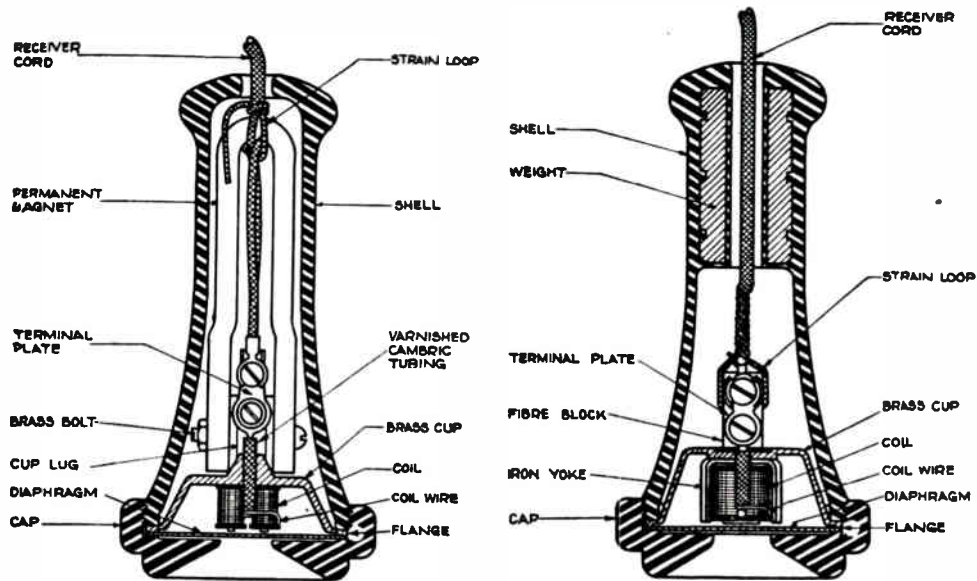

Fig. 117. Two sectional views showing the construction and parts of two types of telephone receivers. Examine all the parts carefully and note the names of each. The receiver on the right has a lead weight at the top of the shell to make it heavy enough to operate the hook switch, which will be explained later.

direction. But when it reverses, the magnetism of the coils opposes that of the permanent magnet and weakens it, thus making a considerable variation in pull on the diaphragm.

The coils of the receiver electro-magnets are usually wound with many turns of very fine wire, and if these coils are bruised or scratched it often breaks one or more turns of the wire and stops the operation of the receiver.

Some of the other more common receiver troubles are as follows: Loose end cap, allowing diaphragm to fall away from magnets; bent diaphragm, weak permanent magnet, loose cord connections, or broken receiver cord. The wires in these cords often become broken inside the insulation, from twisting and kinking, or from rough handling and dropping of receivers.

Testing with a dry cell, first at the cord tips, then at the receiver terminals, and listening for a click at the diaphragm as the circuit is made and broken, will easily disclose this trouble.

Another type of receiver, often called a "watch case" type, is shown in Fig. 118. These small receivers are used in head sets for telephone operators, and are very similar to those used by radio operators.

Their construction is much the same as the larger ones, except that they are much lighter in weight and have the permanent magnet in more of a circular shape.

### 93. HOOK SWITCH

The receiver is hung on a spring hook when not in use, and this hook operates a switch to disconnect the talking circuit and places the ringing circuit in readiness for the next call. This is called a **Hook Switch**.

By disconnecting the talking circuit, it saves wasting the battery current when the 'phone is not in use. It also disconnects the bell circuit when the 'phone is in use, and thus prevents the bell from being rung while parties are talking. Having this switch operated by the receiver makes it automatic, as the party naturally removes and replaces the receiver when starting and finishing the conversation.

Fig. 119 shows a very simple type of hook switch. While the receiver is on the hook it holds the hook down, and the end of the hook lever presses against the center contact of the switch, keeping it in contact with the spring "C." This closes the ringing circuit.

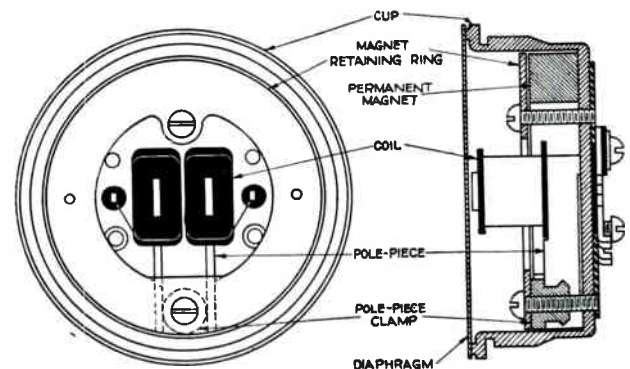

Fig. 118. Sectional view and front view of watch case receiver, such as used on telephone operators' head sets.

When the receiver is removed from the hook, the spring causes the hook to raise and the end of the hook lever to move to the left, allowing the center spring to make contact with "A" and close the talking circuit. It also opens the ringing circuit at the same time.

There are a number of different types of hook switches, but the principle of all of them is very similar and easy to understand.

If the contacts of a hook switch become burned or dirty, or if the contact springs become bent out of shape, it is likely to cause faulty operation of the talking and ringing circuits.

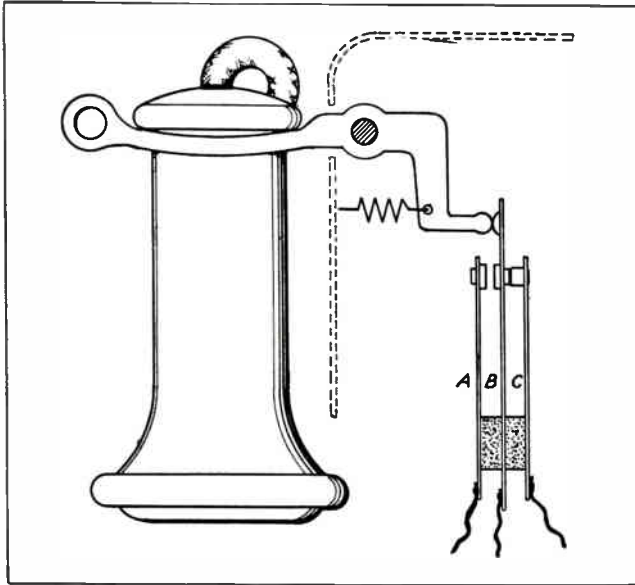

Fig. 119. Sketch showing the principle of a simple "receiver hook switch." Note what the operation of the spring contacts would be if the receiver was raised and lowered.

#### 94. BATTERIES AND CURRENT SUPPLY

Telephones require, for the successful operation of their talking circuits, direct current supply of a very "smooth" or constant voltage value. This is because we do not want any variations in the current, except those made by the transmitter and sound waves.

In small private telephone systems and rural lines, dry cell batteries are often used, and in many cases each 'phone has its own battery.

Large telephone systems for city service use storage batteries or D. C. generators for talking current supply. Generators for this use have special windings and commutators for providing "smooth" D. C., as even the slight sparking and variations of voltage at the commutator of an ordinary power generator would produce a disturbing hum in the 'phone receivers.

Rural line telephones often use a hand-operated magneto to supply current to ring the bells, and some small exchanges do also. However, most exchanges use a generator to produce alternating current or pulsating direct current, for the operators to ring the various parties by merely closing a key switch.

#### 95. INDUCTION COIL

As mentioned before, most telephones that are to be used on lines of any great length use an induction coil. The purpose of this coil is to act like a transformer and increase the voltage of

the impulses in the talking circuit, so they can be transmitted over long lines with less loss.

When a transformer "steps up" the voltage, it reduces the current in the same proportion, and the less current we have to send through the resistance of any line, the less loss we will have. By briefly recalling your study of Ohms Law and voltage drop principles, this should be quite easily understood.

Induction coils have a primary and secondary winding around a core of soft iron, and when the current impulses are sent through the primary, corresponding impulses of higher voltage are set up in the secondary by magnetic induction. Thus the name, "induction coil."

Fig. 120 shows a sketch of an induction coil. "C" and "C" show the ends of a core which is made of a bundle of soft iron wires. "H" and "H" are ends or "heads" to support the coil on the core. "P" and "P-1" are the terminals of the primary winding. "S" and "S-1" are the terminals of the secondary winding.

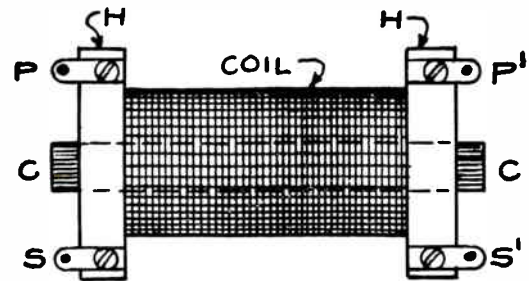

Fig. 120. This sketch shows the construction of the windings and core of a telephone induction coil.

The primary winding should be connected in the transmitter and battery circuit. The secondary winding connects to the receiver and line circuit. These connections will be shown a little later, in a diagram of a complete telephone circuit.

Fig. 121 shows a single, and also a double induction coil. Fig. 122 shows a sketch of the coils, core, and terminals of the induction coil as they are often shown in connection diagrams.

We recall from an earlier section on transformer principles, that transformers will not operate on ordinary direct current, but in the case of this telephone induction coil, the current from the battery is caused to pulsate or increase and decrease rapidly, by the action of the transmitter.

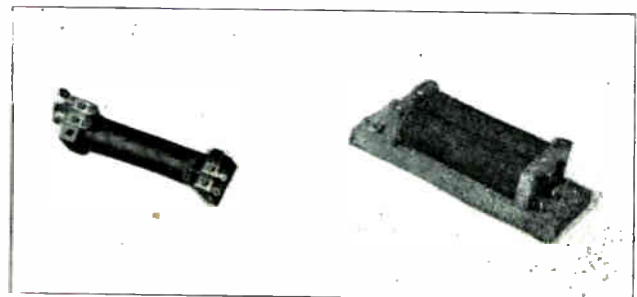

Fig. 121. On the left is shown a single induction coil with the terminal connections plainly visible. On the right is shown a pair of coils mounted on one base.

These variations in the talking current cause the flux of the primary coil to expand and contract, and induce the higher voltage impulses in the secondary.

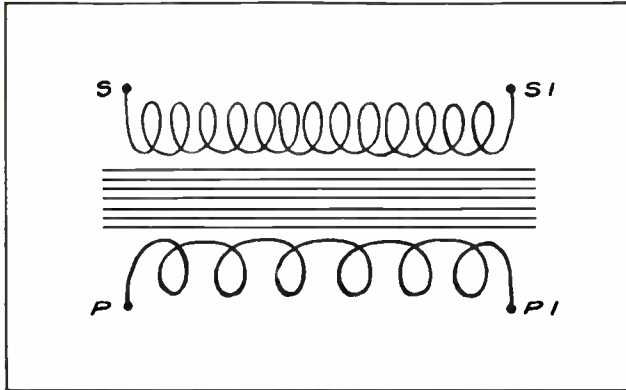

Fig. 122. The primary and secondary windings and core of an induction coil are often shown in the above manner in electrical diagrams.

96. TELEPHONE BELLS

While some telephones in small private systems use ordinary vibrating bells, the more common 'phones in general use in public systems use a Polarized bell, which operates on alternating current.

These bells have two electro-magnets and an armature, which is a permanent magnet; and two gongs instead of one, as in the case of the vibrating bell.

Fig. 122-B shows two views of this type of telephone bell.

In some cases, instead of the armature itself being a permanent magnet, a larger permanent magnet is mounted behind the bell coils and with one end close enough to the armature to maintain induced poles in it.

The coils of these bells are usually wound with many turns of very fine wire, and are designed to operate on very small amounts of current at rather

high voltage, which makes them economical to operate on long lines.

The operating principle of the polarized bell can be easily understood by referring to Fig. 123. You will note that when current flows through the coils in one direction it sets up poles on the electro-magnets, which attract one end of the armature and repel the other, causing the hammer to strike the left gong as in Fig. 123-A.

Then, if we reverse the current as in "B," this reverses the poles of both electro-magnets, causing them to attract and repel opposite ends of the armature to what they did before. This makes the hammer strike the right-hand gong.

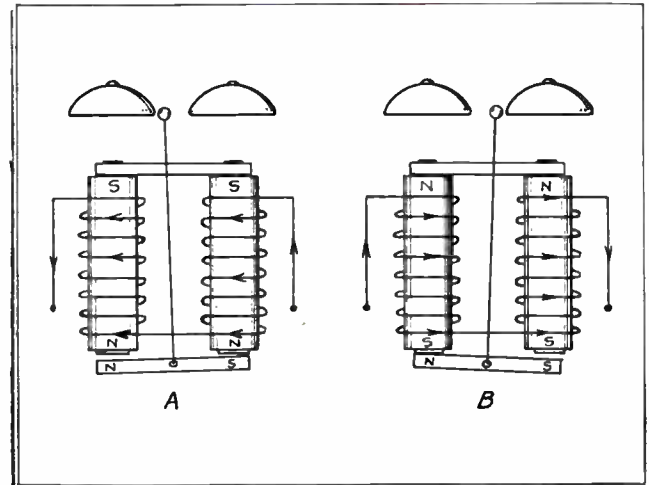

Fig. 123. These sketches show the electrical circuit of a polarized telephone bell. Note the polarity and position of the armature in "A," and again in "B," after the current has been reversed.

Then, if we supply alternating current from a magneto or central generator, it will cause the coils to rapidly reverse and operate the hammer at the same frequency as that of the current supply.

Check carefully the polarity of the permanent magnet, the movable armature, and the electro-magnets in both bells in Fig. 123.

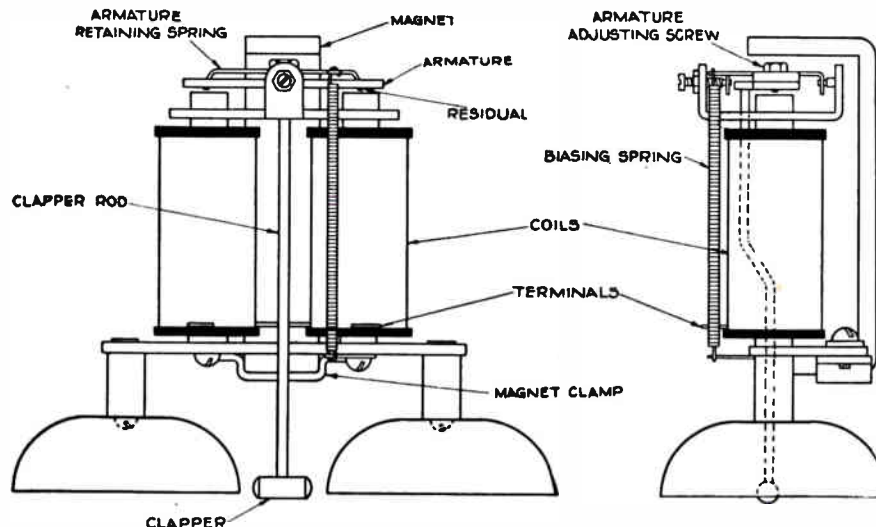

Fig. 122-B. Front and side views of a polarized telephone bell. Note the end of the permanent magnet, which is used to magnetize the armature by induction. Also note the biasing spring attached to one end of the armature.

**97. BIASED POLARIZED BELLS FOR PULSATING D. C. OPERATION**

Sometimes these polarized bells are equipped with a **Biasing** spring attached to their armature. This spring can be noted in Fig. 122-B. It enables the bell to be operated on pulsating direct current, which is sometimes used by the operators at central stations for ringing various parties on the line.

In such cases a rotary pulsating switch is used in the battery circuit to provide the interruptions in the current. The biasing spring normally holds the hammer against one of the gongs when the bell is idle. When current is sent through the coils in the proper direction, the electro-magnets will attract and repel the proper ends of the armature, to cause the hammer to strike the other gong.

When the current is interrupted, the spring draws the armature and hammer back again, striking the first gong once more. This will be repeated as long as the pulsating current flows. See Fig. 124. The pulsating wheel "W" has alternate sections of metal and insulation, so as it is rotated it rapidly makes and breaks the circuit of the battery and bell.

Fig. 125 shows a very good view of a telephone bell with the gongs removed.

polarities of the magnets in both bells "A" and "B" in this figure.

When telephone bells fail to operate, the trouble can usually be found in a loose connection, broken coil lead, weak permanent magnet, loose gongs, or magnet cores loose on keeper or frame.

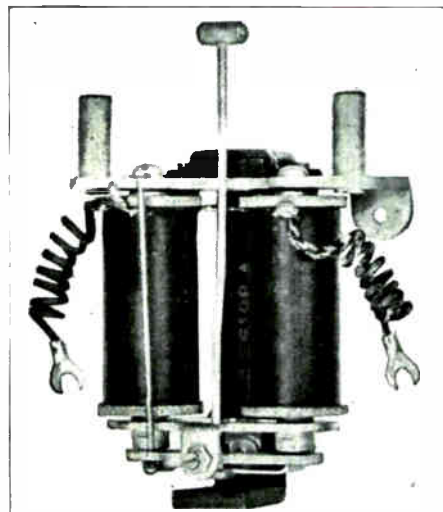

Fig. 125. Photograph of coils, armature, and hammer of a common telephone bell.

**99. TELEPHONE MAGNETOS**

As mentioned before, rural lines often use magnetos at each 'phone for the subscriber to ring any other party on that line, and also to call the central operator. These magnetos, when operated by the hand crank at normal speed, produce alternating current at fairly high voltage, usually from about 80 to 100 volts, and at a frequency of about 20 cycles.

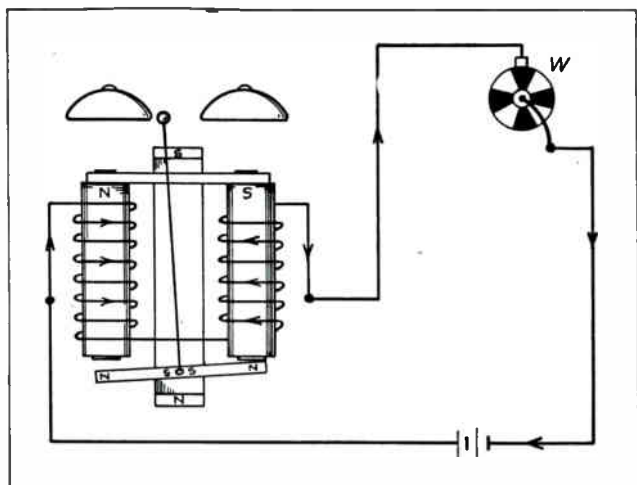

Fig. 124. This sketch shows how a "pulsator" or interruptor can be used to supply pulsating current from a battery and for the operation of telephone bells.

**98. POLARIZED BELL WITH PERMANENT MAGNET ARMATURE**

Another type of polarized bell used in some telephones, has both coils wound in the same direction and uses the permanent magnet for an armature. See Fig. 126.

In these bells the armature has unlike poles at opposite ends, so in order for one of the electro-magnets to attract and the other to repel, they must have like poles. When alternating current is passed through this bell, the polarity of both electro-magnets changes at the same time. This causes attraction of first one end of the armature, and then the other.

Observe carefully the direction of current and

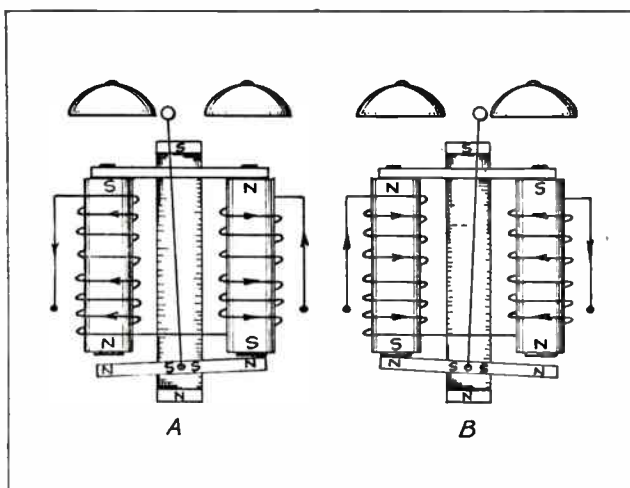

Fig. 126. This sketch shows the construction and windings of another type of polarized bell, which uses a permanent magnet for its armature. Note the polarity and position of armature at "A," and again at "B," after the current has been reversed.

Fig. 127 shows a sketch of a magneto of this type. The armature is usually of the shuttle type with just two large slots, in which are wound many turns of very fine wire. It is located in the base



of the magneto between the poles of several large horseshoe magnets.

The magnets supply the magnetic flux which is cut by the armature winding to generate the voltage. The armature is revolved quite rapidly by means of a large gear on the hand crank shaft, and small pinion on the armature shaft.

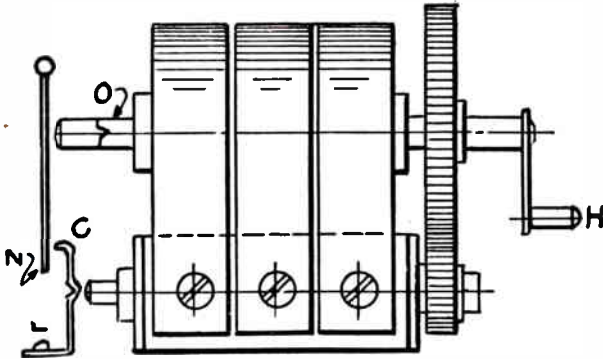

Fig. 127. Diagram of telephone magneto showing shaft extension which operates contact springs.

The crank shaft shown at "O" is equipped with a slotted extension and spring which pushes out against the contact spring "N" each time the crank is turned. This operates a sort of "shunt" switch.

When the magneto is idle this spring falls back, touching contact "C," and shunts out the magneto winding from the line circuit, so the talking current does not have to pass through this resistance.

When the crank is turned the shaft is forced out a small distance and opens these contacts, allowing the magneto current to flow to the line and bells. One end of the armature winding is usually grounded to the shaft, and the other end is insulated and carried out through the center of the shaft, which is hollow. This end or tip of the shaft is in contact with the small spring as the shaft rotates.

Fig. 128 shows two photos of telephone magnetos. The one at the right is equipped with a hand crank for use in a subscriber's telephone. The one at the left is equipped with an extension shaft such as used by central operators in some of the small exchanges.

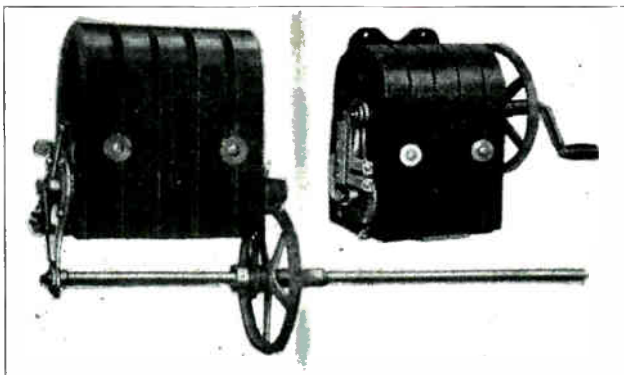

Fig. 128. These photos show two telephone magnetos. The one on the left for use in a small exchange, and the one on the right for a subscriber's telephone.

Some exchanges use a power-driven magneto, having it operated continuously by a small motor. In this case it is only necessary for the operator to close a key or switch to ring the party being called.

In Fig. 128 the spring contacts operated by the magneto shaft are quite clearly shown.

The permanent magnets in these magnetos often become weak after a certain age and need to be remagnetized or replaced. Sometimes a little oil and dirt collects on the contact springs, causing them to fail to make good connections; or they may become bent or worn so they do not make proper contact.

## 100. COMPLETE TELEPHONES AND CIRCUITS

Now that you understand the function and operation of the important parts of a telephone, let's see how they all work together in the complete 'phone.

Fig. 129 shows a common type of party line telephone used on rural lines and in small towns.

The view on the left shows the box closed, and the location of the receiver, transmitter, and bell gongs. On the right the box is opened up, showing the battery and magneto, hook switch in the upper left corner, and bell magnets on the door. The induction coil is not visible in this view.

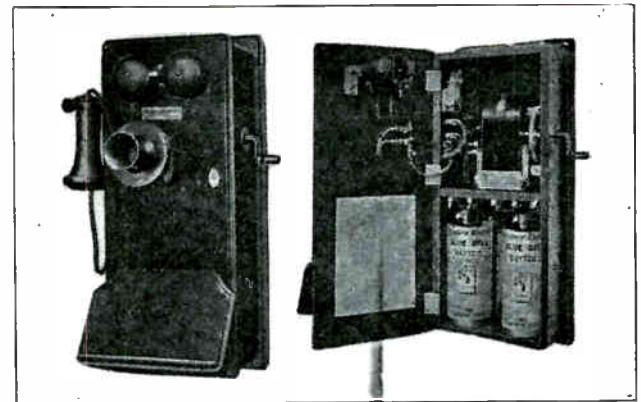

Fig. 129. Common type of party line telephone used on rural lines. This telephone is complete with its own batteries and magneto.

You will note that this 'phone is complete with all necessary parts, and has its own current supply for both the talking and ringing circuits.

Two or more telephones of this type can be connected in parallel on a line, and if desired can be operated without any central exchange or any other equipment.

Any party can ring any other party by a system of different calls, arranged in combination of short and long rings, similar to dots and dashes.

Party lines with a number of these 'phones can also be run to a central office and from there they can be connected to any other line on the entire system. This is the purpose and function of a central office or telephone exchange. It is practical to have on one line only a certain limited number

of 'phones, as otherwise the line would always be busy, and no other subscriber could use it while two parties were already talking over it. On rural lines the number of parties may be from ten to twenty per line. In cities, there may be from two to four parties per line.

When a subscriber on one line wishes to talk to someone on another line, he or she signals the central operator, who can, by means of switches and plugs, connect the **Calling Line** to the one called and then ring the party desired on the **Called Line**. The equipment and operation of exchanges is covered later.

Fig. 130 shows a complete diagram of the electrical circuit and connections of a telephone of the type shown in Fig. 129. Here we can see the relation of each part to the others and get a clearer idea of how they all operate together.

Trace out this circuit very carefully, until you are sure you clearly understand its entire operation.

The receiver is shown off the hook and the hook is raised, allowing the main contact spring to move to the left and close the two contacts on that side, completing the talking and line circuit. The large arrows show where the current flows from the local battery, through the transmitter, induction coil primary, hook switch contacts, and back to the battery.

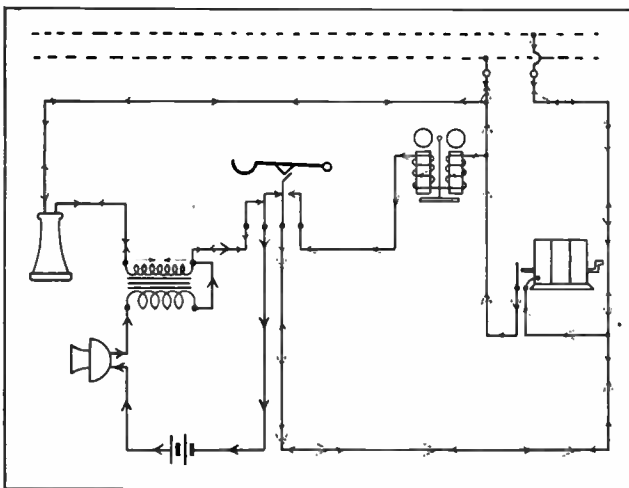

Fig. 130. Diagram showing connections and circuits of a telephone such as shown in Fig. 129.

When the party talks into the transmitter, this local current is caused to pulsate and sets up induced impulses of higher voltage but smaller current, in the secondary coil, receiver and line circuit. This is shown in the small arrows. You will remember that this current induced in the secondary coil and in the receiver circuit is alternating and rapidly reverses, so we show the arrows both ways. It also flows a short distance through one of the same wires with the battery current, but this does no harm.

The magneto is shown here in idle position, so

its spring contact is open and keeps the magneto winding out of the ringing and line circuit at present. When the magneto is operated, the shaft pushes out and closes the circuit, and sends current through the bell and also out on the line to the other bells.

In order to ring anyone, the receiver must be on the hook, keeping the hook down and holding the main spring or line contact to the right and in contact with the spring on that side. The ringing current then flows as shown by the dotted arrows.

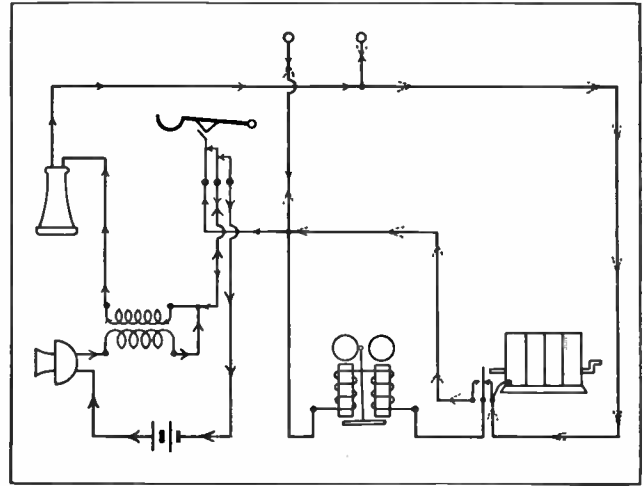

Fig. 131. Circuit diagram of another telephone using a different hook switch and set of magneto contacts. Trace the circuit very carefully and observe its operation.

Fig. 131 shows another telephone circuit, using a hook switch with only three spring contacts instead of four, and a magneto with three contacts instead of one or two. Compare this diagram carefully with Fig. 130. Here again the large arrows show the transmitter and local battery circuit; the small arrows, the receiver and line circuit; and the dotted arrows, the ringing circuit.

You will note that this hook switch does not make and break the ringing circuit as did the one in Fig. 130. Here the ringing circuit is controlled by the magneto springs. When the magneto is idle, the long center spring presses to the right, keeping the bell connected to the line, ready to receive an incoming call. When the magneto crank is turned it forces the shaft outward and pushes the center spring to the left. This short-circuits the bell and makes a connection direct to the line to ring outside bells. In this type of 'phone the subscriber's own bell does not ring when the magneto is operated.

There are a number of different ways to arrange party line telephone circuits, hook switches, magneto contacts, etc.; but if you have a good understanding of these fundamental circuits and the operation and purpose of these important parts, you should have no difficulty understanding any 'phone circuit after tracing out its wiring or diagram.

### 101. CENTRAL ENERGY SYSTEMS AND 'PHONES

In large city telephone systems a central source of current supply is generally used for both the talking and ringing. In such systems the subscriber's 'phone does not need a battery or magneto.

The hook switch and circuit are so arranged that as soon as the receiver is removed from the hook, it closes a circuit and lights a small lamp on the exchange operator's switchboard.

The operator then plugs her 'phone onto this calling line and closes her key so the caller can give her the number desired. Then, if the called line is not busy, the operator connects the calling line to it and rings the party to be called.

A simple circuit for a telephone of this type is shown in Fig. 132. Keep in mind, when tracing this circuit, that the current supply comes in on the line from the exchange.

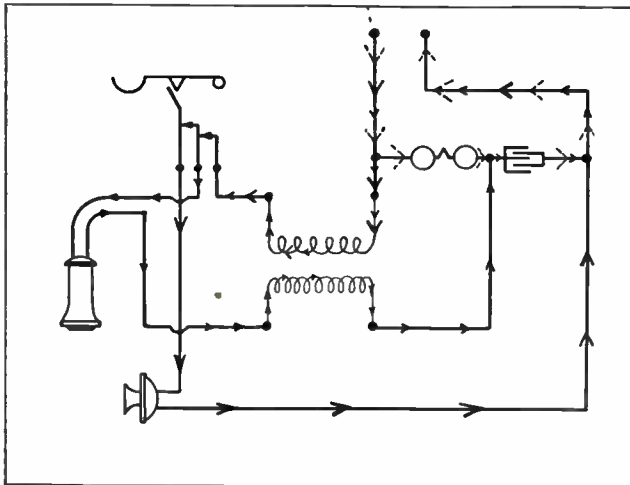

Fig. 132. Wiring diagram for a simple telephone to be used on a central energy system. This telephone gets all the energy from the line and central supply.

You will note that a condenser is used here to prevent the direct current for the transmitter circuit from passing through the bell or receiver circuits.

A condenser will pass or allow alternating current or pulsating direct current to flow in the circuit, but it blocks or stops ordinary direct current.

The "talking current," shown by the large arrows, comes in on the left line wire and passes through the induction coil primary, hook switch, transmitter, and back out on the right line wire. When the party is talking, the induced current in the secondary coil, shown by small arrows, flows out through the condenser and right line wire, to the receiver of the operator or called party; and back in the left line wire, through the primary coil, hook switch and subscriber's own receiver, and returns to the secondary coil. In tracing the receiver and line circuit, consider the secondary coil as the source of this energy.

A different symbol is used here for the bell, as it is simpler to draw in plans and easy to recognize once you are acquainted with it.

Fig. 133 shows a complete telephone of this type, for wall mounting. The bell, condenser and coil are mounted in the box, while the receiver is on the usual hook on the side, and the back of the transmitter can be seen in the front of the open cover.

Note the terminal blocks to which all connections are brought and numbered, making it easy to connect up or test the telephone.

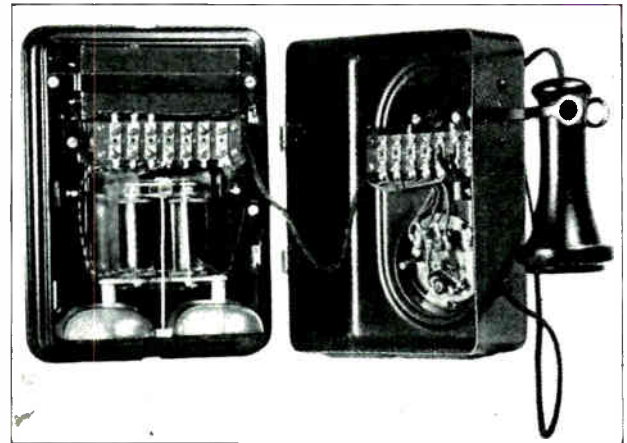

Fig. 133. Photograph of wall type telephone for central energy systems.

Fig. 134 shows another telephone of the central energy type, for use on a desk. This desk-type 'phone has the receiver and transmitter mounted on a separate stand for convenient use on the desk; while the bell, coil, and condenser are in a separate box to be mounted on or near the desk.

The hook switch is inside the upright handle of the stand.



Fig. 134. Common desk type telephone with bell box to be mounted separately.

### 102. TELEPHONE EXCHANGES

As already mentioned, the telephone exchange serves to connect telephones of one line to those of other lines, and there are thousands of these central exchanges throughout this country, to handle the many millions of telephones in use.

The exchange in the small town handles the calls of the subscribers in the town, those of rural lines calling in to city 'phones, and those of one rural line calling through to another line, perhaps running out of town in the opposite direction. Thus this exchange serves the 'phones in that town and surrounding territory. Then it has its Trunk Lines connecting to exchanges of other cities, and can complete a circuit for one of its own subscribers, through the exchange of another town several hundred or even several thousand miles away.

This vast network requires many types of elaborate exchange circuits, which it is not our purpose to cover here, as they represent a very highly specialized type of work. They also require much more time than the average electrician cares to spend on such circuits, unless he intends to specialize in telephone work. But, in order to give you a better understanding of the general operation of the exchange in connection with the 'phones we all use daily, and also to give you a good foundation to work from in case you should later specialize in such work, we will cover in the following material some of the fundamental parts and principles of exchanges.

Telephone exchanges are of two general types, namely, manual and automatic.

The general function of either type is to receive a signal from the calling subscriber, and get a connection and ring his party on any other line as quickly as possible.

With the manual exchange, the plugging, switching and ringing operations are performed by human operators, usually girls. With the automatic exchange these operations are performed by electrical and mechanical equipment.

### 103. SWITCHBOARDS FOR MANUAL OPERATION

Fig. 135 shows a manual exchange or switchboard, for handling one hundred lines. These lines are brought up to Jacks on the upright front of the board.

On the flat, desk-like, part of the board is a set of Plugs, attached to Cords beneath, and also a set of Key Switches. Directly above each jack is a Drop similar to an annunciator drop.

When a subscriber on any line signals the operator, the little drop window or shutter for his line falls down, showing the operator that someone on that line is calling. There are two plugs in front of that line, one for talking and one for ringing.

The operator lifts the talking plug and inserts it in the line jack opening. Then, by pressing her key in one direction, she can answer the Calling Party and receive the number he wishes to call.

If the line of the party desired is not busy, the operator then lifts the other plug in line with the first one, and places it in the jack of the "called" line. Then, by pushing the key in the other direction, she can ring the party desired.

By pushing the key back to the listening position

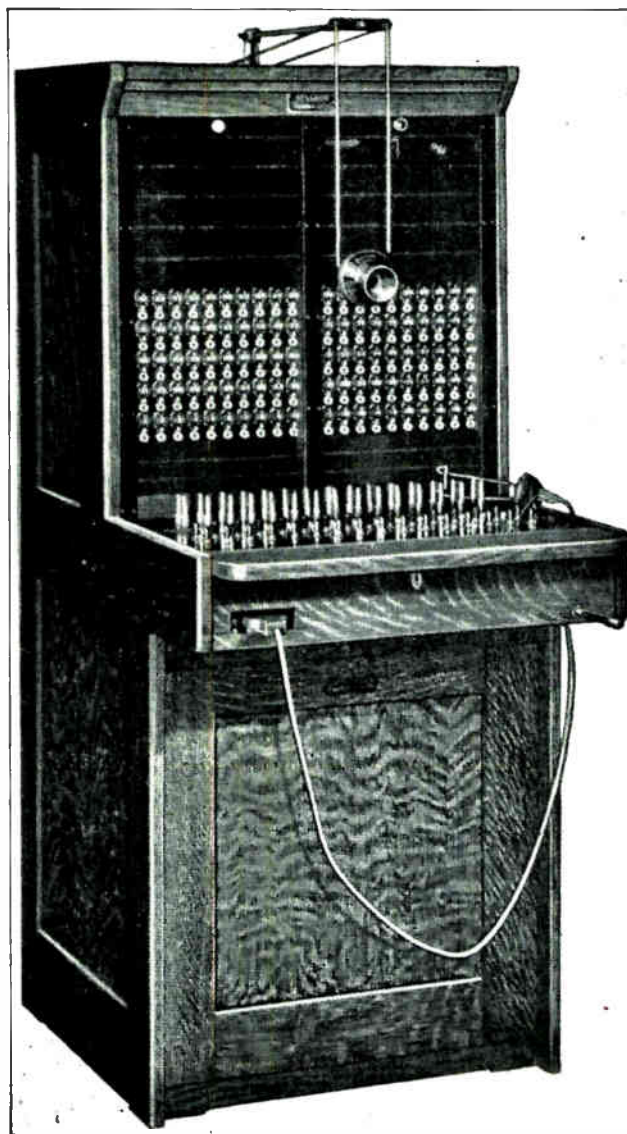

Fig. 135. A small exchange switchboard of the magneto type, showing plugs, jacks, and the operator's transmitter and receiver.

again, the operator can hear the party answer. When he does, she can release the key to vertical or neutral position. The parties then carry on their conversation through the wires in the cords.

The cords are equipped with very flexible wires, and have weights on little pulleys as shown in the left view in Fig. 136. At the right is shown a large view of the pulley and weight. These weights keep the cords straight and pull them down again each time the plugs are dropped to idle position.

The operator's head-set is shown lying on the keyboard in Fig. 135, and the transmitter is shown on an adjustable arm and cord in front of the board.

Fig. 137 shows a closer view of the keys, plugs, and jacks of a board of this type. The key switches are shown in the foreground, and directly behind these and indicated by the arrow is a row of small lamps to show the condition of the circuit to the operator. Behind the lamps are the plugs, and above are the plug jacks and drops.

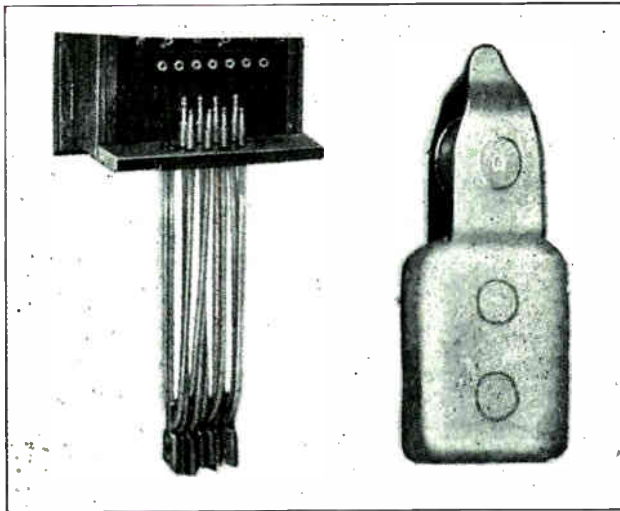

Fig. 136. The view on the left shows the manner in which the plug cords are held straight by the weighted pulleys. A larger view of one of these pulleys is shown on the right.

104. KEY SWITCHES

A very good view of two switchboard keys is shown in Fig. 138. The levers or key handles can be pushed in either direction, and their lower ends have rollers or cams that push and operate a set of spring contacts on either side, depending on which way they are pushed. Examine these switches and all their parts carefully.

complete the lamp circuit. The forward end of the lamp is all that shows in the opening they are placed in.

The bull's-eyes are made in white and various other colors to indicate various circuit conditions.

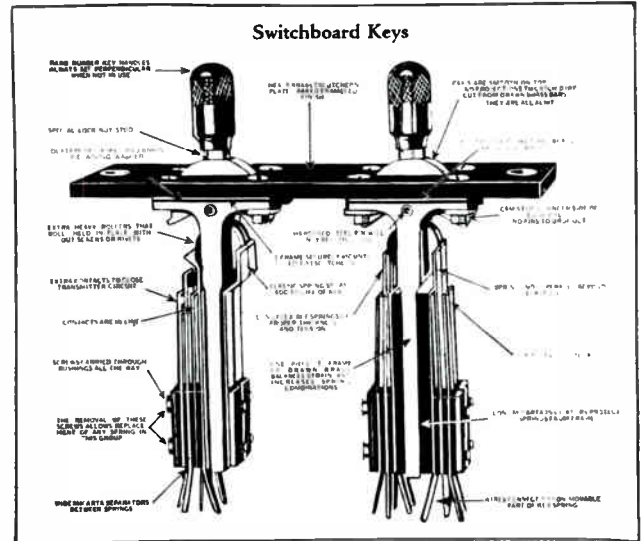

Fig. 138. Here we have an excellent view of two key switches, showing how the key levers and rollers operate the spring contacts, and open and close various circuits.

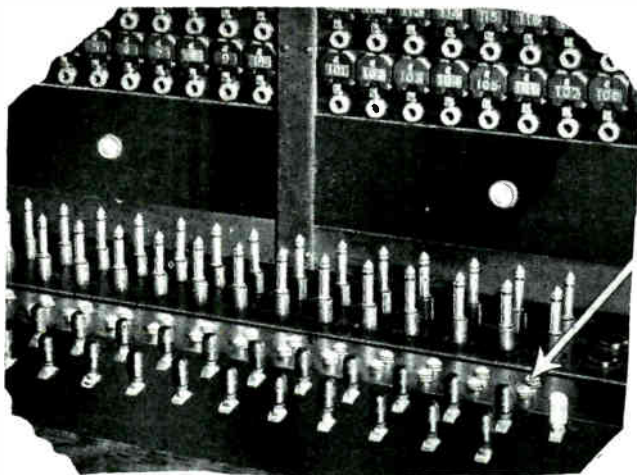

Fig. 137. This photo shows very clearly the arrangement of the operator's key switch, plugs, and jacks.

106. PLUGS

Fig. 140 shows a cord plug. These plugs can be made with two, three, or more separate metal elements for as many separate circuits through them. The plug tip at the extreme right end is part of a small metal rod which runs through the center of the plug to the left end, where the wires are attached. Around this is placed a tube of insulating material. Then another slightly larger, but shorter, metal sleeve is fitted over this. Still another tube of insulation, and a third metal element are often fitted over the first ones, and then an outer shell of insulation over the whole.

105. SWITCHBOARD LAMPS

Fig. 139 shows a special type of lamp used for switchboard signals, and also two of the glass caps or "bull's-eyes" that are used over the ends of the lamps.

These lamps are made very small in order to get them in the small spaces on the boards. The actual size is only about one-fourth that of the photo in this figure. The bulb is held in the two metal clips shown on the top and bottom, and these are separated at the base by a piece of hard insulation. The lamps are pushed into their sockets endwise, and these metal strips make the contacts to

The several separate metal elements and ends of the black insulating sleeves can be seen in Fig. 140, which is an actual size view.

When these lamps are inserted in the jacks, the various jack springs make contact separately with each of the plug elements and circuits.

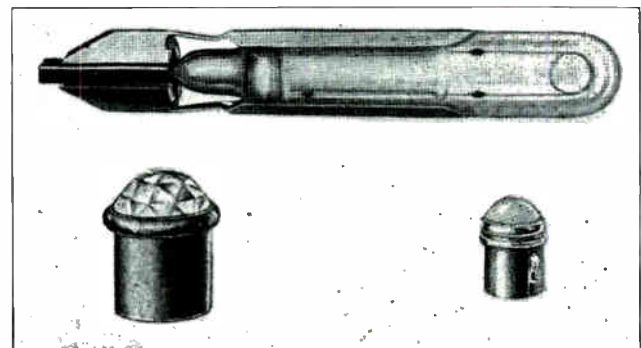

Fig. 139. The upper view shows one of the special telephone switchboard lamps, and below are shown two types of glass caps, or bull's-eyes used with such lamps.

107. JACKS AND DROPS

A complete jack, with the drop and drop magnet mounted above it, is shown in Fig. 141. This view clearly shows the jack thimble, contact springs, wire terminals, drop magnet, armature, and shutter. Examine the photo and printed description very carefully.



Fig. 140. Full-sized view of a switchboard plug showing how the several circuits are obtained through its tip and insulated sleeves.

Note that the armature to operate the drop is at the left end of the drop magnet, hinged at the top, and attached to a long lever arm which runs over the top of the magnet to the drop latch at the right end. This construction enables a very small movement of the armature to give a greater movement at the drop latch.

The plug would be inserted from the right in the thimble at the lower right-hand corner; and as it goes in, its tip and sleeve elements make contact with the spring shown. It forces some of the springs apart, opening certain circuits, and closes others from the springs to the cord wires.

Fig. 142 shows two diagrams of jack and drop circuits from opposite sides, one without the plug and one with the plug in.

In the upper diagram you will note that springs 3 and 4 are making contact, also springs 5 and 6. Springs 5 and 6 close a circuit from the line through the drop magnet.

spring 5 and thimble 7, thus making a circuit from the line to the cord wires.

108. SIMPLE SWITCHBOARD CONNECTIONS

A sectional view of part of a switchboard is shown in Fig 143. This shows the line connection to a simple jack and drop of the separated type; and also the plug, cord, and switch connections.

When an impulse comes in on the line, the drop magnet releases the shutter, the operator inserts one plug and closes her key to listening position. After receiving the number she inserts the other plug in the jack of the called line (not shown) and pushes key to ringing position, sending current from the board magneto to ring the called party. When this party answers, the talking current from the two lines flows through the jacks, plugs, cords, and key switch. When the conversation is finished, the plugs are pulled and dropped to their present positions in the diagram, the drop reset, and the key restored to normal position.

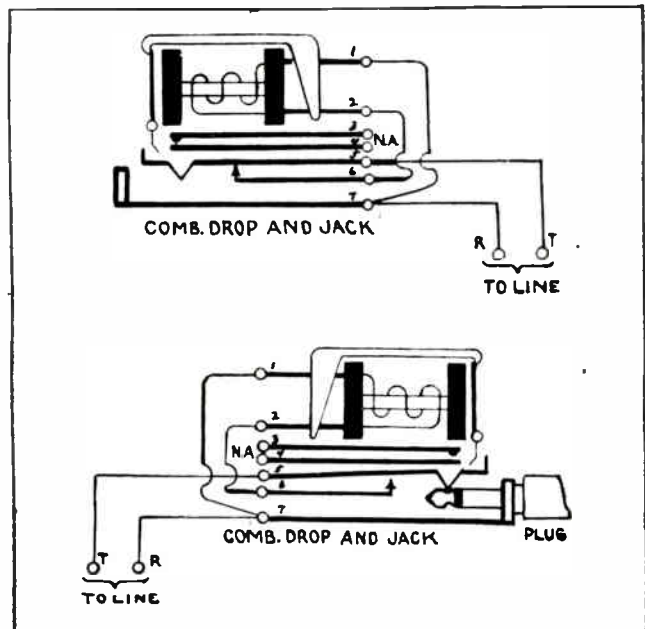

Fig. 142. The upper sketch shows the electrical connections and position of contact springs without the plug inserted. Below are shown the electrical circuit and position of springs with the plug in the jack.

Fig. 144 shows a switchboard with some of the cords in place in the jacks for conversations between various lines.

Many large switchboards use only the signal-lamps to indicate an incoming call, and do not use the magnetic drops.

Fig. 145 shows two views of the inside and back of a manual switchboard. In the left view you can see the drop magnets in the upper section, a group of relays in the center, and the induction coils and part of the terminals below. At the extreme right of this view are shown the wires grouped or cabled along the side of the cabinet.

In the right-hand view the relay panel or "gate" is opened, showing the jacks and cords,

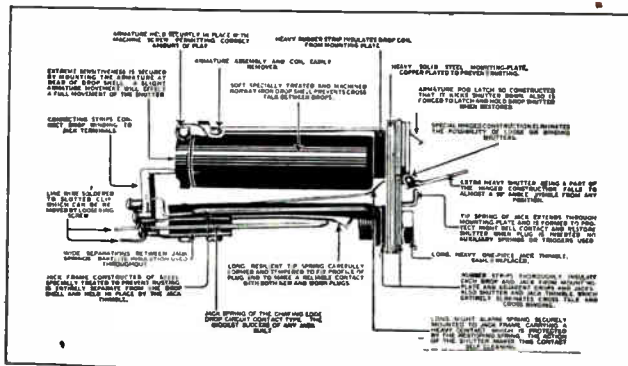

Fig. 141. This descriptive diagram shows the parts of a telephone jack and drop complete. Examine each part and its description very carefully.

In the lower view, showing the plug inserted, we find that springs 5 and 6 have been opened, breaking the circuit through the drop magnet, as it is not needed while the plug is in. Springs 3 and 4 are also opened. This is done by an insulating piece which is not shown here, but fastens 5 and 3 together mechanically, so the upward movement of 5 also forces 3 up. Springs 3 and 4 are not shown connected to any circuit in this illustration.

Referring again to the lower view, we find that the plug has a circuit to its tip and sleeve from

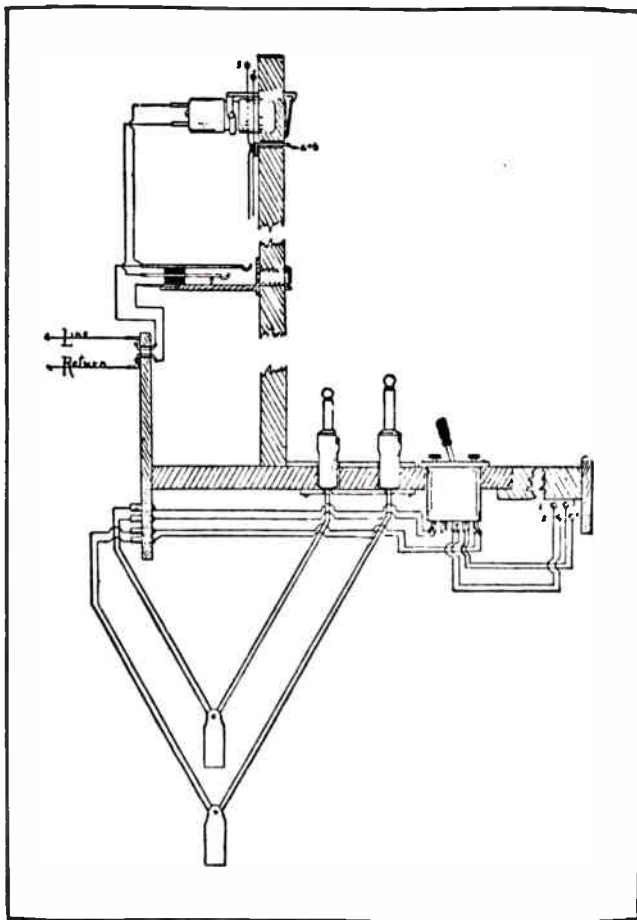

Fig. 143. This simple sketch shows the general operating principle of a manual switchboard.

Fig. 146 shows a small desk type switchboard for mounting on a table or desk in private offices, where an operator is to be able to call various people in the building.

Telephone wiring requires men who are expert in reading plans and making careful and accurate connections of the thousands of wires and devices used in the switchboards.

### 109. TELEPHONE RELAYS

The top photo in Fig. 147 shows a telephone relay. Its armature is at the right-hand end of the magnet, and is bent and hinged to the corner of the magnet frame. When the magnet attracts the lower end of the armature to the left, its upper horizontal portion moves upward at its left end, pushing the center contact springs upward. This causes them to break circuits with the lower contacts and make circuits with the upper ones. So you see that while these relays are constructed differently and are much smaller and more compact than the pony relays used in alarm and telegraph systems, still their operation and principles are much the same.

### 110. CABLES AND TERMINALS

The center photo in Fig. 147 shows a piece of lead-covered telephone cable with many paper-

covered wires inside it, and covering of extra insulation between them and the lead sheath. Cables of this kind are very necessary to carry the vast numbers of wires in telephone systems.

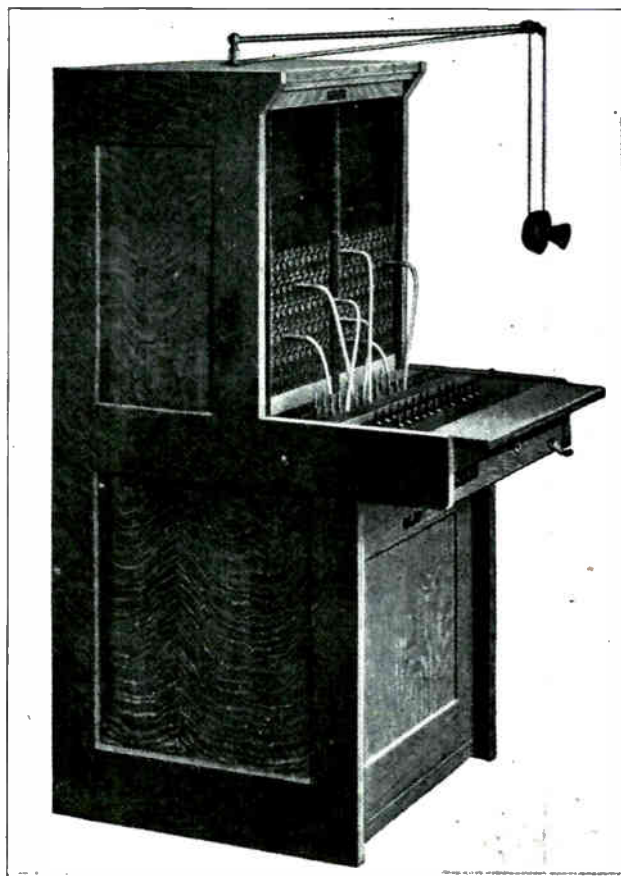

Fig. 144. Side view of a magneto type switchboard with some of the plugs in place in the various line jacks.

The lower view in the same figure shows a terminal block to which a number of wires can be neatly and conveniently connected. The wires from a cable can be soldered to the lower ends of the terminal strips, and the switchboard wires connected to the other ends by means of the small screws shown.

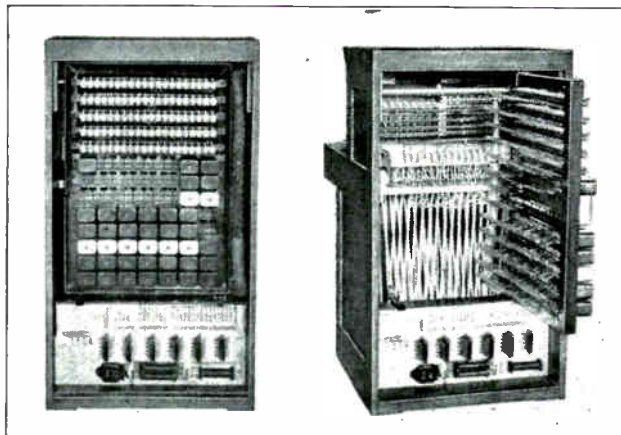

Fig. 145. These two views of the rear of a switchboard show the relays, drops, and cords very clearly. Note the neat and compact arrangement of all parts and wires.

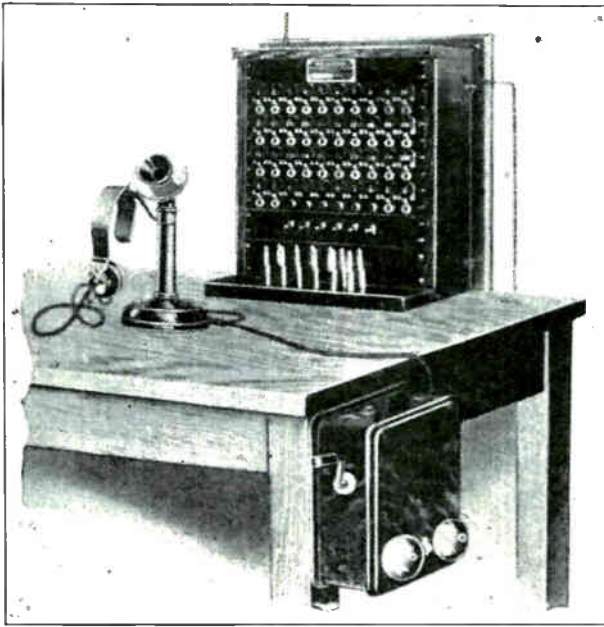

Fig. 146. Small desk type telephone exchange.

These terminal blocks greatly simplify the wiring and testing of telephone and switchboard circuits.

In wiring telephone switchboards, ground connections are also used to simplify much of the wiring. Metal strips and plates are used for common ground connections to the battery negative terminal. This eliminates a number of unnecessary wires.

Some exchanges also use a ground connection to earth for ringing their subscribers.

Fig. 147-D is a complete wiring diagram of a simple manual exchange showing just two subscribers' phones connected through the exchange. The different circuits are marked with different kinds of arrows and symbols.

Trace out carefully, one at a time, the transmitter and receiver circuits of the calling subscriber's

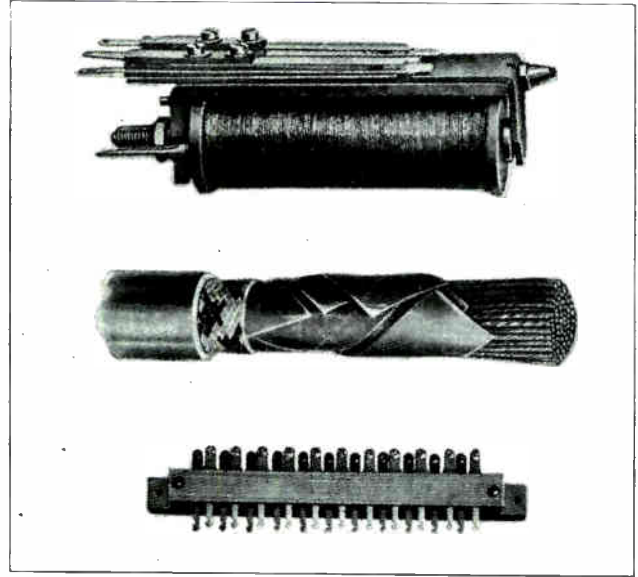

Fig. 147. The upper view shows a telephone relay. In the center is shown a section of telephone cable. Below is a group of terminal springs in a terminal block.

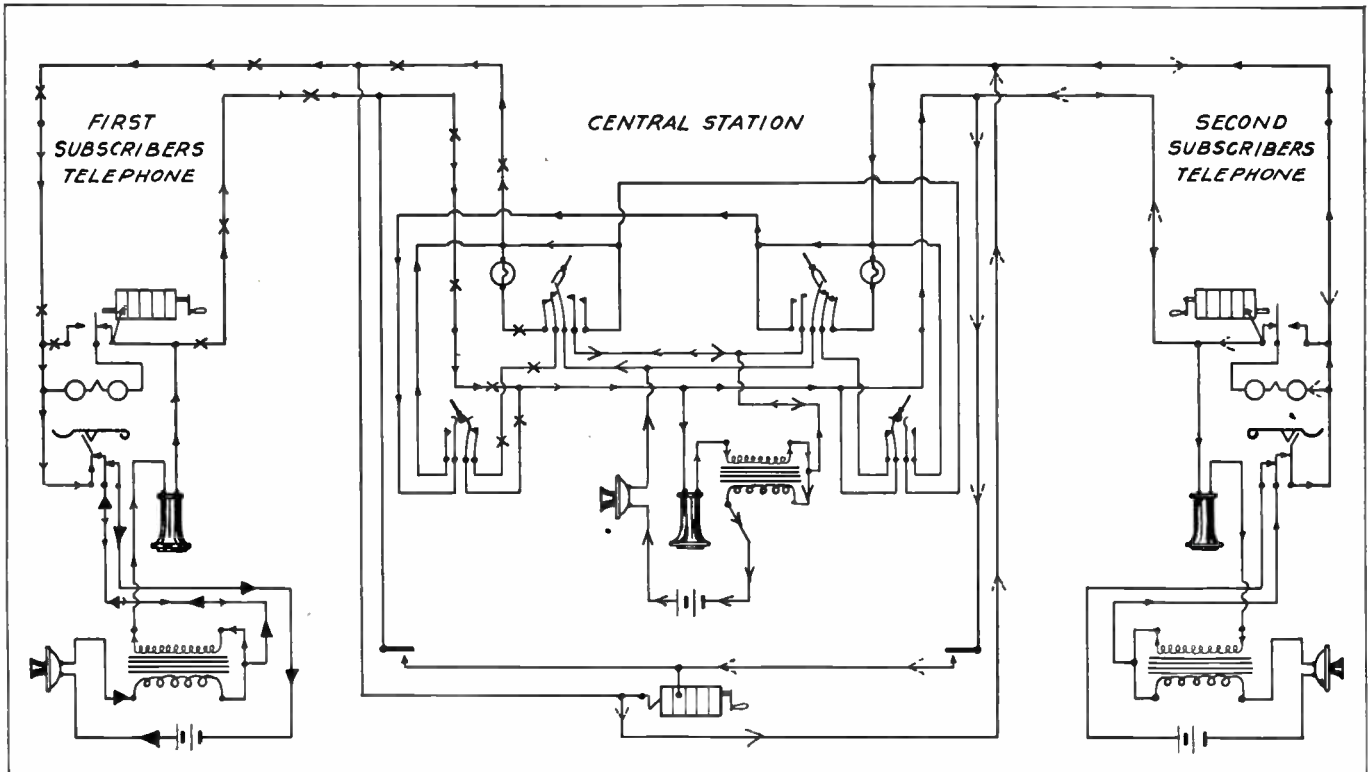

Fig. 147-D. Complete diagram of a simple telephone exchange with two subscribers' telephones connected. This will enable you to trace the talking and ringing circuits which are marked with different forms of arrows and symbols. Carefully tracing this diagram will help you to understand telephone exchange principles more fully.



'phone at the left, and through the exchange to the called subscriber's 'phone at the right. Also trace the operator's magneto and calling circuit to the called 'phone; and the operator's talking circuit. Note the positions the various keys must be in to get the different circuits closed, and in order to trace some of the circuits it will be necessary for you to imagine certain switches are closed to the opposite positions.

There are many other types of exchange circuits, and this simple one shown here is more typical of an army field telephone exchange, but is chosen because of its simplicity and just to give you a good idea of their general nature.

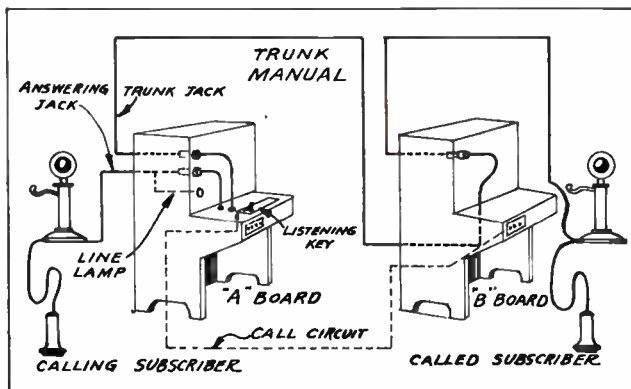

Fig. 147-E. Simple "one-line" diagram showing a telephone circuit through two exchanges and a trunk line.

Fig. 147-E is a simplified diagram showing how a call from one subscriber is routed through his local exchange over a trunk line to the distant exchange, and from there to the called subscriber.

This sketch is what is known as a one-line diagram, using only one line to trace the pairs of line wires actually used.

Fig. 147-F shows a photo of a large manual exchange switchboard in operation, and Fig. 147-G

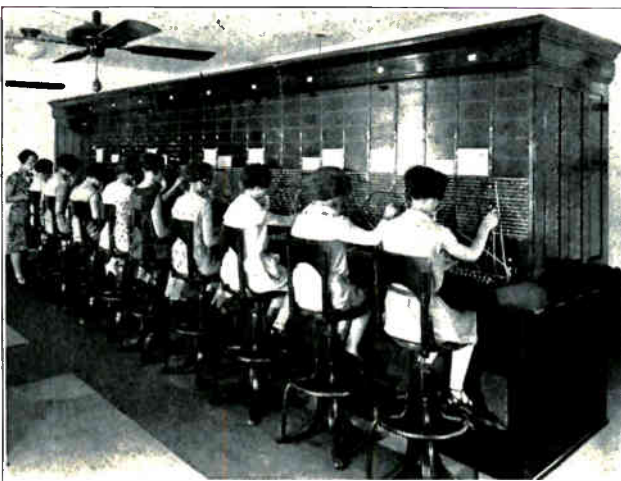

Fig. 147-F. This photograph shows a section of a large manual telephone exchange. Each operator controls a section of the board with its respective plugs and jacks.

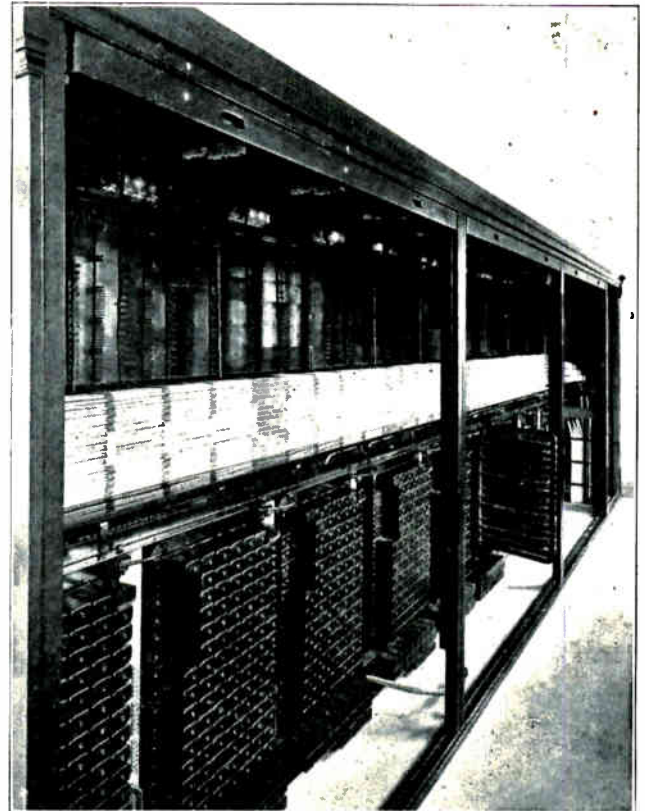

Fig. 147-G. Rear view of a central exchange switchboard of the type shown in Fig. 147-F. Note the very neat and compact manner in which all parts and wires are arranged to simplify connections and testing of such exchange units.

shows the rear of such board. Note the very neat and systematic arrangement of all parts and wires, which greatly simplifies the wiring and testing of such switchboards.

In apartment houses and offices, small telephone installations called inter-communicating systems are often used.

Any party of the group can call any other party by means of proper push buttons. There are separate push buttons and call circuits for each 'phone.

These systems are very useful and practical where the lines are not long and where the system is not large enough to pay to keep an operator.

Fig. 147-H shows the wiring diagram for three such 'phones. Trace out the talking and ringing circuits, and the operation of the system will be clearly understood. A, B, and C are groups of push buttons for calling the different 'phones. The numbers on each button contact indicate which 'phone it will call.

Fig. 147-I shows a photo diagram of five different styles of 'phones which can be obtained for such inter-communicating service.

Fig. 147-J shows two types of inter-communicating 'phones, one with the push buttons on a desk block, and the other having them on its base.

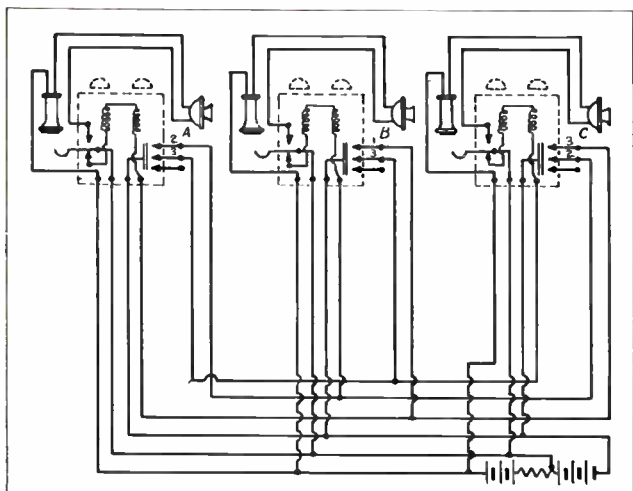

Fig. 147-H. Wiring diagram of three telephones on an inter-communicating system.

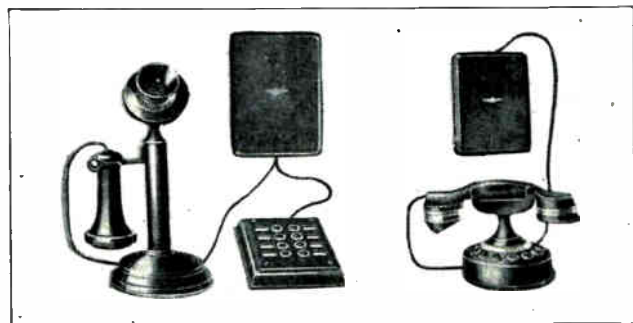

Fig. 147-J. Two types of inter-communicating telephones. The one on the right has the call buttons on the base of its stand.

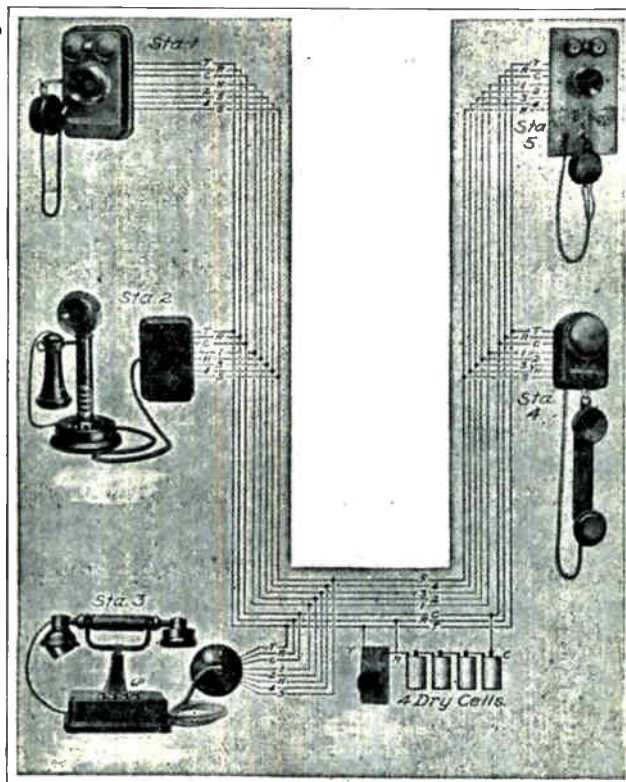

Fig. 147-I. Photo diagram of several types of inter-communicating telephones, showing their connections and batteries, and ringing and talking wires. Such telephone systems are commonly used to communicate with various offices in one building. No exchange or operator is needed, as each party is called by one of a number of push buttons.

Norman Beder  
41 Georgia Ave.  
Brooklyn 7, N. Y.

## AUTOMATIC TELEPHONES

Automatic exchanges do all switching, ringing, and signalling by means of electrical and mechanical devices. This not only saves the cost of labor of numerous operators, but accomplishes faster and more accurate operation. It provides much more complete privacy for telephone conversations, and, because it is purely electrical and mechanical, the possibility of human error is largely eliminated.

The automatic telephone exchange is undoubtedly one of the greatest triumphs of telephone engineering, and they are rapidly replacing many of the largest manual exchanges in this country.

There are several different types of automatic telephone equipment, and most of them are still undergoing rapid changes in the processes of development and perfection. One of the most successful systems is called the "Strowger System", after the man who developed it.

Complete automatic exchange circuits require a great deal more time and study than most students would care to spend on the subject, unless they were preparing to specialize in this work. The fundamental principles of this equipment, however, can be quite simply explained.

The following paragraphs are intended to give you a general understanding of automatic telephones.

### 110. SIMPLE OPERATING PRINCIPLE

The Strowger System uses what is known as the "step by step" equipment. When the subscriber wishes to call a certain party, he dials the desired number with the dial on his own telephone. This dial in its rotation sends a number of impulses to magnets and relays at the exchange, causing them to move a selector element which picks out the desired line. Other parts of the mechanism then test the line to determine whether it is busy or not, and if it is clear an automatic switch starts ringing the called party.

### 111. DIALS, CONSTRUCTION, AND OPERATION.

The principle difference between a subscriber's phone to be used on an automatic exchange and those for manual systems is the dial. The transmitter, receiver, and other parts remaining fundamentally the same.

Fig. 148 shows an ordinary desk telephone, equipped with a dial for automatic operation. You will note that this dial has ten holes or finger openings, around the outer edge of the rotating part.

When this finger plate rests in the normal position, there is a number on a white stationary disk directly under each of these openings. Starting at the one on the right hand side, and reading counter-clockwise, these numbers are 1, 2, 3, 4, 5, 6, 7, 8, 9 and 0.

When the subscriber wishes to dial or call party No. 246, he places his finger in the opening over No. 2, and pulls the dial around to the right until his finger strikes the Stop Hook shown at the bottom of the dial, and then releases it. He then places his finger in the opening over No. 4, and again pulls the dial around to the right until his finger is stopped by the hook. Once more the dial is released, and allowed to return to normal position. Then No. 6 is dialed in the same manner.

Each time the dial is rotated clockwise it catches and winds a helical spring inside the case, and a pawl secured to the rotating plate slides over the teeth of the ratchet on a combined ratchet and gear wheel. When the finger plate is released the spring causes it to return to normal position, and the pawl in this backward movement engages the ratchet and gear wheel, turning them back with it at a definite speed, a certain exact distance for each number dialed.



Fig. 148. Desk telephone equipped with dial for use on automatic exchange systems.

112. IMPULSE SPRINGS.

The rotation of this main gear drives a smaller gear or pinion at higher speed, and this pinion rotates an Impulse Cam, which rapidly opens and closes a set of contacts or Impulse Springs. By means of a worm wheel the pinion also rotates a small speed governor, which causes the gear and dial to turn at a definite speed. This, of course, is necessary to make the impulse springs open and close at regular intervals.

Fig. 149 is a sketch showing the various parts we have just mentioned. Examine this sketch closely, and observe how the main gear drives the pinion, impulse cam, and governor. In the lower right hand corner of the sketch another view of the cam and impulse springs is shown. The arrows indicate their position with respect to the other parts. This view of the governor shows quite clearly how it operates.

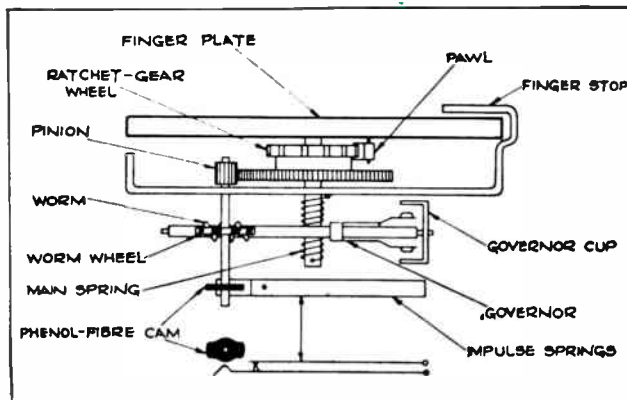

Fig. 150. Another view showing some parts of the dial mechanism more clearly.

the dial returns to normal. In addition to cutting out the resistance of the other telephone parts, these springs also prevent the clicking that would otherwise occur in the receiver during the operation of the dial.

The impulse cam revolves one-half revolution for each movement of one number on the dial, and as the cam has two projections it opens the impulse springs twice in each revolution. Thus, when we dial the number 8, the cam makes four revolutions, and opens the spring contacts eight times. The dial is so set with a certain distance from the number 1 to the finger hook, that an extra one-half revolution is made each time any number is dialed. This will be explained later.

Fig. 152 shows a better view of the top of the dial, and its numbers.

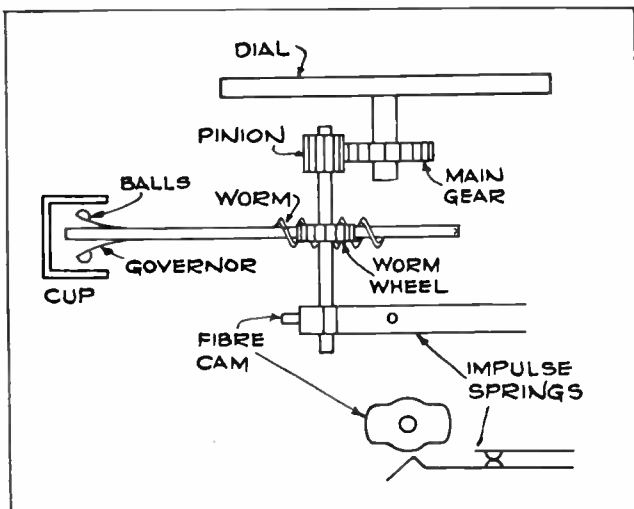

Fig. 149. This sketch shows the mechanism and operating principles of the dial and impulse springs.

If the governor shaft attempts to rotate too fast the small governor balls fly outward on their springs, due to centrifugal force, and rub the inside of the cup, thus retarding the speed of the mechanism.

Fig. 150 shows another view of this same mechanism, in which some parts can be seen a little more clearly than in Fig. 149.

Fig. 151 shows a photo of the complete dial mechanism. In this view you can get an excellent idea of the arrangement of the parts. In addition to the impulse springs at the left of the cam, you will also note an extra set of spring contacts called "Shunt Springs". These are used to temporarily short circuit the other parts of the telephone, during ringing operation. This is necessary because it would be difficult to send the ringing impulses through the resistance of these other parts.

These springs are operated by a small additional cam as soon as the dial is turned from the "off-normal" position. But they are opened as soon as

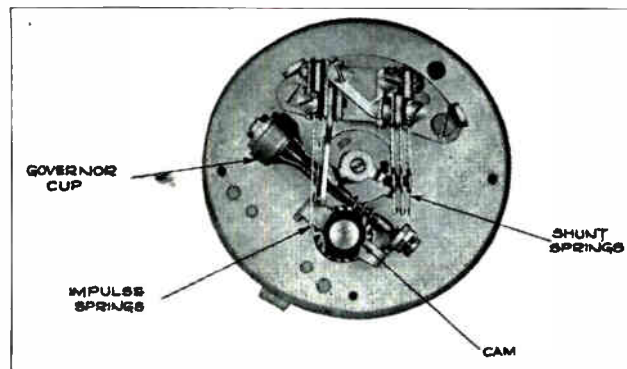

Fig. 151. This photograph shows an excellent view of the impulse springs and cam, shunt springs, and governor of a dial.

113. LINE BANKS AND "WIPER" CONTACTS.

The various groups of impulses, sent into the exchange by dialing different numbers, cause certain relays to energize as each impulse passes through them. These relays and magnets, as before stated, perform the switching and ringing operations.

In order to enable you to understand this equipment and these circuits more easily, let us first

examine the arrangement of the various line terminals at the exchange.

For an exchange to handle 100 lines, the terminals of the lines would be arranged in a Bank of Connectors as shown in Fig. 153.



Fig. 152. Front view of dial, showing finger plate, holes, numbers and finger stop.

In order to eliminate unnecessary wires and simplify this figure only two telephones, Nos. 14 and 33, are shown connected to the bank at present. At first glance the arrangement of the line numbers in this connector bank may seem peculiar, but suppose some automatic device was to move the Wipers of the calling telephone step by step, up into this bank and select a certain line, say No. 14.

One step upward would bring the wipers in line with the lower row of connectors. Then four steps to the right would bring them in contact with No. 14. Dialing the numbers 1 and 4 would have accomplished this.

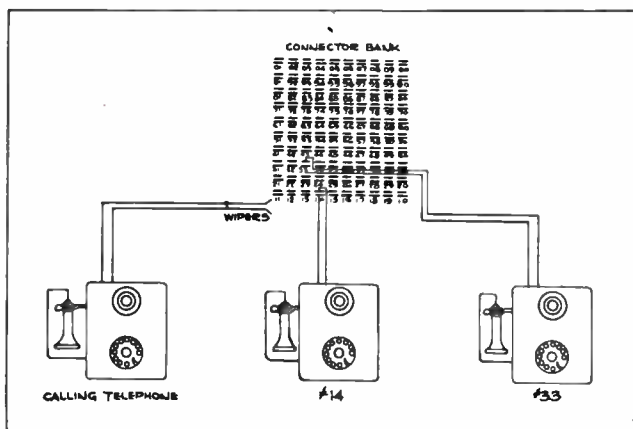

Fig. 153. Simple sketch showing the arrangement and principle of the connector bank of an automatic exchange.

Then suppose we dial the number 33. The first three impulses sent in by the dial would cause the switching magnet to lift the wiper three steps, bringing it in line with the third row of contacts

from the bottom. The next three impulses received would cause the wipers to make three steps to the right, and engage line No. 33.

So we find that these numbers are arranged as they are, for convenience and simplicity in the operation of the mechanical selector.

This figure gives us some idea of the arrangement of the various lines and the connector bank at the exchange.

#### 114. WIPER SHAFT AND SELECTOR MECHANISM.

Fig. 154 shows a sketch of the wipers attached to the shaft which raises and rotates them step by step. It also shows the Vertical Magnets—V. M., and the Rotary Magnets—R. M., which lift and rotate the shaft step by step.

By means of a special relay in the exchange circuit the first impulses which are sent in by the dial come to the lifting magnets, and the next group of impulses are switched to the rotary magnets.

Fig. 155 shows photos of both sides of one of these selector units.

Figs. 154 and 155 should be referred to while tracing out the circuit diagram in 156.

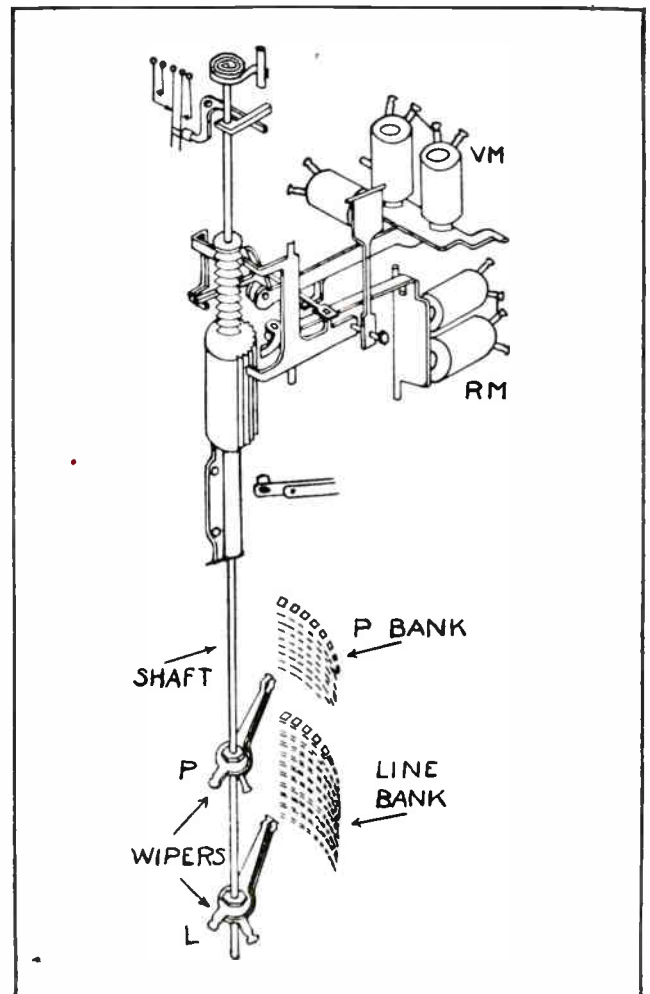

Fig. 154. This diagram shows the arrangement of the selector mechanism with its vertical magnets, rotary magnets, wipers, and wiper shaft.

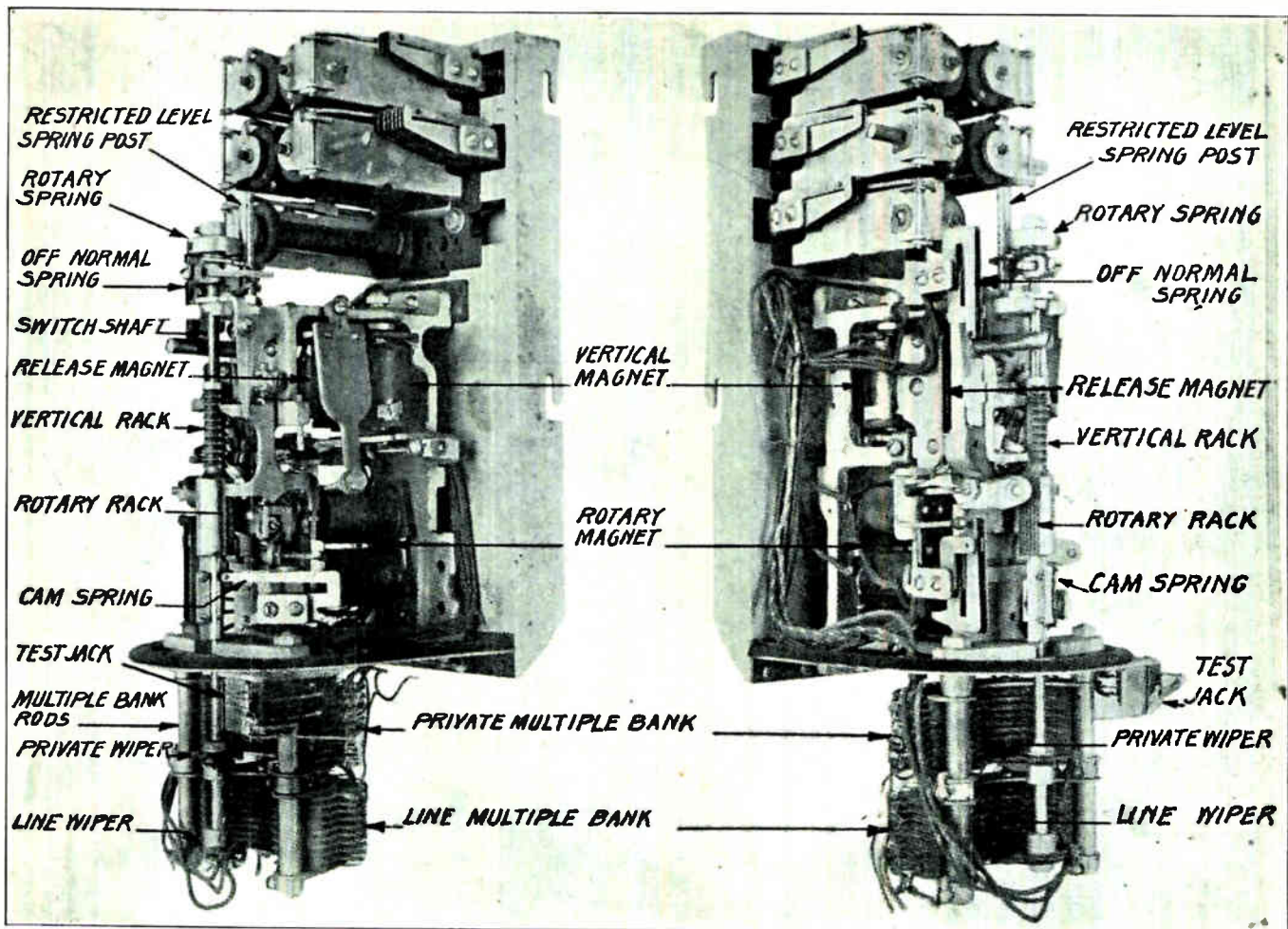

Fig. 155. Two photographs showing front and opposite sides of a complete selector unit. Note the relays above; vertical and rotary magnets, wiper shaft and rack in the center; and the connector banks below.

At the top of each unit in Fig. 155 are the relays which perform different switching operations in the exchange circuit. Underneath these are the vertical magnets or lifting magnets, and below are the rotary magnets.

On the shaft are two sets of notches called the Vertical Rack and Rotary Rack respectively. These are engaged by the hooks which are operated by the lifting and rotary magnets.

After the selector has completed a connection to a certain line, and the conversation is finished, then, when the subscriber hangs up his receiver, it closes a circuit to the Release Magnet, which trips the locking mechanism, allowing the wipers and shaft to return to normal position by the action of a spring and gravity.

#### 115. SIMPLIFIED CIRCUIT OF IMPORTANT PARTS.

In Fig. 156 is shown quite a complete diagram of the more important circuits of the automatic exchange.

It is not at all necessary for every student to trace and understand this diagram at present, but it provides excellent circuit tracing practice, and

if you are sufficiently interested in the principles of automatic telephones, or should later decide to prepare to specialize in this field, this simplified circuit should be of great help to you in obtaining an understanding of the most important parts.

In order to trace a circuit of this kind, it is necessary to do it step by step, and very carefully. If this method is followed, it will be found very interesting, and not nearly as difficult as it first appears.

This diagram shows a complete connection between a calling telephone, the automatic exchange, and the called telephone. Each circuit is traced with different types of arrows to make them easier to follow.

The equipment in the calling phone consists of an ordinary transmitter, receiver, bell, condenser, and switch hook; and in addition to these, the impulse springs, and shunt springs used with the dial telephone.

As soon as the receiver is lifted from the hook, the hook switch will close the circuit, shown by the small solid arrows, from the positive terminal of battery No. 2, through the top winding of relay "1". Then through the shunt switch, impulse

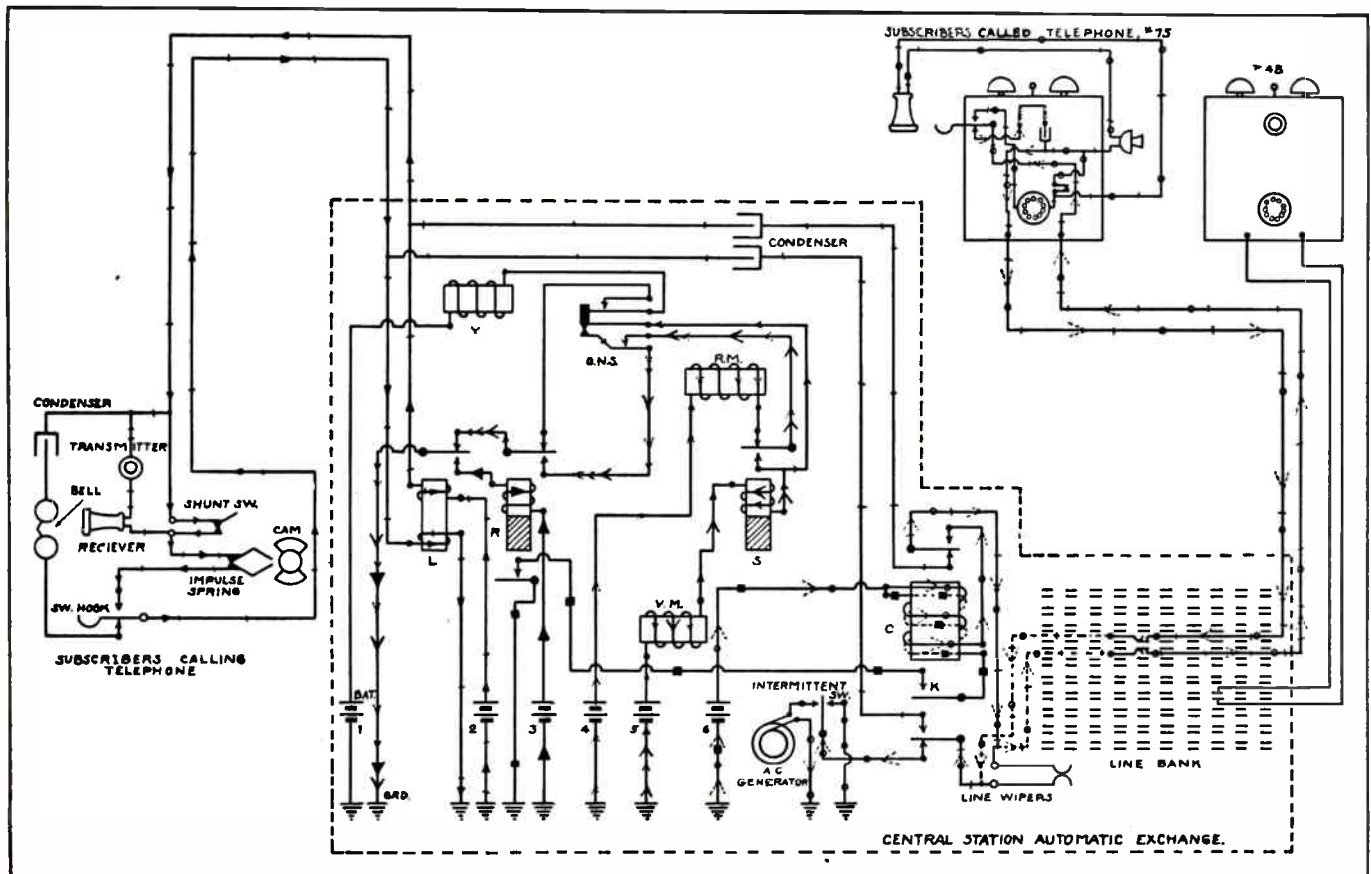

Fig. 156. Complete simplified diagram showing the wiring and operating principle of the fundamental parts of an automatic telephone exchange. Trace this circuit very carefully with the complete instructions given in these pages.

springs, and top contact of the hook switch at caller's phone, back through the lower winding of relay "L", and to ground.

You will note that the ground connections in this circuit are returned to negative of the batteries, so when starting to trace a circuit from any battery, as soon as this circuit is completed back to ground, you will know it has returned to negative of the battery.

To simplify this circuit a number of separate batteries are shown.

These current impulses in the circuit we have just traced, will cause relay "L" to become energized and attract its armature. When this armature is pulled down it closes a circuit shown by the large solid arrows from the positive of battery No. 3, through the coil of relay "R", "make" contact of relay "L", and to ground, which completes this circuit.

The term "make contact" is used here, meaning the contacts made when the relay is energized and the armature attracted. The term "break contact" when used, means the contacts that are closed when the relay is de-energized. In other words, the contacts made when the armature is attracted are referred to as "make contacts". Those made when the armature is released are called "break contacts".

When the circuit just traced through relay "R" is completed this relay becomes energized and at-

tracts its armature. So we find that both relays "L" and "R" became energized merely by the subscriber removing his receiver from the hook.

Now, assume that he dials the figure 1. When the dial is released, and as it returns to normal, the cam is rotated one-half turn, and opens the impulse spring once. This momentarily opens the circuit of the line relay "L", which is de-energized for an instant, and its contacts open the circuit of release relay "R".

However, relay "R" remains energized through this short period even though its circuit was momentarily opened. This is because it is a **Slow Acting** relay, and does not release its armature the instant the current is interrupted, but holds it for about a second afterward. This will be explained later.

If the calling subscriber now dials the number 7, opening the impulse springs seven times, the circuit of relay "L" will be broken each time, and allow its armature to release momentarily seven times. Each time it releases, the circuit of relay "R" is broken for an instant, but relay "R" acts too slowly to de-energize and release its armature during these periods, so it remains closed throughout the seven short interruptions of its circuit. But something else did happen.

Keeping in mind that the armature of relay "R" is now attracted to the "make contact", we find

that the first time the armature of relay "L" was released it closed a circuit shown by the small open arrows from the positive of battery No. 5 through the vertical magnet, V.M., through relay "S", "break contact" of O.N.S., "make contact" of relay "R", "break contact" of relay "L", and to ground.

The letters "O. N. S." stand for **Off Normal Switch**, which will be explained later.

This circuit we have just traced energizes both the vertical magnet and relay "S". Relay "S", being another slow acting relay, will retain its armature in an attracted position during current interruptions of a fraction of a second.

The second time the armature of relay "L" was released it allowed current to flow, as shown by the large open arrows, from positive of battery No. 5 through vertical magnet and relay "S" again, then through the "make contact" of relay "S," "make contact" of the off normal switch, "make contact" of Relay "R," "break contact" of relay "L," and to ground.

The off normal switch is operated by the line wiper shaft as soon as it moves from off normal position. So as soon as the dialing operation is started, the first movement of this shaft closes certain contacts and circuits, but when the shaft is dropped and allowed to fall back to normal, it again opens these circuits.

Shortly after the last impulse of current has passed through the relay "S" it will de-energize and cannot again become energized, because the circuit has been opened at the off normal springs. Each of the seven impulses passing through the vertical magnet causes it to raise the wiper shaft one step, so the line wiper will now rest in line with the seventh row of line bank contacts.

Now we are ready for the subscriber to dial the second number. Let's assume that he dials No. 5. This again rapidly opens the line circuit five times, causing the line relay "L" to release momentarily the same number of times. Each time relay "L" is de-energized, now since the off normal switch is opened, a circuit can be traced as shown by the small dotted arrows from the positive of battery No. 4, through the rotary magnet R. M., break springs of relay "S," "make contact" of off normal springs, "make contact" of relay "R," "break contact" of relay "L," and to ground.

These impulses in this circuit will cause the rotary magnet to become energized each time and rotate the wiper shaft, carrying the wipers five steps to the right. This brings them in contact with No. 75 of the line bank, as indicated in the diagram.

The dotted lines from the normal position of the line wipers show the upward movement of the shaft caused by the vertical magnet, and the rotating movement to the right caused by the rotary magnet; and they show the circuit which will now be completed to the called subscriber's telephone.

As soon as the line wipers are in contact with No. 75 in the bank a circuit is completed through the bell of the called telephone. This circuit can be traced (backwards) by the large dotted arrows from the top brush of the generator, through **Intermittent Ringing Switch**, "break contacts" of relay "C", lower switch spring and lower contact No. 75 on the bank, "make contact" of hook switch, bell and condenser, then back to the upper contact in the bank and upper wiper spring, on through the top "break contact" of relay "C", low resistance winding of relay "C", through battery No. 6, to ground.

This is a long circuit to trace and should be gone over again until you have it well in mind.

You will note that relay "C" has two windings, one of low resistance and the other a high resistance coil of many more turns. The low resistance coil is to receive a heavy current impulse to first attract the relay armature, then the high resistance locking coil will hold the armature attracted with less current.

The current from the generator is A. C. and will not energize the coil of relay "C." The intermittent switch at the generator keeps making and breaking the circuit at regular intervals, so the called subscriber's bell rings for short, repeated periods and not continuously.

This flow of alternating current through battery No. 6 to ground does no particular harm to the battery. We will remember from an earlier article that the alternating current will pass through the condenser at the bell, but this same condenser will not allow direct current to pass. As soon as the called subscriber lifts his receiver off the hook a flow of direct current from battery No. 6, and traced by the round dots, passes over the same circuit we have just traced to the bell, except that the bell is now cut out by the hook switch, and the transmitter is placed across the line.

Trace this carefully by following the round dots. This flow of direct current will now energize the low resistance winding of relay "C," closing contact "K," which acts quickly before any of the other contacts of this relay can move, thus closing a lock circuit in which current flows from the positive of battery No. 6 through the high resistance winding of "C," lower "make contact" of relay "C," "make contact" of relay "R," and to ground. This circuit is traced by the square dots.

With relay "C" fully operated, the talking circuit is now complete through both telephones. This circuit can be traced by the short dashes across the line.

Now, when the calling subscriber hangs up his receiver and breaks the circuit through the line relay "L," it in turn releases and breaks the circuit through relay "R," which, after an instant of delay because of its slow action, releases its upper armature and makes the circuit from battery No. 1 through the release magnet "Y," "make contact"



of off normal spring, "break contact" of relay "R," "break contact" of relay "L," and to ground.

This circuit will energize the release magnet "Y," which trips the wiper shaft, allowing it to fall back to normal position. This action interrupts the circuit of release magnet "Y," because the dropping of the wiper shaft opens the "make contact" of the off normal spring.

When relay "R" was de-energized it also opened the high resistance locking circuit of relay "C," allowing its contact to move back to normal position.

Telephone No. 48 merely shows where another telephone of this number would be connected in the back. It is not expected that you will perfectly understand all of this diagram the first time you trace it through, as it is rather complicated and one which requires some time to absorb. But if you are interested enough in this branch of work to trace each step of the operation through this circuit several times it will not only be excellent practice, but will give you a good understanding of the fundamental principle and more important parts of this type of automatic telephone.

There are a number of other auxiliary relays and contacts used with this equipment in larger exchanges where it is necessary to have a number of line banks from which to select.

There is also an added mechanism which automatically tests out any line before completing the calling circuit. If that particular line is busy at that instant, this relay will close a circuit which gives an intermittent buzzing note to the calling subscriber, indicating that the line he desires is busy.

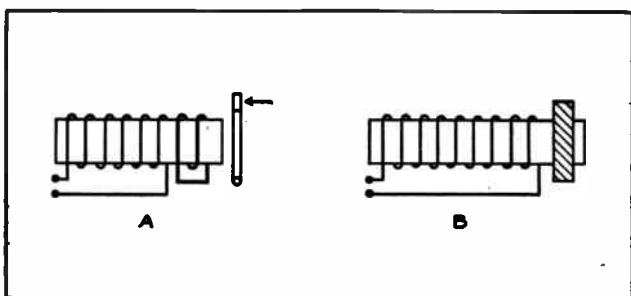

Fig. 157. Two types of slow acting relays. The one on the left has a short-circuited coil of a few turns, and the one on the right has a large copper ring around the end of the core.

### 116. SLOW ACTING RELAYS

The slow acting relays used with these automatic telephones are very interesting devices. In addition to the regular winding on the core there is also a heavy ring of solid copper placed around the core end. Or, in some cases, just a short-circuited winding of a few turns. This copper sleeve, as it is called, acts as a single turn secondary winding.

When the current is interrupted in the main coil of the relay its collapsing flux induces a rather heavy current in this copper ring. The extremely

low resistance of this ring circuit allows the current flow to continue with infinitely small voltage, and as long as there is any flux left from the decreasing current, both in the main coil and in the ring itself.

This persisting flow of current in the ring develops enough magnetism in the core to cause it to retain its armature a little longer. Thus we get the terms "slow acting" relay.

By changing the size of these copper rings, or the number of turns when a shorted coil is used, we can vary the amount of time the relay will delay its action from a very small fraction of a second to one or more seconds.

Fig. 157 shows two sketches of relays of this type. The one at "A" uses a short-circuited coil. The one at "B" uses a copper ring.

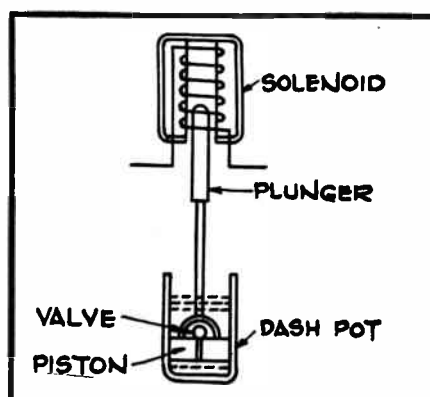

Fig. 158. This sketch shows the use of a dash-pot to slow the action of solenoids and electro-magnets.

Some relays have what is called a "dash-pot" attached to their armature to slow its action. These dash-pots may consist of a plunger in a cylinder filled with oil or air which only allows the plunger to move rather slowly as the oil or air escapes past the edges or through the small opening in the plunger.

Fig. 158 shows a relay equipped with such a dash-pot.

Various selective circuits can be arranged in automatic telephone systems by the use of condensers and choke coils of different sizes.

A condenser placed in the circuit of certain relays will only allow alternating current to pass through and stops all flow of direct current. A choke coil, however, will allow direct current to pass rather freely, but quite effectively blocks the flow of alternating current.

Many of the telephones being installed nowadays for use with manual exchanges are also equipped with a place to mount the dial, because in many localities it is expected that the automatic exchange will replace the manual in a short time.

Fig. 159 shows a very convenient, modern type of desk telephone. With this telephone the receiver and transmitter are both mounted on one handle, so the subscriber doesn't have to move a trans-

mitter stand close to his mouth to carry on a conversation. This receiver and transmitter, when not in use, are laid in a "cradle" which has a small strip in the bottom that is attached to a spring in the stand. This operates a hook switch each time the receiver is removed from or replaced in the "cradle."



Fig. 159. Modern desk type telephone equipped with dial for automatic operation.

Fig. 160 shows a room in an automatic telephone exchange. At the right can be seen a long bank of selectors with white covers over their mechanisms.

Fig. 161 shows a view in another exchange with a switchboard at the left, selector banks in the rear, and a motor generator for supplying the talking and ringing current at the right.

### 117. TELEPHONE LINES

The operation of the millions of telephones in this country today requires a vast network of telephone lines. These lines can be divided into two general classes—the small individual or party lines which connect one telephone or a small group of telephones to the central exchange, and main lines, or Trunk lines, as they are called, which connect from one exchange to another.

The individual or party lines, of course, are only in use when the subscribers whose telephones are on them are talking.

The trunk lines, however, carry the main business between exchanges and large towns, and are kept busy the greater portion of the time. These trunk lines might be called the arteries of the telephone system and are fed by the smaller branch lines from each exchange.

### 118. GROUND CIRCUITS. CABLES

Some telephone lines are made up of two insulated wires for each circuit and known as metallic circuits. Other lines use one insulated wire on the poles, and the other side of the circuit is completed through earth by carefully made ground connec-

tions. Some lines which use a two-wire or metallic talking circuit use a ground circuit for ringing.

Telephone line wires are usually bare and without any insulation except the small glass insulators which support them on the poles. Under normal conditions this is sufficient insulation, because they do not operate at high voltages. Many telephone lines use galvanized steel wire and some use copper wires. Most all of us have seen trunk lines following highways or railroads from one town to another and with their dozens of wires on numerous cross arms on the poles. This type of line is being replaced in many localities by the more compact telephone cables.

The large masses of open wires on the older lines offer a great deal of wind resistance and accumulate enormous loads of sleet at certain times of the year. This has a tendency to break down poles and disable the lines, making them very costly to keep in repair. Where cables are used, one lead sheath about 2 to 3 inches in diameter may carry from 500 to 1,200 pairs of small wires. These individual wires are all insulated from each other with proper wrappings and the entire cable insulated from the lead with an additional wrapping. Such cables are very heavy and not strong enough to support their own weight between long spans. Therefore, they are usually supported by what is called a "Messenger" cable made of stranded steel wires, and to which the lead cable is attached at frequent intervals by means of hooks or wire supports.

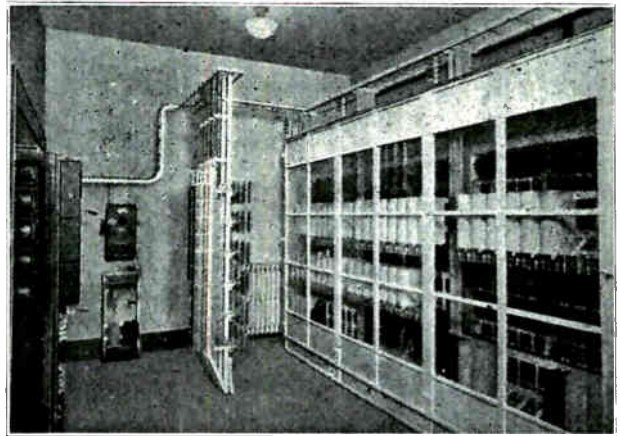

Fig. 160. This photograph shows a view of the selector units in an automatic telephone exchange.

The lead sheath protects the wires from moisture and injury, and cables of this type can be run underground in cities, as well as overhead on poles across the country. In connecting or repairing such cables the small wires are spliced separately, soldered, and carefully reinsulated with sleeves of paper or other insulation over the splice. The numerous splices are often staggered or made a few inches apart to prevent too large a bulge in the cable at the joints.

When the wires are all spliced, a large lead sleeve, which has been previously slipped over the

cable, is then slid over the splice and sealed in place with hot lead, similar to a "wiped" joint in lead piping.

The entire splice is then dried out by pouring hot parafin through it and finally filled with parafin or other insulating compound, and the small filler hole in the lead sleeve is then sealed tightly.

All moisture must be kept from the inside of such cables and splices.

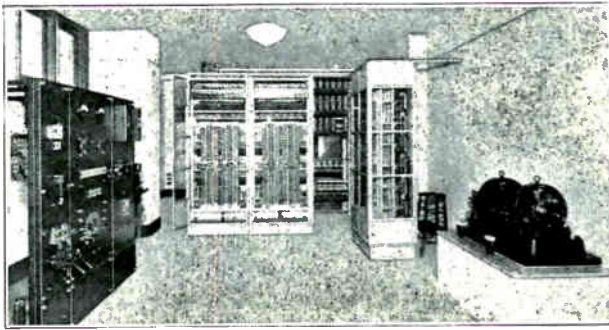

Fig. 161. Here we have another view of an automatic exchange showing the switching units in the background, power switchboard on the left, and motor generator on the right.

### 119. LIGHTNING PROTECTION AND TRANSPOSITION

Where open wire lines are used, it is customary to run lightning ground wires from the top of certain poles along the line down to an earth ground at the bottom of the pole. These wires serve as small lightning rods to drain severe static charges and lightning from the telephone line. Small lightning arresters are often used at the 'phones on rural party lines to ground any lightning charges and prevent damage to telephones and property.

Where telephone lines run parallel to power lines they often pick up, by magnetic induction, an interfering hum. To avoid this, the pairs of wires should occasionally be crossed into opposite positions on the poles or cross arms, so that one wire will not be closest to the transmission line throughout its entire length.

This crossing of wires to prevent induced interference is known as transposition. Sometimes it is also done to avoid "cross-talk" or induction from other telephone wires.

Transposing the wires frequently and evenly will balance out most of this induction. Telephone lines should never be left close enough to high voltage power lines so that there would be danger of them coming in contact with each other, for in case they did people using the telephone lines might be injured.

Satisfactory telephone operation depends to quite an extent on proper line construction. Therefore, all telephone lines should be made with the proper materials and the wires properly spliced with low resistance joints, ground connections kept in good condition, etc.

### 120. PHANTOM CIRCUITS

Considerable economy and saving of wire can be effected in telephone line construction by the use of what are known as "Phantom" circuits. By this method one additional circuit can be obtained for each pair of lines already in existence. This can be done without the addition of any other wires, merely by using two existing lines, one to form each side of the new line or phantom circuit.

By the use of proper induction coils, or Repeater Coils, as they are called, a conversation can be carried on over this phantom line without interfering with either of the two actual lines. A repeater coil is simply a transformer with primary and secondary windings of an equal number of turns.

Fig. 162 shows the manner in which a phantom circuit is obtained from two metallic circuits. Lines No. 1 and 2 are ordinary metallic lines or physical circuits using repeater coils to transfer the current impulses from the transmitter circuits to the lines. Line No. 3 is a phantom circuit obtained by connection of its coil to the exact center of each of the others on lines 1 and 2. With this connection the current in line 3 can divide equally through each of the other lines or pairs of wires and, therefore, does not interfere with their talking currents at all.

With four metallic circuits we can obtain two phantom circuits directly, and then a third phantom circuit between the first two, so we find that where a considerable number of trunk lines are run from point to point a large number of phantom circuits can be arranged to use the same lines.

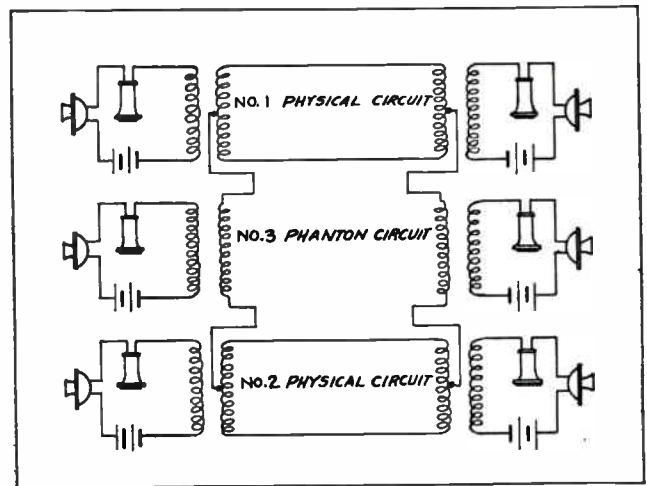

Fig. 162. Elementary sketch showing how a phantom circuit is obtained from two metallic or physical circuits.

This practice is also followed in telegraph work. Telephone lines, if used on trunk circuits and special radio station wires, are constructed with a carefully determined amount of resistance. Special resistance and impedance coils are placed in the circuit of such lines to make them most efficient in the handling of certain frequencies set up by voices or musical notes. This principle will be more fully explained in a later section on radio.

Operators of radio broadcast stations frequently lease wires from the telephone companies to use in picking up and transmitting certain news or entertainment features at quite a distance from a broadcast station. Telephone systems are becoming more and more linked up with the radio stations, not only for amusement programs, but for the transoceanic and commercial conversations as well.

#### 121. TELEPHONE TROUBLES

Faults and troubles arising in telephones or telephone exchanges can usually be located by the same general methods of systematic testing that have been covered in connection with other signal circuits. A diagram of the wiring and connections is always of the greatest help in testing any telephone circuit.

Some of the more common telephone troubles which occur in the separate parts, such as transmitter, receiver, hook switch, etc., have already been mentioned. Other likely places to look for faults are at the spring contacts of key switches and relays, which may have become burned, dirty, or bent out

of shape; wire terminals, which may have become corroded or loose on the binding screws; weak batteries, weak magneto magnets, weak receiver magnets, etc.

Telephone circuits and equipment can often be tested very conveniently with a telephone receiver, as well as with test lamps and buzzers. The receiver can be used to determine if the talking current is coming through to certain circuits, and also to determine whether high resistance circuits are completed or not, by the clicks which should be heard in the receiver when its terminals are touched to any line circuit.

Careful application of your knowledge of the principles of fundamental telephone parts and circuits and methods of systematic trouble shooting should enable you to locate most any of the ordinary troubles in telephone equipment.

Don't forget that a thorough understanding of the material covered in this section on telephones will be of great help to you in any line of electrical or radio work.





**COYNE**  
*Electrical School*  
CHICAGO ~ ~ ILLINOIS



ESTABLISHED 1899

COPYRIGHT 1942

**ELECTRICAL CONSTRUCTION**  
**AND**  
**WIRING FOR LIGHT AND POWER**

*Section One*

**Code, Conductors, Splicing and Soldering**  
**Types of Wiring Systems**

# ELECTRICAL CONSTRUCTION

## Wiring for Light and Power

Electrical construction and wiring offers a tremendous field of opportunity for practically trained men, both in interesting jobs at good salaries with various companies and employers, and also to enter a business of their own.

Naturally, every piece of electrical equipment manufactured and sold each year, must have wiring and circuits to carry the current to it, when it is installed. This includes the billions of dollars worth of electrical machinery and appliances made each year, and also the millions of electric lights and lighting fixtures.

In thousands of old buildings and existing plants, new wires and extensions to the circuits must be run each time additional equipment is installed; and in the new buildings erected, complete new wiring systems must be installed.

Today almost every new home erected in any city or small town, is wired for electric lights and appliances when it is built. Tens of thousands of old houses are being wired, and thousands of others rewired or having improvements and additions made to their wiring, to provide better lighting and more complete use of electrical convenience devices.

Plans are being made to rapidly electrify the last few small towns, which have not yet had electricity, and even the farms are now rapidly electrifying. Nearly one million farms already have their buildings wired, and electric supply from their local power companies' lines, or their own private light plants. Many of our graduates who came from farms, have returned to their own home territories, and made a good living wiring houses and farm buildings, installing and servicing farm light plants, radios, refrigerators, lights, and motors.

### 1. GOOD KNOWLEDGE OF WIRING NEEDED IN MAINTENANCE WORK

Factories and industrial plants throughout this country are over three-fourths electrified at present, and thousands of them employ from one to a dozen or more electrical wiremen, just to take care of their electrical construction and continual expansion.

The few old plants which have been operated by steam or other power, are rapidly changing over to electric power and machines, and modern electric lighting.

Practically every new factory or industrial plant built nowadays, is completely wired and electrified.

These plants keep thousands of trained electrical men constantly employed in interesting and good

paying work, maintaining and repairing their electrical machines, lights, and wiring circuits; and installing the new motors, lights and wiring as it is required.

The field of **Electrical Maintenance** work requires men who know the principles and methods of modern wiring thoroughly, so every electrical man should obtain a thorough knowledge of the material covered in this section, whether he intends to specialize in wiring and electrical construction or not.

The electrical maintenance man in any plant will usually have a great variety of interesting work to do, and an opportunity to use every bit of general knowledge he can obtain.

### 2. VALUE OF GENERAL KNOWLEDGE OF WIRING

The electrician in the small town will also usually be called upon to wire door bells, lights, and power motors; and to shoot trouble and make repairs on everything from a burned out fuse or dead dry cell, to shorts in wiring or faults in power machinery. And even the man who specializes in one line of electrical work, can always use a good general knowledge of electricity, and particularly of methods of wiring.

Many of our graduates make good money in a business of their own in this field, contracting general wiring or specializing in either the wiring of new buildings or old houses.

In addition to wiring contracting, many of them do electrical merchandising, selling lighting fixtures, electrical appliances for the home, radios, etc. A business, often started in a very small shop or the basement of their own home, frequently pays from \$5,000.00 to \$10,000.00 or more per year.

### 3. IMPORTANT POINTS IN WIRING

The important things to be considered in any electrical wiring job are: **First**, the selection of wires of the proper size to carry the amount of current required by the devices, and with the proper insulation according to the voltage of these wires; **Second**, proper mechanical support and protection for the runs of wire; **Third**, secure and permanent splices and connections; **Fourth**, protection and precautions to eliminate all danger of fire or shock.

Each of these features will be covered thoroughly in the following sections. When installing any wiring system these points should be constantly kept in mind, and all work done accordingly.

In former years a lot of electrical wiring was installed rather carelessly, mainly with the idea of supplying current to the devices requiring it, but without proper consideration for permanence, and safety from fire and shock hazard. As a result many fires originated from defective wiring, causing short circuits, sparks, and flashes, or just overheated wires. In other cases, people received electric shocks or injuries by coming in contact with wires that were not properly insulated.

#### 4. INSPECTION—AN ADVANTAGE TO THE TRAINED MAN

Nowadays there is a general tendency in all electrical construction to follow certain very high standards in the selection of materials, quality of workmanship, and precautions for safety. A great deal of the old wiring is being entirely replaced, and new wiring in most towns and localities must be done according to very strict inspection requirements. This is not at all a handicap, but rather it is a decided advantage for the trained electrical man who knows how to do this work as it should be done, and according to these rules. It makes his services much to be preferred to those of the man who does not know modern methods, or will not recognize the value and importance of safety-first rules in electrical wiring.

#### 5. NATIONAL ELECTRIC CODE

To standardize and simplify these rules and provide some reliable guide for electrical construction men the National Electric Code has been provided. This Code was originally prepared in 1897, and is kept frequently revised to meet changing conditions, and improved equipment and materials. It is a result of the best efforts of electrical engineers, manufacturers of electrical equipment, insurance experts, and architects.

This Code book is now published by the National Board of Fire Underwriters, and contains simple specific rules and instructions which, if followed, all tend to make electrical wiring and construction safe and reliable. Every electrician should have an up-to-date copy of the National Code at all times, and should familiarize himself with the more important rules pertaining to his work, and if he does he will find them of great help in making certain decisions on the job, and performing his work in a manner that will always be a credit to himself and his profession.

#### 6. STATE AND LOCAL CODE RULES

Most states now require that all electrical work be done in accordance with the National Code, and even in the few states where this may not be required throughout, most of the towns and cities do require that all wiring within their limits follow the Code.

Throughout the following pages we shall quote occasionally some rules of the National Code.

The Underwriter's laboratory also tests various electrical materials and supplies, such as wire, switches, fuses, insulations, etc. If these are

deemed safe and reliable, and meet the laboratory standards for quality, they carry the underwriters stamp of approval.

This is a good indication for the conscientious electrical man to follow in selecting the best of materials.

Some states have prepared special codes and rules of their own, usually applying to wiring in schools, auditoriums, theatres, and other public buildings, and also to transmission lines, and outdoor construction where the public is involved. These rules, however, are similar to those of the National Code.

A number of towns and cities have their own local code or rules, which in general may be based upon or similar to the National Code, but will have a few specific rules on certain classes of work, which are more rigid than the National Code.

In addition to the National Code and local codes of certain cities, the power companies to whose lines the wiring system may be connected may have some special rules regarding service wires, meter connections, size and type of devices, and class of equipment connected to their system. So, in starting to do wiring in any town, it is well to familiarize yourself with these local rules if there are any.

In addition to these important rules, if you will also follow the instructions given in the following pages, and apply your knowledge of general principles of electricity, along with good common sense and careful workmanship, you should be able to do most any kind of electrical wiring quite successfully.

Certain things in electrical wiring are done according to what might be termed "standard practice". That is, while there are no set rules for them, experienced electrical men have found that certain ways or methods are generally best, and these have been more or less generally adopted by men on the job.

For example, when installing single pole push button switches, the white button is always placed at the top. Following general rules of this kind simplifies the work a great deal and avoids confusion, both in the wiring, and to the owners of the buildings in which it is installed.

Every electrician should always be on the alert to notice and remember these little details or "wrinkles" of the trade. A number of them will be mentioned in this section.

#### 7. CLASSES OF WIRING SYSTEMS

Wiring systems can be separated into the following classes:

D. C. or A. C. systems, and two wire or three wire systems.

Whether direct or alternating current is to be used depends entirely on which is available from the power companies' lines; or, in the case of a private plant, which type of plant is used.

Direct current is generally used only where it is not to be transmitted over distances greater than



one-half mile. It has certain advantages for the operation of special types of variable speed motors, and motors requiring extra heavy starting power for frequent starting and stopping; also where storage batteries are to be charged from the lines, or where arc lamps, and other special D. C. equipment are in use.

Alternating current is equally as good for lighting with incandescent lamps, and much more desirable and economical where the energy has to be transmitted considerable distances. In such cases, it can be transmitted at high voltage for line economy, and then the voltage reduced at the customer's premises by use of step-down transformers.

For power purposes, recently developed alternating current motors will also meet almost every condition that direct current motors formerly were needed for. By far the greater number of wiring jobs which you will encounter will probably be on alternating current systems.

The materials and methods used are just about the same for either D. C. or A. C. systems, except for a few precautions on A. C. circuits which will be covered later.

The simple two wire system is in common use for wiring small homes and buildings where only one voltage and small amounts of power are required. The circuits and connections for such a system are extremely simple, and consist merely of running the two wires to each lamp or device to be used, and of course with the proper fuses and switches. Fig. 1 shows the important parts of a two wire lighting system.

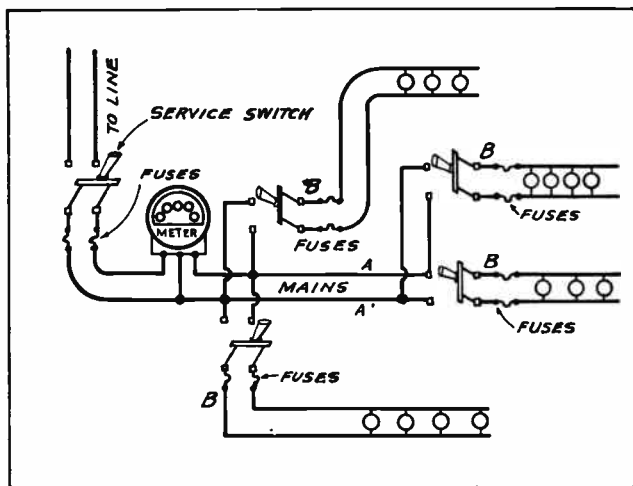

Fig. 1. This sketch shows a simple two-wire system with the service wires, mains and branch circuits.

This system consists of the Service Wires which lead to the power supply, Service Switch and Fuses, Meter, Main Wires or Feeders, and Branch Circuits. Each branch circuit has its own switch and fuses. The separate light switches are not shown in this diagram. All of the circuits marked "B" are branch circuits, while "A" and "A1" are the main wires which feed the branch circuits. The Watthour meter is connected in the mains, near the service

switch, to measure all the energy used in the entire system.

The Edison Three Wire System can be applied to either A. C. or D. C. installations. It provides two different voltages, one for lights and one for motors, and also effects a considerable saving in wire size, where used for lighting only. This system will be explained in detail later.

## 8. WIRING MATERIALS—CONDUCTORS

Before going farther into the methods of wiring it will be well to consider some of the materials used.

Conductors used in wiring for light and power must be somewhat different from those used for low voltage signal wiring, as they usually carry much heavier currents and at higher voltages. They are of course made of copper, as this we know is one of the best conductors of electric current, and its softness and flexibility make it very desirable for use in inside wiring.

The very low resistance of copper enables it to carry the current with much less voltage drop and heat loss. So copper wires and cables are used almost entirely for wiring for light and power. Copper wires for interior wiring are usually "annealed" or softened by a heating process as this makes the copper much more flexible and improves its conductivity.

We found that No. 18 or 16 B. & S. (Brown & Sharpe) gauge wires were used for bell wiring, but No. 14 is the smallest sized wire allowed in wiring for light and power. Sizes 14, 12, 10 and 8 are used in solid wires, but when used in conduit the larger sizes are stranded to obtain greater flexibility.

## 9. INSULATION

Bare conductors can be used in a few places such as on switchboards and distribution panels where they can be rigidly supported and held apart on proper insulators, or insulating panels. For general wiring, however, the wires must be properly insulated to prevent persons from coming in contact with them, and also to prevent short circuits and grounds which would not only interfere with operation of the attached equipment, but also cause fire hazards.

Rubber and braid coverings are the most common forms of insulation. The rubber being of extremely high resistance to electricity provides excellent insulation to confine the current to the wires and prevent leakage to the other wires or metal objects. The cotton braid covering is used over the rubber to protect it from mechanical injury. This is called ordinary rubber covered (R.C.) wire, sometimes designated by the letter "R" only.

It is made with both single and double braid coverings, and is very generally used in interior wiring. Fig. 2 shows three forms of rubber and braid insulation on solid wires, and Fig. 3 shows both a solid and a stranded wire with their insulation.

For outdoor use, we have wires with weather proof (W. P.) insulation, consisting of three or

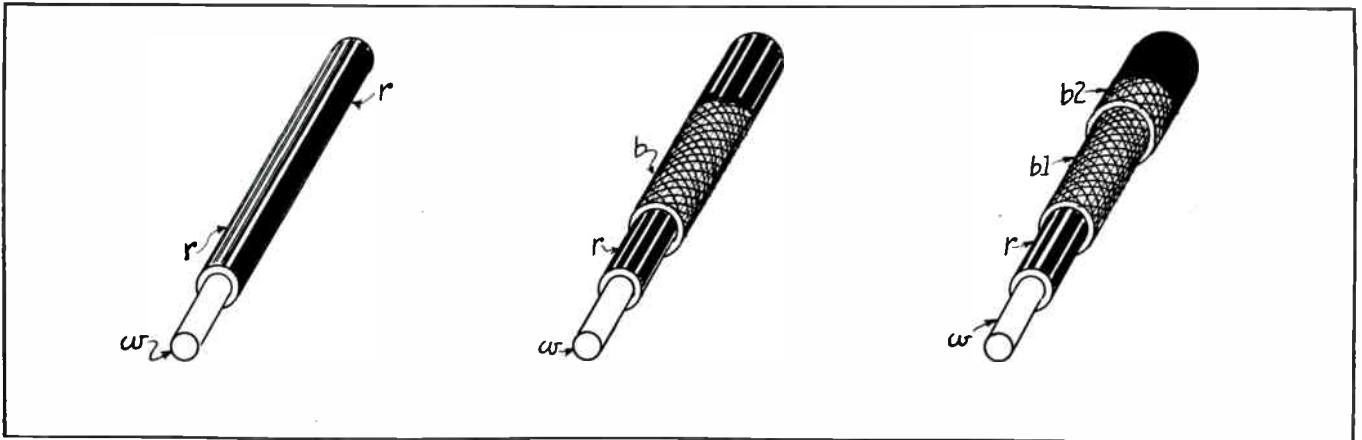

Fig. 2. Three samples of insulated conductors. The wire at the left is covered with rubber only. The one in the center has a layer of rubber and one of cotton braid. The one on the right has one layer of rubber, and two layers of braid. These would be called respectively: Rubber covered (R.C.), Rubber and braid covered, and Rubber and double braid covered.

more layers of braid, soaked or impregnated with moisture resisting compound of a tarry nature.

This kind of insulation is much cheaper than rubber, and is required for outdoor use in many cases, and in some damp locations inside buildings. It should not be used where it is subject to heat or fire, as it is inflammable.

Fig. 4 shows three pieces of wire with weather proof insulation.

For places where the wire is subjected to heat but not moisture, Slow Burning (S. B.) insulation with fire resisting braids is used.

Some wires for use in very dry hot places, or for heater cords, are covered with a layer of asbestos fibres for maximum heat and fire resisting insulation.

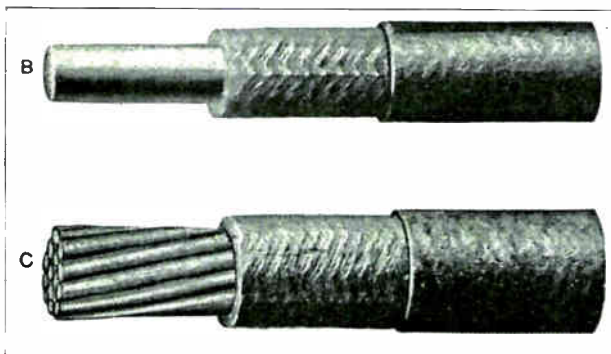

Fig. 3. Examples of solid and stranded conductors with their insulation. The stranded conductors are used in the large sizes because they are more flexible.

Conductors are also prepared with a combination of slow burning and weather proof insulation (S. B. W.). Two such wires are shown in Fig. 5.

Insulated wires are often made up in twisted pairs as shown in Fig. 6, for lamp cords and leads to portable devices. Such wires are usually made of many strands of very fine wires for good flexibility.

The copper wires are usually "tinned" or coated with a thin layer of lead and tin alloy, to prevent corrosion from contact with the chemicals in the rubber, and to make it easier to solder them when splicing.

The outer braid coverings on wires are sometimes made in different colors, particularly black and white, or light gray; or with a colored thread woven into them in order to easily mark or identify certain wires. Reasons for this will be explained later.

For extremely damp places or where wires are to be run under ground, we have wires and cables with a lead sheath over the insulation.

### 10. WIRE SIZE VERY IMPORTANT

Copper wires can be obtained in almost any desired size and with a variety of insulations for various uses.

It is very important to use wires of the proper size for any wiring job, because if they are too small for the current load they have to carry, they will

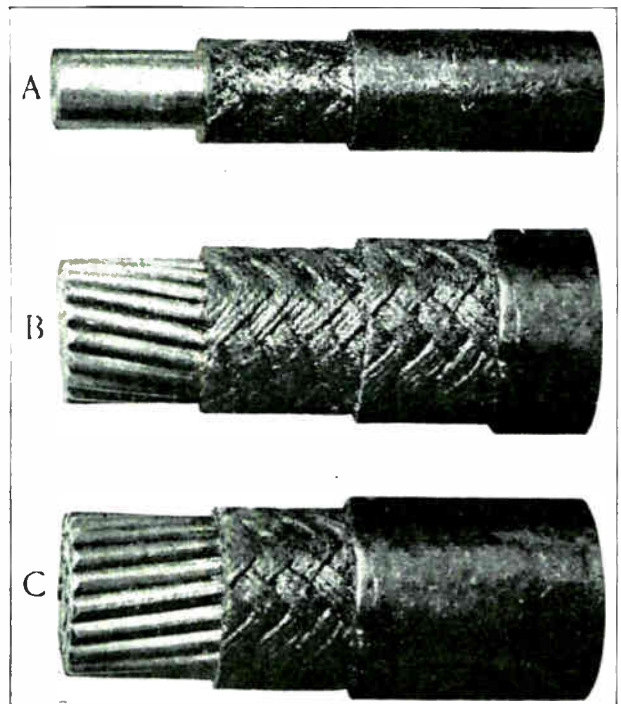

Fig. 4. These wires have what is called "water-proof" insulation, or braid filled with tarry water-proof compound. They are for use outdoors or in damp locations.

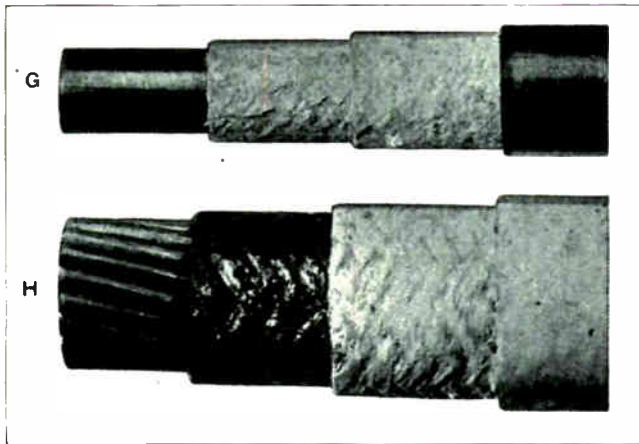

Fig. 5. In this view the upper conductor has a special fire resisting covering known as "slow burning" insulation. The lower conductor has a combination covering of both water-proof and slow burning insulation.

overheat. Excessive heat not only increases the resistance of the wire and creates a greater voltage drop and energy loss, but it also damages the insulation and in some cases results in completely burned out wiring or causes fires.

If wires that are too small are used, the excessive voltage drop causes the lights or equipment to receive less than their rated voltage, which usually results in unsatisfactory operation. This is particularly true of lighting systems, as a very few volts drop will cause an incandescent lamp to deliver much less than its rated light.

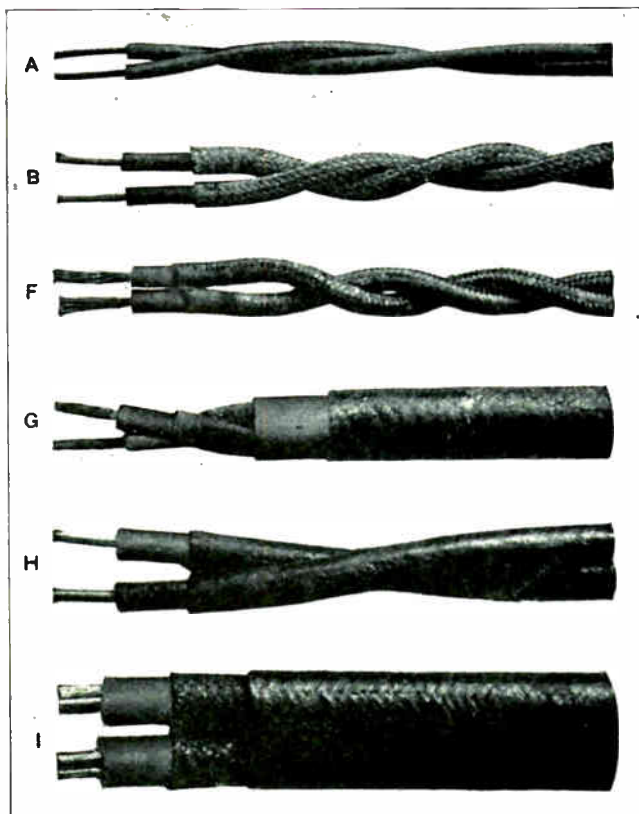

Fig. 6. Conductors are often arranged in pairs for convenience in running two-wire circuits. Several types of these are shown above.

The National Code specifies the maximum amount of current that shall be allowed on the common sized wires, and this should be followed closely for safe and satisfactory results in any wiring system.

Fig. 7 shows a convenient table which gives the maximum current capacity of each size of rubber insulated wire from No. 14 up, to 2,000,000 C. M.

If wires are allowed to carry more than these amounts of current for any length of time, they will heat up and the rubber will rapidly lose its insulating quality at these higher temperatures.

**ALLOWABLE CURRENT-CARRYING CAPACITIES OF CONDUCTORS IN AMPERES**  
 Not More Than Three Conductors in Raceway or Cable

(Based on Room Temperature of 30° C. 86° F.)

Size AWG MCM	Rubber Type RW Type R	Synthetic Type SN	Rubber Type RHT Type RH	Paper	Asbestos Var-Cam Type AVB	Impreg- nated Asbestos Type AI	Asbestos Type A
		Type RU		Synthetic Type SNA			
14	15	18	22	23	28	29	32
12	20	23	27	29	36	38	42
10	25	31	37	38	47	49	54
8	35	41	49	50	60	63	71
6	45	54	65	68	80	85	95
5	52	63	75	78	94	99	110
4	60	72	86	88	107	114	122
3	69	83	99	104	121	131	145
2	80	96	115	118	137	147	163
1	91	110	131	138	161	172	188
0	105	127	151	157	190	202	223
000	120	145	173	184	217	230	249
0000	132	166	199	209	243	265	284
00000	160	193	230	237	275	308	340
250	177	213	255	272	315	334	372
300	198	238	285	298	347	360	415
350	216	260	311	325	392	419	482
400	233	281	336	361	418	450	498
500	265	319	382	404	468	498	554
600	293	353	422	453	525	543	612
700	320	385	461	488	562	588	668
750	330	398	475	502	582	621	699
800	340	410	490	514	600	641	720
900	360	434	519	556	...	...	...
1,000	377	455	543	583	681	730	811
1,250	409	493	589	643	...	...	...
1,500	434	522	625	695	784	...	...
1,750	451	544	650	733	...	...	...
2,000	463	558	666	774	839	...	...

Fig. 7. This very convenient table gives the current carrying capacity for the various sizes of wire, with various grades of insulation.

For wires with other insulation than rubber, you will note that the correct carrying capacity is somewhat higher, as these insulations will stand slightly higher temperatures without damage.

Examine the table in Fig. 7 very carefully, and become familiar with its use, as it will be very convenient to you many times from now on.

The first column gives the wire sizes in A. W. G. gauge numbers, from 14 to 0000 or "four ought" as it is called. From this size up the larger cables have their sizes given in circular mil area, with the last 3 zeros left off, and can be followed on down the third column to 2,000,000 circular mils.

The second column gives the current capacity for rubber insulation, and the following columns give the current capacity for other insulations such as synthetic rubber, paper, cambric, asbestos, etc.

The term **Circular Mil** means the area of a round wire one thousandth (1/1000) of an inch in diameter. This is the common term for rating and calculating sizes of electrical conductors, and will be covered more fully in a later section on wire calculations.

The longer a wire, the greater is its resistance, and the **Voltage Drop** is proportional to both the **Resistance** and the **Current** carried. Therefore, where the wire runs are quite long, we may not wish to allow even the amount of current that the code table does, because the voltage drop would be too great.

In such cases we can determine the exact size of wire to use for any given current load and any desired voltage drop, by use of a simple formula which will also be given and explained in the section on wire calculations.

Referring again to the table in Fig. 7, you will note that the larger the gauge number the smaller the wire. This is a good point to keep in mind so you will not become confused on the sizes and numbers.

Fig. 8 shows a wire gauge often used to determine the exact size of a wire by slipping the bare end of the wire in the slots until one is found that it just fits snugly. The gauge number is marked on the disk at that slot. Be sure to fit the wire to the straight slot and not in the circle at the end of the slot.

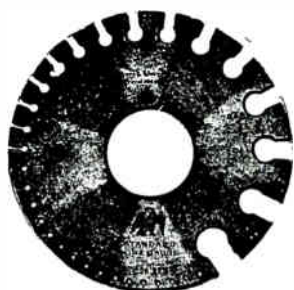

Fig. 8. A wire gauge of this type is commonly used to determine the size of wires for various uses.

It often comes in very handy to remember that when you have a wire of any certain size, another wire three sizes larger will have just about double the area; or one three sizes smaller, about one-half the area. For example, a number 3 wire is just about double the area of a number 6; or a number 2 wire just half the area of a number 00.

Another very handy fact to remember is that a number 10 wire has approximately one ohm resistance per thousand feet, and a number 14 wire has about 2.5 ohms per thousand feet.

## 11. SPLICING

In running wires for any electrical system, it is necessary to make numerous splices of various kinds, and a good knowledge of proper methods of splicing and soldering is of the greatest im-

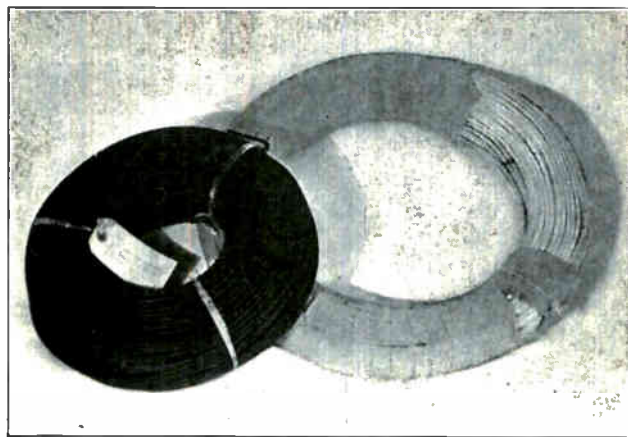

Fig. 9. Two coils of ordinary rubber and braid covered No. 14 wire, such as commonly used in house wiring jobs. The advantage of having the insulation in black and white colors will be explained later.

portance for any electrician to have, whether he follows new wiring or maintenance and repairs.

The old saying that a chain is no stronger than its weakest link, applies in slightly different words; almost as well to a wiring system or, the **circuit or system is no better than its splices.**

Splices properly made and soldered will last almost as long as the wire or its insulation, but poorly made splices will always be a source of trouble and will overheat, burn off their taping, and cause high resistance circuits and sometimes fires.

A good test of an electrician is in the kind of splices he makes.

The requirements for a good splice are, that it should be **Mechanically and Electrically Secure** before the solder is applied. Solder is then applied, not only to strengthen the splice or improve its conductivity, although it does do both to some extent, but for the real purpose of preventing corrosion and oxidization of the copper.

## 12. COMMON TYPES OF SPLICES

Several of the more commonly used splices are the **Pigtail, Western Union, Tee or Tap, Knotted Tap, Fixture Splice, and Stranded Cable Splice.** Each of these will be explained in detail.

## 13. STRIPPING AND CLEANING WIRES

The first very important step in making any splice is to properly strip and prepare the ends of the wire. Stripping means removing the insulation from the wire a proper distance back for the splice to be made. This may range from 1½ inches to 3 or 4 inches for various splices.

The rubber and braid should be removed with a knife, as shown in the upper view in Fig. 10. The knife and wire should be held in a position similar to that used when sharpening a pencil, and the braid and rubber cut through at an angle as shown. **Be very careful not to cut or nick the wire, as it reduces the conducting area, and makes it very easy to break at that point.**

Never cut the insulation as in the lower view in Fig. 10, as one is almost certain to nick the wire in cutting in this manner, and it makes a more difficult splice to properly tape.

After cutting through the insulation and down to the wire, let the blade slide along the wire, stripping the insulation to the end; keeping the blade almost flat against the wire, so it does not cut into the copper.

After removing the insulation with the knife the wire should be scraped with the back of the blade, to remove all traces of rubber and until the wire is thoroughly clean and bright. If the wire is tinned do not scrape deep enough to remove the tinning, but leave on as much as possible, as it makes soldering easier.

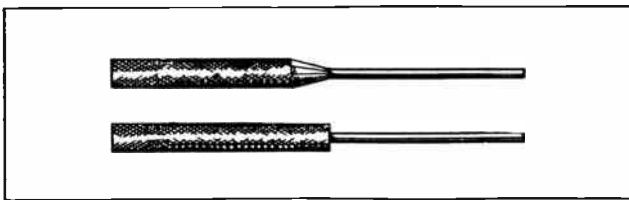

Fig. 10. This sketch shows the proper method of stripping the insulation from a wire in the upper view. The lower view shows the wrong way.

It is impossible to do a good job of soldering if the wires have bits of rubber, dirt, or grease left on them, and as they are very difficult to clean after they are spliced, be sure to do it properly before starting the splice.

A number of wire stripping tools are made and on the market, and some of them are quite fast in operation, but for rubber covered wire and for doing the work right on the job, nothing is much handier than a good sized electricians' knife with a sturdy blade of good steel. A piece of sandpaper can be used to clean the wire if desired.

#### 14. "PIG TAIL" SPLICE

To start a Pig Tail splice, strip and clean about two inches on the end of each wire, then hold the wires as in Fig. 11-A, and twist them together a few turns with your fingers; then finish the ends with a pair of pliers. Be sure that both wires twist around each other, and that one does not remain straight while the other wraps around it. They should appear as in Fig. 11-B.

This splice should have at least five good tight turns, and then the end should be bent back as in Fig. 11-C to prevent it from puncturing the tape.

Three or more wires can be connected together by a pig tail splice, and it is commonly used in making splices of wire ends in outlet boxes, and at places where there is no strain on the wires.

In making any splice, always be sure to wrap or twist the turns tightly around each other, as they should not be able to slip or shift upon each other when the splice is complete but not yet soldered. Make the splice itself tight and strong, and don't depend on the solder to do this.

#### 15. WESTERN UNION SPLICE

For splicing straight runs of wire the Western Union splice is one of the oldest and most commonly used. It is a very strong splice and will stand considerable pull and strain on the wires. It can be used for splicing large solid conductors and line wires as well as the smaller wires.

In starting a Western Union splice, strip and clean about four inches of the end of each wire.

Hold the ends together tightly with your hand or pliers as in Fig. 12-A, gripping them at the point where they cross. Twist them together a couple of gradual or spiral turns as in Fig. 12-B. These are often called "neck" turns. Then wrap the end of each wire around the other wire in five or six neat, tight turns as in Fig. 12-C. A little practice will be required to get the knack of wrapping these ends tightly and smoothly by hand. If one or two turns do not grip the straight wire tightly, pinch them down carefully with the pliers.

To finish this splice, trim the ends off and pinch them down tight with the pliers, so they will not project and damage the tape later. The splice should then appear as in Fig. 12-D.

Practice making this splice a number of times, as it is one of the most common and important ones used, and every practical man should be able to make it well. Each time you make it examine it carefully and try to improve until it is perfect.

Be careful not to nick or mar wires any more than necessary with the "bite" of your pliers, when gripping them during splicing.

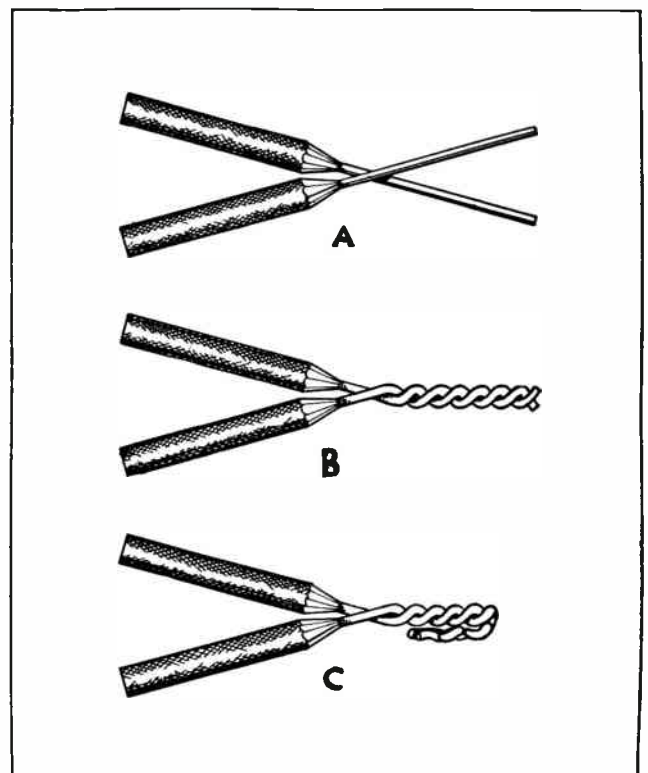

Fig. 11. This diagram shows very clearly the several steps in making a "Pigtail" splice. Examine it very carefully.

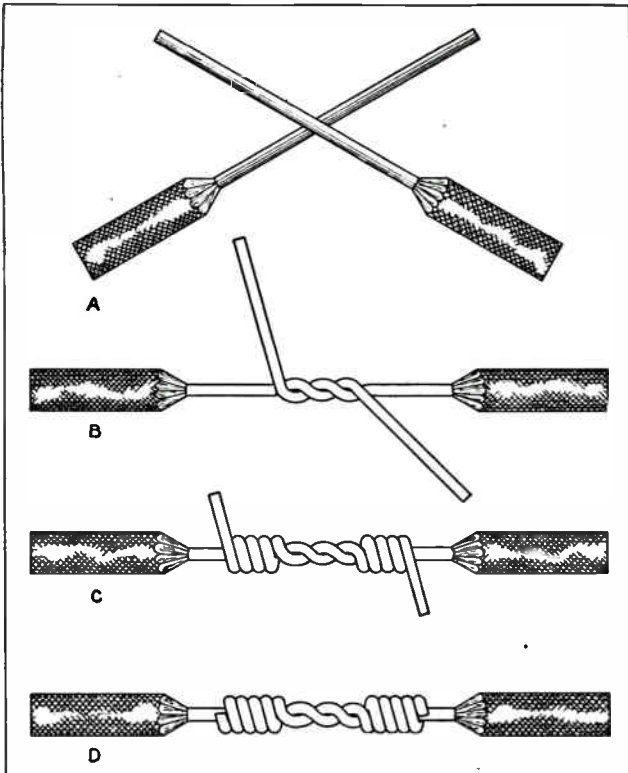

Fig. 12. The above four sketches show the steps and procedure in making a "Western Union" splice.

When making a double Western Union splice in a pair of wires together, always stagger them as shown in Fig. 13, so each splice lies near to undisturbed insulation of the other wire, and so they do not make a large bulge when taped.

Fig. 13-A shows how the ends of the wires should be cut in uneven lengths for such a splice. In 13-B is shown the method of spreading them apart to make the splices, and in 13-C the appearance of the finished splice, before soldering and taping.

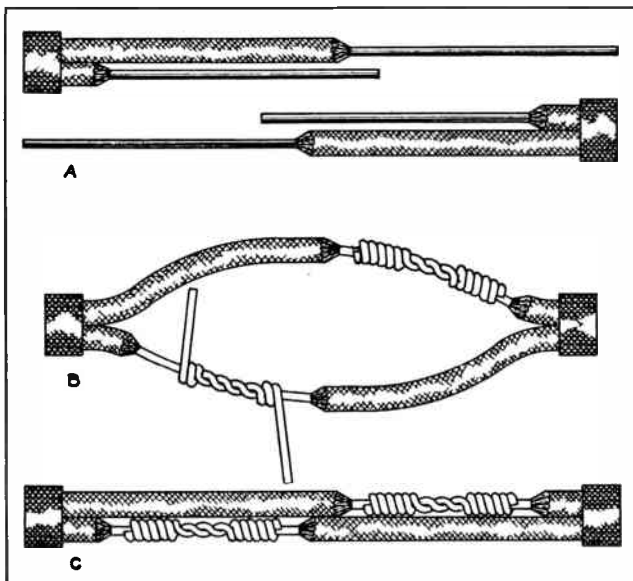

Fig. 13. When making splices in pairs of conductors they should be staggered as shown above so each splice will be near to good insulation on the other wire.

### 16. TAP OR TEE SPLICE

When a tap or branch is to be connected to a main or "running" wire, we use the **Tap splice** shown in Fig. 14. For this splice, bare about 1 inch on the main wire, and about 3 inches on the end of the tap wire. Then wrap the tap wire tightly about the main wire from five to eight turns, as shown in the figure. The turns should be tight enough so they cannot be slid along the straight wire.

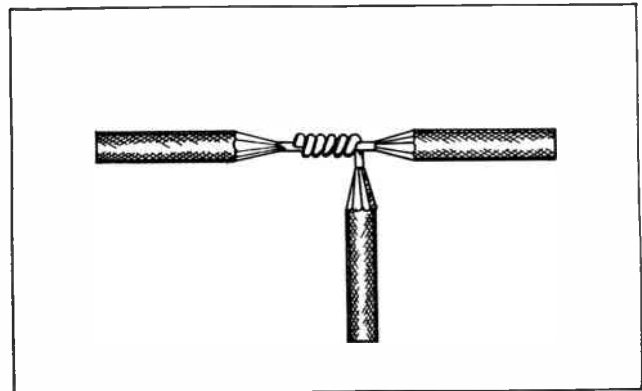

Fig. 14. Simple "Tap" splice used for tapping a "branch" wire to "main" or "running" wires.

### 17. KNOTTED TAP SPLICE

Where there is a possibility of some pull or strain on the tap wire, we can use the **Knotted Tap splice** which cannot be pulled loose as easily. This splice is shown in Fig. 15, and is very easily made, by simply giving the wire one turn on the side of the tap wire opposite to the side on which the main group is to be, and then doubling back around the tap wire, and winding the balance of the turns in the opposite direction around the main wire. This locks the first turn so it is very secure and hard to pull loose.

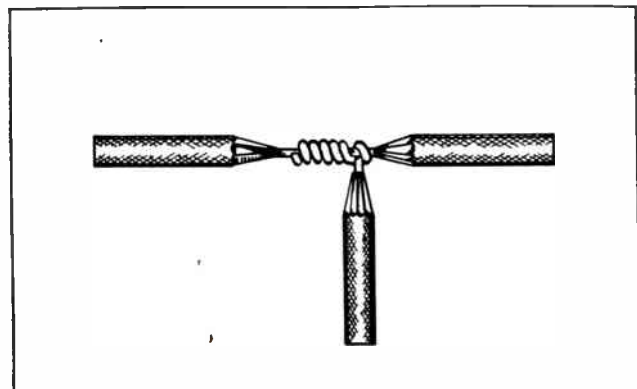

Fig. 15. "Knotted Tap" splice. Note carefully the manner in which the wire is first looped around the branch conductor to lock it securely in place.

### 18. FIXTURE SPLICE

The **Fixture Splice** which is often used to fasten together two wires of different sizes, is shown in Fig. 16. The various steps in making this splice are as follows: First bare about 5 inches of the end of one wire, and 3 inches on the other wire; then

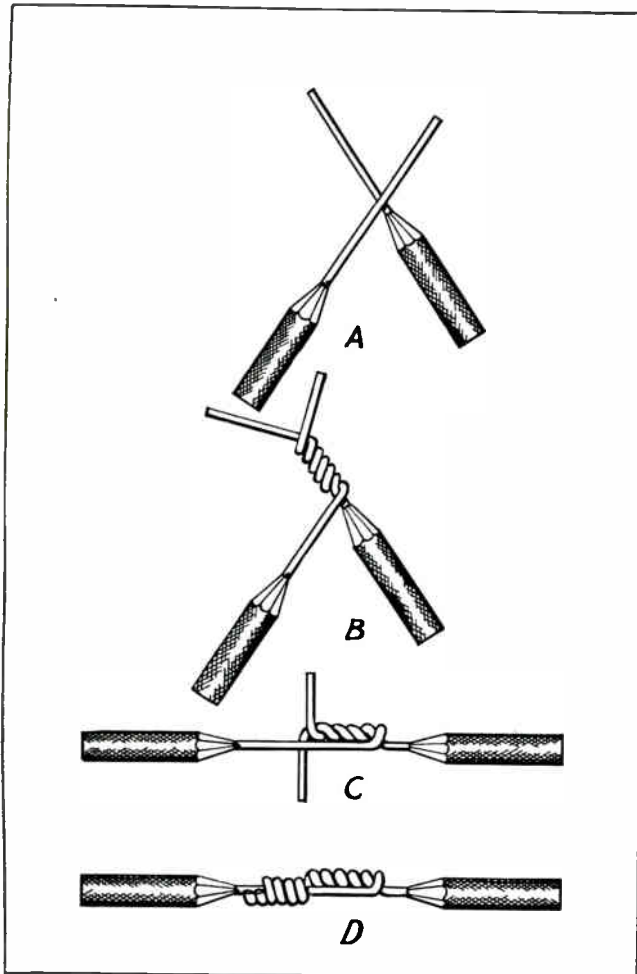

Fig. 16. The above views show the method of making a "Fixture" splice, which is used for connecting together two wires of different sizes.

place them together as shown in Fig. 16-A, with about half the length of the longer bared end crossing the other end, near the insulation. Then twist them both together, as in "B", being sure that they both twist about each other evenly. Then spread the wires apart and bend the twisted ends down tight to the longer remaining bare strip as at "C", and wrap both ends tightly around the wire at this point. The finished splice is shown at "D".

**19. CONVENIENT SPLICE FOR LARGE SOLID WIRES**

Another splice that is very handy for connecting large solid wires together is the one shown in Fig. 17. This splice is made by simply laying the ends of the two large wires together, overlapping from 2 to 4 inches according to their size, and then wrapping them both with a smaller wire. The smaller

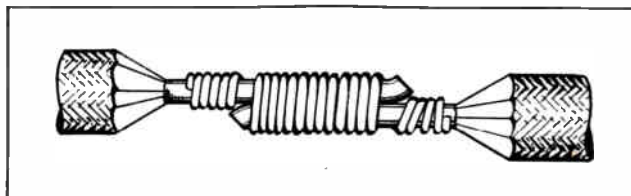

Fig. 17. A very convenient splice to use on large solid conductors. By wrapping them in this manner with the smaller wire we don't have to bend or twist the stiff heavy wires.

wire is much easier to bend, and can be quickly and tightly wound around the large ones. In addition to winding the small wire around both the large ones where they overlap, also wind a few turns around each wire at the end of the splice, as shown in the figure. The ends of the large wire should be slightly bent outward to hold the smaller wire wrapping in place, and prevent the large ones from being pulled out; but be careful not to bend them out far enough to puncture the tape. This splice when well soldered makes one of good conductivity, because of the great area of contact between the small wire turns and the two large ones.

**20. STRANDED CABLE SPLICE**

There are a number of methods used in splicing stranded cables, but the most important points to keep in mind are to be sure to secure enough good contact area between the two groups of wires to carry without overheating the same load of current that the cable will, and to keep the diameter of the splice down as much as possible.

The wires should be stripped back about ten or twelve times the cable diameter, and each strand separately cleaned. Then spread the strands of each cable out fan-wise, as in Fig. 18-A, and butt the cable ends together. Sometimes it is well to cut off

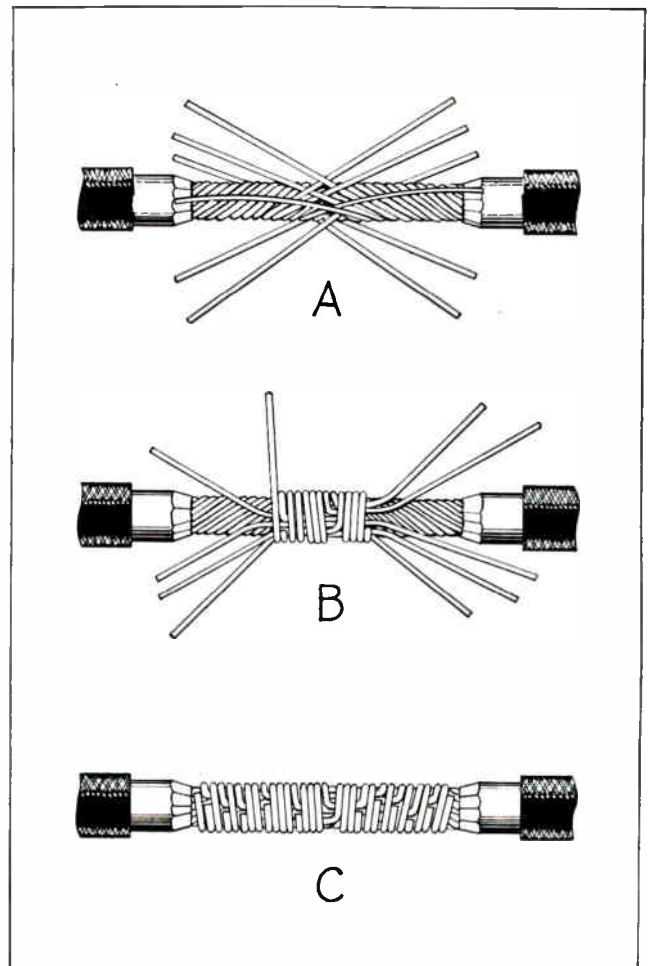

Fig. 18. Examine this diagram very closely and it will be a great help to you in making neat and efficient cable splices.

the ends of a few of the center strands at the point where they butt together, in order to reduce the diameter of the finished splice. A few less than half of the strands can be removed without reducing the current carrying capacity of the joint below that of the cable. This is because the wires of each cable overlap each other, maintaining an area equal to that of the cable anyway.

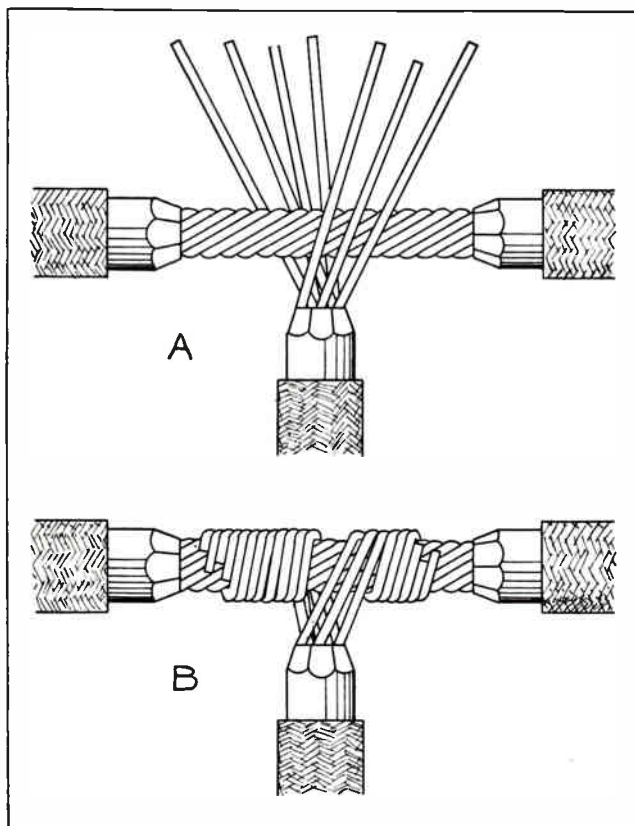

Fig. 19. Method of making a "tap" splice with stranded cables. Note how the wires of the "tap" cable are divided and each group wrapped in opposite directions around the "running" cable.

Next wrap one strand at a time around the cable, starting with strands from the outer surface of the cable, and wind these over the others which are laid tight along the cable. See Fig. 18-B. When one strand is all wound up, start with the next tight to the finish of the first, but continuing to wrap them all in one layer if possible.

The finished splice should appear neat and compact as in Fig. 18-C.

In making a tap cable splice, bare several inches of the main cable and thoroughly clean all the outer strands, removing all rubber from the grooves with a wire brush or pointed tool or knife. Then spread the cleaned strands of the tap cable, dividing them in half and butt them against the main cable in the center of the bare spot as in Fig. 19-A. Then wrap them in opposite directions around the main cable in one layer or as few layers as possible, as in Fig. 19-B, which shows the completed splice.

## 21. SOLDERING SPLICES

All splices made in permanent wiring should be carefully soldered, to preserve the quality and conductivity of the splice.

We have already mentioned that altho soldering does improve the strength and conductivity of a splice to some extent, the main reason for soldering is to prevent corrosion or oxidization from spoiling the good contact of the wires.

## 22. COPPER OXIDE AND ITS EFFECT ON JOINT RESISTANCE

Copper rapidly oxidizes or "rusts" when exposed to air or moisture, and also corrodes very quickly if any chemicals or chemical vapors come in contact with it.

A bright copper wire soon forms a thin brownish film of oxide on its surface if it is not tinned or covered in an air tight and moisture-proof manner. This film will even form between the wires where they are in contact with each other. Copper oxide is of a very high resistance to electric current flow, and a very small amount of it which may be almost unnoticeable, greatly increases the resistance of a splice. This would be likely to cause serious heating of the joint, after a period of possibly a few weeks or months from the time it was made, even though the splice was of low resistance when new.

A very thin layer of solder, properly applied so that it actually unites or alloys with the clean copper surface, will prevent this oxidization or corrosion, and maintain almost indefinitely, the original low resistance of the splice.

In order to obtain this proper bond between the solder and the copper, the copper must be absolutely clean, then treated with a Flux which makes the solder flow freely; and the splice and soldering copper must both be well heated.

If these rules are all kept in mind and carefully followed, you can easily do a good job of soldering that will be a credit and source of pride to you on every job.

## 23. SOLDERING COPPERS

To heat the splice and melt the solder we use a Soldering Copper of the proper size, and which must be kept well cleaned, tinned, and heated. These tools are often called "soldering irons", but they are made of good copper because copper can be readily tinned so the solder will adhere to it and flow over its surface or point; and also because copper will quickly absorb heat from a torch or flame, and easily give up its heat to the splice and solder. Copper is an Excellent Conductor of Heat, as well as electricity, and if you keep in mind that the function of the soldering copper is to impart its heat to the splice, as well as to melt the solder, you will find it much easier to understand soldering and will make a much better job of it. Fig. 20 shows a common soldering copper of the type that is heated in the flame of a blow torch or gas soldering furnace. Such coppers must be reheated frequently, and where much soldering is to



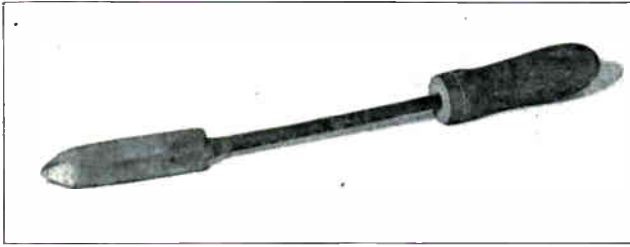

Fig. 20. An ordinary soldering copper of the type commonly used in electrical work.

be done, it is often well to use two of them so one can be heating while the other is in use. Fig. 21 shows a blow torch in use for heating an "iron".

Soldering coppers can be obtained in various sizes, the smaller ones being more convenient for some classes of work, and the large ones holding the heat longer. A half pound copper and a one pound size are generally very good for ordinary wiring.

Wherever electricity is available an electric soldering "iron" can be used very conveniently, as they remain hot while in continual use. They are made in different sizes and with various sized and shaped tips for use on different sized splices and various types of work. Two of these electric "irons" are shown in Fig. 22.



Fig. 21. This photo shows a gasoline blow torch such as commonly used for heating soldering coppers, and splices in electrical conductors.

#### 24. CLEANING AND TINNING

The point of any soldering "iron" must be kept bright and clean and well tinned, or it will not "flow" the solder properly or convey its heat readily to the splice.

When the irons are very dirty or covered with a heavy scale, or pitted, they should be smoothed and cleaned with a file. When in use on the job they require occasional "brightening up." It can be done by rubbing the point on a block of salammoniac which is obtainable in small cakes from electric shops and hardware stores. See Fig. 23.

Rub the heated point on the block and immediately apply a little solder to it in an even thin

coating. Or when a small hole is worn in the block, place a little solder in this hole or pocket and melt it with the "iron," while rubbing it in the solder and against the salammoniac at the same time. This is called "tinning" the "iron."

Dipping the point of the hot soldering copper into the flux occasionally, helps to keep the tinning bright.

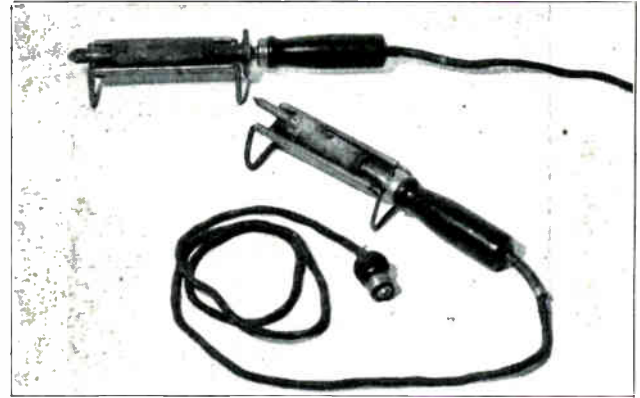

Fig. 22. Electric soldering irons are very convenient where electric current is already available.

#### 25 SUFFICIENT HEAT IS IMPORTANT

Never try to solder a splice without a well tinned, well heated "iron" as it will only waste time and result in a poor job.

If the iron is not hot enough the solder will melt very slowly and become pasty, instead of flowing freely as it should. The iron should be hot enough so the solder will melt almost instantly when touched to its point.

When heating an iron with a blow torch or gas furnace, be sure the flame is blue and clean, otherwise it will blacken and dirty the iron.

#### 26. SOLDER FOR ELECTRICAL USE

Solder as used for electrical work is usually made of about half lead and half tin. It can be bought in the form of long bars, solid wire solder, and "resin core" wire solder.

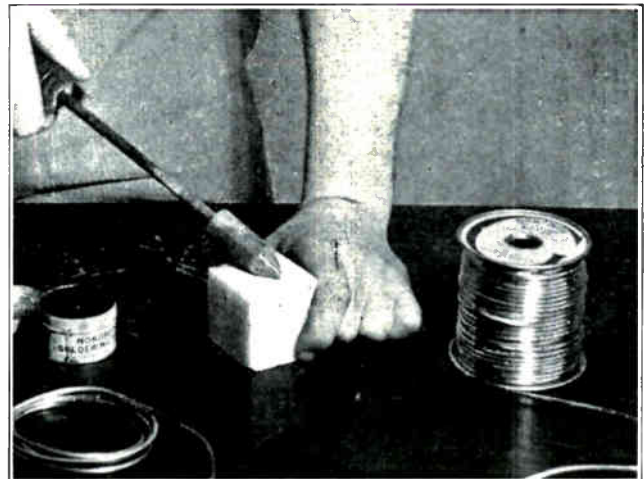

Fig. 23. This photo shows the method of cleaning and tinning a soldering copper with a block of salammoniac.

The wire solder is most commonly used for applying to small splices, and the bar solder for large cable splices and for melting in a solder pot.

The resin core solder is very convenient as the resin carried in the hollow wire acts as a flux, automatically applied as the solder is melted.

### 27. SOLDERING FLUX

Flux should always be used on any splice before applying the solder, as it dissolves the oxide on the metal and causes the solder to flow and unite with the metal much more readily.

Resin is a very good flux and can be used in bar form or powder, and melted on the hot splice. Muriatic acid was formerly used, and while it is a very active and effective flux, it should not be used on electrical work, as it causes corrosion of the wires later. No acid flux should be used on electrical splices.

Several kinds of good flux are prepared in paste form which is very convenient to apply.

These fluxes should be applied to the splice and melted on it with a good hot iron. Excessive flux should not be used, and none should be allowed to remain in the splice, as resin and some of the other fluxes act as insulators if they are not well melted out or "boiled out" of the solder with plenty of heat.

### 28. PROPER METHOD OF APPLYING SOLDER TO SPLICE

When the splice is "fluxed" the solder should be evenly applied and well melted so it runs into the crevices between the wires. It should not be dripped on the splice by melting it above with the iron. Instead the splice should be hot enough to melt the solder when it is rubbed on top of the turns.

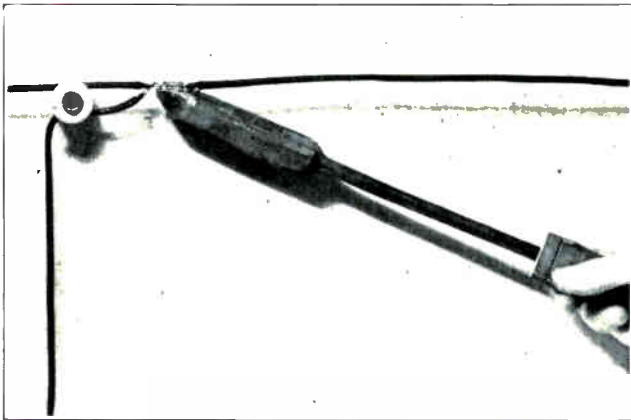

Fig. 24. Soldering copper should always be applied to the under side of the splice, as the splice can be heated much quicker in this manner. A drop of solder should be placed on the tip of the iron and pushed against the under side of the splice. This helps to conduct the heat into the splice very rapidly.

The proper place for the soldering copper is underneath the splice, as heat naturally goes up, and this will heat the splice much quicker. See Fig. 24.

Many beginners have a great deal of difficulty heating a medium sized splice before the copper becomes cold, because they do not understand the principle of heat transfer from the copper to the splice.

### 29. CONDUCTING THE HEAT TO THE SPLICE

Always remember that heat will travel or flow through metals much easier than through air, and while copper is an excellent conductor of heat, there is very little actual contact area between the soldering copper and the rounded turns of the splice.

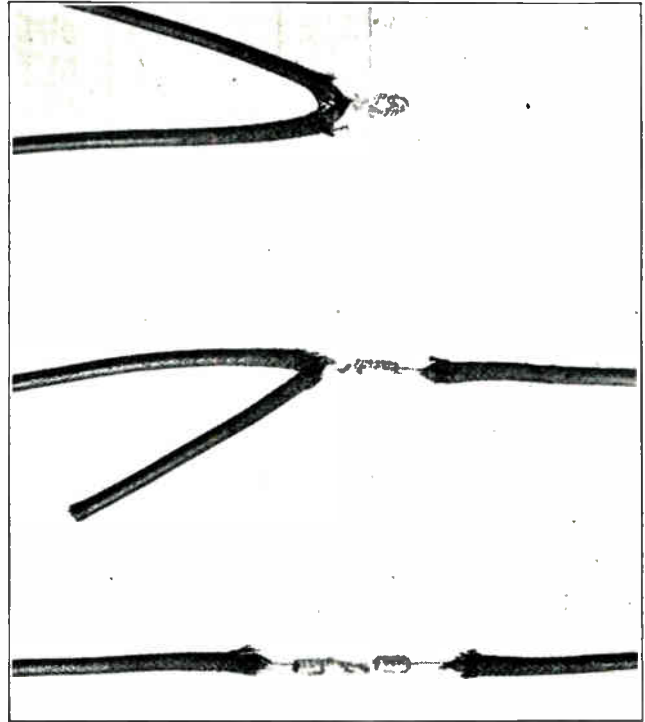

Fig. 24-B. The above three views show soldered splices of the Pigtail type and Western Union type. Note how the solder thoroughly covers and adheres to the entire splice.

Here is a simple little trick of the trade which, once you have tried it, you will never forget, and you will be surprised to see how much it speeds up any soldering job on a splice. Place the heated copper under the splice with one of the flat faces of the tip held fairly level and in contact with the turns of the splice. Then melt or "puddle" a little drop of solder on the copper, by pushing the solder wire in between the copper and the splice. This drop should melt almost instantly, and will provide a much greater area of metal-to-metal contact between the copper and the splice, and the heat will flow into the splice many times faster, heating it well in a very few seconds.

Then, while still keeping the good contact of the soldering copper on the bottom of the splice, run the solder on the top, allowing it to run down through the turns. Examine Fig. 24 again, and you will note the drop or puddle of solder on the iron, and the correct method of applying the solder to the splice.

Do not leave a large bulge of solder on any splice, but melt it off so that just a good coating remains on all turns.

Pigtail splices can be quickly and easily soldered by dipping them in a small ladle of molten solder.

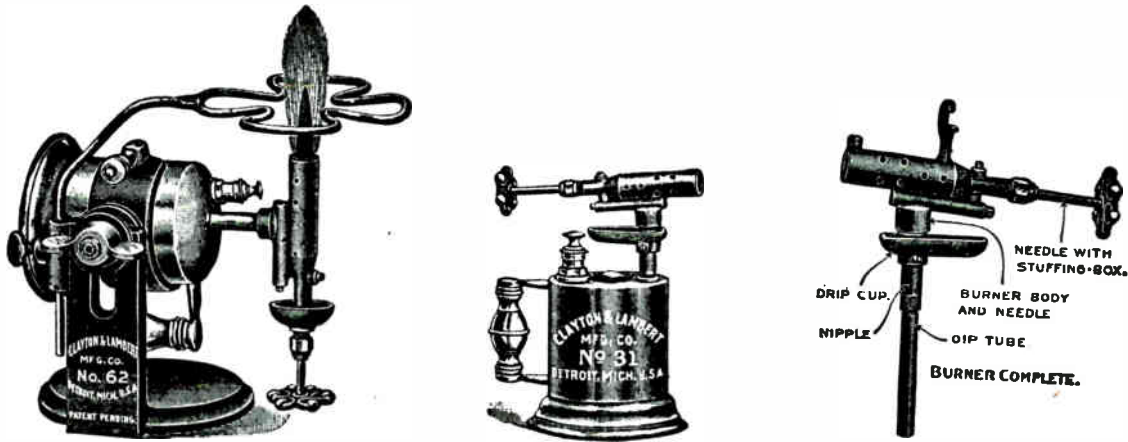

Fig. 25. This view shows the important parts of a blow torch on the right, and at the left the method of using a blow torch in a special stand for heating a lead melting pot.

Convenient small ladles or pots with long handles are made for this use. See Fig. 34.

### 30. SOLDERING LARGE SPLICES

When soldering cable splices, it is often difficult to get the entire splice hot enough before the soldering copper gets cold. The copper of the splice, also being a good conductor of heat, carries it away along the cable nearly as fast as the soldering copper can supply it.

For soldering the larger cable splices, a blow torch is used to heat them, or they are dipped in hot solder, or have the molten solder poured over them and the excess caught in a pan below the splice.

If the insulation near the splice gets too hot, it should be kept cool by wrapping a wet rag around it while soldering.

In using a blow torch care should be taken not to overheat or burn the copper strands, as it weakens them greatly, and also makes a poorer job of soldering.

### 31. BLOW TORCHES

Fig. 25 shows a common gasoline blow torch in the center view, and its burner and valve in a larger view at the right.

To start such a torch, a small amount of gasoline should be run into the drip cup and lighted with a match. This flame heats the burner nozzle directly above, and as soon as it is hot the valve can be opened allowing a fine jet of gasoline to spray into the nozzle, where it immediately vaporizes and burns with a clean blue flame of very high temperature.

If the flame is white and unsteady, the burner is not yet heated enough.

These torches have a small air pump built in the gasoline can, and the air pressure thus supplied forces the liquid up to the burner in the form of a spray.

The valve is of the needle type and should not be closed too tightly or it will damage the needle and valve seat. After extinguishing the torch it is well

to loosen the valve just a little so it will not stick when the metals become cold.

The left view in Fig. 25 shows a torch mounted in a bracket and stand for heating a lead pot.

Fig. 26 shows a regular gasoline lead pot, used for melting larger quantities of lead for large cable work.

### 32. CABLE LUGS

For attaching large cables to the terminals of machines or switchboards, and also for connections which may need to be disconnected occasionally, we use copper cable lugs as shown in Fig. 27.

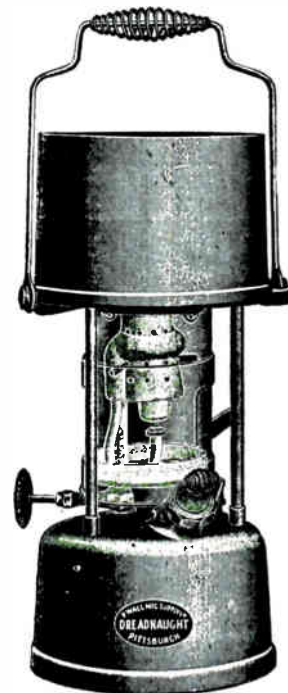

Fig. 26. Gasoline lead melting pot for use in soldering large cables, and cable sheaths.

These lugs are made in different shapes, and for single cables or a number of cables as shown. They have a hollow cup on one end for attaching to the cable, and the other end is flattened and has a hole through it, so it can be securely bolted to a terminal or another lug.

### 33. ATTACHING AND SOLDERING LUGS TO CABLE

To attach a lug to a cable, first strip just enough of the insulation from the end of the cable to allow the bare end to go fully down into the cup. Do not remove too much insulation, as it should cover the cable close to the end of the lug when it is attached.

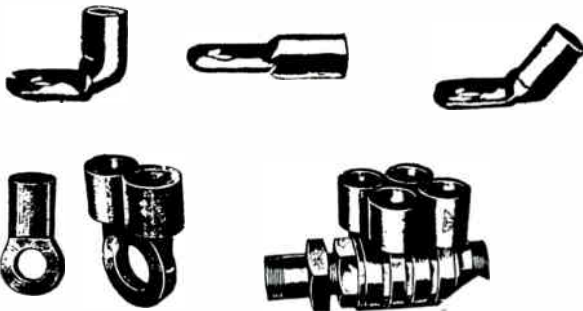

Fig. 27. Several types of soldering lugs used for connecting cable ends together or to the terminal of electrical equipment.

Clean the bared end well, and also make sure the lug cup is clean. Then flux and tin the cable tip and inside of the cup, and melt enough solder in the cup to half fill it. The lug can be held in the flame of a torch until hot and then melt the solder in it. Be careful not to burn your pliers when heating lugs, as it destroys the temper of the steel if the pliers are held in the edge of the flame. The lug can easily be held in the flame with a wire hook, and then taken in the pliers when heated and ready to melt the solder in it.

When the cup is heated and half full of molten solder, push the cable tip down in it, and hold it there while the lug is cooled. A wet rag may be used to cause the solder to harden quickly. Do not move the cable while the solder is hardening.

### 34. SOLDERLESS CONNECTORS

Solderless connectors such as shown in Figs. 28 and 29 are sometimes used for connecting cables. These devices have a sort of sleeve or clamp that is squeezed by the threaded nuts causing them to grip the cable very securely. These are much quicker to use and very good for temporary connections,

but are not allowed for permanent connections in some places.

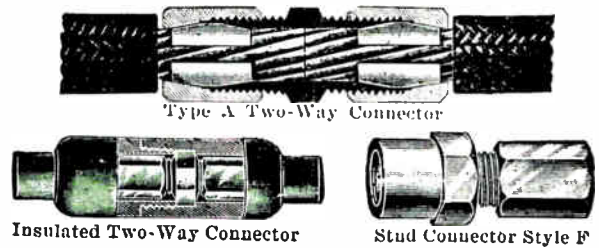

Fig. 29. Several other types of solderless connectors, showing a sectional view of the upper one which illustrates the method in which it grips the cable.

Solderless connectors can also be obtained in several very good forms for smaller wires, and are great time savers on jobs where they can be used.

Another method of splicing solid wires is by the use of the tubes shown in Fig. 30. The wires are slipped into these tubes and then the whole thing twisted into a splice.

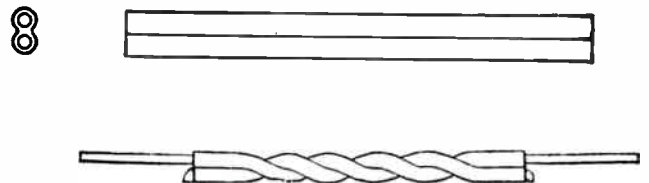

Fig. 30. Twin metal tubes of the above type are often used for splicing large solid conductors.

### 35. LEAD COVERED CABLE SPLICING

When splicing large lead sheath cables, the lead is split back from 10 to 36 inches according to the cable size, and a large lead sleeve slipped over one of the cable ends for use in covering the splice when it is finished. The one or more conductors in the cable are then spliced and taped.

If paper insulation is used on the conductors the moisture is boiled out of them by pouring hot molten paraffin over them. See Fig. 31.

When the splice in the conductors is finished the lead sleeve is slid over it, and its ends are joined to the cable sheath by pouring hot lead over them and "wiping" it on with a pad as it cools. This



Fig. 28. Several styles of solderless connectors used for splicing cables. These connectors grip the cable very securely when their nuts are tightened with a wrench.

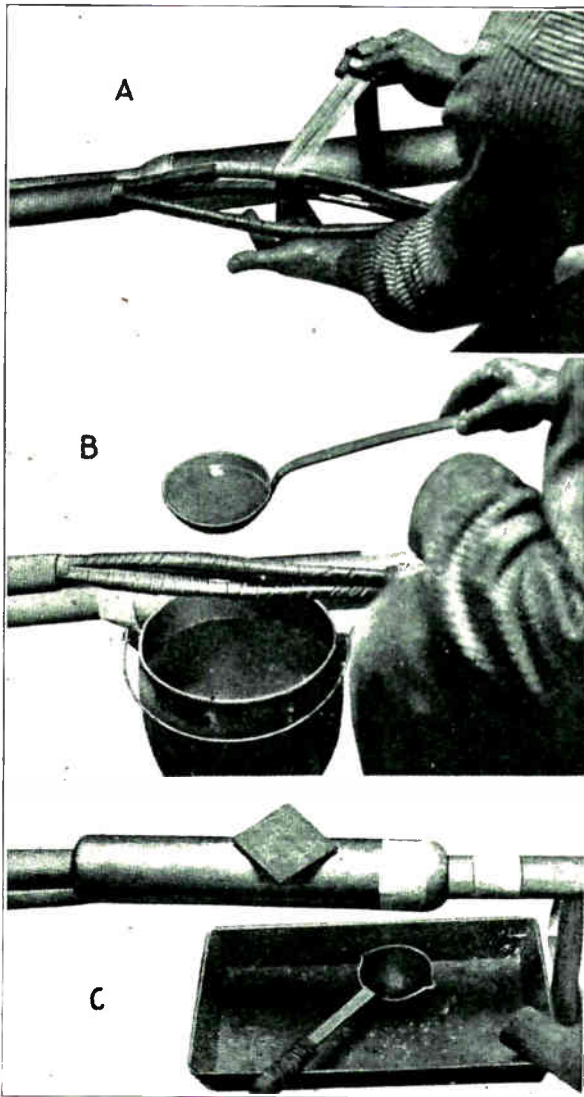

Fig. 31. This view shows several of the important steps in splicing lead covered cables.

is a very critical job and one that requires a lot of practice to get the lead on smoothly and obtain a tight junction, without melting the sheath. The whole joint is then poured full of hot paraffin or insulating compound, through a small drilled hole in the sleeve. Then this hole is plugged tight to exclude all air and moisture.

Fig. 32 shows some of the steps in making such a splice.

### 36. TAPING OF SPLICES

All splices on wires with ordinary rubber and braid insulation should be taped carefully to provide the same quality of insulation over the splice as over the rest of the wires.

Two kinds of tape are used for this, one a soft gum Rubber Tape, and the other known as Friction Tape, which consists of cloth filled with sticky insulating compound.

The rubber tape is applied to the splice first to provide air and moisture tight insulation of high

dielectric strength, and equal to the rubber which was removed. The friction tape is then wrapped over the rubber tape to provide mechanical protection similar to that of the braid which was removed.

In applying rubber tape, cut from 2 to 4 inches from the roll and peel off the cloth or paper strip which separates it in the roll. Then start the end of this strip at one end of the splice, tight to, or slightly overlapping, the rubber on the wires. Stretch it slightly while winding it on spirally. Press or pinch the end down tightly onto the last turn to make it stick in place. See Fig. 33.

A short time after this tape is applied, it becomes very tightly stuck together in almost a continuous mass, so it cannot be unwound, but would need to be cut or torn off. This is ideal for proper insulation.

The friction tape is "peeled" from the roll and applied in a spiral winding of two or more layers.

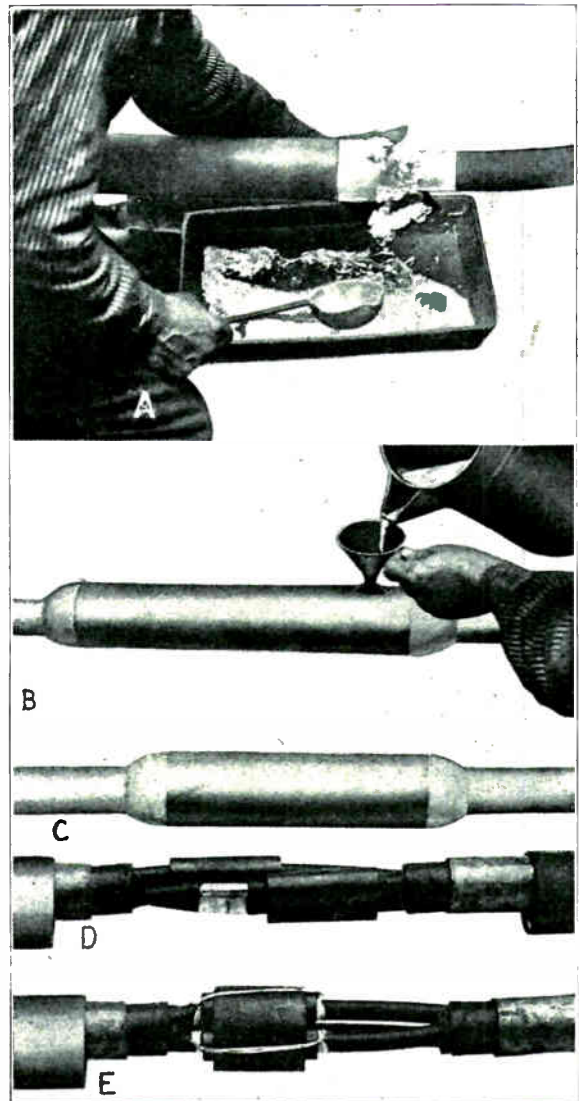

Fig. 32. "A" shows method of "wiping" the joint between the sleeve and sheath of a lead covered cable. "B", Pouring the finished splice full of hot insulating compound. "C", Finished splice with sleeve in place. "D" and "E", Small inner sleeves of insulating material are often used to separately insulate the several conductors.

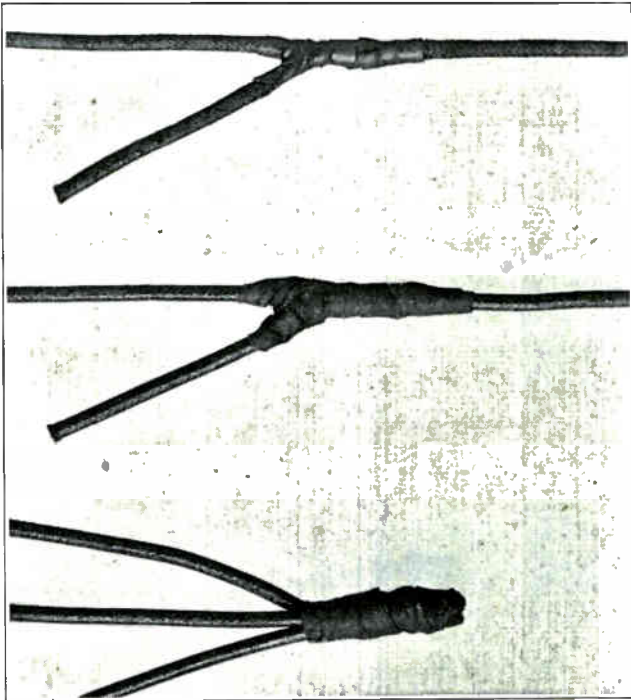

Fig. 33. The upper view shows a "tap" splice covered with rubber tape. The center and lower views show "tap" and "pigtail" splices completely taped with both rubber and friction tape.

Each turn should lap well over the preceding one. Sometimes where one has working room to allow it, the friction tape can be started on the splice without tearing it from the roll, and the roll then passed around the wire, allowing the tape needed to unwind as it is wrapped on the splice.

Friction tape can be torn off the roll, or it can be split in narrower strips by simply tearing it.

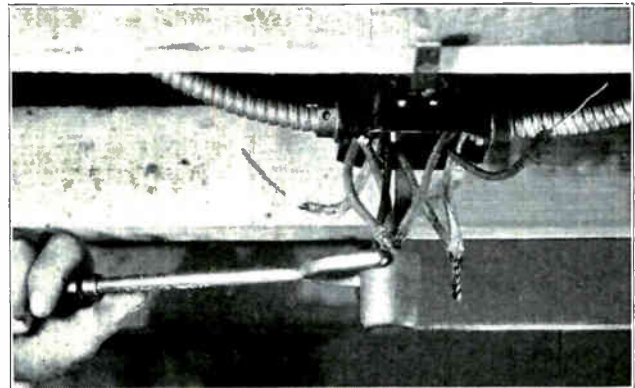

Fig. 34. Pigtail splices can be quickly and conveniently soldered by dipping in molten solder as shown.

## TYPES OF WIRING SYSTEMS

While we have found that the conductors for light and power wiring have good insulation on them, we can also see that this insulation is not sufficient to protect the wires from the mechanical injury and damage they would receive if they were just run loosely and carelessly about the buildings.

For this reason and also for the sake of appearance, all wiring must be run on proper supports, and with proper additional protection to its insulation where necessary. It should be located where it cannot be bumped with moving objects, and out of the way as much as possible.

In addition to the several general classes of wiring systems we have already mentioned, this work is also divided into several types of systems according to the method of installation, and kind of materials used.

Two general divisions are: **Open or Exposed Wiring**, and **Concealed Wiring**.

In open wiring systems the wires are run on the surfaces of the walls, ceilings, columns and partitions, where they are in view and readily accessible.

Concealed wiring systems have all wires run inside of walls and partitions, and within the ceilings and floors, where they are out of view and not easily reached.

Open wiring is often used in mills, factories,

warehouses, and old buildings, where appearance is not important, and where it may often be desirable to make changes in the wiring. One of its advantages is that it is always easy to inspect or repair.

Concealed wiring is generally used in all new buildings for homes, offices, stores, etc.; and also for many modern factories. It is much to be preferred where good appearance is important.

Another way of classifying wiring systems is based on whether or not the wires are run in metal.

### NON-METAL SYSTEMS

1. **Knob and Tube Work**, where the wires are supported by porcelain knobs and tubes. This system may be either open or concealed, and is a very low cost system.

2. **Cleat Work**, where wires are supported by cleats and knobs. This system is also very low in cost but cannot be concealed.

3. **Non-Metallic Sheathed Cable**. This is one of the newer systems to be permitted by the Code, is reasonable in cost, very convenient to install, and can be run concealed or open.

4. **Wood Moulding**, where wires are run in grooves in wood strips. This is a very old system and is now considered obsolete.

### METAL SYSTEMS

5. **Rigid Conduit.** Wires are run in iron pipes. This system is somewhat higher in cost, but is considered the best of all systems, and can be either open or concealed.

6. **Flexible Conduit.** Wires are run in flexible steel tubes. A very reliable system and very convenient to install in certain places. Can be either concealed or open work.

Both of the above are considered as one system by the National Code.

7. **Electrical Metallic Tubing.** Wires run in steel tubes, lighter in weight than regular conduit, and equipped with special threadless fittings. A very good system, and very convenient to install, but has certain code restrictions. Can be used for open or concealed work.

8. **Armored Cable (B. X.).** Wires are encased permanently in a flexible steel casing at the factory, and bought this way. A very reliable system and very convenient to install. May be run either open or concealed.

9. **Surface Metal Raceways.** (Often called metal moulding.) Wires are run in thin flat or oval metal tubes, or split casings. Low in cost, but can only be used for open work.

10. **Underfloor Raceways.** Wires run in metal casings or ducts under floors. Used in factories and offices, but under certain Code restrictions.

This list of the various types of wiring systems will also give you a good general idea of their applications and the materials used. We will now cover each system in detail, with its materials, advantages, and methods of installation.

### 37. KNOB AND TUBE WIRING

The Knob and Tube system is one of the oldest and simplest forms of wiring, and while not as reliable as conduit, it is allowed by the National Code, and is still used to some extent in small towns and rural homes. If carefully installed it will give very good service and at very low cost of installation.

The principal materials required for a wiring job of this type, are the **Porcelain Knobs**, **Porcelain Tubes**, and flexible non-metallic tubing known as "**Loom**".

The knobs are used to support the wires along surfaces or joists of the building. The tubes are to protect the wires where they run through holes in joists or walls, and the loom to protect the wires through holes, or where they enter outlet boxes or run close together.

### 38. KNOBS

Fig. 35 shows an excellent view of a split knob of the type commonly used, and also a porcelain tube in the lower view.

You will note that the knob has grooves on each side, with ridges in them to grip the insulation on the wire. The wire can be run in either groove, but do not run two wires of opposite polarity on one knob.

The nail has a leather washer under its head to

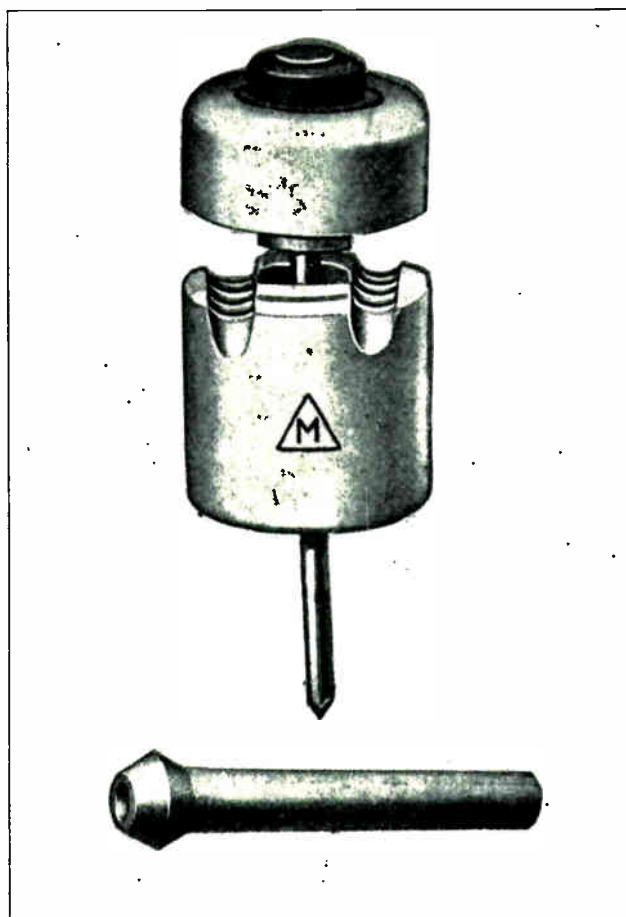

Fig. 35. The upper view shows a common type of split knob with the nail and leather washers which are used with them. Below is a porcelain tube of the type used in Knob and Tube wiring.

prevent splitting the knob caps when driving it tight. Care should be used, however, as it is possible to split the knob cap if it is tightened too much.

Knobs should be placed along the wire not farther than  $4\frac{1}{2}$  feet apart, and in some cases should be more frequent to provide proper support.

Before tightening the knobs, the wires should be drawn up tight so they will not sag and touch the wood, or present a bad appearance.

Wires of opposite polarity supported on knobs, must be spaced three inches or more apart.

Knobs can be used to support either horizontal or vertical wires, as long as the wires are drawn up tight.

Fig. 36 shows several styles and sizes of knobs, and also some porcelain cleats, and both a solid and a split porcelain tube.

The one piece knobs with the grooves around them must have the wires tied to them with a short piece of wire of the same size and insulation as the running wire.

Knobs must hold the wires at least an inch away from the surface wired over.

Sometimes knobs are fastened with screws instead of nails, and the ordinary split knob, such as shown in Fig. 35, would require  $2\frac{1}{2}$ " or 3" No. 10 flat head wood screws.

39. TUBES

Wherever the wires are to run through holes in joists or walls, the porcelain tubes must be used to prevent damage to the insulation by rubbing or vibration.

The standard tube is 3" in length and about 5/8" in diameter, and has a bulge or head on one end. Where the tube must run at a slant, the head should always be placed upwards to prevent the tube from dropping out of the hole. An exception to this is where wires enter an outlet box and the tube is held in place by the wire being bent back toward the nearest knob. The head should then be on the end which will prevent the angle of the wire from pushing it out of the hole.

Either a 5/8" or 11/16" wood bit can be used for boring the holes for standard porcelain tubes, and it is well to bore them with a little slant so the tubes will not tend to work out of the holes.

Other tubes can be obtained, both longer and larger than the common 3" size.

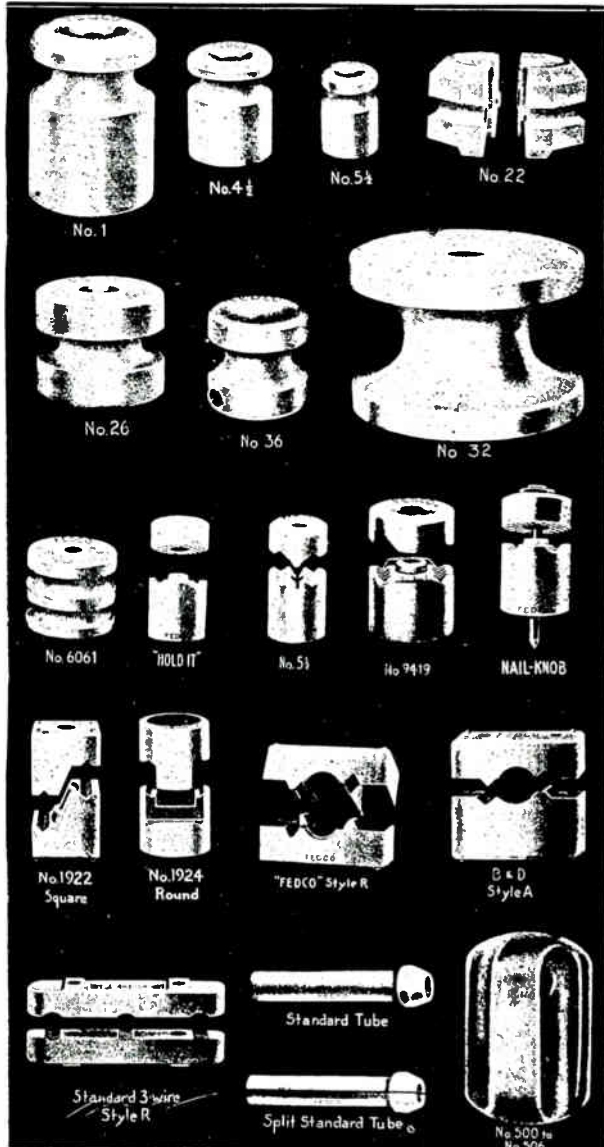

Fig. 36. Several different types of solid and split knobs, cleats and tubes.

40. LOOM

Fig. 37 shows a piece of the flexible "loom", and Fig. 38 shows a larger view of a small piece, in which you can see the inside construction of this woven insulation.



Fig. 37. A piece of "loom" or flexible insulation used to protect wires in certain places in Knob and Tube wiring.

Wherever wires enter an outlet box for a switch or lamp, a piece of loom must cover the wires from within the outlet box to the nearest knob outside the box. Fig. 39 shows a metal clamp used for fastening the end of the loom into the box. This clamp grips the loom with small teeth and wedges it tightly in the hole to prevent it from ever slipping out.

Where wires must be closer than 5 inches apart or where they must be run inside a wall, ceiling, or floor, for more than four and a half feet without knobs, they must be completely covered with loom. By protecting the wires in this manner they can be fished through difficult places in old house wiring, where knobs cannot be placed.



Fig. 38. Enlarged view showing the fabric and construction of a piece of "loom".

Some electricians occasionally try to cheat the Code and the customer by placing short pieces of loom only at each end of such a wire run, and not clear through. But when caught by a careful inspector, or when it causes a fire, such work as this costs the electrician far more than the extra loom for a good job would have cost.

In some places even in new house wiring it may be desired to run five or six wires or more between the same two joists. This cannot be done with knobs and still keep them all five inches apart. It can be done, however, by covering the wires with loom and running them all between two joists, or by grouping them all on one joist under loom straps.

Where one wire crosses another, or crosses a pipe of any kind, if it cannot be supported well away by a knob, a porcelain tube or piece of loom five or six inches long can be slid on the wire and taped in place at its ends, to hold it directly over the wire or pipe to be crossed.

Wherever wires are attached to switches or enter outlet boxes, or where a tap is taken from a wire, a knob should be located close to this point to take all possible strain off from the splice or switch, or edge of the outlet box. See Fig. 40-A, which shows



how a knob can be used both to support the running wire and to secure the tap wire and keep any strain off the splice.

Fig. 40-B shows how an extra knob should be placed near the point where a splice is made to a running wire which is not supported by a nearby knob.

Fig. 41 shows a section of a knob and tube wiring system in which you can observe a number of the parts and methods which we have mentioned for this type of work.

Examine this photo closely and note the important points shown.

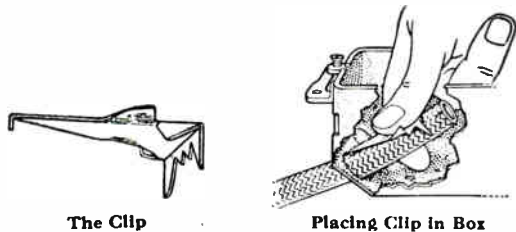

Fig. 39. "Loom" can be fastened securely in the outlet box with clips as shown above.

#### 41. RUNNING THE WIRES

When wiring a new building with a knob and tube system, it is quite easy to install the wiring between the joists in walls and ceilings before the lath and plaster are put on.

The wires should be run for the mains and branch circuits, and the outlet boxes for switches and lights should be installed. The boxes should be set so their edges will be about flush with the plaster surface, or a little beneath it. They should not be "recessed" or set in, more than  $\frac{1}{4}$  inch at the most. These outlet boxes will be explained later.

When running wires in old buildings, advantage can usually be taken of unused attics or basement ceilings, making it quite simple to run the wires in these places. Where the wires are likely to be disturbed or injured, if run on protruding knobs, it is well to protect them by running a board along

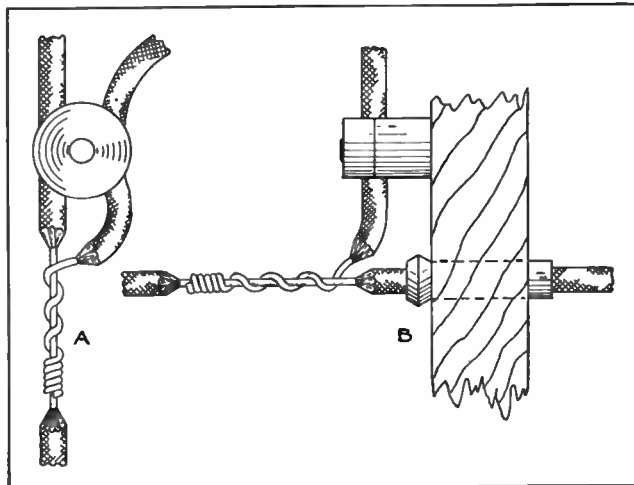

Fig. 40-A. Sketch showing a Knob used both to support the "running" wire and to keep the "tap" wire from putting any strain on the splice.

Fig. 40-B. When no Knob is near on the "running" wire an extra one should be placed on the "tap" wire close to the splice in the manner here shown.

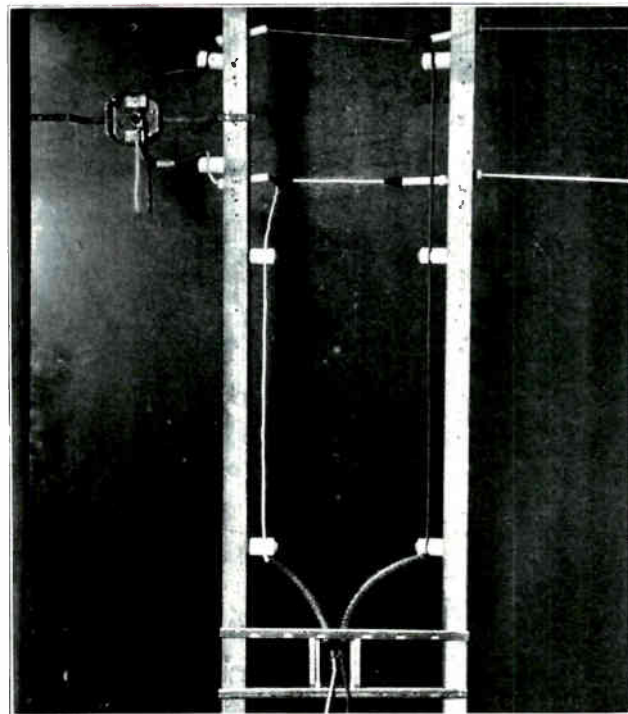

Fig. 41. This photo shows several of the most important features in a Knob and Tube wiring system. Note particularly the manner in which the "loom" extends from the outlet box, the use of the porcelain tube where the wires cross, and position of tubes in the joists when they are near to knobs as shown.

them, or by running the wires through the joists in tubes.

Where the wires are run through walls to switch boxes or wall light outlets, they can usually be pushed up or dropped down between the vertical joists and pulled out through the outlet opening.

A "mouse" and string, as formerly described in the section on signal wiring, can be used to good advantage to pull the wires through vertical walls.

Where they must be run horizontally through hollow floors or ceilings, a steel fish tape can be pushed through first, and used to pull in the wires. These fish tapes are long, thin, flat pieces of springy steel and obtainable in different sizes and lengths. They can be pushed and wiggled quite a distance through spaces between joists, and even around corners and obstructions to quite an extent. They are also used for pulling wires in conduit, as will be explained later.

Fig. 42 shows a piece of fish tape rolled in a coil for convenient carrying.

An ordinary jointed steel fishing rod, or a long thin stick with an eye in the end, can often be used very well to push wires into difficult places, or to push a string through and then use the string to pull in the wires.

#### 42. OUTLET BOXES

Where wires are attached to switches or fixtures, proper outlet boxes should be used. Fig. 43 shows a common type of outlet box for use with switches or convenience outlet receptacles. This box is made of thin steel and in sections, so it can be made wider to hold several switches or receptacles if desired.

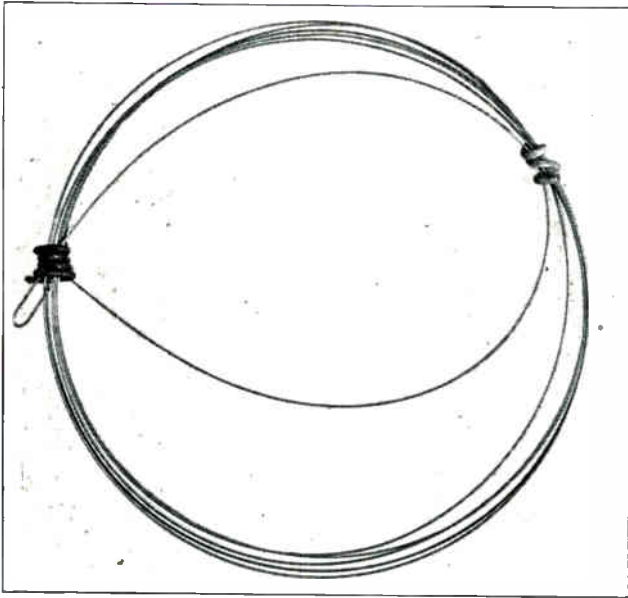

Fig. 42. A coil of steel fish tape, such as used for pulling wires into difficult places in a building, or through conduit.

The small detachable "ears" on each outer end are to fasten the box to the lath or wall, and they are adjustable so the box can be set out farther by merely loosening the screws in the "ear". These boxes have "knockout" pieces or round sections cut nearly through the metal, so they can be punched or knocked out with a hammer. These openings are for the loom and wires to enter the box for connecting the switch.

Such outlet boxes provide a rigid support for the switches or receptacles, and a protection around the back of the devices where the wires are connected.

The center and lower views in Fig. 43 show a clamping plate and screw inside the box with special shaped notches for gripping the loom or flexible conductor sheath where it enters. Note that the notches in this plate come directly over two knockout slugs.

Outlet or knockout boxes of this type can be obtained with the small knockouts to fit loom, or with

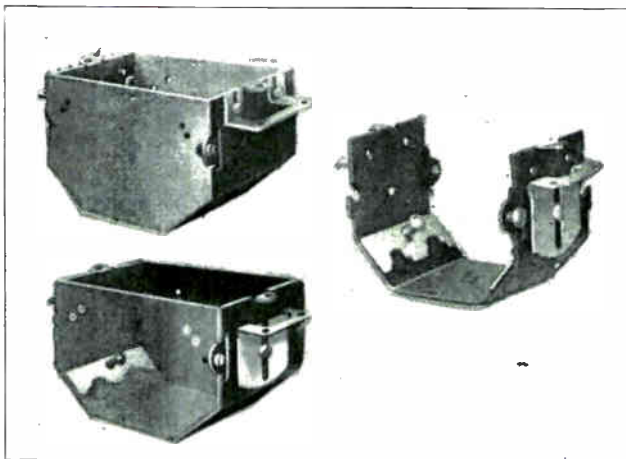

Fig. 43. Several views of a sectional outlet box of the type used for mounting switches and receptacles.

larger ones for conduit, but the boxes are standard size to fit all push button or lever switches.

Fig. 44 shows a double outlet box for two switches or receptacles. The screws in the small "lips" at the center of each end are for fastening the switches or receptacles in the box.

Fig. 45 shows a type of ceiling outlet box, used to attach wires to lighting fixtures, and also to support the fixture in wiring of old houses. Boxes of this type, but at least  $1\frac{1}{2}$  inches deep are commonly used for ceiling outlets in new buildings.

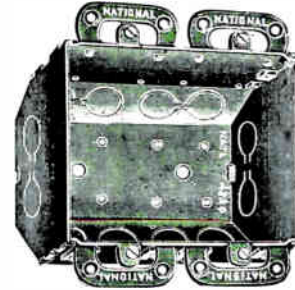

Fig. 44. Double outlet box for mounting two switches, two receptacles, or a switch and receptacle.

Fig. 46 shows some of the various types of outlet boxes and covers available. You will note that some of these have both small and large knockouts, so they can be used either with loom for knob and tube wiring, or with conduit.

Fig. 47 shows an outlet box with bar hanger used to support it between joists, and you can also note the fixture stud in the center of the box for attaching a lighting fixture. This box also contains two new style loom clamps.

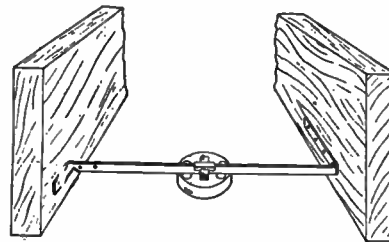

Fig. 45. A metal bar or hanger is used to support outlet boxes between the joists.

Fig. 48 shows how large solid knobs are often mounted on racks to support various numbers of power cables.

### 43. CLEAT WIRING

In cleat wiring systems the wires are run in pairs and supported in grooves in the ends of porcelain cleats such as shown in Fig. 49. This view shows a two-wire cleat, but they are also made for three wires.

These cleats are fastened to the walls or ceilings with two screws through the holes shown. They must support the wires at least  $\frac{1}{2}$ " from the surface wired over, and keep them at least  $2\frac{1}{2}$ " apart.

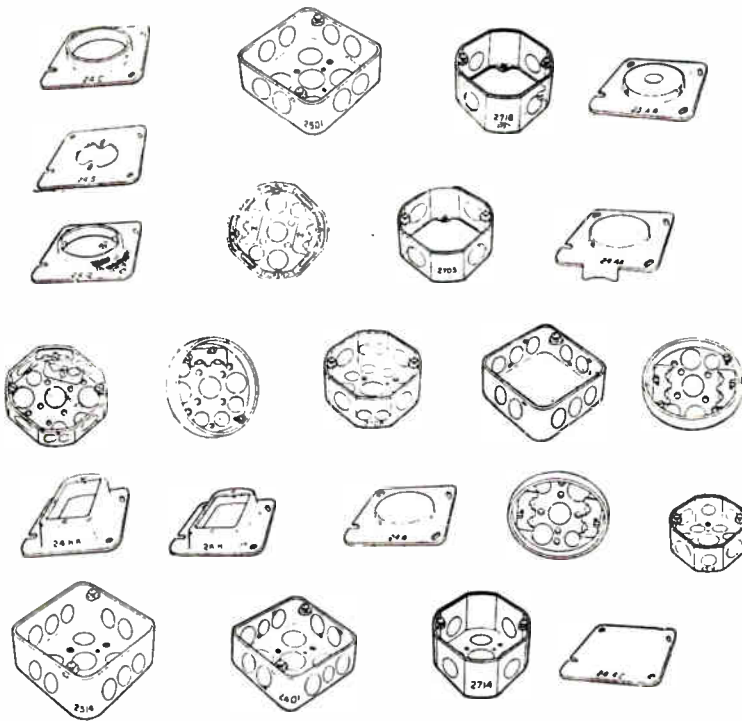

Fig. 46. Several types of outlet boxes and covers. Note the arrangement and size of the "knock-out" openings.

Cleats should not be placed farther apart than  $4\frac{1}{2}$  feet along the wires, and in many places should be closer.

Cleat wiring may be used as part of a knob and tube or other system, but must always be run exposed.

Tubes or loom must also be used where the wires pass through walls or partitions.

#### 44. CLEAT FITTINGS

To attach fixtures to a cleat wiring system we can use an outlet box that fastens to the ceiling or wall with screws and is covered by the canopy of the fixture. Loom must be used where the wires enter the box.

For installing plain lamps with reflectors only, cleat receptacles or rosettes, such as shown in Fig. 49-B, are used. The two in the upper row are to be mounted on the same surface the cleats are on, and the wires should be attached directly to the termi-

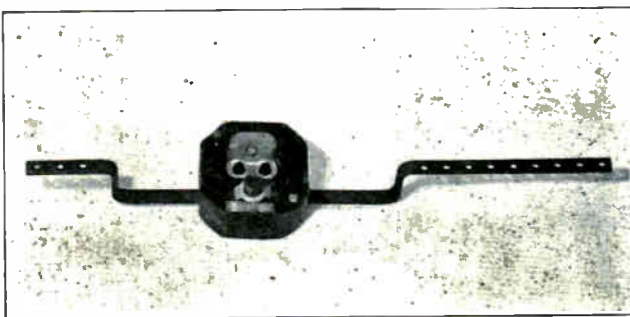

Fig. 47. This photo shows the inside of a common outlet box with fixture stud and "loom" clamps in place, and also the bar used for mounting the box.

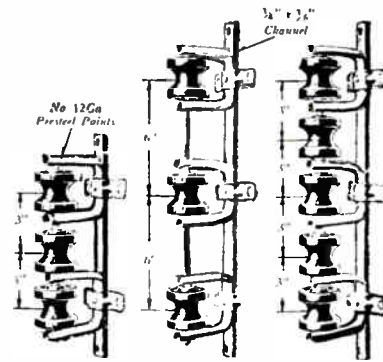

Fig. 48. Large solid knobs on special brackets of the type shown above are often used to support runs of several large wires or cables. Open wiring systems in factories and industrial plants often make use of knobs or cable racks of this type. They are very convenient to install, and the knobs can be removed by withdrawing the rod which runs through them, thus making it easy to place the wires on the inside of the knobs if desired, or in other cases they are tied to the outside of the groove with a tie wire.

nals of the receptacles. Lamp bulbs can be screwed into the openings shown. The two in the center row are called "rosettes" and are used to suspend lamps on drop cords. The two below are other types of drop cord rosettes, and the one at the left can be used either with cleat or moulding work.

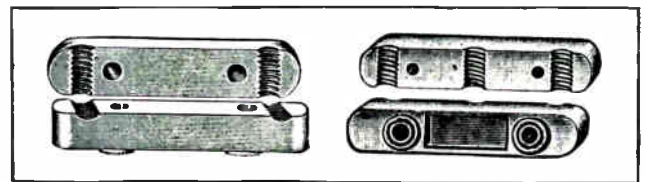

Fig. 49. Porcelain cleats of the type used for holding two or three wires in cleat wiring systems.

Surface type snap switches are commonly used in cleat work, and a porcelain Switch Back is used to hold the switch base and wires  $\frac{1}{2}$  inch away from the mounting surface.

The same general rules are followed in cleat work, as were given in knob and tube work, for protecting wires where they may cross pipes or each other. We should also use cleats near splices or connections to devices, as we do with knobs, to remove any possible strain from the splices.

#### 45. NON-METALLIC SHEATHED CABLE

This system of wiring consists of wires encased in a covering of protective fabric. Fig. 50 is a sketch of a piece of this cable of the two-wire type, and shows the extra insulation on the wires as well as the outer covering, which is somewhat similar to loom.

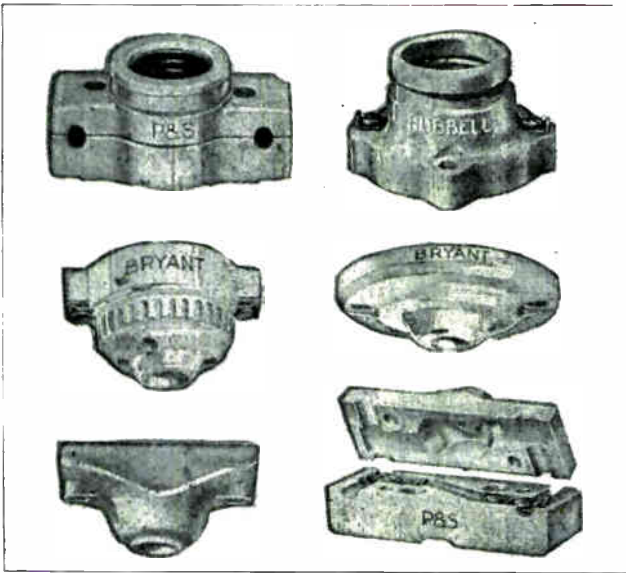

Fig. 49-B. Several types of porcelain receptacles used for attaching lamps or drop cords to a cleat wiring system.

This material is known by several different trade names such as "Romex," and "Loomflex," and can be obtained in either two-wire or three-wire cables. Fig. 51 shows a piece of each kind, and the method of fastening them to the walls or partitions with metal straps.

This type of cable is very flexible and very easy to install and, as before mentioned, it can be run either exposed or concealed. In concealed wiring it can be run between joists or through holes without any additional protection, and simply fastened in place by the small metal straps, such as shown in Fig. 51. This cable is very popular for wiring old buildings.

#### 46. INSTALLING ROMEX

The holding straps must not be spaced farther apart than three feet, and the cable should always be run along some supporting surface such as a joist, wall, or ceiling. When run across joists or open spaces it should be supported by a board. When it is being run concealed in new buildings the straps can be placed 4½ feet apart, and in old buildings, where it is impractical to support the cable with straps, it can be fished from one outlet to another, similarly to wires covered with loom.

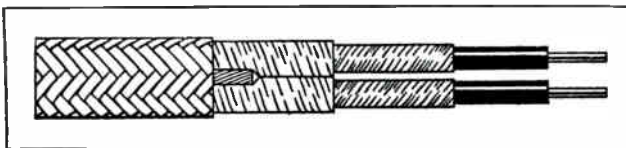

Fig. 50. This sketch shows the construction of a piece of non-metallic sheathed cable or "Romex". Note the heavy layers of extra insulation on the wires, and also the strong outer braid covering.

Even though the original cost of this material is somewhat higher than that of the same number of feet of wire with knobs and tubes, the ease with which it can be installed makes the finished system very reasonable in cost.

Any bends in such cable runs should be carefully made so as not to injure the covering and insulation of the cable, and the bends should have a radius of not less than five times the diameter of the cable.

Regular outlet boxes of the type already explained are used where switches and fixtures are to be installed. All cable runs must be continuous and without splices from one outlet box to the next.

Where the cable comes through the floor, or is run along a partition within six inches of a floor, it should be protected by running it through rigid conduit or pipe.

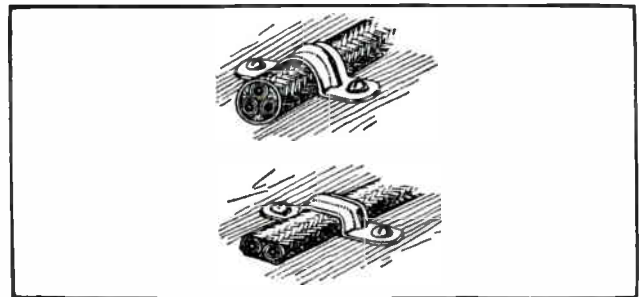

Fig. 51. This view shows a piece of three-wire and one of two-wire non-metallic sheathed cable, and also the method of attaching this cable to a surface with metal straps and screws.

#### 47. GROUND WIRES AND FITTINGS

One form of this sheathed cable has a bare copper wire run under the outer covering, parallel to the insulated wires. This wire is used for grounding the various outlet boxes and fixtures, and it should be securely grounded at the service switch, or entrance to the building.

Fig. 52 shows several methods of attaching the

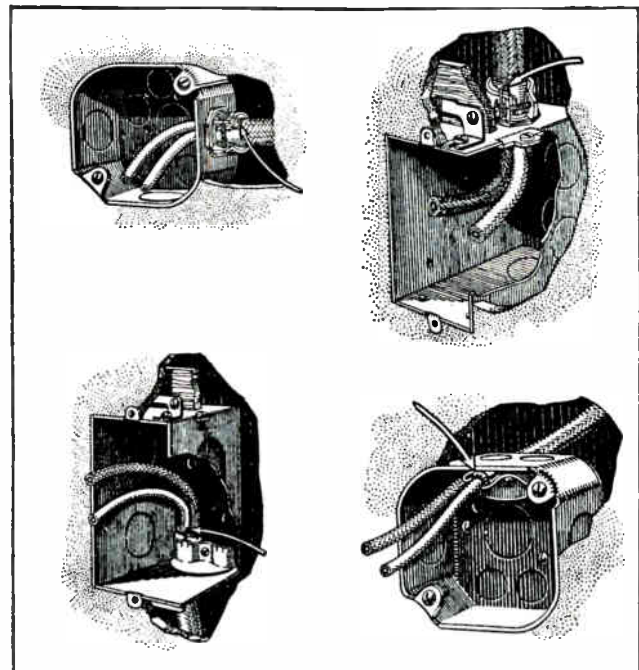

Fig. 52. The four views above show methods of attaching Romex to outlet boxes with special clamps for this purpose. Note the ends of the wires, which are to be stripped back to allow the splicing or connection.

cable to common outlet boxes. The two upper views show the use of a "squeeze" clamp, which is attached to the outlet box with a lock-nut, and into which the cable is inserted and then gripped by tightening the screw of this clamp. The two lower views show another type of clamp similar to those used for fastening loom.

The ground wires should be stripped back six or eight inches through the outer covering of the cable to allow the wires to be stripped for connections in the box, and then this ground wire is attached to the cable clamp, as in Fig. 53, thus effectively grounding the outlet box. The ground wire must not in any case be left inside the box.

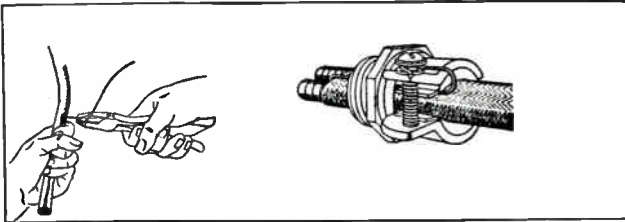

Fig. 53. This sketch shows the method of stripping back the extra ground wire in non-metallic sheathed cable, and also the manner in which it is attached to the outlet box clamp.

Fig. 54 shows a method of installing non-metallic cable in the joists of a new house, and Fig. 55 shows how it can be installed in the attic of either a new or old building.

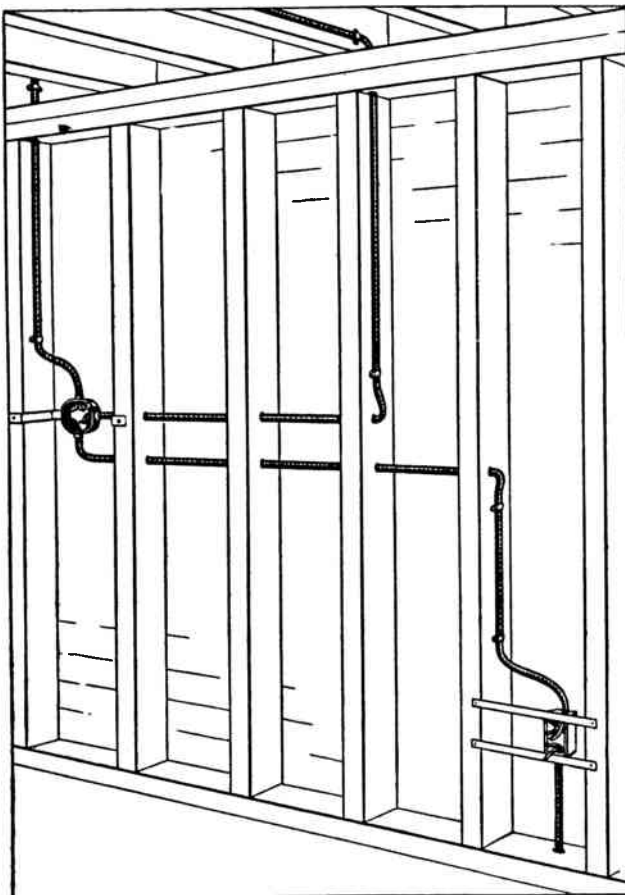

Fig. 54. A section of an installation of RomeX, showing how it is run through and along joists of a building.

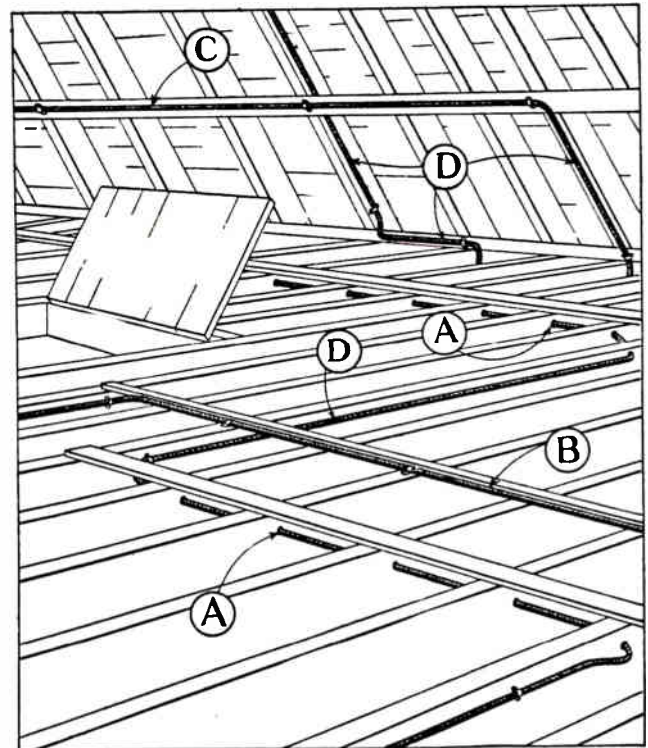

Fig. 55. RomeX is a very convenient type of wiring to install in the attics and walls of finished buildings.

In general, the installation of non-metallic cable is very similar to that of armored cable, or B.X., which is covered in a later section.

#### 48. WOOD MOULDING

As previously mentioned, this system of wiring is not used much any more, but you may possibly still find some installations of it, where an extension in the same type of wiring might be desired. Even then, it would probably be better to install metal moulding or raceway, unless the other system had to be matched exactly.

Fig. 56 shows a sketch of a piece of this moulding, and the manner in which the wires are run in the grooves, and the wood cap placed over them.

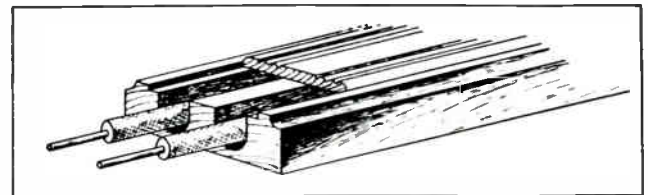

Fig. 56. A piece of wood moulding of the type sometimes used in making additions to old systems of this type.

When installing switches or fixtures with this type of system, the moulding is either cut to allow the mounting of a special porcelain block or fitting to which the wires are attached, or in some cases connection may be made direct to the switches, which can be mounted flush with the surface of the moulding. A special fitting is also required where tap splices are made to running wires.

We would not advise using this type of wiring in any case, except where absolutely necessary to match some existing system. In many old systems of this type the wiring can be made a great deal safer and more dependable if it is entirely removed and replaced with a more modern system.

### RIGID CONDUIT WIRING

While this system is a little more expensive to install, it is usually by far the safest and most satisfactory type of wiring. In this system the wiring is enclosed throughout in rigid steel pipe, which can be run either exposed or concealed in wood building partitions, or even embedded in the concrete or masonry of modern fire-proof buildings.

Concealed conduit must, of course, be installed in either frame or masonry buildings while they are being erected, although additional runs of exposed conduit are sometimes added or installed in finished buildings.

#### 49. ADVANTAGES OF CONDUIT WIRING.

With the conduit system grounded as required by Code rules, there is practically no chance of fire or personal injury, due to any defects in the wire or insulation, because in such cases the wire becomes grounded to the pipe, and will immediately blow the fuse and open the circuit as soon as the fault occurs. In case of any momentary grounds or short circuits in such systems, the fact that the wires are enclosed in metal pipe makes it almost impossible to start any fires.

Some of the general advantages of conduit wiring are as follows:

1. The wiring is much more compact, and takes up less space than when strung out on knobs.
2. The grounded metal conduit shields the conductors magnetically, and prevents them from setting up external magnetic and electro-static fields that would otherwise interfere with telephones or radio equipment.
3. Conduit forms an absolutely rigid support for the wires without placing any strain on them, and also affords excellent protection from any mechanical damage or injury to the conductors.
4. It provides a very convenient method of grounding the circuit at any desired point.
5. It is suitable for both low voltage and high voltage wiring, depending upon the insulation of the wires or cable used; while the other systems mentioned can be used only for voltages under 600, and several of them under 300.

In addition to the above advantages, rigid conduit can be made absolutely water-proof, and is, therefore, suitable for wiring in damp locations.

In wiring new homes the slight extra cost is well worth while, because a conduit system will certainly be the most dependable and permanently satisfactory one obtainable. Many of the larger cities require that all new homes have conduit

wiring installed. Practically all modern apartment buildings, offices, hotels, and department stores use conduit wiring exclusively, and industrial plants and buildings of fire-proof construction use it very generally. Many towns require the use of conduit for the entrance of service wires to the buildings, even though the building itself may use some other form of wiring.

Conduit pipe is very much like ordinary gas or water pipe in general appearance, except that it is somewhat softer, so it can be more easily bent for making turns and offsets in the runs.

Fig. 57 shows a piece of rigid conduit, and a sectional view of the end, as well as the threads on the right hand end.



Fig. 57. Piece of rigid conduit or pipe, in which wires are run in conduit systems.

Conduit is made in standard sizes from  $\frac{1}{2}$ -inch to 6-inch inside diameter. These standard sizes are  $\frac{1}{2}$ -inch,  $\frac{3}{4}$ -inch, 1-inch,  $1\frac{1}{4}$ -inch,  $1\frac{1}{2}$ -inch, 2-inch,  $2\frac{1}{2}$ -inch, 3-inch, 4-inch,  $4\frac{1}{2}$ -inch, 5-inch, and 6-inch. These dimensions are approximately the actual inside diameter, usually being a little larger in each case. The  $\frac{1}{2}$ -inch size is the one most commonly used for ordinary house wiring, and  $\frac{3}{4}$ -inch is used on some of the main runs.

The inside surface of conduit piping is smoothed by the manufacturers, so it will have no rough spots that might cut or damage the insulation on the wires. It is also enameled to prevent rusting.

The outside surface is usually coated with water-proof enamel, or galvanized. One process for treating both inside and outside is called "Sherardizing", and is a process whereby zinc is applied to the surface while hot, in such a manner that it actually alloys with the pipe.

#### 50. CONDUIT FITTINGS AND METHODS OF INSTALLING

Conduit is made in ten-foot lengths for convenient handling and installation. Where longer runs are required between outlets, it is necessary to couple the ends of the pipe together by threading them with a die, and using a pipe coupling. Such joints should be thoroughly tightened to make them as water-tight as possible and to provide a good electrical circuit, as the Code requires that the entire conduit system be continuous, for the purpose of having a complete ground circuit.

Fig. 58 shows the method of using a die to thread the end of a piece of conduit, and the proper position to hold the die stock handles.

Fig. 59 shows a sketch of a pipe coupling at the left as it would be used to attach two straight lengths of conduit together. The view at the right shows a coupling used with a nipple to attach runs of conduit to an outlet box.

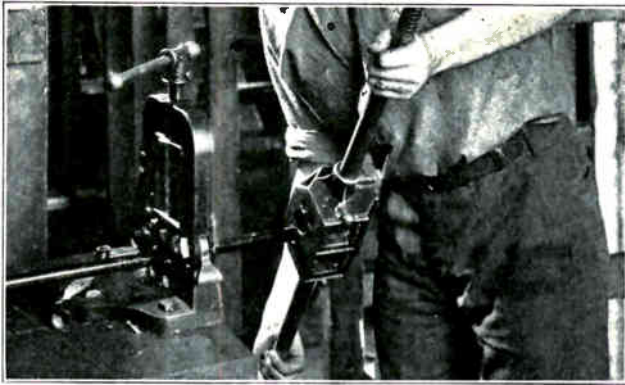

Fig. 58. Threading the ends of rigid conduit. Note the method of holding and operating the die.

Standard outlet boxes of the type already shown and described, with knockouts of the proper size, are used with conduit systems.

The common method of attaching the conduit to the outlet box is to thread the pipe end and screw a lock-nut well back on the threads. Then insert the threaded end in the box and screw on the end bushing. By tightening the lock-nut on the outside, the conduit is then securely fastened to the box. The box also becomes a part of the complete grounded circuit, and for this reason the lock-nuts should be well tightened with a wrench, to insure good connections.

Fig. 60 shows a conduit bushing on the left, and a lock-nut in the center view.

The bushing not only helps to secure the pipe to the box, but also has a smooth rounded end to protect the wires from damage against the edges of the conduit.

Never attach a small conduit to a hole that is too large in the outlet box, without using proper reducers or washers to get a secure connection.

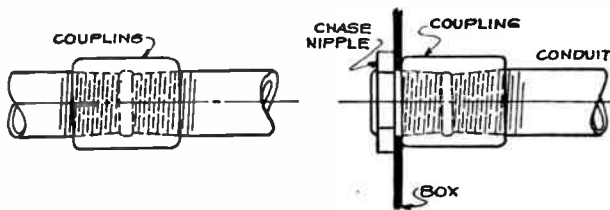

Fig. 59. Threaded couplings are used to connect lengths of conduit together, and in some cases to connect them to outlet boxes with a special nipple.

## 51. REAMING, CUTTING AND BENDING OF CONDUIT

The ends of all lengths of conduit are reamed at the factory to eliminate sharp corners that might otherwise damage the insulation on the wires. When you cut shorter lengths they should be reamed, as shown in Fig. 61, before coupling them together, or attaching them to outlet boxes. This removes any possible sharp edges on the inner corners, and protects the insulation of the wires from damage when drawing them in.

When a piece of conduit shorter than ten feet is required, it can easily be cut to the desired length

with a hack-saw, as shown in Fig. 62. Considerable care should be taken in measuring the length of conduit runs, so that the piece will be cut the proper length to fit the location of the outlet box, and avoid mistakes that will waste time and conduit.

Where a conduit run must turn a corner or go around some obstruction, the smaller sizes can be easily bent with a tool called a "hickey."

Fig. 63 shows the method of bending a piece of ½-inch conduit with one of these hickeys. The conduit can either be laid on the floor, as shown in this view, or fastened in a pipe vise securely mounted on a bench or truck. Special stands with pipe legs for attaching to floor are also obtainable for conduit bending and cutting. Fig. 63-B shows two types of hickeys or grips without the pipe handles in them.



Fig. 60. A bushing and lock nut of the type most commonly used in attaching conduit to outlet boxes.

## 52. SIZES AND TYPES OF BENDS, AND NUMBER ALLOWED

In making conduit bends care should be used not to bend them too sharply and cause the pipe to flatten, as this will reduce the inside opening, and make it difficult or impossible to draw the wires through it. The inside radius of any bend should not be less than six times the rated diameter of the conduit. This means that the bend would form part of a circle with a radius six times the conduit diameter. (Radius is distance from center to outside of a circle).

Thus, if we were bending ½-inch conduit, the inner radius of any bend should not be less than three inches, which would mean that the curve of the pipe should conform to, or fit the outer edge of a circle six inches in diameter.

Fig. 64 shows several of the more common bends made in conduit, and the names by which they are called. Not more than four right angle bends are allowed in any single run of conduit between outlet boxes. This is because the greater the number of



Fig. 61. Reaming the end of a piece of conduit after cutting to remove sharp edges, which might damage the insulation on the wire.

bends the harder it is to pull the wires through the pipe.

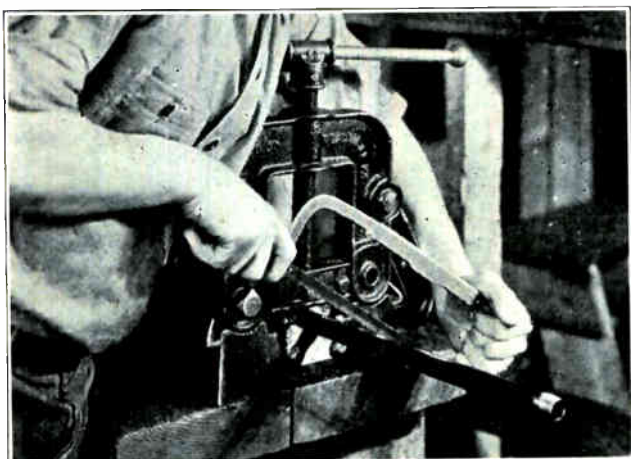

Fig. 62. Cutting a piece of rigid conduit with a hack saw. It should always be cut squarely as otherwise it is difficult to properly ream and thread it.

### 53. CONDUIT FITTINGS

While the sizes from  $\frac{1}{2}$ -inch to  $\frac{3}{4}$ -inch can be quite easily bent, on the larger sizes it is quite customary to buy manufactured elbows. However, the larger conduits can be bent on the job with power bending equipment, or by use of block and tackle, and some secure anchorage for the pipe. Sharp turns in conduit can be made by the use of fittings commonly known as condulets and unilets. These fittings are also made for attaching one length of conduit to another, and for crossing conduits, and for practically every need that can arise in a conduit installation.



Fig. 63. Smaller sizes of conduit can be easily bent into the required curves and shapes with a bending "hickey", in the manner shown here.

Fig. 65 shows a number of these fittings with their proper letters, by which they are marked and specified when buying. Examine these fittings and note their various applications carefully. The letter

L denotes an elbow or fitting used to make a right angle turn. An L.R. fitting is one that is used to make a turn to the right, while an L.L. fitting is one used to make a turn to the left.

These directions are determined by holding the condulets up with the opening toward you, and the short L. on the lower end. Then, if this short extension points to the right, it is an L.R., or if it points to the left it is an L.L. fitting.

An L.B. is one with a pipe opening in the back. An L.F., one with a pipe opening in the front.

There are also Tee fittings with a tap opening on the back or either side desired, and cross fittings with openings on both sides, as well as the ends. The fittings here mentioned are the ones more commonly used and, along with the special fittings made, will fill almost every need that can arise.

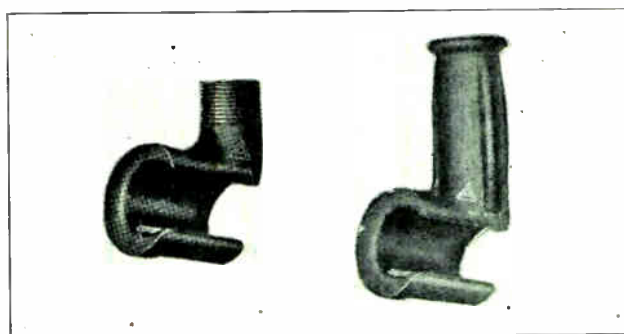

Fig. 63-B. These views show two types of grips or "hickeys" used with a pipe handle for bending conduit.

### 54. PULL BOXES AND JUNCTION BOXES.

In addition to these fittings, and the regular outlet boxes used for mounting switches and fixtures, there are also pull boxes, which are used at various points in long runs of conduit to make it easier to pull in the wires in shorter sections at a time.

Sometimes the run of conduit is so long, or has so great a number of bends, that it is impossible to pull the wires through the whole distance at once without running the risk of breaking them or damaging the insulation. In such cases the wires can be pulled through as far as the first pull box along the run, and then looped back, and pulled through the following section.

In other cases boxes are used where there are junctions in the wiring system and a number of splices must be made. These are called "Junction"

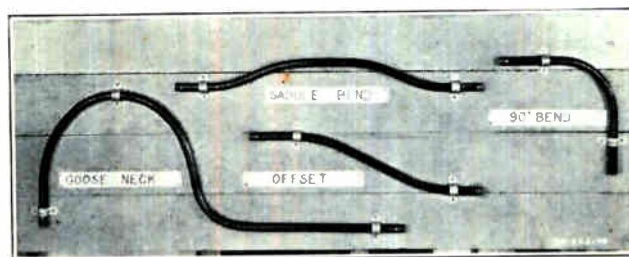

Fig. 64. This photo shows several of the more common bends frequently made in conduit. Note the names given to each. The saddle bend can, of course, be made much deeper in the form of a "U" when required.



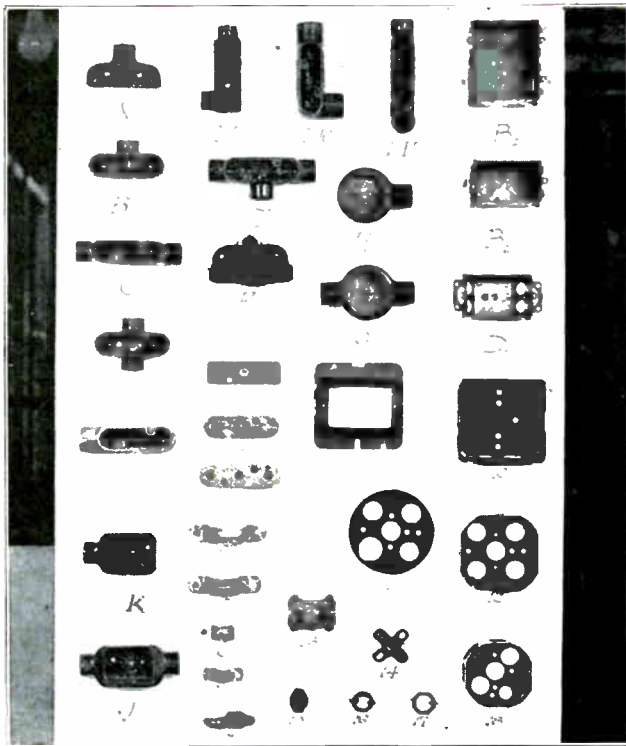

Fig. 65. This photo shows a number of the more common types of conduit fittings and outlet boxes, also porcelain covers for the fittings, conduit straps, fixture stud and lock nuts.

boxes. Several of the more common types of outlet boxes are shown in Fig. 65. There are many types of special boxes for almost every possible requirement, but those shown and mentioned here will fill the need in 95 per cent or more of the cases in ordinary wiring jobs. Fig. 65-B shows a number of the covers used on these boxes. Some are blank for merely closing the boxes, and others have openings and screws for attaching switches or receptacles, or for leading out wires to other terminals or systems.

## 55. SUPPORTS FOR CONDUIT

Conduit is supported and fastened with pipe straps, which may have either two holes for nails or screws, or a single hole. Fig. 65 shows several different types and sizes of straps.

When these straps must be attached to brick or masonry it is necessary to first drill holes in the masonry with a star drill, such as shown in Fig. 66. These drills can be obtained in different sizes, and are used to make holes of any desired depth by simply tapping them with a hammer and gradually rotating them in the hole. Those of the larger size can be used to make openings clear through a wall for the conduit to pass through.

When holes are made for conduit fasteners a special plug can be driven tightly into these holes to receive wood screws or nails; or a more desirable method is to use expansion bolts, similar to those shown in Fig. 67. For expansion bolts the star drill holes must be made the proper size to fit the

bolt, and when the expansion shell is inserted, and the bolt screwed into it, it causes the shell to spread and tightly grip the sides of the hole.

For fastening conduit or wiring materials to tile, a toggle bolt such as shown in Fig. 68 is used. These bolts have a hinge bar or cross-piece, which can be folded against the side of the bolt so they can be pushed into a small hole in the tile. Then, by turning the bar crosswise, the ends of this bar catch on the inner side of the hole, making a very secure anchorage.

In buildings of concrete or masonry construction the pipe is embedded in the cement, brick, or tile and requires no supports, except to hold it in place temporarily while the concrete is being poured, or the masonry erected around it.

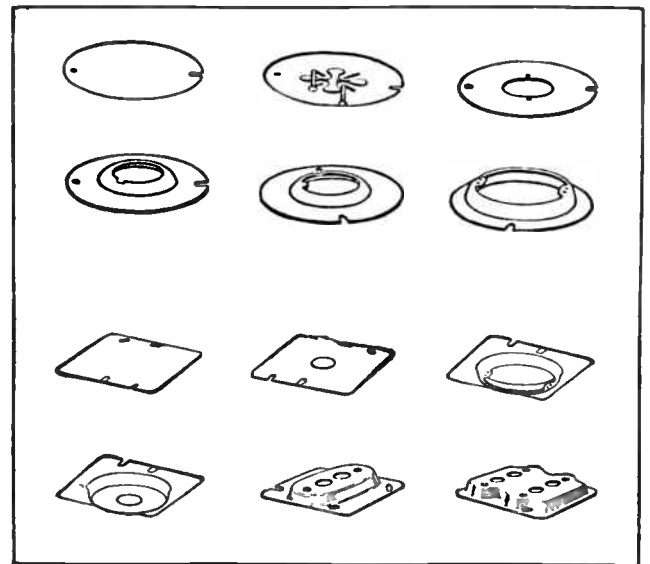

Fig. 65-B. Various types of covers can be obtained for outlet boxes and for mounting switches, lamp receptacles, etc.

The Code requires that in all conduit installations the pipe and fittings must be installed complete before any wiring is put in, and the wires should not be run until all mechanical construction work around the building is finished. This rule is made to avoid the possibility of the wires being damaged.

Ordinary rubber covered wire, with either single or double braid, can be used in conduit systems; but double braid must be used on wires larger than No. 8. In special locations where it is particularly dry and hot, wire with slowburning insulation can be used.

For use in conduit, wires No. 6 and larger must be stranded for better flexibility and ease in pulling them in.



Fig. 66. This view shows the cutting nose of a star drill, such as used for drilling holes in masonry for attaching or running conduit in buildings of masonry construction.

56. PULLING WIRES INTO CONDUIT

To pull wires into a conduit system we first push a steel "fish tape" through the pipe. This can be forced through the allowed number of bends quite easily, as a rule. The wires are then attached to the end of the fish tape and pulled in the conduit. All the wires in any one run should be pulled in at one time. It is very difficult and impractical to draw wires into pipe that already has several in it, because of the friction of the sticky insulation of the moving wires rubbing against the stationary ones.

This same rule applies when repairing or replacing wires in conduit. You may wish to replace only one or two wires, but it will often be better to remove the entire group, and then pull the new ones in with the old wires.

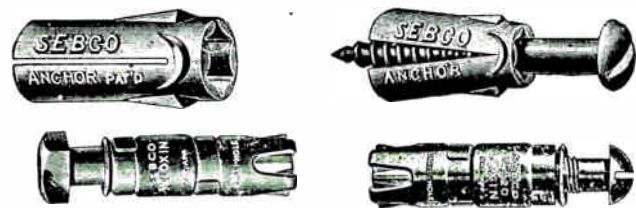

Fig. 67. Several types of expansion bolts and shells used for fastening conduit strips to holes and masonry.

No splices are allowed in wires in the conduit, or at any place except in the proper fittings or outlet boxes.

If we were to attempt to pull wires with splices into a run of conduit, the taping might be pulled off at some bend or corner, leaving the bare splice to cause a ground or short circuit.

As each section of the wiring is pulled into the runs of conduit, the ends can be cut off at the outlet box, always allowing enough to make the necessary splices and connections. It is much better to



Fig. 68. Toggle bolts of the type used to attach conduit to tile walls or ceilings.

allow a couple of inches extra and cut these off when installing the switches and fixtures, than to have the wires too short, and have to replace them or draw them up in a manner that places a strain on them.

Sometimes considerable difficulty is experienced in pulling wires into long runs with a number of bends, but a great deal of this can be eliminated by the proper care. If a large number of wires are to be pulled into any conduit, or if they have been

NUMBER OF CONDUCTORS IN CONDUIT OR TUBING

One to Nine Conductors Rubber-Covered—Types R, RW, RH, and \*\*RHT—600 V.

Size of Conductor	Number of Conductors in One Conduit or Tubing								
	1	2	3	4	5	6	7	8	9
No. 18	1/2	1/2	1/2	1/2	1/2	3/4	3/4	3/4	3/4
14	1/2	1/2	1/2	1/2	1/2	3/4	3/4	3/4	3/4
12	1/2	1/2	1/2	1/2	1/2	1	1	1	1 1/4
10	1/2	3/4	3/4	3/4	1	1 1/4	1 1/4	1 1/4	1 1/2
8	1/2	1 1/4	1 1/4	1 1/4	1 1/2	1 1/2	2	2	2
6	3/4	1 1/4	1 1/4	1 1/4	1 1/2	2	2	2	2
4	3/4	1 1/4	1 1/4	1 1/2	2	2	2	2 1/2	2 1/2
3	3/4	1 1/4	1 1/4	1 1/2	2	2	2 1/2	2 1/2	2 1/2
2	3/4	1 1/2	1 1/2	2	2	2 1/2	2 1/2	3	3
0	1	1 1/2	2	2	2 1/2	2 1/2	3	3	3
00	1	2	2	2 1/2	2 1/2	3	3	3 1/2	3 1/2
000	1	2	2	2 1/2	2 1/2	3	3 1/2	3 1/2	3 1/2
0000	1 1/4	2	2 1/2	2 1/2	3	3	3 1/2	4	4
250000	1 1/4	2 1/2	2 1/2	3	3	3 1/2	3 1/2		
300000	1 1/4	2 1/2	3	3	3 1/2	3 1/2	4		
350000	1 1/4	2 1/2	3	3 1/2	3 1/2	4	4		
400000	1 1/4	3	3	3 1/2	4	4	4		
450000	1 1/2	3	3	3 1/2	4	4 1/2	4 1/2		
500000	1 1/2	3	3	3 1/2	4	4 1/2	4 1/2		
550000	1 1/2	3	3 1/2	4	4 1/2	5	5		
600000	2	3	3 1/2	4	4 1/2	5	5		
650000	2	3 1/2	3 1/2	4	4 1/2				
700000	2	3 1/2	3 1/2	4 1/2	4 1/2				
750000	2	3 1/2	3 1/2	4 1/2	4 1/2				
800000	2	3 1/2	4	4 1/2					
850000	2	3 1/2	4	4 1/2					
900000	2	3 1/2	4	4 1/2					
950000	2	4	4	5					
1000000	2	4	4	5					
1250000	2 1/4	4 1/4	4 1/2	6					
1500000	2 1/2	4 1/2	5	6					
1750000	3	5	5	6					
2000000	3	5	6						

Fig. 69. This table gives the proper number of wires of different sizes which can be allowed in various conduits. It is very convenient to use in selecting the proper size of conduit for certain number of wires of any desired size.

started and don't come through easily, it is well to withdraw them and blow some powdered soap stone, or even powdered soap, into the conduit. This lubricates the wires, and eliminates a great deal of the friction, without doing any damage to their insulation. This is particularly useful when pulling in large cables.

Never use oil or grease of any kind on the wires, as it is very injurious to the insulation.

While pulling on the wires from one end, it is a very good idea to have someone feed them carefully in to the point where they are drawn in. Keeping the wires straight and free from kinks and twists will help considerably to make them pull in with the least possible friction.

Sometimes in vertical runs of conduit, instead of using a steel fish tape, a "mouse" consisting of a small steel ball or piece of steel chain, is dropped through the pipe with a string attached, and this cord can then be used to pull in the wires; or a large rope which in turn can be attached to the wires.

Wires in long vertical runs of conduit in high buildings should be supported at various intervals,

either by driving wood wedges into the pipes at outlet boxes, or by looping the wires around strain insulators in special boxes. This is done to remove from the wires near the top the strain of the weight of a long vertical run.

**57. NUMBER OF CIRCUITS AND WIRES ALLOWED IN ONE CONDUIT**

Wires of different voltages, such as bell wires and wires for light or power, must never be run in the same conduits.

When running wires for alternating current systems, the two wires of a single phase, or three wires of the three phase system, must all be run in the same conduit; otherwise, they will set up magnetically induced currents in the iron pipe, which will cause it to overheat.

Running all the wires of the same circuit through the one pipe causes their magnetic flux to be neutralized, because the currents flow in different directions through the different wires.

Fig. 69 shows a table which gives the proper number of wires that can be allowed in conduit of any given size; or, in other words, this table can be used to determine the sizes of conduit required for any number of wires of a certain size.

For example, from 1 to 4 No. 14 wires will require 1/2-inch conduit, while 5 to 7 can be run in 3/4-inch conduit, and from 7 to 9 in 1-inch conduit. To run 5 number 10 wires requires 1-inch conduit, or to run 3 number 6 wires requires 1 1/4-inch conduit.

These figures are for double braid insulation.

**DIMENSIONS OF RUBBER-COVERED CONDUCTORS**  
Types R, RW, RP, and RH

Size AWG-CM	Approx. Diam. Inches	Approx. Area Sq. Ins.	Size CM	Approx. Diam. Inches	Approx. Area Sq. Ins.
13	.14	.0154	450,000	1.08	.91
16	.15	.019	500,000	1.12	1.09
14	.20	.031	550,000	1.17	1.08
12	.22	.038	600,000	1.22	1.16
10	.24	.045			
8	.30	.071	650,000	1.25	1.23
			700,000	1.29	1.30
6	.41	.13	750,000	1.33	1.38
4	.45	.16	800,000	1.36	1.45
2	.52	.21			
1	.59	.27	850,000	1.39	1.52
			900,000	1.43	1.60
0	.63	.31	950,000	1.46	1.68
00	.67	.35	1,000,000	1.49	1.75
000	.72	.41			
0000	.78	.48	1,250,000	1.68	2.22
			1,500,000	1.79	2.52
250,000	.86	.58	1,750,000	1.90	2.85
300,000	.92	.67	2,000,000	2.00	3.14
350,000	.98	.75			
400,000	1.03	.83			

No. 18 to No. 8, solid conductor, No. 6 and larger, stranded.

Fig. 70. This table gives the diameter of various sized wires in inches and fractions. These diameters are given both for bare and insulated wires.

This table is very easy to read and use, by simply noting the sizes of the wire in the left-hand column and the number of wires desired in the row across the top, and then reading down under this number to the line for that size of wire, where the proper size of conduit will be found.

Examine this table carefully and become familiar with its use because it will prove very convenient.

For wire groups and combinations not shown in the table, it is recommended that the sum of the cross sectional areas of the wires to be run in any conduit should not be more than 40 per cent of the area of the opening or bore in the conduit.

Under such conditions, however, it is usually well to consult the Inspection Department before going ahead with the work.

Dimensions of Rubber-Covered Wire.

Wire	Area	Wire	Area	Wire	Area
14	.031	225,000 C.M.	.55	1,000,000 C.M.	1.74
12	.038	250,000 C.M.	.58	1,100,000 C.M.	2.04
10	.045	300,000 C.M.	.67	1,200,000 C.M.	2.16
8	.071	350,000 C.M.	.75	1,250,000 C.M.	2.22
6	.13	400,000 C.M.	.83	1,300,000 C.M.	2.27
5	.15	450,000 C.M.	.91	1,400,000 C.M.	2.40
4	.16	500,000 C.M.	.99	1,500,000 C.M.	2.52
3	.19	550,000 C.M.	1.08	1,600,000 C.M.	2.63
2	.21	600,000 C.M.	1.16	1,700,000 C.M.	2.78
1	.27	650,000 C.M.	1.23	1,750,000 C.M.	2.85
0	.31	700,000 C.M.	1.30	1,800,000 C.M.	2.89
00	.35	750,000 C.M.	1.38	1,900,000 C.M.	3.05
000	.41	800,000 C.M.	1.45	2,000,000 C.M.	3.14
0000	.48	850,000 C.M.	1.52		
		900,000 C.M.	1.60		
		950,000 C.M.	1.68		

Fig. 71. Table of areas of various wires and cables in square inches. These figures are very convenient when calculating the area of a number of conductors to go in conduit. Areas given include insulation.

The table in Fig. 70 gives the diameter and area in fractions of an inch for the different sized wires with insulation, while table 71 gives the area in fractions of a sq. inch of the more common sized wires. These tables will make it easy to determine the total area of a number of wires of any size that you might desire to run in conduit. Then it will be easy to tell whether this is more than 40 per cent of the size of the conduit, by referring to table 72, which gives the area in sq. inches of the different standard sizes of conduit.

DIMENSIONS OF CONDUIT

Conduit	Area	40% of Area	Conduit	Area	40% of Area
1/2	.306	.122	3	7.34	2.93
3/4	.516	.206	3 1/2	9.94	3.97
1	.848	.339	4	12.7	5.08
1 1/4	1.49	.596	4 1/2	15.9	6.36
1 1/2	2.03	.812	5	19.9	7.96
2	3.32	1.328	6	28.8	11.52
2 1/2	4.75	1.9			

Fig. 72. This table gives both the total area of the inside opening in conduit, and 40% of the area of the different sizes, which is the amount that can be occupied by the conductors.

This latter table also shows in two of the columns, 40 per cent of the area of each size conduit, which makes it a very handy table. As an example of its use, if we were required to run six number 6 wires and four number 2 wires all rubber covered, we would multiply the area of a number 6 wire, which is .13, by 6; or  $.13 \times 6 = .78$ . Then also multiply the area of a number 2 wire which is .21, by 4; or  $.21 \times 4 = .84$ . Then .78 plus .84 equals 1.62 square inches, total area for all the wires.

Now in the column headed "40 per cent of the area" it will be found that a 2½-inch conduit will be required, as it is the next larger, and 40 per cent of its area will be 1.90 square inches.

Ordinarily the Code doesn't permit more than nine wires of any size in one conduit. Sometimes it is not advisable to allow even this many, not only because of the difficulty in pulling them in but also because if one wire breaks down or develops a short or ground, the arc is likely to damage the insulation of all the others and cause trouble in other circuits as well.

Where lead covered conductors are to be run in conduit, the table in Fig. 73 will be very convenient for determining the proper size of conduit for any number of lead covered wires of a given size.

SIZE OF CONDUIT FOR THE INSTALLATION OF WIRES AND CABLES

Lead Covered Wires (0-600 Volts)												
Size of Conductor	Size of Conduit to Contain Not More than Four Cables											
	Single Conductor Cable				2-Conductor Cable				3-Conductor Cable			
	1	2	3	4	1	2	3	4	1	2	3	4
	Cables in One Conduit				Cables in One Conduit				Cables in One Conduit			
14	½	¾	¾	1	¾	1	1	1½	¾	1½	1½	1½
12	½	¾	¾	1	¾	1	1½	1½	1	1½	1½	2
10	½	¾	1	1	¾	1½	1½	1½	1	1½	2	2
8	½	1	1½	1½	1	1½	1½	2	1	2	2	2½
6	¾	1½	1½	1½	1½	2	2½	2½	1½	2½	3	3
4	¾	1½	1½	1½	1½	2	2½	2½	1½	3	3	3½
3	¾	1½	2	1½	2	2½	3	3	1½	3	3	3½
2	1	1½	1½	2	1½	2	2½	3	1½	3	3½	4
1	1	1½	2	2	1½	2½	3	3½	2	3½	4	4½
0	1	2	2	2½	2	2½	3	3½	2	4	4½	5
00	1	2	2	2½	2	3	3½	4	2½	4	4½	5
000	1½	2	2½	2½	2	3	3½	4	2½	4	4½	5
0000	1½	2½	2½	3	2½	3	3½	4½	3	5	6	6
250,000	1½	2½	3	3	...	...	...	...	3	6	6	...
300,000	1½	3	3	3½	...	...	...	...	3½	6	6	...
350,000	1½	3	3	3½	...	...	...	...	3½	6	6	...
400,000	1½	3	3	3½	...	...	...	...	3½	6	6	...
450,000	1½	3	3	4	...	...	...	...	4	6	6	...
500,000	1½	3	3½	4	...	...	...	...	4	6	...	...
600,000	2	3½	4	4½	...	...	...	...	...	...	...	...
700,000	2	4	4	5	...	...	...	...	...	...	...	...
750,000	2	4	4	5	...	...	...	...	...	...	...	...
800,000	2	4	4½	5	...	...	...	...	...	...	...	...
900,000	2½	4	4½	5	...	...	...	...	...	...	...	...
1,000,000	2½	4½	4½	6	...	...	...	...	...	...	...	...
1,250,000	3	5	5	6	...	...	...	...	...	...	...	...
1,500,000	3	5	6	6	...	...	...	...	...	...	...	...
1,750,000	3	6	6	...	...	...	...	...	...	...	...	...
2,000,000	3½	6	6	...	...	...	...	...	...	...	...	...

The above sizes apply to straight runs or with nominal offsets equivalent to not more than two quarter-bends. It is recommended that bends have a minimum radius of curvature at the inner edge of the bend of not less than 10 times the internal diameter of the conduit.

Fig. 73. This table gives the number of lead covered wires of different sizes that can be contained in various sized conduits.

58. GROUNDING CONDUIT SYSTEMS

When the entire conduit system is installed complete from the service switch and meter throughout the entire building, it must be thoroughly grounded as near to the source of current supply as possible. This ground connection should be made at a water-pipe whenever available. If no piping systems are in the building which can be depended upon for a good ground connection, then a good ground rod or piece of pipe can be driven into the ground

eight feet deep to make sure that it is always in contact with moist earth, or a large plate of metal can be buried several feet in the earth, and covered with charcoal and salt as well as earth.

All conduit systems are required to be grounded, whether any part of the wiring within them is grounded or not. These ground connections from the conduit to the waterpipe or ground rod should be as short as possible, and always accessible for inspection, as they must be maintained in good, unbroken condition at all times.

Where the wiring system is not polarized and none of its wires are required to be grounded, the conduit can be grounded by use of copper ground strips, as shown in Fig. 74, or by extending a piece of conduit from the regular conduit system to the waterpipe and attaching it securely at both ends with special clamps.



Fig. 74. Copper grounding strip of the type shown above is often used to ground conduit systems to the waterpipes or earth grounds.

Where wires are used for grounding, the wire should not be smaller than a No. 8, and should be attached to the waterpipe with a special grounding clamp, two styles of which are shown in Fig. 75.

Fig. 76 shows three styles of grounding clamps, the upper one of which is equipped with a cable lug, into which the heavy ground wire or cable should be securely soldered. The lower view shows two clamps that are used to attach both the ground wire and a piece of conduit to the waterpipe.

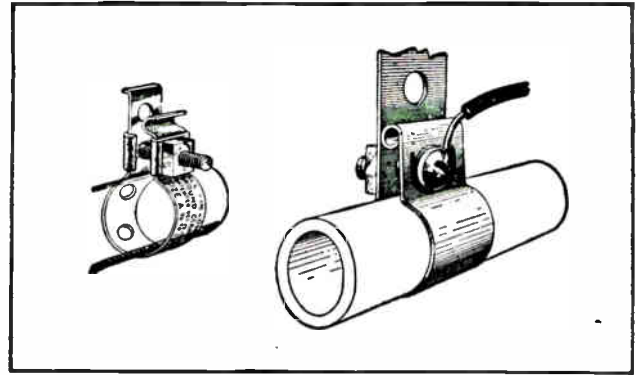

Fig. 75. Two types of grounding clamps used to securely attach ground wires to waterpipes.

These are used for polarized wiring systems, which will be explained later, and in which it is required to ground the neutral wire of the system with a ground wire, which is run through a short piece of conduit that is also connected to the waterpipe. This conduit not only acts as a ground for the conduit system, but also as protection for the ground

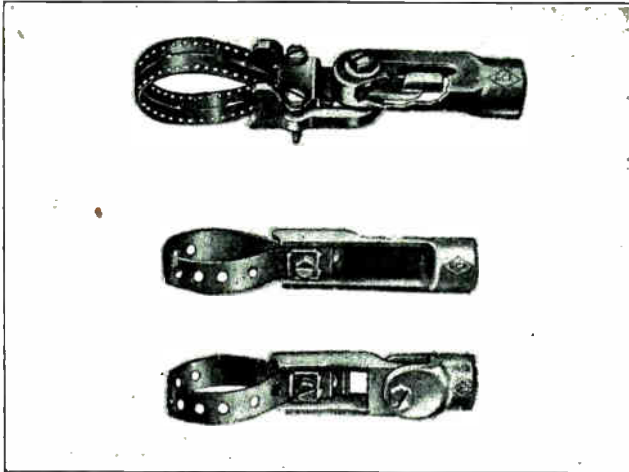

Fig. 76. Several approved type ground clamps used to attach both the conduit and ground wire to waterpipes.

wire of the electrical system. Always scrape all paint or rust from any pipe before attaching the ground clamp.

This thorough grounding, as previously mentioned, is an essential requirement for maximum safety from fire and shock hazard in a wiring system, and should be done with the greatest of care by the electrician when installing such systems.

Fig. 77 shows what is called an isometric or phantom view of a house in which a conduit system has been installed. This view shows the service and meter box in the basement, and the various runs of conduit to baseboard, convenience outlets and wall switches, wall and ceiling light fixture out-

lets on both the above floors, as well as a light in the attic.

### 59. ELECTRICAL METALLIC TUBING

This is a lightweight pipe, much like rigid conduit, which has recently been approved by the Fire Underwriters. It is made with very thin walls, so thin in fact that we are not permitted to thread it. This means that threadless fittings are used, which saves considerable labor.

Fig. 78 shows one of the fittings in a sectional view which shows the manner in which the tapered split sleeves are drawn in by the threads to grip the pipe.

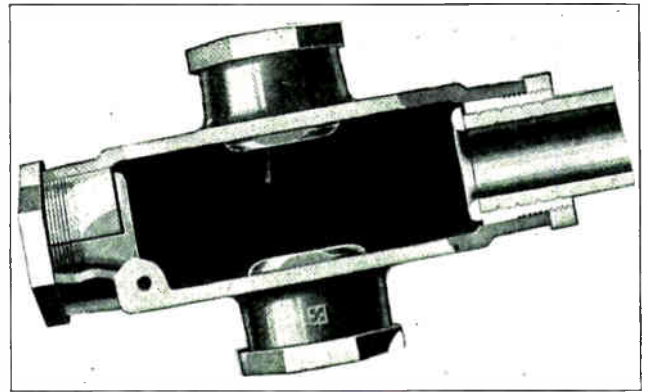

Fig. 78. Sectional view of a fitting for threadless conduit, showing the special gripping sleeves inside its ends.

Fig. 79 shows how easily the fittings can be placed on or removed from the pipe, by slipping the lock-nuts on the pipe and the grip-nuts inside the fitting. This tubing is lighter and easier to han-

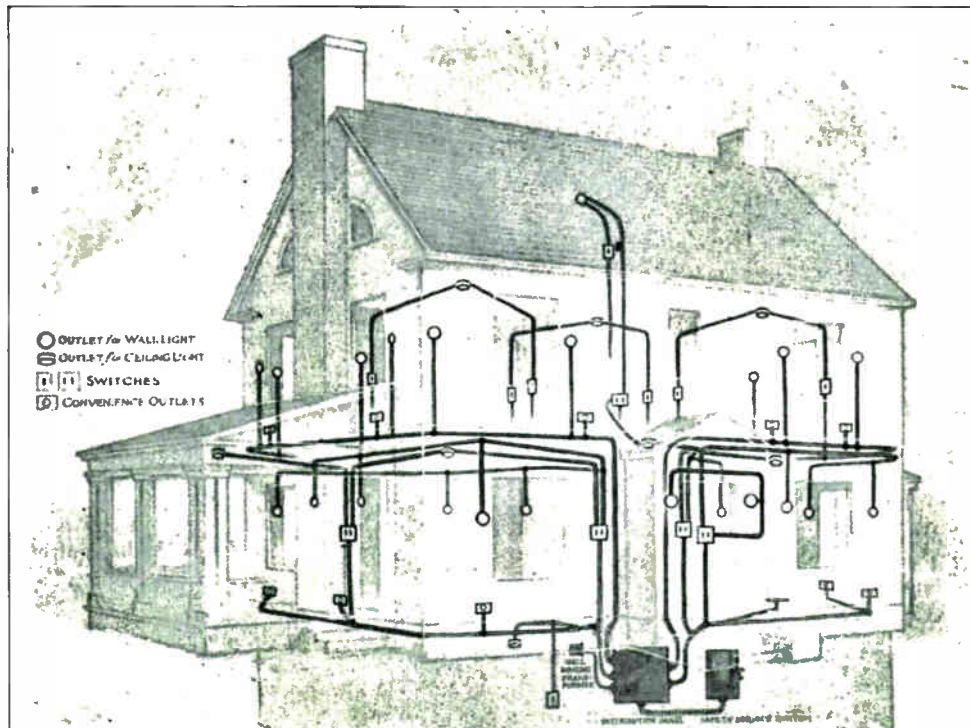

Fig. 77. Isometric or phantom view of a house in which conduit is installed. Note the arrangement of conduit in walls and ceilings, and the locations of various outlets,

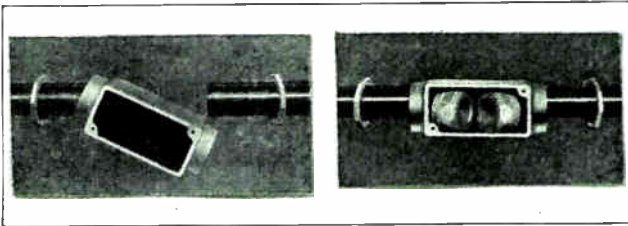

Fig. 79. This view shows the convenient manner in which threadless fittings can be installed with conduit.

It is lighter than regular conduit and is lower in price. It can be bent with less effort, and the cost of installation, due to the saving of time, is also less. Special couplings and fittings of all types are supplied for this tubing, similar to conduit fittings but with the grips for threadless pipe. Fig. 80 shows a coupling used for threadless tubing.

Split bushings are also made for use of standard conduit fittings with metallic tubing.

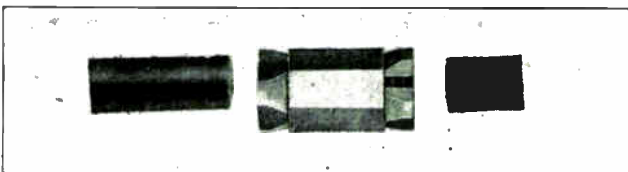

Fig. 80. Special coupling used for connecting together lengths of threadless conduit or electric metallic tubing.

In most cases, the same rules apply to this metallic tubing as to the standard conduit, except that it cannot be threaded. This tubing and its special fittings must be so finished that it will never be mistaken for rigid conduit. It may be finished in either enamel or zinc and in standard sizes is approved in sizes from  $\frac{1}{2}$ " or 2". Its use is restricted to voltages of 600 volts or less, to No. 0 wire or smaller, and no circuit therein shall be fused for over 30 amperes. It can be used either concealed or exposed in dry places where it cannot be subjected to mechanical injury or corrosive vapors.

Even with all these restrictions, its advantages, as noted above, make it a desirable system when put to its intended use. Fig. 81 shows a section of an installation of threadless tubing.

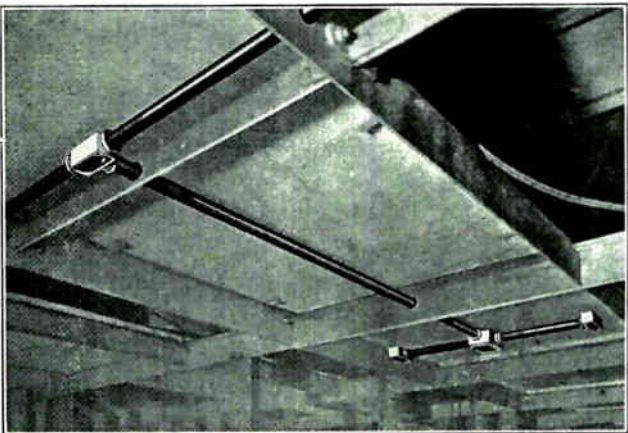

Fig. 81. Section of an installation of electric metallic tubing with threadless fittings.

## 60. FLEXIBLE CONDUIT

Flexible conduit is used very much the same as rigid conduit, except that its flexibility permits it to be fished into walls and partitions in old buildings, where rigid conduit cannot be conveniently installed.

As mentioned before, flexible conduit consists of tubing made of spirally wound steel strips, the turns of which are securely locked together to form a continuous metal casing in which the wires are run. Figs. 82 and 83 show pieces of flexible conduit of different types, which will give you a general idea of its construction.

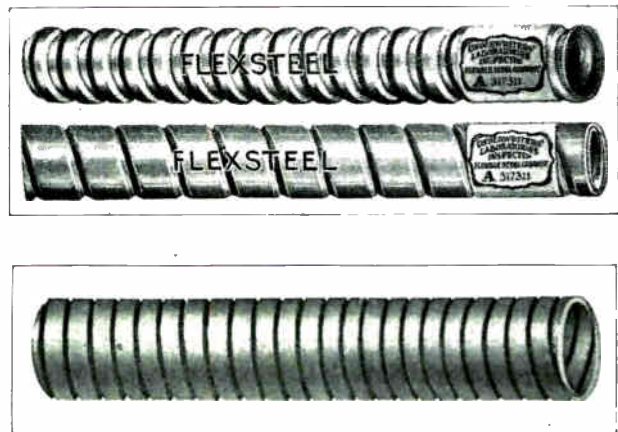

Fig. 82 & Fig. 83. Pieces of several types of flexible conduit, showing how it is constructed of narrow steel strips wound spirally.

Like rigid conduit, flexible conduit must be run continuously from one outlet to the next, and the entire system grounded.

Fig. 84 shows several types of couplings used in connecting lengths of flexible conduit together, and also to attach it to outlet boxes. The upper left view shows an ordinary straight coupling and the grooves which enable it to grip the turns of the conduit when it is bolted on. The lower left view shows a fitting for making sharp turns with flexible conduit, where it attaches to an outlet box. The upper right hand view shows a coupling that can be used for attaching flexible to rigid conduit, or for attaching flexible conduit to an outlet box, with an added nipple. The lower right view shows a very common connector used for attaching either flexible conduit or armored cable to outlet boxes.

Flexible conduit is not as waterproof as rigid conduit is, and should not be used in very damp places, unless rubber covered wires with lead sheaths are used, and it should not be imbedded in concrete.

Its particular advantages are ease of installation, getting through difficult places with a number of bends, and for running flexible leads from rigid conduit to motors or other electrical machines.

Fig. 85 shows a photograph of a motor connected up with flexible conduit. This is one of its very definite advantages as it allows a motor to be moved slightly to tighten belts, etc.

The same type of outlet boxes, conduit straps, and many of the same general rules for rigid conduit are also used for flexible conduit.

The more important points of conduit wiring systems have been carefully covered in this section, and it will be well for you to get a good general understanding of this system, as it is one of the most important of all and is in very extensive use.



Fig. 84. Several types of couplings used for connecting flexible conduit together or to outlet boxes.

## 61. ARMORED CABLE

On the outside, armored cable looks much like flexible conduit. But there is this difference; while the latter has the wire pulled in after it has been installed, armored cable has the wires already in when purchased. It is made in two types and is frequently known as BX or BXL. The former consists of one, two, three or four conductors with rubber insulation and heavy waxed braid, and then an addition of an armor of steel ribbon.

Fig. 86 shows a piece of 3-wire BX and one with two wires. Note the color markings of the wires and the extra twin braid over each group.

BXL is made in a similar way but has the addition of a lead sheath just under the steel armor. This makes it waterproof and permits it to be used where there is moisture, or where it is exposed to the weather. BX may be obtained with wires from No. 4 to No. 14.

## 62. ADVANTAGES OF ARMORED CABLE WIRING

Armored cable wiring is a very convenient system for use in old wood construction buildings. While rigid conduit is usually used for concrete work, and sometimes used for other types of buildings, it is occasionally found too expensive for certain jobs. The use of armored cable or BX gives us a first class job at low cost, can be installed almost as cheaply, and is much better than Knob and Tube

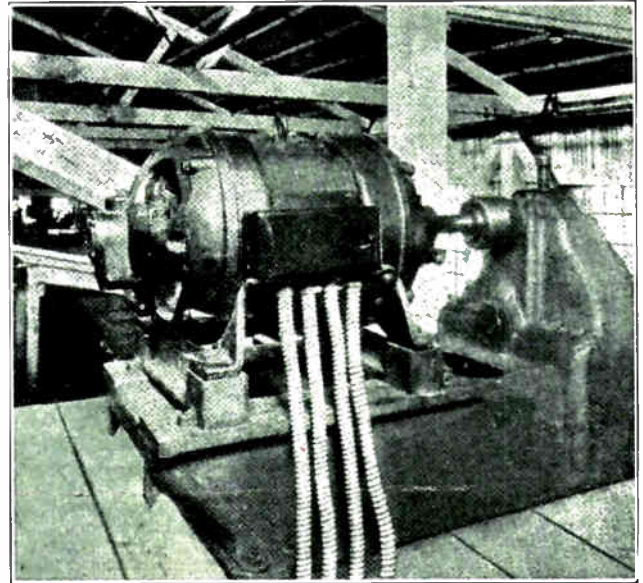

Fig. 85. Flexible conduit is very convenient for motor connections, as it allows some movement of the motor for belt tightening, etc.

work. It makes a good job on all new work, and is absolutely the best system for old house wiring. It is very convenient and economical to install because its flexibility makes it easy to run in difficult places and because, when BX is installed, the wires are in also and do not have to be pulled in later.

The same outlet and switch boxes are used for BX as for conduit, and are installed with BX fittings made for the purpose and clamped securely to the BX armor, and then fastened to the boxes with a lock-nut. Fittings are also made so that BX can be used in conjunction with the other systems of wiring. Several of these fittings are shown in Fig. 87.

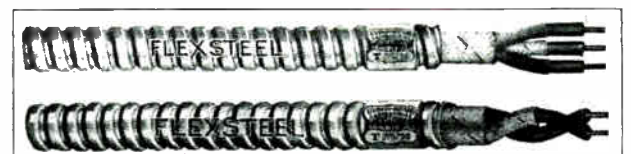

Fig. 86. Pieces of two different types of two-wire and three-wire armored cable. This material is supplied with the wires already in the armor.



Fig. 87. Several types of fittings used for attaching armored cable to outlet boxes or rigid conduit.

Where possible BX should be fastened to the surface wired over with the proper size pipe straps. BX must be continuous from outlet to outlet. A violation of this would mean that you would have splices outside the outlet boxes, which is against the rule for metal systems, and then besides, you would increase the chance of not having a perfect ground throughout the system. The braids over

the insulation of the different wires have different colors so the wireman can trace the "hot" or grounded wires, as will be explained later.

BX can be bought in rolls of 250 ft. or less, and then cut into the desired lengths with a hack saw. Fig. 88 shows a coil of BX as it would be bought.

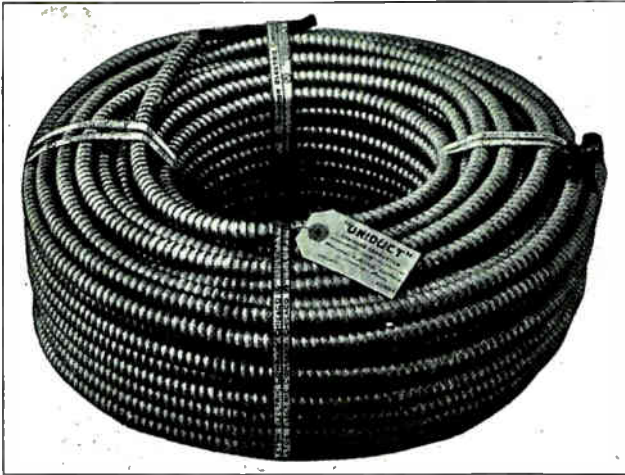

Fig. 88. A coil of armored cable or "BX" showing its convenient flexibility, which is one of the decided advantages of this material for wiring systems.

### 63. CUTTING AND STRIPPING BX

To cut BX, simply hold it firmly in a vise or against your knee or a piece of wood, and cut across one turn of the spiral steel wrapping, being sure to cut clear through one turn or strip of this steel, but do not cut into the insulation of the wire underneath.

To cut clear through the one turn it is necessary to cut partly thru a neighboring turn. Practice this cutting and you will soon find just the proper angle

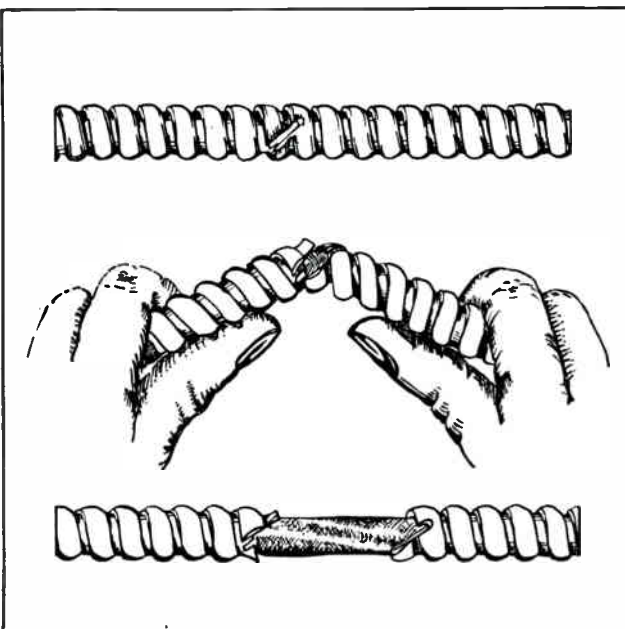

Fig. 88-B. The top view shows the proper method of cutting BX armor with a hack saw. The center view shows how it can then be broken apart without damaging the conductors or insulation inside. A short section of the armor can then be pulled off the end of the cable as shown in the lower view.

to hold the hack saw, and it will become very easy to make a neat cut. See Fig. 88-B.

When the armor strip is cut through, bend the BX to open the cut and the armor will separate, and then the wires can be cut through squarely and easily with the hack saw.

To attach BX to an outlet box make the cut as described about 6 inches from the end, but only through the metal. Then bend the BX at the cut and separate the armor, and the short length can be easily pulled off from the ends of the wires. This leaves them ready to split the outer braid and strip the insulation for splicing. Fig 89 shows a piece prepared in this manner. A special fibre bushing should be used to protect wire insulation from the sharp end of the armor.

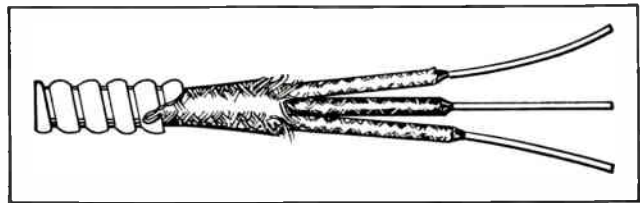

Fig. 89. This sketch shows how the ends of conductors in armored cable can be stripped for connections and splicing.

### 64. USE OF BXL

BXL or lead sheath BX is a very good system to use in underground work, running from one building to another, such as from a residence to a garage in the back end of the house-lot. A ditch of the proper depth, say 2 ft., can be dug. As the cable is flexible, this ditch does not necessarily have to be absolutely straight, but may be around any obstacle that might be in the way. Where galvanized rigid conduit is used more care has to be taken, and the joints where the lengths of conduit are coupled together must be leaded to keep out moisture. **Great care should be taken in handling BXL, so as not to crack the lead.** This precaution, of course, should be taken with all lead covered cables, but it is very necessary with BXL, as damage to the lead cannot be detected by inspection, and will only show up possibly weeks afterwards when moisture has time to leak through and cause a short.

### 65. METAL RACEWAYS OR MOLDING

Metal Raceways or metal molding is one of the exposed wiring systems that is quite extensively used. Although it does not afford such rugged and safe protection for the wires as conduit and armored cable do, it is a very economical and quite dependable system, and is very convenient to install in finished buildings where new wiring or extensions to the old are to be installed. One of the advantages of metal molding is its neat appearance where wiring must be run on the surface of walls or ceilings in offices, stores, etc.

It must never be run concealed or in damp places.

Two of the leading manufacturers of metal raceway materials call their products respectively, wire



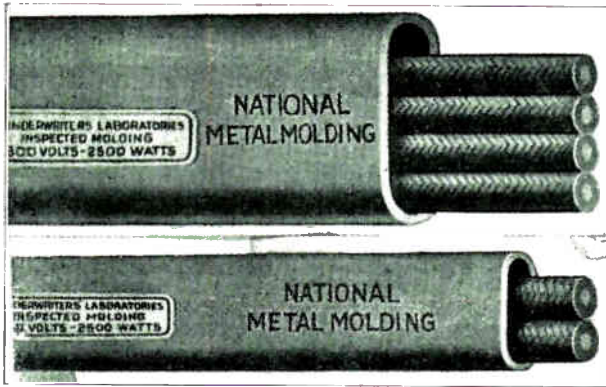

Fig. 90. Two pieces of metal molding of a very neat appearing type for exposed wiring systems.

mold and metal molding, and they are quite commonly known by these names.

Fig. 90 shows two pieces of one style of molding called "Ovalduct", and in which the wires are drawn after it is installed, similarly to conduit.

Fig. 91 shows another style that comes in two strips. The back strip is installed and then the wires are laid in it and the cap snapped in place over them.

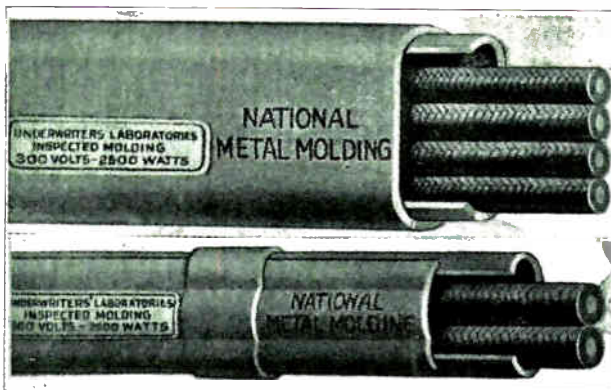

Fig. 91. Another type of metal molding with a removable cap or cover strip, which can be placed on after the wires are insulated.

Various types of fittings for couplings, corner turns, elbows, outlets, etc., are provided to fit these moldings. Fig. 92 shows a number of these fittings, and Fig. 93 shows a closer view of a common elbow fitting.

Many of the rules for BX systems apply also to metal raceways, such as: it must be continuous from outlet to outlet, must be grounded, and all wires of an A.C. circuit must be in one raceway, etc.

You will note from the Figures 90 and 91 that metal raceways are made in two sizes for either two or four wires. Another size is available now for 10 wires, but is to be used only in certain places as allowed by the Code or local authorities. Wires sizes No. 14 to No. 8 can be used with these moldings, and the wire must be rubber and braid covered, and installed with no splices except at proper boxes or fittings.

Fig. 94 shows a fitting that can be used as a junc-

tion box and for splices, or for an outlet box when a cover is used with an opening as shown.

Fig. 95 shows several sizes of boxes to be used with metal raceways, for mounting switches and receptacles. Note the wall plates which are to be attached to the surface wired over, and have slots in their edges for the molding to be slipped under

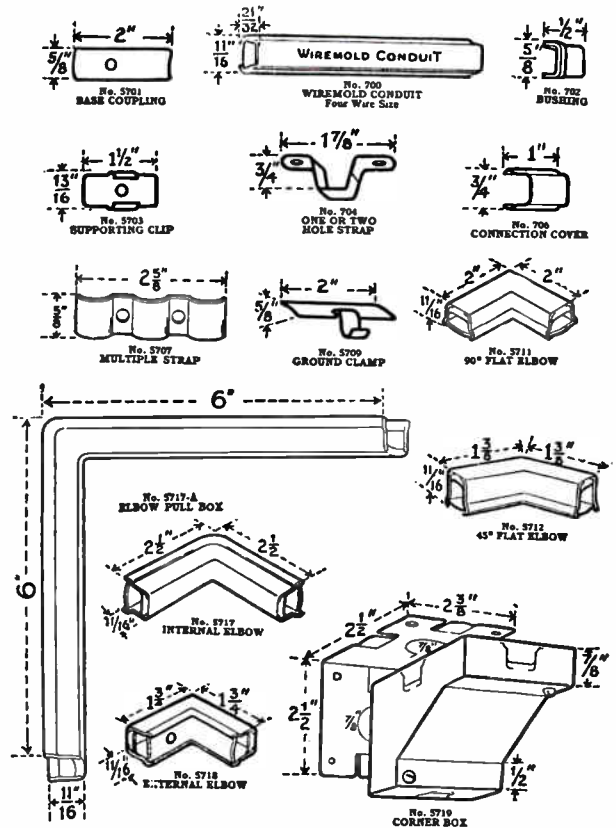

Fig. 92. A number of various types of fittings are provided for use with metal molding in making turns in the corners of walls and ceilings.



Fig. 93. A common form of elbow used with metal raceways or moldings.

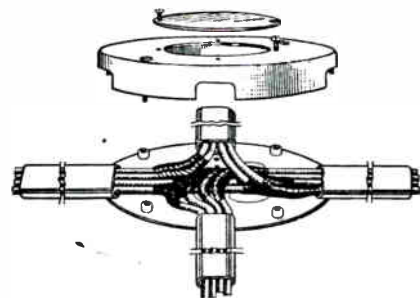

Fig. 94. This view illustrates the use of a junction box in which splices can be made, and various runs of metal raceway attached together. We can also attach lights or receptacles to the smaller opening in the cover of this box.

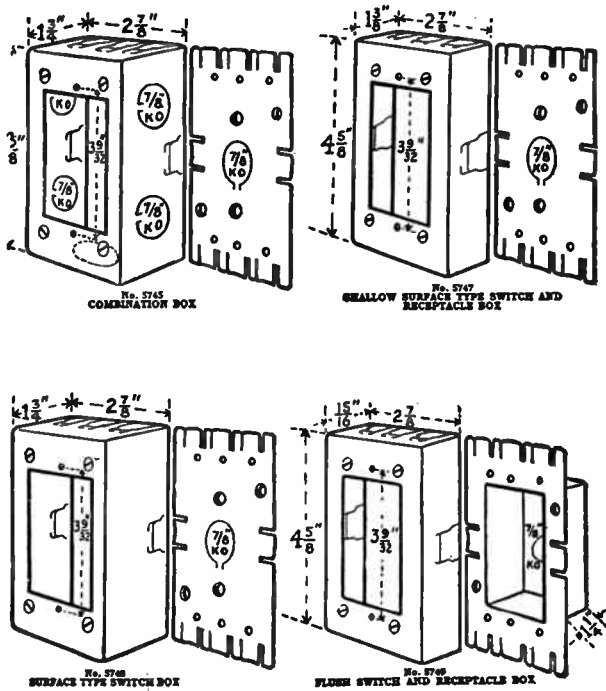

Fig. 95. Several styles and sizes of outlet box for use with metal molding and in which switches or receptacles can be installed.

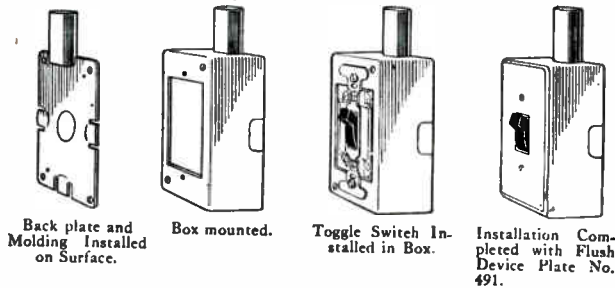

Fig. 96. These views show the various steps in installing a switch in the outlet box of a metal raceway system.

to anchor it to them. Fig. 96 shows how these boxes are installed and the switches mounted in them.

Fig. 97 shows a number of other fittings for various uses as their descriptions indicate.

Metal molding can also be bent to fit or go around various corners or obstructions. For this purpose a bending tool, such as shown in Fig. 98, is used. This device has a rounded fitting on its handle, to make the molding bend in a neat curve of the proper size and without flattening. Molding is easy to bend because of its thin walls.

### 66. NEAT APPEARANCE

Fig. 99 shows the neat appearance of a run of metal molding to two ceiling light fixtures. This view shows that it is one of the best appearing of all exposed systems of wiring.

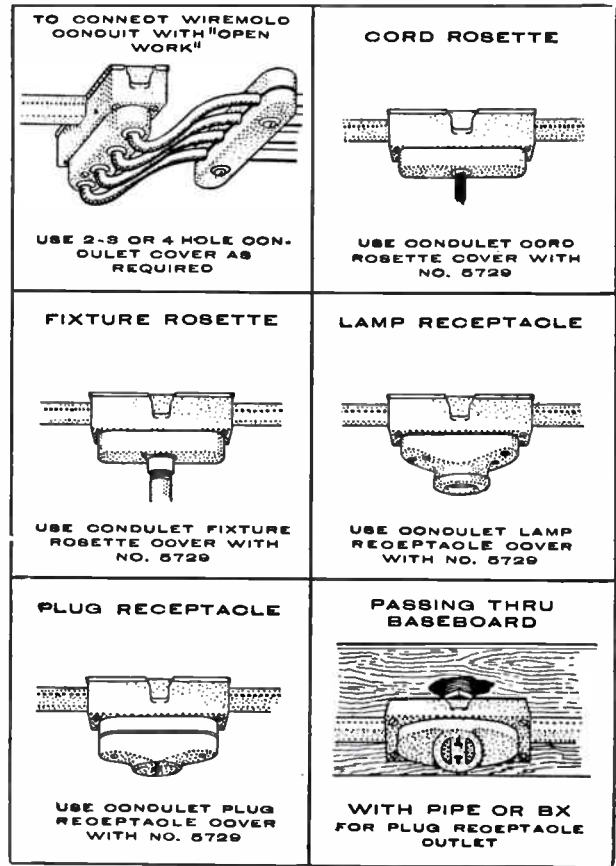

Fig. 97. Above are shown a number of fittings used with metal molding and an explanation of the use of each.

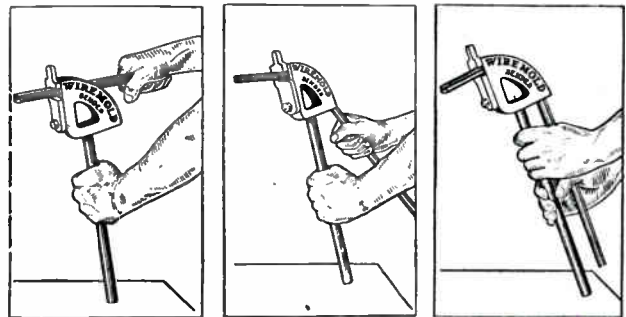

Fig. 98. This view shows a bending tool, and the method in which metal molding can be bent into different shapes for turns and corners.

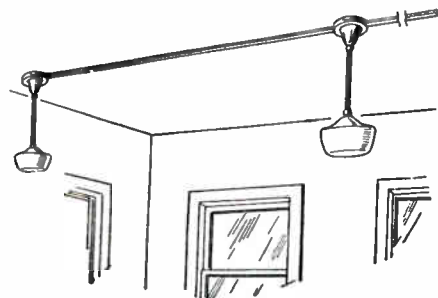

Fig. 99. Section of a metal raceway wiring system with two light fixtures attached. Note the neat appearance of this type of wiring for exposed work.

The method of attaching a fixture canopy to the ceiling plate and fixture stud, is shown in Fig. 100, and Fig. 101 shows how connections are made to the running wires, for drop cords and light fixtures.

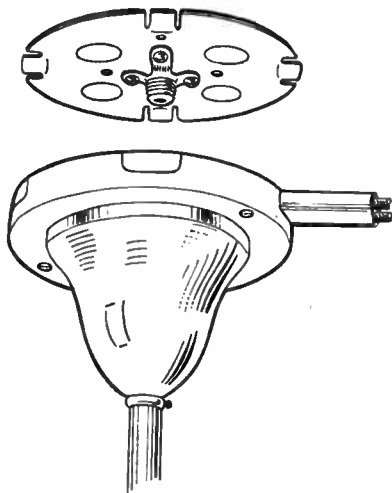

Fig. 100. This sketch shows the ceiling plate and fixture stud to which the light fixture and canopy are attached, and also the slots for attaching the molding to this plate.

Note the porcelain connector block used to attach the fixture wires to the running wires by terminal screws instead of splices.

Fig. 102 shows the installation of a convenience outlet and the method of attaching a piece of BX to the same box, to run to a wall light fixture.

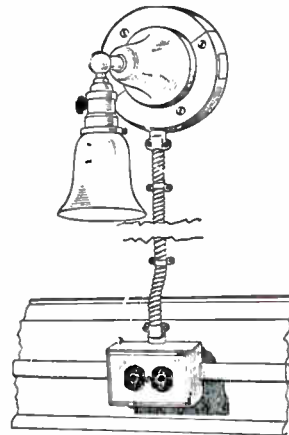

Fig. 102. Convenience receptacle and box on a metal molding system, showing BX attached for a branch circuit to a light.

### 26. DUCT SYSTEMS

Another modern type of wiring which is becoming quite common in large industrial plants and office buildings is known as duct wiring. Instead of using iron pipe or conduit, the wires are run in round or oval fibre ducts or tubes, as shown in Fig. 103.

Advantages of this type of wiring system are the ease and economy of installation and the large number of wires that can be installed in the ducts. These ducts, with their joints properly sealed with waterproof cement, can be imbedded in concrete of new buildings. They can also be interconnected with conduit systems by means of proper fittings.

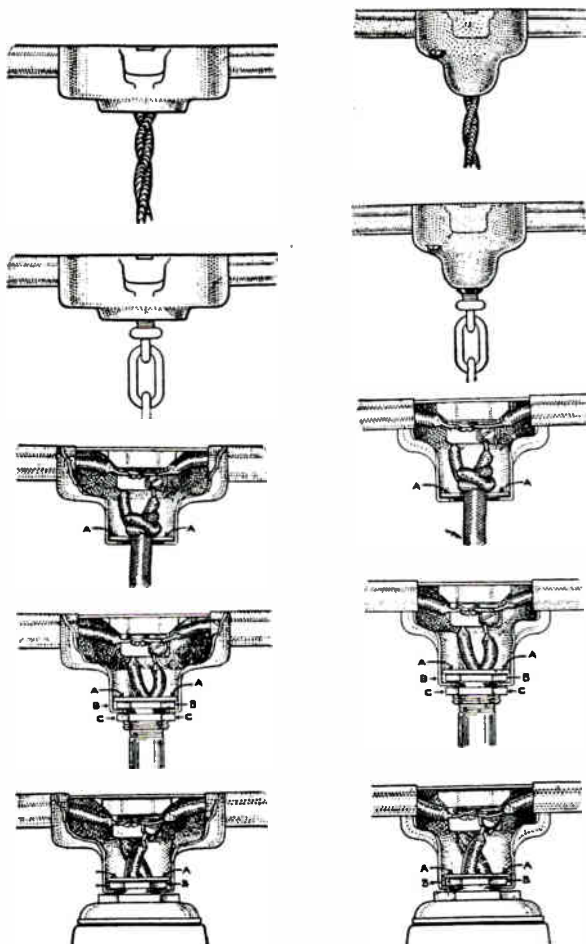

Fig. 101. The above views show a number of styles of fittings used with metal molding and the method of making connections for fixtures. Note the connector blocks used for attaching fixture wires to the running wires.

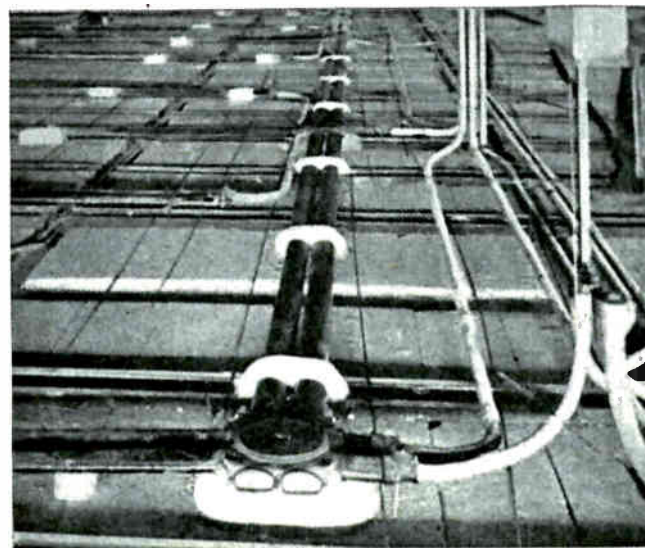

Fig. 103. This picture shows an installation of oval duct just before the concrete is poured.

27. TROUGH WIRING

Square metal troughs such as shown in Figs. 104 and 105 are very convenient in industrial plants where flexibility is desired for frequent wiring changes when machines are moved from one location to another. Another advantage is that these ducts are permitted to carry up to a maximum of 30 wires per duct. However, not more than 20% of the duct area should be filled with wires.

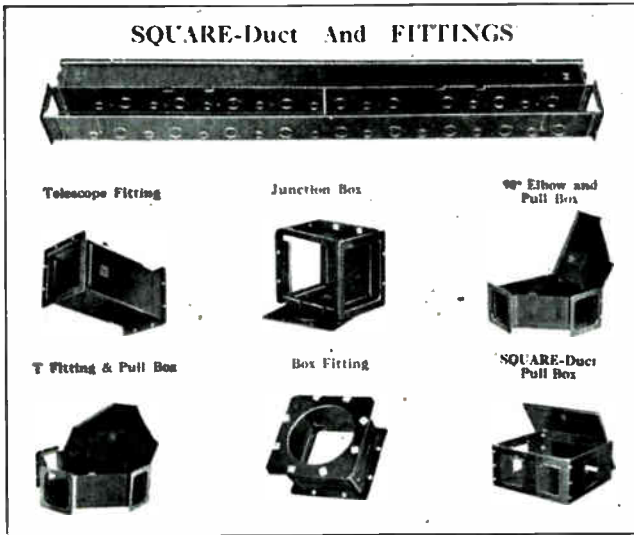

Fig. 104. Square duct as shown above comes under the classification of "wireways and busways."

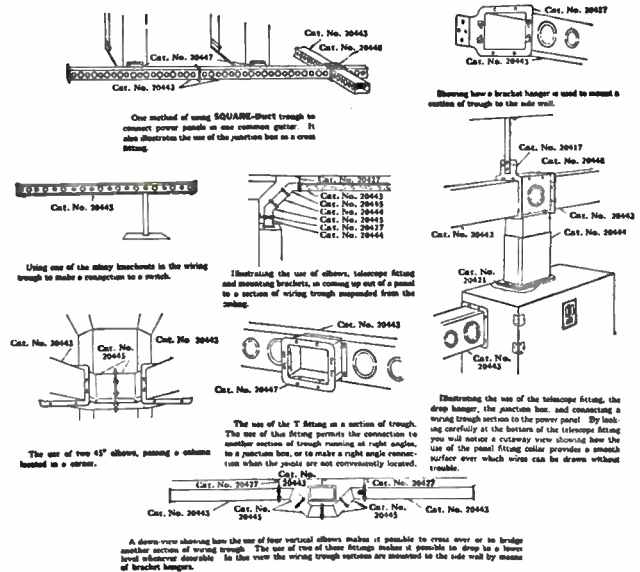

Fig. 105. The above drawings show several different arrangements for using square duct.

Removable cover strips and frequently spaced knockouts permit convenient accessibility of wires and changes of outlets. Suitable fittings are obtainable for turns, junctions, tees, and for coupling to extension circuits in conduit or B.X. Metallic trough systems must be continuous throughout their length, and must be grounded the same as conduit systems. They can be run through walls, but must not be concealed or imbedded in concrete.





ESTABLISHED 1899

**COYNE**  
*Electrical School*  
CHICAGO ~ ~ ILLINOIS



COPYRIGHT 1942

**ELECTRICAL CONSTRUCTION**  
**AND**  
**WIRING FOR LIGHT AND POWER**

*Section Two*

**Fuses and Switches**

**Three-Wire Systems, Polarized Wiring**  
**Wire Calculations, Installation Methods**  
**Business Methods and Estimating**  
**Trouble Shooting**

## FUSES AND SWITCHES

### 68. FUSES

Every wiring system, no matter what type it may be, must be properly fused. This is a strict requirement of the National Code, and an absolute necessity, both to protect the wiring and equipment on the circuits as well as persons who might handle them.

Fuses in electrical circuits are similar in purpose to safety valves on steam boilers. With a boiler, whenever the steam pressure rises so high that it is unsafe and more than the strength of the boiler should stand, the safety valve opens and relieves this pressure. In electrical circuits, whenever the current load becomes more than the wires can stand without overheating and burning their insulations, the fuse blows and opens the circuit. So we can readily see the great importance of having in every electrical system fuses of the proper size and type.

Fuses are made in many different styles and sizes for different voltages and current loads, but they all operate on the same general principle, that is, opening the circuit by melting a piece of soft metal which becomes overheated when excessive current flows through it.

The temperature rise which melts a fuse depends upon the amount of excess current, the duration of excess current, and the ease with which heat escapes from the fuse.

### 69. LEAD LINK FUSES

Early types of fuses were simply a piece of lead wire connected in the circuit, through which current flowed to the lines and devices to be protected. This lead wire, being soft and easy to melt, would blow out as soon as the current load in amperes went above a certain amount. These pieces of wire were kept short and fastened securely under terminal screws, so that their resistance would not be high enough to cause much voltage drop in the circuit. By selecting the proper size of lead wire they could be made to open the circuit at almost any desired current load. This type of Link or lead wire fuse is not very safe or dependable. Such fuses have a tendency to oxidize and corrode, and become quite inaccurate after being in service a while. In addition to this, when they do blow out, the molten metal spatters over equipment, and is likely to injure persons if they are nearby.

### 70. CARTRIDGE FUSES

You will still find lead link fuses in use in some places, but in general they have been replaced by the modern Cartridge Fuses on all circuits of over 30 amperes capacity, and some of less; and by the Plug Fuse on circuits with under 30 amperes load.

Fig. 103 shows two types of cartridge fuses and the renewable fuse link used with them. This type of fuse consists of a hard fibre cylinder in which the fuse strip of soft metal is contained. This strip is gripped tightly by the brass screw caps on the end of the fuse chamber, so the entire cartridge can be conveniently mounted in a Fuse Block. Several types of fuse blocks are shown in Fig. 104.

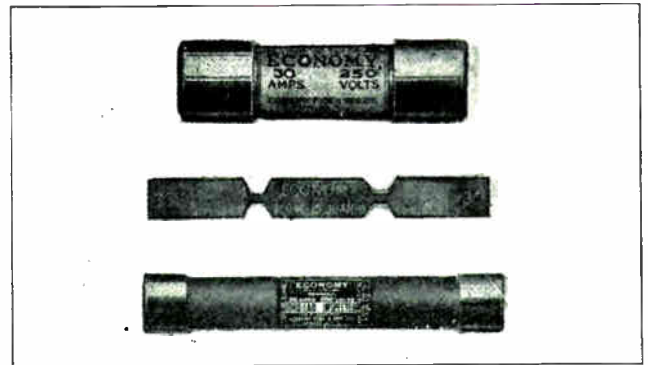

Fig. 103 The above view shows two types of cartridge fuses and one of the fusible lead links which are used inside these cartridges.

The fuses are held in the blocks by spring clips which grip the metal ferrule at the end of the cartridge. This makes them very easy and quick to renew when one blows out. The cartridge fuse is much more reliable and accurate because the fuse link is enclosed in the cartridge, and its temperature is not affected by air currents as is the open fuse link.

With a cartridge fuse, when the link blows out the arc or flame and molten metal are all confined within the cartridge, except in very rare cases when a heavy short circuit may cause the cartridge to explode.

Most cartridge fuses are of the renewable type in which the burned out link can be quickly replaced by unscrewing the ferrules or caps at the ends. The burned piece can then be removed and a new link inserted, the ends being folded over and securely gripped by the caps when they are screwed back on, or held under bolts on the knife blade type. The cost of this renewal link is very small, and as the cartridge very seldom needs to be replaced, the proper fusing of circuits is of very small expense compared with its protection value.



Fig. 104. These porcelain fuse blocks are equipped with spring clips in which the cartridge fuses are held.

## 71. "CUT-OUT" BLOCKS AND KNIFE BLADE FUSES

The porcelain blocks for holding the fuses are often called **Cut-Out Blocks**. The smaller fuses are used in circuits up to 60 amperes and are made in the ferrule type, or with the round end caps. Large sizes for from 65 to 600 amperes are made in the knife-blade type, with short flat blades attached to the end caps. These blades fit into clips on the fuse block, which are similar to regular knife switch clips. This type of construction is used on the heavier sizes because it gives a greater area of contact surface at the clips for heavy currents to flow through. Fig. 105 shows two knife-blade type cartridge fuses.

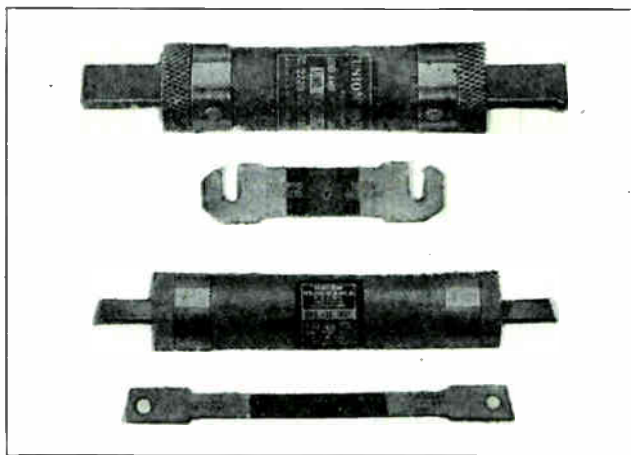

Fig. 105. For the heavier loads of current, knife blade type cartridge fuses of the above type are used.

Ferrule type fuses for voltages from 250 to 600 are commonly made in the following ampere ratings: 3, 5, 6, 10, 20, 25, 30, 35, 40, 50, and 60.

Knife-blade type fuses for the same voltages are made with current ratings of 65, 70, 75, 80, 90, 100, 125, 150, 175, 200, 225, 250, 300, 350, 400, 450, 500, 550, and 600.

## 72. PLUG FUSES

Plug fuses are made with ampere ratings as follows: 3, 6, 10, 12, 15, 20, 25, 30. These plug fuses are the type most commonly used for fusing branch circuits in house wiring systems. They are made with a threaded base to screw into a socket in the cut-out block, similar to lamp sockets. Several types of plug fuses are shown in Fig. 106. Those in the top row are ordinary fuses with small mica windows, so it is easy to see when they have been blown. The fuse shown below with an extra element is of the renewable plug type. These fuses when blown can be taken apart and the small link replaced similarly to the renewal of the cartridge fuses.

Fig. 107 shows several types of cut-out blocks for plug fuses.

When any circuit is overloaded a small amount beyond the capacity of its wires and fuses, the fuses gradually become warmer and warmer, until the link melts out and opens the circuit. When a

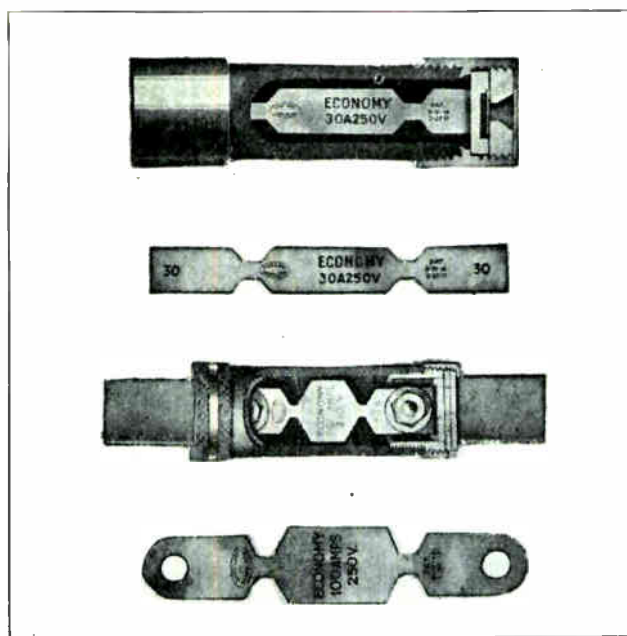

Fig. 105-B. These sectional views show the construction and arrangement of cartridge fuses and the manner in which the fuse strips are fastened in them. Note the difference in the mounting of this strip in the upper and lower cartridges.

circuit becomes severely overloaded or a short circuit occurs, the fuse blows instantly, and sometimes with considerable flash. This is as it should be because, if fuses didn't blow at once, a short circuit would very quickly ruin the insulation of the wires with the intense heat of the great rush of current.

## 73. NATIONAL CODE RULES ON FUSES

In general, every electrical circuit and system should be protected by fuses of the proper size connected in series with its lines, and care should be used never to allow fuses to be replaced with others that are too large. The National Code is very strict in the matter of fusing circuits and a few of the most important rules are as follows:

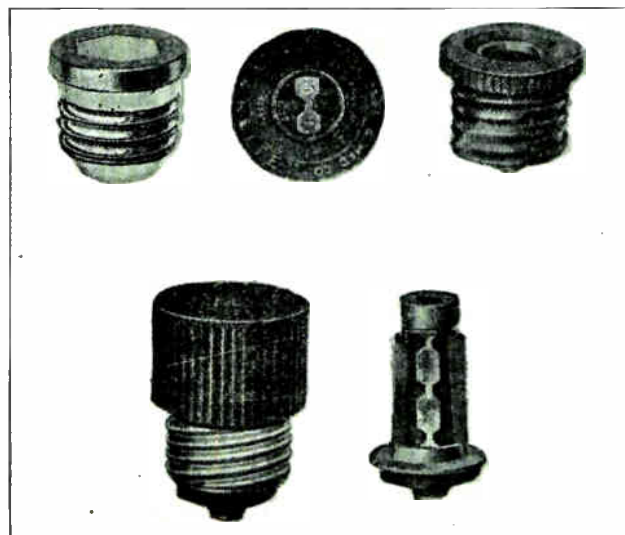

Fig. 106. The three fuses in the upper row are of the ordinary plug type with fusible windows to show when the link is blown out. The lower view shows a refillable plug fuse and one of its refill elements.



1. Fuses must be provided at every point where the wires of a system change in size, except when fuses closer to the service are small enough to protect these wires.

2. Fuses on fused switches must be placed on the dead side of the switch when it is open.

3. Every ungrounded service conductor should be provided with a fuse, except the neutral wire of a polarized system, which must never be fused at any point.

4. All ungrounded wires of branch circuits should be protected by fuses.

5. Two-wire branch circuits on ungrounded systems must have both wires protected by a fuse in each wire.

6. Ordinary branch circuits using No. 14 wire must be protected by fuses not larger than 15 amperes at 125 volts, or 10 amperes at 250 volts.

Sometimes, when a fuse blows, some person who doesn't understand the function and safety value of a fuse may replace it with a piece of copper wire or in some cases even put pennies behind plug fuses. This is exceedingly dangerous practice and should never be used under any circumstances, as it is practically treating the wires of an electrical system, as if the safety valve of a boiler were locked.

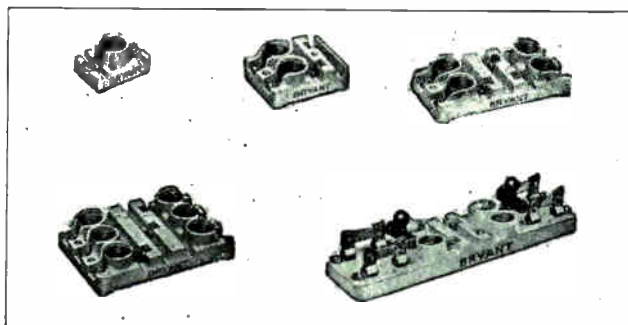

Fig. 107. Several types of "cut-out" blocks or fuse blocks for plug fuses are shown above.

When the size of fuses for any certain circuit is not specified by the Code, it can easily be determined by the use of the Watts law formula. If we know the voltage of any circuit and the load rating in watts of the equipment on any circuit, we can easily find the current in amperes by dividing the watts by the volts. This will indicate the proper size of fuses, providing we are also sure that the size of the wires is large enough to carry this load.

The table previously given, showing the current capacity of rubber covered wires, will also be a convenient guide to the selection of proper fuses. More about fuse troubles and maintenance will be covered in a later section on trouble shooting, and in the advanced sections on motors and power machinery, additional information will be given on the proper sizes of fuses for machines of different horse-power ratings.

#### 74. PANEL BOARDS AND FUSE CABINETS

In small house-wiring systems, the fuses are usu-

ally placed at the place where the supply wires enter the house and near the service switch and meter.

In some small homes there may be only one circuit and one pair of fuses, and in larger homes or those better equipped with complete electric wiring there may be from 2 to 6 or more branch circuits and fuses. Fig. 108 shows two types of fuse blocks and safety switches in metal boxes. This is the modern and approved way to install them.

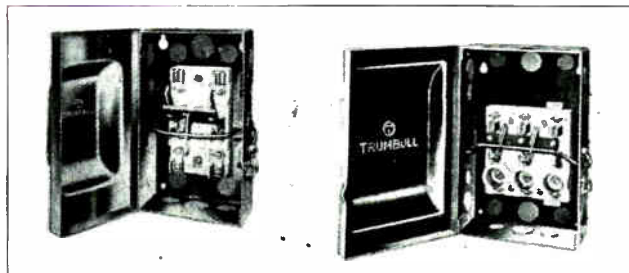

Fig. 108. Fuse blocks of either the cartridge or plug fuse type are commonly mounted with a safety switch in metal boxes.

In larger buildings—such as apartment houses, stores, and offices—there may be from a dozen to a hundred or more branch circuits, all requiring separate fusing.

In such cases it is common practice to install in one central cabinet all the fuses for a large group of circuits. Fig. 109 shows two such cabinets, one for a two-wire system and one for three wires. Both have main service switches which disconnect the entire cabinet and all circuits from the supply wires, and also separate switches and fuses for each circuit. The branch circuit switches in these cabinets are enclosed under safety panels through which only the handles protrude.

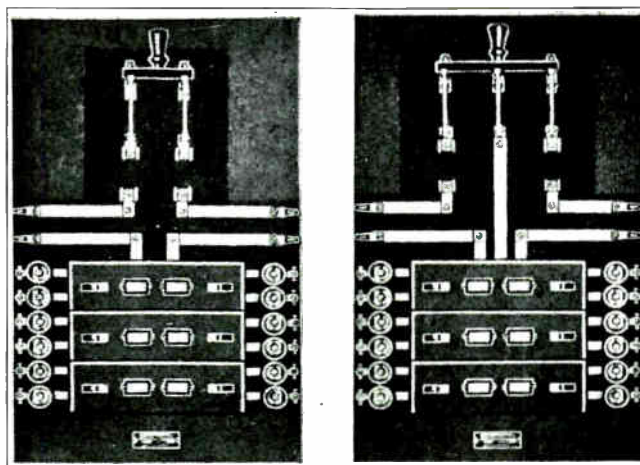

Fig. 109. On the left is shown a two-wire "cut-out" panel, and on the right one for three-wire circuits. Note the arrangement of the safety switch, plug fuses, and branch circuit switches.

Fig. 110 shows a modern fuse cabinet and meter panel of the type used in many large apartment buildings and offices, and Fig 111 shows a connection diagram for an entire cabinet of this type, including the meters.

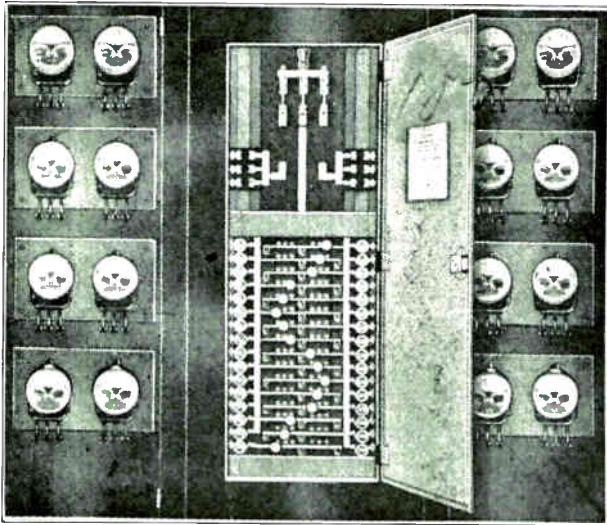

Fig. 110. This is a modern fuse and meter panel for large buildings which have a great number of branch circuits.

## 75. SWITCHES.

There are numerous types of switches used in electrical wiring. It is very important to select the proper types for various applications and to properly understand their use, operation and care.

The purpose of any switch is to conveniently and safely make and break an electrical circuit and start or stop the flow of current, thereby controlling the operation of the devices on that circuit.

## 76. KNIFE SWITCHES

Knife Switches are one of the most common types and are used for opening and closing the heavier circuits, such as main service wires in light and power wiring systems, and also branch circuits to motors and equipment using large amounts of current.

Knife switches consist simply of one or more copper blades hinged at one end and with clips at

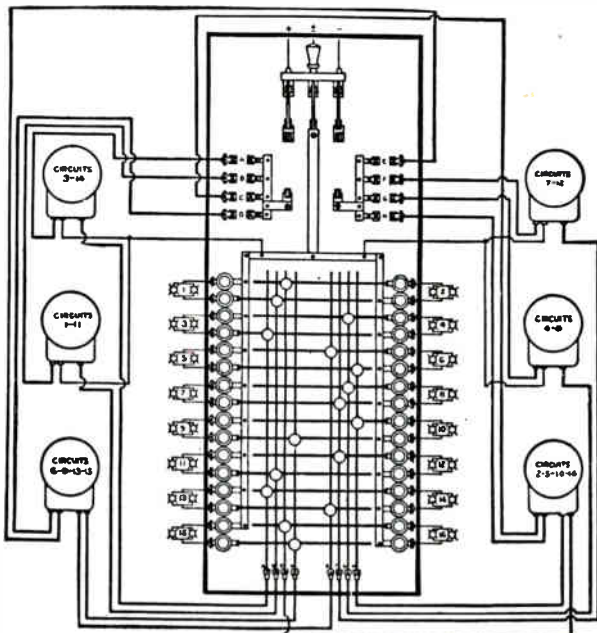

Fig. 111. Wiring diagram for modern fuse and meter cabinet.

the other, and proper terminals for connecting the wires to them. Fig. 112 shows three common types of knife switches. One is called a Single Pole, one a Double Pole, and one a Three Pole switch. The number of poles indicates the number of blades, or the number of wires the switch can open. They are also made with 4 poles or more, and Single or Double Throw. Those shown in the figure are all single throw. Double throw switches have two sets of clips, one at each end, so the blades can be thrown either way into either set of clips, thus shifting from one circuit to another.

Knife switches are made with or without fuse clips as desired. The three pole switch in Fig. 112 is of the fusible type, while the other two switches are not.

When installing knife switches, they should be mounted so that the blades when opened cannot fall closed by gravity, and they should be connected so that when opened the blades as well as any fuse that may be on them will be dead. The blades of knife switches should always be enclosed, except when the switches are mounted on approved switch boards or panel boards.

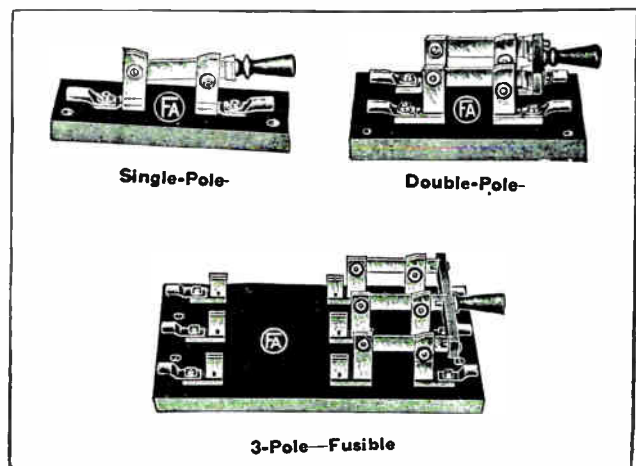

Fig. 112. Three common types of knife switches. The lower one is equipped for knife blade type fuses. Note the lugs which are used for attaching large wires or cables to these switch terminals.

Knife switches that are enclosed in a safety box and used for service switches in wiring systems should have a handle on the outside of the box, so the switches can be opened or closed without opening the door, and some indication or marks should be on the box to show when the handle is in the open or closed position.

Switches used for motor circuits should have a current capacity or continuous duty rating of 125% of the motor current rating.

It is very important that the clips of knife switches be kept properly fitted to the blades, so as to secure proper contact and prevent overheating of the switch due to high resistance.

## 77. SNAP SWITCHES

For the control of lights and branch circuits the Snap Switch is commonly used. There are several types of snap switches made, and their name comes

from the quick snapping action with which they break the circuit. This action is obtained by a small spring and is a very important feature of such small switches, as the speed and suddenness with which it opens the circuit extinguishes the arc much more rapidly and effectively, thus to a great extent eliminating fire hazard and preventing burning of the switch contact.

Snap switches are made in **Single Pole, Double Pole, Three Way, Four Way, and Electrolier** types. Each of these types will be explained.

## 78. SURFACE TYPE SNAP SWITCHES

One of the very common and simple types of these switches is the **Surface Type Snap Switch**. Fig. 113 shows two switches of this type, one of them having the cover removed to show the working parts.

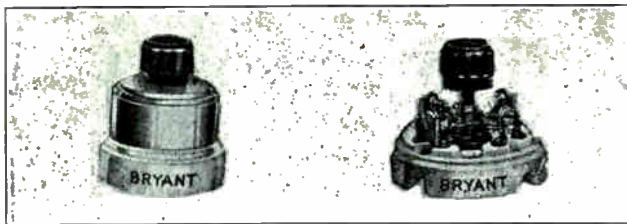

Fig. 113. Above is shown an ordinary surface type snap switch. The view on the right shows the cover removed.

These switches have a small rotating blade that is snapped in or out of stationary clips set on the porcelain base. When the button is turned it first winds a small coil spring on its shaft, and as it is turned farther this spring snaps the rotating blade in or out of the stationary clips.

For convenient connection of the wires, terminal screws are provided. These screws are of soft brass. While they should be tightened enough to hold the wires securely, they should not be forced too tight or their threads are likely to be stripped.

Fig. 114 shows several types of surface type snap switches.

Surface type Toggle or Tumbler switches are being installed in preference to rotary button snap switches in many places today. Fig. 115 shows a surface type toggle switch on the left and two of the tumbler type on the right. These switches are more convenient to operate, as it is only necessary to push their levers up or down, instead of twisting a button as on the rotary snap switch.



Fig. 114. Several types of snap switches. Note the "off" and "on" markings used on indicating switches.

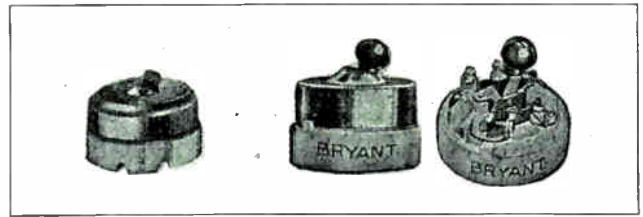

Fig. 115. Toggle and tumbler switches of the above type are very commonly used for surface mounting.

## 79. FLUSH TYPE SWITCHES

The snap switches mentioned so far are called "surface" type, because they are made to mount right on the surface of the wall. This is often not as desirable in appearance as the **Flush Type** switch, which mounts in an opening cut in the wall, has a neat flush cover plate, and is a very popular type. Fig. 116 shows two views of a **Push Button** type switch. The left view shows an open side view and the manner in which the two buttons are used to rock a small blade back and forth. The right view shows the top of a switch of this type.

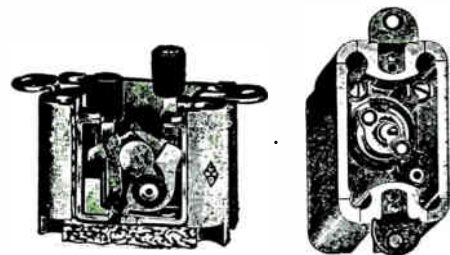

Fig. 116. These two views show the construction and mechanism of push button type snap switches.

Fig. 117 shows another type of push button switch on the left, and a toggle switch on the right. The metal extensions or "lips" on these switches are used to fasten them in the switch box, which is mounted in a hole cut in the lath and plaster. Then the switch plates, or covers, are placed over them and fastened in place with small screws, presenting a finished appearance as in Fig. 118.

Where it is desired to control a separate light by means of a switch on the ceiling near that light, a ceiling pull-cord switch, such as shown in the left view in Fig. 119, is used. The one on the left

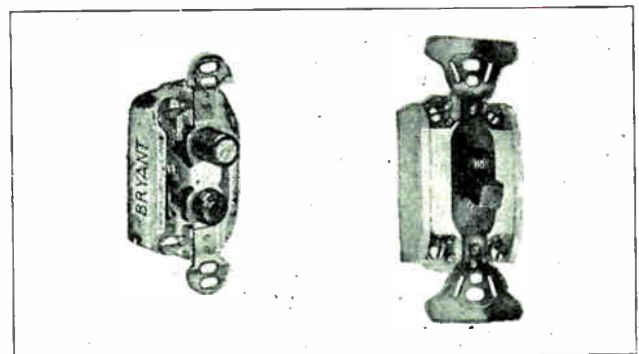

Fig. 117. Above are shown a push button switch on the left and a toggle switch on the right. Both are for flush mounting in switch outlet boxes.

is made to mount right on the surface of the ceiling, while the one on the right is made to mount in the side of the outlet box or fixture canopy and is called a Levolver switch.

There are also small snap switches which are enclosed in lamp sockets called Key Sockets or Pull Chain Sockets. Fig. 120 shows a key socket on the left and a pull chain socket in the center.

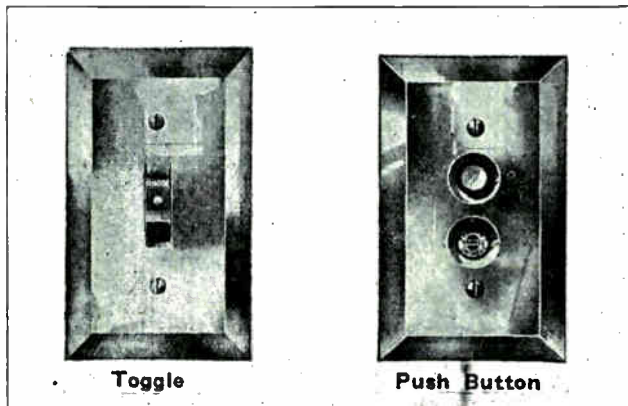

Fig. 118. This shows the finished appearance of properly mounted flush type switches with the covers placed over the outlet boxes.

80. SINGLE POLE SWITCHES

Single Pole Switches are used to break only one wire of a circuit, and must always be connected in the ungrounded wire. They are used to control a light from one place only, and are the most commonly used of all switches in residence lighting systems. Single pole switches can always be easily distinguished from the others because they have only two terminals for the wires, and only one blade.

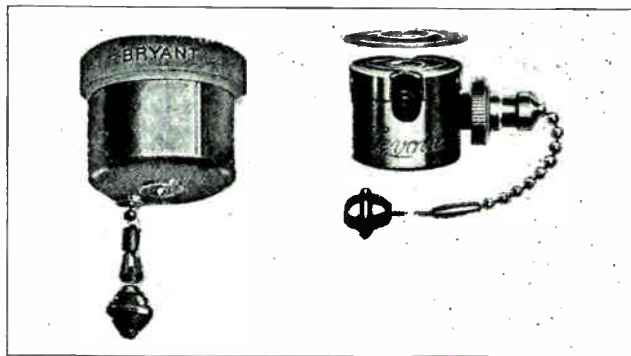

Fig. 119. Two types of pull cord switches for ceiling mounting and used to control individual lights.

81. DOUBLE POLE SWITCHES

Double Pole Switches are used to open both wires to a light or device, and thus break all connections from it to the line. Opening both sides of the circuit at once also more quickly extinguishes the arcs at the switch points. A double-pole surface-type switch always has four terminals and two blades. These blades are mounted one above the other on the shaft, and are insulated from each other. On this type of switch, never connect the line wires to opposite terminals, but always to terminals on the same side of the switch.

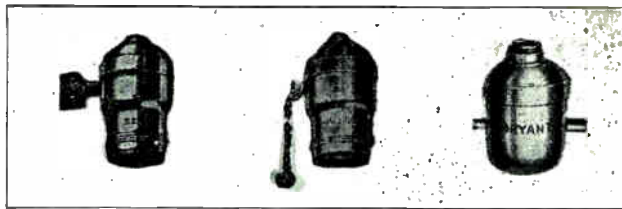

Fig. 120. On the left is a key socket or switch for controlling lights on drop cords. The center view shows a pull-chain socket, and on the right is a push button switch that can be mounted on the end of a suspended pair of wires.

Fig. 121 shows some of the symbols used for common surface-type snap switches, so you will be able to recognize them in the following connection diagrams.

Fig. 122 shows the connections of a single pole switch and a double pole switch for controlling the lamps, "L" and "L".

82. THREE-WAY SWITCHES

Three-Way Switches are used to control a light or group of lights from two different places, so they can be turned on or off at either switch. This is a connection very commonly used in all modern homes for lights in halls, on stairways, and other places. It is also very convenient for controlling garage, barn, or yard lights, as the lights outside can be turned on at the house and off again at the garage or barn. Or the lights can be turned on at the outer buildings and turned off at the house.

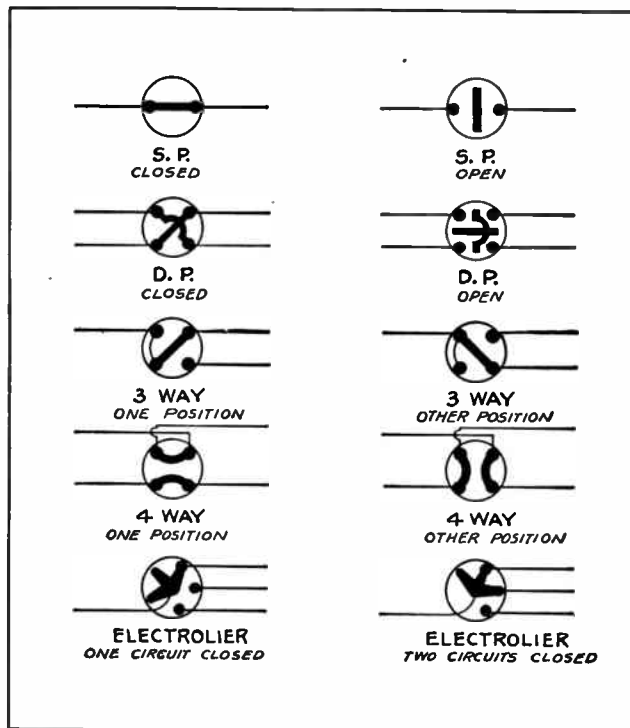

Fig. 121. The above symbols will be used to represent various types of switches in the following connection diagrams. Close examination of these symbols will also help you obtain a better understanding of each of these switches.

Three-way surface-type switches have four terminals and usually one blade. Sometimes there are two blades in one line. Two of the terminals are permanently connected together in the switch with

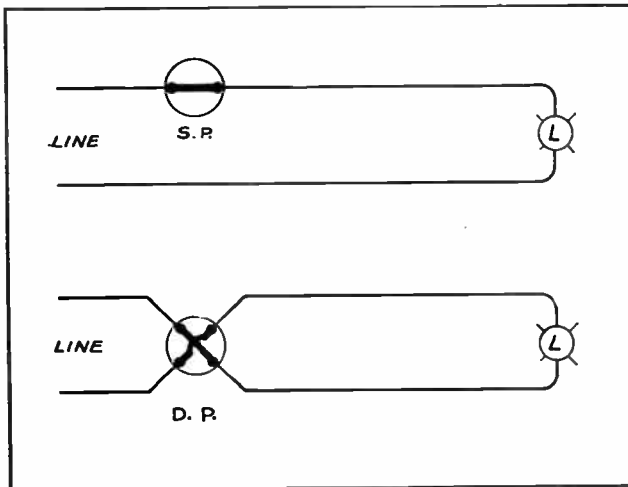

Fig. 122. The top diagram shows a simple single-pole switch connected to control one light. The lower diagram shows a double-pole switch connected to break both sides of the circuit to a light.

a shunt wire. Usually these terminals can be located by a strip of sealing wax in a groove between them on the base of the switch. This wax covers the shunt wire. This construction is one means of telling a three-way switch from other types of surface snap switches. On flush type switches, the three-way is the only one which has just three terminals.

Fig. 123 shows the connection diagram for two three-way switches used to control a light from two different points. Note that the line always connects to the shunt terminal of one switch and the lamp to the shunt of the other switch. The other two terminals of each switch are connected together as shown. This is a good rule to remember in connecting up three-way switches. Trace this diagram carefully and you will find the circuit to the lamp is closed. Shifting either switch blade will open it, and again shifting either one will close it once more.

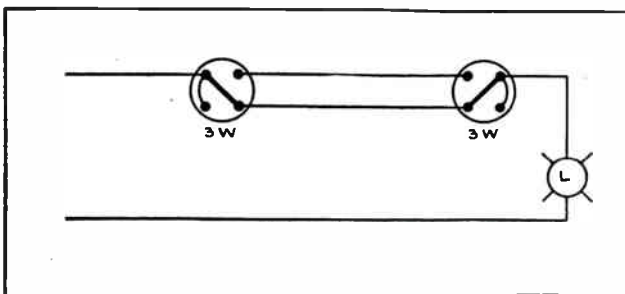

Fig. 123. Two three-way switches used for controlling a light from two different places. Note carefully the manner of connection.

Fig. 124 shows another method of connecting three-way switches, known as the Cartweis system. This method is not approved by the Code as it places line wires of opposite polarity on adjacent terminals of the switch. This is in contradiction to the rule given for the common approved connection and is not considered as safe.

However, this method is sometimes used on 32 volt systems and saves one wire where both switches are to be located near the line wires, as in a case where a live line is run from a house to the

garage or barn to operate other devices there in addition to the light.

The first system should always be followed in interior wiring in houses with 110 volt circuits.

### 83. FOUR-WAY SWITCHES

Four-way switches are used where it is desired to control a light or group of lights from more than two places. By their use in combination with three-way switches, we can control a light from as many places as desired.

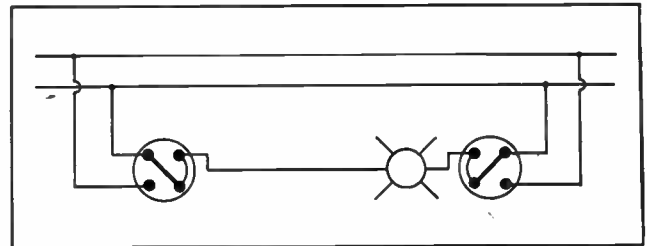

Fig. 124. This sketch shows the Cartweis system of connecting three-way switches. This method should not be used on 110-volt circuits in interior wiring.

The four-way surface-type switch has four terminals and two blades, and can be quite easily distinguished from the other switches because its blades always connect to adjacent terminals on the sides of the switch. No matter which position the switch is in, the blades always connect together one or the other set of adjacent terminals.

Fig. 125 shows a method of connecting two three-way switches and two four-ways to control a light from four different places.

The important points to note in this connection are as follows: The two three-way switches are always connected at the ends of the control group, with their shunts to the line and lamp, as before mentioned. Any number of four-way switches can then be connected in between them as shown. With surface-type snap switches, the one wire connecting the three-way and four-way switches together should always be crossed at each switch as shown, but the other one just connected straight through from terminal to terminal on the same side of the switches as shown. With some flush-type switches it is not necessary to cross the wires on one side of the four-ways, as they are already crossed inside the switches.

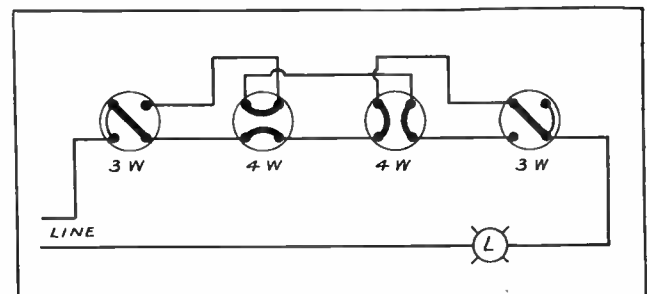

Fig. 125. This diagram shows two three-way and two four-way switches connected to control a light from four different places. Note carefully the connection and arrangement of the three-way switches at the ends, and the manner in which the wires to one side of the four-way switches are crossed.

Trace the diagram in Fig. 125 very carefully and you will find that, with the switch blades in their present position, the circuit to the lamp is closed. Moving any one of the switch blades into its other position will open the circuit, and moving any other one will close it again.

This type of connection is a very valuable one to know, and you will find it much easier to understand and remember the rules for its connection if you try drawing several combinations with different numbers of switches and tracing them out to see if they give the desired results.

A very important rule to remember in installing three-way and four-way switches is that they must all be connected in the ungrounded wire of the line, and never to the grounded wire. This is a Code rule, as it is with single pole switches, to make sure that the "hot" or ungrounded wire to the light is always open when the switch is turned off.

#### 84. SUBSTITUTING VARIOUS SWITCHES

Sometimes in emergencies you may not have the proper switches on hand and certain others can be substituted temporarily if desired. For example, you can use either a three-way or four-way switch in place of a single pole switch. To use a three-way in place of a single pole, connect the line wire to the shunt terminal and the lamp wire to either of the separate terminals, as in the upper view in Fig. 126.

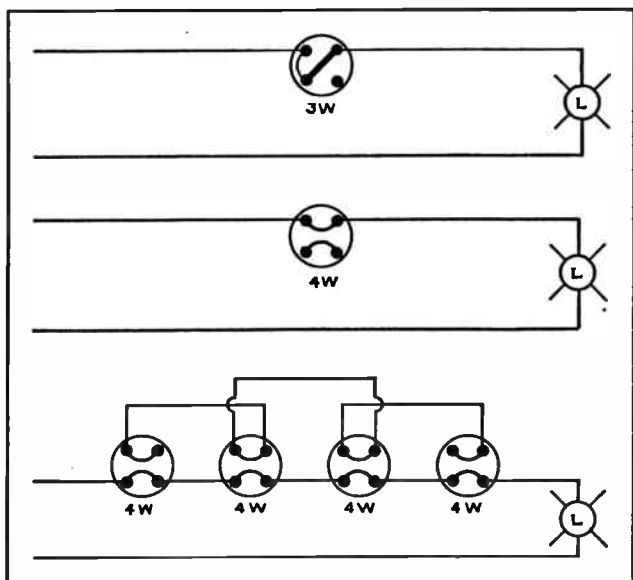

Fig. 126. The above three diagrams show methods of substituting various switches when the proper ones are not available. The top and center connections show the use of three-way and four-way switches in place of single-pole switches. The lower connection shows four-way switches used in place of three-way switches at the ends of the group.

To use a four-way switch in place of a single pole, connect the line and lamp wires to any two adjacent terminals, as in the center view in Fig. 126.

To use four-way switches in place of the usual three-ways at the ends of a group for controlling a light from several places, connect them as shown in the lower view in Fig. 126.

, Some of these switches will cost more than the proper ones for which they are substituted—for example, three-way and four-way switches cost much more than single pole switches—so these substitutions should only be made in emergencies.

#### 85. ELECTROLIER SWITCHES

Electrolier Switches are used to control one or more circuits, such as several lights on a chandelier, or the several sections of a heater element in an electric range, etc. These switches are obtainable with two or three circuits. Fig. 127 shows a method of connecting a three-circuit electrolier switch to turn on one, two, or all three of the lamps; or turn them all off if desired. In the upper view all lamps are out, in the center view only one lamp is on, and in the lower view two lamps are on. If the rotating element of the switch were turned one more point to the right all three lamps would be on.

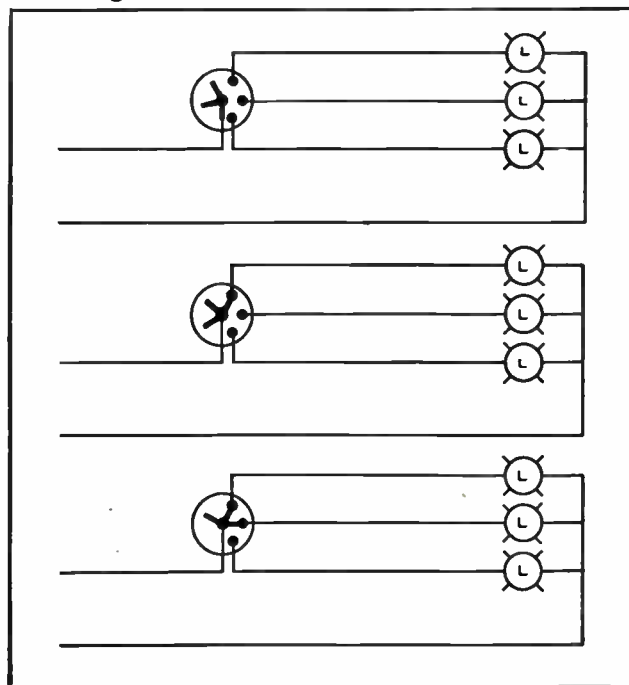

Fig. 127. These three diagrams show the manner in which an electrolier switch can be used to turn on one or more lights at a time.

These switches are very commonly used on electric ranges and heaters, to get low, medium, or high heat.

Fig. 128 shows several of the connections for push button and toggle-type flush switches. The sketch at "A" shows the terminal location and connections of a single-pole push button switch connected to control one lamp. "B" shows the terminals and connections of another type of flush single-pole switch. "C" shows a double-pole switch connected to control one lamp. "D" shows two flush-type, three-way switches connected so that either one can turn the light on or off. "E" shows two three-way switches and one four-way switch connected to control a light from three places. The wires are crossed at the four-way switch, as is necessary with some types of flush four-ways. "F" shows the connection of two three-ways and one four-way, using the

type of four-way switch that has its terminal connections crossed inside, so the wires are run straight through. "G" shows a flush-type two-circuit electrolier switch with connections made to its marked terminals for turning on first one light, then both lights, then both off. "H" shows a two-circuit electrolier switch connected to first turn on one light, then turn it off; next turn on the second light, and then turn it off. "I" shows a three-circuit electrolier switch connected to first turn on one light, next turn on two lights, next all three lights on; then all off.

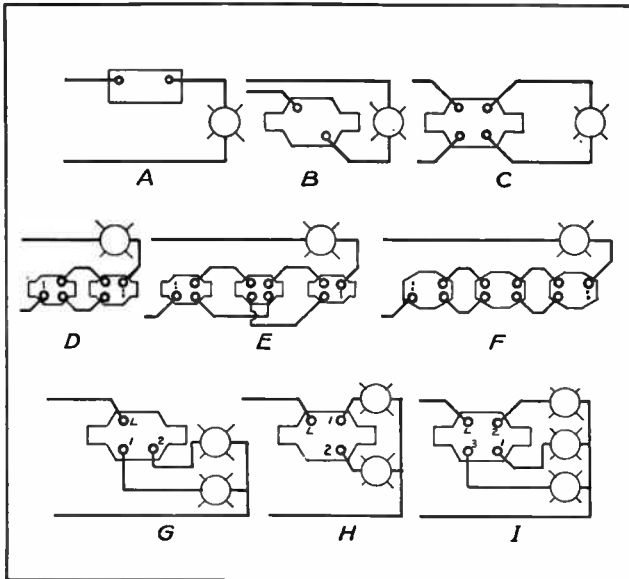

Fig. 128. The above sketches show methods of connecting flush type switches as represented by manufacturers' symbols. Check each connection with its explanation in the accompanying paragraphs.

A great many types of special switches are made for different applications. However, with a good understanding of these more common types, and a careful examination of the blades, terminals, and parts of any switches you may encounter, you should be able to understand them quite easily.

Sometimes the small copper blades and clips of snap switches become badly burned from the arcing when the circuit is interrupted or because they don't fit properly and make good contact with each other.

Snap switches are made in different current ratings according to the load they are supposed to control, and they should never be placed in circuits where they have to carry more current than they are rated for, because this will overheat them, burning and softening the blades and clips until they are useless. When a snap switch arcs badly or sticks frequently it is usually an indication of a defect in the switch or an overload on it.

## 86. CONVENIENCE OUTLETS AND RECEPTACLES

In the preceding pages we have occasionally mentioned outlet boxes for convenience receptacles. A modern house-wiring system is not merely to sup-

ply proper lights and convenient control for them, but should also include in all rooms a sufficient number of convenience outlets for the attachment of portable household electrical devices, such as fans, heaters, curling irons, toasters, sewing machines, vacuum cleaner, and the many other electrical devices used in the home today. These convenience outlets may be installed in the baseboard, or mounted higher up in the walls, or even in the box with the switches.

The same outlet boxes as are used for flush-type switches can be used for convenience receptacles, and either a single or double plug receptacle can be installed. Fig. 129 shows both a single and a double receptacle of this type, with the cover plates which fit over the outlet boxes.

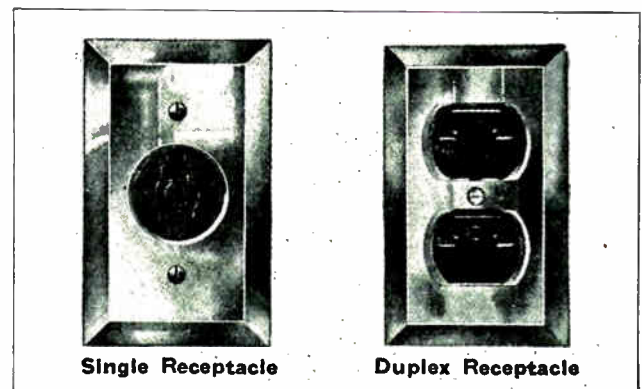

Fig. 129. Every home that is wired for electricity should have a sufficient number of convenience outlets or receptacles of the types shown above.

Fig. 130 shows the receptacles without covers and ready to be installed in the outlet boxes. The metal "lips" on the ends of each one are for attaching them to the outlet boxes with screws. These receptacles are generally connected to wires that are always alive and are not controlled by switches. All that is necessary to obtain from them current for portable devices is to push the prongs of the plug, which is on the end of the cord, into the slots in the receptacle, where they are gripped by spring contacts inside the receptacle.

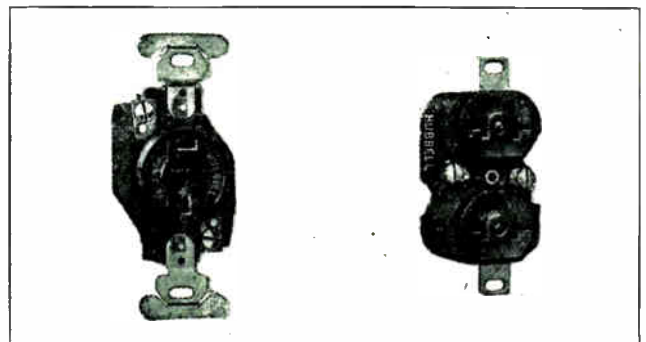

Fig. 130. These receptacle units are mounted in ordinary outlet boxes similar to those used for flush type switches. Note the terminal screws for connection of the wires to the receptacle, and also the metal "ears" for attaching the receptacle to the outlet box.

### 86-A. ATTACHMENT PLUGS

Small receptacle plugs can be obtained for screwing into threaded lamp sockets, and receive the prongs of the regular cord plug. These are commonly known as attachment plugs. Fig. 131 shows both sections of an attachment plug; close together in the left view, and separated at the right. The upper or male cap section in the right-hand view has two connection screws on its prongs, and can be quickly and easily attached to the cord of a portable device.

For certain portable tools requiring three and more wires, special plugs can be obtained. Some of them also have an extra wire for grounding the

portable tool to the conduit system for safety to the operator.

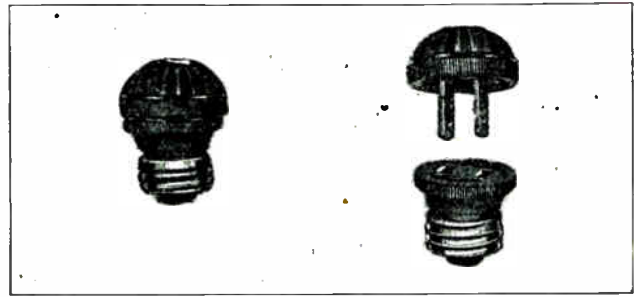

Fig. 131. Two views of an attachment plug of the type which can be screwed into a socket. The male element with the two brass prongs is attached to the cords of portable devices, and can then be plugged into any receptacle of this type.

## THREE-WIRE SYSTEMS

### 86-B. TWO-WIRE AND THREE-WIRE SYSTEMS

We have already mentioned that wiring systems can be either two-wire or three-wire systems.

The two-wire system does not need very much explanation as its connections and principles are very simple. This is the system commonly used in small homes, and consists of two main wires brought into the building from the power company's lines, and properly equipped with service switch, fuses, and meter.

From this point several branch circuits with two wires each can be run to the various groups of lights or outlets about the house. Two-wire lighting circuits are usually of 110 to 125 volts, and two-wire D. C. or A. C. power circuits are commonly of 220 or 440 volts.

It is a very simple matter to connect lights or motors to these circuits, with the proper switches and fuses where needed. The load devices are all connected in parallel, and while usually we need pay no attention to positive or negative polarity, we do need to know which wire is the grounded one and which the ungrounded. This will be explained a little later.

### 87. EDISON THREE-WIRE SYSTEM

The three-wire system is used extensively by power companies on their lines to the customers' buildings, and in most all of the larger homes and modern office buildings, hotels, stores, and factories.

This system is often thought to be somewhat complicated but in reality it is very simple to understand for anyone with a knowledge of the principles of electric circuits, such as you have already obtained.

The Edison three-wire system gets its name from the fact that it was originally used by Thomas Edison, who connected two 110 volt D. C. generators in series to obtain 220 volts between two outside wires, and 110 volts between each outside wire and the center or neutral wire. See Fig. 132.

You will recall that when any two generators or sources of current supply are connected in series, it adds their voltages; so it is easy to see how the two different voltages are obtained in this system.

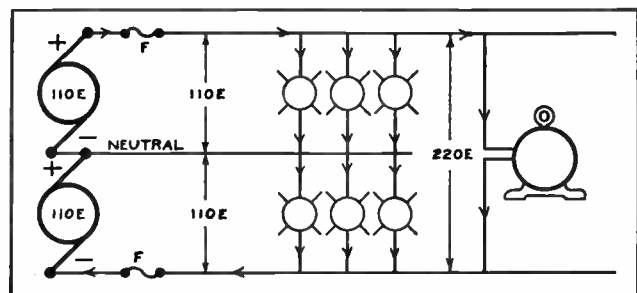

Fig. 132. This diagram shows the arrangement of two generators in series to supply an Edison three-wire system. Note that this arrangement provides both 110 volts for lamp circuits and 220 volts for motor circuits.

The advantages of the three-wire system are that it provides 110 volts for lights and 220 volts for motors, with only three wires, and it effects a great saving in the size of conductors and copper costs even when used for lighting alone. This is because when there is an equal number of lights on each side of the system, they all really operate on 220 volts, with two groups of lamps in series across the outside wires.

The current tends to flow through both generators in series and through both groups of lamps



in series, and no current will flow in the neutral wire, as long as the number and size of lamps is equal on each side of the system:

### 88. SAVING IN COPPER BY USE OF THREE-WIRE SYSTEM

With the lamps operating at 220 volts and two in series, they require only one-half as much current in amperes to supply their rated wattage, as they would if they were operated on 110 volts. Therefore, smaller wires can be used and we find that this system saves over 50 per cent of the wire cost, except on certain small circuits where the Code requires a certain minimum size of wire.

The simple sketch and problem in Fig. 133 will illustrate how this reduction of current is obtained. We will use even figures of 100 volts and 200 volts to make them easy to follow. In "A" we have six 100 volt lamps of 200 watts each. The total wattage of the six lamps will be  $6 \times 200$  or 1200 watts. The current required for this wattage will be  $W \div E$  or  $1200 \div 100 = 12$  amperes, which will be the load on the wires. In "B" the lamps are connected two in series and each of these pairs connected across the 200 volt wires.

The total wattage of the lamps remains the same, or 1200 watts, and now the current will be  $W \div E$  again or  $1200 \div 200 = 6$  amperes. So with this connection the wires only need to carry one-half as much current.

This can also be checked in another way as follows: We know that the current required by each 100 volt, 200 watt lamp will be  $200 \div 100$  or 2 amperes. So when they are all connected in parallel it will require 12 amperes to operate them. But when they are connected as at "B", the same two amperes which lights the upper lamps must pass on through the lower one as well, so it now requires only  $3 \times 2$  or 6 amperes, at 200 volts.

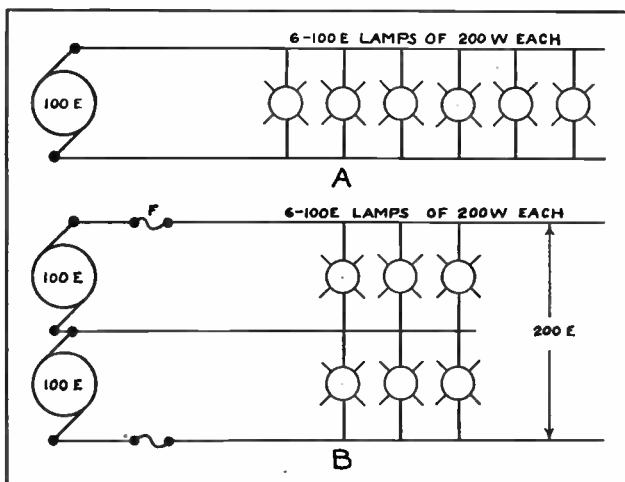

Fig. 133. By the use of Watts law determine the current required for the six lamps on 100 volts in the upper circuit; then determine the current required on the three-wire system below with the lamps operating on 200 volts in groups of two in series. This will show the reason for considerable saving in the size of the wires on three-wire systems.

### 89. UNBALANCED SYSTEMS

So far we have considered only a balanced load condition where no current flows in the neutral wire. Now let's see what will happen if the load is unbalanced or if one of the lamps is turned out on the upper side of the system in Fig. 133-B. We will illustrate this separately in Fig. 134. In this case the lower side will require 6 amperes and the upper side only 4 amperes. Two amperes will now flow out along the neutral wire from the lower generator, to make up this shortage. The upper generator supplies 4 amperes which flow through both groups of lamps and through the lower generator as well; and the lower generator supplies 6 amperes, four of which still flow through the outer wires and both groups of lamps, and two of which flow through the neutral and lower wires and lower groups of lamps only. The generators automatically assume their proper share of load whenever the load balance changes. Note the size of the current arrows which show this division of current. This is due to the fact that the resistance and the voltage drop of each group of lamps vary with their number.

For example, if the lamps in Fig. 134 are all 100 volt, 200 watt lamps their resistance will be 50 Ohms each. Then, according to our rule for finding the total resistance of a parallel group, that of the two upper lamps will be  $50 \div 2 = 25$  Ohms resistance between wires "A" and "B". The total resistance of the three lower lamps in parallel will be  $50 \div 3$  or  $16\frac{2}{3}$  Ohms between wires "B" and "C".

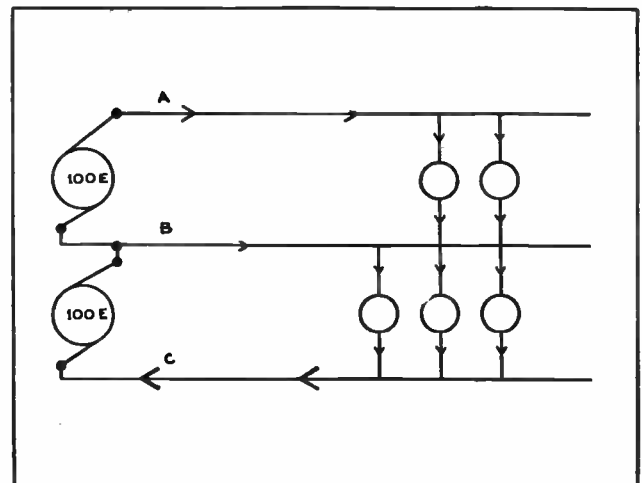

Fig. 134. This sketch shows an unbalanced three-wire system. Note carefully the division of current between the two generators and circuits and the direction of current flow in the neutral wire.

Each generator delivers 100 volts, so that is the voltage applied to each group of lamps. The current through the upper group will be  $E \div R$  or  $100 \div 25 = 4$  amperes. The current through the lower group will be  $100 \div 16\frac{2}{3} = 6$  amperes. So we find that a simple application of Ohms law explains why the generators will each automatically supply their proper share of the current load.

The amount of current flowing in the neutral wire will always be in proportion to the amount of

unbalanced load, and it may be in either direction according to which side of the system is the more heavily loaded.

### 90. "SOLID NEUTRAL" FOR THREE-WIRE SYSTEMS

The ideal condition for a three-wire system is to have no current flowing through the neutral, so we should always try to keep the load as evenly balanced as possible when connecting up the two-wire branch circuits to the three-wire mains.

Of course, it is impossible to keep such a system perfectly balanced at all times, because of lights and devices on the different circuits being turned on and off. This is the reason we need the neutral wire, and also one of the reasons the Code requires that on the modern polarized system the neutral must not be fused. This is the reason it is often termed a **Solid Neutral**. Many of the older non-polarized systems, however, have fuses and switches in the neutral.

### 91. EFFECTS OF OPEN NEUTRAL AND UNBALANCED LOAD

Now let's see what will happen in such a system if the neutral were fused and this fuse blew out while the load was unbalanced. In Fig. 135 we normally have a balanced load of eight lamps when all are turned on, but at present two in the upper group are turned off and the fuse in the neutral is blown.

Assume that the lamps are each of 100 Ohms resistance, and let's find out how much current will be flowing through the six lamps with 200 volts applied by the two generators in series, and their neutral open.

The resistance of the upper and lower groups of lamps being unequal, we must first figure that of each group separately and then, as the two groups are in series, we will add them to obtain the total resistance of all the operating lamps.

The resistance of the upper two lamps in parallel will be  $100 \div 2$  or 50 Ohms. That of the lower four in parallel will be  $100 \div 4$  or 25 Ohms. Then  $50 + 25 = 75$  Ohms, total resistance.

Now, according to Ohms law, we find that with 200 volts applied the current will be  $200 \div 75$  or  $2\frac{2}{3}$  amperes. This current will all flow through the upper two lamps, and then divide out through the lower four, so the upper lamps will burn much brighter than the lower ones.

The reason for this can also be checked by our knowledge of Ohms law and voltage drop principles. We know that the voltage drop across any device or group of devices in parallel is proportional to the resistance of the devices and the current flowing through them, or  $E_d = I \times R$ . Then, with a current of  $2\frac{2}{3}$  amperes flowing through the upper two lamps, which have a combined resistance of 50 Ohms, we find we have  $2\frac{2}{3} \times 50$ , or  $133\frac{1}{3}$  volts drop across them, which accounts for their burning much too bright. On the lower group with the

same current flowing through a resistance of 25 Ohms, we will have  $2\frac{2}{3} \times 25$ , or  $66\frac{2}{3}$  volts drop across the lamps, which accounts for their burning very dim.

This over voltage applied to the upper group will cause their filaments to be severely overheated, and possibly burned out if they are left long in this condition.

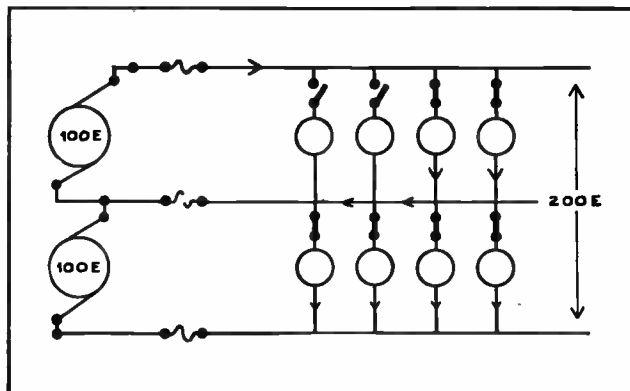

Fig. 135. This diagram illustrates what would happen if the neutral wire was to become opened on an unbalanced three-wire system. The upper two lamps would then burn excessively bright, and the lower four would burn very dimly.

From this we see what a common indication of a blown neutral fuse or a non-polarized three-wire system would be when part of the lamps burn excessively bright and others burn very dim.

This cannot happen on the modern polarized system where the neutral has no fuse and is always closed, allowing the generators to balance up the load by applying 100 volts at all times to each side of the circuit. If this had been the case in Fig. 135, the lamps would have remained at normal brilliancy, as  $100 E \div 50 R$  of the upper group would cause just two amperes, or one ampere for each lamp, to flow through them; while  $100 E \div 25 R$  of the lower group would cause four amperes, or one ampere for each lamp, to flow through them. The neutral wire would carry the difference.

While it is not likely that the neutral will often have to carry as much current as the outer wires, on a properly balanced three-wire system, it is possible for it to happen occasionally, so the Code requires that the neutral wire be the same size as the others, except on loads over 200 amperes, where we can reduce the size of the neutral 30%. This reduction is allowed either from the maximum connected load, or by applying what is known as a **Maximum Demand Factor**, which will be explained later.

We have illustrated the principles of the three-wire system with two D. C. generators as the source of the two different voltages, because it is easy to understand and was the first method of obtaining this system. In a number of places this method is still in use, where 110 and 220 volts D. C. are used. In other cases a special three-wire generator is used, having a connection to a center point in its arma-

ture winding to obtain the neutral or half voltage wire.

This system can also be used just as readily on A. C., by using two transformers connected in series, or merely a center tap from the 220 volt secondary winding of one transformer, as shown in Fig. 136. This is by far the most common type of three-wire system in use today, and is applied to power systems at 220 or 440 volts A. C., as well as to house wiring systems of 110 and 220 volts.

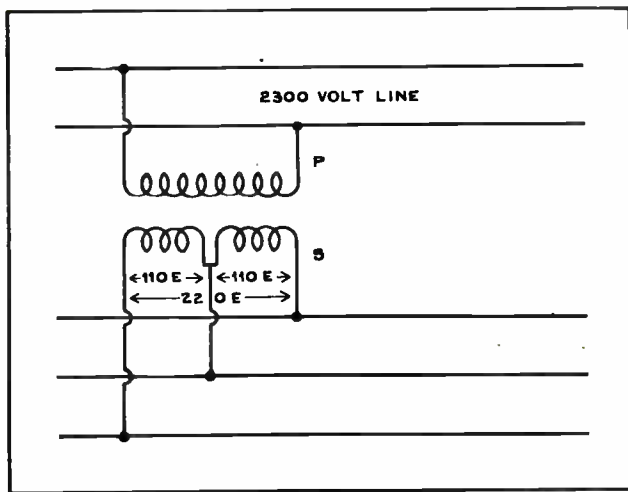

Fig. 136. Three-wire A.C. systems can be conveniently obtained by the use of a center connection to transformer windings as shown above.

## 92. POLARIZED WIRING SYSTEMS

This system has been mentioned several times so far, particularly with reference to the grounding of various circuits and devices. The term polarized in this case refers to the grounding and marking or identification of the neutral wire.

The modern polarized wiring system is one that has the neutral wire thoroughly grounded at the service switch, and this grounded wire distinguished throughout the entire system by a different color from the "hot" or ungrounded wire.

Generally, we use a wire with black or red insulation for the ungrounded wire, and one with white or light gray insulating braid for the grounded wire. This applies to wires from 14 to 6 in size. On larger wires and cables, other methods of marking the grounded wire are used. Its ends can be coated with white paint or tagged, or at the service entrance the ends left for the power company's man to connect his wires to, can have the insulation stripped off the grounded wire for a short distance. The identification of the grounded wire should be carried on through every branch circuit, fixture wire, etc., right up to the device using the current.

The other very important rule for a polarized system, as previously mentioned, is that the neutral or grounded wire must not be fused at any point, but must always be complete and unbroken from the service box to the very tip of light sockets

or devices to which it is attached. Or, in other words, it must be what is called a **Solid Neutral**.

## 93. SAFETY FEATURES AND ADVANTAGES OF POLARIZED WIRING

Another advantage of maintaining this unbroken grounded wire, and having it plainly marked, is so that it can always be connected to the threaded or outer element of lamp sockets and receptacles; while the "hot" or ungrounded wire must always be connected to the inner or center terminal of such sockets. This eliminates practically all danger of anyone getting a shock by touching the socket, even if the insulation of the outer element failed, allowing it to touch the shell or casing.

You will find the terminal screws of the latter type sockets, receptacles, and switches are also identified by one screw having a yellow or brass color, and the other a white or silvery color.

The grounded wire should, of course, attach to the lighter colored screw, and the "hot" wire to the brass colored screw.

When using BX as switch leads, we must make an exception to the rule. In this case we sometimes connect the black and white wires together.

This is because we must have one black wire and one white one coming out of the outlet for connection to the light fixture, as in Fig. 136-B. In order to do this, we must connect the white wire of the BX, which runs to the switch, to the black wire in the ceiling outlet.

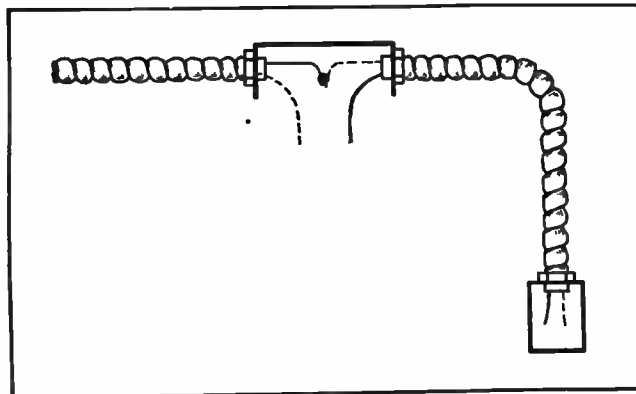

Fig. 136-B. This sketch shows the manner in which the white and black wires in a polarized system are connected at the outlet boxes for ceiling lights and wall switches.

We should then remember that the white wire at the switch is the "hot" one, and the black wire at the ceiling outlet is the return wire from the switch, and it should be connected as usual to the yellow screw on the fixture.

In order to make this protection positive and dependable, you can readily see that the grounded wire must always be complete clear back to the transformer, and we should never place any switch in this side of the circuit, unless it also opens the ungrounded wire at the same time it opens the

grounded one. Double pole snap switches, for example, open both wires at the same time. Single pole switches when used must always be placed in the ungrounded wire.

Having this neutral wire grounded, as well as the conduit, gives us added protection against fire or shock hazard from the conduit system.

In case the insulation of the "hot" wire becomes defective, and allows it to touch the conduit, this causes a short circuit and immediately blows the fuse, indicating a defect on the circuit, which can be repaired at once. Using this system with a solid neutral also eliminates the possibility of having an open neutral and burned out lamps when the load is unbalanced.

#### 94. GROUNDING NEUTRAL WIRE OF POLARIZED SYSTEMS

At the transformers you will always find three wires coming from the secondary winding. The center one of these is the neutral, and is grounded by the power company. The ground inside the building at the service switch should be heavy copper wire not smaller than No. 8, as previously mentioned, and this wire should be protected from possible breakage by being run inside the piece of conduit to the waterpipe, where it is attached by use of a ground clamp, previously described.

The end of this ground wire at the service box is usually connected to the "neutral strap" in the switch box, and also to a brass grounding screw that will be found in the modern steel switch cabinet.

We do not ground the service switch or any part of an interior D. C. wiring system, but one wire of the D. C. line is grounded at the power plant.

On all alternating current systems, however, this additional grounding of the neutral wire as well as the conduit, and the identification of this wire throughout the system are great safety features and advantages, and make the polarized system a very desirable one to use.

#### 95. PARTS OF WIRING SYSTEMS

Every wiring job consists of at least two, and sometimes three, important parts. They are the Service, Feeders, and Branch Circuits. All jobs must have the service and branch circuits, and on the larger installations the main circuits feeding from the service to the branch circuit panels are called feeders.

The service can be divided into two parts also. One part is the running of the wires from the transformer or line to the building service entrance, which would be the Drip Loops or weather cap on the building. The other part is the running of the wires from the drip loop into the service switch.

#### 96. SERVICE WIRES

The service wires from the pole are usually run by the power company from whom the power is to be purchased. These wires should have weather-proof insulation, and be attached to insulators at

the house in a manner to keep all strain off from the drip loop and weather cap.

See Fig. 137, which shows how these wires would be attached to the building, and also a method of bracing a porch, or part of a building, to stand the strain that long heavy service wires might place upon it.

The Drip Loop, or slack loops of wire from the insulators to the weather cap, are used to prevent water from running down the wires into the conduit.

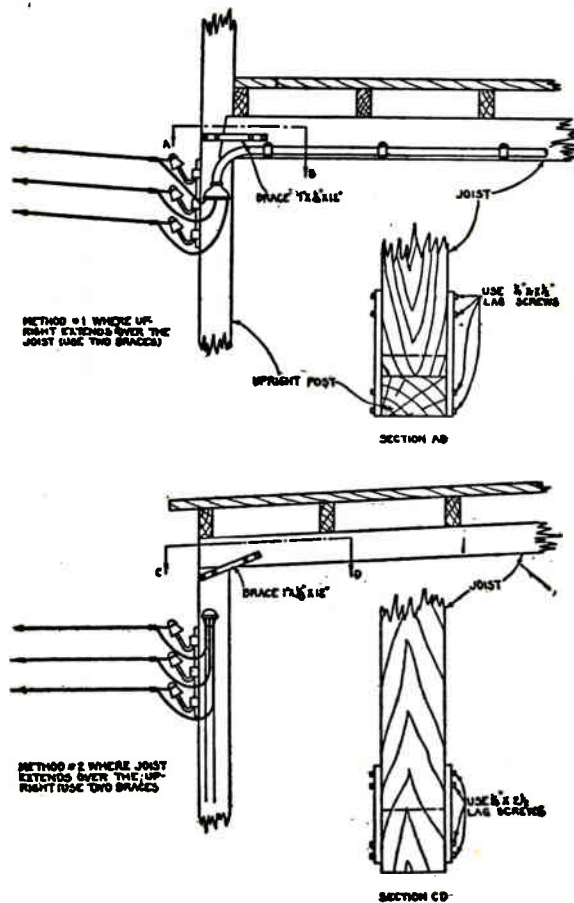

Fig. 137. The above two sketches show the method of arranging the connections of service wires to a building with strain insulators, drip loops, and weather heads. Also note the method of bracing a porch or corner of a building to stand the strain of a long run of service wires.

The electrician wiring the house can use either conduit or knob and tube work for running the service on in to the service switch. The Code recommends the use of conduit, and it is much the best.

The service wires must be at least No. 8 and rubber covered. This requires  $\frac{3}{4}$ " conduit, which can be run from a point near the outside insulators, either up or down the outside wall, or along horizontally, to a convenient place for entrance to the service switch inside. The wires and conduit should be larger if the load requires.

This conduit should always be equipped with a Weather Cap, such as one of the types shown in Fig. 138, so the wires enter from the under side and no water can enter the conduit.

In some cases a "B" conduit fitting can be used, or the upper end of the conduit bent in an inverted "U", and an "A" conduit used to form the weather protection. The strain insulators and weather cap should be located 15 to 18 feet from the ground if possible.

If knob and tube work is used for the service, the wires should also enter the building high up, to be out of reach from the ground outside. They should also pass through properly sloped tubes where they enter the wall.

Service wires should enter the building at a point as near as possible to the service switch, and this switch should be located near a door or window if possible. This location of the switch is to make it more easily accessible in case of fire.



Fig. 138. Weather head fittings of the types shown above are used on the end of conduit at the service entrance to prevent water from entering the conduit.

## 97. FEEDERS

On larger jobs, such as apartment buildings, stores, and offices, cut-out blocks, or fuse cabinets are often located on the various floors or in various sections or apartments. The feeders are run from the service switch to these branch circuit panels, and the wires must be of the proper size according to the load in amperes which they are to carry.

Sometimes several buildings are connected together by feeders, in which case there must be a suitable **Feeder Control** switch at one end or the other, to separate the systems in each building when necessary.

Service or feeder wires when passing over any buildings must clear the roofs 8 ft. at their nearest point.

## 98. BRANCH CIRCUITS

Practically all wiring systems have **Branch Circuits**, which may be referred to as the wires beyond the last set of fuses.

Most branch circuits are two-wire circuits, although some are three-wire. On all ordinary two-wire branch circuits of under 125 volts, we must use at least No. 14 wire, and generally fuses of not over 15 ampere size.

In addition to lamps, we may connect appliances of not over 660 watts or 6 amperes each to these branch circuits.

## 99. TYPES OF BRANCH CIRCUITS

Branch circuits are sub-divided into:

**Lighting Branch Circuits**, which are intended to supply energy to lighting outlets only, and are governed by the rules just given.

**Combination Lighting and Appliance Branch Circuit**, which as its name implies is a combination of

lighting and power outlets with limits as previously mentioned.

**Appliance Branch Circuits**, which supply energy to permanently wired appliances or to attachment plug receptacles.

Appliance Branch circuits are further sub-divided into:

**Ordinary Appliance Branch Circuits**, using as a rule receptacles and plugs rated at not over 15 amperes at 125 volts, using at least No. 14 wire and fused not to exceed 15 amperes. On these circuits we may use appliances rated at not over 1320 watts.

**Medium Duty Appliance Branch Circuits**, wired with No. 10 wire, and fused for 25 amperes, where we may use appliances rated not to exceed 15 amperes or 1650 watts each.

**Heavy-Duty Appliance Branch Circuits**, wired and fused as above, for appliances between 15 and 20 amperes.

Appliances using over 20 amperes should be supplied by individual circuits.

## 100. LOADS ON WIRING SYSTEMS, AND SIZE OF SERVICE WIRES

The total connected load on any wiring system can easily be calculated by adding up the rating in watts of all the lamps and devices connected to the system.

Then, by dividing this wattage by the voltage of the system, we can determine the current in amperes which would flow if all the devices were ever operated at once. This would be called the maximum load.

In the ordinary building there is almost never a time when all lights or devices are turned on at once. However, careful tests and measurements on various classes of buildings show certain average loads which represent the usual case. In various types of buildings these loads vary from 25 per cent to 85 per cent of the connected load.

Until 1928 the National Code required the installation of service wires and feeders large enough to take care of the **Maximum Connected Load**. If there was a total connected load of 500 amperes in the building, the service wires had to be large enough for this load, even though there was practically no chance of 500 amperes ever being used at any one time.

## 101. DEMAND FACTOR

The Code now permits us, under certain conditions, to consider the **Maximum Demand** instead of the **Maximum Connected Load**, when figuring the size of service and feeder wires. To do this we use what is called the **Demand Factor**. This figure is obtained from the ratio of the maximum demand to the connected load of the type of system we are considering. It is based on the area, as determined by the outside dimensions of the building and the number of floors; and it may be applied to interior wiring systems supplying both lights and ap-

pliances. This demand factor also varies with the use to which the building is put.

Let us consider an example for an ordinary single-family dwelling. If the house is  $30' \times 45'$  and two stories high (not counting unoccupied basements or unfinished attics or porches) then its area will be  $30' \times 45' \times 2 = 2700$  sq. ft.

For the first 2000 sq. ft. of such buildings, we allow one watt per sq. ft. or 2000 watts; and for the balance .60 watts per sq. ft. The balance in this case is  $2700 - 2000$ , or 700 sq. ft.

With this balance we can use the demand factor, which is .60 for this type of building. Then  $.60 \times 700 = 420$ . We must always add an extra 1000 watts for appliances.

The total load, or maximum demand, will then be  $2000 + 420 + 1000$  or 3420 watts. If this is to be on a balanced three-wire system we can divide the watts by 220 volts, or  $3420 \div 220 = 15.5 +$  amperes, to allow for on the service wires. If it is to be a 110 volts system then  $3420 \div 110 = 31.9 +$  amperes. (Note—Wherever the + sign is used after an answer figure, it indicates this figure is approximate and not carried out to long decimal fractions.)

In residence buildings of the apartment type, for from two to ten families, we use .70 as the demand factor, and add 1000 watts for each apartment for appliances. The demand factor can also be applied to the total allowance for appliances.

In stores, including department stores, we allow two watts per sq. ft., except for display cases and show windows. For counter display cases, allow 25 watts per linear ft. (per ft. of length); for wall and standing cases, 50 watts per linear foot; and for show windows, 200 watts per linear ft. In such buildings 1.00 is used as a demand factor.

In garages, allow  $\frac{1}{2}$  watt per sq. ft., and use 1.00 as the demand factor.

In industrial plants and commercial buildings, the service wires are calculated for the specified load of the equipment. This takes into consideration the average load factor, which will be covered in a later section on motors.

Other kinds of installations are covered in the Code and can easily be referred to when required.

Keep in mind that the demand factor applies only to services and feeders, and not to branch circuits.

## WIRE CALCULATIONS

### 102. WIRE CALCULATIONS

A great deal of valuable information on the size of copper wires, their resistance, and current carrying capacity can be obtained from convenient tables; and they should be used whenever possible as they are great time savers.

There are certain cases, however, when tables are not available or do not give just the needed information, and a knowledge of simple wire calculations is then very important.

For example, the table in the National Code which gives the allowable current carrying capacities is based on the heating of the wires and does not consider voltage drop due to resistance of long runs or lines. Both of these considerations are very important and should always be kept in mind when planning any electrical wiring system.

The wires must not be allowed to heat enough to damage their insulation, or to a point where there will be any chance of igniting nearby materials. If wires are allowed to heat excessively, it may cause the solder at joints to soften and destroy the quality of the splices; and in other cases it may result in expansion of the wires and resulting damage. Heat is also objectionable because it increases the resistance of the wires, thereby increasing the voltage drop for any given load,

### 103. VOLTAGE DROP

Whether or not the wires heat noticeably, the resistance and voltage drop on long runs may be great enough to seriously interfere with the efficient operation of the connected equipment. Incandescent lamps are particularly critical in this respect and a drop of just a very few volts below the voltage for which they are rated, greatly reduces their light and efficiency. In the case of lighting circuits, the current reduces when the voltage at the lamps is below normal.

Motors are not affected by small voltage variations quite as much as lamps are, but they will not give their rated horsepower if the voltage is below that at which they are rated. When loaded motors are operated at reduced voltage, the current flow actually increases, as it requires more amperes to produce a given wattage and horsepower at low voltage than at the normal voltage. This current increase is also caused by the fact that the opposition of the motor windings to current flow reduces as their speed reduces. The reason for this will be explained later.

From the foregoing we can see that it is very important to have all wires of the proper size, to avoid excessive heating and voltage drop; and that, in the case of long runs, it is necessary to determine

the wire size by consideration of resistance and voltage drop, rather than by the heating effect or tables alone.

To solve the ordinary problems requires only a knowledge of a few simple facts about the areas and resistance of copper conductors and the application of the simplest of arithmetic.

#### 104. GAUGE NUMBERS BASED ON RESISTANCE

You have already learned that wire sizes are commonly specified in B. & S. gauge numbers. This system was originated by the Brown & Sharpe Company, well known manufacturers of machine tools. The B. & S. gauge is commonly called the American Wire Gauge, and is standard in the United States for all round solid electrical wires.

These gauge numbers are arranged according to the resistance of the wires, the larger numbers being for the wires of greatest resistance and smallest area. This is a great convenience, and a very handy rule to remember is that increasing the gauge by three numbers gives a wire of approximately twice the area and half the resistance. As an example—if we increase the gauge from No. 3, which has .1931 Ohms per 1000 ft., to No. 6, we find it has .3872 Ohms per 1000 ft., or almost double.

Brown & Sharpe gauge numbers range from 0000 (four ought), down in size to number 60. The 0000 wire is nearly  $\frac{1}{2}$  inch in diameter and the number 60 is as fine as a small hair.

The most common sizes used for light and power wiring are from the 0000 down to No. 14; and also, of course, the Nos. 16 and 18, which are used only for fixture wiring.

#### 105. CIRCULAR MIL, UNIT OF CONDUCTOR AREA

In addition to the gauge numbers, we have a very convenient unit called the **Mil**, for measuring the diameter and area of the wires. The mil is equal to

$\frac{1}{1000}$  of an inch, so it is small enough to measure and express these sizes very accurately. It is much more convenient to use the mil than thousandths or decimal fractions of an inch. For example, instead of saying a wire has a diameter of .055", or fifty-five thousandths of an inch, we can simply say or write 55 Mils. So a wire of 250 Mils diameter is also .250", or  $\frac{1}{4}$  inch, in diameter.

As the resistance and current-carrying capacity of conductors both depend on their cross-sectional area, we must also have convenient small units for expressing this area. For square conductors such as bus bars we use the **Square Mil**, which is simply a square  $\frac{1}{1000}$  of an inch on each side. For round conductors we use the **Circular Mil**, which is the area of a circle with a diameter of  $\frac{1}{1000}$  of an inch. The abbreviation commonly used for circular mil is C.M.

These units simplify our calculations considerably, as all we need to do to get the area of a square conductor in **Square Mils**, is to multiply one side by the other, measuring them in mils or thousandths of an inch.

To get the area of a round conductor in **Circular Mils**, we only need to square its diameter in mils or thousandths of an inch. (To square a number merely multiply it by itself).

#### 106. CONVERSION OF SQUARE MILS TO CIRCULAR MILS

In comparing round and square conductors, however, we must remember that the square mil and circular mil are not quite the same size units of area. For a comparison see Fig. 139. At "B" we have shown a circle within a square. While the circle has the same diameter as the square, the corners of the square make it the larger in area. So just remember this little illustration, and it will be easy to recall that the area of one **Circular Mil** is less than that of one **Square Mil**. The actual ratio

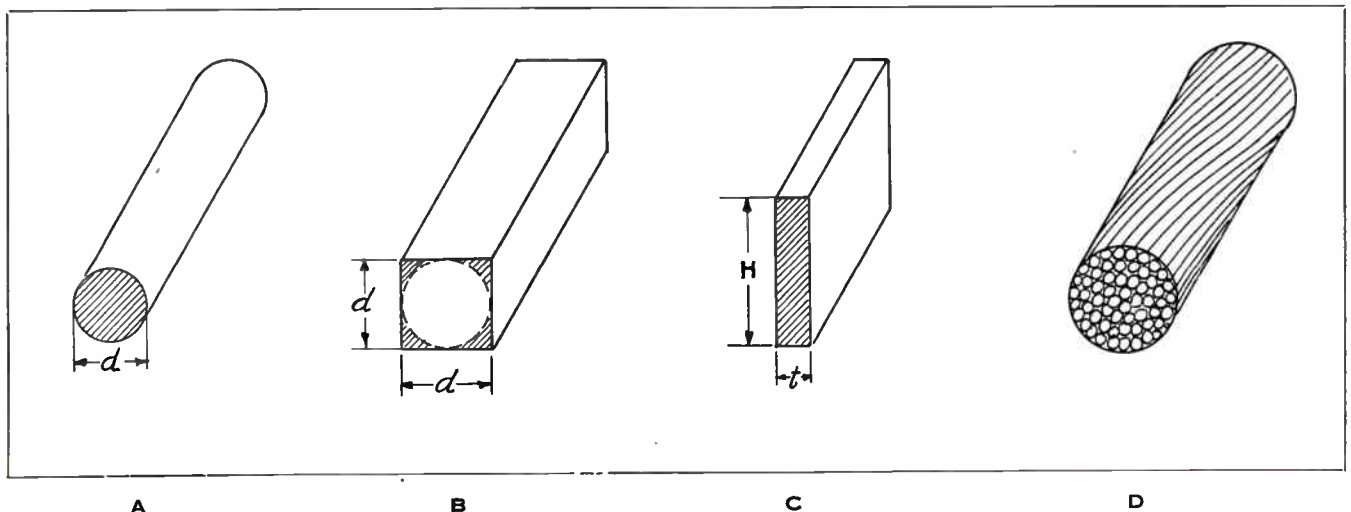

Fig. 139. Electrical conductors are commonly made in the several shapes shown above. Note particularly the comparative areas of round and square conductors as shown at "B", and refer to these illustrations when making the calculations explained in the accompanying paragraphs.

between them is .7854, or the circle has only .7854 of the area of a square of the same diameter.

Then if we wish to find the Circular Mil Area from the number of Square Mils, we divide the Square Mils by .7854. If we wish to find the Square Mil Area from Circular Mils, multiply the Circular Mils by .7854.

For example, if the conductor at "A" in Fig. 139 is a No. 0000 and has a diameter of 460 mils, what is its area both in circular mils and in square mils? The C.M. area is  $460 \times 460 = 211,600$  C.M. Then the sq. mil area is  $211,600 \times .7854 = 166,190.64$  sq. mils.

If the bus bar at "C", in Fig. 139, is  $1\frac{1}{2}$  inches high and  $\frac{1}{4}$  inch thick, what is its area in square mils, and what size of round conductor would be necessary to carry the same current that this bus bar would? First, the dimensions of a  $\frac{1}{4}$ " x  $1\frac{1}{2}$ " bus bar, stated in mils, are 250 mils x 1500 mils. Then the area in sq. mils is  $250 \times 1500 = 375,000$  sq. mils.

To find what this area would be in circular mils we divide 375,000 by .7854, and find it would be 477,463.7 C.M. The nearest size to this in a round conductor is the 500,000 C.M. size, which we would use in this case.

Bus bars of the shape shown at "C" in Fig. 139 are commonly used in wiring power plant or large distribution switchboards. These bars ordinarily range in thickness from .250" to .375"; and in height, from 1" to 12". On voltages under 600 they can be used bare, when properly mounted on switchboard panels. On higher voltages they are usually taped to avoid shock hazard.

It is quite common practice to allow about 1000 amperes per sq. inch on such busses when they are located in well ventilated places. This is a very convenient figure and should be remembered.

When heavier currents than one of the thin bars can carry, are to be handled on a switchboard, several bars are usually mounted in parallel with small spaces between them for air circulation and cooling.

Stranded conductors, such as shown in Fig. 139-D, are used on all sizes larger than 0000. As stranded conductors are not solid throughout, we cannot determine their area accurately by squaring their diameter. This diameter also varies somewhat with the twist or "lay" of the strands.

To determine the cross-sectional area of such conductors, we get the area of each strand, either from a wire table or by calculation from its diameter, and then multiply this by the number of strands, to get the total area of the cable in C.M.

The following wire table gives some very convenient data and information on the common sizes of conductors, and will be very convenient for future reference as well as during your study of this section.

WIRE TABLE. (Bare Solid Copper)  
B & S Gauge

Size B&S Gauge	Diameter in Mils	Area in Circular Mils	l.bs. per 1000 feet Bare Wire	(Ohms) per 1000 feet at 60° F. Resistance
Solid Wire				
26	15.94	254.1	.77	40.75
25	17.90	320.4	.97	32.21
24	20.10	404.01	1.22	25.60
23	22.57	509.5	1.54	20.30
22	25.35	642.4	1.95	16.12
21	28.46	810.1	2.45	12.78
20	31.96	1022.	3.10	10.14
19	35.89	1288.	3.90	8.04
Solid Strand				
18	40.30	1624.	4.917	6.374
16	50.82	2583.	7.818	3.936
14	64.08	4107.	12.43	2.475
12	80.81	6530.	19.77	1.557
10	101.9	10380.	31.43	.9792
9	114.4	13090.	39.63	.7765
8	128.5	16510.	49.98	.6158
7	144.3	20820.	63.02	.4883
6	162.	26250.	79.46	.3872
5	181.9	33100.	100.2	.3071
4	204.3	41740.	126.4	.2436
3	229.4	52630.	159.3	.1931
2	257.6	66370.	200.9	.1532
1	289.3	83690.	253.3	.1215
0	324.9	105500.	319.5	.09633
00	364.8	133100.	402.8	.07639
000	409.6	167800.	508.	.06058
0000	460.	211600.	640.5	.04804

Stranded Cable—Circular Mil Sizes

Approximate Diameters	500.	250000.	756.8	.04147
	547.7	300000.	908.1	.03457
	591.6	350000.	1059.	.02963
	632.5	400000.	1211.	.02592
	707.1	500000.	1514.	.02074
	774.6	600000.	1816.	.01729
	836.7	700000.	2119.	.01481
	866.	750000.	2270.	.01382
	894.4	800000.	2422.	.01296
	948.7	900000.	2724.	.01153
	1000.	1000000.	3027.	.01036
	1118.	1250000.	3784.	.00839
	1225.	1500000.	4540.	.00692
	1323.	1750000.	5297.	.00593
1414.	2000000.	6054.	.00518	

The above table of diameters, areas, weights, and resistance of copper wires will be very convenient whenever you have a problem of wire sizes or calculations.

### 107. RESISTANCE OF CONDUCTORS

As previously mentioned, it is often necessary to determine the exact resistance of a conductor of a certain length, in order to calculate the voltage drop it will have at a certain current load.

The resistance per 1000 ft. of various wires can be obtained from the accompanying wire table, and from these figures it is easy to calculate the resistance of smaller or greater lengths.

Suppose you wish to find the total resistance of a two-wire run of No. 10 conductors 150 ft. long. First multiply by 2, to get the entire length of both wires; or  $2 \times 150 = 300$  ft. Then, from the table, we find that the resistance of No. 10 wire is .9792 Ohms per 1000 ft. Our circuit is less than 1000 ft.; or  $300/1000 \times .9742 = .29226$  Ohms; or approximately .29, which would be accurate enough for the ordinary job.



In another case, we wish to run a short outdoor line between two buildings, a distance of 1650 ft., and using No. 1 wire. What would its total resistance be? The total length of both wires will be  $2 \times 1650 = 3300$  ft. From the table, we find the resistance of No. 1 wire is .1215 Ohms per 1000 ft. Then as 3300 ft. is 3.3 times 1000, we multiply  $3.3 \times .1215 = .40095$  or approximately .4 Ohms.

The National Code table for carrying capacities of wires, allows 100 amperes for No. 1 R.C. wire. We find, however, that if we have this much current flowing through our line, the voltage drop (Ed) will be  $I \times R$  or  $100 \times .4 = 40$  volts. This is too much to be practical, because even if we applied 120 volts to one end of the line, the lamps or devices at the other end would receive only  $120 - 40$ , or 80 volts. The watts loss in the line would be  $I \times Ed$ , or  $100 \times 40 = 4000$  watts, or 4 KW.

So we find that the practical load for such a line would be about 25 amperes, which would give a voltage drop of  $25 \times .4$  or 10 volts. If we now apply 120 volts to the line, the equipment at the far end will receive 110 volts, and the loss will only be  $25 \times 10$  or 250 watts.

#### 108. RESISTANCE OF COPPER PER MIL FOOT

In many cases we may need to calculate the resistance of a certain length of wire or bus bar of a given size.

This can be done very easily if we know the unit resistance of copper. For this we use the very convenient unit called the **Mil Foot**: This represents a piece of round wire 1 mil in diameter and 1 ft. in length, and is a small enough unit to be very accurate for all practical calculations. A round wire of 1 mil diameter has an area of just 1 circular mil, as the diameter multiplied by itself or "squared", is  $1 \times 1 = 1$  circular mil area.

The resistance of ordinary copper is 10.79 Ohms per Mil Foot, but we generally use the figure 10.8 as sufficiently accurate. This figure or "constant" is important and should be remembered.

Suppose we wish to determine the resistance of a piece of No. 12 wire, 50 ft. long. We know that the resistance of any conductor increases as its length increases, and decreases as its area increases. So, for a wire 50 ft. long, we first multiply, and get  $50 \times 10.8 = 540$ , which would be the resistance of a wire 1 C.M. in area and 50 ft. long. Then we find in the table that the area of a No. 12 wire is 6530 C.M., which will reduce the resistance in proportion. So we now divide:  $540 \div 6530 = .0826 +$  Ohms.

In another case we wish to find the resistance of 3000 ft. of No. 20 wire, for a coil winding perhaps. Then,  $3000 \times 10.8 = 32,400$ ; and, as the area of No. 20 wire is 1022 C.M., we divide:  $32,400 \div 1022 = 31.7 +$  Ohms.

Checking this with the table, we find the table gives for No. 20 wire a resistance of 10.14 Ohms per 1000 ft. Then for 3000 ft. we get  $3 \times 10.14 = 30.42$  Ohms. The small difference in this figure and the one obtained by the first calculation, is caused by using approximate figures instead of lengthy complete fractions.

We can use the mil ft. unit and its resistance of 10.8 to calculate the resistance of square bus bars, by simply using the figure .7854 to change from sq. mils to C.M.

Suppose we wish to find the resistance of a square bus bar  $\frac{1}{4}'' \times 2''$ , and 100 ft. long. The dimensions in mils will be  $250 \times 2000$ , or 500,000 sq. mils area. Then, to find the circular mil area, we divide 500,000 by .7854 and get 636,618+ C.M. area. Then,  $100 \text{ ft.} \times 10.8 = 1080$  Ohms, or the resistance of 100 ft. of copper 1 mil in area. As the area of this bar is 636,618 C.M., we divide:  $1080 \div 636,618 = .001,696 +$  Ohm, total resistance. According to the allowance of 1000 amperes per sq. inch, such a bus bar could carry 500 amperes, as it is  $\frac{1}{4}'' \times 2'' = \frac{1}{2}$  sq. inch area. With a 500 ampere load, the voltage drop would be  $I \times R$ , or  $500 \times .001696 = .848$ , or approximately .85 volts drop.

The following table gives the allowable current carrying capacities of wires with rubber insulation; also those with varnished cloth and other insulations, such as slow burning, etc. This table gives the current allowed by the National Code.

#### ALLOWABLE CURRENT CARRYING CAPACITY OF WIRES

B. & S. Gauge Number	Area in Circular Mils	Allowable Current in Amperes		
		Rubber Insulation	Varn. Cloth Insulation	Asbestos Insulation
18	1,621	3	..	5
16	2,583	6	..	10
14	4,107	15	23	32
12	6,530	20	29	42
10	10,380	25	38	54
8	16,510	35	50	71
6	20,750	45	68	95
5	33,100	52	78	110
4	41,740	60	88	122
3	52,630	69	104	145
2	66,370	80	118	163
1	83,690	91	138	188
0	105,500	105	157	223
00	133,100	120	184	249
000	167,800	138	209	284
0000	211,600	160	237	340
	250,000	177	272	372
	300,000	198	299	415
	350,000	216	325	462
	400,000	233	361	488
	500,000	265	404	554
	600,000	293	453	612
	800,000	340	514	720
	1,000,000	377	583	811
	1,500,000	434	698	

The capacities above are based on copper having 98 per cent of the conductivity of pure copper wire. For insulated aluminum wire the capacity will be taken as 84 per cent of the values given in the table. Wires can be connected in parallel for greater capacity only by the consent of the inspection department of the National Board of Fire Underwriters.

**109. ALLOWABLE VOLTAGE DROP**

We must remember, however, that this table does not take into consideration the length of the wires or voltage drop. For this reason we may often wish to use larger wires than the table requires.

In lighting installations, we should never use wires so small that there will be over 2 per cent drop on branch circuits, or 3 per cent drop on feeder circuits. Generally the voltage drop should not be more than 1 to 2 per cent. On power wiring installations, there should usually not be over 5 per cent drop. This means that on a 110 volt branch circuit we should not have over  $.02 \times 110$  or about 2.2 volts drop; on 220 volt feeder circuits, not over  $.03 \times 220$  or 6.6 volts drop; and on 440 volt power circuits, not over  $.05 \times 440$  or 22 volts drop, etc.

**110. SIMPLE FORMULA FOR CONDUCTOR AREA**

For selecting the proper size of conductor for any known load in amperes, and to keep the voltage drop within the desired practical limit, we have a very simple formula that will tell us the circular mil area of the conductor to use.

This formula must, of course, consider the resistance of copper, the total length of the line, and the current load in amperes. It is as follows:

$$\text{C.M.} = \frac{10.8 \times L \times 2 \times I}{E_d}$$

In which:

C.M. = Circular mil area of conductor.

10.8 = Resistance of copper per mil ft.

L = Length of line in feet.

2 = Is to multiply by to obtain total length of both wires.

I = Load in amperes.

$E_d$  = Allowable voltage drop in volts. (Not in per cent.)

(Note: The figure 2 is also used for Edison three-wire systems, as the current never has to flow through more than the resistance of two wires.)

Now let's see how we would use this handy formula for choosing the size of wire on a certain job. Suppose we wish to run a feeder 200 ft. long to a branch panel on which the load consists of: Twenty-six 60 watt, 110 volt lamps; ten 200 watt, 110 volt lamps; and one 10 h.p., 220 volt motor.

First, we will find the total load in watts. Twenty-six 60 watt lamps will use  $26 \times 60$ , or 1560 watts. Ten 200 watt lamps will use  $10 \times 200$ , or 2000 watts. As there are 746 watts in 1 h. p., the 10 h. p. motor will use  $10 \times 746$  or 7460 watts. (Assuming 100% efficiency.)

Then  $1560 + 2000 + 7460 = 11,020$  watts. Assuming this load to be balanced, the current will all

flow over the two outside feeder wires at 220 volts. So to find the current we use the formula  $W \div E = I$ , or  $11,020 \div 220 = 50+$  amperes.

We will allow 6 volts drop on the feeders, and, using the wire size formula, we will substitute the values we have found, as follows:

$$\text{C.M.} = \frac{10.8 \times 200 \times 2 \times 50}{6}$$

Working this out, we find we get 36,000 C.M. area for the wire. Looking this up in the table we find that the next size larger is No. 4 wire, which has 41,740 C.M. area. As the Code table allows 70 amperes for this wire with rubber insulation, we find we are quite safe in using it from this standpoint.

Try out the foregoing formula on some imaginary problems of your own, until you can use it easily because it is very commonly used in electrical layouts and estimating.

**111. VOLTAGE DROP FORMULA**

If we wish to determine what the voltage drop will be on a certain installation already made, or on the wires proposed for a job, we can simply transpose the formula we have just used, interchanging voltage drop for C.M. area, as follows:

$$E_d = \frac{10.8 \times L \times 2 \times I}{\text{C.M.}}$$

Suppose we have a two-wire, 110 volt installation where the load is 25 amperes and the feeder is 120 feet long, and only supplied with 110 volts.

The Code allows us to use a No. 10 wire for 25 amperes, and the area of No. 10 wire is 10,380 C.M. Then, substituting these values in the formula, we have

$$E_d = \frac{10.8 \times 120 \times 2 \times 25}{10,380} \text{ or } 6.24 \text{ volts,}$$

whereas we should not have more than 3% of 110, or about 3.3 volts drop.

In another case, suppose an electrician used No. 14 wire for a 110 volt branch circuit in a factory and this circuit had twelve 100 watt lamps and two 60 watt lamps connected to it, and was 90 ft. long. The total watts in this case would be 1320 and at 110 volts, this would be a load of 12 amperes. It would be quite natural to use No. 14 wire, as the Code allows 15 amperes for this size, and it is the size so commonly used. But checking it with our formula we find that No. 14 wire has an area of 4107 C.M., and that

$$E_d = \frac{10.8 \times 90 \times 2 \times 12}{4,107} \text{ or } 5.6+ \text{ volts drop,}$$

which would certainly not be satisfactory.

Using the other formula again, we can easily determine the size of wire that should have been used on this job to keep within the normal 2 volts drop.

$$\text{C.M.} = \frac{10.8 \times 90 \times 2 \times 12}{2} \text{ or } 11,664 \text{ C.M. Area}$$

As the next larger wire is No. 8, this should have been used; or as a No. 10 wire has 10,380 C.M. area, it could be used, with slightly over 2 volts drop.

So we find that it is very important to be able to do these simple wire calculations on certain jobs, and you will find this material of great value, both in learning how to use the formulas, and in using them and the tables for future reference.

The following table of voltage drop per 1000 ft., per ampere, with various sized conductors is also very convenient, and the wire table on the next page gives a lot of very valuable data on copper conductors. that will often prove very useful.

TABLE OF VOLTAGE DROP

Size B. & S. Gauge	Volts drop per 1000 feet per ampere	Size B. & S. Gauge	Volts drop per 1000 feet per ampere
18	6.374	250,000.	.04147
16	3.936	300,000.	.03457
14	2.475	350,000.	.02963
12	1.557	400,000.	.02592
10	.9792	500,000.	.02074
9	.7765	600,000.	.01729
8	.6158	700,000.	.01481
7	.4883	750,000.	.01382
6	.3872	800,000.	.01296
5	.3071	900,000.	.01153
4	.2436	1,000,000.	.01036
3	.1931	1,250,000.	.00829
2	.1532	1,500,000.	.00692
1	.1215	1,750,000.	.00593
0	.09633	2,000,000.	.00518
00	.07639		
000	.06058		
0000	.04804		

Volts Lost Per 1000 Feet per Ampere.

Gauge Equivalents with Weights and Resistances of  
Standard Annealed Copper Wire

B. & S. American Wire Gauge No.	Diameter In Inches	Area Circular Mils	Ohms at 68 deg. Fah.			Feet		Pounds			B. & S. American Wire Gauge No.
			Per 1,000 Ft.	Per Mile	Per Pound	Per Pound	Per Ohm	Per 1,000 Ft.	Per Ohm	Per Mile	
0000	0.460	211600.	0.04906	0.25903	0.000077	1.56122	20497.7	640.51	12987.	3380.	0000
000	0.40964	167805.	0.06186	0.32664	0.00012	1.9687	16255.27	507.95	8333.	2680.	000
00	0.3648	133079.	0.07801	0.41187	0.00019	2.4824	12891.37	402.83	5268.	2130.	00
0	0.32486	105534.	0.09831	0.51909	0.00031	3.1303	10223.08	319.45	3225.	1680.	0
1	0.2893	83694.	0.12404	0.65490	0.00049	3.94714	8107.49	253.34	2041.	1340.	1
2	0.25763	66373.	0.1563	0.8258	0.00078	4.97722	6429.58	200.91	1282.	1060.	2
3	0.22942	52634.	0.19723	1.0414	0.00125	6.2765	5098.61	159.32	800.	840.	3
4	0.20431	41743.	0.24869	1.313	0.00198	7.9141	4043.6	126.35	505.	665.	4
5	0.18194	33102.	0.31361	1.655	0.00314	9.97983	3206.61	100.20	310.	528.	5
6	0.16202	26251.	0.39546	2.088	0.00499	12.5847	2542.89	79.462	200.	420.	6
7	0.14428	20817.	0.49871	2.633	0.00797	15.8696	2015.51	63.013	126.	333.	7
8	0.12849	16510.	0.6529	3.3	0.0125	20.0097	1599.3	49.976	80.	264.	8
9	0.11443	13094.	0.7892	4.1	0.0197	25.229	1268.44	39.636	50.	209.	9
10	0.10189	10382.	0.8441	4.4	0.0270	31.8212	1055.66	31.426	37.	166.	10
11	0.090742	8234.	1.254	6.4	0.0501	40.1202	797.649	24.924	20.	132.	11
12	0.080808	6530.	1.580	8.3	0.079	50.5906	632.555	19.766	12.65	105.	12
13	0.071961	5178.	1.995	10.4	0.127	63.7948	501.63	15.674	7.87	82.9	13
14	0.064084	4107.	2.504	13.2	0.200	80.4415	397.822	12.435	5.00	65.5	14
15	0.057068	3257.	3.172	16.7	0.320	101.4365	315.482	9.859	3.12	52.1	15
16	0.05082	2583.	4.001	23.	0.512	127.12	250.184	7.819	1.95	41.3	16
17	0.045257	2048.	5.04	26.	0.811	161.22	198.409	6.199	1.23	32.7	17
18	0.040303	1624.	6.36	33.	1.29	203.374	157.35	4.916	0.775	26.0	18
19	0.03589	1288.	8.25	43.	2.11	256.468	124.777	3.899	0.473	20.6	19
20	0.031961	1021.	10.12	53.	3.27	323.399	98.9533	3.094	0.305	16.8	20
21	0.028462	810.	12.76	68.	5.20	407.815	78.473	2.452	0.192	12.9	21
22	0.025347	642.	16.25	85.	8.35	514.193	62.236	1.945	0.119	10.24	22
23	0.022571	509.	20.30	108.	13.3	648.452	49.3504	1.542	0.075	8.13	23
24	0.0201	404.	25.60	135.	20.9	817.688	39.1365	1.223	0.047	6.44	24
25	0.0179	326.	32.2	170.	33.2	1031.038	31.0381	0.9699	0.030	5.12	25
26	0.01594	254.	40.7	214.	52.9	1300.180	24.6131	0.7692	0.0187	4.06	26
27	0.014195	201.	51.3	270.	84.2	1639.49	19.5191	0.6099	0.0118	3.22	27
28	0.012641	159.8	64.8	343.	134.	2067.364	15.4793	0.4837	0.0074	2.56	28
29	0.011257	126.7	81.6	432.	213.	2606.959	12.2854	0.3835	0.0047	2.03	29
30	0.010025	100.5	103.	538.	338.	3287.084	9.7355	0.3002	0.0029	1.61	30
31	0.008928	79.7	130.	685.	539.	4414.49	7.72143	0.2413	0.0018	1.27	31
32	0.00795	63.	164.	865.	856.	5226.915	6.12243	0.1913	0.0011	1.01	32
33	0.00708	50.1	206.	1033.	1357.	6590.41	4.85575	0.1517	0.00076	0.803	33
34	0.006304	39.74	260.	1389.	2166.	8312.8	3.84966	0.1204	0.00046	0.634	34
35	0.005614	31.5	328.	1820.	3521.	10481.77	3.05305	0.0956	0.00028	0.504	35
36	0.005	25.	414.	2200.	5469.	13214.16	2.4217	0.0757	0.00018	0.400	36
37	0.004453	19.8	523.	2765.	8742.	16659.97	1.92086	0.06003	0.00011	0.317	37
38	0.003965	15.72	660.	3486.	13772.	21013.25	1.52292	0.04758	0.00007	0.251	38
39	0.003531	12.47	832.	4395.	21896.	26496.237	1.20777	0.03755	0.00004	0.199	39
40	0.003144	9.88	1049.	5542.	34823.	33420.63	0.97984	0.02992	0.000029	0.138	40

No. 140. This very complete table of data for copper conductors will often save you a great amount of time if you become familiar with its use, and refer to it for the information it contains. It will be a good plan to compare the sizes, areas and resistance of a number of the more common sized wires given in this table. This will help you to understand the gauge numbers and in making selections of proper conductors for various jobs in the future.

## INSTALLATION METHODS

### 112. LAYOUTS AND PLANS

In starting any wiring job, whether you are working for a contractor or in business for yourself, there are certain general steps to be followed. Regarding simple knob and tube installations, it is not necessary to say much more about the details of this work than has been previously covered. However, remember that before running any wires, one should have the location of all outlets well in mind, and preferably sketched on a plan; and then marked on the frame work of the new building, if it is such; or upon the walls and ceilings of an old building in which the wiring is being installed after the house has been built.

### 113. LOCATION OF LIGHT AND SWITCH OUTLETS

Ceiling outlets for lighting fixtures should be carefully located and centered to give a balanced appearance in the room, and to afford the best distribution of light.

Wall light outlets should be placed about the walls with proper regard for locations of doors, windows, and large permanent pieces of furniture. Outlets for wall bracket lights should be approximately 66 inches from the floor, if the fixture turns upward from the outlet. If it is of the type that hangs downward, the outlet should be about 72 to 74 inches from the floor. These heights, of course, will depend somewhat upon the ceiling height in various rooms, and the scheme of decoration used. Outlets for wall switches should be about 52 inches from the floor to the bottom of the outlet box, and their locations should be carefully chosen to give the greatest convenience in control of the lights. For example—it is common practice to have the control switches for one or more lights near the front door or entrance to the house, so they can be turned on as soon as the person comes inside at night. In other rooms of the house, switches can be placed either near doors, or in the most convenient locations, to save as many steps as possible. The owner of the building should of course be consulted on such matters, in order to give the best possible satisfaction in the finished job.

After the outlets have all been located, the shortest and most direct runs should be chosen for the various wires to fixtures and switches. Then if there is no blue print already provided for the job, a complete wiring diagram of each floor should be laid out on paper to be sure to get the proper circuits and control of lights and equipment with the fewest possible wires.

### 114. KNOB AND TUBE INSTALLATION

If knob and tube wiring is being installed in a

new building, the holes for the porcelain tubes can be drilled through the center of the joists, as these holes are not large enough to materially weaken the woodwork. Knobs can be placed along the joists for circuits to be run in the walls, and also along the joists in unfinished attics and basements. Before determining the location of the meter and service switch, we should locate the probable point at which the power company will bring the wires from their pole line into the building, and the service switch and meter should be located near this point if possible.

In knob and tube installation in new buildings, the wiring should, of course, all be installed before the lath and plaster are put on the walls. The thickness of lath and plaster that are to be used should be carefully considered, so that the edges of the outlet boxes will be about flush with or about an eighth of an inch under this surface.

### 115. MAKING CONNECTIONS TO SWITCHES AND FIXTURES

When the wires are attached, and the ends brought out in the box, it is well to plug the outlet box with a wad of newspaper to keep the wire ends from becoming damaged or the box clogged with plaster. After the plaster is on and has hardened, the fixtures can be hung and connections made to them and the switches.

In making all such connections, be sure to strip enough of the end of the wires to make a good hook, or one complete turn under the terminal screws, but don't strip an excessive amount so there would be more bare wire than necessary around the switch terminals or fixture connections. See that these wires are bright and clean before placing them under the screws, and always bend the hook in the end of the wire to the right, that is, clockwise or in the same direction the screw head turns. This causes the screw to wrap the wire hook tight around it; while if the hook is made in the opposite direction it often opens up and works out from under the screw head when it is tightened. Don't twist these screws too tight, because they are usually of soft brass and the threads can be easily stripped.

### 116. BX AND NON-METALLIC CABLE INSTALLATION

The same general rules apply to wiring a new building with BX or non-metallic sheathed cable. Either of these materials can be run along the joists and through holes in the framework as required. Before cutting the various lengths of wire, BX, or cable for any run, be sure to measure them

accurately and allow a few inches extra for stripping the ends and making splices and connections. It is always much better to allow a few inches over and trim this off when making the final connections, rather than to find the wires or cable too short and then have to replace them. Always tighten BX and cable clamps securely in the outlet box openings to effect a good ground.

When wiring old buildings, great care should be used not to damage the plaster or decorations, and not to make any unnecessary dirt or mess around the building. When cutting holes in the plaster on walls or ceilings to locate outlet boxes, a cloth or paper should be spread underneath to catch all plaster dust. Sometimes an old umbrella can be opened and hung or held up side down under the place in the ceiling where the hole is being made, so it will catch all of this dirt and keep it off from rugs and furniture.

### 117. LOCATING AND CUTTING OUTLET BOX OPENINGS

Be careful not to cut any of these holes so large that the fixture canopies or switch plates will not cover them neatly. In case the plaster cracks or a mistake is made so that the hole cannot be completely covered, it should be filled with plaster of paris, or regular patching plaster, to make a neat appearance.

Outlet box holes can be cut through the plaster with a chisel. The size of the holes should be carefully marked by drawing a pencil around the outlet box, held against the plaster. In locating the exact spot to cut these openings in the plaster, it is well to first cut a very small hole in the center of the spot where the larger one is to be made, using this to locate the cracks between the lath. Then it is possible to shift the mark for the larger hole up or down a little so the lath can be cut properly, to leave a place in the wood for the screws which fasten the box to the wall. If this method is not followed, sometimes two complete laths are cut away, and the metal ears on the box, which have the screw holes in them, will not reach from one remaining lath to the other.

On wall outlet openings we should always try to cut clear through one lath and a short distance into two adjacent ones. Fig. 141-A shows the wrong way that laths are sometimes cut, and "B" shows the proper way in which they should be cut.

For cutting round holes a regular plaster cutter can be obtained, which fits into an ordinary brace and can be rotated the same as a drill.

For ceiling outlets never cut the lath any more than necessary to bring the wires or BX through.

### 118. RUNNING WIRES AND BX INTO DIFFICULT PLACES

A number of methods have already been described for pulling and fishing wires, cable, and BX into walls and openings in finished buildings; so that, with a little ingenuity and careful thought,

you will be able to solve almost any problem of this kind that you may encounter.

In pulling wires into spaces between the joists in walls, a flashlight placed in the outlet box hole is often a great help in feeding the wires in, or in catching them with a hook to draw them out of the outlet opening.

Where it is necessary to remove floor boards, it should be done with the greatest of care, so as not to split the edges and make a bad appearing job when the boards are replaced. A special saw can be obtained for cutting into floors without drilling holes to start the saw. Then, if the beading or tongue is split off with a thin sharp chisel driven down in the crack between the boards, the board from which the tongue has been removed can be pried up carefully without damaging the rest of the floor.

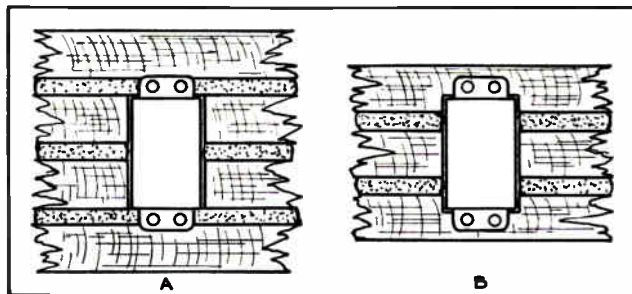

Fig. 141. The view at "A" shows the wrong method of cutting lath to install an outlet box for switches. Note that the metal "ears" do not reach over the lath to provide any anchorage for the screws. At "B" is shown the correct method of cutting the lath to make a secure mounting for boxes of this type.

If it is necessary to run wires or BX crosswise through a number of floor or ceiling joists, it can usually be done by boring the holes through them at a slight angle, and then working the wires or cable through. Where tubes are used, be sure to place the heads up in these slanting holes, so the tubes cannot work out.

Sometimes it is necessary to remove baseboards and cut holes behind these, to aid in fishing the wires or cable up or down through floors and into the walls at this point. In other cases, a channel can be cut in the plaster behind the baseboard, and BX or non-metallic sheathed cable run in this channel, and the baseboard replaced to cover it.

Whenever removing baseboards in this manner, be very careful not to split the "quarter-round" wood strips or trimming that is often fastened along the edges of the baseboard. A broad putty knife is a very good tool to use in removing these strips.

A key-hole saw is very useful in cutting through laths to make outlet openings. Let us emphasize once again that in installing old house wiring, thoughtfulness, care, and neatness are the greatest essentials in leaving the customer satisfied.

### 119. CONDUIT INSTALLATION

When installing conduit wiring systems in new buildings, the entire plan should be carefully gone

over first, to make sure that proper number of wires for each circuit and the proper sizes of conduit have been selected. A great deal of time and money can be saved by planning these things in advance and thereby avoiding costly mistakes.

After the outlets have been located and the boxes carefully installed on their proper supports and hangers, the lengths of conduit can be cut, bent, and fitted in place.

In running conduit in wood frame buildings, care must be taken not to damage or weaken the building structure. In some cases a conduit run cannot be made in the shortest and most direct line, because it would necessitate the notching of joists at some distance from any support. This should not be done, as it is likely to weaken them too much. Instead, it is better to run the conduit along between the joists for some distance and then make the cross run near a wall or partition support, so the notches in the joists can be near their ends where the strain is not so great.

Fig. 142 is a view looking down on a group of ceiling joists, and which illustrates the proper method of running conduit in such cases.

In certain types of frame-building construction, finished floors are laid on strips an inch or more thick over the soft-wood floors. In such cases, with the permission of the contractor or architect, the conduit can often be run between these floors, thus saving considerable labor and materials.

All lengths of conduit should be screwed into their couplings as tightly as possible, to make the conduit ground circuit complete and the entire system secure and tight.

In attaching the conduit to outlet boxes, screw the lock-nut well back on the threads, insert the threaded end of the pipe in the knock-out opening, and screw the bushing on this end as far as it will go. Then tighten the lock-nut securely with a wrench.

## 120. SPECIAL PRECAUTIONS FOR CONDUIT IN CONCRETE BUILDINGS

When installing conduit in concrete buildings, there are sometimes fewer problems than with wood construction, but there are a number of different details which must be observed. In this type of building, conduit generally runs directly by the shortest path from one box to the next; and when the concrete is poured around it, the conduit, instead of weakening the structure, has a tendency to strengthen it.

Just as soon as the wood forms for a certain section of the building are set up, the electrician must be on the job to install the conduit and outlet boxes. In most cases he must be on hand practically all the time these forms are going up, as there are certain places where it is necessary to install the boxes or conduit as the carpenters are placing the wood forms.

The locations of outlet boxes, particularly those for ceiling lights, should be lined up carefully and

straight, so the fixtures will present a neat appearance when they are installed. If these boxes are carelessly located, it is almost impossible, and certainly a mighty costly job, to correct them after the concrete is poured.

After the locations for the outlets have been carefully marked on the boards, the conduit can be cut to the proper lengths, reamed, threaded, and fitted to the outlet boxes.

Before the boxes are nailed in place, the ends of all conduits should be tightly plugged, either with wood plugs or with special disks which are held in place by the bushings. These plugs are to keep soft concrete from running into the pipes. Then the outlet boxes should be packed tightly with newspaper, so that there is no possibility of their filling up with wet concrete. Then the boxes should be nailed securely in place so that there is no chance of their being moved before or during the time the concrete is being poured. If these precautions of plugging conduit and outlet boxes are not observed, you will often encounter a very difficult and expensive job of drilling hard concrete out of the boxes or pipes.

The installation of the complete conduit system is what we term "roughing in." None of the wires should be pulled in until all mechanical work on the building is completed. Sometimes on big buildings this requires weeks or months after the conduit has been installed, so you can see how important it is to have complete and accurate sketches and plans of the whole electrical system.

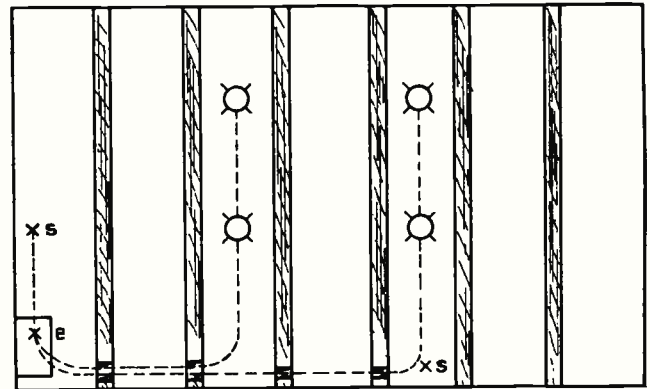

Fig. 142. Ceiling joists should not be notched in their centers in order to run conduit by the shortest path to outlets. Instead the joists should be notched near walls or supports, and the conduit bent to run through these notches, and then back between the joists to the outlets as shown in this diagram.

## 121. PULLING IN THE WIRES

When we are ready to pull the wires into the conduit, the outlet boxes should be cleaned out and all plugs removed from the ends of the pipe.

On very short runs, the ends of the wires can sometimes be twisted together and the group simply pushed through from one outlet to the next. More often, however, we will need to push the steel fish tape through first, and then pull the wires through with it, as previously described. This is

usually a job for two men, one to feed the wires into the conduit straight and even, without allowing them to cross or kink, and the other man to pull on the fish tape.

We should not forget to use powdered mica or soap stone to lubricate the wires when necessary on long runs.

On short runs where the wires pull in rather easily, it may only be necessary to hook them through the loop in the fish tape and twist them together a few times. On more difficult runs, it is sometimes necessary to solder these twisted loops so there will be no chance of their pulling loose from the fish tape.

## 122. FINAL TESTS

When the wires are all pulled in and the ends cut off at the outlet box, allowing the extra length for splices and connections, these ends can then be stripped and cleaned. Before any connections are made, all wires should be thoroughly tested with a dry cell and buzzer or magneto and bell, to make sure there are no shorts or grounds which might have occurred through damaging the insulation when the wires were pulled in.

After the splices are made, it is a good idea to

make another thorough test before they are soldered, to see that all connections are proper and that no faults have developed.

The soldering should then be done immediately, before the bare copper has time to oxidize or corrode. Then all splices should be thoroughly and carefully taped, both with rubber and friction tape. Never slight this part of the job because, if you do, shorts or grounds are likely to develop when the poorly taped splices are pressed back into the outlet boxes.

In hanging fixtures care should be taken to make a neat job of it, and not to dirty the light-colored ceiling by rubbing hands or black materials against it. In some cases the fixture splices are soldered, while in others solderless connectors can be used. These connectors are especially desirable in buildings where no smoke or soot from the soldering operation can be allowed.

After all wiring is complete and all devices connected up, make a final test at the fuse box to be sure there are no shorts or grounds on the "hot" wire. If the system tests clear, then insert the fuses if the service has been connected to the power line, close the switch and test all switches and lights for satisfactory operation.

---

# BUSINESS METHODS AND ESTIMATING

## 123. SALESMANSHIP

For the man who may plan to enter a business of his own sooner or later, the following common sense principles of salesmanship and business methods, as well as the simple practical tips on estimating, should be very useful.

In most towns, whether they are small villages or medium-sized or larger cities, there are opportunities for a wide-awake electrical contractor who knows his business and gives first-class, up-to-date service.

Even in the small towns or localities, where there seems to be considerable competition already existing, an aggressive man can often build up a splendid business with certain classes of work that are overlooked by the present organizations; and in some cases, where the existing prices charged for this work are high, the man starting in on a small scale with low overhead expense can often do first-class work at a more reasonable price, and thereby build up a good business and reputation for himself.

This, of course, cannot be done by merely locating in a place, and waiting for the business to

come to you. It requires active salesmanship and some advertising to get established and build up a business of this nature.

A great many men have the ability and qualifications necessary, and with training of the kind covered in the course, should be able to make a real success, and certainly should not overlook these opportunities.

## 124. NOT MUCH CAPITAL REQUIRED TO START

As mentioned in an earlier section, a great number of our graduates have started splendid businesses of their own with a few small jobs to begin with, doing the work in their own basements or homes, on such repair jobs as were taken in. Of course, the smaller wiring jobs for various customers are done on their premises, and do not require at the beginning an elaborate outlay of tools and materials. As the business grows, one can acquire more tools and materials, some of which should be kept on hand. Later he may rent a shop or building for a store and place to repair electrical equipment.



The very fact that you have had training at an institution of this kind often makes a prospective customer more inclined to try your work and ability, and if you uphold your reputation from the start by putting your knowledge into practice and doing first-class work on every job, your success will be quite certain.

#### 125. PERSONAL CONTACT WITH CUSTOMERS VERY IMPORTANT

Very often the easiest way to secure the first jobs is by personal contact and salesmanship. Wherever new buildings are being erected there are possible customers for wiring jobs, whether these buildings are small private garages, complete homes, stores, factories, or office buildings.

Even where there is very little construction taking place, there are usually homes or buildings with old style and very incomplete wiring systems. Their owners can often be easily convinced that the addition of convenience outlets, more lights, and better lighting fixtures would be a convenience or actual saving of time in the home that would well repay the small cost of installation.

In approaching a customer with a suggestion of this kind, it is often a great help in interesting them, to carry along a few good-looking pictures of homes properly wired, illustrating the great improvement in appearance and the many conveniences thus obtained. A Foot Candle Meter to test the light and fixtures in a home will often interest a customer a great deal from the very moment you call. Their interest at first may be almost entirely in the instrument, but if you can get them to go about the house with you, and see the actual readings, and the evidence which the meter gives of poor lighting, then they can usually be interested in the greater comfort and reduced eye-strain, as well as the much better appearance of the home where proper lighting is installed.

It may be necessary to make even twenty or thirty calls of this kind to secure one job, but this should not be allowed to discourage one, because it doesn't take so much time to make these calls, and even if a great number are made without results at that particular time, many of them will result in business in the near future.

If you can succeed in leaving a good impression of yourself, your knowledge of the subject, and your sincerity and desire to be of service, many of these persons will call you back later, perhaps to do some small job; or will recommend you to their friends who may have wiring or repairs to do. Of course, you should always leave some small card or folder with your name, address, and telephone number, so they can conveniently get in touch with you later.

#### 126. MODERN METHODS AND INSTRUMENTS TO SECURE INTEREST AND CONFIDENCE OF CUSTOMER

Some instrument, such as the Foot Candle Meter mentioned, or perhaps a volt meter for testing the

voltage at the outlets and lamp sockets, will tend to leave the impression that you are up-to-date and well qualified to do good work whenever they may need you.

A free inspection of the wiring and electrical appliances in a home is often a very good method of approach. If conditions are found in the wiring which are likely to be hazardous from the fire or shock standpoint, this can be called to the attention of the owner in a diplomatic and pleasant manner, and a recommendation made that they be fixed or changed at the first opportunity.

Minor repairs on plugs or cords of appliances, defective light switches or sockets, and things of this kind can often be made in a few minutes time, and with almost no cost to the electrician. They will, however, usually create a great amount of good will, and be the cause of securing future business.

A few weeks of "missionary work" of this nature will usually be required to get things started and begin to bring in the jobs, but remember that any business organization or experienced business-man expects to do these things when starting out in any locality.

It is well to keep in mind that one's personal appearance is important in making calls on home owners or prospective customers. A neat, business-like appearance tends to create confidence and respect.

#### 127. ESTIMATING—TIME AND MATERIAL BASIS

When it comes to giving a price on a job, there are several ways in which this can be handled. The time and material basis is ideal for the electrician, and can usually be made satisfactory to the customer. When a job is done in this manner, the customer pays you by the hour for the work of installing the system, and also pays you for the material, which you may buy wholesale and sell to him at retail prices, thus making a reasonable profit in addition to your wages.

If you merely make fair wages on the first several jobs this should be quite satisfactory, for you will be obtaining experience, not only in doing the actual work and gaining confidence in your knowledge and ability, but also in the time required for each type of work, and the costs of various items. You should keep a very careful record of these things, as they will be of great assistance in making accurate estimates on future jobs.

#### 128. COST PER OUTLET

Totaling the entire expense of any job of a certain class of wiring and then dividing this by the number of outlets, will give you a basis on which to estimate jobs of this type in the future. After experience on several installations, you can quote prices at so much per outlet on jobs of any type, such as knob and tube, BX, or conduit wiring. These different classes of wiring are, of course, to be done at different prices per outlet.

Before giving such an estimate, however, you should always look over the building or plans very carefully, to make sure that you are not running into certain difficulties in the installation that will run the expense considerably higher than you expected. In certain types of construction, or where certain special requirements have to be met to please the customer or to satisfy the local inspector, it will be necessary in making your estimate to add a certain amount to the usual price per outlet.

It is well to emphasize here that you should not discuss with your customers the basis or method by which these figures are obtained, because in some cases they may use this as a wedge to force a competitor to cut his prices below yours.

### 129. OVERHEAD EXPENSE AND PROFIT

After you obtain a start and are doing larger jobs, a certain percentage should be added to the cost of materials and labor for overhead expense and profit. These things may sometimes need to be explained to customers, so they do not get the impression that you are overcharging them for certain items.

There is always certain to be some overhead expense or cost of doing business, regardless of whether you have a shop or merely operate your business from your home. This overhead consists of certain small items of expense which you cannot charge directly to the customer, but should properly proportion over the charges for each job.

Some of these items are as follows:

- Telephone Bills
- Electric Light and Water Bills
- Rent; or Taxes, if you own a building
- Insurance, both Fire and Liability
- Non-Productive Labor
- Advertising
- Truck and hauling expenses
- Depreciation of stock and materials you may carry on hand
- Bad or uncollectable bills
- Bookkeeper, or any office help
- General office and shop expense

The item of profit on medium and large sized jobs is one that you are justly entitled to. If you buy your supplies and materials from a large dealer at wholesale prices and charge the customer the regular retail price, this is one source of profit, and a certain reasonable percentage can be added to your wage allowance on any job to complete your per cent of profit.

In other words, there is no use of operating a business if you cannot show at the end of each year a substantial profit or gain. The cost of any job, then, should be divided into at least four items:

1. Net Cost of Material
2. Net Cost of Labor
3. Overhead Expense
4. Profit

Experience has shown that on a small business of under \$20,000.00 gross per year, the overhead will frequently run as high as 30 to 35 per cent. The larger the volume of business, the less the percentage of overhead should be; and with a gross business of \$60,000.00 per year we would usually figure about 20 to 25 per cent. Your profit should certainly be at least 10 per cent above all expenses, and this should be in addition to a fair salary for your time.

If you do a total of \$40,000.00 worth of business in a year, at the end of the year, your income tax report should show that, after paying all bills and your salary and considering all debits and credits, there remains a clear profit of 10 per cent, or \$4,000.00.

By adding all your overhead items together you should get about 25 per cent, or \$10,000.00. If your overhead is more than that amount it shows that there is something wrong in your methods, and you should try to reduce it during the next year, by looking over each item to see where economy can be effected.

### 130. METHOD OF FIGURING OVERHEAD AND PROFIT IN AN ESTIMATE

When figuring on any certain job we don't know, of course, what the gross price is going to be, and, therefore, have to make allowances for these extra items. For example, suppose we consider a job where we find the material will cost \$32.00. The next item to consider will be the labor. While this varies a great deal in different sections of the country, we might estimate it to be about equal to the cost of the material, or slightly more, and we will say it is \$33.00. This makes a net cost, so far, of \$65.00 for material and labor. If we are going to allow 25% for overhead and 10% for profit to make the total cost, or 100%, this leaves 65% for the net cost. If \$65.00 is 65% of the cost, then 100%, or the total cost, would be \$100.00, which should be the price quoted for this job. If you multiply the net cost for labor and materials by .54 it will give the approximate total cost, including the extra 35% for profit and overhead.

In some cases, of course, a job can be quoted at a figure which doesn't cover these extras. For example, where you have a chance to sell equipment which you buy direct from a dealer for a certain job and do not have to carry in stock yourself, this reduces your overhead. In fact the more of this class of business you can do and the less idle stock you carry, the greater your profit will always be. However, in an active business of any size some standard items must always be kept on hand.

### 131. ALWAYS DO FIRST-CLASS WORK

Never make a practice of trying to get a job by cutting your price so low that you have to install poor materials, or do a poor job of the installation.

Always do first-class work at a fair price, and explain to your customers that you are certain they will remain better satisfied with this kind of work than if you cut the price and give them a poor job.

### 132. GETTING NEW CONTRACTS

Very often a number of new jobs can be secured by keeping in close touch and on friendly terms with building contractors and architects, and those in your community who are in a position to know first of new buildings being erected and who may perhaps recommend you for the electrical work.

### 133. PRACTICAL ESTIMATING PROBLEMS

As an example of laying out a job and materials for the estimate, let's consider the installation shown in Fig. 143.

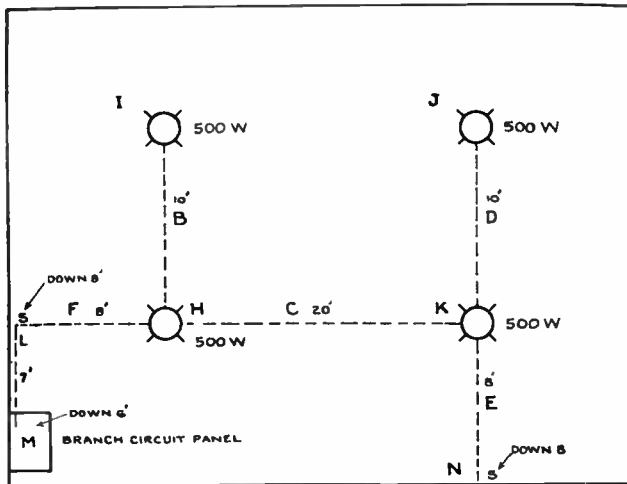

Fig. 143. Layout of a wiring system for four large lights, showing the measurements to be taken in preparing a list of the materials for such a job. Note the explanation and list given in the accompanying paragraphs.

This diagram shows a room in a finished building, such as a store or shop, where the customer desires an installation of exposed conduit. As this is not a new building and there are no blue prints, you should make a rough sketch of the proposed wiring system; and, after locating the outlets and switches, measure the room carefully for the necessary lengths of material. We have four outlets, each for a 500-watt lamp, which means we will need two branch circuits. We will assume that the layout is such that outlets "H" and "I" can be on one circuit, and "J" and "K" on the other. With the distance shown No. 14 wire and ½-inch conduit can be used. The wires for both circuits from the cut-out box to the outlet "H" can be run in one conduit. At the point marked "L" one circuit will have a wire looped down for a switch connection to control lights "H" and "I". Where the conduit changes direction to run down the walls to the cut-out boxes and switches, condulets can be used.

From this lay-out we find the approximate list of materials will consist of the following (not including the cut-out box or fuses):

- 85 feet ½-inch conduit
- 4 4-inch Octagon outlet boxes

- 4 Fixture studs
- 2 Type L ½-inch condulets
- 1 Type LBR ½-inch condulets
- 3 ½-inch blank conduit covers
- 2 Flush switch condulets
- 2 Flush switch conduit covers
- 2 Single-pole flush switches
- 9 ½-inch conduit bushings
- 9 ½-inch lock-nuts
- 20 ½-inch pipe straps
- 225 feet of No. 14 R.C. wire

Also the necessary solder, tape, and screws.

After making up an estimate from the above, it is generally a good plan to add 5% to cover small items that cannot be foreseen in advance.

In another case, suppose we consider a house-wiring job where our records show that we can figure by the outlet. Assume this to be a knob and tube installation in a new building under construction, and that there are to be 50 outlets, half of which are lighting outlets and half are flush switches or flush receptacles. If our records show that on this sized job we should get \$2.75 per lighting outlet and \$3.25 per switch or convenience outlet, then the estimate should be \$150.00, plus the service price, which the records may show will average \$15.00; thus we make the total estimated price \$165.00. In such cases as this your records of previous jobs of similar type will be of great assistance in making an accurate and intelligent bid.

### 133-A. WIRING PLANS AND LAYOUTS

Figures 144 and 145 show the basement and first floor plans of a one-story bungalow, with a layout of the wiring system. This is a very simple system with just the ordinary number of lights and convenience outlets, and could quite easily be installed in an old house, using BX or non-metallic sheathed cable. (Before checking these layouts examine the symbols shown in Fig. 148).

The heavy dotted lines show the circuits feeding to the lights and outlets, while the light dotted lines show the wires from the lamps to the switches which control them. The wiring does not need to run exactly as the lines are shown here, but could, of course, be altered somewhat to suit the building.

In the basement, which in this case is wired with conduit, the equipment is as follows:

"A" is the service switch and branch circuit fuse box.

"B" and "C" are lights controlled by a switch at the head of the stairs.

"D" is the laundry light, controlled by a switch at the door to the laundry room.

"E" is a convenience outlet for washing machine, flat iron, etc.

"F" and "G" are lights on drop cords, controlled by switches on the light sockets.

"H" is a bell transformer which is connected to the junction box "J".

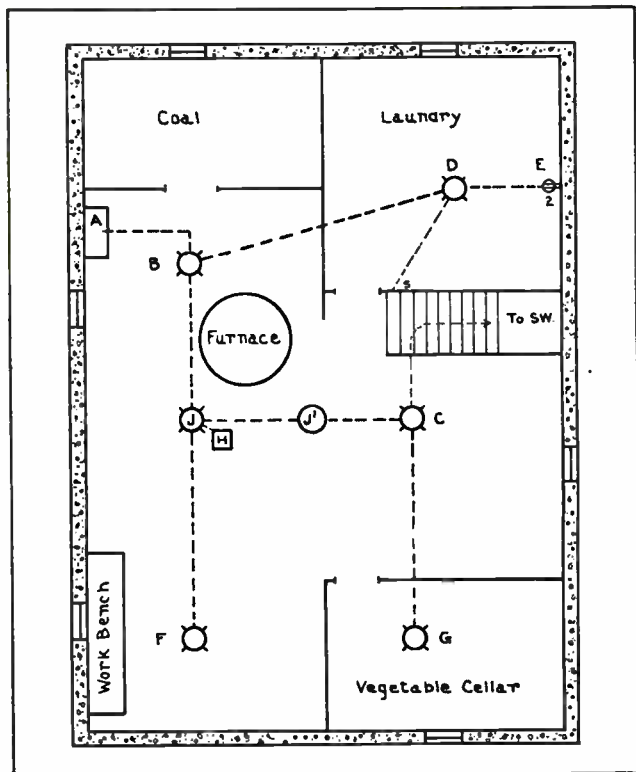

Fig. 144. This diagram shows the basement wiring plan for a one-story building. Check carefully each of the circuits and outlets shown with the explanations given.

“J-1” is a junction box from which BX will be run up through the partition to feed the branch circuits on the floors above.

The number of wires which we will have in each of these runs will be as follows:

“A” to “B”—six wires, three black and three white.

(One two-wire circuit for the basement, and two circuits for upstairs)

“B” to “J-1”—seven wires, four black and three white.

“J” to “F”—two wires, one black and one white.

“C” to “G”—two wires, one black and one white.

“B” to “D”—two wires, one black and one white.

“D” to “E”—two wires, one black and one white.

“J-1” to “C”—three wires, two black and one white.

“D” to switch outlet—two black wires.

“C” to switch outlet—two black wires.

Here again, we can see one of the advantages of polarized wiring, as white wires can be connected to white, and black to black, leaving much less chance for mistakes and wrong connections than if we use all black wires.

In the floor above we have one ceiling light in the center of each room except the living room, which has two; and one in the hall near the bathroom. There is also a light at the head of the stairway. The living room and kitchen lights are

each controlled from two different places, by three-way switches. This provides the convenience of being able to turn them on or off at either door at which one might enter these rooms.

The six double convenience-outlets shown represent just a minimum for an installation of this type; so it might be desirable to install several more of these while wiring the house. The convenience-outlets are located near each other on opposite sides of the walls in the different rooms. This greatly simplifies the wiring as one run can be made to take care of each pair of these outlets.

The dotted lines in this view show only the runs from the lights to the switches which control them. The branch circuits to the lights are not shown; as their position would be a matter of choice and convenience, according to the construction of the house and the points at which they could be best carried through partitions, floors, and ceilings.

Fig. 146 shows a sample form for listing the outlets used on a job, such as shown in Figures 144 and 145. The lighting, switch, and convenience-outlets for this particular job are shown listed on this form. Forms of this type are a great help in getting an accurate list of all the parts and fittings needed for the various rooms of any house-wiring job.

In wiring a new home we would undoubtedly put in a greater number of lights and convenience outlets, as well as three-way switches for selective

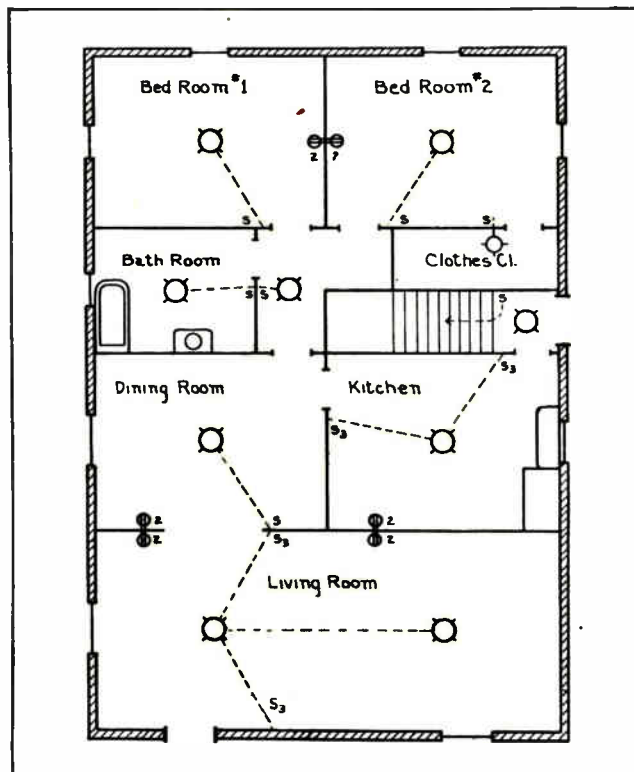

Fig. 145. Wiring diagram for a bungalow residence. Note the location of lights, switches, convenience outlets, etc.

ROOMS	CEILING OUTLETS	WALL BRACKETS	CONVENIENCE OUTLETS	SWITCH OUTLETS	REMARKS
BASEMENT	2			1	AT HEAD OF STAIRS
LAUNDRY	1		1	1	
VEG CELLAR	1				
WORK BENCH	1				
BELL TRANSF	1				
LIVING RM.	2		2	2	3 WAYS
DINING RM.	1		1	1	
KITCHEN	1		1	2	3WAYS
BATH	1			1	
BED RM.*1	1		1	1	
BED RM.*2	1		1	1	
HALL	1			1	
CLOSET		1		1	
ALL CONVENIENCE OUTLETS ARE DOUBLE					

Fig 146. Simple forms of this type are a great help in totaling the number of outlets for any job. Other forms are used for listing the material for each room and the total wiring job.

control. Fig. 147 shows a cut-away view of the first floor in a modern home, which gives some idea of the arrangement of wall bracket lights, convenience outlets, and switches. In addition to those shown, there would probably also be a ceiling light in the living room, dining room, and kitchen.

### 134. WIRING SYMBOLS

Fig. 148 shows a number of the more common symbols used in marking various electrical outlets on the building plans. Examine each of these carefully and become familiar with them, as they will be a great help to you in reading any blue prints supplied either by contractors or architects where the electrical wiring of any building is laid out in advance. A knowledge of their use will also be very handy to you in drawing up a sketch or plan for a building in which you may be laying out the wiring system yourself.

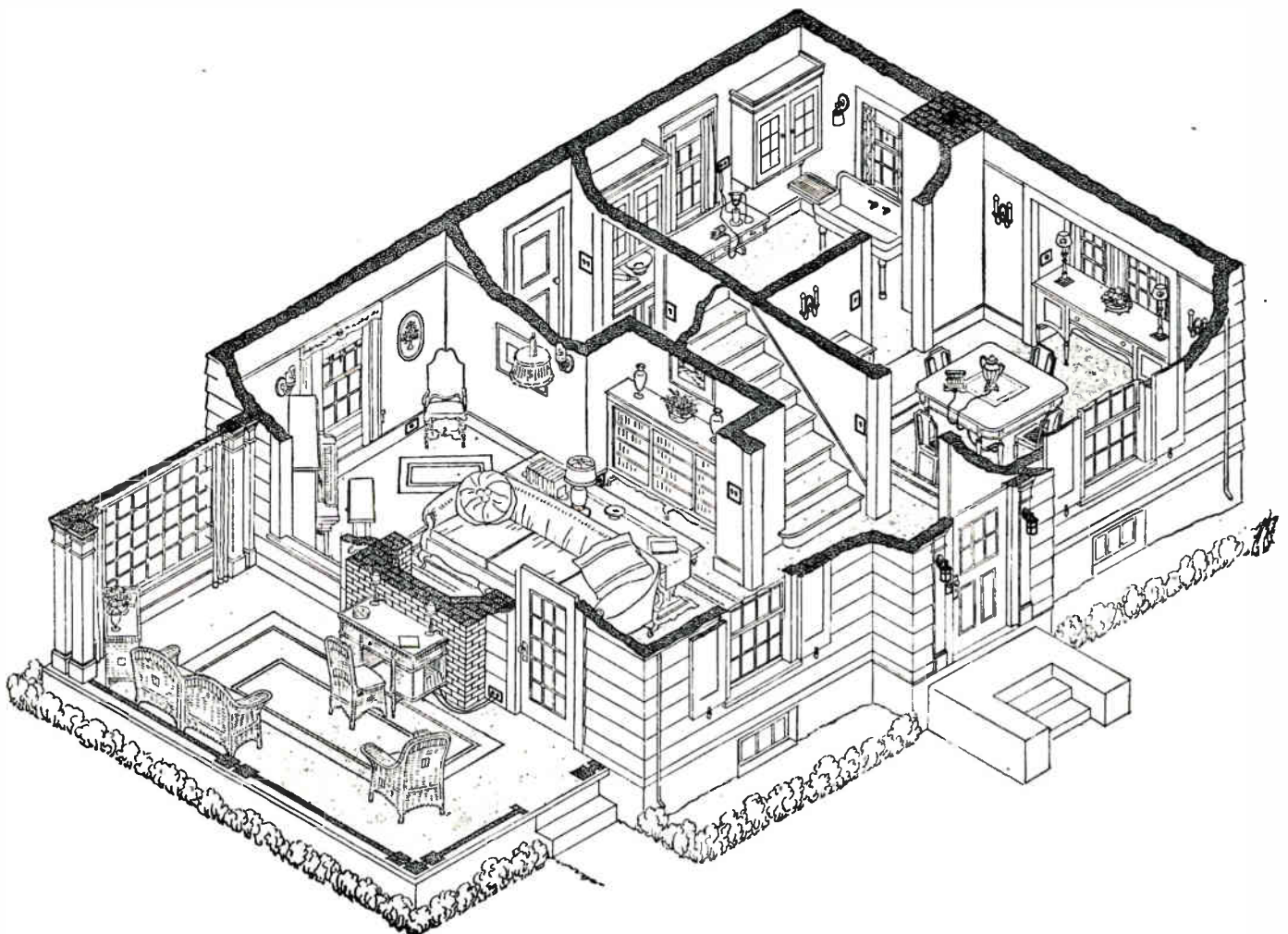

Fig. 147. Sectional view of ground floor of a house, showing the location and arrangement of lights, switches, and convenience outlets.

STANDARD SYMBOLS FOR ELECTRICAL EQUIPMENT OF BUILDINGS					
Ceiling Outlet		Automatic Door Switch	S <sup>D</sup>	Feeder Run Exposed	-----
Ceiling Fan Outlet		Key Push Button Switch	S <sup>K</sup>	Feeder, Run concealed under Floor	——
Floor Outlet		Electrolier Switch	S <sup>E</sup>	Pole Line	○-○
Drop Cord		Push Button Switch and Pilot	S <sup>P</sup>	Push Button	
Wall Bracket		Remote Control Push Button	S <sup>R</sup>	Annunciator	
Wall Fan Outlet		Motor		Interior Telephone	
Single Convenience Outlet		Motor Controller		Public Telephone	
Double Convenience Outlet		Lighting Panel		Local Fire Alarm Gong	
Junction Box		Power Panel		Local Fire Alarm Station	
Special Purpose Outlet-Lighting, Heating and Power as Described in Specification		Heating Panel		Fire Alarm Central Station	
Special Purpose Outlet-Lighting, Heating and Power as Described in Specification		Pull Box		Speaking Tube	
Special Purpose Outlet-Lighting, Heating and Power as Described in Specification		Cable Supporting Box		Nurses Signal Plug	
Exit light		Meter		Maid's Plug	
Pull Switch		Transformer		Horn Outlet	
Local Switch- Single Pole	S <sup>1</sup>	Branch Circuit, Run concealed under Floor Above	——	Clock (Secondary)	
Local Switch- Double Pole	S <sup>2</sup>	Branch Circuit, Run Exposed	-----	Electric Door Opener	
Local Switch-3 Way	S <sup>3</sup>	Branch Circuit, Run concealed under Floor	——	Watchman Station	
Local Switch-4 Way	S <sup>4</sup>	Feeder, Run concealed under Floor Above	——	4 No. 14 Conductors in 3/4 in. Conduit Unless Marked 1/2 in.	
This Character Marked on Tap Circuits Indicates 2 No 14 Conductors in 1/2-in. Conduit.		3 No. 14 Conductors in 1/2 in. Conduit.			

Fig. 148. The above wiring symbols with their explanations should be very carefully studied so you will be able to recognize the more common of these symbols readily and easily when working with wiring diagrams or plans. Make a practice of referring to these symbols every time you find one you cannot recognize in a diagram.

135. NEW HOUSE WIRING PLAN

Figures 149 and 150 show the wiring plans for the first and second floors of a modern home. These plans show a more complete system of lights, convenience outlets, three-way switches, etc., such as we would be most likely to install in a new building. Some home-owners might not care to go to the expense of quite as complete an installation as these plans show, but whenever possible the customer should be sold on the idea of wiring the house complete for every possible need when it is erected, as it is so much cheaper to install these things when the house is being built than to put them in afterward. With the ever-increasing use of electrical appliances and light in the home, the owner is likely to regret it later if the home is not quite completely wired. However, it is very easy to leave out a few of the items in a suggested plan of this type, if desired.

By referring to the chart of wiring symbols in Fig. 148, you will be able to recognize each of the

outlets in this wiring plan. Check each of them carefully until you have a thorough understanding of the location of each outlet and what they are for.

The dotted lines in these diagrams only show which outlets are connected together, and the runs from the switches to the lamps which they control. The plans do not show where the conduit or BX runs come up from the basement or from one floor to the other.

Several different organizations, such as the General Electric Company and the National Contractors' Association, have some very valuable printed forms, which can be obtained to aid you in listing materials for an estimate; and also sample forms for contracts with the customer. The Society for Electrical Development furnishes valuable material and information, such as the Franklin Specifications and Red Seal Plan for good lighting, which should be of great value to anyone in business for himself.

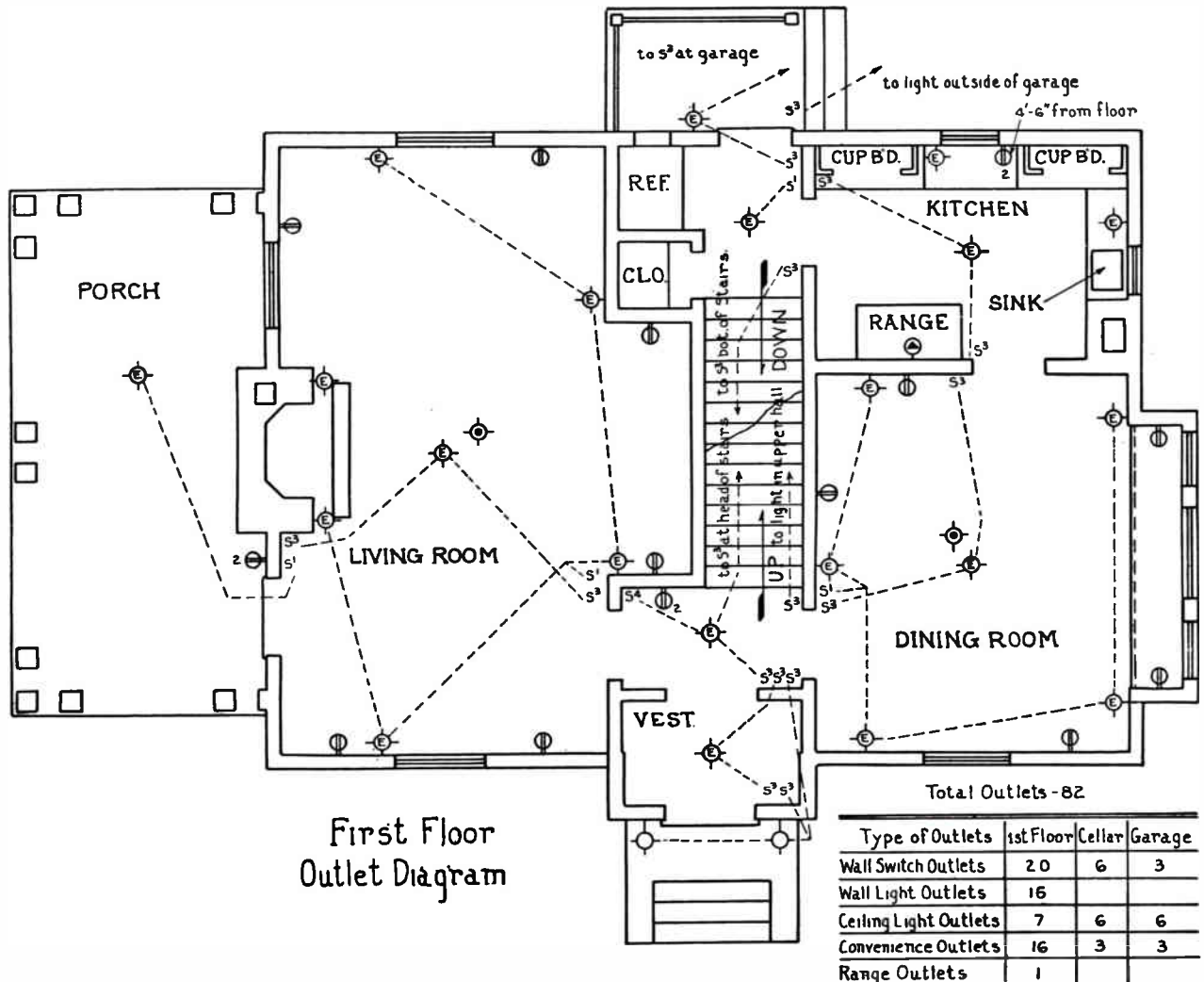

Fig. 149. This wiring diagram gives a more complete layout of the proper lights, switches and convenience outlets for a modern wiring job in a new building. Compare each of the different outlet symbols with those in Fig. 148.

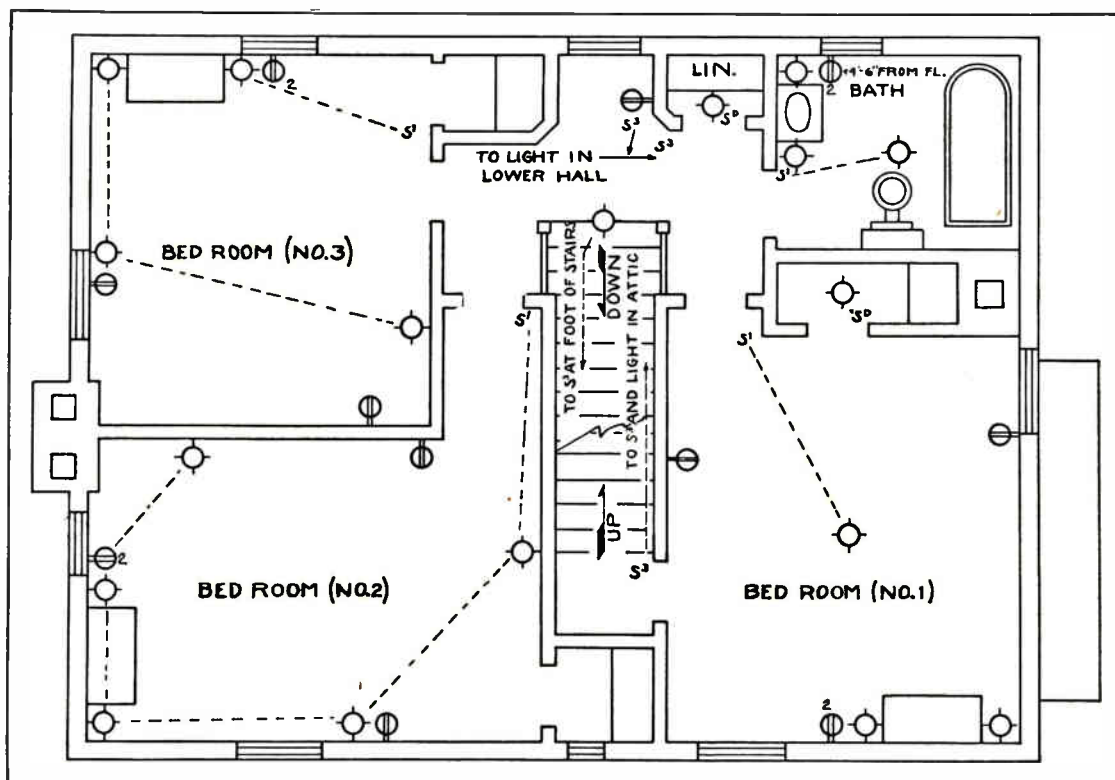

Fig. 150. Second-floor plan and wiring diagram. Note the location of the switches to control the various lights, and particularly the three-way switches for controlling lights from more than one place. Compare this diagram to the one in Fig. 149, to get a complete understanding of the arrangement of switches at the stairway.

### 136. TOOLS

Perhaps you will wonder how many and what type of tools will be required to start in electrical wiring. It is not necessary to have such a complete or elaborate layout on tools to start your first jobs with. A list of the more common and necessary ones for this type of work are as follows:

Several screw drivers of various sizes  
 Side-cutting pliers.  
 7 or 8-inch diagonal cutting pliers.  
 Long-nosed pliers.  
 6-inch combination pliers.

8-inch gas pliers.  
 Claw hammer.  
 Ballpein hammer.  
 Wood chisels, one narrow and one wide.  
 Cold chisel.  
 Hack-saw frame and blades.

Hand saw.  
 Key-hole saw.  
 Corner brace and wood bits.  
 Hand drill or push drill.  
 Stillson pipe wrench.

Six-foot rule.  
 Blow torch and soldering iron.  
 Two or three putty knives, for prying off wood strips.  
 100 ft. steel fish tape.

In addition to this list, an electrician who owns his own shop should acquire as soon as possible a boring machine, step ladders, conduit bender, vise, pipe cutter, pipe reamer, stock and dies for threading pipe, and set of star drills. A number of other items will be found convenient as the shop or business grows, and these can be purchased as the profits of the business will pay for them.



## TROUBLE SHOOTING

### 137. TROUBLE SHOOTING

Whether you are employed as an electrical wireman or maintenance man, or in the business for yourself, a great deal of your work may often be what is commonly known as "Trouble Shooting."

This covers a wide range, from such small jobs as finding a short circuit in a domestic flat iron to tracing out troubles in a power circuit of some large shop or factory. In any case, it usually requires merely a thoughtful application of your knowledge of circuit tracing and testing. We have previously recommended and will emphasize here again the necessity of keeping cool when emergencies of this sort arises, and going about the location of the trouble in a systematic and methodical manner, testing one part of the circuit or system at a time, until the trouble is cornered.

Keep in mind that every trouble shooting problem can be solved, and someone is certainly going to solve it. If you succeed in locating and remedying the trouble, it will always be to your credit, and it may be the source of new business for you or a promotion on the job.

In general, the same methods can be followed for trouble shooting and testing in light and power circuits as have previously been explained in the section on signal wiring. A dry cell and buzzer, taped together and equipped with a pair of flexible leads five or six feet long, is always a handy device for this work.

Where part of the system is still "alive", or supplied with current, a pair of test lamps are very handy. These can be connected together in series for 220-volt tests or one can be used separately for testing 110-volt circuits. They are particularly handy when testing for blown fuses, and this test will often locate the source of trouble. A test lamp will light when connected across a burned out fuse if there is a load on the line.

### 138. FUSE TROUBLES

In testing wiring circuits we should first start at the service switch or fuse box. Test to see if the line is alive from the outside service wires, and if it is, then test the fuses. The fuses may be checked by testing across diagonally from the service end to the house end. This test will show which fuse is blown. If the contact springs or clips which hold cartridge fuses are blackened or burned, this is likely to be the cause of the trouble. Sometimes these springs become bent and do not make a good contact to the ferrule on the fuse. This results in a high-resistance connection and heating, which softens and destroys the spring tension of the clips.

When clips or springs are found in this condition they should be renewed.

Fig. 151 shows several conditions that will often be found with cartridge fuse clips. When fuses of the cartridge type are found to be blown, it is well to examine them a little before replacing. If the fuse link is found to be blown in the manner shown at "A" in Fig. 152, it is probably caused by a light overload, which gradually heated the fuse to a point where one end melted out. Occasionally you may find the fuse burned in two at the middle and not at the narrow points where it is supposed to blow. This condition is shown at "B", and is sometimes caused by the slow heating of the fuse, and from the heat being conducted away from the ends by the fuse clips, thus causing the center to melt first. When a fuse has been blown from a severe overload or short circuit, it will often be found melted in two at both of the narrow spots, allowing a whole center section to drop out, as in Fig. 152-C. In such cases there will be a tremendous rush of current that may melt the first point open in a fraction of a second, but the extremely heavy current flow may maintain an arc across this gap, long enough to melt out the other weak point also.

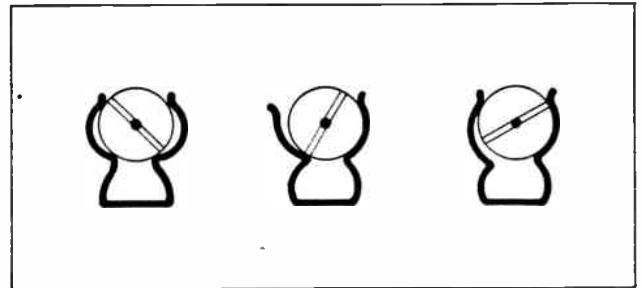

Fig. 151. Fuse clips that are bent out of shape in the manner shown above very often cause heating of the ferrules which results in blown fuses, and other fuse troubles. Burned or weakened fuse clips should be replaced and new ones adjusted to fit the ferrule of the fuse outlet.

With plug fuses, we can also very often tell something of the nature of the trouble by the appearance of the window in the blown fuses. If the window is clear and shows the strip melted in two, it was probably a light overload which blew the fuse. But if the window is badly blackened by a violent blowing out of the fuse, it is usually an indication of a severe overload or short circuit.

### 139. COMMON CAUSES OF SHORT CIRCUITS

Wherever blown fuses are encountered it is well to check up on possible causes and conditions in the circuits before replacing the fuses. Sometimes we may find that someone had just connected up and

tried out some new electrical appliance which may have been defective or of too great a load for the circuit and fuses. Frequently these devices will be found connected up wrong. Sometimes by inquiring of the people on the premises we can find the probable cause of the trouble.

For example, the lady of the house may have been ironing when suddenly there was a flash at the iron, the lights went out, and the iron cooled off. This would probably indicate a defective cord on the iron or a short circuit on the plug or element. In another case one of the children may have stumbled over a cord to a floor lamp causing all the lights to go out, which would indicate that wires were probably jerked loose and shorted at the lamp or plug; or that the insulation of the cord may have been broken through, causing the wires to short within the cord.

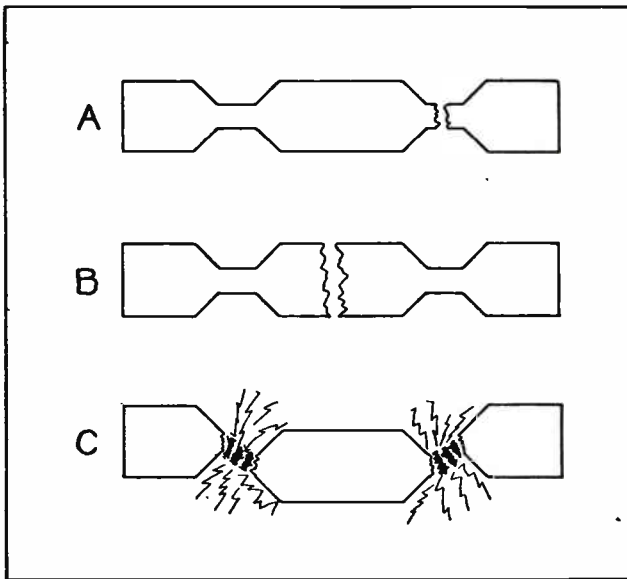

Fig. 152. The above views show several ways in which fuse links may blow. Note particularly the lower view which is the manner in which fuses are often blown by short circuits or severe overloads.

If fuses are blown frequently, it is usually an indication of an overloaded circuit, and in such cases another circuit and set of fuses should be installed. If the circuits are already fused for 15 amperes and are ordinary ones with No. 14 wire, they should certainly not be equipped with larger fuses, as it is in violation of the Code, and the wires might be overheated.

A very handy test for "shorts" is to remove the fuse from the socket and screw a lamp bulb in its place. Then, if the lamp still burns when all the equipment on this circuit is turned off, it indicates a short circuit on the wires.

#### 140. LOCATING SHORT CIRCUITS AND GROUNDS

In locating a short circuit, it is well to see that each light on the circuit is turned off, and each plug removed from any convenience outlets which may be on the circuit. If this clears the trouble it indi-

cates that one of these devices is at fault. By having someone watch the test lamp in the fuse socket as these devices are plugged in one at a time and switched on again, the one causing the trouble can be found by watching for the lamp to light up to full brilliancy. The lamps will burn dimly if there is any load connected to the line. A great majority of fuse troubles in homes can be traced to defective cords of portable devices.

If removing these devices from the circuit doesn't clear the trouble, then it must be in the wiring. Then we should go along the circuit and open up the outlet boxes, pulling out the splices and even disconnecting them, if necessary, to locate the trouble within one section. In a great majority of cases shorts in the wiring system will be found at poorly taped splices in the outlet boxes. It is very seldom that any defects occur in the wires themselves, especially if they are installed in BX or conduit. Sometimes, however, if repair or construction work has been going on around the building, the trouble may be caused by someone having driven a nail into a piece of non-metallic sheathed cable, metal molding, or even through the light-walled electric metallic tubing, or they may have cut the wires in two with a saw or drill.

Here is another place where inquiry as to what has been happening just before the trouble occurred may help you to locate it.

In shops or factories, blown fuses may be caused by installing additional equipment on certain circuits until they are overloaded, or by the addition of a motor that is too large for the circuit on which it is installed. In other cases a belt may be tightened too much, or the bearings of some machine not properly lubricated, causing a rather severe overload on the driving motor. If the voltage at the service box is too low this will cause motors to draw more than the normal load of current and will blow the fuse.

Whenever some of the lights on any system are found to be burning excessively bright and some of the others very dimly, remember that the cause is likely to be a blown-out neutral fuse on one of the older installations of non-polarized wiring.

The troubles which have been mentioned are some of the most common and are the most frequently encountered. A number of others will come up in your experience, but if you always follow the general methods given in this material and apply your knowledge of circuits and principles of electricity you should have no trouble in locating them. Every time you find and correct some source of trouble which you have not met before, it should be a source of pleasure and satisfaction to you, because of the added experience it gives and the greater ease with which you will probably be able to locate a similar trouble the next time. So, let us once more recommend that you always welcome any trouble shooting problem as a test of your ability and a chance to get good experience.





ESTABLISHED 1899

# COYNE

## *Electrical School*

CHICAGO ~ ~ ILLINOIS



COPYRIGHT 1942

## ILLUMINATION

**Incandescent Lamps, Nature of Light**  
**Illumination Principles, Light Measurement**  
**Reflectors, Light Distribution**  
**Factory Lighting, Office Lighting**  
**Store Lighting**  
**Show Windows, Electric Signs**  
**Flood Lighting, Street Lighting**  
**Aviation Lighting**  
**Mercury Vapor Lamps**  
**Home Lighting**

## ILLUMINATION

The history of artificial light is a very interesting one, and is romantic in many ways

In a practical Reference Set of this kind we have not much time or space for detailed history, but a few of the high spots in the development of artificial lighting will probably make the study of our present lighting equipment much more interesting, and enable us to more fully appreciate the equipment itself.

Mankind has been trying to create better forms of artificial light for many hundreds of years. Not being satisfied with the daylight hours given them by the sun, men have tried by a number of means to create light, in order to be able to see during the hours of darkness and to make better use of some of this time.

Probably the first artificial lights were burning wood fagots carried about in the hands. Then came the first oil lamps for burning vegetable oils and whale oil from a vessel; and later the lamps with cloth wicks for burning kerosene.

These kerosene lamps are still used by the thousands where electricity is not yet available. But even on farms and in small villages kerosene lamps are rapidly giving way to electric lighting.

Wax and tallow candles were also a popular form of light for many years. Chandeliers, or candle holders, with large numbers of candles in them were used to get a greater source of light for large rooms and auditoriums.

However, all of these sources of light were inclined to flicker and give off smoke and fumes, and were very inconvenient.

### 141. EARLY ELECTRIC LIGHTS

Up to the time of the development of electric batteries and generators, and less than one hundred

years ago, there were no very powerful or steady sources of artificial light.

Electric arcs or flames drawn between two carbon electrodes were one of the first types of electric light, and while they were not entirely steady or free from smoke, they were able to produce great amounts of very bright light.

The first arc lamp to be used commercially was one installed in the Dungeness light house in England in 1862, and from this time on arc lights came into quite general use for lighting interiors of large buildings and for street lighting.

Powerful arc lights of a highly improved type are used today for search lights, flood lights, and in motion picture work; while some of the older type are still in use in street-lighting systems.

### 142. EDISON'S INCANDESCENT LAMP

From 1840 on a number of experiments were made with incandescent lamps, or the heating of high resistance metal or carbon strips to a glowing temperature by passing electric current through them. But none of these were successful or practical until Thomas A. Edison invented the carbon filament incandescent lamp in 1879.

Edison's first lamps consisted of very thin filaments of carbonized thread, then paper, and later bamboo; all sealed in glass bulbs from which the air was removed by vacuum pumps, to eliminate oxygen and prevent the filament from burning up.

Later lamps of this type were developed with thin metal wire filaments, and the modern incandescent lamp has a tungsten filament, which can be heated to temperatures of 2800 to 3000 degrees centigrade before it will melt. This enables it to operate at glowing white or incandescent heat and give off great amounts of clean steady light.



Fig. 152-B This night photograph of the business section of one of our large cities is a good illustration of the extensive use of electric light. A single one of these large buildings will use many thousands of electric lamps.

Edison also developed the first efficient electric generators to supply current for his lamps, and in 1882 built in New York City the first central station generating plant for supplying electricity for light and power. From that time on the development of electric lighting has been rapid, and today modern electric illumination is one of the greatest advantages of our civilization, and one of the greatest fields for the trained electrical man to enter.

#### 143. USES AND ADVANTAGES OF ELECTRIC LIGHT

Electric light in the home greatly improves the appearance, increases comfort, speeds the work of the housewife, and reduces eye strain and makes it a pleasure for members of the family to read or study during evening hours. And the cost of electric light is low enough to be within the means of almost every family today. It is cleaner, safer and more convenient than any other form of artificial light we have.

In shops and factories, electric light speeds up production and reduces errors, increases safety and generally improves the morale of employees.

In stores, hotels, and office buildings electric illumination is used on a vast scale and makes the rooms as bright at night as at noonday, whether they have outside windows or not.

The exteriors of buildings in cities are beautifully flood lighted and streets are lighted brightly with electric lamps; and now great airplane landing fields have their special lighting equipment which makes them nearly as bright at night as during the day.

Practically every new building erected in any town or city is wired for electric lights, and many older buildings which have not had lights are rapidly being wired for them today.

Thousands of homes, offices, and industrial plants with the older wiring systems are being rewired for modern and efficient electric illumination.

Almost everyone today realizes the value of better lighting; and its advantages and economy are so apparent, when properly presented, that this is one of the greatest fields of opportunity for the trained electrical man who knows the principles of modern illumination.

This field also provides some of the most fascinating and enjoyable work of any branch of the electrical profession.

#### 144. NATURE OF LIGHT

In commencing our study of practical illumination, it will be well to get a general understanding of the nature of light.

Light is energy in wave form, and can be transmitted through space and through certain transparent objects. When these waves strike our eyes, they register through our eye nerves and upon our brain cells an impression which we call light. We are familiar with sound waves and how they are set

up by disturbance or motion of air and transmitted by vibration through air, water, and some solids. We also know that electro magnetic waves are set up around conductors carrying electricity. In the case of radio energy, these waves are of very high frequency and short wave length. Light waves are considered to be of an electro-magnetic nature, and are known to be of extremely high frequency and much shorter wave length than the shortest radio waves.

Light is generally the result of intense heat, and the sun is, of course, our greatest source of light.

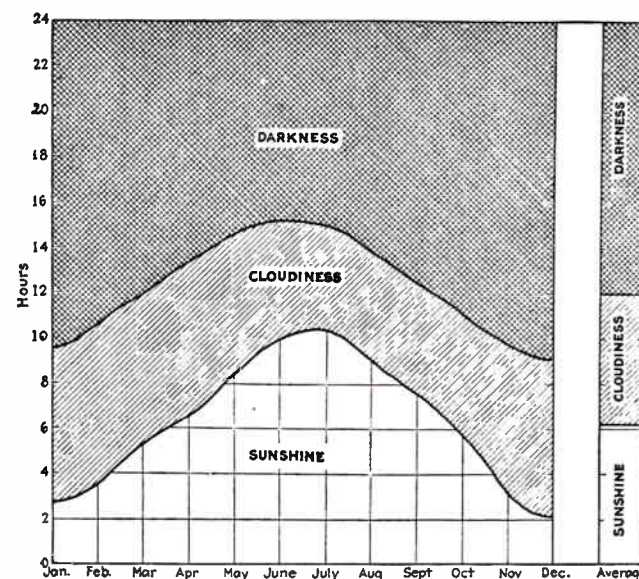

*This chart shows how little actual daylight we have over a considerable period of the year*

Fig. 152-C. Examine this chart carefully and note the number of hours per day that daylight is available, and you will see how necessary some form of efficient illumination becomes, in order to make good use of the hours of darkness.

#### 145. LIGHT COLORS, WAVE FREQUENCIES

The different colors of light are due to the different wave frequencies. Ordinary sunlight, while it appears white, is really made up of a number of colors. In fact, it is composed of all the colors of the rainbow, and a rainbow is caused by the breaking up or separation of the various frequency waves of sunlight by the mist or drops of water in the air at such times.

White light or daylight is generally the most desirable form for illumination purposes, but it must contain certain of the colors which compose sunlight, as it is the reflection to our eyes of these various colors from the things they strike that enables us to see objects and get impressions of their color. Certain surfaces and materials absorb light of one color and frequency, and reflect that of another color; and this gives us our color distinction in seeing different things.

White and light colored surfaces reflect more light than dark surfaces do.

The ordinary incandescent lamp supplies a good form of nearly white light that is excellent for most classes of work, but for color matching and

certain other jobs requiring close separation of colors, a light of more nearly daylight color is needed. For this work lamps are made with blue glass bulbs to supply more of the blue and white light rays, and less of the yellow and red rays of the ordinary electric light bulb. More on the units and measurement of light will be covered later.

#### 146. PRINCIPLES OF GOOD LIGHTING

To secure good lighting, or effective illumination, we must not only have sufficient light of the proper color, but must also avoid glare and shadows.

No matter how much light we may have, if there are sources of bright glare in range of the eyes, or definite black shadows from standing or moving objects, it is still not good illumination.

Glare is very tiring to the human eye and we all know that if we look directly at the sun or a bright unshaded light bulb, it is painful to the eyes.

The pupils of our eyes must change their openings or adjust themselves to different intensities of light, and as they do not do this instantly, we cannot see things well when we first look away from a bright light to objects or spaces less brightly lighted.

The same thing applies with shadows which cause dark areas intermixed with the light ones. The eyes cannot change rapidly enough to see well or be comfortable when they must be continually moving from light to shadow, etc.

Glare and shadow are both caused by very bright sources of light concentrated in small spots, or a "point source" of light, as we say.

The more the light from a source is concentrated at one point, the brighter will be the glare if we look at this point, and the more distinct will be the shadows of objects illuminated by this source.

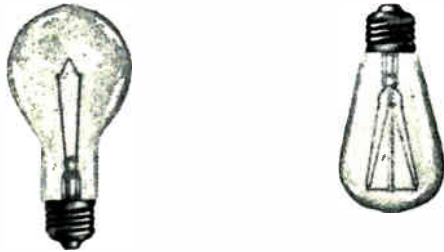

Fig. 153. Two common types of incandescent lamps of which there are many millions in use today.

#### 147. REFLECTORS

While the incandescent lamp is a wonderful, clean, efficient, and convenient source of light, those of the larger sizes are bad sources of glare if they are within the normal range of vision. This can be avoided by the use of proper shades and reflectors.

Because these lamps have their light produced at one small source, the filament, they are also producers of very definite shadows, unless they are cov-

ered with diffusing globes to soften and spread out their light over a greater area.

Reflectors, shades, and diffusing globes for the various classes of lighting installations will be covered a little later.

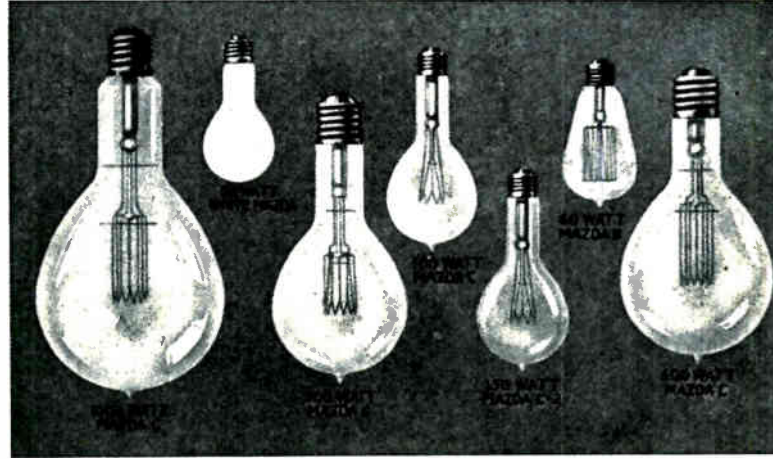

Fig. 154. This view shows various types and sizes of Mazda lamps, ranging from 50 to 1000 watts each.

#### 148. TYPES OF INCANDESCENT LAMPS

Now that we know something of the nature of light and the most important fundamentals of good illumination, let us return to our common source of electric light, the incandescent lamp.

These lamps are now made in sizes from a fraction of a watt to 50,000 watts each, and will fit practically every conceivable lighting need.

Extremely small lamps are made for surgical instruments, telephone switchboards, flashlights, etc.

Carbon filament lamps are not used much any more, although they can still be obtained for certain uses where they are desired.

The tungsten filament lamp, which is commonly known as the **Mazda Lamp**, is the one most generally used.

Two of these lamps are shown in Fig. 153. The one on the right is one of the smaller size, which are still used and have the same shaped bulb as the carbon lamps, and are known as type "B". The one on the left is one of the larger sized lamps with the newer shaped bulb, called the type "C".

Fig. 154 shows a number of bulbs of different shapes and sizes, such as are commonly used in general lighting today.

One of the newest styles of lamps is the type "A", which are made in sizes from 10 to 200 watts and are frosted on the inside of the bulb. This is a very great improvement as it softens the light and reduces glare without materially reducing their efficiency. These new bulbs have stronger filaments, and present a beautiful pearl-colored appearance. They are ideal for use where reflectors or bowls are not used over them. Fig. 155 shows four of these type "A" lamps of the more common sizes for home and general lighting use.

The larger Mazda lamps of 150 watts and over are usually made with clear glass bulbs and known as the type "C". As these larger lamps are generally enclosed in diffusing bowls or mounted high up and out of range of ordinary vision, their clear glass bulbs are not so objectionable. Fig. 156 shows two of these type "C" lamps, and you will note that they have long necks to keep the heat of the filament farther away from the base and sockets. Some of the larger ones even have a mica heat barrier in the neck, as shown in the right-hand lamp in Fig. 156.

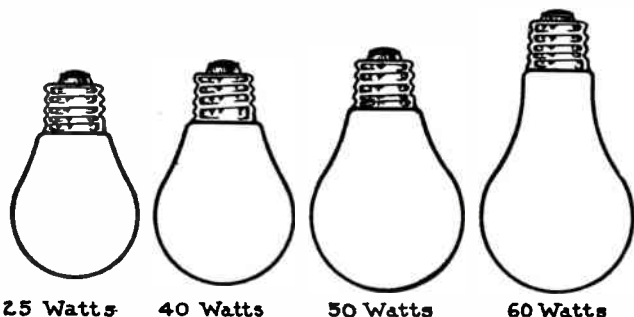

Fig. 155. These four lamps are the sizes most commonly used in general home lighting, and show the shape of the newer type bulbs.

The smaller sized lamps have the air withdrawn from the bulbs before they are sealed, so the filaments operate in a vacuum to prevent their burning up, as before mentioned. The larger sizes are filled with an inert gas, such as nitrogen, to keep the filaments from burning up and also to keep the intense heat away from the glass bulb and permit the lamps to be operated at higher temperatures.

### General Lighting Service

110, 115 and 120 Volts

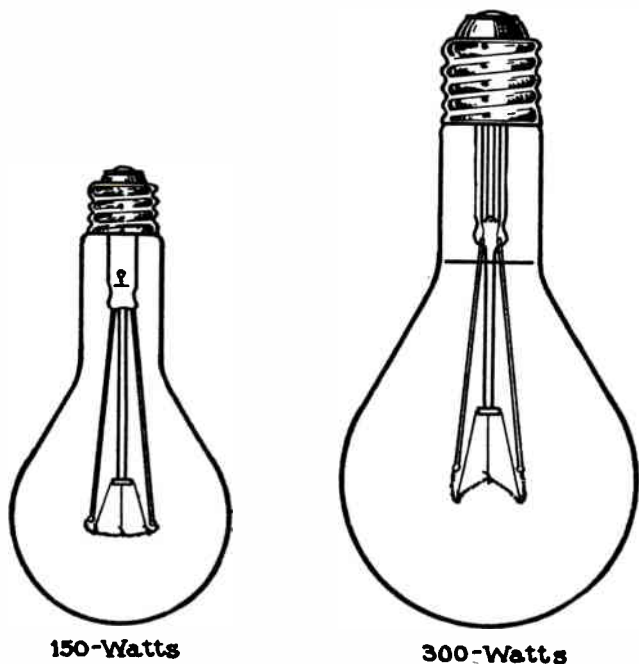

Fig. 156. Two of the larger Mazda lamps, such as used for office and factory lighting. Note the shape of the filament wires and the manner in which they are attached to the heavy "lead-in" wires, and supported by small brace wires.

Fig. 157 shows several types of special bulbs for decorative lights in homes, hotels, theatres, etc. The bulb on the left is an ordinary type "A" in shape, but can be obtained with orange or other colored glass, to give a soft colored light. The others are known as "flame tip" bulbs for candle type fixtures.

The blue glass lamps for producing the "daylight color" for color matching etc., are called the "C-2" type. While this color is very desirable in department stores, art studios, dye plants, etc., the yellow light of a clear bulb would be more desirable in foundries or forging shops, as rays of this color will penetrate a dusty, smoky atmosphere better.

Lamps of 500 watts, 1000 watts, and up are generally used for street lights, flood-lights, motion picture photography, lighting airplane landing fields, etc.

### Decorative Lamps

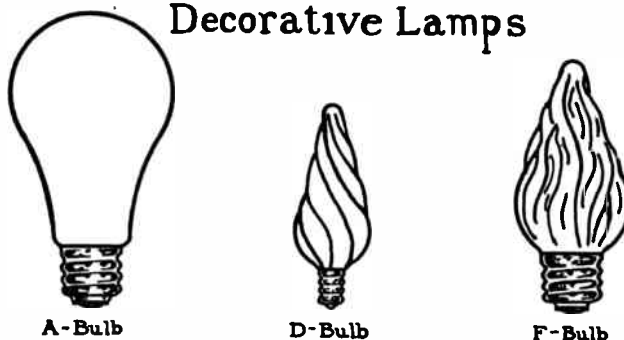

Fig. 157. Lamps of the above type are used for decorative lighting in homes, offices, theaters, etc. The type "A" lamp on the left has the ordinary shaped bulb but can be obtained in various colors.

### 149. LAMP LIFE AND RATED VOLTAGES

The life of the average Mazda lamp is about 1000 hours of burning time. Many of them will last much longer, as shown by the test data in Fig. 158, but others burn less time and, therefore, make about 1000 hours the average. After lamps have been operated a long time, their light output becomes less until in some cases it is better to discard them than to wait for them to burn out.

Hours Burned	0	200	400	600	800	1000	1200	1400	1600	1800
Number lamps remaining.	100	97	94	89	77	60	39	17	3	0

Fig. 158. These figures, taken from an actual test on 100 lamps, show the life in hours, or the number of hours which the various lamps burned.

These lamps are commonly made for voltages of 110, 115, and 120; and some are made for 220, 240, and various other voltages. The 110 volt lamp is, however, the most common type. These various voltage ratings are obtained by slight changes in the filament resistance of the lamps.

### 150. EFFECT OF VOLTAGE ON LIFE AND EFFICIENCY OF LAMPS

Incandescent lamps should always be operated at their rated voltage. If they are operated on lower voltages they will not give nearly as much light



or be as efficient in the amount of light produced per watt of energy consumed. If they are operated at voltages above their rating, they will burn very bright and operate at higher efficiency, but the life of the filament will be materially shortened. So the best balance between efficiency and lamp life is obtained by operating lamps at their rated voltages. A small change in voltage will make a considerable change in the lamp's efficiency and life, as shown by the table in Fig. 159 for lamps operated 5% below rated voltage. The term "Lumen" is the name of the unit used to measure light delivered by the lamp, and will be explained later.

For Lamps operated at 5% below normal voltage

Lumens will be	17% below normal
Watts " "	8% " "
Efficiency " "	10% " "
Lamp Life " "	Double

Fig. 159. This little table shows how important it is to have incandescent lamps operated at their proper rated voltage.

Fig. 160 shows another illustration of the changes that take place in the watts used and the light produced at different voltages below normal. This test data also shows the amount of electric energy in watts which is wasted when the lamp is operated at lower voltage and lower efficiency.

### 151. UNITS OF LIGHT MEASUREMENT

Now, before we undertake to plan illumination layouts or select equipment for certain applications,

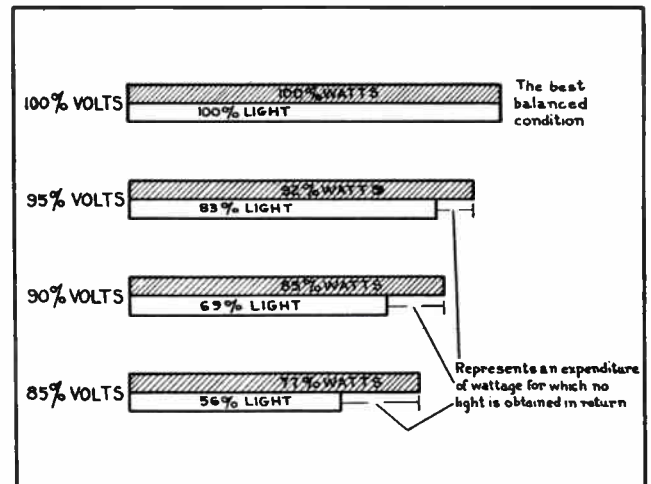

Fig. 160. This chart shows the actual amount of light lost and energy wasted when lamps are operated at less than their rated voltage.

let us find out a little more about actual quantities of light, units of measurement, etc. An understanding of these units and principles is just as important in illumination as Ohms Law is in general electrical work; and you will find them very interesting, as they show us still more about the nature of light.

We have been speaking of incandescent lamp sizes and their rating in watts, which is a very convenient term for general use and for buying lamps, etc. While the rating in watts will give us a general idea of the sizes of the lamps, it does not tell us just how much light a certain lamp can be expected to produce.

### 152. CANDLE POWER AND LIGHT MEASURING DEVICES

Lamps were formerly rated in **Candle Power**, using a standard candle as a basis of comparison.

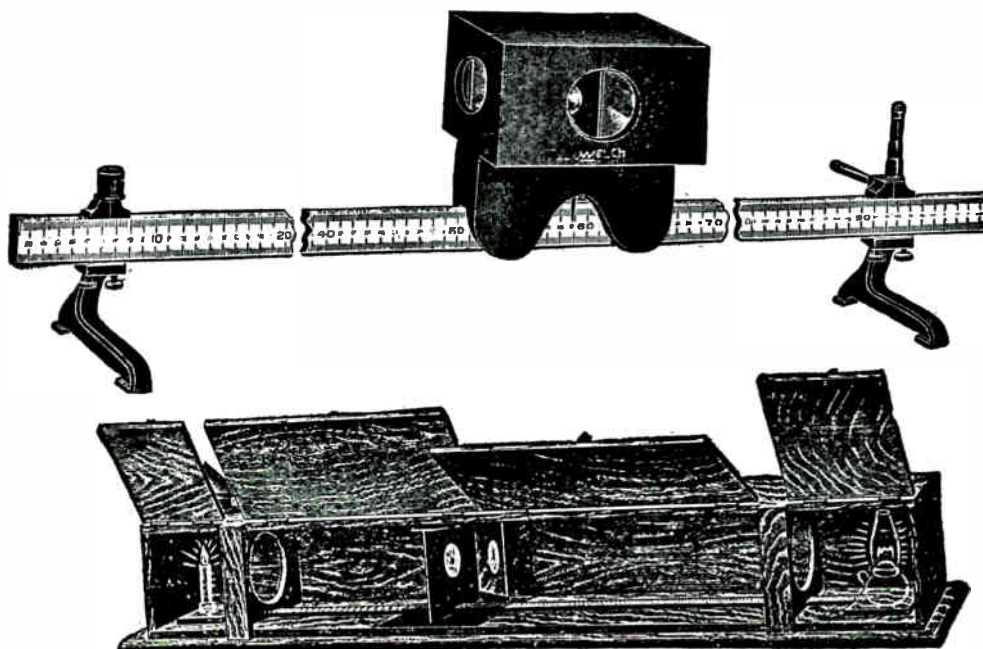

Fig. 161. Two types of photometers, such as used for measuring the light from any source by comparing it with that from a standard source. The readings are obtained from the scales at the point where the light from each source is balanced on the mirror or waxed paper, whichever may be used in the sliding element.

For measuring the candle power of a certain lamp or comparing it with the standard candle, we use a device called a **Photometer**. In principle this device works as follows: A piece of white paper, having in its center a spot which is oiled or greased to make it more transparent than the rest, is held up between the standard candle and the light source to be measured. Let us assume that we first place it exactly half way between them. We will now examine the oiled spot from the side on which our lamp under test is located. If the spot appears dark it shows that there is less light striking it from the candle on the opposite side than from the lamp under test. Then we can move the paper screen closer to the candle until the spot appears to be the same color as the rest of the paper, which will indicate an equal amount of light is striking it on both sides. Then by comparing the distance that the two light sources are from the screen we can find out how much brighter the tested lamp is, or how many candle power to rate it at.

Fig. 161 shows two types of photometers which operate on this principle. The upper one carries a mirror in a sliding dark box, which has small openings in each end for the light to enter from each source. The standard candle and the light to be tested are placed at opposite ends of the marked scale or bar. Then, by moving the mirror box back and forth along the slide until the light on both sides of the oil spot is equal, we locate the balance point, and the candle power of the new source can then be read on the scale at this point. This instrument should be used in a dark room.

The lower device in Fig. 161 has a "grease spot" screen arranged to slide along a scale in a "dark box", and between the two sources of light, until a balance point is found by the appearance of the grease spot as previously explained.

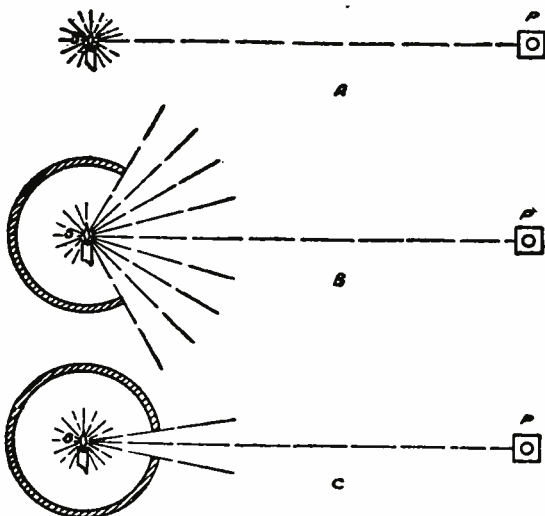

Fig. 162. If we have a photometer or light measuring device at "P," it shows that the amount of light coming in one direction from the candle to the instrument, will remain the same in all three of the above tests.

153. MEAN SPHERICAL CANDLE POWER

This method of measuring or comparing sources of light which we have just described, only takes into consideration the light coming from the source in one direction, or striking an object in one certain spot. For example in Fig. 162 we have a photometer at "P" to measure the light from a candle.

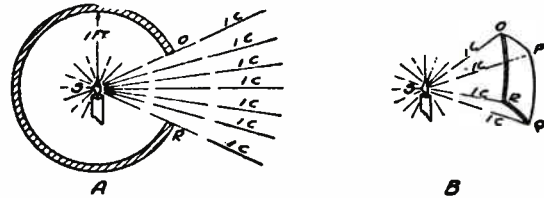

Fig. 163. The "lumen" or unit of light quantity is the measurement of a definite amount of light, such as that which escapes from the opening in the above illustration.

In view "A" the candle is entirely exposed and the photometer gets its reading only from the very small cone of light that comes in its direction.

In "B" we have the candle partly enclosed in a sphere, the inside of which is dead black, so that it absorbs all the light which strikes it and reflects none. The photometer will still read the same, however.

Again at "C" we have the opening closed still more, but the photometer will still read the same as long as the direct beam to it is not interfered with.

So these devices measure only the light coming from a source in one direction, and take no account of that escaping in all other directions.

The light around a lamp may not be quite as bright in all directions, because of the shape of the flame or filament as the case may be. If we measure the candle power in a number of places at equal distances all around a lamp and average these readings, the result is known as the "Mean Spherical Candle Power". This comes somewhat closer to giving the total light emitted from the source.

154. LUMENS, UNIT OF LIGHT QUANTITY

For stating the total amount of light actually given off by a source we use the unit **Lumen**.

Let us enclose a light which gives off 1 candle power in all directions, in a hollow sphere which has a radius of 1 foot, or diameter of two feet, and the inside of which is dead black so it will reflect no light. See Fig. 163. Now, if we cut a hole in the sphere 1 foot square as shown at OR, the amount of light that will escape through this hole will be 1 lumen. If the area of the opening was 1/4 sq. ft., then the light emitted would be 1/4 lumen; or if the opening was 1/2 sq. ft., the escaping light would be 1/2 lumen; etc. A sphere with a 1-foot radius has a total area of 12.57 sq. ft., so if we were to remove the sphere the total light emitted would be 12.57 lumens from a 1 candle power source.

A Lumen may be defined as the quantity of light which will strike a surface of 1 sq. ft., all

points of which are 1 foot distant from a source of 1 candle power.

From this we find that we can determine the number of lumens of any lamp by multiplying its mean or average candle power by 12.57.

We can now rate or measure in lumens the total light of any lamp, and also compare the number of lumens obtained with the number of watts used by a lamp. All Mazda lamps of a certain size and type will give about the same number of lumens each, but the lumen output per watt, and their efficiency, varies with their size. The larger the lamp the higher the efficiency, and it ranges from about 10 lumens per watt for small lamps to 20 or more lumens per watt on lamps of 1000 watts and larger.

The table in Fig. 164 gives the lumen output of common Mazda lamps and their wattages. These values vary a little from time to time, with the improvement made in lamps, but this table will serve as a convenient guide in selecting the proper size of lamps to get a certain desired amount of light.

LUMEN OUTPUT OF MULTIPLE MAZDA LAMPS

110-115-120 Volt Standard Lighting Service Clear Lamps		Standard Lighting Service 110-115-120 Volt MAZDA Daylight Lamps		220-230-240-250 Volt Service Clear Lamps	
Size of Lamp in Watts	Lumen Output	Size of Lamp in Watts	Lumen Output	Size of Lamp in Watts	Lumen Output
100	1530	100	990	100	1100
150	2535	150	1650	.....	.....
200	3400	200	2210	200	2920
300	5520	300	3590	300	4560
500	9800	500	6370	500	8350
750	14550	.....	.....	750	13125
1000	20700	.....	.....	1000	19000
1500	33000	.....	.....	1500	27300

Fig. 164. This table shows the number of lumens of light delivered by various sizes and types of Mazda lamps, and will be very convenient for future reference on any lighting problems.

155. FOOT CANDLES. UNIT OF ILLUMINATION INTENSITY

Electric lamps are a source of light, and the result of this light striking surfaces we wish to see is illumination.

While the lumen will serve as a very good unit to measure the total light we can get from any source, we must also have a unit to measure the intensity of light or the illumination on a given surface, such as the top of a desk or work bench, or at the level of work being done on a machine, etc. The unit we use for this is the Foot Candle.

A foot candle represents the intensity of illumination that will be produced on a surface that is one foot distant from a source of one candle power, and at right angles to the light rays from the candle. See Fig. 165. The foot candle, then, is the unit we use in every day illumination problems to determine the proper lighting intensity on any working surface.

Referring again to Fig. 163, we find that the surface O P Q R is illuminated at every point with an intensity of 1 foot candle, and we also know that the total amount of light striking this surface is 1 lumen. This shows the very simple and convenient

relation that has been established between these units, in their original selection by lighting engineers. This relation can be expressed as follows: When one Lumen of Light is evenly distributed over a surface of 1 sq. ft., that area is illuminated to an intensity of 1 foot candle.

This is a very convenient rule to remember. It shows that, if we know the area in square feet that is to be lighted and the intensity in foot candles of desired illumination, we can then multiply these and find the number of lumens that will be required to light the area. For example, if we desire to illuminate a surface of 50 sq. ft. to an average intensity of 5 foot candles, 250 lumens must be supplied at a distance of one foot from the surface. More light will be required as the distance is increased. See Art. 157.

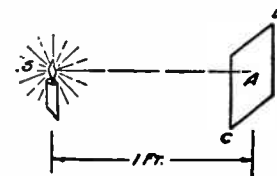

Fig. 165. The unit foot-candle refers to the intensity of illumination on a surface one foot distant from the standard source of one candlepower, as shown above.

156. FOOT CANDLE METER

There are a number of large and elaborate devices used in laboratories for making exact tests and measurements on light and lighting equipment; but for practical convenient use right on the job, the Foot-Candle Meter is extensively used.

Fig. 166 shows a view of the back of one of these meters opened up. They consist of a flashlight battery, small standard lamp bulb, rheostat for adjusting the lamp voltage to proper value, and a voltmeter to check this voltage and make sure the lamp is being operated at proper voltage and brilliancy.



Fig. 166. This view shows the important parts of a foot-candle meter. Note the arrangement of the standard lamp behind the paper screen, and also the rheostat and voltmeter used in making proper adjustments.

In front of the lamp is a long square chamber, over the side of which is placed a piece of tough white paper. Along the center of this strip of paper is a row of uniform grease or oil spots which allow more light to show through them than the rest of the paper.

We all know that the farther any object is from

a certain source of light, the less light will strike it. So the oil spots appear quite bright near the lamp, and are gradually dimmer as they get farther away from the lamp. Those still farther away appear darker than the paper, because, with normal light striking the paper from outside the instrument, there is less light behind these spots than on the observer's side, so they appear dark.

This, we find, is the same general principle of the photometer explained earlier. Between the bright appearing spots and the dark appearing ones, there will be one or two that appear the same color as the rest of the paper around them. This is the point at which the light within the instrument is exactly equal or balanced with that striking it from the outside, and at this point we can read the intensity of the outside light in foot candles, on a scale printed along the paper strip.

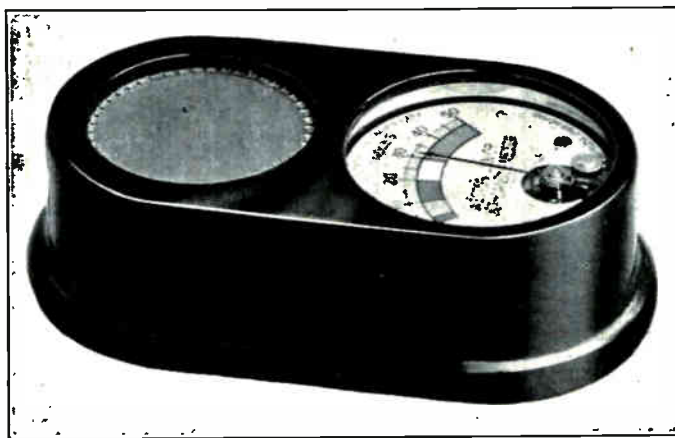

Photo Courtesy Western Electrical Instrument Co.

Fig. 167. Newer type of convenient light meter, using a photo-electric cell to give a direct reading in foot candles on a meter.

To use a foot-candle meter, the rheostat switch should be turned on and the knob rotated until the voltmeter needle comes up to a mark on its scale, which indicates that the lamp is operating at proper voltage and brilliancy. Then the meter is held face up toward the light source, and at the level of the working surface where the illumination is required. The shadow of your body should not be allowed to fall on the face of the meter during tests. A number of such tests at various places in a room will give the average foot candle intensity and show us whether the illumination is sufficient for the class of work being done.

Tables of proper illumination standards for various classes of work will be given later.

The standard foot-candle meter is made to read intensities from 1 to 50 foot candles. It is possible to test intensities lower and greater than this by operating the lamp in the meter at less or more than its rated voltage, by setting the rheostat to hold the voltmeter needle at the extra marks which are provided for this purpose on the scale.

Ordinary daylight is far too bright to measure with these meters and is of a color that does not match the meter lamp accurately.

On a normal summer day with the sun shining, the intensity of illumination outdoors may be 500 foot candles even in the shade, and 5000 to 8000 in the direct rays of the sun.

157. INVERSE SQUARE LAW FOR LIGHT

We have already mentioned that the farther any object is from a source of light, the less light it receives from that source.

A very important rule to remember is that the illumination on a surface varies directly with the candle power of the source of light, and inversely with the square of the distance from the source.

So we find that a small change in distance from a light will make a great change in the illumination on an object. The reason for this is illustrated in Fig. 168. Here we have a standard candle, and if the surface at "A" is 1 foot from the candle, its illumination intensity will be 1 foot candle. If we move the surface or plane to "B", which is two feet from the source, the same number of light rays will have to spread over four times the area, as that area increases in both directions. Then the illumination intensity at double the distance is only 1/4 what it was before, as the distance or 2 squared is 4, and this is the number of times the illumination is reduced.

If we move the surface to "C", which is 3 feet away from the light source, the rays now are spread over 9 times the original areas, and the intensity of illumination on the surface will now be only 1/9 of its former value, or 3<sup>2</sup> equals 9. So we call this the Inverse Square Law for Light.

158. LIGHT REFLECTION

We all know that light can be reflected from certain light-colored or highly-polished surfaces. This fact is made good use of in controlling and directing light in modern illumination.

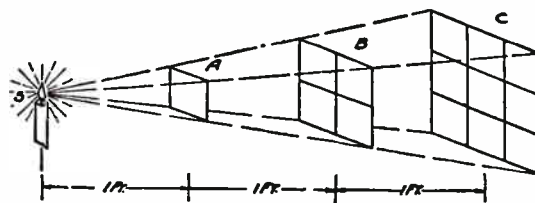

Fig. 168. Note how the illumination intensity becomes less on any surface as its distance from the light source increases. The farther the surface is from the source, the greater the area a given number of light rays must be distributed over.

Some surfaces and materials are much better reflectors than others. Generally the lighter the color, or higher the polish of a surface, the more light it reflects, and the less it absorbs.

The percentages of light that will be reflected from some of the more common materials are as follows:

Highly polished silver.....	92%
Good silvered-glass mirrors.....	70% to 80%
White blotting paper.....	82%
Yellow paper .....	62%
Pink paper .....	36%
Dark brown paper.....	13%

The better classes of reflectors are used in directing the light of sources where we want it. The colors of walls and ceilings and their reflecting ability should also be considered in lighting interiors of buildings.

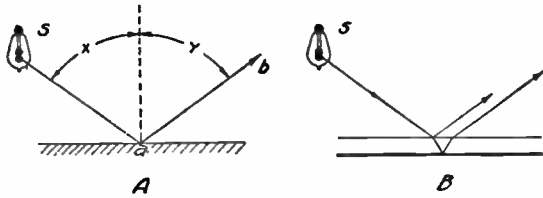

Fig. 169. Note the angle of light reflection from a smooth surface as shown at "A." The illumination at "B" shows how light is reflected from both surfaces of a piece of silvered glass.

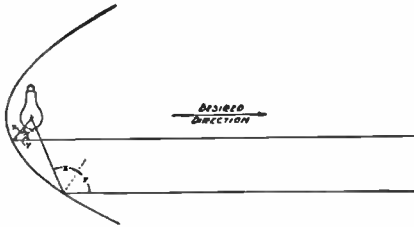

Fig. 170. This illustration shows how a curved reflector can be made to send all the light rays from a source in one direction. The shape of such a reflector is called a "parabola."

159. CONTROLLING AND DIRECTING LIGHT WITH REFLECTORS

Bare incandescent lamps are wonderful sources of light, when we consider their efficiency and the quantity and quality of light they produce, but they may also be rather wasteful of light unless proper reflectors are used to direct their light where we want it.

Bare Mazda lamps are a source of bad glare which is very tiring to the eye, and they create bad

shadows which impair vision and are likely to cause accidents in industrial lighting.

A bare lamp also wastes a great deal of its light which goes upwards and sidewise and not down as we usually want it to. So, to direct the light as desired, we use reflectors with the proper shapes and curves. These reflectors turn back the light that would otherwise go up and sidewise, and send it down either in a broad or narrow beam as desired.

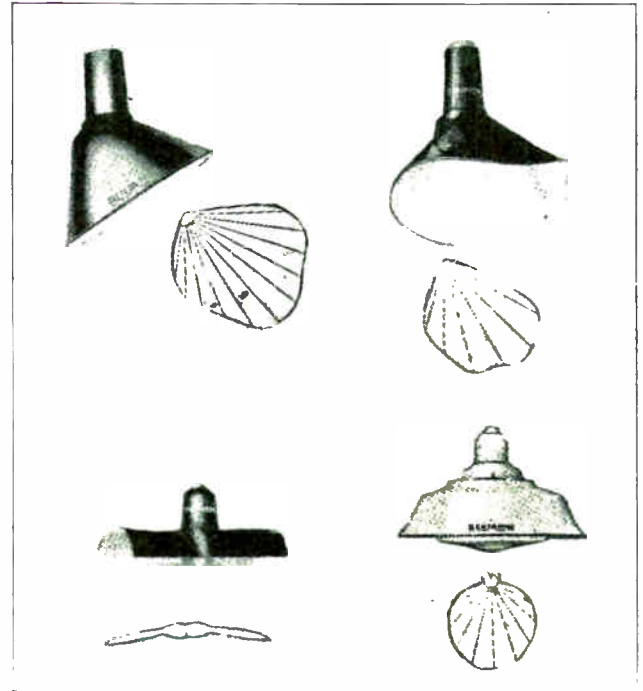

Fig. 172. The two top reflectors and the one at the lower left show how light can be controlled in any direction desired, by using the proper shape of reflector. The unit at the lower right shows a reflector which also has a glass diffusing bowl.

160. TYPES OF REFLECTORS

Fig. 171 shows several types of metal reflectors of different shapes, and beneath each one is shown the characteristic curve of light distribution for that type of reflector. From these curves it will be seen that the curvature of a reflector can be made to spread or concentrate the light more or less, as desired.



Fig. 171. Above are shown several types of porcelain enameled, metal reflectors. Note how their various shapes give different distribution of the light, as shown by the curves under each reflector.

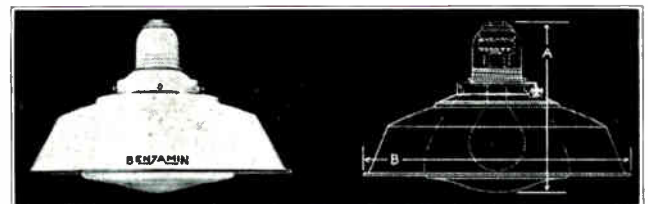

Fig. 173. This larger view of the diffusing unit shows the position of the bulb and glass bowl in the reflector. This is a very efficient and popular type unit for factory lighting and other similar work. (Illustration Courtesy of Benjamin Electric Co.)

Fig. 172 shows several other types of reflectors. The upper two are used for throwing the light to one side and downward, and the lower left one for spreading the light in two narrow horizontal beams. The lower right hand unit is a combined reflector and glass diffusing bowl.

The ordinary reflectors direct the light downward and shield the eyes from side glare of the lamps. This is often sufficient when the lamps are mounted high enough to be above the ordinary line of vision.

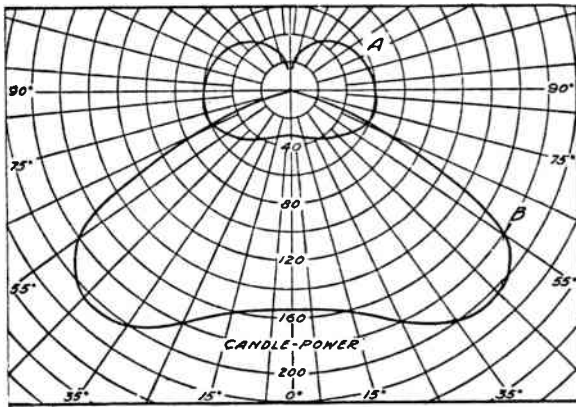

Fig. 174. This shows the manner in which the light distribution from a lamp or reflector can be plotted on a chart, to give a characteristic curve for that light or reflector.

161. ENAMELED METAL REFLECTORS

The inside surfaces of metal reflectors of the types here shown are covered with heavy white porcelain enamel, to give them a high reflecting efficiency. While polished metal can be used as a reflector it usually tarnishes in a short time and is then not much good. So porcelain enamel or glass is better.

Fig. 174 shows a curve of light distribution, and also the manner in which the various candle-power measurements are plotted on the chart, to indicate the illumination intensities at different points along the curve.

The reflector unit with the glass bowl reflects the light downward, and the bowl enclosing the bulb has a milky white color and spreads or softens the light from the bulb so there is no glare even when looking up at the unit from underneath. Broadening the source of light in this manner also softens the shadows a great deal, making this type of lighting unit a very popular one for commercial and industrial buildings.

Fig. 173 shows a larger view of this unit and also a sketch which shows the shape of the glass bowl and the location of the lamp. These units have ring-shaped slots in the top of the reflector to allow a small amount of light to reach the ceilings, and eliminate the dark spots that would otherwise be above a metal reflector and cause quite a contrast to the lighter areas around them.

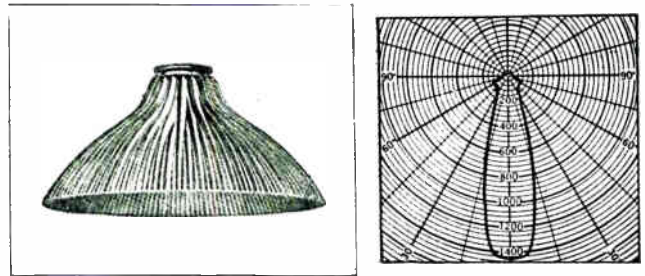

Fig. 176. Corrugated glass reflectors of this type break up or diffuse the side rays from a lamp and also reflect a greater portion of the light downwards, as shown in the curve at the right.

162. MIRRORED GLASS REFLECTORS

Glass shades and reflectors are also used extensively where there is not too great danger of breakage. Some glass reflectors have the outside silvered and then covered with dark paint. The silvered surface makes the inside of the unit of higher reflecting efficiency, and the dark paint stops all side light and glare.

Fig. 175 shows several types of glass reflectors of this kind. You will note that the glass is corrugated to break up the light rays, diffusing them enough to prevent reflection of the sharp outlines of lamp filaments. If this is not done the light from such a reflector might cause spots of glare on glossy paper or bright metal surfaces if they were worked upon under these lights.

Another type of glass reflector in quite common use is the sharply corrugated type shown in Fig. 176. These reflectors break up the light from the bulb enough to reduce the side glare considerably. While they don't soften the light source as much as some of the other types, they are very good for certain applications. Note the curve of light distribution for the reflector in Fig. 176 which shows that this type of unit directs a greater part of the light downward.

Fig. 177 shows one of these glass reflectors with a special type of holder which allows them to be easily removed for cleaning. This reflector has a different shape from the one in Fig. 176, which you will note changes its light distribution curve considerably.

163. PRISMATIC REFLECTORS

This type of glass reflector is made with grooves running in both directions, so that its outer surface



Fig. 175. Corrugated, mirrored glass reflectors of the above type are very efficient in preventing side glare and directing light downwards to the surface where it is desired.

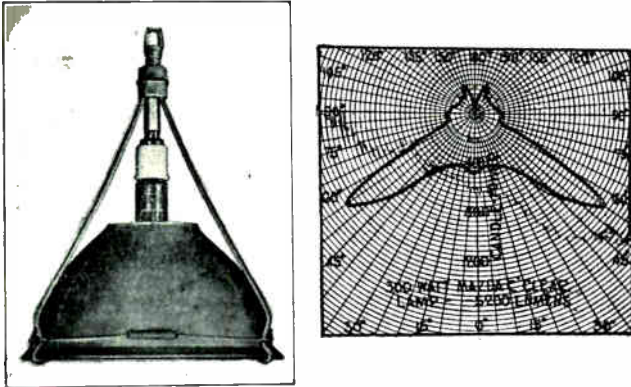

Fig. 177. These glass reflectors mounted in convenient hangers, as shown above, are very commonly used in factory lighting and in some classes of general office lighting.

in reality consists of a number of little prisms, which very effectively break up or diffuse the light. These reflectors present a very good appearance and are quite frequently used in office and store lighting. Fig. 178 shows three units of this type. You will note that the bulbs are entirely enclosed with these fixtures, so there is no chance of any direct glare from the lamp.

#### 164. OPAL GLASS REFLECTORS AND DIFFUSING BOWLS

Glass lighting fixtures using white or opal-colored glass are made in a great variety of shapes and sizes for general lighting and offices and stores. Opal-colored glass diffuses the light very effectively, and thus softens the source so there is very little glare or shadow if the fixtures are properly installed.

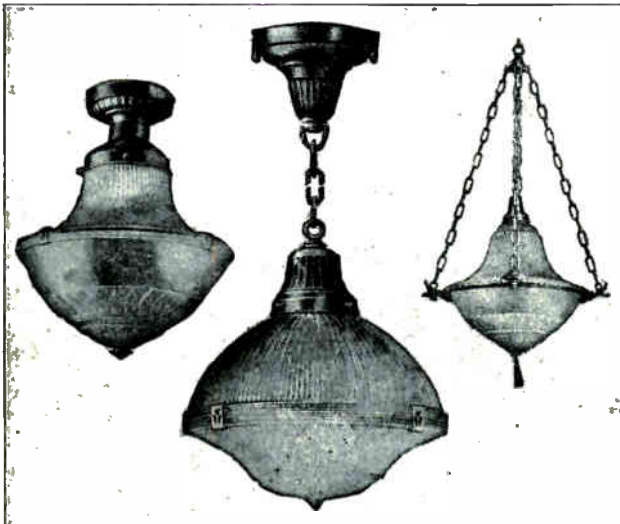

Fig. 178. Several styles of prismatic glass lighting units. Note that these units completely enclose the lamp so that all light is diffused or softened before reaching the eye.

There are two different grades of opal glass, known as light opal and dense opal, either of which will, of course, absorb or stop a certain amount of light from the bulb. But this small loss is more than made up by the greater efficiency of lighting which is free from glare and shadows. Persons can actually see much better with a little less light

if these effects which are so tiring to the eye are not present.

Fig. 179 shows two types of glass bowls of a very popular style. These are fastened in the metal canopy with thumb screws, which can be seen in this illustration. This enables the globes to be easily removed for cleaning and replacing the bulbs. When attaching the globes to a fixture of this type, the thumb screws should be tightened firmly and evenly; but not too tight, as it is possible to crack the glass globe in this manner.

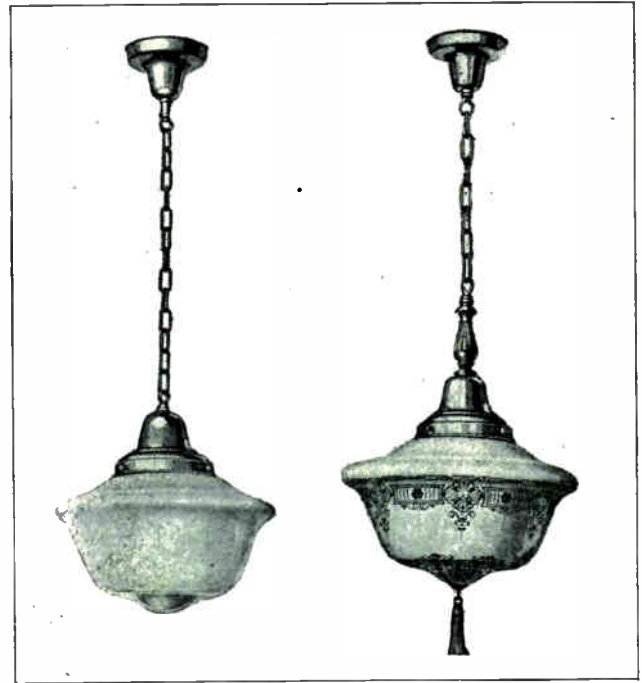

Fig. 179. Enclosing glass bowls with milky white or opal colored glass, make very efficient units for office lighting.

Fig. 180 shows two styles of glass fixtures which are made for mounting closer to the ceilings.

Glassware or fixtures of the types here described can be plain opal-colored, or made more ornamental with decorative painting on the outside. These decorations, of course, reduce the efficiency of the fixture somewhat by absorbing a certain amount of light. Fig. 181 shows another popular type of glass fixture in which the lower part of the bowl is opal-colored and the upper part is clear glass. Then, above the bowl, is suspended a broad opal reflector. The clear glass in the top of the bowl allows considerable light to go upward and strike the under side of the opal reflector, from which it is again deflected downward to the working surface. Glass lighting fixtures of these types allow a certain amount of light to go upward, lighting the ceilings more or less uniformly, and present a very cheerful appearance as well as softening the light generally and reducing shadows.

#### 165. GENERAL CLASSES OF LIGHTING UNITS

Lighting fixtures are often classed in three general divisions called:—Direct, Indirect, and Semi-

**Indirect.** The direct lighting fixture is one from which the greater part of the light comes directly from the bulb down to the working plane. The metal and glass reflectors of the first types described come in this class. The indirect lighting fixture is one in which no light comes directly down from the bulb to the working plane, but instead is all first thrown upward to the ceiling or to a broad reflector above and then directed downward. Lights of this type are used where it is very essential to avoid even the slightest glare and to eliminate shadows almost entirely. With such fixtures we might say that the ceiling is our secondary source of light; and as we know that shadows are more pronounced when the light comes from small "point" sources, we can readily see that light coming from the broad area of a ceiling would produce almost no shadows.

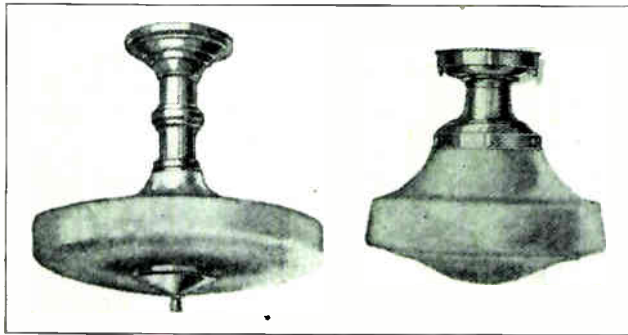

Fig. 180. Short fixtures of the type shown above can be used for mounting close to the ceiling in low rooms.

Fig. 182 shows a view in a drafting room which is lighted with indirect fixtures of this type. You will note that the light is all directed first to the ceiling and produces a very uniform light throughout the entire room. While this type of light is a little more expensive and requires more lamps and current than a direct lighting installation, it is one

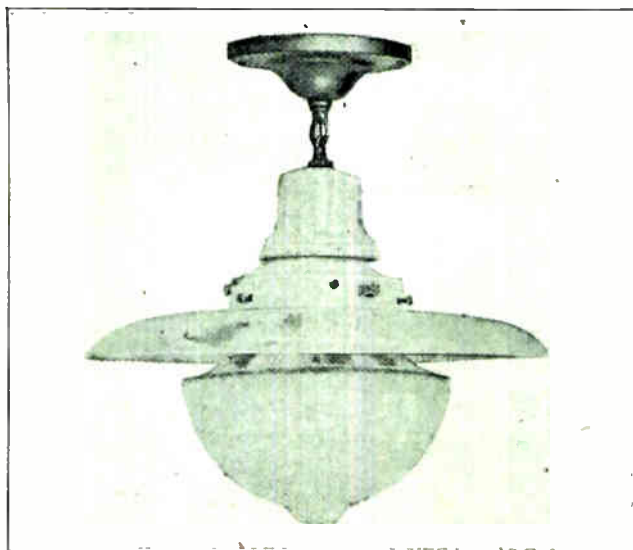

Fig. 181. This fixture has a bowl, the lower part of which is white to diffuse the light, and the upper part is clear to allow the light to go upward and strike the reflector, from which it is directed back to the working surface in a well diffused manner.

of the very best classes of installations where exacting work is to be done.

Semi-indirect fixtures are those from which part of the light is directed downward through a diffusing globe, and the balance is thrown upward, and then reflected back by the ceiling. Some fixtures are also classed as Direct Diffusing, because while practically all of their light is thrown directly down to the working plane, it must pass through a diffusing bowl as with some of those previously described.



Fig. 182. This drafting room is lighted with indirect fixtures which throw their light to the ceiling first. The ceiling then reflects it downward to the working surface.

166. DEPRECIATION FACTOR

Almost all lighting fixtures are subject to a very definite reduction in efficiency from the collection of dust and dirt on their light transmitting or reflecting surfaces. Few people realize what an effective absorber of light a thin film of dust actually is.

In some installations where a beautiful selection of fixtures has been made and the lighting is of very sufficient intensity when the installation is new, after a few months the dirt that is allowed to accumulate on the fixtures absorbs from 1/4 to 3/4 of

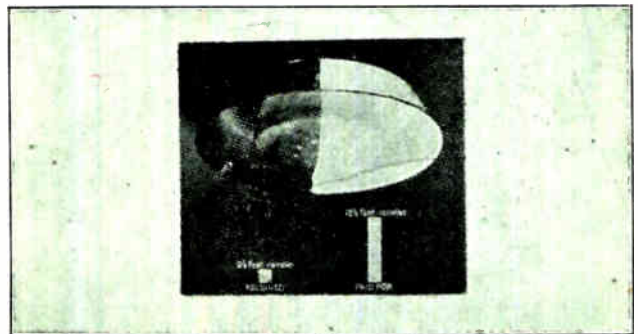

Fig. 183. This is an actual photo showing how much of the light can be lost if the reflectors are not kept cleaned.

the light. This is particularly true in certain industrial plants where smoky, oily, and dusty atmospheres exist. Fig. 183 shows an actual view of a fixture of which one side has been cleaned and the other side left with the remaining accumulation of oil and dirt. This is undoubtedly a worse case than is ordinarily encountered, but it serves as a good illustration of the necessity of keeping fixtures clean. Regardless of the amount of money spent



in purchasing fixtures that will eliminate glare and shadow, a great deal of the electricity used will be wasted and the lighting will be unsatisfactory if the fixtures are not kept clean. An occasional washing with soap and water will remove ordinary dust and dirt from lighting fixtures, and where necessary special cleaners can be employed.

Of course, it is impossible to prevent some dust and dirt from accumulating, even if the fixtures are cleaned frequently; so when we are selecting fixtures we generally allow a certain amount for this Depreciation Factor. This will vary from 1.2 to 1.6, and a good, safe average value to use is 1.4. This means that in planning a lighting installation, after determining the foot candles of lighting intensity that would be required to produce the desired illumination, we should then multiply this by the figure 1.4, to have enough light reserve to keep the lighting satisfactory in spite of ordinary depreciation.

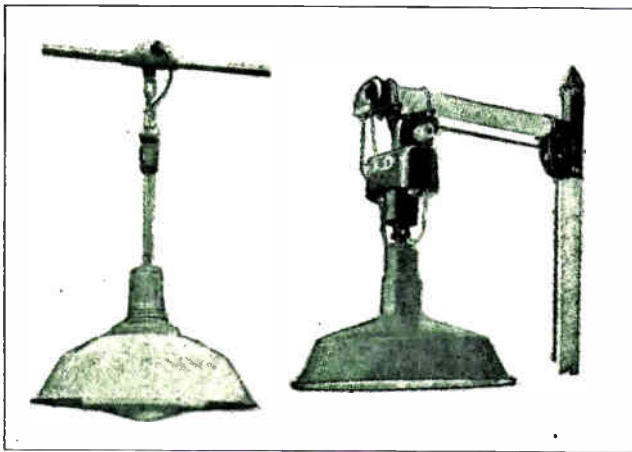

Fig. 183-B. Special hangers of the above type are often used with lamps which are mounted very high in shops or factories. They allow the lamps to be lowered with a chain for convenient cleaning and repairing.

Some fixtures, of course, collect more dust than others in the vital places where it interferes with their light distribution. In some cases when buying fixtures, the depreciation factor for that particular type will be given by the manufacturer or dealer, but when this value is not known, the average factor of 1.4 can be generally used.

167. COEFFICIENT OF UTILIZATION

Another very important item to consider in planning a lighting installation is what is called the Coefficient of Utilization. You will recall that earlier in this section we mentioned that, if we knew the number of square feet that had to be illuminated and the foot-candle intensity to which it was desired to illuminate the area, the product of these values would give the lumens that would have to be utilized to produce the desired illumination.

When we say these lumens must be utilized we mean that they must be effectively used and not absorbed or wasted in other places besides the working surfaces. Only a part of the total light

emitted by any lamp reaches the working plane, as a certain amount will be absorbed by the reflector or enclosing glassware of the fixture, and some will be absorbed by the walls, ceilings and other objects. In some cases part of the light that is directed upwards and sidewise from the fixture is again reflected to the working surface.

The coefficient of utilization therefore refers to the percentage of light used at the working plane.

So we find that the coefficient of utilization depends on the type of fixtures; and on the color of walls and ceilings to quite an extent, as the darker colors absorb and waste much of the light from the source, while light colors reflect back to the working surface more of the light which strikes them.

Under average conditions a unit of the type shown in Fig. 173 has a coefficient of utilization of about .70.

Fig. 184 shows a table of coefficients of utilization for various types of reflectors. You will note that the figures given vary for light or dark walls and ceilings.

COEFFICIENTS OF UTILIZATION									
This table applies to installations in square rooms having sufficient lighting units symmetrically arranged to produce reasonably uniform illumination. To obtain the coefficient for any rectangular room, find the value for a square room of the narrow dimension and add one-third of the difference between this value and the coefficient for a square room of the long dimension.									
Reflection Factor	Ceiling		Light 70%			Medium 35%			Dark 20%
	Walls	Light Output	Light 50%	Medium 35%	Dark 20%	Medium 35%	Dark 20%	Dark 20%	Dark 20%
Reflector Type	Light Output	Ratio = Room Width Ceiling Height							
Prismatic Glass		1	.42	.38	.35	.36	.34	.33	
		1 1/2	.50	.46	.43	.44	.42	.41	
		2	.56	.52	.49	.50	.47	.45	
		3	.63	.59	.55	.56	.53	.51	
Bowl-Frosted Lamp		1	.70	.66	.63	.63	.60	.57	
		1 1/2	.31	.27	.24	.24	.21	.18	
		2	.37	.33	.30	.30	.27	.24	
		3	.43	.39	.35	.34	.31	.27	
Dense Opal		1	.49	.45	.42	.43	.41	.39	
		1 1/2	.54	.50	.47	.48	.46	.44	
		2	.50	.46	.43	.44	.41	.39	
		3	.56	.52	.49	.50	.47	.44	
Steel Bowl		1	.38	.36	.34	.35	.33	.33	
		1 1/2	.45	.43	.41	.42	.40	.40	
		2	.49	.47	.45	.46	.44	.44	
		3	.54	.52	.50	.51	.49	.49	
Percelain Enamelled		1	.59	.57	.55	.56	.54	.54	
		1 1/2	.43	.40	.38	.39	.37	.37	
		2	.52	.49	.47	.48	.46	.46	
		3	.63	.60	.58	.59	.57	.57	
Indirect		1	.22	.19	.17	.14	.12	.07	
		1 1/2	.27	.24	.22	.22	.17	.15	.09
		2	.31	.28	.26	.20	.18	.11	
		3	.36	.33	.31	.24	.22	.13	
Mirrored Glass		1	.42	.39	.37	.28	.26	.16	
		1 1/2	.27	.24	.21	.20	.17	.14	
		2	.34	.30	.27	.25	.22	.18	
		3	.39	.35	.32	.29	.26	.21	
Light Opal		1	.45	.41	.38	.34	.31	.25	
		1 1/2	.51	.47	.44	.40	.37	.29	
		2	.24	.21	.19	.16	.14	.10	
		3	.30	.27	.24	.20	.18	.13	
Semi-Indirect		1	.34	.31	.28	.23	.21	.15	
		1 1/2	.39	.36	.33	.27	.25	.18	
		2	.45	.41	.38	.34	.31	.25	
		3	.51	.47	.44	.40	.37	.29	
Dense Opal		1	.25	.20	.17	.18	.16	.14	
		1 1/2	.30	.26	.23	.24	.21	.19	
		2	.35	.31	.28	.23	.21	.15	
		3	.41	.37	.34	.33	.30	.26	
Enclosing		1	.48	.44	.41	.39	.36	.31	
		1 1/2	.23	.20	.17	.18	.16	.14	
		2	.30	.26	.23	.24	.21	.19	
		3	.38	.34	.31	.28	.25	.22	
Semi-Enclosing		1	.41	.37	.34	.33	.30	.26	
		1 1/2	.48	.44	.41	.39	.36	.31	
		2	.32	.28	.26	.27	.25	.21	
		3	.40	.36	.33	.34	.32	.30	
Opal Bowl		1	.45	.41	.38	.39	.37	.35	
		1 1/2	.52	.47	.44	.45	.42	.40	
		2	.59	.54	.51	.51	.48	.46	
		3	.66	.61	.58	.58	.55	.53	

Fig. 184. This table shows the percentage of light which we can expect to obtain at the working surface, from lamps used in different types of reflectors, and in rooms of different shapes. Note that the color of walls and ceilings also influences this percentage.

The ratio of the room width to its ceiling height is also considered, because in narrow high rooms more of the light strikes the walls. In wide rooms

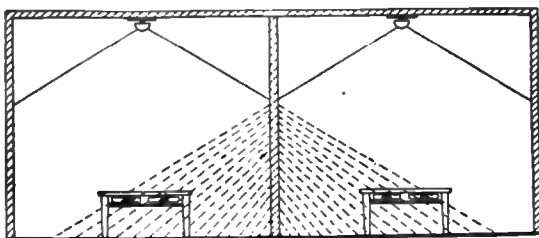

Fig. 185. This sketch shows how the walls of narrow rooms absorb a certain amount of the light. If the wall in this case was removed and the room was twice as wide, note how the light beams from the two lamps would overlap and produce more light on the benches.

which are not obstructed by partitions, the light from the several lamps overlaps and not as much of it is absorbed by walls; thus the utilization factor is raised somewhat. Fig. 185 shows a sketch of a room and what the effect on the light would be, both with and without the center partition.

Fig. 186 shows the amount of light absorption and reflection obtained from painted walls and ceilings of different colors, and from this we can see that in many cases it would pay to coat them with white or light colored paint, to reduce light waste by absorption. The white or lighter colored paints greatly improve the utilization factor by increasing reflection.

**168. WORKING PLANE**

Now that we have considered some of the more common types of lighting units for industrial and commercial lighting and some of the important points governing their efficiency, let us find out something about the proper location and arrangement of lights to obtain best results and efficiency.

In mounting fixtures for industrial or commercial lighting we must consider the distance the light will have to travel from them to reach the Working Plane. This term refers to the level at which the light is used. In an office, it may be the top of the desk; or in a drafting room, the top of the tables; in a store, the counter top; and in a machine shop, the height of the machine or bench at which the operator works.

As it is very seldom that the maximum light is wanted at the floor, we must plan to obtain the proper intensities at the working plane.

Examination of the equipment or work in a room or building, will readily show at what height from the floor the working plane is; but if no measurements can be made, it is usually assumed to be about 2½ feet from the floor.

**169. MOUNTING HEIGHT**

The next important point to consider in the location of the fixtures is the proper Mounting Height. This is the perpendicular distance from the working plane to the source of light; and it is, of course, this distance that affects the coefficient of utilization and the light intensity obtained at the working plane.

The distance from the floor to the ceiling in any room is called the Ceiling Height.

With direct lighting the source of light is the lamp itself and its reflector. In indirect and semi-

indirect lighting the source is considered to be at the ceiling. Fig. 187 illustrates this.

**170. NUMBER AND LOCATION OF LIGHTS**

In general, we should never try to skimp on the number of lights or lighting circuits when planning a lighting installation. If good lighting is economy, then it is certainly false economy to try to save on wiring materials or fixture costs by cutting down on the number of lighting outlets or trying to spread them as far apart as possible.

At the rate standards of lighting are improving today in all classes of up-to-date buildings, it is far better to plan for the future and to put in adequate lighting while it is being installed.

Best results can be obtained by having sufficient outlets close enough together to give even distribution and uniform lighting.

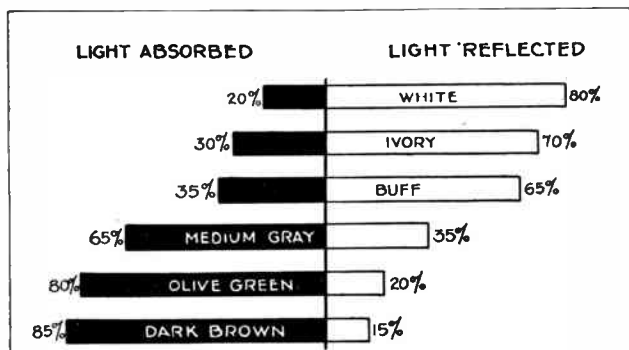

Fig. 186. The above chart shows the percentages of light that will be absorbed and also the percentage that will be reflected, by walls and ceilings painted with different colors.

**171. SPACING DISTANCE**

In small rooms that are enclosed by permanent partitions and where one lamp is sufficient, it is, of course, a simple matter to locate this unit in the center of the ceiling. In large rooms where a number of lamps are necessary, we need some rule or standard by which to determine the number and spacing of the lights.

The distance between lights or lighting outlets is known as the Spacing Distance. This distance will vary somewhat with the shape and height of the room, but it can easily be determined by the following simple rule: For best efficiency the spac-

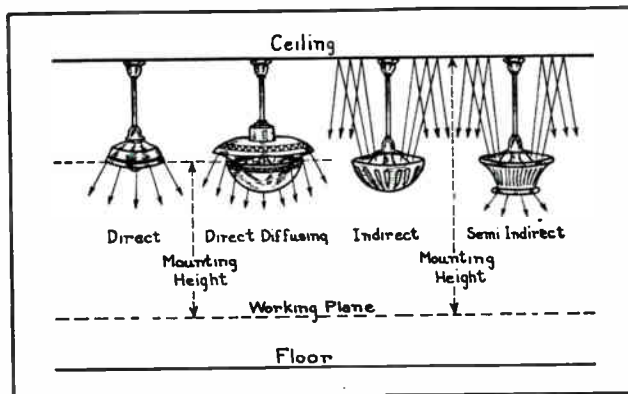

Fig. 187. This sketch shows how the mounting height is obtained with different types of fixtures.

ing distance should be the same as the mounting height.

In some cases this may seem unnecessarily close, but if good illumination is desired, lights should seldom be spaced more than  $1\frac{1}{2}$  times the mounting height. There may be certain cases where a building when it is first erected will not need that much general lighting, but if it is later changed to some other use, the standard amount of illumination may become very necessary.

**172. LIGHTING BAYS**

In large rooms where a number of lights are to be installed they should be lined up as neatly as possible for good appearance. In some buildings the larger rooms have posts or supports at uniform distances throughout them, which sort of divide them into Bays. If possible, the lights should be arranged uniformly in these bays.

In planning an illumination layout, however, we should divide the room or space into imaginary bays or squares, as soon as the mounting height and spacing distance have been determined. The width of each bay should be made the same as the spacing distance, and each bay should have a light in the center of it. See Fig. 188.

**173. PRACTICAL ILLUMINATION PROBLEM**

Let us assume that the size of the room shown in this Figure is 30x40 ft., and 13 ft. high. We will assume that the working plane is  $2\frac{1}{2}$  ft. from the

floor, and that the lighting units will hang down  $2\frac{1}{2}$  ft. from the ceiling. In this case our mounting height will be  $13' - 5'$ , or  $8'$ . Then, for maximum efficiency, the spacing distance should be about 8 ft., and not over 12 ft., if good lighting is desired. As the building is 30 ft. by 40 ft., a spacing distance of 10 ft. will give us 10-foot light bays, which will fit this space evenly. So we will adopt the 10-foot spacing distance, and bays  $10' \times 10'$ , as shown by the dotted lines. This layout will require 12 lights.

Spacing the rows of lights 10 ft. apart leaves 5 ft. between the outside rows and the walls; which

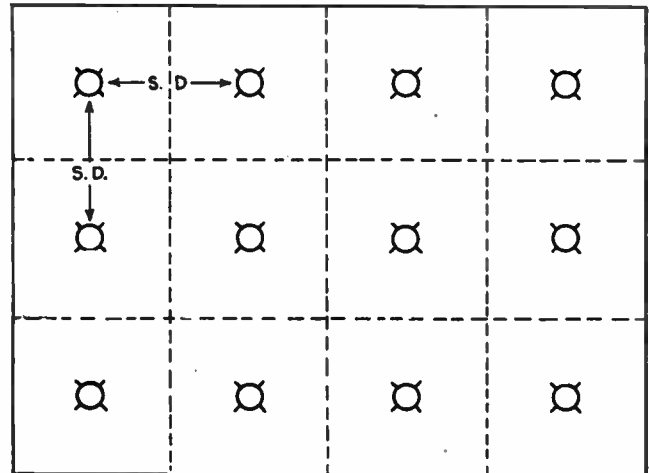

Fig. 188. Dividing the area which is to be illuminated into "light bays," as shown by the dotted lines, greatly simplifies an illumination problem.



Fig. 188-B. This photo shows a view in a well lighted machine shop. It is easy to understand why production can be increased and greater safety obtained in a shop which is lighted in this manner. (Photo Courtesy Light Magazine).

should be all right, unless some special bench work is to be done along the walls.

Now that we know the number of lights to use and that the area of the bays to be supplied by each light is 10x10, or 100 sq. ft., our next step is to choose the desired illumination intensity.

The required intensity in foot candles will vary considerably for various classes of work. For example, a shop doing nothing but coarse assembly work may only require 8 to 10 foot-candles (F.C.) while another shop doing very fine machine work may require 20 to 50 F.C. A store or office may need 10 to 20 F.C., while a drafting room or sewing room requires 20 to 40 F.C.)

Let us assume that our problem is for an office building where the owner desires 15 F.C. intensity.

Now, in order to determine the required lumens to produce this intensity, we recall that we must consider the utilization factor, according to the type of fixture and the color of the room walls and ceiling. We will use for this job a light opal-glass unit of the semi-enclosed type, and assume our walls and ceilings are both light colored.

Looking up this fixture in the table of utilization coefficients in Fig. 184, and in the column for light walls, light ceilings, and a room with a ratio of width to height of about 2, we find the coefficient is .45.

If we wish to assure the proper lighting intensity after the fixtures are installed a while, we must also consider the depreciation factor of, say 1.4.

Now we are ready to lay out all this data in a simple formula to make our final calculation of required lumens as follows:

$$L = \frac{F.C. \times B. A. \times D.F.}{C.U.}$$

In which:

- L = Lumens required per bay
- F.C. = Foot-candles desired intensity
- B.A. = Bay area (one bay)
- D.F. = Depreciation factor
- C.U. = Coefficient of utilization

So, substituting our values, we have:

$$L = \frac{15 \times 100 \times 1.4}{.45}, \text{ or } 4666 + \text{ Lumens per bay.}$$

Now, from our table of lumen output of Mazda lamps in Fig. 164, we find that a 300-watt lamp gives 5520 lumens, so that would do very well for this job.

It will be well to review this problem until you thoroughly understand each step of it and the reasons for using each of the factors we applied in calculating the spacing distance, size of bays, number of outlets, size of lamps; as these are the important factors in any commercial illumination problem. Once you have obtained an understanding of these fundamentals and a little practice in using them in the simple formula given here, you should be able to lay out a practical illumination job very easily.

### 174. STANDARD ILLUMINATION INTENSITIES IN FOOT-CANDLES

For your convenience in determining the proper illumination intensity to use for various classes of work and different buildings, a list of the standard foot-candle intensities for the most common classes of lighting is given here:

#### RECOMMENDED FOOT-CANDLE INTENSITIES

##### COMMERCIAL INTERIORS

Auditoriums .....	3 to 5
Automobile showrooms .....	10 to 20
Banks .....	10 to 20
Barbershops .....	10 to 20
Bowling alleys (general).....	8 to 10
On pins .....	20 to 30
Pool and billiards (general).....	8 to 10
On tables .....	20 to 30

OFFICES (private and general).....	10 to 30
Close work .....	20 to 30
No close work.....	10 to 20
File rooms .....	8 to 10
Vaults .....	8 to 10
Reception rooms .....	8 to 10

RESTAURANTS .....	8 to 10
SCHOOLS .....	8 to 30

Auditoriums .....	8 to 10
Drawing rooms .....	20 to 30
Laboratories .....	10 to 20
Manual training rooms.....	10 to 20
Study rooms and desks.....	10 to 20

##### STORES

General .....	10 to 20
Automobile .....	10 to 20
Bakery .....	10 to 20
Confectionery .....	10 to 20
Dry goods .....	10 to 20
Grocery .....	10 to 20
Hardware .....	10 to 20
Meat .....	10 to 20
Clothing .....	10 to 20
Drugs .....	10 to 20
Electrical .....	10 to 20
Jewelry .....	10 to 20
Shoe .....	10 to 20

##### SHOW WINDOWS

Large cities	
Downtown .....	100 to 200
Outer districts.....	50 to 100
Neighborhood stores .....	30 to 50
Medium-sized cities	
Downtown .....	50 to 100
Outer districts .....	30 to 50
Small towns .....	30 to 50

##### THEATRES

Auditoriums .....	3 to 5
Foyer .....	8 to 10
Lobbies .....	10 to 20

## CHURCHES

Auditorium .....	8 to 10
Sunday-school rooms .....	10 to 20
Pulpit or rostrum.....	10 to 20
Art-glass windows .....	30 to 50

## INDUSTRIAL INTERIORS

## ASSEMBLING

Rough .....	8 to 10
Medium .....	10 to 20
Fine .....	20 to 30
Extra fine .....	50 to 100

## MANUFACTURING

Screw machines .....	10 to 20
Tool making .....	20 to 30
Inspecting .....	50 to 100
Drafting rooms .....	20 to 40

## ELECTRICAL MANUFACTURING

Battery rooms .....	8 to 10
Armature winding .....	12 to 20
Assembly .....	10 to 20

## FOUNDRIES

## MACHINE SHOPS

Rough work.....	8 to 10
Grinding and polishing.....	10 to 20
Fine machine work and grinding.....	20 to 50

## TEXTILE MILLS

## ENGRAVING

## JEWELRY MANUFACTURING

This list of recommended illumination intensities will give the proper values for most any kind of ordinary illumination. While it does not, of course, mention every possible class of work, a general study of the intensities required for the various types of work covered will enable you to determine the proper intensities to use on almost any problem you may encounter.

The lower values given in the list are the minimum values for efficiency in the class of work for which they are given. The higher values are recommended as the best practice where maximum efficiency is desired.

When we sum up the recommendations given in the foregoing list, we find that a good general division of proper intensities to keep in mind is as follows:

**5 to 10 FOOT-CANDLES**

Suitable for coarse work, such as rough assembly and packing. Sufficient for warehouses, stockrooms, aisles, etc. This is enough light to prevent a gloomy appearance.

**10 to 15 FOOT-CANDLES**

Considered good lighting for most kinds of work on light-colored surfaces, but is not sufficient for fine details on dark-colored surfaces.

**15 to 25 FOOT-CANDLES**

Excellent lighting. Permits quick and accurate work, and stimulates workmen and speeds up production enough to more than pay for the small extra cost of the light.

**50 to 100 FOOT-CANDLES**

Needed only for extremely fine and accurate

operations, inspection, etc. Generally used only at local spots where needed, and along with general lighting of lower intensities.

Another good general rule to remember is that, for ordinary factory lighting, 200-watt lamps in standard R.L.M. reflectors and spaced 10 ft. apart will usually give very satisfactory lighting. The R.L.M. dome is a common type of unit which is approved by the Reflector and Lamp Manufacturers Association, and is very commonly used in industrial lighting.

If there are certain sections which require more light, larger bulbs can be used in the units at these points, provided the outlets are wired to stand the increased load. For this reason it is usually better to install wires plenty large enough to carry a certain increase of load in case of future improvement in the lighting.

Observing the lighting needs and selecting and recommending the proper illumination intensities for various buildings and classes of work is a very interesting and profitable field, and should prove very easy and enjoyable work for the man with a good understanding of the fundamental principles of illumination covered in this section. Practice using the tables and simple formulas, until you can use them easily in planning any ordinary illumination system. Fig. 188-B shows a splendid example of good illumination in a machine shop.

**175. FACTORY LIGHTING PROBLEM**

Suppose we have a job of lighting a factory room 55 ft. wide, 100 ft. long, and 17 ft. high. The work to be handled is not very fine, the material is light-colored, and the owner desires good illumination, which in this case should be obtained with an intensity of about 12 foot-candles.

Let us say the average working plane is about 30 inches, or  $2\frac{1}{2}$  feet, from the floor; and that the lighting reflectors chosen will hang down  $2\frac{1}{2}$  feet from the ceiling. Then if the room is 17 ft. high, the mounting height will be  $17 - 5 = 12$  ft.

We decide to use the maximum efficient spacing distance, which we have learned is  $1\frac{1}{2}$  times the mounting height. Then  $1\frac{1}{2} \times 12 = 18$  ft. spacing distance.

Each light bay will then be  $18' \times 18'$  or 324 sq. ft. This figure will be approximate and may need to be corrected to suit the shape of the room, for even rows of lights. Then, to find the number of outlets, we can divide the total floor area by the square feet per bay. The floor area will be  $55' \times 100' = 5500$  sq. feet. Then  $5500 \div 324 = 16.9+$ ; or, we will say, 17 outlets.

Now, as our room is nearly twice as long as it is wide, a good uniform arrangement will be the three rows of 6 outlets in each, or 18 outlets. This will be one more than our figures call for, but when balancing up the rows for appearance, it is always better to add a light or two than to remove any. See the layout for this problem in Fig. 189. This ar-

range will give a spacing of  $18\frac{1}{3}$  ft. between the rows of lamps, and  $16\frac{2}{3}$  ft. between the lamps in the rows. It also leaves a space of  $9\frac{1}{6}$  ft. between the rows and the walls on the sides, and  $8\frac{1}{3}$  ft. at the ends.

Now that we have decided upon the number of outlets, our next step is to determine the exact number of sq. ft. per bay. So we will divide the total floor area by the number of outlets, or  $5500 \div 18 = 305.5+$  sq. ft. per bay.

Before we can complete our problem and determine the number of lamp lumens required per bay to maintain 12 foot-candles of illumination, we must consider our utilization and depreciation factors.

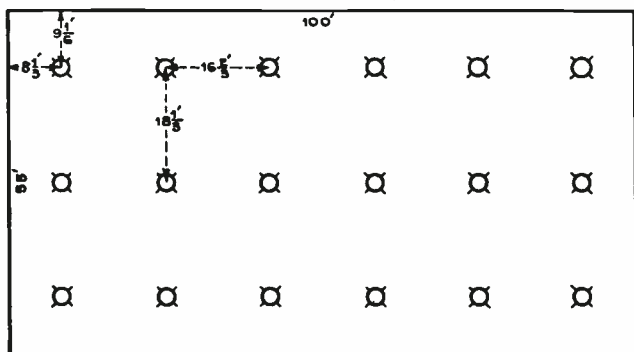

Fig. 189. This sketch shows the arrangement and spacing of lights for a practical factory lighting job.

We will assume that we are going to use steel dome, porcelain-enameled reflectors, and that the walls and ceilings of the room are both light-colored.

By referring to the table in Fig. 184, we find that for this fixture used with light walls and ceilings, and in a room whose ratio of width to height is about 2, the utilization factor is .57. Then, using 1.4 as our average depreciation factor, our problem can be completed by the formula for lumens, which we have previously used.

$$L = \frac{12 \text{ F.C.} \times 305 \text{ B.A.} \times 1.4 \text{ D.F.}}{.57 \text{ C.U.}}$$

In which we will recall—

- F.C. = Desired foot-candles
- B.A. = Bay area in sq. ft.
- D.F. = Depreciation factor
- C.U. = Coefficient of utilization

Working out this formula with our figures for this job, we find it gives 8989.4+ lumens required. Then, from the table in Fig. 164, we find that a 500-watt lamp gives 9800 lumens, so it will be plenty large enough for this job.

If the glare from bare bulbs in these units should be objectionable to any of the operators, we can install bowl frosted lamps.

The upper view in Fig. 190 shows what happens when lighting units are spaced too far apart. This produces contrasting spots of bright light with shadows in between, and is very poor practice. The lower view shows the more uniform illumination obtained by proper spacing of the units at distances not to exceed  $1\frac{1}{2}$  times their mounting height.

### 176. OFFICE LIGHTING PROBLEM

In another problem, suppose we have a room 92 ft. square and 13 ft. high which we wish to illuminate to an intensity of 10 foot-candles, with indirect lighting fixtures. Assume the working plane to be 3 ft. from floor.

When using indirect fixtures, we will remember, our source of light is considered to be at the ceiling, so in this case we do not subtract the length of the fixture from the ceiling height to obtain the mounting height. Instead, we subtract just the height of the working plane; so  $13 - 3 = 10$  ft., which will be the mounting height.

In this case we will use the proper spacing distance for maximum efficiency, which is the same as the mounting height, or 10 ft. Then the first estimate for the bays will be  $10' \times 10'$  or 100 sq. ft.

The total floor area is  $92' \times 92' = 8464$  sq. ft. Then the estimated number of outlets will be  $8464 \div 100 = 84.6+$ .

As the room is square, we can use 9 rows of 9 lights each, or a total of 81 outlets; which is close enough, because we are using close spacing anyway.

Now to get the accurate number of sq. ft. per bay, we divide the total floor area by the chosen number of outlets, or  $8464 \div 81 =$  approximately  $104\frac{1}{2}$  sq. ft. per bay.

We will assume the walls and ceilings to be light-colored, as the ceilings should certainly be to get reasonable efficiency from indirect fixtures, with which the light must be reflected from the ceiling.

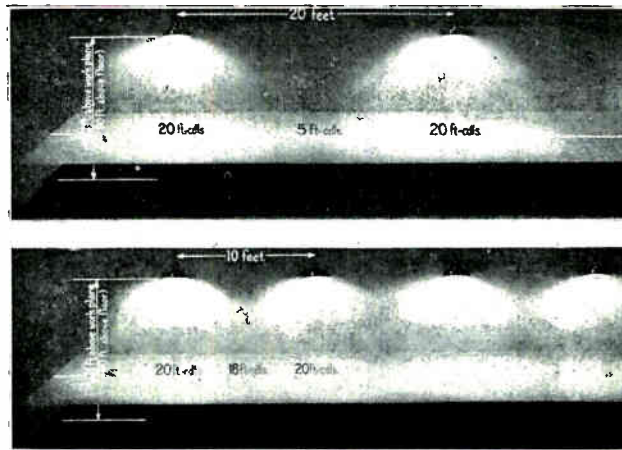

Fig. 190. Note in the upper view the very undesirable effect of uneven illumination, which results from spacing lighting units too far apart. Below is shown the much more efficient lighting obtained with proper spacing distance.

Referring to Fig. 184 again, we find the coefficient of utilization for indirect fixtures and light-ceilings and walls is .42. This is for a room of 5 to 1 ratio of width to ceiling height; as the one in our problem has a ratio of about 7 to 1, or  $92 \div 13$ . But the table only gives these ratios up to 5, and we will recall that on ratios above 5 the difference is very little anyway.

With indirect fixtures, the depreciation factor is likely to be rather high unless both the fixtures



Fig. 191. This photo shows a view in a well lighted store. Plenty of good light always pays in such places as this. (Photo Courtesy Light Magazine).

and ceiling are kept very clean; so we will use 1.6, or the maximum average depreciation factor.

Then our final problem can be stated in the formula:

$$L = \frac{10 \times 104.5 \times 1.6}{.42}, \text{ or } 3981\text{-lamp lumens required.}$$

From the table in Fig. 164, we find that the next size larger than this is a 300-watt lamp, which gives 5520 lumens. This is more than our estimate calls

for but it is a good general rule always to select a lamp with the next larger rating in lumens, rather than to use one smaller.

Of course, if we find that for a certain layout the next larger lamp has a considerably greater lumen output than is actually required, we can, if desired, rearrange the layout to slightly increase the spacing distance and size of bays. But, in general, it is a good plan to have a little extra light, to keep it up to standard after the bulbs and fixtures start to depreciate.

Another thought to always keep in mind, is that, while a certain illumination system may be considered excellent today, in a year or two it may be desired to increase the intensity considerably with improving standards.

Fig. 191 shows a well-lighted store in a medium-sized town, using 500-watt lamps on 10-ft. centers.

For store and office lighting, it is general practice to use direct-diffusing, indirect, or semi-indirect fixtures. Both the opal glass bowls and prismatic glass are quite popular.

In office lighting jobs, one should always inquire whether the present layout of desk, equipment, and

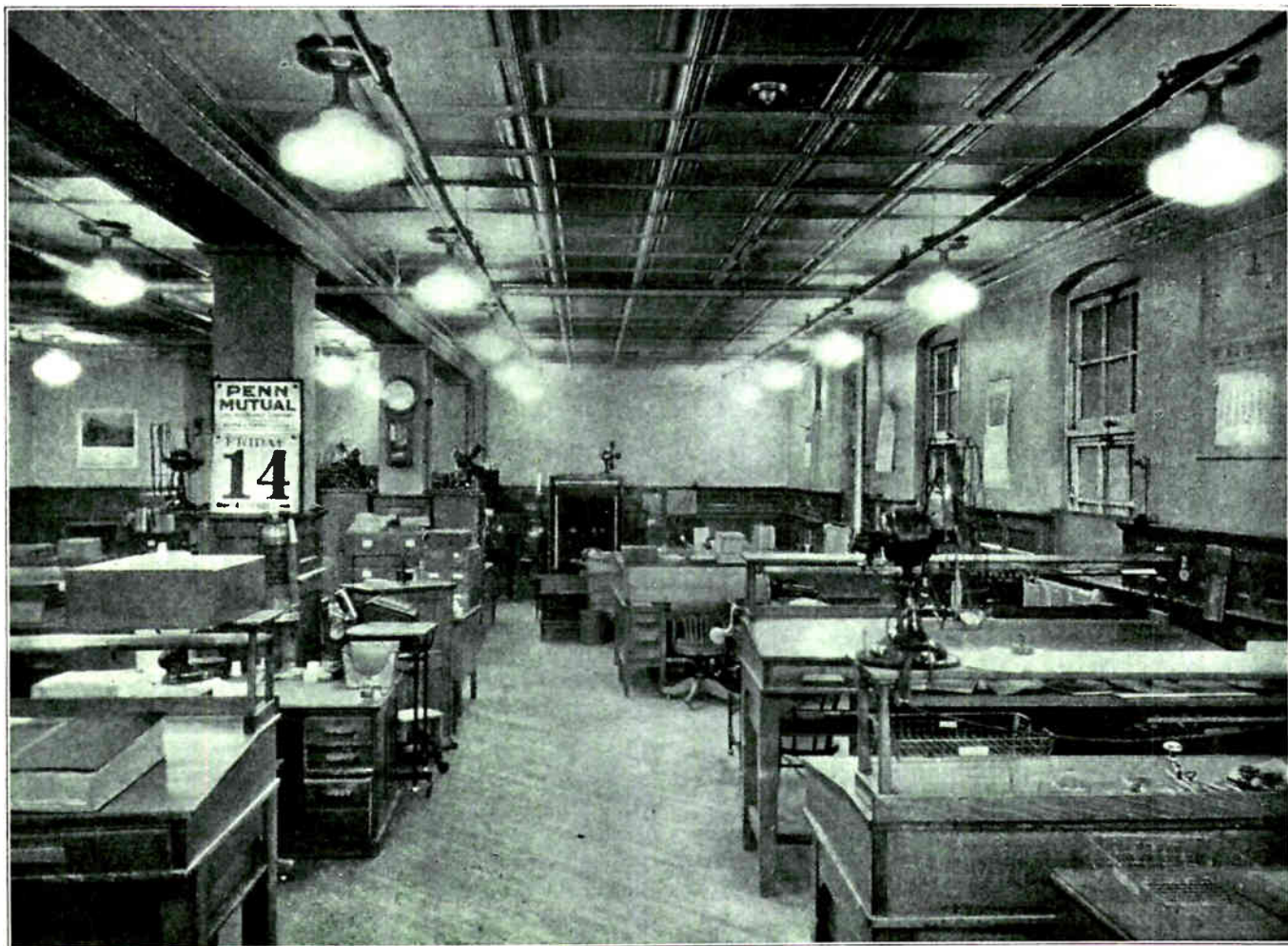

Fig. 192. A well lighted office, such as shown above, permits much faster and more efficient work with less eye strain for employees. It also provides a more cheerful atmosphere which improves the morale of those working in such places. (Photo Courtesy Light Magazine).

small private offices is permanent or not. Many offices change these things around quite frequently, and in such cases good general lighting which is sufficient for almost any work or condition in the office will save a lot of trouble and remodeling of the lighting system.

Fig. 192 shows a very good office lighting system using enclosed glass bowls, which diffuse the light nicely over the desks and equipment.

Fig. 193 is an installation of indirect lighting units, which shows the soft even light distribution obtainable with such fixtures and the absolute freedom from glare or noticeable shadows.



Fig. 193. This office is lighted with indirect units which are ideal for avoiding all glare and shadow effects. (Photo Courtesy Light Magazine).

### 177. SHOW-WINDOW LIGHTING

Show-window lighting is a branch of store lighting which has proven to be one of the best sales stimulants that the modern store has. On busy streets where large numbers of people pass by, a well lighted show window with goods interestingly displayed will attract a great amount of attention to a store that many people might otherwise pass by.

A number of tests made on stores with various show-window lighting intensities showed the interesting average results listed in Fig. 194.

In show-window lighting the light sources should be concealed, as we must remember it is not the lights the store owner wants to sell but rather the goods the light is to shine on.

Effect of lighting intensities on show window results

Foot candles intensity	Increase in no of people stopping	Estimated hourly profit on sales	Hourly lighting cost	Merchants net hourly gain
15		7.50	3.5 cents.	
40	33%	10.00	7.5 "	2.46
100	73%	13.00	12. "	5.36

Fig. 194. The above table shows the results obtained with different lighting intensities in show-windows. Such tests as this certainly prove that good show-window lighting pays.

The reflectors should be set so their light shines downward and back into the window, in order to put proper light on the side of the objects which faces toward the customer. The light should never

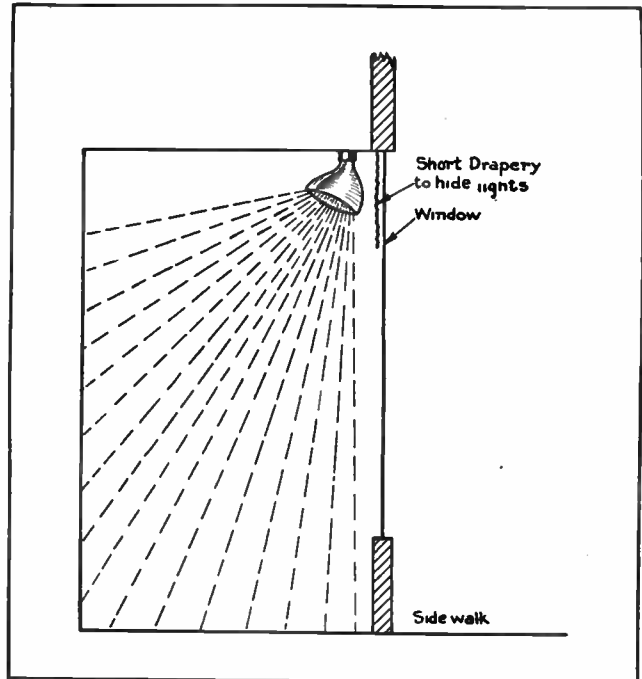

Fig. 195. This illustration shows how the light should be directed on the objects displayed, and not toward the window or observers.

be directed toward the window glass or passers by, as it would then have a tendency to cause glare in people's eyes and defeat its entire purpose. Fig. 195 shows how a lighting unit can be concealed in the front top corner of the window, and the manner in which it should distribute its light rays over the depths of the window.

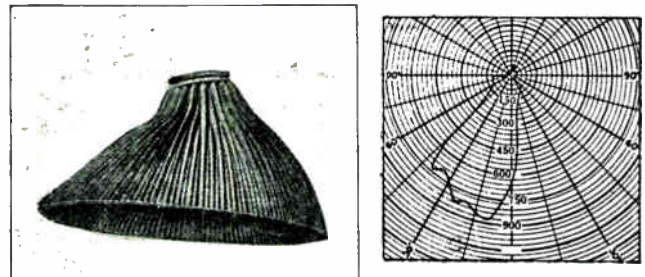

Fig. 196. A common type corrugated glass show-window reflector. Note how the light distribution curve compares with the desired angle of light shown in Fig. 195.

### 178. SHOW-WINDOW REFLECTORS

Fig. 196 shows a typical show-window reflector of the corrugated glass type, and also its curve of light distribution and the manner in which its shape directs the light to fit show-window needs.

Fig. 197 shows two of the corrugated glass show-window reflectors with silvered and painted outer surfaces. The one on the left is shaped to throw the light down and slightly back into a shallow window, while the one on the right is curved to direct the light farther back into deep show-windows.

Fig. 198 shows a group of show-window reflectors mounted behind the concealing curtain, as mentioned before. A row of 150-watt lamps in such reflectors as these, spaced on 12-inch centers, will give excellent show-window lighting. If the same



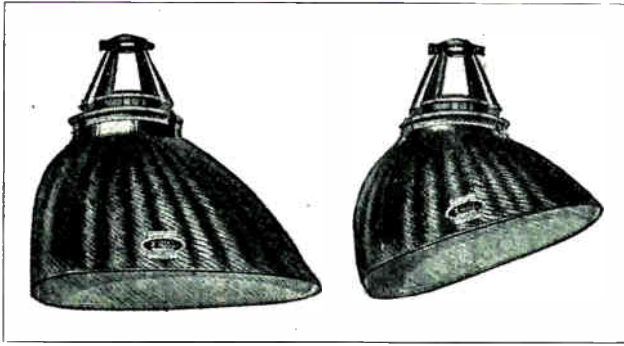

Fig. 197. Mirrored glass show-window reflectors with different shapes, to properly direct the light in windows of different depths.

sized lamps and reflectors are spaced on 18-inch centers, it will give good lighting, and on 24-inch centers fair lighting.

Foot-candle intensities for show windows were given in the list in Article 174.

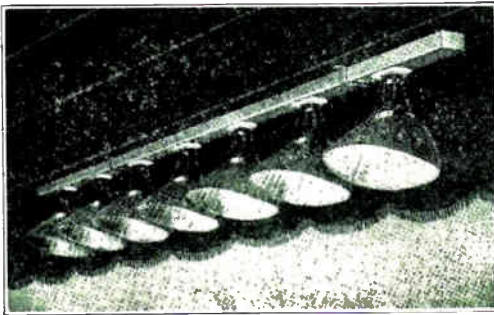

Fig. 198. This photo shows the manner in which show-window reflectors should be mounted and concealed for best results.

### 179. SPOT AND COLOR FLOOD LIGHTS

Proper use of special show-window flood lights and colored spot lights on certain objects will give very beautiful and attractive effects that in practically every case will pay well for the cost of installing and operating. Fig. 199 shows an adjustable show-window flood light with a detachable color screen which can be fitted over it. A number of different color screens can be obtained at very low cost, to make changes in color effects, and to keep up interest in a window display. Fig. 200 shows a spot light on the left, and on the right is a small reflector used for lighting display cases in store interiors.

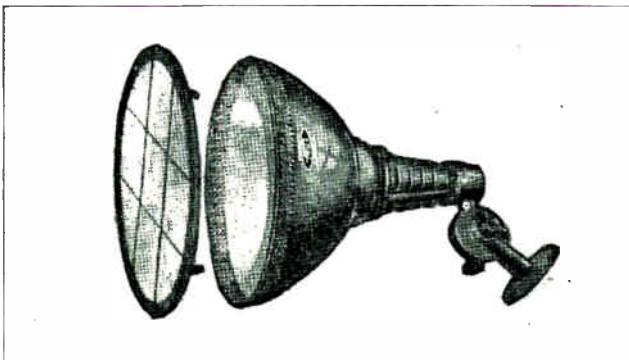

Fig. 199. Adjustable flood lights with colored screens can be used to produce beautiful and decorative effects.

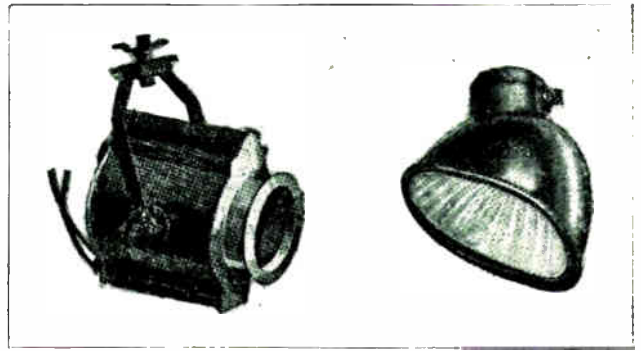

Fig. 200. On the left is shown a spotlight for concentrating bright light on certain objects in show-windows. The small reflector on the right is of the type commonly used in glass counters and display cases.

### 180. COUNTER LIGHTING

For lighting display cases and interiors of glass counters we can also use compact tubular reflectors with special long slender bulbs made for the purpose. These reflectors fit neatly under the wood or metal corner frames of the counters, so they do not obstruct the view or create a bad appearance in the case. Fig. 201 shows the method of installing this material in a glass show-case. Fig. 202 shows several different lengths of these trough-like reflectors and a number of the fittings used with them. The wires can be run in special small tubing, some of which is also shown.

Fig. 203 shows what remarkable effects can be obtained with properly concealed show-window

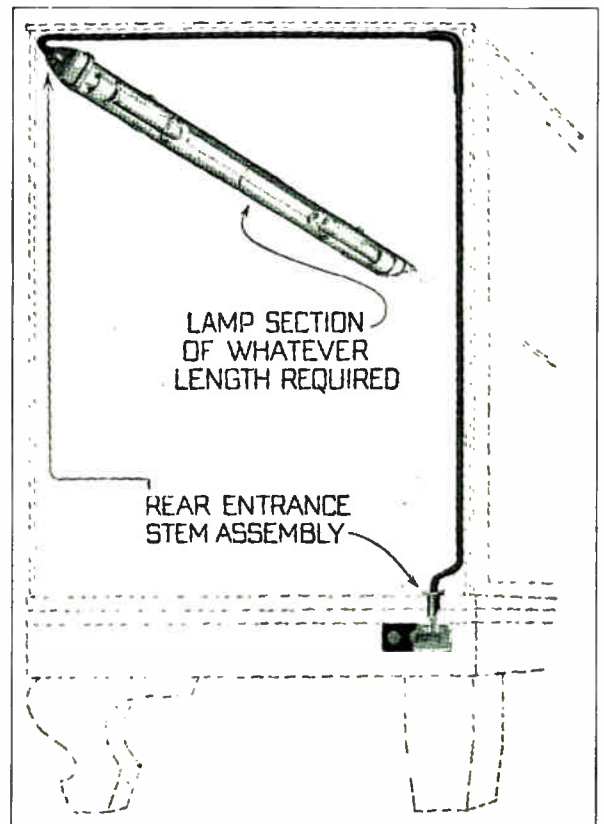

Fig. 201. Long trough-shaped reflectors with special tubular lamps are obtainable for convenient installation in glass counters as shown above.

lights, and properly distributed illumination in the window.

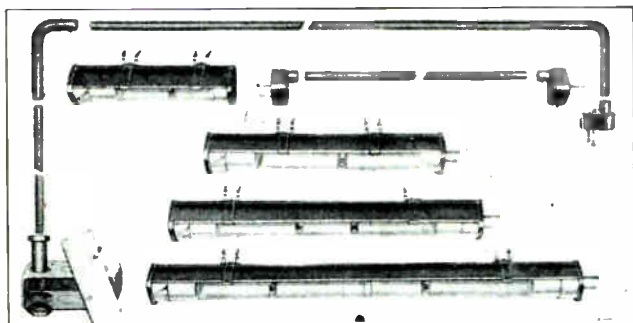

Fig. 202. Show case and counter lighting units are made in convenient sections which can be easily plugged together for lighting cases of different lengths.

### 181. ELECTRIC SIGNS AND BILLBOARDS

Electric signs today are made in such a great variety of styles and types and to produce such beautiful and life-like effects in some cases, that one might think them very complicated devices. While some of the larger ones are marvelous pieces of mechanical construction and use very ingenious arrange-

ments of electrical circuits, they are really not hard to understand for one who knows the principles of electric circuits and the general principles of sign construction and operation.

### 182. BILLBOARD LIGHTING

One of the simplest forms of illuminated signs is the billboard type which consists simply of large flat panels on which are painted the pictures and words of the advertisement. Many of the illustrations for such signs are made up on large paper sections and pasted on the boards. This makes it economical to change or renew them as desired.

Billboards of this type are quite commonly equipped with electric lights, because, in many cases, they actually attract the attention of more people when lighted at night than they do during daylight hours.

Fig. 204 shows the common method of mounting the reflectors on conduit extensions out over the top edge of the board. With the reflectors in this position they do not obstruct the view of observers, and they direct their light toward the sign and away from the observers' eyes, so that the lights themselves are hardly noticeable.

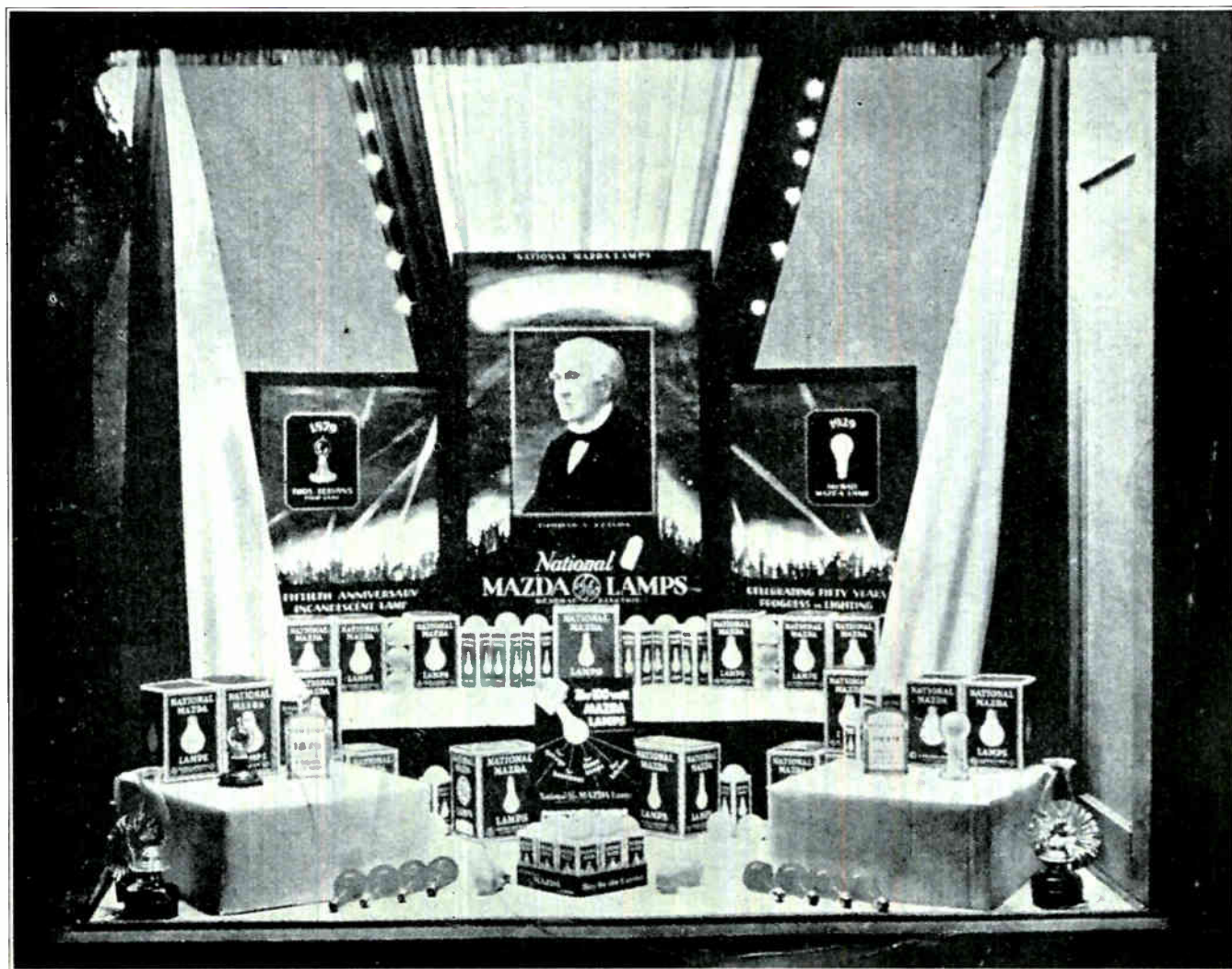

Fig. 203. This exhibit of Mazda lamps in a show-window of an electric store, shows the very beautiful and decorative effects which can be produced by proper show-window lighting. (Photo Courtesy of Light Magazine)

This is ideal, because it is the sign we want people to see and not the lights. This principle is a very good one to keep in mind in illuminating problems, as the best results are often obtained by having the light sources practically concealed, or at least very inconspicuous; leaving the illuminated object to be the principal attraction to the eye.

Billboard lights should be mounted several feet out in front of the boards as shown in Fig. 204, because if they are placed close to the top edge, the light strikes the board at a sharp angle and causes glare and shadows. Mounting them out the proper distance from the board allows their light to diffuse evenly over the board.

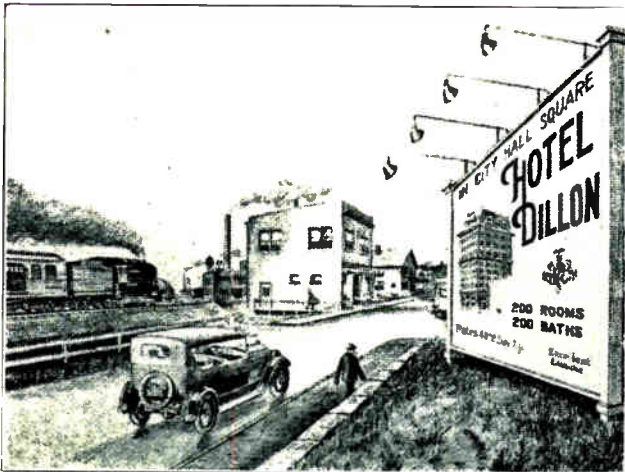

Fig. 204. This view shows the manner of mounting reflectors on conduit extensions for billboard lighting. Note how the reflectors are curved to direct the light on the board, but away from the observers.

In some cases where reflected glare from the lamps above the board comes at just the exact angle to strike the eyes of observers who are slightly below the board, the lights can be arranged out in front of the bottom edge of the board and pointed upward, as shown in Fig. 205-B. This method of mounting can also be used where billboards are viewed from above and we desire to keep the reflectors out of the direct range of vision.

The mounting as shown in Fig. 205-A is to be preferred whenever it is possible to use it, because the position of the reflectors keeps their inside surfaces and the bulbs more free from dirt and rain.

Billboard reflectors mounted on conduit extensions should usually be braced with steel wires running to the top of the board, to prevent the wind from blowing the reflectors sidewise.

### 183. ELECTRIC SIGNS, CONSTRUCTION AND OPERATION

Many electric signs are made of steel framework covered over with sheet metal. These can be made in square, round, high narrow, or long horizontal shapes; as well as ornamental designs. Some signs of this type merely have letter shapes cut in the sheet metal on both sides and covered with opal or colored glass. Light bulbs inside them cause the glass letters to show up brightly at night.

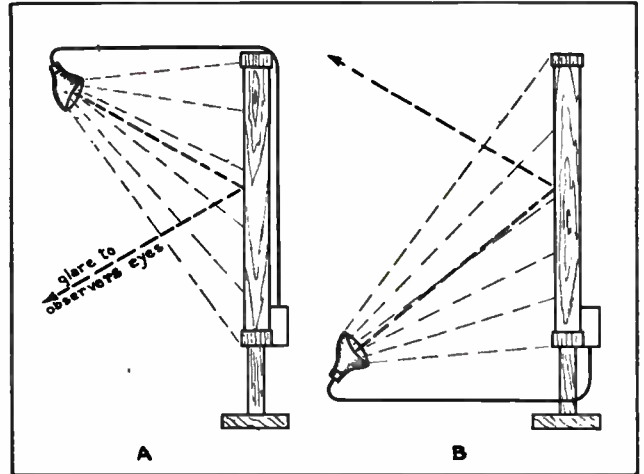

Fig. 205. If objectionable glare is produced by mounting the units above the board as in "A," they can be reversed and mounted below as shown at "B."

Other signs have lamp receptacles screwed into small round holes in the sheet metal, and bulbs screwed in these receptacles and projecting out from the face of the sign. These bulbs can be obtained in various colors, and arranged in rows to form letters or patterns of almost any desired shape.

Beautiful action effects can then be obtained by connecting the bulbs to motor-driven flashers. By causing groups in sign borders to light up and go out progressively or in numerical order, they can be made to appear as though they are actually moving, thus giving the "chaser" and "fountain" border effects, and other action displays so commonly used on large signs.

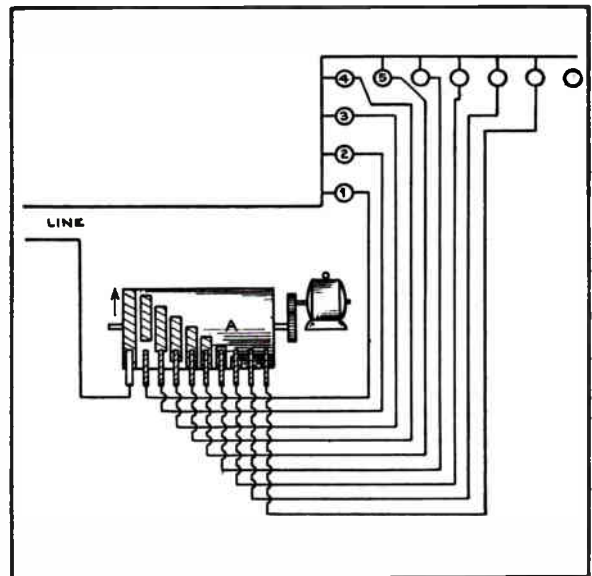

Fig. 206. This diagram shows connections for a sign flasher to be used to light the lamps 1, 2, 3, 4, etc., in rotation.

### 184. FLASHER CIRCUITS

Fig. 206 shows how a flasher can be connected to light a row of lamps in order, and then extinguish them in the same order. A motor-driven drum has a number of circular metal segments attached to it, and arranged with their ends staggered, or one behind the other in a slanting row. A number of

spring-brass or copper brush contacts slide on these segments as the drum is rotated. The metal strip on the left end of the drum may be continuous, or nearly so, in the form of a ring around the drum. This ring is connected by a "jumper" to all other segments, so with one line wire connected to the left brush contact, all segments are kept alive or in contact with the lower live wire throughout the rotation of the drum.

If the drum rotates in the direction shown by the arrow, the segments will strike the stationary contacts in order, from left to right, closing the circuits to the lamps in order—1, 2, 3, 4, 5, etc. All lamps are connected by a common wire back to the top line wire.

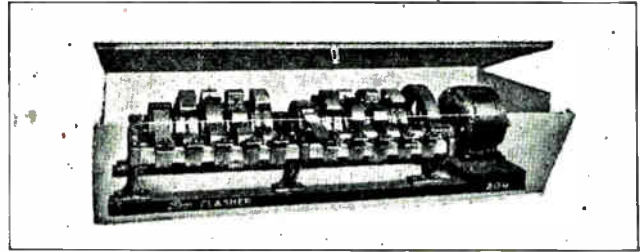

Fig. 207. Motor-driven sign flasher mounted in weather-proof box. Flashers of this type are made with different numbers of drum units and contacts, to produce a great variety of effects.

proper length so that one lamp of the four is out all the time, and as the drum rotates, the dark lamp is first No. 1, then 2, 3, 4, and repeat. This matches up with the next group, as all groups are operated from the same flasher; so it produces an appearance of continuous motion around the sign border.

A large sign may have several thousand lamps on it, connected in groups to several branch circuits or return wires, and one wire from each lamp connected to its proper flasher wire.

You can see, however, from Fig. 206-A, that the manner of grouping the connections simplifies them, and makes it only an easy matter of circuit testing to connect each wire to its proper flasher brush.

Fig. 207 shows a photo of a sign flasher such as commonly used with signs of the type just described. Note that this flasher has two separate sections, and rotating segments made of strips of brass or copper bent to shape and attached to the shaft-like separate wheels. Fig. 208 shows a large sign which uses this type of flasher.

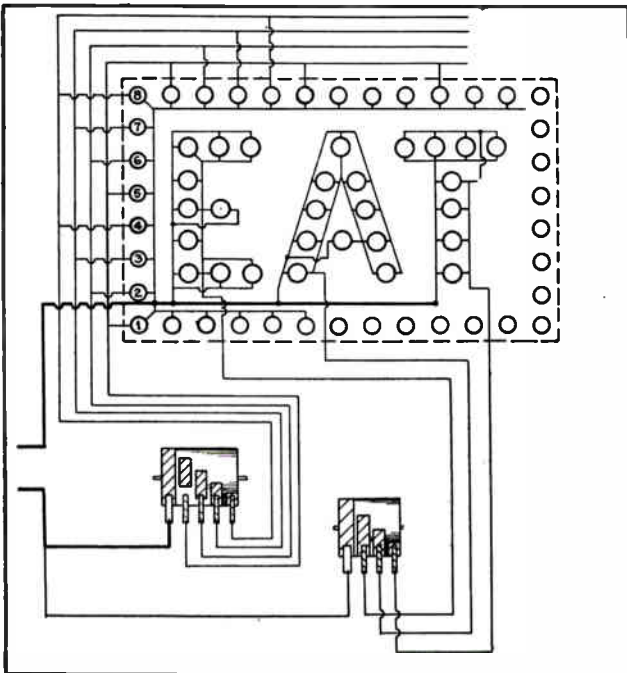

Fig. 206-A. Wiring diagram for two flashers used to obtain combination effects on an electric sign. The flasher at the left controls the border lamps only, while the one on the right controls the letters of the sign.

Flashers of this type can be obtained with many dozens of contacts, to be used to gradually spell out whole words composed of lamps on the sign.

Several flashers of this type with different numbers of contacts and operated at different speeds may be used together on one large sign to get the various combination effects desired. Fig. 206-A shows how two flashers are used, one to provide a "chaser" border effect, and the other to flash the letters of the word "Eat" on in rotation, and then all off.

You will note that to produce the motion effect in the border, it is not necessary to use a flasher with as many contacts as there are lamps. Instead, these lamps are connected in parallel groups, so that every fourth one is connected to the same flasher contact. This makes the lamps come on in the order 1, 2, 3, 4, and also 5, 6, 7, 8, coming on at the same time; or lamps 1 and 5 together, 2 and 6 together, etc. The segments on the drum are usually of the



Fig. 208. Large signs of the above type often use several flashers, and a combination of lamps and Neon tubes to produce very beautiful effects.

Sign lamps are often mounted in sheet metal channels or troughs which have the inner sides and back painted white. This gives a more sharply defined shape to letters and figures, as it prevents the light from spreading so much. Very striking effects can also be produced by using lamps under black inverted trough-shaped letters, mounted so they stand out slightly from a white background as shown in Fig. 209.

Many large flasher signs also have lighted billboard areas combined with the motion effects. Some

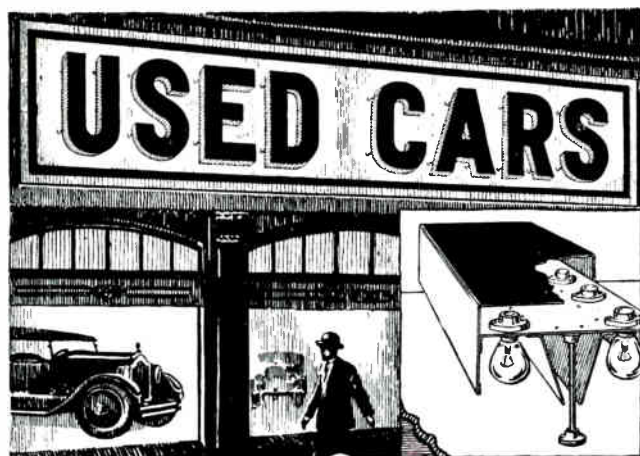

Fig. 209. Very attractive signs can be made with inverted trough units, to produce outstanding black letters on white background as shown above.

of the largest flasher signs which have special "moving letters", or continuous reading effects, use a paper roll with holes punched in it, similarly to a player piano roll. This paper is in the form of an endless belt, and is drawn slowly along between a large metal plate and a "bank" of small contact "fingers". The holes in the paper are arranged in the form of letters or shapes which are to travel across the sign. The sign face has a bank of lamps arranged in rows both ways, the same as the contacts are; so as groups of contacts drop through the holes in the moving paper and strike the metal plate completing their circuits, corresponding lamps light up on the sign.

Fig. 210 shows the arrangement of the contacts and lamps, and the method of connecting them. The wires are grouped or cabled together but can be easily traced from the contacts to the lamps and you can see that any contact that is allowed to touch the metal plate will close a circuit to a corresponding lamp.

The sketch in this figure shows only a comparatively few lamps, but on a sign of this type they are so numerous and close together that almost any letter or figure can be made to light up by having the groups of holes punched in the paper in the desired shape. Then as the paper moves and the holes slide from one set of contacts to another, the lighted letter on the sign shifts from one set of lamps to the next and moves across the sign.

Fig. 211 shows a splendid example of the advertising value and beautiful effects of combined electric sign and decorative lights on the front of a theatre building.

### 185. NEON TUBE SIGNS

Neon gas signs are very attractive and the peculiar reddish color is one that attracts the eye and penetrates foggy or smoky atmospheres very effectively.

These signs are made of long glass tubes which are bent into the shapes of letters or figures desired, and then filled with neon gas. They are then sealed air and gas tight and mounted on a back-

ground or frame, or in some cases in sheet metal channels or trough letters.

Neon is a rare gas which is extracted from the air where it exists in very small quantities. When high voltage electricity is passed through it, it glows with the peculiar reddish hue already mentioned. Neon tubes are operated at voltages ranging from 5000 to 20,000, according to the size and length of the tubes.

These high voltages are usually obtained by use of small step-up transformers right at the sign, and the high voltage wires must be very carefully insulated along the sign framework.

One special neon sign transformer delivering 30 milliamperes at 15000 volts will operate about 60 feet of ordinary neon tubing, or 30 feet of blue tubing using argon and helium.

Some of the smaller signs of this type are operated with ordinary spark coils, but their light is not as steady as that of signs operated with transformers.

One of the particular advantages of neon signs is that the tubing can be heated and bent to form letters written out in complete words, and also the most intricate curves and designs for decorative figures.

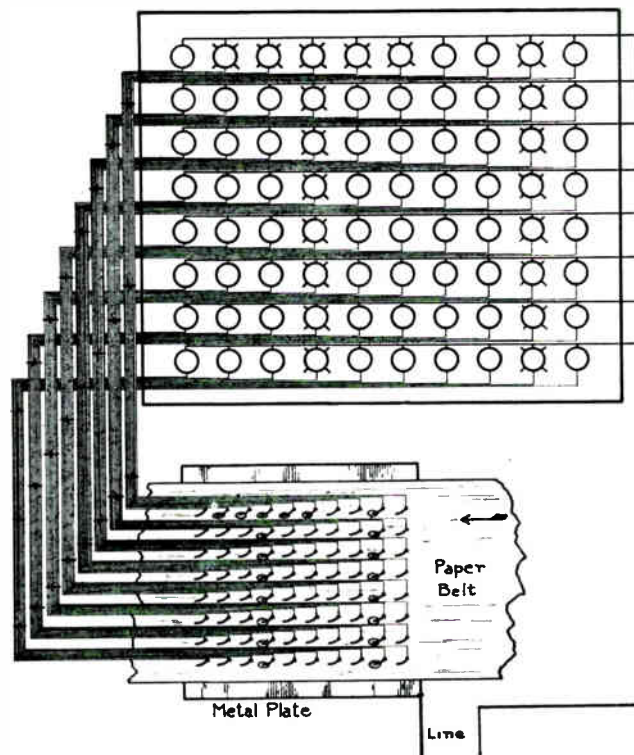

Fig. 210. The above diagram illustrates the principle of signs with traveling reading matter. Note how each contact on the paper belt is wired to a lamp in a corresponding position on the sign above.

In addition to neon gas, some signs use tubes with mercury vapor, which give a beautiful blue color when high voltage is applied to them. Green color is obtained with mercury vapor in amber colored glass tubes. By using helium gas and amber colored glass, gold, pink and other colors can be obtained.

Various letters and sections of tube signs can be operated with flashers, and some large signs use a combination of neon and mercury vapor tubes with various colored incandescent lamps, to create some very beautiful and striking effects.

The glass tubes of neon signs must be very carefully handled, as they are easily broken; and the least crack in a tube will allow the gas to leak out.



Fig. 211. This photo of the front of a large theatre shows what beautiful effects can be obtained by the use of flasher signs and lights on the building itself.

### 186. SIGN WIRING, AND CONSTRUCTING SMALL SIGNS

Electric signs are one of the most profitable forms of advertising illumination, and in many localities offer a very good field for the trained man to install or service them.

Sign manufacturers will make almost any type or design of metal sign to the specifications of the customer or electrician. You can also build the smaller ones very easily in your own shop if you desire.

The frame should be of angle iron, and covered with substantial sheet metal to form a box of the desired shape and size. The letters and figures can be painted on, after the sign has had a coat of weather-resisting paint.

A color combination that serves well both for day and night visibility is a dark blue background with white letters. If the sign is to be lighted with bulbs,

cut 1½" round holes in rows along the letter shapes. Two-piece threaded sign receptacles can be screwed tightly into these openings. Then wire up the receptacles, either in parallel or with one common wire and separate wires to a flasher if desired. All connections, including the binding screws on receptacles, should be soldered to prevent corrosion!

Then the connections, backs of receptacles, and all exposed metal edges should be covered with a good coat of weather-proof paint or sealing compound. If the sign is large its circuits should be divided so that none carries over 15 amperes, and each circuit should be fused separately.

In small towns one can often have the local tin-smith or metal shop build the sign bodies, and a sign painter decorate them. In this case the electrician can wire and hang them, and share the profits.

In hanging signs over sidewalks, they should be fastened very securely so there will be no chance of their ever falling and injuring anyone. They should be bolted to a substantial part of the building and braced with chains from above and both sides.

The local authorities should also be consulted on their rulings before any signs are hung over public walk-ways.

### 187. FLOOD LIGHTING

Flood lighting of building exteriors is another interesting branch of advertising illumination. It is a particularly attractive form of display on buildings having light-colored walls and good appearing architecture.

Flood lights on buildings are usually concealed on a ledge or balcony of the building so their rays are directed upward and at the proper angle against the sides of the structure.

They should never be placed in a position where they can shine into the eyes of passers-by.

Fig. 212 shows several styles and sizes of flood light Projectors. Note their weather-proof housings and adjustment feature, to allow them to be "aimed" or pointed at the area to be lighted.

Fig. 213 shows the shape of the concentrated beams thrown by shallow-type reflectors and also those from deeper reflectors which spread the beams over a greater area.

In many cases where it is not convenient or possible to locate flood light projectors on the same building they are to light, they are located on some other building nearby, and perhaps across a street.

For best efficiency, the beams must be able to come from a short distance out from the vertical walls, rather than be directed too nearly parallel with the walls they are to light. Certain effects, however, can be produced by units quite close to the walls or columns to be lighted.

Fig. 214 shows a row of powerful flood lights on the parapet of a skyscraper, and used to light the narrower portion of the building which projects on up from this level.

Beautiful effects can be obtained by properly

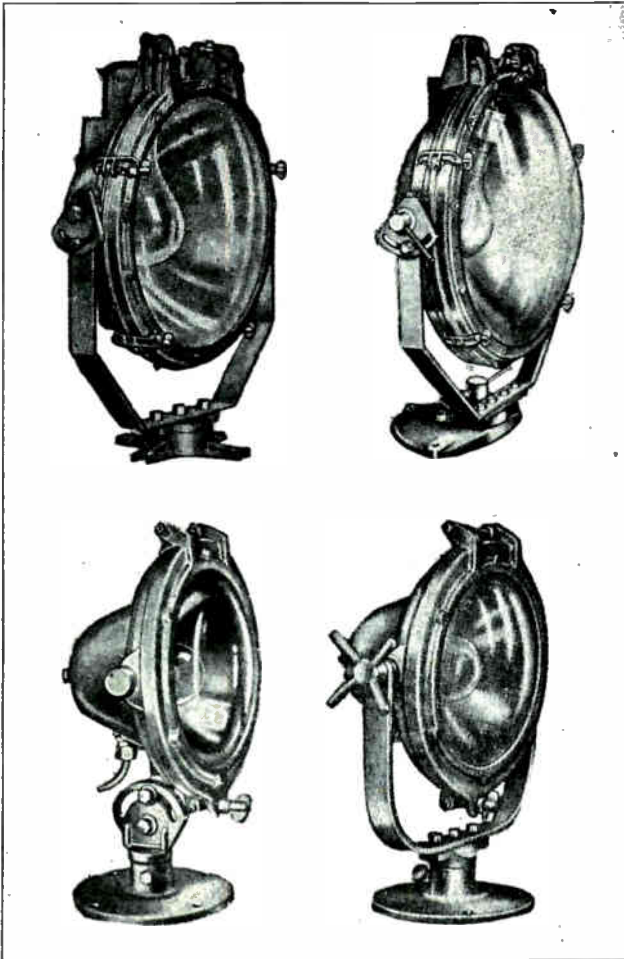

Fig. 212. Several types of flood light projectors. Note the weather-proof construction and adjustment features of these units.

using mixed colors on buildings of striking architecture, and also by use of "dimmer rheostats" automatically operated by small motors in connection with automatic tilting mechanisms, to cause changing and moving colors to play over the building.

The deeper-colored lights such as red and blue are, of course, not as efficient as the white or amber ones, because the color lenses absorb some of the light. The effects obtained with colors, however, are well worth the extra cost.

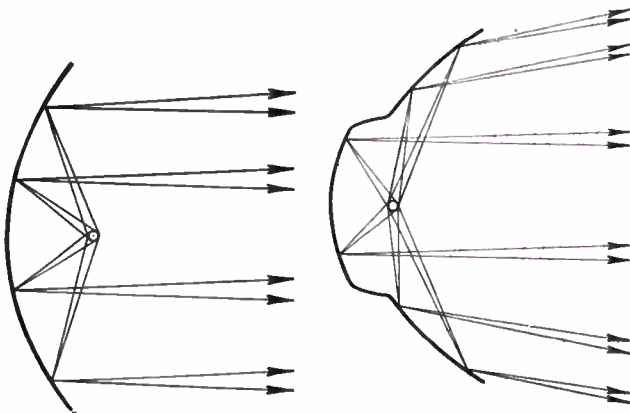

Fig. 213. This diagram shows how reflectors with shallow or deeper curves can be made to concentrate or spread the beams of light as desired.

Fig. 215 shows the effect of flood lighting on the top of a large office building.

Flood lights are also very extensively used for lighting railway yards, race tracks, bathing beaches, and places where construction work is being done at night. In public parks flood lights are often used to illuminate fountains and monuments, with very beautiful results. Fig. 216 shows an illuminated fountain which uses water-proof projectors mounted right in the water. In the background is a beautiful example of flood lighting on a tower.

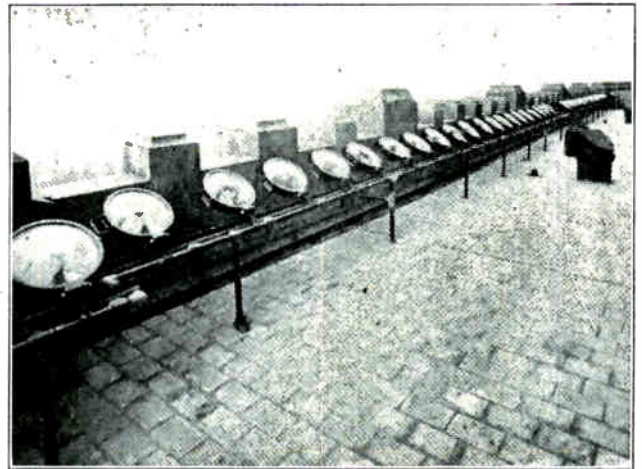

Fig. 214. This photo shows a row of flood light projectors in use on the top of a skyscraper office building. (Photo Courtesy Light Magazine).



Fig. 215. This building is a very good example of the beautiful effects obtainable with modern flood lighting. (Photo Courtesy Light Magazine).

### 188. STREET LIGHTING

Street lighting is becoming so common that many of us fail to notice or appreciate it any more. But when we think of the benefits derived, in the reduction of accidents and increased business on well lighted streets, and that in many of the larger cities great lamps of 1000 to 3000 watts each light the streets nearly as bright at night as in the daytime, we find it is really a wonderful branch of electric illumination. The installation and maintenance of street lighting systems furnish profitable employment to great numbers of trained electrical men,



Fig. 216. The fountain in the foreground is illuminated by flood lights placed within its bowl, and in weather-proof projectors. In the background is shown a well flood-lighted tower.

and in the small and medium-sized towns often provide a worthwhile contract for some alert graduate who can convince the officials of his home town that better street lighting pays.

Arc lamps, which were formerly extensively used, are being rapidly replaced by Mazda lamps, because of their greater simplicity and reliability.

Where arc lamps are still in use, it is a simple matter for the trained man to make any necessary adjustments on their coils and mechanisms which feed the carbons as they burn away, or to locate any trouble on the system.

Incandescent lamps of from 200 to 2500 watts or more are commonly used for new street lighting installations.

### 189. SUSPENSION TYPE UNITS

For overhead lighting systems in small and medium-sized towns, clear lamps of 200 to 500 watts or larger are often placed in simple reflectors of the type shown in the lower left view in Fig. 217. These units are then suspended from overhanging arms on poles, or hung from steel wires stretched across the street between poles or buildings. Reflectors of this type are low in cost, and when mounted at the proper height, provide quite effective lighting. These bare lamps, however, are the cause of a certain amount of undesirable glare and shadows.

Directly above the reflector in Fig. 217 is shown a swivel cross-arm used for hanging such reflectors. The porcelain insulators on the ends of the arm are

for the purpose of attaching the wires of the lamp circuit.

On the right in Fig. 217 is shown a street lighting unit of the medium-priced, enclosed type which is also for overhead suspension. These units soften and diffuse the light and produce more even illumination, with less glare and shadows.

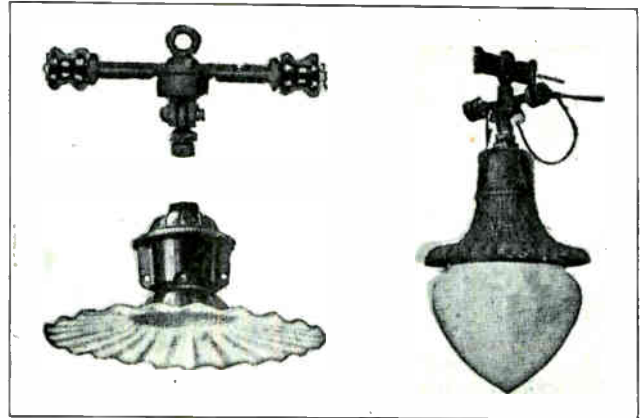

Fig. 217. Above are shown two types of street lighting units and also a swivel cross arm or hanger used in their mounting.

Fig. 218 shows two types of "cutout" or "disconnect" pulleys for use with overhead street lights. These pulleys allow the lamp to be lowered for cleaning, inspection, and repairs. When the lamp is lowered by releasing its supporting chain or rope, it is disconnected from the line by the prongs of the cutout pulley dropping out of their sockets. This makes the lamp safe to work on, and when it is pulled back in place, a guiding device causes the connecting prongs to slip back in their clips as the lamp is drawn up tight in the cutout head.

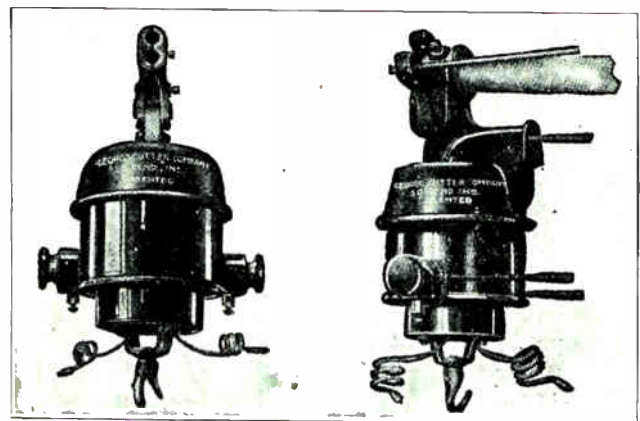

Fig. 218. Cut-out pulleys used for disconnecting and lowering street lights for cleaning and inspection.

### 190. POST TYPE UNITS AND STREET LIGHT CIRCUITS.

Where more elaborate street lighting is desired, enclosed glass units on top of posts at the side of the streets are commonly used. Fig. 219 shows several styles of these units both for single and double lamps.

Street lights are commonly connected in series



on high-voltage circuits, to make possible the use of smaller wires, as the distances between them are considerable. You will remember that when devices are connected in series the current is the same in all parts of the circuit, and that which flows through one device flows through all the others as well. These circuits are often operated on 2300 volts and higher, so the wires must be well insulated, and considerable care should be used in working around such circuits. We can now see the advantage of using cut-out pulleys when working on these lamps.

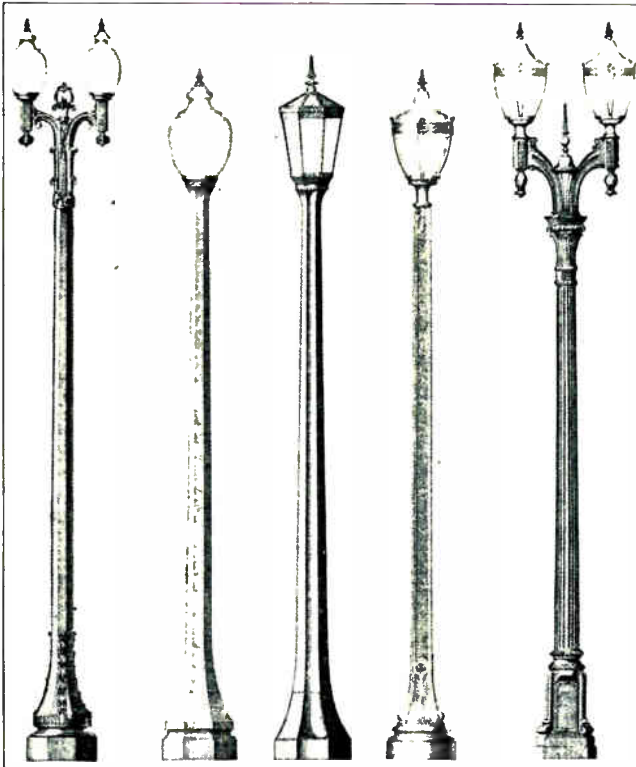

Fig. 219. Hollow concrete or metal posts with large globes, as shown above, are used in many of the better appearing street lighting installations.

### 191. SERIES LAMP "CUTOUTS"

On the older series street-lighting circuits, if one lamp burned out, all lamps on that circuit went out, because they were all in series. Nowadays there are in use special sockets which have short-circuiting springs that cut out the lamp if it opens the circuit. Fig. 220 shows a sectional view of a socket of this type from which the operation of prongs can be easily understood. A thin film or strip of insulating material is placed between the tips of these spring contacts and remains there as long as the lamp is in good condition.

If we have, for example, a circuit of 100 lamps in series and 2300 volts is applied to this circuit, the voltage drop across each lamp when operating will be about 23 volts. This voltage drop we know is proportional to the current flow and to the lamp resistance. This low voltage will send current through the lamp, but will not puncture the insulat-

ing film in parallel with the lamp. However, if a lamp burns out and opens the circuit, all current momentarily stops flowing. With no current flowing there is no voltage drop at any of the lamps, and the full 2300 volts will be applied for an instant across the springs of the lamp which has opened the circuit. This voltage is high enough to puncture the insulating film and burn it out, thus shorting the defective lamp out of the circuit, and allowing the others to operate once more.

Special transformers at the sub-station compensate for the reduced resistance and voltage drop due to the loss of the one lamp. These will be explained later in the section on transformers.

Instead of applying the high voltage of the line circuit directly to the lamps and sockets, many modern series street lighting systems use small transformers at each lamp to reduce the voltage for the filament. All of these transformer primaries are connected in series, as in Fig. 221. This increases the safety and reduces lamp socket insulation costs. It also permits the use of lamps with filaments of larger diameter and lower resistance. They are, therefore, stronger and more rugged and also of higher efficiency.

The current through these low-voltage lamps may be from 6 amperes to 20 amperes, or more on the different sizes; and they are made for voltages from 6.6 to 60.

Wiring for street lights can be run on the poles where suspension type units are used, and underground for better appearance with post type units. Underground wiring can consist of lead covered cable buried in a trench and run up through the hollow poles to the lamps, or of rubber covered wires or lead covered wires in underground ducts of tile or fibre conduit.

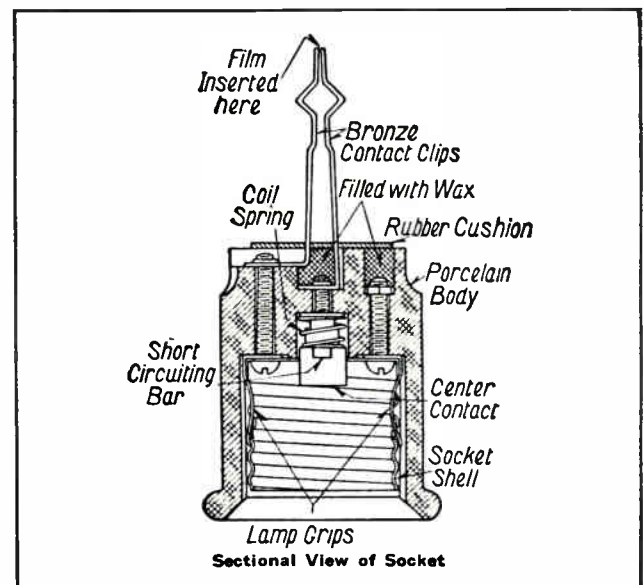

Fig. 220. This sketch shows a sectional view of a socket and "film cut-out" used with series street lamps. Note how these cut-out springs on contact clips short circuit the shell and center terminals of the lamp socket. The insulating film is not shown between the contact clips in this illustration.

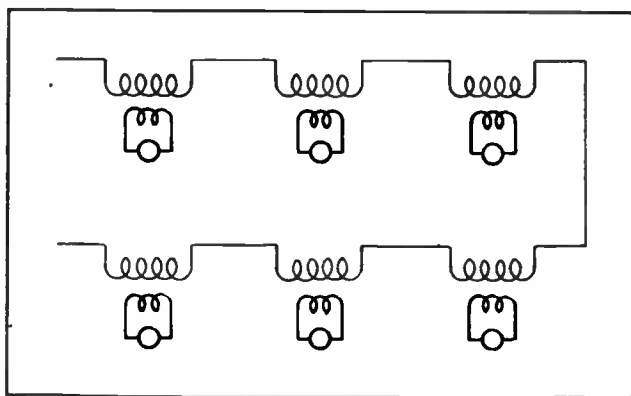

Fig. 221. This diagram shows the manner of connecting series street lighting transformers which are used to reduce the voltage at each light.

## 192. MOTION PICTURE LIGHTING

Electric light is used on a tremendous scale in the motion picture industry, both in the photography and in the operation of projector machines in theatres; and the lighting of the theatres themselves.

In the taking of motion pictures there are used some of the highest foot-candle intensities that are encountered in any branch of illumination. While it was formerly thought that such pictures had to be taken in sunlight, powerful electric lights now reproduce effects of sunlight or daylight in almost any required intensity.

Arc lamps were formerly used very extensively

and still are to some extent, as the color of their light rays is particularly good for exposing the older types of film. However, there has been developed a new type of film that is sensitive to the yellow and white rays of incandescent lamps, and, therefore, these lamps because of their quieter and cleaner operation are rapidly replacing many of the arc units. Mazda lamps require much less attention and adjustment than arc lights, and provide a steadier light. Their quieter operation is a great advantage in their favor for the filming of talking pictures.

The constantly changing lighting requirements on various movie "sets" and the care and maintenance of the lighting units provide a great field of fascinating work for trained electrical men who know practical illumination.

Single lamps of 10,000 watts each and larger are commonly used in motion picture photography, and "banks", or portable units, consisting of 4 to 12 or more lamps are used.

An interesting problem, and one which will help you to realize the size of this equipment, will be to calculate the current that will be required by two banks of six 10,000 watt lights each, and two single 20,000 watt lights if they are operated on a 110-220 volt, three-wire circuit. Also determine the size of cable necessary to carry this current to the lights in a temporary location 150 feet from their generator, with not over 5 volts drop.

# AVIATION LIGHTING

The aviation industry is fast becoming one of the heavy users of modern and efficient electric illumination.

A great deal of night flying as well as daylight flying must be done to maintain fast air-mail and passenger schedules, and the safety of night flying depends on electric illumination in many ways.

Aviation lighting can be divided into the following classes:

- Airport lighting
- Route beacons
- Lights on planes

Many millions of dollars have already been spent in airport lighting, and it is undoubtedly safe to say that within a very few years every town of any size in this country will have a lighted airport.

## 193. AIRPORT LIGHTING EQUIPMENT

A well-lighted airport requires the following equipment:

- Landing field beacon light
- Landing field flood lights
- Boundary lights
- Obstruction lights
- Approach lights
- Illuminated wind-direction indicator
- "Ceiling" projector
- Hangar lights
- Shop lights.

Many of these lights are rated by government standards, and the airports are given ratings by the government according to the type and completeness of lighting equipment used.

#### 194. AIRPORT BEACONS

The purpose of the airport beacon is to direct pilots to the airport. These beacons are rotating or flashing searchlights of 15,000 to 100,000 candlepower, and are usually mounted on a tower or on the top of one of the hangers, so their beams will be unobstructed in all directions. If a flashing light is used, the flashes should not be less than 1/10 of a second in duration, and should be frequent enough to make the light show 10 per cent of the time. Beacon lights for airports or route beacons usually have two bulbs mounted on a hinged socket base, so if one bulb burns out the other is immediately swung into place by a magnet. This is necessary to make these units dependable at all times.

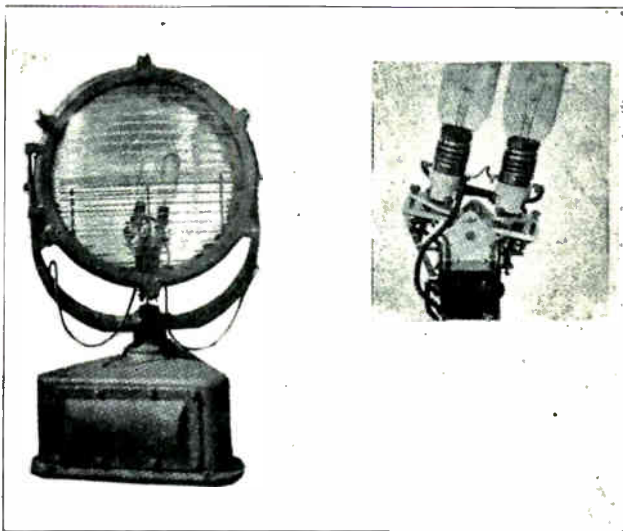

Fig. 222. On the left is shown a typical rotating beacon, such as used at airports and along air routes. On the right is a view of the double lamp mechanism, which swings a new lamp in place if the one in use burns out.

Fig. 222 shows on the left a beacon light unit mounted on the case which contains the revolving motor and mechanism. On the right is shown the double lamp unit which can also be seen inside the light at the left. This light has a 24 inch diameter, and uses a 1000 watt, 115 volt bulb, and develops 2,000,000 beam candlepower. Such a light can be seen by the pilot from a distance of 10 to 35 miles in fair weather, and is a great help in guiding him to the airport.

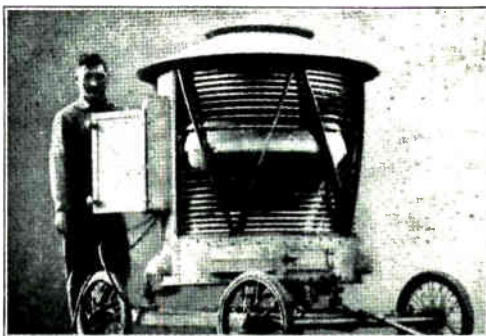

Fig. 223. This large landing field light has a lens similar to those used in lighthouses, and is mounted on a light truck for portable use at airports.

#### 195. LANDING FIELD FLOOD LIGHTS

Landing field flood lights are used to illuminate the surface of the landing field, in order to enable pilots to land their planes safely. In landing a plane it is very important for the pilot to be able to see the ground and judge his distance from it, also to see the length of the field or runways on which he has to bring the plane to a stop.

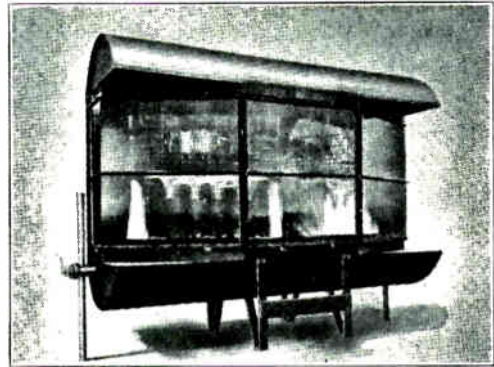

Fig. 224. A landing field lighting unit which has a number of powerful lamps mounted behind the glass front, in a manner to spread their light over a wide area.

Flood lights should also illuminate the field well enough to show up any uneven surfaces. Some fields are lighted by several different flood lights located on opposite sides of the field, while others use a bank or group of lights located near the hangars. Sometimes a large portable light is used, so it can be moved about by hand on a light weight wheeled truck. Fig. 223 shows a unit of this last mentioned type.

Fig. 224 shows a large unit in which a number of lamps are mounted, and you will note that its shape allows the beams from the several lamps to spread over a wide angle in order to cover the entire field from this one light source.

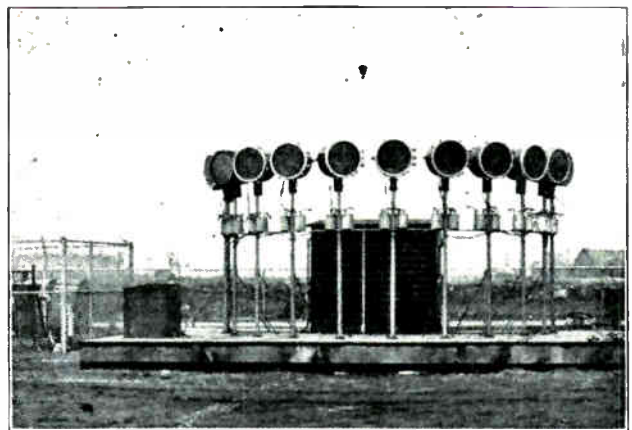

Fig. 225. A number of smaller projectors, arranged as shown, provide very effective distribution of light over the field.

Fig. 225 shows a number of smaller flood lights arranged to throw their separate beams over the field in a wide spread fan shape. Whatever type of flood lights are used, they should light the field uniformly and without harsh shadows, and their color should be such that they do not distort normal



Fig. 226. This photo shows a well-lighted airport at night, and illustrates the great advantage and safety feature of such lighting for night flying.

colors or appearance of objects. They should keep all light in an upward direction at an absolute minimum, to avoid glare in the pilots' eyes. For this reason flood light units are equipped with reflectors and lenses which spread their beams in a wide angle horizontally, but very narrow in the vertical plane.

The vertical beam spread is usually not over 5 or 10 degrees, and the units should be so adjusted that the top edge of this beam does not point above a horizontal line. Flood light units should be kept down close to the ground, preferably within 10 feet. If the top of their beams is higher than this it often makes the ground surface appear closer to the pilot than it really is, when he views it from above the beam.

Fig. 226 shows a well lighted landing field which is illuminated by a 24 KW floodlight. Fig. 227 shows a bank of smaller 3000-watt flood lights in action at night.



Fig. 227. This landing field is lighted with a group of small flood lights such as shown in Fig. 225.

The four lamps on the left in Fig. 228 are some of the types and sizes commonly used in airport flood lights, while the one on the right is of the type used in beacon lights. Note the special construction of the filaments and sockets of the larger

lamps, and the peculiar shaped bulb of the middle one, which keeps the glass farther from the heat of the filament.

Planes should always be landed against the wind, so as the wind changes the pilot must change his direction of approach and landing run. For this reason it is best to have either portable lights, or lights located on two or more sides of the field, so the direction of the light beams can be changed with the wind and avoid making it necessary for the pilot to ever face the beams.

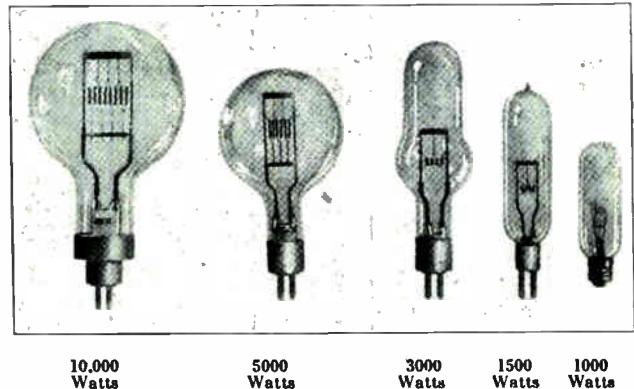

Fig. 228. Here are shown a number of powerful lamps of the type which are used in airport flood lights and beacons.

Fig. 229 shows an excellent layout for permanent flood lights located around the field and remotely controlled by switches in a control room at the hangar. The devices marked "remote controllers" are magnetically operated switches which close the circuits to these large lights, as their current would be too heavy to handle with the push buttons. Note that parkway cable is used to supply high voltage to step-down transformers at each light. This circuit is shown in a "one line" diagram until it reaches the remote control switches, where the two conductors are shown separated.

Parkway cable of this type can be buried under the ground surface 10" or more, and makes a very good system of wiring for airports, where of course no overhead wires should be used.

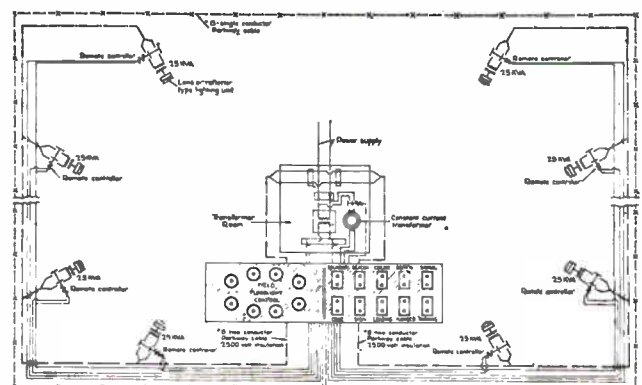

Fig. 229. Wiring diagram for a very practical and efficient airport flood lighting system. The lights are fed by individual transformers, and all remotely controlled from one central point.

## 196. BOUNDARY LIGHTS

Boundary marker lights are used to indicate to the pilot, the location of the edges of the landing field, and are very essential in order to enable him to judge the length of the field and the proper place to approach the ground. These lights are white in color and should be either 25 watt lamps if connected in parallel, or 600 lumen series lamps. They should be spaced from 75 to 125 feet apart for best efficiency, and never more than 300 feet apart. Boundary lights are to be mounted 30 inches above the ground, and the circuits must not have over 5 per cent voltage drop at the farthest points.

Fig. 230 shows three common types of boundary lights. The one in the center is simply a lamp of the proper size enclosed in a weather proof glass globe, and mounted on a special pipe fitting on a 30-inch pipe.

These units on the pipe stems are not very visible in the day time, so it is well to have a circle of whitewashed gravel or crushed rock about 3 ft. in diameter around their bases.

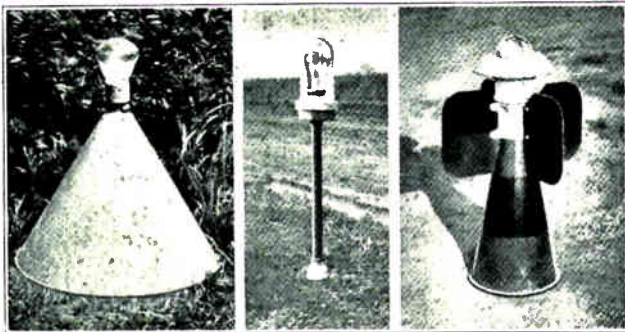

Fig. 230. Several types of boundary lights used for indicating the outline and extent of the landing field at night.

The unit shown at the left in Fig. 230 has a white metal cone base, which makes it very visible. This unit uses a prismatic glass globe which is more efficient than the clear glass, as it directs a stronger beam of the light upward.

Units such as this and also the one on the right in the figure can be merely set on the ground and connected to the circuit by detachable plugs. This makes an added safety feature in case they are struck by a plane, as they will tip over easily without doing so much damage to the plane.

## 197. APPROACH AND OBSTRUCTION LIGHTS

Approach lights are simply certain boundary lights that are equipped with green globes to indicate good points of approach to the runways of a field. They can also be used to indicate wind direction by turning on only those which are on the proper side of the field to bring a plane in against the wind.

Approach lights should have 50 watt parallel lamps or 1000 lumen series lamps, because their green globes absorb more of the light.

Obstruction lights are red and should be placed on tops of all trees, chimneys, water tanks, power or telephone poles or radio towers which are near to the landing fields. They should also have 50 watt parallel or 1000 lumen series lamps, and 100 watt lamps are recommended in some cases.

We have mentioned several times the possible use of either parallel connected lamps or series lamps for airport lights. Both systems are in use.

The series system has the advantages of lower cost of copper wire and less voltage drop, particularly in the longer circuits such as those to boundary lights or flood lights located on far edges of the field.

The parallel system has the advantages of being somewhat safer due to its lower voltage, using lower cost lamps, and being a somewhat simpler system, as it doesn't require sockets with film cut-outs or constant current transformers.

The selection or choice of one system or the other would depend to some extent upon the size or area of the field, the number of lights to be operated, and the distance from the source of current supply.

## 198. ILLUMINATED WIND DIRECTION INDICATORS

It has already been mentioned that planes should be landed against the wind in order to reduce their landing speed. Wind direction indicators are, therefore, used at airports to show an approaching pilot the direction of the wind. These are very necessary, as his own air speed may make it difficult for him to tell the wind direction accurately unless he can see moving clouds or smoke.

A "wind cone" or tapered cloth sack with an opening in the small end is commonly used for a wind direction indicator. In other cases a large wind vane shaped like an arrow or sometimes like a small plane may be used.

These devices should be mounted on a pole or tower, or on the top of hangars in some conspicuous place. To be effective at night as well as during the day, they should be illuminated from above by one large reflector and light, or better still by four reflectors mounted on 2 ft. brackets as shown in the left view in Fig. 231. These reflectors should have 150 watt lamps in them, and a 60 watt red lamp above the unit to serve as an obstruction light.

In some cases wind cones are lighted from the inside by a 200 watt lamp and reflector pointed in their mouth, and free to revolve with the cone as the wind direction changes.

The right hand view in Fig. 231 shows a "wind tee" shaped like a plane, and lighted by rows of bulbs on its wings and body.

## 199. "CEILING" PROJECTORS

The "ceiling" projector light is used to determine the "ceiling" height. This term applies to the height of clouds or fog above the landing field. It is quite important to know this "ceiling" height

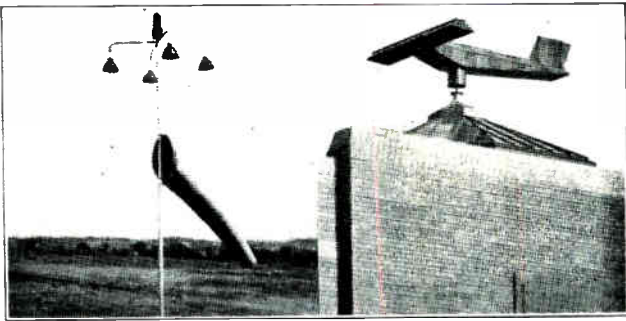

Fig. 231. On the left is shown a wind-cone, with four lights mounted above it, for illuminating the cone at night. On the right is a wind tee made in the shape of a small airplane. This can also be illuminated by rows of lamps on its wings and body.

and be able to report it by radio to aviators approaching from a distance. This gives them an idea of how close they will have to approach the ground in order to see the landing field or its lights.

This information regarding "ceiling" heights can also be transmitted to various other airports along the route, either by telephone or radio, thus keeping the pilot informed of weather conditions at various airports which he may have to use.

For a "ceiling" light a 500-watt, narrow beam projector can be used. If this unit is tilted upward at an angle of 45 degrees with the horizon, then the spot where its beam strikes the under side of clouds or fog will be directly above a spot on the ground, which is the same distance from the light unit as the bright spot on the cloud is above the earth. This can be proven by the fact that the diagonal of a square is at an angle of 45 degrees with either its base or vertical side, and, of course, the base of a square is the same length as its vertical side. See Fig. 232.

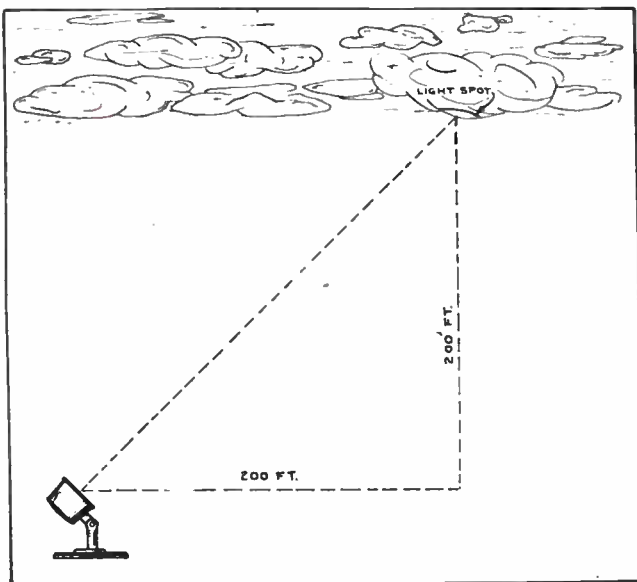

Fig. 232. This diagram illustrates the method of calculating the height of clouds or fog with a ceiling projector.

Other angles can be used, and then with a simple quadrant and pointer set in the same plane as the projected beam, and a definite distance away from

the projector; we can by sighting along the pointer toward the point where the beam strikes the clouds, obtain a direct reading of the "ceiling" height.

## 200. HANGAR AND SHOP LIGHTING

The interior lighting of airport hangars and repair shops is another very important use for electric illumination. In the handling of planes in and out of the hangars, and in making repairs on them, good lighting is a great time saver and promoter of safety.

In the shops where some of the very critical repair and adjustment of engine or plane parts must be made, it is equally important to have efficient illumination. Fig. 233 shows an exterior view of a well-lighted hangar in the upper part of the figure, and an inside view below. Industrial lighting fixtures and principles can be applied to these buildings.



Fig. 233. The top view shows the outside appearance of a well lighted hangar, and below is shown the inside of the hangar and the arrangement of the lighting units.

## 201. AIRWAY LIGHTING OR ROUTE BEACONS

The Federal Government requires airway beacons approximately every ten miles along principal flying routes. These beacons should consist of projectors at least 24 inches in diameter, using 1000-watt lamps and producing 2,000,000 beam candlepower. These units are kept continually revolving at a speed of six revolutions per minute by a small motor and gear mechanism.

In addition to the revolving beacon there should be two "On Course" lights with 18-inch, 500-watt projectors to indicate to the pilot the direction of the next airport. These course lights can be equipped with a mechanism to keep them continuously flashing the number of that particular beacon in the Morse Code. This also indicates to the pilot the distance he has progressed along the course. These lights can be fitted with amber or red cover glasses, while the rotating beacon uses a white beam.

Fig. 234 shows a typical airway beacon on a tower which is also equipped with a "wind-cone". This particular beacon is located at an intermediate landing field. Where beacons of this type are near to power lines they can obtain the energy for their lights from these lines. In other cases they must be equipped with an independent lighting plant similar to farm lighting plant installations. These beacons and plants have to be maintained and inspected by trained men, as their condition and dependable operation are very important. Imagine yourself in the place of a pilot, and the great comfort you would receive from being able to see at least one beacon ahead at all times along your route. These airway beacons are a great safety factor in night flying.

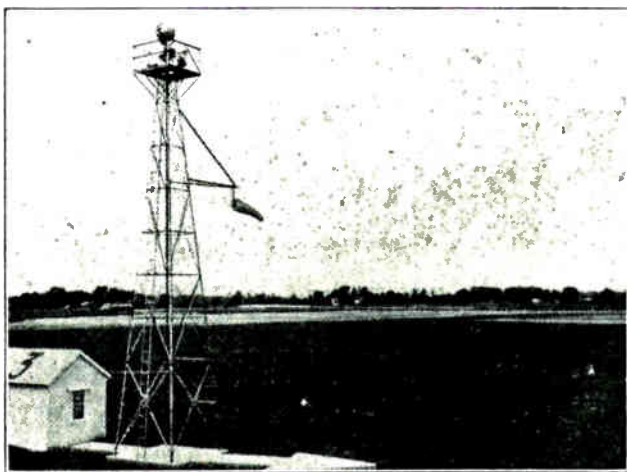

Fig. 234. This photo shows a typical airway beacon mounted on a steel tower, and also provided with a wind-cone for day-light use only.

## 202. AIRPLANE LIGHTS

It may seem rather surprising to talk of lights on airplanes, as probably a great many people don't even realize that planes carry lights. Government regulations require, however, that every plane which flies between sunset and sunrise must be equipped with flying lights, to indicate its position and direction of flight to other pilots.

These lights consist of small automobile-type lamps of 18 or 21 candlepower, mounted in stream-lined pyralin shells. These are mounted on the tip of each wing, and one on the top of the tail or rudder. The left wing light must be red and the right one green, while the tail-light shows clear white. Government specifications can be obtained governing the proper angles between these lights. Airplanes also require lights on the control-board in the pilot's compartment. These lights are usually equipped with a small rheostat so they can be adjusted to just the right brilliancy to show the instruments, and in this manner avoid glare in the pilot's eyes and enable him to see better in the darkness ahead.

Many of the larger planes, or planes intended for night flying, are equipped with powerful landing

lights for use in landing on unlighted fields. These units use a lamp with a concentrated filament which requires about 35 amperes. They are, therefore, kept switched off when the plane is flying, and turned on only when needed for use in making a landing. Otherwise they would place a very heavy drain on the battery.

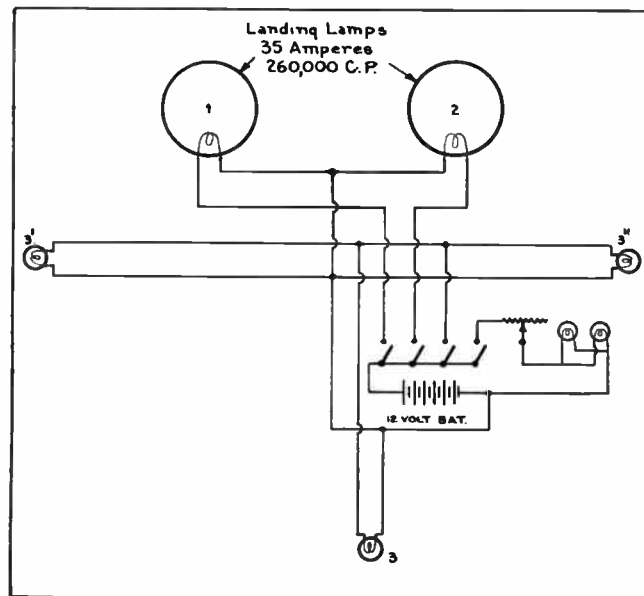

Fig. 235. Simple wiring diagram for lights on an airplane. Trace this circuit and note which lights each of the switches control.

Ordinary flying lights and landing lights can be supplied from a light-weight battery carried aboard the plane. Fig. 235 shows a wiring diagram for the commonly used lights on a plane, and Fig. 236 shows the mounting of wing tip and rudder lights. The upper part of this figure shows the tail-light mounted on top of the plane rudder, in its stream-lined shell. You will note that the front end of this shell is painted black while the rear end, or more sharply tapered end, is clear and allows the light to escape in this direction. The lower left view shows a wing tip

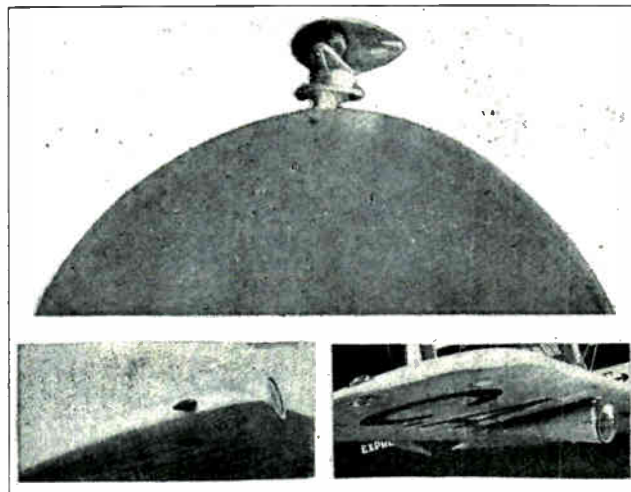

Fig. 236. The top view shows a tail-light mounted on the rudder of an airplane. The two views below show two methods of mounting wing tip lights and landing lights.

light for the right wing, and also a landing light which is built in, or stream-lined, with the forward edge of the wing. The lower right view shows a different form of mounting for the wing light, and also for the landing light, which in this case is hung underneath the wing in a stream-lined shell.

This stream lining is exceedingly important, and every device of an electrical nature or otherwise, that is attached to the outer surface of any airplane, should be stream-lined to prevent air resistance to the forward motion of the plane. The greater part of this resistance occurs at the trailing ends or edges of such devices where violent whirling eddy currents are set up in the air, causing a sort of vacuum at these ends or edges; so you will notice that all of these devices taper most toward their rear ends. This is a very good point to keep in mind when installing any equipment on airplanes.

Fig. 237 shows the interior lighting of a large cabin-type passenger plane. Many of these planes carry lighting of this nature, which not only makes them very attractive in appearance but makes it possible for passengers flying at night to read, play cards, or otherwise occupy their time.

Where large numbers of lights are used in this manner the plane is usually equipped with a wind-driven generator mounted on the outside of the fuselage, or between the wings, in a stream-lined casing and driven by a small wind propeller.

From the foregoing material on aviation lighting, we can see that this is developing into a tremendous field for trained electrical men who have a good

knowledge of the principles of electric wiring and testing, as well as the fundamentals of illumination.

It will be well for every student to keep on the alert for opportunities in this field, and not to overlook the possibility of being the first in his home town to suggest that they provide a well-lighted airport for the general good of the town; and possibly get the job of laying out and installing the equipment.

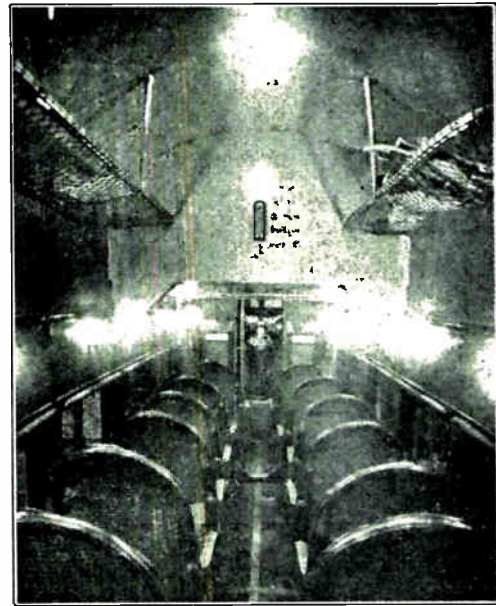

Fig. 237. The insides of large cabin-type planes are often lighted to give many of the same comforts and conveniences as a Pullman coach.

## MERCURY VAPOR LAMPS

A special type of lighting unit, which has become very popular and generally used in industrial plants and large machine-shops, is the Mercury Vapor Lamp.

Its particular advantage lies in the yellow-green color of the light it produces. This light is particularly good for certain machine-shop operations, and the handling and assembling of small bright metal parts, as well as in textile mills.

Lamps of this type are not intended for commercial or home lighting, but only for such special applications as mentioned, and where its peculiar color is not objectionable. Ordinary Mazda lamps produce a light which, as before mentioned, is largely white in color, but also contains a considerable percentage of violet and red rays. These rays are somewhat tiring to the eyes in certain classes of work.

The Mercury Vapor lamp produces light with

a predominance of yellow and green rays and a small percentage of violet and blue. In light of this color small objects, such as screws, pins, bolts, nuts, etc., stand out very sharply. Therefore, the use of this type of lighting unit increases production speed and reduces errors in machine shops, with less eye-strain for employees. Large automobile manufacturing plants have installed many thousands of these units.

### 203. MERCURY VAPOR TUBES

The source of light in a Mercury Vapor lamp is a long glass tube, approximately an inch in diameter and 50 inches long, in which there is sealed a small quantity of mercury. This tube is suspended at a slight angle so the mercury runs down to the lower end, at which there is a bulb equipped with a metal electrode sealed into the glass and in contact with this pool of mercury.



Fig. 238 shows a view of a complete unit with the tube mounted in its trough-shaped reflector. The lamp mechanism, which will be explained later, is in the metal housing above the reflector. The upper end of the tube has two bulb-like horns or extensions on the glass, with a metal electrode sealed into each one. Wires from each end of the tube connect to proper coils in the lamp mechanism and from this to the supply line. Most of the air has been exhausted from the tubes of these lights, leaving them to operate in a vacuum. When they are cold most of the mercury is condensed and run to the pool at the lower end of the tube, so it is necessary to use a spark or impulse of rather high voltage to vaporize a small amount of the mercury.

We should understand that a high voltage spark will pass through a much greater distance in an ordinary vacuum than through open air, so by applying about 2000 volts from an induction coil in the lamp mechanism, we can start an arc through the tube.

As soon as a little mercury vapor is built up it forms of soft green arc or light throughout the full length of the tube. Thus the name Mercury Vapor Arc.

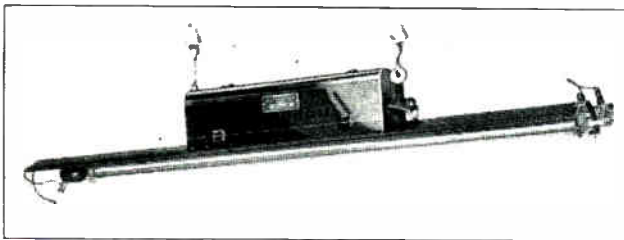

Fig. 238. This view shows a complete mercury vapor lamp. Note the mounting of the tube under the long reflector, and the manner in which the lamp is hung at a slight angle.

As long as the lamp is operated this arc continues to agitate the surface of the mercury pool and create sufficient vapor to keep it going. After the vapor forms and the arc is established, the resistance of the lamp tube is low enough so the arc can be maintained with from 70 to 100 volts, and about 3.8 amperes on the common sized lamp. The total wattage rating of the lamp is about 450 watts, part of which is used up in the resistors and coils. The voltage from the lamp coils is about 120 to 130 volts, but not all of this is applied to the tube.

The source of light from these units, being spread over such a long tube, distributes the light softly and evenly with very little glare and shadow effects, which is one of their decided advantages.

The average life of the tubes is two years or more if they are properly cared for, but they should be very carefully handled as it is easy to crack them and allow air to leak in if the tubes are strained or bumped. For this reason they are protected by long metal bars running full length of the tube and attached to the ends of the reflector.

## 204. LAMP MECHANISM

Fig. 239 shows a top view of the lamp mechanism and coils. This consists of a pair of resistance units at the left end, and next to these are the coils of an auto transformer which raises the line voltage, and has taps brought out to terminals to obtain the proper voltage adjustment for the operation of the tube. The pair of coils at the right of the center are those of an induction coil which generates the high voltage for the starting spark to ignite the tube

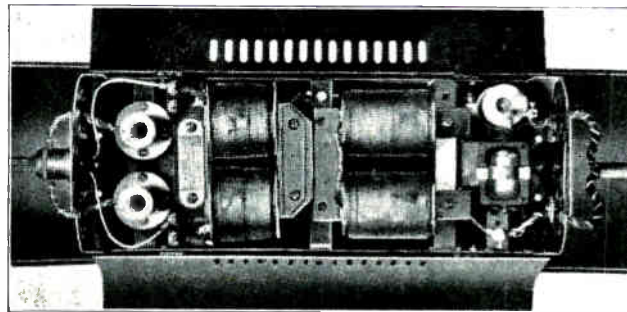

Fig. 239. Above is shown the mechanism and coils of a mercury vapor lamp. Also note the mercury shifter switch at the extreme right end.

or start the lamp. Just to the right of these coils is a small mercury switch in a glass tube. This switch is mounted on a pivot so when the coils are energized and the ends of their cores become magnetized they attract a small iron plate on the mercury switch, tilting it up and causing a "V" shaped depression in the glass to separate the pool of mercury and break the circuit.

When this circuit is broken and the flux around the induction coils is allowed to collapse, it induces a high voltage of about 2000 volts in these coils. There is also an added resistance unit just above this tilting or "shifter" switch in this view.

## 205. LAMP CIRCUIT AND OPERATION

Fig. 240 shows a simplified wiring diagram for an A. C. mercury vapor light. Examine this diagram carefully and note the connections and circuits through the various coils and the tube.

We know that alternating current is constantly reversing in direction, but let's assume for the moment that the current is entering at the lower line wire as shown by the small arrows. We can trace this flow of current through the lower half of the auto transformer—A.T., then through both windings of the induction coil—I.C., through the mercury switch—M.S., and protective resistance—R3; then back to the upper line wire.

This flow of current energizes the induction coils and magnetizes their cores. This magnetism attracts the metal plate or armature on the mercury switch, causing it to tilt and break the circuit we have just traced.

When this current stops and the flux around the induction coils collapses, it induces the high voltage previously mentioned, and this is applied to the ends of the lamp tube as shown by the dotted arrows.

We also find that this high voltage is applied across the two terminals at the lower end of the tube. One of these wires we know is connected to the electrode in contact with the mercury, and the other one is connected to a thin metal starting band which is clamped around the stem of the tube, and also attaches to a strip of metal foil which is pasted to the under side of the bulb.

The high voltage across these two points sets up a capacity charge through the glass to the mercury, exciting the surface of the mercury and emitting the first mercury vapor. As soon as this vapor is started, the high voltage across the ends of the tube establishes the arc. After the arc is started the line current will flow alternately through resistance R1 and R2, and into the two horns or electrodes at the upper end of the tube, as shown by the large arrows, down through the tube and back through both windings of the induction coil, to the center tap of the auto transformer. From here it returns to either line wire, according to the polarity of the A.C. line at that instant.

The auto transformer A.T. serves to increase the voltage of the tube slightly above the 110 volts on the line.

You will note that the current flows through the tube in only one direction, so we find that this tube also acts as a rectifier as well as a source of light. In other words, current can flow from the metal electrodes at the top of the tube, into the mercury vapor, but it cannot flow from the vapor back into these electrodes, because of the high resistance film built up at their surfaces the instant the reverse current attempts to flow. This principle will be more fully explained in a later section.

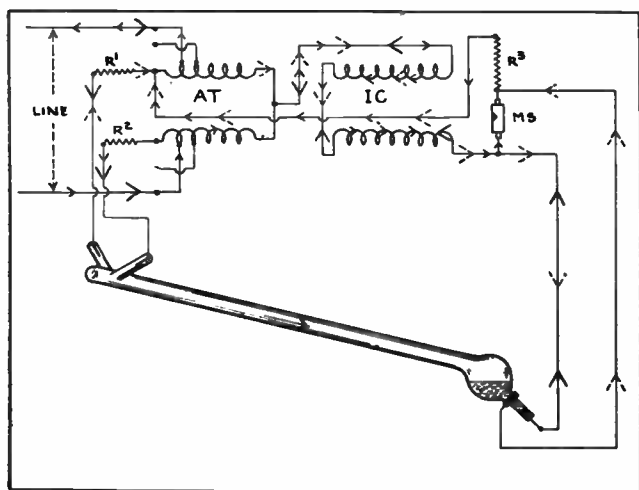

Fig. 246. Wiring diagram of a mercury vapor lamp, showing the various circuits traced through the tube and coils.

These mercury vapor lights are also made to operate on direct current, and those for D.C. operation have no transformer, but merely the pair of induction coils and mercury switch in addition to the tube; so their circuit is much simpler than the one we have just traced.

## 206. INSTALLATION

When installing lighting units of this type they should be suspended by two pieces of chain or strong rope, and hung with the tube at the proper angle; or otherwise they will not operate satisfactorily. This angle can easily be determined by leveling the tops of the hooks provided with the unit, as these hooks are made in uneven lengths to obtain the proper slope for the tube. The upper end of the reflector should be about 8 inches higher than the lower end when the mounting is finished.

The next step is to insert the shifter switch in its mounting and connect its terminals to the binding post provided. This shifter when mounted, should rotate freely, and it should not be possible for it to slip to either side far enough so that the metal armature can touch either of the iron cores of the induction coils. Next, the tube should be unpacked and washed clean before mounting. Remember to handle these tubes very carefully to avoid cracking them. To test new tubes before placing them in the lamp, or for testing old tubes that are thought to be defective, the condition of the vacuum can be determined by the sound of the mercury in the tube when it is allowed to run slowly from one end to the other. Tilt the tube up so the mercury runs slowly down to the opposite end, and if it produces sharp-sounding metallic clicks like shot rolling in the tube, this indicates that the vacuum is good. If the mercury slides to the bottom end of the tube without producing these clicks it is an indication that the tube has leaked air and the vacuum is destroyed.

The end with the two horns should be at the higher end of the reflector. Place the tube in the holding clamps and tighten them securely, but not too tight, or the glass may be cracked when heated. It should be possible to rotate the tube with the fingers after the clamps have been fastened. Be sure that the single negative terminal points straight down from the black bulb. Observe the mercury to see that it covers the metal contact which is sealed in the glass at this terminal. If these lamps are operated without sufficient mercury in the bottom end the tube may be ruined.

After the tube is installed, it is a very simple matter to connect its terminals to the wires provided on the lamp unit and reflector.

## 207. OPERATING VOLTAGE

The tubes are rather critical as to their operating voltage, and if the line voltage is considerably lower than normal because of voltage drop, the lamps may not start promptly. In this case, when they are turned on the mercury switch may keep operating and clicking repeatedly, without starting the lamp. When this happens the voltage at the line terminals should be tested with a volt meter, and if it is found too low the connections can be shifted to the inner taps shown on the auto transformer coils. This will enable the transformer to raise the voltage on the tube.

These terminals are usually marked for the different voltages, so it is easy to tell where to connect the line wires. When these lamps are connected on circuits from 95 to 125 volts, wires not smaller than No. 12 should be used, and each circuit for a single lamp should be fused for 15 amperes.

For each additional lamp placed on any branch circuit, the fuse should be increased by 10 amperes per lamp.

## 208. CARE AND MAINTENANCE

If mercury vapor lamps are installed in cold rooms they may be somewhat slow in starting and also give less than normal candlepower. In such cases it may also be necessary to change the line connections to apply higher voltage to the tube; or even to increase the line voltage somewhat.

The resistance units used with these lamps occasionally burn out but they can be very easily replaced, as they are screwed into standard sockets on the unit, the same as a lamp or plug fuse would be.

In maintaining a group of these lamps it is very important to keep the tubes clean by washing them occasionally with soap and water, and also to keep the negative terminal and starting band free from dust and dirt. An accumulation of dirt around the starting band will often allow the high voltage starting current to flash over at this terminal and cause the lamp to fail to start.

If a lamp fails to start after several operations of the shifter switch it should be turned off until the trouble is located, so that this switch will not be damaged by continuous operation. Failure to start is usually due to one of the following causes: low line voltage, very cold tube, blown fuses, burned out resistance unit, stuck or broken shifter switch, loose connection, cracked tube, or dirt accumulated at the starting band on the negative terminal. Checking each of these items systematically will usually locate the trouble.

The transformer or induction coils can easily be tested for open circuits, shorts, or grounds, as explained in previous sections.

Be very careful not to connect an A.C. lamp on a D.C. circuit, or a 60 cycle A.C. lamp on a 25 cycle circuit, or it will be burned out.

Extra tubes and resistance units can be obtained from the lamp manufacturers and kept on hand for convenient and prompt repairs.

The extensive use of this type of lamp in manufacturing plants will make this material very valuable for any maintenance electrician to know, and have on hand for future reference.

## 209. HIGH INTENSITY MERCURY VAPOR LAMPS

A recent developed mercury vapor lamp known as the high intensity mercury vapor lamp, is shown in Fig. 241. This lamp produces a bluish white light which is excellent for machine shop or other industrial operations where metal parts are to be handled.

This lamp has a very high efficiency, of about 40 lumens per watt, as compared with 15 to 18 lumens per watt for ordinary incandescent lamps. These lamps are made in 250 and 400 watt sizes.

The larger size is constructed with two bulbs, one within the other as shown in Fig. 241. The inner bulb contains mercury vapor, and a small amount of argon gas, two main operating or arc electrodes, A and B, and one auxiliary starting electrode C.

An evacuated space between the inner and outer bulbs helps to retain enough heat for best operation of the lamp.

These lamps start on about 5 amperes at 20 volts, and after heated up, they operate on about 2.9 amperes at 150 volts. These special voltages are supplied by individual auto transformer or reactor units used with each lamp. This permits operation of the lamps on regular 110 or 220 volt A. C. circuits.

When these lamps are first turned on they produce a faint blue glow from a small arc started between electrodes A and C. After a warm up period about 10 or 12 minutes, the main arc forms between electrodes A and B, producing very intense blue-white light. The larger sized lamps of this type must be operated in a vertical position to prevent the arc from bowing and melting the glass bulb.

## 210. SODIUM VAPOR LAMPS

One of the newer types of lamps which is coming into use for highway and street lighting, uses sodium vapor in which an arc is set up by means of special electrodes connected to an individual transformer for each lamp.

The sodium vapor and electrodes, as well as the starting filaments are located within a sealed inner glass bulb. (See Fig. 242.) An outer sealed bulb maintains an evacuated space or "vacuum envelope" around the inner bulb, to help retain the heat required for these lamps to operate at best efficiency.

The filaments in each end of the bulb are used to heat the vapor and throw off electrode to start the lamp, after which an arc is maintained between the anodes in opposite ends of the tube. A small amount of neon gas is included in these lamps to aid in starting the arc.

The lamps produce a light of yellow color which is very good for clear vision on highways and streets. The efficiency of these sodium lamps is about 45 lumens per watt, or almost 3 times as high as that of ordinary incandescent lamps.

They operate on from 2 to 28 volts and 5 to 10 amperes. The special voltages required for the filaments and electrodes are supplied by separate windings of a special small transformer for each lamp as shown in Fig. 242.



Fig. 241

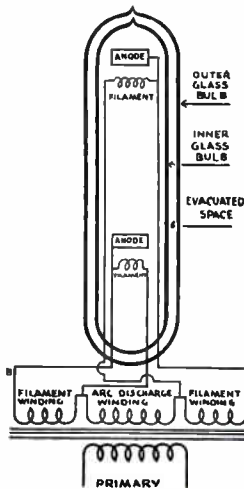

Fig. 242

## HOME LIGHTING

With all the vast number of homes in this country that are wired for electricity, there are still hundreds of thousands of old houses to be wired, as well as the many thousands of new ones that are built yearly.

Another very important fact to consider, from the standpoint of opportunities for the trained electrical man, is that actually a majority of the homes that have been wired a few years do not have efficient or adequate lighting. This is partly because the old style fixtures installed years ago were not made very efficient, and partly because it used to be the opinion that home-lighting fixtures should be chosen for beauty and appearance, rather than for lighting efficiency.

This idea is out-of-date, and the most important essential in modern home-lighting is first to see that the wiring and fixtures are planned and chosen to give adequate light of the right quality; and second, to give proper attention to the appearance and artistic features.

We should keep well in mind that good fixtures are now made to provide ample and proper lighting, as well as pleasing appearance and decorative effects.

Properly designed lighting is one of the greatest comforts and conveniences that any home owner can enjoy, and in building new homes or remodeling old ones, the lighting should be considered equally as important as many pieces of the furniture, and as one of the most important features of the decorations.

Home lighting does not require any elaborate calculations, but the illumination for practically any room can be easily planned by application of the simple fundamentals of illumination, and the general rules on the following pages. Furthermore, the great number of homes which really require improved lighting and more modern fixtures, offer splendid opportunities right in his own neighborhood, to practically every graduate who wishes to take advantage of them.

### 211. LIVING ROOM LIGHTING

The living room is, of course, one of the most important rooms to have well lighted, as in the average home this room is the one in which the members of the family spend much of their time, and also one that we wish to have most attractive when guests are present.

Proper lighting units for the living room are the ceiling shower or cluster, wall bracket lights, and portable floor or table lamps. The ceiling fixtures are often called chandeliers or by the more modern name Luminaire. No one of these types of lights is alone sufficient for a well-lighted living room, but two or all three of them should be combined to obtain the varied or complete lighting effects desirable.

### 212. CHOICE OF CEILING, WALL, OR PORTABLE UNITS

The ceiling fixture for the average sized living room should consist of four or more lamps of 40 watts each or larger, and they should be equipped with glass shades to soften the light and prevent glare.



Fig. 243. This photo shows a living room lighted only by the ceiling fixture. There is plenty of light in the center of the room, but you will note the room appears very plain.

The purpose of the ceiling fixture is to provide general light throughout the room, and it should provide sufficient light to give the room a bright and cheerful appearance.

Ceiling fixtures should, of course, be chosen of a design and color to harmonize with the room furnishings and decorations, and they can be hung either quite close to the ceiling in low rooms, or suspended down farther in higher rooms.

Usually they will shed a more even light on the ceil-



Fig. 244. The same living room as shown above lighted only with portable lamps, for reading directly under these lamps.

ing if they are down from 18 to 30 inches from it. The bottom of the fixture should be at least 6 ft. 6 in. or more from the floor; and preferably 7 ft. or more, even if it is necessary to use a very short fixture close to the ceiling.

Fig. 243 shows a living room lighted by a ceiling fixture only, and while the room is fairly well lighted, the general appearance is plain and drab and the light is centered too much above and below the fixture.

Portable floor and bridge lamps, as well as table lamps, are very good for local spots of light and for reading in a chair directly beneath them without lighting the rest of the room. They also add a great deal to the decorative appearance, with their local spots of light and their colored shades.

There is in many homes, however, a wrong tendency, to depend on portable lamps almost entirely for living room light. Portable lamps are not intended for this, and do not give sufficient general illumination for many occasions.

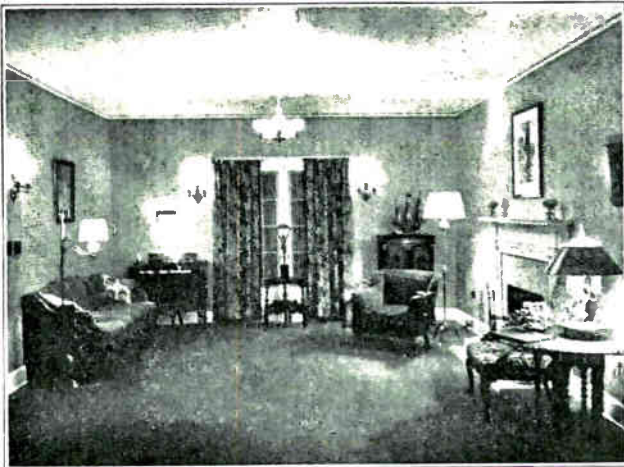

Fig. 245. Here we have the same room lighted by the ceiling unit, wall lights, and portable lamps. Compare carefully the different effects in the three photographs on this page.

Fig. 244 shows a room using only the portable lamps, and while the effect is restful and fine for a quiet evening alone with a book, it would not do at all for a room full of company, with card games or social gatherings.

Floor lamps with open tops, and in some cases extra lamps and reflectors to direct light to the ceiling, are very useful and beautiful in their effects.

Fig. 245 shows a room well lighted by the ceiling luminaire and portable lamps, and with the walls "livened up" by wall bracket lights. A combination of lighting units of this kind provides wonderful decorative possibilities and comfort, by the use of all or certain ones of the lights at proper times.

Novelty table lamps, concealed cove lights, and artificial electric windows, can also be added to produce beautiful effects and increased attractiveness of the living room. Some of these are shown in Fig. 246.

Sun parlors or porches should also be well equipped with outlets for floor and table lamps; and ceiling fixtures of a type that give a soft light are desirable.

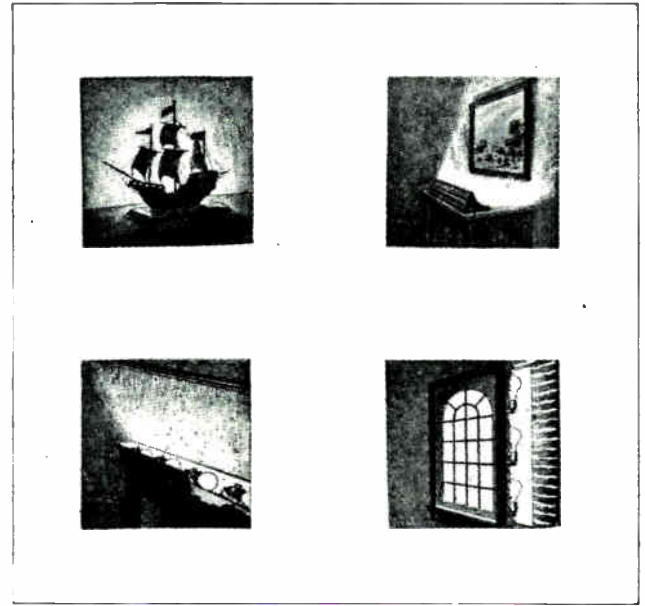

Fig. 246. These four views illustrate some of the effects obtainable with lights placed behind decorative objects, concealed coves, and artificial windows.

### 213. DINING ROOM FIXTURES

In the dining room we should have a flood of soft white light on the table, and sufficient light on the walls and ceiling to prevent them from appearing dark and depressing. There should also be a reasonable amount of light on the faces of the diners. Here we can use a good-looking ceiling fixture with four or more shaded lamps of about 50 watts each or larger. This fixture should be hung low enough to center its light well on the table, and yet not low enough to shed too much light in the eyes of persons seated at the table. About 30" to 36" above the table is generally a good height.

Buffet lights add to the appearance, and provide part of the extra light needed for the walls. A very well-lighted dining room is shown in Fig. 247.

Beautiful effects in dining room lighting can also be

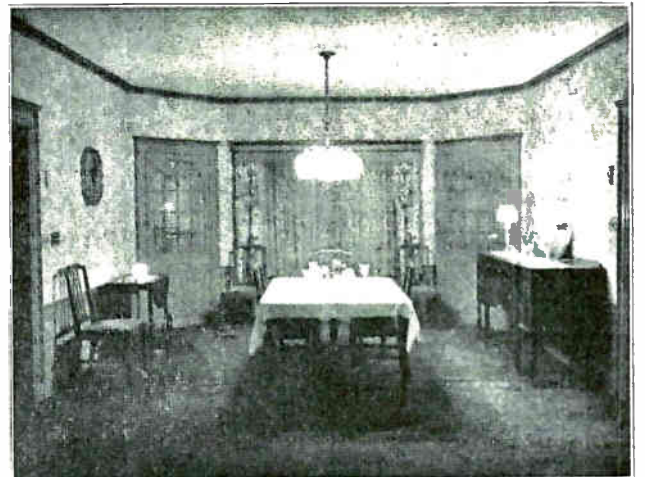

Fig. 247. The above dining room photo shows the manner in which the light should be principally centered on the table, and yet should light the walls and ceiling sufficiently to prevent a dark appearance in the room.

obtained with a semi-indirect ceiling fixture and wall lights of the types shown in Fig. 248.

Semi-indirect ceiling luminaires of this type shed soft white light on the table to make the dishes, food, and silverware show up to excellent advantage; and they also direct sufficient light on the ceiling to give a cheerful and well-lighted appearance to the room.

The inverted bowl wall lights of the type shown in Fig. 248, add the small fountains, or touches of light on the walls, which just complete the good appearance of this room.

Fig. 249 shows a number of popular fixtures which are both efficient and beautiful in appearance. These units deliver a sufficient quantity of well diffused light, and add to the comfort, appearance, and actual value of a home enough to be worth many times their cost.

The semi-indirect unit in the upper right corner of Fig. 249 is typically a dining room fixture, and the one in the center of the top row is particularly good for use in low living rooms. The others are typical living room fixtures.

Fig. 250 shows several styles of fixtures for dining room lighting.

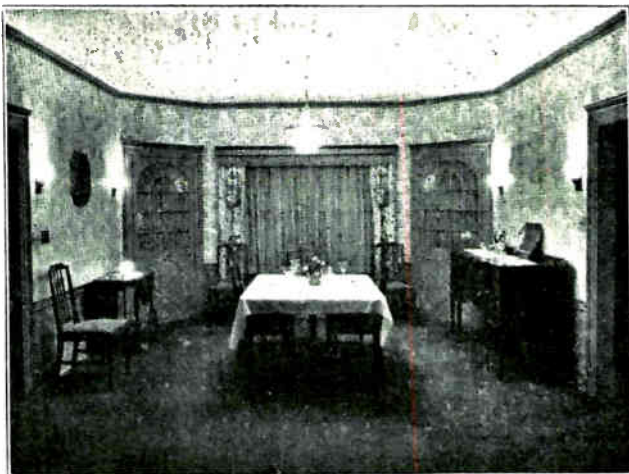

Fig. 248. A combination of a semi-indirect ceiling fixture with shaded wall lights of the type shown, produces a very beautiful lighting effect.

### 214. BEDROOM LIGHTING

Bedrooms should also be well lighted with soft light that is not tiring to the eyes of one lying in bed. Ceiling units of the types shown in Fig. 251 and mounted close to the ceiling are very good.

It is very important to have sufficient light at dressing tables and on mirrors; and wall bracket lights or attachable brackets for clamping on each side of the mirrors should be provided.

Portable lamps on small tables by the beds, or clamp lights to mount on the heads of beds are ideal for reading lights.

Plenty of convenience outlets should be provided around the walls of bedrooms, for the attachment plugs of portable lamps, curling irons, fans, etc.

A switch controlling one of the lights in the room should be located near enough to the bed to be within easy reach of a person either in bed or right at its edge.

The clamp lights on the head of the bed will accomplish this, or in some cases a small light is mounted under the bed with a switch at the head of the bed. These lights will shed sufficient light on the floor to enable one to move about the room easily, and yet they do not throw light in the faces of other sleepers. Fig 251-A shows a well lighted bedroom.

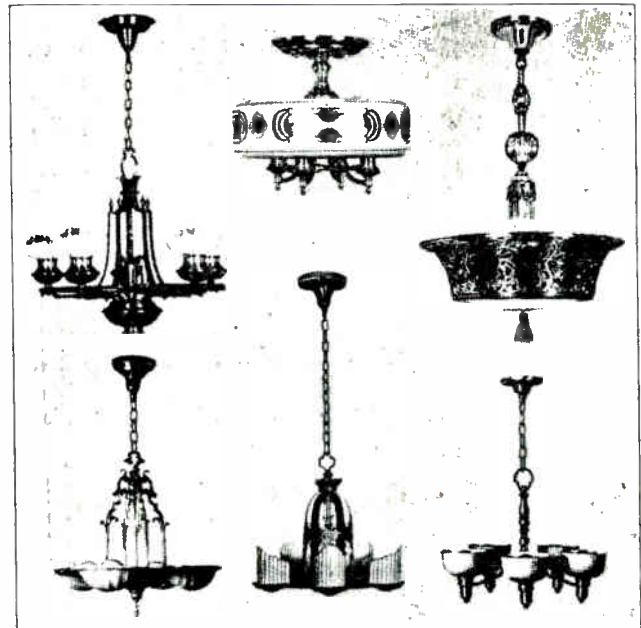

Fig. 249. Several very efficient and popular types of dining room and living room fixtures.

### 215. KITCHEN UNITS

The kitchen is one of the simplest rooms in a house to properly illuminate, and yet it should always receive careful attention, because it is the one in which the housewife spends a great deal of her time.

A low hanging fixture should never be used in a kitchen, but instead a short unit which is high up and close to the ceiling should be used. It should be of the enclosed type with a dense white glass

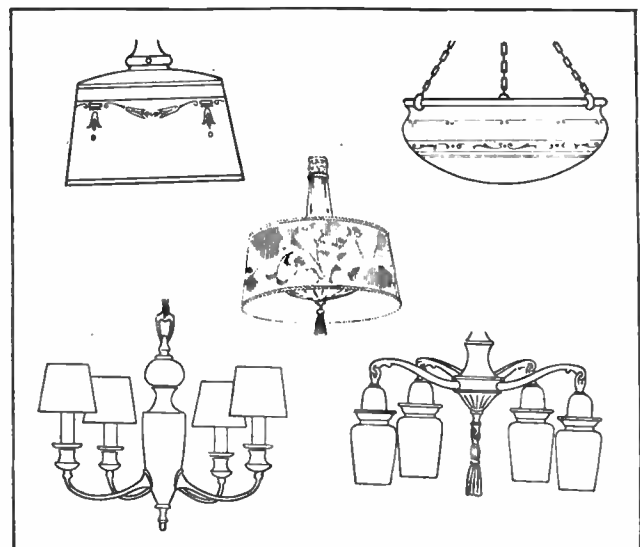

Fig. 250. Units of the above type are very appropriate for dining room lighting.

bowl, and equipped with at least a 100-watt lamp. Such a unit will provide well diffused light of good intensity throughout the ordinary kitchen. In

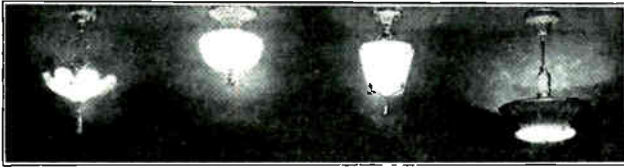

Fig. 251. Several types of bed room fixtures which are mounted close to the ceiling and produce soft, well-diffused light.

addition to this overhead unit, it is usually well to have a wall bracket light with a white glass shade mounted over the sink, and possibly one over the range. Fig. 252 shows how cheerful a kitchen can be made with proper lighting and light colored walls and ceiling.



Fig. 251-A. This photo shows a well lighted bedroom, using the dome light in the ceiling and portable lights on the dresser and table.

The left view in Fig. 253 shows more clearly, the shape of the kitchen unit and wall light and on the right is shown a very good unit of the porcelain enameled, metal dome type, to be used in the laundry room in basements.

Lighting units of this type are so low in cost compared to their value in the home, that it is often very easy to sell the home owner modern kitchen and laundry lighting equipment and get the job of replacing his old ones with the new.

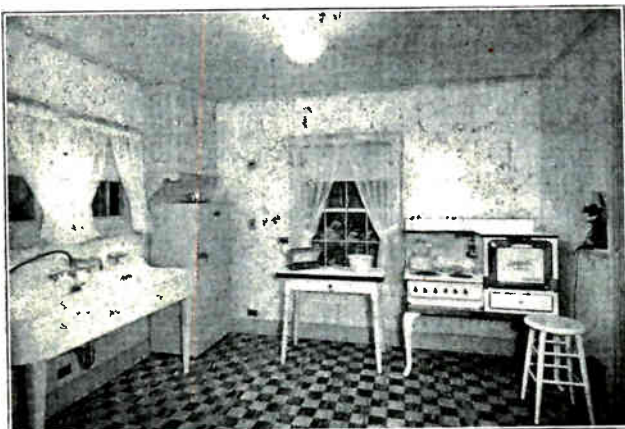

Fig. 252. A well lighted kitchen, such as shown above, is one of the greatest conveniences in any home.

Clothes closets should be equipped with a wall bracket light over the door, and enough to one side so if a pull-cord switch is used the cord will not hang directly in the doorway. A wall switch at the door or just inside may also be used.



Fig. 253. At the left is shown the arrangement of ceiling unit and wall bracket light for kitchen. On the right, a very efficient type of reflector for laundry rooms and basement lighting.

## 216. BATH ROOM LIGHTS

Bath rooms should have two wall bracket lights above the wash stand, one on each side of the mirror. Another above the mirror is also very convenient for general light in the room and for combing one's hair. Bath room lights can be controlled by key sockets or pull chain sockets on the bracket lights at the mirror or by wall switches for lights out of reach. If chain sockets are used on non-polarized wiring systems, insulator links should be put in the chains to reduce chances of persons obtaining shocks by touching the chain when one hand is on a faucet.

The mirror lights should be low enough to well illuminate one's face and the under side of the chin for shaving, and should use 50-watt inside frosted bulbs.

Large dark colored bath rooms may also require a ceiling light.

## 217. PORCHES, ATTICS, BASEMENTS, AND GARAGES

Porches and entrances can be made safer and much better appearing at night, by the use of ceiling lights of lantern design on the porch, or bracket lights of suitable weather proof type at each side of doors.

Attics and basements should be lighted with drop-cord lights or other low cost units, and in sufficient number to enable one to work conveniently in any part of them. Where basements are used for children's play rooms ceiling fixtures similar to kitchen units can be used, and controlled by pull-cords or wall switches.

Garages should not be forgotten, and the light should be controlled by three-way switches both from the house and garage as previously explained. One or more attachment plug receptacles should also be provided, to permit the use of portable trouble lights or vacuum cleaners around the car. Fig. 254 shows a number of the various types and sizes of Mazda lamps commonly used in home lighting.

In wiring any home for lights remember to install plenty of convenience outlets in all rooms, and three-way or four-way switches where they will add to the convenience in controlling the lights.

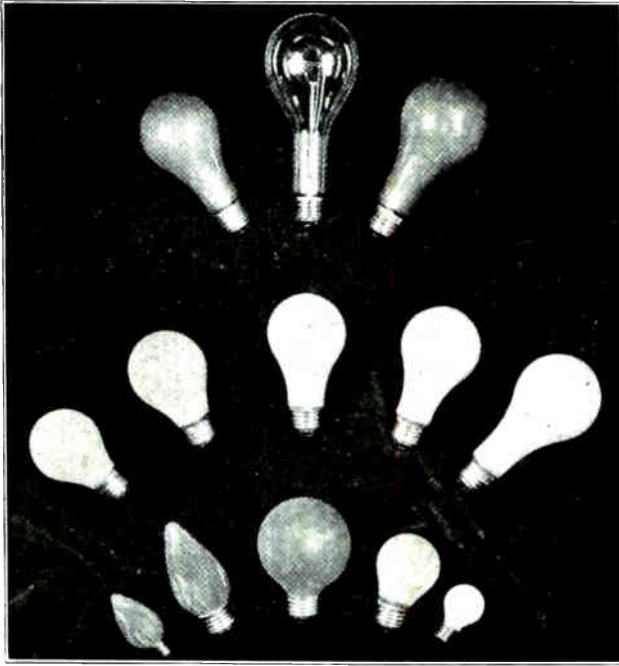

Fig. 254. Above are shown a number of modern Mazda lamps of the types commonly used in home lighting.

**218. QUALITY WORK PAYS**

Always recommend lighting equipment that will be a permanent satisfaction to your customer as well as a credit to yourself. The home owner's pride in the appearance of his home, and his concern for the comfort, convenience and safety of his wife and children, are points that should not be forgotten in selling good lighting.

In completing this simplified practical material on illumination you can readily see that it is one

of the greatest fields of opportunity for profitable and interesting work that the electrical industry offers to the trained man. We are certain that whether you choose to specialize in this line of work, either as an employee of a contractor or fixture dealer, or in business for yourself, you will find the material covered in this section of great value to you. No matter what line of electrical work



Fig. 255. Sectional view of new type student or reading lamps, showing diffusing bowl, shade and stand.



Fig. 256A. Note the contrast in these two photos. The new I. E. S. lamp on the right provides more adequate light with much less shadow and glare, and greatly reduces eye strain and fatigue.



you may follow, a practical knowledge of these principles of good illumination will prove handy to you many times in the coming years.

### 219. I. E. S. STUDENT LAMPS

A very excellent and efficient new type of lamp for reading, student's use, or office desk work is called the I. E. S. (Illumination Engineering Society) student lamp. This lamp has been carefully designed to meet best lighting standards, and to provide ample lighting intensity with a minimum of glare and shadow.

A view of this lamp is shown in Fig. 255. The exact diameter of the shade and its height from the table have been carefully determined. The color and reflecting quality of the shade material are also important. The dense opal glass inverted bowl

on which the shade rests is also an important feature in the efficient operation of this lamp. This bowl softly diffuses the downward light and blends the bowl brilliancy nicely with the light from the reflecting surface of the shade. The bowl also permits enough light to go up to the ceiling to provide some general illumination in the room and thus avoid sharp contrasts.

A very interesting feature of one model of this I. E. S. lamp is that it is equipped with a special 3-light bulb to permit control of the amount of light for various purposes. These lamps are made in 50-100-150 watt, and also 100-200-300 watt size. They have two filaments controlled by an electrolier switch in the lamp. On the smaller size one filament is of 50 watts and one of 100 watts. Either of these can be operated separately. Another position of the switch puts both filaments in operation in parallel, using 150 watts.

## FLUORESCENT LAMPS

One of the newer types of lighting units is the fluorescent lamp. Fluorescent lamps have recently been installed by the thousands in industrial plants, offices, stores and homes. They are much more efficient than incandescent lamps, and they also provide several colors of light including white, daylight, blue, yellow, green, pink and red.

Other advantages of fluorescent lights are, that they have low surface brightness and create less glare, and they only produce about half as much radiant heat as produced by incandescent lamps of the same wattage. This makes them ideal for use in modern air conditioned buildings where any excess heat is undesirable. These lamps also have a rated life of 2500 hours.

Fluorescent lamps are tubular in shape as shown in Figure 256, and are made in sizes of 6, 8, 15, 20, 30, 40 and 100 watts; with lengths of 9, 12, 18, 24, 36, 48, and 60 inches. Figure 258 shows several types of fluorescent fixtures for office and store lighting at the top of figure, and a typical industrial type fixture below. Fluorescent lights are also made in smaller sizes for homes and in desk lamp patterns.

### 220. PRINCIPLE OF OPERATION

In fluorescent lamps the light is produced by an electrical discharge producing ultraviolet or invisible rays which impinge upon a chemical coating on the inside of the glass tube, causing the chemical



Fig. 256. Several different sizes of fluorescent lamps, shown without their fixtures or auxiliary units.

to glow or to become fluorescent, and to emit visible light.

Some of the chemicals or phosphors commonly used in fluorescent lamps are Zinc Silicate, Calcium Tungstate, Cadmium Borate, Zinc Beryllium Silicate and Magnesium Tungstate.

A small amount of argon gas and mercury vapor is enclosed in the lamp tube to facilitate starting and maintaining the arc or electron discharge between the electrodes in opposite ends of the lamp tube. Figure 257 (top view) shows the location

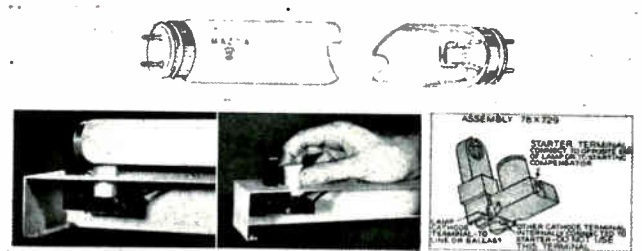

Fig. 257. Upper view shows an open section of a fluorescent lamp tube. Note starting electrode inside tube, at right end. Also note end caps and terminal pins by which lamp is held in sockets. Lower views show compact, replaceable lamp starter switches.

and arrangement of the electrodes and lamp terminals.

To start the operation of a fluorescent lamp, the electrodes must be momentarily connected in series across the line, to cause them to heat up and emit sufficient electrons to establish the arc. After the lamp is started the arc creates sufficient heat to keep up the electron flow, and the electrodes should be disconnected to prolong their life. This requires some form of automatic starting switch, such as shown at the lower left in Figure 259 and also in the lamp circuit diagrams in this same figure.

Two common types of starting switches or units are the thermal switch and the neon glow switch. The operation of these will be explained later.

Fluorescent lamps also require a reactor or ballast

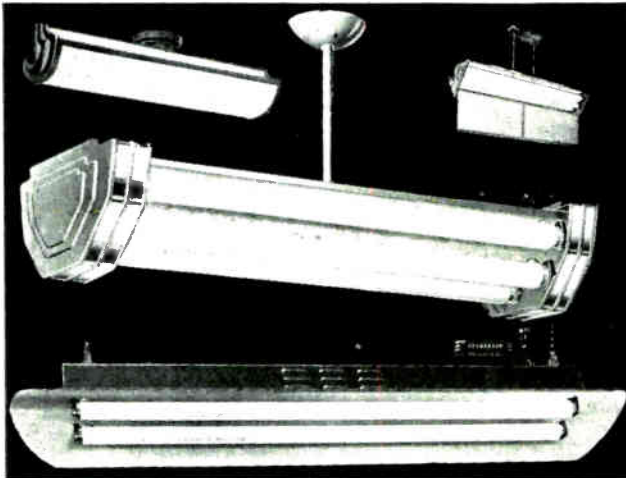

Fig. 258. At the top of the above illustration are shown 3 types of fluorescent light fixtures for store and office lighting. Note how the diffusing glass cover of one side of one unit swings down for cleaning or lamp replacement. The lower view shows a unit for factory or industrial lighting. Accessory units are in the case above the reflector.

coil to limit the flow of current through the lamp tube after the arc is established. This is due to the fact that as the arc temperature increases and its resistance is thereby lowered, the current flow would continue to increase, causing a still hotter arc of lower resistance, until the lamp would quickly burn out.

The effect of the reactor or choke coil in series with the lamp on an A. C. circuit, produces increased counter voltage of self induction as the current increases and thereby limits the current flow to normal lamp operating values. It is therefore highly important that fluorescent lamps of different sizes be operated only with properly designed ballast coils.

These ballast coils also serve another purpose in the operation of the lamps. Fluorescent lamps require a much higher voltage to start the arc than is required to keep them operating once they are started. This momentary high starting voltage kick is obtained from the ballast coil in the form of self induced voltage when the starting switch interrupts the flow of starting current through the ballast coil and starting electrodes. This circuit and operation can be traced in the lamp wiring diagrams shown in Figure 259.

Therefore, the complete lamp control unit consisting of the starting switch and ballast coil serves three important functions: 1. Preheats the electrodes to supply ample electrons for starting. 2. Provides a surge of relatively high voltage to start the arc between the electrodes and through the tube. 3. Prevents the arc current from increasing beyond proper limits for each size of lamp.

Some fluorescent lamp units also have a condenser connected in the control circuit, across the starter switch contacts, to increase the starting voltage impulse and to eliminate radio interference from the arc at the switch points when the starter circuit is opened.

Some of the larger fluorescent lamps using long

tubes, require a higher voltage for operation than is supplied by the normal lighting service lines. Such lamps have an auto transformer included in their control unit for stepping up the line voltage to proper value for lamp operation. The auto transformer and ballast coil are frequently combined in one unit.

**221. OPERATION OF STARTER SWITCHES**

Before starting the lamp the contacts of the thermal switch are in closed position. When line voltage is applied to the lamp the switch completes a circuit through the two lamp electrodes in series and through the ballast coil. The thermal switch has a bi-metallic strip which becomes heated by the current flow within one or two seconds. The heat causes the strip to expand and open the switch contacts, interrupting the relatively heavy starting electrode current through the ballast coil, thereby giving the necessary starting voltage impulse to the lamp tube. See diagrams in Figure 259.

The thermal switch strip is held open by the continuous flow of current through a small heater coil. Sometimes after fluorescent lamps are switched off it may require a short period of time for the thermal switch to cool off and close so the lamp can again be started.

Glow switches operate on the negative discharge principle used in neon indicator lamps. This type of switch is enclosed in a small glass bulb. See illustration at lower left corner of Figure 259.

One of the electrodes in this switch is made of a bi-metallic strip. The two electrodes are separated under normal conditions and form a part of a series circuit through the lamp electrodes and ballast coil.

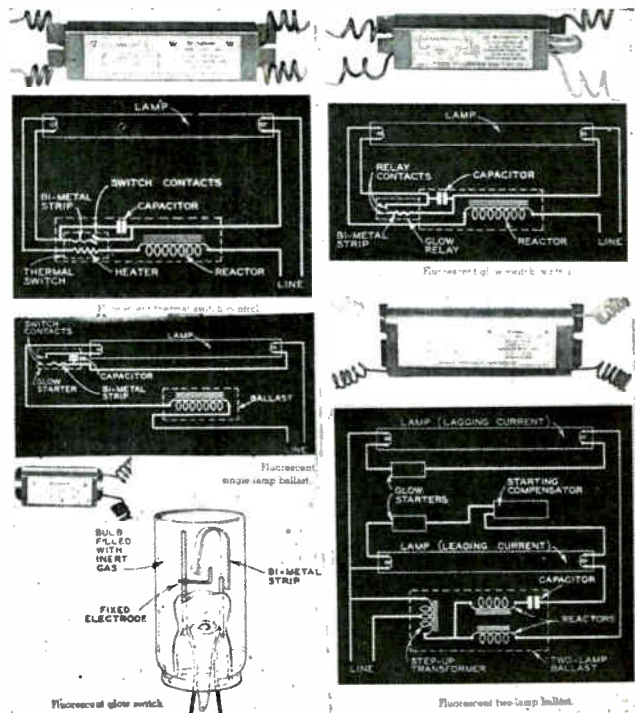

Fig. 259. At lower left is shown a glow type starter switch. Other views show common types of fluorescent lamps circuits and ballasts or auxiliaries.

When voltage is first applied, no current flows except as a result of a glow discharge through the neon gas between the two electrodes of the switch. This causes heating and expansion of the bi-metallic element and closes the contacts or electrodes together, allowing the necessary current to flow for heating the lamp electrodes.

When the contacts close however, the glow discharge is shorted out, and the bi-metallic strip cools and opens the contacts, interrupting the flow of starting current through the ballast coil and giving the necessary high voltage starting impulse to the lamp.

After the lamp arc is established the switch will not again glow or heat up, as it is so designed that the remaining available voltage across its electrodes during lamp operation is insufficient to break down the neon gap between the switch electrodes. Thus if the lamp is turned out the starter switch is immediately ready for restarting.

Many of the later type fluorescent lighting units have the starter switches built in a small tubular metal case which is plugged into the lamp circuit through a small round opening in the lamp housing unit. This permits quick and easy replacement in case the starter switch becomes defective. See Fig. 257.

## 222. FLUORESCENT LAMP TROUBLES AND SERVICE

Fluorescent lamps of the better makes should give very little trouble in service if properly installed and if supplied with proper operating voltage. However, there are a few common trouble possibilities with which you should be familiar if you plan to install or maintain these units.

Fluorescent lights should only be installed on circuits having a voltage range within the rating of the ballast coils. For example, lamps with ballast rated at 110 to 125 volts, will operate much better on circuit voltages within that range.

Fluorescent lamp tubes blacken in color rather uniformly throughout the life of the lamp. The ends of the tubes will often show dense black or brown rings after they are nearly worn out, but should not show much blackening during the first 500 hours of use, if lamps are operating properly and on correct circuit voltage. Early blackening indicates loose contacts, defective starter, improper ballast or wrong operating voltage.

Each time a fluorescent lamp is started the electrodes lose a little of their electron emissive material. Therefore these lamps will have longer life if not turned on and off too frequently.

Fluorescent lamps operate best at surrounding temperatures of 65° to 90° F but may give satisfactory performance at temperatures of 50° F, if the supply voltage is in the upper half of the ballast rating.

If a lamp fails to start it may be due to a burned out lamp tube, lamp loose in sockets, worn out

starter switch, defective ballast coil, low voltage or no voltage on supply circuit. First check supply line voltage, lamp contacts for tightness, test lamp in another fixture or fluorescent lighting unit, and try replacing starter switch. If none of these steps disclose or remedy the trouble a new ballast coil may be required.

Slow starting of lamps is often due to sluggish starting switches, low line voltage, low ballast rating, or lamp in too cold a location.

If the ends of the lamp remain lighted it indicates a probable short circuit in the starter switch. Starters which have been in service for some time frequently fail in this manner, and when they do they should be replaced. On some of the newer type 40 watt lamps using no-blink starters, the lamp ends may remain lighted on a lamp tube that is worn out.

If the lamp blinks on and off it generally indicates a worn out lamp tube. Test the lamp in another fixture or replace the starter and if lamp still blinks on and off replace it with a new one. Low line voltage, low ballast rating, low temperature or cold drafts may also cause blinking.

If the ends of a lamp remain lighted or if lamp blinks on and off, the trouble should be immediately remedied or the lamp or starter should be removed from the circuit. A blinking lamp can shortly ruin the ballast, lamp and starter.

Sometimes a new lamp will flicker slightly for a short time and then this will clear up. If it continues to flicker the cause may be a defective starter, defective lamp tube, or to the lack of a starting compensator on two-ballast lamps.

Fluorescent lamps have some stroboscopic effect due to the dying out of the light at the zero voltage period of the A. C. cycle. This is only noticeable when viewing rapidly moving objects under these lights. If this effect is objectionable for certain classes of work around revolving machinery or printing presses, it can be overcome by the use of two-lamp ballasts or by operating 3 adjacent lamps on a 3 phase circuit. Combining incandescent lamps with fluorescent lamps will also help to relieve this condition.

Fluorescent lamps, operate as a form of arc discharge, and therefore may cause some radio interference. Well grounded fixtures, short wire leads from lamp terminals to ballast and metal mountings for lamp sockets, all help to keep down radio interference. Additional condensers are sometimes installed in these lamps to reduce radio interference.

While fluorescent lamps have proven highly popular and efficient, it should not be assumed that they will entirely replace incandescent lamps for many years, as incandescent lamps have certain advantages and suitability for certain applications, which are not obtainable with fluorescent lamps. In fact, a combination of incandescent and fluorescent lamps produces ideal lighting for certain classes of work.



ESTABLISHED 1899

# COYNE

*Electrical School*  
CHICAGO ~ ~ ILLINOIS



COPYRIGHT 1942

## ARMATURE WINDING AND TESTING

### *Section One*

**Direct Current Armatures**  
**D. C. Motor and Generator Principles**  
**Magnet Wires, Insulations, Coil Winding**  
**Lap Windings, Wave Windings**  
**Element Windings, Multiplex Windings**  
**Rewinding Old Armatures**  
**Armature Testing**  
**Emergency Repairs**

# ARMATURE WINDING AND TESTING

## Section One

### D. C. ARMATURES

This section covers one of the most interesting and important branches of practical electricity. There are many thousands of new motors and generators built each year which must be wound and tested by experts at the factories. There are also many millions of electric motors in use in this country which have to be maintained, tested, operated, and occasionally completely rewound.

Power companies have expert armature winders to repair their great generators when their windings develop trouble. Industrial plants and factories, some of which have thousands of motors in one plant, require armature winders to repair the motors that burn out. Then there are the small companies which have only a few motors and don't have their own electrician, so they must send their machines to some armature shop for repairs. Many of our graduates operate a very profitable business of their own in armature winding and motor repair.

Numerous smaller factories that do not keep a regular armature winder, much prefer to have a maintenance electrician who can wind armatures when necessary. In many cases we find that the general electrician, who does the wiring and repairing around the plant, is also called upon to test and rewind armatures in emergencies. So a knowledge of this subject will often enable you to land a good job, and to advance into greater responsibility and higher pay.

Fig. 1 shows a large group of motors for overhauling and rewinding in a modern repair shop, and Fig. 2 shows a section of the winding department in this same shop.

We have mentioned armature testing, as well as winding, and wish to emphasize the importance of obtaining a good knowledge of testing and trouble shooting, to be able to locate troubles and faults in the windings of motors and generators.



Fig. 1. This photo shows a view in a modern electric repair shop. Note the great number and variety of electrical motors and generators which go through this shop by the thousands each year. They are tested, rewound, reinsulated, and generally repaired before going back in service.

In many cases some small fault, such as an open circuit, short circuit, or "ground", right at the leads or connections of an armature winding, will seriously interfere with the operation of the machine. Many times such faults that don't require a complete rewinding can be quickly repaired, and the machine put right back in service with very little lost time.

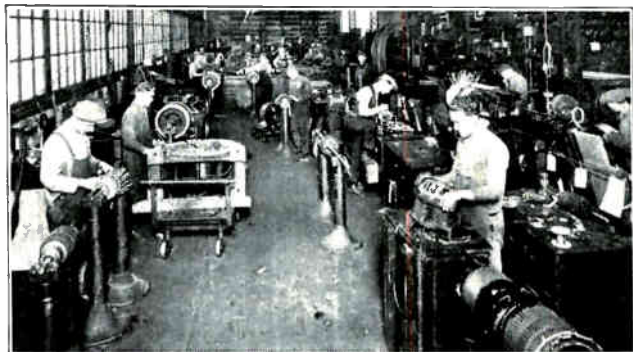

Fig. 2. This view shows a section of the Armature Winding Department of the same shop shown in Fig. 1.

There are actually thousands of electricians in the field today who do not know how to locate and repair such faults, and instead must take motors out of service and send them out to be repaired. In many cases windings are pulled apart unnecessarily to find troubles that could have been easily located by a test, without even removing the armature from the machine. It is needless to say that the maintenance electrician who knows how to systematically test for and locate these troubles, and can make quick repairs and put a machine back in service with the least delay, is the man who gets the best job and the best pay.

A good knowledge of armature construction and windings not only makes it easier to understand testing and rewinding, but is also a great help to you in thoroughly understanding the motors and generators covered in the later sections. So make a careful and thorough study of this section, and you will find it very interesting and valuable.

## 1. GENERATORS AND MOTORS

In order to properly understand armature winding it is necessary to first know something of the construction and principles of motors and generators, and the function of the armature in these machines.

An electric generator is a machine used to convert mechanical energy into electric energy.

An electric motor is a machine used to convert electric energy into mechanical energy.

In actual construction these two machines are practically the same, the difference in them being merely in the way they are used. In fact, in many cases a generator can be used for a motor, or a motor used as a generator, with very slight changes and adjustments.

The more important parts of a D.C. motor or generator are the **Frame**, **Field Poles**, **Armature** and **Commutator**. In addition to these, the brushes, bearings, and a number of other small parts are needed to complete the machine.

Fig. 3 shows a machine with the front bearing plate removed. The field poles can be seen at "B", and are securely attached to the inside of the frame. The armature is shown resting inside the field poles, where it is rotated during operation. The commutator can be seen on the front end of the armature. The extra poles shown at "A" in this view will be explained later.

## 2. FIELD POLES

The field poles are made of iron, either in the form of solid cast blocks or in many cases built up of thin strips or **Laminations**, pressed and bolted tightly together. These iron cores are then wound with a great many turns of insulated wire, forming what are called **Field Coils**. These coils may consist of from a few hundred to several thousand turns, according to the size and voltage of the machine. We find then that the completed field pole is simply a large electro-magnet, and its purpose is to supply a strong flux or field of magnetic lines of force for the armature conductors to rotate in.

The field frame is not only to provide a support for the field poles, but also provides a flux path for the complete magnetic circuit between the outer ends of the poles. The field coils are connected together in such a manner that each one will produce a magnetic pole opposite to the one next to it. They are then supplied with direct current to maintain constant polarity at the pole Shoes or Faces.

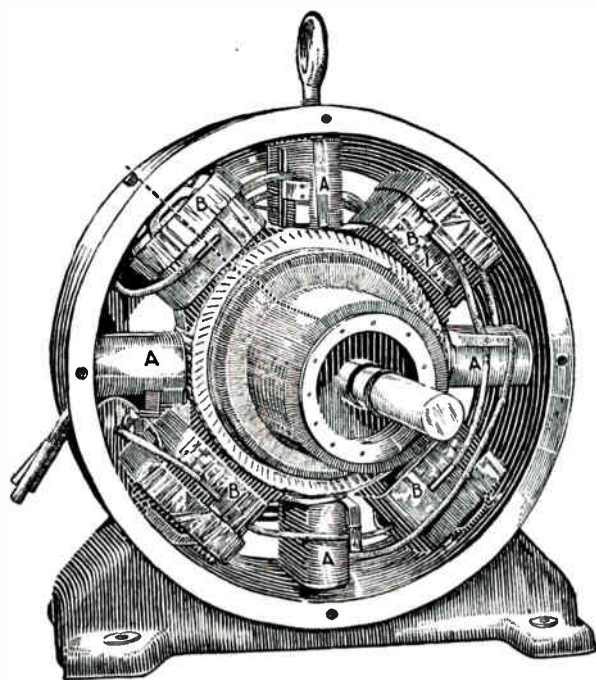

Fig. 3. This view of a D.C. generator with the front bearing bracket removed shows the field poles, armature, and frame very clearly.

### 3. ARMATURES

The armature is also made of iron and is always of laminated construction, or built up of thin iron sheets pressed tightly together. The laminated construction is used to prevent the flow of induced Eddy Currents in the armature core. The core has a number of slots around its entire outer surface, in which the armature coils are placed. See Fig. 5. The iron armature core provides a magnetic path for the flux of the field poles, and also carries the coils which are rotated at high speed through the field flux.

In a generator, it is the cutting of these coils through the flux which produces the voltage. In a motor, it is the reaction between the field flux and the flux around the armature conductors, which causes the Torque or turning effort.

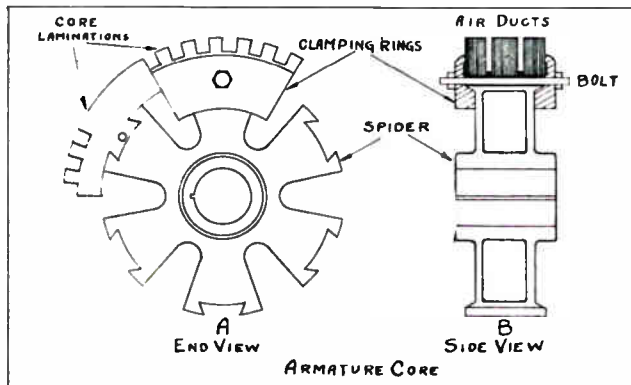

Fig. 4. The view at "A" shows the manner in which core laminations are assembled on a spider to make up the large armatures. At the right is a sectional view, showing the manner in which the laminations are assembled and clamped to the spider rim, and the air ducts which are left for ventilation and cooling.

Small armatures are often constructed of laminations in the form of complete disks which merely have a hole through their center for the shaft, and possibly bolt holes for clamping them. This makes a core which is solid clear to the shaft. In the larger machines it is not necessary to have the entire core solid, so the laminations are assembled like the rim

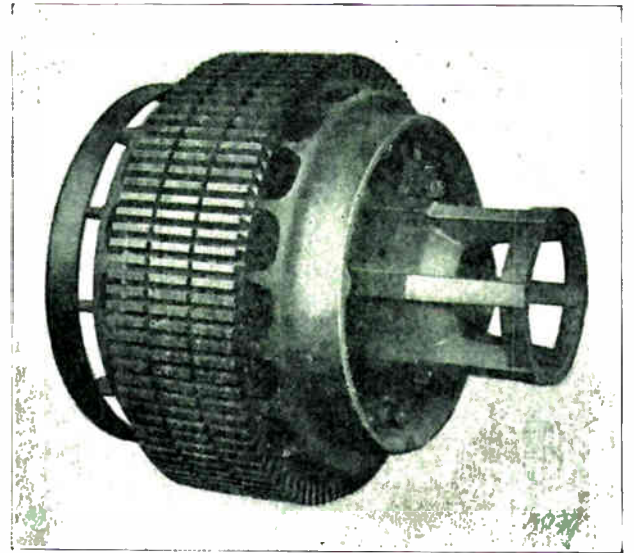

Fig. 5. Completely assembled D.C. armature. Note the manner in which the laminations are clamped together by the heavy end rings, and also note the slots around the armature core in which the coils will be laid.

of a wheel, on the outside ends of short spokes, as shown in Fig. 4-A. This wheel or center framework is called the Spider, and the sections of core laminations are dovetailed into the spider, as shown in the figure. Heavy clamping rings at each end of the group, and drawn tight by bolts, hold the entire core in a solid, rigid unit.

Fig. 4-B shows a sectional view through such a spider and core. Note the spaces or air ducts that are left between the laminations, for ventilation and cooling of the core and windings.

Fig. 5 shows a completely assembled core of this type without the shaft or the commutator.

Fig. 6 shows a complete armature with the winding in place and the commutator shown at the left end. Note how the coils are neatly fitted into the slots and held in place by wedges in the top of the slots. The ends of the coils are tightly banded with steel banding wire to prevent them from being thrown outward when rotated at high speed.

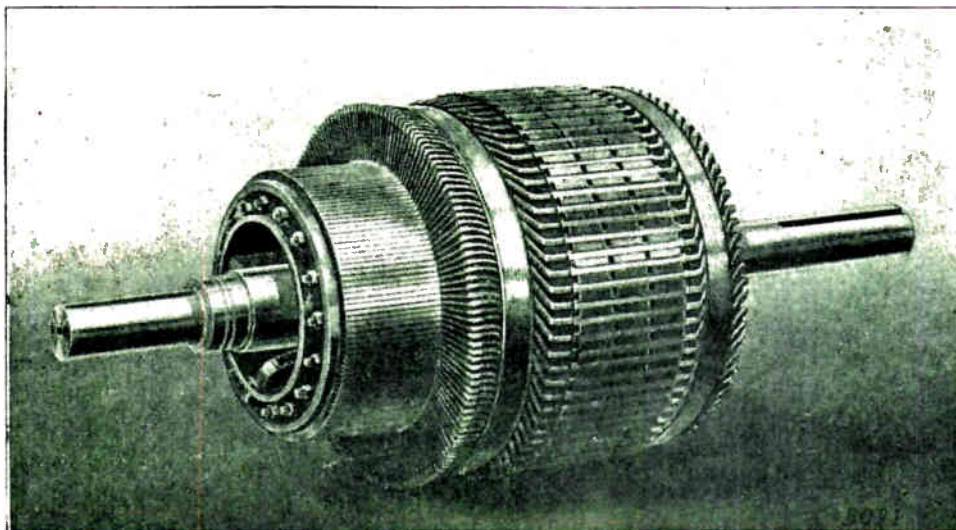

Fig. 6. The view at the left is a photo of a large D.C. armature for a 150 KW, belt driven generator. The commutator is at the left and the bars or segments can be plainly seen. Note how the armature coils are held in the slots by wedges and by the band wires around each end of the armature. (Photo Courtesy Crocker-Wheeler Electric Company.)

### 4. ARMATURE SLOTS

There are several different types or shapes of slots used for holding the coils in armature cores. Several of these are shown in Fig. 7. This figure shows end views of the slots and sectional views of the coils in them. The one at "A" is called an "open type slot", and is used where the coils are completely wound and formed before being placed in the slots. This type of slot has the advantage of being very easy to place the coils in. Bands around the core must be used to hold the coils in slots of this shape when the armature is rotated.

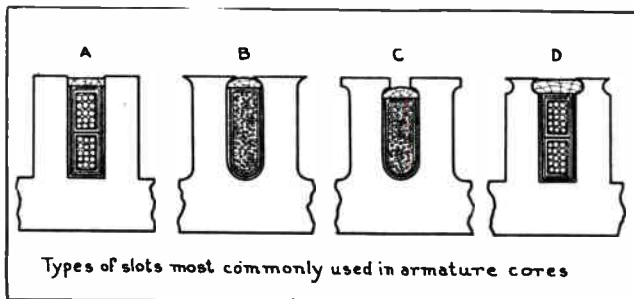

Fig. 7. The above diagram shows four common types of armature slots. Note carefully the manner in which the coils are arranged and insulated, and also the wedges which hold them in the slots. The wedge in the slot at "A" would be held in place by band wires around the armature.

"B" and "C" show slightly different types of partly closed slots, which are used with armatures on which the coils are wound directly into them. This type of slot gives a better distribution of flux from the field poles to the armature than the open ones do. This is due to the projecting lips which reduce the broad air gap over the top of the slot. With these partly closed slots the coils are held securely in place by wedges slipped over their top edges and under the iron lips.

"D" shows an open type slot which has a groove in each side of its top, through which the slot wedge is driven.

### 5. COMMUTATORS

Commutators are constructed of a number of segments or copper bars, mounted in the form of a cyl-

inder around the shaft. They are mounted near to the end of the armature core, so the coil ends can be connected to each of these bars. Between each bar and the next is placed a thin mica strip or segment, which keeps them entirely insulated from each other.

See Fig. 8-A, which is an end view of such a commutator. B- and B+ are the brushes which rest on the commutator surface F. The black lines at "M" are mica insulating strips.

At "B" is shown a sectional view cut endwise through a commutator, showing the shape of the bars or segments and the notches cut in each end, so they can be held securely together by the heavy Clamping Rings. When the bars are all fitted in place by the clamping ring "V" is drawn up tightly by the clamping nut "R", this locks the segments to the commutator core or center, in a sort of dovetail construction. The raised part of the segment at "L" is called the Riser or Neck. At "U" are shown slots in the segments where the coil leads are attached.

The heavy black lines represent slots mica insulation which keeps all bars well insulated from the clamping rings, core, and shaft. Examine this diagram carefully as it shows the typical construction features of small and medium sized commutators.

On very large machines where the commutators have a large diameter, they are sometimes mounted on a spider similar to those described for large armatures. Commutators are held in place on the shaft by use of keys and slots, or special locknuts, in each end.

On some of the very small armatures of fractional horsepower machines, the commutators are tightly pressed on to the shaft, and held in place by the extremely tight fit.

Fig. 9 shows a large engine-driven D.C. generator from the commutator end. This commutator is mounted on a spider and you can note the brushes resting on its outer surface. Part of the field poles can also be seen around the left side of the frame.

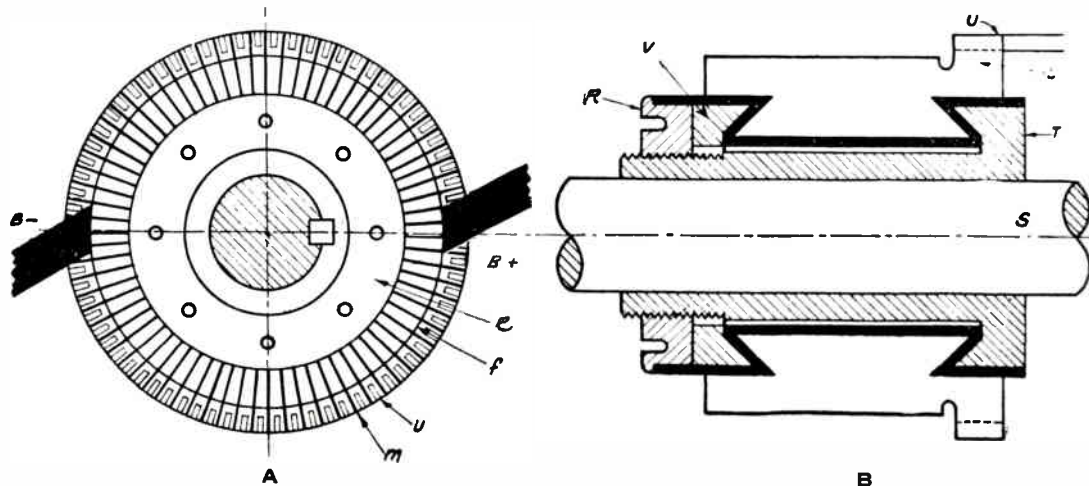

Fig. 8. At "A" is shown an end view of a commutator, illustrating the manner in which the bars or segments are assembled and kept separated by strips of insulation between them. At "B" is a sectional view showing how the commutator segments are clamped and held in place by clamping rings which fit in their grooves.



Machines of this type are made in sizes ranging from less than 100 horsepower to many thousands of horsepower, and small motors are made in sizes down to 1/50 horsepower and less.

Keep in mind, however, that regardless of the size of the machine the general operating principles are the same; so if you obtain a thorough understanding of the purpose of the important parts and the fundamental operating principles of one type or size, these things will apply equally well to all others.

## 6. OPERATING PRINCIPLES OF GENERATORS AND MOTORS

So far we have only discussed the mechanical parts and construction of generators and motors. It is also very important that you have a good understanding of the electrical features and operating principles of these machines, for two reasons. It will help you understand armature windings much easier, and also provide a foundation for your study of these machines in the later sections.

The operating principles of generators and motors are not nearly as complicated, when properly explained, as many men without training think they are.

## 7. GENERATION OF VOLTAGE

We have learned that a generator is a machine which when driven by mechanical power will gen-

erate voltage or electro motive force, and supply electric energy to the circuit or load to which it may be connected.

You will also recall from the section on elementary electricity that a generator operates on the principle of electro-magnetic induction, and that the voltage is produced by the wires or conductors cutting magnetic lines of force.

Fig. 10 shows a diagram of a very simple form of D.C. generator, consisting of two field poles marked "N" and "S", and one armature coil connected to two commutator segments, which are in contact with the positive and negative brushes. These brushes are to collect the current from the commutator bars as the coil and the commutator revolve on the armature. If we revolve the coil rapidly through the magnetic flux between the north and south poles, a voltage will be generated in the coil; and if there is a complete external circuit through the lamps or load as shown, this voltage will cause current to flow out through this circuit and back through the armature coil continuously, as long as the rotation continues and the circuit remains closed. As the coil revolves, either side of it passes first the north pole and then the south pole, and cuts through the lines of force first in one direction and then the other. Therefore, the

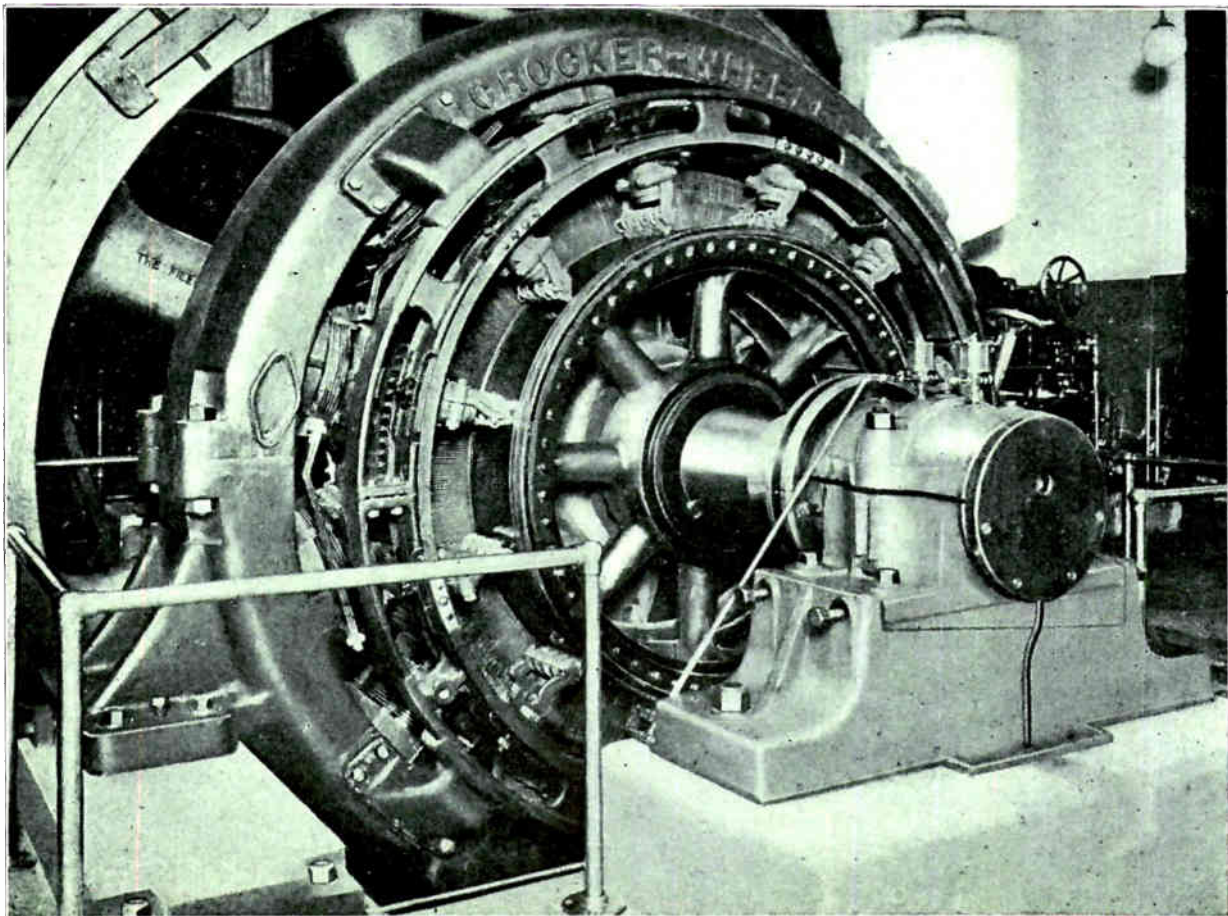

Fig. 9. This photo shows a large 400 KW. 225 volt D.C. generator which is direct connected to a steam engine. This machine is designed to run at 110 R.P.M. and, therefore, it has a larger diameter than those which operate at higher speeds. This generator has 12 field poles and 12 sets of brushes. (Photo Courtesy Crocker-Wheeler Electric Company.)

voltage generated in the coil will be continually reversing or alternating in direction.

If this coil was provided with collector rings instead of commutator bars the entire circuit would be supplied with alternating current. Always remember that **alternating current is generated in the windings of any ordinary D.C. generator.**

### 8. COMMUTATOR ACTION

Now we come to the purpose of the commutator, which is to **rectify this alternating current or change it to direct current**, as it flows out to the external circuit. This is accomplished in the following manner.

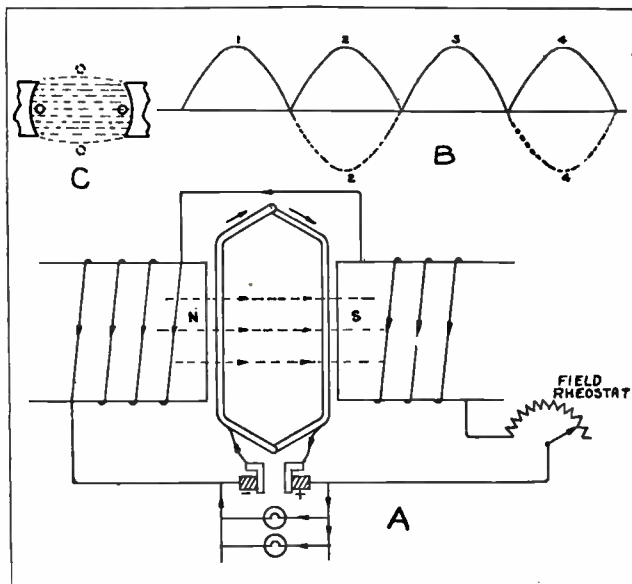

Fig. 10. The above diagram shows the principles of a simple D.C. generator. Note the manner in which the field coils are connected to the brushes, and the rheostat used for controlling the amount of field current.

The field poles and brushes are, of course, held rigidly in one position and always keep about the same position with regard to each other. Thus the positive brush will always be at the right place to collect current from the coil side which is passing by the south pole, and the negative brush will always be at the proper position to connect with coil sides passing the north pole. So the current will always flow out at the positive brush and back in at the negative brush, regardless of the speed of the armature.

### 9. VOLTAGE CURVES. PULSATING DIRECT CURRENT

We learned in a previous section that the voltage or current of any circuit can be conveniently represented by curves, as shown at "B" in Fig. 10. These curves show the variation and direction of the voltage that would be produced by this simple generator.

The combined solid and dotted line curves 1, 2, 3, and 4, represent the alternating impulses that are produced in the armature coil. Curves 1 and 3 above the line indicate voltage in one direction, while 2 and 4 below the line indicate voltage in the opposite direction. The vertical distance, from the

center line, at any point along these curves, indicates the value of the generated voltage at that particular point of the coil revolution.

The rise and fall of the curves is due to the coil approaching and leaving the strong field flux directly under the poles. When the conductors of the coil are in the position shown by the dotted circles at "C", and are practically out of the effective field and moving parallel to the few lines of force, they do not generate any voltage. This position between two field poles is called the **Neutral Plane**. As the coil rotates back into the stronger field of the poles, the voltage gradually builds up higher until it reaches a maximum when the conductors are in the strong field at the center of the poles, as shown by the solid line curves. If we ignore the dotted curves 2 and 4 below the line at "B", and consider them to be placed above the line, the curves will then represent the **pulsating direct current** which exists in the external circuit due to the action of the commutator.

Large generators are never constructed with only one coil on the armature, but usually have a considerable number of coils placed in the slots around the armature surface, and connected to as many commutator segments. The use of this greater number of coils produces impulses closely following each other, and in fact overlapping, so that the variation or pulsation of current, as shown in Fig. 10-B, is considerably reduced.

Fig. 11-A, B, and C shows approximate voltage curves for the individual coils of three simple generators, each with a different number of coils on its armature. The one shown at "A" has two coils placed 90 degrees apart. One of these coils will be passing through dense flux directly under the center of the poles, while the other coil is at right angles to the poles and moving parallel to the flux. Therefore, the voltage induced in one coil will be at maximum value, while that in the others is at zero value. The result is shown by the curves, and we can see that due to the overlapping voltage impulses the current flow in the external circuit will be much steadier. By comparing this with the number of coils in "B" and "C", and also observing the curves representing their voltage, we find that the greater number of coils we use the less pulsation there will be in the current flowing to the external circuit, and the closer it approaches to true direct current. The curves in this figure only show the positive halves of each cycle, due to the rectifying effect of the commutator.

### 10. FACTORS THAT DETERMINE MACHINE VOLTAGE

We may recall that in an earlier section on magnetic induction we learned that a **single conductor must cut 100,000,000 lines of force per second to generate one volt**, and that the voltage produced by any generator depends on the speed with which lines of force are cut.

This, in turn, depends on three principle factors as follows—**strength of the field** or number of lines of force per pole, **speed of armature rotation**, and **number of turns in series** between the brushes.

We can readily see that the stronger the field, the more lines of force will be cut per revolution of the coil. If we strengthen or weaken the field of any generator its voltage will increase or decrease proportionately. The voltage of generators while in operation is usually controlled by varying their field strength.

The faster an armature turns, in revolutions per minute, the greater will be the speed of movement of its conductors and the greater the number of lines of force cut per second. So we find that the voltage of a generator will also vary directly with the speed.

If a simple generator, such as shown in Fig. 10, has one volt produced in each side of its coil, then the pressure at the brushes will be 2 volts; because the two sides of the coil are in series, and their voltage adds together. If we were to increase the number of turns in this coil from one to ten, the pressure at the brushes would be 20 volts, because all ten turns would be in series and their voltages would add. So we find that the number of turns per coil in an armature winding will proportionately effect the voltage produced.

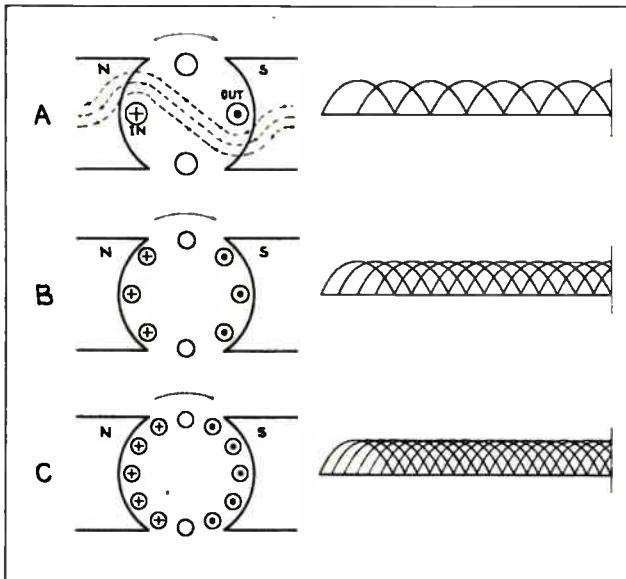

Fig. 11. The above diagram shows the voltage curves for three simple generators with different numbers of conductors in their armatures. Note how the greater number of conductors produces direct current of a more constant value.

## 11. ARMATURE FLUX AND ITS ACTION IN GENERATORS

When a generator is connected to an external circuit on which we have a load of lamps or motors, the amount of connected load and the resistance of the external circuit will determine the current which flows. This current, of course, must all flow through the armature winding continuously, and it sets up magnetic lines of force around the armature conductors, as shown in the upper view in Fig. 12.

The reaction between this flux and that of the field poles causes the field flux to be distorted or pushed out of its straight path as shown.

When the magnetic lines from the north field pole strike the counter-clockwise lines around the left armature conductor, they deflect downward, and travel with them to a certain extent. Then as they encounter the clockwise lines around the right hand conductor they are deflected upwards.

These lines, of course, have a tendency to try to straighten or shorten their path, and thereby exert considerable force against the movement of the armature conductors, and in opposition to the force applied by the prime mover which drives the generator.

This force will, of course, depend upon the amount of current flowing in the armature conductors and the strength of the flux which they set up. For this reason the greater load we have connected to the external circuit, the more power will be required from the prime mover, to drive the generator.

## 12. MOTOR PRINCIPLES

If we take this same machine which has been used as a generator, and send current through its armature and field coils from a line and some other source of electric supply, the reaction between the lines of force of the field and those of the armature conductors will set up Torque or twisting effort to rotate the armature, as shown in the lower view in Fig. 12.

You will note that, in order to obtain rotation of the motor in the same direction the armature formerly turned as a generator, we must reverse the current through the armature coils. Use the right hand rule for magnetic flux around a conductor, and check carefully the direction of the flux set up, with the direction of current flow through these conductors. The current is flowing in at the conductor nearest the north pole, and, therefore, sets up a clockwise flux around this conductor. In the other conductor the current is flowing out and sets up a counter-clockwise flux. The lines of force of the field coming from the north pole in striking those around the left conductor will be deflected upwards over the top of this conductor, and as they continue across and strike the lines in the opposite direction on the right hand conductor, they will be deflected downward and under it. Their tendency to shorten and straighten their path will then cause this force or torque to rotate the armature counter-clockwise. With a pulley or gear connected to the shaft of such a motor we can thus derive mechanical power from electric energy.

## 13. COUNTER E. M. F. IN MOTORS

We must remember that as the motor rotates its armature conductors will still be cutting lines of force of the field. As the conductors of the motor in Fig. 10 are revolving in the same direction they did in the generator, this voltage induced in the

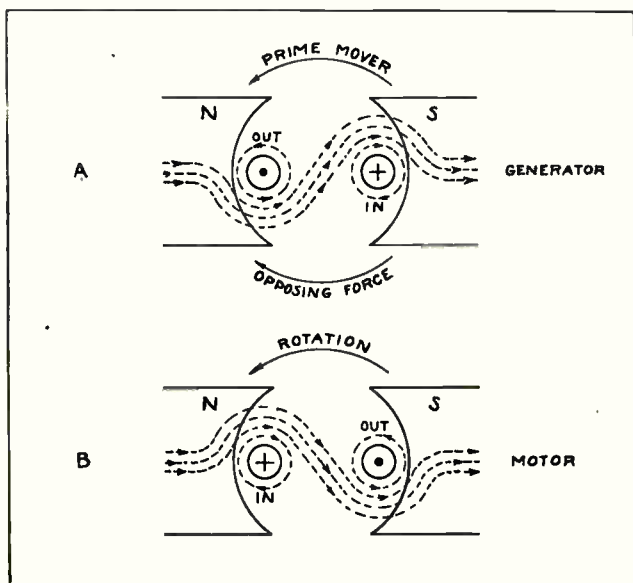

Fig. 12. This sketch shows the manner in which motor torque is produced by the reaction between the flux of the armature conductors and the field flux. Examine both "A" and "B" very carefully, and check the direction of current in the conductors, the direction of flux around them, and the direction of the resulting movement.

coils will be in the opposite direction to the applied line voltage. This voltage, which is always generated in the coils of any motor during operation, is therefore called **Counter Electro-Motive Force**, and usually referred to as counter E. M. F., or counter voltage.

The applied voltage is equal to the counter E.M.F. plus the voltage drop in the armature or,  $E = C. E. M. F. + I. R.$

As the counter voltage opposes the applied line voltage it regulates the amount of current the line will send through the armature. The resistance of the armature winding is very low, being only about  $\frac{1}{4}$  of an ohm in the ordinary 5 horsepower, 110 volt motor. From this we can see that if it were not for the counter voltage an enormous current would flow through this armature.

Applying Ohms law, or  $E \div R = I$ , we find that  $110 \div \frac{1}{4} = 440$  amperes. Actually a motor of this size would ordinarily draw only about 10 amperes when operating without mechanical load; so we can see to what a large extent the current must be controlled by the counter voltage.

This counter voltage can be determined in the following manner. We know that  $I \times R = E$ , so  $10 \times \frac{1}{4} = 2\frac{1}{2}$  volts, or the voltage required to force 10 amperes through the armature resistance. If we subtract this from the applied voltage we find the counter voltage, or  $110 - 2\frac{1}{2} = 107\frac{1}{2}$  volts, counter E. M. F.

#### 14. GOVERNOR EFFECT OF COUNTER E. M. F.

When a load is applied to a motor it tends to slow down a little, and as the conductors then cut through the field flux at less speed, the generated counter E. M. F. will be less, and will allow the applied voltage to send a little more current through

the armature. This additional current increases the motor torque and enables it to carry the increased mechanical load. If the mechanical load is entirely removed from a motor it will tend to speed up, and as the speed increases the armature conductors move through the field flux faster. This increases the counter E. M. F. which will immediately reduce the current flow, by its opposition to the applied line voltage. So we find that **The Counter E. M. F. of a Motor Armature Acts Like a Governor to Control Its Speed.**

We should also remember that if a motor is loaded to a point where the armature slows down too much, or stops entirely, the counter voltage will fall too low and allow the applied voltage to send excessive current through the armature and possibly burn out its windings. The counter voltage in a motor armature, of course, depends upon the number of turns in the coils, the speed of rotation, and the field strength, the same as the voltage in a generator does.

Counter voltage plays a very important part in the starting of motors, and will be further discussed in the section on D.C. motors; but be sure you have a thorough understanding of its principles as covered in this section.

#### 15. ARMATURE COILS

Armature windings merely consist of a number of coils of wire, arranged uniformly in the slots of the armature core, and connected to the commutator bars to form series or parallel circuits between the brushes. Many untrained electricians think armature windings are very complicated. This is not necessarily true. The windings are the heart of the machine, and its operation depends on them, but there is nothing so mysterious or complicated about these windings that a trained man cannot easily understand.

**The Important Things to Know Are the Manner of Constructing the Coils, Insulating Them, Placing Them in the Slots, and Making the Connections to the Commutator.**

These things are all very easy to learn, for one who already knows the principles of electricity and series and parallel circuits.

We are now ready to take up coil construction and insulation, and the connections will be explained a little later.

#### 16. NUMBER OF TURNS AND SIZE OF WIRE

We have found that the number of turns in the coils of a generator winding has a definite effect on the voltage it will produce; and that in a motor the number of turns regulates the counter voltage, and thereby determines the line voltage which can be applied to the motor.

The size of the conductors has no effect on the voltage generated in these machines, but does determine the current their windings can carry. The larger the conductors or the more of them which are connected in parallel, the more current the windings

can stand without overheating. It is this conductor area that determines the current capacity of generators, or the full load current ratings of motors. So in general, high voltage machines use more turns of smaller sized wire and more coils connected in series; while low voltage, heavier current capacity machines, use fewer turns of larger wire.

The shape of wires used for armature coils depends on the kind of machine and the shape of the slots. Round wires are most commonly used for small armatures, except those for the starting motors of automobiles and such very low voltage machines. These are usually wound with one or two turns of square or rectangular wires or bars.

Windings for large size motors and generators generally use square or rectangular conductors in order to utilize all the space in the slots.

17. WIRE INSULATION

Armature coils of more than one turn must have all turns well insulated from each other. Round magnet wire, and also the smaller square wires, are usually supplied with the insulation already on them.

The more common forms of insulation used on magnet wires are enamel, cotton, and silk coverings. The silk and cotton covered wires can be obtained with either single or double layers of this insulation. Combinations of enamel and cotton, or enamel and silk are also used.

In specifying or buying magnet wire we usually refer to its insulation by the first letters of the coverings used, as follows: E. for enamel covered; S.C. for single cotton; D.C. for double cotton; S.S.

for single silk; D.S. for double silk; S.C.E. for single cotton and enamel; etc.

The plain enamel insulation is generally used only on the very small wires, but combined enamel and cotton or silk coverings are used on quite large wires.

The enamel used for insulating magnet wires is of a very good grade, being of very high dielectric strength, and flexible enough to allow the wire to be bent in a curve around a wire of its own size without damaging the enamel insulation.

Very small motors of the fractional horsepower portable types often use windings with only enamel insulation, because of the very small space this insulation occupies, and the ease with which it conducts heat to the outside of the coils.

It is well to Use Wires With Sufficient Insulation to Protect Them From Short Circuits in the Finished Coils. However, we must also remember that the Thicker Insulations Require More Space and, Therefore, Allow Fewer Turns in a Slot of Any Given Size.

Round magnet wires can usually be obtained in sizes from No. 46 to No. 6 B. & S. gauge.

The table in Fig. 13 gives the diameters of magnet wires from No. 14 to No. 44 B. & S. gauge. These diameters are given for the bare wires and also for wires with various insulations. The table also gives the areas and weights of these wires, and in the right-hand section some additional data which is very convenient in calculating and winding various coils.

Size B. & S. Gauge	Diam. bare wire in in.	Metric equiv in M.M.	Diam. enam. wire in in.	Diam. S.C.E. in in.	Diam. S.S.E. in in.	Diam. S.C.O. in in.	Diam. D.C.O. in in.	Diam. S.S.O. in in.	Diam. D.S.O. in in.	Area. Cir. Mils.	Ohms per 1,000 ft.	Ohms per pound	Feet per ohm	Feet per pound
14	.0641	1.628	.0661	.0711	.0681	.0691	.0741	.0661	.0681	4107	2.521	.2028	396.6	80.44
15	.0571	1.450	.0590	.0640	.0610	.0621	.0671	.0591	.0611	3287	3.179	.3225	314.3	101.4
16	.0508	1.291	.0526	.0576	.0546	.0558	.0608	.0528	.0548	2583	4.009	.5128	249.4	127.9
17	.0453	1.150	.0471	.0521	.0491	.0503	.0553	.0473	.0493	2048	5.085	.8153	197.8	161.8
18	.0403	1.025	.0419	.0469	.0439	.0453	.0503	.0423	.0443	1624	6.374	1.296	156.9	203.4
19	.0359	.9116	.0375	.0425	.0395	.0409	.0459	.0379	.0399	1288	8.038	2.061	124.4	256.5
20	.0320	.8118	.0335	.0385	.0355	.0370	.0410	.0340	.0360	1022	0.14	3.278	98.66	323.4
21	.0286	.7229	.0299	.0344	.0319	.0330	.0370	.0305	.0325	810.1	12.78	5.212	78.24	407.8
22	.0253	.6438	.0267	.0310	.0287	.0296	.0336	.0273	.0293	642.6	16.12	8.287	62.05	513.2
23	.0226	.5733	.0239	.0282	.0259	.0269	.0309	.0246	.0266	509.5	20.32	13.18	49.21	648.4
24	.0201	.5106	.0213	.0256	.0233	.0244	.0284	.0221	.0241	404.0	25.63	20.95	39.02	817.6
25	.0179	.4547	.0191	.0234	.0211	.0222	.0262	.0199	.0219	320.4	32.31	33.32	30.95	1031
26	.0159	.4049	.0170	.0210	.0190	.0199	.0239	.0179	.0199	254.1	40.78	42.97	24.54	1300
27	.0142	.3606	.0152	.0192	.0172	.0182	.0222	.0162	.0182	201.8	51.38	54.23	19.46	1639
28	.0126	.3211	.0135	.0175	.0155	.0166	.0206	.0146	.0166	159.8	64.79	133.9	15.43	2067
29	.0113	.2859	.0122	.0162	.0142	.0153	.0193	.0133	.0153	126.7	81.70	213.0	12.24	2607
30	.0100	.2546	.0108	.0148	.0128	.0140	.0180	.0120	.0140	100.5	103.0	338.6	9.707	3287
31	.0089	.2268	.0097	.0137	.0117	.0129	.0169	.0109	.0129	79.70	129.9	538.4	7.698	4145
32	.0080	.2019	.0087	.0127	.0107	.0120	.0160	.0100	.0120	63.21	163.8	856.2	6.105	5227
33	.0071	.1798	.0077	.0117	.0097	.0111	.0151	.0091	.0111	50.13	206.6	1361	4.841	6591
34	.0063	.1601	.0069	.0109	.0089	.0103	.0143	.0083	.0103	39.75	266.5	2165	3.839	8311
35	.0056	.1426	.0062	.0102	.0082	.0096	.0136	.0076	.0096	31.52	328.4	3441	3.045	10480
36	.0050	.1270	.0055	.0095	.0075	.0090	.0130	.0070	.0090	25.00	414.2	5473	2.414	13216
37	.0045	.1131	.0050							19.83	522.2	8702	1.915	16660
38	.0040	.1007	.0044							15.72	658.5	13870	1.519	21610
39	.0035	.0897	.0039							12.47	830.4	22000	1.204	26500
40	.0031	.0799	.0035							9.888	1047	34980	.9550	33410
41	.0028	.0711	.0031							7.845	1333	54000	.7630	42900
42	.0025	.0633	.0028							6.250	1680	87400	.6050	52800
43	.0022	.0564	.0025							4.850	2120	132000	.4670	66400
44	.0020	.0502	.0023							4.000	2670	212500	.3850	82600

The above tables show average diameters which are subject to variations as follows:  
 Bare Wire—Sizes No. 30 and larger, 1% plus or minus. Sizes No. 31 and finer .0001" plus or minus.  
 Enamelled Wire—Varying from .0001" plus or minus on the fine sizes to .0005" plus or minus on the heavy sizes.  
 Fabric covered Wire—Will take approximately the same variation as the bare and enamelled wire.  
 Thickness of insulation can be varied to meet special space or dielectric requirements.

Winding Data Based on Actual Winding Space				
Size Wire	Low Tension Coils		High Tension Coils Turns per sq. in.	Method of Determining Actual Winding Space
	Turns per sq. in.	Ohms per cu. in.		
14	177	.037		Let D = outside diam. finished coil d = inside diam. finished coil L = overall length finished coil An = Actual winding space low tension coil with out cotton tape At = Actual winding space low tension coil taped with cotton tape. Ah = Actual winding space high tension coil Then Ab = (L-d) [(D-d) - (d+h) / 2] Ac = (L-d) [(D-d) - (d+h) / 2] Ad = (L-d) [(D-d) - (d+h) / 2]
15	225	.060		
16	282	.098		
17	348	.146		
18	431	.229		
19	528	.354		
20	647	.547	653	
21	793	.845	806	
22	980	1.315	988	
23	1297	2.195	1205	
24	1590	3.400	1465	
25	1970	5.31	1810	
26	2395	8.15	2280	
27	2980	12.75	2680	
28	3990	21.50	3270	
29	4870	33.10	3930	
30	5960	51.20	4750	
31	7330	79.40	6240	
32	8960	122.2	7650	
33	11920	205.5	9350	
34	14500	315.0	11150	
35	17600	482.0	13800	
36	21700	750.8	16700	
37	28700	1250	21300	
38	34100	1870	25300	
39	43000	2980	32600	
40	52000	4490	41700	
42	91700	12600	72500	
44	120600	28800	106500	

Fig. 13. The above table gives some very valuable data, which will be of great help in determining the number of turns of any given size wire which can be placed in a slot of a certain area. Observe the thickness of the various types of insulation on these wires.

## 18. TYPES OF COILS

There are two general methods of winding armature coils. The proper number of turns can be wound directly into the armature slots, as is generally done on the small machines; or the coils can be wound and formed complete before inserting them in the slots, which is the more common method with larger armatures.

Fig. 14-A shows a **Diamond Type Coil** before and after pulling or shaping. The unfinished loop coil consists of three wires wound in parallel the desired number of turns, and after the coil is wound a layer of cotton tape is wound over it, with each turn lapping over the last by half its width. The coil is then pulled with a coil spreader into the shape shown in the lower view at "A".

At "B" is shown a coil of the same type wound with five wires in parallel instead of three. Coils are often wound with several wires in parallel in this manner because several small wires are more flexible than one large one. In other cases they are wound in this manner so their ends can be connected to a greater number of commutator bars.

One loop or coil connected between two commutator bars is called an **Element**. So coils wound with three wires in parallel are called **Three Element Coils**.

The coil at "A" is called a three element coil, while the one at "B" is a five element coil. The coil shown at "C" in Fig. 14 is known as the **Eickemeyer type**. The upper view shows it before taping, and the lower view after it has been taped and shaped. At "D" is shown a single turn coil of copper ribbon or bar, shaped into a wave coil with a diamond twist on the back end.

## 19. COIL AND SLOT INSULATION

In addition to the insulation on the wires themselves it is also necessary to insulate the coils and entire winding from the slots and armature core.

The insulations used for this purpose serve both to protect the coils from mechanical injury from contact with slot edges, and also to electrically insulate them from the slots.

The materials commonly used for **Mechanical Protection** are as follows: **Hard Fibre, Fish Paper, Manila Paper, Vulcanized Fibre, and Press Board.**

## 20. FIBRE AND PAPER INSULATIONS

Hard fibre, vulcanized fibre, and pressboard or fullerboard, are made of dense hard paper or pulp layers tightly packed under hydraulic pressure, and have a dielectric strength or voltage breakdown test of about 200 volts per mil (1/1000 inch), at thicknesses from 50 to 150 mils.

These materials are used wherever insulating material of exceptional mechanical strength is needed, as for armature slot wedges, etc.

Fish paper is made from rag stock and by a treating process becomes a hard fibre-like paper which is very strong and tough. It is very commonly used for lining armature slots.

Manila paper is made from linen or manila fibre, producing a tough, strong paper which when dry has very good insulating properties.

Fish paper and manila paper are commonly made in thicknesses from 4 to 28 mils. These materials give considerable electrical insulation, as well as mechanical protection to the coils.

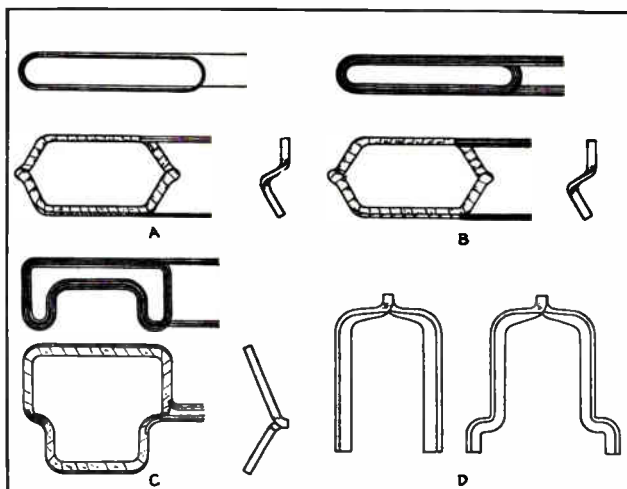

Fig. 14. This diagram shows several of the more common types of armature coils, both in the rough loop form and in the finished taped form.

## 21. VARNISHED CLOTH INSULATIONS

The materials particularly for **Electrical Insulation** are as follows: **Yellow Varnished Cambric, Black Varnished Cambric, Varnished Silk, Oiled Muslin, and Yellow Oiled Canvas.**

Yellow varnished cambric is a strong, closely woven cloth having an especially soft finish, and is treated with high-grade insulating varnish. The varnish is baked into the cloth, producing a tough, flexible material with a very high dielectric strength and a smooth glossy surface. This can be obtained either by the yard, or in standard width tape, and is used for insulating slots and for wrapping coils. It is commonly made from 7 to 12 mils thick.

Black varnished cambric is also a varnished cloth and is used in the form of straight cut tape for insulating wires and cables, and in a bias cut tape (cut at an angle to the weave) for taping armature coils.

Varnished silk is made of Japanese silk treated with a very high-grade insulating varnish and oven cured. This material is very light and thin, and has very high dielectric strength per mil. It is commonly used in 3 and 5 mil thickness, where light weight and minimum thickness are required.

Oiled muslin is a linen finish cloth, coated with oil and oven-cured to set the film to a hard smooth surface. It is a very flexible cloth of good insulating properties, and does not deteriorate much with age or vibration.

Yellow oiled canvas is a high grade duck cloth, treated with oil to produce a flexible water-proof material. It is commonly used for insulating field coils and for pads under railway motor field coils,

etc. It can be obtained in 45 mils thickness and either by the yard in 36" width, or in standard width tapes.

## 22. HEAT-RESISTING INSULATION

For Heat Resisting and High Quality Electrical Insulation we use Mica, Micanite, Mica Paper, and Mica Cloth.

Mica is a mineral which is mined in flake or sheet form, and is one of the very few materials which will maintain a high dielectric strength at high temperatures. It is not very strong mechanically in its original form, but is generally made up in sheets by cementing numerous thin flakes together. This is called micanite, and is used for insulating armature slots, between high voltage coils, and for commutator insulation. Flexible sheets are made by cementing mica splittings or flakes to paper or cloth.

A little thought and good judgment will enable you to select the proper insulating material from the foregoing list, according to the requirements for flexibility, space, insulation, and mechanical strength.

The following examples can be used as suggestions, however:

Typical insulation for 220 volt D.C. armature winding, with coils wound with D.C.C. round wire:

1. Slot insulation, fish paper .004" thick.
2. Slot insulation, a layer of varnished cambric .008" thick.
3. Coils taped with "half lapped" cotton tape .004" to .007" thick.
4. Entire coil dipped in insulating compound and baked.

Typical insulation for 500 volt armature winding, with coils wound with D.C.C. round wire:

1. Slot insulation, fish paper .004" thick.
2. Slot insulation, fish paper and mica .012" thick, made up of fish paper .004" thick, 3 layers of mica splittings .002" to .003" thick, one layer of Japanese paper .001" thick; all cemented together.
3. Coils taped with "half lapped" cotton tape .007" thick.
4. Entire coil dipped in insulating compound and baked.

## 23. WINDING COILS

After the proper size of wire and the number of turns for the coils have been determined, either from the old winding in cases of rewinding, or from the designer's data on new machines, the next step is to wind the coils.

We should be very careful to get the proper number of turns and the right size of wire, as well as proper wire insulation.

When winding the coils care should be used to get them the correct length to fit the armature slots. If they are wound too short they will be

very difficult or perhaps impossible to place in the slots. If they are too long, they will make the winding too bulky at the ends, and possibly cause it to rub the machine frame or end plates.

When rewinding an armature it is a good plan to pattern the new coils carefully after one of the old ones which has been removed, both in size and shape.

In winding an armature on which there are no coils to compare with, and no coil measurements given, it is well to make the first coil from your own measurements of the armature, and then try this finished coil in the proper slots before making the others.

Special machines can be obtained for winding and shaping coils of various sizes, and these are generally used in large repair or manufacturing shops. Fig. 15 shows an adjustable coil winder, for making coil loops of various sizes.

For the small shop or the occasional rewinding job to be done by the maintenance electrician, simple coil winding forms can be made up at very low cost.

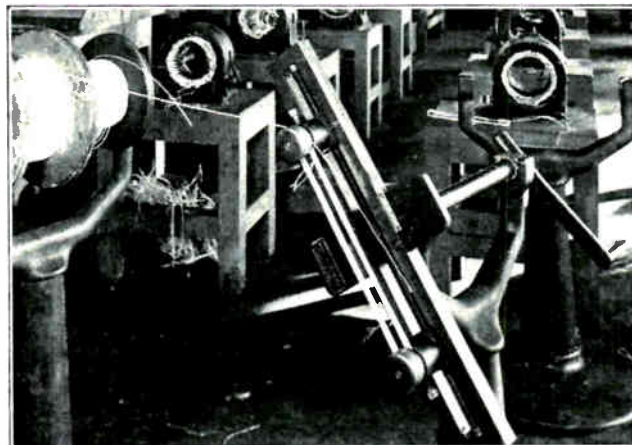

Fig. 15. The above view shows a coil winder which can be used for winding coil loops of different sizes, by adjusting the end pins along the slide. When the crank is turned the wire is wound directly from the spool into the slots on these end pins.

Fig. 16 shows several of these forms which can easily be made from pieces of board. At "A" is shown a flat board with 6 nails or wood pins driven in the proper shape to make a plain diamond coil. By moving the nails or pins, coils of most any desired size and shape can be made.

In Fig. 16-B is shown a method of placing another thick piece of board on the first one and driving the nails for the points of the coil, in the edge of this board at an angle. When the wires are wound over the corner of this board and down under these end nails, it shapes the twist in the coil ends as shown.

Fig. 16, C and D, show how an adjustable winding form can be made, which can be rotated on a large center bolt by means of a crank. This enables a coil to be rapidly wound, by allowing the wire to

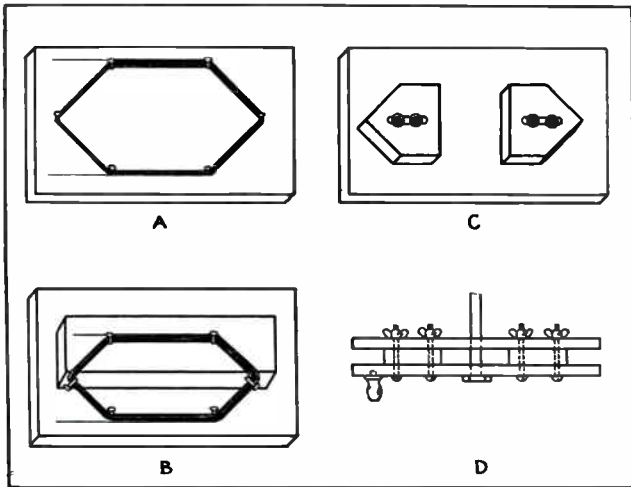

Fig. 16. Simple board forms can be made as shown above for winding coils of various sizes. These are very economical and easy to make, and a very handy device for the small repair shop to have.

run directly from a spool into this form as it is rotated; similarly to the coil winder shown in Fig. 15.

The two center blocks can be fitted with slots so they are adjustable for making coils of different sizes. When adjusted to the proper size for the coils to be wound, the other side-board can be put in place and the whole form clamped together by the bolts and wing nuts shown.

#### 24. TAPING AND SHAPING OF COILS

Coils that are wound on forms of this kind can be tied together with short pieces of wire as they are removed from the form, removing these tie wires, however, before taping the coil.

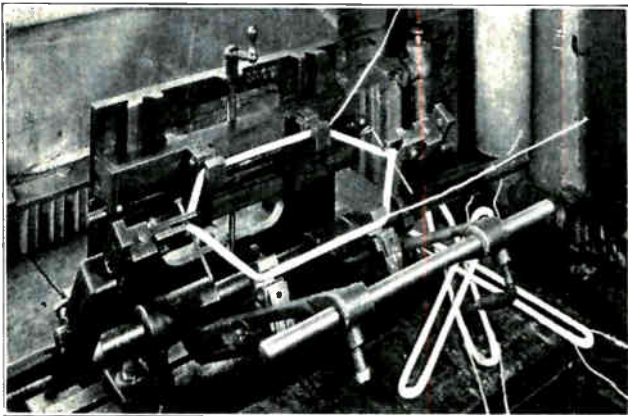

Fig. 17. This photo shows a coil shaping machine, which is used for pulling diamond coils into the proper shape and putting the twist in the ends as shown. This machine is adjustable to shape coils of different sizes.

If the coils are to go in open type slots, they can be completely taped before inserting them. If they are to go into partly closed slots with narrow top openings, the wires must be fed into the slots a few at a time until the coil is all in place. Then the ends of the coil can be taped, and twisted in shape to fit compactly together in the smallest possible space. With the coils in the slots, the points can be gripped with duck bill pliers and twisted to just the right curve.

If desired, the coil ends can be twisted before placing them in open type slots, by hooking a spike or bolt through the coil end and giving it a pulling twist, while the coil is held spread out on four pins or a block.

Remember that to make a neat and well balanced winding it is very important to get all coils of the same size and shape, and the ends twisted uniformly and evenly. Fig. 17 shows a coil shaping machine used for shaping and twisting the coils before they are placed in open type slots.

Fig. 18 shows several coils in various stages of completion. The first coil at the left is just a plain coil loop of the proper length, before taping or shaping. In the center are three of these coil loops already taped. The two coils at the right are completely taped and shaped. Note the sleeving placed

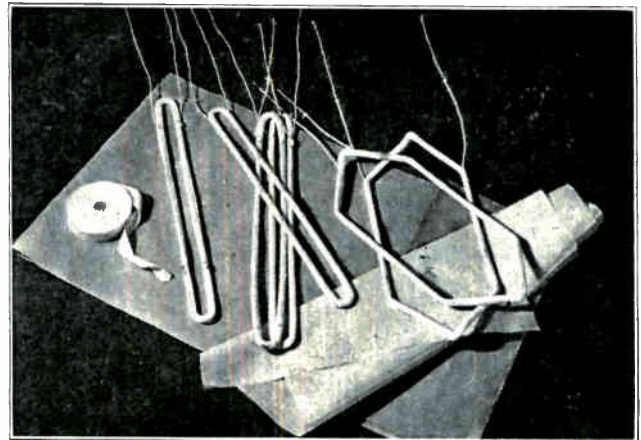

Fig. 18. Above are shown several armature coils, both in the unfinished loops and the completely taped coils. Also note the roll of cotton tape and the varnished cambric used for insulating the coils and slots.

on the coil leads for marking and protection. A roll of cotton tape such as used for these coils is also shown, and underneath the tape and coils are shown a sheet of fish paper and a roll of varnished cambric such as used for slot insulation.



## LAP AND WAVE WINDINGS

Armature windings can be divided into two general classes, according to the methods of connecting the coils to the commutator. These are called **Lap** windings and **Wave** windings. These names are derived from the appearance of the coils when they are traced through the winding.

Fig. 19 shows a section of a lap winding. Starting with the coil at the left, trace the path of current through this coil as shown by the arrows, and then on through the next coil, etc. The coils are all alike but the one on the left is drawn with heavier lines to make it easier to trace the first one. Examining this diagram, we find that each coil overlaps the next as we trace the circuit through them; thus the name **Lap Winding**.

Fig. 19-B shows the method of connecting coils for a wave winding. Starting at the left lead, trace the path of current through the two coils shown by the heavy lines. Note the location of the north and south field poles, which are shown by the dotted rectangles and marked "N" and "S". We find, by tracing the circuit through, that each coil in this circuit is separated from the last by the distance of one pair of poles, and you will note the wave-like appearance of the two coils traced in heavy lines, and from this appearance the name **Wave Winding** is derived.

**Lap Windings** are known as parallel windings and are generally used for lower voltages and machines which must carry heavy currents.

**Wave Windings** are known as series windings and are generally used for machines of higher voltage and smaller currents.

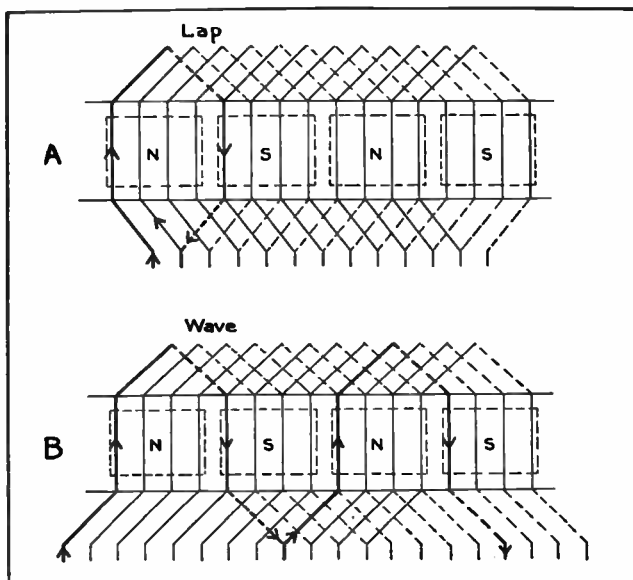

Fig. 19. The two above diagrams show the connections for a lap winding at "A", and a wave winding at "B". Observe carefully the manner in which the leads are brought out from the coils to the commutator bars.

In tracing through a lap winding from one brush to the next, we find two or more groups of coils in parallel between these brushes; while in tracing a circuit of a wave winding, we find a number of coils are in series between the positive and negative brushes.

Both lap and wave windings are used in armatures from fractional horse power sizes to those of hundreds of horse power. The type of winding selected by the designer depends on several factors in the electrical and mechanical requirements of the machine. Wave windings require only two brushes on the commutator. Lap windings generally have as many brushes as there are field poles. Wave windings are quite commonly used on motors for street cars and electric locomotives, because these machines are generally used on quite high voltage. Another advantage of wave-wound machines for this class of work is that their two sets of brushes can be located at adjacent poles and also on whichever side of the commutator they may be most convenient and accessible for inspection and repairs.

TYPE	POLES	BRUSHES	SPACING	CIRCUITS
LAP	2	2	180°M.	2
	4	4	90°	4
	6	6	60°	6
	8	8	45°	8
	10	10	36°	10
	12	12	30°	12
WAVE	4	2	90°	2
	6	2	60°	2
	8	2	45°	2
	10	2	36°	2
	12	2	30°	2

Fig. 20. This convenient table gives the number of brushes and circuits, and the brush spacing for lap and wave windings with different numbers of poles.

The table in Fig. 20 gives the number of brushes, brush spacing, and the number of circuits for lap and wave windings with different numbers of poles. These figures are given for **Simplex** windings, which will be explained later.

### 25. CURRENT FLOW THROUGH A LAP WINDING

Fig. 21 shows a complete four-pole winding of the lap simplex type. This diagram shows the position of the field poles by the dotted lines and markings "N" and "S". It also shows the direction of current flow through the armature conductors under each pole and the position of the brushes with relation to those of the poles. Note that the two negative brushes are connected together in parallel and the two positive brushes connected the same. This winding is drawn out in a flat plan view so that you can more conveniently trace the entire circuit and see all the coils. The last six slots on the right

have only one coil side in each, while all the other slots have two coil sides in each.

If these coils were wound in a round armature with 24 slots as represented here, the first six coil sides on the left would overlap the last six on the right; and the top sides of coils A, B, C, D, E, F, would go in the same slots respectively with coil sides, A', B', C', D', E', F'. The current flow through this winding can be easily traced by starting at the negative brush G, and entering the left lead of coil A, coming around this coil and leaving at its right lead. As there is no brush on segment 2 of the commutator, we must re-enter at the left lead of the coil B, following this coil around and out at its right-hand terminal; then through coils C, D, E, and F in the same manner, going out of the right lead of coil F, to the positive brush H. This completes one circuit.

Next trace the other circuit from the same brush G through coil lead B, which continues through the coil at the far right end of the winding. Trace this current counter-clockwise through coils F', E', D', C', B', and A', leaving at positive brush J.

The other two circuits from the negative brush I can be traced through in the same manner by starting with leads C and D. Thus we find we have four circuits in parallel, or the same number as there are poles.

Note that there are six coils in series in each circuit, and that the number of coils per circuit is equal to the total number of coils divided by the number of circuits.

By comparing this winding with the sketch at A in Fig. 19, we can see that it is nothing more than a number of coils all connected in series, with the finish of one coil attached to the start of the next, etc.

All coils for any given winding are connected the same as the first one. The two ends of each coil are connected to adjacent commutator bars, and this connection is known as the **Simplex Connection**.

Each coil lies in two slots and spans over the intervening slots. They are placed in the slots, one after the other, completely around the armature. In order to arrange the coil ends more compactly and in less space, one side of each coil is placed in the bottom of the slot, and the other side in the top of its slot. This permits the ends of the coils to fit closely together without crossing each other unnecessarily.

**26. COIL SPAN**

The number of slots spanned by one coil is known as the **Coil Span**. The two factors which govern this coil span are the number of slots in the core and the number of poles. When we know the number of slots and the number of poles of any machine, the correct full pitch coil span for its armature winding can be found as follows: **Divide the total number of slots by the number of poles, and the next whole number above this answer will be the number of slots the coil should span.**

For example, if we have an armature with 21 slots and for a machine with 4 poles, then  $21 \div 4 = 5\frac{3}{4}$ . The coil span, of course, cannot be a whole number and a fraction, and therefore the next whole number above  $5\frac{3}{4}$  is selected. So the coil span will be 6 slots.

The top side of coil No. 1 will lie in slot No. 1, and the bottom side in slot No. 6.

In another case, we have a 28-slot armature to be wound for a four-pole machine. Then  $28 \div 4 = 7$ ; and the next whole number above this being 8, we will use a coil span of 1 to 8.

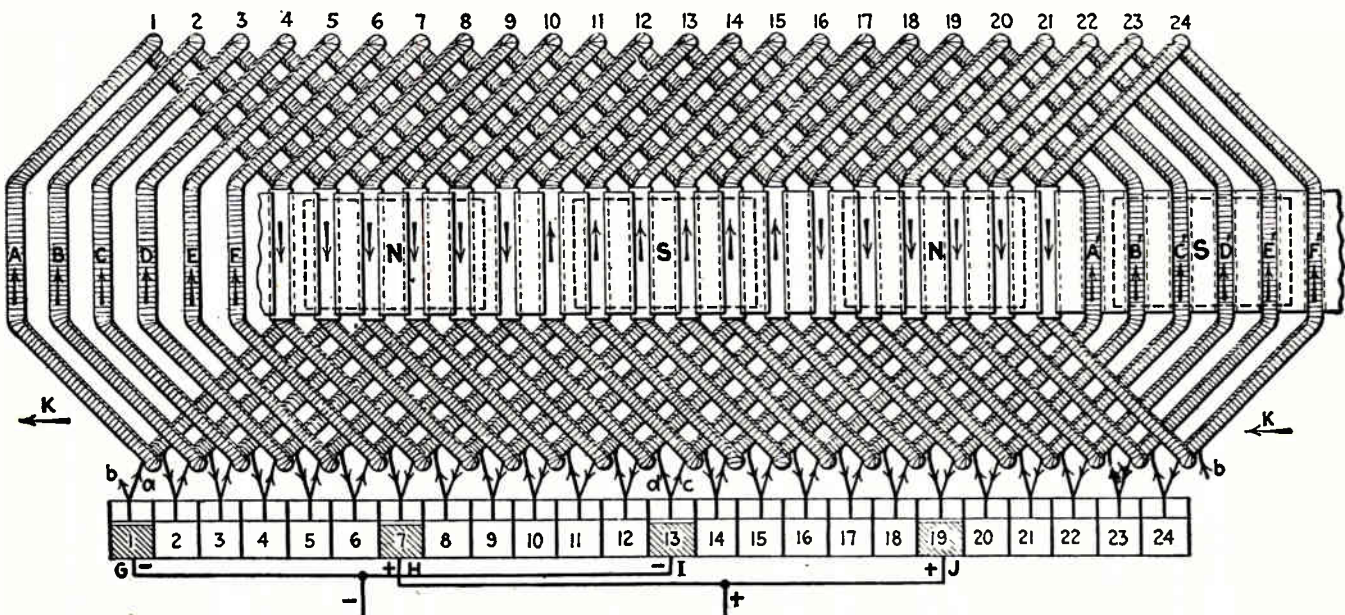

Fig. 21. The above diagram shows a complete four-pole lap winding of the Simplex type for a generator. Note the manner in which the coils are laid in the slots, with one side of each coil in the bottom of a slot and the other side in the top of its slot. Also trace out this winding carefully with the instructions given on these pages.

## 27. PREPARING AN ARMATURE FOR WINDING

Now that we know how to make the connections for a lap or wave winding and how to determine the correct coil span for a given number of slots and poles, our next step will be the actual placing of the coils in the slots. Before this is done, however, the slots must be prepared and insulated to protect the coils from grounding against the sides or corners of them. The slots should be smoothed out carefully with a flat file, to remove the sharp edges and burrs which are often found in the bottom and sides of slots. The commutator should also be prepared by making a slot in the Neck or Riser of each bar, in which the coil leads will be placed. We should also test across each pair of bars or segments with a 110-volt test lamp to make sure that no bars are shorted together, due to defective mica insulation between them. A test should also be made from the segments to the shaft, to be sure that no part of the commutator is grounded to it. This should always be done before starting a winding, because if the commutator is defective the armature will not operate properly when the winding is in.

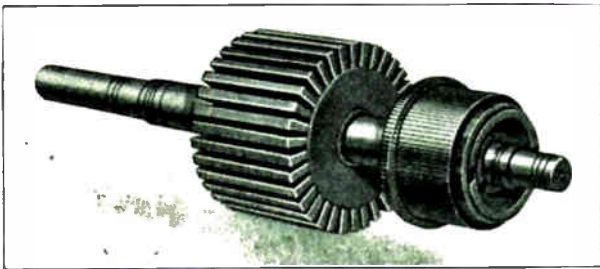

Fig. 22. The above photo shows a D.C. armature prepared for winding. The slots are cleaned and smoothed out, and the necks of the commutator bars have been slotted to receive coil leads.

Fig. 22 shows an armature with the core and commutator prepared for winding, and in Fig. 23 is shown an armature with the insulation placed in the slots. Note that this slot insulation is allowed to project slightly at the ends of each slot, to protect the coils at these sharp edges; and also out of the tops of the slots a short distance, to make it easier to slide the coils in, and to protect them from scratching or damaging the insulation while they are being placed in the slots. Also note the insulation wrapping on the coil support ring at the left end of the armature. All such metal parts against which the coils may rest should be thoroughly insulated by wrapping with fish paper or varnished cambric and tape, before any coils are placed in the slots.

## 28. INSERTING COILS FOR A LAP WINDING

By referring to the several sketches in Fig. 24, the method of laying coils in place in the slots can be observed. In the three views at "A" the coils are wound in from the left to right, as shown by the arrow. Note carefully the manner in which each

coil overlaps the last, and the manner in which the diamond shaped ends of the coils allow them to fit closely and neatly together, if they are properly shaped and twisted at the ends. In order to obtain a satisfactory winding job, it is essential that all coils be exactly the same size, and uniformly fitted in the slots and at their ends. Care and practice on these points are necessary to make a rugged and well-balanced winding.

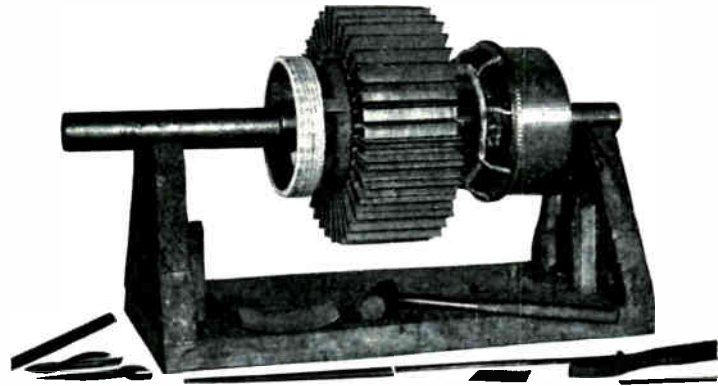

Fig. 23. This armature has the slot insulation in place ready to receive the coils, and you will also note that the coil support ring at the left end has been wrapped with insulating tape. The armature is mounted in a stand and free to revolve so it will be more convenient to place the coils in all the slots.

The coils at "B" in Fig. 24 are wound into the slots in the opposite direction around the armature, or to the left when facing the commutator end. Armatures may be wound in either direction, as it makes no difference in their operation. The direction in which the coils are placed in depends on the shape of the twist or curl at their ends, and the important point to remember is that if the coils are shaped as shown at "A", they must be laid in the slots to the right, in order to get their ends to fit together compactly. If the twists on the coil ends are made in the opposite direction, as at "B", then the coils must be laid in the armature to the left.

Sometimes coils fit very tightly in the slots and it is necessary to use a driver of some kind to force them down to the bottom of the slots. Such a coil driver can be easily made from a piece of hard fibre about three inches wide and six inches long, and just thin enough to slide easily through the top of the slot. After the coil is started in the slot, this driver is laid on top of it, and by tapping the top of the driver with a mallet the coil can be driven down in place. Extreme care should be used, however, not to apply too much force, as it may result in broken or cut insulation on the coil.

After the bottom side of the first coil is in place in the slot, (leave the top of this coil out for the present), the lower coil lead should be brought out to the commutator and driven into the slot in the proper segment. The angle of this lead, or whether it connects to a segment in line with the center of the coil as in Fig. 24, or is connected straight out to a bar in line with the side of the coil, depends upon the position of the brush with relation to the field poles.

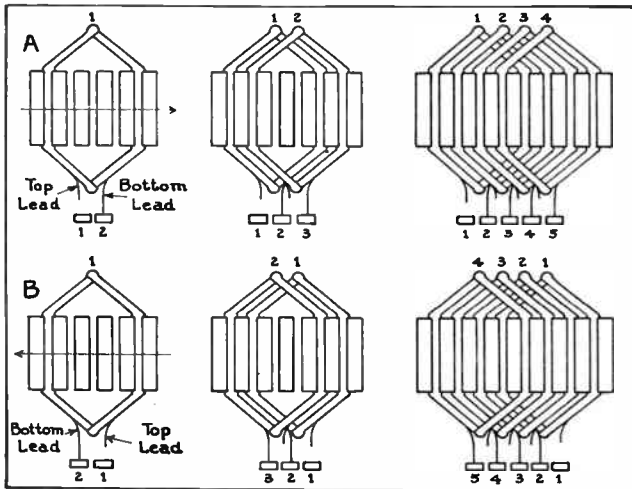

Fig. 24. The above diagrams show the method of laying coils of a lap winding in the slots. Note the direction in the coils are laid in or progress around the core, according to the shape of the twist at their ends.

An explanation of these two different methods of connecting the coil leads is given a little later.

Now the first coil is in place and its lower side in the slot, the bottom lead connected to the commutator segment but the top side of the coil left out of its slot, and the top lead left unconnected. The second coil should be placed in the next slot and its bottom lead connected to the next adjacent commutator segment, but the top side of this coil and its top lead should also be left out, as with the first one. The next two coils are placed in the slots in the same manner. When the fifth coil is inserted both sides can be placed in the slots, as the coil span is one to five, and the top side of the fifth coil will lie in the slot with the bottom side of the first coil. The top lead of the fifth coil should be left disconnected from the commutator.

**29. CONNECTING THE COILS**

From this point on, both sides of all the other coils can be placed in the slots as the winding progresses, but all of their top leads should be left unconnected until all coils are in, and the bottom leads all in place.

A layer of varnished cambric should then be wound tightly around the bottom leads, and should be wide enough to extend from the ends of the coils to the commutator, so it will thoroughly insulate the bottom leads from the top ones. The top leads can then be connected to the commutator segments as follows:

The top lead of coil No. 2 in Fig. 24 will connect to segment No. 2, with the bottom lead of coil No. 1.

After carefully making this first connection, all the other leads can be connected in the same manner: the top lead of coil No. 3 to bar No. 3; the top lead of coil No. 4 to bar No. 4; etc.

After all the top leads are in place, the winding should be carefully tested for shorts, opens, and "grounds." This should always be done before soldering the leads to the commutator. The method

of making these tests is explained in a later article.

We are now ready to trim off the excess insulation at the top of the slots. Fold in the edges neatly over the coil and place the slot wedges over it to hold the coils in. If the slots are not equipped with lips or grooves to hold the wedges in place, the armature should be banded with steel wires. The top leads are also quite often banded with steel wire or heavy twine to hold them rigidly in place and prevent their being thrown outward by centrifugal force when the armature is run at high speed.

If steel wire is used for banding these leads, they should first be well wrapped with several layers of fish paper or varnished cambric, to prevent any possible short circuits between them and the steel banding wire.

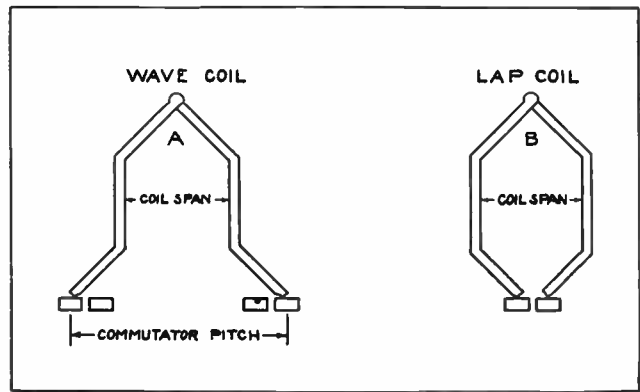

Fig. 24-C. At "A" is shown a coil for a wave winding and at "B" a coil for a lap winding. Note the difference in the way their ends or leads are brought out to the commutator bars, and the manner in which either side of the wave coil is braced in two directions by the angle of its front and back connections.

The shape of wave-wound coils, their connections, and the manner in which they differ from lap windings, has already been explained. Wave windings have the advantage of their coils being more securely braced and held in place by the way they are arranged in the armature. This is due to the manner in which the coil ends are bent in the opposite direction from the coil side in the slot, while those of the lap winding are bent in the same direction as shown in Fig. 24-C.

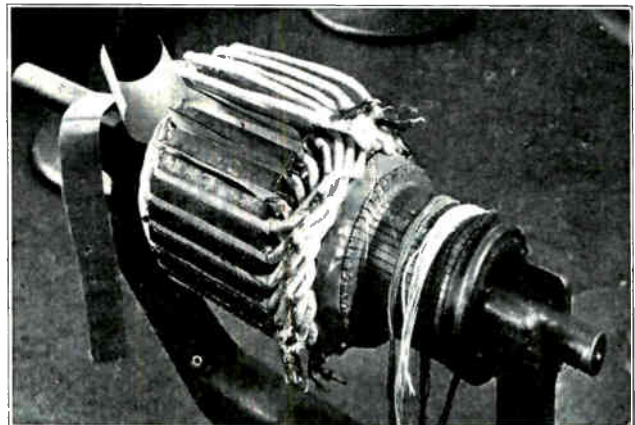

Fig. 24-D. This photo shows an armature completely wound, with the exception of laying in the last top coil sides, and connecting the leads to the commutator.

When an armature is in operation there is considerable centrifugal stress, which tends to throw the windings out of the slots; so the more rugged the winding can be made the better it is.

Automobile starting motors frequently use wave windings in open type slots, and even without bands on the armature. This is because the strength of the heavy wave coils is sufficient to hold the winding in place. Large A.C. machines which have wound rotors very often use wave windings, because of the greater mechanical strength of these windings when completed.

Fig. 25 shows a diagram of a complete wave winding. By tracing the coils, we find that there are only two circuits in parallel between the positive and negative brushes, but that there are eight coils in series. Two brushes are all that are needed to complete the circuits through all coils, but more brushes may be used, if desired, in order to reduce the current intensity in each brush. There can be as many brush groups as there are poles.

In Fig. 25, the two coils indicated by X and X are at present short circuited by the positive brush. Each pair of coils must reverse in polarity as they move from one pole to the next, and this current should reverse when the segments connecting these coils are shorted by the brush or, in other words, the brush should short circuit the coil as it passes through the neutral plane in the center of the space between two poles.

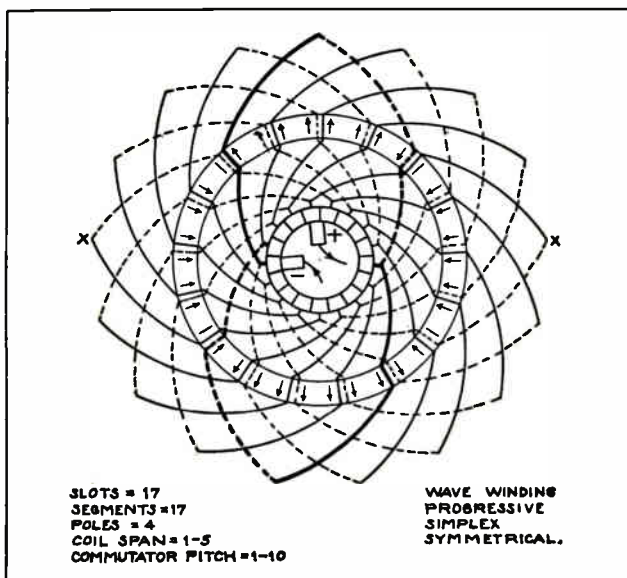

Fig. 25. This diagram shows a complete four-pole wave winding for an armature with 17 slots. Note the coil span and commutator pitch, and trace out the two coils shown with heavier lines.

### 31. PROCEDURE FOR WAVE WINDINGS

Wave windings are made much the same way as lap windings, and the coil span will be the same for a given armature regardless of which winding is used. The coils are laid from the bottom of one slot to the top of the other, the same as described for a lap winding, and they may also be wound

either to the right or to the left. There is a difference, however, in the manner of making connections of their coil leads to the commutator bars, and in the distance between leads of any one coil. This distance between the coil leads is expressed by the number of commutator bars between them, and is known as **Commutator Pitch**. After this commutator pitch has been determined the coils are placed in the slots much the same as with a lap winding.

Commutator pitch for wave windings can be determined by the following formulas.

For a progressive wave windings—

$$\text{Pitch} = \frac{\text{Segments} + \text{plex}}{\frac{1}{2} \text{ the number of poles}}, \text{ plus } 1$$

The term **Plex** refers to the methods of connection of the coils to the commutator, known as simplex, duplex, and triplex. These will be explained later.

In this formula simplex equals 1, duplex equals 2, triplex equals 3.

For retrogressive wave windings—

$$\text{Pitch} = \frac{\text{Segments} - \text{plex}}{\frac{1}{2} \text{ the number of poles}}, \text{ plus } 1.$$

### 32. PROGRESSIVE AND RETROGRESSIVE

In Fig. 25 the coil sides which lie in the tops of the slots are shown by solid lines, while those which lie in the bottoms of the slots are shown by dotted lines. If we start at the negative brush and trace the top lead of the upper coil shown in the heavy lines, we find that the bottom lead of the second coil in this circuit connects to a commutator bar just to the right of the one at which we started, and if we trace on around the next pair of coils we arrive at a bar one more step to the right. This is known as a **Progressive Winding**, and applies to either lap or wave windings.

If, after tracing through two coils, the bottom lead of the second coil connects to a bar to the left of the one at which we started, it is called a **Retrogressive Connection**.

### 33. INSERTING COILS OF A SYMMETRICAL WAVE WINDING

Fig. 26 shows the procedure of laying in the coils for a winding such as shown in Fig. 25. At "A" the first coil is placed in the slots and the bottom lead brought out to its commutator segment. The proper point for this first connection can be found by locating a commutator segment that is in line with the center of the coil as shown at "A". Then divide by 2 the commutator pitch which has previously been determined, and count off this number of bars to the right of the center bar, which has been located. This will locate the proper bar to connect the bottom lead of the first coil to. This distance is shown from "A" to "B" in Fig. 26-A.

Sometimes a mica segment will be in line with the center of the coil and in this case we start to count with the next bar to the right as No. 1. If

the commutator pitch happens to be an odd number, dividing this by 2 will give a whole number and a fraction, in which case we should use the next larger whole number.

After the first coil is in place but with its top side and top lead left out, the second coil is inserted in the next slot to the right and the bottom lead will be connected to the next bar to the right of the first one. The third and fourth coils are inserted in the same manner, leaving their top sides and leads out. The fifth coil can have both sides placed in the slots, but its top lead should still be left unconnected, as should all the other top leads, until all coils are in place.

When the winding is completed around the armature and the bottom sides of the last four coils are in their slots, then the top sides of the first coils can be placed in on top of these. After all coil sides and bottom leads are in place, the top leads are then connected to the commutator bars.

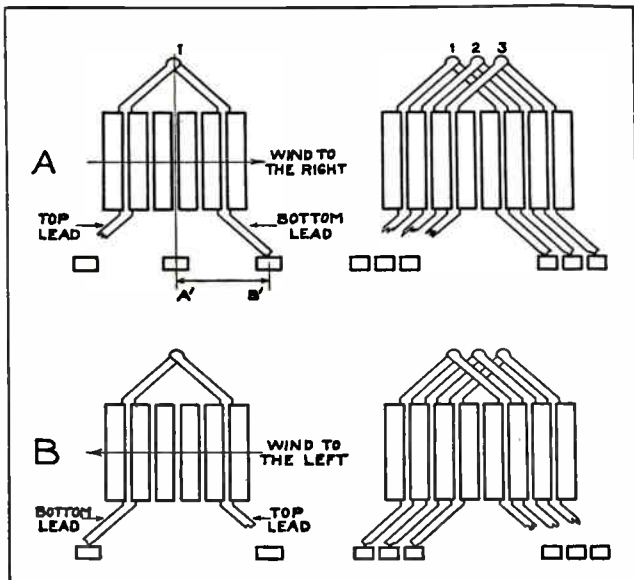

Fig. 26. The above views show the method of laying the coils of a wave winding in the slots. One side of each coil should go in the bottom of the slots, and the other sides in the tops of slots, and the coils should be laid in in the directions as shown and according to the shape of the twist on their back ends.

### 34. DETERMINING COMMUTATOR PITCH AND CONNECTING THE COILS ON WAVE WINDINGS

The armature shown in Fig. 25 has 17 slots and 17 commutator segments and is connected simplex. We will use it for an example to determine the commutator pitch.

We have learned that for a wave winding:

$$\text{Commutator pitch} = \frac{\text{Segments} + \text{plex}}{\frac{1}{2} \text{ number of poles}}, \text{ plus } 1,$$

$$\text{or: — pitch} = \frac{17 + 1}{2}, \text{ plus } 1$$

In which:

17 = slots

1 = simplex

2 = 1/2 of 4 poles

With a commutator pitch of 10, the coil lead

from the top side of one coil will connect to bar No. 1, and the lead from the bottom of the same coil to bar No. 10, counting toward the coil that is being checked. After the first top lead is connected all the others are connected in the same way.

The completed winding is then wedged and banded if necessary, as was done with the lap winding.

We should remember that some armatures cannot be wound wave except by using dead coils or bars. The commutator pitch formula determines whether a winding can be connected wave or not. When a commutator pitch is a whole number and a fraction the winding cannot be connected wave without using dead coils or bars.

### 35. ELEMENT WINDINGS

That part of the armature winding which is connected between two commutator bars is called a **Winding Element**. A simple winding element would consist of one complete turn of wire. Each side of this turn or coil is referred to as an armature conductor or sometimes as an "inductor". Each element, therefore, will have at least two conductors, and may have many more, according to the number of turns per coil.

In many armatures the coils are wound with several conductors in parallel and the ends of each of these conductors can be connected to separate commutator bars. This will, of course, require a greater number of commutator bars than there are slots in the armature. But many machines are designed in this manner to reduce the voltage between bars.

It is not good practice to have too high a voltage across adjacent commutator bars, because of the greater liability of puncturing the mica insulation and the increased tendency to flash over or arc between bars while the machine is in operation.

Carbon particles from the brushes and metallic dust from the commutator tend to start small sparks or arcs of this kind; and if the voltage between bars is too high, the arcs will be maintained and possibly burn the mica insulation between the bars. If this mica becomes charred or deeply burned, it results in a short circuit between bars, which will cause the coils of the windings to heat up and possibly burn out.

On high voltage machines the voltage between bars usually doesn't exceed about 25 volts. On smaller machines it may range from 2 to 10 volts. So we can readily see that the higher the voltage the machine is to be operated at, the greater number of commutator bars it will usually have. This number of bars is determined by the designer or manufacturer in building machines on any given voltage.

The number of slots in an armature is determined by the number of poles and the practical number of slots which can be used per pole. The slots, of course, cannot be too numerous or close together, or there will not be sufficient iron between the coils

to provide a good magnetic path through the armature for the field flux.

The number of slots is generally considered in determining the exact number of commutator bars, as the number of bars is usually a multiple of the number of slots. For example, an armature with 24 slots might have 24, 48 or 72 commutator bars. In the latter case the coils would be wound with three conductors in parallel, and the six leads from each coil connected to the proper bars.

So we find that armature windings can be called single element, double element, or three element windings, according to the number of conductors in parallel in the coils, and the number of bars in proportion to the number of slots.

### 36. WINDING SMALL ARMATURES

In the following paragraphs we will explain in detail the method of winding a small two-pole, two-element, non-symmetrical armature having 12 slots and 24 segments.

The slots should first be lined with fish paper about 7 to 10 mils thick, and varnished cambric about 7 mils thick. The fish paper is placed in the slot, next to the iron core, and the varnished cloth or cambric is placed inside the fish paper. To complete the insulation of the core we generally use at each end a fibre lamination which is shaped the same as the iron core laminations and has the same number of slots stamped in it. This protects the coils at the corners of the slots.

The armature should be held or clamped with the commutator end next to the winder.

In winding the first coil the number of turns will depend on the size of the armature and its voltage rating. If this number is taken from coils in an old winding, the turns in one or more of the old coils should be very carefully counted.

When winding an armature that has twice as many bars as slots, we wind two coils in each slot, thereby providing enough coil leads for all bars.

The first coils for this armature will go in slots 1 and 7, winding to the right of the shaft, at both the front and back ends of the core. After winding in one coil, a loop about 4 inches long should be made at slot No. 1. Then continue and wind the same number of turns again, still in slots 1 to 7. When the last turn is finished, run the wire from the 7th slot over to the 2nd, and make a loop at slot 2. Next wind a coil in slots 2 and 8, and again make another loop at slot 2. Then place another coil in the same slots 2 and 8, and finish with a loop at slot 3, etc. This places two coils and two loops in each slot, and the same procedure should be followed until there are two coils and two loops in every slot.

The slot insulation should then be folded over the tops of the coils, and the wedges driven in.

The loops are next connected to the commutator, one loop to each segment, and they should be connected in the same way that they were made in the winding. That is, the first and last single wires are

brought together and connected to a segment straight out from the first slot. The second loop in the first slot is connected to the next bar, and the first loop in the second slot connected to the next, etc.

To avoid mistakes these loops should be marked with cotton sleeving which is slipped on over them as they are made. Red sleeving could be used on the first loop of each slot, and white sleeving on the second, which will make it easy to locate the first and second loops for each slot. This winding would be used in a two pole frame, and has two circuits with 12 coils in each. If 110 volts were applied to this winding the voltage between adjacent commutator segments would be  $110 \div 12$ , or  $9\frac{1}{6}$  volts, which is not too high between adjacent bars. If this same armature had a commutator of only 12 segments, the voltage between bars would be  $110 \div 6$ , or  $18\frac{1}{3}$  volts, which is a little high for this sized armature.

### 37. ELEMENT WINDINGS FOR LARGE ARMATURES

In winding large armatures having twice or three times as many segments as there are slots, the coils are made up specially for the type of armature and wound with two or more wires in parallel.

In Fig. 27-A are shown the coils for two-element armatures. These coils are wound with two wires in parallel; and when the coil is completed, two small coils or elements are in each bundle. These two elements are taped together with cotton tape. The top and bottom leads of one element are marked with sleeving of one color, and those of the other element are both marked with sleeving of another color.

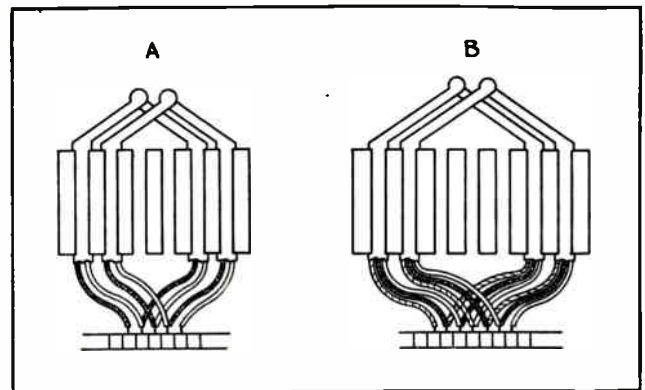

Fig. 27. The diagram at "A" shows the connections of lap coils for a two element winding. At "B" are shown the connections for a three element winding. Note how the separate windings in each coil are connected to two separate commutator bars.

These coils are placed in the slots the same way as single element coils, the only difference being that there are two bottom leads to connect instead of one. When connecting the bottom leads a definite system should be followed in the colors. If black and red sleeving are used to identify the two elements, first connect a black lead and then a red. When the second coil is placed in, again connect a black lead and then a red one.

In order to avoid mistakes in the connections, all

coils should be connected in a similar manner. When the top leads are connected use the same system, and connect around the armature in the same direction. This method can be used on any armature, regardless of the combination of slots and segments.

Fig. 27-B shows the coils for a three-element winding having three wires wound in parallel in each coil, and the leads marked with three separate colors. These colors are alternated when the bottom leads are connected in, each succeeding coil being connected similarly. The top leads are connected around the armature in the same direction as the bottom leads were, and the colors alternated in the same manner.

An armature winding may be of 2, 3, 4, or more elements, and the system for connecting these coils is the same as for a single element wave winding, only more than one lead is connected to the commutator from each coil. The leads are marked with sleeving and the colors are alternated as in the lap windings.

Many 2 and 3 element wave-windings have dead coils which are not connected in the armature circuit. They occur when the number of segments in the commutator is less than a multiple of the number of slots. When a winding has one dead coil it should be left in the slots to mechanically balance the armature; but if more than one dead coil occurs in a winding they may be left out, provided they are at equally distributed points around the armature core.

### 38. CHANGING AN OLD MOTOR FOR NEW CONDITIONS

It is often desired to change the voltage or speed at which a motor may operate, and in such cases some change is usually made in the windings. We have already learned that the voltage of an armature winding depends on the number of turns per coil. So it is evident that if any change is made in the number of turns between brushes it will have a direct effect on the voltage. The voltage of a winding will vary directly with the number of turns.

For example, a winding has 10 turns per coil of wires 4000 C.M. in area and operates on 110 volts. If we wish to rewind this machine for 220 volts we can do it by using 20 turns per coil of wire with 2000 C.M. area. This rewind armature would operate on 220 volts with the same speed and horse power as it formerly did on 110 volts.

It will be necessary, however, to change the field coil connections also. If they were formerly connected two in series and two in parallel, as in Fig. 28-A, they could be reconnected all in series, as shown in Fig. 28-B, and would then operate satisfactorily on 220 volts.

If the field coils are all connected in series on 110 volts, they cannot be changed for 220-volt operation without rewinding. To rewind them for double voltage, we should use approximately twice as many turns of wire, of a size one-half as large

as the wire with which they were formerly wound.

The resistance of the field coils will have to be increased to stand the increased voltage. This, of course, will reduce the amount of current flowing, but the additional number of turns will maintain approximately the same ampere-turn strength of the field magnets. **If we change the number of turns in the winding of an armature and leave the applied voltage the same, its speed will vary inversely with the number of turns.**

For example, if an armature is wound with 25 per cent more turns, the speed will decrease about 25 per cent if the machine is left on the same voltage.

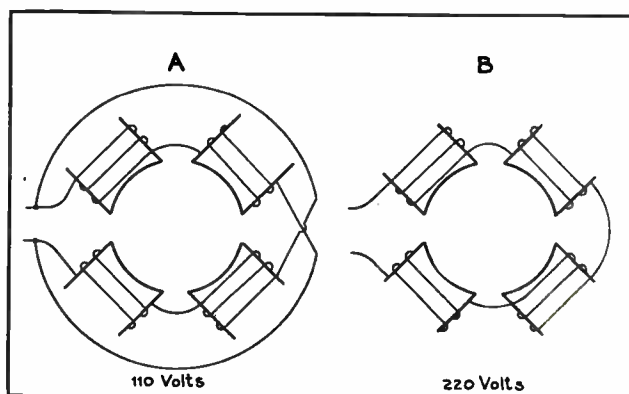

Fig. 28. The above diagram shows the methods of changing the field pole connections from parallel to series to be able to operate them on higher voltage.

### 39. MULTIPLEX WINDINGS

In some cases, where armature windings are designed to carry very heavy currents and at lower voltages, the connections can be arranged to provide a greater number of circuits in parallel through the windings. Windings connected in this manner are called **Multiplex Windings**. Those which we have covered so far have been **Simplex Windings**; and, in the case of the lap windings described, they have had the start and finish leads of each coil connected to adjacent bars of the commutator. Fig. 29-A shows a coil of a lap winding connected in this manner. With simplex connections a lap winding will have only as many circuits in parallel as there are field poles.

If we simply move the finish lead of a coil one segment further from the starting lead, and use a wider brush to span two bars instead of one, we have provided twice as many circuits through the winding, or two circuits for each pole. This is called a **Duplex Connection** and is shown in Fig. 29-B.

If we move the leads one more segment apart, we provide 3 circuits per pole, and have what is known as a **Triplex Connection**, as shown in Fig. 29-C. In this case the brush must be wide enough to span three commutator segments.

Fig. 30 illustrates the difference between simplex and duplex connections, with simplified winding diagrams. These sketches are laid out to show the winding in a straight form. On the actual armature the ends of this winding would come together at the points marked X and X.



In Fig. 30-A is shown a simplex connection with the start and finish leads of each coil connected to adjacent segments. If we start at the positive brush and trace the circuit to the left to the negative brush, we will pass through 12 coils in series; and the same will be true of the other circuit traced to the right from the positive brush to the point X, which in reality connects back to the negative brush in the actual winding. So we find we have two circuits in parallel between the brushes, and each of these circuits consists of 12 coils in series. If we assume that each coil is wound with a sufficient number of turns to produce 10 volts and with wire of a size that will carry 5 amperes, then this winding will produce 120 volts between brushes and have a total capacity of 10 amperes.

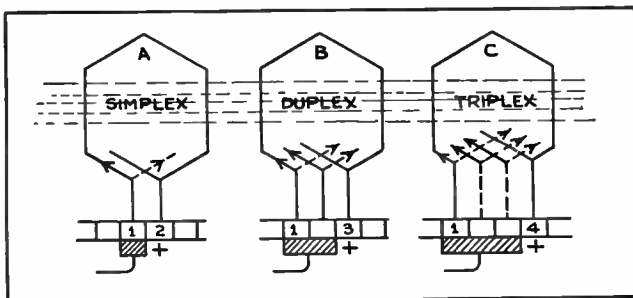

Fig. 29. "A" shows the connections for a coil of a simplex lap winding. "B" shows the connections for a duplex lap winding, and "C" those for a triplex lap winding.

This is easily understood by recalling our laws of series and parallel circuits. We know that when coils are connected in series their voltages are added. So 12 coils with 10 volts each will produce  $12 \times 10$ , or 120 volts.

Connecting circuits in parallel does not increase their voltage, but does increase the current capacity; so with two circuits each having five amperes capacity and connected in parallel, the total current capacity will be 10 amperes.

In the lower sketch of Fig. 30-B, we have simply moved the start and finish leads of each coil one bar farther apart, which in effect makes two separate windings, or 4 circuits in parallel between the positive and negative brushes. In this diagram we have lengthened the coils of one section simply to make them easier to trace separately from the other. Tracing through any one of these four circuits from the positive to negative brush, we now find there are only six coils in series. So the voltage of this winding will be  $10 \times 6$ , or 60 volts. But as we now have four circuits in parallel between the positive and negative brushes, the current capacity of this winding will be  $4 \times 5$ , or 20 amperes. The wattage of either winding will be the same, however.

The brush span for a simplex winding is generally equal to the width of two to 3 segments, while for a duplex and triplex winding it must be increased proportionately.

Wave windings can also be connected duplex or triplex if the commutator pitch is a whole number.

So the surest way to determine whether a wave wound armature can be connected duplex or triplex, is to calculate the commutator pitch; and if this number is a whole number and fraction the winding cannot be connected multiplex.

#### 40. NEUTRAL PLANE—IMPORTANT TO COMMUTATION

We have learned that the coils of a motor or generator winding must have their polarity reversed as the coil sides move thru the neutral plane between two field poles. As the armature rotates and the segments slide under the brushes, the brushes repeatedly short circuit the coils which are connected to adjacent brushes. In order to avoid bad sparking at the brushes this short circuit must occur at the time the coil is dead, or passing thru a neutral point where no voltage is induced in it. This means that the brushes must always be in the correct position with regard to field poles, in order that they may short circuit the coils at the right time. This point is of great importance to good commutation, and will be more fully discussed later.

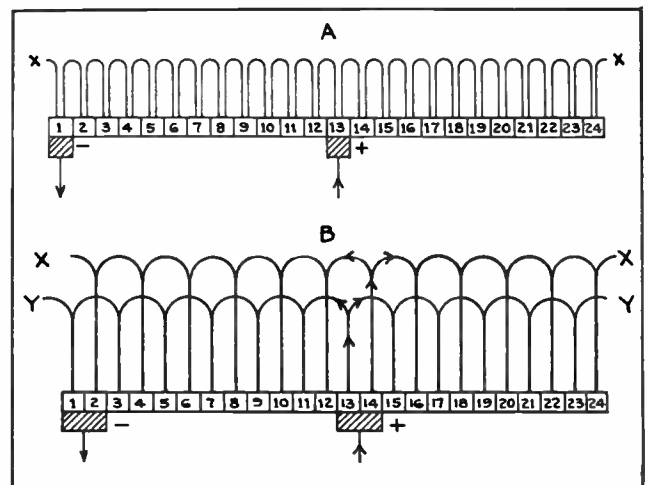

Fig. 30. At "A" is shown a simplified diagram of the circuit in a winding connected simplex lap. At "B" the winding is connected duplex, doubling the number of circuits from positive to negative brush.

#### 41. SYMMETRICAL AND NON-SYMMETRICAL CONNECTIONS

The angle at which the coil leads are brought out from the slots to the commutator segments depends upon the position of the brushes with respect to the poles. If the brushes are placed in line with the centers of the field poles, then each coil lead comes out from the slots at the same angle, to two bars directly in the center of the coil. This is called a **Symmetrical Connection**, as it leaves the coil and leads in a symmetrical diamond shape.

Fig. 31-A shows this condition on a machine which has the brush located in line with the center of the field pole, and you will note that the leads are of equal length and brought out from the slots to the two bars in the center of the coil span. If the brushes of the machine are located at a point between the field poles, the coil leads must be carried to one side in order to be connected to the seg-

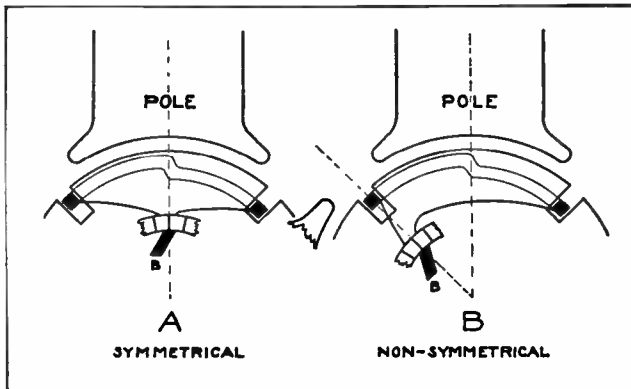

Fig. 31. Note the position of the brushes with respect to the poles, and also the shape of the end connections of the above lap winding coils for symmetrical and non-symmetrical windings.

ments at the time they are short circuited by the brush.

Fig. 31-B illustrates this condition. One lead is brought straight out from the slot to the segment, while the lead from the other side of the coil is carried clear across to the adjacent segment. This is called a Non-Symmetrical Connection, because of the lengths and unbalanced shape of the coil leads.

Whether the brushes are located in line with the center of the field poles or in line with the neutral plan depends, to quite an extent, on the mechanical design of the machine. In some cases the brushes are much easier to get at for adjustment and replacement, if they are located as in Fig. 31-B.

In small fractional-horse-power motors there is generally very little space between the centers of the field coils and the end shields. So the brush holders are frequently bolted to the end shields at a point between the poles. This makes necessary the use of a non-symmetrical connection on the armature coil leads.

On larger machines, where there is plenty of space for the brush holders, they are usually placed in line with the centers of the field poles, and the coil leads of the armature are connected symmetrically.

## 42. COLLECTING DATA FROM OLD WINDINGS

When rewinding any armature, care should be taken to collect sufficient data while dismantling the old winding to enable you to put in the new winding correctly. It is a very good plan to mark the slots and commutator segments from which the first coil and leads are removed. This can be done with a prick-punch or file, as shown in Fig. 32. One small punch mark can be placed under the slot that held the top coil side, and two dots under the slot that holds the bottom side of the same coil. The top leads are then traced out to the commutator, and each bar that they connect to should be marked with one dot. Next trace the bottom leads to the commutator, and each of the bars they connect to should be marked with two dots. This can be done with both lap and wave windings, and is a positive way of keeping the core and commutator marked,

to be sure to replace the coils and connections properly.

If necessary, you can also make a sketch or diagram of the first few coils removed. This sketch can be made similar to the ones in Fig. 32, and can show the exact coil span, commutator pitch, etc.

In addition to marking the core and commutator and keeping a diagram of the winding and connections, the following data should be carefully collected as the old winding is removed.

1. Turns per element.
2. Size of conductor.
3. Insulation on conductor.
4. Coil insulation.
5. Slot insulation (layers, type, and thickness.)
6. Extension of slot insulation from each end of core.
7. Extension of straight sides of coils from each end of the core.
8. Over-all extension of the winding from the core, both front and back.

If these things are carefully observed and recorded, you should have no difficulty in properly replacing most any type of winding and getting it back in the same space, and with the same connections. It will, of course, require a little practice to be able to make your coils exactly the proper size and shape so they will fit neatly and compactly in the armature.

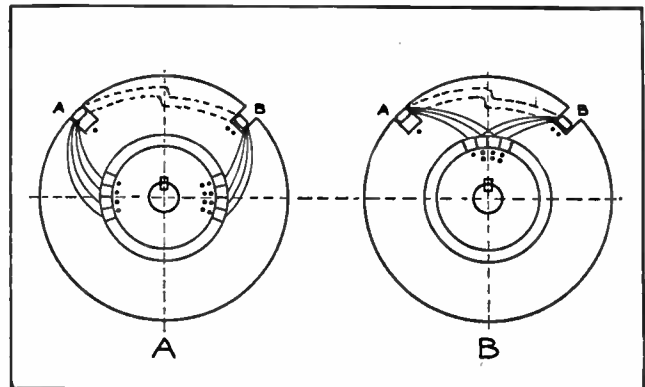

Fig. 32. A very simple and sure way of marking the commutator and armature when removing an old winding is shown above. Compare these sketches carefully with the instructions given, so you will be able to replace winding correctly.

## 43. BANDING ARMATURES

Wire bands, as previously mentioned, are generally used on large armatures having heavy coils, to hold the coil ends securely in place. If the core has open slots, bands are often used over the core to hold the wedges in place. High-grade steel piano wire is commonly used for this purpose and can be obtained in rolls in various sizes. This wire is usually tinned at the factory.

When a banding machine is not available, a lathe can be used to hold the armature while the bands are wound on. A layer of paper or cloth is usually placed under the band. Cloth makes the best foundation for bands placed on the coil ends, as the cloth tends to keep the bands from slipping off. A layer

of fuller board or fish paper can be used under bands placed around the core. Grooves about  $1/32$  of an inch deep are usually provided for the bands on cores with open slots.

The paper should be cut carefully to the exact width of this groove, so it will fit snugly and without sticking out at either side. The banding wires should be wound on under tension, so they will be firm and tight when completed. A simple tension clamp or brake can be made by cutting two strips of fibre  $1/4$  inch by  $1\frac{1}{2}$  by 6 inches, and bolting these together with two small bolts, using wing nuts on each end. Place these pieces of fibre in the tool post of the lathe and run the wire between them. Then, by adjusting the two wing nuts, any desired tension may be obtained.

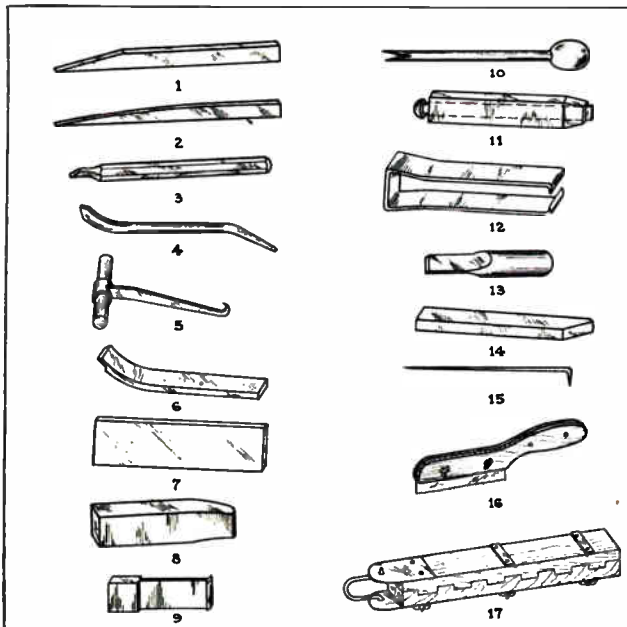

Fig. 32-C. Above are shown a number of the more common tools used in armature windings. No. 1 is a stripping tool for stripping open slot armatures and stators. No. 2—coil lifter for lifting coils from the slots. No. 3—lead lifter for lifting coil leads from commutator risers. No. 4—lifting tool for prying tight coils from slots. No. 5—coil hook to break coil ends loose from insulating varnish. No. 6—coil puller for sliding top sides of coils into slots. No. 7—fibre slot drift for driving coils into slots. (4 thicknesses needed:  $3/16$ ",  $5/16$ ",  $7/16$ ",  $9/16$ ".) No. 8—steel slot drift for driving coils to the bottom of partly closed slots. No. 9—push cutter for trimming edges of slot insulation. No. 11—wedge driver for driving wedges into partly closed slots. No. 12—wire scraper for removing insulation from ends of coil leads. No. 13—lead drift for driving coil leads into commutator risers. No. 14—one sided chisel to cut off leads at risers. No. 15—commutator pick for picking out short circuits between segments. No. 16—under cutting saw for under cutting commutator mica. No. 17—banding clamp for placing tension on banding wires while winding them.

To start the first band, make a hook of heavier wire and attach the band wire securely to this hook. Then slip the hook under the ends of a couple of coils close to the ends of the slots and start winding the band wire on the core. Make two or three gradual turns around the core to get the band wire over to the first slot. As the first turn is wound in the slot, narrow strips of tin should be placed in the slot under it, and every few inches apart around the core. Drawing the first turn tight will hold these strips in place, and other turns are then wound on over them. Wire should be wound with the turns tightly together until this groove is full. Then

fold up the ends of several of the tin strips to hold these wires in place, run the wire across to the next groove with a couple of gradual turns around the core, and start the next band without cutting the wire. Continue in this manner until all the bands are on. Then, before releasing the tension on the wire, run a thin layer of solder across each group of band wires in several places, to keep them from loosening when the end wires are cut.

After cutting the wires between the bands, cut these ends off to the proper length, so that they will come directly under one of the tin clamping strips. Then fold in the ends of all these strips tightly and solder them down with a thin layer of solder.

These tin strips are usually about 15 mils thick, and  $1/4$  inch wide, and should be cut just long enough so that their ends will fold back over the bands about  $1/4$  inch.

#### 44. ARMATURE TESTING

We have already mentioned the importance of being able to systematically test armatures to locate faults and troubles in their windings. One of the most common devices used for this purpose is known as a Growler, and sometimes also called a "bug" or "mill."

A growler is constructed of laminated iron in the form of a core, around the center of which a coil of insulated wire is wound, as shown in Fig. 33. When this coil is connected to an alternating current supply it sets up a powerful alternating magnetic field at the two poles of the growler.

Growlers are made with poles shaped at an angle, as shown in the illustration at "A", so that small and medium sized armatures can be laid in these poles. Growlers are also made with poles shaped as shown in Fig. 33-B, so they can be conveniently used on the inside of large alternating current windings, as will be explained later.

The growler shown at "B" has its windings arranged in two separate coils and the leads are connected to a double-throw, double-pole switch, so that the coils can be used either in series or parallel by changing the position of the switch. This permits the growler to be used on either 110 or 220 volts, and also makes possible an adjustment of growler field strength for testing windings with different numbers of turns and high or low resistance.

#### 45. GROWLER OPERATION AND USE

When an armature is placed in a growler and the current turned on in the coil, the flux set up between the poles of the growler builds up and collapses with each alternation; thus cutting across the armature coils and inducing a voltage in them, in a manner similar to the action in a transformer. If there are no faults of any kind in the armature winding, no current will flow in the coils from the voltage induced by the growler; but, if there is a short circuit between two of the commutator segments or within the turns of a coil, an alternating current will flow in this shorted coil when it is placed at

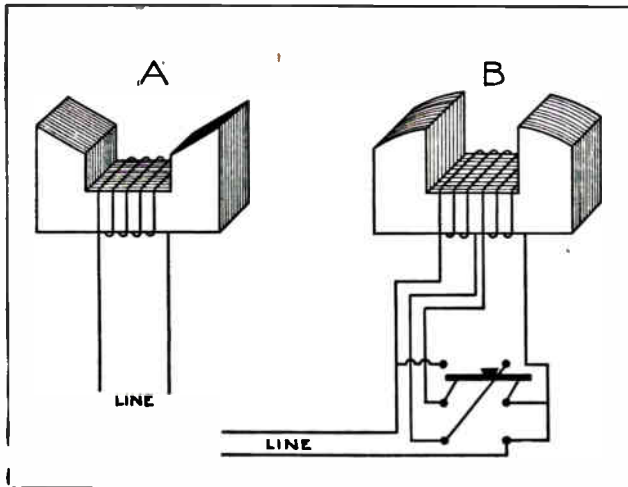

Fig. 33. Two types of "growlers". The one at "A" is for testing armatures, and the one at "B" for use inside of stator cores. Note the switch and double coil arrangement of the growler at "B", which can be used to connect the coils in series or parallel to vary the strength of the growler flux.

right angles to the growler flux. This secondary current, which is flowing in the armature coil will set up alternating flux around it and in the teeth or edges of its slots.

Now, if we hold over the opening of this slot a thin piece of steel, such as a hacksaw blade, the steel will vibrate rapidly. A short circuit is the only fault that will give this indication, so we see that this method is a very simple one for locating shorted armature coils.

It is best to make all tests with a growler on coils that are in the same plane of the growler flux; so, as we test from one slot to the next, the armature should be rotated, in order to make the tests on all coils in the same position. Sometimes it is difficult to rotate the armature without turning off the current from the growler coil.

A low-reading ammeter, with a scale ranging from  $2\frac{1}{2}$  to 10 amperes, is quite commonly used with a growler. A rheostat should be connected in series with a meter and a pair of test leads, as shown in Fig. 34. These test leads consist of two pieces of flexible wire several feet long to the ends of which are attached a pair of sharp test points or spikes. Sometimes these points are made of flat spring steel or brass and are attached to a wood or fibre hand-piece in a manner that permits them to be adjusted close together or farther apart. This makes it convenient to test adjacent commutator bars or bars farther apart.

If these test leads are placed across a pair of adjacent commutator bars which connect to a coil lying in the growler flux, we will obtain a definite reading on the ammeter. If we continue around the commutator, testing pairs of adjacent bars while rotating the armature to make the test on coils which are in the same plane, each pair of bars should give the same reading. In the case of a faulty coil the reading may either increase or decrease, depending on the nature of the fault.

#### 46. GROWLER INDICATIONS ON WAVE WINDINGS

When testing wave-wound armatures, if the leads of two coils are shorted the indication will show up at four places around the armature. Fig. 35 shows a winding for a four-pole wave armature in position for testing in a growler. The heavy lines represent two coils which complete a circuit between adjacent commutator bars, 1 and 2. The top side of one of these coils and the bottom side of the other connect at bar 10. It will be seen from this diagram that a short circuit between bars 1 and 2 would cause our steel strip to vibrate over the four slots shown by the small double circles.

Practically all four-pole automotive armatures are wave-wound, so it is well to remember that a short between any two of their bars will be indicated at the four places around the armature.

#### 47. COMMON ARMATURE TROUBLES

In addition to short circuits a number of the other common troubles are as follows: grounded coils or commutator bars, open coils, shorts between commutator bars, and reversed coil-leads. In addition to the growler, which can be used to locate any of these faults, we can also use a galvanometer and dry cell to locate several of these troubles by testing at the commutator bars. This method will be explained a little later.

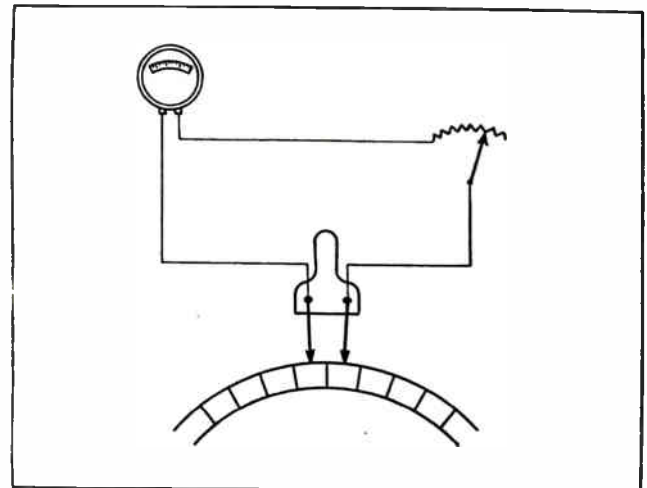

Fig. 34. This sketch shows connections of an ammeter and rheostat with test points on a "hand-piece". Meter and test leads of this sort are used for locating faults in armature windings.

Fig. 36 is a simplified drawing of a two-pole, 24-coil, lap winding in which are shown a number of the more common faults which might occur in armature windings, as follows:

Coil 1 is short-circuited within the turns of the coil.

Coils 20 and 21 have their terminals loose in the commutator bars.

Coil 19 has an open circuit.

Coil 5 is connected in reverse order.

Coil 12 is grounded to the shaft or core of the armature.

Coils 6 and 9 are shorted together.

Coils 15, 16 and 17 are properly connected

in relation to each other, but have their leads transposed or connected to the wrong commutator bars.

Coil 13 has a short between its commutator bars.

The commutator bar to which coils 2 and 3 are attached is grounded to the shaft.

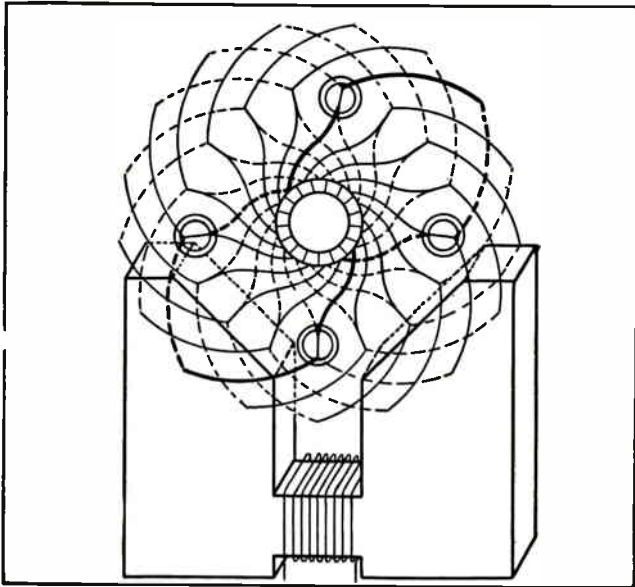

Fig. 35. The above diagram shows the coils of a four-pole wave armature which is in place in a growler for testing.

Now let's cover in detail each of these faults and the exact method of testing and locating them.

#### 48. SHORT CIRCUITS

In Fig. 36 we found that coil 1 had a short circuit within the coil, which is probably the result of broken or damaged insulation on the conductors. To test for this fault, we will place the armature on the growler and close the switch to excite the growler coil. Place the steel strip over an armature slot which is at least the distance of one coil span from the center of the growler core. Now turn the armature slowly, keeping the steel parallel with and over the slots. When the slot containing coil 1 is brought under the steel, the induced current flowing in this local short circuit will set up flux between the teeth of this slot, which will attract and repel the steel strip, causing it to vibrate like a buzzer. This indicates that that coil is short circuited. Mark this slot with a piece of chalk and proceed with the test. Again rotate the armature slowly and test each slot, at all times keeping the strip over slots that are in the same position with respect to the growler. When the slot which contains the other side of the shorted coil is brought under the steel strip, it will again vibrate. Mark this slot. The two marked slots should now show the span of the exact coil which is shorted.

If we find no other slots which cause the steel to vibrate, we know there is only one short in the armature. This test will apply to armatures of any size, regardless of the number of poles in their winding, and whether they are wound lap or wave.

In order to locate on the commutator the bars to which the leads of the shorted coil are attached, adjust the test points of the hand-piece so they will span adjacent commutator bars. Place these test points on two adjacent bars, and adjust the rheostat until the meter reads about  $\frac{3}{4}$  of its full scale reading. Note this reading carefully and, by rotating the armature, check the readings of all the other bars in this same position.

When the test leads are placed on the bars that connect to the shorted coil, the reading will be lower than the other readings obtained. How low will depend on how many turns of the coil are short circuited. If the short is right at the leads or commutator bars and is of very low resistance, no reading will be obtained between these bars.

#### 49. LOOSE COIL LEADS

In testing for loose coil leads, such as shown on coils 20 and 21 in Fig. 36, the steel strip would not vibrate at any slot due to this fault; but, in testing between commutator bars with the hand-piece, when the ammeter leads are placed on the commutator bars to which these coils are connected, the reading between them and adjacent bars would drop to zero, indicating an open circuit.

#### 50. OPEN CIRCUIT

In testing for an open circuit, such as shown in coil 19 in Fig. 36, the steel strip would, of course, give no indication of this fault. So we must locate it by again testing around the commutator with the hand-piece. When these leads are placed across the bars to which the open coil is connected, we will get a very low reading. The reason that any reading at all is obtained is because there are always two paths for the current to travel through the winding, unless it is open at some other coil also.

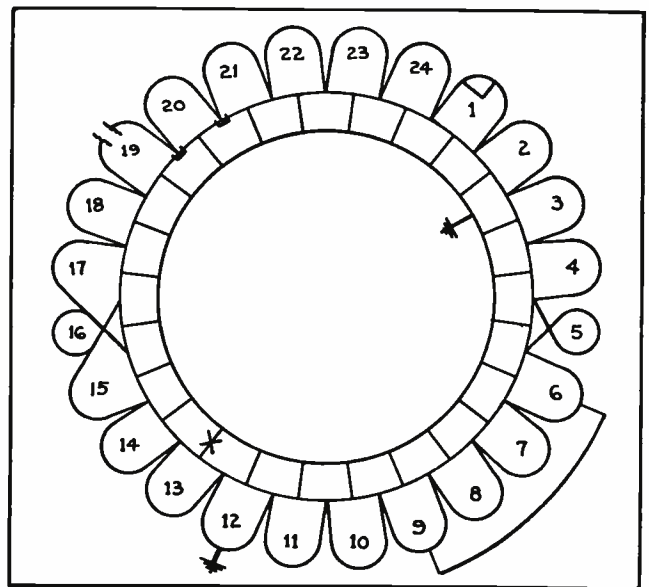

Fig. 36. This diagram of a two-pole lap winding shows a number of the more common faults which may occur in armature coils and at the commutator segments.

With an open circuit only at coil 19, we would still have a circuit through all the other coils in series. The voltages induced in the coils which lie in the

active position for the growler flux would tend to neutralize each other, but there is often a slightly unbalanced condition in the windings which would allow a little current to flow through the ammeter.

If there are three coils of the armature in the active flux of the growler and one side of coil 19 is one of these, then there will be three good coil sides working against two good coil sides with their induced voltages; and, since coil 19 is open circuited, the reading would be about  $1/3$  normal. The exact amount of this reading, however, will depend upon the pitch of the coils and the size of the armature. The main point to note is that one open circuit in an armature does not necessarily give a zero reading, unless the coil sides on each side of the test points are perfectly balanced electrically.

#### 51. REVERSED COIL

In testing for a reversed coil such as No. 5 in Fig. 36, the steel strip will not vibrate at any slots, and testing from bar to bar with the ammeter leads on adjacent bars will not show up this fault either; because the induced current is alternating and the motor will not indicate the reversed polarity of the coil. So, in testing for reversed coils, we should spread the test points on the hand-piece far enough apart so they will touch bars 1 and 3. In this manner we will get a reading of two coils in series. Then, when we place the test points on bars which are connected to coils 4 and 5, or 5 and 6, two coils will be in series in each case; but, as the voltage in one will be opposite in direction to that in the other, the reading will be zero.

So, in testing for reversed coils we test two coils at a time by spreading the test leads apart to span an extra commutator segment, and the indication for the reversed coils will be a zero reading.

#### 52. GROUNDED COILS

Coil 12 in Fig. 36 is grounded. The steel strip or vibrator will not indicate this fault, nor will the bar to bar test with the ammeter leads. To locate a ground we should place the test leads one on the commutator and one on the shaft or core of the armature. If the first test is made between the bar of coil 8 and the shaft, we would obtain a very high reading on the ammeter, because this would give the reading of the 4 coils in series between the grounded coil and this bar.

As we test bars closer to the grounded point the reading will gradually decrease, and the two bars that give the lowest reading should be the ones connected to the grounded coil. The sum of the readings from these two bars to the shaft should equal the reading of a normal coil.

#### 53. SHORTS BETWEEN COILS

In Fig. 36 coils 6 and 9 are shorted together, which places coils 6, 7, 8, and 9 in a closed circuit, through the short and the coil connections to the commutator bars. In this case the steel strip will vibrate and indicate a short circuit over each of the slots in which these coils lay. A bar to bar test with

the ammeter leads would not give a definite indication, but the readings on these bars would be lower than normal.

#### 54. REVERSED LOOPS

In the case of coils 15, 16, and 17 in Fig. 36, which are properly connected to each other but have their leads transposed or placed on the wrong commutator bars, the steel strip will not vibrate or give any indication. The bar to bar test with the ammeter leads would, however, show double readings between bars 1 and 2, normal readings on bars 2 and 3, and double reading again on bars 3 and 4. This indicates that the coils are connected in the proper relation to each other, but that their leads are crossed at the commutator bars.

#### 55. SHORTED COMMUTATOR SEGMENTS

In the case of coil 13 in Fig. 36, which is short circuited by a short between its commutator bars, the steel strip would vibrate and indicate a short circuit over both slots in which this coil lies. The bar to bar test of the ammeter will give a zero or very low reading across these two bars, depending upon the resistance of the short circuit between them.

If the winding is connected lap, the short would be indicated in two places on the core; and if it is connected wave for four poles, it would be indicated in four places on the core.

#### 56. GROUNDED COMMUTATOR SEGMENTS

The commutator bar to which coils 2 and 3 are connected in Fig. 36, is grounded to the shaft. The steel strip will not indicate this fault. Testing with the ammeter leads between other commutator bars and the shaft would show high readings on the meter; but, as we test bars that are closer to the grounded one, the reading falls lower and lower, and will be zero when one test lead is on the grounded bar, and the other on the shaft.

If an absolute zero reading is obtained it indicates the ground is at the commutator bar.

#### 57. GALVANOMETER TESTS ON ARMATURES

We have mentioned that a galvanometer and dry cell can be used to test armature windings for open circuits and short circuits in coils. You will recall, from the description of a galvanometer in an earlier section on elementary electricity, that this instrument is simply a very sensitive voltmeter which will read a fraction of one volt. Fig. 37 shows a method of making galvanometer tests on armatures. Two leads from a dry cell should be held against bars on opposite sides of the commutator and kept in this position as the armature is rotated. This will send a small amount of direct current through the coils of the winding in two paths in parallel.

If the positive lead in Fig. 37 is on the right, a current will flow from this lead through the commutator bar to the right side of the winding. If all coils of the winding were closed and in good condition,

the current would divide equally, part flowing through the top section of the winding to bar 3 and the negative lead, and the other part flowing through the lower section of the winding to the same bar and lead. When this current is flowing through the armature and we test between adjacent bars with the galvanometer, the instrument reads the voltage drop due to the current flowing through the resistance of each coil. So the galvanometer test is quite similar to that with the ammeter leads and growler.

In testing for an open circuit with the galvanometer leads placed on adjacent bars connected to good coils, there will be no reading in the section of the winding in which the open coil is located; but when these leads are placed across the bars connected to the open coil, the needle will probably jump clear across the scale, because at this point it tends to read practically the full battery voltage. Of course, if there are two open circuits in this half of the armature, no reading will be obtained at any pair of bars. This is a good indication that there is more than one open. If a test is made all the way around the commutator and no open circuits are present, the galvanometer should read the same across any pair of bars. You should be careful, however, to secure at all times a good contact between these test leads and the bars, and also be sure that the battery leads make good connection to the commutator as the armature is rotated. Otherwise variations in the readings will be obtained.

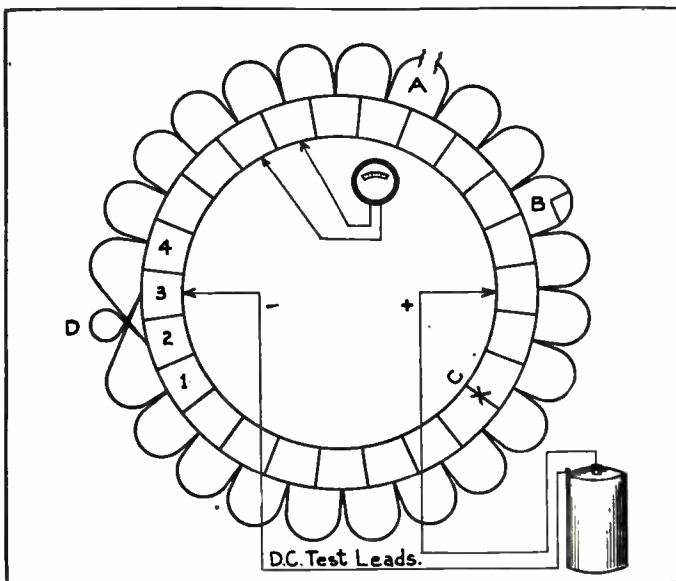

Fig. 37. This diagram shows the method of testing with a galvanometer and dry cell to locate various faults in an armature.

A lower reading than normal between any two bars will indicate a shorted coil, and a zero reading indicates a short between two commutator bars. When galvanometer leads are placed on bars 2 and 3, which are connected to coils with their leads transposed, the reading will be normal; but in testing between bars 1 and 2, or 3 and 4, the reading will be double. This indicates that the leads at bars 2 and 3 are the ones reversed.

The methods and indications described for each of the foregoing tests should be carefully studied until you are quite sure you understand the principles in each case. It is not expected that you will be able to remember each of these tests until you have actually tried them a number of times. However, with the instructions given in the foregoing paragraphs, you need not hesitate to undertake any of these tests, if you have this material on hand to refer to during the first few times you make them.

#### 58. CUTTING OUT FAULTY COILS

In many cases when a machine develops some fault in the coils of its armature, it is inconvenient to take it out of service for complete rewinding or for the amount of time required to replace the defective coils with new ones. At times like this, when it is extremely important that a machine be kept in service in order not to stop or delay production on the equipment it operates, a quick temporary repair can be made by cutting the faulty coils out of the armature circuit. This is done by using a jumper wire of the same size as the conductors in the coils, and which should be soldered to the same two bars to which the defective coil was connected. This jumper will then complete the circuit through this section of the armature, and will carry the current that would normally have been carried by the defective coil.

Fig. 38 shows the manner in which an open circuit coil can be cut out with such a jumper. For each coil that is cut out of a winding a slightly higher current will flow through the other coils of that circuit. The number of coils that can safely be cut out will depend on the position in which they occur in the armature.

In some cases several coils may be cut out, if they are equally distributed around the winding; but if several successive coils became defective and were all cut out with a jumper, it might cause the rest of the coils in that circuit to burn out.

Other factors that determine the number of coils which can be cut out in this manner are: the number of coils per circuit, the amount of load on the motor or generator, and the size of the machine. If the defective coil is grounded, its two ends should be disconnected from the commutator bars before the jumper is soldered in place. Shorted coils should be cut at the back end of the armature and these cut ends well taped. The jumper wire should be well insulated from the leads of other coils.

Repairs of this type should be considered as only temporary and, as soon as the machine can be conveniently taken out of operation, the defective coils should be replaced with new ones; or the armature rewound, if necessary.

Keep well in mind this method of making temporary repairs, as there are frequent cases on the job when the man who knows how to keep the machinery running through important periods of production or operation can make a very favorable impression on his employer by demonstration of this ability.

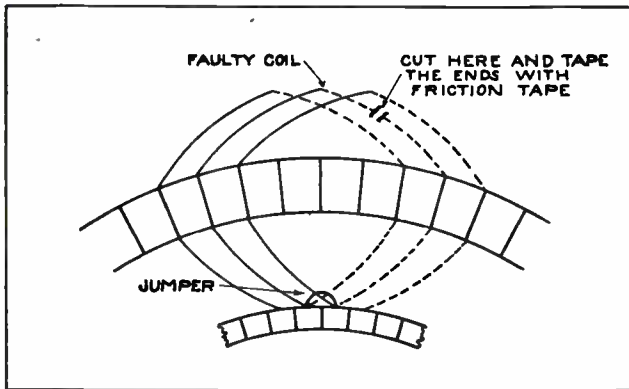

Fig. 38. The above diagram shows the method of cutting out a defective coil, and completing the circuit through the winding with a jumper at the commutator bars to which this coil connects.

If you have carefully studied the material in this section, the knowledge you have obtained of the

principles of D. C. machines and their windings will be of great value to you.

While you are actually winding armatures in the department in the shops, you will be able to observe and put into practice many of the important things covered in this Reference Set.

If you get the important points covered in the intensely practical lectures on this subject, and do your work on the windings thoughtfully and carefully, you should be able to quite easily rewind or repair armatures, or locate their troubles when necessary on the job.

Remember that the important points are to get the correct number of turns of proper sized wire per coil, correct coil and slot insulation, and proper connections to the commutator.

By referring to this Reference Set you will find dependable information on all these points.



Norman Beder  
41 Georgia Ave.  
Brooklyn 7, N. Y.



ESTABLISHED 1899

**COYNE**  
*Electrical School*  
CHICAGO ~ ~ ILLINOIS



COPYRIGHT 1942

**ARMATURE WINDING  
AND TESTING**

*Section Two*

**Principles of A C Motors and Generators**  
**Single and Polyphase Machines**  
**Winding Stators**  
**Connecting Stators**  
**Star and Delta Connections**  
**Reconnecting for Changes in Voltage**  
**Speed, Frequency, Phases**  
**Insulating Varnish, Baking**  
**Stator Troubles and Tests**

## ALTERNATING CURRENT WINDINGS

The previous section covered the windings for D. C. generators and motors only. This section will deal with the principles and windings of A. C. machines.

Alternating current is very extensively used for light and power purposes, and most of the large power plants generate alternating current because it is so much more economical than D. C. to transmit over long lines. The reason for this will be explained in a later section on alternating current.

The general use of A. C. in industrial plants and power plants makes it very important for one to know these principles of A. C. machines and the methods of winding, connecting, and testing them.

### 59. PRINCIPLES OF A. C. GENERATORS

We have learned that voltage can be generated in a conductor by moving it through a magnetic field, and that alternating voltage will always be generated in the windings of a D. C. generator, because during rotation the conductors are continuously passing alternate N. and S. poles.

Let us review this principle briefly, to be sure we have it well in mind as we start the study of A. C. machines.

In the Elementary Section on electro-magnetic induction we learned that the direction of induced voltage in any conductor depends on the polarity of the field or direction of the lines of force, and the direction of movement of the conductor.

In Fig. 39-A and B we have another illustration of this principle. At "A" the lines of force from the field poles are passing downward and the conductor is being moved to the right. This will induce in the wire a voltage that will tend to cause current to flow in at the end we are facing, or away from us, if this conductor is part of a closed circuit. Check this with the right-hand rule for induced E. M. F. in generators.

This rule is here repeated for your convenience. **Hold the thumb, forefinger, and remaining fingers of your right hand, all at right angles to each other. Then, with your fore-finger pointing in the direction of the flux, and your thumb in the direction of the conductor movement—the remaining fingers will point in the direction of the induced E. M. F.**

Try this rule also with Fig. 39-B, where the conductor is moving in the opposite direction, through the same magnetic field; and you will find the induced voltage has reversed with the direction of the conductor movement.

The circular arrows around the conductors indicate the direction of the lines of force which will be set up around them by their induced currents. Check this also by the method mentioned in an earlier section, of considering the field lines as moving rubber bands rubbing the conductors, and setting up the new or induced lines in the direction the bands would revolve a pulley, etc. Also note the symbols used to indicate the direction of induced E. M. F. in the conductors: + for voltage in, and the dot for voltage out.

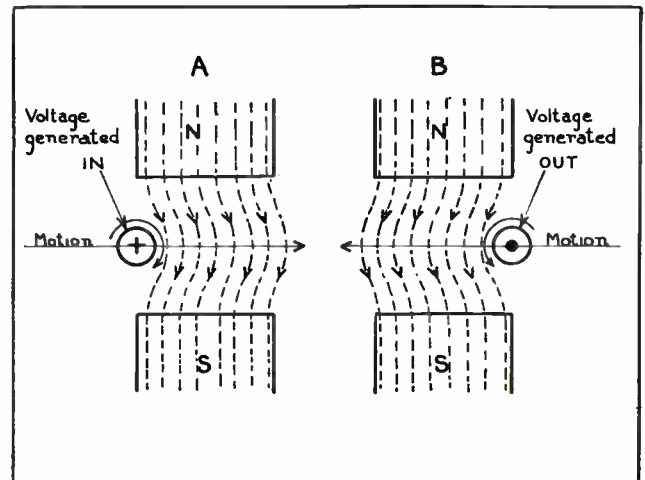

Fig. 39. This diagram illustrates the method of producing E.M.F. in conductors by cutting them through magnetic lines of force. Note carefully the direction of the induced voltage at both "A" and "B".

In Fig. 40-A we have two conductors of a coil, mounted in slots of an armature and revolving clockwise. In their position at "A" the conductors are not generating any voltage, as they are in the neutral plane and are not cutting across lines of force. At "B" the direction of induced voltage will be "in" at conductor "F" and "out" at "G"; so if the conductors are connected together at the back of the armature their voltages will add together.

In Fig. 40-C the conductors are both in the neutral plane again, so their induced voltage once more falls to zero.

At "D" conductor "G" is passing the north pole and conductor "F" is passing the south pole, so they are both moving through the field flux in opposite directions to what they were at "B", and their induced voltage will be reversed. At "E" both conductors are again back in the neutral plane, or at the point they started from.

A curve indicating the voltage generated is shown

under these various steps of generation in Fig. 40. At "A" the voltage curve is starting at the zero line, as the conductors start to enter the field flux. At "B", where the conductors are cutting through the dense field directly under the poles, the curve shows maximum positive voltage. From this point it falls off gradually as the conductors pass out of the flux at the poles, until it again reaches zero at "C". Then, as the conductors each start to cut flux in the opposite direction, the curve shows negative voltage in the opposite direction or below the line, reaching maximum value at "D". At "E" the negative voltage has again fallen to zero.

## 60. CYCLES AND ALTERNATIONS

Upon completion of one revolution with the simple two-pole generator we also complete what we term one Cycle of generated voltage. The single positive impulse produced by the conductor passing one complete pole, and shown by the curve from "A" to "C", is called one Alternation. It takes two alternations to make one cycle. Therefore, each time a conductor passes one north and one south pole it produces one cycle.

There are 360 Mechanical Degrees in a circle, or in one revolution of a conductor on an armature; and in generators we say that a conductor travels 360 Electrical Degrees each time it passes two alternate field poles and completes one cycle. So One Cycle consists of 360 Electrical Degrees, and One Alternation consists of 180 Electrical Degrees.

In a machine having more than two poles, it is not necessary for a conductor to make a complete revolution to complete a cycle, as One Cycle is produced for each pair of poles passed. So a four-pole generator would produce two cycles per revolution; a 12-pole generator, 6 cycles per revolution; etc.

## 61. FREQUENCY OF A. C. CIRCUITS

Alternating current circuits have their frequency expressed in cycles per second, the most common frequencies being 25 and 60 cycles per second.

If frequency is expressed in cycles per second and if a conductor must pass one pair of poles to produce a cycle, then the frequency of an A. C. generator depends on the number of its poles and the speed of rotation.

For example, if a four-pole machine is rotated at 1800 R. P. M., the frequency of the current it produces will be 60 cycles per second. Its conductors will pass two pairs of poles per revolution, or  $1800 \times 2 = 3600$  pairs of poles per minute. Then, as there are 60 seconds in a minute,  $3600 \div 60 = 60$  cycles per second.

A generator with 12 poles would only need to rotate at only 600 R. P. M. to produce 60 cycles per second. The conductors in such a machine would pass six pairs of poles per revolution; or at 600 R. P. M. they would pass  $6 \times 600$  or 3600 pairs of poles per minute. And again,  $3600 \div 60 = 60$  cycles per second.

The symbol for frequency is a small double curve like a sine wave, or  $\sim$ . Thus  $60 \sim$  means 60 cycles per second.

The speed at which A. C. motors will operate depends on the frequency of the circuit they are connected to and the number of their poles. This will be more fully discussed later.

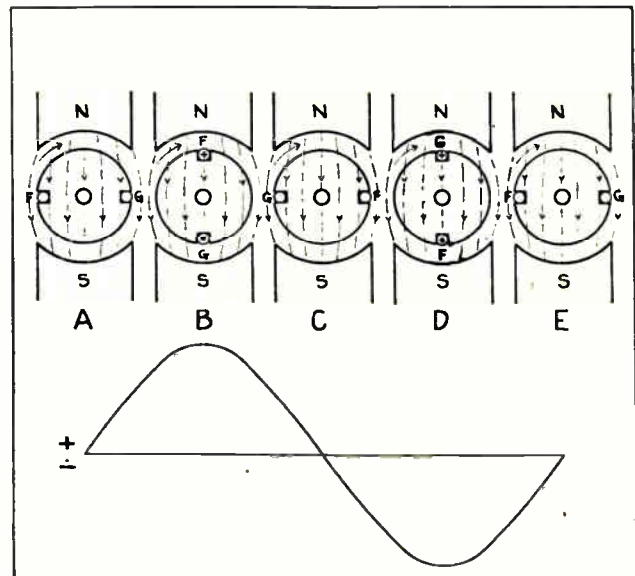

Fig. 40. The above diagram shows step by step the development of a complete cycle of alternating voltage. Compare each of the generator sketches with the voltage of the curve directly beneath it.

## 62. REVOLVING FIELD ALTERNATORS

Alternating current generators are commonly called Alternators. So far we have discussed generators with their conductors revolving on an armature through stationary field flux. Now, why wouldn't it work equally well to have the armature conductors stationary and revolve the field, causing the lines of force of the moving field poles to cut across the conductors?

This is exactly what is done with a great number of A. C. generators or alternators; and, while some of the smaller ones are made with revolving armatures, most of the larger ones are of the revolving field type.

This type of construction has two very important advantages for large power plant alternators. The first of these advantages is that if the armature conductors are stationary the line wires can be permanently connected to them and it is not necessary to take the generated current out through brushes or sliding contacts. This is quite an advantage with the heavy currents and high voltages produced by modern alternators, many of which are designed to supply from several hundred to several thousand amperes, at voltages from 2300 to 13,200 and higher.

Of course, it is necessary to supply the current to the revolving field with slip rings and brushes, but this field energy is many times smaller in amperes and lower in volts than the main armature current.

The other big advantage is that the armature conductors are much larger and heavier than those of the field coils, and much more difficult to insulate because of their very high voltage. It is, therefore, much easier to build the armature conductors into a stationary element than it is in a rotating one.

The field, being the lighter and smaller element, is also easier to rotate and this reduces bearing friction and troubles, as well as air friction at high speeds.

With large revolving field alternators, the stationary armature is commonly called the Stator, and the rotating field is called the Rotor.

### 63. SINGLE PHASE CURRENTS

Fig. 41 shows a sketch of a simple revolving field alternator, with one coil in the slots of the stator or stationary armature. The circles in the slots show the ends of the coil sides, and the dotted portion is the connection between them at the back end of the stator. Inside the stator core is a two-pole field core with its coil mounted on a shaft so it can be revolved.

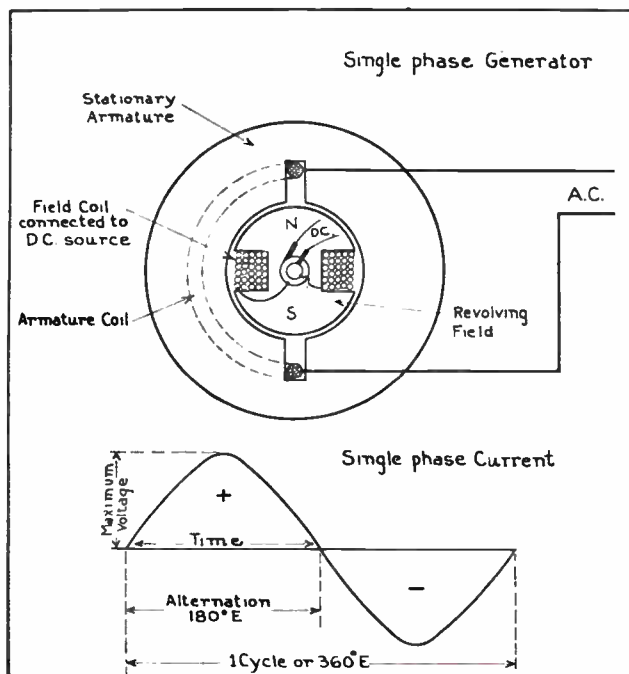

Fig. 41. Sketch of a simple single-phase alternator of the revolving field type, showing a single coil in the stator slots. The curve at the bottom of the sketch shows the single-phase alternating voltage which will be produced when the field revolves past the stator coil.

When direct current is supplied to the field core through the slip rings and brushes shown, the core becomes a powerful electro-magnet with flux extending from its poles into the stator core. Then, as the field is revolved the lines of force from its poles revolve with them and cut across the conductors in the stator slots.

As each coil side is passed first by the flux of a north pole and then a south, the induced E. M. F. and current will be alternating, as it was with the revolving armature type previously shown. The curve underneath the generator shows the complete

cycle which will be produced by one revolution of the two pole field; so this machine would have to revolve at 3600 R. P. M. to produce 60-cycle energy.

Revolving fields are made with four or more poles, to produce 60-cycle energy at lower speeds.

Fig. 42 shows a large alternator of the revolving field type, with 36 poles. Each revolution of this field will bring 18 pairs of poles past any given coil, and so produce 18 cycles per revolution. Then, if its speed is 200 R. P. M.,  $200 \times 18 = 3600$  cycles per minute, or 60 cycles per second.

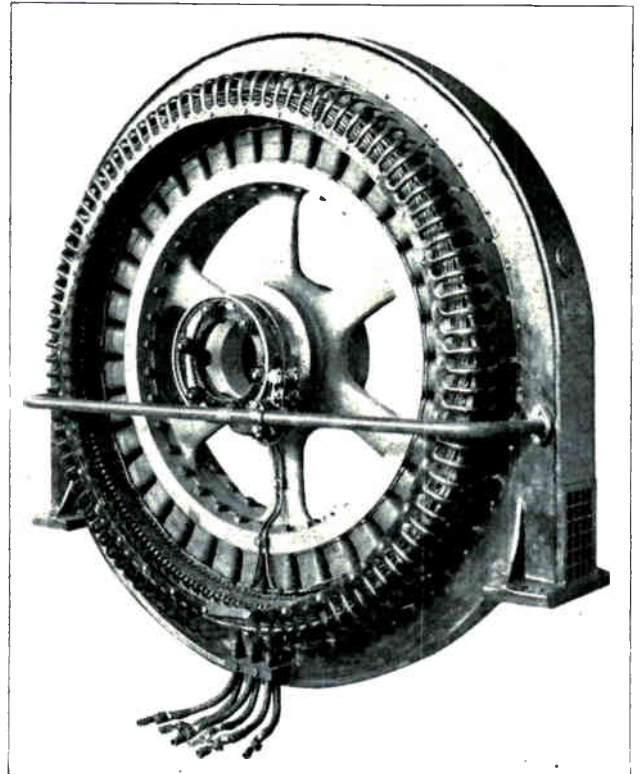

Fig. 42. This photo shows a large 36-pole alternator of the revolving field type. Examine its construction carefully as you study the explanation given on this page.

Note carefully in this figure the slip rings, brushes, and wires which carry the D. C. from the rings to the field coils. Also note the armature coils arranged in the slots of the stator, and at the bottom the cables by means of which the line leads are attached to these coils.

The generator shown in Fig. 41 will produce what is known as Single Phase alternating current, as shown by the curve in this same figure.

Single-phase A. C. flows in a simple two-wire circuit, and consists of alternations 180 degrees apart, or current that continuously reverses in direction and varies in amount.

This current first flows out in the top wire of the line and back in the lower one; then dies down, reverses, and flows out in the bottom wire and back in the top one. Or, we might say, it consists of continuously recurring alternations.

Even if the generator in Fig. 41 had a number of stator coils connected in series and just two leads

connected to the group, it would still deliver single-phase current.

**64. TWO PHASE CURRENTS**

Generators are also made to produce 2-phase and 3-phase currents. Circuits supplied by 2 and 3-phase energy are often called polyphase circuits, meaning that their currents are divided into more than one part.

Fig. 43 shows a sketch of a simple 2-phase alternator, which has two separate coils placed in its stator at right angles to each other; or displaced 90 degrees from each other.

As the field of this generator revolves it will induce voltage impulses in each of these coils, but these impulses will not come at the same time, because of the position of the coils.

Instead, the voltages will come 90 electrical degrees apart, as shown in the curves in Fig. 43. The curve "A" shows the voltage generated in coil "A" as the poles pass its sides. As these poles rotate 90° farther their flux cuts across coil "B" and produces the voltage impulses shown by curve "B", which are all 90° later than those in curve "A".

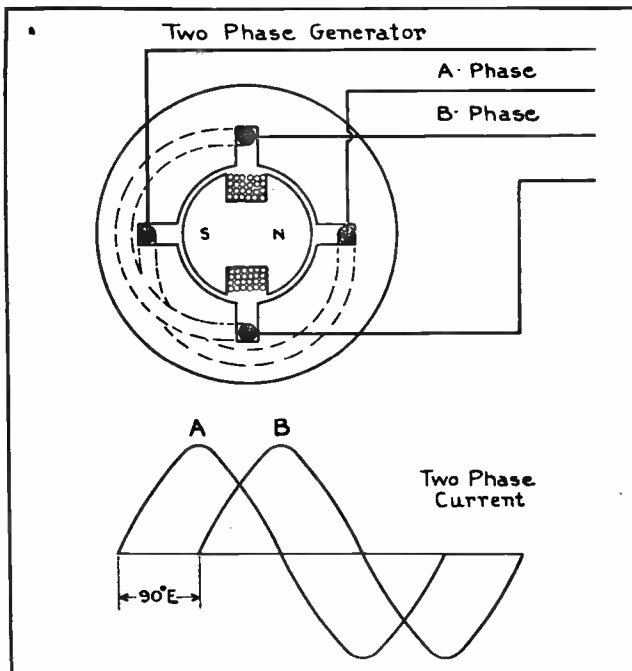

Fig. 43. Sketch of a simple two-phase A.C. generator or alternator. The curve at the bottom of the sketch shows the two-phase voltage that will be produced when the field revolves past the two coils in the stator.

These two separate sets of impulses are each carried by their own two-wire line circuits as shown in the diagram.

So we see that a two-phase circuit is simply a circuit of two parts, or having two sets of alternations occurring 90 degrees apart. In the curve you will note that these alternations or impulses overlap each other, and that while one is at zero value the other is at maximum value. So with a circuit of this type, there is always voltage existing in one phase or the other as long as the circuit is alive.

This feature is quite an advantage where the energy is used for power purposes, as these overlapping impulses produce a stronger and steadier torque than single-phase impulses do.

For this same reason three-phase energy is still more desirable for motor operation and power transmission, and is much more generally used than two-phase.

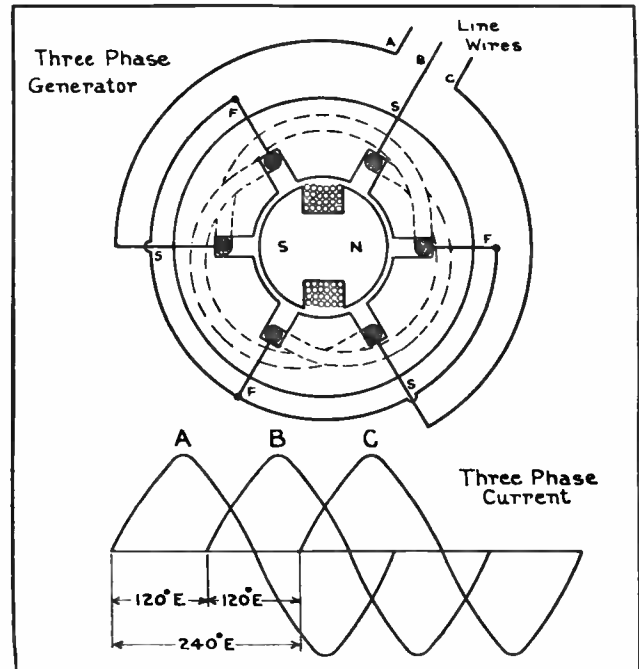

Fig. 44. This sketch shows the arrangement of the stator coils in a simple three-phase alternator and beneath it the curves for three-phase energy.

**65. THREE-PHASE CURRENTS**

Fig. 44 shows a sketch of a simple three-phase alternator, with three coils in its stator, and spaced 120 electrical degrees apart.

As the field poles revolve past coils "A", "B", and "C" in succession, they induce voltage impulses which are also 120 degrees apart, as shown in the curves in the figure.

The line leads are taken from the coils at points 120 degrees apart and the other ends of the coils are connected together at "F". This type of connection is known as a Star connection of the coils to the line. Another common connection for three-phase windings is known as the Delta connection. Both of these will be explained later.

The principal points to note are that a three-phase circuit is one with three parts, or three separate sets of alternations occurring 120° apart and overlapping each other. These impulses are carried on three line wires, and the current flows first, out on wire "A" and in on wires "B" and "C"; then out on wire "B" and in on wires "A" and "C"; then, out on wires "C" and in on wires "A" and "B"; etc.

Additional features of single-phase and polyphase circuits and machines will be covered later. But,

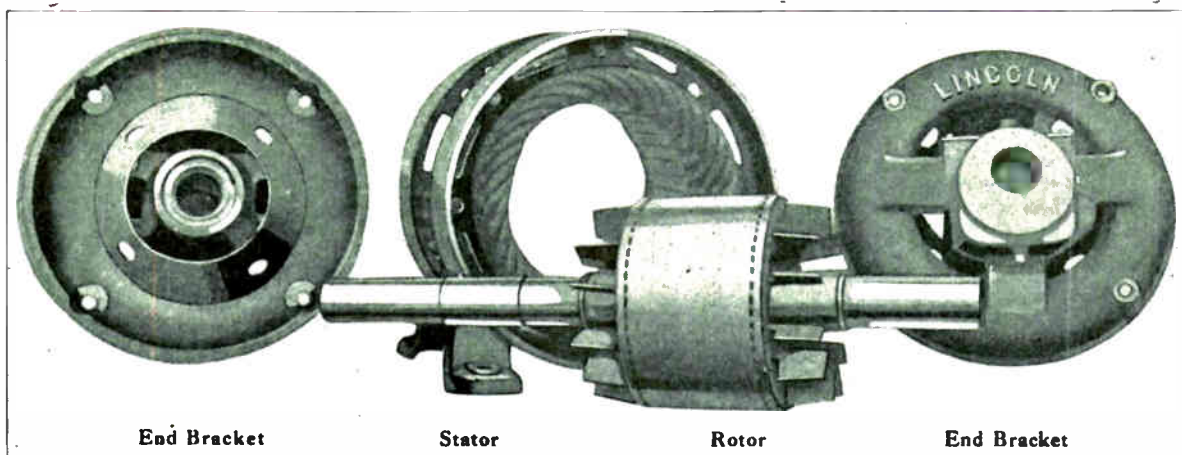

Fig. 45. Above are shown the more essential parts of an A.C. induction motor. Note carefully the construction of each part and the names by which they are called.

now that you know the difference between these forms of alternating current, you will be able to understand the various A. C. windings much easier.

### 66. CONSTRUCTION OF A. C. MOTORS

The most common type of A. C. motor is known as an **Induction Motor**. This name comes from the fact that the currents in the rotor are induced in it by the flux of the stator coils.

Fig. 45 shows the more important parts of an A. C. induction motor, with the names of each. Note that the stator coils are placed in the slots around the inside of the stator core very much as the coils of a D. C. armature are placed in slots around the outside of the armature.

### 67. ROTORS

A. C. induction motors have two common types of rotors, known as **Squirrel-Cage rotors** and **Phase-wound rotors**.

The rotor shown in Fig. 45 is of the squirrel-cage type; and, instead of having wire windings, it has heavy copper bars buried in closed slots around its surface and all connected together by rings at each end.

Fig. 46 is a cut view of such a rotor, showing how the bars are imbedded in the core iron. The end rings are made of copper or brass; or, in some cases, of aluminum. The short blades on the end

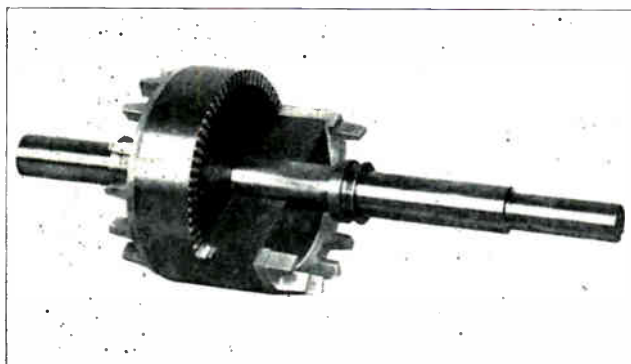

Fig. 46. This view shows a sectional view of a squirrel-cage rotor for an A.C. induction motor. Note the manner in which the copper bars are imbedded in the surface of the core.

rings act as fans and set up an air draft to cool the rotor and machine windings while the motor is in operation.

Fig. 47 shows a slightly different type of squirrel-cage rotor, in which the ends of the bars can be seen projecting from the core ends. This rotor is also equipped with fan blades for ventilating the machine, and you can note the air space left between the laminations of the core. These spaces are also for cooling purposes.

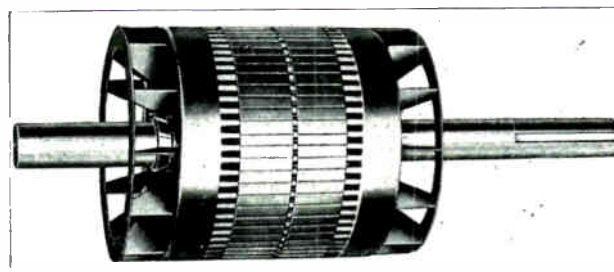

Fig. 47. Another style of squirrel-cage rotor showing the bars of the winding and also the ventilating fans.

The purpose of the end brackets shown in Fig. 45 is to support the bearings in which the rotor shaft turns. These bearings must always be in such condition, and the brackets so lined up, that they will support the rotor so that it does not rub or touch the stator core.

Fig. 48 shows in greater detail some of the smaller parts used in the construction of A. C. motors. In the center is shown the shaft to which the rotor core is keyed; and above this are a bearing sleeve, shaft key, oil ring, and stator coil. At the left end of the shaft is shown a rotor lamination, and beneath it an end ring and rotor bar. In the upper right-hand corner is a stator lamination, showing the shape of the slots and teeth; and below this is one of the frame rings used for clamping together and supporting the stator core laminations.

Phase-wound rotors for A. C. induction motors

have windings placed in the slots of their cores, similarly to D. C. armatures. Their windings are generally connected wave.

**68. STATORS**

Stators for A. C. motors are constructed of laminations which are stamped from soft iron. One of these was shown in Fig. 48. The slots are cut on the inside of the stator cores, instead of on the outside as with D. C. armatures.

Two types of these slots are shown in Fig. 49. This view also shows the slot insulation and method of protecting the coils and wedging them into the slots.

In large stators, the groups of laminations are spaced apart to leave an air duct every few inches for cooling the windings and core.

The partly closed slots shown at "A" in Fig. 49 are used on small stators where the wires are fed into the slots a few at a time. The open-type slots as shown at "B" are used on large stators which have their coils wound and insulated before they are placed in the slots.

**69. TYPES OF A. C. WINDINGS**

Three of the commonly used types of windings for A. C. stators are the Spiral Type, Lap, and Wave windings.

The spiral-type winding is used very extensively on small single-phase motors.

The poles are wound in a spiral form, as shown in Fig. 50. The wire is started in the two slots to

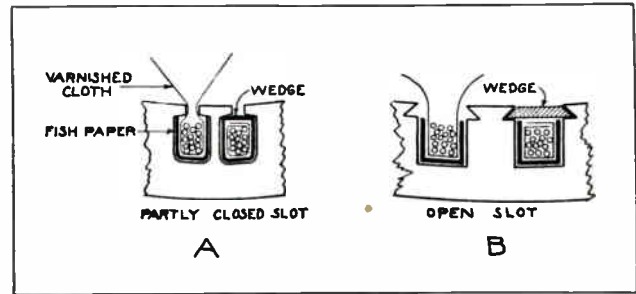

Fig. 49. The above diagram shows two common types of stator slots with the slot and coil insulation in place around the coils. Also note the wedge used for holding the finished coils in place.

be used as the center of a pole, and after winding the desired number of turns in this coil we continue right on in the same direction in the next pair of slots, with the same wire. In this manner we build up the coils for one pole, working from the center to the outside. Sometimes more than one slot is left empty in the center as the first winding is placed in.

**70. SKEIN WINDINGS**

Another method, which uses what is known as the Skein Coil for making spiral windings, is illustrated in Fig. 51.

In this method the long skein coil is first made up of the right number of turns and the proper length to form the several coils. The end of this skein is then laid in the center slots as shown at "A" in Fig. 51, and the long end given one-half

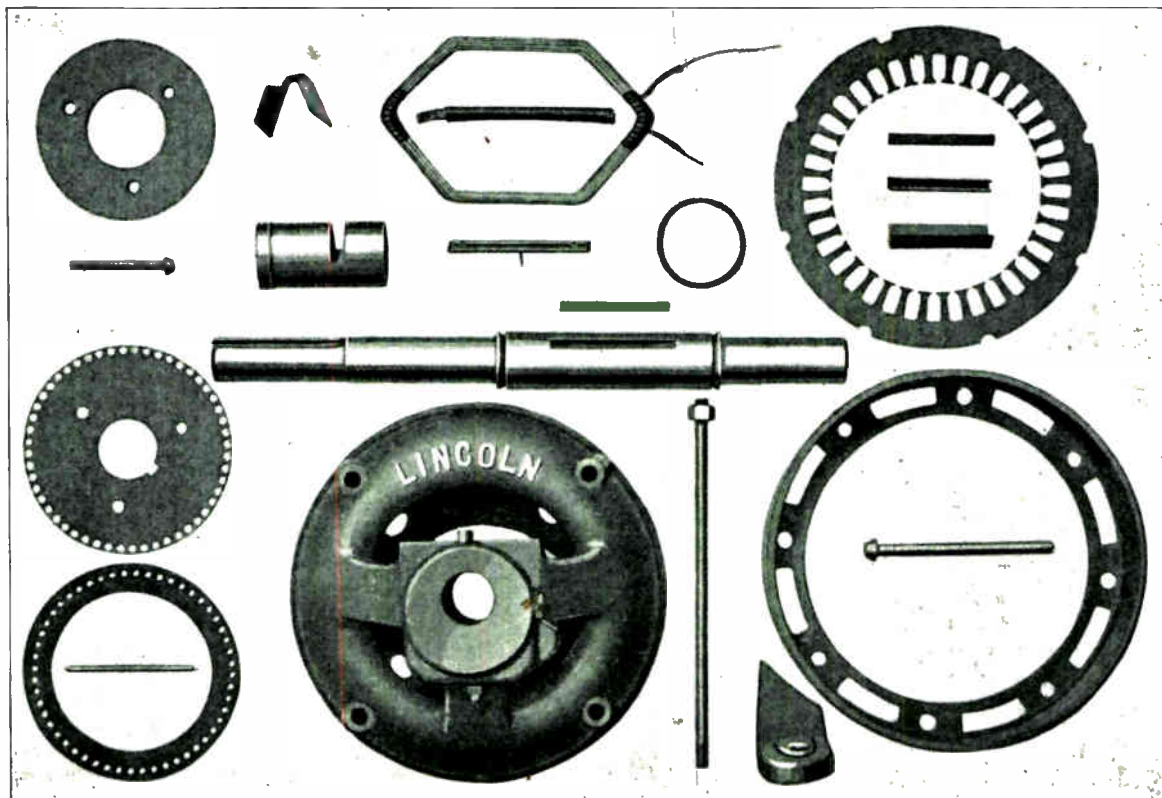

Fig. 48. Here are shown a number of the smaller parts used in the construction of A. C. motors of the induction type. Note the shape of the laminations for both the rotor and stator cores, and compare each of these parts with their explanations given on these pages.



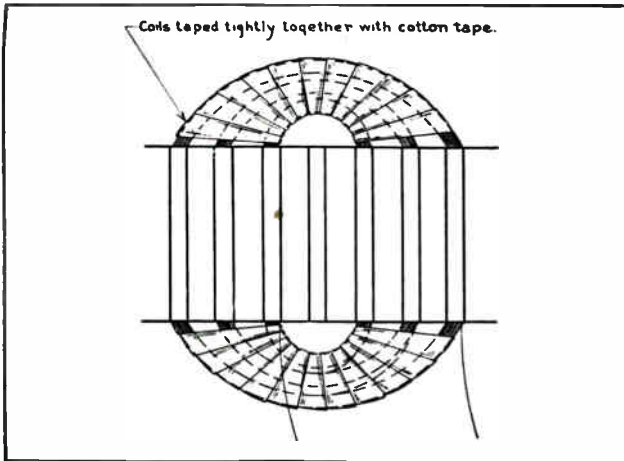

Fig. 50. This diagram illustrates the method of winding the coils for a spiral-type stator winding. Note how the wire continues from one coil to the other, as shown by the dotted lines under the tape at the lower end.

twist near the ends of the slots, as shown at "B". The remaining end is then laid back through the next two slots—at "C"—and again twisted one-half turn so its sides cross near the first coil end. Then the last loop is laid back through the outer two slots to complete the coils for this pole.

Trace the circuit through this finished coil, starting at the left lead, going through each coil, and coming out at the right-hand lead.

This skein method of winding is quite a time-saver where a number of stators of the same size and type are to be wound. After carefully measuring to get the first skein coil the right length, the balance of the coils can be made on the same form, and the stator poles wound very rapidly.

If there are only two or three small stators to be wound, the first method described is generally best.

## 71. RUNNING AND STARTING WINDINGS FOR SINGLE-PHASE MOTORS

Single-phase A. C. motors of these small induction types generally have two windings called the Running Winding and Starting Winding. The first winding placed in the slots as we have just described is the running winding. The starting winding is always placed in the slots over the running winding coils after they are all in the slots. This starting winding is usually wound with wire about one-third as large as that used for the running winding, and with about half as many turns. The starting winding coils are displaced  $90^\circ$ , or exactly one-half the width of one pole, from the coils of the running winding.

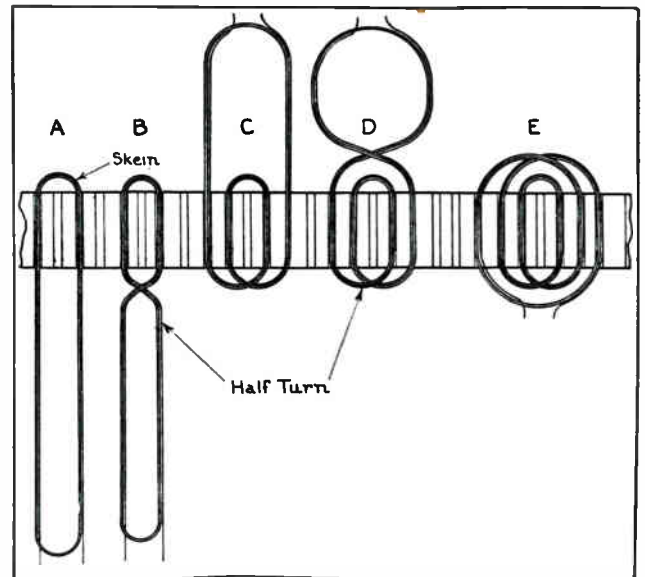

Fig. 51. Skein type windings as shown above are often used to save considerable time when winding a number of stators which are all alike. Note carefully the various steps of twisting the coil and laying it in place in the slots.

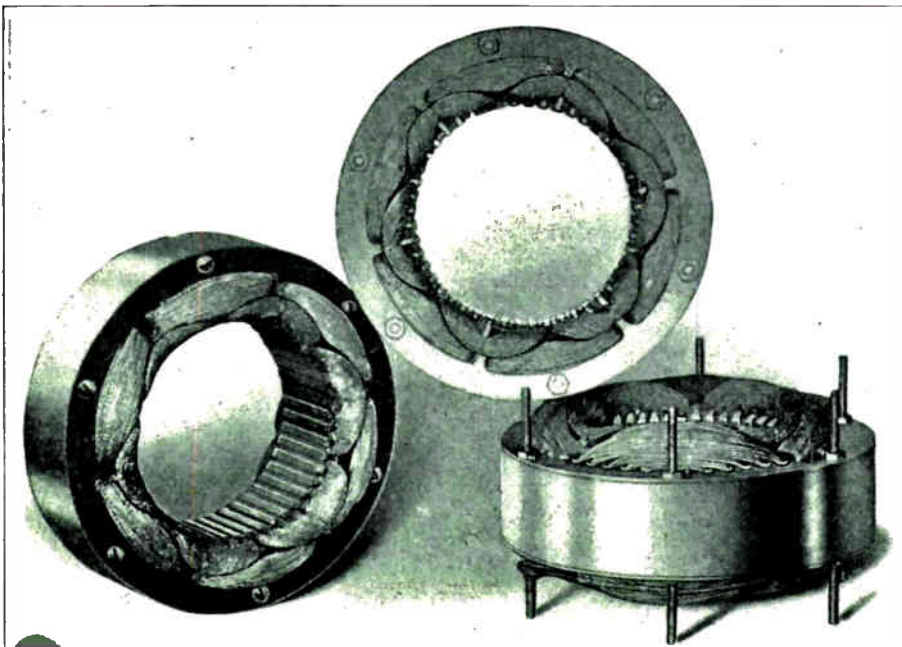

Fig. 52. On the left are shown several views of small single-phase stators for A.C. induction motors. Both the starting and running windings can be clearly seen in each of these views. Note how the starting winding overlaps the coils of the running winding about one-half their width or  $90^\circ$ . This type of winding is known as a single-phase split-phase.

In starting to wind these coils, their centers are located where the edges of the running coils meet. This brings the edges of the starting coils together at the center of the running coils, and very often in the slots which were left empty when the running coils were wound. Windings of this type are known as single-phase, split-phase windings. The term "split phase" is used because the different numbers of turns in the starting and running windings cause them to be of different inductance, which makes the alternating current impulses in one winding lag slightly behind those in the other winding. This produces around the stator a sort of shifting or rotating magnetic field, which in turn cuts across the bars of the rotor, inducing current in these bars.

The reaction between the flux of the stator currents and rotor currents is what produces the torque or turning effect of this type motor.

The principles of inductance and split-phase operation will be more fully covered in a later section.

Fig. 52 shows several small stators and the positions of their starting and running windings.

### 72. CONNECTIONS OF STARTING WINDING

The starting and running windings are connected in parallel to the single-phase line, but a centrifugal switch is connected in series with the starting winding as shown in Fig. 53. This switch is arranged so that when the motor is idle it is held closed by springs.

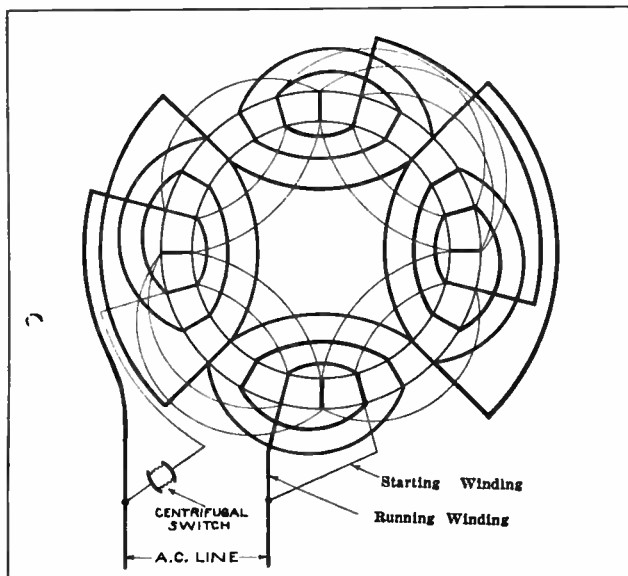

Fig. 53. The above diagram shows the complete circuits through both the starting and running windings of a single phase stator. Trace out each winding carefully and note how the coils are connected to produce alternate north and south poles around the stator.

When current is applied to the windings, both the starting winding and running winding are in use while the motor is starting and getting up to speed; but as soon as it reaches full speed, the switch, mounted to revolve on the shaft of the

motor, is thrown open by centrifugal force, thereby opening the circuit of the starting winding. The motor then runs on the running winding only.

The starting winding must never be left in the circuit longer than just the few seconds required to start the motor. If it is left connected longer than this it will overheat and probably burn out.

Fig. 54 shows a simple sketch illustrating the method of connection of the starting and running windings to the line, and also the connection of the centrifugal switch. Remember that this switch must always be connected in series with the starting windings.

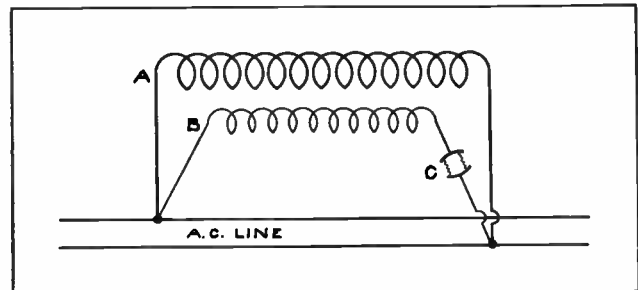

Fig. 54. This is a simplified diagram showing the manner in which the starting and running windings of a single phase motor are connected in parallel to the line. The centrifugal switch "C" is connected in series with the starting winding as shown.

### 73. CENTRIFUGAL SWITCHES

There are many different types of centrifugal switches used on single-phase motors; but the general principle of all of them is the same, in that they open the circuit of the starting winding by centrifugal force when the motor reaches nearly full speed.

Fig. 55 shows a sketch of one of the common types of these switches. The two views on the left show the stationary element, which is mounted on the end bracket of the motor; and the view on the right shows the rotating element, which is mounted on the shaft of the rotor. On the stationary element we have two terminals, "B" and "B", to which the line and starting winding leads are connected. These semi-circular metal pieces are separated from each other; so that there is no circuit between them

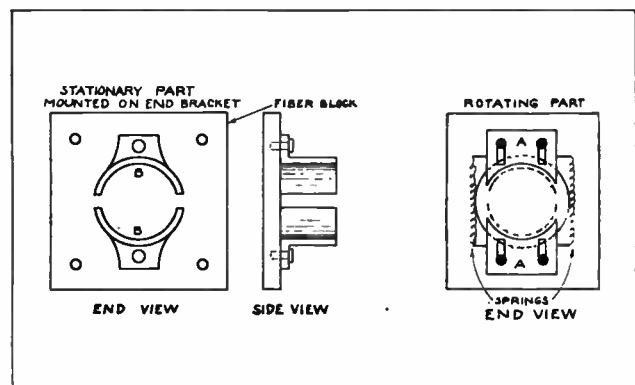

Fig. 55. These sketches illustrate the principle of a simple centrifugal switch, such as used for starting single phase motors. Examine each part closely as you read the explanations given on these pages.

drawn together over the cylinder formed by "B" and "B". This closes a circuit between them when the motor is idle. When the motor starts and begins to revolve at high speed the weight of the pieces "A" and "A" causes them to be thrown outward to the ends of their slots, thus disconnecting them from "B" and "B" and opening the circuit of the starting winding.

**74. OPERATING PRINCIPLES OF TWO-PHASE MOTORS**

Two-phase motors are designed to operate on two-phase alternating current and have two windings, each covering one-half of each pole, or spaced 90° apart, similarly to the starting and running windings of a single-phase motor.

Each of the windings in a two-phase machine, however, is of the same size wire and has the same number of turns. Instead of being wound with spiral coils, two-phase windings are generally made with diamond-shaped coils similar to those used in armatures. A section of a two-phase winding is shown in the lower left view of Fig. 56, and you will note the manner in which the three coils of each phase overlap in forming the winding for one pole of the motor.

In the upper view of this figure are shown the curves for two-phase current with alternations 90° apart. When this current flows through the two windings, it sets up poles that progress step by step around the stator so rapidly that it produces what is practically a revolving magnetic field. The progress of this field and the magnetic poles can be observed by tracing out and comparing the several views in Fig. 56. The dotted lines running vertically through the curves in the upper view indicate the polarity of the curves at that instant. These will be referred to as "positions".

For example, in position 1, "A" and "B" are both positive; and, referring to position 1 at the leads of the windings, we find that current will flow in at the starting leads of the two windings which are marked "S" and "S". The polarity set up will be as shown by the positive and negative marks in the sketch above these coils and at position 1.

At this instant we find that the current flows in at all of the six wires on the left and out at all six on the right. See Fig. 56B, lower line. This will set up a magnetic flux or polarity as shown in the sketch of the magnetic circuit, position No. 1 shown at D. This shows that the center of the pole at this instant will be in the exact center of the coils, and that a north pole will be produced at this point on the stator teeth.

At position No. 2 in the current curves, "B"-phase is still positive but "A" is changed to negative; so the current in the starting lead of "A"-phase will reverse as shown at position No. 2 and cause a reversal of the polarity around the "A" group. As

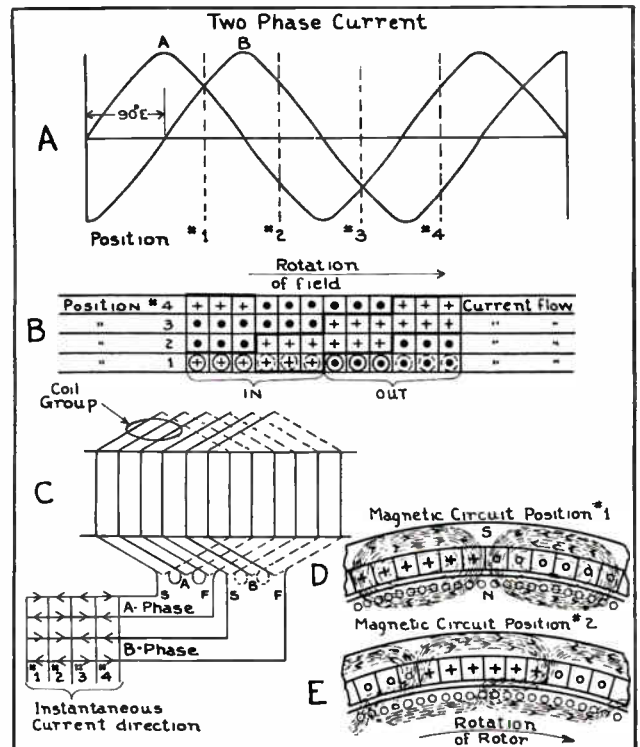

Fig. 56. The above diagrams show step by step the manner in which a revolving field is produced in a two-phase motor winding. Refer to each of the five sketches frequently when reading the descriptions in these columns. This figure illustrates a very important principle of induction motors and is well worth considerable study.

except when the metal pieces "A" and "A" are this group covers the first half of the pole, these three slots will change in polarity. The first three slots of the second pole will also change and cause the pole to move three slots, to the right as shown in position No. 2 of the field rotation sketch.

This shift of the magnetic pole is also illustrated in position 2 of the magnetic circuit sketch. At position 3 on the current curves, "B" has changed to negative and the current in the leads of the "B"-phase coil will reverse, causing the last three slots in each pole to change in polarity so the center of the pole moves three more slots to the right, as shown in position 3 of the field rotation sketch.

We find that as the currents in the coil groups reverse in this manner and keep shifting the magnetic poles to the right, a corresponding change or movement of the field takes place in the stator, as we have seen in positions 1 and 2 of the magnetic circuit. As this flux moves to the right and cuts across the rotor bars, it induces currents in them and the reaction between the poles of this secondary current in the rotor and the stator poles causes the field of the stator poles to be distorted from its natural shape, as shown in position 2 of the magnetic circuit. It is from this field distortion that the torque or twisting force is produced and causes the rotor to turn. It may be necessary to read the preceding paragraphs and trace the diagrams several times in order to thoroughly understand this principle, but it is well worth the time.

### 75. OPERATING PRINCIPLES OF THREE-PHASE MOTORS

The rotating action of the field in a three-phase motor is very much the same as that of two-phase machines, with the exception that only one-third of the pole, or two slots, reverse at a time. In the two-phase machine one-half of the pole, or three slots, change at each reversal of current. The coil groups of the three-phase winding should be placed in the slots in such a manner that they alternate in the same order as the currents change in the three-phase system.

If we observe the three-phase current curves in Fig. 57 we find that the alternations change polarity or cross the center line in the order A, C, B; A, C, B; etc. The coil groups should be wound in to correspond with these current changes, or in the order A, C, B; etc., as shown in Fig. 57.

A very interesting fact to know about three-phase systems is that at any given time the voltage or current curves above the zero line will exactly equal those below the line. For example, in Fig. 57 at position 1, A and B are each at about half their maximum positive value, while "C" is at full maximum negative value. A vertical line through these curves at any point will show the same voltage or current relation.

There is another condition that always exists in three-phase windings, and with which you should be familiar. You will notice that when tracing current in towards the winding on the line wires the

center group, or "C"-phase, will be traced around the coils in the opposite direction to "A" and "B". This should be the case in any three-phase winding, and will be if the coils are properly connected. This may seem confusing at first, but keep in mind that the three currents never flow toward the winding at the same time and that there will always be a return current on one of the wires. At any time when all three wires are carrying current, there will either be two positives and one negative or two negatives and one positive.

When these three currents flow through a three-phase winding, as shown in Fig. 57, three consecutive coil groups will be of the same polarity, and the next three groups will be of opposite polarity, thus building up alternate poles, N.S., N.S., etc.

Trace out and compare each of the positions 1, 2, 3, and 4 in Fig. 57 as was done in Fig. 56, and you will find how the field poles progress around the stator to produce a revolving magnetic field in a three-phase motor.

### 76. TERMS AND DEFINITIONS FOR A. C. WINDINGS

The following terms and definitions should be studied carefully, in order that you may more easily understand the material in the following pages.

A **Coil Group** is the number of coils for one phase for one pole.

The formula for determining a coil group is:

$$\text{Coils per group} = \frac{\text{poles} \times \text{phases}}{\text{Slots}}$$

The term **Full Pitch Coil Span** refers to coils that span from a slot in one pole to a corresponding slot or position in the next pole.

The formula for determining full pitch coil span is:

$$\text{Full pitch coil span} = \frac{\text{Slots}}{\text{poles}} + 1$$

NOTE: Full pitch is also known as 100% pitch. In some cases a winding may be more than full pitch, but should never exceed 150% pitch.

The term **Fractional Pitch** applies to coils which span more or less than full pitch. A fractional pitch should never be less than 50% of full pitch.

We have already learned that there are 360 electrical degrees per pair of poles; so, in the study of the following material be sure to keep in mind that any single pole, regardless of size, has 180 electrical degrees.

The term **Electrical Degrees Per Slot** is commonly used to express the portion of the pole which one slot covers, and is abbreviated  $E^\circ$  per slot.

The formula for determining the electrical degree per slot is:

$$\text{Electric degrees per slot} = \frac{180 \times \text{poles}}{\text{slots}}$$

Some of the material just covered may seem to

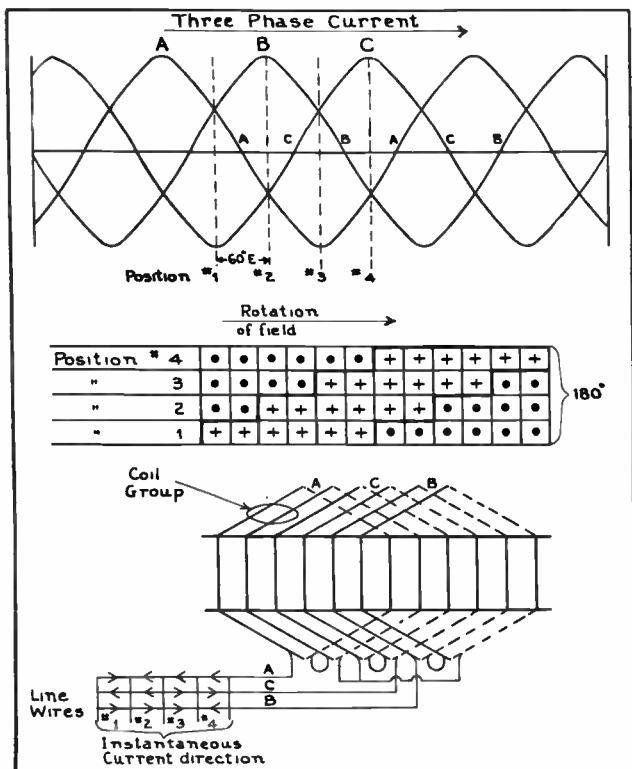

Fig. 57. The above diagrams show the development of the rotating field of a three-phase alternating current motor. Compare carefully the top, center, and lower diagrams and note the manner in which the field poles gradually advance in the slots as the current alternates in the three phases A, C, and B.

you to be somewhat technical or theoretical, but a thorough study of the principles and terms on these preceding pages will help you obtain a better understanding of many of the most important and practical features in the winding and testing of alternating current machines.

### 77. LAP WINDINGS FOR A.C. MACHINES

Both lap and wave windings are used for A.C. motors and generators, but some of the rules which were given for these windings on D.C. machines do not apply to A.C. machines.

Instead of classing them as parallel and series windings, as we did for D.C., they are defined for A.C. as follows:

A lap winding is one in which all coils in a pole group can be traced through before leaving that group.

A wave winding is one in which only one coil in each pole group can be traced through before leaving that group.

Lap and wave windings are practically the same as to polarity and general characteristics.

On D.C. machines with a certain number of coils the wave connection gives the highest voltage. This is not true of A.C. windings, as the A.C. wave connection gives no higher voltage than the lap. A single circuit A.C. lap winding puts all possible coils in series, so it gives just as high voltage as the wave.

The wave winding is stronger mechanically than the lap winding, and for that reason it is generally used for phase-wound rotors, as there is often considerable stress on their windings due to centrifugal force and starting torque.

Stators are generally wound with lap windings. In the design of A.C. stators, the number of slots is determined by their size and the number of poles, and is selected for convenience in connecting the type of winding desired for the purpose of the machine.

### 78. TWO PHASE A.C. WINDING EXAMPLE

When the total number of slots is evenly divisible by the product of the number of poles and the number of phases, there will be an equal number of coils in each group and the same number of groups in each phase. This is known as an equal coil grouping.

For example: if we have a machine with 72 slots and we wish to wind it for 6 poles and 2 phase operation, then, to determine the coils per group, we use the formula:

$$\text{Coils per group} = \frac{\text{Slots}}{\text{poles} \times \text{phases}}$$

or, in this case,

$$\text{Coils per group} = \frac{72}{2 \times 6} = 6$$

Then there would be 6 coils in series in each pole group, and twelve such groups in the winding.

These twelve groups are divided into six parts for the six poles, and each part is again divided in two for the two phase-groups. Then these small groups of six coils each are connected into one phase of a two-phase winding.

A simple form of two-phase lap winding for two poles is illustrated in Fig. 58.

The starting leads of the coils for the "A" and "B" phases are marked "S A" and "S B", while the finish leads are marked "F A" and "F B". This winding could not be connected for three phase because the coils in each pole are not evenly divisible by three.

Note that the starts of each phase are 90° apart, or displaced from each other by one-half the width of one pole.

This should be remembered when connecting any two-phase winding, as the starts for these windings must always be spaced this distance apart.

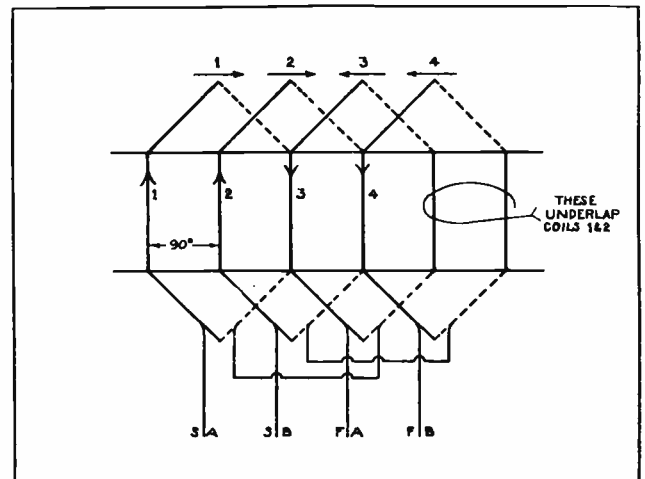

Fig. 58. This sketch shows the coils and connections of a simple two-pole, two-phase winding. Examine the connections of the coils carefully and note the direction of current in each coil.

### 79. COIL POLARITY IMPORTANT

When there is more than one coil per group the coils must be very carefully connected, as all coils of the same group must be connected for the same polarity, or, so that current flows in the same direction through all coils of this group. This is a very important rule to remember and is illustrated in Fig. 59.

The two coils in the group at "A" are properly connected; that is, the finish of one is connected to the start of the next; so that the flux will unite around the sides of these coils, as it should to produce the pole. The coils in group "B" are improperly connected, with the finish of one to the finish of the other. So in this case the current in the right hand coil is reversed. This causes the flux of the two coils to oppose and neutralize each other and therefore they cannot build up a strong magnetic pole in the stator core.

Check the connections of these two groups of coils carefully, so you will know the right and wrong methods.

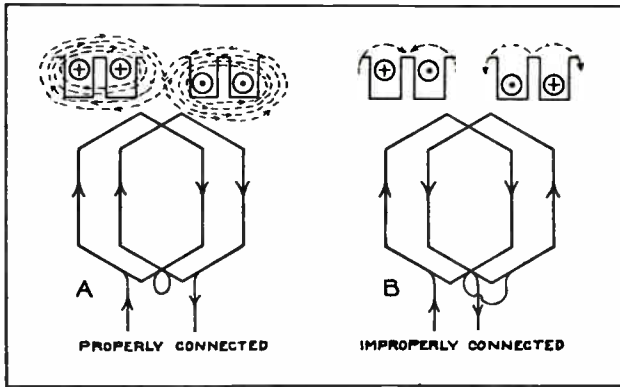

Fig. 59. Above are shown both the right and wrong methods of connecting stator coils to obtain the right polarity. Note the conditions of magnetic flux set up in the slots with each connection.

Fig. 60 shows a simple two-pole, three-phase winding with one coil per phase group and three groups per pole. This winding only has one coil per group. Observe very carefully the method of connecting the coil groups together. You will note that they are connected to give alternate polarity —N, S, etc. Also note that there are two coil sides per slot, one lying on top of the other.

The leads from the coil ends are referred to as top and bottom leads, the one from a coil side lying in the top of the slot being called the top lead, and the one from a bottom coil side is called the bottom lead.

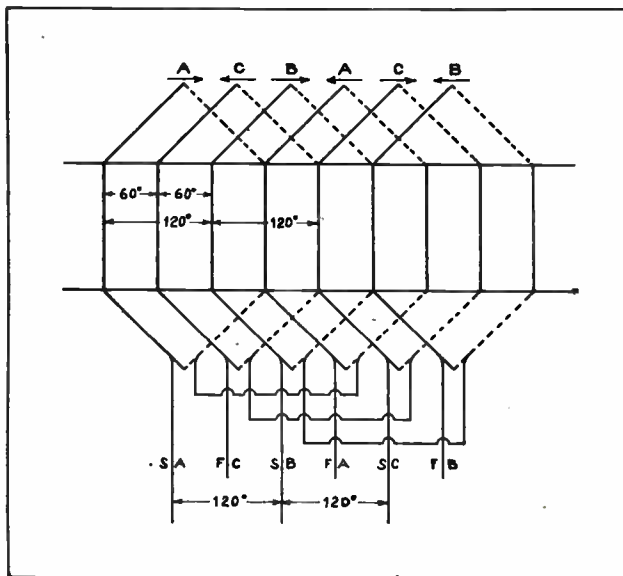

Fig. 60. This sketch shows a two-pole, three-phase winding. Note the spacing in degrees between the coil sides and line leads, and also the arrangement of the coil connections.

In making the connections from one pole group to the next of the same phase, always connect like leads together; that is, bottom leads together and top leads together for the short jumper arrangement. This rule should be followed strictly, in order to produce the alternate poles which are necessary in the winding to make the machine operate. If any of these coils is connected wrongly, the coils

will overheat, as their self-induction will be neutralized and too much current will flow through them. This principle will be explained in a later section.

### 80. TYPES OF COILS FOR STATOR WINDINGS

Stators of 15 h. p. and under, and for less than 550 volts, usually have partly closed slots and are commonly wound with "fed in" or "threaded in" windings. For this type of winding we can use either the threaded-in diamond coil or what is known as a basket coil. Fig. 61 shows a coil of each type.

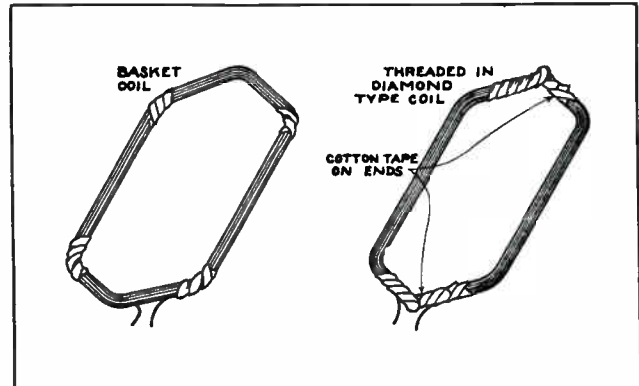

Fig. 61. Two common types of coils used in winding small stators with partly closed slots. These coils can be easily fed into the narrow slot openings.

The diamond coil is wound, shaped, and the ends taped with half lapped cotton tape before the coil is fed in the slots. The basket coil is simply wound to the approximate shape, and to the proper length and size; but is left untaped except for little strips of tape at the corners just to hold the wires together until they are placed in the slots. The ends of these coils are taped after they are placed in the slots, or in some cases on small stators the coil ends are left untaped. After placing the coils in the slots, their ends are shaped with a fibre drift and a rubber or rawhide mallet, so the coil ends can pass over each other.

These basket coils are generally used only for the smaller machines, and the diamond coils are usually more desirable for the larger machines.

The untaped sides of either of these types of coils make it possible to feed the wires one or two at a time into the narrow slot openings. Thus the name "fed in" coils.

### 81. PROCEDURE FOR WINDING A THREE PHASE STATOR

The following paragraphs describe in detail the procedure of winding a three-phase stator of 36 slots and 6 poles.

Let us apply the formula:

$$\text{Coils per group} = \frac{\text{Slots}}{\text{poles} \times \text{phases}}$$

or, in this case,

$$\text{Coils per group} = \frac{36}{6 \times 3} = 2 \text{ coils per group}$$

The full pitch coil span will then be found by the coil span formula:

$$\text{Full pitch coil span} = \frac{\text{slots}}{\text{poles}} + 1$$

or, in this case,

$$\text{Full pitch coil span} = \frac{36}{6} + 1 = 7.$$

The first coil will then span or lie in slots one and seven.

After the slots have been insulated, begin by placing one side of the first coil in any slot with the leads of the coil toward the winder, as shown in Fig. 62.

One side of the next coil is then placed in the slot to the left of the first, which will make the winding progress in a clockwise direction around the stator. Four more coils are then placed in the slots in a similar manner, leaving the top sides of all of them out.

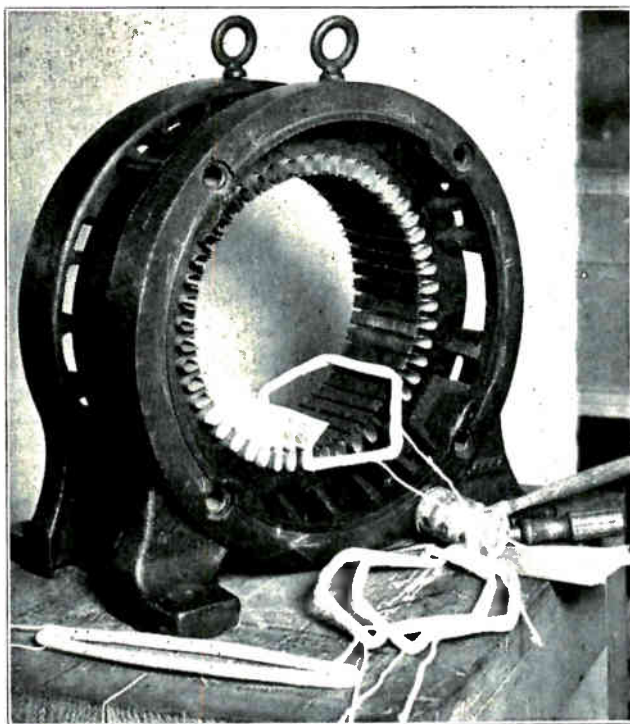

Fig. 62. This view shows a method of starting the first coil for a stator winding. The fish paper insulation is in all slots and the varnished cambric has been placed in several.

When the bottom side of the seventh coil is placed in the seventh slot, its top side is laid on top of the first coil, as shown in Fig. 63. The bottom of eighth coil is placed in the eighth slot and its top is placed on top of the bottom side of the second coil.

This procedure is followed until all the coils are in place, the bottom sides of the last six coils being slipped in under the first six coils, the top sides of which were left out of the slots. Fig. 64 shows a view of a stator from the back end, after the last

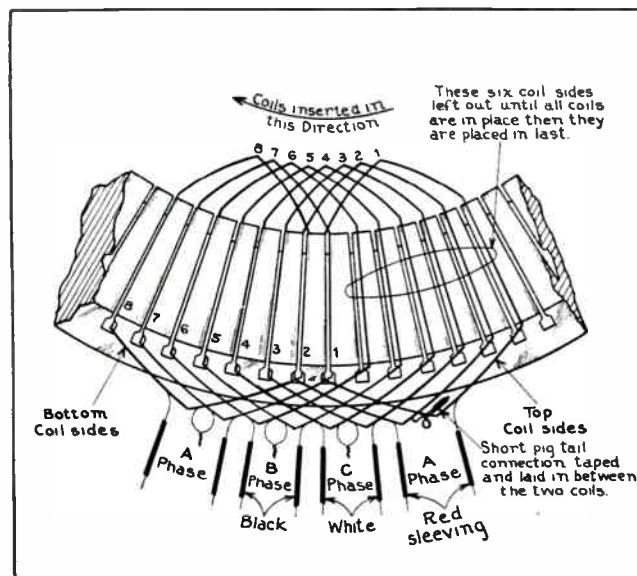

Fig. 63. This diagram illustrates the method of placing the first coils in a stator and the proper rotation for inserting them. Note the sleeving used for marking the leads of the different phase groups, and also the several coil sides which are left out of the slots until those of the last coils are inserted under them.

coils have been laid in under the top sides of the first coils. These top sides are now ready to be inserted in the slots and then the slot insulation can be trimmed, folded in over the coils, and the slot wedges put in place.

While the coils of the winding just described were laid in to the left of the first, or clockwise around the stator, they can be laid either clockwise or counter-clockwise, according to the shape of the end twist of the coils.

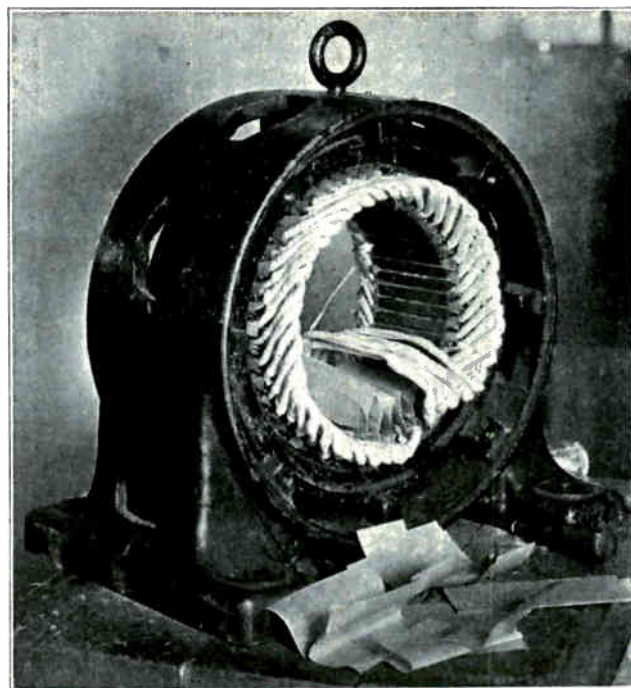

Fig. 64. This photo shows a stator winding nearly completed and ready for the top sides of the first coils to be placed in on the bottoms of the last coils which were inserted. The insulation has been neatly folded down over the coils in most of the slots.

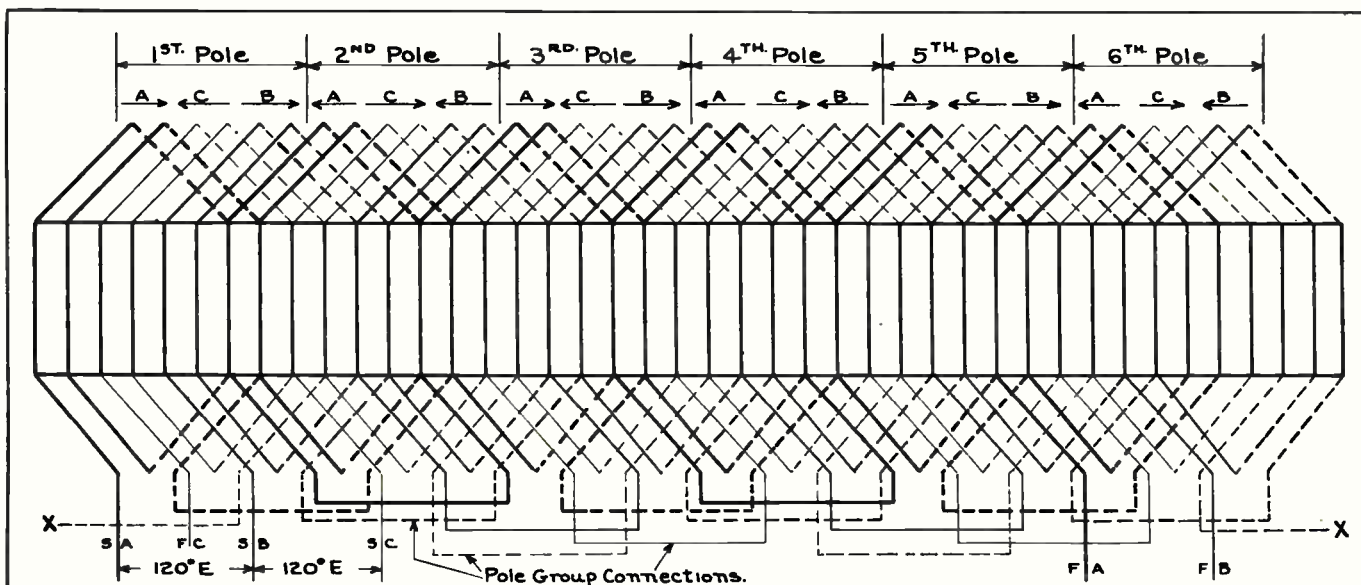

Fig. 65. Complete diagram of a three-phase, six-pole winding for a machine with 36 slots. The coils of each phase are shown in lines of different thickness in order that they may be easily traced through the winding. Trace these circuits very carefully and note the manner in which the coils are connected to obtain alternate N. and S. poles. Also note how the coil groups of each phase overlap to complete the three phases of each pole of the winding. Refer to this diagram frequently while studying the accompanying pages, and also at any time you may need it when connecting a three-phase winding.

## 82. MARKING AND CONNECTING COIL LEADS

In winding stators of small size it is general practice to connect the coils into groups as they are fed in the slots. You will notice in Fig. 63 that the bottom lead of the first coil is connected to the top lead of the second. The top lead of the first coil and the bottom lead of the second are identified or marked with sleeving of the same color. All of the following groups are connected together the same as the first; but the unconnected leads of the second group are marked with a different colored sleeving than the first, and the third group with still another color. For the fourth group we again use the same color as for the first, and from there on the colors are duplicated on the other groups, the same as on the first three.

When all the coils of this 36-slot winding are in place there will be five more poles similar to the one in Fig. 63.

After the wedges are in the slots the pole group connections are made as shown in Fig. 65. This diagram shows the connections of the groups into a three-phase winding.

Careful observation of the starting leads of A, B, and C phases will show that there are three separate windings spaced two-thirds of a pole, or 120 electrical degrees, apart.

You will note however, that the windings are placed in the stator in the order A, C, B, from left to right; thus actually making the effective spacing 60 degrees for certain connections.

After selecting the top lead of any convenient coil in the winding for the start of A phase and connecting all groups of a corresponding color into one winding, the second start, or B phase, is selected. This lead must be taken from the top of the third group, counting A phase as number one. All groups

for B phase are then connected and, last of all, those for C phase are connected. The C phase should start at the top lead of the fifth coil group, which would be the same distance from B as B is from A.

There will then be six leads left, three starts and three finish leads. In Fig. 65, these leads are marked SA, FC, SB, SC, FA, and FB, and you will note that they are all from top sides of coils. In selecting the starting leads for such a winding, we choose three groups which are close to the opening for the line leads in the frame or end-bracket.

Fig. 66 shows a complete connection diagram for a two-phase, four-pole winding with 24 slots. The coils are laid in the slots the same as for a three-phase winding. There are three coils per group and two groups in each pole. The coils are also connected into groups the same as for a three-phase winding, and the pole group connections made similarly, except with two groups per pole instead of three.

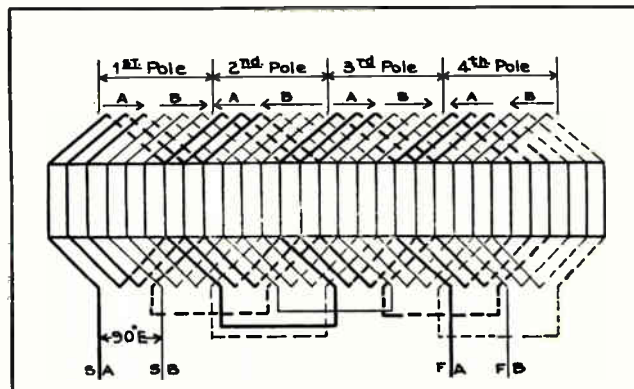

Fig. 66. Complete two-phase winding for a four-pole machine with 24 slots. Note the similarity between this diagram and the one in Fig. 65 as to the arrangement of coils and connections between pole groups; but also note that there are only two phase groups per pole, and the different spacing in electrical degrees between the leads in this winding and the three-phase winding in Fig. 65.



### 83. PROCEDURE FOR CONNECTING A 3 PHASE WINDING

Fig. 67 shows complete four-pole, three-phase winding in a stator with 48 slots. The coils are all in place, but no group connections have been made. You will note that all top and bottom leads are brought out at the points or ends of the coils, and all in the same position on the coils, in order to make a neat and systematic arrangement of the leads and to simplify the making of connections.

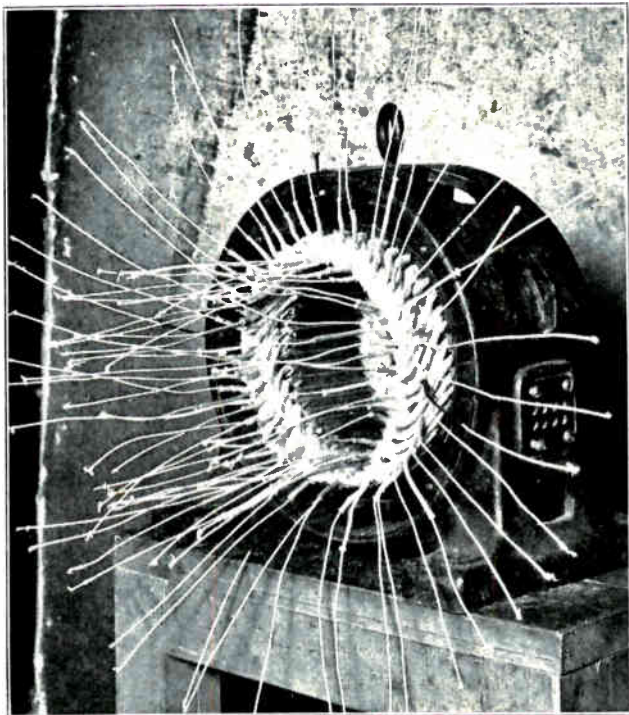

Fig. 67. The above photo shows a stator with 48 slots wound for four poles, three phase. The coils are all in the slots and the leads are marked with sleeving and ready for the connections to be made.

The bottom leads of all coils are bent out around the edge of the frame, and all top coil leads are arranged straight out from the stator core. The next step would be to strip the ends of these leads and temporarily connect them in bunches for making a ground test from the coil leads to the stator. This test can be made with a 110-volt test lamp, and it should always be done before connecting any coils, to make sure that none of them are grounded because of damage to their insulation while they were being placed in the slots.

To make sure that no coils in any group are open, the start and finish leads of each group should also be tested by placing one wire of the 110-volt line on a start and the test lamp on the finish lead.

Note that all coil leads are marked with sleeving and that every fourth bottom lead and also every fifth top lead are marked with longer sleeving, as these leads are those of the start and finish of each pole group.

### 84. MAKING "STUB" CONNECTIONS

The next step will be to cut off all leads of the coil groups that are marked with the short sleeving,

about 3 inches long. Strip the insulation from about  $1\frac{1}{2}$  inches of their ends; then connect them together, the bottom lead of one coil to the top of the next. This is shown in Fig. 68, and the pigtail splices of these coil groups can be plainly seen.

The bottom leads of the pole group are still shown sticking out around the frame, and the top pole group leads are projecting out from the center of the core.

### 85. POLE AND PHASE CONNECTIONS

In Fig. 69 the coil-group connections have been soldered, taped, and folded down between the coil ends and the pole group leads have been connected together. The bottom lead of one group is connected to the bottom lead of the the next group of the same phase and color. The top lead of one group is also connected to the top lead of the next group of the same phase. This places all pole groups of each phase in series in the winding. These pole-group leads are commonly called jumpers.

You will note that the three starts for the phases which are marked SA, SB, and SC are taken from the first, third, and fifth pole groups, near the line-lead opening in the frame.

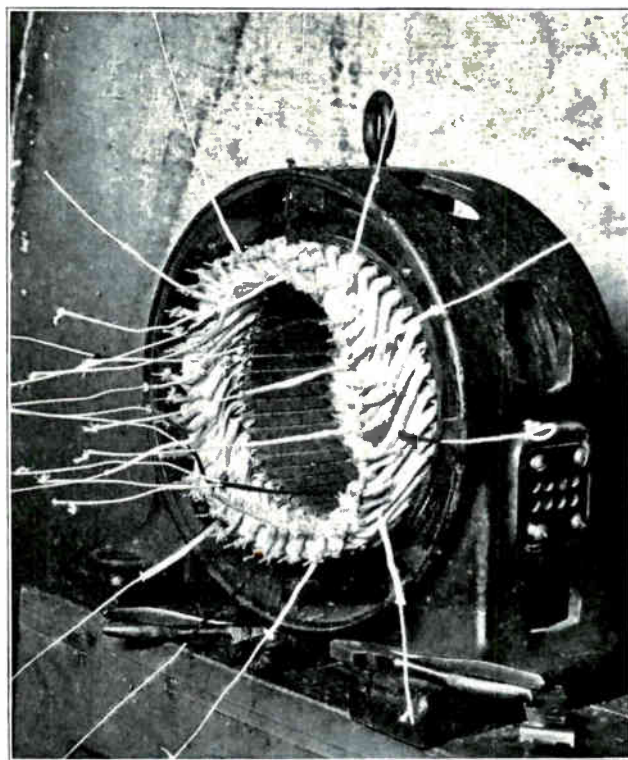

Fig. 68. This view shows the same stator as in Fig. 67, except that the coil group connections have been made. By looking carefully you can see the bare pig-tail splices of these connections around the winding. The pole group leads are not yet connected.

The three finish leads marked FA, FB, and FC, are shown at the top of the winding.

In Fig. 70 the three finish leads are shown connected together at the top of the machine, and the three start leads are connected to heavy rubber covered wires for the line leads.

The pole-group leads are now folded or pressed

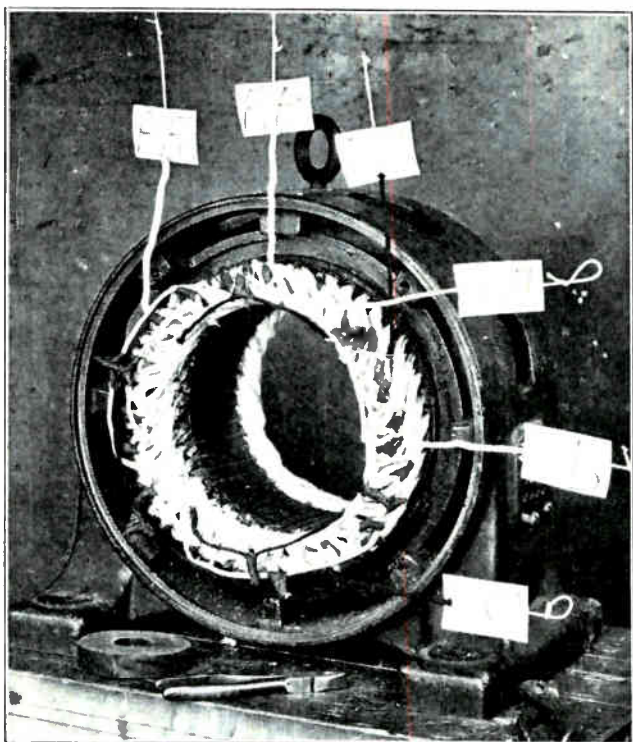

Fig. 69. Again we have the same stator as in the last two figures, but in this case the connections are one step farther along. The coil group connections have been soldered and taped, and the pole group connections are made, leaving only the start and finish leads of each phase. These are marked by the tags as shown.

down around the outside of the coil ends to make them clear the end bracket and rotor, and the winding is then ready for the insulating compound and baking.

### 86. UNEQUAL COIL GROUPING

The lap windings previously covered have all had equal coil grouping, that is, the same number of coils in consecutive groups. In some cases it is necessary to wind a stator with unequal coil groups in the winding. This is because the number of slots does not happen to be evenly divisible by the product of the number of poles and the number of phases. The unequal coil grouping to be used in such a case will have two or more groups in each pole, with an unequal number of coils per group.

For example, suppose we have a 48-slot machine to wind for 6 poles and 3-phase. In this case the product of the poles and phase, is  $6 \times 3$ , or 18. The number of slots, or 48, is not evenly divisible by 18 so we cannot use equal coil grouping.

This stator can, however, be wound satisfactorily for three-phase by using the following coil grouping: Three coils in group "A", three coils in group "C", then two coils in group "B", which completes the first pole.

For the second pole the small group should be shifted to another phase; so we will place three coils in group "A", two in group "C", and three in group "B", etc. Thus we keep rotating or shifting the small group from one phase to the next throughout the winding.

The tables in Fig. 71 show the manner in which

this grouping will even up the coils per phase in the complete winding. These tables show unequal groupings which are commonly used in two and three-phase motors.

The horizontal lines or rows show the number of coils per group in each phase, for each of the poles. The vertical columns show the number of coils per group throughout the entire winding. By adding the columns for each phase you will find that the number of coils per phase is the same in all three phases.

### 87. STAR AND DELTA CONNECTIONS

After the coil groups and pole-group connections in a three-phase winding have been completed, six leads remain to be connected for line leads.

The two methods of connecting these are known as Star and Delta connections. These connections are very important, as they determine to quite an extent the voltage rating of an A. C. generator or motor.

The left view in Fig. 72 shows the star connection for an A. C. winding. The three coils—A, B, and C—represent the three-phase windings of the machine and are spaced  $120^\circ$  apart. The center connection of this star is the point at which all three of the finish leads of the winding are connected together. The three outer ends of the coils are the starts, and are connected to the line wires.

The sketch at the right in this figure shows the method of making the star connection right on the leads of a winding.

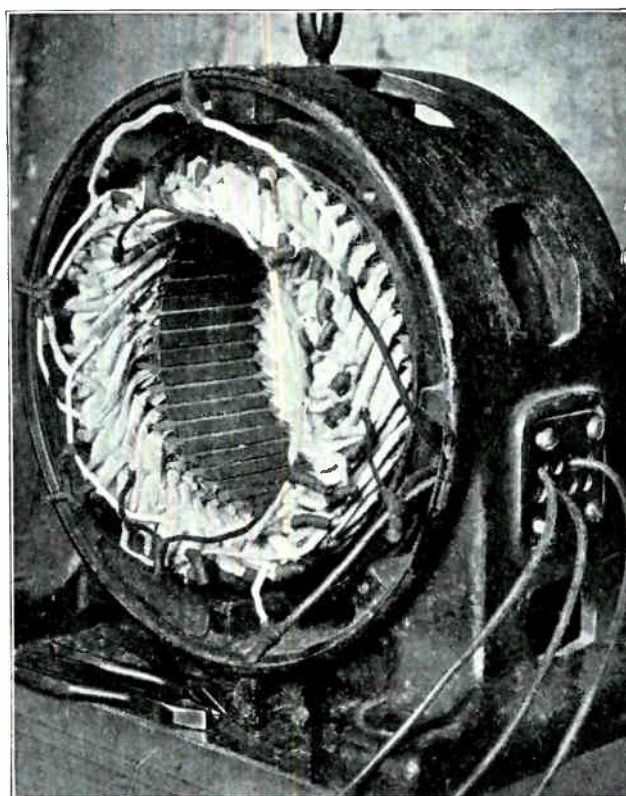

Fig. 70. The last step in the connections has now been completed and the starts and finishes of the first groups are connected to the line wires which are brought out through the right side of the frame.

The symbol for the star connection is a mark consisting of 3 small lines 120° apart and connecting at the center. The letter Y is also commonly used.

The left view in Fig. 73 shows the delta connection for an A. C. winding. The three coils—A, B, and C—again represent the three-phase winding of the machine, and are connected together in a closed circuit with the start of "A" to the finish of "C", start of "C" to finish of "B", and start of "B" to finish of "A".

The line leads are then taken from these points at which the windings are connected together.

The sketch at the right in Fig. 73 shows the method of making the delta connection right on the leads of a winding.

The symbol for the Delta connection is a small triangle, Δ.

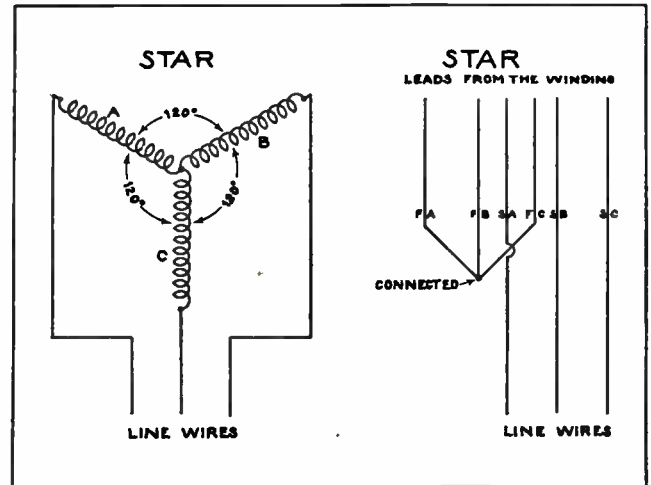

Fig. 72. The above two sketches illustrate the method of making star connections with alternating current windings. Note the phase displacement between the three windings on the left and also the manner in which two windings are placed in series between any pair of phase wires. The sketch at the right will be convenient for reference when connecting machine windings in this manner.

	A	C	B
POLE # 1	3	3	2
" 2	3	2	3
" 3	2	3	3
" 4	3	3	2
" 5	3	2	3
" 6	2	3	3

48 SLOTS 6 POLES  
3 PHASE

	A	C	B
POLE # 1	4	5	4
" 2	5	4	5
" 3	4	5	4
" 4	5	4	5

54 SLOTS 4 POLES  
3 PHASE

	A	C	B
POLE # 1	3	2	2
" 2	2	3	2
" 3	2	2	3
" 4	2	2	2
" 5	3	2	2
" 6	2	3	2
" 7	2	2	3
" 8	2	2	2

54 SLOTS 8 POLES  
3 PHASE

	A	C	B
POLE # 1	5	4	
" 2	4	5	
" 3	5	4	
" 4	4	5	
" 5	5	4	
" 6	4	5	

54 SLOTS 6 POLES  
2 PHASE

Fig. 71. The above table shows unequal coil groups which can be used for two and three phase windings. Note how this arrangement of coils places an equal number in each phase when the winding is complete, even though there is not the same number in each phase of any one pole.

### 88. VOLTAGE OF STAR AND DELTA CONNECTIONS

By carefully comparing these two forms of connections in Figures 72 and 73, you will note that the delta connection has only half as many turns of wire in series between the line leads of any phase, as the star connection. We know that the number of turns or coils in series directly affects the voltage, so we can see that for a given voltage per phase, the star connection for a generator will produce higher voltage than the delta, and that the star connection when used on a motor will enable the motor to be used on higher line voltage.

The delta connection, however, has two windings in parallel between any two line or phase leads, so it will have a greater line current capacity than the star connection.

As the star connection places twice as many coils in series between line wires as the delta connection,

it might at first seem that it would give double the voltage of a delta connection. The voltage increase, however, will not be quite double, because the spacing of the two windings in the machine is 120° apart and consequently their maximum voltages occur at slightly different periods of time. The placing of the C phase winding between the windings of A and B phases, as explained in Art. 82, actually reverses its phase relation to the other two windings by 180 degrees; and in the star connection this puts phase voltages in series which are only 60 degrees displaced. So when two equal voltages which are 60 degrees apart are connected in series, their total voltage at any instant will not be double, but will be approximately 1.73 times the voltage of either one.

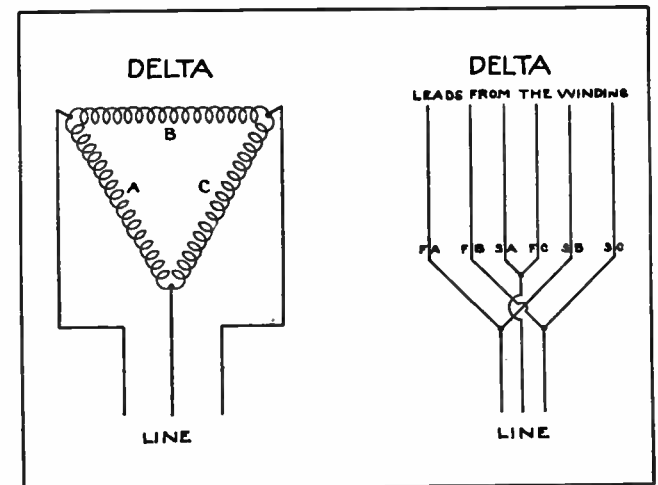

Fig. 73. These diagrams show the method of making delta connections for alternating current windings. The sketch on the left shows that with this delta connection two windings are in parallel between any pair of phase wires. The sketch on the right shows the manner of making a delta connection to the leads of a machine winding.

This value is obtained by vectorial addition instead of numerical addition. Fig. 74 shows how this can be done graphically or with lines drawn to scale

and at the proper angles to represent the voltages to be added. The line from "B" to "A" represents 100 volts of one winding, and the line from "B" to "C" represents 100 volts of another winding 120° out of phase with the first. However, as one of the phases is reversed with respect to the other, we will draw a line in the opposite direction from B to D, to represent the voltage 180° displaced, or in the reverse direction to that shown by line B A. This voltage will then be 60° displaced from that in the other phase, shown by line B C.

By completing our parallelogram of forces as shown by the light dotted lines we can now determine the vectorial sum of the two phase winding voltages in series, by measuring the diagonal line B. E. If the lengths of the lines "B C" and "B D" are each allowed to represent 100 volts by a scale of 1/8 inch for each 10 volts, we find by measuring the length of the line "B E" that it is 1.73 times as long as either of the others, so it will represent about 173 volts.

Observation of Fig. 74 will show that a straight line drawn from A to C would be exactly the same length as the line from B to E. In many cases these vector diagrams are drawn in this manner by merely reversing the arrow on line A B and leaving off lines B D, C E, and B E.

This same method can be applied to find the sum or combined force of two separate mechanical forces acting at an angle. If we have a force of 100 lbs., acting in a direction from "B to C", and another equal force acting from "B" to "D", then the combined force "B to E" will be approximately 173 lbs.

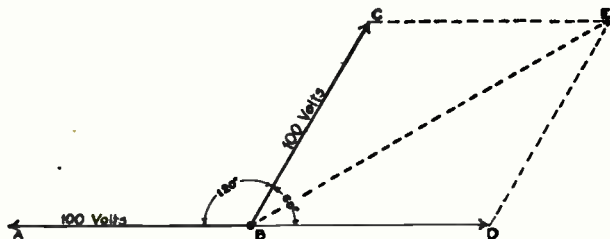

Fig. 74. The above diagram illustrates the method used to determine the sum of two voltages that are 60° out of phase, as when two phases of a three phase winding are connected finish to finish.

Another method of calculating the sum of voltages which are out of phase will be given in a later section; and the use of vectors, or lines and angles for such problems will also be more fully explained in that section.

The important fact to remember is that the star connection always gives 1.73 (or, to be exact, 1.732) times the voltage of the delta connection. So, in changing from delta to star we multiply the delta line voltage by 1.732; and in changing from star to delta we divide the star line voltage by 1.732, or multiply it by .5774, to get the delta line voltage.

### 89. FRACTIONAL-PITCH WINDING

Fractional-pitch windings, also known as short-chord windings, are those in which the coil span is

less than full pitch. There are several reasons for making windings with fractional-pitch coils. The shorter coils used in these windings provide greater mechanical strength of the winding, and they also produce a lower voltage than full-pitch coils. Fractional-pitch windings are also used to improve the power factor of alternating-current machines, as will be explained in a later section.

By referring to Fig. 75, you will note that the length of the coil between its ends or points is reduced by making the coil span less than full pitch. In this figure the large coil which spans from slot 1 to slot 7 is assumed to be a full-pitch coil, so a coil laid in slots 1 and 6 will be a fractional-pitch coil and will have 83 1/3% pitch. The shorter the coil ends are, the greater the mechanical strength of the coil.

Most two and three-phase motor windings use a coil span of less than full pitch, and generally about 75 to 85 per cent of full pitch. If a generator winding is changed from full pitch to fractional pitch, the coils which are thus shortened will not span from the center of one pole to the center of the next. Thus the generator voltage will be decreased. This voltage reduction will vary with the sine of an angle of one-half the electrical degrees spanned by the coil.

For example, if a machine has 54 slots and 6 poles, the full-pitch coil span would be (54 ÷ 6) plus 1, or 10. The coils for this winding would then span from slots 1 to 10 and this full pitch would, of course, be 180 electrical degrees. Such a coil will span from the center of one pole to the center of the next, and the voltage generated in it will be maximum or 100%.

If we use a fractional pitch coil which lies in slots 1 and 7, it would in this case span only 120 electrical degrees, instead of 180. Since 54 ÷ 6, or 9 slots represent 180 degrees, one slot will represent 20 degrees and 6 slots 120 degrees. One-half of 120 degrees is 60 degrees, and the sine of an angle of 60 degrees is .866. So a fractional-pitch coil spanning

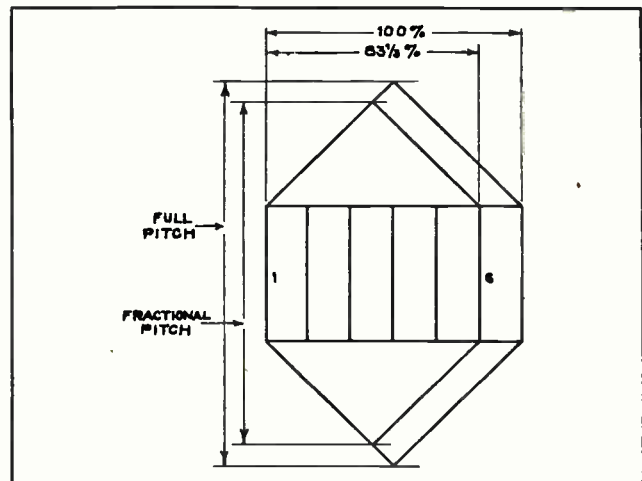

Fig. 75. Note how fractional-pitch windings make the coils shorter as their pitch is decreased. The shorter coils will have greater mechanical strength, which is one of the advantages of this type of winding.

6 slots instead of 9 would only generate a little over 86% of the voltage that would be produced by a full-pitch coil, and this would apply to the entire winding of the machine. The sines of various angles can be found in tables given in a later section on A. C. and will be more fully explained in that section.

### 90. SPECIAL POLE GROUP CONNECTION

Fig. 76 shows a system of connections very often used on three-phase motors. This system of connections will give the same results as the one previously described in this section and can be used on any two or three-phase winding. You will note that instead of connecting from the finish of a certain coil group to the finish of the next coil group of that phase, this finish lead is carried over to the start of the third coil group of that phase, skipping the second one and leaving it to be connected when the counter-clockwise connections are made. This produces the same polarity as though all coils of a certain phase were connected together in succession from finish to finish, start to start, etc.

Compare this method with that shown in Fig. 65. One of the advantages of this system is that on heavy windings it allows the end connections to fit more compactly against the coils and in a small space in the machine, and it also permits the use of equalizer connections to correct magnetic unbalance.

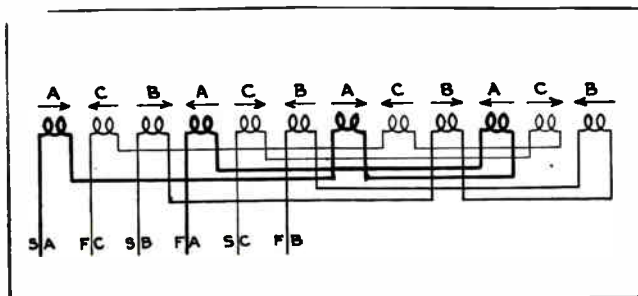

Fig. 76. This diagram shows a different method of connecting together the pole groups of the winding to allow a more compact arrangement of the leads on heavy windings. This method simply connects every other pole of one phase in a straight series group without crossing the leads; then connects back to get the remaining poles of those phases which were skipped the first time. These are connected in another straight series group and to the first group in a manner to produce alternate N. and S. poles throughout that phase.

### 91. ROTOR WINDINGS

We have previously mentioned that some alternating current machines have wound rotors using windings similar to those of a D. C. armature, but instead of these coils being connected to the bars of the commutator, they are connected together for two or three-phase the same as stator coils are. The main leads are then connected to slip rings on the rotor shaft. Such windings are used on machines for variable speed duty and machines where extra-heavy starting torque and certain power factor characteristics are required.

Fig. 77 shows a diagram of a "phase-wound" rotor of four poles and 24 slots, wave wound. This type of winding is used very extensively on large rotors which have heavy coils made of copper bars, and

the connecting system is practically the same as for all wave windings. This rotor can be used satisfactorily with either a two or three-phase stator winding.

The actual winding procedure for such rotors is practically the same as for D. C. armatures, except for the difference in the connections.

### 92. CHANGING OPERATING VOLTAGE OF INDUCTION MOTORS

Very often the maintenance man is confronted with a problem of changing the operating voltage of induction motors to permit them to be operated on a different line voltage, in case they are moved to a new locality where the original operating voltage is not obtainable.

The voltage of any individual motor winding varies directly with the number of turns it has connected in series.

If you remember this simple rule it will help you solve many problems in making voltage changes on equipment. There are, of course, certain practical limits beyond which this change of voltage should not be carried. For example, if we have a winding operating at 220 volts we might, by reconnecting, be able to increase the number of turns in series to a point where the winding would stand 2300 volts, but it is doubtful whether the insulation would stand so high a voltage.

It is almost always permissible to reconnect a winding to operate on a lower voltage than it has been designed for; but, when reconnecting a machine to increase its operating voltage, the insulation should always be considered. The usual ground test for the insulation of such equipment is to apply an alternating current voltage of twice the machine's rated voltage, plus one thousand volts. This voltage should be applied from the winding to the frame for at least one minute and a test should be made after the winding is reconnected, or on any new winding

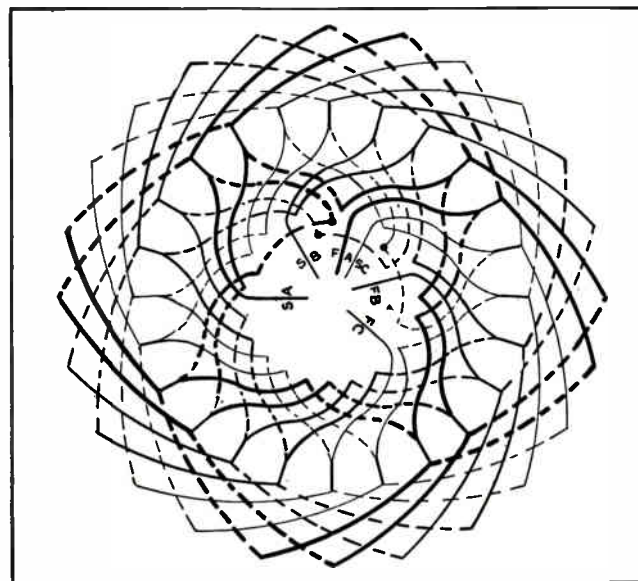

Fig. 77. This sketch shows a complete winding diagram of a 24-slot wave-wound rotor. Rotors with windings of this nature are sometimes called "phase-wound" rotors.

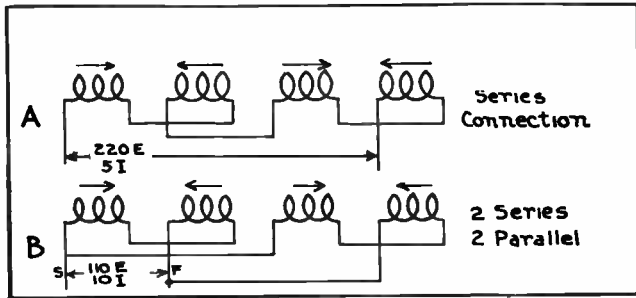

Fig. 78. The above diagram shows the method of reconnecting poles of the winding from series to series-parallel to be operated on a lower voltage.

before it is placed in operation. When a winding is reconnected for a different voltage, it should be arranged so that the voltage on each coil group will remain unchanged.

Fig. 78 illustrates the manner in which this can be done. In the diagram at "A", 220 volts are applied to four coil groups in series, which places 55 volts on each group, and we will assume this voltage will cause 5 amperes to flow. The same winding is shown again at "B", reconnected for 110 volts, with two groups in series in each of two parallel circuits. When 110 volts are applied to these two parallel groups we will still have 55 volts per coil, and the same amount of current will flow. The rotating magnetic field will not be affected any differently as long as the amount of current per coil is not changed and the polarity of the coils is kept the same. This explains why it is not necessary to change the rotor winding when the winding in the stator is reconnected for a different voltage.

In reconnecting two or three-phase windings all phases must be connected for the same number of circuits, and when connecting the groups for a winding having several circuits, extreme care should be taken to obtain the correct polarity on each group.

93. TEST FOR CORRECT POLARITY

In changing the connections of a three-phase winding one must be very careful not to connect the phases in a 60° relation instead of 120° as they should be. By referring to Fig. 79 we can see that it would be easy to connect the wrong end of the B-phase to the star point. This would reverse the polarity of the entire B-winding, and cause the stator winding to fail to build up the proper rotating field. The result would be that the motor would not develop proper torque, and the winding would heat up and burn out if the reverse connection were not located and corrected at once.

To avoid making a mistake of this kind, trace through each winding, starting from the leads or terminals and proceeding to the star connection at the center of the winding. As each successive coil group is traced through, place an arrow showing the direction in which that group was passed through. When all three phases have been traced through in this manner and the arrows on the groups are inspected, the sketch or connection is correct if the arrows on adjacent groups reverse.

That is, they should point alternately clockwise and counter-clockwise around the winding as in Fig. 79.

94. EFFECT ON CURRENT WHEN CHANGING THE VOLTAGE

It is common practice among most manufacturers to design machines that can readily be connected for either of two common voltages. This is accomplished by a series or parallel arrangement which can be more easily understood by comparing Figs. 79 and 80. In the center of each of these diagrams is shown a small schematic sketch that illustrates in a simple manner the series or parallel arrangement of the coils. This center sketch in Fig. 79 shows that there are twice as many coil groups in series between the terminal leads as there are in the connection in Fig. 80. This means that if the winding in Fig. 79 is properly connected for 440 volts the one in Fig. 80 would be correct for 220 volts.

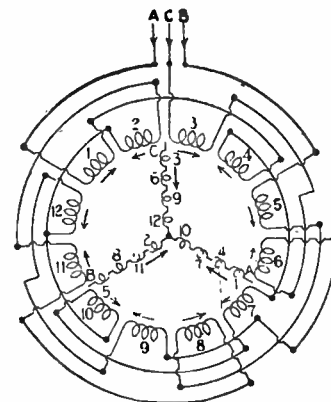

Fig. 79. This diagram shows a 3-phase, four-pole winding in which the pole groups in each phase are all four connected in series, and the three series groups connected star as illustrated by the diagram in the center. Don't confuse the inner and outer diagrams as they are entirely separate and each shows the same winding merely in a different manner.

We know that in any motor the horse power depends on the number of watts which are used in its circuit, and we also know that the watts are equal to the product of the volts and the amperes; so, if we wish to maintain the same horse power of a motor at one-half its normal voltage, we can see that it will have to carry twice as many amperes at full load.

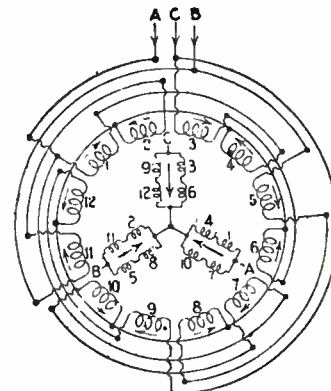

Fig. 80. This diagram shows the same three-phase, four-pole winding which was shown in Fig. 79, but in this case the four pole groups of each phase have been connected two in series and two in parallel, and then the phase groups connected star as shown by the center sketch.

By comparing the center diagrams in Figs. 79 and 80, we can see that this extra current can be carried all right by the windings as they are reconnected for the lower voltage in Fig. 80. In this connection there are two circuits in parallel which, of course, will have twice the cross-sectional area of copper that the single circuits in Fig. 79 had.

If the number of poles in the machine is evenly divisible by 4—as, for example: 4, 8, 12, 16, etc.—the winding may be connected in four parallel circuits, as shown in Fig. 81. By comparing this with the connections and voltages of Figs. 79 and 80, we find it will be proper to operate the winding in Fig. 81 at 110 volts, and four times the current which was used in the connection in Fig. 79; which should maintain the same horse power. The increased current in this connection is again provided for by the four circuits in parallel.

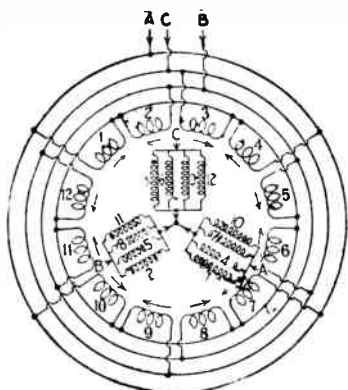

Fig. 81. Again we have the three-phase, four-pole winding. This diagram has all four poles of each phase connected in parallel and the three phase groups connected star as shown by the center sketch.

On this same principle, if the number of poles of a machine can be evenly divided by 6, it will be possible to reconnect the windings for either three or six parallel groups, as shown in Figs. 82 and 83.

Before attempting to make such changes in connections, a check should be made to see if the winding can be connected for the desired number of circuits. A simple rule for this is that the total number of poles must be evenly divisible by the number of circuits desired, otherwise the winding cannot be changed to that connection.

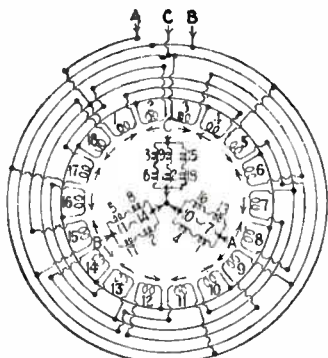

Fig. 82. This diagram shows a six-pole, three-phase winding with the six poles of each phase connected two in series and three in parallel, and then the three phase groups connected star

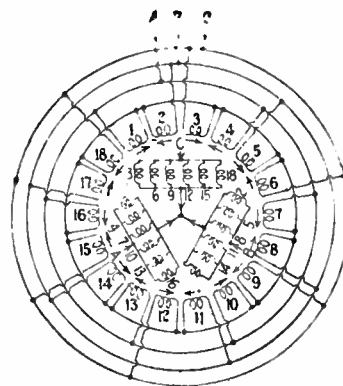

Fig. 83. In this case the six-pole, three-phase winding has all six poles of each phase connected in parallel and the three-phase groups connected star. These diagrams from 79 to 83 inclusive show additional practical applications of series and parallel circuits to obtain different voltage and current capacities of machine windings.

### 95. SPECIAL CONNECTIONS FOR CONVENIENT VOLTAGE CHANGES

Inasmuch as some factories and plants may be supplied with more than one voltage for power purposes, manufacturers commonly supply motors that can easily be changed from one voltage to another; for example, 110 to 220 volts, or 220 to 440 volts; or from either of the higher voltages to the lower ones.

In most cases each winding is divided into two parts with suitable leads from each section brought outside the motor. These leads can be conveniently changed for either one or two voltages.

Practically all repulsion induction motors that use a spiral type winding are provided with this arrangement for two voltages. Fig. 84 shows the windings and terminal block of such a machine and the manner of changing the connections for either 110 or 220 volts. Two poles are connected in series with leads 1 and 4 brought out to the terminal block, and also two poles in series with leads 2 and 3. By simply changing the connections of the line leads and one or two short jumper wires at these terminals, the winding can be changed to operate on either of the two voltages given.

A similar system is also used on two or three-phase motors. Fig. 85 shows the method of arranging the leads of a three-phase winding and the connections from the winding to the terminal block. The two small diagrams on the right-hand side of this figure show the method of changing the line and jumper connections to operate the motor on either 440 or 220 volts. In this figure the windings of the motor are represented by the heavy black lines arranged in the delta connection, with separate leads for each section of the winding brought out to the terminal block.

Fig. 86 shows a diagram of a star-connected stator winding, and the arrangement of the leads from the separate winding sections to the terminal block. The small sketches on the right-hand side of this figure also show the method of arranging the line leads and jumpers to change this machine for operation on either 220 or 440 volts.

96. CHANGE IN NUMBER OF PHASES

In certain emergency cases it is desirable to know how to change a motor from three-phase to two-phase operation, or vice versa. The following example will illustrate the procedure that should be used in making a change of this kind. Suppose we have a machine that is connected three-phase and has 144 slots in the stator and a 24-pole winding. The coils are connected 4-parallel delta for 440 volts, and we wish to reconnect them for operation on two-phase at the same voltage. 144 coils connected for three-phase would have  $144 \div 3$ , or 48, coils per phase. This would be connected for four-parallel circuits, so there would be  $48 \div 4$ , or 12, coils in series across the line.

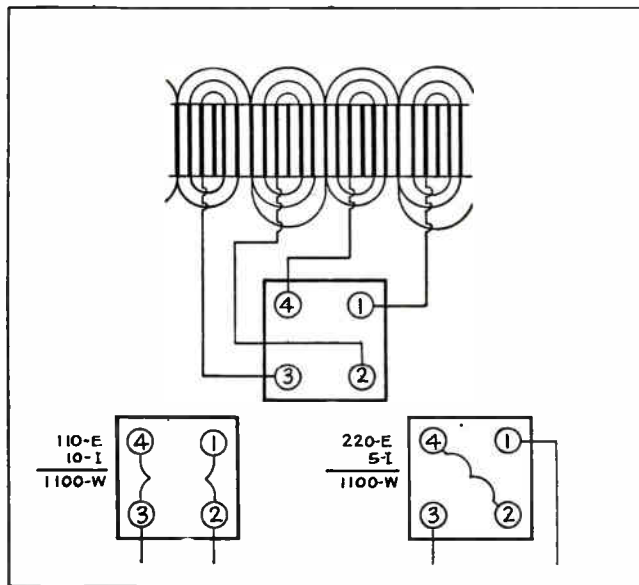

Fig. 84. This diagram shows how the terminals of a single phase winding can be arranged for convenient changing from series to parallel, so they can be operated on two different voltages.

Remember that these 12 coils are connected in series on 440 volts, so we would have approximately  $36\frac{2}{3}$  volts applied to each coil in the original winding. This winding is to be regrouped for two-phase, which means that if it is connected single circuit there would be  $144 \div 2$ , or 72, coils in series. To maintain the same voltage on each coil, the same number of coils must be connected in series across the line as before; or  $72 \div 12 = 6$  parallel circuits in which we must arrange the coils for the two-phase winding.

According to the formula for determining coils per group, the three-phase winding would have  $(144 \div 24) \div 3$ , or 2 coils per group.

As a two-phase winding would have  $(144 \div 24) \div 2$  or 3 coils per group, it will be necessary to reconnect some of the coil leads for this new grouping.

97. CHANGES IN FREQUENCY

Sometimes it is desired to change a motor which has been operating on one frequency so that it will operate on a circuit of another frequency. The

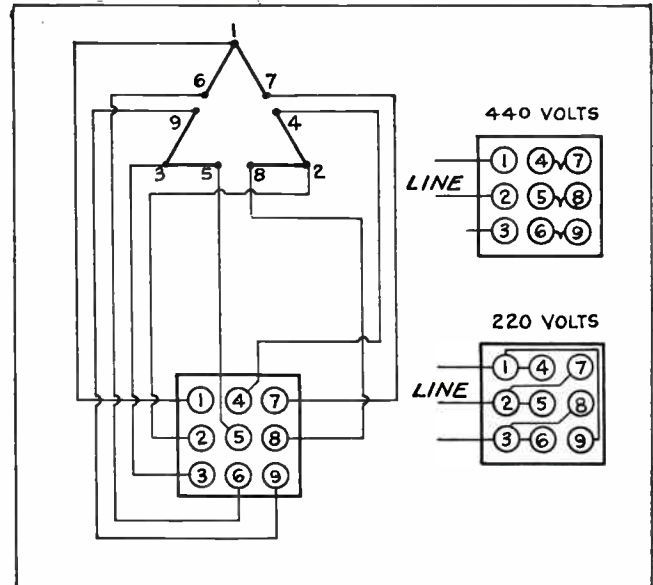

Fig. 85. Sketch showing the arrangement of the leads for a three-phase delta winding, and the manner in which they can be arranged on a terminal block for convenient voltage changes.

most common frequency for alternating current circuits in this country nowadays is 60 cycles, but occasionally a 25-cycle circuit or one of some other odd frequency is encountered.

We have learned that when an induction motor is running, a rotating magnetic field is set up in the stator and that it is this field which induces the secondary current in the rotor and produces the motor torque; also that this same rotating field cuts across the coils in the stator itself and generates in them a counter-voltage which opposes the applied line voltage and limits the current through

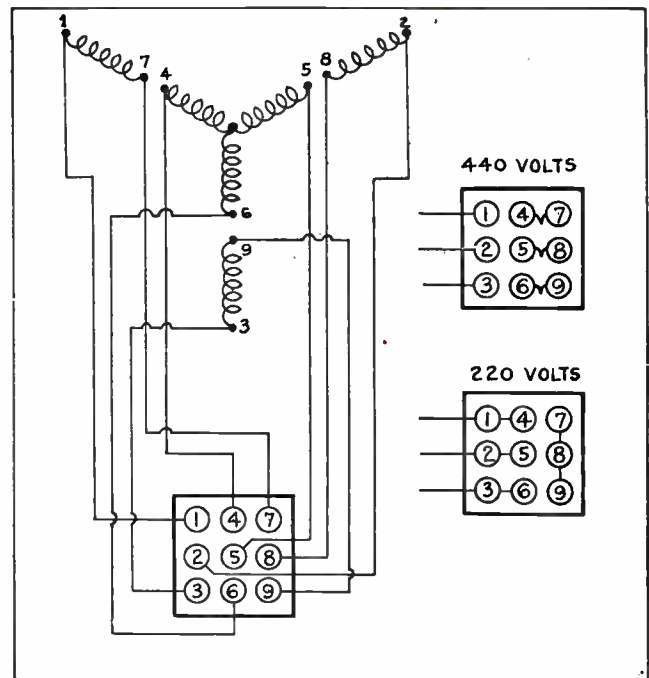

Fig. 86. The above diagram shows a winding which is connected star and has its leads all brought out to a terminal block for convenient change from 440 to 220 volts.



the winding. The speed of field rotation governs the strength of the counter E.M.F., and therefore regulates the amount of current which can flow through the winding at any given line voltage.

There are two factors that govern the speed of rotation of this magnetic field. These are the number of poles in the winding and the frequency of the applied alternating current. The effects of changing the number of poles will be explained in a later article. Any change that is made in the frequency of the current supplied to a motor should be offset by a change of voltage in the same direction, and in the same proportion.

This should be done so the current through the coils will be kept at the same value. For example, if a motor is to be changed from 30 to 60 cycles, the magnetic field will rotate twice as fast and the counter-voltage will be doubled. This means that if we are to maintain the same current value in the stator coils the line voltage should also be doubled. If the winding is to be operated on the same voltage at this higher frequency, the number of turns in each group across the line should be reduced to one-half the original number, in order to allow the same current to flow.

This procedure should, of course, be reversed when changing a motor to operate on a lower frequency.

The horse power of any motor is proportional to the product of its speed and torque or turning effort. So, when the frequency is varied and the stator flux kept constant, the horse power will vary directly with the change in speed.

## 98. CHANGING NUMBER OF POLES AND SPEED

It is very often desired to change the speed of motors for various jobs around manufacturing and industrial plants. This can be done by changing the number of poles in the stator windings of A.C. motors.

The speed of an induction motor is inversely proportional to the number of poles; that is, if the number of poles is increased to double, the speed will decrease to one-half; or, if the poles are decreased to one-half their original number, the speed will increase to double. This rule assumes that the speed of the rotor will be the same as that of the revolving magnetic field. There is, however, a small amount of "slip" between the speed of the rotor and that of the revolving field. This causes the rotor to turn slightly slower than the field.

A very simple formula which can be used to determine the speed of the rotating field of such motors and the approximate speed of the rotor is as follows:

$$\frac{120 \times \text{frequency}}{\text{poles}} = \text{R.P.M.}$$

When changing the number of poles of an induc-

tion motor, if the voltage is varied in the same direction and same proportion as the change produced in the speed, the torque will remain practically the same and the horse power will vary with the speed. Therefore, the horse power increases with the higher speeds and decreases at lower speeds, in exact proportion to the change of speed.

## 99. SPECIAL CONNECTIONS FOR CONVENIENT SPEED CHANGES

Generally the change in the number of poles is confined to a variation of only one pair of poles, as for example, changing from 6 to 8 poles or from 10 to 12, etc. There are, however, specially-built motors which have windings so connected that they can be changed from outside the motor by suitable arrangement of the leads and a switching device. Such motors can be changed to operate at either full speed or one-half of full speed.

Fig. 87. shows a lap three-phase winding which may be connected for either two or four poles by changing the connections of its leads outside the motor. This winding will produce the same torque at both speeds and will develop twice the power when running as a two-pole motor and the higher speed than it will develop as a four-pole motor and operating at the lower speed.

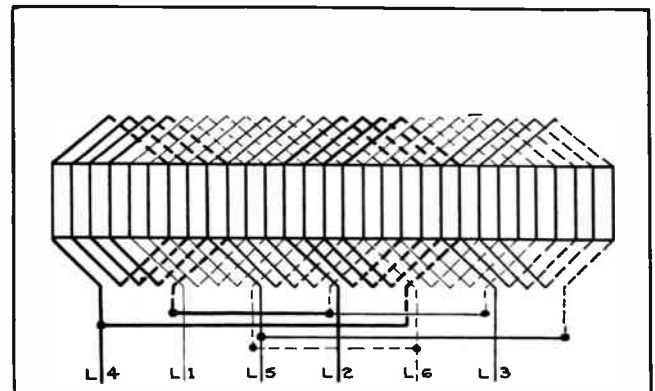

Fig. 87. A three-phase lap winding with six line leads brought out for convenient connection into either two or four poles. This enables the speed of the machine to be easily changed.

Six leads are brought outside the motor frame and the external connections should be made as follows: For two poles, connect the line leads to L 4, L 5, and L 6. Then connect L 1, L 2, and L 3 together. For four poles, connect line leads to L 1, L 2, and L 3, and leave L 4, L 5, and L 6 open or unconnected. This winding has two coil-groups per phase and when such a winding has as many groups in each phase as it has poles it is known as a salient pole connection.

You will notice that in the four-pole winding only two groups are used to build up four magnetic circuits in the stator. This is known as a consequent pole connection.

In connecting two-speed windings of this kind they are usually made fractional pitch for the high speed connection. When reconnecting windings for

a different number of poles it will be necessary to change some of the group connections.

### 100. PROCEDURE OF RECONNECTING FOR CHANGE IN SPEED

The following example illustrates the necessary changes to make in reconnecting a machine for a different number of poles. Suppose we have a motor that has been operated at 300 R.P.M. on 25 cycles frequency. On inspecting the winding and connections we find that it is a 10-pole, 3-phase winding, connected series delta, and operating at 440 volts. We also find that the winding has 120 coils with a fractional-pitch coil-span of 1 to 12. Each group, therefore, has  $(120 \div 10) \div 3$ , or 4 coils. We wish to increase the speed of this motor 25% at the same voltage. 25% of 300 R.P.M., or the normal speed is 75; so the new speed should be 375 R.P.M.

To determine the number of poles that will be required for this speed we can use the formula:

$$\frac{120 \times \text{frequency}}{\text{speed}} = \text{poles}$$

$$\text{or, in this case, } \frac{120 \times 25}{375} = 8$$

As the number of poles is to be changed, the coils per group must also be changed. This will be accomplished by reconnecting the coil leads; and, according to the formula for coil group, the number of coils for the new connection should be

$$(120 \div 8) \div 3 = 5 \text{ coils per group.}$$

After the coils have been regrouped the next factor to consider is the voltage. We have already said that the voltage will change directly with and in proportion to the speed; so that a 25% increase in speed will also produce a 25% increase over the original voltage, which in this case would be  $440 \times 1.25$ , or 550 volts. This would be the voltage necessary to use for the winding if it were left connected series delta. But, as we wish to operate the motor on the same voltage as before, some change must be made in the connections to permit it to be operated at 440 volts.

If we change the original connection of series delta to a two-parallel star connection, the voltage would then be  $(550 \div 2) \times 1.732$ , or 476 volts. If we consider the effect of the coil span on the voltage, we find that this will bring it about right with the 8 pole connection. The coil span already in the winding is 1 to 12, and of course, will remain the same for the new connection, as we are only changing the connections and not the coils. Full pitch coil span for the 8 pole connection would be  $(120 \div 8) + 1$ , or a span of 1 to 16; or covering 15 slots.

Leaving the coil span at 1 to 12, makes it 4 slots less than full pitch, for the new 8 pole connection. As each pole group represents 180 degrees;

then, with a coil span of 15 slots, each slot will represent  $180 \div 15$ , or 12 electrical degrees. The new coil span is 4 slots less than full pitch, and  $4 \times 12 = 48$ , the number of degrees less than full pitch. Full pitch would be 180 degrees; so  $180 - 48 = 132$  electrical degrees for the new coil span.

We recall that the voltage changes with the sine of an angle of one-half the number of electrical degrees. One-half of 132 equals 66, and the sine of an angle of 66 degrees is .9135. This means that the correct voltage to apply to the new winding will be  $476 \times .9135$ , or 435 volts. This will be for all practical purposes near enough to the desired voltage.

### 101. USE OF INSULATING VARNISH AND COMPOUNDS ON WINDINGS

All windings, whether D. C. or A. C., should be thoroughly impregnated with a good grade of insulating varnish before they are put into service.

This varnish serves several very important purposes. When properly applied it penetrates to the inner layers of the coils and acts as extra insulation of the conductors, thereby increasing the dielectric strength of the insulation between them. This compound within the coils and in their outer taping, greatly reduces the liability of short circuits between conductors and of grounds to the slots or frame.

When a winding is thoroughly saturated with insulating varnish and this varnish is properly hardened, it adds a great deal to the strength of the coils and holds the conductors rigidly in place. This prevents a great deal of vibration that would otherwise tend to wear and destroy the insulation, particularly in the case of alternating current windings where the alternating flux tends to vibrate the conductors when in operation.

Insulating varnish also prevents moisture from getting in the coils and reducing the quality of the insulation; and it keeps out considerable dust, dirt, and oil that would otherwise accumulate between the coils. Keeping out moisture, dust, and oil greatly prolongs the life of the insulation.

### 102. AIR DRY AND BAKING VARNISHES

There are many grades of insulating varnish, some of which require baking to "set" or harden them, and others which have in them certain liquids or solvents which make them dry and harden very quickly when exposed to air. The first type are called baking varnishes and the latter are called air dry varnishes.

Good air-dry insulating varnish will set or harden in from 20 to 30 minutes, but it should be allowed to dry out thoroughly for about 24 hours before the windings are put in service. Air dry varnish is not considered quite as good as the better grades of baking varnish. Therefore, the latter should be used wherever a bake oven or some means of applying heat is available.

### 103. METHODS OF APPLYING INSULATING VARNISH

There are three common methods by which insulating varnish can be applied to coils and windings. These are: dipping, brushing, and spraying.

Dipping is considered the best method and should be used for all small windings of stators and armatures, and for armatures and stator coils and field coils. To dip these coils or windings, a pan or tank of the proper size and depth will be required. Before dipping the windings they should be thoroughly dried out in a bake oven at about 212° F., in order to drive out all moisture and to heat the coils so that when they are dipped the varnish will rapidly penetrate to their inner layers.

The coils should be allowed to remain in the varnish until all bubbling has ceased. When they seem to have absorbed all the varnish possible they should be slowly withdrawn from the tank at about the same rate as the varnish flows from them of its own accord. This will give them a uniform coating with the least possible accumulation of varnish at the lower end. They should then be allowed to drain until the varnish stops dripping and becomes partially set. The time required for this will depend on the size of the winding or coils.

When dipping a large number of small coils, considerable time can be saved by arranging a drip board set at an angle, so the coils can be hung above it and the varnish which drips from them will run down the board and back into the tank. With this method other coils can be dipped while the first set are draining.

After all the surplus varnish is drained from the coils they should be baked. When placing them in the oven it is a good plan to reverse their positions, so that any excess varnish on the bottom ends will tend to flow back evenly over their surface when first heated.

### 104. GOOD VENTILATION IMPORTANT WHEN BAKING

When a large number of coils are being baked at one time and practically fill the oven, trouble is sometimes experienced with insufficient ventilation. If the air inside the oven is not kept moving through the coils, and fresh air constantly supplied, the vapors from the varnish will cause a green coating to form on the coils and greatly decrease the insulating qualities of the varnish, and it may also permit an accumulation of highly explosive vapors. With large ovens, fans are sometimes used to force an air draft and insure good ventilation. Small ovens are usually provided with a chimney at the top and an air inlet at the bottom, so the heated air can rise and provide its own circulation.

Fig. 88 shows an electrical baking oven and a large D. C. armature to which a coat of varnish has been applied and which is ready for baking. This oven has an automatic temperature-control to keep

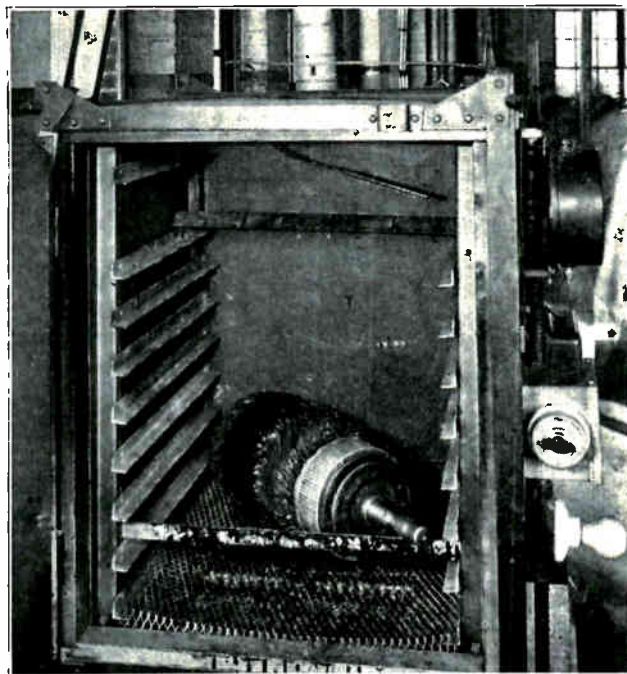

Fig. 88. This photo shows a D.C. armature in place in an electrical bake oven and ready for the insulating compound on the windings to be baked.

the temperature uniform throughout the baking operation. Also note the ventilation chimney on top of the oven.

When applying the varnish with a brush, the winding should, if possible, be preheated to drive out the moisture and permit the varnish to flow deeper into the coils. Varnish can be applied with an ordinary paint brush, and this method is used where the dipping tank is not large enough to accommodate the winding, or where no dipping tank is available.

Spraying is used principally on large windings and gives a very good surface for a finishing coat.

The ends of coils should be given two or three coats of varnish as an added protection against mechanical damage and moisture, and to help prevent flash-overs to the frame of the machine.

### 105. PROPER TIME AND TEMPERATURES FOR BAKING

Fig. 89 shows a convenient table which gives the proper temperatures and approximate time in hours for baking insulating varnishes. You will note that when baking complete armature or stator windings more time is required to thoroughly bake the larger sizes. Also note that a slower baking produces a more elastic and better quality of insulation.

In emergency cases, where time is very important, the windings can be baked at the higher temperatures in a much smaller number of hours, but the varnish will be somewhat more brittle and inclined to crack or check when any strain is placed upon it. Never attempt to bake windings at temperatures very much higher than those given in the first column of this table, or you are likely to damage the insulation

already on the coils. When a job doesn't need to be rushed, it is much better to bake it at the lower temperatures and for the longer periods given in the table, which will give a much more durable and dependable insulation.

In addition to the advantages already mentioned for this form of insulation, it also provides a smoother surface on the windings and coils, making them much easier to clean, either by means of a brush, compressed air, or by washing them with a mixture of carbon-tetra-chloride and gasoline or some such solution to remove grease and oil.

Fig. 89-B shows a stator winding heavily coated with a solid mass of insulating compound applied by repeated dipping. Note the rugged protection this gives the winding. To remove a winding which has been treated in this manner it is necessary to heat it first, in order to soften the compound.

Size of Armature or Stator Core Diameter	248°F. Quick Baking	224°F. Elastic Baking	212°F. Extra Elastic Baking
Under 6 Inches	4 to 6 hrs.	6 to 8 hrs.	8 to 10 hrs.
6 to 12 Inches	12 hrs.	24 hrs.	36 hrs.
12 to 18 Inches	24 hrs.	36 hrs.	48 hrs.
18 to 24 Inches	36 hrs.	48 hrs.	60 hrs.

Fig. 89. This convenient table gives the proper temperature and time in hours for baking insulation of windings of different sizes.

### 106. TROUBLES OF INDUCTION MOTOR WINDINGS

By far the greater number of defects which occur in windings during service or operation are caused by short circuits, open circuits, and grounds. Water may have found its way into the coils, or oil from the bearings may have destroyed the quality of the insulation. Metallic dust and grit sometimes work into the windings and cause short circuits; or a static charge from a belt-driven machine may cause punctures or small pin holes in the insulation, which results in flash-overs and grounds.

Any one of the above mentioned faults is also likely to show up just after a motor has been rewound or repaired. So, if a machine doesn't operate properly after having been rewound, it is quite likely that some of the coils are connected wrong or that there is a short, open, or ground in some coils because of work carelessly done in the repair shop.

The average small induction motor when running properly is almost noiseless, and even in the larger motors only a uniform, gentle humming should be heard. This humming noise is due largely to vibration of core laminations, which are caused to vibrate slightly by the reversals of the magnetic field. This vibration will be in synchronism with the frequency of the alternating current in the windings. In addition to this humming, which is unavoidable even in the best of motors, there is also a slight

whistling noise caused by the fan blades on the rotor, friction of the air with the revolving parts, and air passing through ventilation ducts. This air whistling is harmless and it will continue for a short period after the current is shut off and while the machine is still turning. If a motor is unusually noisy there is probably some defect responsible for the noise.

A deep, heavy growling is usually caused by some electrical trouble resulting in an unbalanced condition of the magnetic field in the windings.

If a shock is felt when the frame is touched it is quite sure evidence that one or more coils in the winding are grounded to the core or frame. This is a very dangerous condition with any voltage and particularly so with voltages above 220. A grounded coil on a 440-volt machine may result in a very dangerous shock, and it is for this reason that the frames of motors should be grounded when the machines are installed.

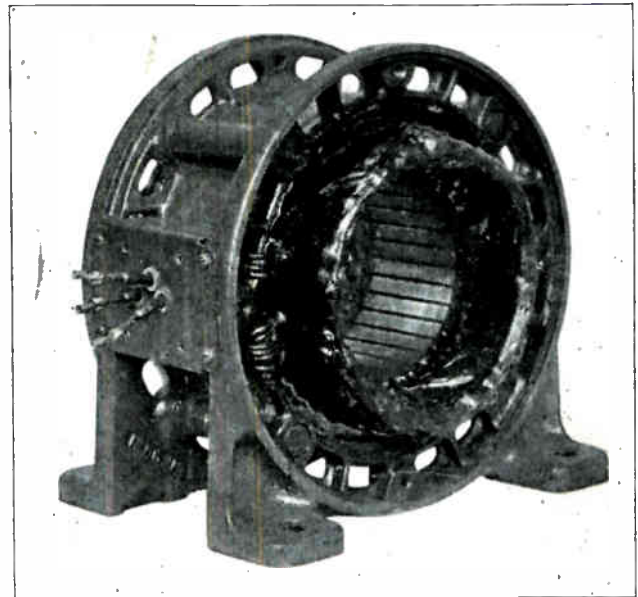

Fig. 89-B. The above photo shows a stator winding heavily impregnated with insulating compound. Note how insulation of this type affords mechanical strength and protection to the windings and would also prevent dirt, oil and moisture from getting in between the coils.

When the frames are grounded in this manner and a coil does become grounded, it will usually blow a fuse, thus indicating a defect at once.

Fig. 90 is a diagram of a three-phase winding in which are shown a number of the more common faults occurring in such windings. These faults are numbered and listed for your convenience in locating them.

1. The last coils in the second and fourth groups of phase "A" are grounded.
2. The last coil in the third group of phase "A" is shorted.
3. The start and finish leads of the first coil in the second group of phase "A" are shorted together at the stubs.

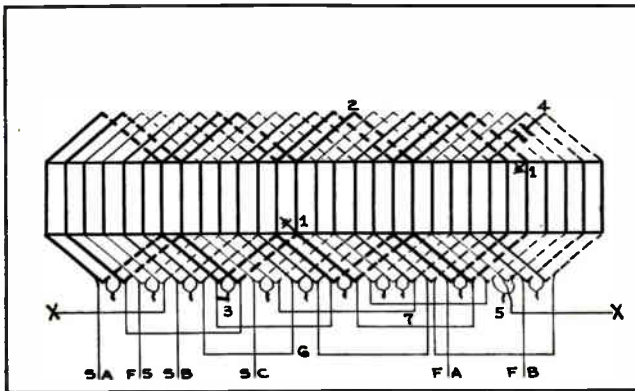

Fig. 90. The above is a diagram of a three-phase winding in which are shown a number of the more common faults that occur in stator windings.

4. The last coil in the fourth group of phase "B" is open.

5. The last coil in the third group of phase "C" is reversed.

6. The second coil group of phase "B" is reversed.

7. The second coil group of phase "C" and third coil group of phase "B" have wrong numbers of coils connected in them.

8. Another fault known as "reversed phase" occurs when the three starts are spaced in the wrong position. This fault is not shown in this sketch.

The following paragraphs describe in detail the methods of testing to locate these faults and also the method of correcting them.

### 107. GROUNDED COILS

The usual effect of one grounded coil in a winding is the repeated blowing of a fuse when the line switch is closed. That is providing the machine frame and the line are both grounded. Two or more grounds will give the same result and will also short out part of the winding in that phase in which the grounds occur. A quick and simple test to determine whether or not a ground is present in the winding, can be made with the test outfit shown in Fig. 91. This test set consists of several dry cells connected in series with a small test lamp and pair of test leads.

In place of the dry cells and low-voltage lamp, we can use two test leads connected to a 110-volt line and with a 10-watt lamp in series. In testing with such a set, place one lead on the frame and the other in turn on each of the line wires leading from the motor. The line switch should, of course, be open before making any test. If there is a grounded coil at any point in the windings the lamp will indicate it by lighting.

To locate the phase that is grounded, test each phase separately. In a three-phase winding it will be necessary to disconnect the star or delta connections. After the grounded phase is located the pole-group connections in that phase can be disconnected and each group tested separately. When the test leads are placed one on the frame and the other

on the grounded coil group, the lamp will indicate the ground in this group by again lighting. The stub connections between the coils and this group may then be disconnected and each coil tested separately until we locate the exact coil that is grounded.

### 108. HIGH RESISTANCE GROUNDS

Sometimes moisture in the insulation around the coils, or old and defective insulation will cause a high-resistance ground that is difficult to detect with a test lamp. In this case we can use a test outfit consisting of a telephone receiver and several dry cells connected in series, as shown in Fig. 92. Such a test set will detect a ground of very high resistance, and this set will often be found very effective when the ordinary test lamp fails to locate the trouble.

### 109. REPAIRS FOR GROUNDED COILS

When the grounded coil is located it should either be removed and reinsulated, or cut out of the circuit, as shown in Fig. 93. At times it is inconvenient to stop a motor long enough for a complete rewinding or permanent repairs. In such cases, when trouble develops it is often necessary to make a temporary repair until a later time when the motor may be taken out of service long enough for rewinding or permanent repairs.

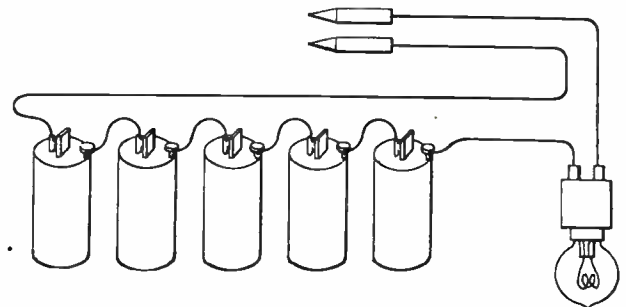

Fig. 91. Several dry cells in series with a low voltage test lamp and a pair of test leads or "points" make a very convenient test outfit for locating a number of the troubles in motor windings.

The sketch in Fig. 93 shows a coil group consisting of the three coils on the left. The single coil on the right is the first one of the following group which is not all shown in this sketch. Coil 2 is defective and the temporary repair will be the same whether the fault is a short, an open, or a ground. A jumper wire of the same size as that used in the coils, is connected to the bottom lead of coil 1, and across to the top lead of coil 3, leaving coil 2 entirely out of the circuit. Coil 2 should then be cut at the back of the winding, as shown by the dotted lines in the sketch. If the defective coil is grounded it should also be disconnected from the other coils, as shown on the diagram.

### 110. ONE OR MORE TURNS SHORTED TOGETHER

Shorted turns within coils are usually the result of failure of the insulation on the wires. This is

frequently caused by the wires being crossed and having excessive pressure applied on the crossed conductors when the coils are being inserted in the slot. Quite often it is caused by using too much force in driving the coils down in the slots. In the case of windings that have been in service for several years, failure of the insulation may be caused by oil, moisture, etc. If a shorted coil is left in a winding it will usually burn out in a short time and, if it is not located and repaired promptly, will probably cause a ground and the burning out of a number of other coils.

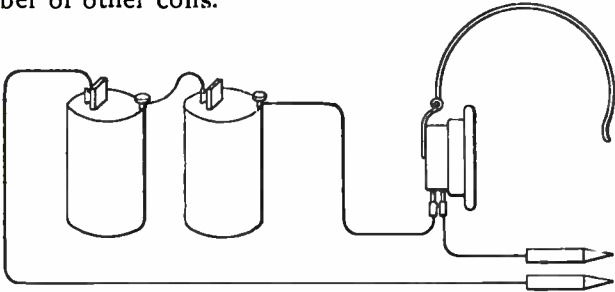

Fig. 92. A telephone receiver can also be used in series with dry cells and test leads for locating high resistance grounds occurring in windings.

One of the most practical ways of locating a shorted coil is by the use of a growler and thin piece of steel, similar to the method described for D. C. armatures. Fig. 94 shows a sketch of a growler in use in a stator. Note that the poles are shaped to fit the curvature of the teeth inside the stator core. The growler should be placed in the core as shown and the thin piece of steel should be placed the distance of one coil span away from the center of the growler. Then, by moving the growler around the bore of the stator and always keeping the steel strip the same distance away from it, all of the coils can be tested.

Fig. 95 shows a photo of a growler in use on a large stator. The steel strip is held over the slot the proper distance from the growler for the size of coils or coil span used in this case.

If any of the coils has one or more shorted turns the piece of steel will vibrate very rapidly and cause a loud humming noise. By locating the two slots over which the steel will vibrate, we can find both sides of the shorted coil. If more than two slots cause the steel to vibrate, they should all be marked and all shorted coils should be removed and replaced with new ones, or cut out of the circuit as previously described.

### 111. SHORTED COIL GROUPS

Sometimes one coil or a complete coil group becomes short circuited at the stubs or end connections. The test for this fault is the same as that for a shorted coil. If all the coils in one group are shorted it will generally be indicated by the vibration of the steel strip over several consecutive slots, corresponding to the number of coils in the group.

The stub connections should be carefully ex-

amined and those that appear to have poor insulation should be moved during the time that the test is being made. It will often be found that when the shorted stub connections are moved during the test the vibration of the steel will stop. If these stubs are reinsulated the trouble should be eliminated.

### 112. OPEN COILS

When one or more coils become open-circuited by a break in the turns or a poor connection at the stubs, they can be tested with a test lamp and dry cell such as previously shown and explained. If this test is made at the ends of each winding, an open can be detected by the lamp failing to light. The insulation should be removed from the pole-group connections and each group should be tested separately. After locating the coil group that is open, untape the coils between that group and test each coil separately. In making this test it is not necessary to disconnect the splices or connections.

In many cases the open circuit will be at the coil ends or stubs, due to a loose connection or broken conductor. If the trouble is at this point it can usually be located by careful observation and checking. If the trouble is a loose connection at the stub, it can be repaired by resoldering the splices; but if it is within the coil, the coil should either be replaced or have a jumper placed around it, as shown in Fig. 93, until a better repair can be made.

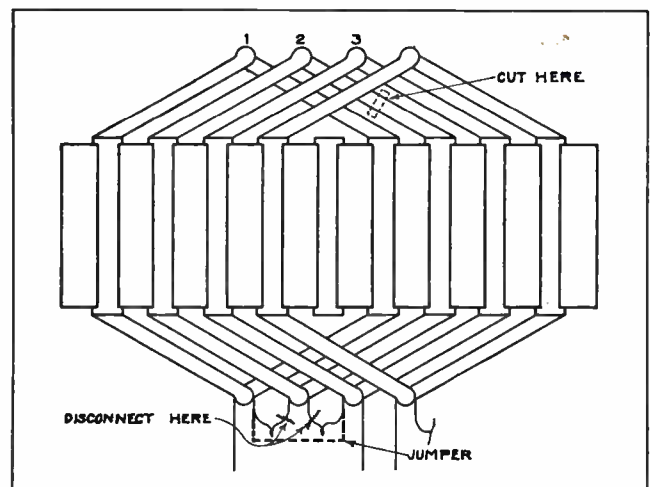

Fig. 93. This diagram illustrates the method of cutting a defective coil with a jumper. In this manner a machine can be quickly repaired and kept in service until such time as the defective coil can be replaced.

### 113. REVERSED CONNECTIONS

Reversed coils cause the current to flow through them in the wrong direction. This fault usually manifests itself—as do most irregularities in winding connections—by a disturbance of the magnetic circuit, which results in excessive noise and vibration. The fault can be located by the use of a magnetic compass and some source of low-voltage, direct current. This voltage should be adjusted so it will send about one-fourth to one-sixth of full

load current through the winding; and the D. C. leads should be placed on the start and finish of one phase. If the winding is three-phase, star-connected, this would be at the start of one phase and the star point. If the winding is delta-connected, the delta must be disconnected and each phase tested separately.

Place a compass on the inside of the stator and test each of the coil groups in that phase. If the phase is connected correctly, the needle of the compass will reverse definitely as it is moved from one coil group to another. However, if any one of the coils is reversed the reversed coil will build up a field in the opposite direction to the others, thus causing a neutralizing effect which will be indicated by the compass needle refusing to point definitely to that group. If there are only two coils per group there will be no indication if one of them is reversed, as that group will be completely neutralized.

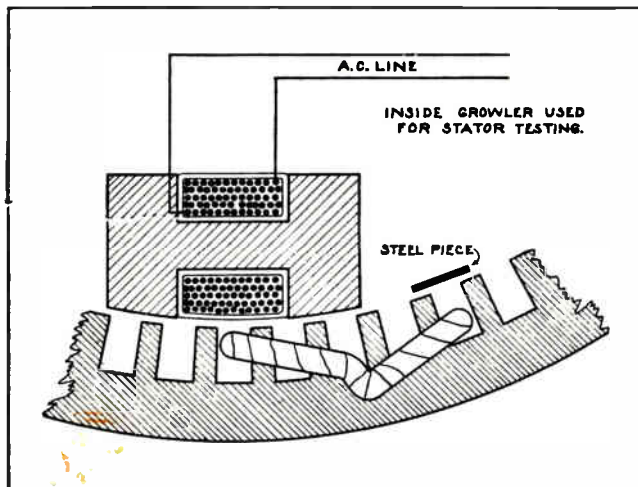

Fig. 94. The above view shows the manner in which a growler can be used to induce current in a shorted coil and indicate the short circuits by vibration set up in the steel strip at the right. This is a very simple and effective method of locating short circuits.

#### 114. REVERSED COIL GROUPS

When an entire coil group is reversed it causes the current to flow in the wrong direction in the whole group. The test for this fault is the same as that for reversed coils. The winding should be magnetized with direct current, and when the compass needle is passed around the coil groups they should indicate alternately N. S., N. S., etc. If one of the groups is reversed, three consecutive groups will be of the same polarity. The remedy for either reversed coil groups or reversed coils, is to make a visual check of the connections at that part of the winding, locate the wrong connection, and reconnect it properly.

When the wrong number of coils are connected in two or more groups, the trouble can be located by counting the number of stubs on each group. If any mistakes are found they should be remedied by reconnecting properly.

#### 115. REVERSED PHASE

Sometimes in a three-phase winding a complete phase is reversed by either having taken the starts from the wrong coils or by connecting one of the windings in the wrong relation to the others when making the star or delta connections. If the winding is connected delta, disconnect any one of the points where the phases are connected together, and pass current through the three windings in series. Place a compass on the inside of the stator and test each coil group by slowly moving the compass one complete revolution around the stator.

The reversals of the needle in moving the compass one revolution around the stator should be three times the number of poles in the winding.

In testing a star-connected winding, connect the three starts together and place them on one D. C. lead. Then connect the other D. C. lead and star point, thus passing the current through all three windings in parallel. Test with a compass as explained for the delta winding. The result should then be the same, or the reversals of the needle in making one revolution around the stator, should again be three times the number of poles in the winding.

These tests for reversed phases apply to full-pitch windings only. If the winding is fractional-pitch, a careful visual check should be made to determine whether there is a reversed phase or mistake in connecting the star or delta connections.

#### 116. TESTING SPLIT-PHASE MOTORS

If a split-phase motor fails to start when a line switch is closed, the trouble may be due to one or several of the following faults:

1. Tight or "frozen" bearings.
2. Worn bearings, allowing the rotor to drag on the stator.
3. Bent rotor shaft.
4. One or both bearings out of alignment.
5. Open circuit in either starting or running windings.
6. Defective centrifugal switch.
7. Improper connections in either winding.
8. Grounds in either winding or both.
9. Shorts between the two windings.

#### 117. TIGHT OR WORN BEARINGS

Tight bearings may be caused by failure of the lubricating system; or, when new bearings are installed, they may run hot if the shaft is not kept well oiled.

If the bearings are worn to such an extent that they allow the rotor to drag on the stator, this will usually prevent the rotor from starting. The inside of the stator laminations will be worn bright where they are rubbed by the rotor. When this condition exists it can generally be easily detected by close observation of the stator field and rotor surface when the rotor is removed.



Fig. 95. This photo shows a growler in use in a large stator. Note the size and shape of these coils and the position of the steel strip which is just the width of one coil from the center of the growler.

#### 118. BENT SHAFT AND BEARINGS OUT OF LINE

A bent rotor shaft will usually cause the rotor to bind when in a certain position and then run freely until it comes back to the same position again. An accurate test for a bent shaft can be made by placing the rotor between centers on a lathe and turning the rotor slowly while a tool or marker is held in the tool post close to the surface of the rotor. If the rotor wobbles it is an indication of a bent shaft.

Bearings out of alignment are usually caused by uneven tightening of the end-shield plates. When placing end-shields or brackets on a motor, the bolts should be tightened alternately, first drawing up two bolts which are diametrically opposite. These two should be drawn up only a few turns, and the others kept tightened an equal amount all the way around. When the end shields are drawn up as far as possible with the bolts, they should be tapped tightly against the frame with a mallet and the bolts again tightened.

#### 119. OPEN CIRCUITS AND DEFECTIVE CENTRIFUGAL SWITCHES

Open circuits in either the starting or running winding will cause the motor to fail to start. This fault can be detected by testing in series with the start and finish of each winding with a test lamp.

A defective centrifugal switch will often cause considerable trouble that is difficult to locate, unless one knows where to look. If the switch fails to

close when the rotor stops, the motor will not start when the line switch is closed. Failure of the switch to close is generally caused by dirt, grit, or some other foreign matter getting into the switch mechanism; or by weakened springs on the switch. The switch should be thoroughly cleaned with gasoline and then inspected for weak or broken springs.

If the winding is on the rotor, the brushes sometimes stick in the holders and fail to make good contact with the slip rings. This causes sparking at the brushes. There will probably also be a certain place where the rotor will not start until it is moved far enough for the brush to make contact on the ring. The brush holders should be cleaned, and the brushes carefully fitted so they move freely with a minimum of friction between the brush and the holders. If a centrifugal switch fails to open when the motor is started, the motor will probably growl and continue to run slowly and the starting winding will burn out if not promptly disconnected from the line by a fuse or switch. This is also likely to be caused by dirt or hardened grease in the switch.

#### 120. REVERSED CONNECTIONS AND GROUNDS

Reversed connections are caused by improperly connecting a coil or group of coils. The wrong connections can be found and corrected by making a careful check of the connections and reconnecting those that are found wrong. The test with D. C. and a compass can also be used for locating reversed coils. Test the starting and running windings separately exciting only one winding at a time, with the direct current. The compass should show alternate poles around the winding.

The operation of a motor that has a ground in the windings will depend on where the ground is, and whether or not the frame is grounded. If the frame is grounded then when the ground occurs in the winding it will usually blow a fuse. A test for grounds can be made with a test lamp and dry cells, or a 110-volt lamp and leads. One test lead should be placed on the frame and the other on a lead to the winding. If there is no ground the lamp will not light. If it does light, it indicates a ground due to a defect somewhere in the insulation.

#### 121. SHORT CIRCUITS

Short circuits between the two windings can also be detected by the use of a test lamp. Place one of the test leads on one wire of the starting winding and the other test lead on the wire of the running winding. If these windings are properly insulated from each other the lamp should not light. If it does light, it is a certain indication that there is a short between the windings. Such a short will usually cause part of the starting winding to burn out. The starting winding is always wound on top of the running winding; so, if it becomes burned out due to a defective centrifugal switch or a short cir-



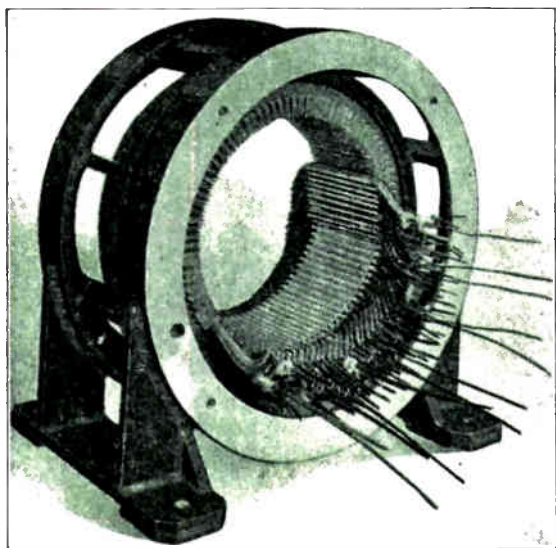

Fig. 96. The above photo shows a stator partly wound with factory-made coils. Coils of this type can be purchased ready made from many manufacturers so they can be quickly and conveniently inserted, and speed up repairs of the machines.

cuit, the starting winding can be conveniently removed and replaced without disturbing the running winding.

Single phase motors are very simple to rewind, and in many localities there are a great number to be rewound or repaired each year. Many of them need only to have the centrifugal switches cleaned and adjusted, or fitted with new springs. Others have only a loose or grounded connection which can be quickly repaired.

Many of our graduates start a fine business of their own, or make considerable money in their spare time from their regular job, by repairing small motors of fans, washing machines, and others. With a few lbs. of wire and a little insulation material many men do this work right at home in their own basements or garages.

In many cases you can get old motors of both

small and large sizes, that the owners have planned to discard because they did not know they could be rewound or knew no one nearby who could rewind them. Such cases are splendid opportunities for you to get additional experience and practice and to get started in this line of work if you choose.

In any case, let us again emphasize the importance of applying the instruction covered in this section, and keeping familiar with it by frequent reference to its pages, for any question or problem of this nature which you may have.

You are very likely to find a knowledge of armature winding, connecting and testing very valuable on some job when you least expect it.

Welcome every opportunity to get added experience of this nature, and use this Reference Set frequently and you should be able to make a definite success of any job of armature winding or testing.

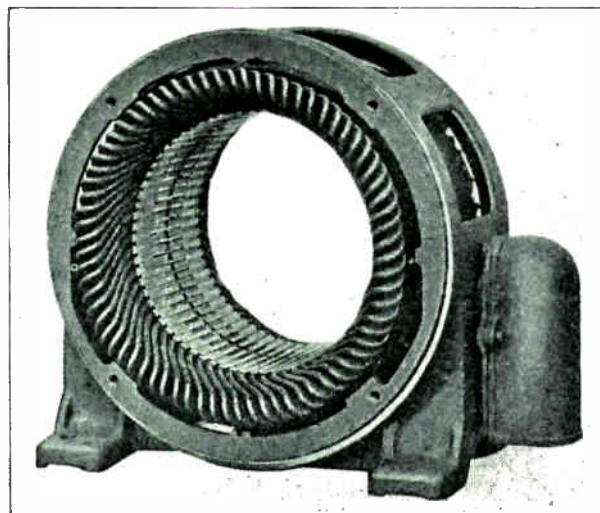

Fig. 97. This view shows the neat appearance of the stator in which the coils are of the proper size and shape and carefully placed in the slots.

## DATA FOR CONSTRUCTING GROWLERS

### 122. GROWLER SPECIFICATIONS

Laminations designed for use in making small transformers may be used to good advantage in constructing a growler for use in testing armatures or stators.

Fig. 98 shows how the laminations may be trimmed and arranged for use in constructing a growler for use in testing either armatures or stators.

After the laminations are trimmed as shown by the dotted lines, at "A" they are stacked as shown in Fig. 98B, so as to form the letter "H." Place the piece with the center bar attached on the work bench and then butt the "I" piece against the center bar as shown. The next two laminations are reversed so as to break joints. That is, if the "I" piece is on the right for the first layer, it should be on the left for the next layer, and so on. Continue stacking the laminations alternately on first one side and then the other until you have a stack about one-inch high.

The laminations must then be bound together either with bolts or by use of a clamp as shown at "C" in Fig. 98. Two pieces of fibre or wood about 3 inches long with a hole in each end may be used as a clamp. After the core is assembled, it should be carefully insulated. The part of the core which will come in contact with the wire should be covered with a layer of varnished cambric or oiled paper. The cambric may be wound around the core and over the fibre strips.

The 110 volt A. C. winding consisting of about 2000 turns, or 2 oz. of No. 34 S.C.E. wire should be carefully wound on the center part of the core as

shown in the Fig. 98C. Terminals should be provided on the fibre clamp so that the ends of the coil may be attached to them, or the two clamping bolts may be used as terminals as shown by the drawing.

After the coil is completed, it may be dipped in insulating varnish, or if varnish is not available, it should be wound with tape to protect the coil. This little growler will be very serviceable in testing small and medium sized armatures or stators.

Fig. 99 contains complete constructional data for another growler which is very convenient for use in shops where a large number of armatures are tested.

Fig. 100 shows complete constructional data for another style of growler to be constructed from laminations  $5\frac{1}{2}$ " x  $4\frac{1}{2}$ ". The laminations are stacked together to form a stack about 1 inch high. They are then bolted together with a strip of wood on each side of both ends. These clamping bolts should be  $\frac{1}{4}$ " x  $2\frac{1}{4}$ ". The 4 pieces of wood may be cut from strips of wood  $3\frac{1}{4}$ " long by 1" wide by  $\frac{1}{4}$ " thick. The two base supports are 5 inches long by  $1\frac{1}{4}$  inches wide by 1 inch thick. The base supports are fastened to the upright strips by wood screws inserted through the bottom.

Varnished cambric or some other good grade of insulation should completely cover all parts of the iron core which will come in contact with the coil. The coil should be wound around the center leg of the core as shown in Fig. 100. About 2 oz. of No. 31 S. C. E. wire will be required for the coil. Terminal posts may be mounted on the base strips to accommodate the ends of the coil, and for connection of the 110 volt A. C. line.

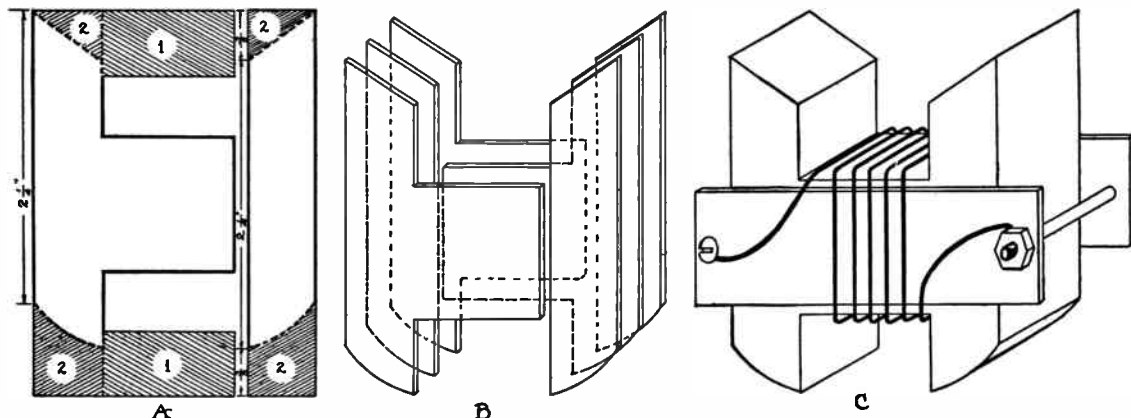

Fig. 98. This figure shows how a combination internal and external growler can be made from "E" & "I" transformer laminations by cutting off shaded portions.

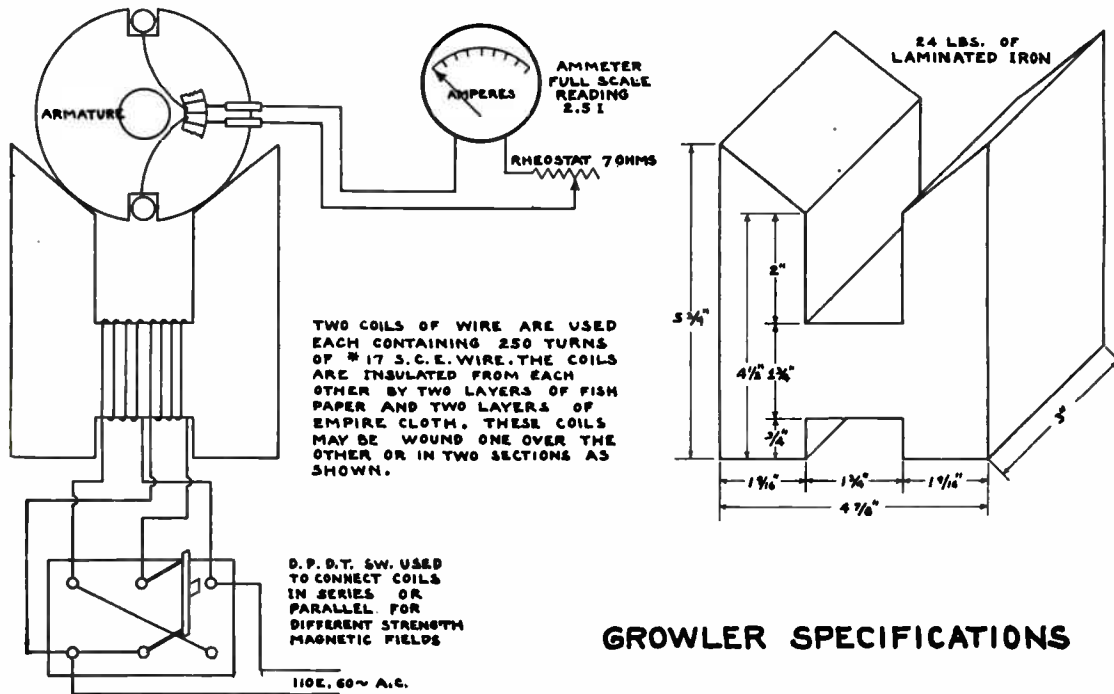

Fig. 99.

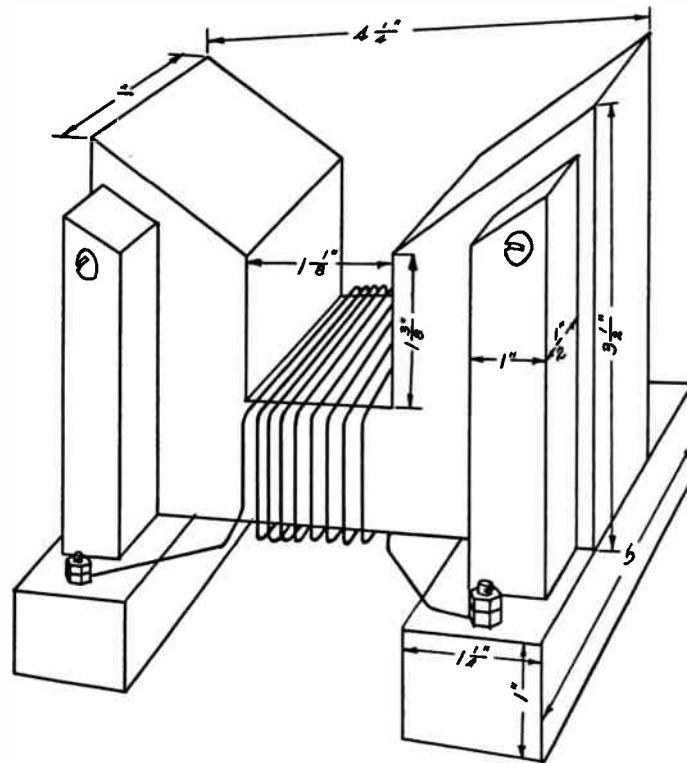

Fig. 100. A medium sized growler for armature testing.



ESTABLISHED 1899

# COYNE

## *Electrical School*

CHICAGO ~ ~ ILLINOIS



COPYRIGHT 1942

# DIRECT CURRENT POWER AND MACHINES

## *Section One*

### **D. C. Generators**

**Construction and Operating Principles**

**Types of Generators and Their Applications**

**Operation and Care of Generators**

**Parallel Operation**

**Three Wire Generators and Balancers**

**Commutation and Interpoles  
for Generators and Motors**

## D. C. GENERATORS

Direct current energy and machines are very extensively used for traction work and certain classes of industrial power drives.

The principal advantages of D. C. motors are their very excellent starting torque and wide range of speed control.

D. C. motors are excellent for operating certain classes of machines which are difficult to start under load, and must be driven at varying speeds, or perhaps reversed frequently. Their speed can be varied over a very wide range, both above and below normal speed.

Many thousands of factories and industrial plants use electric motors exclusively for driving their various machines, and in certain classes of this work D. C. motors are extensively used. They are made in sizes from  $\frac{1}{10}$  h. p. to several thousand horse power each, and are used both for group drive and individual drive of various machines.

Fig. 1 shows an installation of large D. C. motors in use in a steel mill. These motors are located in the power room as shown, and are connected to shafts extending through the wall at the right, to drive the great rolls which roll out the hot steel in the adjoining room.

Fig. 2 shows a smaller motor used for driving a metal working machine. Where a separate motor is used for each machine in this manner, it is classed as individual motor drive. Millions of electric motors are used in this manner in industrial plants.

For operation of street cars and elevated trains

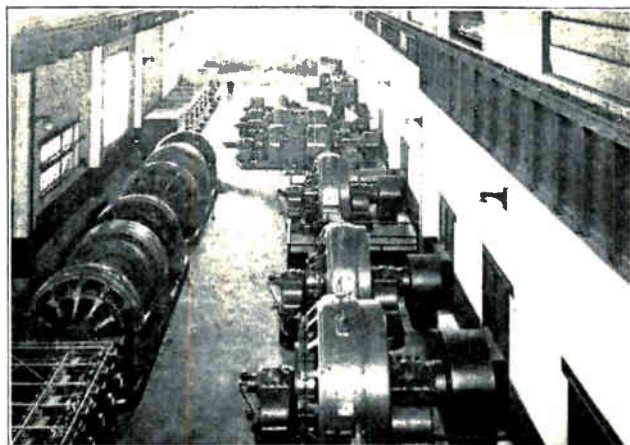

Fig. 1. This photo shows a group of large D. C. motors in use in a steel mill. Machines of this type, ranging from several hundred to several thousand horsepower each, are used in this work.

in cities, and electric railways across the country, series D. C. motors are extensively used, because their great starting torque enables them to easily start a loaded car or train from a standing position, and quickly bring it up to very high speeds.

Fig. 3 shows a powerful electric locomotive which is driven by several electric motors of several hundred horse power each.

D. C. motors are commonly made to operate on voltages of 110, 220, and 440, for industrial service; and from 250 to 750 volts for railway service.

Elevators in large skyscraper office and store buildings also use thousands of powerful D. C. motors, to smoothly start the loaded cars and swiftly shoot them up or down, ten, forty, or 70 stories as desired.

Here again their good starting torque, smoothness of operation, and accurate control for stopping exactly at floor levels, make them very desirable.

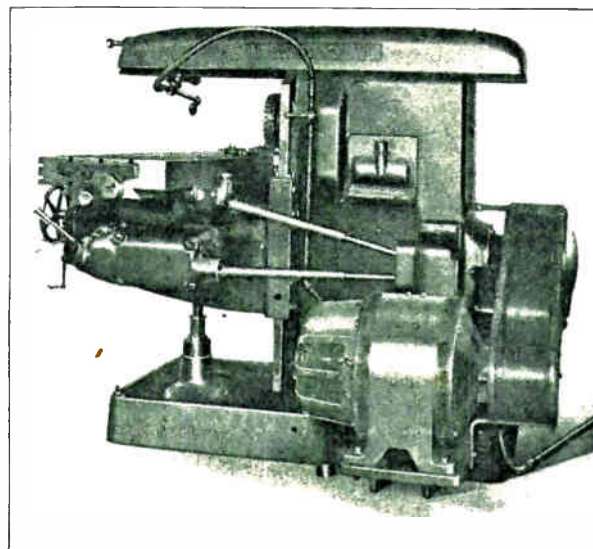

Fig. 2. Hundreds of thousands of small and medium sized motors are used to drive individual machines, as shown in this view.

One modern type of elevator equipment uses direct current motors and what is known as variable voltage control. The variable voltage for each elevator motor is supplied by a separate D. C. generator, which is designed to vary its voltage as the load on the car varies, thus providing even speed regulation and extremely smooth starting and stopping.

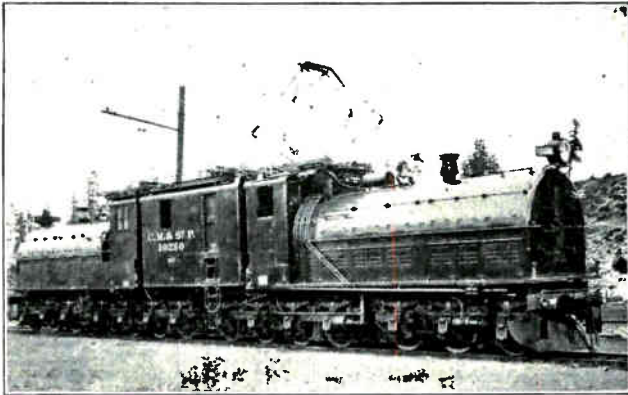

Fig. 3. Electrical locomotives of the above type often use six or eight powerful D. C. motors to turn their driving wheels.

Fig. 4 shows a large D. C. elevator motor with its cable drum and magnetic brake attached on the right hand side.

Because of the extensive use of direct current for elevators in large buildings, and for traction purposes, some large cities have their central business districts supplied with D. C., and the outlying districts where the power must be transmitted farther are supplied with A. C.

Direct current generators are used to supply the direct current wherever it is extensively used; and many privately owned power plants use D. C. generators because of the simplicity of their operation in parallel, where several are used.

In the operation of D. C. generators the speed at which they are driven is not as critical as it is with A. C. generators. Small D. C. generators can be belt driven; but this is not practical with A. C. generators, because a slight slip of the belt would cause their speed to vary, and make trouble in their parallel operation.

D. C. generators are made in sizes from 60 watts for automotive use, up to those of several thousand kilowatts for industrial and railway power plants. Their voltages range from 6 volts on automotive generators to 440 volts for industrial purposes; and on up to 600 and 750 volts for railway work.

The smaller sizes for belt drive operate at speeds from 300 to 1800 R. P. M., while the larger sizes which are direct connected to steam, oil, or gas engines, run at speeds from 60 to 250 R. P. M.

When these generators are driven by direct shaft connections to reciprocating steam engines, a large flywheel is usually provided on the same shaft to produce a more even speed. It will also deliver power to the generator during suddenly increased loads, until the engine governor can respond.

D. C. generators are not so well adapted for direct connection to steam turbines, because of the very high speeds of the turbines, and the great stress these speeds would set up in the commutators and windings of the generators.

When driven by turbines, they are usually coupled together by gears. For example a 360 R. P.

M. generator can be driven by a 3600 R. P. M. turbine, through speed reducing gears with a ratio of 10 to 1.

Fig. 5 shows a small D. C. generator driven by a vertical steam engine. Note the flywheel used to maintain even speed and voltage, and also note the commutator and brushes which are in plain view on this generator.

Fig. 6 shows a larger D. C. generator also driven by a steam engine; which, in this case, is of the horizontal type and is located behind the generator. Note the very large flywheel used on this machine, and also the commutator and brush rigging on the left.

Direct current is not much used where the energy must be transmitted over distances more than one-half mile to a mile, as it requires high voltage to transmit large amounts of power over longer distances; and it is usually not practical to operate D. C. generators at voltages above 750.

Where large amounts of power are used in a compact area, such as in a large factory, in mines, steel mills, or densely built up business section of cities, D. C. finds its greatest use.

Where direct current is desired for use at a considerable distance from the location of the power plant, alternating current may be used to transmit the energy at high voltage, to a substation in which a motor generator set is used to produce D. C.

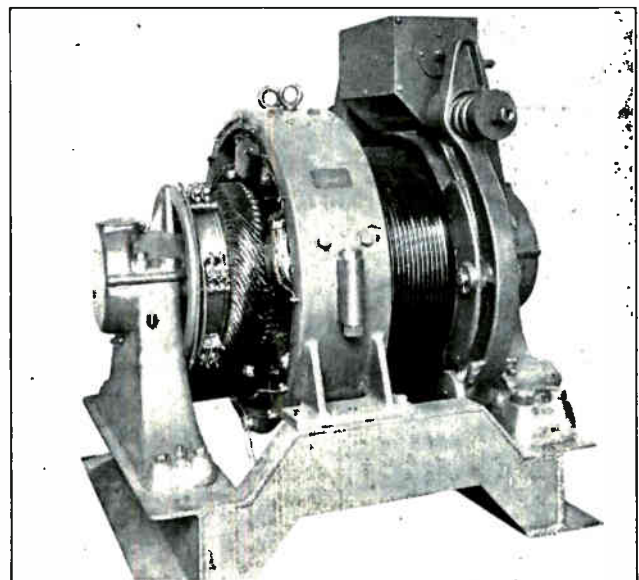

Fig. 4. This photo shows a D. C. elevator motor with the magnetic brake on the right end of the cable drum.

Fig. 7 shows a motor generator of this type, consisting of an A. C. motor on the left, driving a D. C. generator on the right. In this case the two machines are coupled directly together on the same shaft.

Other common uses for Direct Current are for electro-plating, electrolytic metal refining, battery charging, operation of electro-magnets, farm lighting plants, and automotive equipment.

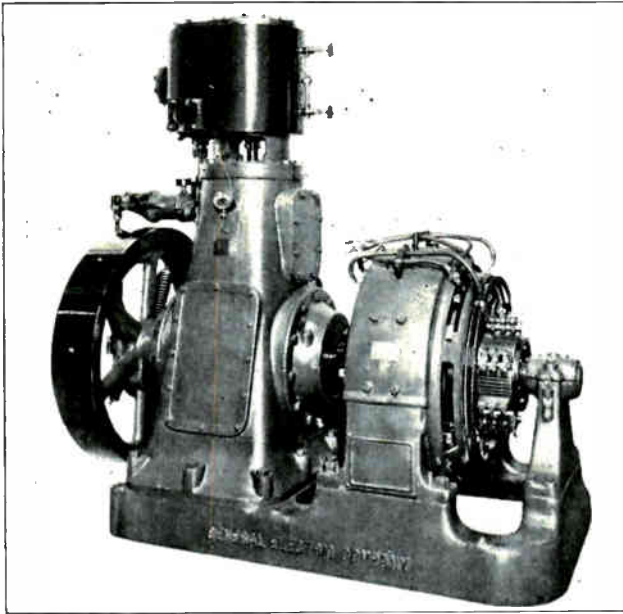

Fig. 5. Small engine-driven D. C. generators of the above type are used in a great number of privately owned power plants.

D. C. generators for electro-plating and electrolytic refining, are made to produce low voltages, from 6 to 25 volts, and very heavy current of several thousand amperes on the larger machines.

Garages use thousands of small motor generators, to produce D. C. for battery charging; and stores and plants using large fleets of electric trucks, charge their batteries with D. C. from larger charging generators.

Train lighting with the thousands of batteries and generators for this work is another extensive field for D. C. equipment.

Many thousands of D. C. farm lighting plants are in use throughout this country, supplying direct current at either 32 volts or 110 volts for light and power on the farms.

Powerful electro-magnets requiring direct current for their operation, are used by the thousands to speed up the handling of iron and steel materials in industrial plants, railway shops, etc. Fig. 8 shows a large magnet of this type which is used for lifting kegs of nails and bolts. This illustration also shows how the magnetism acts through the wooden kegs, proving what we have learned in an earlier section—that magnetism cannot be insulated.

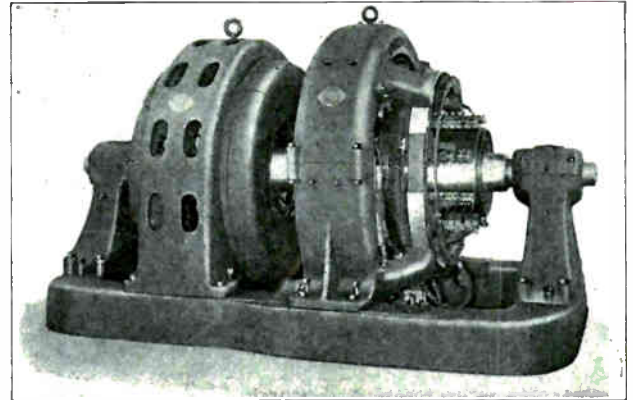

Fig. 7. Motor generator sets of the above type are very extensively used for changing A. C. to D. C. The D. C. generator is shown on the right and is driven by the A. C. motor on the left.

The automotive field is an enormous user of direct current equipment. Each modern automobile has a complete little power plant of its own, consisting of its D. C. generator, series D. C. starting motor, battery, lights, ignition coil, horn, etc. Many millions of D. C. generators and motors are in use on cars and trucks in this country alone. Fig. 9 shows a common type of 8 volt, shunt-wound, D. C. automotive generator.

Many powerful busses also use gas electric drive, having a gasoline engine to drive a D. C. generator, which in turn supplies current to D. C. motors geared to the axles. This form of drive provides

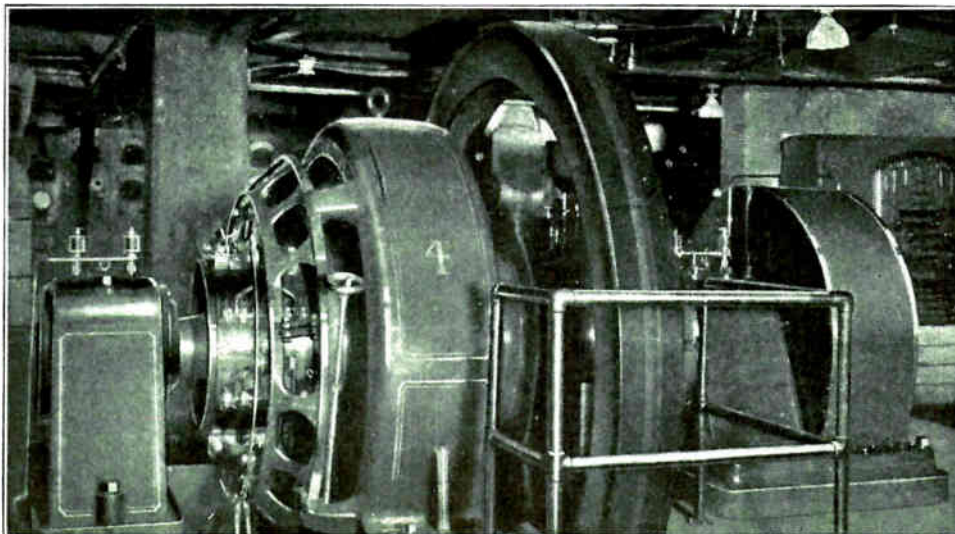

Fig. 6. This photo shows a large D. C. generator such as used in a great many industrial and railway power plants. Note the large fly wheel which is used to keep the speed of the generator even and "smooth out" the pulsations produced by the strokes of the engine.



Fig. 8. Direct current is used to operate powerful electro-magnets of the above type for handling metal materials in industrial plants, warehouses, foundries, and iron yards. Note the manner in which these kegs of bolts are lifted by the magnet, even though the wooden heads of the kegs are between the magnet and the metal to be lifted. In plants where the principal supply of electricity is alternating current small motor generators are often used to supply the direct current for magnets of this type.

smoother starting and stopping, greater hill climbing ability, higher speeds on level roads and eliminates gear shifting. Diesel-Electric trains also use D. C. generators and motors.

With this great variety of uses for direct current and D. C. machines you can readily see the value of making a thorough study of the equipment and principles covered in this section. The opportunities open to a trained man are certain to be much greater if he has a good knowledge of the operation, care and testing of direct current machines of all common types.

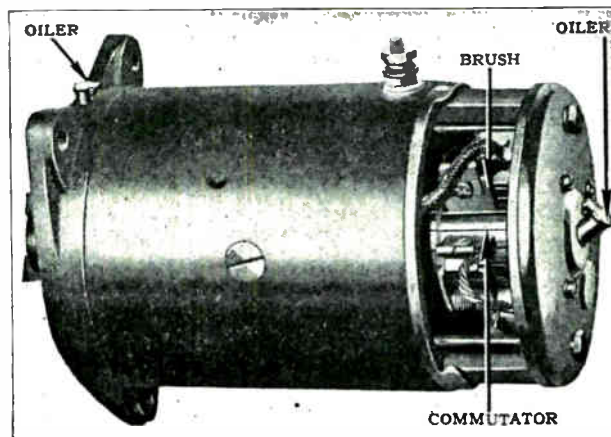

Fig. 9. Direct current generators of the above type are used by the millions on automobiles.

## D. C. GENERATORS

It has already been stated in an earlier section, that D. C. generators and motors are almost exactly alike in their mechanical construction, and that in many cases the same machine can be used either as a motor or a generator, with only slight changes in the field connections, brush adjustment, etc. This is a very good point to keep in mind while studying the following material, as many of the points covered on construction, operation, load ratings, temperatures, etc., will apply to either a motor or a generator.

### 1. GENERATOR RATINGS

D. C. generators are always rated in kilowatts, a unit of electric power with which you are already familiar. It will be well to recall at this point, however, that one kilowatt is equal to 1000 watts, and approximately 1.34 h. p. You will also recall that the watts or kilowatts consumed in any circuit are equal to the product of the volts and amperes. Therefore, with a machine of any given voltage, the greater the load in K. W., the greater will be the load in amperes of current carried by the windings of that machine.

The K. W. rating of a D. C. generator is the power load that it will carry continuously without excessive heating, sparking, or internal voltage drop.

If a load greater than a machine is designed or rated for is placed upon it for an extended period, it will probably give trouble due to one of the three causes mentioned; and if the overload is very great and left on too long it will cause the armature winding to burn out.

Nearly all generators are designed to be able to carry some overload for short periods without injury to the machine. This is usually from 15 to 25 per cent, for periods not longer than an hour or so.

### 2. OPERATING TEMPERATURES

The safe temperature rises in electrical machinery are determined by the temperatures the insulating materials will withstand without damage. All other materials in the machine are metals which may be subjected to quite high temperatures without much damage.

Of course the higher the temperature of the copper windings the greater their resistance will be, and the higher will be the losses due to voltage drop in the machine.



Ordinary combustible insulations such as silk, cotton, and paper, should never be subjected to temperatures higher than 212° F. (or 100° C). Mica, asbestos, and other non-combustible insulations may be subjected to temperatures as high as 257° F., or 125° C.

In establishing temperature rise ratings for electrical machinery, it is assumed that the temperature in the rooms where the machines are installed will never be over 104° F. or 40° C. This gives, for the ordinary insulations, a permissible rise of 212 — 104, or 108° F. or 60° C. For non-combustible insulations the permissible rise is 257 — 104, or 153° F. or 85° C.

Ordinary generators and motors are usually guaranteed by the manufacturers to operate continuously at full load, without exceeding a temperature rise of 35° C., 40° C., or 50° C., as the case may be.

The temperatures of machines can be checked by placing small thermometers in between, or close to, the ends of their windings. A good general rule to remember, is that if the hand can be held on the frame of the machine near the windings without great discomfort from the heat, the windings are not dangerously hot.

### 3. GENERATOR SPEEDS

The speeds at which generators are operated depends upon their size, type of design, and method of drive. The speed is of course rated in R. P. M. (revolution per min.) but another expression commonly used in referring to the rotating armatures of electrical machines is the *Peripheral Speed*. This refers to the travelling speed of the outside or circumference of the rotating element, and this surface is commonly known as the *Periphery*. This speed is expressed in feet per second or feet per minute.

The centrifugal force exerted on the armature conductors or commutator bars depends on the peripheral speed of the armature or commutator. This speed, of course, depends on the R. P. M., and the diameter of the rotating part.

The larger the armature, the farther one of its conductors will travel in each revolution. When a coil of a bi-polar, (two pole) machine makes one revolution, it will have passed through 360 actual or mechanical degrees and 360 electrical degrees. But a coil of a six pole machine will only have to rotate 120 mechanical degrees to pass two poles, and through 360 electrical degrees.

So we find that with the same flux per pole in the larger machine as in the two pole one, the same E. M. F. can be generated at a much lower speed with the multipolar machine.

Small generators of two or four poles and for belt drive, have long armatures of small diameter and may be operated at speeds from 120 to 1800 R. P. M. Larger machines for slower speed drive by direct connection to the shafts of low speed re-

ciprocating engines, may have as many as 24 or more field poles, and operate at speeds of 60 to 600 R. P. M. Armatures for these lower speed machines are made shorter in length and much larger in diameter, so their conductors cut through the field flux at high speeds, even though the R. P. M. of the armature is low.

The peripheral speeds of armatures not only determine the voltage induced and the stresses on the coils and commutator bars, but also determine the wear on brushes and the type of brushes needed, as will be explained later.

### 4. TYPES OF DRIVES

Belt driven generators are not much used in large plants any more because of possible belt slippage, and the danger of high speed belts. A number of older plants and many small ones use belt driven machines, and with fairly satisfactory results if the proper belts and pulleys are used.

One advantage of small belt driven generators is that they can be designed for high speeds and are much lower in cost.

The engine type generator with the large diameter, slow-speed armature, direct connected to the engine shaft, is more commonly used. Steam engines are a very desirable form of prime mover for generators, because of their high efficiency, simple operation, and because they can be operated on the ordinary steam pressures.

Steam turbines are used to drive D. C. generators in plants where space is limited, because they are so small and compact.

Water wheels are used for prime movers where convenient water power is available. Generators for water wheel drive may be either low or high speed type, according to the water pressure and type of water wheel used.

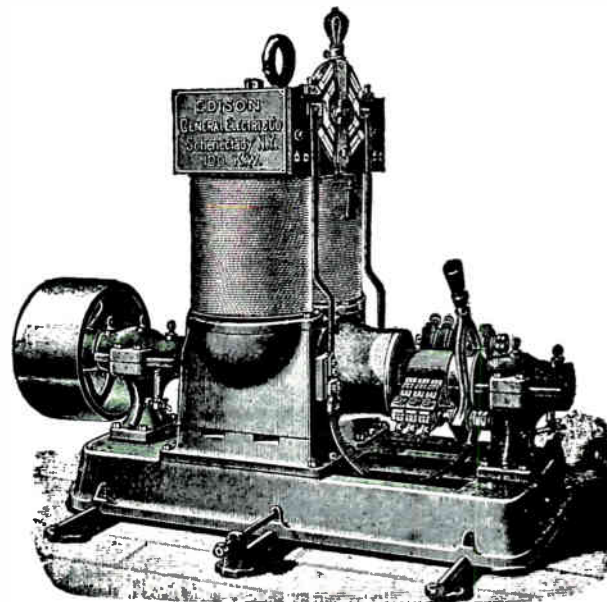

Fig. 10. An early type of D. C. generator developed by Thomas Edison. Note the construction of the field magnets of this machine.

## 5. MECHANICAL CONSTRUCTION OF D. C. GENERATORS

We have already learned that a generator is a device used to convert mechanical energy into electrical energy. We also know that the principal parts of a D. C. generator are its field frame, field poles, armature, commutator, brushes, bearings, etc.

The purpose of the field poles is to supply a strong magnetic field or flux, through which the armature conductors are rotated to generate the voltage in them.

D. C. generators were the first type commercially used, and the early types were very simply constructed with two large field poles in the shape of a huge bipolar electro-magnet. The armature was located between the lower ends of these magnets, as shown in Fig. 10. This figure shows one of the early types of Edison generators of 100 K. W. size.

## 6. FIELD FRAMES

Modern generators and motors have their field poles mounted in a circular frame, as shown in Fig. 11. This figure shows a two-pole field frame with the two large poles mounted on the inside of the frame. The field coils can be plainly seen on the poles.

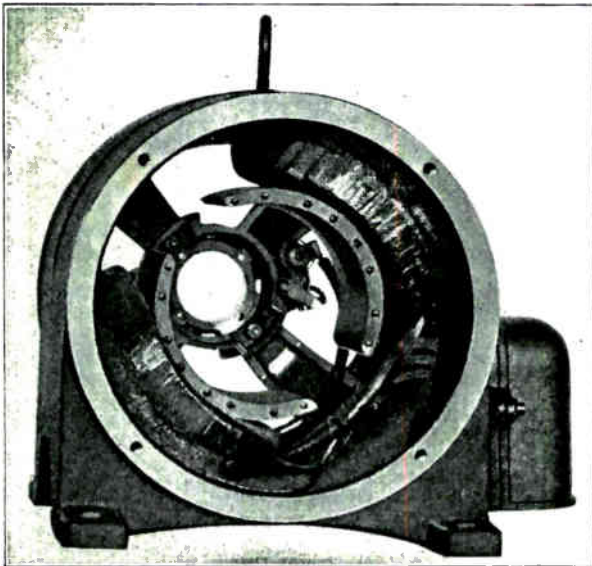

Fig. 11. Field frame of a modern generator or motor. Field coils located on the poles set up powerful magnetic flux in which the armature rotates.

The circular frame, in addition to providing a support for the field poles, also provides a complete closed path of magnetic material for the flux circuit between the poles. For this reason the frames are usually made of soft iron.

For the smaller and medium sized machines, they are generally cast in one piece with feet or extensions for bolting to a base. The inner surface is usually machined smooth where the poles are bolted to it, or in some cases the poles are cast as a part of the frame. The ends of the frame are machined to allow the bearing brackets to fit properly.

The frames for larger generators are usually cast in two pieces for more convenient handling during installation and repairs. They can be split either horizontally or vertically. Fig. 12 shows a frame of this type for an eight-pole machine. Note where the halves of the frame are joined together and bolted at each side.

## 7. FIELD POLES

There may be any equal number of field poles in a generator or motor frame, according to its size and speed. These poles are made of soft iron to keep the magnetic reluctance as low as possible.

The poles can be cast as a part of the frame on smaller machines, but are usually bolted into the larger frames. It is very important that they should fit tight to the frame to prevent unnecessary air gaps and reluctance in the magnetic circuit.

The ends of the poles which are next to the armature are usually curved and flared out into what are called Pole Shoes or Faces. This provides a more even distribution of the field flux over the armature core and conductors. These pole shoes are generally machined to produce an even air gap between them and the armature core.

Pole shoes are often made of laminated strips to keep down the induced eddy currents from the flux of the moving armature conductors. These laminated pole shoes are then bolted to the field poles. The machine in Fig. 11 has laminated pole shoes of this type.

In some large machines the entire field poles are often laminated for the same reason as the pole shoes are.

The field coils may be wound with round or square copper wire or with thin copper strip or

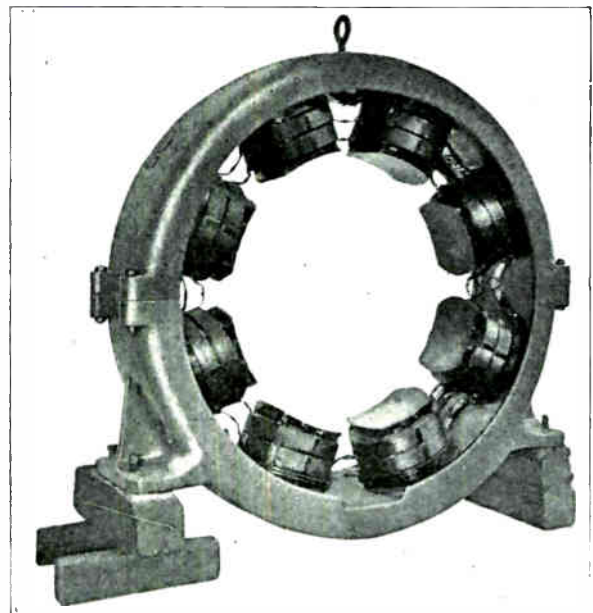

Fig. 12. Field frame for an eight-pole D. C. generator. Note the manner in which the frame is built in two sections for convenience when installing and making repairs.

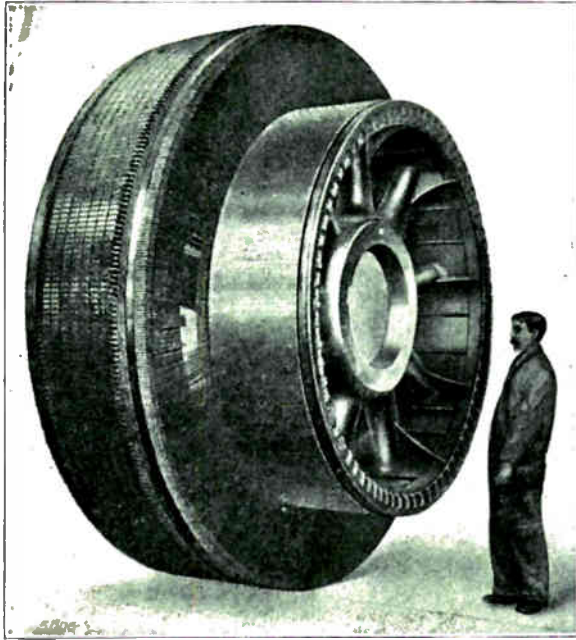

Fig. 13. This large armature shows the size to which D. C. generators can be built. An armature of this size would develop several thousand horsepower.

ribbon. These coils are connected to produce alternate north and south poles around the frame. In Fig. 12 the connections between the field coils can be noted.

## 8. ARMATURES

We have already learned a great deal about this very important part of D. C. machines, as armature construction and winding were thoroughly covered in the preceding section. A few of the points that are particularly good to keep in mind throughout the study of D. C. motors and generators will be briefly reviewed here.

The function of the armature, we know, is to carry the rotating conductors in its slots and move these swiftly through the magnetic flux of the field, in order to generate the voltage in them.

Armature cores are made of thin laminations of soft iron which are partially insulated from each other either by a thin coating of oxide which is formed on their surface when they are being heat treated or by a thin layer of insulating varnish. This laminated construction prevents to a great extent the eddy currents which would otherwise be induced in the core as it revolves through the field flux.

The very soft iron and steel in armature cores and its excellent magnetic properties also greatly reduce hysteresis loss. Also remember that the number of turns per coil and the method of connecting these coils will determine the voltage that is induced in a generator armature, or the counter-voltage in a motor armature.

Fig. 13 shows a very large armature of a D. C. generator with the commutator on the right. This

view clearly shows the coils in the slots, and the long risers which extend from the commutator bars up to these coil ends. This armature and commutator give some idea of the size to which the larger D. C. generators and motors can be built.

## 9. COMMUTATORS

A commutator, we already know, is a device used to rectify or change the alternating E. M. F. which is induced in the armature, to a direct E. M. F. or voltage in the external circuit. A commutator might also be called a sort of rotating switch which quickly reverses the connections of the armature coils to the external circuit as these coils pass from one pole to the next.

The manner in which the commutators are constructed of forged copper bars which are insulated from each other by mica segments, was covered in a preceding article under D. C. armatures.

Figs. 14 and 15 show two excellent views of commutators of slightly different types. The smaller one in Fig. 14 is held together by the ring nut shown on the right, while the larger one is known as a "bolted type" commutator, and has bolts which draw the V-rings tightly into the grooves in the bars.

## 10. BRUSHES

The brushes slide on the commutator bars and deliver the current from a generator winding to the line; or, in the case of a motor, supply the current from the line to the winding. Most of these brushes are made of a mixture of carbon and graphite molded into blocks of the proper size. While this material is of fairly high resistance, the very short length of the brushes doesn't introduce enough resistance in the circuit to create much loss. The

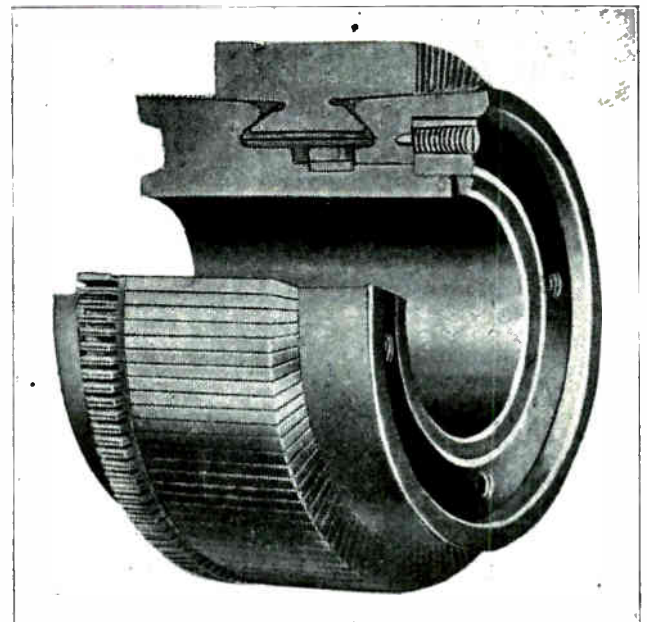

Fig. 14. The above photo shows an excellent sectional view of a commutator for a D. C. machine.

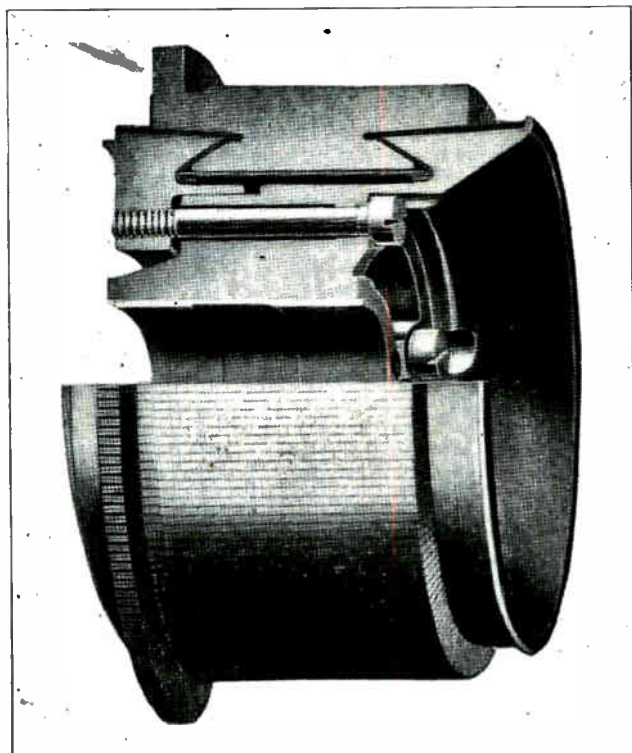

Fig. 15. This view shows another type of commutator in which the bars are held in place by bolts that are used to draw the clamping rings tight.

properties of the carbon and graphite tend to keep the commutator clean and brightly polished as the brushes slide on its surface. Some resistance in the brush material is an advantage, as it tends to prevent severe sparking during the period the commutator bars are short circuited. This will be explained in a later section on brushes.

Brushes must be of the proper size and material to carry, without undue heat, the full load currents of either a generator or motor. The carrying capacity of the brushes is a figure generally set by the manufacturers to indicate the number of amperes the brush will carry per square inch of cross-sectional area. This figure takes into account the heat due to overloads, friction, short circuit currents in the coils, voltage drop at the contact, and the heat produced by sparking.

Fig. 16 shows two common types of generator brushes to which are attached Pig Tails of soft stranded copper. These copper pig-tails are used for making a secure connection to carry the current from the brush to the holder and line.

### 11. BRUSH HOLDERS

Brushes are held firmly in the correct position with relation to the commutator by placing them

in brush holders. The brush holders in common commercial use today may be classed under three general types, called **Box Type**, **Clamp Type**, and **Reaction Type**.

The box type holder was one of the first to be developed and used, while the clamp type has been developed in two forms known as the "swivel" and "parallel" motion types. Fig. 17 shows sketches of these several types of brush holders. The upper views in each case show the holders assembled on round studs, while the lower views show them bolted to rectangular studs.

A brush holder, in addition to providing a box or clamp to hold the brush in place, also has springs to hold the brush against the commutator surface and under the proper tension. Fig. 18 shows a box-type brush holder and the springs which apply the tension on the brush, and the view on the right shows this brush holder from the opposite side, mounted in the rocker ring. The requirements of good brush holders are as follows:

1. To provide means for carrying the current from the brush to the holder stud, either with a flexible copper connection or by direct contact between the brush and the holder. This must be accomplished without undue heating or sparking between the brush and holder, as this would result in a rapid burning and damage to the holders.
2. To provide means for accurately adjusting the brush on the commutator or ring.
3. To hold the brush firmly at the proper angle.
4. To permit free and quick movement of the brush in order that it may follow any uneven surface of the commutator or ring.

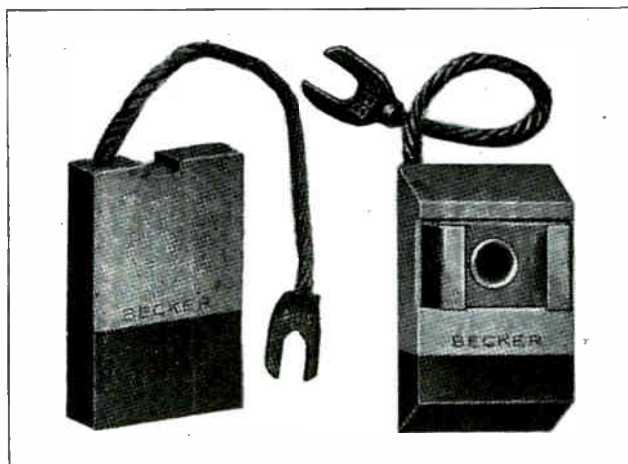

Fig. 16. Two common types of carbon brushes used for D. C. machines. Note the flexible copper leads used for connecting them to the brush holders.

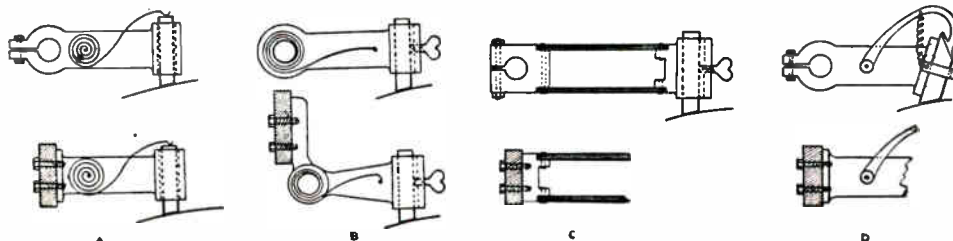

Fig. 17. The sketches on the left show several common types of brush holders. At "A" are two views of box-type holders. "B" and "C" are known as clamp-type holders; while "D" is a brush holder of the reaction-type.

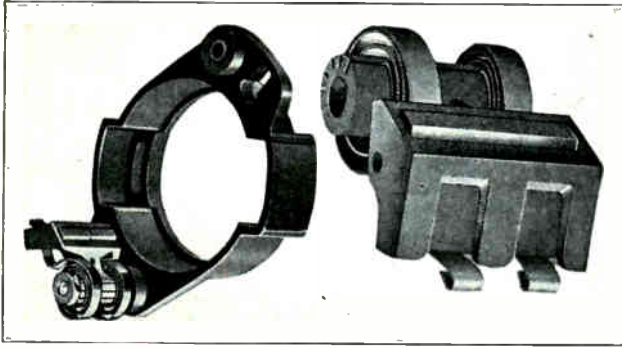

Fig. 18. Above are shown two box-type brush holders. The one at the left is simply attached to its holder stud sleeve and springs, while the one at the right is mounted on the holder stud which is fastened in a brush rocker arm.

5. To provide a tension spring of such length or shape that the tension on the worn brush will be very little less than that on a new brush.

6. To have a brush hammer so constructed that it will bear directly on the top of the brush and not give a side push either when the brush is full length or nearly worn out.

Fig. 19. shows a brush holder of the Reaction Type, in which the brush is held securely between the commutator surface and the Brush Hammer shown on the top in this view. The spring used with this brush holder is a coiled steel wire and can be seen on the back of the holder near the hammer hinge.

Brush holders are generally mounted or attached to a Rocker Ring by means of holder studs, as shown in Fig. 20. The holders can usually be adjusted on these studs both sidewise and up and down, to provide the proper spacing and tension. The purpose of the rocker frame or ring is to allow

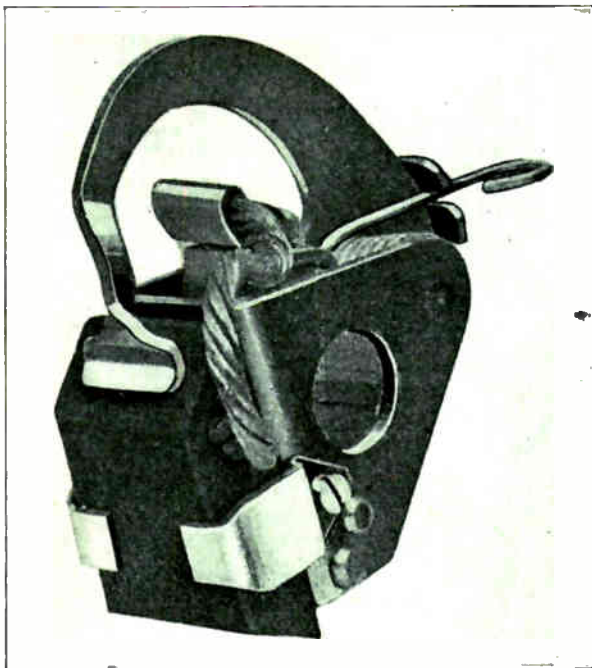

Fig. 19. Reaction-type brush holders keep the brush in place by the pressure of a "brush hammer", as shown on top of the brush in this view.

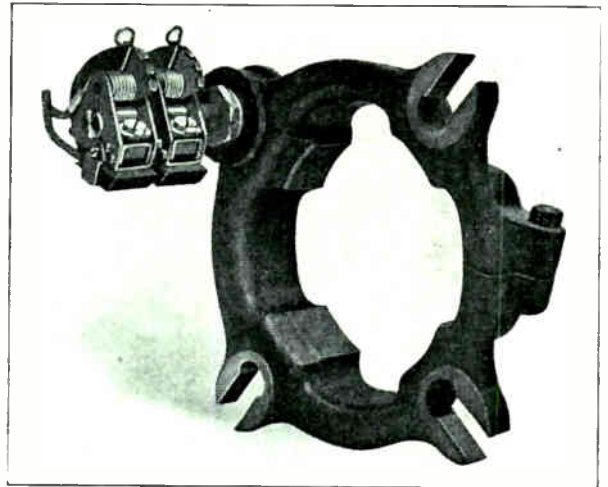

Fig. 20. Above are shown two brushes in their holders which are mounted on a brush rocker arm for a four-pole machine. Note the coil springs by which the brush tension on the commutator can be adjusted.

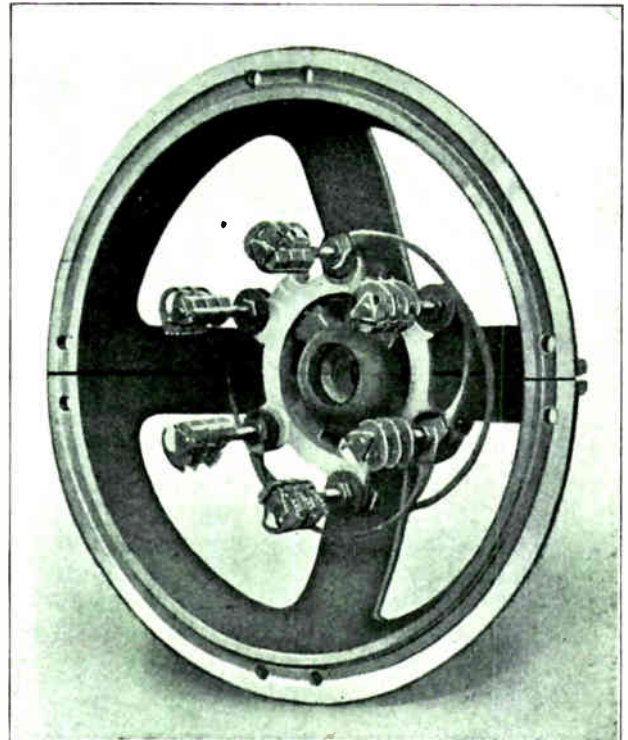

Fig. 21. This view shows a complete set of brushes and holders mounted on the rocker arm, which in turn is fastened in the end bracket of the machine.

the entire group of brushes to be rotated through a small arc, so their position can be adjusted for varying current loads on the machine. This is often necessary on machines that do not have interpoles — as will be explained later.

Frequently there are two or more brushes mounted on each stud, as several small brushes are more flexible and will fit themselves to uneven commutator surfaces much better than one large brush. The brush holder studs are, of course, insulated from the rocker frames by means of fibre washers and bushings.

Fig. 21 shows six sets of brushes mounted on the brush holder studs and rocker frame, which in turn is mounted in the end bracket of the machine.

## 12. BEARINGS

As previously mentioned, the bearings of motors and generators are to support the armature properly centered between the field poles and to allow it to rotate freely when the machine is in operation. These bearings are mounted in bearing brackets and held firmly at the ends of the machine; or, in some cases, they may be mounted in pedestals which are separate from the field frame.

These bearings are of two common types, called sleeve bearings and ball bearings. Roller bearings are also used in some cases. Sleeve bearings are made of babbit metal on the medium and larger sized machines, while bronze is used for very small, high-speed machines. Bearing metal must always be of a different grade than that in the shaft, be-

cause two similar metals will rapidly wear away or eat into each other when they are rubbed together.

Sleeve-type bearings are commonly oiled by oil rings or chains which rotate in the oil well and carry a small amount of oil up on top of the shaft continuously while it is rotating. In other cases, on smaller machines, the oil is fed to the shaft by a cotton wick. Ball and roller bearings are lubricated with a light grade of grease.

A more thorough study of bearings will be given in a later section. The principal point to remember at this time in connection with bearings is the importance of keeping all bearings properly lubricated with clean oil. There should always be enough oil to be sure that the bearings are receiving it; but never oil them excessively and thus cause an overflow which may run into the winding and damage their insulation or get on the commutator and destroy its clean, bright surface.

# OPERATING PRINCIPLES OF D. C. GENERATORS

We have learned that the E. M. F. or voltage in a generator is produced by electro-magnetic induction when the conductors of the armature are rotated through the lines of force of the field.

We also know that the amount of voltage produced depends on the number of lines of force which are cut per second. This in turn depends on the strength of the field, the speed of armature rotation, and the number of turns or coils in series between brushes.

The voltage that will be produced by a generator can be calculated by the formula:

$$E = \frac{P \times \Phi_p \times Cr \times \text{RPM}}{10^8 \times 60 \times M.}$$

in which:

- P = No. of field poles
- $\Phi_p$  = Total useful flux per pole
- Cr = Total No. of inductors on armature
- $10^8$  = 100,000,000 lines of flux to be cut per sec. by one conductor
- 60 = 60 sec. per min.
- M = No. of parallel conducting paths between the + and - brushes.

For example, suppose we have a machine with 4 poles and with 200 armature inductors (conductors) in four parallel circuits between the brushes. The machine runs at 1200 R.P.M., and we will assume that the useful flux per pole is 3,000,000 lines.

Then  $E = \frac{4 \times 3,000,000 \times 200 \times 1200}{100,000,000 \times 60 \times 4}$ , or 120 volts.

You may not need to use this formula often, but

it serves to show what the voltage of generators depends upon in their design and also to illustrate the factors of greatest importance in regulating the voltage of a generator.

It is an easy matter to determine the direction of induced voltage in the conductors of a generator by the use of Fleming's Right Hand Rule, which has been previously stated and explained.

The rule is one that you will have a great deal of use for in connection with generators, so we will repeat it here.

Place the first finger, thumb and remaining fingers of the right hand all at right angles to each other. (See Fig. 22). Let the first finger point in the direction of magnetic flux from the field poles, the thumb in the direction of conductor rotation, and the remaining fingers will indicate the direction of induced voltage.

This rule can be used either with diagrams or at the machine to quickly determine the direction of induced voltage in any conductor, where the direction of conductor movement and field polarity are known.

## 13. MAGNETIC CIRCUIT IN A GENERATOR

The number of conductors in the armature of a generator usually remains unchanged once it is built, and while the speed can be varied somewhat, the machine is generally operated at about the speed for which it is designed. So we find that the voltage adjustment or variation during the operation of a generator will depend largely upon the field strength. It would be well, therefore, to consider

more in detail some of the factors upon which this field strength depends, and also the methods by which it can be varied.

Every generator or motor has what is called a **Magnetic Circuit**. This is the path followed by the flux of its field poles through the poles themselves, and through the armature core, and field frame — as shown in Fig. 23.

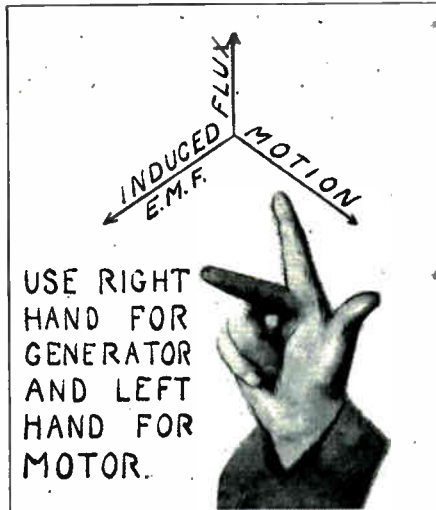
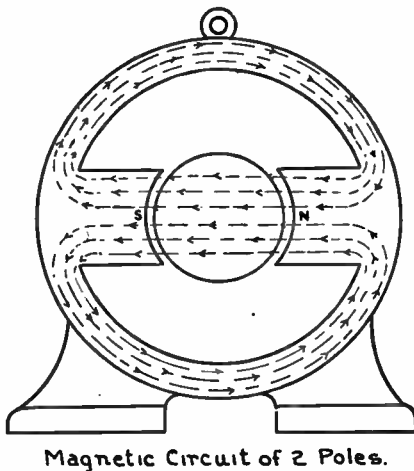

Fig. 22. This figure shows a method of holding the fingers to use the right-hand rule for determining direction of induced voltage in generators.

There are always as many magnetic circuits in a generator as it has poles. That is, a two-pole generator will have two magnetic circuits. A four-pole generator four magnetic circuits, etc. These magnetic paths must be continuous and will complete themselves through air unless iron or steel is provided. It is advisable, therefore, to have as much of the magnetic circuit through iron as possible, in order to reduce the reluctance of the circuit and increase the strength of the field.

The magnetic paths of commercial generators are completed through an all-iron or steel path, with the exception of the air gap between the armature core and field poles. If this air gap is increased it



Magnetic Circuit of 2 Poles.

Fig. 23. The above diagram shows the magnetic circuit or path of the field flux in a simple two-pole machine.

will weaken the strength of the field and reduce the generator voltage considerably.

Fig. 24 shows a sketch of a four-pole generator frame and the four magnetic circuits which it will have. It is very easy to determine the direction of flux at any pole of a generator if we know which ends of the pole are N. and S., and simply remember the rule that magnetic flux always travels from a north to a south pole in the external circuit. Examining Fig. 24 again, we find that the flux from either north pole divides and half of it goes to each of the south poles, then through the air gap and armature core which form the external circuit for the field poles. The internal circuit from the south pole back to the north pole is completed through the field frame. From this we see that each pair of field poles of a generator form a sort of horse-shoe magnet.

The area of the field poles and frame must be great enough to carry the flux without saturation. For highest efficiency, generators are operated at field densities considerably less than saturation, and generally at about 20,000 to 40,000 lines per sq. inch.

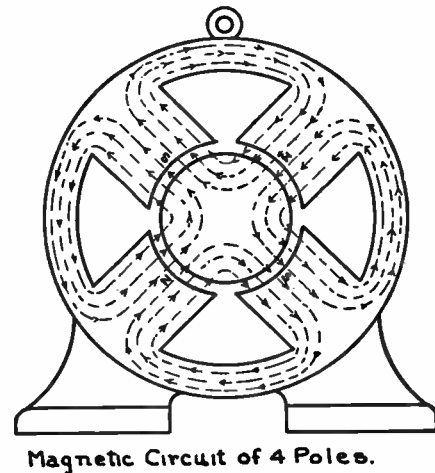

Magnetic Circuit of 4 Poles.

Fig. 24. Magnetic circuits in a four-pole machine. Note the direction of flux from N. to S. poles in the external circuit and from S. to N. poles in the internal circuit of the field.

#### 14. FIELD EXCITATION

We know that the strong magnetic field of the poles in a generator is set up by direct current flowing through the coils on these iron poles. This current is called the **Field Exciting Current**. The strength of the field will, of course, depend on the number of turns in the field coils and the amount of current which is passed through them. So, by controlling excitation current with a rheostat, we can readily adjust the strength of the field and the output voltage of the generator.

Generators are classed as either **Separately Excited** or **Self-Excited**, according to the manner in which their coils obtain the exciting current.

A **separately excited generator** is one that has its field excited from some source other than its own armature. This source may be either a storage battery or another small D.C. generator. Alternating current cannot be used to excite the field poles of

either a D.C. or A.C. generator. So alternators are practically always separately excited by current from storage batteries or D.C. generators. Separately excited D.C. generators are sometimes used for electro-plating machines and work of this type, and have their field coils wound for a certain voltage. This voltage may range from 6 to 25 for battery excitation; and from 110 to 220 when excited from another generator.

Fig. 25 shows a sketch of a simple two-pole D.C. generator which has its field separately excited from a storage battery. Note the field rheostat which is provided to vary the field current and the generator voltage.

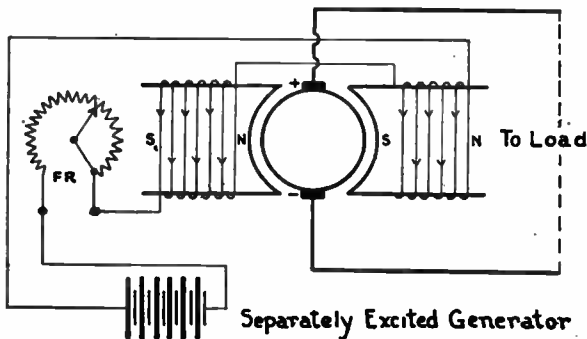

Fig. 25. This diagram shows a simple D. C. generator which has its field separately excited from a storage battery.

A self-excited generator is one that receives its field current from its own armature winding. Fig. 26 shows a sketch of a simple generator of this type. You will note that the field coils are connected across the positive and negative brushes of the armature in parallel with the line and load. The field will at all times receive a small amount of D. C. from the armature, whether there is any load connected to the line or not. Practically all commercial D.C. generators are self-excited.

### 15. BUILDING UP VOLTAGE IN A GENERATOR

With a separately excited generator, as soon as the circuit is closed from the source of direct current for the field, the field will be magnetized at full strength, and the generator voltage will build up immediately as soon as the machine goes up to full speed.

A self-excited generator must build up its voltage more gradually from the small amount of residual magnetism in the poles when the machine is started. You will recall that residual magnetism is the magnetism which remains in or is retained by the iron of the field poles even when their current is shut off. This residual magnetism, of course, produces only a very weak field.

When the machine is first started up and the armature conductors begin to cut this weak residual field, a very low voltage is generated in them. As the field is connected to the armature this first low voltage slightly increases the strength of the field. Then as the conductors cut through this slightly

stronger field a little higher voltage is induced in them. This increases the field strength still more, which in turn builds up a greater voltage in the armature and further increases the field strength. This continues, and the strength of the field as well as the armature voltage keep on getting greater, until the point of Saturation is reached in the field poles.

The saturation point, you will remember, is when a magnetic circuit is carrying its maximum practical load of flux. When this point is reached it would require a considerable increase of current in the field coils to make even a small increase in the flux of the poles. So we find that self-excited generators build up their voltage gradually from residual magnetism as the machine comes up to speed.

Sometimes it may require a few seconds after the machine has reached full speed for its voltage to come up to normal value.

### 16. FAILURE TO BUILD UP VOLTAGE

With self-excited generators, it is, of course, necessary that the flux lines produced by the field coils be of the same polarity as the residual magnetism in the iron of the poles. Otherwise, the first low voltage applied to the field coils would tend to neutralize the residual magnetism and cause the generator to fail to build up its voltage. For this reason, self-excited generators will build up voltage only when rotated in the proper direction. Generators may, however, be made to build up voltage when rotated in the opposite direction by changing the field connections.

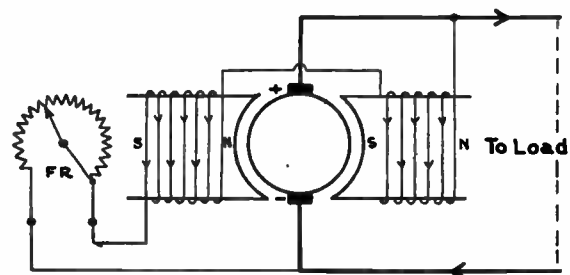

Fig. 26. This simple two-pole machine has its field coils self-excited by connection to its own armature brushes. Note the field rheostat at F. R., which is used to control the field strength.

After a generator has been idle for quite a period it sometimes loses its residual magnetism to such an extent that it will not build up voltage until it is first separately excited. Some of the causes of a generator failing to build up voltage are as follows: Weak or dead residual magnetism, low speed, poor brush-contact on the commutator, severe overloads, open field circuits, or high resistance connections.

Removing the cause of the trouble will usually start the machine generating, but if it does not a low voltage storage battery or some other source of direct current applied to the field coils momentarily and in the proper direction will generally



cause the machine to promptly build up voltage again.

On some generators it is necessary to cut out part or all of the resistance of the field rheostat before the machines will build up voltage.

### 17. VOLTAGE ADJUSTMENT AND REGULATION

When a generator is running at normal speed, its voltage can be conveniently controlled and adjusted by means of the field rheostat, as shown in Figs. 25 and 26. On most D.C. generators this adjustment is made manually by the operator, putting resistance in or out of the field circuit by means of this rheostat. In some cases automatic voltage regulators are used to control this voltage according to the load on the machine. This automatic regulating device will be explained later.

The terms "control" and "adjustment" refer to changes made in the voltage by the operator or automatic device. The term "voltage regulation" refers to some change in the voltage which the machine makes of its own accord as the load is changed or varied. This change is inherent in the machine and is determined by its design and construction.

### 18. NEUTRAL PLANE

The neutral plane in a generator is that point between adjacent field poles at which the armature conductors are traveling parallel to the lines of force, and in a very weak field. Normally, when the generator is not carrying a load this neutral plane is half way between adjacent poles of opposite polarity, as shown in Fig. 27.

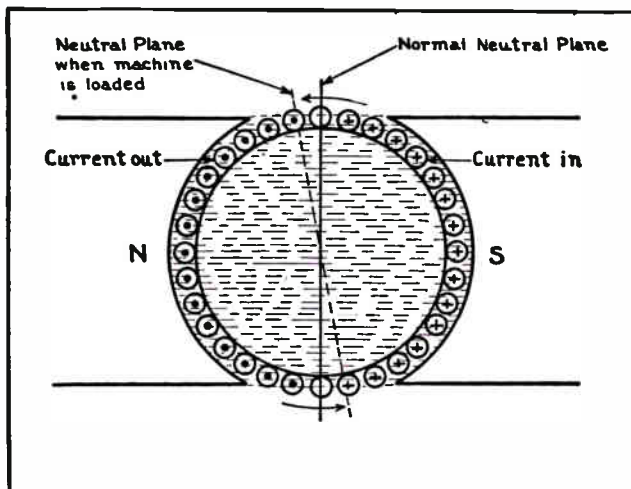

Fig. 27. This diagram shows the normal path of flux through the armature of the generator when the machine is not operating under load. Note the position of the normal neutral plane and also the position this plane takes when a machine is loaded.

When the conductors are passing through this point they do not generate any voltage, as they are not cutting across the lines of force. It is at this point that the commutator bars attached to the conductors usually pass under the brushes, where they are momentarily short circuited by the brushes. If the brushes were allowed to short circuit coils while they were passing through a strong

flux under a pole, and generating appreciable voltage, it would cause very severe sparking at the brushes. So it is important that the brushes be adjusted properly for this neutral plane.

### 19. ARMATURE REACTION

In addition to the flux which is set up between the field poles from their coils and exciting current, there is also to be considered the flux around the armature conductors. When a load of any kind is connected to a generator and its voltage begins to send current out through the line and load, this current, of course, flows through the armature conductors of the generator as well.

The greater the load placed on the machine the greater will be the current in the armature conductors and the stronger will be the flux set up around them.

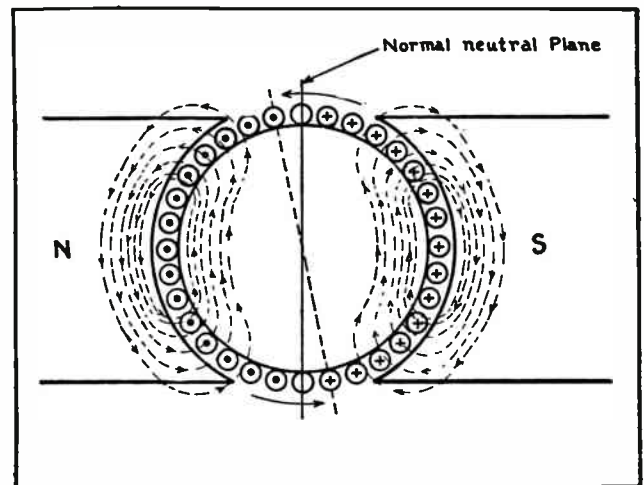

Fig. 28. This sketch shows the magnetic flux set up around the armature conductors of the simple two-pole machine when current is passing through them.

The armature flux is set up at right angles to the flux of the field poles, and therefore tends to distort the field flux out of its straight path between poles. This effect is known as **Armature Reaction**.

Fig. 28 shows the position of the armature flux as it would be when set up by current in the conductors, if there were no field flux to react with it. In actual operation, however, the armature and field flux of the generator are more or less mixed together or combined to produce the distorted field shown in Fig. 29. Here we see that the lines of force from the field poles have been shifted slightly out of their normal path and are crowded over toward the tips of the poles which lie in the direction of the rotation of the armature. This causes the field strength to be somewhat uneven over the pole faces, and more dense on the side toward which the armature is rotating.

You will also note that this distortion of the field has shifted the neutral plane, which must remain at right angles to the general path of the field flux.

As the armature flux depends on the amount of current through its conductors, it is evident that the greater the load on the machine, the greater

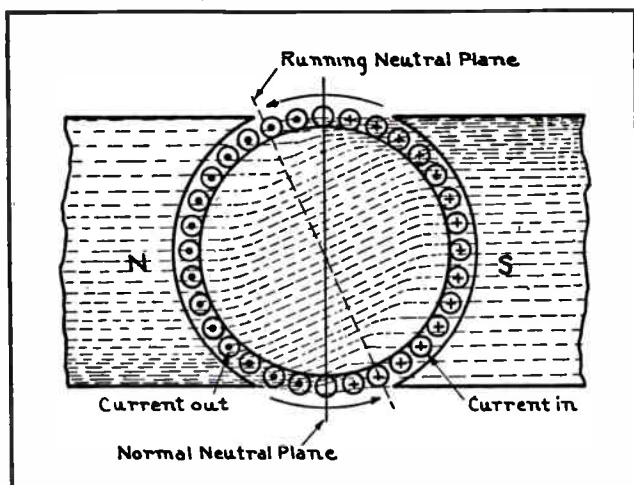

Fig. 29. This view shows the manner in which the magnetic lines of the field are distorted from their normal path by the effect of armature reaction. The neutral plane is shifted counter clockwise, or in the direction of rotation as shown by the dotted line.

will be the armature reaction and field distortion; and the farther the neutral plane will be shifted from its original position. So unless a generator is provided with some means of overcoming the effect of armature reaction, it will be necessary to shift the brushes with varying loads in order to obtain sparkless commutation.

Some machines are provided with commutating poles or interpoles, as they are sometimes called, which are placed between the main field-poles to neutralize this feature of armature reaction and thereby eliminate the necessity of shifting the brushes with changes of load. These poles and their operation will be more fully explained later.

The tendency of the armature flux to distort the field flux constantly exerts a force in the opposite direction of rotation and this force is what requires more power of the prime mover to drive the generator when its load is increased.

## 20. ARMATURE RESISTANCE AND I. R. LOSS

All armature windings offer some resistance to the flow of the load current through them. While this resistance is very low and usually only a frac-

tion of an ohm, it nevertheless causes a certain amount of voltage drop in the internal circuit of the armature. In other words, a certain small amount of the generated voltage is used to force the load current through the resistance of the armature winding. The greater the load on a generator, the greater will be the voltage drop through the armature.

As we know, this voltage drop is always proportional to the product of the amperes and ohms; and for this reason it is often referred to as *I. R. Drop*.

We can also determine the watts lost in an armature, or converted into heat because of its resistance, by squaring the current and multiplying that by the resistance, according to the watts law formula. Therefore,  $I^2 \times R$  will equal the watts lost in an armature due to its resistance. In which:

$I$  = the load current

$R$  = the resistance of the armature only.

This armature resistance can be measured with instruments connected to the commutator bars at the brush locations; or it can be calculated, if we know the size of the wire, the length of the turns in the coils, and the number of paths in parallel in the armature.

## 21. VOLTAGE DROP IN BRUSHES AND LINES

There is also a certain amount of voltage drop at the brushes of a generator which is due to the resistance of the brushes themselves and also the resistance of the contact between the brushes and commutator. This resistance is also very low and will cause a voltage drop of only about one or two volts on ordinary machines under normal load.

In addition to the voltage drop encountered in the generator, we also have the drop in the line which leads from the generator to the devices which use the current produced by the generator.

Knowing that the voltage drop in both the line, or external circuit, and the generator internal circuit will vary with the amount of load in amperes, we can see the desirability and need of some voltage adjustment or regulation at the generator, to keep the voltage constant at the devices using the energy.

# GENERAL TYPES OF D. C. GENERATORS

Direct current generators can be divided into several classes, according to their field construction and connections. They are called respectively: Shunt Generators, Series Generators, and Compound Generators.

The shunt generator has its field coils connected in shunt or parallel with the armature, as shown in Fig. 30-A. Shunt field coils consist of a great many turns of small wire and have sufficient resistance so that they can be permanently connected across the brushes and have full armature voltage applied to them at all times during operation. The

current through these coils is, therefore, determined by their resistance and the voltage of the armature.

Series generators have their field coils connected in series with the armature, as shown in Fig. 30-B; so they carry the full load current. Such coils must, of course, be wound with heavy wire in order to carry this current and they usually consist of only a very few turns.

Compound generators are those which have both a shunt and series field winding, as shown in Fig. 30-C.

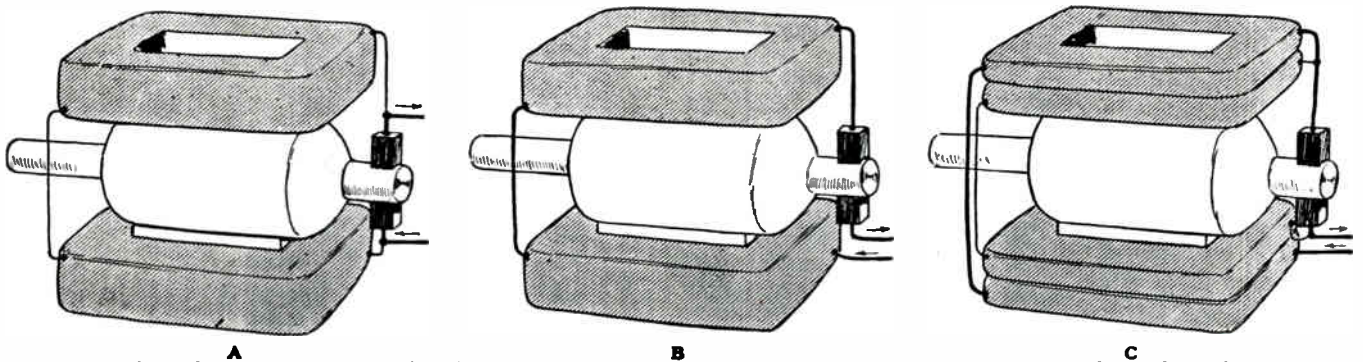

Fig. 30. "A" shows the connections of the field coils for a shunt generator. Note that they are connected in parallel with the brushes and the armature. "B" shows the connection of the field coils for a series machine. "C" illustrates the connection of the field coils for a compound generator. Note that at "C" the shunt coils next to the armature are connected in parallel with the brushes while the series coils on the outside are connected in series with the brushes.

Each of these machines has certain characteristics which are particularly desirable for certain classes of work, as will be explained in detail in the following paragraphs.

## 22. SHUNT GENERATORS

Fig. 31 is a simple sketch showing the method of connecting the field winding of a shunt generator in parallel with its armature. The field rheostat, F.R., is connected in series with the shunt field winding to regulate the field strength, as previously explained.

It is well to note at this point that, in various electrical diagrams, coils of windings are commonly represented by the turns or loops shown for the shunt field at "F", while resistance wires or coils are commonly shown by zigzag lines such as those used for the rheostat at "F.R."

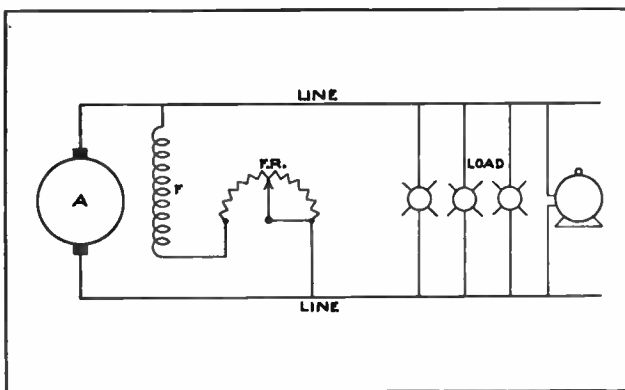

Fig. 31. This diagram shows the connections of a shunt generator. The shunt field winding "F" is connected in series with the field rheostat and then across the brushes. Note that this field winding is also in parallel with the load on the line.

Fig. 32 shows the connections of a shunt generator as they would appear on the machine itself. By comparing this diagram with the one in Fig. 31 and tracing the circuits of the field and armatures, you will find they are connected the same in each case.

The shunt generator, being a self-excited machine, will start to build up its voltage from residual magnetism as soon as the armature commences to rotate. Then, as the armature develops a small amount of voltage, this sends some current through

the field, increasing the lines of force and building up the voltage to full value, as previously explained. However, if there is a heavy load connected to the line the shunt generator may refuse to build up its voltage, as the heavy load current flowing thru the armature causes a voltage drop thru the armature and brush resistance and reduces the terminal or output voltage of the armature. This reduces the voltage supplied to the field and may weaken the field enough to prevent the generator from building up voltage.

## 23. VOLTAGE CHARACTERISTICS OF SHUNT GENERATORS

The voltage of the shunt generator will vary inversely as the load due to the same reason mentioned in the preceding article. Increasing the load causes increased voltage drop in the armature circuit thus reducing the voltage applied to the field. This reduces the field strength and thereby reduces the generator voltage.

If the load on a shunt generator is suddenly increased, the voltage drop may be quite noticeable; while, if the load is almost entirely removed, the voltage may rise considerably. Thus we see that the voltage regulation of a shunt generator is very poor, because it doesn't inherently regulate or maintain its voltage at a constant value.

The voltage may be maintained fairly constant by adjusting the field rheostat, provided the load variations are not too frequent and too great.

Shunt generators are, therefore, not adapted to heavy power work but they may be used for incandescent lighting or other constant potential devices where the load variations are not too severe.

Shunt generators are difficult to operate in parallel because they don't divide the load equally between them. Due to these disadvantages shunt generators are very seldom installed in new plants nowadays, as compound generators are much more satisfactory for most purposes.

Fig. 33 shows a voltage curve for a shunt generator and illustrates the manner in which the voltage of these machines varies inversely with the load. You will note that at no load the voltage of the

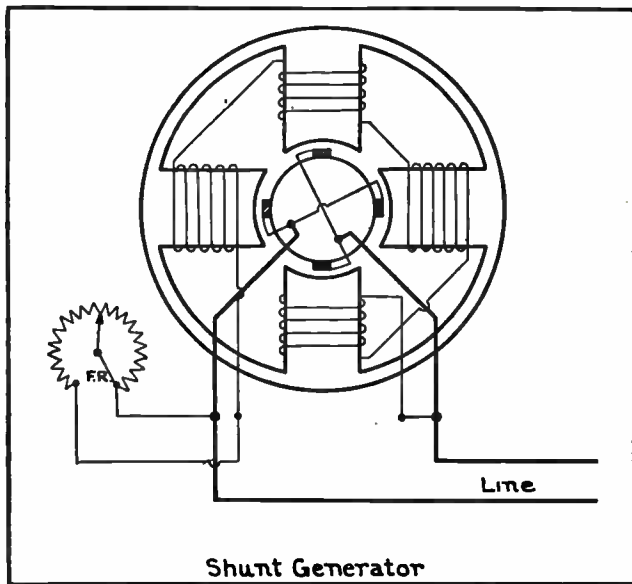

Fig. 32. This sketch shows the wiring and connections of the brushes and field coils for a four-pole, shunt generator.

generator is normal or maximum, while as the load in kilowatts increases the generator voltage gradually falls off to a lower and lower value.

### 24. SERIES GENERATORS

These machines have their field coils connected in series with the armature and the load, as shown in Fig. 34. The field winding is usually made of very heavy wire or strip copper, so that it will carry the full load current without overheating.

By referring to Fig. 34 we can see that with no load connected to the line, it would be impossible for any current to flow through the series field and therefore the generator couldn't build up voltage. So, in order for a series generator to build

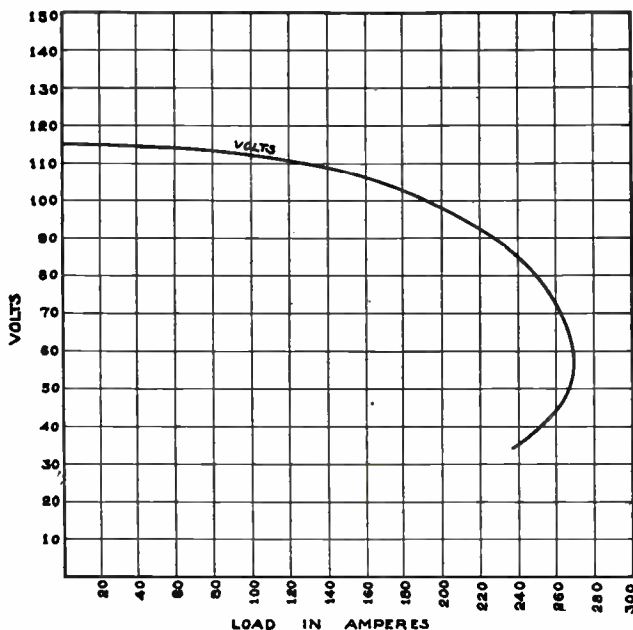

Fig. 33. This curve illustrates the voltage characteristic of a shunt generator. Note how the voltage drops as the load in kilowatts is increased. Full load in this case is 240 amperes.

up voltage when it is started, we must have some load connected to the line circuit.

### 25. VOLTAGE CHARACTERISTIC OF SERIES GENERATORS

The greater the load connected to such a generator, the heavier will be the current flowing through the field winding and the stronger the field flux. This causes the voltage of a series generator to vary directly with the load; or to increase as the load is increased and decrease as the load decreases. This, you will note, is exactly the opposite characteristic to that of a shunt generator.

As most electrical equipment is to be operated on constant voltage and is connected to the line in parallel, series generators are not used for ordinary power purposes or for incandescent lighting. Their principal use has been in connection with series arc lights for street lighting and a number of series generators are still used for this purpose.

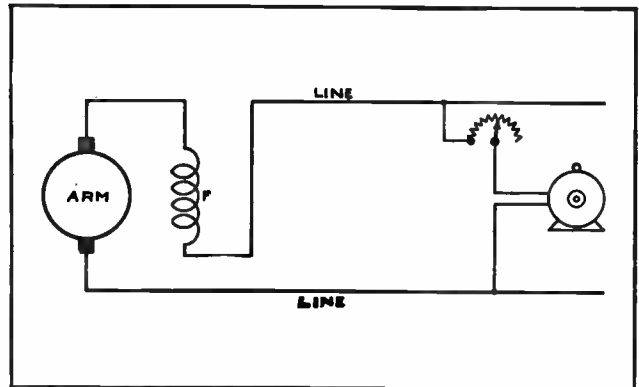

Fig. 34. This sketch shows the connections of a series generator. The series field at "F" is connected in series with the armature and the line. Note that no current could flow through this field if there was no load connected to the line.

With a load of this kind, the current must always remain at the same value for the series lamps and, therefore, the generator field and voltage will remain fairly constant. You can readily see that a series generator would be entirely impractical for ordinary power and light circuits, because, if the load is decreased by disconnecting some of the devices, the voltage on the rest will drop way below normal.

### 26. SERIES FIELD SHUNTS

Fig. 35 shows a curve illustrating the voltage regulation of a series generator. The voltage of such machines can be adjusted by the use of a low-resistance shunt connected in parallel with the series field coils, as shown in Fig. 36. This figure shows the connections of a series generator as they would appear on the machine. By tracing the circuit you will find that the field coils are connected in series with the armature and load.

The purpose of the shunt is to divide the load current, allowing part of it to flow through the series field and the rest through the shunt. By varying the resistance of this shunt, we can cause

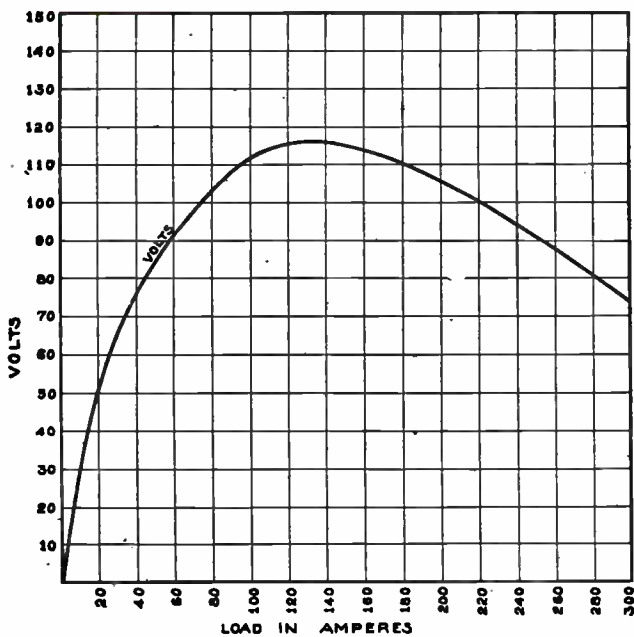

Fig. 35. This curve shows the voltage characteristic of a series generator. Note that the voltage increases rapidly as the load on the machine is increased up to about full load. Full load in this case is 125 amperes.

more or less of the total load current to flow through it, thus either weakening or strengthening the series field.

These shunts are generally made of very low resistance material, such as copper ribbon or strips of metal alloy with higher resistance than copper, in order to make them short in length and compact in size.

By referring again to the curve in Fig. 35, you can see that the voltage regulation of a series generator is also very poor.

### 27. COMPOUND GENERATORS

The fields of a compound generator are composed of both shunt and series windings, the two separate

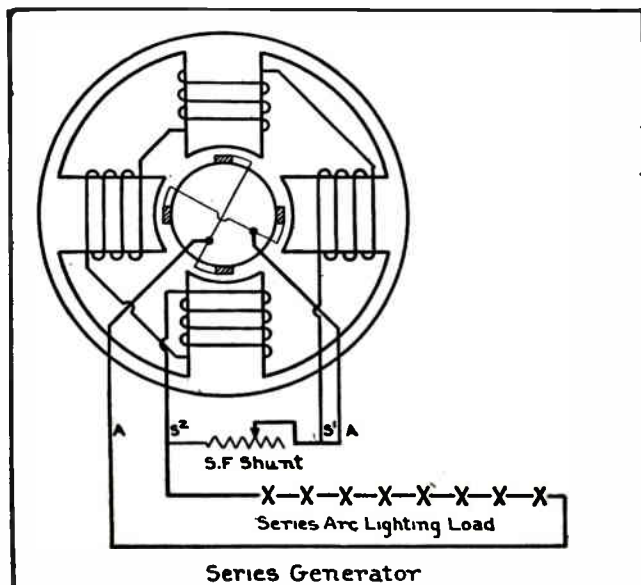

Fig. 36. Connections of brushes and field coils of a four-pole, series generator.

coils being placed on each pole. Fig. 37 shows the connections of both the series and shunt fields of a compound generator.

The shunt field is connected in parallel with the armature and therefore it maintains a fairly constant strength. The series field, being in series with the armature and load, will have its strength varied as the load varies. These machines will therefore have some of the characteristics of both shunt and series generators.

We have found that the shunt generator tends to decrease its voltage as the load increases and that the series generator increases its voltage with increases of load. Therefore, by designing a compound generator with the proper proportions of shunt and series fields, we can build a machine that will maintain almost constant voltage with any reasonable variations in load.

The shunt field winding of a compound generator is usually the main winding and produces by far the greater portion of the field flux. The series field windings usually consist of just a few turns, or enough to strengthen the field to compensate for the voltage drop in the armature and brushes as the load increases.

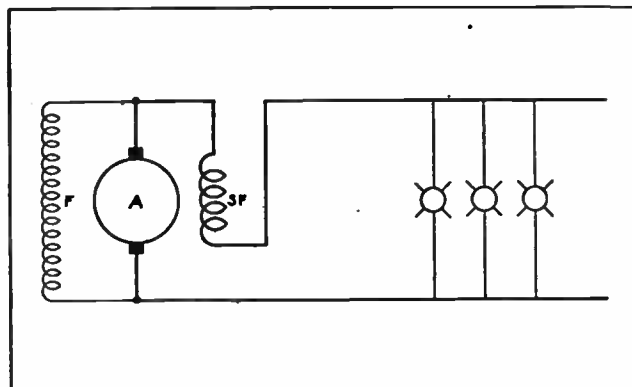

Fig. 37. This sketch shows the connections of a compound generator. The shunt field is connected across the brushes. The series field is connected in series with the line.

Compound generators can have the shunt field strength adjusted by a rheostat in series with the winding, and may also have a shunt in parallel with the series field for its adjustment. The series field shunt on these machines, however, is not generally used for making frequent adjustments in their voltage, but is intended for establishing the proper adjustment between the series and shunt field strengths when the generators are placed in operation.

The variation in the strength of the series field, which compensates for the voltage drop with varying load, makes it unnecessary to use the field rheostat with these machines, as is done with shunt generators.

Fig. 38 shows the complete connections for the armature and fields of a compound generator. You will note that the series winding is composed of just a few turns of very heavy wire on each pole and is in series with the armature and line. The

shunt winding is composed of a far greater number of turns of small wire and is connected in parallel with the armature brushes.

By referring back to Fig. 12, you will note the series coils wound on the poles over or outside of the shunt winding, which is wound next to the pole cores.

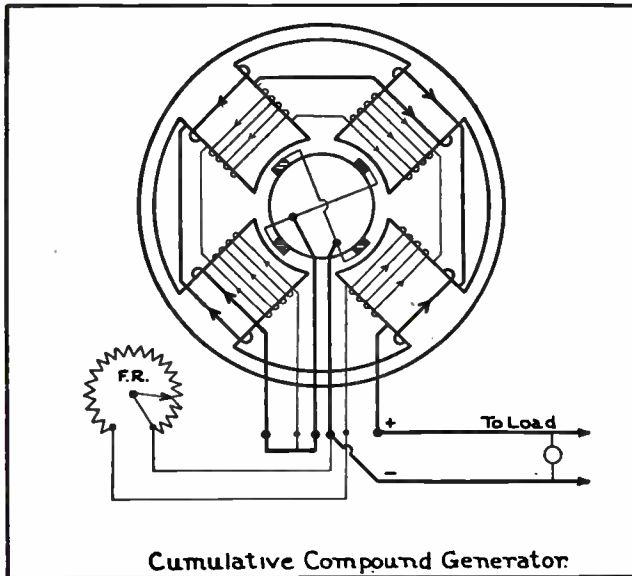

Fig. 38. Connections of brushes and field coils for a four-pole, cumulative compound generator. Note that the direction of current through the series field winding is the same as that through the shunt coils.

### 28. CUMULATIVE AND DIFFERENTIAL COMPOUND GENERATORS

In the type of compound generator which we have just described the series coils are wound in the same direction as the shunt coils, so their flux will aid and strengthen that of the shunt field. They are therefore known as Cumulative Compound machines. This name comes from the fact that the two windings both work together, or add their fluxes, to build up the total cumulative field.

Some compound generators have the series fields wound in the opposite direction, so that their flux opposes that of the shunt field. Such machines are known as Differential Compound generators. Their uses will be explained later.

### 29. FLAT COMPOUND GENERATORS. VOLTAGE CHARACTERISTICS

When a compound generator has just enough of series field to compensate for the voltage drop in its own armature and brushes, and to maintain a nearly constant voltage from no load to full load on the generator, it is known as a Flat Compound machine.

The voltage regulation of such a machine is very good, as it automatically maintains almost constant voltage with all normal load variations. Such machines are very commonly used for supplying current to general power and light circuits where

the load is not located too far from the generator and the line drop is small. Fig. 39 shows the voltage curve of a flat compound generator at F.

### 30. OVER COMPOUND GENERATORS. VOLTAGE CHARACTERISTICS

Where the load is located some distance from the generator or power plant and the line drop is sufficient to cause considerable reduction of voltage at the current-consuming devices when the load is heavy, the generators are commonly equipped with series field windings large enough to compensate for this line drop as well as their own armature and brush voltage drop. Such machines are called Over Compound generators and are by far the most common type used in power work.

The voltage of an over compound generator will increase slightly at the generator terminals with every increase of load. These voltage increases are due to the greater number of turns in the series field winding. Every increase of load increases the current through these series turns, thereby strengthening the field enough to actually raise the voltage a little higher at full load than at no load.

This voltage increase at the generator terminals makes up for the additional voltage drop in the line when the load is increased. Therefore, if the series and shunt fields of such a machine are properly adjusted, it will maintain a very constant voltage on the equipment at the end of the line.

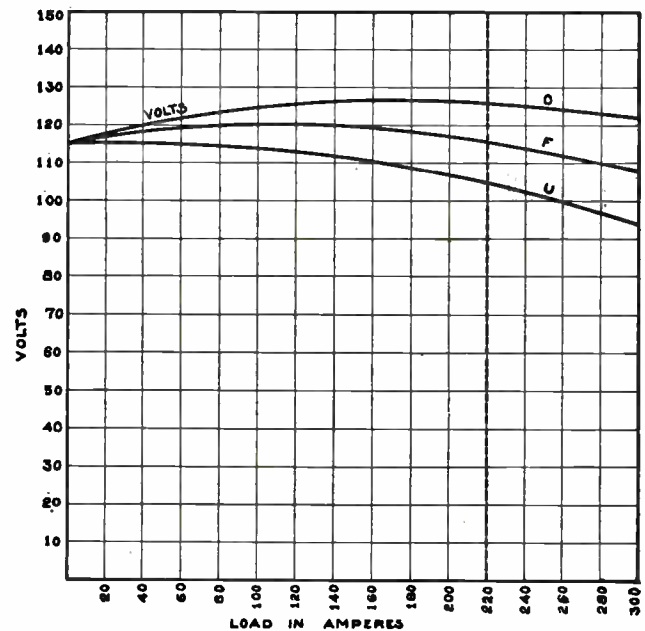

Fig. 39. These curves show the voltage characteristic of a flat compound generator at F, over compound at O, and under compound at U. Full load in this case is 220 amperes.

The adjustment of the shunt and series fields of these machines can be made with the usual shunt field rheostat and series field shunts.

The voltage regulation of an over compound generator is very good, and for ordinary power

purposes they don't require frequent adjustment of the rheostat or any special voltage regulating equipment, because this regulation is inherent in the design and operation of the machine. Over compound generators are usually made and adjusted so that the terminal voltage will be from 4½% to 6% higher at full load than at no load.

### 31. DIFFERENTIAL COMPOUND GENERATORS

Any compound generator can be connected either cumulative or differential, by simply reversing the connections of the series field windings so that these coils will either aid or oppose the flux of the shunt field.

Compound generators are usually designed to operate cumulative unless otherwise ordered for special purposes.

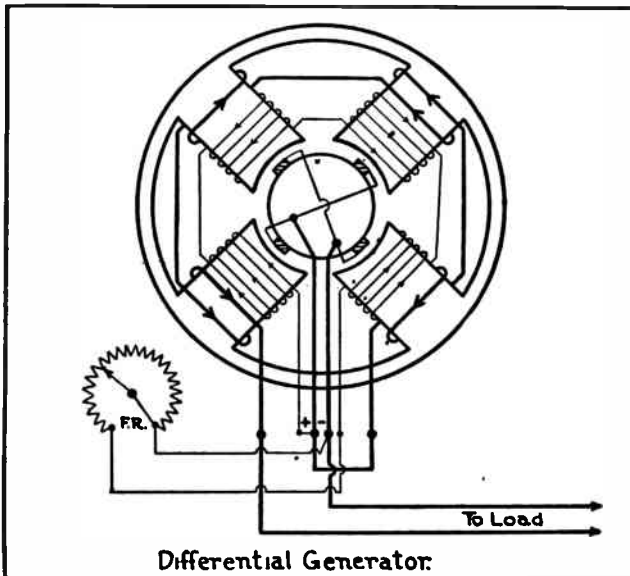

Fig. 40. Connections of brushes and field coils for a four-pole, differential, compound generator. Note that the direction of current through the series field coils is opposite to that in the shunt coils.

When the series field coils are connected differential, and so that their flux opposes that of the shunt field, each increase in the load on the machine will cause quite a decided voltage drop, as it increases the current in the differential winding and thereby weakens the field flux.

The voltage of these machines, therefore, will vary inversely with the load and considerably more than it varies with the shunt generator. The voltage regulation of differential compound generators may be classed as very poor, but they have advantages in certain classes of work.

For the generators used in welding, where sudden and severe overloads are placed on the machine in starting the arcs, or for any machines that have frequent severe overloads or the possibility of short

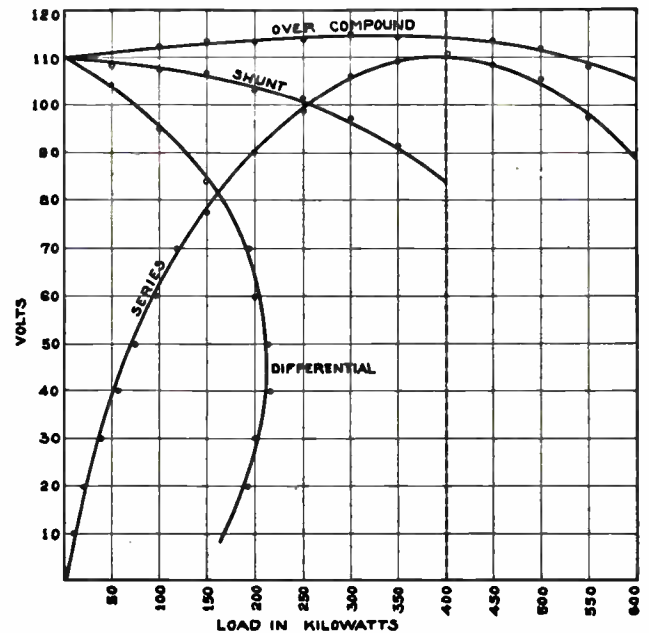

Fig. 41. This chart shows the curves of several types of generators all together so they can be easily compared.

circuits, the differential compound winding is a good protective feature.

When an overload is placed on the line, the additional current in the differential series coils tends to neutralize the shunt field flux and thereby reduces the generator voltage considerably. This also reduces the amount of current which will flow through the armature, and therefore protects it from overheating.

The shunt field winding of the differential generator should be the main field winding and determine the polarity of the pole. The series field should at no time determine the polarity of the poles, unless the shunt field circuit is open or except in case of a short circuit across the brushes.

Fig. 40 shows the connections of a differential compound generator. Note that the current flows in opposite directions in the shunt and series windings around the field poles.

Fig. 41 shows the curves for the several types of generators just described and provides a good opportunity to compare the voltage characteristics of shunt, series, and compound generators. Note how rapidly the voltage of the differential machine falls off as the kilowatt load increases.

It will be well to keep in mind the different voltage characteristics of these machines and the principles by which their voltage regulation is obtained, because you will encounter all types in various plants in the field. Therefore a knowledge of their field connections and adjustment, and the proper methods by which these connections can be changed to obtain different characteristics, will often be very valuable to you.

## OPERATION OF D. C. GENERATORS

In commencing the study of the operation of generators, it will be well to first consider prime movers, or the device, used to drive the generators.

The term Prime Mover may apply to any form of mechanical power device, such as a steam engine, steam turbine, gas or oil engine, or water wheel. These devices, when used to drive electric generators, are designed to operate at a constant speed at all loads up to full load. They are usually equipped with governors which maintain this constant speed by allowing the correct amount of power in the form of steam, gas, or water to enter the prime mover, according to the variations of current load on the generator.

The prime mover should always be large enough to drive the generator when it is fully loaded, without any reduction in speed which would be noticeable in the generator voltage output.

It is not our purpose in this Electrical Reference Set to discuss in detail the design or operation of prime movers, although in a later section they will be covered to a greater extent with regard to their operation.

### 32. CALCULATION OF PROPER H.P. FOR PRIME MOVERS

To determine the proper size of engine or prime mover to drive a D.C. generator of a given rating in kilowatts, we can easily calculate the horse power by multiplying the number of kilowatts by 1.34.

You will recall that one h. p. is equal to 746 watts, and one kilowatt, or one thousand watts, is equal to 1.34 h. p.

Multiplying the kilowatt rating of the generator by 1.34 gives the horse power output of the machine. This horse power output can also be determined by the formula:

$$\text{H. P.} = \frac{E \times I}{746}$$

In which:

$E$  = the generator voltage

$I$  = the maximum current load rating

746 = the number of watts in one h. p.

In addition to the electrical horse power output of the generator, we must also consider its efficiency, or the loss which takes place in its windings and bearings.

If the efficiency of a generator is known to be 80%, the formula to determine the horse power required to drive it will be as follows:

$$\text{H. P.} = \frac{E \times I}{e \times 746}$$

In which:

$e$  = the efficiency of the generator, expressed decimally.

We should also allow a certain amount for any overload that the generator is expected to carry. A

convenient rule for determining the approximate horse power required to drive any generator, is to multiply the kilowatt rating of the machine by 1.5, which will usually allow enough extra power to make up for the loss in the generator.

For example, if we have a generator which is rated at 250 volts and 400 amperes, and this machine has an efficiency of 90%, we can determine the necessary horse power by the formula, as follows:

$$\text{H. P.} = \frac{250 \times 400}{.90 \times 746}, \text{ or } 148.94 \text{ h. p.}$$

The kilowatt rating of this same generator would be 100 KW, as can be proven by multiplying the volts by the amperes. So, if we simply multiply  $100 \times 1.5$ , according to our approximate rule, we find that 150 h. p. will be required. This is approximately the same figure as obtained by the use of the other formula.

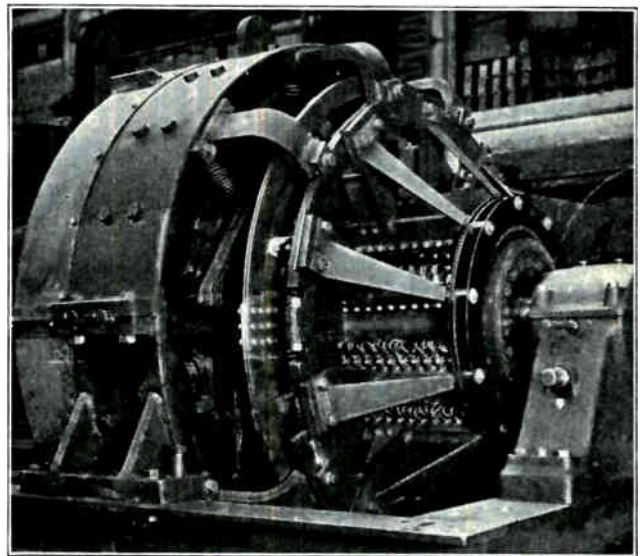

Fig. 41-A. This photo shows a large modern D. C. generator with a welded frame. The capacity of this generator is 1000 KW. What horse power will be required to drive it and satisfactorily maintain the speed when the generator is 10% overloaded? Assume the efficiency of the generator to be 93%.

If the generator has less than 90% efficiency and if it is known that the load will be up to the full capacity of the generator at practically all times, and occasionally a little overload, then it is better to allow slightly greater horse power than in the problem just given.

Prime movers for the operation of generators should be equipped with governors which are quick enough in their response so that they do not allow the generator to slow up noticeably when additional load is applied.

There is generally some adjustment provided on these governors which can be used to set the prime mover to run the generator at the proper speed to maintain the proper voltage.



As the voltage of the generator depends upon its speed, we should keep in mind that its voltage can be adjusted by adjusting the governors or throttle of the prime mover.

### 33. INSPECTION BEFORE STARTING GENERATORS

When starting up a generator we should first make a thorough examination, to make sure that the prime mover and generator are both in proper running order. The oil wells should be examined to see that there is sufficient oil in all main bearings and that the oil rings are free to turn. Be careful, however, not to flood oil wells, because excess oil allowed to get into the windings of the generator is very damaging to the insulation, and may necessitate rewinding the machine.

On small and medium-sized machines only a little oil need be added from time to time, unless the oil wells leak. On large machines, where the armature is very heavy, forced lubrication is necessary to maintain the film of oil between the shaft and bearings. With these machines an oil pump is used to force oil to the bearings at a pressure of 20 to 30 lbs. per square inch to insure proper lubrication. Some bearings are also water cooled, having openings through the metal around the bearing for water to flow through and carry away excessive heat.

If there are auxiliaries of this kind, they should be carefully examined and checked before running the machine.

### 34. STARTING GENERATORS

Before starting up a generator it is usually best to see that the machine is entirely disconnected from the switchboard. This is not always necessary, but it is safest practice. Next start the prime mover and allow the generator armature to come gradually up to full speed. Never apply the power jerkily or irregularly.

Power generators are always rotated at their full speed when operating under load. When the machine is up to full speed the voltage can be adjusted by means of the field rheostat which is connected in series with the shunt field.

The machine voltage can be checked by means of the switchboard voltmeter, and it should be brought up to full operating voltage before any switches are closed to place load on the generator.

After the voltage is adjusted properly, the machine may be connected to the switchboard by means of the circuit breakers and switches. Where circuit breakers are used they should always be closed first, as they are overload devices and should be free to drop out in the event there is an overload or short circuit on the line.

After closing the circuit breaker the machine switch may be closed, completing the connection of the generator to the switchboard. As the switch is closed the operator should watch the ammeter and voltmeter to see that the load is normal and to

make any further necessary adjustments with the field rheostat.

If the generator is operating in parallel with others, the ammeter will indicate whether or not it is carrying its proper share of the load. The load on any generator should be frequently checked by means of an ammeter or wattmeter to see that the machine is not overloaded.

The temperature of the machine windings and bearings should also be frequently observed in order to check any overheating before it becomes serious.

### 35. CARE OF GENERATORS DURING OPERATION

After the machine is running, the most important observations to be made frequently are to check the bearing oil and temperature, winding temperatures and ventilation, voltage of the machine as indicated by the volt meter, and the load in amperes shown by the ammeter. Commutator and brushes should also be observed to see that no unusual sparking or heating is occurring there.

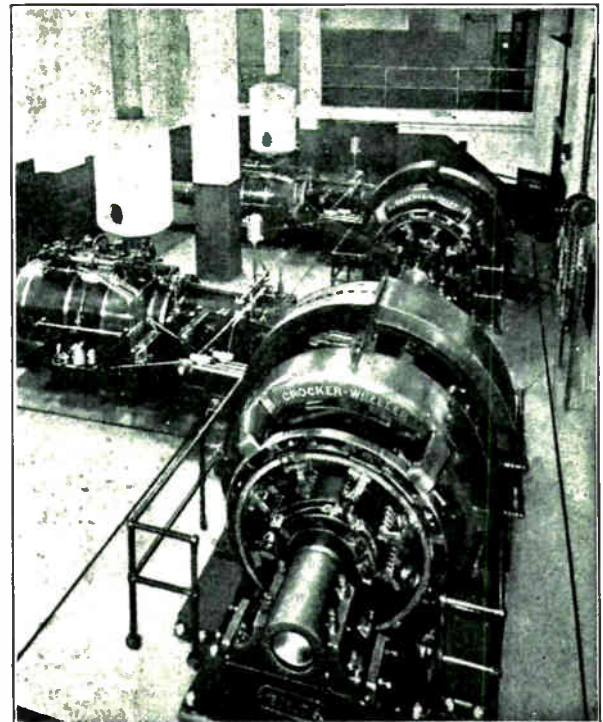

Fig. 41-B. This view shows two engine-driven D. C. generators in a power plant. Two or more machines of this type are commonly operated in parallel.

Commutators should be kept clean and free from dirt, oil, or grease at all times. Brushes should be kept properly fitted and renewed when necessary, and the commutator surface kept smooth and even for the best results.

All parts of an electric generator should be kept clean at all times as dust and oil tend to clog the ventilating spaces in the windings, destroying the value of the insulation, and also interfering with proper commutation.

The supply of ventilating air in the generator room should be frequently checked to see that it is

not restricted, and that the temperature of the armature is not allowed to become too high. Moisture is very detrimental to the generator windings and water in or around the generator is very dangerous, unless confined in the proper pipes for such purposes as cooling bearings, etc. Never use water to extinguish fire on any electrical equipment.

### 36. PARALLELING D. C. GENERATORS

Where direct current is used in large quantities the power is usually furnished by several generators operating in parallel, rather than by one or two very large machines. The larger machines when operated at full load, are, of course, more efficient than smaller ones, but the use of several machines increases the flexibility and economy of operation in several ways.

If only one large generator is used and the load is small during a considerable part of the time, it is then necessary to operate the machine partly loaded. The efficiency of any generator is generally less when operating at less than full load, as they are designed to operate at highest efficiency when they are fully loaded or nearly so.

When several machines are used, the required number can be kept in operation to carry the existing load at any time. Then if the load is increased additional machines may be put in operation, or if it is decreased one or more machines may be shut down.

In a plant of this kind if any generator develops trouble it can be taken out of service for repairs, and its load carried by the remaining machines for a short period, if it doesn't overload them more than the amount for which they are designed.

### 37. IMPORTANT RULES FOR PARALLEL OPERATION

As we learned in the previous section on series and parallel circuits, when generators are connected in parallel their voltages will be the same as that of one machine. The current capacity of the number of generators in parallel, however, will be equal to the capacity of all of them, or the sum of their rated capacities in amperes.

To operate generators in parallel, their voltages must be equal and their polarities must be alike.

The positive leads of all machines must connect to the positive bus bar and the negative leads of all machines must connect to the negative bus bar. This is illustrated by the sketch in Fig. 42, which shows two D. C. generators arranged for parallel operation. You will note that if the switches are closed the positive brushes of both machines will connect to the positive bus bar, and the negative brushes are both connected to the negative bus bar.

The voltmeters connected to each machine can be used to check the voltage as the machine is brought up to speed, in order to be sure that it is equal to the voltage of the other machine which may already be running and connected to the bus. If the voltages are unequal to any great extent, the machine of

higher voltage will force current backward through the one of lower voltage and tend to operate it as a motor.

It is, therefore, very important that the voltage be carefully checked before closing the switch which connects a generator in parallel with others.

If the polarity of one machine were reversed, then when they are connected together it would result in a dead short circuit with double voltage or the voltage of both machines applied in series.

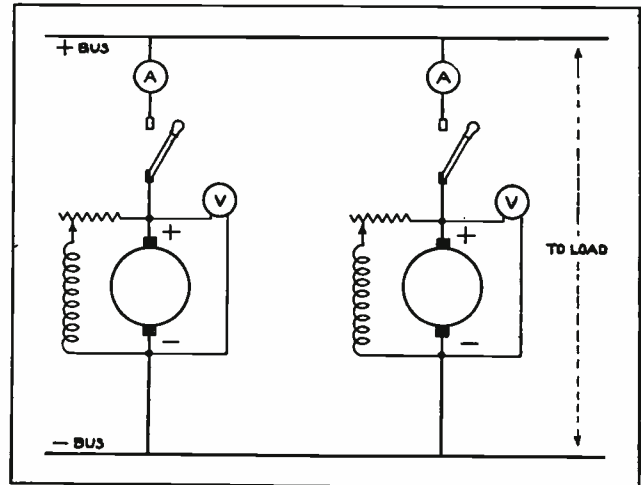

Fig. 42. This simple sketch shows a method of connecting two D. C. generators in parallel. Note the polarity of the generator brushes and bus bars.

Just try making a sketch similar to Fig. 42 and reverse the polarity of one generator and see what would happen. You will find that the positive of one machine feeds directly into the negative of the other, and so on around a complete short circuit.

The resistance of the machine windings, bus bars, ammeters and connections is so low that an enormous current would flow, until circuit breakers or fuses opened the circuit. If no such protective devices were provided, the windings would be burned out or possibly even thrown out of the slots, by the enormous magnetic stresses set up by the severe short circuit currents.

You can readily see that in such matters as these your training on electrical principles and circuits becomes of the greatest importance, as you should at all times know the results of your movements and operations in a power plant, and know the proper methods and precautions to follow.

### 38. CORRECTING WRONG POLARITY

If the polarity of a generator should build up wrong, or in the reverse direction, it will be indicated by the voltmeter reading in the wrong direction, and these meters should always be carefully observed when starting up machines.

Sometimes the generator will build up wrong polarity because its residual magnetism has reversed while the machine was shut down. Sometimes stopping and starting the machine again will bring it up in the right polarity if some load is connected on the circuit. If it doesn't, the polarity can be corrected by momentarily applying a low voltage

source of direct current to the field coils and sending current through them in the proper direction.

In power plants where several D. C. generators are used, they are generally arranged so their fields can be connected to the bus bars, assuring proper excitation and polarity.

### 39. COMPOUND MACHINES BEST FOR GENERAL SERVICE

Shunt wound generators will operate quite satisfactorily in parallel on constant loads if their voltages are kept carefully adjusted to keep the load divided properly between them. If the voltage of one machine is allowed to rise or fall considerably above or below that of the others, it will cause the machine of lower voltage to motorize and draw excessive reverse current, and trip open the circuit breakers.

If the voltage of one machine falls only a little below that of the others, the back current may not be sufficient to open the breakers, but would be indicated by the ammeter of this machine reading in the reverse direction.

Shunt generators are not very often used in large power plants, because of their very poor voltage regulation and the considerable drop in their voltage when a heavy load is applied. A plain shunt generator can usually be changed for compound operation by simply adding a few turns of heavy wire around the field poles, and connecting them in series with the armature, with the right polarity to aid the shunt field flux.

The compound generator is best suited to most loads and circuits for power and lighting service and is the type generally used where machines are operated in parallel in D. C. power plants.

Series generators are not operated in parallel and in fact they are very little used, except for welders, test work or in older street lighting installations.

### 40. SIMILAR VOLTAGE CHARACTERISTICS NECESSARY FOR PARALLEL OPERATION

Compound generators can be readily paralleled if they are of the same design and voltage. They usually have similar electrical and voltage characteristics and should be made with the same compounding ratios. That is, the compounding effects of the machines must be equal even though they are of unequal size.

Machines of different kilowatt ratings can be satisfactorily operated in parallel, if they are made by the same manufacturer or of the same general design, so that each will tend to carry its own share of the load. If their compounding is properly proportioned, the voltage rise of each generator should be the same for a similar increase of load.

When a D. C. generator is operated in parallel with others and its voltage is increased, it will immediately start to carry a greater share of the current load. We can, therefore, adjust the load on the various machines by increasing or decreasing their voltages the proper amount.

### 41. TESTING AND ADJUSTING COMPOUNDING OF GENERATORS

The compounding effects of different generators can be tested or compared by separately loading in increasing amounts and observing their voltmeters. This can be done by connecting one of the machines to the switchboard, or to a special loading rheostat, and operating the machine under normal voltage. Then apply a certain amount of load to it and observe the voltmeter closely, to note the amount of increase in the voltage due to the compounding effect.

It will probably be well to check the voltage increase as the load is changed from one-fourth to one-half, and then to three-fourths and full load values. By testing each generator in this manner we can determine which of them has the greatest overcompounding effect, or produces the highest increase in voltage for the various increases in load.

If this compounding is found to be different on the various machines, it can be adjusted by means of the series field shunt, which will allow more or less of the total load current to flow through the series winding of the compound field.

When a number of machines of similar design are thus properly adjusted they should operate satisfactorily in parallel under all normal load changes.

In case the machines do not properly divide their loads and one is found to be taking more than its share of any load increases, this can be corrected by very slightly increasing the resistance of its series field circuit by adding a few feet of cable in the series field connection.

The series field windings may be connected to

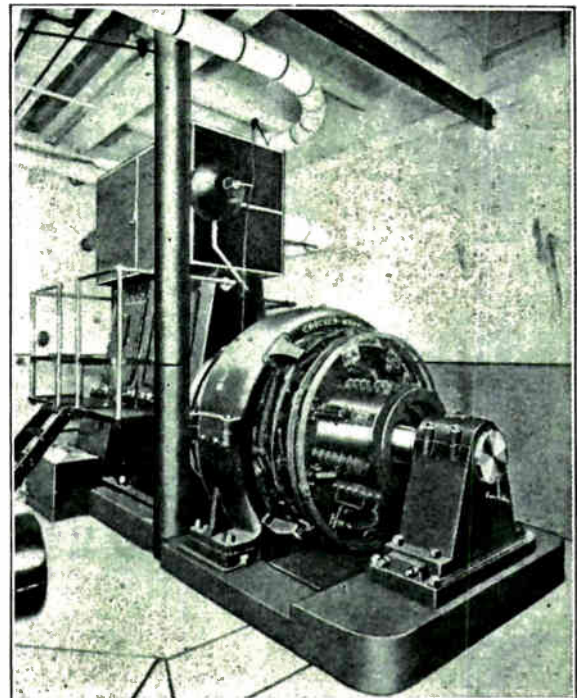

Fig. 42-A. Large D. C. generator driven by a vertical engine. If this machine is rated at 250 volts and 3000 amperes, what is its capacity and KW?

either the positive or negative brush leads of the armature; but, where compound generators are operated in parallel, the series field lead of each machine must be connected to the same armature lead, either positive or negative, on all generators.

#### 42. EQUALIZER CONNECTIONS

When compound generators are operated in parallel, an equalizer connection should be used to equalize the proportion of currents through their series fields and to balance their compounding effects.

This equalizer connection, or bus, is attached to the end of the series field next to the armature. Its purpose is to connect the series fields of all generators directly in parallel by a short path of very low resistance, and to allow the load to divide properly between them. When this connection is properly made the current load will divide between the series fields of the several machines in proportion to their capacity.

The equalizer allows the total load current to divide through all series fields in inverse proportion to their resistance, independently of the load on the armature of the machine and of the armature resistance and voltage drop. This causes an increase of voltage on one machine to build up the voltage of the others at the same time, so that no one machine can take all the increased load.

The connecting cables or busses used for equalizer connections between compound generators should be of very low resistance and also of equal resistance. This also applies to the series field connections from the generators to the main buss, if the machines are of the same size.

If the machines are located at different distances from the switchboard, bus cables of slightly different size can be used, or an additional low resistance unit can be inserted in the lower resistance leads.

Whenever possible, leads of equal length should be used; and, in the case of cables, it is sometimes advisable to loop them or have several turns in the cable to make up the proper length. If these cables or busses were of unequal resistance on machines of the same size, there would be an unequal division of the load through the machines, and the machine having the lowest resistance would take more than its share of the load.

When machines of unequal size are to be paralleled, the resistance of the series field leads should be in proportion to the resistance of the series field windings.

Fig. 43 shows a wiring diagram for two compound generators to be operated in parallel. Note the series and shunt field windings, and also the series field shunts and shunt field rheostat. The equalizer connections are shown properly made at the point between the series field lead and the negative brush. From this point they are attached to the equalizer bus on the switchboard. The voltmeters are connected directly across ammeter shunts which are in series with the positive leads of each machine. These shunts will be explained later.

The machine switches for connecting the generators to the bus bars are also shown in this diagram; but the circuit breakers, which would be connected in series with these switches, are not shown.

#### 43. LOCATION OF EQUALIZER SWITCHES

On machines of small or medium sizes and up to about 1,000 ampere capacity, the equalizer switch is often the center pole of the three-pole switch, as shown in Fig. 43.

The two outside switch blades are in the positive and negative leads of the machine. For machines requiring larger switches, three separate single-pole switches may be used for greater ease of operation. In this case the center one is usually the equalizer switch.

It is quite common practice to mount all of these switches on the switchboard, although in some installations the equalizer switch is mounted on a pedestal near the generator. In this case, the equalizer cable or bus is not taken to the switchboard but is run directly between the two machines.

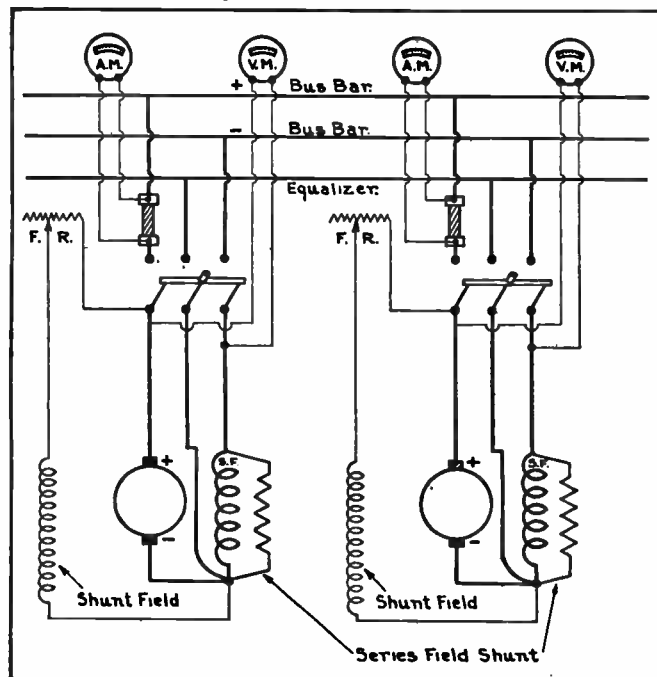

Fig. 43. This diagram shows the connections for two compound D. C. generators to be operated in parallel. Note carefully the connections of the equalizer leads, series and shunt fields and instruments.

Regardless of the location of the equalizer switches, they should be closed at the same time or before the positive and negative machine switches are closed.

Where three-pole switches are used, all of the poles are, of course, closed at the same time; but, if three single-pole switches are used, the equalizer should be closed first. If the positive and negative switches are closed one at a time, the switch on the same side of the armature from which the equalizer connection is taken should be closed second.

The series field should always be paralleled before

or at the same instant that the generator armature is paralleled with the main bus, in order to insure equalization of the compounding effects and to allow the machine to take its proper share of the load at once.

#### 44. INSTRUMENT CONNECTIONS WITH PARALLEL GENERATORS

Current instruments and devices—such as ammeters, overload coils on circuit breakers, current coils of wattmeters, etc.—should always be connected in the armature lead which doesn't contain the series field winding. This is shown by the ammeter shunts in Fig. 43, which are properly connected in the positive lead.

If these devices are connected in the lead which has the series field in it, the current indications will not be accurate, because current from this side of the machine can divide and flow through either the equalizer bus or the armature.

Ammeters and other current devices should indicate the amount of current through the armature of the machine. It is not necessary to measure the current through the series fields, since they are all in parallel with each other.

The voltage generated in the armature will determine the amount of current which is carried through it, and it is possible to control the armature voltage of any machine by the adjustment of the shunt field rheostat and thus vary the load carried by each generator.

Voltmeters should be connected, as shown in Fig. 43, at a point between the generator brushes and

the main switch, so that the voltage readings can be obtained before this switch is closed. This is necessary because we must know the voltage of the generator before it is connected in parallel with the others.

#### 45. STARTING, PARALLELING and ADJUSTING LOAD ON GENERATORS

In starting up a generator plant with several machines, the first generator can be started by the procedure previously described and connected to the bus as soon as its voltage is normal. The second generator should then be brought up to speed and its voltage then carefully checked and adjusted to be equal to that of the first machine. Then this second machine can be connected to the bus. The ammeters of both machines should then be read to see that they are dividing the load equally or in proportion to their sizes.

By adjusting the voltage of any generator with its field rheostat, it can be made to take its proper share of the load. After this adjustment is made, the same procedure can be followed on the remaining machines. If there are a number of branch circuits and switchboard panels feeding to the lines and load, the switches on these panels can be closed one at a time, applying the loads to the generators gradually.

To shut down any machine, adjust its shunt field rheostat to cut in resistance and weaken its field, lowering the voltage of that generator until its ammeter shows that it has dropped practically all of its load. The circuit breaker can then be opened and the machine shut down.

## THREE-WIRE D. C. SYSTEMS

The Edison three-wire D. C. system is used chiefly where the generating equipment is to supply energy for both power and lighting. The advantages of this system are that it supplies 110 volts for lights and 220 volts for motors and also saves considerably in the amounts and cost of copper, by the use of the higher voltage and balancing of the lighting circuits.

Some of these features of 3-wire systems were also explained in Section 2, on Electrical Wiring.

One of the most simple and common methods of obtaining the two voltages on three-wire circuits is by connecting two 110-volt generators in series, as shown in Fig. 44.

We know that when generators are connected in series in this manner their voltages add together, so these two 110-volt machines will produce 220 volts between the outside or positive and negative wires. The third, or neutral, wire is connected to the point between the two generators where the positive of one and negative of the other are connected together. The voltage between the neutral wire and either outside wire will be 110 volts, or the voltage of one machine.

Generators for this purpose may be either shunt or compound, but the compound machines are more generally used. They can be driven by separate

prime movers or both driven by the same prime mover if desired; and the drive may be either by belt or direct coupling.

In general the operation of a three-wire system is practically the same as for a two-wire machine. The voltage of each generator may be adjusted by means of the shunt field rheostat.

As these machines are operated in series instead of parallel, it is not necessary to have their voltage exactly even; but they should be kept properly adjusted in order to maintain balanced voltages on the two sides of the three-wire system.

There is no division of the current load between these generators—as in the case of parallel machines—as the main current flows through both machines in series. When the voltage of both machines is properly adjusted, they can be connected to the switchboard busses. The ammeters should then be observed to note the current in each wire.

#### 46. DIRECTION AND AMOUNT OF CURRENT IN THE NEUTRAL WIRE

The ammeter in the neutral wire is of the double-reading type, with the zero mark in the center of the scale, and it will read the amount of current flowing in either direction.

When the load on a three-wire system is perfectly

balanced, the neutral wire will carry no current and the set operates on 220 volts. In this case the two outside ammeters will read the same and the center ammeter will read zero. When there is an unequal amount of load in watts on each side of the system it is said to be unbalanced, and the neutral wire will carry current equal to the difference between the current required by the load on one side and that on the other.

This current may, therefore, flow in either direction, according to which side of the system has the heaviest load. Referring to Fig. 44—if the greater load were on the lower side, the extra current required would be furnished by the lower generator; and the current in the neutral wire would be flowing to the right, or away from the generators. If the heavier load were placed on the upper side of the system, the extra current would be supplied by the upper machine, flowing out on its positive wire and back to the line on the neutral wire.

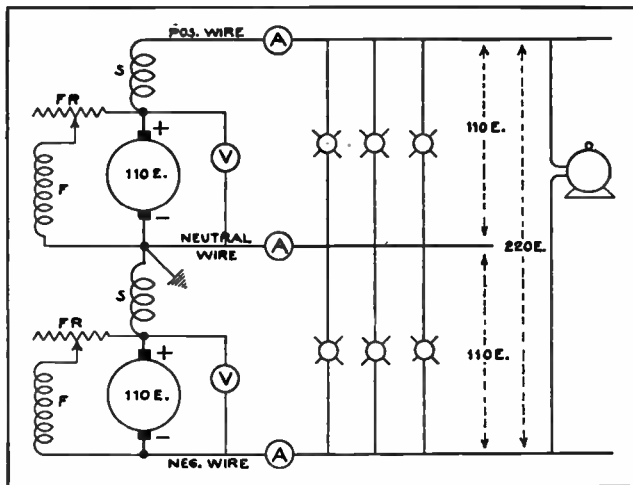

Fig. 44. This sketch shows two D. C. generators connected in series for providing three-wire, 110 and 220 volt service.

#### 47. BALANCED SYSTEM MORE ECONOMICAL

For efficient operation, the amount of unbalance should not exceed 10% of the total load. In many cases, however, it is allowed to exceed 15% or more. If the load could always be kept perfectly balanced, no neutral wire would be required as all of the load devices would be operated two in series on 220 volts.

Without the neutral wire, if one or more of the lamps or devices should be disconnected, the remaining ones on the other side of the system would operate at more than normal voltage. This was thoroughly explained under the heading, "Three-Wire Systems", in Section Two of Electrical Construction and Wiring.

In most systems it is practically impossible to keep the load balanced at all times, and, therefore, the neutral wire is necessary to carry the unbalanced load and keep the voltages equal on both sides of the system. It is very seldom, however, that the neutral wire will have to carry as much current as the outside wires. Therefore, it may be made smaller than the positive and negative wires.

Quite often the neutral wire is made one-half the size of either of the outer wires, unless local rulings require it to be of the same size. If the neutral wire is made one-half the size of the outer ones, a three-wire system of this type will require only 31.3% of the copper required for the same load on a two-wire, 110-volt system.

The neutral wire is generally grounded, as shown in Fig. 44.

#### 48. THREE-WIRE GENERATORS

In some cases a special three-wire generator is used, instead of the two machines in series, to produce a three-wire D. C. system. An early type of three-wire generator, and one which is still used for certain installations, consists of a 220-volt armature equipped with both a commutator and slip rings.

The armature coil connections are made to the commutator in the usual manner, and 220 volts is obtained from the brushes on the commutator. In addition to the leads from each coil to the commutator bars, other leads are taken from points spaced 180° apart around the winding and are connected to a pair of slip rings mounted on the shaft near the end of the commutator. This supplies single-phase alternating current at 220 volts to the slip rings.

From the brushes on these slip rings two leads are taken to opposite ends of a choke coil, which consists of a number of turns of heavy wire wound on an iron core similar to a transformer core. This connection is shown in Fig. 45.

A tap is made at the exact center of this choke coil for the third or neutral wire. In some cases a choke coil is mounted on the armature shaft and rotated with it; but in most cases this coil is stationary and outside of the machine, having its connections made through the slip rings and brushes. These coils are often referred to as three-wire transformers or compensators.

#### 49. PRINCIPLE OF THE BALANCE COIL

The neutral wire, being connected to the center of the coil, is always at a voltage about one-half that between the positive and negative brushes. Therefore, if 220 volts are obtained between these brushes, 110 volts are obtained between either the positive and negative wire and the neutral.

When the load on a three-wire generator of this type is perfectly balanced, no current flows in the neutral wire and all of the load current is supplied from the commutator by the positive and negative D. C. brushes. There is, however, a small amount of alternating current flowing through the choke or balance coil at all times, as there is an alternating voltage applied to it from the slip rings as long as the machine is operating. This current will be very small, as a choke coil of this type offers a very high impedance or opposition to the flow of alternating current.

This impedance, or opposition, is composed of the ohmic resistance of the conductors in the coil, and also of the counter-voltage generated by self-induc-

tion whenever alternating current is passed through such turns of wire wound on an iron core.

Direct current, however, can flow through a coil of this type with only the opposition of the copper resistance, as the flux of direct current is not constantly expanding and contracting like that of alternating current, and so doesn't induce the high counter-voltage of self-induction.

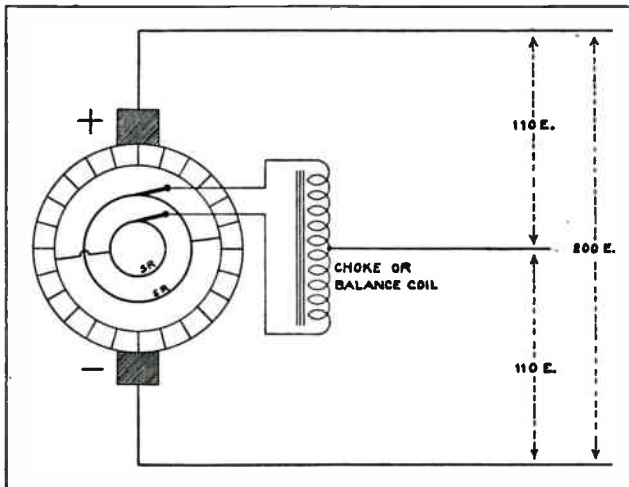

Fig. 45. The above diagram shows the commutator, slip rings, and balance coil of a three-wire D. C. generator.

## 50. UNBALANCED LOAD ON THREE-WIRE GENERATORS

When a system such as that shown in Fig. 45 is unbalanced and has, we will say, a heavier load between the positive wire and neutral, the unbalanced current flowing in the neutral wire will return to the center tap of the choke coil. From this point it will flow first in one direction and then in the other, as the alternating current reverses in direction through the coil. Thus it returns to the armature winding, through first one slip ring and then the other.

If the lower side of the circuit is loaded the heaviest the unbalanced current will flow out through the choke coil in the same manner, passing first through one half and then the other, to reach the neutral wire.

The choke coil must, of course, be wound with wire large enough to carry the maximum unbalanced current that the neutral wire is expected to carry. It must also have a sufficient number of turns to limit the flow of alternating current from the slip rings to a very low value, in order to prevent a large waste of current through this coil.

Three-wire generators of this type can stand considerable unbalanced load without much effect on the voltage regulation. They are very compact and economical and are used to some extent in small isolated D. C. plants, where the circuits carry a load of 110-volt lamps and equipment, and also 220-volt motors.

Fig. 46 shows a three-wire generator on which the slip rings can be seen mounted close to the end of the commutator.

## 51. THREE-WIRE MOTOR GENERATORS OR BALANCER SETS

Three-wire circuits may also be obtained by means of a 220-volt D. C. generator in combination with a motor-generator or balancer set. These balancer sets consist of two 110-volt machines mounted on the same bed plate and directly connected together by their shafts. See Fig. 48. The armatures of both machines are connected in series with each other, and across the positive and negative leads of the 220-volt generator, as shown in Fig. 47.

This allows 110 volts to be applied to each armature and operates both machines as motors when the load is perfectly balanced. Either machine can, however, be operated either as a motor or as a generator, if the load on the system becomes unbalanced.

If one side of the system has a heavier load connected to it, the machine on this side automatically starts to operate as a generator and is driven by the machine on the other side, which then operates as a motor. This condition will immediately reverse if the greater load is placed on the opposite side of the system. A balancer set of this type will, therefore, supply the unbalanced current in either direction, and will maintain 110 volts between the neutral and either outside wire.

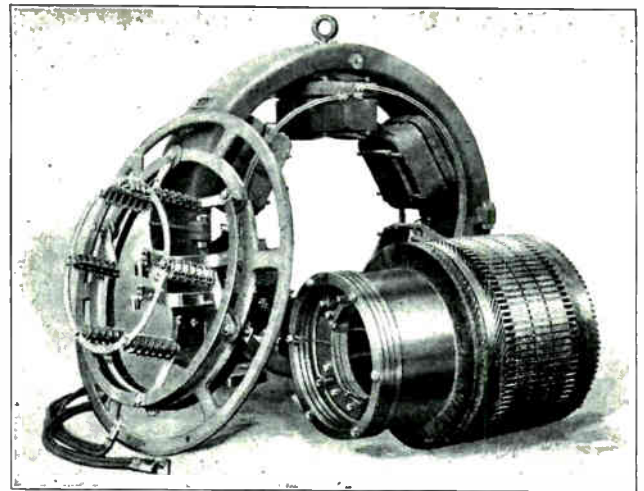

Fig. 45-B. This view shows a three-wire generator disassembled. You will note the slip rings mounted on the end of the commutator.

Where these machines are larger than one or two kilowatts, a starting rheostat should be used to limit the flow of current through their armatures until the machines attain full speed. After they reach full speed, they generate sufficient counter-voltage to limit the current flow through their armatures while operating as motors.

The neutral wire is connected between the armatures of the motor generator set where their positive and negative leads connect together.

## 52. EFFECTS OF SHUNT AND SERIES FIELDS OF BALANCER GENERATORS

Either shunt or compound machines may be used for these equalizers, but compound machines are

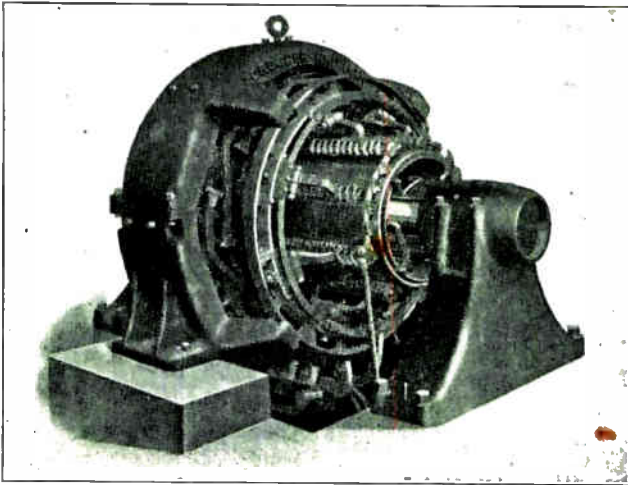

Fig. 46. Assembled three-wire generator. Slip rings can be seen at the right-hand end of the commutator. If this machine is rated at 500 KW, what should the maximum load in amperes be on both of the 110 volt circuits it supplies?

used more extensively. The number of turns in the series field coils must be carefully selected to provide the proper compounding effects. Generally the number of turns is very small, so that the voltage rise due to compounding will not be very great.

If this series field produces too great a voltage rise on either machine, that machine will be apt to take more than the unbalanced part of the load. The machines shown in Fig. 47 are of the compound type and have their series fields connected in series with the armatures and the positive and negative line wires.

The shunt fields are connected in parallel with their armatures and are both in series with a field rheostat, which can be used to increase the strength of the field of one machine and decrease that of the other at the same time.

The series fields are connected so that they increase the field strength when either machine is operating as a generator, but tend to decrease or oppose the flux of the shunt field on either machine when it operates as a motor. This is caused by the reversal of the direction of current through the series field and armatures as the unbalanced load is shifted from one side of the system to the other. Current through the shunt fields, however, continues to flow in the same direction at all times, because they are connected across the positive and negative leads from the main generator.

If the compounding effect of the balancer machines tends to strengthen the field of either one operating as a generator, the voltage of that machine will rise slightly; while the compound effect on the machine operating as a motor weakens its field and tends to make it speed up.

As long as the load on the system is perfectly balanced, both machines operate as differential motors without any mechanical load. The current through their armatures at such times is very small, being only sufficient to keep the armatures turning against the bearing and friction losses and to supply the small electric losses in the machines.

### 53. BALANCING OF UNEQUAL LOADS

When a system is unbalanced, the neutral current divides between the two armatures, driving the one on the lightly loaded side as a motor and passing through the other as a generator. In Fig. 47 the upper side of the system has the heaviest load, and the lower side has the highest resistance. This will cause the excess current from the greater load to flow back through the neutral wire and through the series of the lower machine, in a direction opposing its shunt field. This weakens the field flux and causes this machine to speed up and tend to act as a motor to drive the upper machine as a generator.

As the voltage of the generator unit rises slightly with the increased speed, it causes part of the unbalanced load to flow through it, and its series field, in a direction aiding the flux of the shunt field.

This increases its voltage still more, which enables it to take its proper share of the unbalanced current and to compensate for the voltage drop on the heavily loaded side of the system.

If the heaviest load is placed on the other side of the system, the current through the series fields of both machines will reverse, and cause the one which was operating as a generator to speed up and operate as a motor.

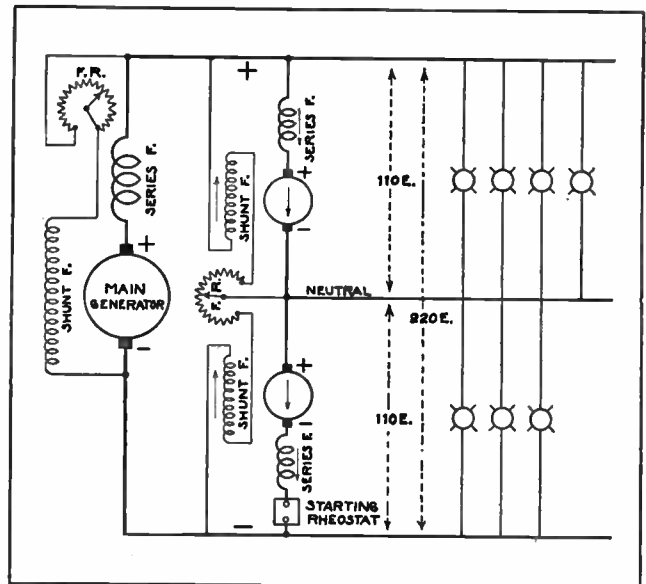

Fig. 47. This diagram shows the connections for the main generator and two balancer machines of a three-wire system.

The motor armature must take enough more than one-half of the neutral current to supply the losses of both armatures.

Referring again to Fig. 47, we find that the connections of the field rheostat, F. R., are such that when the handle or sliding contact is moved upward it will cut resistance out of the shunt field of the upper machine and add resistance in series with the shunt of the lower machine. This would produce the desired effects when the upper machine is operating as a generator and the lower one as a motor.



As this change of resistance increases the field strength voltage of the generator, it weakens the field strength and increases the speed of the motor.

The shunt fields can be controlled separately, if desired, by connecting a separate rheostat in series with each field. In Fig. 44 the shunt fields of each machine are connected in parallel with their own armatures. By changing these connections so that the shunt field of each machine is connected across the armature of the other machine, the machine which is operating as a generator will increase the current flow through the motor field and improve the torque of the motor armature.

Fig. 48 shows a motor-generator balancer set of the type just described.

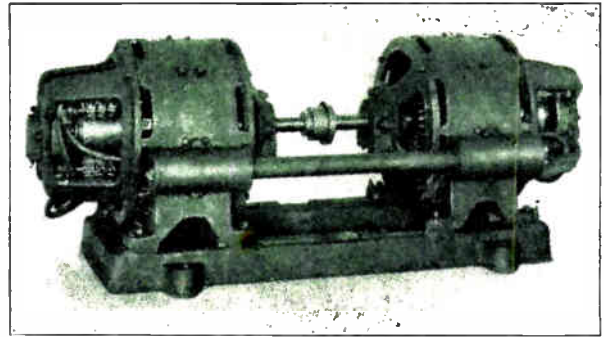

Fig. 48. Photo of a motor-generator balancer set used for three-wire system machines of this type are used considerably, where the unbalanced load is small compared to the total load on the main generator.

## COMMUTATION AND INTERPOLES

The term "commutation" applies to the process of reversing the connections of the coils to the brushes, as the coils pass from one pole to another in rotation.

The function of the commutator, as we already know, is to constantly deliver to the brushes voltage in one direction only, and thereby rectify or change the alternating current generated in the winding to direct current for the line.

We have also learned that commutation for the various coils, or the contact of their bars with the brushes, should take place when the coils are in the neutral plane between adjacent poles; at which point there is practically no voltage generated in them.

The reason for having commutation take place while the coils are in the neutral plane is to prevent short-circuiting them while they have a high voltage generated in them. This would cause severe sparking, as will be more fully explained later.

### 54. PROCESS OF COMMUTATION

The process of commutation, or shifting of coils in and out of contact with the brushes, is illustrated in Fig. 49. Here we have a sketch of a simple ring-type armature with the ends of the coils shown connected to adjacent commutator bars. This winding is not the kind used on modern power generators, but it illustrates the principles of commutation very well, and is very easily traced.

We will assume that the armature in this figure is rotating clockwise. All of the coils which are in front of the north and south poles will be generating voltage, which we will assume is in the direction shown by the arrows inside the coils.

As the coils are all connected in series through their connections to the commutator bars, the voltage of all of the coils on each side of the arma-

ture will add together. The voltages from both halves of the winding cause current to flow to the positive brush, out through the line and load, and back in at the negative brush where it again divides through both sides of the winding.

Now let us follow the movement of one coil through positions A, B, and C; and see what action takes place in the coil during commutation.

We will first consider the coil in position A, which is approaching the positive brush. This coil is carrying the full current of the left half of the winding, as this current is still flowing through it to commutator bar 1 and to the positive brush. The coil at "A" also has a voltage generated in it, because it is still under the edge of the north field-pole.

An instant later when the coil has moved into position B, it will be short-circuited by the brush coming in contact with bars 1 and 2.

### 55. SELF INDUCTION IN COILS SHORTED BY BRUSHES

As soon as this coil is shorted by the brush, the armature current stops flowing through it, and flows directly through the commutator bar to the brush. When this current stops flowing through the coil, the flux around the coil collapses and cuts across the turns of its winding, inducing a voltage in this shorted coil. This is called voltage of self-induction, and it sets up a considerable current flow in the shorted coil, as its resistance is so low. Note that the voltage of self-induction always tends to maintain current in an armature coil in the direction it was last flowing when generated from the field pole.

As long as the coil remains shorted, the current set up by self-induction flows around through the coil, bars, and brush. But as the coil moves far

enough so bar 2 breaks contact with the brush, this interrupts the self-induced current and causes an arc. Arcing or sparking will tend to burn and pit the commutator, and is very detrimental to the commutator surface and brushes. Methods of preventing arcing will be explained later.

As the coil which we are considering moves on into position C, its short circuit has been removed and it is now cutting flux under a north pole. This will generate a voltage in the opposite direction to what it formerly had, and it still feeds its current back to the positive brush through bar 2.

So we find that, by shifting the contact from one end of the coils to the other as they pass from pole to pole and have their voltages reversed, the same brush always remains positive.

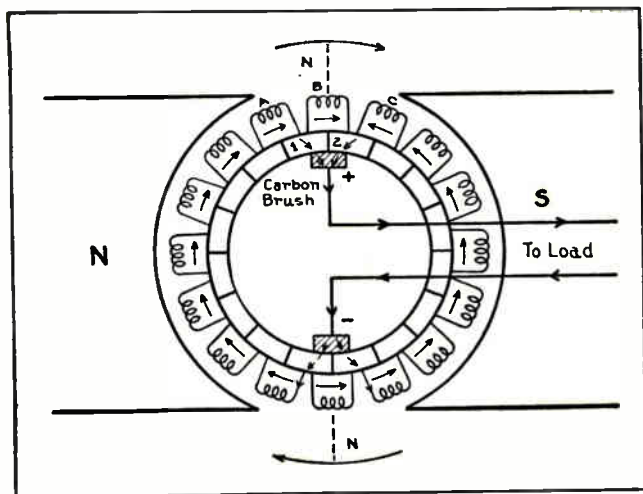

Fig. 49. This diagram illustrates the principles of commutation in a generator. Examine each part of it very carefully while reading the explanation given on these pages.

## 56. IMPORTANCE OF PROPER BRUSH SETTING FOR NEUTRAL PLANE

The time allowed for commutation is extremely short, because when a generator armature is turning at high speed, the bars attached to any coil are in contact with a brush for only a very small fraction of a second.

The reversal of the coil leads to the brushes must take place very rapidly as the coils are revolved at high speed from one pole to the next. On an ordinary four-pole generator each coil must pass through the process of commutation several thousand times per minute. Therefore, it is very important that commutation be accomplished without sparking, if we are to preserve a smooth surface on the commutator and prevent rapid wear of the brushes.

Brushes are made in different widths according to the type of winding used in the machine; but, regardless of how narrow the brushes may be, there will always be a short period during which adjacent commutator bars will be shorted together by the brushes as they pass under them.

We have found that, in order to avoid severe sparking during commutation, the coils must be

shorted only while they are in the neutral plane, when the coil itself is not generating voltage from the flux of the field poles. Therefore, the brushes must be accurately set so they will short circuit the coils only while they are in this neutral plane.

## 57. SHIFTING BRUSHES WITH VARYING LOAD ON MACHINES WITHOUT INTERPOLES

The neutral plane tends to shift as the load on a generator is increased or decreased. This is due to the fact that increased load increases the current through the armature winding and the additional armature flux will cause greater distortion of the field flux. The greater the load, the further the neutral plane will move in the direction of armature rotation.

If the brushes are shifted to follow the movement of this neutral plane with increased load, commutation can still be accomplished without severe sparking. For this reason, the brushes are usually mounted on a rocker arm which allows them to be shifted or rotated a short distance in either direction around the commutator.

In addition to the sparking which is caused by shorting coils which are not in the neutral plane, the other principal cause of sparking is the self-induced current which is set up in the coils by the collapse of their own flux when the armature current through them is interrupted.

We have previously stated that this self-induction will set up a considerable flow of current in the shorted coils. Then, when the coil moves on and one of its bars moves out from under the brush and thus opens the short circuit, this current forms an arc as it is interrupted.

Sparking from this cause can be prevented to a large extent by generating in the coil a voltage which is equal and opposite to that of self-induction.

Shifting the brushes also helps to accomplish this, by allowing commutation to take place as the coil is actually approaching the next field pole.

This is illustrated in Fig. 50. In this figure you will note that the brushes have been shifted so that they do not short circuit the coils until they are actually entering the flux of the next pole beyond the normal neutral plane.

The voltage of self-induction always tends to set up current in the same direction as the current induced by the field pole which the coil is just leaving. If, at the time the short circuit on the coil is broken, the coil is entering the flux of the next pole, this flux will induce in the coil a voltage in the opposite direction to that of self-induction. This will tend to neutralize the voltage and currents of self-induction and enable the short circuit to be broken when there is practically no voltage or current in the shorted coil.

Keep in mind that this is the required condition for most satisfactory commutation.

If the load on generators doesn't change often

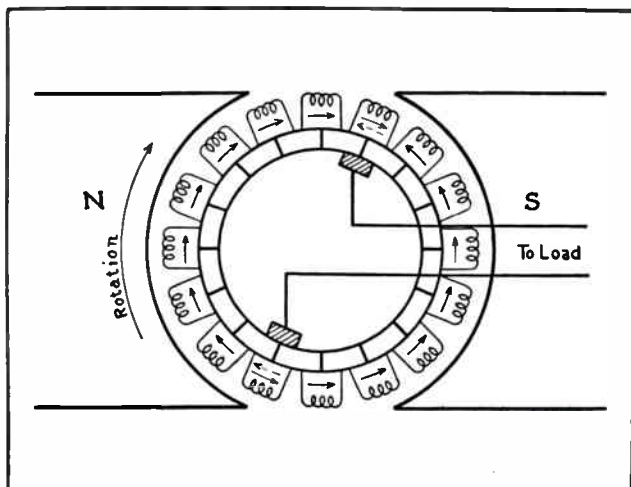

Fig. 50. This sketch shows the method of shifting the brushes to short circuit coils in a position where they will be generating the voltage to neutralize that of self-induction.

or suddenly, manual shifting of the brushes with each change of load and new position of the neutral plane, may be all that is required to prevent sparking; but when the load changes are frequent and considerable, it would be very difficult to maintain this adjustment by hand.

Where the manual method is used to maintain proper commutation, it is common practice to adjust the brushes to a position where they will spark the least for the average load. Then, even though a certain amount of sparking results when the load rises above or falls below this value, the brushes are not changed unless the sparking becomes too severe.

Fig. 51 shows a D. C. generator without the shaft or bearing post. The brushes of this machine are all attached to the ring framework as shown, and this entire assembly can be rotated to shift the brushes, by means of the hand wheel at the left.

Referring again to Fig. 50, the solid arrows show the direction of the voltage of self-induction, and the dotted arrows show the direction of the voltage which is induced by the flux of the field pole which the coil is approaching. These two voltages, being in opposite directions, tend to neutralize each other, as has previously been explained.

### 58. USE OF COMMUTATING POLES TO PREVENT SPARKING

On the more modern D.C. machines commutating poles, or interpoles, are employed to hold the neutral plane in its normal position between the main poles, and to neutralize the effects of self-induction in the shorted coils. These interpoles are smaller field poles which are mounted in between the main poles of the machine, as shown in Fig. 52.

The interpoles are wound and connected so they will set up flux of proper polarity, to generate voltage in the opposite direction to that of self-induction, as the armature coils pass under them. Fig. 53 shows a sketch of a simple generator with interpoles, or commutating poles, placed between the main field poles.

We will assume that this armature is rotated in a clockwise direction, and that its armature conductors have generated in them voltage which tends to send current in through the conductors on the left side, and out through those on the right side of the winding. Recalling that the voltage of self-induction tends to maintain current in the same direction in the conductor as it was under the last field pole, we find that this voltage is generated "in" at the top conductor in the neutral plane and "out" at the lower one.

### 59. POLARITY OF INTERPOLES FOR A GENERATOR

If you will check the polarity of the interpoles, you will find that their flux would be in a direction to induce voltages opposite to those of self-induction in each of these two conductors. The direction of these voltages is shown by the symbols placed just outside of the conductor circles. So we find that, if these commutating poles are made to set up flux of the right polarity and in the right amount, they can be caused to neutralize the effects of self-induction and distortion of the neutral plane almost entirely.

These poles are called "commutating poles" because their principal purpose is to improve commutation and reduce sparking at the commutator and brushes.

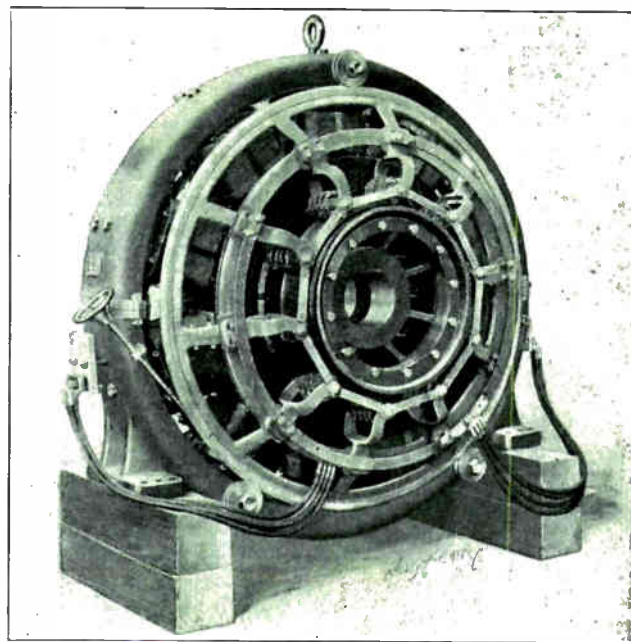

Fig. 51. This end view of a generator with the pedestals, bearing, and shaft removed shows very clearly the brush ring mounted in grooved rollers on the side of the field frame. The hand-wheel at the left can be used for rotating this ring to shift the brushes to the proper neutral plane.

In order to produce the desired results the interpoles of a generator must be of the same polarity as the adjacent main pole in the direction of rotation.

### 60. STRENGTH OF COMMUTATING FIELD VARIES WITH LOAD

In order that these commutating poles may pro-

duce fields of the proper strength for the varying loads on the generator armature, their windings are connected in series with the armature, so that their strength will at all times be proportional to the load current. In this manner, the strength and neutralizing effect of the interpoles increases as the load increases, and thereby tends to counteract the effect of increased load on field distortion and self-induction.

In this manner, interpoles can be made to maintain sparkless commutation at all loads and thus make unnecessary the shifting of the brushes for varying loads.

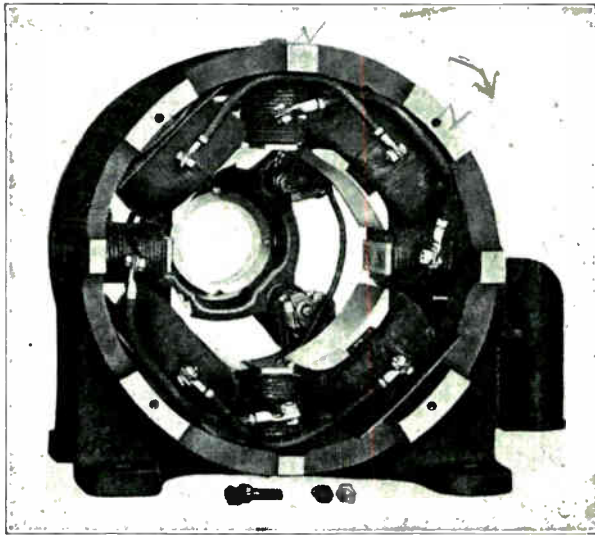

Fig. 52. This photo shows a four-pole, D. C. generator with commutating poles. These commutating poles or interpoles are the smaller ones shown between the main field poles.

Referring again to Fig. 52, you will note that the windings on the interpoles consist of a few turns of very heavy cable, so that they will be able to carry the armature current of the machine. The strength of the interpoles can be varied by the use of an interpole shunt, which is connected in parallel with the commutating field to shunt part of the armature current around these coils. The connections of this shunt are shown in Fig. 54-A. The interpole shunt is usually made of low resistance materials, such as bronze or copper, so it will carry the current readily without undue heating.

This method of weakening the strength of the commutating field is quite commonly used on the larger machines. The terminals of the commutating field are usually connected directly to the brushes, to eliminate confusion when making external connections to the machine.

### 61. ADJUSTMENT OF BRUSHES ON INTERPOLE MACHINES

On machines of small and medium sizes, the end plate or bracket on the generator is sometimes slotted, as shown in Fig. 54-B, to allow the brushes to be rotated or shifted within a very limited range. With such machines, the brush-holder studs are

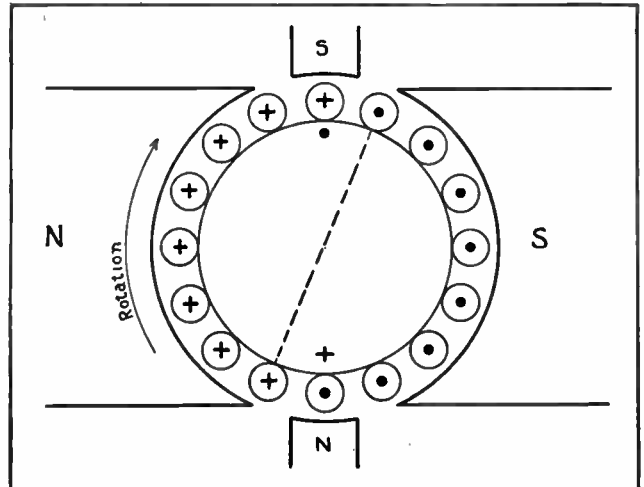

Fig. 53. This sketch illustrates the manner in which interpoles generate voltage opposite to that of self-induction in the conductors which are shorted by the brushes.

mounted rigidly in the bracket but are, of course, insulated from the metal with fibre sleeves and washers.

When the brushes are to be rotated the bolts which hold the end plate to the field frame are loosened slightly and the entire end plate is shifted. This allows the armature coils to be commutated at a point where the effects of the interpole are just great enough to neutralize or balance self-induction.

Before removing the end plate to make repairs on a machine of this type, it is well to mark its position, so that you can be sure to get it replaced in the correct position. This can be done by making one or two small marks in line with each other on both the field frame and the end plate. The marks can be made with a file or prick punch.

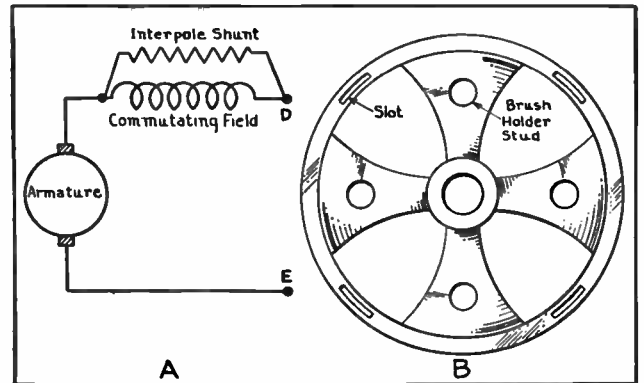

Fig. 54. At "A" is shown the connection of an interpole shunt for varying the strength of the commutating field. "B" shows an end bracket with slots to allow it to be rotated slightly to shift the brushes. The brush holders on this machine would be mounted on this end bracket.

### 62. ADJUSTING INTERPOLES BY CHANGING THE AIR GAP

The strength of interpoles can also be varied by placing iron shims or thin strips between the interpole and the field frame of the machine, as shown in Fig. 55. It is possible in this manner to vary the width of the air gap between the face of the interpoles and the armature core.

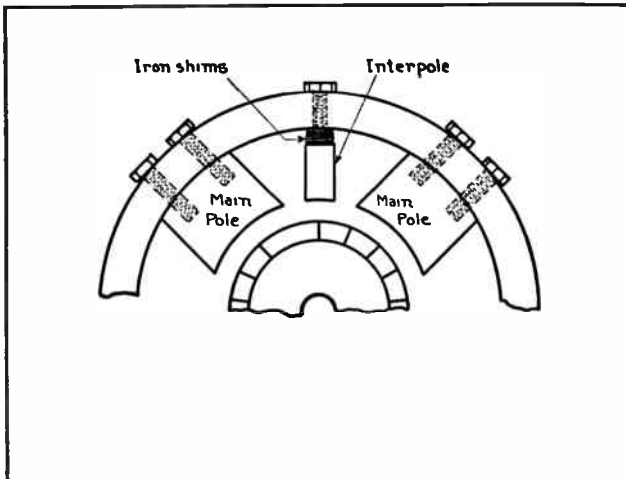

Fig. 55. Thin iron shims can be used under an interpole to vary its strength by changing the air gap between the pole and the armature.

Decreasing the air gap reduces the magnetic reluctance of the interpole field path, thereby strengthening its flux and increasing its effect on commutation. This method can be used on machines of any size and when no other visible means of varying the interpole strength is provided, shims are probably used.

On some machines, the number of interpoles may only be one-half the number of main field poles; in which case they will be placed in every other neutral plane and will all be of the same polarity. By making these interpoles of twice the strength as would be used when a machine has one for each main pole, we can still effectively neutralize the self-induction in the coils. This is true because, with a modern drum-wound armature, when one side of any coil is in one neutral plane the other side will be in the adjacent neutral plane.

For this reason, if interpoles are placed in every other neutral plane, one side of any coil will always be under the interpole while this coil is undergoing commutation. This is illustrated by the sketch in Fig. 56, which shows a four-pole generator with only two interpoles.

As both sides of any coil are in series, the double strength of the interpole over one side will neutralize the effects of self-induction in the entire coil. This type of construction reduces the cost of the generator considerably and is often used on machines ranging up to six-pole size.

### 63. COMMUTATION ON MOTORS

The problem of obtaining sparkless commutation on D. C. motors is practically the same as with D.C. generators.

Motors as well as generators must have the connections from the brushes to the coils reversed as the coils pass from one pole to another of opposite polarity. This is necessary to keep the current from the line flowing in the right direction in all coils in order to produce torque in the same direction under all field poles.

During commutation, the coils of a motor arma-

ture are momentarily short circuited by the brushes, the same as with a generator.

This shorting and commutation should take place while the coils are in the neutral plane between the field poles, where they are doing the least work or producing the least torque.

We also know that the coils of any motor armature have a high counter-voltage generated in them as they rotate under the field poles. This counter-voltage will be at its lowest value while the coils are passing through the neutral planes; which is another reason for having commutation take place at this point in a motor.

### 64. POSITION OF NEUTRAL PLANE IN MOTORS

The neutral plane of a D.C. motor will also shift with load variations and changes in armature current, but this shift will be in the opposite direction to what it is in a generator. This is due to the fact that the rotation of a motor will be opposite to that of a generator if the current direction is the same in the motor armature as in the generator armature.

Motor coils also have counter-voltage of self-induction produced in them when they are shorted by the brushes. In a motor, the direction of this self-induced voltage will be opposite to that in a generator, as the motor armature currents are in the opposite direction to those in a generator armature of the same direction of rotation.

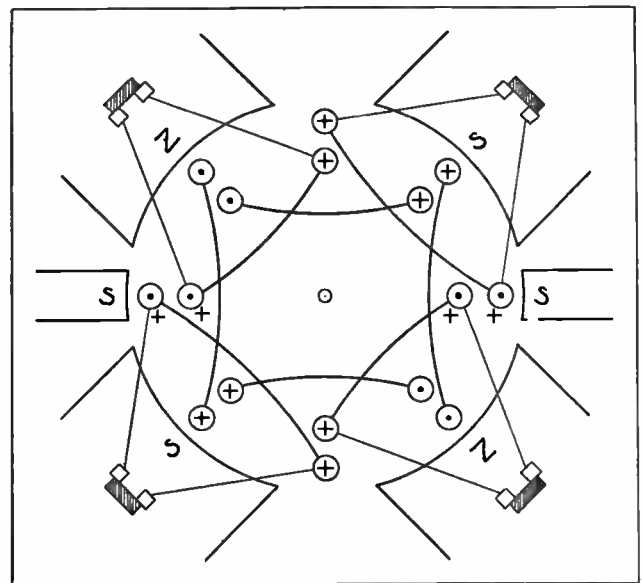

Fig. 56. This simple sketch illustrates the manner in which two interpoles can be used to neutralize self-induction in the coils of a four-pole machine.

We can, therefore, improve commutation on a motor by shifting the brushes in the opposite direction to that used for a generator. Motor brushes should be shifted against the direction of rotation, when the load is increased.

Fig. 57 is a sketch of the armature conductors and field poles of a simple D.C. motor, showing the position of the neutral plane with respect to the direction of rotation.

The heavy symbols in the six armature conductors on each side show the direction of the applied current from the line, which is flowing "in" on the conductors at the right and "out" on those on the left side. The lighter symbols in the single conductors at the top and bottom show the direction of the currents set up in this coil by self-induction when the coil is shorted. The symbols shown outside of the conductor circles indicate the direction of the counter E.M.F. produced in the motor winding. This counter-voltage always opposes the direction of the applied line voltage.

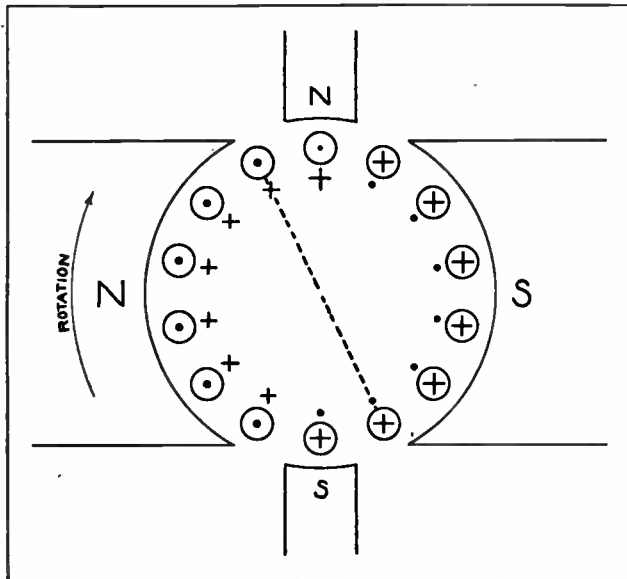

Fig. 57. This sketch shows the position of the neutral plane with respect to rotation in a motor. Compare this with Fig. 53 for a generator.

### 65. POLARITY OF INTERPOLES FOR MOTORS

Interpoles or commutating fields can also be used on motors to improve commutation at all loads and to eliminate the necessity of frequent shifting of the brushes.

On a motor, these interpoles are connected in series with its armature, the same as those of a generator are, but the polarity of motor interpoles must be the same as that of the adjacent main poles in the opposite direction to rotation. This is because the self-induced voltages in the coils shorted by the brushes in a motor are opposite to those in a generator with the same direction of rotation.

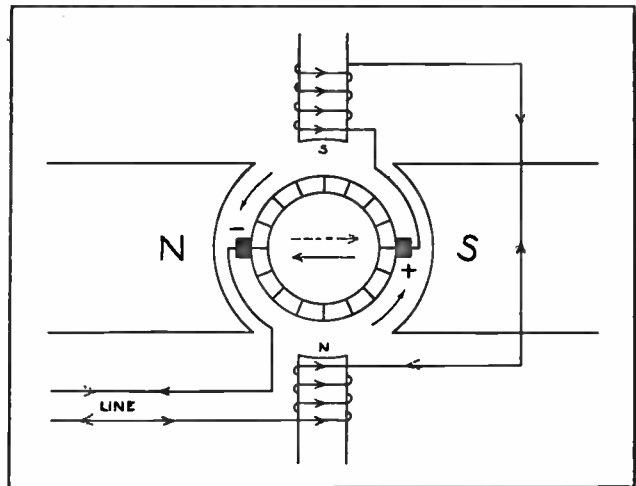

Fig. 58. This diagram shows the connections of the interpoles for a two-pole generator or motor.

Fig. 58 shows the connections of the interpoles for a two-pole D.C. motor. You will note that one armature lead is connected directly to the negative brush, while the other lead connects first to the commutating field and then, through these poles, to the positive brush.

If this connection is properly made when the machine is assembled, it is not necessary to make any change in the connections of the commutating field when the motor is reversed. Either the armature current or field poles must be reversed to reverse the rotation, so that the relation of the commutating poles will still be correct.

This connection can be the same whether the machine is operated as a motor or generator, because a generator rotated in the same direction as a motor will generate current in the opposite direction through the armature. This is shown by the dotted arrows in Fig. 58, while the solid arrows show the direction of motor current.

As the commutating poles are in series with the armature, this reversed current will also reverse the polarity of the commutating field, and maintain the proper polarity for generator operation.

These principles of commutation and interpoles should be kept well in mind, as an efficient maintenance electrician or power plant operator will never allow unnecessary sparking to damage the brushes and commutator of machines of which he has charge.

Norman Beder  
41 Georgia Ave.  
Brooklyn 7, N. Y.



# COYNE

## *Electrical School*

CHICAGO ~ ~ ILLINOIS



ESTABLISHED 1899

COPYRIGHT 1942

# DIRECT CURRENT POWER AND MACHINES

## *Section Two*

**Switchboards and Switchgear**  
**Knife Switches, Circuit Breakers, Relays, Busses**  
**Switchboard Layout and Wiring**  
**D. C. Meters**  
**Voltmeters, Ammeters, Wattmeters**  
**Kilo-watt Hour Meters, Operation, Reading and Testing**  
**Recording Instruments, Demand Meters**  
**Wheatstone Bridge**  
**Megger.**



## D. C. SWITCHBOARDS

In power plants, substations, and industrial plants where large amounts of electric power are generated or used, it is necessary to have some central point at which to control and measure this power. For this purpose switchboards are used.

The function of the switchboard is to provide a convenient mounting for the knife switches, circuit breakers, rheostats, and meters which are used to control and measure the current. The equipment located on the switchboard is generally called **switchgear**.

### 66. TYPES OF SWITCHBOARDS

Switchboards are of two common types, known as **panel boards** and **bench boards**. The latter are also called **Desk-type boards**.

Panel-type boards consist of vertical panels of the proper height and width, on the face of which the switchgear is mounted. On the rear of the board are located the bus bars and wires which connect the switches, circuit breakers, and meters to the various power circuits which they control or measure the energy of. Fig. 59 shows a panel-type switchboard for a D. C. power plant. Examine it carefully and note its construction and the arrangement of the equipment mounted on it.

Bench-type switchboards have the lower section built like a bench with a sloping top, and above the rear edge of the bench section is a vertical panel which contains the instruments.

The sketch in Fig. 60 shows an end view of a bench-type switchboard with the panels mounted on a pipework frame. Boards of this type are used mostly for remote-control switchboards, where the switches and circuit breakers are operated by electro-magnets and solenoids, which are controlled by small push-button or knife switches on the bench portion of the board.

Another type of switchboard which is frequently used in industrial power plants is known as the **truck type**. These boards are built in separate sections, which can be drawn out on rollers for convenient repairs and adjustment to switchgear. Fig. 61 shows a section of a truck-type board, removed from the main board, and showing the oil switch and bus bars which are mounted in the frame behind the front panel.

Bench-type and truck-type switchboards will be more fully explained in a later section on A. C. switchboards.

### 67. SWITCHBOARD PANEL MATERIALS

Switchboard panels are sometimes made of slate or marble, as these materials are good insulators

and have good mechanical strength as supports for the switchgear.

Slate is cheaper than marble and is easier to drill and cut for mounting on the frames and for mounting the switchgear. Slate is not quite as good an insulator, however, and is usually not used for voltages over 500 or 750.

Marble is a better insulator and can be used on voltages up to 1100. Marble presents an excellent appearance, but it is more difficult to keep clean. It is also very hard to drill or cut.

A newer material recently developed for switchboard panels, and known as **ebony asbestos**, has a number of very important advantages for this work. It is made of a composition material in which asbestos fibre and electrical insulating compounds are mixed and formed under great pressure into smooth-surfaced panels.

This material has a beautiful natural black finish, is lighter in weight, and has better insulating qualities and mechanical strength than either slate or marble. In addition to these advantages, ebony asbestos is also much easier to drill and cut, which makes it easy and economical to install.

Steel panels are also coming into use for switchboards, and have the advantage of great strength and durability. The switchgear on steel panels must, of course, be insulated from the metal at all points.

### 67-A. GENERATOR AND FEEDER PANELS

The common panel-type switchboards are usually made about ninety inches high, and as wide as necessary to provide the required space for the equipment needed. They are practically always built up in vertical sections or panels, each of which is used for the control of separate circuits. Panels of greater width are used for the main circuits or generator circuit control, and sub-panels of narrower width are used to control the separate feeder circuits, which supply the energy to the various lines or power circuits controlled from the switchboard.

Fig. 59 shows two generator panels on the right, and six feeder panels on the left. Note the difference in the size of the switches and circuit breakers on the main panels and sub-panels. By referring to this same figure, you will also note that each vertical panel is divided into three sections. This type of construction facilitates repairs and changes of certain equipment, without disturbing the rest of the equipment on that panel.

For example, if the switches on a panel are to be changed to others of different size or type, the sec-

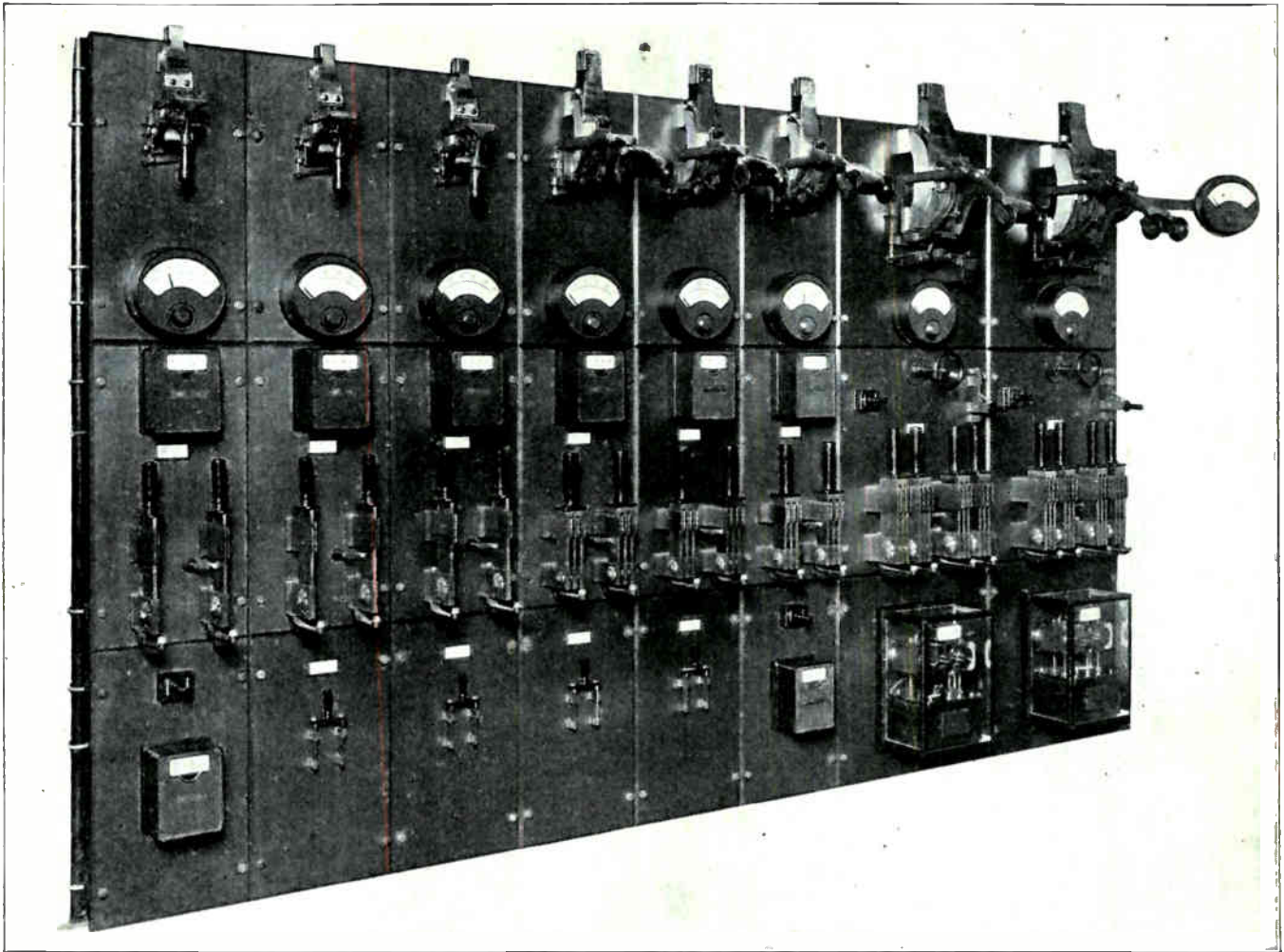

Fig. 59. This photo shows a modern panel type switchboard equipped with knife switches, meters, and circuit breakers. The two large panels on the right are the main generator panels and are equipped with field rheostats and instrument switches and much larger circuit breakers. The six smaller panels on the left are feeder or distribution panels. Examine all the parts and details of construction of this board very carefully, and refer to this figure frequently while reading the accompanying pages.

tion containing them can be removed and a new one drilled and inserted. It is not necessary to disturb the other two sections, or to leave unsightly holes in the board where the old switches were removed.

Sectional construction of panels also reduces the danger of cracked panels which might result from mechanical strains or vibration if larger single panels were used.

Switchboard panel material can be obtained in thicknesses from  $\frac{1}{2}$ " for very small boards for light duty, to 2" or more for large heavy-duty boards. These panels are usually beveled on the corners of the front side, for better appearance.

#### 68. SWITCHBOARD FRAMES

Switchboard panels are commonly mounted on either angle iron or pipe-work frames.

Where angle iron is used, it should be of the proper size to give the required strength and rigidity for proper support of the panels and switchgear. The board should not bend or vibrate noticeably during operation of heavy knife-switches or circuit-breakers.

Angle iron of  $1\frac{1}{2}$ " to 3" is commonly used. It

can be cut to proper length by means of a hack saw, and drilled for the bolts with which the panels are attached, and also for the bolts which hold the angle irons of adjoining panels together.

Fig. 62 shows how the panels should be bolted to the angle irons at "h," and the method of bolting the angle irons together at "h2". The panels should be carefully marked for drilling, so they will line up neatly and give the proper appearance when finished.

Short bolts of the proper length, with washers and nickle-plated cap nuts, can be used to provide good appearance of the front surface of the board.

These bolts and nuts should be tightened sufficiently to hold the panels securely, but not tight enough to crack the corners of the panels.

The bolt holes can be drilled in the panels with ordinary metal drills used in a breast drill or an electric drill. Slate and marble are hard and should, therefore, be drilled slowly or the drill should be cooled while it is cutting. Ebony asbestos is very easy to drill; in fact, nearly as easy as hardwood.

The lower ends of the angle irons should have

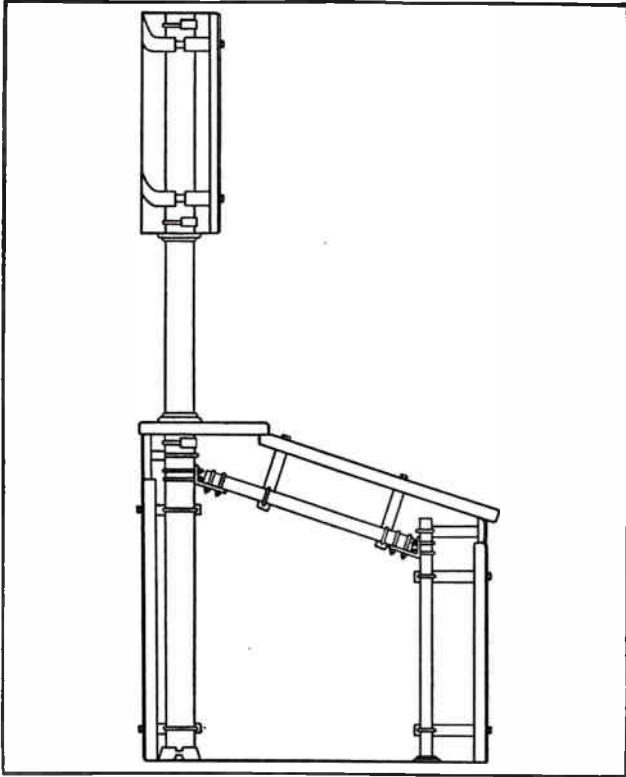

Fig. 60. The above diagram shows an end-view of a "bench-type" switchboard mounted on pipe frame work. This type of board is often referred to as "desk type".

"feet" bent in them or attached with bolts, for secure anchorage to the floor. The upper ends should be braced to keep the switchboard rigid.

#### 69. PIPE FRAMES AND THEIR ADVANTAGES

Pipe-work frames are very convenient to install, as they do not require drilling as angle iron does. The pipe frame-work is held together by special clamps, as shown in Fig. 60. Fittings with holes for the panel bolts are also provided to clamp on the pipes. The pipes are attached to the floor with threaded floor-flanges.

Standard pipe sizes can be used; the common sizes being  $1\frac{1}{4}$ " to 2", or larger for very heavy boards. Special clamp fittings can be obtained for mounting bus insulators and various devices on the rear of the board. Other fittings are used for attaching brace pipes to secure the framework and board in a vertical position.

Pipe-work frames are very popular and are extensively used, as they provide a very flexible frame

which can easily be adjusted to fit various panels and devices by merely sliding the clamp fittings. One of the pipes of the frame can be seen on the left end of the board shown in Fig. 59.

#### 70. KNIFE SWITCHES. TYPES

Knife switches, used for controlling the various circuits on switchboards, are made in single, double, and three-pole types. The smaller and medium sizes are generally two or three-pole; but the larger ones are generally single-pole, for greater ease of operation. Three-pole switches or three single-pole switches are used to control the circuits of compound generators, the three poles being used in the positive, negative, and equalizer leads.

Three-pole switches are also used for circuits of the Edison three-wire system. Other D. C. circuits are usually two-wire, and they use either one two-pole or two single-pole switches.

Equalizer switches are sometimes mounted on small panels on pedestals near the generators, to eliminate the necessity of running equalizer busses

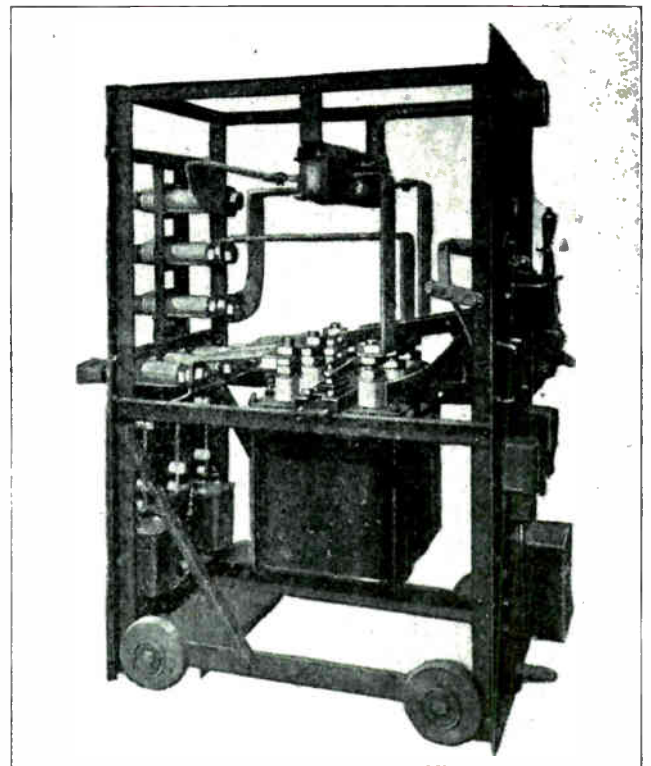

Fig. 61. This view shows a unit of a "truck type" switchboard on which the sections can be drawn out on rollers to make repairs and adjustments more conveniently.

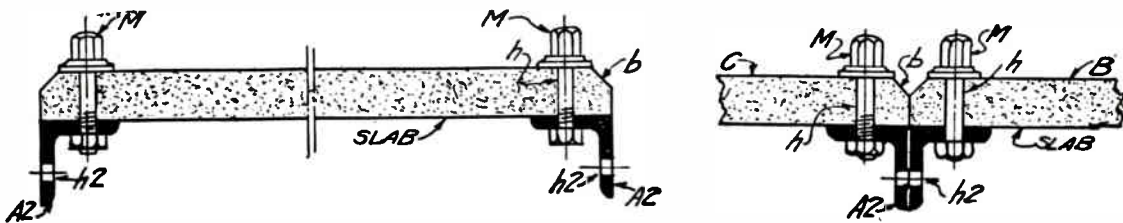

Fig. 62. The above sketches show the method of attaching switchboard panels to the angle iron frame work. Note how the panels are bolted to angle irons, and the angles bolted together between panels. Also note the type of bolts, nuts, and washers used with this construction.

to the switchboard. In such cases, the main panels for compound generators will also use two-pole switches.

### 71. CONSTRUCTION OF SWITCHES

Knife switches consist of three essential parts called the blade, hinge, and clips. The blades are made of flat copper bus bar material and are attached to the hinges by means of short bolts and spring washers. This fastening gives the required tension for good contact between the blades and hinges, and yet allows freedom of operation. See Fig. 63.

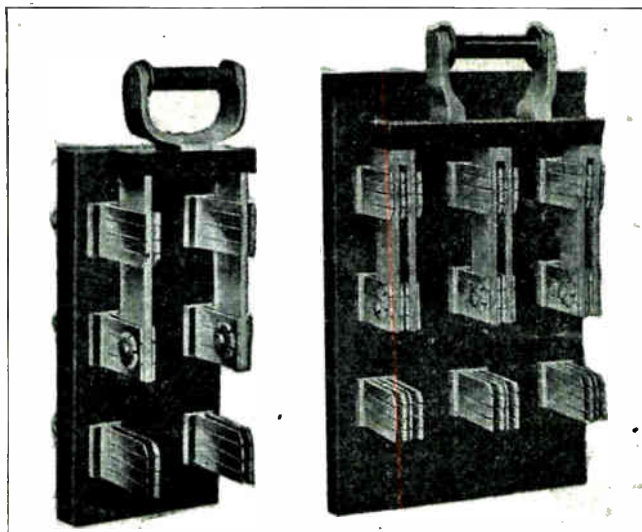

Fig. 63. Above are shown a double-pole and three-pole knife switch. Note carefully the construction of the switch plates, hinges, and clips.

Switch clips are made of two or more thin, springy pieces of copper, mounted in a block. The blades are inserted between these clips when the switch is closed. The clips are usually slotted to make them more flexible and allow them to make better contact with the blade of the switch. These details of construction can be observed by examination of the switches shown in Fig. 63, and also those on the switchboard in Fig. 59.

Switch blades are equipped with insulating handles and guards on their free ends. The hinges and clips usually have threaded studs of copper attached directly to them, for convenient mounting on the switchboard panels. Bus bars or cable lugs on the rear of the board are attached to these studs by means of extra nuts provided with them.

The switch at the left in Fig. 64 shows the studs and the nuts used both for holding the switch on the board and for attaching cable lugs or bus bars. This switch and also the double-pole switch on the right in this figure, are both of a newer type which has double blades and single clip prongs.

Knife switches on switchboards are practically always mounted with the blades in a vertical position and the clips at the top. This allows easier operation and prevents danger of the switch falling closed by gravity.

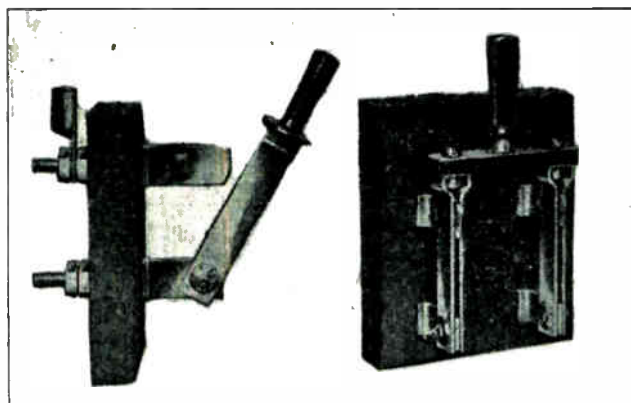

Fig. 64. Single-pole and double-pole switches of a modern type. Note the manner in which the hinges and clips are attached to the board and the method of making cable or bus connections to the studs on the back of the board.

### 72. SWITCH MOUNTING AND CURRENT RATINGS

In mounting switches on the panels, the hinges and clips should be carefully lined up so that the blades will fit well and make good electrical contact.

All knife switches are rated in amperes according to the copper area of their blades and the contact area of clips and hinges. They are commonly made in sizes from 50 amperes to one thousand ampere capacity; and for heavy power circuits they are made to carry 6000 amperes or more.

You will note that a number of the switches on the right-hand side of the switchboard in Fig. 59 have multiple blades in each pole. This gives a much greater contact area between the blade surfaces and hinges and clips, and also allows air to circulate through the switches to cool them.

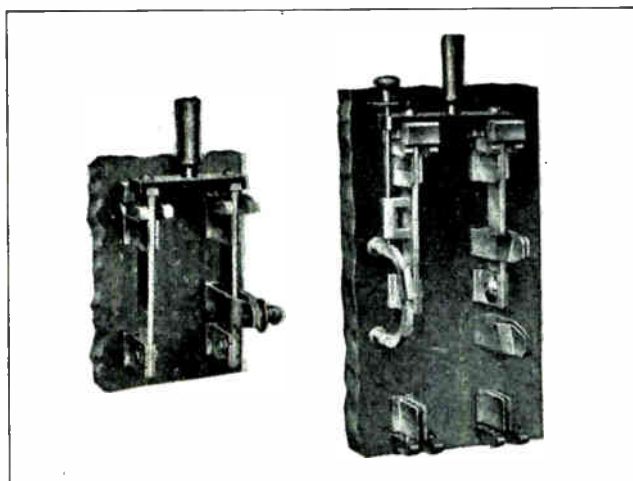

Fig. 65. A number of special types of knife switches are made with auxiliary clips and blades as shown above. These two switches are used as field discharge switches for generators.

Switches should never be loaded above their rated capacity in amperes for any great length of time, or they will overheat. Hinges or clips which are loose or poorly fitted will also cause overheating of the switch at these points. If switches are allowed to overheat too much, the copper will become soft and

lose the springy qualities which are necessary for tight fitting of the clips. Overheated switches often cause the copper clips or blades to turn a bluish color. Switches that have been heated to this extent will probably need to be replaced.

### 73. CARE AND OPERATION OF SWITCHES

New switches should be carefully fitted and "ground in" before loading. "Grinding in" can be done by coating the switch-blades with vaseline or oil mixed with abrasive powder, and then opening and closing the switch a number of times. This grinds and polishes the sides of the blades and clips to make their surfaces perfectly parallel and provide a good contact between them.

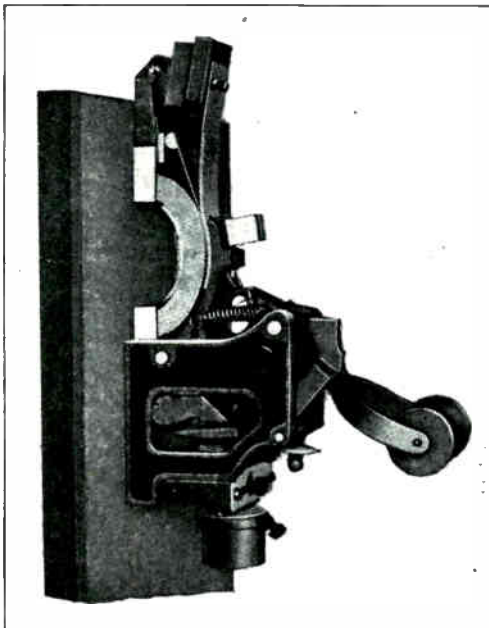

Fig. 66-A. This photo shows a common type of air circuit breaker in closed position. Note the manner in which the main contacts and auxiliary contacts conoect with the stationary contacts on the panel.

Never open knife-switches under heavy load, if they have a circuit-breaker in series with them. Opening the switch under load will draw an arc at the point where the blades leave the clips. These arcs tend to burn and roughen the blades and clips, making the switch hard to operate and also destroying the good contact between the blade and clips.

Where circuit-breakers are provided they should always be tripped open first and the knife-switch opened afterward. This prevents arcing at the switch and is also much safer for the operator, as the arcs drawn by opening switches under heavy current load may be very dangerous.

Knife-switches should be kept lubricated with a thin film of petroleum jelly or light vaseline.

Special types of knife-switches, with snap-action blades operated by springs, are made for use in the shunt field circuits of generators. Field circuit switches often have auxiliary blades to close the field across a resistance just before the main blades open. Such switches are called **field discharge switches**. Two types of these switches are shown

in Fig. 65. Their purpose is to prevent the setting up of high voltages by self-induction due to the collapse of the flux around the shunt field coils when this circuit is opened.

### 74. CIRCUIT BREAKERS

For opening heavy power-circuits in case of overload or short circuits, automatic circuit breakers are commonly used. These are divided into two general classes, known as **air circuit-breakers** and **oil circuit-breakers**. Air breakers will be described here and oil breakers will be covered in a later section.

An air circuit-breaker is a type of electric switch equipped with special contacts and a trip coil to open them automatically in case of overload on the circuit. Thus they provide for equipment the same protection as would be afforded by fuses.

For circuits which frequently require overload protection, circuit-breakers are much more suitable than fuses, as the breakers can be quickly closed as soon as the fault is removed from the circuit.

Circuit breakers are commonly made in single-pole, double-pole, and three-pole types, and for various current ratings, the same as knife switches are. Figures 66-A and 66-B show two views of a single-pole circuit-breaker. The view in 66-A shows the breaker in closed position, and in 66-B it is shown open.

The main current-carrying element or bridging contact is made of a number of thin strips of copper curved in the form of an arch and fitted closely together. This copper leaf construction permits the ends of this main contact to fit evenly over the surface of the two lugs, or stationary contacts, which are mounted in the switchboard and attached to the bus bars.

### 75. CIRCUIT-BREAKER OPERATION

When the breaker is closed by means of the

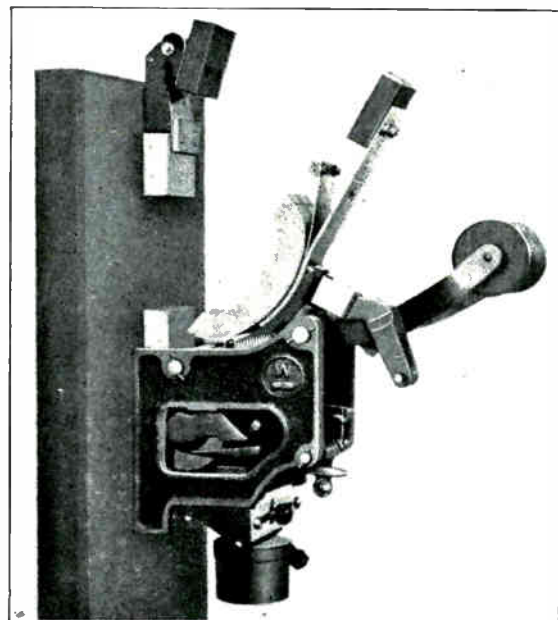

Fig. 66-B. This view shows the same circuit breaker as in fig. 66-A, except that it is now in open position. Again note carefully the construction and position of the main contacts and arcing contacts. Also note the trip adjustment on the bottom of the breaker.

handle, a lever action is used to force the main contact tightly against the stationary contacts under considerable pressure.

Auxiliary arcing contacts and tips are provided above the main contact, as shown in the figures. The intermediate contact, or the one directly above the main contact, consists of the heavy copper spring with a removable copper tip. The top arcing contact on the movable element is carried by a long copper spring and has a removable carbon tip.

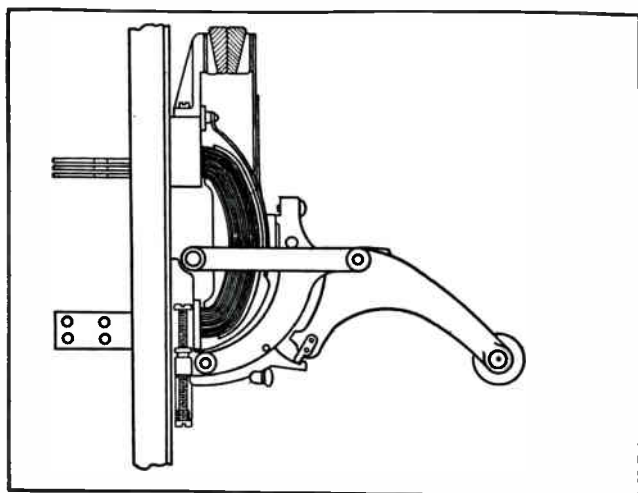

Fig. 67. This sketch shows a side-view of a circuit breaker in closed position and illustrates the copper "leaf" construction of the main contact. Note the copper stubs which project through the board for connections to bus bars.

When the breaker is opened, the main contact opens first and allows the current to continue flowing momentarily through the auxiliary contacts. This prevents drawing an arc at the surface of the main contact and eliminates possible damage to this contact surface, which must be kept bright and smooth and of low resistance, in order to carry the full load current without loss.

The intermediate contact opens next and it may draw a small arc, because the remaining circuit through the carbon tips is of rather high resistance.

The carbon contacts open last and the most severe arc is always drawn from these points. Carbon withstands the heat of the arc fairly well, and these contacts are easily and cheaply renewed whenever they have been burned too badly by repeated arcs.

Circuit-breakers of this type can usually be tripped open by means of a small lever or button, as well as by the automatic trip coil. When released they are thrown quickly open by the action of springs or gravity on their moving parts.

Fig. 67 is a sketch showing a side view of an air breaker in which can be seen the leaf construction of the main contact, and also the bus stubs to which the connections are made at the rear of the board.

When a circuit-breaker is closed the contacts close in the reverse order, the carbon tips closing first, intermediate contact second, and the main contact last. This construction and operation eliminates practically all arcing and danger of pitting at the ends of the main contacts. It is very important, how-

ever, to keep the auxiliary contacts and carbon arcing tips properly adjusted and occasionally renewed, so that they make and break contact in the proper order.

## 76. CIRCUIT-BREAKER TRIP COILS OR OVERLOAD RELEASE

Fig. 68 shows a single-pole and a double-pole circuit breaker which are both in closed position. The overload coils, or trip coils, can be seen on each of the breakers in this figure. These coils are of the series type and consist of a very few turns of heavy copper bar or cable, inside of which is located an iron plunger.

When the coil is connected in series with the line and breaker contacts, any overload of current will increase its strength and cause it to draw up the plunger. The plunger then strikes the release latch and allows the breaker to open.

An adjustment is provided for raising and lowering the normal or idle position of the plunger so that the breaker can be set to trip at different currents and loads. Trip coils of this type are known as series-type overload release coils and are commonly used on breakers up to 500 amperes capacity. The circuit-breakers shown in Figures 66-A and B have electro-magnets and armatures which trip the holding latches, and also an oil dash-pot to delay the opening of the breaker on light overloads. The adjustments for these devices can be seen below the breaker in these figures.

## 77. SHUNT TRIP COILS AND OVERLOAD RELAYS

For circuit breakers of 500 amperes and more, it is not usually practical to use series overload-coils, because of the large sized conductor which would be needed to carry the current.

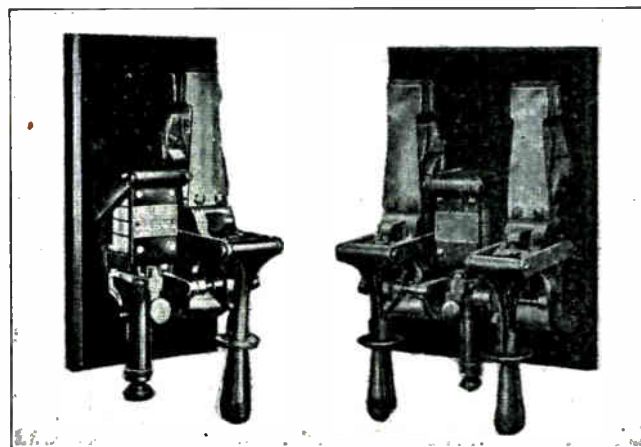

Fig. 68. Single-pole and double-pole, circuit breakers, showing the overload trip coils and their adjusting mechanism for operation of the breakers at different current loads.

On these larger breakers, shunt trip coils are used, and these coils are wound with a greater number of turns of small wire and are operated from an ammeter shunt. Shunt trip coils are not connected directly to the ammeter shunts, but are operated by a relay which obtains from the ammeter shunt the

small amount of energy needed for its coil.

The greater the current flow through ammeter shunts, the greater will be the voltage drop in them. This voltage drop is usually only a few milli-volts, and as it is difficult to wind the shunt trip coils to operate on this small fraction of a volt, **overload relays** are generally used to close a circuit to these coils.

The overload relay is a very sensitive instrument, having a small coil designed to operate on a very low voltage of 50 to 100 milli-volts; and this coil is connected across the ammeter shunt.

The tension spring on the armatures of these relays is adjustable so the relay can be made to close its contact and energize the shunt trip coil on the breaker, at any desired current load within the range for which the relay and breaker are designed.

### 78. REVERSE CURRENT RELAYS

Some circuit-breakers are also equipped with reverse current protection to cause them to open in case of reversed polarity of a generator or reversed current flow in the line.

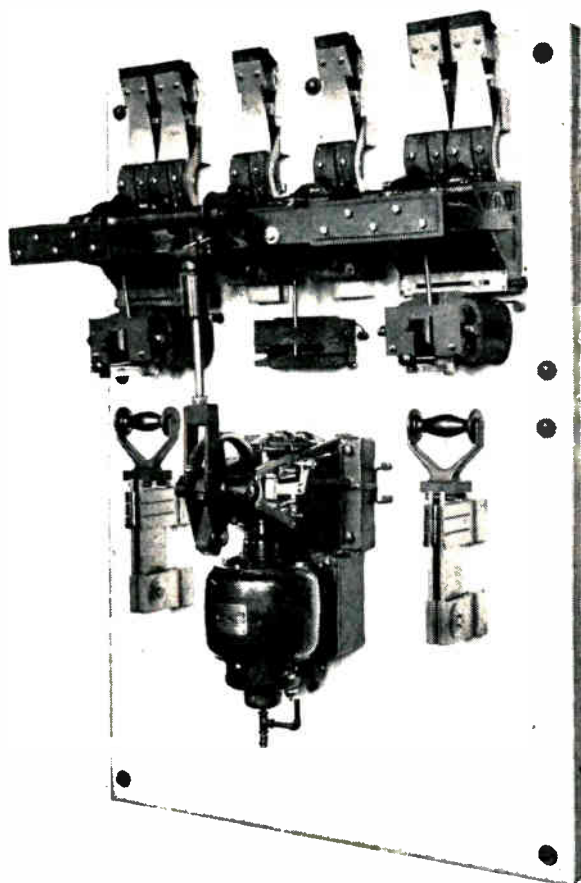

Fig. 69. Large, heavy duty circuit breaker equipped with a motor for automatic reclosing, after it has been tripped either by an overload, or by remote control.

Reverse-current relays are used to trip the breakers to obtain this protection. These relays have two elements or windings similar to the field and armature of a simple motor. One is called the **potential or voltage element**, and the other the **current element**.

The current coil or element is connected across the terminals of the ammeter shunt. The potential coil is connected directly across the positive and negative leads or busses and serves to maintain a constant field flux.

The direction of current through the current element or moving coil of the relay is determined by the direction of current through the ammeter shunt. When the current through the ammeter shunt is in the normal direction, the moving coil tends to hold the relay contacts open and keep the shunt trip-coil of the circuit-breaker de-energized.

If the current through the ammeter shunt is reversed this will reverse the polarity of the voltage drop across the shunt and send current through the movable element of the relay in the opposite direction. This reverses its torque and causes the coil to turn in a direction which closes the relay contacts and energizes the shunt trip-coil which trips the breaker.

These relays are also adjustable so they can be set to open the circuit-breaker at the desired amount of reversed current.

### 79. CIRCUIT-BREAKER CARE AND MOUNTING

Circuit-breakers are one of the most important pieces of switchgear and afford a great deal of protection to the electrical machinery on their circuits as well as to operators. They should be kept in good repair and adjustment, and should be frequently tested to be sure that they will open freely and quickly when necessary. The main contacts should be kept clean and well fitted, and arcing contacts should be renewed when badly burned. Operating springs and trip coils should be kept carefully adjusted.

Heavy-duty circuit-breakers require considerable force on the handle to close them, and also deliver quite a shock to the switchboard when they fly open. For this reason, switchboard panels carrying heavy breakers should be thick enough and sufficiently well braced to provide a rugged mounting for the breaker, and to prevent vibration of the board when the breaker is operated.

Fig. 69 shows a large circuit-breaker which also has a motor for automatically reclosing it. Such breakers can be equipped for remote control by the operator or for automatic reclosing by a time element or relay, after the breaker has been tripped open for a certain definite period.

### 80. INSTRUMENT SWITCHES

In addition to the knife switches and circuit-breakers, special switches are used for the switching and control of motor circuits. These may be of the **plug type**, **pull and push button type**, or **rotary button type**. These switches are mounted in openings drilled through the board, so that the handles or buttons project from the face of the board; and the switch element is mounted on the rear for con-

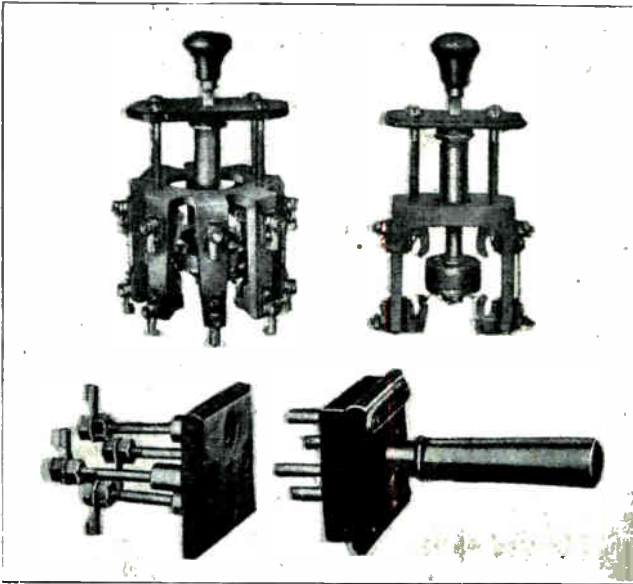

Fig. 70. Instrument switches of the above types are frequently used for changing the connections of various meters to different switchboard panels and busses.

venient connections to the smaller wires of instruments and relays.

Fig. 70 shows two instrument switches of the pull and push type in the upper view and one of the plug type in the lower view.

### 81. BUS BARS. MATERIALS AND MOUNTING

Copper bus bars are commonly used for connecting together the various switches, circuit breakers, and heavy power circuits on switchboards. Long busses are usually mounted on insulators attached to the rear of the switchboard frame or panels, while short lengths may be supported by the studs or bolts to which they connect.

Bus bars are generally run bare for the lower voltages up to 750 or, in some plants, even higher. Busses for higher voltages can be wrapped with varnished cloth or friction tape after they are installed.

Copper bus bar materials can usually be obtained in sizes from  $\frac{1}{8}$ " to  $\frac{1}{2}$ " in thickness, and from 1" to 4", or even 6" wide. When very heavy currents are to be carried, several bus bars are usually run in parallel and mounted with their flat sides vertical, as shown in the right-hand view in Fig. 71.

This arrangement of the busses allows air to circulate freely through them and helps to keep them cool. The view on the right in Fig. 71 shows two separate busses, "A" and "B", each consisting of three bars. One set is the positive bus and one is negative. Both sets are mounted in a base of insulating material, shown at "C", and supported by metal brackets attached to the switchboard frame.

The insulation used for mounting and spacing the bars can be hard fibre, slate, bakelite, or ebony asbestos.

In the left view in Fig. 71 is shown a single bus bar supported by a porcelain bus insulator.

Busses of opposite polarity and for voltages up to 750 should be spaced several inches apart wherever possible. When they are run closer together they should be well mounted and braced so they cannot easily be bent or vibrated together.

### 82. CONNECTING BUS BARS TOGETHER

Where bus bars are joined together, they can be fastened either by means of bolts through holes drilled in the copper or by bus clamps which do not require drilling the bars.

Fig. 72 illustrates the use of a common type bus clamp, consisting of two triangular pieces with three holes for the bolts which draw the parts of the clamp up tightly and grip the bars together. These clamps are very easy to install, as they do not require any drilling of the bars.

Copper bus bars can be cut to the proper length with a hack saw; and where bolts are used for connections the bars can be drilled with an ordinary metal drill.

Fig. 73 shows the method of connecting bus bars to the studs of switches or circuit-breakers, by means of two nuts and a short strip of bar connected to the main bus by a clamp. All joints and connections in bus bars should be made tight and secure, to avoid overheating when the current flows through them. Where the sections join the copper should be well cleaned of all dirt and oxide.

Copper bus bars of the smaller and medium sizes can be easily bent to various angles where necessary, but care should be used not to bend the corners too sharply and cause the bar to crack.

In locations where the busses are well ventilated, it is common practice to allow about 1000 amperes per square inch of cross-sectional area of the bars.

### 83. EXPANSION JOINTS OR LOOPS IN BUSES

Where long busses are run, some allowance should be made for expansion and contraction with changes in temperature, or sufficient strains may be set up to warp the busses or crack the switchboard panels by twisting the studs.

A special loop or "U"-bend is sometimes put in a long bus to absorb this expansion in the spring of

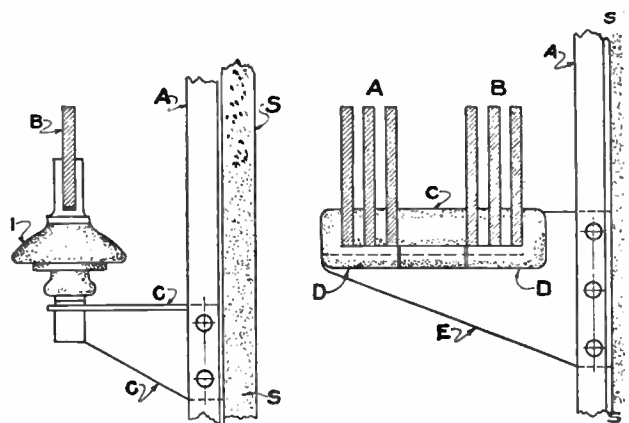

Fig. 71. The above diagrams show methods of mounting and installing bus bars on the back of switchboards.



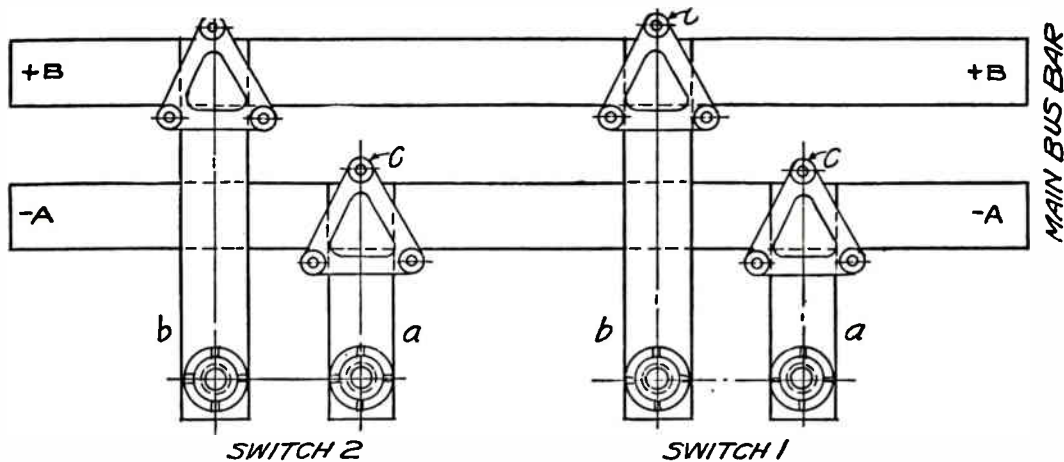

Fig. 72. Bus bars can be connected together by means of special clamps as shown above. These clamp pieces are held securely gripped to the busses by means of short bolts through the holes in their three corners. Clamps of this type save the trouble of drilling the copper busses.

the bend. In other cases, bus ends can be overlapped and held fairly tight with two bus clamps, but not tight enough to prevent the lapped ends from sliding on each other under heavy strains. One or more short pieces of flexible cable can then be connected around this joint to carry the current without heating. The cable ends should be soldered into copper lugs, and these securely bolted to the bus on each side of the slip joint.

#### 84. SWITCHBOARD LAYOUT AND CIRCUITS

It is not a difficult matter to lay out and erect an ordinary switchboard for a small power plant or distribution center.

A plan should be laid out on paper for the required number of circuits. The desired switches, circuit-breakers, and meters for the control and measurement of the power, should be included in this sketch or plan.

After the load has been determined for the various circuits, the size of the switches and devices for the proper current ratings can be obtained from the manufacturer's specifications.

Panels can then be selected large enough to hold these devices in neat, uncrowded arrangement.

The simplest type of switchboard would at least contain switches for each of the main circuits and feeder circuits. There should also be on each of these circuits some form of overload protection, such as fuses or circuit-breakers.

On circuits of not over 500 amperes capacity and

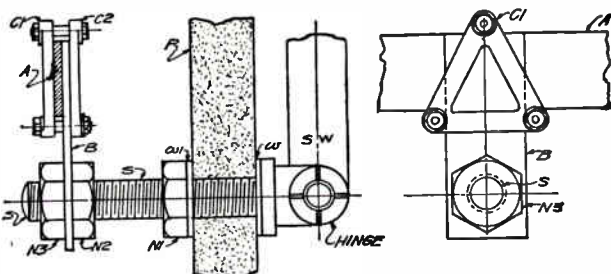

Fig. 73. Two views showing the method of connecting bus bars to the studs of switches and circuit breakers.

which are very seldom subject to overload, cartridge fuses will provide economical overload protection.

On heavy power circuits or any circuits which are subject to frequent overloads or occasional short circuits, circuit-breakers should be used. Circuit-breakers eliminate the replacement of fuse links and enable the circuit to be closed back into operation more quickly.

Usually it will be desired to measure the load in amperes on some of the circuits, if not on all of them. Ammeters of the proper size should be used for this purpose.

Where only one generator is used, one voltmeter may be sufficient to check the voltage of the main busses. Where several generators are operated in parallel, we will need one voltmeter for the main bus and probably one for each generator, in order to check their voltages before connecting them in parallel.

Sometimes one extra voltmeter is used for checking the voltage of any one of the generators which is being started up. This is done by the use of a voltmeter bus and plug switches for connecting the meter to whichever machine is being started up. A meter used in this manner is often mounted on a hinged bracket at the end of the switchboard, as shown in Fig. 59.

Wattmeters are often used to obtain instantaneous readings of the power in certain circuits. Watt-hour meters may be installed for showing the total power consumed per hour, per day, or per month, on any circuit.

In medium and larger sized plants, recording voltmeters and ammeters are often used to keep a daily record of the voltage and current variations. These instruments will be explained in a later section on D. C. meters.

#### 85. SWITCHBOARD WIRING

Fig. 74 shows a wiring diagram for a simple D. C. switchboard with three panels, as shown by the dotted lines. The main generator-control panel is on the left, and contains the main switch, circuit-

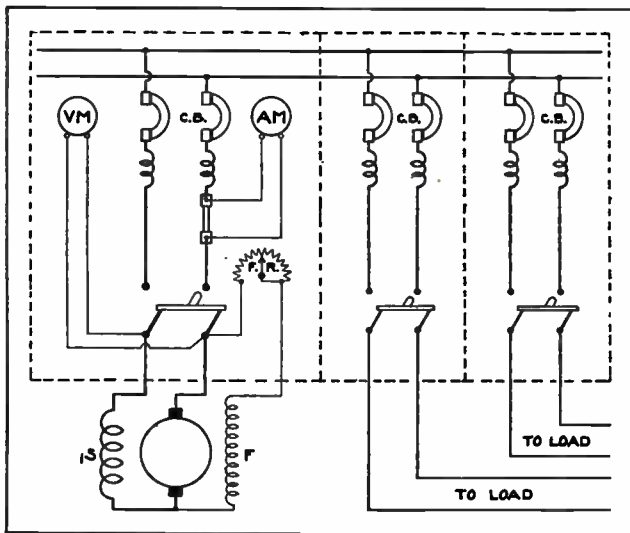

Fig. 74. The above diagram shows the wiring and equipment for a simple switchboard with one generator panel and two distribution panels.

breaker, voltmeter, ammeter and shunt, and the shunt field rheostat.

The two feeder panels on the right merely have switches and circuit breakers in each circuit.

Note that the circuit breakers and knife switches are in series in each circuit; so that, when the breaker in any circuit is tripped, there will be no current flowing through the switch.

The coils in series with each pole of the circuit-breakers are the series overload-release coils, which trip the breakers in case of an overload of current.

Note that the voltmeter is connected on the generator side of the main switch, so a reading of the generator voltage can be obtained before the machine is connected to the busses.

Fig. 75 shows a wiring diagram for a switchboard with two generator panels and two sub-panels or feeder panels. A number of feeder panels could be added to either side of this board if necessary.

Equalizer connections are shown for the generators, which are compound and are to be operated in parallel.

The circuit-breaker trip-coils are not shown in this diagram.

Circuits for switchboard instruments and meters which do not require heavy currents, are usually made with No. 12 or No. 14 switchboard wire, which has white colored slow-burning insulation. These wires can be held on the back of the board with small metal clamps and screws.

Examine the wiring and check the locations and connections of the various devices shown in Fig. 75.

### 86. LOCATION OF METERS AND SWITCHGEAR

Refer again to Fig. 59 and note the positions and arrangement of the various switchgear and devices on the board. Knife switches are usually mounted so their handles come about in the center of the board height, or a little lower, as this height is very convenient for their operation. Watthour and recording meters are frequently mounted along the lower panel-sections, underneath the knife switches.

Voltmeters and ammeters are usually placed above the knife switches, at about eye level or a little above, so they can be easily read.

Circuit-breakers are commonly placed at the top of the board, so any smoke or flame from their arcs cannot reach other instruments or blacken and burn the switchboard.

When air circuit-breakers open under severe overloads or short circuits, they often draw long, hot arcs. The flame, heat, and smoke from these arcs are driven upward by their own heat. Therefore, if meters or instruments were located above the breakers and close to them, they would be likely to be damaged.

Mounting the breakers at the top of the boards also places them up high enough so operators are not likely to be bumped or burned when the breakers fly open or, as we say, "kick out".

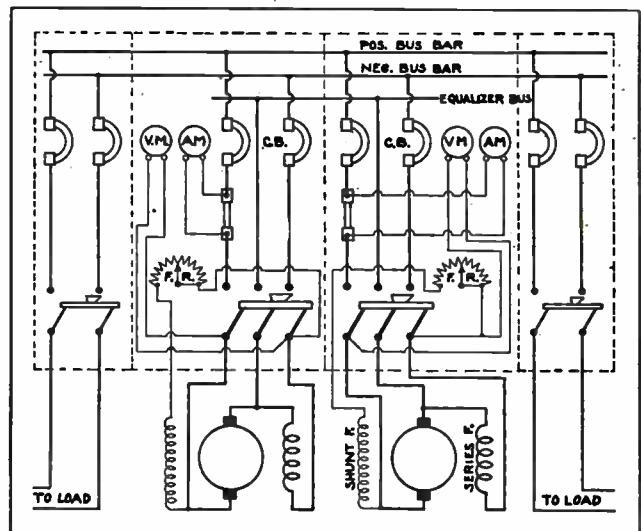

Fig. 75. Wiring diagram for a D. C. switchboard with two main generator panels and two or more feeder panels. Additional feeder panels would be connected to the board and busses the same as the two which are shown. Note carefully the arrangement of all of the parts and circuits shown in this diagram.

## DIRECT CURRENT METERS

Electrical meters are used for accurately measuring the pressure, current, and power in various electrical circuits. There are a great number of types of meters, some of which are used only in laboratory work and others that are more commonly used in every-day work by the practical man.

These latter types are the ones which we will principally consider in this section. The meters most frequently used by electricians and operators are the voltmeter, ammeter, and wattmeter. These instruments are made both in portable types and for switchboard mounting.

### 87. TYPES OF METERS

The portable meters are used for convenient testing of machines and equipment wherever they are located, while the switchboard types are permanently mounted on switchboards for measuring the energy of certain circuits on these boards.

Voltmeters and ammeters are also made in recording types, which keep a record of their various readings throughout certain periods of time.

Wattmeters are divided into two general classes, called *indicating* and *integrating*.

The indicating instrument merely indicates the power in the circuit at any instant at which it is read. Integrating wattmeters, or watt-hour meters as they are commonly called, keep summing up the total amount of energy in kilowatt hours which is used throughout any certain period of their operation.

### 88. PARTS AND CONSTRUCTION OF D. C. METERS

Most meters operate on magnetic principles or use the magnetic effect of electric currents to produce the movement of the meter needle.

Ordinary D. C. voltmeters and ammeters, consist

of a permanent magnet of horse-shoe shape which supplies a magnetic flux or field, a delicately balanced coil of fine wire which is rotated in this field, a pointer, scale, and case.

Fig. 76 shows the principal parts of a meter of this type, with the case or cover removed. The poles of the permanent magnet are equipped with pole shoes which have curved faces to distribute the flux evenly over the rotating element. In the center of the space between the magnet poles can be seen a round soft iron core which aids in concentrating and distributing the magnetic field over the space in which the coil moves. The needle is attached to this rotating or moving element so it will swing across the scale when the coil is rotated. This type of construction is known as the D'Arsonval, because it was first developed by a Frenchman named D'Arsonval.

Fig. 76-A shows a separate view of the moving coil with the needle attached. Also note the small coil-spring on each end of the moving coil. This coil is usually wound with very fine wire on a light-weight aluminum frame, the shaft of which is then set in jeweled pivots made of first-grade sapphires. These pivots make it possible for the coil to move with an extremely small amount of energy which makes the instrument very sensitive and accurate.

### 89. OPERATING PRINCIPLES OF D. C. VOLTMETERS AND AMMETERS

The operating principles of meters of this type are very similar to those of a D. C. motor. When a small amount of current is sent through the turns of the moving coil, it sets up around this coil a flux which reacts with the flux of the permanent magnet field and exerts torque to turn the moving coil against the action of the fine coil springs. The coil springs tend to hold the pointer, in normal or zero position, usually at the left side of the scale.

The greater the current passed through the moving coil, the stronger will be its flux; and the reaction between this flux and that of the permanent magnet will tend to move the needle across the scale, until the magnetic force is balanced by the force of the springs.

The amount of voltage applied to the coil will determine the amount of current flow through it. So the distance that the pointer is moved across the scale will indicate the amount of voltage or current in the circuit to which the meter is attached.

The same type of meter element can be used for either a voltmeter or ammeter, according to the manner in which the instrument is connected to the circuit to be measured.

The permanent magnets used with good-grade meters are made of the best quality of steel, and are usually aged before they are used in the meters. This aging process leaves them with a certain

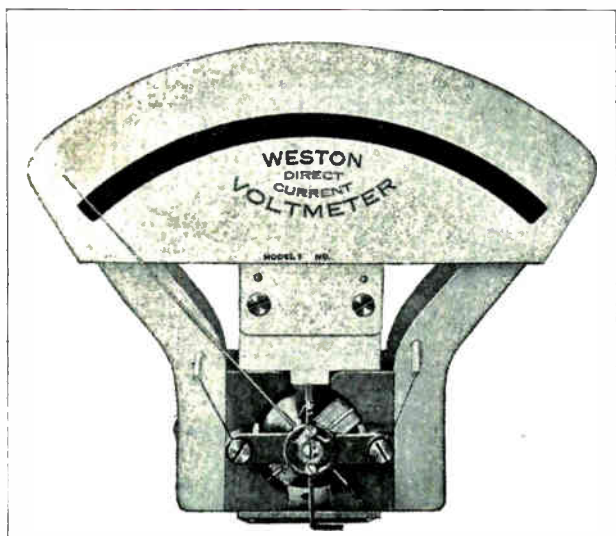

Fig. 76. The above view shows the important parts of a D. C. voltmeter. Note the horse-shoe magnet which provides the magnetic field in which the movable coil rotates. The movable coil with the pointer attached can also be seen between the magnet poles.

amount of magnetic strength, which they will retain for very long periods without noticeable weakening.

The pole shoes are made of good-grade soft iron to provide a low reluctance path for the flux of the permanent magnets. An additional stationary core of soft iron is often placed within the rotating coil, to provide a better magnetic path between the pole shoes, and to more evenly distribute the flux.

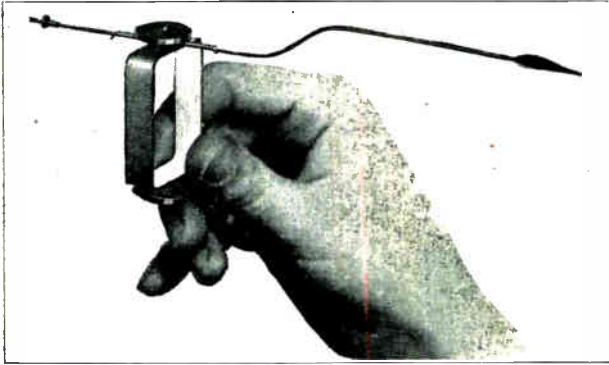

Fig. 76-A. An excellent view of the movable coil, pointer and spring of a D. C. meter.

#### 90. DAMPING OF METER NEEDLES OR POINTERS

As the aluminum coil-frame is rotated through the flux of a meter of this type, small eddy currents are induced in the frame. These tend to set up a damping effect which slows or retards the rapid movement of the coil and needle, making the instrument more stable and preventing the needle from vibrating back and forth with small fluctuations in the voltage or current.

Some instruments have a light-weight air-vane attached to the needle, to provide a further damping effect and to prevent the needle from striking against the case at the end of the scale when sudden increases occur in the voltage or current of the circuit.

Small rubber cushions, or "stops", mounted on light wire springs are usually provided at each end of the scale to limit the needle travel and prevent it from striking against the case. These stops can be seen in Fig. 76.

Meter scales are usually printed in black on a white cardboard background, and are located directly behind the pointers, as shown in Fig. 77.

To obtain very accurate readings, some instruments have a mirror strip parallel to the scale and directly behind the pointer. In reading a meter of this type, one should stand in such a position that the pointer covers its own reflection on the mirror. This eliminates viewing the meter from an angle and perhaps reading the voltage or current at a scale line which is not directly under the pointer.

The instrument shown in Fig. 77 is one for switchboard use and is designed to be mounted flush with the surface of the board by setting the case in an opening cut in the switchboard panel. This meter is provided with a marker, or additional black needle with a round head, which can be set

in any desired position on the scale by turning the button on the front of the case. This makes it easy to tell when the voltage of the generator or circuit has reached normal value, as the moving needle would then be directly over the marker.

#### 91. CARE AND ADJUSTMENT OF METERS

Because of the delicate construction of the moving coils and the manner in which they are mounted in jeweled bearings, electric meters should be very carefully handled when they are being moved about; because, if they are dropped or severely jarred it may damage the mechanism and cause their readings to be inaccurate. Jarring also tends to weaken the permanent magnets. Meters should not be mounted where they are subject to severe vibration or mechanical shocks.

On many meters adjustments are provided by means of which the tension on the coil spring can be regulated by a small screw, thereby correcting any slight inaccuracies in the meter reading. Pivot screws should be kept tight enough to prevent too much end play of the shaft and coil, but never tight enough to keep the coil from moving freely.

#### 92. VOLTMETERS

When meter elements of the type just described are used for voltmeters, the moving coil is connected in parallel, or across the positive and negative wires of the circuit on which the voltage is to be measured.

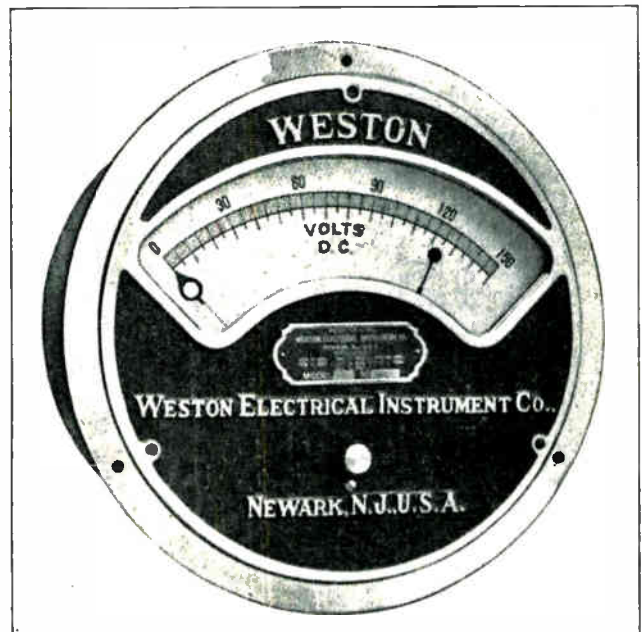

Fig. 77. Switchboard type voltmeter for mounting flush with the surface of the board. Note the stationary index pointer or marker, to indicate when full voltage is reached by the movable pointer.

It is difficult to wind a sufficient number of turns on the moving coil to have high enough resistance to stand the full line voltage on ordinary power and light circuits. For this reason, special resistance coils are connected in series with the moving coil element and the meter terminals, as shown in Fig. 78.

These resistance coils limit the current flow through the meter to a very small fraction of an ampere, and thereby allow the meter element to be constructed of light weight and as delicately balanced as required for accuracy. Voltmeter resistance coils can be located either inside the case or outside. Portable instruments usually have them located within the case, while with switchboard instruments the resistance coils are sometimes mounted on the back of the switchboard behind the instrument.

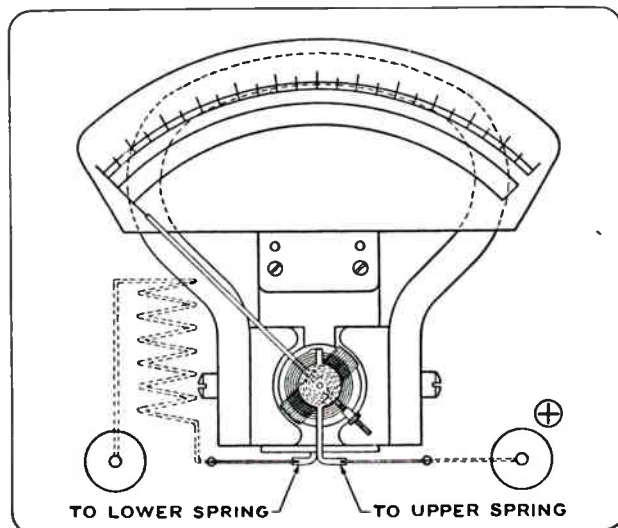

Fig. 78. This diagram shows the parts also the connections for a D. C. voltmeter.

By changing the number of these coils in series, or by changing their size and resistance, we can often adapt the same meter element for use on circuits of different voltages. When a meter is changed in this manner to operate on a different voltage, a different scale will probably also be required.

Fig. 79 shows a view of the inside of a voltmeter in which are mounted four resistance coils that are connected in series with a meter element.

Fig. 80 shows two types of external voltmeter resistance coils that can be used for mounting on the rear of the boards with voltmeters for switchboard use. With these resistance coils in series with the voltmeter element, it requires only a few milli-volts across the terminals of the moving coil itself to send through it enough current to operate the meter. Therefore, when the instrument is used without the resistance coils it can be connected directly to very low voltage circuits of one volt or less, and used as a milli-volt meter.

Whether it is used with or without the resistance coils, the strength of the flux of the moving coil and the amount of movement of the needle will depend entirely upon the voltage applied, because the current through the coil is directly proportional to this voltage.

Any type of voltmeter, whether for portable or switchboard use, should always be connected across the circuit, as shown in Fig. 81 at "A".

### 93. AMMETERS AND AMMETER SHUNTS

The construction and parts of an ordinary D.C. ammeter are the same as those of the voltmeter. When the instrument is used as an ammeter, the terminals of the moving coil are connected in parallel with an ammeter shunt, and this shunt is connected in series with the one side of the circuit to be measured, as shown in Fig. 81-B.

The ammeter shunt is simply a piece of low resistance metal, the resistance of which has a fixed relation to that of the ammeter coil. The load current in flowing through this shunt causes a voltage drop of just a few milli-volts and this is the voltage applied to the terminals of the ammeter coil.

In other words, the meter element simply measures the milli-volt drop across the shunt; but, as this drop is always proportional to the current flowing through the shunt, the meter can be made so that the load in amperes can be read directly from the meter scale.

This principle can be explained by another method, as follows: We know that electric current will always divide through any number of parallel paths which it is given. As the ammeter shunt is connected in parallel with the instrument coil and is of much lower resistance than this coil, the greater part of the load current passes through the shunt, and only a very small fraction of the current flows through the meter coil.

The use of a shunt in this manner eliminates the necessity of constructing meter coils large enough to carry the load current. This would be practically impossible on meters of this style for heavy duty circuits. Shunts also make possible the use of the same type of moving coil element for either ammeters or voltmeters.

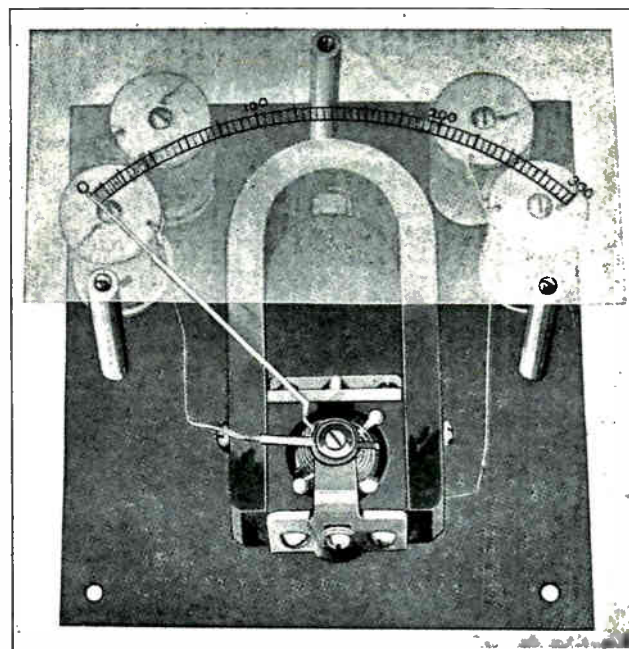

Fig. 79. The above view shows a D. C. voltmeter of a slightly different type, with the case removed to show the resistance coils which are connected in series with the movable element.

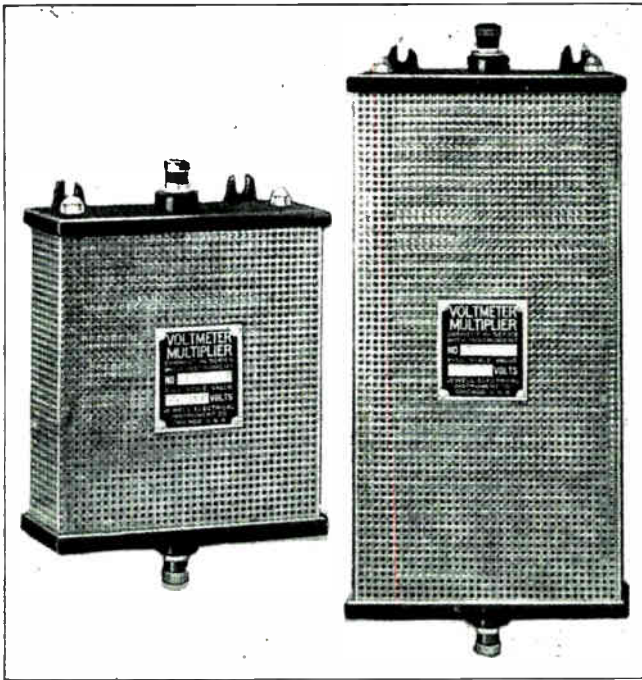

Fig. 80. External resistors for use with voltmeters and wattmeters. Resistors of this type are to be mounted outside the meter case, and usually on the rear of the switchboard

Ammeter shunts for portable instruments are usually mounted inside the instrument case; and for switchboard instruments on heavy power circuits, the shunt is usually mounted on the rear of the switchboard.

To obtain accurate readings on the meters, ammeter shunts should be made of material the resistance of which will not change materially with ordinary changes in temperature, as the shunt may become heated to a certain extent by the flow of the load current through it. The material commonly used for these shunts is an alloy of copper, manganese, and nickle, and is called "manganin". This alloy has a temperature co-efficient of almost zero; in other words, its resistance doesn't vary any appreciable amount with changes in its temperature. Manganin is used also because it doesn't develop thermo-electric currents from its contact with the copper terminals at its ends.

Ammeter shunts for use with D.C. ammeters are made in sizes up to several thousand amperes capacity. Fig. 82 shows several sizes and types of these shunts. Note the manner in which the strips of alloy are assembled in parallel between the bus connector stubs. This allows air circulation through the shunt to cool it.

#### 94. CONNECTION OF AMMETERS AND SHUNTS

Remember that ammeter shunts or ammeters must always be connected in series with the line and never in parallel. The resistance of meter shunts is very low and if they were connected in parallel across positive and negative wires of a circuit, they would produce a severe short circuit,

which on heavy circuits would be dangerous to the person connecting the meter and would at least blow the fuse and kick out circuit breakers. It would also probably burn out the meter or destroy the shunt.

Fig. 83 shows a common type of portable meter, such as is used in testing various electrical machines and circuits. The protective case and convenient carrying handle make these instruments very handy for use on the job. Voltmeters, ammeters, and wattmeters of this type are very essential in any plant where a large number of electric machines are to be maintained.

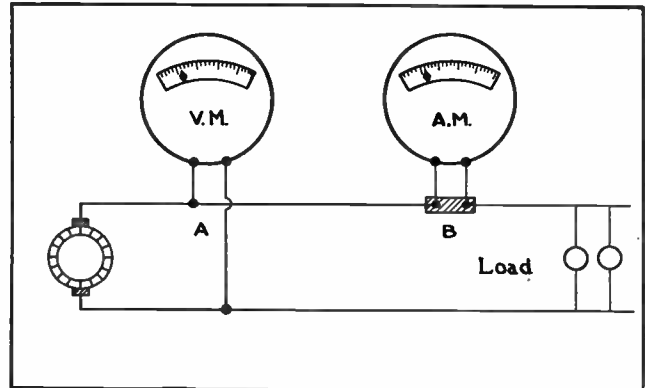

Fig. 81. This diagram shows the proper methods of connecting voltmeters and ammeters to electric circuits. Note carefully the manner of connecting voltmeters in parallel with the line and ammeters or their shunts in series with the line.

Testing the voltage and current of motors of different sizes will often disclose an overload or defective condition in time to prevent a complete burnout or serious damage to the machine windings.

Some portable instruments have two separate elements in the case and two separate scales, one for a voltmeter and one for an ammeter. Portable instruments of this type are very convenient for tests, but extreme care must be used to be sure to connect the voltmeter terminals in parallel and the ammeter terminals in series with any circuit to be tested.

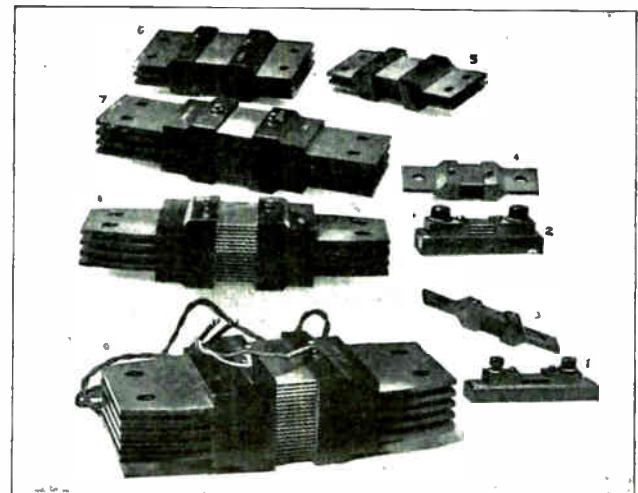

Fig. 82. The above photo shows several sizes and types of ammeter shunts which are generally used with ammeters where heavy loads are to be measured.

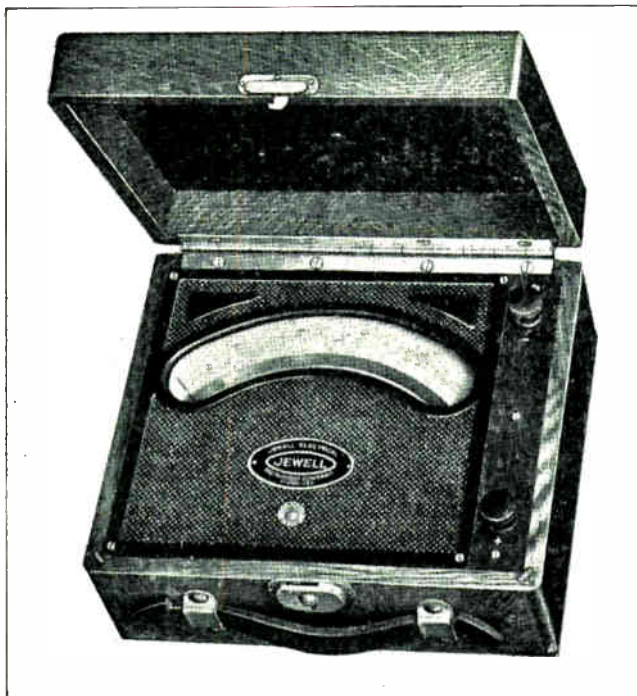

Fig. 83. Portable meters of the above type are very convenient and necessary devices for the practical electrician to use in testing various machines and circuits.

D. C. meters must be connected to the line with the proper polarity, and their terminals are usually marked "positive" and "negative", as shown in Fig. 84. If meters of this type are connected to the line with wrong polarity, the needle will tend to move backwards and will be forced against the stop wire or the meter case at the zero end of the scale.

The meter shown in Fig. 84 is another type of switchboard meter for surface mounting. This instrument doesn't require cutting any opening in the switchboard panel, since the meter is mounted flat against the front surface of the panel.

Fig. 85 shows another type of switchboard meter commonly used in power plants. Meters of this style often have the scale illuminated by electric lamps placed behind it. This makes the meter easier to read when the operator is some distance away, or working at the other end of the switchboard.

These meters are often mounted on a hinged bracket at the end of the switchboard so that they can be seen from any point along the board.

### 95. INDICATING WATTMETERS

Wattmeters, as previously mentioned, are used for measuring the power of circuits in watts. As this power is proportional to both the voltage and amperage of the circuit, wattmeters use two coils, one of which is known as the voltage or potential element, and the other as the current element.

The potential element is connected across the line, similarly to a voltmeter coil; while the current element is connected in series with one side of the line, similarly to an ammeter coil.

A diagram of the internal wiring and the connections of a wattmeter is shown in Fig. 86.

The potential coil is the movable element and is wound with very fine wire and connected in series with resistance coils, similarly to those used in the voltmeter. As this coil is connected across the line, the strength of its flux will always be proportional to the line voltage.

The current element is stationary and consists of a few turns of larger wire. As this coil is connected in series with the line, its strength will be proportional to the load and the current which is flowing. This current element supplies the field and takes the place of the permanent magnet used in voltmeters and ammeters.

As the turning effort, or torque, exerted on the movable coil is the result of reaction between its flux and the flux of the current element, the pointer movement will always be proportional to the product of these two fields and will, therefore, read the power in watts directly from the scale.

The coils of these instruments are not wound on iron cores but are wound on non-magnetic spools or in some cases the wires are stiff enough to hold their own shape in the coils. Wattmeters of this same design can be used on either D.C. or A.C., as they will read correctly on A.C. circuits if the reactances of both the moving and stationary coils are equal.

Wattmeters are designed for different amounts of voltage and current and should never be used on circuits with a greater amount of power in watts than they are rated for, nor circuits with higher voltage or heavier currents than the instruments are designed for.

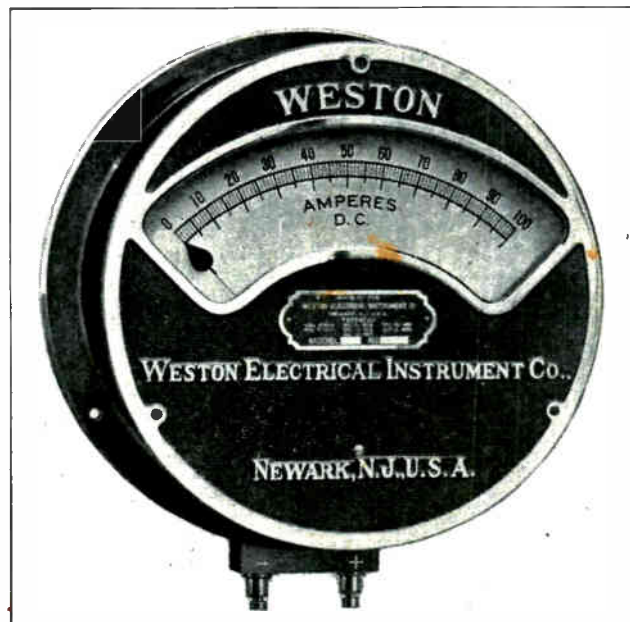

Fig. 84. Switchboard type ammeter for surface mounting. This meter does not require any large opening to be cut in the switchboard panel.

The terminals for the potential and current elements can be distinguished by their size, as those of the current element are usually much larger than those of the potential element. Extreme care should

be used never to connect these in the wrong relation to the circuit, because if the current coil is connected across the line, a short circuit will result.

Fig. 87 shows the internal construction of a D.C. wattmeter. In this view the current coils, consisting of a few turns of heavy wire, can be plainly seen. The potential coil cannot be seen, however, as it is inside of the current coil.

## 96. WATTHOUR METERS

The common type of meter used in homes, factories, and power plants for measuring in kilowatt hours the total amount of power used during any certain period, is known as a watthour meter.

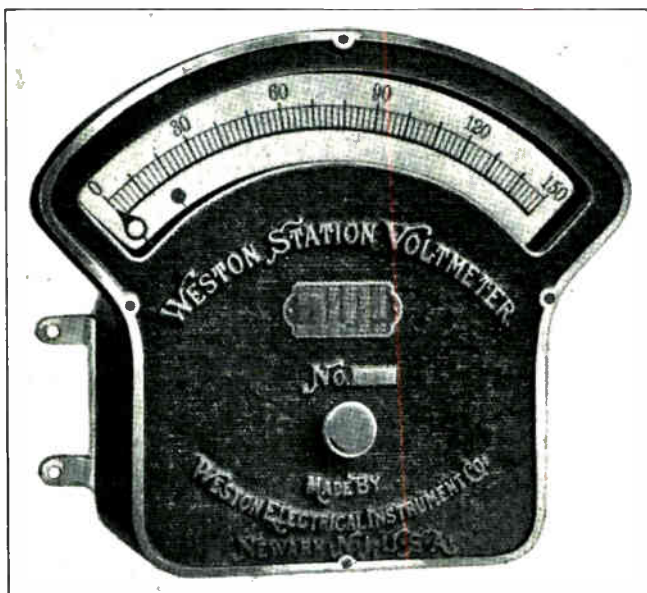

Fig. 85. The above view shows a large voltmeter of the type commonly used on power plant switchboards. The scale of these meters can be illuminated with lamps placed behind them so the meter can be read from any place along the board.

These meters have a current and potential element somewhat similar to those in the indicating wattmeter. The potential element, however, is allowed to revolve continuously, like the armature of a D. C. motor, as long as there is any load on the circuit line to which the meter is attached.

This element is not limited to a fraction of a turn by the coil springs, as in the case of indicating meters, but is mounted on a vertical shaft set in jeweled bearings and is free to revolve completely around, with the application of very small torque.

This rotating element is connected to a series of gears which operate the hands or pointers on the clock-like dials of these instruments. The current element consists of a few turns of large wire and is connected in series with the line, or in parallel with an ammeter shunt which is connected in series with the line. This stationary current coil provides a magnetic field similar to that of a D.C. motor, and in which the potential coil or armature element rotates.

## 97. PRINCIPLES OF WATTHOUR METERS

The potential element, being connected across the

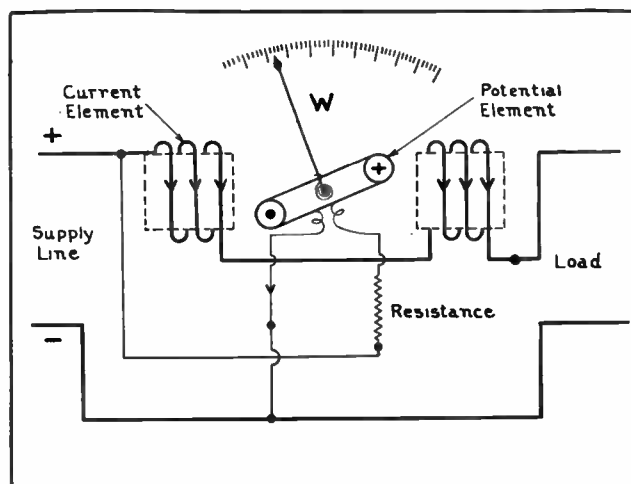

Fig. 86. This diagram shows the potential and current coils of a wattmeter. Note the manner in which each of these elements are connected in the circuit. The movable coil is shown in a sectional view so you can observe the direction of current through its turns and note how the flux of this movable coil will react with that of the current coils and cause the pointer to move.

positive and negative leads of the line, is always excited and has a very small current flowing through it as long as it is connected to the circuit. This coil usually has additional resistance coils placed in series with it, to limit the current flow to a very small value. Therefore it doesn't waste any appreciable amount of current by being permanently connected across the line.

As long as no load current is flowing through the line and the current element of the meter, there is no field flux for the flux of the potential coil to react with, and so it doesn't turn. As soon as load is applied to the line and current starts to flow through the stationary coils, it sets up a field which reacts with that of the potential coil, causing the latter to start to turn.

The greater the load of current, the stronger will

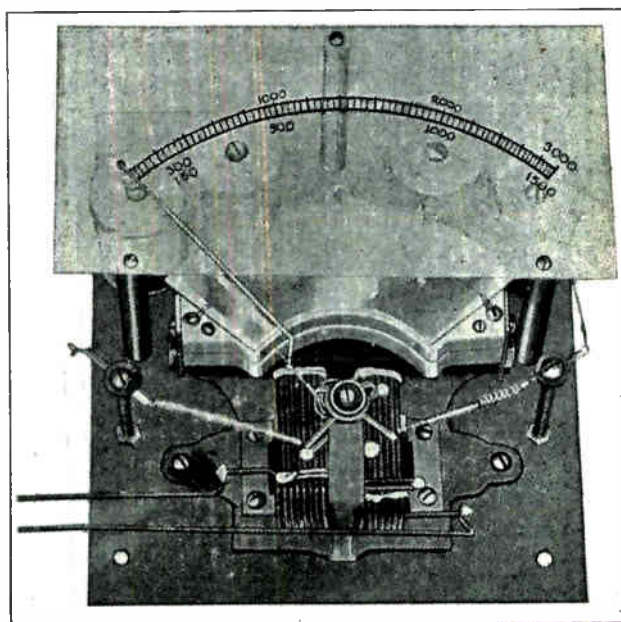

Fig. 87. This view shows the current coils, resistor coils, and general construction of a common type wattmeter.



be this field and the faster will be the rotation of the potential element or armature. This will cause the pointers on the dials to revolve faster and total up power more rapidly. The longer the load is left on the circuit, the farther these pointers will be revolved and the greater will be the total power reading.

### 98. CONSTRUCTION OF POTENTIAL AND CURRENT COILS

Fig. 88 shows three views of the armature or potential element of a watthour meter, both partly wound and completely wound. The coils of fine wire are wound on a drum or hollow ball of light weight non-magnetic material and are held in place by a coating of insulating compound. You will note that they are wound similarly to the coils of a simple D.C. motor armature. The leads of the coils are brought up to a very small commutator located on the top end of the shaft at the right.

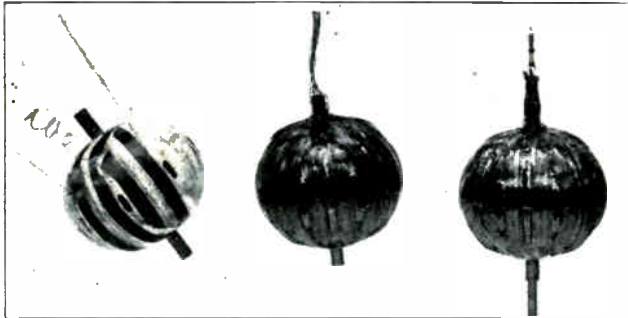

Fig. 88. The above photo shows several potential or armature coils of watthour meters and illustrates the manner in which they are wound.

Fig. 89 shows both the current coils and potential coil of a watthour meter. The current coils are wound of heavy copper strip and are each divided in two sections. They are mounted close to the potential or rotating element, which can be seen just inside of them. You will note at the top of this figure the very small metal brushes mounted on wire springs and in contact with the small commutator to which the leads of the potential element are attached. Directly above this commutator is the small wormgear which drives the series of small gears that operate the dials. The brushes of the meter are connected in series with the proper resistance coils and then across the line wires, and they complete the circuit through the potential element, or armature, of the meter.

These brushes are commonly made of silver or some very good conducting material, in order to prevent resistance and voltage drop at the brush contact with the commutator.

### 99. DAMPING DISK AND MAGNETS

The speed at which the armature of the watthour meter will rotate depends upon the voltage applied to the potential element and the current flowing through the current element. Because of the very slow speed at which this armature revolves, its

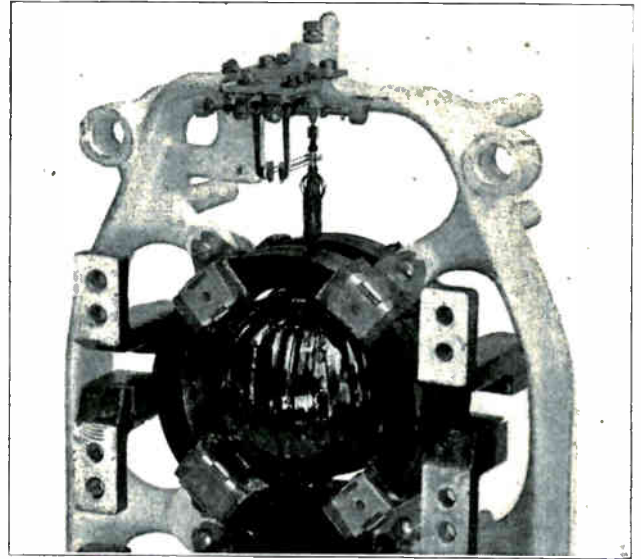

Fig. 89. This view shows the potential and current coils and also the commutator and brushes of a watthour meter.

speed is not regulated by counter-E.M.F., as armatures of direct current motors are.

In order to prevent over-speeding and to make the driving torque remain proportional to the power applied, the motor armature must have some damping or retarding effect to oppose the torque exerted by the magnetic fields. This counter-torque is obtained by mounting a thin aluminum disk upon the lower end of the armature shaft, and allowing it to rotate in the field of one or more permanent magnets of the horse-shoe type. This disk and the damping magnets can be seen in the lower part of the meter, shown in Fig. 90 with the cover removed.

As the aluminum disk is rotated, it cuts through the lines of force from the magnet poles and this generates eddy currents in the disk. The reaction between the flux of these eddy currents and that of the magnets tends to oppose rotation, just as placing a load upon a generator will produce counter-torque and require effort from the prime mover to turn it.

The induced eddy currents will be proportional to the speed of rotation of the disk and, as the flux of the permanent magnets is constant, the counter-torque exerted by the disk will be proportional to the product of the flux from these eddy currents and that from the permanent magnets.

When the load on the meter is increased, the speed of its armature increases, until the counter-torque developed by the disk just balances the torque exerted by the armature. In this manner, the armature speed is maintained proportional to whatever load is applied to the meter, causing the pointers on the dials to read the correct power in kilowatt hours.

This type of meter is often referred to as a watt-hour meter, but the gears and speed of most of them are so adjusted and of the proper ratio so that the readings will be in kilowatt hours, instead of watt hours.

### 100. ADJUSTING DAMPING EFFECT

The amount of damping effect produced by the disk can be adjusted by moving the poles of the permanent magnets in or out along the disk. If the poles are moved closer to the outer edge of the disk where it will cut their flux at higher speed, a greater amount of eddy current will be induced and cause a greater damping effect, and if the magnet poles are moved closer to the shaft where the disk is traveling at lower speed, the induced eddy currents will be less, and the damping effect will be reduced.

### 101. COMPENSATING COIL

No matter how carefully the armature of a meter of this type may be mounted, there is always a slight amount of friction to offer resistance to its rotation. Some of the energy produced by the meter coils will be required to overcome this friction and the friction of the gears on the dials.

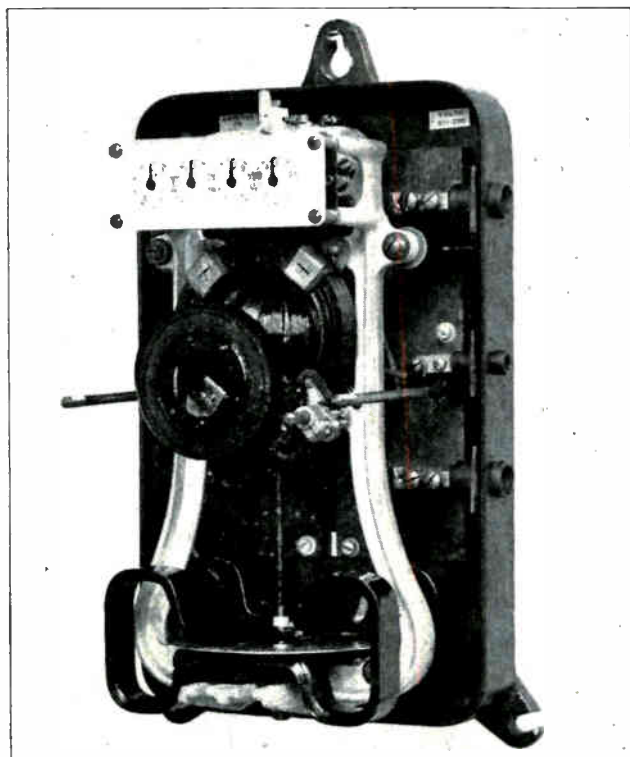

Fig. 90. Complete view of a KW-hour meter with the cover removed clearly showing the dials, current and potential coils, compensating coil, damping disk, and drag magnets.

In order to make a meter register accurately on light loads, this friction should be compensated for. This is done by means of a coil consisting of many turns of fine wire, connected in series with the armature or voltage coil of the meter. This compensating coil is mounted on an adjustable bracket in a position where its flux will react with that of the potential and current coils.

This coil can be seen in front of the current coils and armature of the meter shown in Fig. 90. By having this coil adjustable, it can be moved closer to or farther from the meter coils and its effect can

be accurately adjusted so it will just compensate for the friction, and no more.

Sometimes these coils have a number of taps provided at various sections of the winding and also a small switch to shift the connections to include more or less of the turns of the coil. This also provides an adjustment of the amount of torque the coil will exert to overcome friction.

Fig. 91 shows the coils and connections of a D.C. kilowatt-hour meter. You will note in this figure that the friction compensating coil is connected in series with the armature and resistance coil, and this group are connected across the positive and negative line wires.

Current coils are connected in series with one side of the line so they will carry the full load current. The terminals of a watthour meter of this type are usually marked for the line and load connections, and these connections must, of course, be properly made so that the meter will run in the right direction.

### 102. WATT-HOUR CONSTANT AND TIME ELEMENT

A given amount of power in watts must pass through a watthour meter to produce one revolution of the armature and disk. For example, it may require a flow of energy representing 6 watt-hours, or the equivalent of 6 watts for one hour, to produce one revolution of the meter armature. This amount would be termed the watthour constant of the meter.

Knowing the number of watts per revolution, it only remains to get the total number of revolutions during a certain period of time, in order to know or measure the total amount of energy passed through the meter during that time. As each revolution of the armature is transmitted to the gears which operate the pointers on the dials, the total power in kilowatt hours can be read directly from these dials.

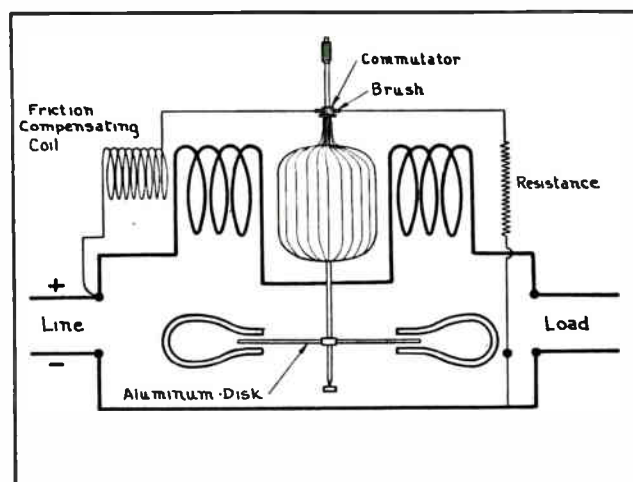

Fig. 91. This diagram shows the coils and circuits of a KW-hour meter and the manner in which they are connected to the line and load.

The operation of the gears and dials or registering mechanism is very simple. The worm-gear on

the upper end of the armature shaft is meshed with the teeth of a gear which is the first of a row or chain of gears all coupled together. This gear has attached to it a small pinion which meshes with the teeth of the next gear and drives it at  $\frac{1}{10}$  the speed of the first one. This second gear, in turn, drives the third gear  $\frac{1}{10}$  as fast as it runs, and the third drives a fourth, the speed of which is again reduced to ten times lower than the third one.

Referring to Fig. 90, when the pointer on the right has made one complete revolution, the pointer on the next dial to the left will have travelled just one division or one-tenth of a revolution.

When the first pointer has made ten revolutions, the second one will have completed one revolution, and the third pointer will have moved one point. When the first pointer completes 100 revolutions, the second will have completed 10; and the third will have completed one revolution.

In this manner the first dial will have to make 1000 revolutions to cause the left-hand dial to complete one revolution.

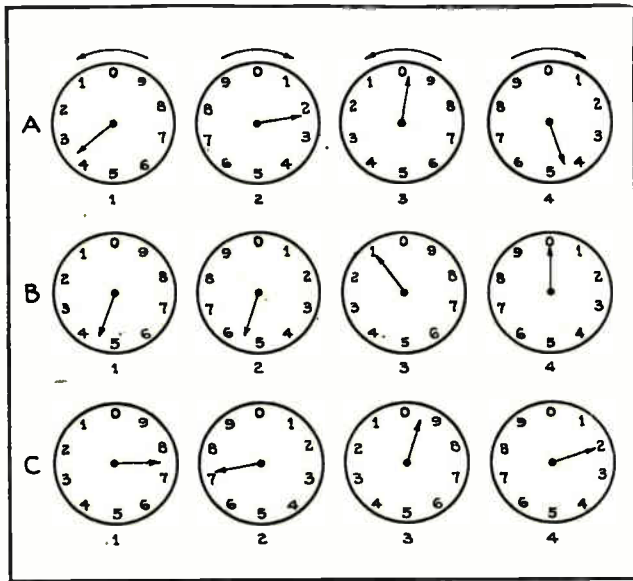

Fig. 92. The above sketches, A, B, C, show the dials of a kilowatt-hour meter in three different positions. If you will practice reading each set of these dials with the instructions here given, you will be able to easily and accurately read any KW-hour meter.

### 103. READING WATTHOUR METERS

By noting the figures at which the pointers stand, in order from left to right, we can read the kilowatt hours indicated by the meter. Some meters used on larger power circuits are adjusted so that their dials and pointers don't show the amount of power directly, but provide a reading which must be multiplied by some certain figure, such as 10, 20, or 50, to obtain the correct total reading. This figure is called a **constant** or **multiplier**, and it should be used whenever reading a meter of this type. This constant, or multiplier, is usually marked beneath the dials of the meter.

When reading kilowatt-hour meters, we should **always read the last number which has been passed by the pointer on any dial**. Some care is required

in doing this until one has had enough practice to do it automatically. If each dial is not carefully observed, mistakes will be made; because **each adjacent pointer revolves in the opposite direction to the last**, as can be seen by the numbers marked on the dials shown in Fig. 92-A.

When the pointer is almost directly over one of the numbers, there may be a question as to whether the pointer has actually passed this number or is still approaching it. This should always be determined by referring to the next dial to the right to see whether or not its pointer has completed its revolution. If it has completed the revolution or passed zero on its dial, the pointer to the left should be read as having passed its number.

If the pointer to the right has not completed its last revolution, the one next to the left should not be read as having passed its number, even though it may appear to be beyond the number.

If the readings are carefully checked in this manner there is very little chance of mistakes.

On the second dial from the left in Fig. 92-A, the pointer revolves in a clockwise direction, and it might easily appear that it has passed the No. 2. By checking with the dial next to the right, however, we find that this pointer, which revolves counter-clockwise, has not quite completed its revolution or passed zero. Therefore, the dial at the left should still be read as No. 1. The correct reading for a meter with the pointers in the position shown in Fig. 92-A would be 3194 kilowatt hours.

The reading for the pointers in Fig. 92-B should be 4510 kilowatt hours. Here again the pointer on dial No. 3 appears to be on figure No. 1; and, by checking with dial No. 4, we find that its pointer is on zero or has just completed a revolution; so it is correct to read dial No. 3 as No. 1.

The reading for the set of dials in Fig. 92-C should be 7692. The pointer on dial No. 2 in this case appears to have passed No. 7; but, by checking with dial No. 3 to the right, we find its pointer has not quite completed its revolution; therefore, the dial to the left should be read as No. 6.

### 104. "CREEPING"

The armature of a watthour meter will sometimes be found to be rotating slowly, even when all load is disconnected from the circuit. This is commonly called **creeping** of the meter. It may be caused by a high resistance ground or a short on the line. The resistance of such a ground or short may not be low enough to cause the fuse to blow, and yet there may be a small amount of current flowing through it at all times.

If the load wires are entirely disconnected from the meter and the disk is still creeping, it may be due to the effects of stray magnetic fields from large conductors which are located near the meter and carrying heavy currents, or it may be caused by the fields from large electrical machines located near by.

For this reason, watthour meters, or for that

matter any other electric meters, should not be located within a few feet of large machines, unless they are magnetically shielded, and they should be kept at least a few inches away from large conductors carrying heavy currents.

Large bus bars or cables carrying currents of several hundred or several thousand amperes set up quite strong magnetic fields around them for distances of several feet, and very strong fields a few inches away from them.

Sometimes a very small load such as a bell transformer or electric clock may cause the meter to rotate very slowly, but this is actual load and not creeping.

Vibration of the building or panel to which the meter is attached may sometimes be the cause of creeping. In some cases this may be stopped by proper adjustment of the compensating coil; or a small iron clip can be placed on the edge of the aluminum disk, if the clip does not rub the damping magnets as the disk revolves.

When this iron clip comes under the poles of the permanent magnets, their attraction for the iron will stop the disk and prevent it from creeping. As long as this clip doesn't touch the permanent magnets, it will not interfere with the accuracy of the meter; because its retarding effect when leaving the poles of the magnets is balanced by its accelerating effect when approaching the poles.



Fig. 93. Common type of recording voltmeter used for keeping an hourly and daily record of the voltages on the system to which it is attached.

## 105. TESTING KILOWATT-HOUR METERS

Kilowatt-hour meters can be tested for accuracy, or calibrated, by comparison with standard portable test instruments.

A known load consisting of a resistance box can be connected to the load terminals of the meter when all other load is off. Then, by counting the revolutions per min. of the disk and comparing this

number with the revolutions made by the disk of a "rotating standard" test instrument, the accuracy of the meter can be determined.

When no standard load box or test instrument is available, a test can be conveniently made with a known load of several lamps or some device of which the wattage is known.

For this test the following formula should be used:

$$\frac{WHK \times 3600 \times R}{W} = \text{seconds}$$

In which:

WHK = the watt-hour constant marked on the meter disk.

3600 = number of seconds in an hour.

R = any chosen number of revolutions of the disk.

W = known load in watts which is connected to the meter.

For example, suppose we wish to test a meter which has a constant of .6, marked on its disk. We can connect a new 200-watt lamp, or two 100-watt lamps across the load terminals of the meter, after all other load has been disconnected. At the instant the lamp load is connected, start counting the revolutions of the meter and observe accurately the amount of time it requires to make a certain number of revolutions. Let us say it is 5 revolutions.

Then, according to the formula, the time required for the disk to make these 5 revolutions should be:

$$\frac{.6 \times 3600 \times 5}{200}, \text{ or } 54 \text{ seconds}$$

If it actually requires longer than this, the meter is running too slow. If the time required to make the 5 revolutions is less than 54 sec., the meter is running too fast.

Remember where to find this formula for future reference, as it may often be very convenient to use.

## 106. RECORDING INSTRUMENTS

In power plants or substations where large amounts of power are generated and handled, it is often very important to keep accurate records of the voltage, current, and power on principal circuits at all hours of the day and night.

Records of this kind will show any unusual variations in load or voltage and they are often the means of effecting great savings and improvements in the operation of power plants and industrial electric machinery.

It is usually not practical for an operator or electrician to keep constant watch of meters to obtain a record of their readings hourly or more often. Recording meters which will mark a continuous record of their readings on a paper chart or disk can be used for this purpose.

## 107. DIRECT-ACTING RECORDING METERS

One of the simplest types of recording instruments uses the ordinary meter element and has a case quite similar to that used for D. C. voltmeters

or ammeters, and has a small ink cup and pen attached to the end of the needle or pointer. This pen rests lightly on a paper disk which is rotated once around every 24 hrs. by a clock-work mechanism inside the meter. See Fig. 93.

As the disk slowly revolves, the pointer pen traces on it a line which shows the movements of the pointer and the variations in voltage or current, whichever the instrument is used to measure.

The paper disks have on them circular lines which represent the voltage or current scale. By the position of the ink line on this scale the voltage or amperage at any point can be determined. Around the outer edge of the disk is marked the time in hours, so the readings for any period of the day can be quickly determined. Fig. 94 shows a disk from a meter of this type.

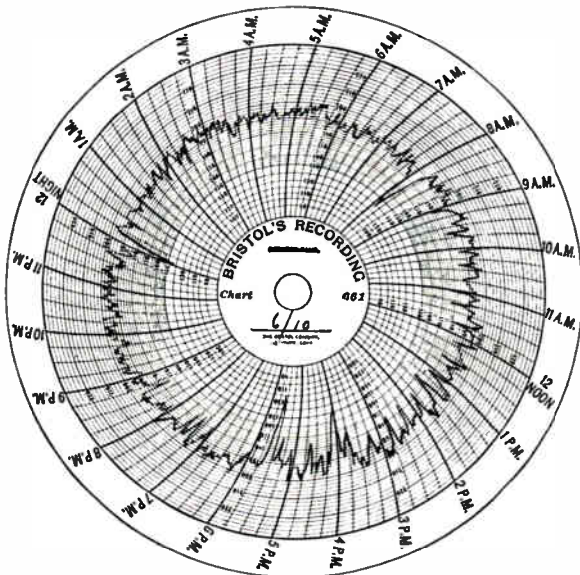

Fig. 94. Paper disk or chart from a direct acting recording meter. The irregular black line shows the voltage curve traced by the pointer and pen throughout each hour of the day and night.

Recording meters of the type just described are called **Direct-Acting** instruments. One of the disadvantages of meters of this type is that the friction of the pen on the paper chart does not allow the pointer and pen to move freely enough to make the meter very sensitive or accurate on small variations in the voltage or current. They also require frequent winding, replacing of charts, and refilling of the pen, but they are low in cost and very satisfactory for certain requirements.

#### 108. RELAY TYPE RECORDING METERS

Another type of recording instrument in very common use is the **Relay Type**, which operates on the electro-dynamometer, or Kelvin balance, principle.

The Kelvin balance consists of a set of stationary coils and a set of movable coils. These coils can be seen at the top of the instrument shown in Fig. 95, which is a relay-type recording meter.

The thin moving coils are shown balanced be-

tween the larger stationary coils, and are equipped with a torsion spring which tends to oppose their movement in either direction.

Any change of voltage or current in these coils changes the repulsion or attraction between the fields of the moving and stationary elements, and will force the coils of the moving element up or down. This moving element then operates a set of relay contacts which close a circuit to the solenoids or small operating motor which moves the pen.

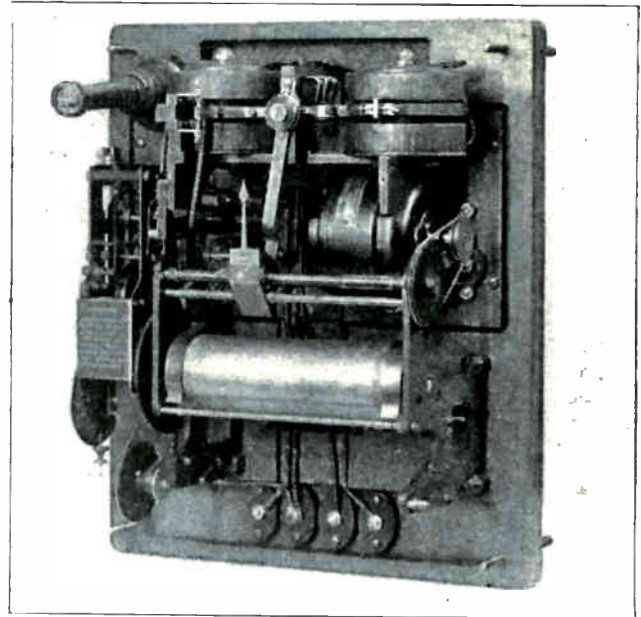

Fig. 95. This photo shows a complete recording instrument of the relay type with the cover removed. Note the stationary coils and balance coils at the top, and the roll for carrying the paper chart beneath the pointer.

The instrument shown in Fig. 95 uses a motor for the operation of the pen and pointer. The motor, which can be seen above the chart roll, revolves a worm shaft which moves the pen. The movement of the pen also readjusts the counter-torque spring on the movable coil so that it is balanced properly for the new position of the pen. This causes the balance coils to open the relay contacts and stop the motor; so the pen will remain in this position until another change of the voltage or current occurs.

The "clock" mechanism which drives the paper chart in this type of instrument is electrically wound and therefore does not require frequent attention.

Fig. 96 shows a recording instrument of this type, with the chart roll in place. This paper chart is continuous throughout the roll. So, as the roll travels and the pen moves sidewise across it, a continuous record of the voltage or power is kept. When the end of one roll is reached, a new one can be inserted.

Fig. 97 shows the connections for a recording meter of the type just described. Terminals 1 and 2 are for the motor circuit, and 3 and 4 are for the control circuit.

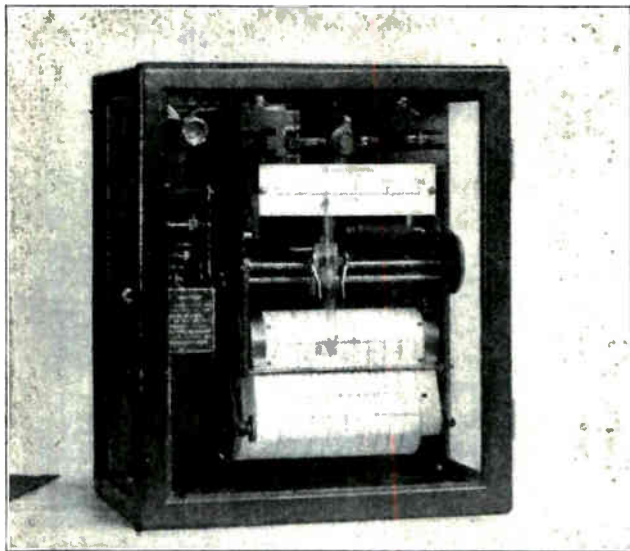

Fig. 96. This view shows the recording instrument which was shown in Fig. 95, with the paper chart in place. The glass ink cup and pen can be dimly seen attached to the lower part of the pointer.

109. LOAD DEMAND INDICATORS

Power and lighting loads which are of a steady or constant nature and do not vary greatly throughout the day are most desirable to power companies. Loads which have high "peaks" in proportion to the average hourly load, require the operation and maintenance of generating equipment which is sufficient for these peak periods, and may be either idle or lightly loaded at other periods. This tends to reduce the operating efficiency and economy in the power plant, and power companies will often give a customer lower rates per KW hr, on his power if his peak load is not over a certain percentage higher than his average load.

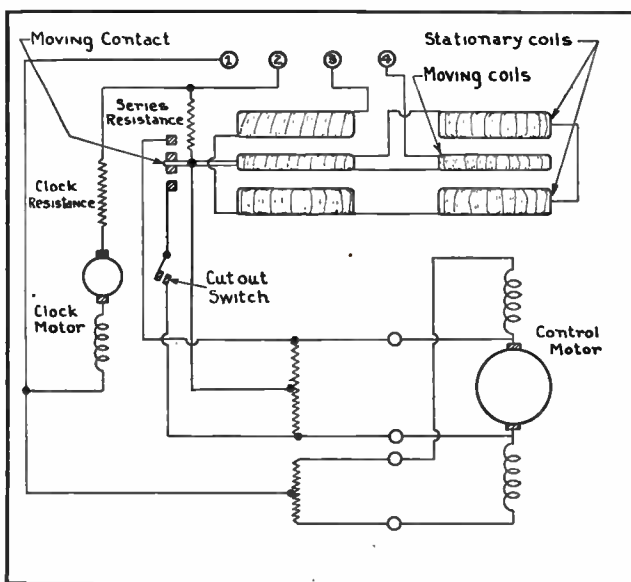

Fig. 97. This diagram shows the coils and winding of a recording meter such as shown in Figs. 95 and 96.

To determine the maximum load, or peak, for any period during the day or week, Maximum Demand

Indicators are used. They are sometimes called "max. meters".

One type of demand indicator is the Wright maximum ampere-demand indicator, which operates on the thermal or heat expansion principle.

This instrument consists of a specially shaped sealed glass tube, as shown in Fig. 98. In this tube is sealed a certain amount of colored liquid, usually sulphuric acid, and a certain amount of air.

A resistance coil of platinoid metal is wound around the bulb as shown at "A" in the figure. This coil is connected in series with the line and load, or in parallel with an ammeter shunt. When current passes through the coil it causes it to become slightly heated and this heat expands the air in the bulb "A".

This expansion increases the air pressure and forces more of the liquid over into the right-hand part of the tube. If the liquid is forced high enough in this tube, some of it will run over into the small Index Tube, "C".

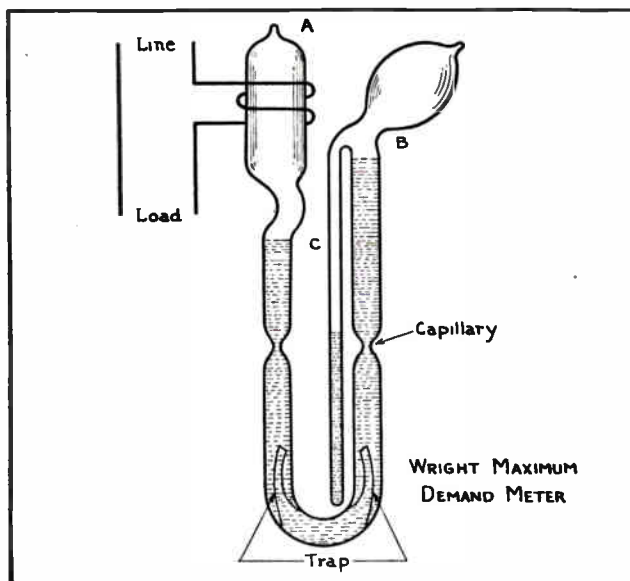

Fig. 98. This sketch illustrates the principle of a common type maximum demand meter which operates by expansion of the air in the bulb "A", when current is passed through the coil around this bulb.

As the heat developed in the resistance coil is proportional to the square of the current passing through it, the index tube "C" can be graduated or equipped with a graduated scale behind it; so the maximum current in amperes can be read from the height of the liquid in this tube.

A momentary increase in load will not register on an indicator of this type, because it requires a little time for the heat in the coil to expand the air inside the tube. This is a desirable feature, as it usually is not desired to measure peak loads that last only an instant.

A load increase which lasts for 30 minutes will register the full amount, or 100%, of the increase.

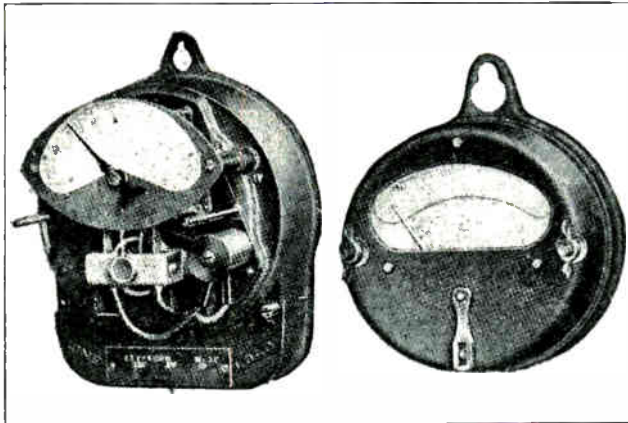

Fig. 98-A. Two types of demand meters using pointers operated by magnets and thermostats instead of liquid to indicate maximum load.

After a reading, this type of instrument can be reset by tilting the tube and allowing the liquid to flow back into tube "B".

Small, inverted, glass funnels are fastened inside the bottom of each side of the tube, to prevent the passage of air from one side of the tube to the other. These are called traps. When the tube is tilted to reset the indicator, these traps remain covered with liquid and prevent air from passing through.

Recording wattmeters or ammeters also serve as maximum-demand meters, as they show all load variations.

Another type of maximum-demand meter uses a combination of a wattmeter element and pointer and a watt-hour meter time element, to allow the wattmeter pointer to register only over certain time periods.

Some demand meters use a thermostatic strip to move the pointer as the strip is expanded and warped by the heat of the load current.

Fig. 98-A shows demand indicators of these types.

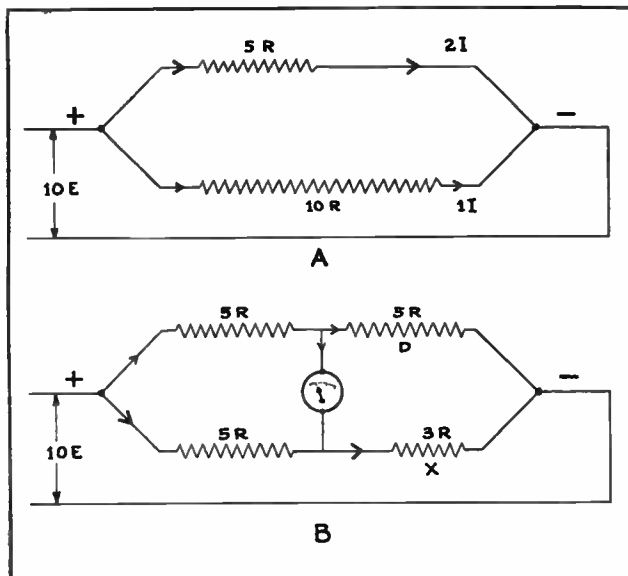

Fig. 99. The sketch at "A" shows the manner in which current will divide in inverse proportion to the resistance of two parallel circuits. At "B" is shown the manner in which current will flow through a galvanometer placed between four resistances, one of which is of a different value than the rest.

### 110. WHEATSTONE BRIDGE

This instrument is a very convenient device for measuring the resistance of electric circuits or devices, by comparison with standard resistances of known value.

You have already learned that electric current will tend to follow the path of lowest resistance, and will divide through parallel paths in inverse proportion to their resistance.

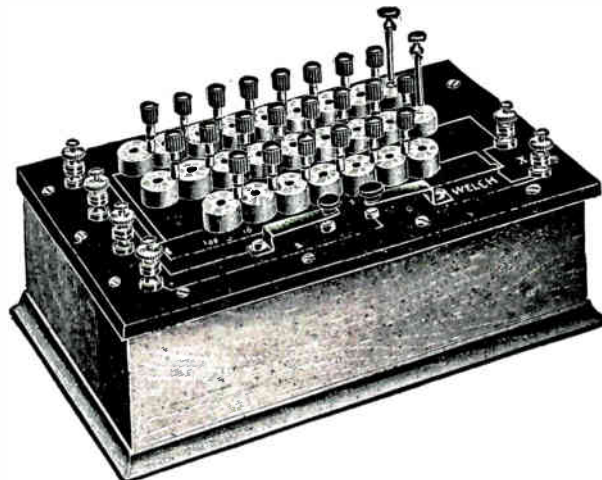

Fig. 100. Resistance box of a common Wheatstone bridge. Note the plugs which are used for varying the amount of resistance in the circuit.

For example, suppose we have one resistance coil of 5 ohms and one of 10 ohms connected in parallel, as shown in Fig. 99-A. If we apply 10 volts to the end terminals, 2 amperes will flow through the 5-ohm coil and 1 ampere through the 10-ohm coil.

Now let us connect a group of four coils as shown in Fig. 99-B. Here we have two coils of 5 ohms each in series on one path, and a 5-ohm coil and a 3-ohm coil in series on the other path.

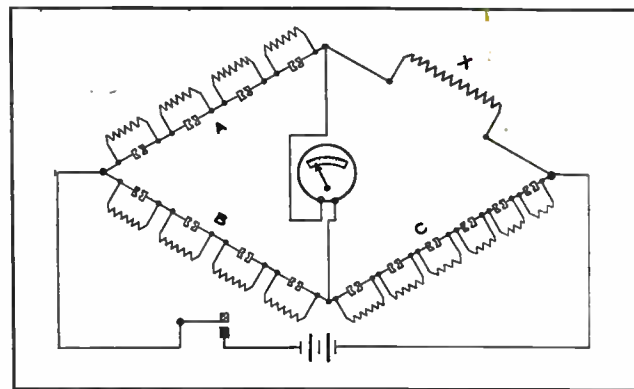

Fig. 101. This diagram shows the connections and principle of a Wheatstone bridge or resistance balancer. Note how the split metal sockets can be used to short out various resistance coils when a metal plug is inserted in these sockets. Study this diagram carefully while referring to the explanations on these pages.

If we now connect a sensitive galvanometer across the center of the paths between the coils, as shown, it will indicate a flow of current from the upper path to the lower when voltage is applied to the terminals of the group.

Tracing from the positive terminal to the center of the group, the resistance of each path is equal,

but from this point on to the negative terminal the lower path or coil "X" has the lowest resistance. For this reason, some of the current tends to flow down through the galvanometer wire to the lower coil or easier path.

If we changed the coil "D" to one of 3 ohms, both sides of the circuit would again be balanced and no current would flow through the galvanometer.

On this same principle, if the resistance of coil "X" is not known, we can determine it by varying the resistance of coil "D" in known amounts until the galvanometer indicates zero, or a balanced circuit. We would then know that the resistance of coil "X" is equal to whatever amount of resistance we have in coil "D" to secure the balance.

### 111. OPERATION AND CIRCUIT OF WHEATSTONE BRIDGE

The Wheatstone Bridge operates on the same general principle just described. It consists of a box of resistance coils with convenient plugs for cutting coils of various resistance in and out of the balancing circuits. Fig. 100 shows the resistance box of a bridge of this type.

Some bridges have knobs and dial switches instead of plugs for switching the resistance units; and some have the galvanometer built in the top of the box, and the dry cells inside.

Fig. 101 shows a diagram of a common type of bridge and the method by which the coils can be left in the various circuits or shorted out by inserting metal plugs in the round holes between metal blocks attached to the ends of each resistance coil.

The coil or line of which the resistance is to be measured is connected at X. The circuits A, B, and C are called **Bridge Arms**. A and B are called **Ratio**

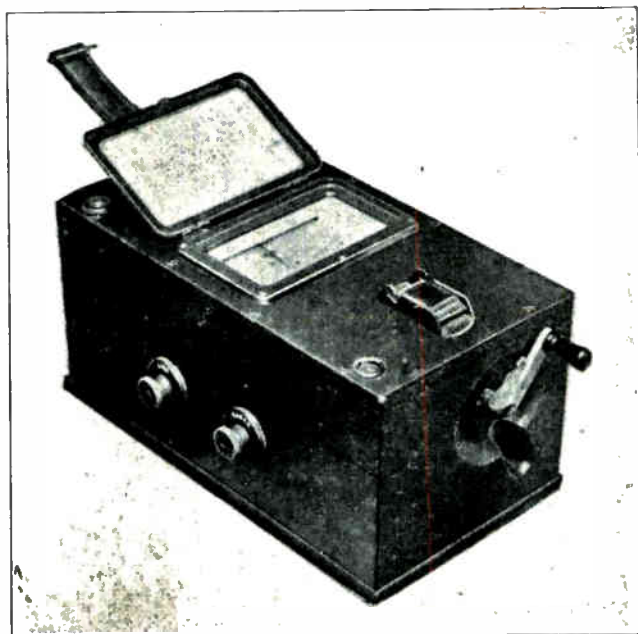

Fig. 102. The above photo shows a "Megger", or device used for measuring the resistance of insulation and high resistance circuits. This instrument contains its own D. C. generator as well as meter element.

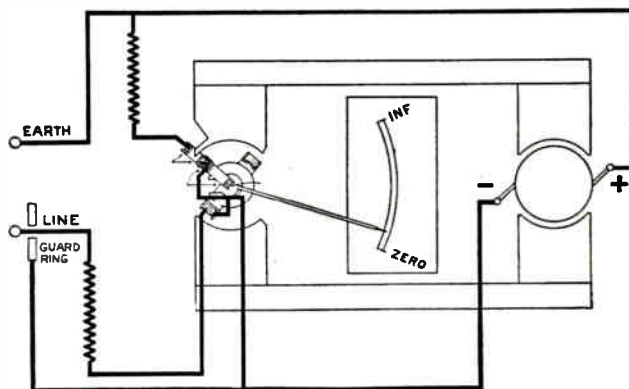

Fig. 103. Simple circuit showing the connections and principles of a "Megger". Note the arrangement of the D. C. generator armature and meter element at opposite ends of the magnet poles and the connections of this device to the line or test terminals.

**Arms**, or balance arms; and C is called the **Rheostat Arm**.

Arms A and B usually have the same number of resistor units of similar values in ohms. Arm C has a number of resistors of different values.

When the unknown resistance, X, has been connected in and the bridge arms so balanced that the galvanometer shows no reading when the button is pressed, the resistance of X in ohms can be determined by the use of the following formula:

$$X = \frac{A}{B} \times C,$$

In which:

- X = resistance in ohms of device under test.
- A = known resistance in ratio arm A.
- B = known resistance in ratio arm B.
- C = known resistance in rheostat arm C.

The Wheatstone bridge is a very convenient device for testing the resistance of coils or windings of electrical equipment; of lines, cables and circuits; and of the insulation on various wires or devices.

There are a number of types of bridges for resistance measurement, most of which are supplied with a connection chart and instructions for operation. So, with a knowledge of their general principles as covered here, you should be able to use and operate any ordinary bridge.

### 112. "MEGGER"

Another testing instrument frequently used by the practical electrician for testing the resistance of insulation on electrical machinery is known as a **Megger**. This name comes from the fact that this instrument is commonly used to measure resistances of millions of ohms; and a million ohms is called one meg-ohm.

The megger consists of a small hand-operated D. C. generator and one or more meter elements, mounted in a portable box, as shown in Fig. 102. When the crank is turned, the D. C. generator will produce from 100 to 1000 volts D. C., according to the speed at which the generator is rotated and the number of turns in its winding.

Normal operating voltage is usually from 300 to 500 volts, and is marked on the meter scale. Some



of these instruments have a voltmeter to show the generator voltage, and an ohm-meter to indicate the insulation resistance of the device under test.

The terminals of the instrument can be connected to one terminal of a machine winding and to the machine frame. Then, when the crank is rotated the insulation resistance in meg-ohms can be read directly from the scale.

Fig. 103 shows the internal connections of a megger and the terminals for connections to the equipment to be tested. As the insulation of electrical machines or lines becomes aged, or in some cases where it has been oil or water-soaked, its resistance in ohms is considerably reduced. Therefore, the resistance test with the megger is a good indication of the condition or quality of the insulation.

Periodic megger tests of electrical equipment and records of the insulation resistance will often show up approaching trouble before the insulation breaks down completely and burns out the equipment.

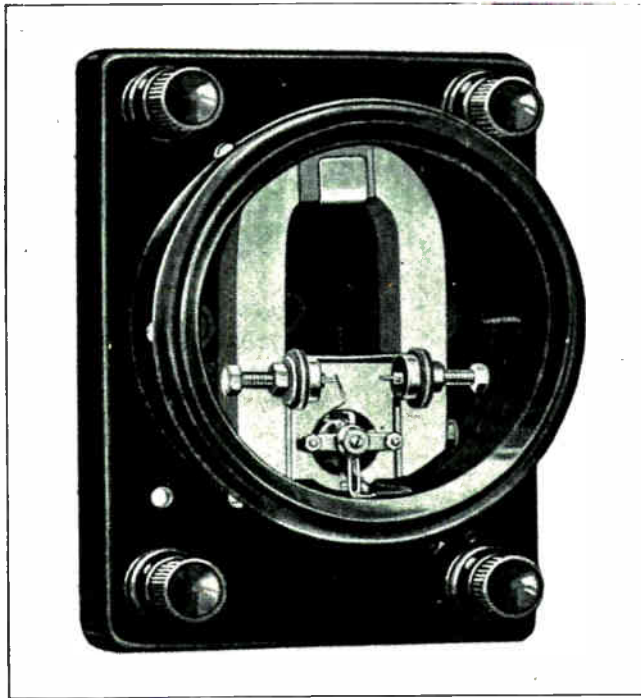

Fig. 104. Very sensitive relays such as shown above are commonly made with the same principal elements used in voltmeters or ammeters. Relays of this type can be used to open or close various circuits at any set voltage or current values.

Either the Wheatstone bridge or the megger can be used to determine the approximate location of grounds or faults in cables and long lines, by measuring the resistance from the end of the line to the fault, through the cable and its sheath or the earth. Then, by comparing this resistance with the known resistance total of the line or with its resistance per foot or per 1000 ft., the distance to the fault can easily be calculated.

### 113. METERS ESSENTIAL IN ELECTRICAL WORK

A number of simple and practical tests of resistance can also be made with voltmeters and ammeters, and the use of ohms law formulas. By applying voltage of a known value to any device and accurately measuring the current flow set up by this voltage, we can readily calculate the resistance of the circuit or device by the simple formula:

$$R = \frac{E}{I}$$

While on the subject of meters, it will be well to mention that very sensitive relays are often made from regular meter elements, using a short armature or moving contact in place of the regular pointer or needle. Fig. 104 shows a relay of this type. In this figure you can see the short contact needle attached to the moving coil, and the adjustable contacts on each side of this needle.

By proper adjustment of the contacts of relays of this type, they can be made to close or open circuits when the voltage or current values rise above or fall below any certain values.

Keep well in mind the importance of ordinary electric meters in the work of any practical, up-to-date electrician, and remember that **great savings in power or equipment can often be made by the proper use of electrical meters and instruments.**

For testing the efficiency of machines, checking operations in power plants, inspection of electrical equipment, and for trouble shooting and fault location, electrical meters of the proper types are of enormous value.

The trained practical man should never overlook an opportunity to effect a saving or improve operation by the selection and use of the proper meters.

## Changing Meters for Higher or Lower Readings

In certain cases an electrician may not have suitable meters for testing all of the various circuit voltages and current loads in the plant, and in such cases it is often very convenient to know how to change the meters on hand, to indicate voltages or currents other than those for which they were designed. This can quite easily be done by changing the resistors on voltmeters or the shunts used with ammeters.

In recent years instrument manufacturers have begun to standardize on the construction of essential parts of meters. This not only reduces original costs and makes it easier to secure repair parts, but it also makes certain meters more flexible or adaptable to a wider range of service. For example, many volt meters and ammeters are now made with a standard moving coil having a resistance of  $2\frac{1}{2}$  ohms and designed to give full scale deflection of the pointer with a current of 20 milliamperes, or .020 amperes. According to Ohm's Law formula,  $I \times R = E$ , or  $.020 I \times 2.5R = .050E$ , or 50 millivolts drop, or pressure applied to force full scale current through this coil. A coil having  $2\frac{1}{2}$  ohms for a 50 millivolt reading would be on a basis of 50 ohms per volt, as one volt or 1,000 m.v.  $\div 50 \text{ m.v.} = 20$ , and  $20 \times 2.5 = 50$ .

Now if we wish to use this 50 m. v. meter to measure 100 m.v., or double the present voltage rating, we should simply double the resistance of the meter circuit or add  $2\frac{1}{2}$  ohms more resistance in series with the  $2\frac{1}{2}$  ohm moving coil. Then  $2\frac{1}{2} + 2\frac{1}{2} = 5$  ohms total resistance, which when connected across a 100 m.v. circuit would draw  $.100 \div 5$  or .020 amperes and again give full scale deflection. If we now remark or recalibrate the scale for 100 m.v., we have doubled the range of the meter.

You can readily see that if the  $2\frac{1}{2}$  ohm coil were connected on a circuit of double its rated voltage without increasing the resistance, the coil would receive double current and be burned out. Therefore, in changing voltmeter resistances to adapt the meter for correct readings of higher voltage values, we simply use the following formula to determine the correct resistors to use in series with the meter coil:

$$\frac{\text{Desired voltage range}}{\text{Full scale meter coil current}} = \text{Total resistance for meter circuit.}$$

Then by subtracting the resistance of the moving coil from this total resistance we can determine the amount of extra resistance to use in series for the higher readings. For example, suppose we wish to adapt this same meter element for a full scale read-

ing of 150 volts, and for safe use on a 150 volt circuit.

$$\text{Then } \frac{150 E}{.020 I} = 7500 R. \text{ total resistance}$$

Then  $7500 - 2.5 = 7497.5$  ohms of additional resistance to be used.

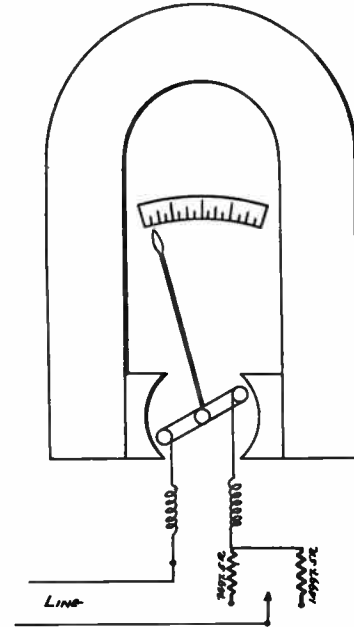

Fig. 105. This diagram shows a meter designed for reading two different voltages.

If we wish to use the same meter for dual service or 150 and 300 volt circuits, we can arrange another resistor of 14997.5 ohms as shown in Fig. 105. Then by connecting the wires of the circuits to be tested to the proper terminals or resistors we can measure either voltage. Some multiple range meters have these extra resistors located inside the case and connected to proper terminals. These meters may also have the scale marked for 3 or more voltage ranges.

The same changes can be applied to ammeters to adapt them for other ranges by changing the resistance of the shunts which are used with this same standard meter element and  $2\frac{1}{2}$  ohm moving coil. Using only the meter coil without any shunt the instrument's capacity and full scale reading would be only 20 milli-amperes. If we wish to change it to measure current up to 100 M.A. or 5 times its former rating, we would place in parallel with the moving coil a shunt having a resistance one-fourth that of the coil or,  $2.5 \div 4 = .625$  ohms resistance for the shunt.

With this shunt connected in parallel with the meter as shown in Fig. 106, the current will divide in inverse proportion to the resistance of the two parallel paths, and  $4/5$  of the current, or 80 M.A.

will pass through the shunt, while  $1/5$  of the current, or 20 M.A. will pass through the meter coil.

When making such changes for scale readings of 2 amperes or less, we should determine the shunt resistance according to the desired division of current between the meter coil and the shunt, as we have just done in the foregoing problem. This is due to the fact that in order to obtain readings which are accurate at least within one per cent on

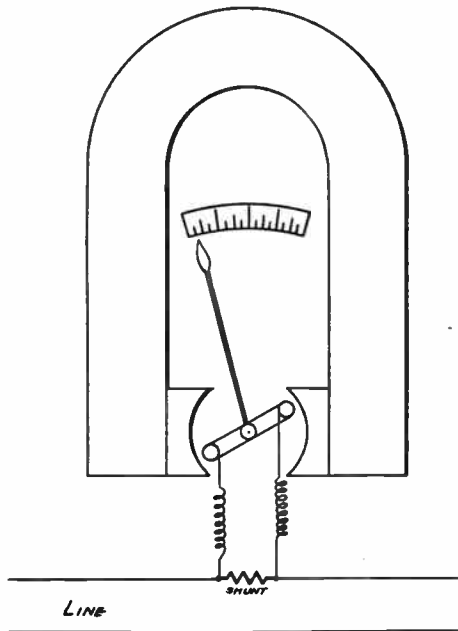

Fig. 106. This figure shows how the ammeter shunt is connected in parallel with the meter coil.

such small current loads, we must consider the amount of current which flows through the meter element. However, for changes over 2 amperes the following simple formula can be used to determine the shunt resistance:

$$\frac{\text{Voltage rating of meter coil}}{\text{Desired current capacity}} = \text{Resistance of shunt.}$$

Then if we want to change this same type of meter with the 50 millivolt coil to measure currents up to 10 amperes at full scale reading,

$$\frac{.050}{10} = .005 \text{ ohm shunt}$$

to be used in parallel with the meter element. Note that the shunt resistance is  $1/500$  of the meter coil resistance, and the meter coil current of .020 is  $1/500$  of the new full scale current of 10 amperes. If we desire to change this type of meter to read 200 amperes, then,

$$\frac{.050}{200} = .00025 \text{ ohm shunt.}$$

Meters which use these standard coils of  $2\frac{1}{2}$  ohms resistance for M.A. current, at 50 ohms per volt, are guaranteed by the manufacturers for accuracy within one per cent. This is accurate enough for all ordinary shop tests. When a higher degree of accuracy is required for laboratory measurements, etc., meters with higher resistance moving elements are used. The more resistance per volt which is used in the meter coil, the higher the degree of accuracy will be.