

GERNSBACK LIBRARY
NO. 45 (1951)



RADIO TUBE Fundamentals

George J. Christ

R_k

C_k

reprinted by
Lindsay Publications Inc

RADIO TUBE FUNDAMENTALS

by

GEORGE J. CHRIST

*Transmission Engineer, New York Telephone Co.; Instructor, Division of General Education,
New York University*



Gernsback Library No. 45

PUBLISHED BY

Gernsback Publications, Inc.

25 West Broadway,

New York 7, N. Y.

Radio Tube Fundamentals

by George J. Christ

Originally published by
Gernsback Publications, Inc.
New York

Original copyright 1951
by Hugo Gernsback

Reprinted by Lindsay Publications Inc
Bradley IL 60915

All rights reserved.

ISBN 1-55918-362-4

2008

1 2 3 4 5 6

WARNING

Remember that the materials and methods described here are from another era. Workers were less safety conscious then, and some methods may be downright dangerous. Be careful! Use good solid judgement in your work, and think ahead. Lindsay Publications Inc. has not tested these methods and materials and does not endorse them. Our job

is merely to pass along to you information from another era. Safety is your responsibility.

Write for a complete catalog of unusual books available from:

Lindsay Publications Inc
PO Box 12
Bradley IL 60915-0012

For a fascinating selection of the highest quality books for experimenters, inventors, tinkerers, mad scientists, and a very few normal people... visit

www.lindsaybks.com

Radio Tube Fundamentals

INTRODUCTION	5
CHAPTER 1...THE ELECTRON	7
The atom. Positive nucleus. Electrons in motion. Electron volt. Electron energy. Conductors and insulators. Free electrons. Electron drift. Electron speed. Thermionic emission. The cathode. The filament. Cathode and filament material. Primary electrons. Secondary electrons. Electron multiplier. Field emission. Photoelectric emission.	
CHAPTER 2...THE DIODE	14
Plate current. Space charge. Saturation point. Characteristic curve. Diode load resistance. Diode load voltage. Plate dissipation. Plate voltage. Plate resistance. Maximum plate current. Ionization. Gas-diode characteristics. Phantotrons. Voltage regulators. Voltage-regulator design.	
CHAPTER 3...THE TRIODE	22
Physical structure of the triode. Plate current cutoff and saturation. Plate characteristic family. Mutual or transfer characteristics. Static curves vs. dynamic curves. Triode load resistor. Plate resistance. Amplification factor. Transconductance. The mho. Voltage amplification. Phase. The triode load line. Distortion. Class A amplifiers. Class A efficiency. Fidelity of Class A. Class AB amplifier. Class AB1. Class AB2. Class AB push-pull. Class B amplifier. Class B efficiency. Class C amplifier. Voltage amplifiers and power amplifiers. Power input and power output. Push-pull and parallel power tubes. Harmonic distortion. Oscillation in amplifiers. Grid current. Power amplification. Power sensitivity. Plate efficiency. Interelectrode capacitance. Miller effect. Perveance. Figure of Merit. Gas triodes. Thyratrons. Behavior of gas triodes.	
CHAPTER 4...THE TETRODE	47
The screen grid. Screen-grid interelectrode capacitance. Tetrode circuit. Tetrode characteristics. Secondary emission. Negative resistance. Tetrode transconductance and amplification factor.	
CHAPTER 5...THE PENTODE	52
Suppressor grid. Pentode characteristic curves. Amplification factor, transconductance, and plate resistance of pentodes. The pentode circuit. Constant- μ or sharp cutoff tubes. Modulation distortion. Cross-modulation. Variable- μ or remote cutoff tubes. Pentode equivalent circuit. Power pentodes. Beam-power tubes. Virtual suppressor. Construction of the beam tube. Beam-power tube characteristics. Plate dissipation. Screen-grid dissipation.	
CHAPTER 6...MULTIPURPOSE TUBES	64
Dual and triple-purpose tubes. Multigrad tubes. Pentagrid mixer. Pentagrid converter. Socket connections.	

CHAPTER 7 . . . PHOTOTUBES AND INDICATOR TUBES	68
Vacuum and gas phototubes. Phototube characteristics. Phototube types. Applications of phototubes. Indicator tubes. Indicator-tube types. Applications of indicator tubes.	
CHAPTER 8 . . . VACUUM-TUBE GRID BIAS	72
Separate bias sources. Bias battery. Bias from the power supply. Shunt-diode circuit. Voltage-doubling bias supply. Self-bias systems. Cathode bias. Grid-leak bias. Back-bias method. Bias in battery portables.	
CHAPTER 9 . . . RADIO-TUBE APPLICATIONS	79
The half-wave rectifier. The voltage doubler. Transformer power supplies. The full-wave rectifier. Maximum inverse peak voltage. Detectors. Selection of proper diode load. Time constant of the diode load. Automatic volume control. Delayed automatic volume control. FM detection. Ratio detector. Triode detectors. Oscillators. Oscillator bias. Mixers. Converters. Conversion gain.	

Introduction

ON the many occasions that the practical radioman works with radio circuits, he undoubtedly has to consider some of the ideas involved in radio-tube design. He is always looking in his tube manual for tube voltage ratings, if for nothing else. He probably recognizes the terms and through experience has learned to use them to some extent. No doubt he may often want to know more about the characteristics of radio tubes and why one tube differs from the next. This book is intended to give the radioman the tube information he wants, in the way he is accustomed to using it.

There are many classifications for radio tubes. Tubes may be considered according to the number of elements they contain—diode, triode, tetrode, pentode, hexode, heptode, etc. Tubes may be judged by the work that they must do—whether we want them to deliver large amounts of voltage or power. Tubes may be classified according to their physical characteristics—glass or metal, miniature or large size. We can also discuss tubes from the standpoint of their use in particular circuits—audio amplifiers, radio-frequency or video amplifiers, detectors, rectifiers, etc. Some tubes have remote cutoff characteristics, while others cutoff sharply. Each type of tube, because of its individual performance, has its place in a particular circuit. These various classifications are interrelated, hence nearly all tubes can be placed in a number of different categories.

Since radio tubes are *electron* tubes, the reader should get to know the electron, what it is, how it is made to move, how it is controlled, and how it behaves in radio tubes and circuits.

An electron in motion is an electric current. Moving electrons cause magnetic fields and wave motion. The first chapter covers basic principles so that the reader can easily follow the later detailed information on vacuum tubes. The various tube types are completely covered and circuit diagrams are included to help in the discussion. Typical tubes are picked from the tube manual and their characteristics are explained. The make-up of tubes of various kinds is discussed in detail, beginning in a logical and orderly sequence with the diode and continuing with the triode and pentode through to the multi-element tubes which have special application. A section of this book is devoted to representative circuits in order to help put across the ideas talked about in the text. Tubes do not work by themselves, but always in connection with resistors, inductors, and capacitors. These circuit elements have a strong influence on the behavior of radio tubes, hence we find the study of tubes *and* of circuits an inseparable combination.

The publishers acknowledge with thanks the cooperation of Mr. H. B. Davis for the material on Vacuum-Tube Grid Bias appearing in Chapter 8, and the Radio Corporation of America for the graphs and data excerpted from their tube manual appearing on pages 25, 53, 55, 66, and for illustrations on pages 52, 63, and 69.

Chapter 1

The Electron

THE atom, about which we hear so much these days, is one of the smallest particles of a material, whether a liquid, gas, or a solid. A bar of copper is made up of many billions of tiny copper atoms, a cubic inch of oxygen is likewise made up of many billions of oxygen atoms. The atom itself is composed of smaller subdivisions which determine the mass electric charge and identity of the substance. Of these elementary particles which comprise the atom, those of importance in electronic conduction have been identified and for our purposes may be considered as consisting mainly of a positive nucleus, with negative electrons revolving about it. The atom normally has enough negative charges in the form of electrons to neutralize the positive charge of the nucleus, hence the atom is neutral and has no charge.

Electrons in Motion

In metals, electrons in one atom are not too far from electrons in adjacent atoms. Electrons in the outer shell of a particular atom are relatively far away from the positive attractive force of the nucleus of that atom, and therefore only weakly held by it. This means that the positive nucleus of the atom right next to it attracts it almost as much as its own nucleus. These electrons are free to drift about in almost any direction inside the metal, changing places with one another in an aimless fashion. Fig. 101 gives an idea of how this happens. Electrons, marked *e*, are equally spaced from the positive nuclei. If some external voltage is put across the metal, the electrons suddenly find themselves on a one-way street, always moving toward the positive terminal of the applied voltage. Negative particles are attracted to positive poles, just as north and south poles of magnets are attracted to one another. This movement of electrons is an electric current

flow; the more electrons that move in a given time, the greater the electric current.

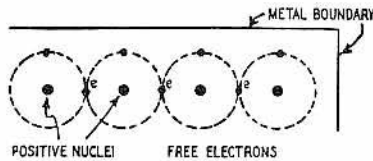

Fig. 101—Electrons marked *e* are free to move.

Electron Volt

Very often, especially in cathode-ray tube design, it is necessary to know how much energy an electron in motion has. This energy is measured in terms of electron volts. The electron volt is the energy an electron acquires as it moves through a drop of one volt. An electron, leaving the cathode of a radio tube with zero volts on the cathode and 300 volts on the plate, would strike the plate with an energy of 300 electron volts.

Conductors and Insulators

Metals have great numbers of free electrons, hence are good conductors. Substances with relatively few free electrons, such as glass, are insulators. Individual electrons in motion do not move very fast through a conductor, even when the current is strong. The number of free electrons is so great that the drift does not have to be speedy, even for large currents. The actual speed of this general drift of electrons is only about an inch or two per second. It is the sudden impulse that travels practically instantaneously along the conductor, just as a row of dominoes falls when placed on end in a row and the nearest one is pushed over. The "impulse" travels along the row while the dominoes themselves move only slightly. In an electric circuit, the speed is so much greater that an electric impulse moves around the circuit with the speed of light. The electrons themselves, however, just continue to drift from the negative battery terminal to the positive terminal (through any external circuit) just as long as the voltage is applied.

If we enable the electrons to escape from the metal (and the restraining force of the positive nucleus), they are on their own, and since they have practically no weight, and much more room in which to move, can travel very fast in a gas or vacuum. If 100 volts were applied to the plate of a radio tube, an electron leaving the cathode would travel to the plate so fast that it would reach a speed of 3,600 miles per second by the time it reached the plate. The greater the positive pull on the electron, the faster it travels. Electrons have been known to travel as rapidly as 168,000 miles per second when about 200,000 volts was used as an attractive force.

If we can break the electron loose from the metal where it is normally held, we can control its speed and direction. Radio tubes do this, some in different ways than others. An easy way in which to force electrons to leave a metal is to heat the metal. This technique is called thermionic emission.

Thermionic Emission

Thermionic emission is the method most often used to force electrons from a metal into a vacuum or gas. When a metal is heated, the random motion of the free electrons is speeded up. Some of the electrons begin to move so rapidly that they break through the metal surface into the surrounding gas or vacuum. The electron is really boiled out of the metal in much the same way that water is boiled to produce steam. The heated metal is called an emitter because it emits electrons when it is heated. The filament of the ordinary light bulb emits electrons all the time that it is lit, but the electrons have no place to go except to fall back on the filament. On the average, electrons emitted this way do not travel very far from the heated metal unless there is some other attractive force pulling them away. With radio tubes we want the electrons. Any light we get in the process is incidental. The radio tube has an especially designed emitter which is used as one of its electrodes. In some tubes, this emitter is called the *cathode*, in others the *filament*.

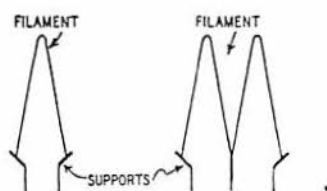

Fig. 102—Types of filament structures.

The metal used for the emitter is selected for the maximum desired emission. Some tubes, such as those used in radio transmitters, must carry more current than others. Their cathodes or filaments must emit many more electrons than receiver type tubes. Cathode or filament material in some tubes may be a pure metal, such as tungsten or thorium. In others, pure tungsten with a coating of thorium or barium or strontium oxide is used. The pure tungsten emitter works at high temperatures, actually at white heat, uses considerable heating power in the process. Such a filament is very strong mechanically and is found in large transmitter power tubes that handle more than 1,000 watts. Thoriated tungsten filaments are used in transmitting tubes under 1,000 watts. The coating of thorium greatly

increases the number of emitted electrons, permitting the use of a lower filament temperature. In this case the filament need only be heated to a bright yellow.

The most efficient emitter is the oxide-coated type. It is only necessary to heat the tube element to a dull red glow to supply enough electrons. It can be heated indirectly. The tube element in this case is called a cathode, is made up of nickel and coated with barium or strontium oxide. This type is used in small transmitting and most receiving tubes.

Filaments and Cathodes

Tube emitters can be directly heated as in the filament type tube, or indirectly heated as in the cathode type. The heated filament type can be supplied either by direct or alternating current. Directly heated filaments, such as those used in portable battery receiver tubes are normally d.c. operated, rather thin in construction, and require very little heating power.

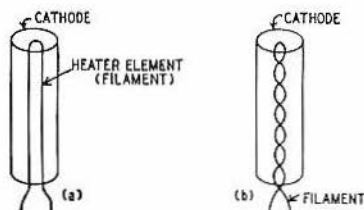

Fig. 103—Indirectly-heated cathodes.

Representative types are the 1R5, 1A7-GT, 1T4. Fig. 102 shows several filament structures. Filaments that are heated by a.c. (such as the 5Y3-GT and 6B4-G) are heavier and sturdier in construction than those heated by d.c. and require considerably more current. The heavy filament permits the concentration of the heating surface in a relatively small area so that the current fluctuations in the filament itself, caused by the a.c., are prevented from causing a variation in the electron flow. The filaments of these tubes are usually ribbon-shaped so that the necessary emission surface can be supplied with less material.

As mentioned above, the indirectly heated emitter is called a cathode. With this type emitter, the filament serves only as a heating unit, and raises the temperature of the surrounding cathode until emission is obtained from the surface of the cathode. There is usually no physical connection between filament and cathode. Alternating current is readily used on such filaments without difficulty since the cathode is indirectly heated to a uniform temperature. Indirectly-heated cathodes are illustrated in Fig. 103-a and Fig. 103-b. The filament in Fig. 103-b is twisted in order to have minimum

hum level when the filament is heated by a.c. Alternating current, in flowing through such a filament, sets up opposing magnetic fields which effectively neutralize each other.

Secondary Emission

Secondary emission is a type of emission which may be either useful or harmful, depending upon conditions. Electrons move from cathode or filament toward a positive electrode (the plate) with a speed that depends on the positive voltage—the larger the voltage, the higher the electron speed. The electron can move so fast that it can knock other electrons out of the electrode it strikes. Electrons thrown out in this way are called *secondary* electrons. The process is termed secondary emission because the primary electrons (cathode electrons) have to break the other (secondary) electrons free. The harder the primary electron strikes, the more secondary electrons will be emitted. The number of secondary electrons emitted also depends upon the type of material. In some cases where a great many electrons are wanted, the speeding primary electron is made to hit a specially treated metal anode. In the ordinary vacuum tube, secondary emission may be harmful, and tube designers take great pains to prevent or limit it.

We may well wonder about these advantages or disadvantages of secondary emission. Secondary emission can produce more electrons than the original number and if more electrons are produced, an increase in current flow results—more electrons, more current. The electron multiplier tube makes use of this increase in secondary electrons, and is shown in simple form in Fig. 104. An electron emitted from the cathode is attracted to the

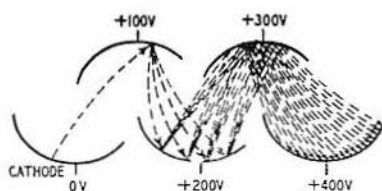

Fig. 104—Electron multiplier uses secondary emission.

+ 100-volt electrode, but strikes it so hard that other electrons are released by secondary emission, say in this case, about four. We then have four electrons for one. The four electrons then move to the + 200-volt electrode, and four more electrons are emitted for each moving electron for a total of sixteen. The new sixteen electrons go on to the + 300-volt electrode where 64 new electrons are emitted. This sequence continues step by step through

the multiplier, depending upon the increase in number of electrons required. In this way, some multipliers can increase the number of electrons by 100,000 times.

Secondary emission can be harmful also. For example, if the electrons in vacuum tubes hit the tube walls hard enough, secondary electrons may be released from the glass itself. These electrons are negative particles, and when they leave the parent glass atom the atom becomes positively charged. As more and more of these glass atoms lose secondary electrons (which then go to the anode plate) more glass atoms become positively charged. The positive atoms in the glass in turn attract primary electrons and the process is multiplied just as in the electron multiplier. This effect can become so concentrated that the glass becomes heated in one spot, softens, and becomes punctured. Such trouble can occur in large transmitting type tubes or cathode-ray tubes where the very high voltages that are used can give the electron enough speed to break down the glass walls of the tube. In practice, this harmful secondary emission is prevented by using protecting shields or by focusing the stream of electrons to the desired electrode. In receiving-type tubes a carbon spray is applied to the inside of the glass wall which makes the glass wall negative enough to keep the harmful electrons away.

Field Emission

This is a type of emission which has special use in gas tubes, such as the cold-cathode tube. Field emission is brought about by having a sufficiently high positive charge near enough to the metal so that the electrons are pulled from it. With thermionic emission, the electrons were "boiled out" of the cathode before they were pulled over to the positive plate. With field emission, there is no increase in this regular normal activity of the electrons in the cathode by heat. In this case, the attraction of the positive plate for the electron is great enough to overcome the normal attraction of the positive nucleus holding the electron to the atom in the cathode. This type of emission is used in mercury-arc rectifier tubes as well as cold-cathode tubes.

Photoelectric Emission

Photoelectric emission is the release of electrons by light. Light (a form of energy) transfers energy to the surface electrons of the metal that it strikes. This increased energy may speed up some of the free electrons in the metal, permitting them to escape. As in the case of thermionic emission, where electron emission is increased with heat, the amount of photoelectric emission depends upon the light intensity—the stronger the light, the more electrons are emitted. In addition, the number of electrons emitted depends upon the color of the light and upon the emitting material. This type of emission is made use of in vacuum tube control circuits set up to operate

under control of a light source. This is discussed in more detail in Chapter 7, page 68.

Everything electrical involves the electron. It has fixed standards. Being negative, it travels to positive electrodes; the higher the voltage, the speedier the trip. It goes headlong into an anode hard enough to knock other electrons out. It takes energy from light and converts it to electric current. It produces light by striking luminescent substances such as the screen in the picture tube of a television receiver. The electron also objects to moving into magnetic fields and tries to bend away from them.

By understanding the behavior of electrons we can predict fairly well how they will perform in various circuits. Since electron tubes are the means by which we can most expertly control electrons, the study of tubes, the different types and their particular characteristics, leads directly to a good working understanding of radio circuits.

Chapter 2

The Diode

THE diode has two electrodes, a cathode (or filament) acting as a source of electrons, and a plate (or anode) to receive them. Make the plate attractive to negative electrons, as in Fig. 201-a, and you have the basis for the diode circuit. The current flowing from the cathode to the positive plate is called the *plate current*. In this circuit electrons flow from cathode to plate, but, since there is no load, the plate current of the tube cannot be put to work; the circuit is not very practical. However, it can be used to describe how electrons behave in radio tubes. In the diode, the cathode is a small pencil-like cylinder surrounded completely by a cylindrical (or oval) metal sheet acting as the plate. See Fig. 201-b. Although this illustration shows a cathode, many diodes have directly heated filaments. The diode tube may be constructed with a single cathode (or filament) and a single plate. The 1B3-GT is a single diode having a directly heated filament. The 35W4 is a single diode, but uses a cathode. Two such diodes can be enclosed in a single glass tube. It is then called a duo-diode or twin diode. Twin diodes, depending on their construction, may have either a single or double cathode. The 5V4-G and the 6AL5 are typical examples.

Space Charge

The number of electrons that actually move from cathode or filament to plate depends upon two things: the number that are boiled out of the cathode or filament, and the attractive force which pulls them to the plate. With thermionic emission, more and more electrons are emitted as the temperature of the emitter is increased. If there were no positive voltage at the plate, electrons would collect in the space between the cathode and the plate. This electron "congregation" forms a "negative sheath" about

the cathode and is called the *space charge*. If the cathode were made hotter, more electrons would be boiled out, but the existing negative space charge

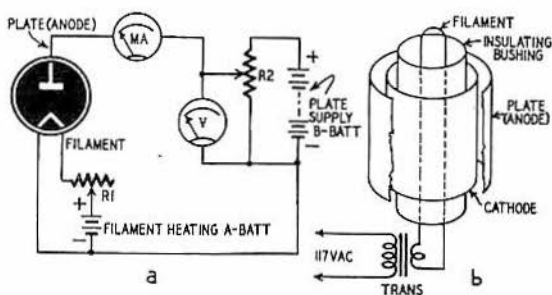

Fig. 201—Elementary diode circuit and diode structure.

would tend to repel the newly emitted electrons back to the cathode. The amount of space charge is determined by the amount of electron emission, the voltage on the positive electrodes, and whether the tube is a gas or vacuum type.

Saturation Point

In Fig. 201-a a small positive voltage on the plate exerts an attracting force on the emitted electrons. By varying R2 we can make the plate increasingly positive; more and more electrons flow to the plate, and the

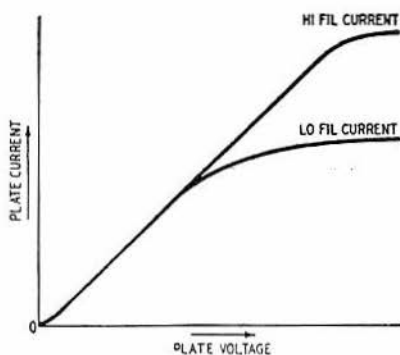

Fig. 202—A diode characteristic curve.

milliammeter in the plate circuit shows a larger current. Theoretically, this could continue up to the point where there would not be enough electrons to satisfy the pull of the increasingly positive plate. The electron flow

would stop increasing and the current would level off. Technically speaking, we say that the saturation point has been reached. Fig. 202 shows how this happens. The curves illustrate how the plate current increases with increasing plate voltage. This graph also shows that more electrons can be made to flow if the cathode is made hotter (by increasing the filament current). Notice that both curves level off (saturation point), since any further increase in plate voltage results in only a *slight* increase in plate current. In normal tube operation, regardless of the size of the space charge, there are always enough electrons on hand to prevent saturation for all values of plate voltage. Fig. 202 is called a *characteristic* curve since the graph shows the characteristics or behavior of the tube.

Under operating conditions, the cathode is capable of emitting all the electrons necessary to develop a full space charge which then adjusts itself to neutralize the effect of the plate voltage. In this way, only enough electrons are drawn from the cathode to produce the plate current shown on the tube characteristic curve. If the plate voltage were increased, the space charge would have to increase to neutralize the increased attractive force of the positive plate and the electron flow would increase. If the plate could be moved closer to the cathode, the effect would be the same—more space charge, more current. In rectifier tubes where large plate currents are required, the distance between the cathode and plate is very small. In the 5V4-G, this distance is only about .02 inches. The use of an inert gas, such as neon or argon in a tube considerably reduces the effect of a space charge. This is discussed in more detail in this chapter under the heading of Gas Diodes.

Diode Load Resistance

The diode can be put to work by adding a load resistance R in series with the tube, as in Fig. 203. This circuit permits the transfer of power from

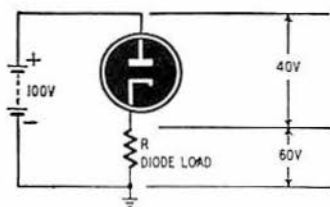

Fig. 203—The load is in series with the diode.

the diode circuit to the following tube. The voltage drop across the load resistance varies with the plate current of the tube. The larger the plate current, the greater will be the voltage drop across the load. The electron

flow in such a circuit develops a voltage drop across the tube itself, as well as across the load, and the sum of these voltage drops must equal the supply voltage. If, in Fig. 203, the supply voltage is 100 volts, and the voltage drop across the load is 60 volts, then the remaining voltage drop, or plate voltage, is 40 volts.

If the battery in Fig. 203 is replaced with an a.c. voltage, as shown in Fig. 204, the effect is somewhat different. Electrons flow to the plate only

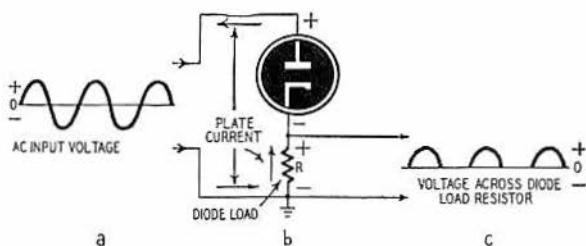

Fig. 204—The voltage across the diode load is positive.

when it is positive with respect to the cathode. When the plate is negative, as during the negative half of the a.c. cycle, no electrons flow. Fig. 204-a shows the wave shape of the input voltage, while Fig. 204-c shows the output voltage. The current through the load is pulsating, since electrons

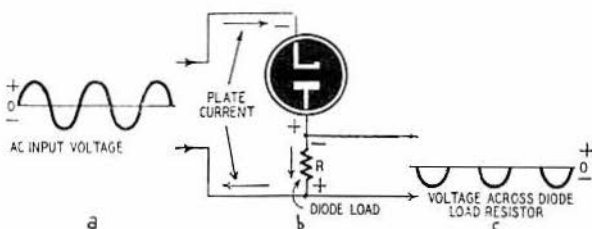

Fig. 205—The voltage across the diode load is negative.

only flow when the plate is positive. The diode acts as a rectifier because the current pulses produce voltage pulses of unchanging polarity across the load resistance. In Fig. 204-b, the output voltage across the diode load is positive with respect to ground. Fig. 205 shows a method of reversing the output voltage polarity. In this case, the diode is simply inverted.

Picking the correct value of load resistance must be done carefully.

Selection of the proper value of diode load is covered in Chapter 9, page 85.

Plate Dissipation

A voltage (called the plate voltage) is developed across the tube when electrons flow through it. This voltage drop, divided by the electron flow (current) is called the *plate resistance* because it wastes power in the form of heat, just as any ordinary resistance. Although electrons are extremely small, invisible under the most powerful microscope, they are still particles having definite weight. In accelerating under the plate voltage, they strike the plate with considerable force. This produces heat at the plate, and a real loss in energy results. The tube must be able to rid itself of the heat thus developed. The tube manual indicates how much power (in terms of watts) the plate of a particular tube can dissipate. The energy lost by the plate comes from the power supply. Where a tube, whether a diode or any other type, exceeds its plate dissipation rating, the plate of the tube may glow. Tubes in which there are heavy currents are designed to have large plates in order to safely dissipate the heat. Radiation of heat from the plate is more easily accomplished if the plate is made black. In large transmitting tubes, water cooling methods are used to aid in dissipating this heat.

Maximum Plate Current

Excessive current flow in the tube can cause damage to the plate. The cathode, the fundamental electron source, can also be harmed by improper operating conditions. If the cathode is forced to exceed its permissible maximum peak plate current, it may become damaged or destroyed. This can be caused by excessive plate voltage, too high a filament temperature, or a combination of both conditions.

In vacuum tubes all gases are removed so that the electrons are free to travel in the vacuum between the cathode and the other electrodes. Sometimes small traces of gas (air) may still be present. The emitted electrons can collide with the gas particles and create positive ions which tend to strike the cathode. These ions are relatively heavy and may damage the oxide coating. Positive ions tend to neutralize the negative space charge, thereby increasing the plate current beyond its limits, damaging the plate. In gas tubes, however, a small amount of argon, neon, or other inert gases are intentionally put in the tube before it is sealed. Liquid mercury which will vaporize when the tube is heated is also used.

Gas Diodes

In the gas diode, electrons are boiled from a cathode and form a space charge, just as in the case of the vacuum diode. If the voltage at the plate is made sufficiently positive, electrons will move to the plate, and on their

way may hit some small particles of the gas. If they do, they break the particles into positive and negative parts. The positive parts are called *ions*, and because they are positive, will move toward the negative cathode. The negative parts are mostly electrons which add to the regular electron flow from the cathode. The net total flow, electrons to plate and ions to cathode, therefore is much greater than if there were no gas in the tube. If the voltage on the plate is positive enough, so many gas particles will be split that the positive ions will be great enough in number to neutralize the negative space charge. When this happens (with little or no negative space charge to hold back the electrons) the total electron flow goes up sharply and the tube is said to have reached its breakdown point. Fig. 206

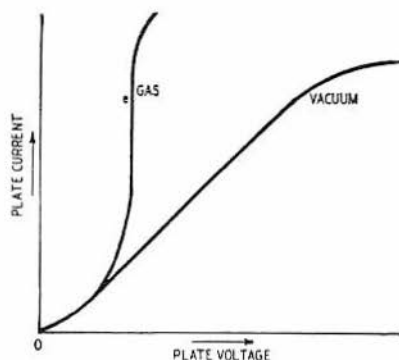

Fig. 206—Comparison of gas and vacuum diode characteristics.

is a comparison of vacuum and gas diode characteristics. The curve shows that with no space charge the plate current is no longer controlled by the plate voltage and the total electron flow is limited only by the resistance in the plate circuit. Gas-tube circuits are designed so that the maximum plate current is held to a value of about point e on the curve.

Phanotrons

Gas-filled diodes, commercially called phanotrons, are usually filled with mercury. They work with a plate-voltage drop of 10 to 15 volts. The familiar tungar tube for battery charging is a mercury-filled tube. Larger tubes are built to rectify voltages as high as 20 kilovolts. The phanotron handles power up to about 100 kilowatts. For greater output, the mercury-arc rectifier and its counterpart the ignitron are used. These have a mercury pool at the bottom of the tube, rather than a hot cathode, and must be fired with a special electrode. They handle currents as high as 25,000 amperes.

Voltage Regulators

Another type of gas diode is the voltage regulator in which the cathode is not heated by any external source. A positive voltage on the plate is made high enough to pull the electrons from the surface of the unheated cathode. The step-by-step operation is shown in Fig. 207.

With a small plate voltage, the plate current goes up from O to A because a small number of free particles, both plus and minus, move to their attracting electrodes. Increasing the plate voltage further to B causes no increase in plate current because there are no more free particles. A further increase in plate voltage draws a few electrons from the cold cathode, until at C the electrons begin to move fast enough to split some gas particles

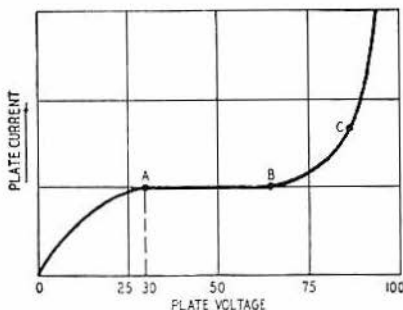

Fig. 207—Characteristic curve of cold-cathode, gas diode.

and cause ionization or breakdown, an action caused by the combined flow of ions to the cathode and electrons to the plate. The positive ions of the gas then accelerate toward the cathode, bombard the cathode with sufficient strength to raise the cathode temperature, thus permitting release of electrons from the cathode surface.

Typical voltage regulators are the 0B3, 0C3, and 0D3, cold-cathode, gas diodes. They are used in the output of power rectifiers to keep the terminal voltage constant with changing load. Fig. 208 is a simple circuit showing how the regulator works. The 0D3 operates at 150 volts. The tube must have at least 180 volts to start it. Assume that the output from the power supply is 250 volts and the current required by the load is 25 ma. To stabilize at 150 volts, the tube will draw about 11 ma. The total current

through R will be 36 ma and R therefore should be about $\frac{250-150}{.036} = 2780$

ohms. Before the tube ionizes, only the load current flows, so that the drop through R is $2780 \times .025 = 69$ volts. The voltage across the tube is initially $250 - 69 = 181$ volts, over the minimum necessary to start conduction through the tube.

With this arrangement, if the voltage went up to 260 volts, the drop across R would have to be 110 volts instead of 100, and the current would be $\frac{110}{2780} = 39.5$ ma. The load is only 25 ma, so that the tube takes $39.5 - 25 = 14.5$ ma. The tube manual tells us that the 0D3 regulates 150.5 volts with this current.

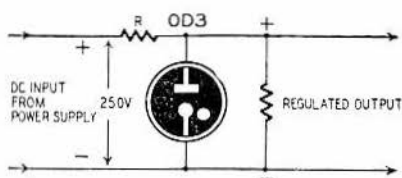

Fig. 208—Voltage-regulator circuit.

If the load in this circuit is a changing one, resistance R would have to drop the voltage with the tube load to be within the tube limits. The top current the 0D3 can draw is 40 ma. With 250 volts, 2780 ohms gives a voltage drop of about 96 volts if the tube draws $96/2780$ or 34.5 ma. With 34.5 ma the tube regulates at about 154 volts. Therefore, even if the load were entirely removed, the 0D3 will not be overloaded, and the circuit design is correct.

Chapter 3

The Triode

THE diode can change, but cannot boost the incoming signal. The addition of a third electrode, called the control grid, enables us to use the tube as an amplifier. The amplifier tube makes possible the radio receivers, transmitters, and television sets we have today. Modern improvements have been made, more grids have been added, but it is the original third electrode, the control grid, that has first say over the electron flow.

Fig. 301 shows the physical structure of a triode. The control grid

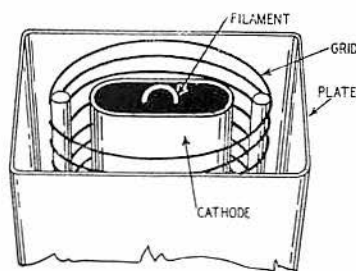

Fig. 301—Physical structure of a triode.

consists of many fine wires stretched across the space between the plate and cathode. Unlike the plate, the main job of the grid is not to collect electrons, but just to control them. We also permit the grid to collect electrons, but only for certain special purposes. The plate is the main collector of electrons.

Plate Current Cutoff and Saturation

The grid is mounted closer to the cathode than the plate and for this

reason has first control of electrons boiled out of the cathode. Because the control grid is made of wire strands instead of a solid metal sheet, almost all the electrons that the grid controls can shoot right by it and pass on to the

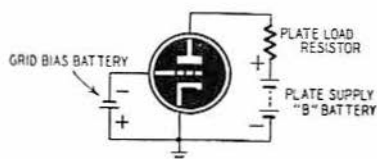

Fig. 302—Basic triode circuit.

plate. As with the diode, the electrons that move to the plate are drawn from the negative space charge because more electrons are boiled off than are needed. If the grid is made negative with respect to the cathode by putting a battery in the grid circuit as shown in Fig. 302, the negative charge on the grid overcomes some of the positive attraction of the plate and cuts down on the number of electrons that reach the plate. This voltage that we're putting on the grid (actually between grid and cathode) is called bias. There are many different ways of biasing a tube; these methods are shown in Chapter 8.

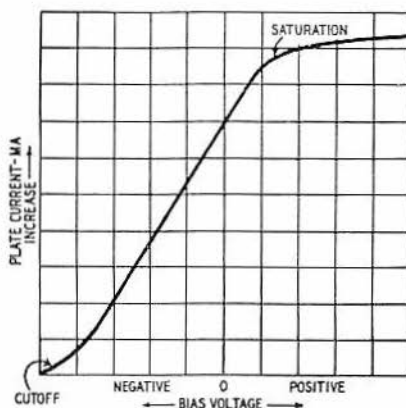

Fig. 303—Triode characteristic curve.

The more negative the grid becomes (by increasing the size of the C- or bias-battery) the smaller will be the current through the tube. The grid can be made more and more negative until it completely overrides all of the plate attraction and no electrons will reach the plate at all. The electron current of the tube would then be cut off. The above graph in Fig. 303

shows how the plate current varies as the bias is made more or less negative. In this case, the supply voltage, from a battery or power supply, is kept constant. The point at which the tube current stops flowing is called the cutoff point.

If the grid were made less and less negative with respect to the cathode, the plate would draw more and more electrons from the space charge. We could help the plate by turning the C-battery completely around, making the grid positive. The graph in Fig. 303 shows that as the grid is made increasingly positive the plate current, beyond a certain point, increases only very slightly. We then say that the tube has reached saturation. This saturation point is similar to the saturation point of the diode. When the control grid is made positive, it will also collect a few electrons, but not many since its surface is small. In such cases, the tube must be designed to carry the grid current.

Plate Characteristic Family

If we kept the bias on the grid fixed at some particular value and varied the plate voltage, the plate current flow could be measured and plotted in a graph as shown in Fig. 304. The bias in curve A is kept fixed at zero volts,

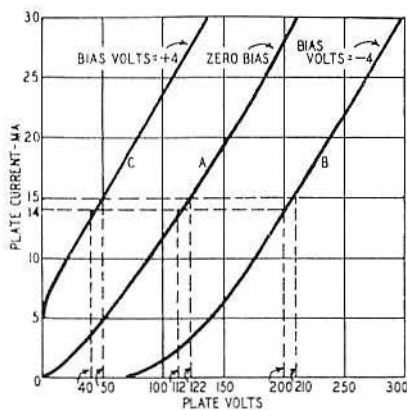

Fig. 304—Family of plate characteristic curves.

while the voltage between the plate and cathode is gradually increased from zero to some maximum value. If a bias of -4 volts were placed on the grid and the plate current measured again with different plate voltages, the current would change as shown in curve B. With positive 4 volts on the grid, the curve is like C. Curves of this type are called plate characteristic curves, and if we plot more than one for different values of bias we have a family of plate characteristic curves. Fig. 305 shows a family of plate char-

acteristic curves for a representative triode such as the 6J5. A curve with some value of positive bias is not shown, since we normally do not put a positive bias voltage on the control grid of a tube.

Mutual or Transfer Characteristics

In Fig. 305 the grid voltage (for a particular curve) was held constant

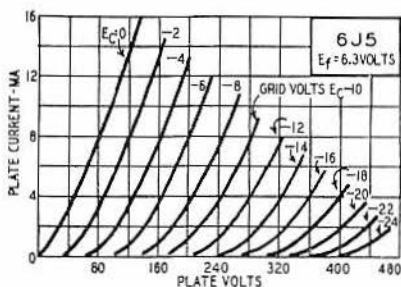

Fig. 305—Plate characteristics for the 6J5.

while the plate voltage was changed and changes in plate current were measured. Changes in plate current could also be measured by holding the

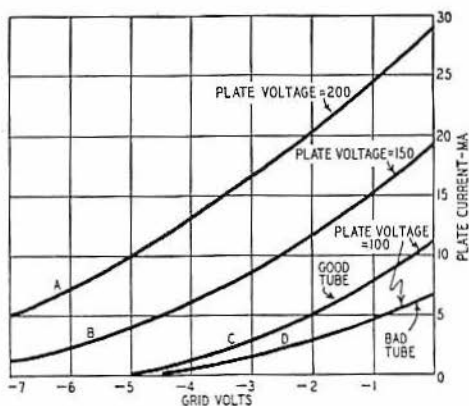

Fig. 306—Transfer or mutual characteristics.

plate voltage constant and changing the grid voltage. In fact, all the information in the curves of Fig. 305 could be *transferred* in terms of plate current versus grid voltage. This gives the *transfer characteristics*, important because they show directly how a change in grid voltage, E_c , affects the flow of electrons in the plate circuit. A family of transfer characteristic curves

appears in Fig. 306. Transfer characteristics are sometimes called mutual characteristics.

Static Curves vs. Dynamic Curves

The triode in Fig. 302 has a load resistor between the plate and the power supply in order to develop the output signal voltage. We also have to supply an a.c. input signal voltage. Since the curves drawn in Fig. 304, Fig. 305, and Fig. 306 were based on a circuit that was not complete—that is, did not have a load resistor (nor did it have an input signal)—we call such curves static curves. If we were to include a load resistor and make the circuit into a practical one, we would have to do our graphs all over again. Such a set of graphs are called dynamic curves. In order to see the difference between a static curve and a dynamic curve, let's lift curve B out of Fig. 306 and put it into Fig. 307. Note that the slope or steepness of the

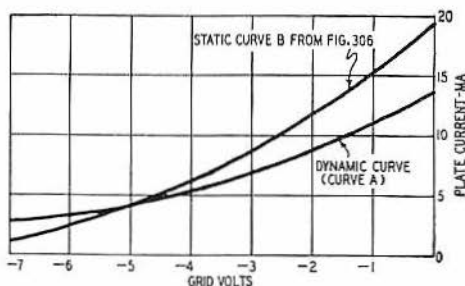

Fig. 307—Comparison of a static and dynamic curve.

dynamic curve (curve A) is not as great as that of the static curve (curve B). As we make the value of load resistor greater and greater, the slope of the dynamic curve becomes less and less. In Fig. 308 are shown the dynamic characteristics of a triode with various loads in the plate circuit. The important dynamic characteristics of a triode are plate resistance, amplification factor, and transconductance.

Plate Resistance

Notice that the three curves shown in Fig. 304 have about the same slope, except near the cutoff point. This means that whichever curve we use, a *small* change of plate voltage will cause the same change of plate current. Look at the vertical dash lines in Fig. 304. For curve C the lines cover from 40 to 50 volts; for curve A the dash lines cover from 112 to 122 volts; and for curve B from 200 to 210 volts. For each one of these, then, we have represented an increase of 10 volts. Follow each pair of

dotted vertical lines up to the curves and then move over along the horizontal dash lines. The increase in current is the same in each case. A 10-volt change in plate voltage causes about a 1-ma change in plate current. From Ohm's law we remember that $R = \frac{E}{I}$, or, in this case, $R_p = \frac{E_p}{I_p}$. R_p represents the internal or dynamic plate resistance of the tube, E_p is the voltage between plate and cathode, and I_p is the current from cathode to the plate. We could calculate the plate resistance of our triode in this way:

$$R_p = \frac{\text{change in plate voltage}}{\text{change in plate current}} = \frac{10}{.001} = 10,000 \text{ ohms.}$$

On the straight line part of the curves, R_p is about the same for all of

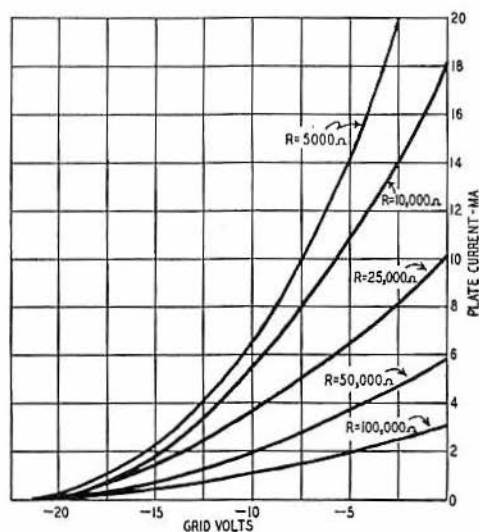

Fig. 308—Dynamic characteristics for various loads.

the curves. However, a plate voltage change of 10 volts on the curved portion of the graph gives a much lower change in plate current and the dynamic plate resistance would therefore be much greater.

Amplification Factor

A change in grid voltage changes the plate current. In Fig. 306 we see how the current increases as the bias is made less negative. The plate voltage is kept fixed for each curve. In curve C a voltage of 100 on the plate causes an 11-ma flow of plate current when the bias is zero. In order to get 11 ma on curve B (that is, with a negative 4-volt grid bias) the plate

voltage must be increased to about 180 volts. Therefore, a 4-volt change in grid voltage requires an 80-volt change in plate voltage to maintain the same plate current. Another way of saying this is that if we decreased the current by making the grid more negative (- 4 volts in this case) we could get back our original amount of plate current by increasing the plate voltage by 80 volts. From this we see that the control grid has much more influence over the tube current than the plate, since - 4 volts on the grid cut down the current to such an extent that it took 80 additional volts on the plate to bring it up again. The ratio of these two is called the amplification factor of the tube. The radio symbol is mu or μ . In the example just discussed:

$$\mu = \frac{\text{change in plate voltage}}{\text{change in grid voltage}} = \frac{80}{4} = 20.$$

Transconductance

The greater the slope, or the steeper we make a mutual characteristic or transfer characteristic curve, the more the current will change as we change the grid voltage. This change in plate current with a change in grid voltage is called transconductance. For example: a change in the grid voltage from - 2 volts to 0 volts in curve C of Fig. 306 causes a change of about 6 ma in the current flowing from cathode to the plate.

$$\text{transconductance} = \frac{\text{change in plate current}}{\text{change in grid voltage}} = \frac{.006}{2} = .003 \text{ mho.}$$

The mho is the unit of conductance. Conductance is exactly the opposite (the reciprocal) of resistance. The mho, the symbol for which is G_m , is simply the ohm spelled backward.

The ordinary tube tester has a meter scale marked transconductance in micromhos. The tube tester, of course, cannot measure a curve. It converts readings of plate current in terms of plate slope. In Fig. 306, for example, the slope of curve C is fairly steep. However, when the tube begins to wear out, it may drop down and more closely resemble curve D. Notice the smaller value of plate current obtained with curve D, although curve D was obtained by using the same voltages as on curve C. The worn tube will not give as great a change in plate current with a given change in grid voltage as it did when it was new. In this case the meter in the tube tester measures a low current and therefore shows a low scale reading in micromhos. When the radioman using the tube tester moves the dial to G_m , he sets it at a point that will give him the exact plate current in terms of rated transconductance.

Voltage Amplification

A current can flow through the tube shown in Fig. 302 even in the

absence of an incoming signal. The tube or plate current (starting at the cathode) will flow to the plate, causing a voltage drop across the tube. The current continues through the plate-load resistor, giving us a voltage drop across it. We can follow the current through the battery or power supply and then back to the cathode or original starting point. The voltage across the tube and across the load resistor are unvarying d.c. voltages since they are caused by an unvarying current.

Now suppose a sine wave signal voltage is fed into the grid circuit. Since the incoming signal is impressed between grid and cathode of the tube it will cause the plate current to change accordingly. The current which flows through the tube may be conveniently considered as two currents—our original steady direct current, and a portion which is varied by the incoming signal. The varying part of the plate current (often called a.c.) is the part we're interested in. The varying electron flow, or so-called a.c. component, causes a varying voltage drop across the load resistance. The varying voltage measured across the plate load resistor is the output signal voltage and is calculated by multiplying the amount of varying current times the value of load resistance. The voltage appearing across the load resistor should have the same waveform and frequency as the incoming signal, but will be much greater in amplitude because of the mu or amplification factor of the tube. Even though the tube has an amplification factor, the over-all amplification of the whole circuit is less because part of the output is lost in the plate resistance. The circuit amplification can be quite easily calculated by dividing the output signal voltage by the input signal voltage. This can be expressed by the formula:

$$\text{voltage amplification} = \frac{\text{a.c. output voltage}}{\text{a.c. input voltage}}$$

However, we have seen that the output voltage is measured by multiplying the varying plate current times the load resistance. If, for example, the incoming signal is two volts, the plate current of our tube 5 ma (.005 ampere) and the load resistance has a value of 10,000 ohms, we can easily calculate the amplification of the stage.

$$\text{voltage amplification} = \frac{.005 \times 10,000}{2} = \frac{50}{2} = 25.$$

This means that the amplification of our circuit is 25. An incoming signal of one volt would produce 25 signal volts across the load resistor. An incoming signal of 2 volts would produce 50 signal volts across the load resistor, etc. Offhand, it might seem very easy to increase the amplification of the stage by simply increasing the value of the plate-load resistance, but as we do so the plate current decreases and we get a corresponding decrease in output signal voltage across the plate load resistance. Too great an increase

in resistance would reduce the voltage at the plate to such an extent that the electron flow which depends on the plate voltage would no longer be in direct proportion to the grid voltage changes and the tube would not amplify properly.

We can also calculate the voltage amplification of a stage if we know the amplification factor of a tube, its plate resistance and the value of the load resistance. Let's start by looking at Fig. 309. The plate resistance of the tube, R_p , is considered to be in series with the load resistance R_L . A varying current is going to flow in this circuit, controlled by the input signal, which we call E_s . If the tube had absolutely no amplification we could calculate the varying current which would flow by using Ohm's law. Since R_p and R_L are in series, $I_p = \frac{E_s}{R_p + R_L}$. Note that in the denominator, R_p and R_L have been added. This is permissible since the two are in series. If we now assume that the tube does have amplification, the signal voltage is increased by an amount equal to the amplification factor of the tube and the assumed signal voltage. E_o becomes μE_s . Thus we can calculate the varying current in the circuit:

$$I_p = \frac{\mu \times E_s}{R_p + R_L}$$

Actually, however, we're not really interested in I_p . What we're interested in is the varying voltage across the load resistor, R_L . The voltage across this resistor, using Ohm's law again, is

$$E_o = I_p \times R_L$$

We can change this around a bit and say that

$$I_p = \frac{E_o}{R_L}$$

Now we've got two formulas for the varying current flowing in the circuit. Let's put down both of them.

$$I_p = \frac{E_o}{R_L}; \quad I_p = \frac{\mu \times E_s}{R_p + R_L}$$

Since the varying plate current, I_p , is the same in both cases we can then say:

$$\frac{E_o}{R_L} = \frac{\mu \times E_s}{R_p + R_L}$$

All we have to do now is to multiply both sides by R_L and the formula turns out to be:

$$E_o = \frac{\mu \times E_s \times R_L}{R_p + R_L}$$

E_o is a shorthand way of writing output voltage (signal voltage developed across the load resistor). E_s means input signal voltage, while R_L is the plate-load resistor and R_p is the plate resistance of the tube.

We can now put this formula to work. Suppose a triode tube such as a 6J5 has a rated amplification factor of 20, an input signal voltage of 2 volts, and a plate resistance of about 7,700 ohms. If we use a load resistor having a value of 8,000 ohms, the amplification of the circuit would be:

$$E_o = \frac{\mu \times E_s \times R_L}{R_p + R_L} = \frac{20 \times 2 \times 8000}{7700 + 8000} = 20.4 \text{ volts.}$$

This shows that the input signal of 2 volts has been increased to 20.4 output volts, or an amplification of 10.2 times. Note that the amplification of the stage (10.2) is lower than the mu or amplification factor of the tube (20).

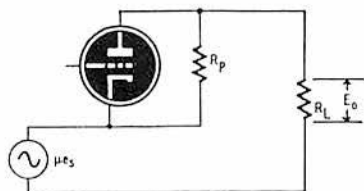

Fig. 309—Circuit for calculating stage gain.

We could get a greater gain by increasing the value of the load resistor, but we would also have to increase the size of our power supply.

Phase

As in the case of the diode, the voltage on the plate of a triode (with no cathode bias) is equal to the supply voltage minus the voltage drop across the load resistor. With no input signal on the grid, the electron flow would be constant. Another way of saying this is the voltage drop across the tube and the voltage drop across the load resistor, when added together, are equal to the supply voltage. If we have a supply voltage of 200 volts and the drop across the load resistor is 50 volts, then the plate voltage, or the drop across the tube must be equal to 150 volts. If the supply voltage remains constant at 200 volts and the drop across the load resistor increases to 125 volts, then the drop across the tube becomes only 75 volts.

If we were to put an input signal into the triode, this would mean that the voltage across the load resistor would vary and so would the voltage drop across the tube. Assume that the incoming signal starts at zero and gradually becomes more positive. With an increasingly positive charge on the control grid, the plate current will increase. An increase in plate cur-

rent means an increasing voltage drop across the load resistor. As a result, the voltage drop across the tube, the plate voltage, would decrease. The plate voltage, therefore, goes down (becomes less positive) while the grid voltage goes up (becomes more positive). Since one voltage, the plate voltage, decreases as the other voltage, the signal voltage, increases, they behave in an opposite manner. Technically speaking, we say that they are 180 degrees out of phase. This also holds true if the signal goes in the other direction—that is, becomes negative. A negative signal on the grid means a reduction in plate current, less drop across the plate load resistor and

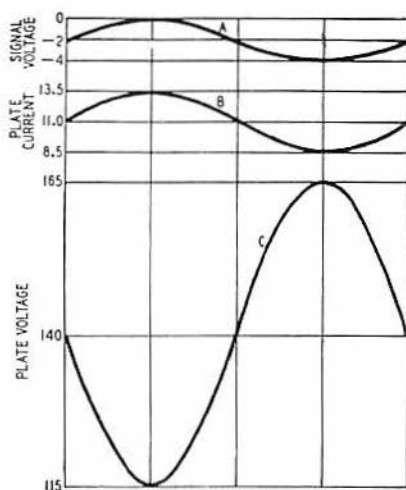

Fig. 310—Signal and plate voltages are 180° out of phase.

hence more voltage on the plate of the tube. Curves A, B, and C, of Fig. 310 show these phase relations graphically.

Load Line

In order to be of any use, the triode must work into some kind of a load. It's not enough just to decide that we need to use a load resistor in order to take advantage of the amplifying properties of the triode. We also need to know the correct value of load resistance. Picking the wrong value could possibly result in two serious defects. The amount of gain that we would get out of the circuit using the triode might be sharply reduced, and whatever output signal we did get might be seriously distorted. In order to predict how a particular triode might behave, we can draw a graph called a load line. A load line is drawn by using a little bit of our fundamental knowledge of radio, plus the tube manual. We can use the 6J5, a popular triode, and arbitrarily pick a value of 20,000 ohms for a first choice

of load resistance. With a value of load resistance of 20,000 ohms and a plate supply voltage of 280 volts, the characteristic curves of Fig. 305 can be used to determine how our circuit will work in practice.

Let's start by assuming that our tube is completely cut off and that there is absolutely no flow of current from cathode to the plate. With no current flow, there cannot possibly be any voltage drop across the load resistor, and as a result the full supply voltage appears on the plate of the tube. Therefore, in Fig. 311, X is the spot where the plate voltage is 280

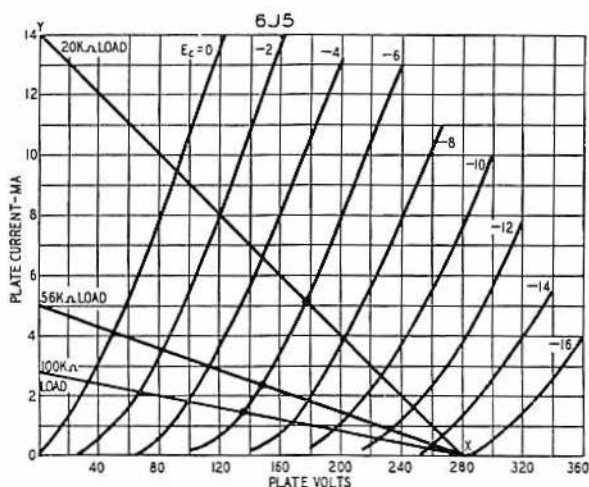

Fig. 311—The value of the load determines the output linearity.

volts and the plate current is zero. This condition would actually exist if the current were cut off. But in order to draw a load line we need another point on our graph. Let's imagine that our full supply voltage appears as a voltage drop across our load resistor. Of course, this is possible only theoretically. With the entire supply voltage appearing as a voltage drop across the load resistor, our plate voltage is zero. Thus, when plate voltage = zero, plate current = $\frac{280}{20,000} = 14$ ma, the point shown as Y in Fig. 311.

If we now draw a straight line between X and Y, we will have our load line. We do not have to stick to our original choice of 20,000 ohms for a load resistor. The same illustration shows load lines for 56,000 ohms and for 100,000 ohms. Changing the value of plate load resistance changes the steepness or slope of the dynamic characteristic curve.

Now go back to our first choice of load resistor, 20,000 ohms. With a load resistor of 20,000 ohms and a starting bias of -6 volts, the plate current will be 5.2 ma. If we were to increase and decrease the bias by equal

amounts, the plate current would change. For example, a decrease in bias to -4 volts would result in a plate current of 6.6 ma, while an increase in bias to -8 volts would give a plate current of 4.0 ma. Although we have changed our bias by equal amounts, the plate current does not change by equal amounts. This is easier seen if placed in tabular form:

Bias	Plate current	Voltage across load	Voltage change
-4	6.6 ma	132 volts	28 volts up
-6	5.2 ma	104 volts	
-8	4.0 ma	80 volts	24 volts down

In practice, the starting bias of -6 volts would be varied by the incoming signal. Note that although the bias is varied uniformly, the variation of voltage across the load resistor is *not* uniform. Since the voltage change across the load is the output signal, a non-uniform variation means distortion.

We can repeat this procedure, but this time let's use the 56,000-ohm load resistor, start with a bias of -6 volts once again, and increase and decrease this bias in equal amounts. Our results in tabular form would be:

Bias	Plate current	Voltage across load	Voltage change
-4	3.0 ma	168 volts	34 volts up
-6	2.4 ma	134 volts	
-8	1.82 ma	102 volts	32 volts down

We still do not get a uniform variation across the load, but the percentage of distortion has decreased. If we now use a 100,000-ohm load, our results will be:

Bias	Plate current	Voltage across load	Voltage change
-4	1.8 ma	180 volts	30 volts up
-6	1.5 ma	150 volts	
-8	1.2 ma	120 volts	30 volts down

The change across the load increases and decreases in a linear manner.

Quite apparently, as we increase the size of our load resistor, our output becomes less distorted. In addition, as we learned earlier, when the value of load resistor is increased, we more nearly approach the amplification factor of the tube—or, in other words, we get more gain.

There is a definite limit to the size of the load resistor. If you will once again examine the tabulated results you will see that as we increase the size of the load resistor, the voltage drop across the resistor goes up, but a larger drop across the load means that much less voltage for the plate of the tube.

We can overcome this difficulty by increasing the output of our power supply, but while this is theoretically possible, it is not a very practical approach.

For those who wish to experiment with resistance-coupled amplifiers, the tube manual supplies resistance-coupled amplifier charts giving actual figures for gain, output, and values of load resistance for a large variety of tubes.

Class A Amplifiers

When we consider the small number of elements that go to make up the triode, the various uses to which the tube can be put is truly amazing. Its versatility as an amplifier alone is such that we ordinarily divide its use as an amplifier into four different classifications for the sake of convenience. Radio tube amplifiers are listed as class A, class AB (subdivided into class AB1 and class AB2), class B, and class C. This doesn't mean that class A is better than class B, or that class C makes a very poor type of amplifier. The particular class into which we put a tube is determined by the work that the tube is going to do, and how efficiently the tube is expected to do its job. Assume that we want to operate a triode tube class A. In order for us to be able to say that the tube is definitely working as a class A amplifier, the first requirement is that the amplified waveshape of the voltage appearing across the load be an exact (or very nearly exact) reproduction of the input signal. To make sure that we meet this prime requirement we can make use of the mutual or transfer characteristic curve. We start out with a fixed value of plate voltage and also with a fixed value of d.c. bias voltage. Look at Fig. 312. These graphs are useful in that they tell us what current will flow through the tube for different values of grid bias. If we send a signal into our amplifier tube, all that the signal will do will be to vary the bias on the tube—but this in turn will vary the plate current. If we make the bias more negative (as it would be during the negative portion of the incoming signal) the plate current will decrease. Moving to the left along the horizontal axis line is our graphical way of saying that the bias has become more negative. During the positive portion of the incoming signal, the bias is made less negative. In Fig. 312-a the resultant variation of current through the tube has a waveform which is the same as the incoming signal. Our input is in terms of voltage, our output in terms of current. However, since the output current flows through a resistor (the load resistor), it is in effect converted into a voltage. The voltage across the load resistor will be determined by the current flowing through it. In other words, the waveshape of voltage across the load will be of the same waveshape as the current going through it. Due to the amplifying properties of the tube, the output voltage will not only have the same wave-

shape as the input signal voltage, but will be much larger, as illustrated.

If you will look at the graph in Fig. 312-a you will see that part of the plate current line is straight, but the lower portion seems to have a curve to it. The straight part is called the linear portion. Observe that the line marked A goes up to meet the linear portion of the curve, and, as a matter of fact, our original starting bias puts us at the approximate center of that straight portion. This is just about the most important part of class A amplifiers. We have to start with a value of bias such that we are close to the center part of the graph. There's one more thing we can learn from our graph. Whether the signal comes into our tube or not, we can always read a certain amount of plate current. The plate current flows at all times, the tube getting no rest at all. Just think for a moment about the efficiency of a machine that operates constantly with no chance to recuperate. Its efficiency is low. If now, you'd like to gather all your facts about class A amplifiers and check them off as we go along, here they are once again: (1) The class A amplifier is a reasonably faithful amplifier. It doesn't change the input signal, just makes it bigger. (2) Plate current flows at all times and, (3) as a result, the efficiency of the tube is low.

Because the amplification of the triode also depends upon the voltage at the plate, the triode is better used in circuits where the d.c. load resistance is not too great. It is better as a power amplifier than as a voltage amplifier. It can handle plate current changes better than voltage changes. The loudspeaker in a radio receiver requires large current changes so that it can move the diaphragm magnetically. The loudspeaker is fed through a transformer whose d.c. resistance is low. Therefore the d.c. voltage at the plate of the triode-power amplifier is not much less than the supply voltage.

As a class A amplifier, the tube cannot be driven too hard. To get good quality the output is held down, and the efficiency is only about 20% (a lot of power is wasted in R_p). If driven into the curved part of the dynamic characteristic to get more output, the output signal will have a second harmonic.

Class AB Amplifier

Using a tube as a class A amplifier results in low efficiency. This doesn't mean that the tube won't amplify the signal or that it will distort it. In order for the tube to work in the first place, it must receive power from some source, either a battery or a power supply. Instead of using this power conservatively, the tube wastes a lot of it.

Let's readjust our starting bias so that we move our initial operating point (point A) further down on the mutual characteristic curve as shown in Fig. 312-b. Our output waveform is incomplete, but there is also another important fact. Plate current doesn't always flow through our load resistor.

Although the signal may be constantly present, part of the time the tube plate current is cut off. With the tube current flowing only intermittently,

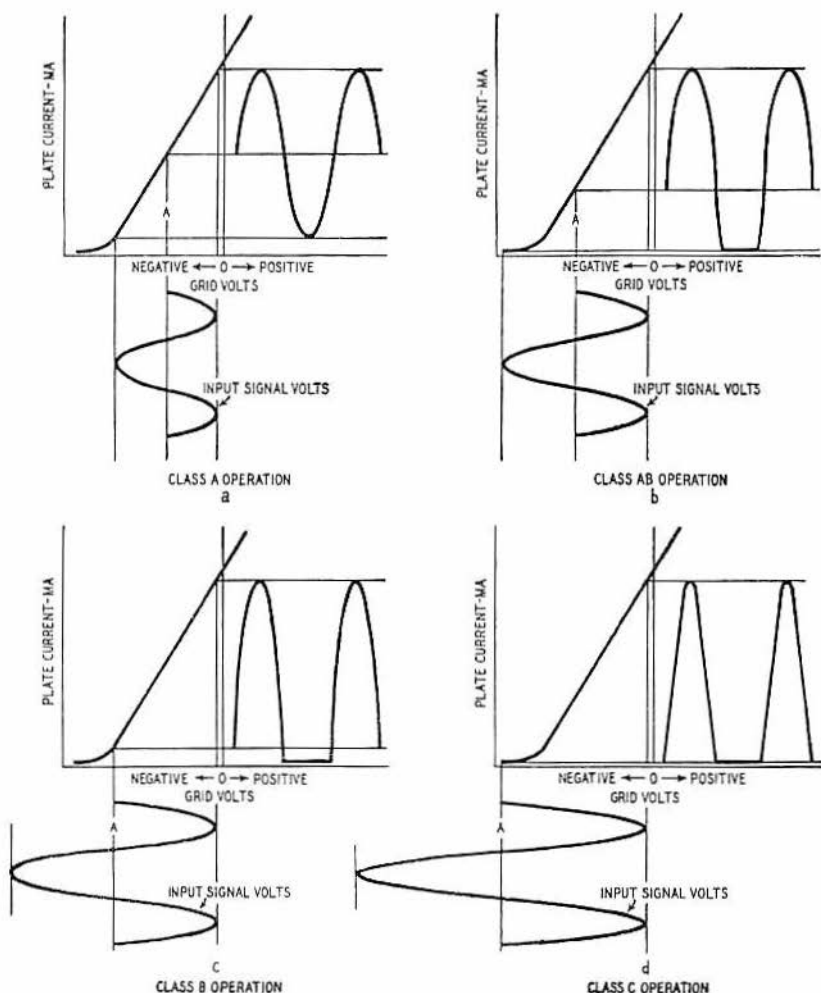

Fig. 312—Characteristic curves for four classes of vacuum-tube operation.

less power is wasted in the plate, the plate gets a chance to rest, the efficiency goes up, but so does the distortion. To eliminate the distortion problem, class AB operation requires two tubes operated in push-pull. In order to have the tubes operate at a lower portion of the characteristic curve (to improve the efficiency) a negative grid bias is used which is

somewhat higher than that employed in class A operation. Because of the value of negative bias used in class AB, the plate current is kept down, and as a result higher values of plate voltage can be used. Using a larger bias and a higher plate voltage in class AB means that a larger input signal can be used and that we can get more power output. Since the distortion is controlled because the output of both tubes cancels distortion effects, balanced tubes should be used. In many cases, duo-triodes such as the 6SN7 are well suited to accomplish this.

Class AB amplifiers are frequently listed as class AB1 and class AB2. The first of these, class AB1, is so biased and operated that current does not flow in the grid circuit. The bias for class AB1 is so chosen that it is never exceeded by the peak positive value of the incoming signal. In operating a push-pull amplifier class AB2, the incoming signal has a positive peak greater than the negative grid bias, consequently the grid becomes positive for a small portion of the incoming signal, hence the grid draws current. Tubes operated class AB are usually power amplifiers.

The class AB amplifier is more efficient when driven into the curved part of the tube characteristic. Second harmonic distortion is minimized by working two tubes in push-pull. The class AB amplifier, because it is driven harder than class A, works at slightly higher efficiencies, up to about 30%.

Class B Amplifier

Because the efficiency of a tube depends upon the power loss in the plate, it can be improved by cutting down on the length of time that the current flows through the plate resistance. We can put a negative bias on the tube (much stronger than in the case of class A or class AB) so that in the absence of an incoming signal, the plate current is reduced almost to zero, that is, the tube is biased almost to cutoff. Remember, in a class A amplifier, plate current flows all the time—signal or no signal. Now we're going to give our tube a chance to rest. No signal—no current in the tube's plate circuit. When the signal is applied, only the positive halves of the signal are amplified and practically no current flows during the negative half. Plate current will flow when the positive part of the incoming signal overcomes the bias enough to let current flow. In Fig. 312-c the graph shows the tube biased almost to cutoff, so that with no signal there is hardly any electron flow in the tube, and negligible power loss. The output wave is distorted, however, because its lower half is gone. Working two tubes in push-pull brings in the other half of the wave, wiping out most of the distortion. The class B amplifier delivers a high output power because it is driven very hard. It has high efficiency because the plate current flows for about half the time. When worked in push-pull, the tubes must be well balanced, so that the output waveshapes of both tubes are the same, thus

keeping the distortion down. Matched tubes can be had for this purpose.

The class B amplifier can be used to amplify either audio- or radio-frequency signals. When used as an audio amplifier, it must be used in push-pull. The class B amplifier can be used singly in a transmitter when amplifying an r.f. carrier only. The carrier in the transmitter is a single sine wave frequency, rather than a mixture of signals as in voice or music. In a transmitter the tank circuit or tuned output circuit supplies the missing part of the output waveform. Efficiencies for single-ended operation are about 35%, but for push-pull increases to about 50% to 60%.

Class C Amplifier

The class B amplifier allows plate current to flow in a tube about 50% of the time or for 180 degrees of the total 360-degree cycle of the input wave. Increasing the initial bias or starting bias will cut down on this time of current flow, further increasing tube plate efficiency. This is done with the class C amplifier in which current flow time is cut by as much as $\frac{2}{3}$, or for as little as 120 degrees of the 360-degree cycle. Such a short pulse would be enough to excite a tuned circuit (same as class B single-ended amplifier used for amplifying r.f.). However, the class C amplifier cannot be used in push-pull (or singly) with audio signals, because part of the wave would be lost. Fig. 312-d shows class C operation as applied to a transfer characteristic.

Voltage Amplifiers and Power Amplifiers

Up to now, our discussion has included both voltage and power amplification. An amplifier tube is designed to amplify either in terms of voltage or power. In the voltage amplifier, the amplified output voltage appears as a drop across the load resistance, developed by the varying current in the plate circuit. This output voltage is the product of the varying plate current and the load resistance (current times resistance). In voltage amplifiers we usually have a small current (the tube-plate current) flowing through a rather large resistor (the plate-load resistor). The reason for this is that we're interested in the voltage across the load. There's no use having a large current flowing through a tube unless it's absolutely necessary. When we talk about voltage amplifiers we're simply saying that what we're interested in is the voltage across the load, and the larger that voltage is with relation to the input signal voltage, the more amplification we have. We've got to remember, however, that the load resistor does take energy from the power supply. The amount of power taken by the load is so small that we can usually disregard it.

With the exception of the output tubes, we try to operate the tubes in a receiver as voltage amplifiers. Until we get to the output tube, all we're interested in is in making the incoming signal (voltage) as large as

possible. When we get to the output tube, the story becomes somewhat different. The output tube has the job of pushing the speaker cone. If you push the cone of a speaker lightly with your finger, you mightn't think that it takes much energy, but for the output tube it's a big job. Since the output tube is really going to have to work, it must deliver power to the speaker—usually through an output transformer. It must deliver this power in the form of relatively large amounts of current to move the speaker cone magnetically. For this reason we call such tubes power tubes. Incidentally, the tube doesn't have to deliver power just to a speaker to be called a power tube. A power tube could furnish power to the grid of some succeeding tube or other load, such as a resistor.

In the case of the voltage amplifier, the tube is worked so that maximum voltage gain (amplification) is obtained. With a power amplifier, we are mainly interested in the power output. Power tubes usually have a rather large amount of current flowing through the tube compared to tubes used as voltage amplifiers. For this reason the electrodes used in power amplifier tubes must be made strong enough to support such a current. The filament, or cathode, must be sturdily built to deliver a large current, and the plate must be large enough to dissipate the heat generated by the bombardment of tremendous numbers of electrons. The wires of the grid must be rather widely spaced so as not to interfere with the flow of current from filament to plate.

Power Input and Power Output

In many respects, a tube can be considered as a piece of electrical machinery. We put a certain amount of power in and we get a certain amount of power out. Naturally, we're interested in putting in as little power and getting out as much as we possibly can. We can easily calculate the power going in. Measure the plate voltage (d.c.) and multiply it by the d.c. plate current. The answer will be the power going into the plate of the tube, measured in watts. The power output is measured in much the same way. We still measure the plate voltage, but this time we read the varying current in the plate circuit. Multiply the amount of varying current (termed the a.c. component) by the plate voltage, and you have the power output, in watts. Power input is sometimes called d.c. power input, while output power is termed a.c. power output.

Push-Pull and Parallel Power Tubes

An important advantage for push-pull operation is the reduction of second harmonic distortion. There are other advantages. Since the plate power is supplied through the balanced center tap of the output transformer, any hum originating in the power supply is balanced out. In addition, you can get more than twice as much power out of two tubes in push-pull as

you can get out of a single tube, under proper operating conditions. For example, a single tube might be able to operate with a 7-volt input signal, but can handle an input signal of 10-volts when operated in push-pull. Since the control grids of both push-pull tubes receive the same input, the combined output is more than twice the output of a single tube. However, to get this, the input signal must be more than twice the signal voltage applied to a single tube. If the input signal were the same to either a single tube, or a push-pull amplifier, the output power would be the same for both.

Power output tubes can also be connected in parallel. The parallel connection takes the same amount of signal input as a single tube, but provides double the output. Note that this is not the case with the push-pull arrangement. However, tubes in parallel operation do not help minimize hum or distortion. Sometimes power output tubes connected either in parallel or push-pull go into oscillation (generate signals of their own). This can be stopped by inserting half-watt carbon resistors in series with each grid. The value is not critical; resistors ranging from 15 to 100 ohms can be used.

Grid Current

The bias placed on the control grid of a tube is such that it makes the control grid negative with respect to the cathode. Under such conditions the control grid will not attract electrons, also negatively charged. However, an input signal coming into the control grid from some outside source will have the effect of changing the bias on the tube. The negative part of the incoming signal will make the control grid even more negative. When the incoming signal becomes positive, it has the effect of partially or totally overcoming the negative grid bias. If the positive part of the incoming signal is strong enough, it not only will overcome the original negative bias on the tube, but will make the control grid positive with respect to the cathode. Under such conditions the control grid will attract electrons, and a current will flow from cathode to the control grid. This current, the grid current, will flow from the cathode to the grid, through the grid circuit and then back to the cathode. Some power, however small, is lost in the form of heat when grid current flows. Whether or not grid current will flow in a particular amplifier depends upon the amount of bias and upon the strength of the incoming signal. Some tubes are designed to carry a small amount of grid current, others are not. Grid current, flowing through the grid bias resistor, creates a negative bias which is in opposition to the initial positive grid potential.

Power Amplification

If a tube is so biased and operated that grid current flows, power will be used in the grid circuit. Since this power is due to an a.c. signal, we can

consider it as a.c. power. The power amplification of a tube is simply a comparison between the a.c. power output and the a.c. power input. We can determine the power amplification of a tube by dividing the output power by the power in the grid circuit, sometimes called the input power.

Power amplification is a term that we can apply only to a power tube in which the grid draws current. Obviously, if the grid is negative under all conditions, it will not attract electrons; the grid circuit will not have any power loss. We would then have no way in which to compare the output power with the input power (as defined above) since there would be no input power. However, we can still obtain an idea of the tube's power amplifying properties by measuring the power sensitivity of the tube.

Power Sensitivity

We can get some indication of the power amplification of a tube by comparing the output power with the amount of signal fed into the tube. The power sensitivity of a tube is the relation between the amount of power coming out of a tube with respect to the amplitude of signal going into the control grid of the tube. If a particular tube yields a fair amount of power output, but does so only if a very strong signal is required at the grid, then such a tube has poor power sensitivity. Power sensitivity is expressed in mhos, the mho being the unit of conductance. Power sensitivity is the ratio of the output power in watts and the square of the input signal. For those who like to have things expressed in terms of formulas:

$$\text{power sensitivity} = \frac{\text{power output in watts}}{\text{input signal squared}} = \frac{P_o}{(E_{in})^2} \text{ (r.m.s. volts).}$$

Plate Efficiency

We never get as much power out of a machine as we put into it. If we did, the machine would be 100% efficient. The same with a tube used as a power generator. We never get out as much power as we put in. Nevertheless, calculation of efficiency is still a good idea, since we can then compare the efficiency of one tube with another. The efficiency of a tube, more often called the plate efficiency, is the amount of a.c. power output divided by the d.c. power input. As a general rule, the lower the amplification factor of a triode the better its plate efficiency. This means that if we want power coming out of a tube, we won't get much voltage amplification. This is all right, since in a power tube we are primarily interested in the amount of power we're going to get out of the tube. As far as voltage amplification is concerned, this is the job of the tubes that precede the power tube.

Interelectrode Capacitance

Whenever two metals are brought sufficiently close to each other,

capacitance will exist between them. The closer the metals are, and the greater their area, the larger will be the capacitance. In tubes, capacitance can exist between the plate and grid, between the grid and cathode, and between the plate and cathode. For a typical triode such as the 6J5 these can be pictured as shown in Fig. 313. Fig. 313 shows in schematic form

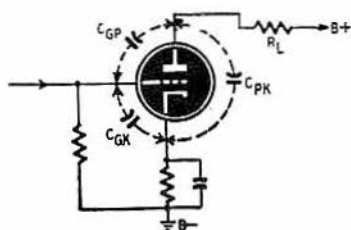

Fig. 313—Triode interelectrode capacitance.

that these capacities are shunt and series paths for the audio or radio frequency to flow through. The capacitance from plate to cathode forms part of the output impedance and acts as a shunt across the load resistor, R_L . The capacitance from grid to cathode and grid to plate is part of the input circuit. The tube manual rates a tube for input capacitance (C_{GK}), output capacitance (C_{PK}), and also lists the plate-to-grid capacitance (C_{GP}). C_{GP} is affected by the amplification factor of the tube (μ) and must be multiplied by μ to get its effect in the input circuit. Neglecting any voltage step-up in the load, the total input capacitance then is:

$$C_i = C_{GK} + C_{GP} (\mu + 1).$$

For example, the 6J5 with a μ of 20 has a total input capacitance of

$$C_i = 3.4 + 3.4 (20 + 1) = 74.8 \mu\text{f}.$$

The input capacitance (represented by C_i) is frequently called *Miller effect*. Triodes with higher amplification factors have higher total input capacitances.

The input capacitance shunts the circuit at the higher frequencies, making the amplification different over the frequency range. With low μ tubes, this effect is not as great, but the amplification is not large. To get high gain, good quality is sacrificed. Use of low-impedance input and output circuits reduces the high-frequency loss, but over-all gain is reduced too.

The capacitance between grid and plate directly couples the plate to the grid. Under certain conditions this can cause oscillation. Oscillation can be deliberate (as in the case of a tuned-grid, tuned-plate oscillator), or can be accidental and unwanted, as in the case of parasitics in the power

amplifier of a radio transmitter. Examine the power amplifier triode in the circuit shown in Fig. 314. The input and output capacitance of the tube can be compensated for in tuning. However, because C_{GP} directly couples the plate to the grid, it provides a path for the a.c. to feed either from plate to grid or from grid to plate. The plate is 180° out of phase with the grid, and therefore it would seem that any signal fed back from plate to grid through the tube would tend to reduce the input signal because it would act in opposition to it. If the plate load is a pure resistance (as it would be at resonance) a pure capacity is coupled back into the grid from the plate. If the plate circuit impedance is capacitive, a resistance would be coupled back into the grid circuit through C_{GP} in addition to the capacity. In Fig. 318 this would happen if the plate circuit was tuned to a slightly higher frequency than the resonant frequency in the grid circuit. In the other case, when the plate circuit impedance is inductive, a *negative resistance* is coupled back into the grid through C_{GP} in addition to the capacity. This occurs when the plate circuit is tuned to a frequency lower than resonance.

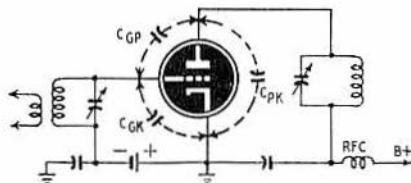

Fig. 314—Tuning circuits include tube capacitance.

If a negative resistance is coupled back and is sufficiently large to offset the regular positive resistance in the grid circuit, oscillation will take place. We should remember that all the leads in a circuit have capacity to ground, depending upon how near they are to the chassis, or other grounded parts. They can be very large compared to the tube interelectrode capacitance.

The interelectrode capacitance of radio tubes becomes increasingly important as the frequency is increased and must be considered in high-frequency television r.f. and i.f. amplifiers, and also in those circuits in which equal amplification of a broad band of frequencies is desired. The amplification factor of a tube depends on the physical placement of the tube electrodes. The closer the tube electrodes are to each other, the higher will be the amplification factor (or a higher G_m). However, lessening the distance between tube electrodes also *increases* interelectrode capacitance. The spacing of the elements in a tube represents a compromise between the high gain which is wanted and undesired interelectrode capacitance.

Perveance

For high-frequency amplifier circuits or for circuits that must uni-

formly pass a wide band of frequencies it is frequently necessary to choose tubes that have very low interelectrode capacitance. At the same time, the gain of such circuits is directly dependent upon the transconductance (G_m) of the tube. As we have seen in the last paragraph, these two characteristics are related to each other since they are determined by the physical structure of the tube. A method of comparison of the relative desirability of various tubes can be set up by dividing the transconductance of a tube (in micromhos) by the sum of the input and output capacitances in $\mu\mu\text{f}$. This is called the *figure of merit* of the tube, and is sometimes referred to as the *perveance* of the tube. For high-frequency r.f. amplifiers and for video amplifiers, tubes having a high perveance are to be preferred.

Gas Triodes

Just as in the case of gas diodes, triodes may also contain a small amount

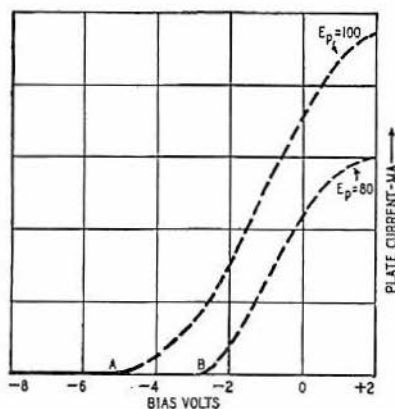

Fig. 315—Transfer characteristics of a gas triode.

of inert gas. Such tubes are called *thyatron*s and are suited for control circuits (trigger circuits) or as rectifiers and oscillators. If the grid of the thyatron is left floating (not connected) its characteristics will be about the same as the gas diode. The tube can be kept from conducting if the control grid is made negative.

To compare the thyatron to a vacuum triode, refer to Fig. 315 which shows the transfer characteristics (in dashed lines) of a gas triode. Addition of gas to the tube causes it to break down, or ionize, at A. Once the tube ionizes, the grid no longer has control. The voltage at the plate of the tube drops to about 15 volts, and the current, as with the gas diode, is limited only by the resistance in the plate circuit. The value of bias at A is called the *critical grid voltage* and is different for different values of plate voltage.

As shown in the illustration, if E_p is 80 volts instead of 100 volts, the bias changes from A to B.

Because we can use the grid to control the firing (conduction) of a thyatron, the tube makes a good rectifier and the output voltage can easily

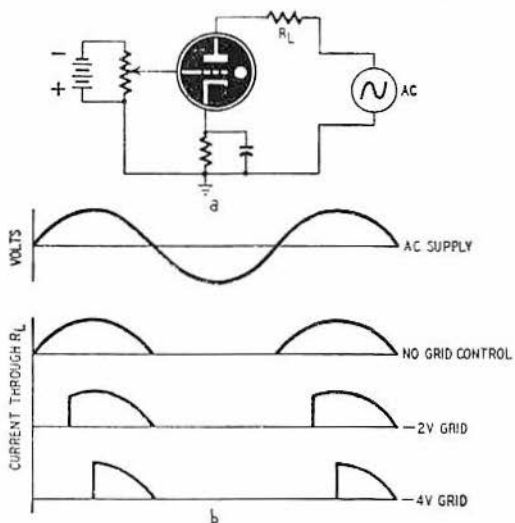

Fig. 316—Grid bias can be used to control the firing action of a gas triode.

be controlled by the grid as the load changes. In Fig. 316-a, if the voltage to be rectified is put on the plate, the plate current would flow only during the positive peaks, as in Fig. 316-b. If the grid were made negative, the tube firing could be delayed so that the total current flow would be less. The illustration shows a few cases with different voltage values.

Chapter 4

The Tetrode

THE tetrode is like a triode, except that a second grid is placed between the control grid and the plate. Fig. 401 shows the electrode placement in the tetrode. The new grid, unlike the control grid, is like a fine screen mesh or closely spaced coil, cylindrical in shape, located about halfway between the plate and control grid. It acts as a screen between the

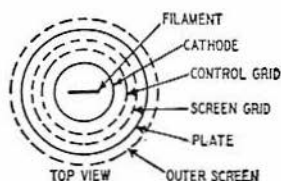

Fig. 401—Structure of the tetrode.

plate and control grid, hence is called the *screen grid*. Because the screen behaves like an electrostatic shield, it does two things. By shielding the plate from the cathode, it tends to take the place of the plate in controlling the flow of electrons from the cathode and at the same time practically eliminates the capacity from plate to cathode. Since the screen grid itself is not a large surface, its own capacity to cathode and plate is not large. In addition, the total capacity between plate and cathode is now made up of two smaller capacities in series which reduce the overall capacitance. Fig. 402 illustrates how the inclusion of the screen grid has the effect of reducing large interelectrode capacitance. Fig. 402-a shows the large interelectrode capacitance between control grid and plate (anode) of a triode. If capacitors

are placed in series, the over-all capacitance is reduced. Fig. 402-b shows that the inclusion of a screen grid has the effect of making the capacitance between control grid and plate into a series capacitor arrangement, reducing

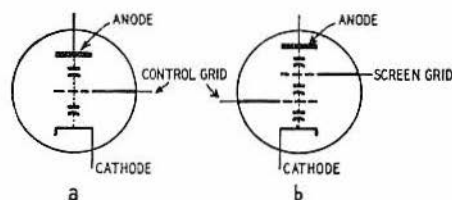

Fig. 402—Tube capacitance in the triode and tetrode.

the capacitance between that element and the plate.

Tetrode Circuit

Electrons, boiled off the cathode, form a negative space charge as in the triode. The screen grid produces an electrostatic field which overrides the effect of the positive plate itself on the electron stream. In the tetrode circuit shown in Fig. 403 the screen grid voltage is set at 80 volts, while the

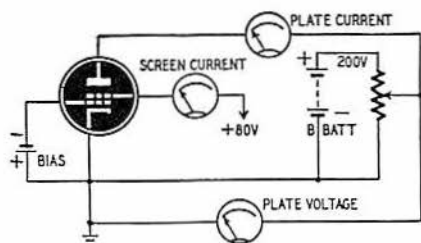

Fig. 403—Circuit for obtaining tetrode characteristics.

voltage on the plate can be changed from 0 to 200 volts. When the plate voltage is zero, all the electrons drawn from the space charge land on the screen grid. Those that try to dash through the mesh are pulled back by the screen. There's no reason for them to go to the plate because the plate has no attraction, no positive charge. If the plate voltage is increased, those electrons that hit the screen directly stay there as before, but those that go through the holes now land on the positive plate. Fig. 404 shows a characteristic curve of the flow of electrons in the tetrode. In Fig. 404-a, the plate begins to get electrons as it becomes more positive from 0 to A. Remember—the plate voltage is increasing, the screen voltage remaining constant. At the same time the screen current decreases as shown from W

to X in Fig. 404-b, while the total electron flow in the tube space stays about the same. As the plate voltage is further increased from about 15 volts to 30 volts, the primary electrons (electrons from the cathode) striking the plate begin to release electrons due to secondary emission, and the plate current decreases at B while the screen current increases again. From B to C the plate actually loses electrons; the current reverses. This comes about because the electrons that go through the screen mesh at top speed are further speeded up by the positive plate and hit the plate so hard that secondary electrons are emitted. These bounce out with such force that

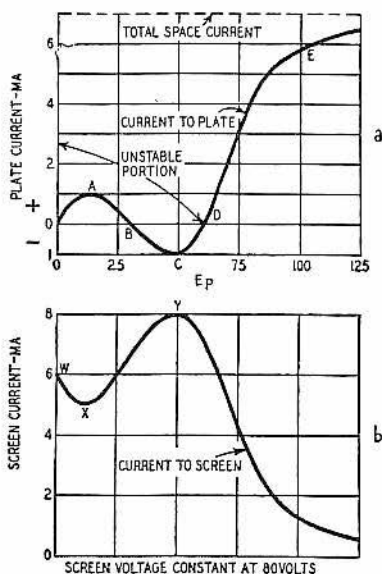

Fig. 404—Tetrode plate and screen characteristics.

they go over to the screen which at this time is at a higher voltage than the plate.

The current reversal keeps up to point C, at which point the plate voltage has become high enough to begin to pull back some of its own secondary electrons. The screen, which had been collecting electrons from the cathode *and* the plate, now loses the plate as an electron supplying source. The screen current begins to decrease again at point Y. The plate continues to collect more and more electrons as the plate voltage is increased, and the characteristic beyond point D to point E looks somewhat like the triode characteristic.

Negative Resistance

In Fig. 404 the plate current goes up or down irregularly until the plate reaches about 75 volts. From A to C the plate current goes down as the plate voltage goes up. In a normal electrical circuit, Ohm's law tells us that current increases when voltage increases, yet from A to C the opposite happens. We call this apparent violation of Ohm's law, negative resistance.

The curve of plate current beyond point E begins to flatten out. The plate current stays almost the same and is not changed much by the plate voltage. This means that the tetrode amplification is independent of the voltage at the plate when worked beyond point E. If proper values of plate and screen voltages are chosen for the tetrode, the amount of plate current will be determined by the screen voltage and will be fairly independent of the plate voltage. For most circuit applications (there are exceptions) the plate voltage should be higher than the screen voltage.

Tetrode Transconductance and Amplification Factor

The transconductance and the amplification factor of tetrodes are higher than those of triodes. This means that a properly operated screen-grid tube gives more gain than a triode. The trouble with getting more gain is that it is usually accompanied by instability, that is, the tube may become erratic in its behavior. By using a screen grid to cut down on grid-to-plate interelectrode capacitance, feedback of energy from plate circuit to grid circuit through tube capacitance is minimized; both gain and stability are obtained.

As a tetrode tube ages, it drops down to the unstable part of the characteristic curve, limiting the tube's range of usefulness. Because of this the tetrode has been replaced almost entirely by the pentode. After the pentode came into general use, the tetrode was developed along special lines as a beam-power tube.

One more word about secondary emission. The effects of secondary emission in the tetrode are most noticeable when the screen potential becomes equal to or greater than the plate voltage. With a constant screen voltage, secondary electrons emitted at the plate will go to the screen with low values of plate voltage. An increase of plate voltage increases the secondary emission and the secondary electrons will continue to go over to the screen up to a certain point while the plate current decreases. However, when the plate voltage reaches a value slightly less than the screen voltage, some of the plate secondary electrons will return to the plate and the plate current will begin to increase. As the plate voltage rises beyond this point, the plate takes more and more of the secondary electrons until it retains

them all, and at this point begins to receive a few secondary electrons from the screen grid also. A properly operated electrode is always worked well beyond this point on the characteristic curve.

Screen Dissipation

The plate of a tube is always much cooler when the load is applied. If all the power delivered to the plate by the power supply could somehow be transferred to the load, the plate would remain cool. Since the transfer of power from the plate to a load is usually well below 100%, any power not transferred must be dissipated by the plate in the form of heat. The plate, with its large metal area, is well equipped to radiate this heat.

Unlike the plate, the screen is not designed nor intended to be used as the point of transfer of power. All the power supplied to the screen must be dissipated by the screen. A comparatively frail structure having a very small area, it is not capable of dissipating much more than its rated quantity of heat. Excessive screen voltage with a consequent rise in screen current can cause the screen to glow and burn out. This could also happen with normal screen voltages in the event that the plate voltage should accidentally be removed.

Chapter 5

The Pentode

WHEN the bad effects of secondary emission from the plate of a tetrode were fully realized, research engineers developed the pentode, a tube having five electrodes. A third grid was added in the space between the screen grid and the plate. The third grid is like the control grid in construction, except that the grid "coils" are not as close together. The wide spacing of the suppressor grid (the third grid) gives minimum interference to the flow of electrons from cathode to plate. The suppressor grid can be tied to the cathode inside the tube, while some pentodes have the connection to the suppressor brought out as a separate lead, making such pentodes highly adaptable to new circuit design. Construction of a pentode is shown in Fig. 501.

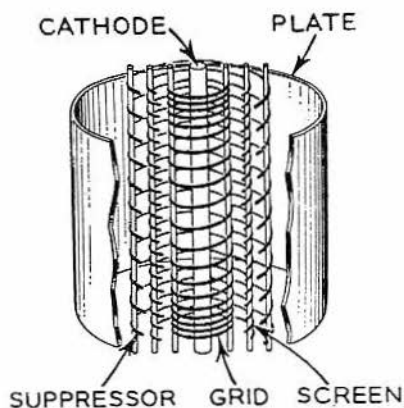

Fig. 501—Structure of the pentode.

The suppressor grid, whether internally or externally connected to the cathode, can be considered an extension of the cathode up into the space between the plate and screen, the area where secondary electrons bounced off the plate normally go. The suppressor is at the same potential as the cathode

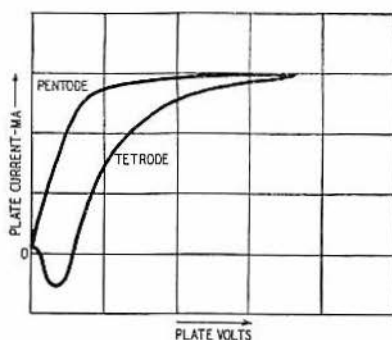

Fig. 502—Tetrode and pentode characteristics.

(the primary electron source) so that it pushes the plate secondary electrons back to the plate, instead of letting them go to the screen. It suppresses the flow of secondary electrons. Any primary (cathode) electrons or secondary

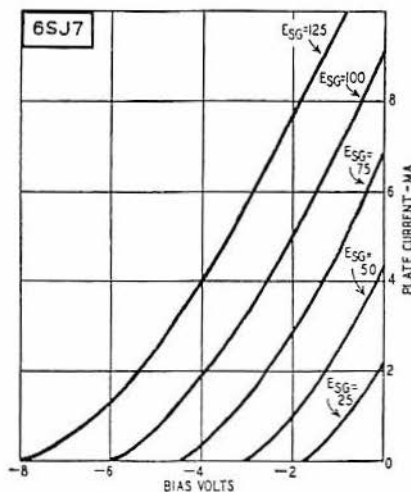

Fig. 503—Pentode characteristics with various values of screen voltage.

(plate) electrons that land on the suppressor are returned to the cathode. For this reason, the plate current does not reverse as it did with the tetrode. We don't worry about secondary emission in the diode or triode since these

tubes have only *one* positive electrode, and electrons, bounced off or out of the plate have no choice but to return to the plate. The effect on the plate characteristic of adding the suppressor to the tetrode is shown in Fig. 502.

If we were to put a positive voltage on the screen grid of a pentode, keeping the grid bias zero, and starting with zero plate voltage, the plate current would increase sharply as we raised the plate voltage. The plate current would then level off, remaining practically constant with further increases in plate voltage. Fig. 503 shows typical characteristic curves for a pentode, such as the 6SJ7. With the pentode, as with the tetrode (under normal conditions) the plate current is sensitive to screen voltage, not to the plate voltage. The screen grid acts like the plate of a triode, except that in this case, the screen does not supply the output signal voltage. Fig. 503 is of interest in that it shows the characteristics for different screen voltages. Note that the plate current is less when the screen voltage (E_{SG}) is less. To see what happens to the plate current with different values of grid bias, the transfer characteristics have to be plotted with different fixed screen voltages, instead of plate voltages as in the case of the triode. The pentode is sensitive to changes in screen voltage, and any effect of loading up or adding resistance to the screen circuit must be taken into consideration.

μ , G_m , and R_p of Pentodes

In Chapter 3 we learned that μ (μ) was the ratio of change in a plate voltage to a change in grid voltage. Referring to Fig. 504, with a plate voltage of 100 and zero bias, the plate current is about 8.8 ma. If we now make the control grid -1 volt, the plate current drops to about 6.9 ma. Offhand we might think that we could very easily bring the plate current up to 8.8 ma again just by increasing the plate voltage. Looking at the graph we can see that in order to bring the plate current back to 8.8 ma with a bias of -1 volt, the slope of the curve is so gradual that it would reach it somewhere way off the paper. As a matter of fact, this would be at about the 1,200-volt point! If, instead of starting with a plate voltage of 100 volts, we started where the plate voltage was 250 volts, the plate current at zero bias would be about 9.2 ma, and with a bias of -1 volt about 7.0 ma. To "bring back" 2.2 ma instead of 1.9 ma as before, by increasing the plate voltage, a much greater change in plate voltage would have to be made. If our graph were large enough we would see that we would have to use about 2,750 volts on the plate. These voltages of 1,200 and 2,750 are ridiculous, of course, in actual practice, but they do show how the μ of a pentode can vary.

The μ of this typical pentode under these conditions is easily calculated:

at a plate voltage of 100

$$\mu = \frac{\text{change in plate voltage}}{\text{change in grid voltage}} = \frac{1,200 - 100}{1 - 0} = 1,100$$

and with a plate voltage of 250 $\mu = \frac{2,750 - 250}{1 - 0} = 2,500.$

The amplification factor of a pentode is much higher than that of a tetrode or triode, hence pentodes are widely used as voltage amplifiers. In practice, the 6SJ7 used as an r.f. amplifier would handle input signal voltages much less than 1 volt, so that the tube's amplification factor would make the plate

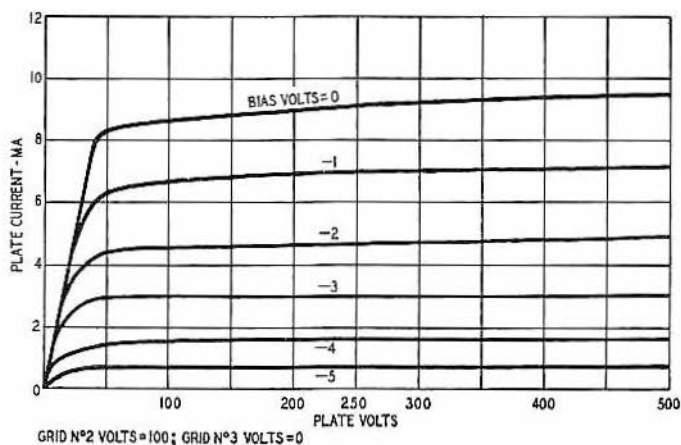

Fig. 504—Pentode characteristics with various values of bias.

voltage vary only between the 100-volt and the 250-volt range. In operation the pentode voltage is high enough so that the plate voltage swings within a comparatively small range, say between 60 volts and 300 volts (but not below 60 volts). If the swings are centered about 100 volts, the μ is 1,100; if around 250 volts the μ is 2,500.

Because the plate current changes very little with changes in plate voltage, the plate resistance is high, usually about a megohm or more. The other tube constant, G_m , has nothing to do with the plate voltage and therefore is not much different from the triode.

The Pentode Circuit

Fig. 505 is a practical operating circuit. R_L is the regular load resistance, while C_p bypasses the a.c. component in the plate circuit so that it does not go down into the power supply. Since a common voltage supply is used for both screen and plate, R_{SG} must be added to the screen circuit

to drop the voltage at the screen. The screen affects the electron flow in the tube, and therefore its voltage must be held constant while the tube is working. The change of electron flow in the screen circuit due to the input signal is bypassed through capacitor C_S so that these changes do not go through R_{SG} and affect the voltage at the screen.

Suppose the tube of Fig. 505 is a 6SJ7. The tube manual says that the

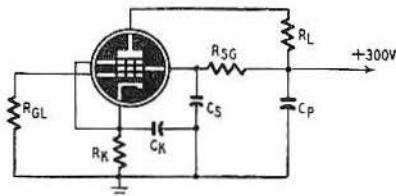

Fig. 505—Typical pentode circuit.

maximum operating voltages are 250 volts on the plate and 100 volts on the screen. Suppose, further, that the input signal has a voltage peak of 0.1 volt and a grid bias of -2 volts is picked as a good operating bias. With a 300-volt supply, a working plate voltage of about 200 volts is picked, and the plate current would be about 4.8 ma. With this current, the 300-volt supply could be dropped to 200 volts by making the load resistor about 20,000 ohms. With an internal plate resistance of about 1.5 megohm (from the tube manual) the net amplification would be:

$$\text{amplification} = \frac{\mu \times R_L}{R_L + R_p} = \frac{2,500 \times 20,000}{1,500,000 + 20,000} = 33.$$

This is the actual amplification we get when the μ , or maximum tube amplification, is 2,500. This means that we are getting a considerable loss of possible amplification. Just looking at the above figures tells us that the value of load resistance should be much higher.

With some pentodes, the tube manual does not list the μ , but the transconductance, G_m , is shown instead. In order to find the net amplification in such cases this equation can be used:

$$\text{amplification} = \frac{G_m \times R_L \times R_p}{R_L + R_p}$$

Suppose that our load resistance was made as high as 500,000 ohms and we wanted to handle the same input signal with the same bias and same screen voltage. Our tube certainly cannot have 4.8 ma plate current now because the voltage drop across the load resistor would be greater than the supply voltage—an obviously impossible situation. We can easily prove

this by multiplying the plate current, 4.8 ma, times the load resistor, 500,000 ohms. The drop would be 2,400 volts—a value much greater than our available supply of 300 volts. Therefore, with a 500,000-ohm load resistor, the plate current would have to drop to less than 0.6 ma, and only about 10 volts would be left on the plate. To keep a plate voltage of at least 100 volts, with a -2 -volt bias, the plate current must be cut down by lowering the screen voltage below 100 volts. The voltage drop across the load resistor then would not be any more than 200 volts.

Characteristic curves for all different screen voltages are not shown in tube manuals since there would be too many for each tube. Resistance-coupled amplifier charts, as shown in the tube manual, can be used instead. Depending upon the available supply voltage and the amplification desired, there are many possible values of plate-load resistance and screen-dropping resistance that can be used. For example, for the 6SJ7, a plate load of 0.47 megohm can be used with a supply voltage of 250 volts. A screen resistor of 2.2 megohms must be added to the screen circuit to keep the voltage at the screen down to about 25 volts. The plate current now is low enough so that the drop across the load resistor is less than 200 volts. In this case, the plate voltage goes down to about 60 volts instead of 100. The curves show that the plate current characteristics are flat below a plate voltage of 100, at lower screen voltages.

The grid-to-plate capacitance is very low, almost negligible. This is because the screen and suppressor grids act as shields. The input and output capacitances are taken care of in circuit design as with the triode.

The pentode is an excellent voltage amplifier. Its plate-circuit resistance is too high to allow much current to flow for power amplification. It is a better voltage amplifier than a power amplifier. It can be used as an oscillator and is employed as a high-gain audio amplifier.

Constant- μ or Sharp Cutoff Tubes

Although the control grid of tubes is often referred to as a mesh, the actual structure consists of either a circular or elliptical spiral of wire. Since the control grid has such a tremendous effect on the flow of electrons, the manner in which the control grid is made is very important. For example, many tubes have the control grid so constructed that the turns of wire which make up the control grid are evenly spaced from each other. A negative bias placed on such a control grid rapidly cuts off the flow of plate current. Since the plate current is so quickly cut off with the application of a negative bias to the control grid, such tubes are called sharp cutoff. Another characteristic of tubes in which the control grid turns are evenly spaced is a uniform amplification factor for different values of grid voltage.

The characteristic curve for a sharp cutoff pentode appears in Fig. 506. Notice the sharpness of the curve (curve B) at the lower portion. This indicates that the plate current is sharply cut off when the bias is increased by just a small amount.

Modulation Distortion

In the discussion on amplification, it was shown that the output voltage of a tube circuit is dependent upon the amount of plate current variations produced in the load resistor. By direct analogy, the greater the current change, the greater the output. Reference to Fig. 506 indicates that except for lower values of plate current, the curves are fairly steep and consequently the output signal is relatively high. However, with lower values of plate current, the curve slope changes, becoming less steep and operating the tube on this portion would produce less amplification.

Now imagine a receiver using sharp cutoff r.f. pentode amplifiers receiving a large value of input signal. If the grid of a sharp cutoff pentode is made much more negative in order to reduce the volume, the signal coming out of the speaker will sound distorted. Such distortion is called *modulation distortion*, and is due to operation of sharp cutoff pentodes with slightly higher than normal negative bias. The excessive negative bias on sharp cutoff pentodes may be due to a volume control setting (increasing bias to reduce volume) or it may be caused by an excessively strong negative incoming signal on the control grid of the tube. If the receiver uses a.v.c. (automatic volume control) the bias developed by the a.v.c. circuit and applied to the control grid of a sharp cutoff pentode, can drive the tube to cutoff. In all these cases, when the plate current of the sharp cutoff pentode is driven to cutoff, or close to cutoff, the result is modulation distortion.

Cross-Modulation

Cross-modulation, sometimes referred to as cross-talk, occurs when two signals interact in a receiver circuit and are heard in the output. In the radio receiver, the tube circuit is usually adjusted to operate with a given fixed bias. This operating point is shifted under control of the a.v.c. to different points on the curve. The a.v.c. of a receiver tuned to a strong signal will shift the operating bias in a negative direction toward the cutoff point to cut down its amplification. Because the tube characteristic is very curved at this point, a relatively strong second signal of a different frequency will modulate the desired signal and cause an unwanted output. The degree of modulation depends upon the curvature of the tube characteristic as well as the strength of the unwanted signal that reaches the grid of the tube. This effect can be reduced by keeping down the strength of the unwanted signal as much as possible before it reaches the first control tube, and also

by using a tube which does not have sharp curvature, such as a remote cut-off type tube.

Variable- μ or Remote Cutoff Tubes

As we have seen, an evenly spaced control grid can result in modulation distortion and cross-modulation. Since these two effects are due to the way the control grid is built, a change in control grid structure will eliminate them. Instead of having a uniformly spaced grid, the grid is modified so that the turns of grid wire are close at the ends, but are spaced fairly widely apart in the center. Because there are less turns at the center, this portion of the grid will not have as much effect on the flow of current. Since the amplification factor is a measure of the control that the grid has over the plate current, this means that the amplification factor is low where the grid turns are widely spaced and higher where the grid turns are closely spaced. For this reason tubes having such control grid structure are called variable- μ tubes. Fig. 506 (curve A) shows the characteristic curve of a variable-

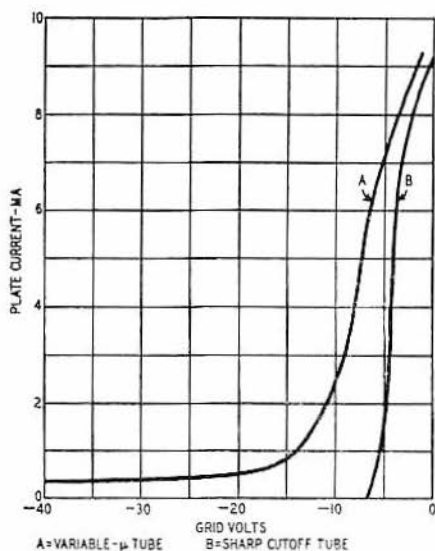

Fig. 506—Characteristics of variable- μ and sharp-cutoff tubes.

μ tube. Notice how the curve slopes gradually as the value of negative bias is increased. As a matter of fact we do not even reach plate-current cutoff, even though a very large bias is applied. Since a very large value of bias would be needed to drive the tube to cutoff and since the plate current decreases gradually as the negative bias is increased, variable- μ tubes are often called remote cutoff.

A glance through the tube manual shows many pentodes, both sharp and remote cutoff types. The 6AB7 is a remote cutoff type, but has a greater G_m , can operate at higher screen voltages than the 6SK7, and has more plate current. The 6BA6, a remote cutoff tube, is a miniature type characterized by low interelectrode capacitance. Because of its small size, its screen and plate dissipation are lower. The elements are much closer together and cannot radiate heat as fast as in the larger tubes. The 6S7 and the 6SS7 are practically the same electrically as the 6SK7 but have a lower heater current. The miniature 6AG5 with its high G_m and low interelectrode capacitance can be used for frequencies up to about 400 megacycles. The remote cutoff tube can be used to advantage in the front end of a radio receiver where there may be wide variations in input signal voltages. Inasmuch as the tube has a long, sweeping curvature, the grid bias can vary over a wide range and still permit good operation. With the 6SK7, for example, the grid bias could vary within a 32-volt range.

Pentode Equivalent Circuit

Because the pentode circuit has high plate and load impedances, it is convenient to treat the pentode circuit on a constant current basis. The equivalent circuit of the pentode is shown in Fig. 507 in which the electrode

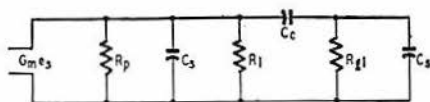

Fig. 507—The equivalent circuit of the pentode.

and shunting capacitances are indicated. The amplified signal coming out of the tube is represented by $G_m e_s$. The load on the tube is made up of C_c (the coupling capacitor) and R_{g1} (grid leak) in shunt with R_l (load resistor) and C_s (shunting capacitances). At the higher frequencies, C_s is a low impedance, reduces the net load impedance on the tube and lowers the circuit gain. C_c on the other hand is a high impedance at low frequencies and divides the output voltage between itself and R_{g1} . Since the voltage appearing across R_{g1} is the circuit output, the amplification is lower at low frequencies also.

Power Pentodes

Although pentodes find their greatest application as voltage amplifiers, specially designed pentodes are used as power amplifiers. The power pentode requires a smaller input signal voltage than the triode to supply a given output. With the triode, amplification is low and plate current vari-

ations are high with low plate voltages. Since the current flow in the pentode is not under control of the plate voltage, but rather the screen voltage, higher currents can be had (if the tube is designed to supply them) because of the relatively high screen voltage. The power pentode is more sensitive and efficient than the triode, but has much more distortion. The structure of the cathode and plate in power pentodes, as in power tubes of other types, must be sturdy enough to tolerate the release (from the cathode or filament) of a large current and its impact on the plate. The other elements, the various grids, are physically placed or constructed so as to provide as little interference as possible with the flow of plate current. Pentodes such as the 6F6 and the 6G6 are classified as power-amplifier pentodes with the 6F6 designed to deliver 4.8 watts as a single tube, and 11 watts in push-pull. The high screen voltages permit the plate currents to be high, so that the bias can be as large as -20 volts. As a result, large amplitude input signals can be handled.

Beam-Power Tubes

Tube designers, in trying to apply the principles of pentodes to power tubes, found that if the emitted electrons were concentrated in a beam, and the plate was moved farther away from the screen, the electrons rushing through the screen in such great densities would form a negative space charge (similar to the cathode sheath described in an earlier chapter) in the region near the plate. This negative space charge acts as a brake on the electrons approaching the plate, slowing them down so that plate secondary emission is greatly reduced. Since the plate is relatively far from the screen, the electrons comprising the space charge do not go to the screen. This space charge then acts as the ordinary suppressor of the pentode and can in fact, be considered a *virtual suppressor*.

While the beam-power tube is in fact a tetrode (it has only four electrodes) it is often referred to as a pentode because it performs more like a pentode than a tetrode.

Fig. 508 shows the internal construction of the tube. The control grid and the screen grid consist of spiral turns of wire. The construction is very similar to that of the tetrode or pentode, with this one exception. Each turn of the screen grid is on exactly the same level as the corresponding turn of the control grid. Since the screen grid is right behind the control grid, and all the turns of both electrodes spaced exactly the same way, the screen grid cannot be said to interfere with or obstruct the flow of current to the plate. Because of this arrangement, the amount of current flowing to the screen is rather small when we consider the large current that travels from cathode to plate.

Fig. 508 shows one of a pair of beam-forming plates, as well as a plate

located rather far away from the screen. This creates a comparatively large area between the plate and screen for the formation of the aforementioned space charge. Because the beam-forming plates are at cathode potential, they confine the electrons to a particular path. If you will look closely at the illustration you will see that the plate is rather far away from the screen, and that there is a rather large area between the plate and the screen.

Normally, we would expect the plate voltage to be higher than the screen (or at least as great as the screen), because we want the electrons from the cathode to go to the plate, not to the screen. Usually, electrons that go to the screen represent just so much wasted effort. The beam tube is an exception, however, in that the screen is operated at a slightly higher voltage than the plate. We might expect the screen to pick up a large quantity of electrons because of this, but remember that the screen is shielded from the flow of current by the control grid. The screen is operated at a high voltage primarily because it, rather than the plate, controls the electron flow. Because it is relatively far from the plate, it does not attract the electrons from the "virtual suppressor" formed in front of the plate. With large screen voltages, large currents can be developed in the plate circuit.

Beam-Power Tube Characteristics

The beam-power tube operates the same as the power pentode except that, because of the special construction, it includes the advantages of the power pentode previously described, while it eliminates some of the bad distortion effects. A beam tube will produce less distortion when low values of plate voltage are used. The amplification factor of beam tubes is lower than that of either the tetrode or pentode, but it is higher than that of the average triode. While this seems a disadvantage, remember that our primary concern in using a beam tube is power output and not voltage amplification. The plate resistance of beam tubes is lower than that of pentodes, an advantage in that it permits the use of transformer coupling in place of resistance coupling.

Plate Dissipation

The term *plate dissipation* as discussed briefly in Chapter 2, is the ability of the tube to dissipate the heat generated in the tube as the electrons strike the plate. With power tubes, the electron bombardment is very heavy and consequently, the plate temperature will rise. Plate dissipation can be calculated by determining the power delivered to the plate of the tube, and subtracting from this figure the power delivered by the tube to the load. For this reason a power tube operates cooler when the load is applied. If the load on a power tube, such as antenna, speaker, or

another tube, must be removed, a resistive dummy load of equal value should be temporarily substituted. Exceeding the permitted plate dissipation by using too high a value of plate current or by an improper load or no load may cause an excessive accumulation of heat at the plate. This can

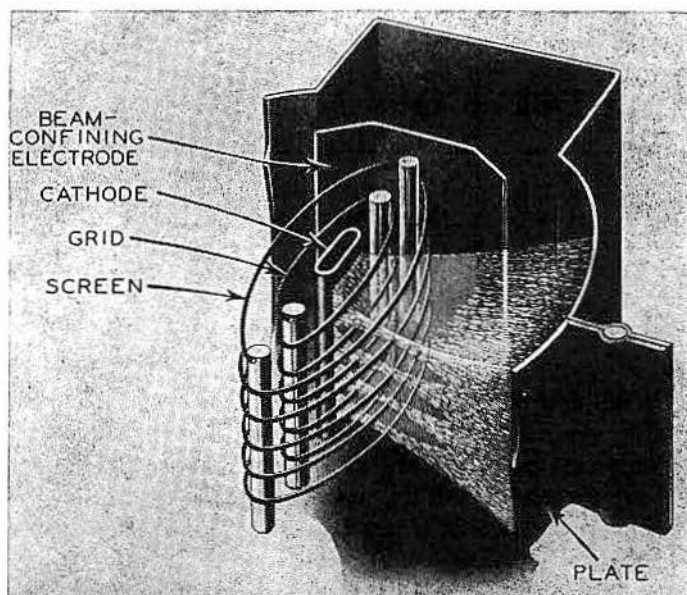

Fig. 508—Physical structure of the beam-power tube. The plate is relatively far from the screen.

happen in radio transmitters if full power is applied to the power amplifier before the output circuit is properly tuned. Under such conditions the plate may actually glow. This is equally applicable to the screen grid. Excessive screen grid dissipation may result in destruction of the screen, since the screen, made of a much smaller metal mass than the plate, cannot too effectively radiate its accumulated heat.

Chapter 6

Multipurpose Tubes

A multipurpose tube is a combination of two or more tubes in one, or the simultaneous use of a tube for more than one purpose. The first step in this direction was taken when a half-wave rectifier (single diode) was made into a full-wave rectifier (two diodes). A full-wave rectifier, such as the 5U4-G, is just two half-wave rectifiers placed within the same glass envelope.

The tube manual covers other special type tubes. Some are merely the combination of two triodes, a triode and a pentode, or a diode and triode, all in one tube. Each unit of these types acts the same as the unit itself would act if it were in a separate tube. For example, the 6A6 or 6N7 are duo-triode amplifiers. These tubes consist of two tubes having a single cathode. Such dual tubes can only be used in a common circuit. Multipurpose tubes come equipped with two individual cathodes or with single cathodes, depending entirely upon the design and structure of the particular tube. Where a multipurpose tube has only one cathode, the electron stream leaving the cathode divides into two parts, and after separating, each of these electron streams becomes independent of each other and are independently controlled. The common cathode is an excellent means for tying two circuits together. The 6SL7-GT, on the other hand, is two triodes, but having separate cathodes, can be used as two separate tubes, and the circuits associated with the two sections in the tube can be independent. The 6AD7 combines a triode and pentode in one tube. The 6AL5 is a double diode similar to the familiar 6H6 with two separate cathodes. Being smaller in size the 6AL5 has smaller capacitances between electrodes and is good up to 700 megacycles.

Multipurpose tubes are not necessarily large in size and are quite often

found in the family of miniature tubes. The illustrations in Fig. 601 show representative types of multipurpose tubes. From a practical viewpoint, multipurpose tubes are identified by their structure. Thus a duo-diode indicates a multipurpose tube consisting of two half-wave rectifiers. A diode-triode means a multipurpose tube comprising a diode and a triode. A duo-

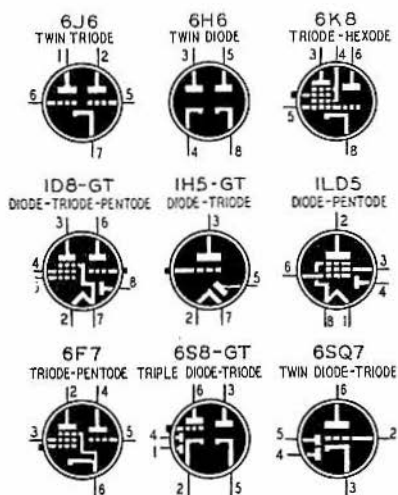

Fig. 601—Representative multipurpose tubes.

pentode or duplex pentode means a double (or twin) pentode radio tube

Multigrid Tubes

The evolution of the radio tube included the addition of more grids. From the triode (one grid) tube design progressed to the tetrode (two grids) and from there to the pentode (three grids). The number of elements in the tube thus went from three to four to five. As we add more electrodes, beyond that of the pentode, we have the six-element tube or hexode, the seven-element tube called the heptode, and the eight-element tube called the octode. The multigrid tube either may have additional grids, such as the 6SA7 or its miniature equivalent, the 6BE6, or may use additional electrodes to form a multipurpose tube, as in the case of the 6K8, a tube acting as a triode and a hexode.

Pentagrid Mixer

It is standard practice in superheterodyne receivers to use multigrid tubes for the purpose of mixing two a.c. signals—an incoming broadcast signal and a signal generated within the receiver itself. The pentagrid, a

tube having five grids, is commonly used for this purpose. A pentagrid mixer tube, the 6L7, is shown in Fig. 602-a. The tube has two separate and independent control grids to which are fed the two signals to be mixed. The tube contains a cathode, a plate, and a total of five grids. The tube, since it has five grids, can be called a pentagrid tube, or counting the total number of tube elements, a heptode. Notice the numbering system used for the various grids. The grids are numbered with relation to their spacing from the cathode, the grid closest to the cathode being called number one, the next number two, etc. Grid 2 is internally tied to grid 4, these two acting as the screen. Grid five, the suppressor grid, is tied to the cathode.

Pentagrid Converter

The pentagrid mixer requires a separate tube in the receiver to act as

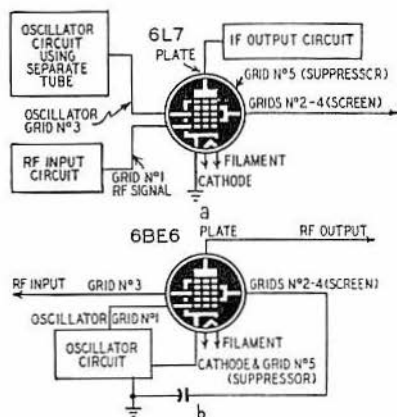

Fig. 602—Pentagrid mixer and pentagrid converter.

a local oscillator. For the sake of space and economy, the separate oscillator tube can be eliminated and the pentagrid tube can be made to function both as a mixer tube and as an oscillator. When working under such conditions (and to distinguish it from the pentagrid mixer) the tube is called a pentagrid converter. Fig. 602-b shows the 6BE6, a typical pentagrid converter. Grid 1 in such tubes is usually the oscillator grid, while grid 2 is internally connected to the screen grid (or grid 4). Grid 2 and grid 4, tied together, act as a screen grid and as the oscillator anode. The cathode and these two grids, connected to an external circuit, form the oscillator section. These three elements will vary the electron stream at a rate depending upon the frequency of oscillation. Grid 5 (tied to the cathode) acts as the suppressor. The incoming broadcast signal is fed into grid 3. In this manner the electron stream going to the plate is controlled or modu-

lated by two separate signal sources—the oscillator and the incoming broadcast signal. The broadcast signal grid is shielded electrostatically from the other grids by means of grids 2 and 4. The pentagrid converter finds its greatest use in receivers operating at broadcast frequencies. In FM and television receivers, the pentagrid mixer using an external oscillator tube has found the greatest application.

Socket Connections

To be able to identify the leads coming from the various elements inside a tube, a socket numbering system is currently used. It is customary to identify the numbers of the various socket terminals by examination of the underside of the socket, or the underchassis view. With the socket in such a position, the numbers are counted off in a clockwise direction. Tube manuals show the socket connections for old and new types of tubes.

More modern tubes make use of either an octal or loktal base. Both the octal and the loktal are sockets having eight connections. If you will look carefully at the guide hole in the center you will see that the guide hole is not a perfect circle but that it has a little groove. This groove is called a keyway and is helpful as a means of identifying socket numbers. The number 1 pin is always the first pin to the left of the keyway, if the tube socket is examined from underneath the chassis.

Although octal sockets have eight connections, this does not mean that a tube must have eight pins coming out of the tube base. Many tubes have only five or six pins but use an octal base just the same. The unused pin on the socket can be ignored, or (as done by many manufacturers) used as a convenient tie-point for mounting radio parts.

The pin numbers of a socket used for miniature tubes are easily identified. All the pins are the same size, but the number 1 pin is recognized by the distance that separates it from the number 7 pin. Pin numbers are read in a clockwise direction using an underchassis view.

Chapter 7

Phototubes and Indicator Tubes

TUBES have been designed in which a beam of light can be used to start a flow of current through a tube. Conversely, there are other tubes in which a flow of current ultimately results in the release of light. Thus, tubes such as phototubes and indicator tubes are related.

Phototubes

A phototube, such as the 929 shown in Fig. 701, is a tube which becomes active with light. The tube consists essentially of two electrodes, a cathode and an anode. Phototubes may be either vacuum or gas types. When light, or other radiant energy, falls on the cathode, the random motion of the free electrons on the specially treated cathode surface is accelerated, so that electrons escape to the positive plate. The quantity of electrons emitted by the cathode is influenced by the amount of light falling on the cathode, and the color of the light (light wavelength). The anode is made in the form of a straight wire while the cathode is a semicircular plate coated with a light-sensitive material.

Phototubes have characteristics resembling those of the regular thermionic types, beyond saturation. Phototubes are designed to have maximum sensitivity for particular colors. The 929 phototube is very sensitive to light which is blue (as is the case in most phototubes), but not too responsive to white light, and therefore not efficient for ordinary light from the regular light bulb. This sensitivity is increased in some tubes by treating the cathode surface with a special coating more sensitive to the red end of the light spectrum.

For special applications where increased sensitivity is desired, a small amount of inert gas, such as argon or neon, is introduced into the tube

envelope. The 918 is such a type tube. The presence of the gas increases the total current flow by means of ionization. The high-vacuum types having a small current flow are less sensitive, but are more linear in speed of response of the current to rapid fluctuations of light.

Phototubes such as the 868, 917, 919 use a four-pin socket. The 921, 922, and 926 have a clip-type mounting. The 924 uses a screw lamp socket, while the 925, 929, and 930 require an octal socket. The principle of the

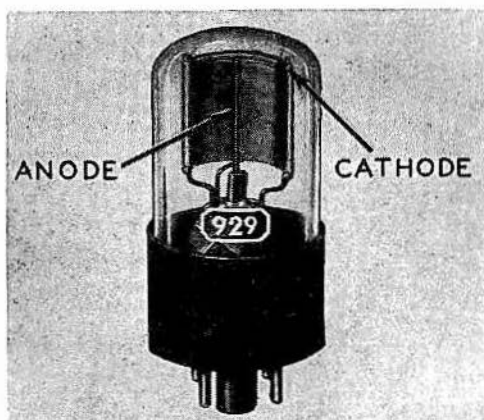

Fig. 701—The physical structure of a typical phototube.

multipurpose tube has also been applied to phototubes. A tube such as the 920 is a gas-filled duo-phototube containing two separate anodes and two cathodes.

Phototube Applications

Phototubes are used in the reproduction of sound, in trigger and control circuits, and can be used to operate thyratrons and relays. Although not used in radio and television circuits, they find considerable application in industry. In the home they have been used to operate oil burners and to open and close garage doors. Phototubes are used in photography to control exposure time in the making of picture enlargements and photostats. They are used in counting circuits and in fire-alarm systems. A typical circuit using a gas phototube for sound reproduction is shown in Fig. 702.

Indicator Tubes

Indicator tubes are types in which electricity is turned into light. The 6E5 and 6U5 are tubes that do this. Fig. 703 shows a typical circuit. The purpose of the tube is to pick up the a.v.c. voltage from the detector and

give an indication of correct tuning. The indicator tube has a cathode and a control grid, as in other vacuum tubes. The plate or target is coated with a fluorescent material that glows when bombarded by electrons. A fourth

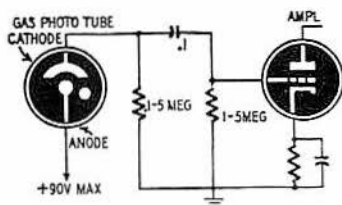

Fig. 702—Circuit using a gas phototube.

electrode called the ray-control electrode is placed between the grid and target. Voltage changes on this ray-control electrode controls the flow of electrons to the target and determines the amount of target surface that

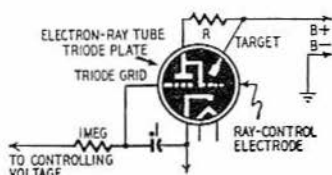

Fig. 703—Indicator-tube circuit.

glows. In Fig. 703 electrons flow to both the target and ray-control electrode. The electron flow is under control of the grid. Electrons moving to the triode plate cause a voltage drop across resistor R. If the control grid allows more electrons to flow, the voltage drop increases, cuts down the voltage on both plate and ray-control electrode and the shadow on the target becomes larger. The a.v.c. voltage on the grid is less negative with lower levels in the receiver, as, for example, when the receiver is detuned. A lower bias on the control grid allows more electrons to flow, drops the voltage at the ray-control electrode, increases the target shadow. When "on signal" the a.v.c. bias is the greatest; less electrons flow, the ray-control electrode is more positive, and the target shadow is reduced.

The 6AF6-G is a twin electron ray indicator (see Fig. 704) which has two ray-control electrodes, each on opposite sides of the cathode, with one target. The tube has no triode section and must be used with a separate

control tube. Both indicators are connected to the same source, but since each control indicator is brought out to separate tube terminals, each can be connected to separate sources to get individual patterns. In AM-FM receivers, one pattern can be used for AM, the other for FM. The 6AF6-G contains only an indicator unit and is used with a separate amplifier tube. The a.v.c. voltage is fed into the 6K7 which is connected as a triode d.c. amplifier.

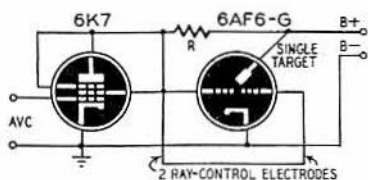

Fig. 704—Twin electron ray indicator.

A receiver is considered correctly tuned in when the indicator tube shadow is minimum. For the shadow, or eye, to close completely, requires a strong signal or a sufficiently sensitive receiver. Indicator tubes also vary in sensitivity. An indicator tube such as the 6E5 requires much less signal for complete closing of the eye than indicator tube type 6U5/6G5.

Tuning indicators have grown more useful in recent years because of their high sensitivity. In some special circuits, they are taking the place of milliammeters and other types of meters.

Chapter 8

Vacuum-Tube Grid Bias

AN electron tube can operate properly only when the relation between the element voltages is correct. Frequently the only difference between two circuits performing unlike functions is the values of the bias voltages on the grids. The importance of the correct bias voltage is not always appreciated. Effects of wrong bias voltage may appear as distortion, low power output, low voltage gain, overheating, and inefficient detection, to list but a few.

Choice of a bias method may be controlled by the circuit for which it is designed. Since, for example, the grid bias controls the plate current, when low plate supply voltages are used it may not be desirable or possible to lower the plate current with a negative bias. The bias methods described here are useful in a variety of circuits. Extremely simple in themselves, they may suggest new answers to otherwise difficult problems.

In Fig. 305 (see Chapter 3) we have a family of curves of the plate characteristics of the 6J5. These curves show the plate current that will flow for different plate and grid voltages. The point often overlooked is that the plate voltage is the voltage between the plate and the *cathode* of the tube and that the grid voltage is the voltage between the grid and the *cathode*. The cathode-to-ground voltage may or may not be the grid bias, depending upon the point to which the grid is returned. For example, in Fig. 801-a with the cathode 10 volts above ground and the grid returned to ground, the grid bias is -10 volts because the grid is 10 volts negative with respect to the cathode. In Fig. 801-b, however, the bias on the tube is zero because the grid and cathode are at the same potential. In Fig. 801-c the bias is -5 volts, the grid being 5 volts lower in potential than the cathode. This can be an advantage when the grid must be directly coupled to a point

having a d.c. voltage above or below ground.

There are two general methods for obtaining bias voltage: (1) using a

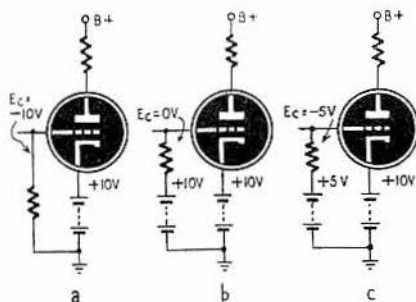

Fig. 801—Bias is the total d.c. voltage between grid and cathode

separate voltage source or (2) applying to the grid the voltage drop developed across a portion of the circuit.

Separate Bias Sources

In the early days of radio a common system of bias was that shown in Fig. 802. The cathode or filament was returned to ground, and a battery

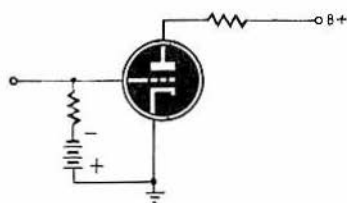

Fig. 802—The tube is biased by the battery.

was connected to make the grid negative with respect to the cathode. This bias method is still used in some circuits today, usually with miniature bias cells in circuits in which no grid current is expected. The same bias would be obtained by putting the bias battery in the cathode circuit, making the cathode positive with respect to ground as in Fig. 801-a. This is not done, however, because the resistance in the cathode circuit would increase with use due to battery aging, and the battery ages faster because it carries the entire plate current.

A common method of obtaining bias from the power supply is shown in Fig. 803. With this circuit the negative voltage is determined by the

voltage of half the transformer secondary winding. This is usually too high for bias use and must be reduced by a voltage divider or other means, resulting in loss of power in heat.

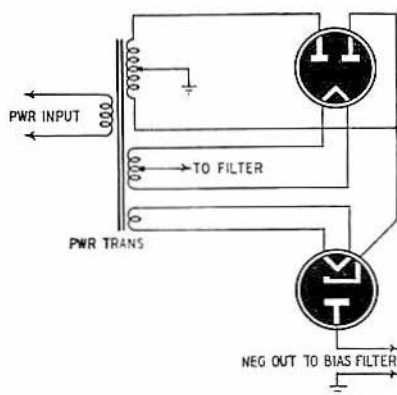

Fig. 803—Method of obtaining bias from the power supply.

A system offering several advantages is the shunt-diode circuit. With the circuit of Fig. 804 a voltage divider is formed by the R-C circuit, allow-

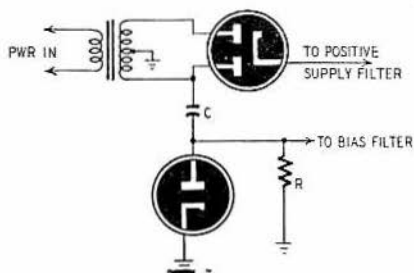

Fig. 804—Shunt-diode bias system.

ing the desired output voltage to be delivered without the high heat loss present in dropping resistors. C is made only large enough to deliver the desired voltage. The excess voltage appears as a drop across the capacitive reactance, which does not produce heat. Low-voltage components may be used in the filter, and the heater may be supplied from the winding serving the other tubes.

The shunt-diode system may also be used as shown in Fig. 805 to provide up to 9 volts bias from the 6.3-volt heater supply. A voltage-doubling

arrangement such as that shown in Fig. 806 may be used for voltages up to 18 volts from the 6.3-volt supply. Low-voltage filter capacitors (of the cathode bypass type) can be used in the filter circuit of Fig. 805 and Fig. 806.

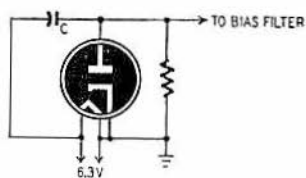

Fig. 805—Bias from the heater supply.

Self-bias Systems

One of the most popular circuits utilizing the second general method of developing a bias voltage is that of Fig. 807. Where tetrodes or pentodes

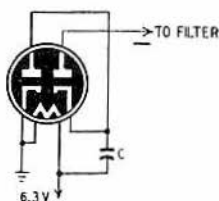

Fig. 806—Voltage-doubling bias circuit.

are used, the bias is developed by both the screen and plate currents in the cathode circuit. In the circuit of Fig. 807 the bias voltage is developed by the plate current of the tube flowing in the cathode resistor R. The

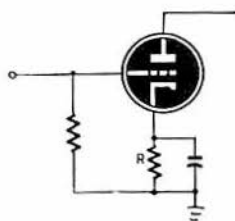

Fig. 807—Bias supplied by a cathode resistor.

current flow is in such a direction as to make the cathode positive with respect to ground. The tube is then biased in the same manner as was shown

in Fig. 801-a. The capacitor from cathode to ground is necessary to prevent the cathode resistor from introducing degeneration or negative feedback. Bias derived from cathode current is satisfactory only when the average cathode current is constant, as in class A amplifiers. In push-pull class A circuits it must be remembered that the plate current is the total quiescent current of two tubes, since both tubes operate simultaneously.

In some class C amplifiers or grid-leak detectors (Figs. 808-a and 808-b)

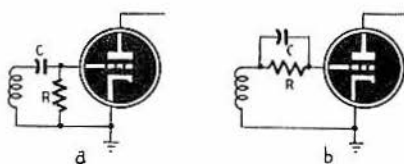

Fig. 808—Grid-leak bias can be used when the grid draws current.

there is initially no bias (class C amplifiers may also be operated with fixed bias). The tube draws grid current on the positive half-cycle of the input signal. The positive grid swing causes current to flow in the grid-cathode circuit, through the grid resistor in such a direction as to develop a negative voltage at the grid and charge the grid capacitor sufficiently to maintain the bias during the negative half-cycle of signal swing. This circuit was very popular years ago when grid-leak detection was used almost exclusively.

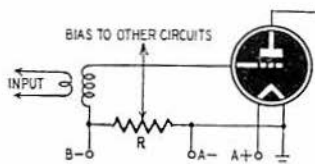

Fig. 809—The back-bias system.

A system, sometimes known as the back-bias method, for developing bias voltage for the output stage of battery amplifiers is shown in Fig. 809. Bias for the grid of the tube is provided by the voltage drop across R . Bias for preceding stages may be taken from appropriate points along R .

In some circuits the bias voltage is developed by floating the negative power-supply lead below ground and grounding the bleeder resistor at the point necessary to give the proper bias voltage. A circuit of this type is shown in Fig. 810.

Since the plate voltage is always measured with respect to the cathode, when self-bias is used the plate voltage is always reduced by the amount of

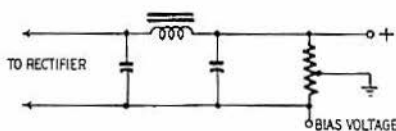

Fig. 810—Bias taken from the bleeder.

self-bias. In receiving sets where small bias voltages are used, this difference is ignored. However, where large bias values are required, the resulting reduction in plate voltage may be serious. That is why separate bias supplies are often used where large bias voltages are necessary.

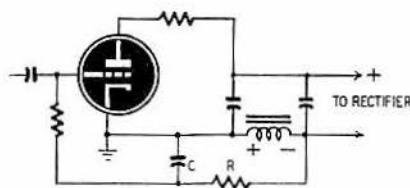

Fig. 811—The filter-choke voltage drop supplies the bias.

A system which does not reduce the plate voltage is shown in Fig. 811. The bias is obtained by placing the filter choke in the negative d.c. lead and utilizing the voltage drop across the filter choke. The voltage developed is equal to the product of the choke's resistance and the total load

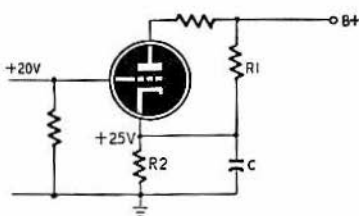

Fig. 812—The cathode is at a higher positive potential than the grid.

current. R and C form a hum filter, necessary because the grid is returned to an unfiltered point in the power supply.

Frequently the grid of a tube must be operated at a relatively high

d.c. voltage with respect to ground. A commonly used method of obtaining the proper bias is shown in Fig. 812. If -5 volts bias is required for a tube operating with its grid at 20 volts above ground, a bleeder network R1-R2 may be used to bring the cathode to 25 volts above ground. The grid is then 5 volts negative with respect to the cathode. Capacitor C is the usual cathode bypass.

Although the circuits shown have assumed tubes using cathodes, the same circuits may be used on filament tubes operating from filament transformers by assuming the center-tap of the transformer to be the cathode. For example, the circuit of Fig. 807 would become that of Fig. 813. The two capacitors across the filament bypass the signal currents across the inductance of the transformer winding.

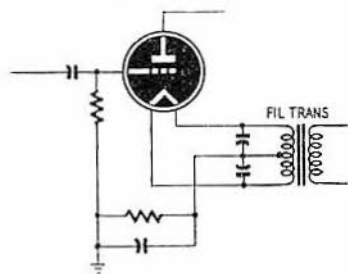

Fig. 813—Bias on a tube having a directly-heated filament.

Some battery portables have the filaments connected in series across a 6-volt battery; by connecting the grids at desired points along the filament line, from zero to nearly 6 volts may be applied to such grids as require bias. A variation of this system is occasionally found in some three-way sets. The plate current through the output tube used for a.c. operation is also used to supply filament current for the other tubes. Thus their filaments become the cathode resistor (or part of the cathode resistor) of the output tube. A few battery portables have used bias from the oscillator tube for the output tube. The oscillator of a superheterodyne uses a circuit like that of Fig. 808, and a small current flows through R. By making part of R the grid leak (or part of the grid leak) of the output tube, bias may be obtained without robbing the B-battery.

Chapter 9

Radio-Tube Applications

THE number of uses to which radio tubes can be put seems almost unlimited. Whether the circuits are old familiar ones or radio tubes used in new and novel arrangements, the information supplied in all previous chapters is still applicable. The circuits shown in this chapter are *not* specialized or unique circuits, but rather are those most widely used. The circuits were chosen to illustrate principles of radio tubes.

The Half-Wave Rectifier

There is only one job that the diode can do, and that is to change a.c. to d.c. The a.c. can have a rather low frequency, such as the frequency of the power line. Or, the frequency can be higher (audio frequency) or still higher (radio frequency), but whatever the frequency of the input, the output will always be d.c.

Fig. 901 shows a basic half-wave rectifier circuit using a 35Z5-GT (or

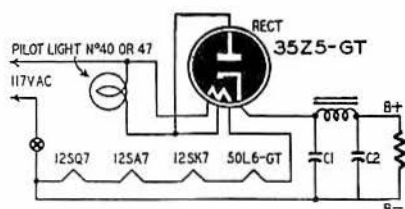

Fig. 901—Basic half-wave rectifier circuit.

miniature 35W4 tube) and is representative of most a.c.-d.c. sets manufactured today. Notice that the filaments of all the tubes in the radio set are in series and that the diode rectifier is effectively bridged across the a.c. power line. The load resistor can be a voltage divider, a bleeder, or may represent some kind of a load, such as the tubes of a radio. The only part of the input a.c. voltage that has any effect on this circuit is the positive half, the negative half of the wave not doing any useful work. Since only half of the input wave is used, the circuit is properly called a half-wave rectifier.

During the time that the voltage on the plate of the diode is positive, current will flow from the heated cathode to the diode plate, back to the power source (the a.c. generator), and then will return from the generator, up through the load resistor, and back to the cathode, or original starting point. During the time that this current flows, the filter capacitors will receive a charge. When the input voltage wave becomes negative, the diode stops conducting and the flow of current through the tube stops. The filter is given an opportunity to discharge and it does so, producing a current through the load in the same direction as the original current. Thus we have a current flowing through the load at all times, whether the input wave is positive or negative. Since this current always flows through the load in the same direction, we call it d.c. The whole process is repeated when the input wave becomes positive again.

Fig. 901 shows the heaters of all the tubes in the radio circuit connected in series. Note that the rectifier tube has a tap for a pilot light (panel lamp). The ripple frequency of a half-wave rectifier is 60 cycles, which makes filtering somewhat difficult, but the small speakers on most a.c.-d.c. sets do not reproduce low frequencies very well, so hum level is not as high as it might otherwise be. The filter choke can be replaced by a resistor, or by the speaker field coil when the receiver uses an electrodynamic type of loudspeaker.

The size of the input filter capacitor C1 affects the d.c. voltage. The larger the capacitance of C1, the greater the output voltage will be (up to about 150 volts) but as C1 is made larger, the strain on the diode becomes much greater, and the life of the tube is reduced.

The regulation (variation of output voltage with load) is very poor. Using a 35W4, for instance, with 117 volts a.c. input and a 16- μ f capacitor, the d.c. output voltage varies from something over 150 volts with a 12.5-ma load down to 100 volts with a 100-ma load.

A supply of this type can be used on d.c. as well as a.c. if the plug is inserted in the power outlet in such a way that the positive d.c. wire is on the plate side. The d.c. output voltage may be somewhat lower when operating this supply from the d.c. power lines.

The Voltage Doubler

There are ways of obtaining output d.c. voltages several times as high as the a.c. input voltage without the use of transformers. A common circuit of this type used in broadcast receivers is the voltage doubler shown in Fig. 902.

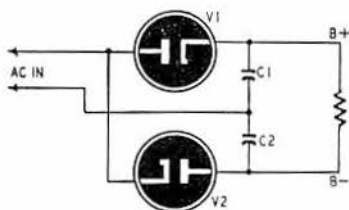

Fig. 902—The voltage doubler.

During each half-cycle of line voltage the plate of V1 is positive and it conducts. This charges capacitor C1 so that the cathode side is positive. On the next half-cycle the cathode of V2 is negative so that it conducts, charging C2. The two series capacitors, C1 and C2, are now charged. The capacitors are so large that the charge on C1 doesn't have time to discharge while C2 is being charged. The series charges add, and a d.c. voltage of nearly twice that of the line (since each capacitor charges to the full line voltage) appears across the B-plus and B-minus terminals. The greater the capacitance, the higher the voltage charge developed across them. For example, with a 60-ma load, a voltage doubler circuit with 16- μ f capacitors has a d.c. output of 228 volts. If 32- μ f capacitors are used, the output voltage is increased to 245 volts.

Transformer Power Supplies

Using the diode connected directly to the power line has the advantage

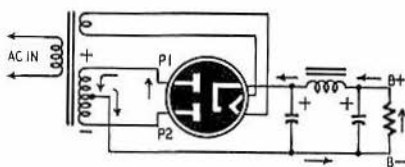

Fig. 903—Transformer-type power supply.

of being economical and light in weight. There are a number of disadvantages. The voltage regulation is very poor, giving a widely varying d.c. output voltage with changes in the load. The power supply is not isolated from the line, but is shunted across it. There is always danger of shock and the possibility of burning out tubes. Even with a doubler, the d.c. output voltage is often insufficient for many applications.

These disadvantages are overcome with the use of a power transformer. In addition to providing a higher voltage, if required, the transformer gives isolation from the line and whatever voltages may be required.

The Full-Wave Rectifier

Fig. 903-a is a diagram of a commonly used power-supply rectifier circuit. It may use two separate rectifier tubes, or, as in the diagram, a single tube with two plates. The polarity of the transformer voltage is as shown by the solid symbols, the top of the transformer being momentarily positive and the bottom negative. Current flows as indicated by the solid arrows, from the cathode to diode plate P1, from that point through one-half of the transformer secondary winding, through the load resistor in the direction shown by the solid arrow, and back to the cathode again. An entire circuit has thus been completed.

On the next half-cycle, the polarity is reversed. Current now flows from the cathode to diode plate P2, through the lower half of the transformer secondary winding, through the load resistor, and then back to the cathode again. Whether diode plate P1 is positive, or diode plate P2 is positive, the current through the load resistor always flows in the same direction.

The operation characteristics of rectifier tubes can be obtained from the tube manual. The type of filter which follows the rectifier tube has considerable influence on the performance and life of the diode, in addition to determining in part the regulation of the power supply and its output voltage. Operation characteristics of a typical rectifier tube, the 5U4-G are shown in Fig. 904. The solid line on the graph shows the behavior of the power supply when using capacitor input filter. Notice how sharply the voltage (d.c.) at the input to the filter drops as the load current is increased from about 25 to 225 milliamperes. The d.c. voltage available is highest when the load is lightest. The operation with choke input filter is shown by the dash lines. Although the available d.c. voltage is lower, the smaller slope of the line indicates much better regulation. If the load is such that it does not vary, or does so only slightly, capacitor input filter is perfectly satisfactory. Choke input should be used if the load is such that it requires a widely varying current.

Maximum Inverse Peak Voltage

On the half-cycle during which one of the plates is not conducting a voltage exists between cathode and the nonworking negative plate because it causes no voltage drop in the load resistor. Unless the spacing and degree of vacuum in the tube are sufficient, there will be an arc-over or flash from the negative plate to the cathode. The maximum inverse peak voltage is almost equal to the peak to peak voltage across the secondary. During the time that the tube operates, the cathode (or filament) is at a high positive potential *above* ground. At the same time the non-conducting plate is well *below* ground. This estimate of the maximum inverse peak voltage is true only when the input voltage is a pure sine wave and there are no momentary surges in the line. For these reasons it is important to operate a rectifier tube well within its permitted maximum inverse peak voltage rating. Tube

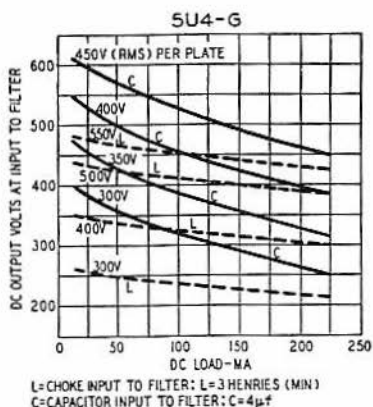

Fig. 904—Characteristics of a 5U4-G rectifier.

manuals list the maximum peak inverse voltage for each tube, and this rating should always be consulted before a tube is chosen for any particular application.

Detectors

A detector is a rectifier. The detector can be a diode, a triode, or any multi-element tube. The detector can be used for AM, FM, or television operation, may be simple or complex—in each instance the detector is a rectifier and acts solely to change a.c. into varying d.c. Detector circuits, especially those using diodes, closely resemble half-wave and full-wave power-supply schematics. Detectors are sometimes called demodulators since the detector strips the modulation characteristic from the carrier.

The frequencies involved when the diode is used as a power-supply

rectifier are very low, and range from 25 c.p.s. to 800 c.p.s. A very common power-line frequency is 60 c.p.s. The only difference between the diode as a rectifier and the diode as a detector is that in the latter case the frequencies involved may be hundreds of thousands or millions of cycles per second. Also, the input waveform is much more complex than that of the simple sine wave used in power frequencies.

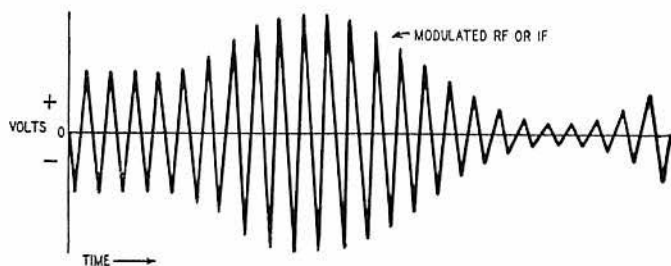

Fig. 905—The amplitude of the modulated r.f. wave is varied at an audio rate.

The diode is widely used as second detector or demodulator in radio receivers. To understand diode detector operation, look at the amplitude-modulated wave in Fig. 905. The amplitude of the r.f. (or i.f.) signal is

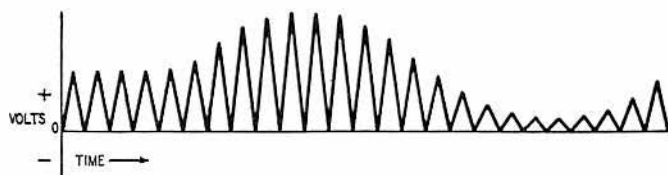

Fig. 906—The detector (or demodulator) removes one-half of the modulated wave.

varied at an audio rate. If this wave were applied to the grid of an audio-amplifier tube operating class A, then the plate current, and therefore the output voltage, would vary from minimum to maximum at the frequency of the r.f. carrier, or, in the case of a superheterodyne, at the intermediate frequency. Since the plate current rises would be as great as the plate current drops (in the case of sine wave modulation) the average plate current would remain the same, no matter what the strength of the signal. And, since the frequency of r.f. or i.f. variation would be too high to hear, no sound would result.

The problem is to remove the r.f. and leave only the audio signal. To do this we rectify the r.f. (or i.f. signal), obtaining a wave like that of Fig. 906. This wave has three components: r.f. (or i.f.), d.c. (pulsating at an audio rate) and audio.

A typical diode detector is illustrated in Fig. 907. The secondary of the last i.f. transformer is connected to a rectifier in series with a load resistor. Each positive half of the input cycle produces a positive voltage pulse across the diode load resistor R and filter capacitor C , in parallel. C charges to a value equal to the peak signal voltage minus the drop across the diode. The resistance of R must be much larger than the reactance of C at the frequency of the r.f. or i.f., yet must be considerably smaller than the reactance of C at audio frequencies. Therefore, if C is too large, or R too low, high frequency response will suffer.

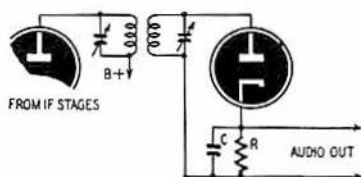

Fig. 907—Typical diode-detector circuit.

The efficiency of the diode detector depends directly on the ratio of the load resistance to the diode plate resistance, so the load resistance should be made as large as the a.f. and r.f. frequencies will allow for best efficiency.

Selection of Proper Diode Load

The values of R and C in Fig. 907 must be carefully selected in order to maintain high efficiency and good linearity. The detector acts as the effective load on the amplifier that precedes it, and should therefore have a high input resistance so that it does not drop the net load on the amplifier and thus reduce its output. The diode should also have a high efficiency so that as much *undistorted* audio signal as possible will be supplied to the first audio amplifier.

The diode, in series with the parallel combination of R and C is a load on the i.f. transformer secondary which reflects through the transformer to the preceding amplifier. If R is too low, the diode input resistance becomes so low that it loads down the amplifier feeding it, reducing its output. In addition, with a low value of R , the detector output would also be low. The diode load resistance should therefore be as high as possible, so that the IR drop in the diode plate circuit will be low, thus giving a correspondingly

high diode voltage efficiency. C is also part of the diode load circuit, and since it is in shunt with R, its reactance at audio frequencies should be high. A low value of capacitive reactance will shunt audio frequencies around the diode load resistance, resulting in reduced detector audio output. However, the r.f. and i.f. component should be discarded at this point which means that C should have a low reactance at r.f. and i.f. frequencies. In other words, we want C to act as a short circuit for r.f. and i.f. but not for audio frequencies. To do this, C should be about 5 to 10 times the value of inter-electrode capacitance between plate and cathode of the diode detector. A suitable range of capacitance would be from about 50 to 100 micromicrofarads.

Time Constant of the Diode Load

Since C is in parallel with R, its rate of discharge depends on the R-C constant (time constant $T = R \times C$, where T is the time in seconds, R is

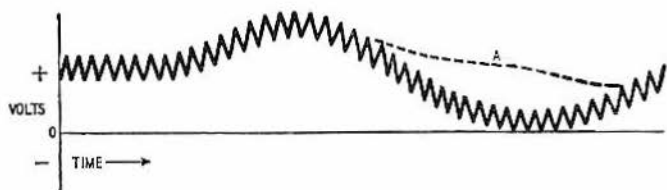

Fig. 908—Improper balance of resistance and capacitance of the diode load results in distortion.

in ohms, and C is in farads). The time constant must be so set that C can charge to the peak of the input wave during each carrier-frequency cycle, and R must be high enough in relation to it so that C will not discharge much through R with each carrier cycle. This gives the ragged effect shown in Fig. 908 where the resistance allows the capacitor to discharge slightly before it is "picked up" again by the next carrier peak.

If R is too small, the wave becomes rougher because the capacitor can lose more of its charge between peaks. If, on the other hand, R is too high, the capacitor will not discharge fast enough during the trough of the audio wave but will hold up as shown by the dashed line at A in Fig. 908, causing severe distortion. An improper balance between R and C would limit the maximum amount that the modulation envelope could vary without causing distortion.

The detector supplies a.f. to the audio amplifier which, of course, acts as a load across R. Since it is in shunt with R, it can seriously affect the proper loading of the detector and cause distortion. As a practical example, consider Fig. 909 and suppose the a.c. input signal to be 12 volts and R to

be 100,000 ohms. With R as the only load, the operating point would be at the point marked O, and the steady d.c. would be about 14.5 volts at 150 microamperes. The d.c. would then vary from about 0 to 29 volts (14.5 volts either side of the operating point) with 100% modulation. If the load beyond R (grid resistor of the next amplifier) had a value of 100,000 ohms, the net detector load would be 50,000 ohms, which, if plotted on Fig. 909, would have about the same slope as the 47,000 ohm curve, or as shown by the dotted line. This means that a 12-volt input signal would be cut off when it got to about 7 volts. The detector could then handle signals having a percentage of modulation as high as $\frac{12-7}{12} \times 100 = 42\%$. With higher percentages of modulation, the a.f. would be clipped. This shows how important the detector load is for proper detector operation.

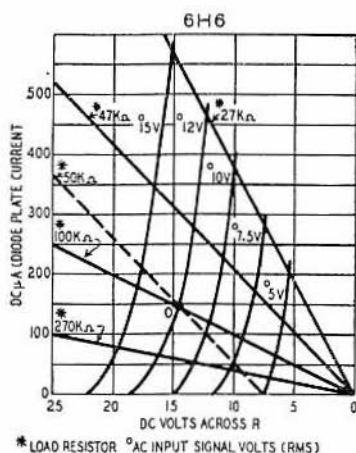

Fig. 909—The value of detector load is important for proper detector operation.

R should be much smaller in value than the impedances (at modulation frequencies) of the loads shunted across it. The audio-frequency load is therefore usually fed to the following tube through a potentiometer arrangement, where the amplifier is connected to the middle of the resistance. This lowers the voltage passed on to the next tube but has less effect on the detector load resistance. In modern detection methods, the d.c. component of the modulation envelope is used for automatic volume control, and additional impedances are added across load resistance R to accomplish this.

shown schematically in Fig. 911. A 6SQ7 (or similar type) could be used.

Note that the two diodes are connected by means of C1. The upper diode plate, D1, is used as a regular diode detector. The lower diode plate, D2, is tied directly to the a.v.c. filter network. Any i.f. signal that comes in is fed directly to D1, the upper diode plate. The rectified signal current, consisting of i.f., a.f., and d.c., flows from D1 back to the cathode. In doing so it goes through the secondary of the i.f. transformer. At this point the signal encounters a filter consisting of R1 and C2. The i.f. is filtered. The d.c. is blocked by C3 and flows through R2 back to the cathode. The audio component flows through C3 which acts as a d.c. blocking capacitor and an

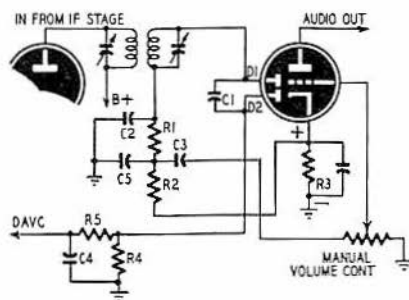

Fig. 911—Circuit using delayed a.v.c.

audio-frequency coupling capacitor. The desired amount of audio signal is then fed to the control grid through the manual volume control.

Now consider the delayed a.v.c. section. The cathode of the diode-triode is biased by means of a cathode resistor, R3. This has the effect of making the cathode positive with respect to diode plate, D2. This bias voltage is usually one or two volts. As a result current cannot flow from the cathode to diode plate D2 until that diode plate is made *more positive* than the cathode. A weak signal, developing only one or two volts on diode plate D2 will have no effect. However, a strong signal coming in and fed to diode plate D1, will be passed along to D2 through capacitor C1. If the signal voltage on diode plate D2 is greater than 2 volts, current will flow from the cathode to D2, and down through R4 to the ground. This will develop a pulsating d.c. voltage across this resistor, which is then filtered by the simple filter consisting of R5 and C4. The a.v.c. voltage is then fed back to some previous i.f. stage as a bias voltage to cut down the strength of the incoming signal.

FM Detection

The diode can be used to detect FM signals. One such circuit is called

a discriminator, and is shown in Fig. 912. Since the input is FM, the problem of the discriminator is to change frequency variations into voltage amplitude variations.

The discriminator is a modified i.f. transformer having its primary tuned to mid-band frequency. The secondary is split, each half going to a regular diode. The i.f. is also fed into the secondary center tap via C3. When the unmodulated carrier is received the diodes get equal induced voltages, opposite in polarity because they are on opposite sides of the center-tapped secondary. The polarity across the ends of the secondary is constantly changing, permitting diode A and diode B to conduct alternately. When diode A conducts, current flows from the plate of that diode through the upper half of the secondary, through the choke, up through R1. The lower end of R1 is negative. Since C1 is shunted across R1, it receives a charge of the same polarity. When diode B conducts, current flows through the tube, up the lower half of the secondary, through the

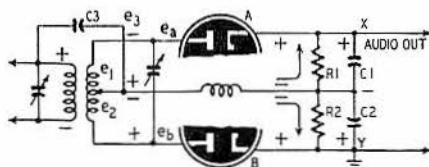

Fig. 912—Discriminator for FM signals.

choke, and then through R2 as shown. This makes the top of R2 negative. C2 shunted across this resistor receives a charge. Since the voltage across C1 is equal and opposite to the voltage across C2, the over-all voltage across X-Y is zero. This comes about because the voltage e_3 fed to the center-tap adds to the induced voltages e_1 and e_2 in the secondary, but since it is electrically halfway between e_1 and e_2 , the sums of the voltages are equal. With the modulated frequency, e_1 and e_2 are still opposite in sign, but the voltage e_3 is no longer electrically halfway between e_1 and e_2 . Therefore the voltage sum, e_1 and e_3 is no longer equal to e_2 and e_3 . A higher voltage appears across C1 and R1 than across C2 and R2, resulting in a difference voltage across X-Y. The magnitude of this voltage depends upon how far the frequency of the incoming signal deviates from its center frequency. At the center frequency, both diodes conduct equally and the voltages across C1 and C2 are equal, but opposite. When the carrier frequency is modulated, the diodes will receive unequal values of voltage. If diode A is made more positive, this results in a greater current through R1 and a greater charge across C1. This makes X *positive* with respect to ground.

If the frequency should shift in the opposite direction, diode B would receive a greater voltage. This means a heavier current through R2, and this time capacitor C2 would receive the stronger charge. This would make X *negative* with respect to ground. When the carrier is no longer frequency-modulated, point X is neutral with respect to point Y. The output voltages must be linear with respect to frequency. The audio-frequency voltage depends upon proper selection of R1 and R2, in the same way that an AM diode detector depends upon its load resistance. As far as the modulation envelope is concerned, the audio signal is the same at the diode load whether it comes via AM or FM.

Ratio Detector

Another type of FM detector is called the ratio detector. See Fig. 913.

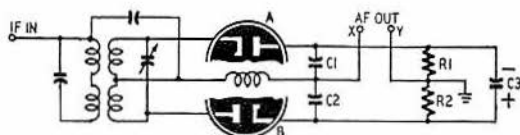

Fig. 913—Ratio detector for FM signals.

The input consists of an i.f. transformer with tapped secondary, as in the discriminator, but with the diodes wired in series so that they conduct during the same half of the i.f. cycle. A relatively high-capacitance, C3, shunted by equal resistances R1 and R2, is connected across the output of the diodes. The time constant of this combination is high enough to maintain a constant potential across C3 regardless of sharp carrier amplitude variations. In this manner the detector develops a limiting action within itself and does not require a pre-limiter stage as with the discriminator. Capacitors C1 and C2 (having identical values of capacitance) are also shunted across the output with the a.f. taken off as shown. The output of each diode, A and B, appears across capacitors C1 and C2, respectively.

With no modulation, the rectified output is divided equally across C1, C2, and R1, R2; the resultant voltage across X and Y is zero and no a.f. appears across these terminals. When the carrier is frequency modulated, as in the discriminator, the d.c. voltage across C1 is no longer equal to C2 because the tap to the secondary is no longer at the electrical neutral and a difference voltage appears across X and Y. This difference voltage varies in magnitude and polarity as the carrier frequency is varied. The greater the frequency change, the greater the audio voltage amplitude.

Triode Detectors

The triode can be used as a detector, and for that matter, so could any multi-element tube. The triode can be made to respond to much weaker signal voltages than the diode; it is a more sensitive detector, but easily subject to overloading and consequent distortion. At one time detector sensitivity was necessary since the tubes preceding the detector had such low amplification factors. With the use of high-gain pentodes in r.f. and i.f. stages, sufficient gain is available at the input to the diode detector. Diode simplicity and fidelity plus careful circuit design has led to the wide use of the diode in AM, FM, and television receivers.

Oscillators

An oscillator is an electronic device for generating an alternating voltage. The word electronic is used deliberately. At power frequencies, such as 60 cycles per second, mechanical devices such as generators or vibrators are most commonly used, but these become impractical as the frequency is increased. At audio, radio, and higher frequencies, the tube, vacuum or gas-filled, is the answer to the generation of a.c.

An oscillator is a means for converting d.c. to a.c. An oscillating circuit comes supplied with a d.c. power source, but furnishes an a.c. output. A simple oscillator is shown in Fig. 914-a. Electrons leaving the heated cathode will be attracted to the positive plate. From the plate the electrons flow through the small coil (feedback coil), from the coil to the power supply, through the power supply, and then back to the cathode. This circuit, sometimes called the plate or output circuit, is complete. The current flowing through the plate circuit produces a magnetic field around the feedback coil. Magnetic lines around the feedback coil will also cut across the tank coil. Although the current flowing through the feedback coil is d.c., even d.c. takes time to reach its full value. During the time that the plate current is building up, the expanding lines of magnetic flux from the feedback coil are cutting across L1 (the tank coil), inducing a voltage across it.

This voltage, induced by the feedback coil across the tank coil, is the same action we get in transformers. If the induced voltage across the tank coil is plus at the top, then the bottom is negative. Note that the tank coil is shunted between grid and cathode of our tube. What we've done is to make the control grid positive with respect to the cathode. With a plus charge on the grid, the plate current rises sharply. Some of the electrons will be attracted to the positive grid, but most of them will continue to the plate. Since the plate current is stronger, the magnetic field around the feedback coil is stronger, and in turn will induce a higher voltage across the tank coil. The plate current will now build up until saturation is

reached. At saturation the plate current levels off, the magnetic field around the feedback coil becomes fixed, consequently no voltage is induced in the tank coil. Since it was this induced voltage which produced such a large plate current, its removal means that the control grid no longer has such a strong positive charge and the plate current starts to reduce in value. As the plate current reduces, so does the magnetic field around the feedback coil. The flux lines from the feedback coil, which also surrounded the tank coil, start to retreat, inducing a voltage across the tank coil whose polarity is exactly opposite to what it was originally. In other words, the top of the tank coil is now *negative*, making the control grid negative. This has the effect of further reducing the plate current, the action driving the plate current to cutoff. The moment the tube is driven to cutoff, the magnetic field around the feedback coil is gone, the induced voltage across tank coil, L1, has disappeared. Once again our tube has zero bias. With no bias on the tube, plate current starts to flow and the entire chain of events is repeated.

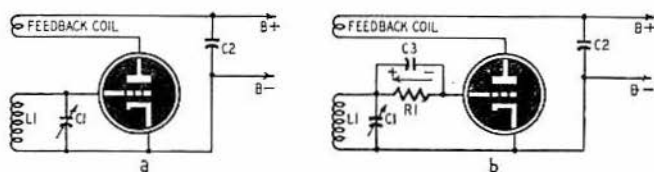

Fig. 914—An oscillator is a means for converting d.c. to a.c.

Note that the current in the plate circuit is d.c. (a changing d.c.), while the voltage induced across the tank coil is a.c. This a.c. voltage, whose frequency is determined by the value of L1 and C1 in the tank circuit, could be increased in amplitude by feeding it into a voltage-amplifier tube. The job of bypass capacitor C2 is to keep r.f. out of the power supply.

Oscillator Bias

Our basic oscillator circuit has a defect. For half the time of operation of this circuit the grid is positive. This wouldn't be bad if the grid were a husky structure like the plate, but the grid is made of fine wire to permit as many electrons as possible through to the plate. The grid can't take much punishment. When we make the grid positive we're asking it to behave like a plate. The constant bombardment of electrons on a positive grid can make the grid get warm; the control grid can get so hot that it will glow. To protect the grid and to bias the tube properly, two circuit elements are used—a grid resistor, R1, and a grid capacitor, C3. These are

connected as shown in Fig. 914-b. A positive control grid draws grid current which flows through R1 in the direction shown. This current produces a voltage drop across R1 and has a polarity such that the control grid end of the resistor is negative. This voltage drop also appears across C3, charging the capacitor. Polarity across C3 is the same as that across R1. When the control grid goes negative, C3 discharges through R1 and helps maintain a negative charge on the control grid. The value of R1 is usually made large, so that before C3 gets a chance to fully discharge, it becomes charged once again by the flow of current through R1. The grid still manages to collect some electrons, but since the combination of R1 and C3 always puts a negative bias on the control grid, the amount of electrons picked up by the grid remains within safe limits.

C3 holds the grid bias from cycle to cycle. If the time constant ($C3 \times R1$) is too large, the capacitor would hold its negative charge too long, so that even the most positive pulse could not overcome it. The oscillator would quit momentarily only to start up again by itself. Depending on the time constant of the grid resistor and capacitor, the oscillator can stop oscillations at an audible rate or at an r.f. rate. R1 and C3 must be specially picked to prevent this.

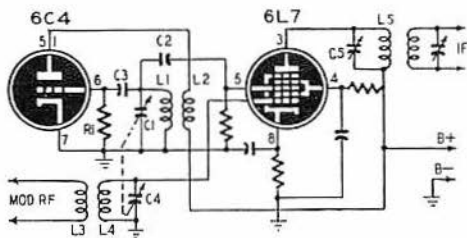

Fig. 915—The mixer circuit uses a separate oscillator tube.

Another thing that can happen, particularly in a power oscillator, is a sudden stoppage of oscillation with reversal of high grid current caused by the electrons striking the grid so hard that they cause secondary emission and the grid loses more electrons than it gains. The grid leak resistance becomes more and more positively biased and more electrons are attracted to it. This can cause excessive plate current and ruin the tube. To prevent this, the grids of large power-oscillator tubes have specially treated surfaces.

Mixers

Radio tubes can take a signal of one frequency and change that signal into higher and lower frequencies. Frequency conversion is used in all modern receivers, whether AM, FM, or television.

Fig. 915 shows a typical mixer circuit. The 6L7 mixer is designed to handle high frequencies, while the same is true of the 6C4 local oscillator. Bias for the 6C4 is obtained when current flows from the control grid of the 6C4 to ground through R1. R1 and C3 supply oscillator bias voltage, just as in Fig. 914-b. Oscillator tuning is done by varying C1 shunted across grid coil L1. Energy is fed back from the plate of the 6C4 through feedback coil L2.

The a.c. voltage generated by the local oscillator is capacitively coupled through C2 into one of the grids of the 6L7. Plate current of the 6L7 will be varied by this local oscillator. Because of this modulation process, one of the frequencies appearing in the plate circuit will be the local oscillator frequency.

At the same time, another voltage is injected into the signal control grid. Coil L3 can go to an antenna, or to some previous r.f. amplifier stage. It transfers the incoming signal by electromagnetic coupling to coil L4, tuned by capacitor C4. This signal voltage also appears between control

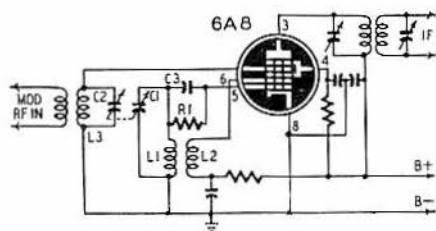

Fig. 916—Conventional converter circuit using a pentagrid tube.

grid and cathode. This signal will modulate the electron stream at the same frequency as that of the incoming broadcast signal. Hence in the output circuit of the 6L7 we will have another frequency—the broadcast signal frequency.

The flow of current is now controlled by two voltages having different frequencies. These voltages will have an effect on each other. By a process known as heterodyne action the two waves mix to produce a third wave which is the sum of the first two. This new frequency is called the sum frequency since it is a result of the addition of the two original modulating voltages. Another new frequency produced is called the difference frequency since it is obtained by the subtraction of one of the modulating voltages from the other. Many other frequencies also appear in the output—frequencies that are harmonics of the original modulating voltages, and of the sum and difference frequencies, but these usually have a very small amplitude.

Although many frequencies are produced in the mixer tube, we're only

interested in one of them—the difference frequency. This difference frequency, called the intermediate frequency, is always lower in value than either the signal frequency or the local oscillator frequency. To select this i.f. from all the other frequencies, a parallel circuit tuned to the i.f. is placed in the plate circuit. This circuit, made up of L5, C5, has a high impedance to the i.f. (the difference frequency). A voltage at the intermediate frequency appears across this tuned circuit. Since it is not resonant to any of the other frequencies coming out of the 6L7, L5, C5 offers a much lower impedance to them and they are bypassed back to the 6L7 cathode.

Converters

The local oscillator and mixer can be economically combined into one tube such as the 6A8. Where a tube performs these two functions it is called a converter. Fig. 916 shows a conventional converter circuit using a pentagrid tube. The oscillator is connected to grids 1, 2, and the cathode. C3 and R1 supply oscillator bias as in Fig. 914-b and Fig. 915. L2 is the feedback coil, while L1 and C1 are tuned to the oscillator frequency. The oscillating electrons act as an oscillating space charge in front of the cathode and are drawn by grid 3, which acts as a screen grid, to the space between grid 3 and grid 4, where they form an "oscillating cathode." They are now affected by grid 4, the signal grid, which controls the flow of the oscillating electrons on their way through screen grid 5 to the plate. Electrons, prior to arriving at the plate, are acted upon by both the control grid (grid 1, or oscillator grid) and the injector grid (grid 4, or signal grid) and the net result in the plate circuit is the combined effect of both. The electrons which collect between grids 3 and 4 form a capacitance from the space charge to grid 4. Since this space charge pulsates at the oscillator frequency, it causes oscillator-frequency currents to flow from grid 4, through the tuned circuit (C2, L3), to ground.

Conversion Gain

In all these tubes, whether mixers or converters, an r.f. signal is fed in, mixed, and passed on to the i.f. section of the receiver. Since the mixed output signal is stronger than the input signal, the tube is said to have a *conversion gain* or conversion transconductance. Conversion gain is symbolized by the letters G_c . As with the transconductance (G_m), G_c depends on the load impedance as well as the grid and screen voltages. Like transconductance, it is the ratio of a change of plate current with respect to a change in signal voltage. However, in this case, the plate contains the i.f. while the r.f. voltage is in the grid. We can set this up as a simple formula by saying $G_c = \frac{\text{change in plate current}}{\text{change in grid voltage}}$. Contrary to mutual conductance, conversion transconductance cannot be measured in a tube tester.



Exceptional technical books for
experimenters, inventors, tinkerers,
mad scientists, and "Thomas-Edison-types."

www.lindsaybks.com

ISBN 1-55918-362-4



9 781559 183628