

RADIO- ELECTRONICS REFERENCE ANNUAL



PUBLISHED BY:

RADIO-CRAFT

• 25 WEST BROADWAY

• NEW YORK 7, N.Y.

hallicrafters *new Model S-40*

New beauty and perfect ventilation in the perforated steel top

Separate electrical bandspread with inertia flywheel tuning.

Tuning range from 540 kc to 42 Mc continuous in four bands

Self-contained, shock mounted, permanent magnet dynamic speaker

All controls logically grouped for easiest operation. Normal position for broadcast reception marked in red, making possible general use by whole family.

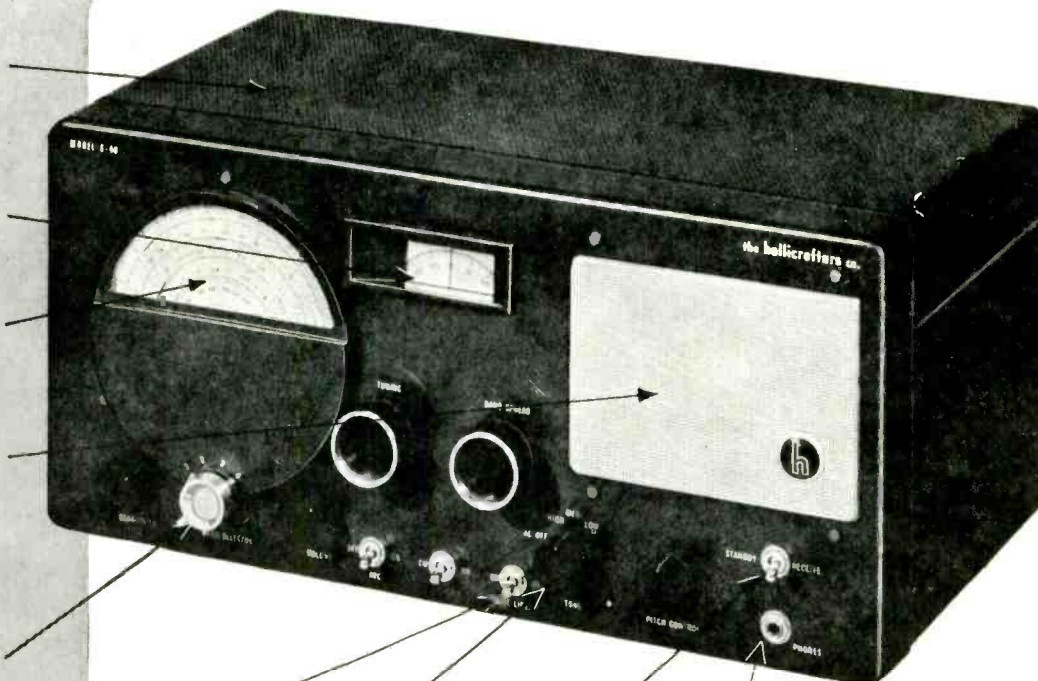

Automatic noise limiter

3-position tone control

Standby receive switch

Phone jack

(APPROXIMATELY)

**New design, new utility in a great \$79⁵⁰
new communications receiver . . .**

Here is Hallicrafters new Model S-40. With this great communications receiver, handsomely designed, expertly engineered, Hallicrafters points the way to exciting new developments in amateur radio. Read those specifications . . . it's tailor-made for hams. Look at the sheer beauty of the S-40 . . . nothing like it to be seen in the communications field. Listen to the amazing performance . . . excels anything in its price class. See your local distributor about when you can get an S-40.

INSIDE STUFF: Beneath the sleek exterior of the S-40 is a beautifully engineered chassis. One stage of tuned radio frequency amplification, the S-40 uses a type 6SA7 tube as converter mixer for best signal to noise ratio. RF coils are of the permeability adjusted "micro-set" type identical with those used in the most expensive Hallicrafters receivers. The high frequency oscillator is temperature compensated for maximum stability.

From every angle the S-40 is an ideal receiver for all high frequency applications.

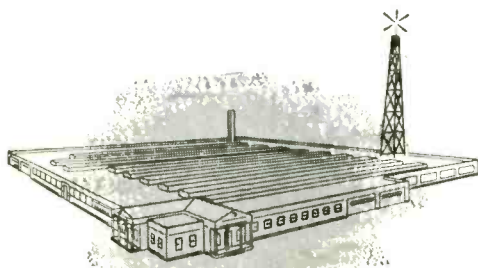

hallicrafters RADIO

THE HALLICRAFTERS CO., MANUFACTURERS OF RADIO AND ELECTRONIC EQUIPMENT, CHICAGO 16, U. S. A.

Sole Hallicrafters Representatives in Canada: Pagers Majestic Limited, Toronto - Montreal

RADIO-ELECTRONICS REFERENCE ANNUAL

CONTENTS

Theory and Engineering

Nomogram Principles	by Fred Shunaman	25
Laws of the Atoms	by Helen M. Davis	31

Construction and Design

3-Tube Reflex Receiver	by W. T. Connatser	4
V.H.F. Transceiver	by I. Queen	9
Hi-Fi Amplifier and Radio Tuner	by Cyril G. Brennan	14
Radio Hearing Aid	by Angelo Montani	15

Aids to Radio Service

Sensitive Signal Tracer	by Clyde Zwicker	6
Dynamic Handful Tracer	by Ralph Bloom	16
Radio Laboratory in Portable Unit	by Wesley Neelands	19
Radios Serviced by Observation	by Lyle Treakle	20

Test Instruments

A Multipurpose Tester	by Bob White	12
All-Band Oscillator	by Bob White	17
Pocket Radio Checker	by Harold Pallatz	22
Diode Crystal Probe	by Robert E. Altomare	23

Sound Amplification

Maximum Fidelity	by J. C. Hoadley	2
A Vibrator Amplifier	by John S. Straede	8
Three-Channel Amplifier	by M. Contassot	11

Charts, Tables and Formulae

Ohm's Law in Graph Form	24
Wattage from Ohms and Amperes	24
Resistance of Wires	26
Frequency from Capacity and Inductance	26
A Decibel Nomogram	27
Frequency-Wavelength Conversion	28
Coil Design Nomogram	29
Capacitor Markings	30
Expanded Wire Table	32
Reactance of Coils and Condensers	35
Decibel Acoustic Scale	38
Scale of Preferred Numbers	38
Radio Unit Conversion Ratios	40
Common Radio Abbreviations	46

1947

MAXIMUM FIDELITY

A NUMBER of years' experience building maximum-fidelity amplifiers and sound systems have led to the formulation of a set of rules, which, if followed, will enable the listener to realize the best from any sound system.

First and foremost, the psychological factor must be considered. People are definitely different in their tastes and desires, and these desires change with the type of program they are listening to. Your amplifier should be equipped with some means of varying its response curve, preferably with independent treble and bass controls.

It is often stated (and rightly so, if the statement is qualified) that a flat amplifier is ideal. If we had a flat microphone, a flat amplifier and a flat speaker, located in a perfect acoustic chamber, and if the speaker output were exactly as loud as the sound source, the system would indeed be ideal.

Even with this theoretically perfect sound system, if we turned the volume down to one-half the loudness of the sound source, it would no longer sound like the original, because we have introduced a new variable, our ears. The human ear's response curve varies with loudness. The lower the volume the less ability there is to hear very low and very high frequencies.

Room acoustics have a profound effect on the ultimate sound of the system, and as there are few ideal rooms outside of broadcasting stations or laboratories, this is another item to be reckoned with. In addition to these things, few pickups, speakers and microphones are flat.

Now that we have an idea of what we have to contend with, let's get down to cases. Though the frequency re-

Excellent reproduction of recorded music depends on three factors: compensation for recording characteristics, a good amplifier, with special attention to the output transformer, and a speaker and baffle system which turns the output to sound with a minimum of distortion

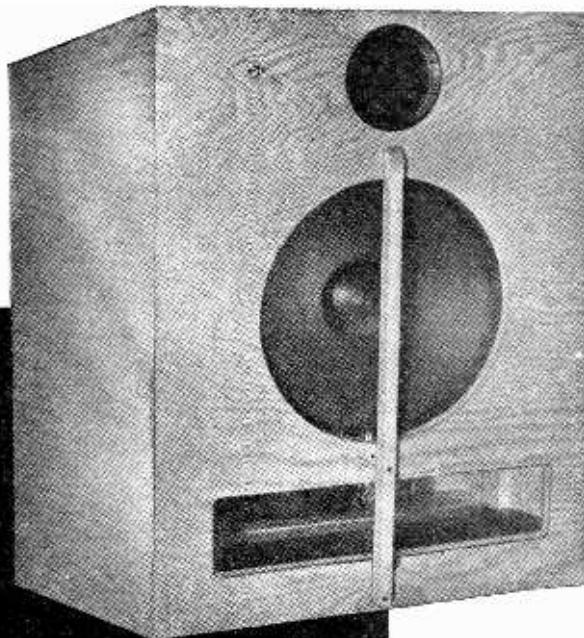

Photo A—Front view of speaker cabinet. Position and comparative sizes of vent and speaker hole are clearly shown here

sponse of a system is important, the most disturbing element in any system is distortion. This will be more apparent at the higher frequencies, so limit the frequency response of the system till it is just sufficient to reproduce the material on hand. There is no advantage in using a system flat from 20 to 20,000 cycles to reproduce a shellac pressing. The high frequency noise and distortion would be unbearable. Neither could we use an inexpensive phono motor with this wide-range system without the rumble in the motor being very apparent. So-called permanent needles when worn cause a particularly annoying type of distortion, in addition to causing permanent damage to the records.

The response of an AM receiver need not be any wider than 40 to 5000 cycles for the average station when broadcasting network programs, and 30 to 9500

cycles is entirely satisfactory for the best AM stations when broadcasting local programs. Limiting the response to 9500 cycles is to suppress any 10-kc beats between other stations located 10 kc apart. For FM reception or transcription reproduc-

tion we can go the limit and provide response from 30 to 15,000 cycles, for only in these sources is the distortion low enough or the range wide enough to warrant this wide range.

In the reproduction of any record we must take into account the various recording characteristics and compensate the pickup accordingly. Standard shellac phonograph records are recorded with a "modified" velocity characteristic. Amplitude of the cutting stylus is held constant from the lower frequency limit to between three and eight hundred cycles, and modified constant-velocity above this crossover frequency provides a five to ten decibel boost at 8000 cycles. See Fig. 1.

This is done for the following reasons:

1. Due to widespread use of crystal type pickups, the manufacturers of records insert a high frequency boost to reduce the compensation necessary to flatten the playback equipment's response. This boost effects a considerable improvement in signal to noise ratio.

2. A large majority of the users of shellac pressings have equipment with serious attenuation of the higher frequencies and no means for the compensation thereof. As the figure shows, there is a falling-off at the low frequency end of the audio spectrum. If the low frequency amplitude were not restricted, either overcutting would re-

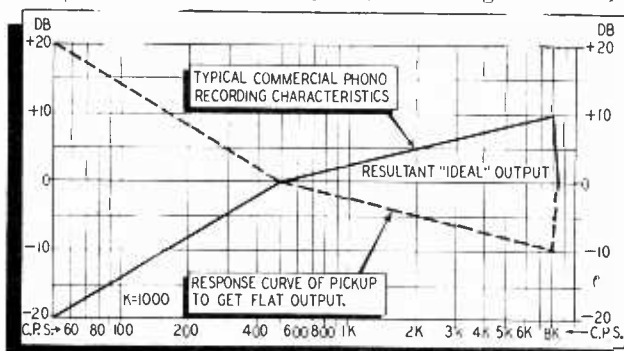

Fig. 1—Recording and response characteristics produce flat output.

sult or the level of the high frequencies would be below the noise level.

Pickup Characteristics

If constant velocity records (without treble boost) are played back with a magnetic pickup the output will be flat with decreasing frequency down to the crossover frequency where constant amplitude begins. Since the magnetic pickup requires successively greater stylus motion at the low frequencies to maintain its output flat, and since the amplitude is held constant below the crossover frequency (300 to 800 cycles) we must provide an equalizer to compensate for this condition. Since practically all commercial records made in the last six or seven years have a treble boost, the magnetic pickup must be further compensated to *reduce* its high frequency response. Otherwise response from commercial records will be excessively brilliant. Fig. 2 shows the usual method of equalization. Constants are approximate and depend on the pickup and transformer, as well as the recording characteristic of the records being played. Condenser C is for treble attenuation. Its value may be anywhere from .002 to .02 μf , depending on the pickup and transformer.

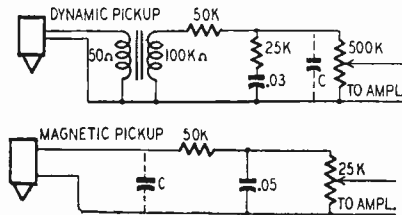

Fig. 2—Two suggested equalization circuits.

A crystal pickup has a *constant amplitude* characteristic. Its output voltage is a direct function of stylus motion independent of frequency up to its high-frequency cutoff point. For constant velocity recording (without treble boost) above the crossover frequency we would have to compensate for the decrease in stylus amplitude with frequency. This is in the order of six db per octave above the crossover frequency. To compensate the pickup for this would require considerable boost at 7000 cycles. However, commercial records insert treble boost at a rate of from two to about five db per octave above the crossover frequency, depending on the record. Thus for some records no high-frequency equalization is required and for others only a small amount. The customary method of compensating crystal pickups for commercial records is shown in Fig. 3. Reduc-

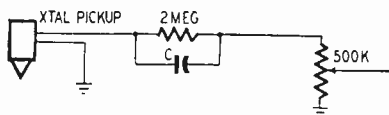

Fig. 3—Equalizer circuit for crystal pickup.

ing the value of C will reduce the amount of treble boost. For maximum boost C should be about .002 μf . When

playing records having considerable treble boost, C should be reduced in value to as low as 50 μf . Transcriptions are recorded with more involved response characteristics (generally they have considerably more treble boost than records) and the manufacturer of the pickup should be consulted for information on equalizers for Orthacoustic, NAB Standard, Columbia or other transcription characteristics.

The Amplifier

Now that we have a suitable flat source of music we wish to amplify it with as low distortion as possible. The easiest way to do so is to build a straightforward amplifier using triode tubes throughout. We can choose between 6A3, 6B4, 2A3, 45 for the output stage. These tubes should be arranged in push-pull, as the attendant cancellation of second harmonic distortion and supply-voltage hum is worthwhile, and reduces the first filter section requirements. Of course, beam tubes (6L6-6V6) can be used with feedback.

The most important purchase in connection with this amplifier is a good output transformer. It will make more difference than any other component. An output transformer may have a power rating of ten watts. This is somewhat deceptive as it is usually measured at some middle frequency, usually 400 or 1000 cycles. The same transformer may only be capable of transferring four watts at 30, and six watts at 12,000 cycles. This is a serious drawback particularly when we wish to boost the

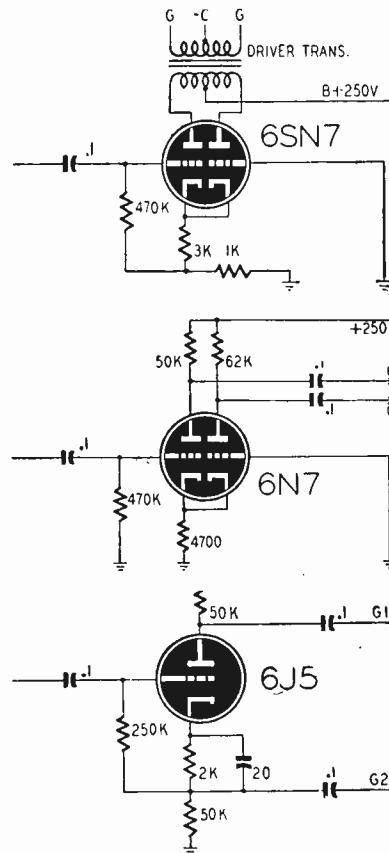

Fig. 4—Three self-balancing phase inverters.

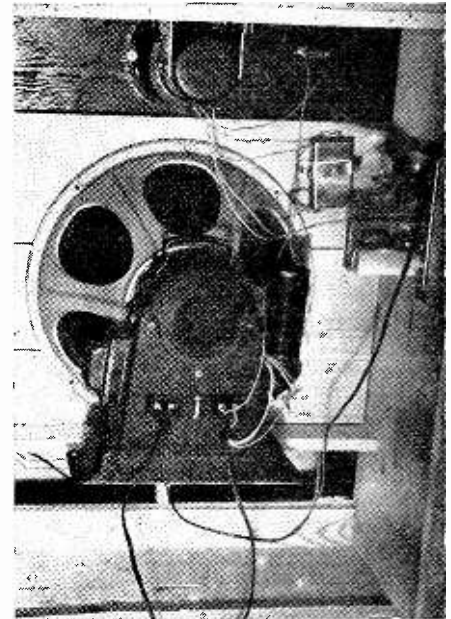

Photo B—Inside view of baffle in Photo A.

high and low frequencies. High-quality units are relatively inexpensive in comparison to the results they will produce. A high-quality output transformer for a 15-watt 6B4 amplifier can be obtained for \$15.00 or so.

An input transformer need not be used if class-A operation is desired, as a phase inverter is adequate. Fig. 4 shows several inverters which are degenerative and consequently self-balancing and of the low-distortion type. If class AB or AB₂ operation to obtain maximum power output is desired, an input transformer is needed to keep the resistance in the grid circuits of these tubes low in the case of a small amount of grid current being drawn.

Fixed bias is desirable as it allows greater power output with lower distortion. Fig. 5 shows a simple way to obtain same when your power transformer does not have a bias tap. A separate transformer winding is required. The rectifier may be a triode similar to those in the amplifier.

If you use an input transformer it is wise, in the case of an inexpensive unit, and essential for a high quality unit, to shunt feed the primary from the driver tube. This does not hold for push-pull drivers, as their d.c. plate current balances out in the output transformer.

Be sure to bypass all cathodes with large enough condensers to eliminate degeneration at low frequencies. It is wise to decouple every stage, both in the interest of low hum level and to eliminate the possibility of motor boating or unwanted interstage coupling.

One should, of course, use as good a speaker as possible and it should be baffled efficiently.

A bass reflex baffle offers many advantages, among which are improved bass response, higher sensitivity and cleaner high-frequency response. The distortion at low frequencies may be

(Continued on page 48)

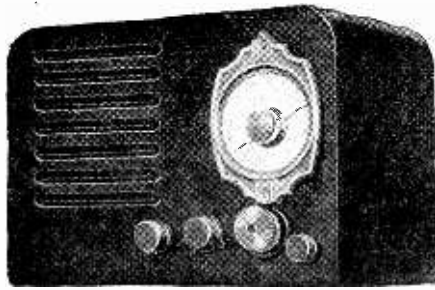

Mr. Connatser's 3-tube radio in its cabinet.

3-TUBE REFLEX

One of the tubes in this novel circuit is the i.f. amplifier, detector and audio amplifier

A FEW years ago, a superheterodyne radio had to consist of at least seven tubes because multiple tubes had not been developed. Now a truly excellent three-tube super is practicable, and the cost is very low.

Those skilled in the art of building radios need nothing further than the schematic diagram which, so far as practicable, is intended to be self-explanatory. However, for others who aspire to build their own set, here are some fundamentals on how best to go about its construction.

First consider the coils. Assume you are building a broadcast set, 1700 kilocycles (kc) down to 540 kc, and that the intermediate frequency (i.f.) is 456 kc. The network C1, C3 and L1 must be such as will cover this band. The condenser C3 can be of the compression type; its purpose is to correct for length of antenna. Thus, if the antenna is very short, more capacity is required in C3. If the antenna is long, less is required.

The coil, L1, should be iron-core. Any radio-frequency iron-core coil can be altered to serve the purpose by completely removing the primary and about 10 turns of the secondary. Also, a small radio-frequency powdered iron-core choke can be reduced to the proper value. You may make your own, if you have the iron core. Start out with very little capacity in C3 and gradually remove turns from L1 and close up on C3 until the full band is covered by C1.

Coil L2 is the oscillator, consisting of a primary connected to prong 6 of the 6A8 tube, and a secondary connected through the 100- μ f condenser C2 and C5 (padding condenser), to a frequency 456 kc higher than L1, or

from 2156 kc down to 996 kc. Coil L2 can best be a good-quality air core factory job, designed for use in a set with 456 kc intermediate frequency. The capacity of condenser C5 must be that specified by the manufacturer of coil L2, usually 350 to 400 μ f. The correct value is most important. If the padder is not correct, the circuits will not track.

Condensers C1 and C2 are ganged, and can have a maximum capacity ranging from 350 to 370 μ f. If section C2 is a cutaway designed especially for 456 kc, no padding condenser C5 is required. In this case the end of the coil shown attached to C5 is connected directly to ground instead.

Neither L1 nor L2 need be shielded if one is mounted above and one below the chassis.

The first i.f. transformer is a 456-kc iron core factory job. It should be good quality, and generally will be pre-tuned when purchased. This is important, as will be explained later.

The coils L4 and L5 make up the second i.f. coupler. L4 has a center tap to which condenser C13 is attached. In the beginning we made up L4 from a small radio frequency choke, and L5 from the primary winding of a radio frequency coil. Small compression type condensers were used to tune the coils. Condenser C13 was attached to the top of L4 with this early coil. Later we purchased replacement windings for a 456-kc i.f. transformer, one of the coils containing the center tap. The mounting shaft is cut in half and the two coils mounted at right angles and as far apart as practicable, in a can 3 to 3½ inches high. Obviously they may be mounted in separate cans.

In the first i.f. transformer the coils

are inductively coupled. In the second, the coils are capacity coupled through condenser C13. Hence, when separated it may be impossible to tune them down to 456 kc. Accordingly, a few turns of suitable wire may have to be added to each of these replacement windings.

The iron-core audio choke, L6, requires an inductance sufficiently large to block audio frequencies. It must have a low d.c. resistance—400 to 600 ohms. Its inductance can be anything from 10 to 15 henries. If you have or can obtain a medium size core, a suitable choke can be made up by winding on about 2200 turns of No. 36 or No. 38 enamel wire. The windings should be placed in smooth even layers with thin wax paper between layers.

The speaker can be of the PM type, from 3½ to 6 inches, and the output transformer, L7, must match the impedance of the output tube and, in addition, the voice coil of the speaker. A universal transformer of suitable design may be used. A dynamic speaker may be used instead of the PM. In this case the field coil will be used to filter the B supply, replacing resistor R10.

Now consider the tubes. The 6A8 is the converter. The 7E7 serves four distinct purposes: 1—It is the i.f. amplifier, and in that role we want it to be the most efficient, hence the low d.c. resistance of L6 and the high screen voltage on this tube. 2—It is the diode detector (prong 3). 3—It provides the a.v.c. (prongs 3 and 4). 4—Finally, it is the first audio amplifier. The cathodes of these two tubes go directly to ground. Negative bias for them is provided in an efficient, inexpensive and novel way. A negative voltage is developed at the oscillator grid (prong 5) of the 6A8 tube, which is dropped to approximate correct value by the resistors R1 and R3. Resistor R3 must be installed close to prong 5 and the other end connected to the a.v.c. circuit. Additional negative bias is provided by the a.v.c. as required.

At this time attention is called to R1. It further reduces the negative bias to the lowest point consistent with stability. This resistor should not be installed until the set is tuned and tried out. Start with 2 megs and vary.

The 32L7 tube serves the double purpose of audio output tube and B-supply rectifier. Due to the excellent filtering throughout the set, resistor R10 can be 500 ohms, or less, at 2 watts. The values

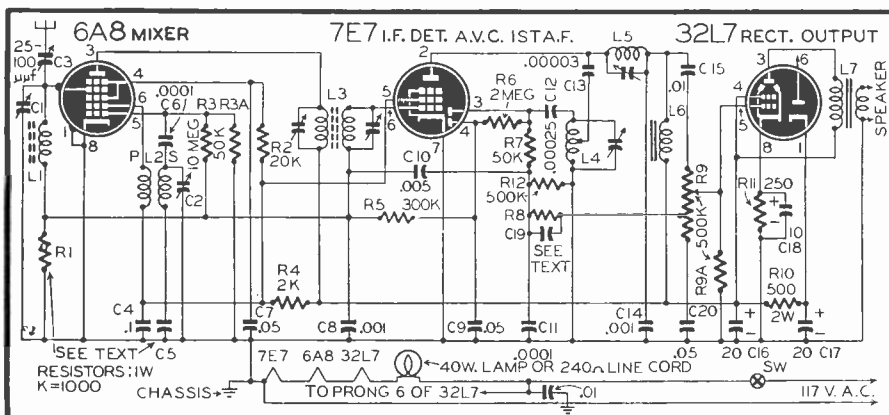

shown for C16 and C17 are about minimum, but higher values may be used.

The tubes shown on the schematic may be replaced by 12A8, 12SF7 and 70L7-GT, with some advantage gained. In the first place, a current-limiting resistor of about 160 ohms, 10 watts, can be mounted within the chassis, clear of all parts subject to injury. Then too, the 70L7 is a better amplifier than the 32L7. Note the different socket connections for the 70L7, and that a different socket with different connections is required for the 12SF7. This tube has but one diode plate; therefore, no connection is made to a second diode. All other parts, connections and values remain the same.

The 6J7 type tube may be used instead of the 7E7 (the 12J7 type instead of the 12SF7), the suppressor grid being used as the diode plate. When this type tube is used, the screen grid should be connected to prong 4 of the 6A8.

One of the unique features of this set is the method of connecting the volume control (R9) and the tone compensation circuit (R8 and C19). (The value of R9 may be increased to one meg.) Note also that the output tube is brought within the a.v.c. circuit. Resistor R8 and condenser C19 are connected between the detector circuit and the tone tap on R9. The value of R8 can be 300,000 ohms; that of C19 200 μ f. An increase in the resistance or a decrease in the capacitance gives a brighter tone, and vice versa. This is the most efficient method of tone adjustment and noise suppression that I've found. The value of condenser C20 is not critical, and can be anything from .01 to .05.

Harmful radio-frequency feedback, or regeneration, is prevented by the network R7, C8, C11. The small amount of audio feedback passing through condenser C13 is grounded out in L4.

The noise level of the set is extremely low, due probably to the limited number of tubes and parts used.

To begin construction you will need a chassis, but this item—except the cabinet—is the last thing to procure

by purchase or home manufacture. When all the parts have been acquired, arrange the layout on a substitute chassis or breadboard so that all leads will be as short and direct as possible, with all controls at the front panel. Grid and plate leads must be very short for best results. It's a good idea to keep leads as close to the chassis as practicable, since leads that stand out from some grounded metal object provide greater opportunity for harmful coupling.

In your tentative layout, you may find that better wiring facilities can be obtained by changing one or more of the parts. Accordingly, juggle them around for the best possible plan. In some cases the position of a part may be as important as its value.

A metal chassis may introduce effects absent in the breadboard hookup, due to its shielding effect and also its capacity to wires running close to it. A layout that works well on the breadboard will usually work well on the chassis, as the latter has a stabilizing tendency.

Chassis size will be determined largely by the size of the speaker used and the diameter of choke coil L6 when this coil is mounted underneath. The size of the cabinet will be determined by size of speaker and chassis.

Fit the speaker to the chassis according to your plan, then lay it aside as the last thing to be permanently installed, to prevent possible injury to the cone.

Always wire the filament circuit first, according to the diagram, then insert the tubes and test by plugging in the line cord. If the tubes light, you will know that the wiring is correct to this point. Now remove the tubes and proceed with the remainder of the wiring.

Use rosin-core solder, the best you can obtain, but do not use it excessively.

Assuming the i.f. transformer, L3, is pre-tuned when purchased, use it as the beginning for tuning the other coils. Tune in a station near 1600 kc and adjust L1 and L2 for best results. Now adjust L4 and L5. Tune in a station near 600 kc to determine whether the

set is tracking, for until you obtain accurate tracking you have a poor radio. A single turn more or less on L1 can change the tracking for better or worse. Now try adjusting the trimmers on L3 for better results, but first make certain of the original position of the adjusting screws.

The antenna can be anything from a few inches to several feet. One of six to ten feet should be sufficient if there are nearby stations.

Some means for checking the continuity of circuits and for shorts is almost a necessity. Even a flashlight battery and a bulb, or a d.c. voltmeter can be used. An open circuit means failure; a short can mean disaster. In general, a constructor is well-advised not to work without at least a cheap multimeter (or preferably one of good quality). Trying to build a set without one is almost like trying to wire up the parts in the dark. Needless to say, a tube manual should be part of the constructor's first equipment, more necessary than his pliers.

With the exceptions noted, the values of the component parts for this set are not too critical. Substitutions may be made where necessary, but it should be remembered that the values specified are used in the original set. Various changes may be made to suit the constructor's taste or the material at hand; the only necessary requirement being ordinary common sense.

With this set (in late October) speaker reception from KSL, over 600 air miles, was constant around the clock; KOA, over 900 air miles, came in after 3:30 P.M.; and other good clear channel stations up to 3000 miles after 6:00 P.M.

The cabinet, tuning dial and chassis shown in the photographs are all home-made. The cabinet, made from materials taken from an apple crate, measures $7\frac{3}{8} \times 4\frac{1}{2} \times 5\frac{1}{2}$ inches; the chassis, made from aluminum, measures $7 \times 4 \times 1\frac{1}{2}$ inches. The dial is made from a disk of wood $\frac{3}{16}$ -inch thick and $2\frac{1}{4}$ inches in diameter, two old volume control bearings, a piece of fishing line for a belt and a tension spring.

Right—Under-chassis view of the Super-Reflex radio, front-chassis view of which is shown below. The dial is a home-construction job.

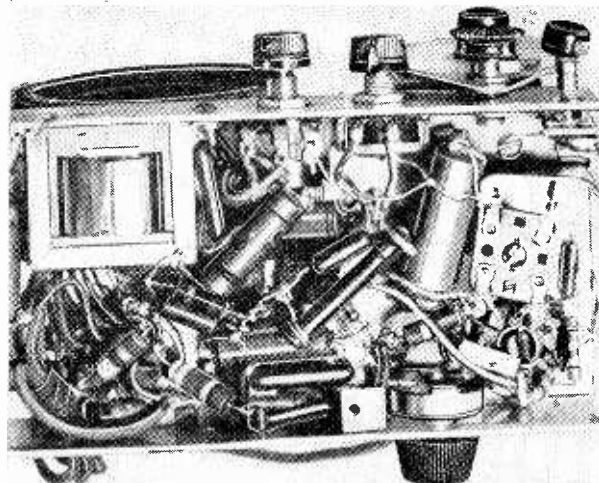
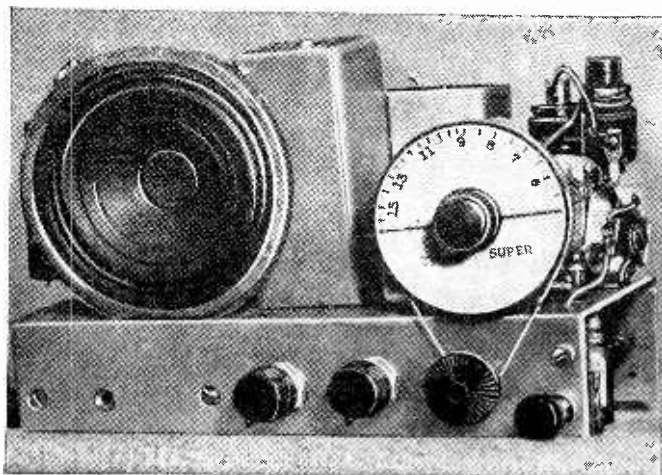

SENSITIVE SIGNAL TRACER

An excellent instrument for radio servicemen in regions of low signal strength. Checks all circuits of a superheterodyne receiver.

BECAUSE of the distance from powerful broadcast stations at this location, many signal tracers are not sensitive enough to give a positive indication when applied to the antenna or first stage of a radio receiver. This tracer was built with the idea of getting a stronger signal and has given satisfactory service for two years.

Standard practice has been largely followed. Switch 1 at the input tunes that stage roughly to i.f. or r.f. It also has a position for antenna, providing a source of modulated signal where needed.

Practically all radios today have intermediate frequencies falling between 440 and 480 kc. The i.f. range was set for these frequencies, no provision being made for the few receivers which use 175 kc. Adjustable Meissner iron-core r.f. coils and 365- μmf tuning condensers were used for the r.f. circuits, and by shunting these with small padders it was possible to tune across the selected intermediate frequency band very nicely. A push-pull wave-change switch out of an old Victor radio was used for this purpose. This unorthodox method of adding an i.f. range is entirely satisfactory and very simple.

It is possible that if old-style 500- μmf tuning condensers could be obtained the padders could be dispensed with,

although there has been absolutely no trouble with the present arrangement.

Construction Details

To get the required sensitivity, three tuned stages were needed. Shielding was also necessary to prevent oscillation, as were the 15,000-ohm resistors across the first two primaries. If two tuned stages are used, there is no tendency to oscillate and there will be enough gain for most applications.

The oscillator section is simple and of standard design. The coils, switch and tuning condenser for it were salvaged from an old Philco radio. The primaries were removed from the coils. This section is the least used part of the instrument, but proves its worth in locating intermittent troubles.

Probes for the r.f. and oscillator sections are made from Belden microphone cable with tiny capacitors near the point of the prod. These capacitors are made from two small strips of copper overlapping each other a quarter of an inch and dressed down to go into the probe. A number of other methods of making r.f. probes have been described in recent radio literature. The idea is that the capacity should be very small. This prevents loading the circuits to which the probe is touched, yet passes enough signal to operate the tracer. (In fact, signals can be picked up with the probe held nearly an inch from r.f. or

i.f. leads of a properly-operating receiver.) About 30 inches is fine for cable length.

The vacuum-tube voltmeter needs no explanation. The cable for this part of the instrument has a 1-megohm resistor near the prod point. Sw6 selects the voltage range. The 1000-ohm control used for the volts scale must have a linear taper. Its pointer is the center one on the panel. The scale was made from Bristol board and calibrated by using a power pack and voltmeter. Zero is in the center. The zero setting is made with the 100-ohm wire-wound variable resistor in series between ground and center-tap of the high-voltage winding (the most negative point in the circuit).

The Two Main Ranges

Dial scales for the r.f.-i.f. and oscillator condensers were also made of white Bristol board. They were calibrated with the help of a signal generator and broadcast stations. The left-hand dial, which controls the r.f.-i.f. gang, has the padder switch mounted above and slightly to the right. When it is in the out position, the instrument tunes over the broadcast band. In the in position, it tunes intermediate frequencies. The padders can be seen mounted above the gang, in the rear-view photograph. The dials are of the large 2 1/16-inch type with celluloid pointer. These look very well, and the hair-line makes accurate readings easy.

The front panel was made from 1/8-inch sheet aluminum. It is 12 inches high by 18 wide, with the 5-inch speaker mounted as shown in the photos. The chassis is 10 x 17 x 3 inches, which is about the right size to mount the parts. Standard phone jacks and plugs were used on the ends of test cables.

The various controls may be seen from the photo. The four electron-ray tubes are lined up along the top, the indicators reading from left to right: r.f.-i.f.; a.f.; v.t.v.m.; oscillator; with the speaker in the center. The pilot light is directly below with the on-off and speaker switch on either side of it. Farther down is the pointer and scale for the v.t.v.m., with its zero-set

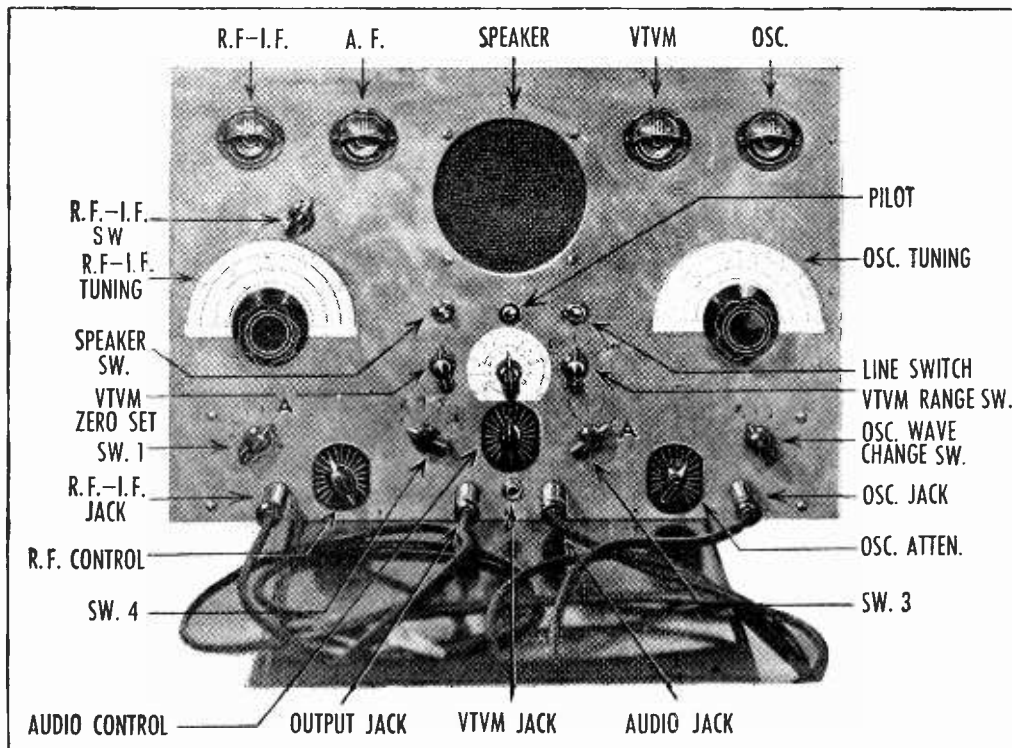

adjustment on one side and its range switch on the other side of it. The two pointers and scales at either side of the panel are the r.f.-i.f. tuning, and the

equipment and methods will cover all points that might be raised in connection with this piece of apparatus. The instrument is adapted to use as a multi-

of misaligned i.f.'s, which can be discovered by tuning the i.f. channel of the tracer and noting the frequency of greatest output. Realignment is sim-

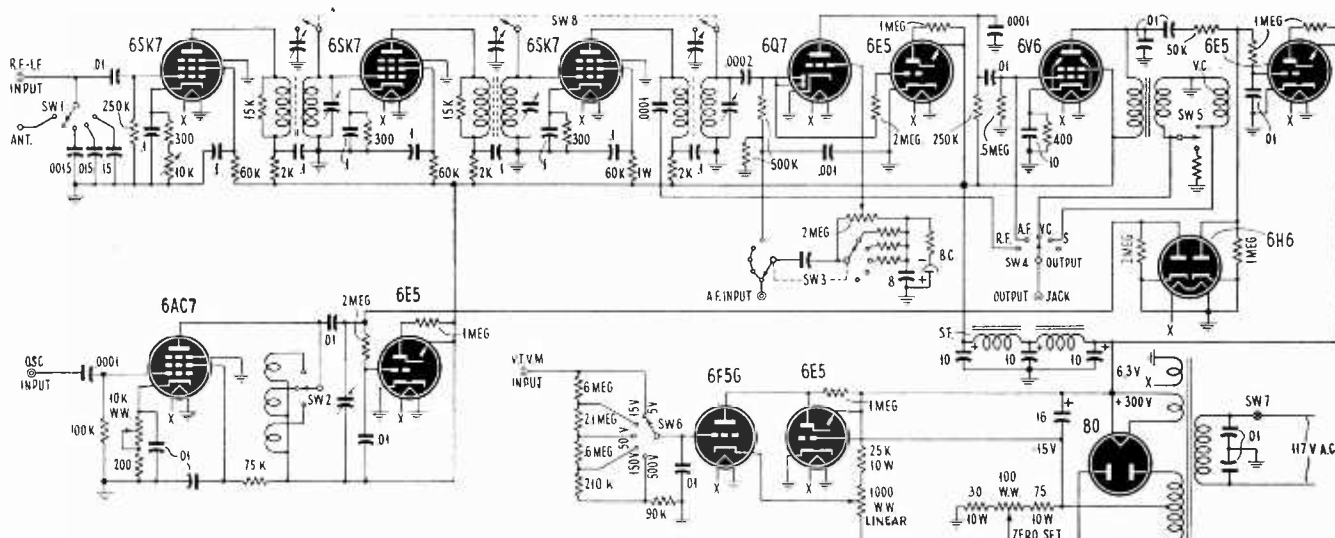

Complete schematic of the sensitive signal tracer. Resistor and condenser values at Switch 3 are explained in note at end of text.

oscillator tuning scales. At the bottom of the panel, reading from left to right (in a staggered line) are the antenna switch (Sw 1) the r.f. level control, the output switch (Sw 4) the audio volume control, the audio input switch (Sw 3) the oscillator attenuator and the oscillator wave-change switch (Sw 2). The jacks used with some of these switches are placed as close to them as possible, to avoid long leads.

Functions of all switches, ray-tubes, dials and input and output jacks are given in the combination photo-sketch on the preceding page. The more important points may be marked directly on the panel face, as was done in the case of this instrument. For example, all the ranges of the v.t.v.m. were printed on the panel. The antenna position of Sw 1 is marked with a large A. The same A (this time for Audio Input) appears on Sw 3. It indicates the full-volume position of the switch, when the volume control has no signal-reducing shunt resistors in parallel with it. The tracer is commonly kept set to the indicated positions, which are the most frequently used.

Possibly the constructor should print the names of every one of the various controls, jacks and indicators on his panel. The designer of an instrument feels so familiar with it—even before it is built—that he seldom feels the need for most of these indications, but a person constructing it from the diagram would doubtless save time if he could distinguish between all controls and switch positions at a glance.

A study of the schematic will show how the tracer may be used for different purposes. A full explanation of the manner of employing it would take another article and is unnecessary. There is no difference in the operation of this and any comparable tracer, and a standard work on signal tracing

channel signal tracer. Clips may be attached to the cables and connected to several parts of a set at the same time. (Note that though the diagram shows standard post-and-ground symbols, these are jacks in the actual instrument, and the ground is made to the shield of the probe cables.) The radio may be left to play till it stops by itself. The eye which opens locates the defect.

Let me suggest that a broadcast signal be used for tracing intermittents. They show up much quicker on a variable modulated signal of broadcast strength than on a steady modulated signal from a signal generator.

An especially valuable feature of the tuned type of tracer is quick detection

ply a matter of setting the tracer's i.f. channel to the correct frequency and adjusting receiver i.f. trimmers to greatest output.

While this instrument is a bit more complicated to build and operate than many simpler ones described, the difference in performance more than makes up for any extra trouble in building and familiarizing oneself with it.

Note: The resistor and condenser values in the audio input circuit (Sw 3) were inadvertently omitted from the schematic. The condenser is .01 μ f (value not critical). The resistor in series with the bias cell is 50,000 ohms, and the resistors shunting the volume control are 2,000, 20,000 and 200,000 ohms respectively.

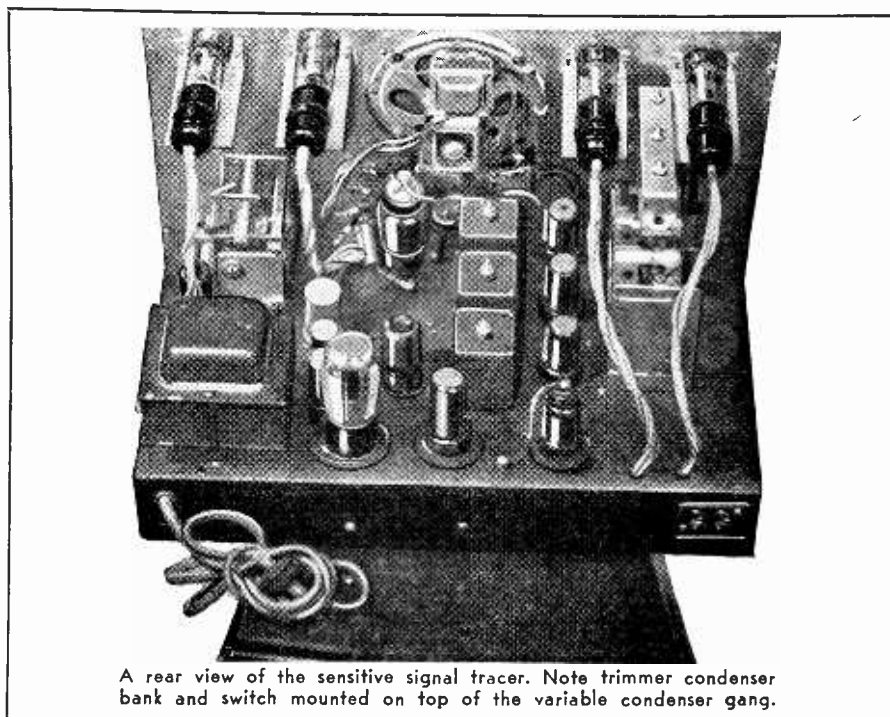

A rear view of the sensitive signal tracer. Note trimmer condenser bank and switch mounted on top of the variable condenser gang.

V. H. F. TRANSCEIVER

This "long-lines" transmitter-receiver covers both the amateur band from 420 to 450 mc and the proposed citizens' band, which includes 460 to 470 mc.

WHEN activity started to boom on frequencies higher than 400 mc, we decided to construct and experiment with a compact, low-power transceiver which would operate at those frequencies. A portion of the 420- to 450-megacycle band (420-430 mc) had just been opened, with the prospect that the band would soon be extended through to 450. Only a little above that is the new citizens' band, from 460 to 470 mc. This transceiver covers a range of 415 to 500 mc, including all the above.

Not much thought had to be given to choice of tubes, as the field was pretty well limited to the well-known and popular 955 acorn type. The small size fits well with the compactness of other components at ultra high frequencies and the low power requirements make it possible to run it efficiently from the a.c. line or from medium-sized batteries.

The complete set, except for speaker or mike and power supply, can be built in a space less than 4 x 4 x 4 inches. This is the size of our unit but the photograph shows unused space within this volume. It is possible, for example, to incorporate a small 2-inch PM speaker or small "B" batteries for the plates.

We were more interested in getting a solid, clear signal out of the antenna and this has been accomplished. Vibration and movement of the transceiver during transmission has no adverse effect on the signal and the frequency once set remains constant. There is no evidence of hand capacity during tuning. This instrument is definitely not a toy and the design has not been limited for the sake of compactness.

Experiments carried on over short distances within the same block show that the waves pass readily through partitions and brick walls. Communication over short distances did not require the receiver to be equipped with antenna. Our experiments show that with no benefit of location a mile or so can be covered. Given the advantage of height the signals should go the line-of-sight limit with a reasonably good signal.

R.F. Section

The circuit is a parallel-line affair but with condenser tuning for convenience and ease of calibration. The lines are 1/4-inch copper tubing, each 2 inches long and separated by about 3/8 inch. The miniature 50-μf condenser is connected across the far ends of the lines. The ends of the tubing connect directly to the tube contacts.

Polystyrene blocks are used to insulate and support the r.f. components. The presence of this material has no appreciable effect on the r.f. fields, and though expensive, it is well worthwhile. Leads between the r.f. and audio circuits go through holes drilled through the polystyrene. The material machines very well, taking saw, drill or tap very nicely.

The plate, grid and cathode circuits must be well isolated from other circuits by suitable r.f. chokes. We wired up a number of these experimentally, taking off turns until we arrived at an optimum in each case. Quite a bit of power can be lost through inefficient or insufficient chokes.

The tuned circuit is set back about 1 1/2 inches from the front panel. This effectively eliminates capacitance effects, which we feared at first. The metal shaft of the variable tuning condenser is extended by means of an insulated coupling and a short length of polystyrene rod. The front panel will accommodate a 2-inch dial but we were unable to locate one in Radio Row and

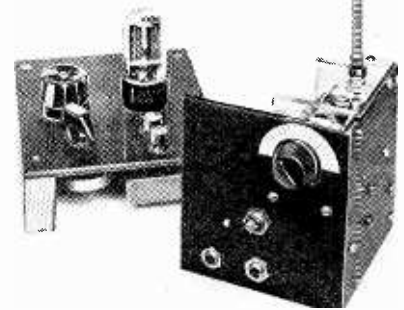

The transceiver with power pack (in rear).

had to be content to make a homemade job. This was done by pasting a circular piece of paper with inked divisions on the panel and using a small bakelite arrow knob.

Power Output vs. Frequency

As might be expected, the output is appreciably greater at the lower frequencies. Even the acorn tube begins to feel the effects of the u.h.f. These can be shown by the following table:

PLATE VOLTAGE	LOW FREQ		HIGH FREQ	
	I _p	I _g	I _p	I _g
100V	.25 ma	490 μA	2.5ma	110 μA
220V	1.5 "	850 "	4.0 "	250 "

These unloaded circuit values show the higher efficiency obtained at the lower end of the range.

The antenna consists of a 1/4-inch aluminum tube about 5 inches long

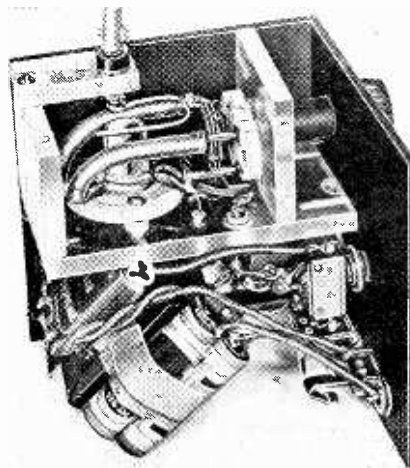

Top — The oscillator circuit. Heavy tubes are "long lines" and bent wire is antenna coupling. Below—Audio section. Batteries strapped to the transformer excite the carbon microphone.

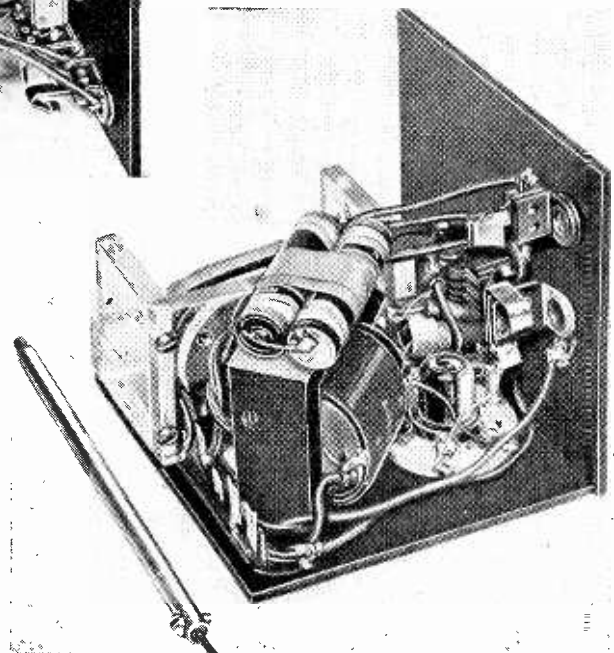

within which a 3/16-inch piece of tubing slides. This means that the total

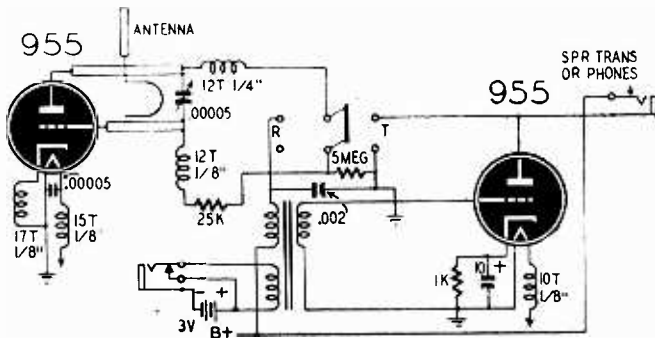

Fig. 1—Schematic diagram of the 420-450 megacycle transceiver.

length can be extended to almost 10 inches. A quarter wave-length is about 6 1/4 inches at 425 mc but the antenna should be experimented with for best results at any frequency. Coupling is provided by a half-turn of No. 16 wire. If a relatively great distance is to be covered it is recommended that another quarter wave-length be added on the other side of the loop, making a dipole. Better yet, an array of directional radiators should greatly increase the range in any given direction, but on the other hand, will take the transceiver a little out of the portable and convenient-to-handle category.

A phone tip at one end of the antenna (held by means of a screw through the tubing) fits into a tip jack and makes the radiator removable when the transceiver is not in use.

Audio Section

The choice of modulator (and audio amplifier) also fell upon the 955 tube, but for different reasons. Here we were concerned with size and power requirements, as well as the fact that two tubes of the same type make for simple testing of tubes and permit putting the best one in the oscillator section. These tubes are not generally tested at the time of purchase and we can only hope for the best. It happened in this case that one was slightly

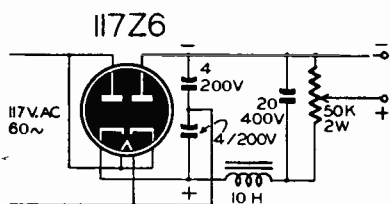

Fig. 2—The variable-voltage power supply.

better than the other as an oscillator on the high frequencies. There is no apparent difference in efficiency in the audio stage.

Microphone Circuit

The circuit is conventional among transceivers. We used a Stancor A-4413 microphone and audio transformer. This is the largest component in the

unit, but its cost is reasonable and it eliminated time and effort that would be spent in adding windings to a straight audio transformer, as is sometimes done. Since the purchased unit matches a 200-ohm microphone and a 10,000-ohm plate to a single grid input the amplifier gives very good results. The output is ample to run a 2- or 3-inch PM speaker and

with phones the signals are really loud! The primary of the speaker transformer (or headphones) acts as the modulation choke.

A carbon mike with two pen-light cells is found to give sufficient modulation. There is plenty of room to add another should the output of any particular mike be found to be low, but 3 volts is ample here. The mike jack is designed to short out the microphone winding when the unit is used as a receiver with no mike plugged in. Otherwise there is a terrific hum due to the open winding. Plugging in puts the battery in series with the winding. If the mike has a "press-to-talk" switch it (the mike) need not be removed even when a long period of transmission is scheduled. The circuit appears in Fig. 1.

We don't find it necessary to include another switch in the speaker secondary to avoid feedback to the mike. If the two are separated by a few feet and if they don't face each other this will not cause trouble. If necessary, however, the switch may be placed right on the speaker and need only be a single-pole single-throw type.

Power Supply

It was found desirable to design a small power supply which would deliver sufficient voltage to run the transceiver during the tests. The size of power transformer we would have liked to use and those available didn't coincide, so we went over to the voltage-doubler a.c.-operated idea. A 117Z6-GT tube is used in the supply, which is illustrated in Fig. 2.

Relatively small condensers are used across the tube elements and a large (capacitance) value across the d.c. output. This eliminates some of the disadvantages of high capacitance input power supplies (such as poor regulation, severe load on tube, etc.). A small choke was included to help smooth ripple. (See Fig. 2.). Hum is inaudible on the speaker. Using headphones there is a slight hum, as might be expected, but when the transceiver is oscillating or super-regenerating it is very low and is lost in the "rush."

The output of the supply can be varied from zero (useful when making

tests within the set or changing tubes, etc.) to a full 225 volts at maximum drain of 13 ma. A voltage control is always desirable in connection with super-regenerating receivers and is a good thing when testing the transmitter at different inputs. It will be noted that the voltage must be progressively increased for satisfactory results as the 500 mc point is approached, otherwise the super-regeneration drops out, leaving only ordinary oscillation and a very insensitive condition.

The operation of super-regenerative receivers and of Lecher wire frequency checks has been covered in the literature. The same principles apply to these higher frequencies. The frequency calibration of receiver and transmitter must be made to a closer tolerance as far as actual dimensions are concerned. In other words, a fraction of an inch difference means more frequency deviation above 400 mc than it does below 150. It will be found that the Lecher measurement will show a sharper indication than at lower frequencies. The coupling should be adjusted so that the same reading will be obtained after several tries, within 1/8 inch or better. Even this short interval represents about 1% of the frequency. The hand must not be kept too near the wires during the measurement. (Fig. 3, which appears below, is the calibration curve.)

The 420-mc amateur hand offers an excellent chance to experiment with reflectors, polarization, etc. Thus, a sheet of aluminum placed behind an antenna will progressively and alternately increase and decrease the signal as it is moved steadily away from (or

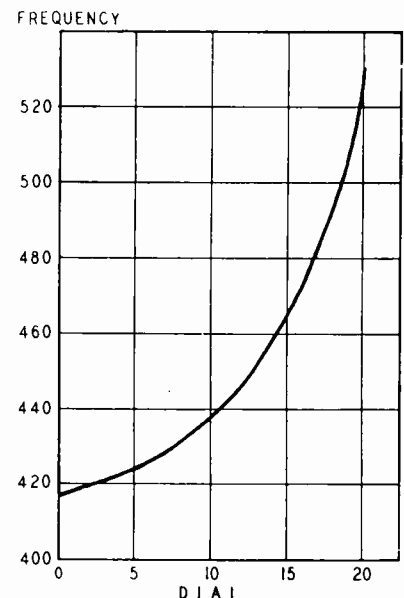

Fig. 3—Calibration curve of the transceiver.

toward) it. Another rod or piece of tubing will act in the same manner. The latter may be held at its center by the hand as it is moved toward and away from the radiator. The effects of polarization are clearly shown in this way.

THREE-CHANNEL AMPLIFIER

It has separate controls for the treble, medium and bass notes.

WE must never lose sight of the fact, in considering the construction of any sound apparatus, such as an amplifier of frequencies in the musical range, that it is the ear which judges the excellence of the instrument—absolutely without appeal! It is therefore indispensable to examine the conditions under which that organ functions, to adapt our sound equipment to it in the best possible manner.

The sensitivity of the ear varies as a function both of the frequency and intensity of the sound. If we consider very weak intensities, the ear hears medium-register sounds much better than basses or high-frequency notes. At medium intensities, all the frequencies are heard equally well, and for very loud sounds, the basses and highs are perceived with greatest intensity.

The Curve of an Amplifier

It appears from the considerations above that giving an amplifier a linear frequency curve is completely illogical. It is necessary to so design the equipment that the listener will hear the sounds reproduced under conditions which approach as close as possible those of listening directly to the sound source itself.

Let us take, for example, the case of a symphonic orchestra. If the listener is in his orchestra seat in the auditorium where the orchestra plays, he hears the music at such an intensity that his ear perceives it with the same relative sensitivity over the whole range of musical frequencies. But if he hears the same program over his radio or from records, through a loudspeaker in his own living-room or bedroom, it is obvious that that intensity will not be as great—the size of a private room being considerably smaller than that of a concert hall. If he turns up the volume control to get the same sound level (which is possible) neighbors with different musical tastes—or those who desire the sleep of the just—will not be slow in protesting energetically. He will therefore regulate the volume to a sound level rather on the weak side.

It is then that the ear registers its discontent with this "sound rationing" by refusing to hear the low and high notes with the same force as the frequencies in the middle of the audible spectrum. But, if our critical listener is clever and especially if he constructs his own amplifier, he will design it with such a response curve that it over-amplifies the highs and the basses relative to the medium frequencies, to exactly the same extent as the ear tends to weaken them. He thus does his own ears a good turn, at the same

(Continued on page 43)

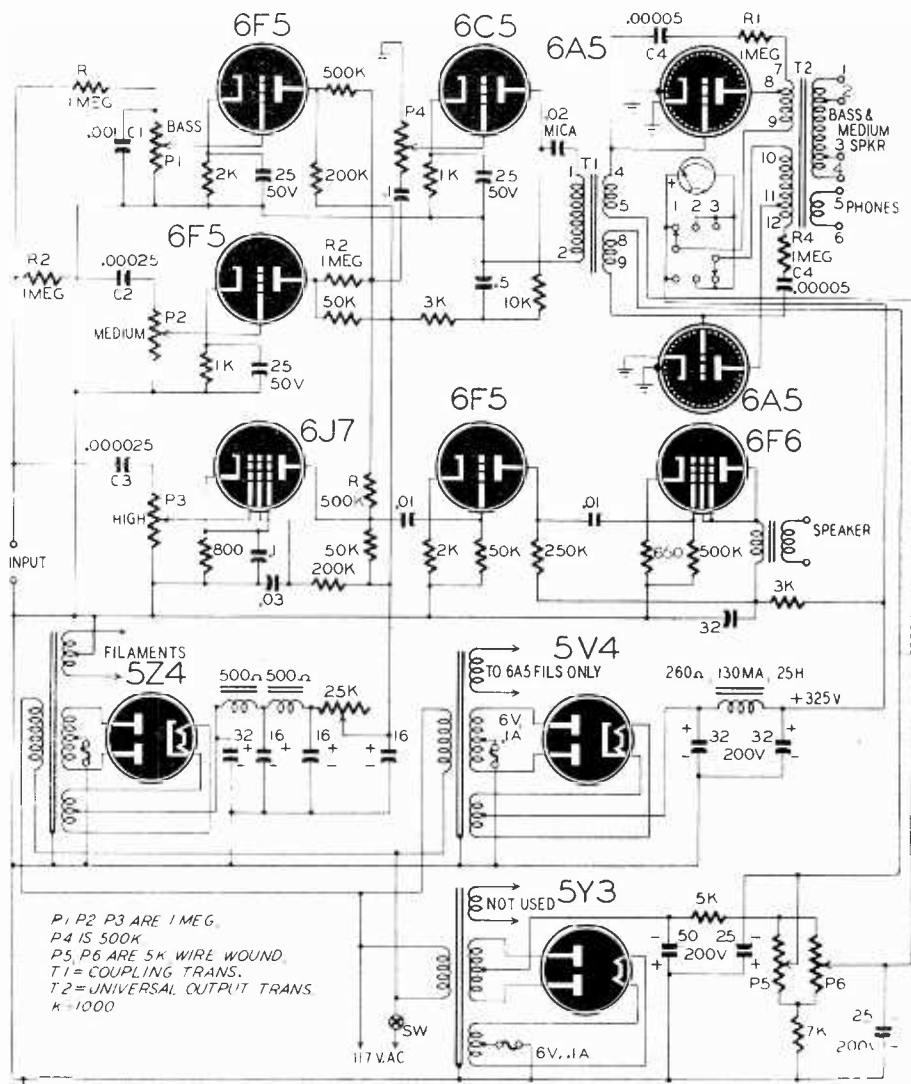
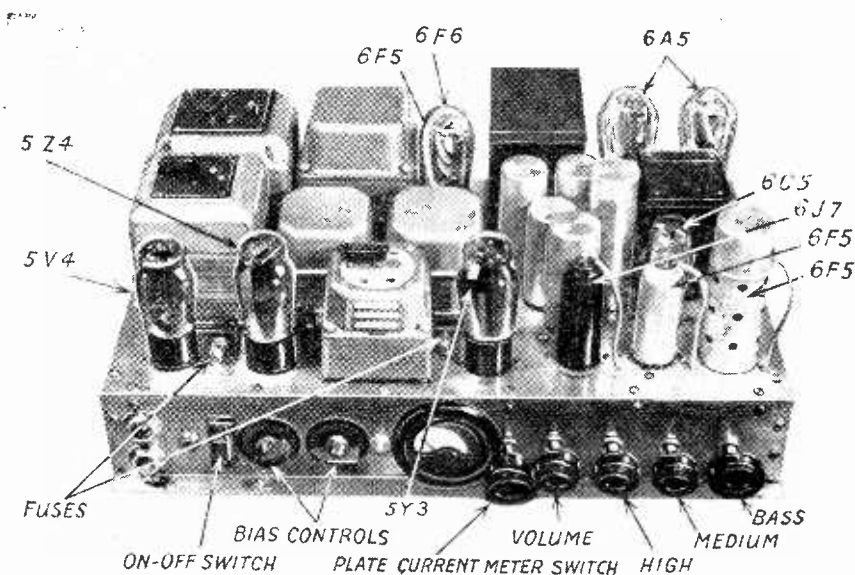

Many original features are to be found in this French high-fidelity, fixed-bias amplifier.

A MULTIPURPOSE TESTER

This meterless instrument measures voltage, current, resistance and capacity, and is a signal tracer and 4-watt amplifier as well.

THE experimenter will find this seven-tube test unit very useful. It incorporates a four-watt audio amplifier with a built-in dynamic speaker; an r.f. test probe; a twin indicator electron-ray tube with its separate amplifier; and a power supply. The tester will trace a signal from aerial to speaker of a receiver, and give a comparative check of signal intensity. It will measure voltage, current, resistance, and capacity; and also test condensers for open and short circuits.

The test unit was built in a ventilated metal cabinet measuring 12 x 7½ x 7 inches. The chassis was made from a ⅛-inch sheet of alloy aluminum measuring 11 x 6½ inches. Since the heavy aluminum cannot be bent easily, it was supported and fastened by means of angle irons.

It is essential that extreme care be taken in wiring and constructing the tester. The leads should be well insulated. The jacks that are not grounded to the chassis can be thoroughly insulated by fastening them with live-rubber grommets mounted in the panel.

Toggle switch Sw1 permits the audio amplifier to operate either the speaker or a pair of phones connected to jacks J10 and J11. R3 serves as a volume control and also operates the power supply switch. The grid cap lead from the 6J7 tube should be shielded to prevent pick-up of stray noise and hum.

The socket of the 6B8 tube is fas-

tened to a three-foot six-wire shielded cable. The tube must be shielded if the 6B8-G glass type is employed. Resistor R12 and condenser C15 are mounted on the probe assembly, but all other parts are located within the cabinet. Switch Sw2 turns on the probe.

The 6AF6-G twin indicator tube has both ray-control electrodes tied together so that two similar shadows are produced. The tube was mounted on a bracket with pins 3 and 7 in a vertical plane. Switch Sw3 turns on the target voltage. The 6K7 tube — connected as a triode amplifier—has two variable bias controls. The 1-megohm unit (R15), which has no dial or calibration, serves to set the shadow angle before making measurements. R16, the 750,000-ohm control, is connected to a four-inch 325° calibrated CA precision vernier dial. The latter unit is used for measurements. The calibrated knob was mounted on top of the cabinet, because in this way the dial reading is not apt to influence the setting of the "eye."

The 6H6 tube rectifies alternating voltages that are impressed on the electron-ray indicator circuit, so that the image will be clear and sharp. Selector switch Sw4 connects the various testing circuits. When the indicator circuit is used in conjunction with the signal tracing amplifier, potentiometer R18 regulates the intensity of the signal affecting the indicator.

The power supply employs a 5Z4 tube

in a conventional full-wave rectifier circuit. By using jacks J8 and J9 the "B" supply can be used to operate or test external circuits, if the current requirement is not too large. The neon lamp serves as a safety "B" indicator. If the lamp should go out or glow dimly, the power supply should be turned off because this would probably indicate a short circuit or a dangerously heavy load. If the "B" supply is being used to supply power to a circuit to be tested, the r.f. probe and audio test prod can be used; but it is impractical to use any of the other tests simultaneously.

Operation of the Tracer

Signal tracing is a very convenient system for locating a defective stage in a receiver or amplifier. For tracing audio-frequency signals, connect a shielded test prod and lead to jack J7. The signal may then be traced from the sound source to the output by touching the prod to successive stage circuits. The r.f. test probe is used for following the signal from the aerial to the detector of a receiver. To operate, turn on switch Sw2, and connect a jumper wire from jack J7 to J6. The signal can then be observed or heard by touching the probe of the tube to the r.f. and i.f. stages. Always connect a lead from J8 to the chassis of the receiver whenever the signal tracer is used.

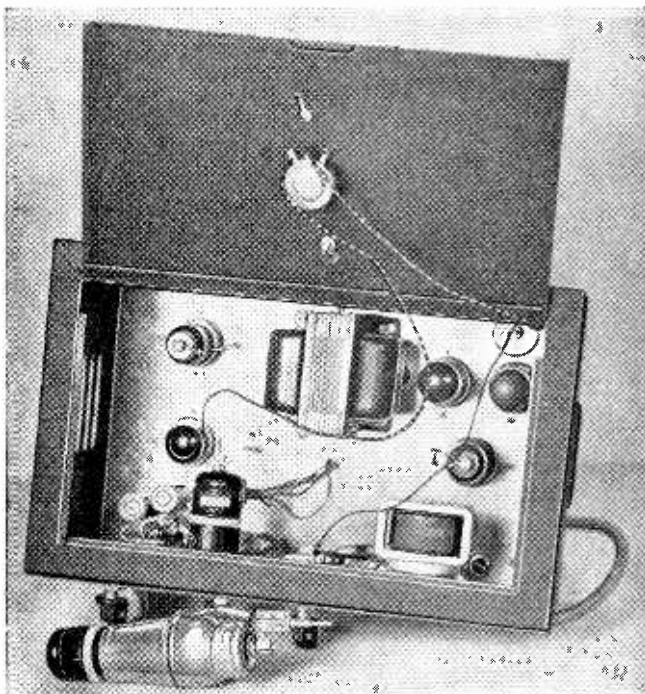

Top and bottom views of the instrument, front view of which appears on next page. All measurements are made with the single dial

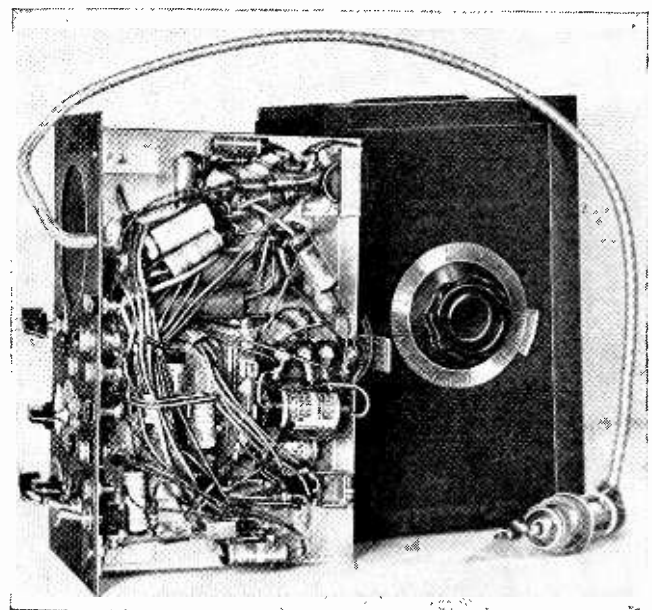

The volume control, R3, should be turned up about halfway for the average signal. The electron-ray indicator tube can be used to observe the intensity of the signal. The tube is turned on by switch Sw3, and connected to the amplifier by turning selector switch Sw4 to position 1. Turn up the intensity control R18 until the indicator tube responds to a signal impressed on the amplifier. Set the uncalibrated bias control R15 so that all of the resistance is cut out. This causes the "eye" to open.

The intensity of two or more signals may be accurately compared or matched with the indicator tube. With no signal present, turn the calibrated dial which operates R16 to 0 degrees (all resistance effective), and adjust the uncalibrated potentiometer R15 until the shadow angle is 0 degrees or the "eye" just barely closed. Turn the intensity control R18 to its maximum setting and do not change the setting during tests. Apply the signal to the unit and note that the green image will overlap. Turn the top calibrated dial R16 until the indicator tube appears just as it did with no signal present. Read the number of degrees indicated by the dial and then repeat the process for other signals. If the reading is less for another signal, the strength is less; if the reading is greater, the signal strength is greater.

To connect the test unit as a voltmeter, turn on the power supply and indicator circuit with the switch mounted on R3, and toggle switch Sw3. Revolve the top calibrated dial (R16) to 0 degrees, and with R15, the uncalibrated control, adjust one section of the twin indicator tube until the "eye" just barely closes. Plug in the test leads to the red jack J1 and the black jack J2. For measuring d.c. voltages connect the lead from J1 to the positive side of the potential to be measured and the lead from J2 to the negative side. Turn the selector switch Sw4 to position 2. If the voltage is not great enough to cause the green image to overlap, switch to position 3, 4, or 5. After the proper range has been selected, rotate the top calibrated dial (R16) until the "eye" opens to the "just barely closed" position. Read the number of degrees indicated and refer to the proper voltage chart.

Two of these voltage charts should be made for each of the four ranges. One set is for a.c. and the other for d.c. voltages. These charts can easily be prepared by applying known voltages and recording the number of degrees deviation from zero required for each voltage. An accurate voltmeter used in conjunction with a variable a.c. and a variable d.c. source can satisfactorily be used to calibrate the tester.

If it is not known whether the voltage is a.c. or d.c., it can be determined by reversing the leads. If the voltage is d.c., the 6AF6-G tube will indicate the voltage only with the positive side connected to J1. If the voltage is a.c., the tube will indicate the potential during both trials.

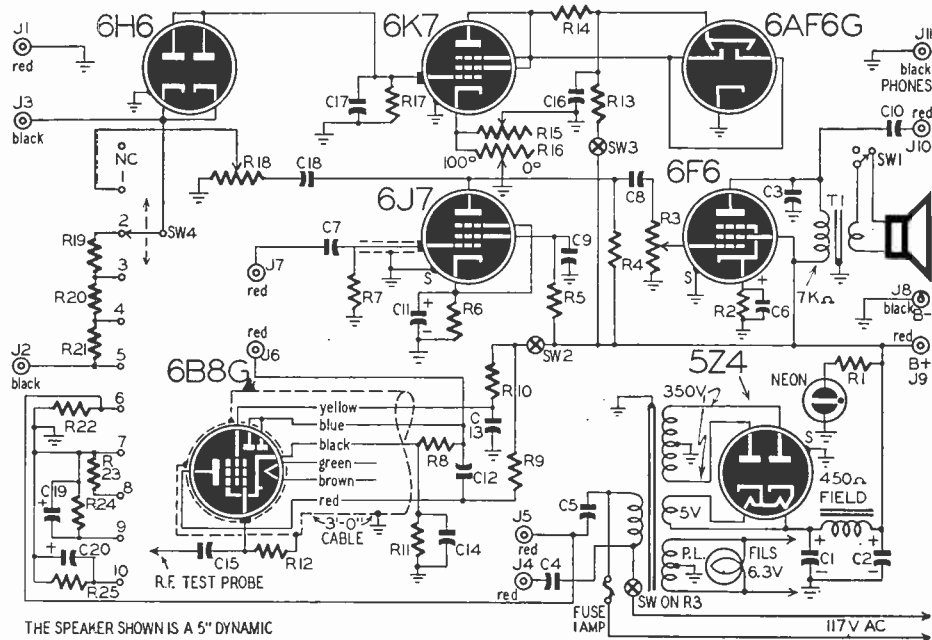

THE SPEAKER SHOWN IS A 5" DYNAMIC

The instrument has more tubes than is usual for such a device. The 6B8-G is in the probe.

Position 5 will measure 1 to 32 volts a.c. or .5 to 41 volts d.c.; position 4, 20 to 400 volts a.c. or 5 to 200 volts d.c.; position 3, 100 to 1100 volts a.c. or 50 to 600 volts d.c., and position 2, 400 to 2500 volts a.c. or 200 to 1500 volts d.c. Position 2 has a much higher theoretical range, but due to arcing or breaking down of the insulation in the selector switch or at the jacks, it is not advisable to apply higher voltages.

One of the leads is connected directly to the chassis; so, take care that the metal cabinet is on an insulated surface well away from the receiver or voltage source and that the operator does not touch the cabinet. It might be worthwhile to insulate the cabinet from the negative side of the "B" supply and to connect a small condenser from the negative side to the chassis.

The test unit can be used for approximate current measurements in cases where the relatively high voltage drop will not upset the operation of the circuits. To set the tester for this function, the following steps should be taken. Turn on the power supply and indicator circuit, revolve the top calibrated dial to 0 degrees, and with the uncalibrated knob set the indicator tube so that the green area of one section just barely touches. Turn selector switch Sw4 to position 7, and plug in the test leads to J1 and J3. Connect the prods in series with the circuit to be analyzed. For d.c. measurements make sure to connect the black lead from J2 so that as the electrons flow from negative to positive, they will enter that lead. Turn the selector switch

(Continued on page 33)

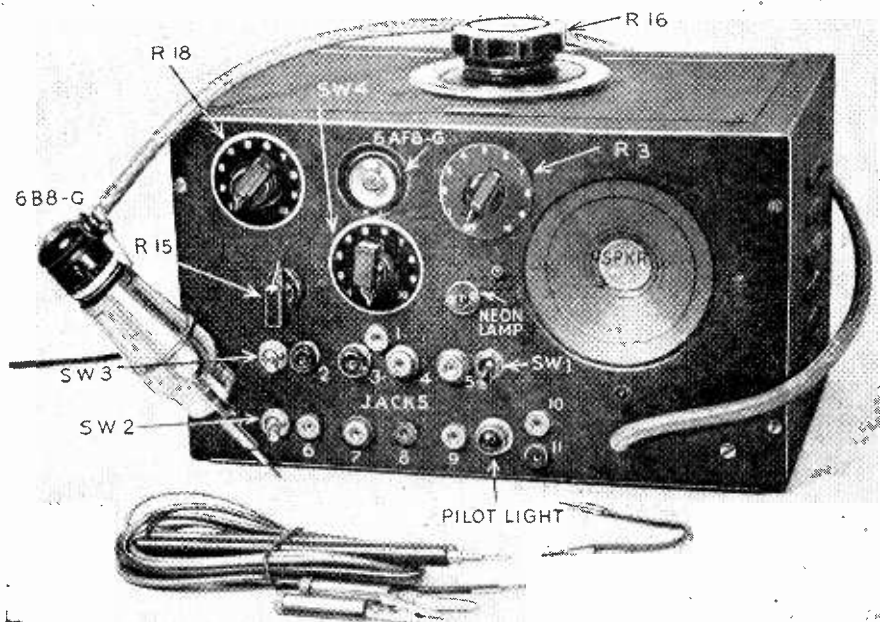

Front view of the instrument, showing controls. Designations refer to the schematic diagram.

HI-FI AMPLIFIER AND RADIO TUNER

Public address system plus a high fidelity superheterodyne receiver



A tuner, amplifier and turntable in one unit.

THIS amplifier, an experimenter's consolidation of circuits, has satisfactory tone, volume and a number of useful auxiliary features. The original model is constructed in a 10 x 8 x 10-inch sloping front, metal cabinet, and on a 9 x 2 x 7-inch chassis; an external speaker is used. Since wiring and components are close, all coupling condensers, a.f. leads, and other sensitive components were shielded thoroughly wherever possible. Output is about 20 watts.

The circuit consists of: a superheterodyne tuner, a volume compressor-expander, a three-channel input with mixers (plus tuner input channel) and a high gain push-pull amplifier.

A double triode 7F7 is used for a two-channel mike input, the grid leaks of each section forming volume controls for the microphones, thus serving as efficient mixers. The plates of the 7F7 are coupled together through a one-megohm resistor, reducing amplification but preventing any motorboating. From here, the a.f. signal travels through a switch on the back of one of the mike controls, through a coupling condenser to the center-tap of the

phono volume control, the lower side of which is shunted with 50,000 ohms to ground.

Compressor-Expander

The higher potential side of the phono control, from whence the signal comes, is fed through a coupling condenser to the grid of 7A7, used in a volume expander-compressor circuit, with little amplification value. Also, the signal from the phono control is fed to the grid of a 7C7, which acts as an amplifier in the volume "expand-compress" circuit.

From the plate of the 7C7, the signal passes to one cathode (coupled to the opposite plate) of a double-diode rectifier 7A6 (or 6H6). A center-tapped potentiometer is coupled between the other cathode and the opposite plate to it, with the center-tap grounded. (See figure). As the signal amplitude increases, so does the potential in the 7A6. The plate end of the expand-compress control will gain negative potential, while the cathode side will be positive, with respect to ground. By moving the control arm to the right or left of center, variable degrees of posi-

tive or negative rectified voltage will be applied as bias to the 7A7; this rectified voltage increases with signal amplitude, giving desired compressed or expanded signal from the 7A7 plate. Expansion of volume is used to increase the dynamic volume range of phonograph records which were compressed during the process of recording. Conversely, compression of volume is sometimes desired when using the amplifier for recording purposes.

Leaving the 7A7, the signal is amplified by a pentode-amplifier 7C7, then by a triode 7A4. Here an audio transformer is used as coupling to a pair of beam-power 6V6's or 6L6's, in push-pull. Inverse feedback is applied by a 5-megohm resistor in series with a blocking condenser between the grid and plate of each 6L6. Since B-plus leads were long, an 8-microfarad condenser was placed directly at the 6L6 screen grids.

(Continued on page 40)

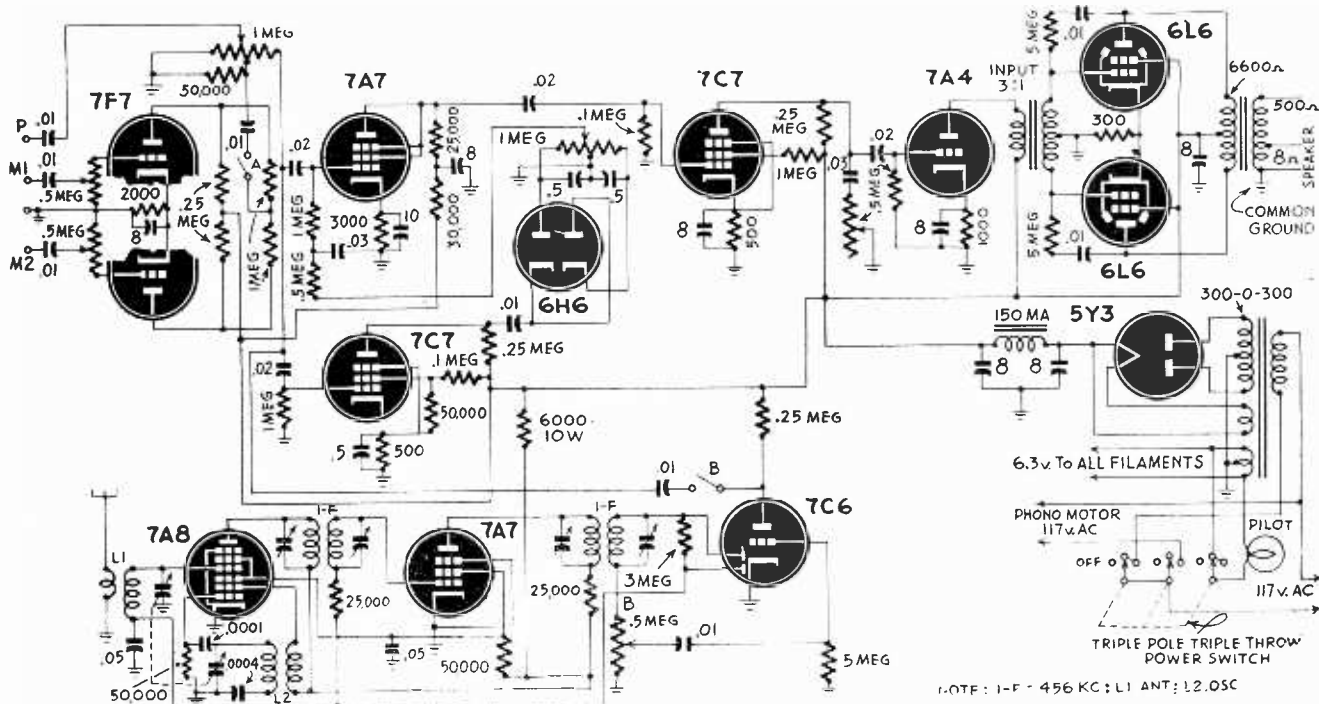

The Superamp comprises a high-fidelity amplifier and a superheterodyne tuner. There is a radio, phonograph and two microphone inputs

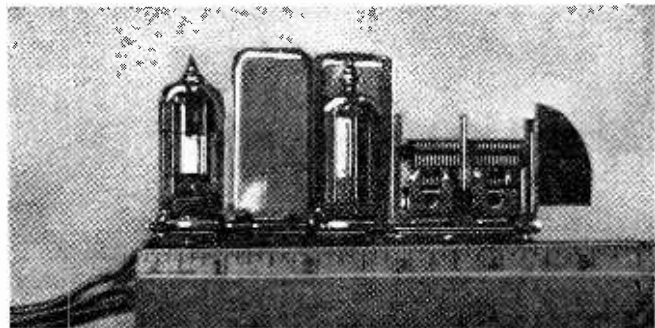

Left—Side view of the radio receiver hearing aid, showing length. Right—The whole instrument may be held in the palm of one hand.

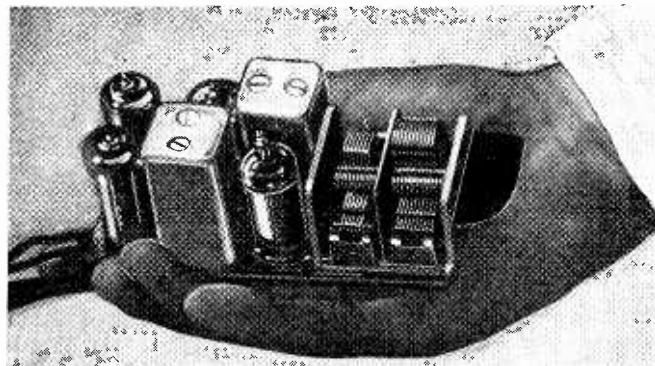

RADIO HEARING AID

This compact little unit becomes, by switching, either a radio receiver or hearing aid, or both at the same time

THE vacuum-tube hearing aid is essentially an audio-frequency amplifier where a compromise has been reached between performance, physical size and weight of the component parts. Frequency distortion is purposely introduced to compensate for the uneven pitch sensitivity of the ear of the wearer. This compensation also takes into consideration whether the acoustic conduction is through air or through bone.

Commercial hearing aids use two-stage, or more generally three-stage amplifiers. This gave us the idea of utilizing the same tubes and component parts for radio reception. After some experiment, the circuit shown at the bottom of the page was adopted, and gives good results in both capacities.

Throwing a switch transforms the set from a hearing aid to a radio receiver embodying the audio-frequency characteristics of the hearing aid. A third switch position where the instrument performs simultaneously as hearing aid and radio-receiver is also mandatory. The wearer can then hear conversation while listening to the radio.

The fact that a hard-of-hearing person can enjoy broadcasts while sitting at his desk or walking in the street may have a moral and also a social value. We hope that some technical reader may benefit from it for his personal use.

For the best performance, the circuit has to be individually "fitted" so far as audio-frequency is concerned; damping that portion of the range where the defective ear is most sensitive.

The superheterodyne circuit has been chosen, incorporating necessary modifications to amplify simultaneously at i.f. and a.f. "Slug" or permeability instead of variable condenser tuning may be preferred because of compactness and reduction of weight. Our apparatus is not exceptionally compact or lightweight because it was assembled with parts available on the radio market at the time. To reduce the dimensions every component part should be redesigned.

The body of the wearer acts as a capacity-coupled antenna. A loop of wire stretched inside the belt of the carrying case forms one element of the input condenser.

Several constructional difficulties were encountered with the wiring. Feedback from the audio-frequency grid leads is the most troublesome. The a.v.c. is also a source of trouble and—although represented in the schematic for sake of completeness—was eliminated in the model shown in the photos. The a.v.c. voltage may be applied to the converter only, since the 1S5 amplifies both at i.f. and a.f. Besides the 1S5 is not a variable-mu tube.

The positions of the switch are: Off; 1 — Hearing-aid; 2 — Radio-Hearing-Aid; 3—Radio. Since we were unable to procure a very tiny switch we depended on plug-in contacts.

To easily visualize the operation of the tube 1S5 and its relative input and output circuits, we may refer to the conventional reflex amplifier. In a reflex amplifier the tube amplifies at r.f. or i.f. and at a.f. The a.f. results from the demodulation of the r.f. or i.f. In the present case the a.f. is generated by the microphone.

The important switch decks are the ones located between the first 1R5 and the 1S5. When they are in position 1.

(Continued on page 38)

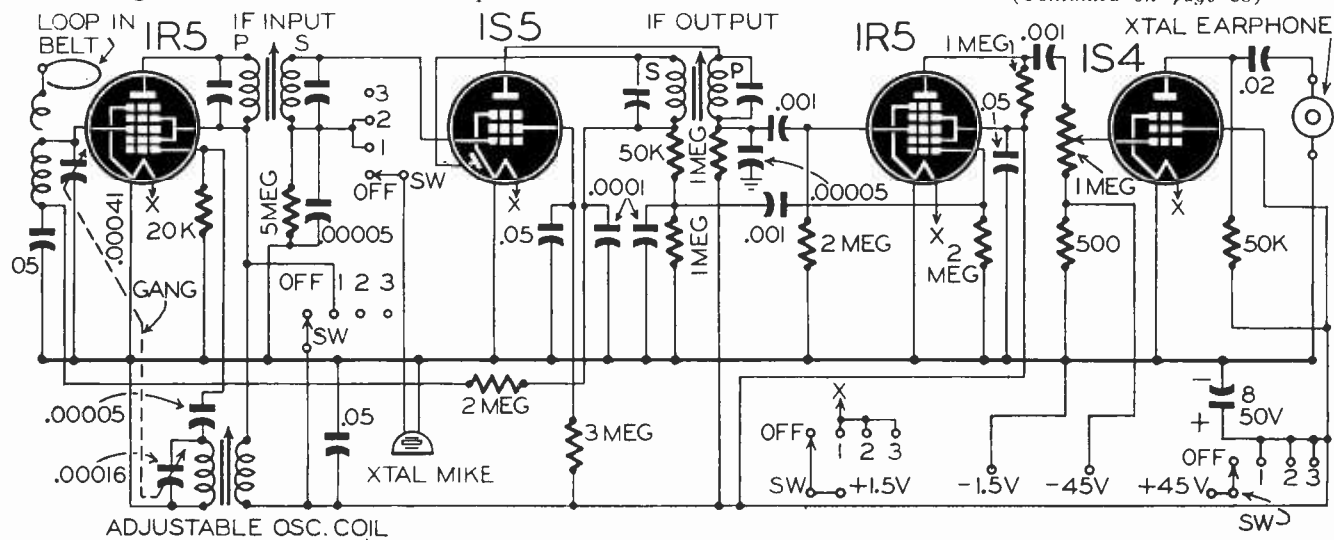

The circuit is not complex, though reflexing and mixing of two channels in the second 1R5 add a few puzzling touches to the schematic.

DYNAMIC HANDFUL

A signal tracer so compact that it can be applied direct to the circuit being tested

THE unit to be described is intended for radio servicemen who are too busy to construct an elaborate signal tracer or audio amplifier.

This tracer was designed primarily to do away with power transformers, external test probes, specially constructed test prods, coils, tuning condensers, tap switches, external amplifiers, high cost of construction, and to save valuable space on the service bench.

There are no special parts to be obtained and it takes very little time to build the tracer. It is so small that it can be placed inside your toolbox together with your other tools.

The volume of the signal tracer is adequate even when connected only to an antenna circuit. Very little hum is noticed when operating it. The open space on the front panel of the tracer lets the heat of the tubes out, indicates when tracer is on by the tubes lighting up, eliminating a pilot light, also provides a space for the line cord if you intend to carry it with you on service calls.

The tracer was assembled on an a.c.-d.c. very small midget radio chassis which was cut in half, leaving the four tube sockets and speaker already mounted, besides the wiring of the output tube and rectifier, which was left intact (because it is usually standard on all midget receivers), thereby saving quite a bit of the work involved by not having to cut tube socket holes, speaker cutout and considerable wiring. There are several well-known makes of midget radios from which the chassis can be cut to leave four tube sockets and a speaker cutout remaining. If a small set cannot be obtained, a chassis

layout is illustrated so that the serviceman can cut the chassis himself.

Any Tube Complement

The serviceman can have his choice of tubes to be used in the tracer. I use a 12Q7, a 12SQ7, a 50L6, and a 35Z5 tube. These were the tubes I had on hand at the time of construction. However, if the serviceman desires, he can use a 12F5, a 12SF5, a 50L6, and a 35Z5 or a 45Z5; or if those tubes are not available, he can substitute a 6Q7 or a 6F5, a 6SQ7 or a 6SF5, a 25L6, and a 25Z6, in which case he will have to use a line cord resistor to drop the voltage for the tube filaments.

The filaments should be wired as shown with tube No. 1 filament connecting to ground to prevent hum.

The tubes are used in this order:

1—untuned detector; 2—1st audio; 3—output; 4—rectifier.

Various circuits were tried such as using 12A7 as an untuned r.f. stage into a 12SQ7 diode plate as a diode detector, into the triode section of the 12SQ7 as first audio, but the results were not as good as the circuit shown.

How To Operate The Tracer

The tracer is so sensitive that it is not even necessary to touch an i.f. or audio grid or plate—just place the prod near the grid or plate and you can pick up a signal, the volume depending on which stage you are testing. In service work I have found this tracer capable of picking up a signal over 3 feet away from a dead set which had an open voice coil in the speaker.

Stage gain can be checked by touching the grid and then the plate of every stage working toward the speaker.

An isolation transformer is unnecessary because of the blocking



Front view of the hold-in-hand signal tracer.

condenser in the circuit. The volume control controls the volume of both the r.f. audio and amplifier sections of the signal tracer.

To operate tracer, plug into electric outlet, touch an antenna to prod A on top of tracer; if several stations come in at once, then it is all set. If a loud hum is noticed, reverse plug in outlet.

Testing procedure will depend on whether set is inoperative or is noisy or fading. If set is inoperative, the short prod is used. It consists of nothing more than a phone tip with a nail soldered to it. The tracer is held in the hand because it only takes a few seconds to touch a grid or plate terminal of a socket to determine if that stage is working properly.

If set is noisy or fades, tracer can be left on the bench and ordinary test leads applied to it to test the various stages of the defective set. There will be a slight detuning due to the long leads when this is done, but this does not interfere with the test that you are making. It may be necessary for you to retune the set a trifle.

Set Testing Tips

When testing an a.c.-d.c. set, make certain that the plug is inserted so that the chassis is connected to the grounded side of the line.

When testing a.c.-d.c. sets, only prod A should be used because both the set

(Continued on page 45)

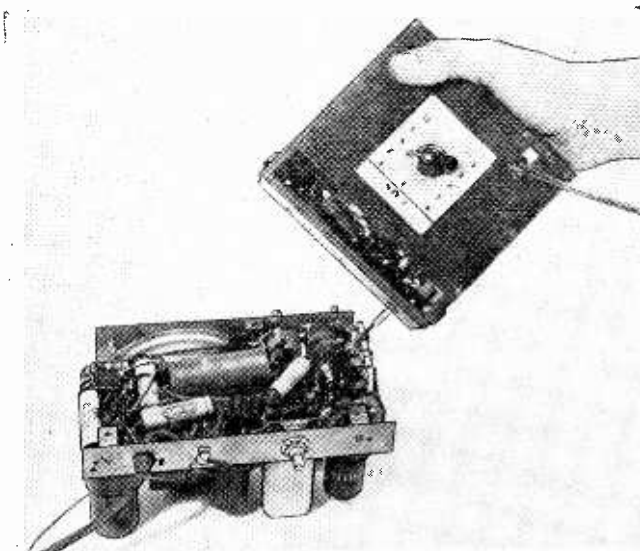

Left—The tracer is inserted in the radio exactly like a probe. Below—A schematic diagram of the "Dynamic Handful" tracer.

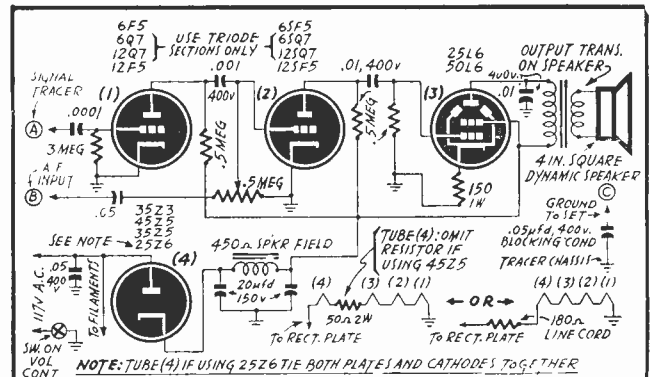

ALL-BAND OSCILLATOR

This signal generator uses plug-in coils to cover the spectrum all the way from 65 to 34,000 kilocycles without a break.

THIS signal generator has a continuous range of 65 to 34,000 kilocycles. The signal may be modulated by the a.f. oscillator which has a continuous range of 24 to approximately 20,000 cycles per second.

A small metal cabinet measuring 10 x 6 x 7 inches provides the necessary shielding for the oscillator. The r.f. Hartley oscillator uses a type 6J7 pentode radio tube. Intensity of oscillation is controlled by potentiometer R5 which varies the screen voltage. The switch mounted on R5 serves to turn off the r.f. oscillator when it is not being used.

If operated on a frequency below 2,000 kilocycles, the output switch may be set for the i.f.-a.f. position. It was discovered that a stronger low radio-frequency output was obtained if the coupling was not made directly to the plate of the oscillator. The a.f. output connection can be used for low radio frequencies because the r.f. choke isolates the plate from the output connection. The intensity of the oscillations reaching the output leads is controlled by R10 at low radio frequencies and audio frequencies; but when operating on a frequency greater than 2,000 kilocycles, the output switch is set to the r.f. position and the intensity must be controlled by the voltage potentiometer R5.

The condition of the 6J7 tube can be determined by connecting a 0-150 d.c. voltmeter across resistor R6 and choke T1. The oscillator tube draws a large current while not oscillating and a much smaller current while oscillating; therefore, a large voltage drop reading will

indicate that the tube is not operating properly. If the grid cap of the oscillator tube is touched, the reading will increase providing the tube is oscillating. If no meter is available, a rough check can be made by connecting a midjet neon lamp to the meter jacks. If the 6J7 is not oscillating, the lamp will glow. It should be noted that the plate current flow will also decrease if the screen voltage is reduced or the coil is removed.

Resistor R6 serves to place the plate of the oscillator tube at a lower potential than the modulator tube so that more modulation may be secured. Either a plate coupling choke or the primary winding of an audio transformer can be used for T1.

The r.f. signal is modulated by turning potentiometer R9 in a clockwise direction from zero until the switch is turned on. The a.f. switch is set for either external or internal operation. The external position connects the modulator tube to the posts marked "External a.f. Source." A microphone or any other similar sound source may be connected to these posts. The internal position connects the other triode sec-

tion of the 6C8-G tube so that it forms a two-stage audio oscillator. The pitch may be varied from 24 to more than 20,000 cycles by the 1-megohm potentiometer R9. This control serves as a tone adjustment when the external posi-

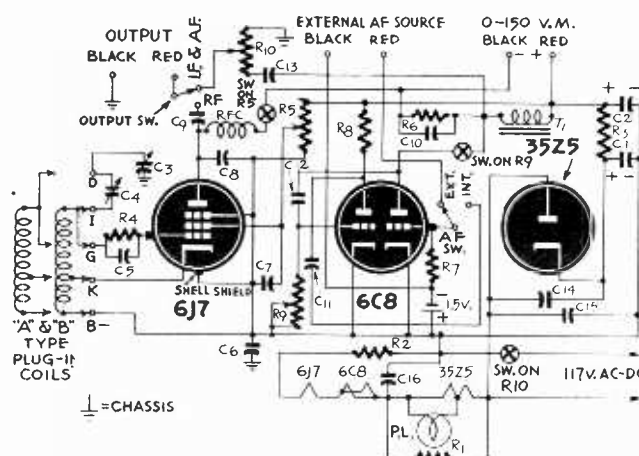

The generator has a switching device which places two condensers in series on the high-frequency bands. Audio tube is a multivibrator.

tion is used. If it is desired to test a.f. equipment, the output may be tapped by turning the output switch to the a.f. position. The intensity is controlled by R10.

A type 35Z5-GT radio tube is used as a half-wave rectifier. The circuit operates from 120 volts a.c. or d.c.

Plug-In Coil Data

Type "A" plug-in coils have the 350- μ mf tuning condenser connected directly across the winding. Type "B" coils

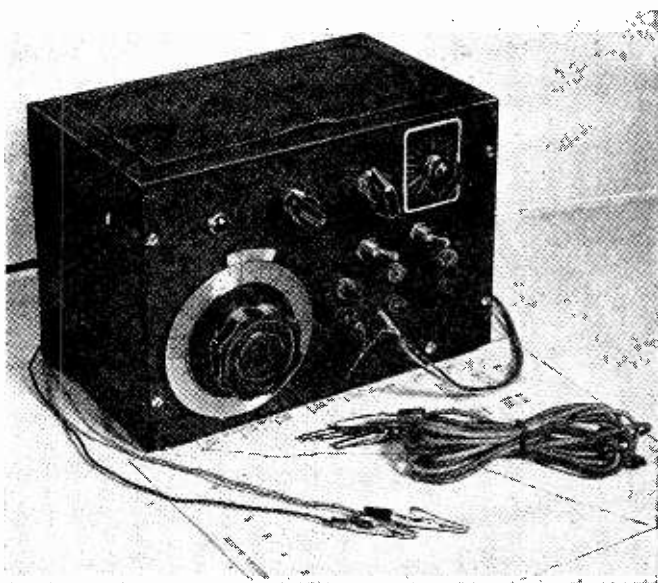

This commercial-looking signal generator has three sets of output jacks, one each for r.f., for i.f.-a.f. and for the external voltmeter.

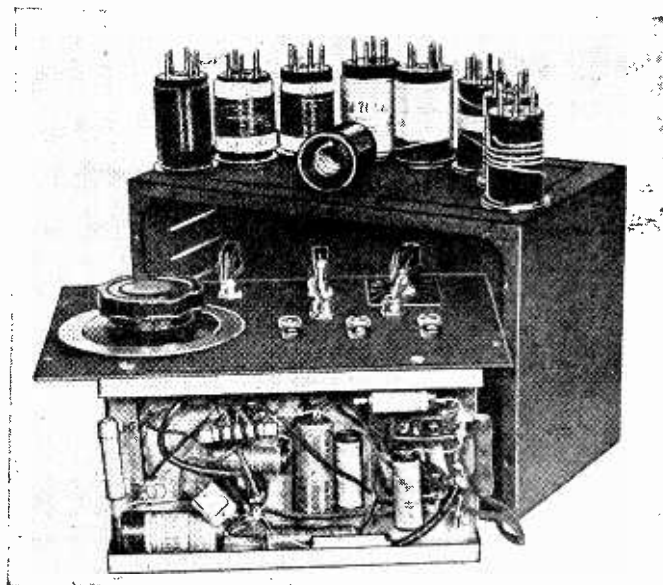

The generator removed from its case. Eight plug-in coils are used, in two styles, so connected as to facilitate tuning over the wide range.

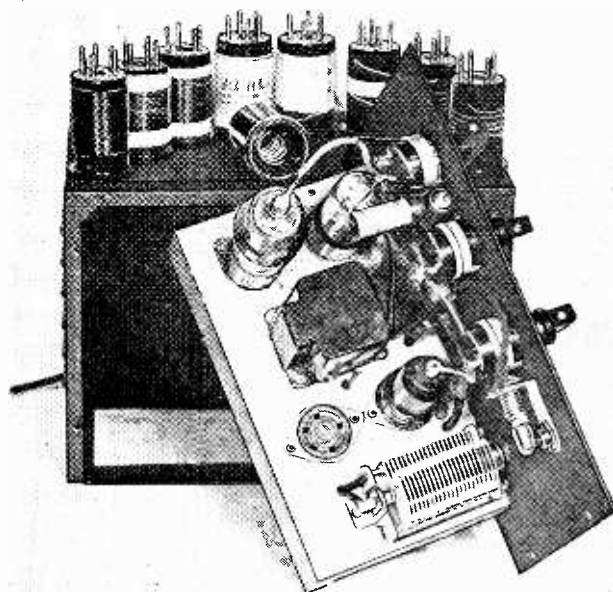
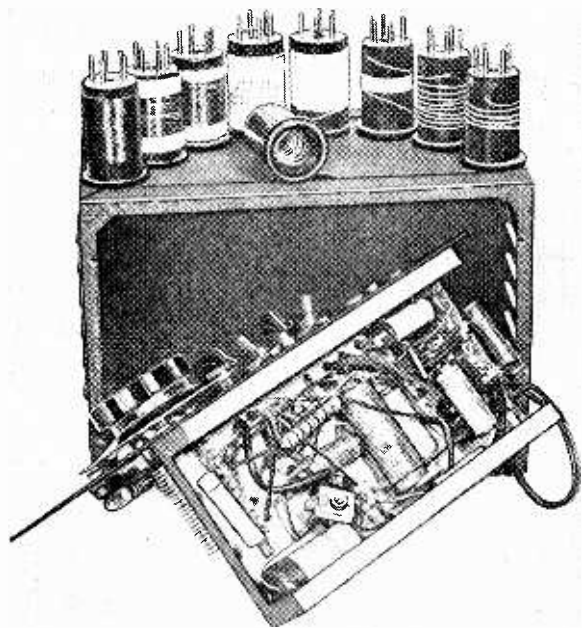

Below-chassis and top views, also cabinet and set of plug-in coils.

connect a small trimmer condenser, which is fixed at a certain capacity, in series with the tuning condenser. The latter type is used for the high-frequency coil, but can be used on any frequency where band-spread operation is necessary or convenient.

The coils are wound in four different styles. The first style consists of a self-supporting v.h.f. coil mounted inside a standard plug-in coil form. The second is a single-layer winding. The third is a layer-wound coil. The first layer is wound directly on the form. This wind-

ing is covered with an insulating paper which is doped in place. The next layers are wound so that the winding ends directly over the place where the one below started. A paper strip is always placed between each layer. The fourth is a jumble winding which is spread over the entire form.

The necessary data is given in the Plug-In Coil Chart. The center of the coil is satisfactory for the tap if no other mention is made in the chart. A change of a few turns up or down will often make for smoother oscillation.

After the signal generator has been constructed and tested, it should be accurately calibrated. If no accurate signal generator is available, the following systems can be used. Obtain an all-wave t.r.f. or superheterodyne receiver with an r.f. stage. If it has approximate calibration and a tuning indicator, fairly accurate results are possible.

The low radio frequencies, 560 to 65 kilocycles, are calibrated through the use of the harmonics generated by the oscillator. Plug in the coil to be calibrated. Disconnect the aerial and ground wires from the receiver. Connect the leads from the output posts of the generator to the ground or chassis and the antenna. Set oscillator controls so that it operates with a modulated signal. Turn the tuning knob to 100°. Several harmonics should fall within the broadcast band. If it is remembered that each harmonic is separated by a frequency equal to the fundamental signal, it will be very easy to determine the frequency of the oscillator. For example, if the oscillator were tuned to 150 kilocycles, the harmonics would be 150 kilocycles apart. The second harmonic would fall on 300 kcs, the third on 450 kcs, the fourth on 600 kcs, the fifth on 750 kcs, etc. The fundamental and first harmonic are identical. Just subtract the smaller number from the next larger. Six hundred from 750

(Continued on page 42)

PLUG-IN COIL CHART

COIL NUMBER	APPROXIMATE FREQUENCY	WINDING DATA	WINDING STYLE	COIL TYPE	OUTPUT SWITCH
1-B-1	34 to 11 Mc.	8 turns Self-supporting 3/4" diameter Tap 3 turns from G Large stiff wire	1	B	R.F.
2-A-2	24 to 7.5 Mc.	4 1/2 turns Spaced 1/4" diameter Center tap Number 28 wire	2	A	R.F.
3-A-2	14 to 3.5 Mc.	9 1/2 turns Spaced 1/4" diameter Tap 5 turns from G Number 28 wire	2	A	R.F.
4-A-2	5 to 2.5 Mc.	17 turns Close wound 1/4" diameter Tap 11 turns from G Number 28 wire	2	A	R.F.
5-A-2	2,500 to 900 Kc.	60 turns Close wound 1/4" diameter Tap 40 turns from G Number 28 wire	2	A	R.F. (or I.F.)
6-A-3	950 to 390 Kc.	100 turns 1/4" diameter Number 28 wire	3 (2 layers)	A	I.F.
7-A-3	500 to 210 Kc.	200 turns 1/4" diameter Number 30 wire	3 (2 layers)	A	I.F.
8-A-3	240 to 110 Kc.	400 turns 1/4" diameter Number 30 wire	3 (4 layers)	A	I.F.
9-A-4	120 to 65 Kc.	800 turns 1/4" diameter Number 36 wire	4	A	I.F.

RADIO LABORATORY IN PORTABLE UNIT

The facilities of a complete service shop are included in a single easily-carried case.

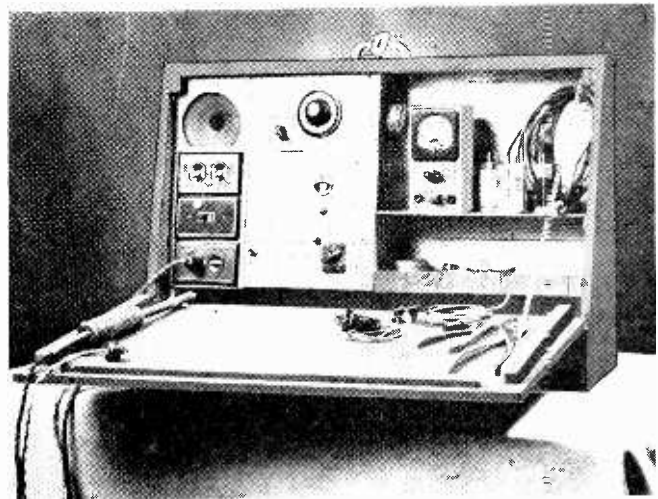

The case contains instruments, receptacles and space for tools

THE housing shortage is no specter of persons. My radio hobby and I had grown up together with space unlimited. There was a large room to tinker in, a big work table, home-made instruments and apparatus, built with no regard for compactness. Then came a better job in a crowded city . . . and a four-room apartment. Also came a baby into our apartment, who in spite of her pint size occupied at least one-half the space. There just wasn't room for so much as a variable condenser to open out. My "junk" was packed and stored in an old unheated shed. But friends kept saying, "Wish you'd take a look at my radio." Besides, I was getting mighty lonely for the feel of a soldering iron. I began making trips to the shed. The photo shows the result.

The whole thing tucks away into a closet when not in use but comes right out into the living room in the evening and perches on a kitchen chair in front of the Chesterfield. There's room in the bottom for tools. The shelves at the right hold test prods, plug-in coils and a pocket volt-ohm-milliammeter. This meter is my one piece of "boughten" apparatus. In the lower left corner is a 110-volt outlet (Fig. 1) controlled by the switch just above it. There's a pilot light shunted across the outlet (so you won't forget and leave the soldering iron on). Above the switch is another outlet and there's another one behind the panel. The test instruments plug into it. This completes the first section. The apparatus is built in sections on masonite backed with metal shields. Different sections can be removed separately. Above the outlets is a four-inch dynamic speaker. The audio channel is located in the lower central section, with the off-on switch at the left. Below the electron-eye is a neon bulb. To the left of the attenuator knob (below) is a single-pole double-throw switch. This is shown in the diagram and explained later. The three pin jacks at the left are: Common, B-plus, and 6.3 volts a.c. The two at the right are Input and Ground. The upper section was built directly on the back of the panel with no chassis but is carefully shielded. The large dial above is for tuning. The pin jacks at the right are for r.f. input (or aerial) and output. To the left is the regeneration control and two diode voltmeter pin jacks. The upper is an a.c. input and the lower is plus d.c. output. The plug-in coil can be seen protruding slightly from behind

the panel at the right. When the lid is opened it can be used as a work-bench, the surface of which will not be damaged by scratches, drill marks or the scars from a hot soldering iron.

The Audio Channel

The circuit diagram is given at Fig. 2. The unit consists of the loud-speaker, 6V6 output tube, 6SQ7 voltage amplifier, 6E5 electron-ray voltage indicator, 2-meg. attenuator and a switching arrangement. The switching arrangement allows one to listen to any audio signal or its effects may be noted on the electron-ray indicator. The electron-ray indicator is especially useful in making voltage gain tests and in balancing phase-inverter circuits. It is sensitive to frequencies above and below the limits of the loud-speaker. The 6V6 is much superior to the more common 6F6 because of its greater sensitivity, which is very valuable when listening to weak signals. Voltage variations of low frequency — hum, etc., cause the edge of the indicator-shadow to waver, flicker or blur. Frequencies above the audible range to 50,000 cycles or more close the eye smoothly but no signal is heard from the loud-speaker. It should be noted that when the speaker is in

the circuit the diode rectifier is inoperative. If it were left in the circuit it would cause distortion. The 2-meg-ohm attenuator causes little loading in any circuit and allows a range of from 1 volt to 500 to be measured. With good building and careful calibration this unit will give accurate a.c. measurements which compare favorably with those of a good electronic voltmeter. Strong i.f. signals are rectified by this instrument and close the eye smoothly. Even r.f. signals from a strong local station have been picked up by a test probe and have found their way to the grid of the 6V6 and appeared as an untuned and unwanted program.

The Neon Tester — shown in the Audio Channel diagram—needs no explanation. As a condenser tester it is the most used apparatus on the panel.

R.F., I.F. and Signal Generator

This, as can be seen from Fig. 3, is a simple one-tube regenerative circuit of the Hartley oscillator type. This is the simplest and most satisfactory circuit for this purpose. It has good

(Continued on page 44)

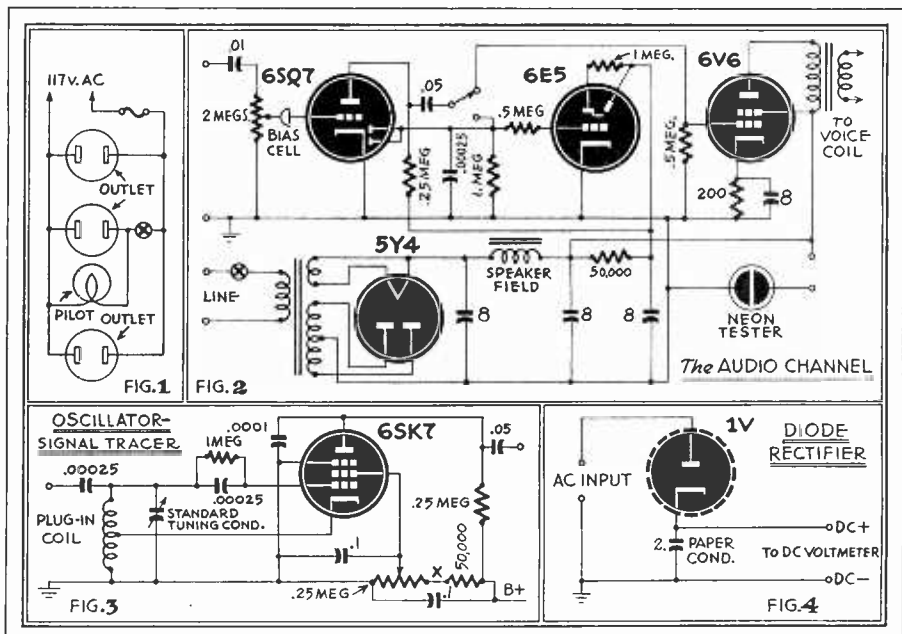

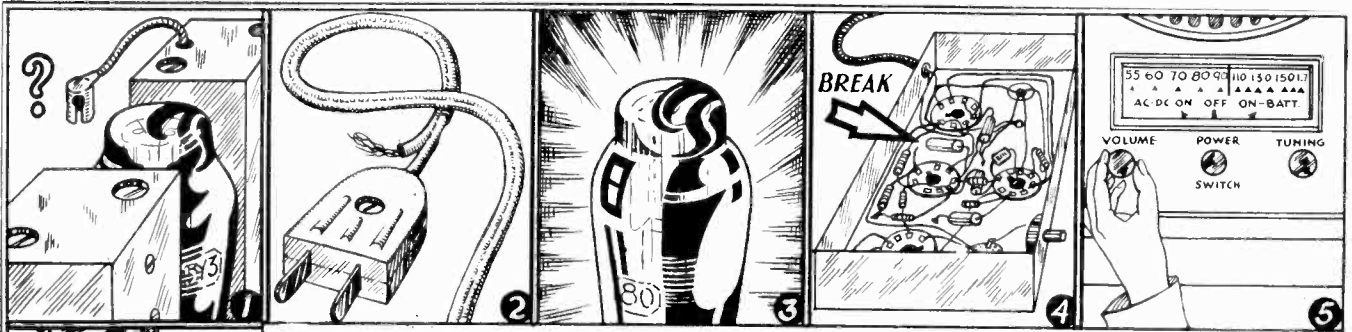

RADIOS SERVICED

Sight, hearing, touch, smell and taste are valuable instruments for servicing radio receivers and electronic devices

DURING about fifteen years of radio servicing I have noticed many beginners (and some not beginners!) tinkering with radios and getting nowhere. I have worked with a few so-called "engineers" and have seen them search for many hours to discover trouble that would have been apparent at once if they had but used their knowledge and observed some things that are quite plain to see.

Careful observation will locate at least seventy-five per cent of all radio troubles. The following system is one I use all the time, and it leads me to the trouble quickly, in most cases. Oldtimers will agree that observation is well worth while, but beginners will find the system something they have wished for since they first became interested in "fixing" radios. These instructions are not likely to be of much use to the man who has so much confidence in his native luck that he plunges into a radio chassis with screwdriver, pliers and soldering iron and really "fixes" the set—so that it needs rebuilding!

All information is as brief and as non-technical as possible so that the novice may derive all possible benefit from the information given.

Let us suppose that we have a six- to ten-tube superhet on the bench and that we are preparing to analyze the trouble. However, this system may be adapted to any other type of circuit also, with proper consideration

given to certain differences of circuit action.

1—First, see that all tubes are in their proper sockets. Often the owner has removed the tubes for testing (for free) and frequently replaces them in the wrong sockets.

2—Next, turn on the set. If tubes do not light, check line cord for breaks. On portables especially, check the switch. 3—Watch the rectifier tube for signs of over-heating, plates turning red, etc. Check for shorted filter condensers, shorted sockets or shorted transformer windings. 4—Turn chassis over and look for wires touching, burned-out resistors, etc.

5—Have the dial set on a strong local station and the volume control set at maximum position. 6—Touch the grid cap of the first audio tube, or the grid terminal. This usually can be easily located as the grid lead comes from beneath the chassis. In the case of the single-ended tubes, touch a test prod to the center of the volume control to get the same results as though your finger were placed there. A loud clear buzz should be heard if all is well in the audio end. 7—If not, pull out the power tube. It should make a thump in the speaker if there is voltage on the plate of the tube. 8—If not, check the voice coil. 9—On midgets, make sure the pilot lamp is O.K.

10—Feel the output transformer. These often become warm when excess current is flowing through the plate winding. 11—The

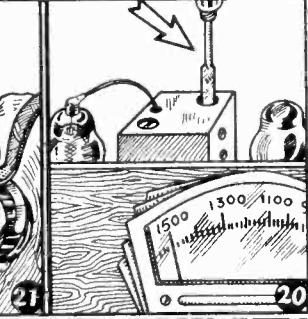
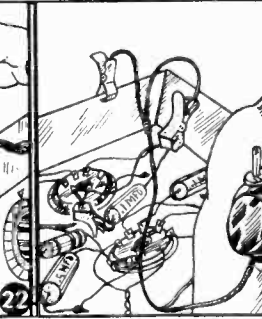
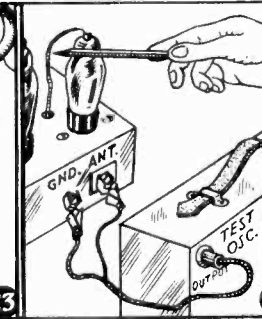
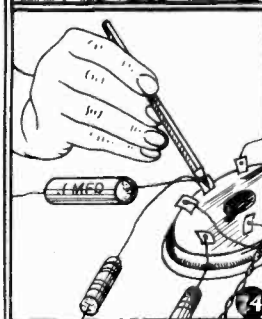
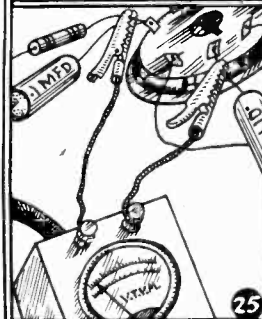
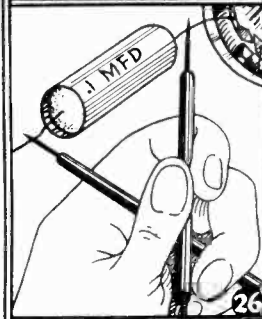
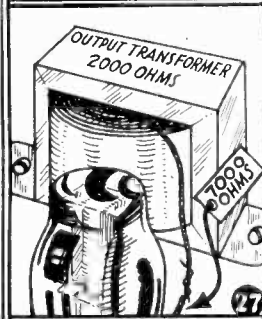
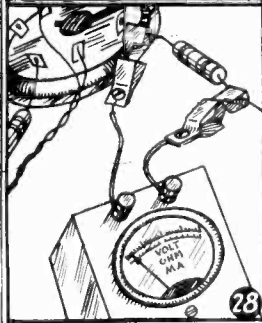

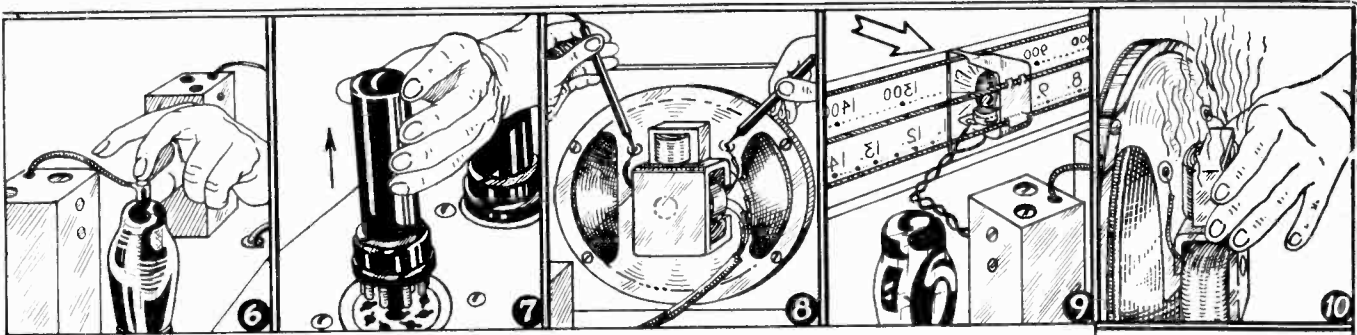

BY OBSERVATION

small tone-compensating condenser connected from plate to cathode (or ground) may be shorted. Disconnect it and see. Or the coupling condenser may be leaking a positive voltage to the grid, causing the tube to draw excessive current.

12—Listen closely to the speaker. There should be some hum if there is any voltage at all on the power tube. If it is entirely quiet look for an open voice coil or broken leads to the voice coil. 13—Listen to the output transformer. You can hear it singing if the voice coil circuit is broken.

14—Watch any tuning indicator that may be present. If it indicates a signal the r.f. end is probably O.K. Electron-ray indicator tubes appear to burn red when no voltage is supplied to their anodes.

15—Have a test prod on the lead-in from a long antenna. Touch the grid of the i.f. tubes. Noise coming through will indicate the stage is in passable condition. Work back toward the antenna post. 16—Turn the wave-band switch to be sure it is set on the broadcast band. If the noise still comes through, but no signal, the oscillator is perhaps not functioning. 17—Occasionally a strong signal will force its way through the i.f. section when the oscillator has stopped. You can double-check this by connecting the test oscillator to the grid of the first detector tube and setting it at a frequency of a local station plus the i.f. frequency of the receiver. The signal will come through if that is your only trouble.

18—Try adjusting the i.f. compensating condensers to be sure some home mechanic hasn't discovered they were loose and screwed them down tight. Mark the original setting and don't turn them far off without returning

to the original—especially if you have no test oscillator.

This procedure should not have taken over five minutes, and the service man should, with a little reasoning, have a good idea as to where the trouble lies—at least, in which stage it lies.

19—If you are without the test oscillator, you still can do a fair job of alignment on a receiver by using the noise pickup of your antenna. If you should be so (un)fortunate as to have your shop in an interference-free location, generate noise with a buzzer or spark coil.

Set the dial at a point where no station is heard. Turn up the volume control and adjust the i.f. trimmers for the highest noise level. The noise has very little effect on the a.v.c. action and accurate adjustment can be made in this manner. 20—Next, tune in a station on the high-frequency end of the dial and adjust the oscillator trimmer until the station is received best. Move the dial off the station and adjust the r.f. trimmers for maximum noise level. Lastly, set dial at the low frequency and adjust padder for maximum noise. The broadcast band is now aligned.

(This system will work only on sets with fixed padders in which no accident has caused the oscillator frequency to be "off." Where the padder has been screwed down so that the intermediate frequency generated by the oscillator is—say—300 kilocycles, an attempt to align will leave the i.f. tuned to 300 kc instead of the normal 450-465 used on most radios. The result is that stations will come in only on that part of the dial at

(Continued on page 34)

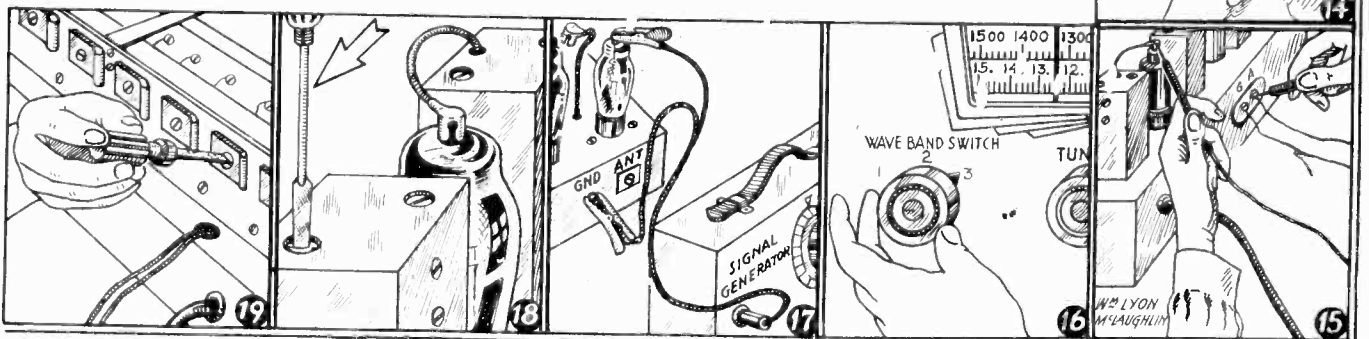
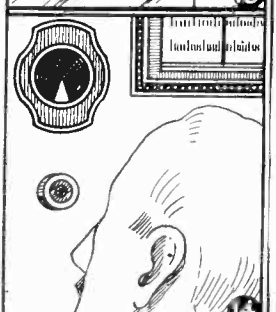
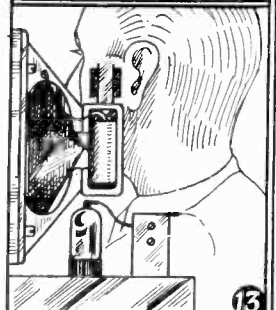
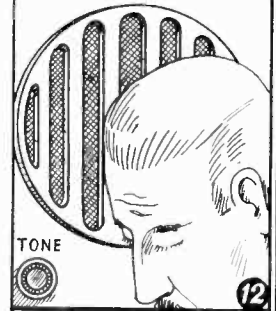
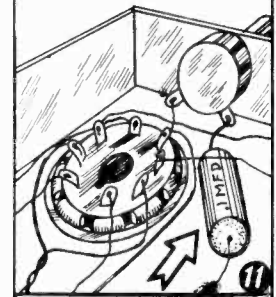

POCKET RADIO CHECKER

A neat multimeter with scales for capacity and a.c. amperes as well as the usual ranges



Widerange Tester. Power consumption is measured through receptacle on top.

EVER wish for a small pocket tester that would do a man-sized job? This meter not only covers the regular ranges, but has condenser and alternating current measuring facilities. Power-line-operated devices are easily checked for correct current drain without opening their line cords. Three switches are incorporated in the circuit to provide a minimum of test lead changes and to increase safety factor when making tests on the power line.

Selecting the meter ranges was one of the main problems. A compromise between versatility and size and cost was our objective.

We first tackled the voltage ranges. Examination of the problem revealed that a 1-volt d.c. range would be useless, as battery voltages start at 1.5 volts. A 1-volt range a.c. meter can be used for numerous testing purposes. This range serves as an excellent output indicator across voice coils, thus facilitating receiver alignment and signal tracing.

Similar pros and cons made us design the voltage measurements to increase in multiples of ten. Reading is thus simplified by having one row of numbers on the scale instead of several. The voltage ranges thus became 10, 100 and 1000 volts, a.c. or d.c., with the addition of a special 1-volt a.c. range, as mentioned above.

Milliammeter ranges were also chosen in multiples of 10, for simple scale reading. 1, 10, 100 and 1000 milliamperes (1 ampere) will cover most service requirements.

Alternating current ranges were made to operate on the same current shunts used for direct current readings, resulting in fewer switching positions, smaller size and less shunt winding. Three alternating current ranges cover measurements from 50 milliamperes to 15 amperes.

A trouble with most pocket testers is that the ohms zero adjustment has to be reset every time the range switch is moved. This bothersome procedure has been minimized to the extent that no resettings are required when fresh batteries are used. Actually the a.c. power line can be used in place of batteries, but then resistance measurements cannot be made in the absence of power lines.

Resistances are measured in three ranges: 0 to 10,000 ohms, 0 to 100,000 ohms and 0 to 1 megohm, and are all found on the same meter scale. These ranges can be extended if a 45-volt battery is added in series with a 45,000-ohm resistor and the 1-meg range, which will now measure 0 to 10 megohms.

Next on our list of ranges is capacity. For these measurements a source of standard frequency is necessary. This is obtained from the a.c. power line. Very convenient ranges available for these measurements are: .001 to .1 microfarad, .01 to 1 microfarad and .1 to 10 microfarads. These ranges fall in the same positions as the 1, 10 and 100 volt a.c. positions on the selector switch. For operation the plug must be

connected to the a.c. power line, and capacity is measured between the jacks marked CAPACITY and PLUS.

To measure approximate wattage consumption, electrical equipment is plugged into the meter receptacle. Power is obtained by means of a cord which is connected to the power line. Before power is applied the range and a.c.-d.c. switches must be set. Power and meter indications are obtained simultaneously by pressing the push button. For apparent wattage, current reading is multiplied by the line voltage. See Fig. 1.

It must be stressed that these readings are only approximate for a.c. wattage, as power factor is not taken into account in our calculations.

Construction and Parts

First on the list of material is a 3-inch, 1-ma milliammeter with an internal resistance of 55 ohms. If a 1-ma milliammeter of smaller resistance is obtainable, then simply adding enough series resistance to make 55 ohms will do.

Three switches are necessary. One eleven-position, two-gang switch is required for range selection. The a.c.-d.c. changeover switch is of the d.p.d.t. toggle type. The power line switch for current and wattage measurement is the push to close variety.

To obtain maximum a.c. sensitivity and linearity and still use a 1-ma meter, the full-wave bridge type meter rectifier is employed.

The case for this tester was home-constructed. Bakelite is used for the entire box. Two thicknesses are necessary. The panel and bottom measure

(Continued on page 47)

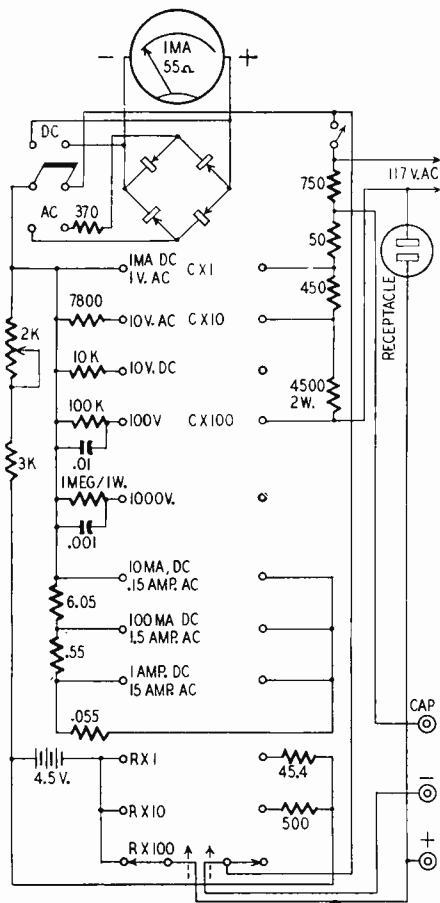

Fig. 1—Schematic of the Widerange Tester.



The insulated bracket holds the battery clear.

DIODE CRYSTAL PROBE

This crystal diode head makes a signal tracer out of your own vacuum-tube voltmeter.

THE majority of present-day vacuum-tube voltmeters are essentially d.c. indicating devices. A rectifier unit is employed to permit measurement of a.c. voltages.

Many factors influence the choice of the rectifier unit and its arrangement with respect to the d.c. indicator. Since operation over a wide frequency range is desirable, it is necessary to make all a.c. leads as short as practicable. Moreover, linear rectification is preferable so the d.c. indicator deflection will be directly proportional to the magnitude of the a.c. voltage.

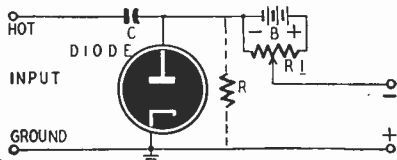

Fig. 1—Diagram of standard type diode probe.

A vacuum-tube diode rectifier, mounted in a convenient probe and arranged to feed the d.c. section by means of a shielded cable, is admirably suited to this purpose.

A wide variety of small vacuum tubes may be conveniently used. In general, it is necessary to choose tubes having a low input capacity. Thus the input impedance will be sufficiently high to preclude loading of the external circuit.

With the advent of the new germanium crystal diode (Sylvania 1N34), the constructor has a useful device which simplifies probe design. Most of the disadvantages of vacuum-tube diodes are eliminated.

A comparison of Figs. 1 and 2 will show immediately the simplicity of the crystal version. Fig. 1 illustrates a typical vacuum diode circuit. Fig. 2 shows its crystal counterpart. Note that a small battery and variable resistor are needed to balance out the contact potential of the diode. The properties of the germanium crystal have been adequately described in the literature.* Hence no attempt will be made to discuss the theory of operation. An actual probe will be described.

The probe is simple to fabricate. It was built into a small penlite flashlight case, details of which may be seen in the photo. It may be used in conjunction with practically any d.c. vacuum-tube voltmeter and with many signal tracers. Note the extremely

small size. The circuit is that of Fig. 2. The capacitor C is .01 μ f and the function of R is taken over by the divider resistors across the input of the vacuum-tube voltmeter. In operation the meter is set up to measure negative d.c. voltage. Full scale meter reading of 1.5 volts d.c. may be obtained with the circuit of Fig. 2 when 1.5 volts a.c. is applied to the probe. To increase the d.c. output voltage, the value of C must be increased. A value of .01 μ f or less is to be preferred, however, in order to keep the input impedance at a high value.

An exploded view may be seen in the second photo. The front row of this photo shows (left to right) the capacitor, C, as it is soldered to a short length of pointed No. 8 wire and the tiny crystal and its mounting. The bakelite tubing fitted into the plastic case cap and the case proper are shown in the second row. In the background of the first photo rests the 7-prong plug which feeds the d.c. indicator.

The crystal will operate well at fre-

quencies as high as 100 mc. The input

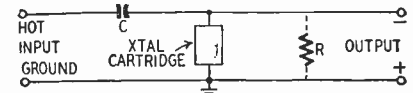
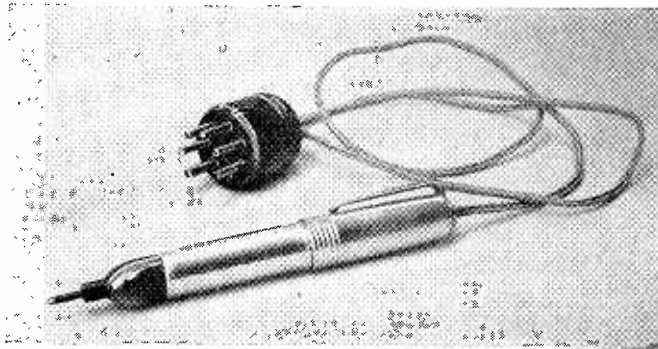

Fig. 2—A diode probe with germanium crystal.

impedance of the unit shown was found to approximate one megohm at 1000 cycles per second. The output is non-linear on the lowest range and the meter must be calibrated accordingly. A linear scale, however, is sufficiently accurate for most purposes.

It is to be emphasized that the a.c. voltage applied to the probe must be limited to somewhat less than 50 volts. To double the applicable voltage, two crystals may be used in series.

The above material is considered merely suggestive. It is hoped the experimenter will find many new uses for the crystal. Doubtless, variant circuits can be adapted to special requirements to suit the user.



The crystal probe in its small penlite case.

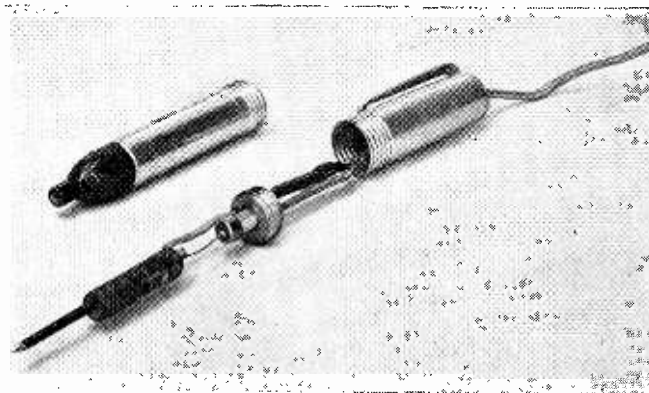

Exploded view of probe. Crystal is at center.

* See "Germanium Crystal Diodes"—Cornelius, *Electronics*, February, 1946.

"H.F. Crystal Diodes"—LeDuc, *RADIO-CRAFT*, March, 1946.

OHM'S LAW IN GRAPH FORM

WATTAGE FROM OHMS AND AMPS

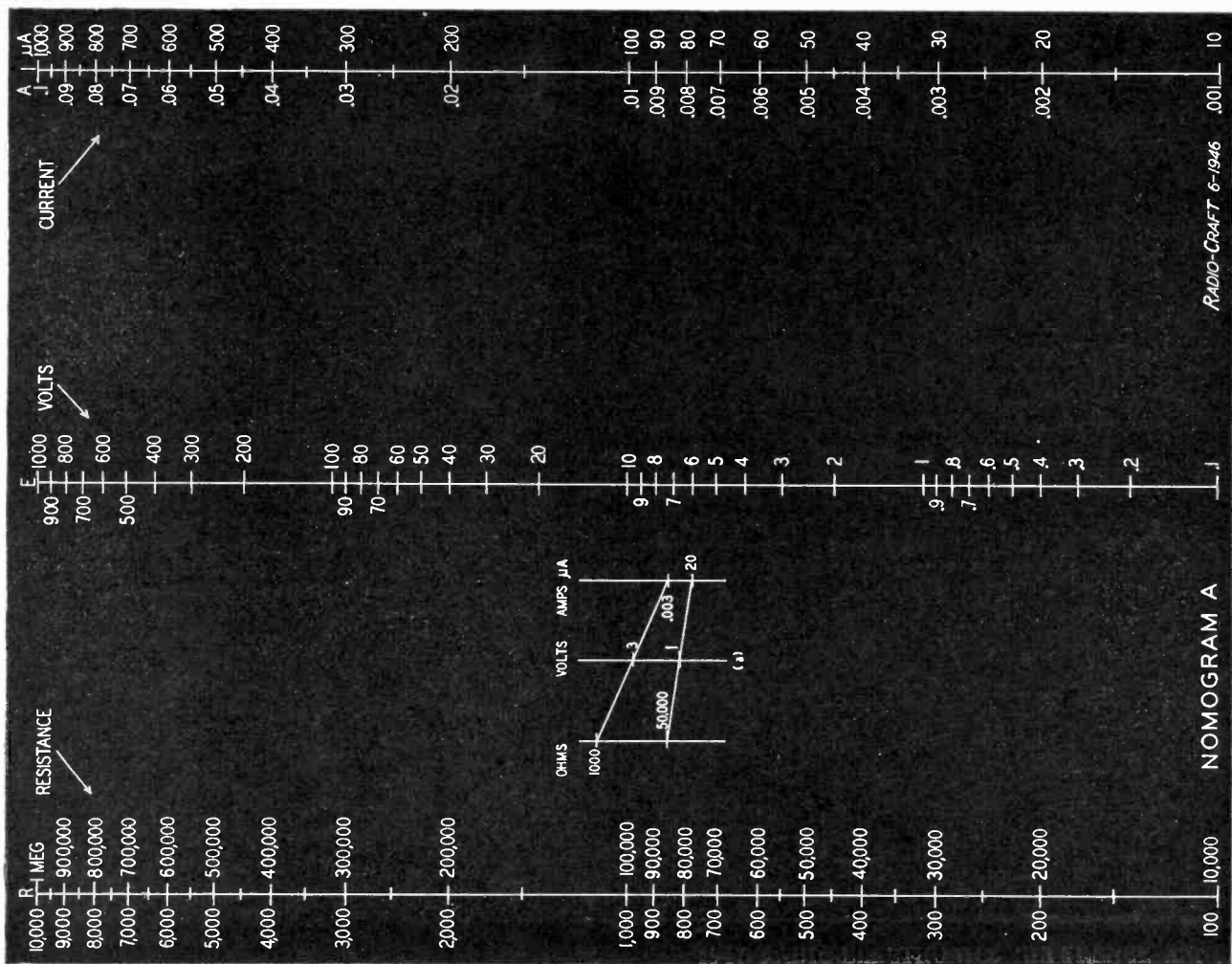

RADIO-CRAFT 6-1946

NOMOGRAM A

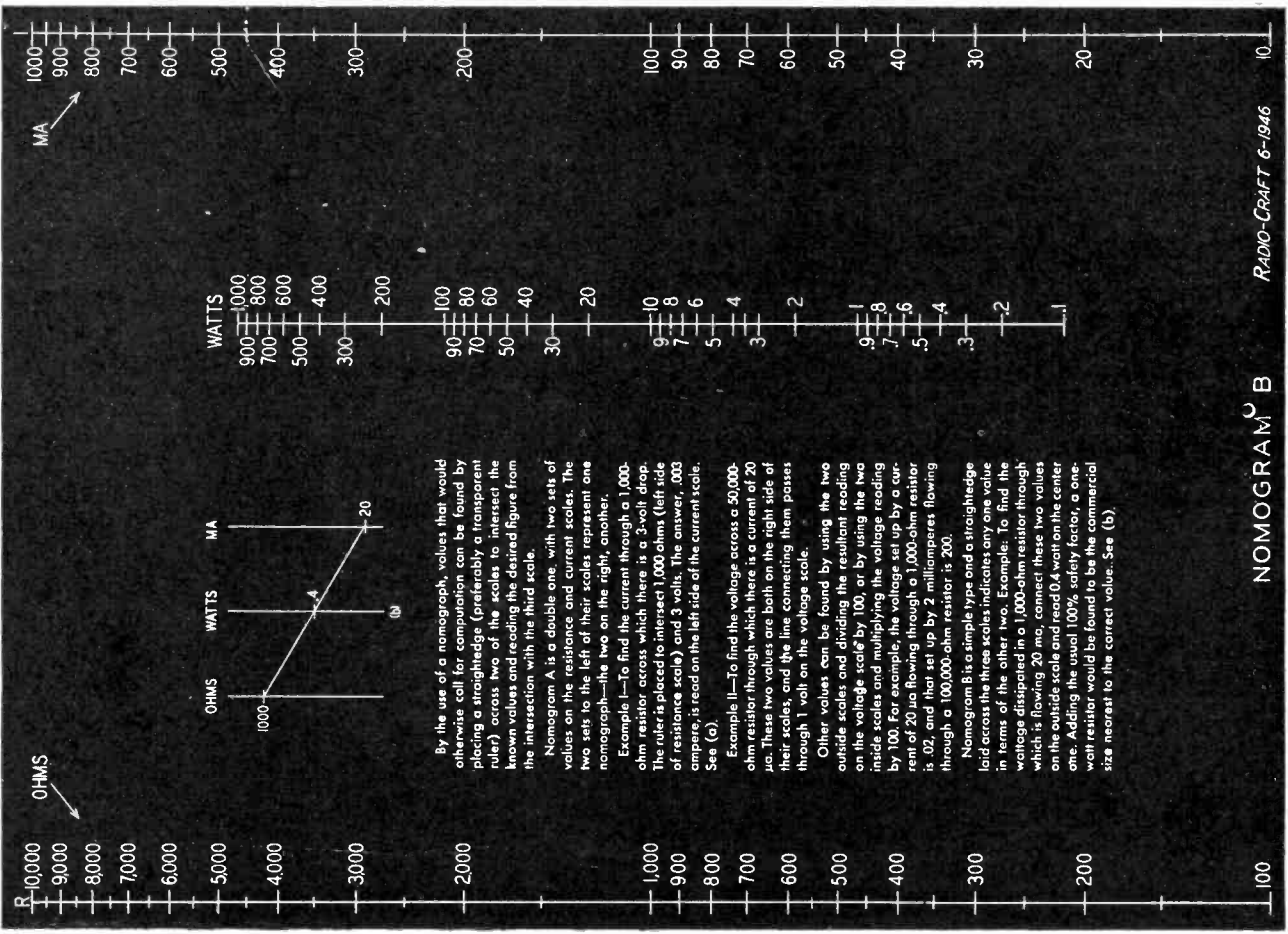

RADIO-CRAFT 6-1946

NOMOGRAM B

By the use of a nomograph, values that would otherwise call for computation can be found by placing a straightedge (preferably a transparent ruler) across two of the scales to intersect the known values and reading the desired figure from the intersection with the third scale.

Nomogram A is a double one, with two sets of values on the resistance and current scales. The two sets to the left of their scales represent one nomograph—the two on the right, another.

Example I—To find the current through a 1,000-ohm resistor across which there is a 3-volt drop. The ruler is placed to intersect 1,000 ohms (left side of resistance scale) and 3 volts. The answer, .003 ampere, is read on the left side of the current scale. See (a).

Example II—To find the voltage across a 50,000-ohm resistor through which there is a current of 20 μ a. These two values are both on the right side of their scales, and the line connecting them passes through 1 volt on the voltage scale.

Other values can be found by using the two outside scales and dividing the resultant reading on the voltage scale by 100, or by using the two inside scales and multiplying the voltage reading by 100. For example, the voltage set up by a current of 20 μ a flowing through a 1,000-ohm resistor is .02, and that set up by 2 milliamperes flowing through a 100,000-ohm resistor is 200.

Nomogram B is a simple type and a straightedge laid across the three scales indicates any one value in terms of the other two. Example: To find the wattage dissipated in a 1,000-ohm resistor through which is flowing 20 ma, connect these two values on the outside scale and read 0.4 watt on the center one. Adding the usual 100% safety factor, a one-watt resistor would be found to be the commercial size nearest to the correct value. See (b).

NOMOGRAM PRINCIPLES

A NOMOGRAM (Greek: A law written down) is a chart made up of a number of lines calibrated to represent quantities in the problems to be solved. A straightedge is laid across two of the lines. The answer to the problem is found where it intersects a third line. Most of the commonest radio problems can be put into nomograph form, hence this type of chart is one of the most useful to radiomen.

This principle of the nomogram is simplicity itself. Fig. 1 shows a typical one, for adding figures from 1 to 10. The outside lines which represent the numbers to be added, may be 10 inches long, divided into equal parts (inches). The totals are found on a line drawn midway between the two.

To calibrate the center line, lay a ruler across the tops and bottoms of the two outside ones. Because $0 + 0 = 0$, the base of the center line is 0. At the top, $10 + 10 = 20$, and the line is so marked. Dividing the center line equally gives us 20 divisions spaced one-half inch apart. If a ruler is now placed across the two 5's on the outside lines, the sum 10 will be read on the center one. Try 5 plus 8 or 9 plus 1.

Multiplication Logarithms

The chart below is hardly useful—it is easier to do the additions mentally than to use the chart. The nomogram becomes valuable when applied to equations like the familiar

$$f = \frac{1}{6.28 \sqrt{LC}}$$

Such application is possible because multiplication and division can be trans-

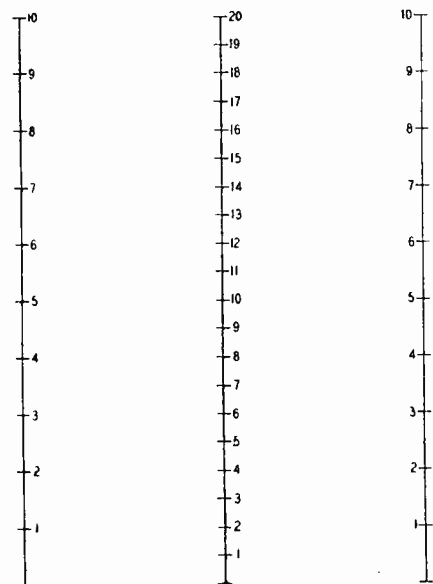

Fig. 1—The fundamental type of nomogram.

formed into addition and subtraction by means of *logarithms*. These are numbers so proportioned to ordinary numbers that the *sum* of the logarithms of any two numbers is equal to the logarithm of their *product*. For example, adding the logarithm of 5 to the logarithm of 6 gives the logarithm of 30.

If we construct a chart like that of Fig. 1, using the *logarithms* of numbers from 1 to 10, we have a nomogram that can *multiply*. Simplest of all multiplication nomograms is the product of two whole numbers—the logarithmic equivalent of Fig. 1. A chart for the common radio equation $IR = E$ (Ohm's Law) is set up in Fig. 2.

Nomogram A is a more practical graph. The two outside scales run (in effect) from 1 to 100 instead of 1 to 10. The center scale can then run from 1 to 10,000 (in this case, from 0.1 to 1,000). A nomogram of this type can be used in many practical radio problems.

Nomograms for all radio uses can be constructed with the help of a small supply of logarithmic cross-section paper, which can be bought at almost any stationery or draftsman's supply house. It is well to get a few sheets of "1 cycle \times 10 divisions per inch" as well as a smaller number of 2-cycle and 3-cycle sheets (also 10 divisions per inch). Some tracing paper completes the outfit. Lacking logarithmic paper, a cheap slide-rule may be pressed into service. (The slide-rule is a perfect example of a logarithmically divided scale.)

The simple chart of Fig. 2 can be made with a piece of 1-cycle and a piece of 2-cycle paper. Lay a piece of tracing paper over the 1-cycle sheet and trace the two outside lines. The middle line is traced from the 2-cycle paper.

More Difficult Problems

Most nomograms express more complex problems than the simple $IR = E$ just described. A common radio problem is: "With a given amount of current through (or voltage across) a resistor, what is a safe wattage rating?" The mathematical formula is $I^2R = W$ (watts). The difference between this and $IR = E$ is that we have a *power* of a number to contend with. I^2 cannot be handled like simple I , but is easy to deal with on a nomographic chart. Multiplication is expressed logarithmically on the chart by simple addition. Powers are expressed by multiplication. The scale for I^2 is simply $I \times 2$, or twice as long as a scale for I would be. I^4 would be four times as long.

Nomograms with scales of different lengths would be clumsy. By making the two outside scales the same length and displacing the product scale as in

Nomogram B, the same result is achieved. The scale can be positioned by selecting a value—say 1 watt—and finding it with two sets of factors—say 10,000 ohms by 10 milliamperes and 100 ohms by 100 ma (0.1 ampere). The intersection of the two indicates the position of the wattage scale.

To construct this nomogram, two sheets of 1-cycle paper are used for each outside scale, permitting the six-cycle wattage scale to be laid out with 3-cycle paper. Top and bottom cycles are not used, as the quantities are outside the range which would be useful to a radioman.

Nomogram C (next page) is an example of a scale in which the final figures are not the ones on which the nomogram is calculated. The equation is: $R = k/C.M.$, where R is ohms per foot, k is the *specific resistivity* of the material and $C.M.$ the wire cross-section in circular mils. Since we are interested in wire sizes rather than circular mils. AWG (B & S) wire size numbers are inserted and the $C.M.$ figures erased after the nomogram is completed. The same thing might have been done on the other outside scale, leaving only the names of the wire material without including the resistivity.

Another new departure appears in Nomogram C. Since we must divide by $C.M.$, that scale is turned upside down, running in the opposite direction to the other two.

All three lines of Nomogram D (page 26) are drawn to the same scale. This is because we are dealing with the products of the square roots of capa-

(Continued on page 33)

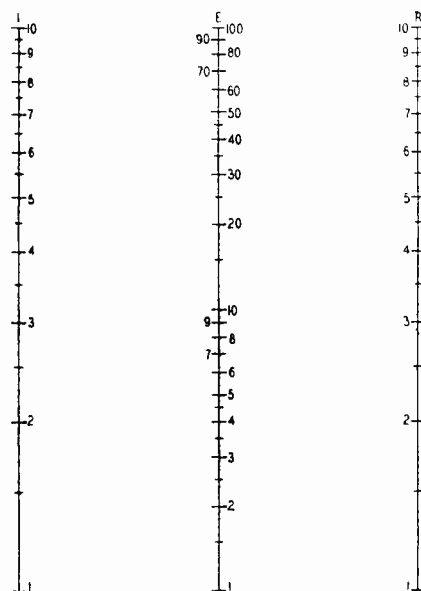
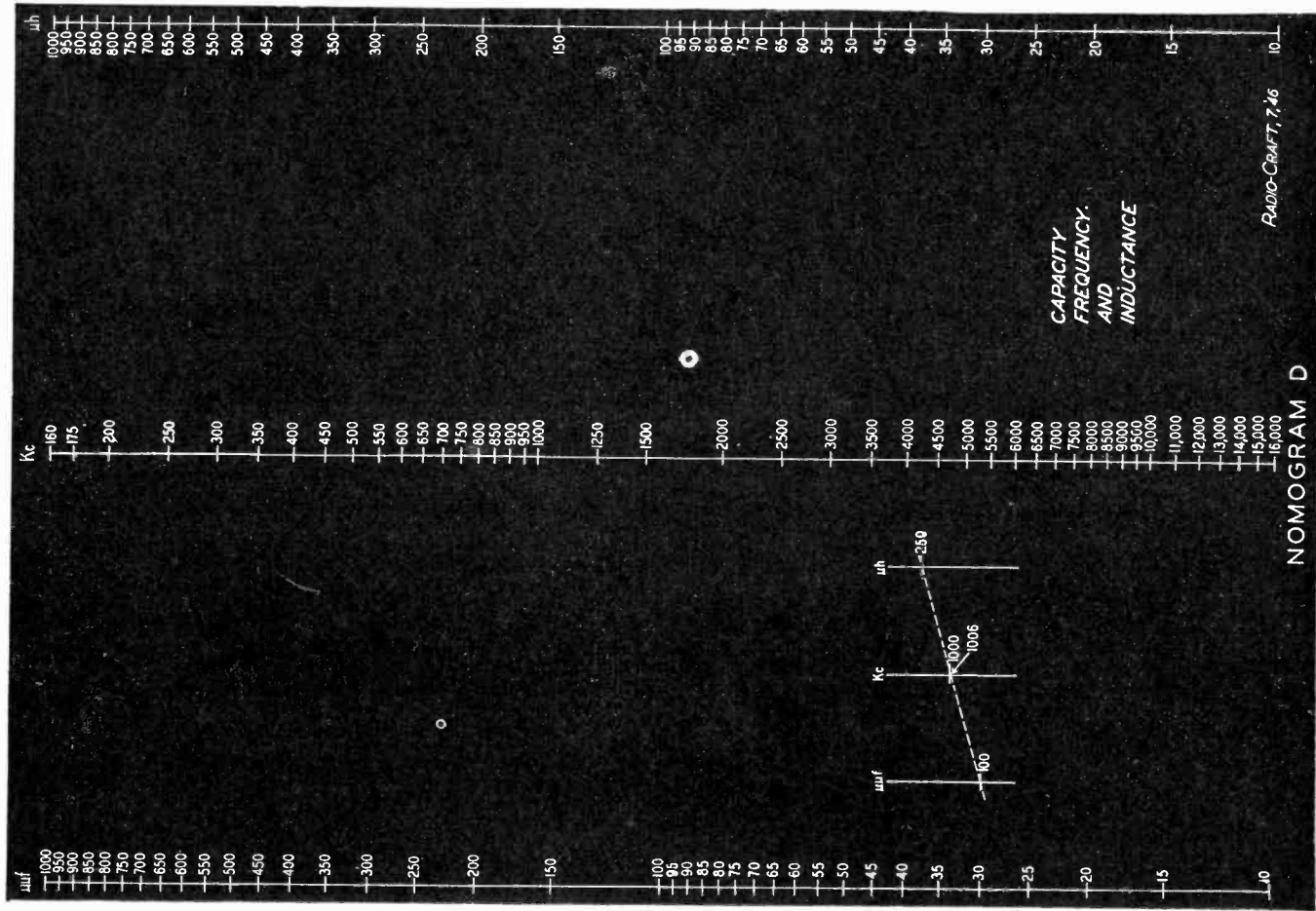
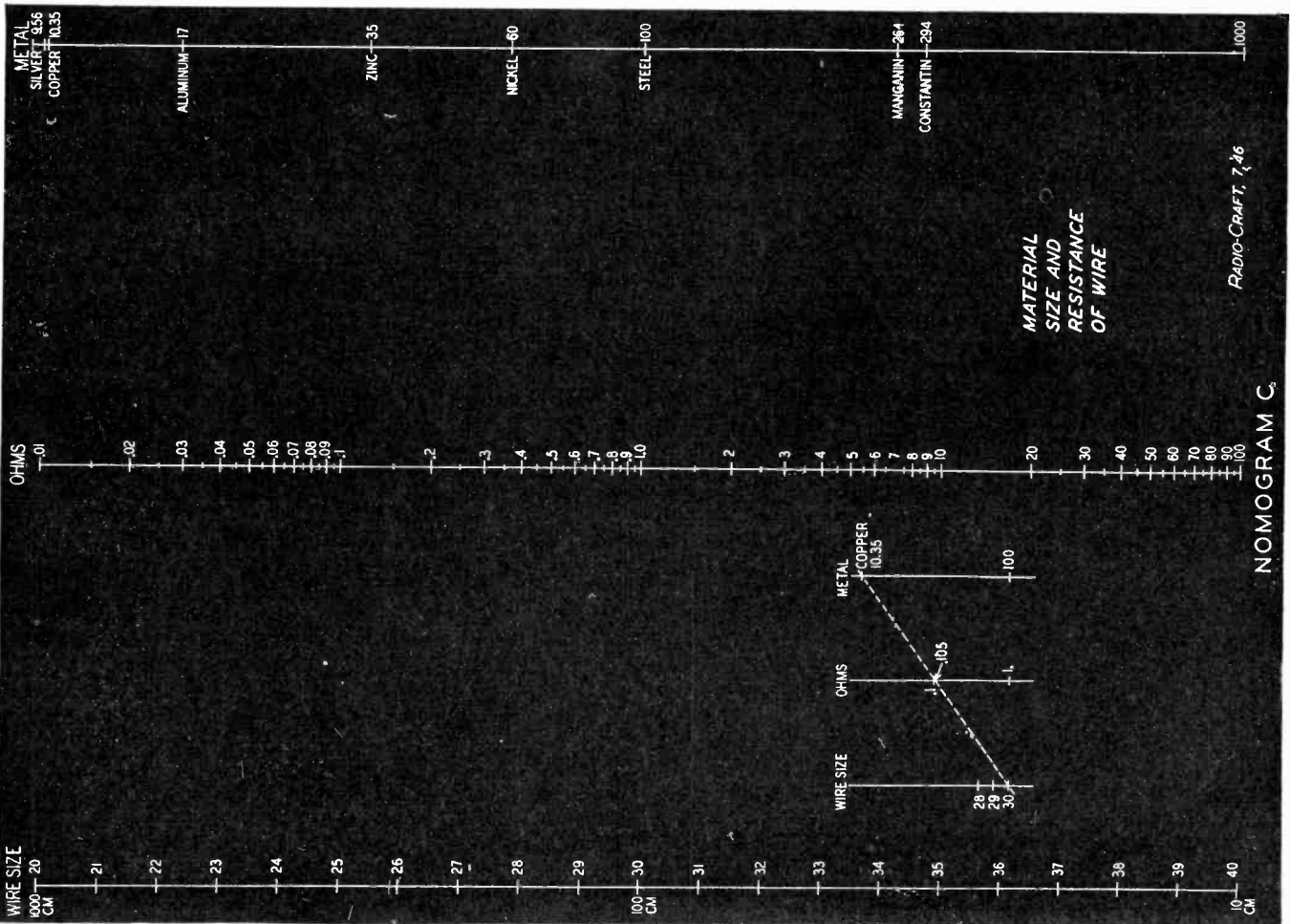

Fig. 2—Most nomograms are forms of this one.



A DECIBEL NOMOGRAM

Most useful of graphic charts, the nomogram is "equivalent to an infinite number of graphs." This one can be used to find a number of solutions to decibel problems

MANY problems may be solved by graphical means. An advantage of such representations is the bird's-eye view which results. To connect two variables it is common to plot a chart which is a line or curve, every point of which indicates one variable in terms of the other. Charts may be designed to correlate frequency vs. dial setting, antenna length vs. reactance, plate voltage vs. plate current, etc.

Another type of graph is the nomograph, which is useful in certain types of problems. This is usually designed to contain three lines or curves, each calibrated in terms of a variable. The nomograph differs from the ordinary chart in that the reader supplies his own indication by the use of a straight-edge, preferably a celluloid or other transparent ruler.

Suppose we wish to show the variation of three quantities: Two may be shown on a chart, but there is no way of showing the third, which will have to be assumed constant. We would need an infinite number of curves on our chart, each corresponding to some value of the third variable. A nomograph is therefore equal to an infinite number of graphs. This is the key to its usefulness.

A useful nomograph is that relating db gain or loss to voltage or power ratio. The three variables are input, output and decibels. In the figure, the left-hand scale is calibrated in values from 1 microvolt to 100 volts in two sections, A and B. The right-hand scale indicates from one-half volt to 500 volts. The center scale shows decibels in two sections, C corresponding to A and D corresponding to B.

As the nomograph stands it indicates voltage gain or loss, but since current varies directly with voltage in any constant impedance circuit, amperes may be substituted for volts and microamperes for microvolts. To extend to power values the center scale must be divided by two for all readings.

To work out a problem, connect the larger of the two voltages, currents or powers at scale E with the smaller at either A or B by means of the ruler. If the output is larger there is a gain, otherwise a loss. The answer is read off at C or D.

Four lines are shown on the figure as examples.

1—We wish to find the voltage gain

of an audio amplifier. Making measurements with a v.t.v.m. we find the output is 55 volts when the input is .15 volt. There is a GAIN of 51.3 db (Line A).

2—We have an r.f. tuner and after repairing and aligning we wish to find its amplification. Applying a signal generator to an artificial antenna we find an output of 3 volts when 1600

microvolts is measured at the input. The GAIN is 65 db (Line B).

3—How much attenuation must we use to obtain an output of .51 volt when 20 volts is applied to the attenuator? All impedances are assumed matched. We must design an attenuator to have a 31.9 db loss (Line C). The same line may be used to show the output when the input and the attenuation are known.

4—As mentioned before, power calculations are the same except that the db scale is read off as one-half its value. The catalog lists a particular amplifier as having 10 watts output. What is its power gain (above 6 milliwatts)? Connect 10 at E with 6000 at A. The gain is 64.2 divided by 2, equals 32.1 db (Line D).

(Continued on page 45)

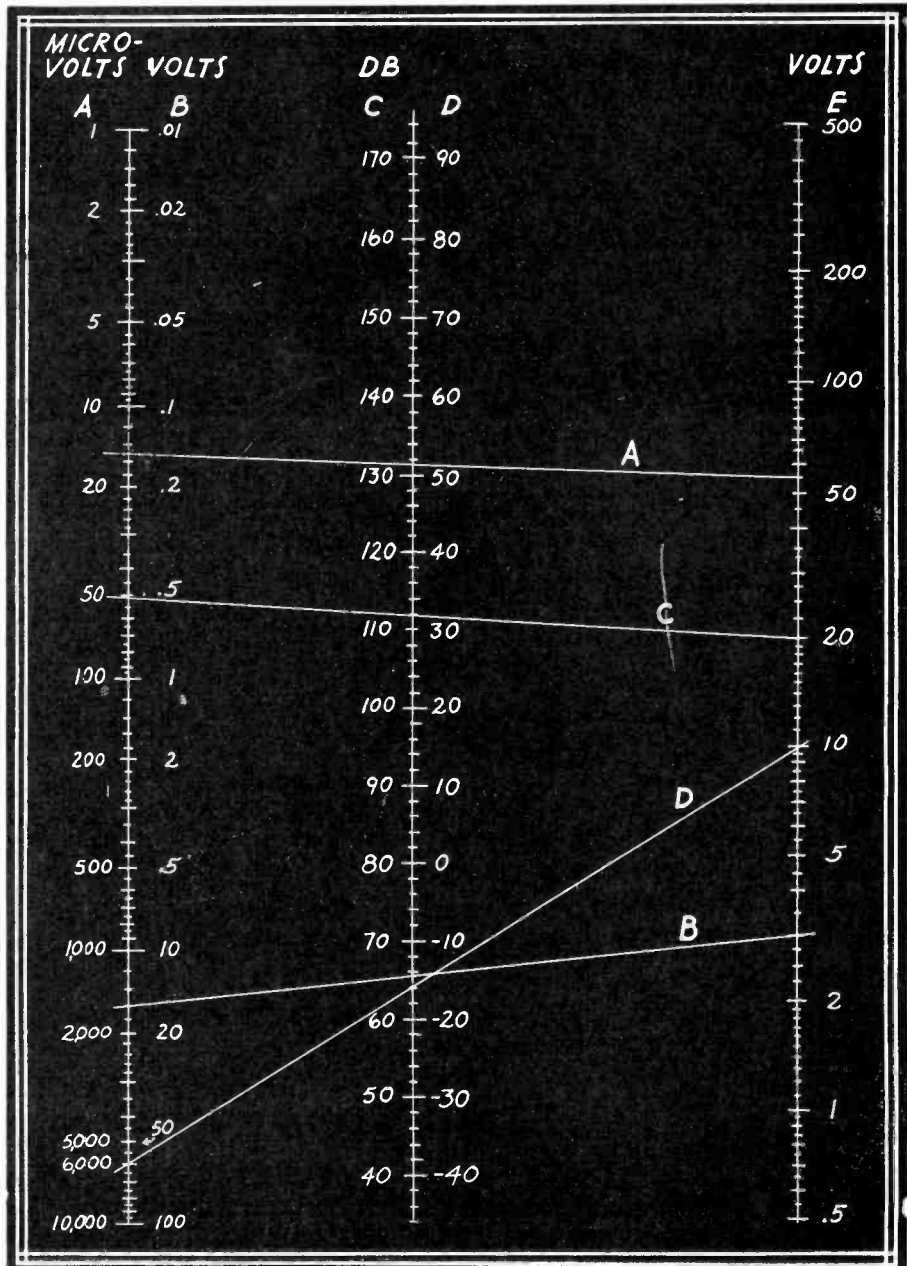

FREQUENCY-WAVELENGTH CHART

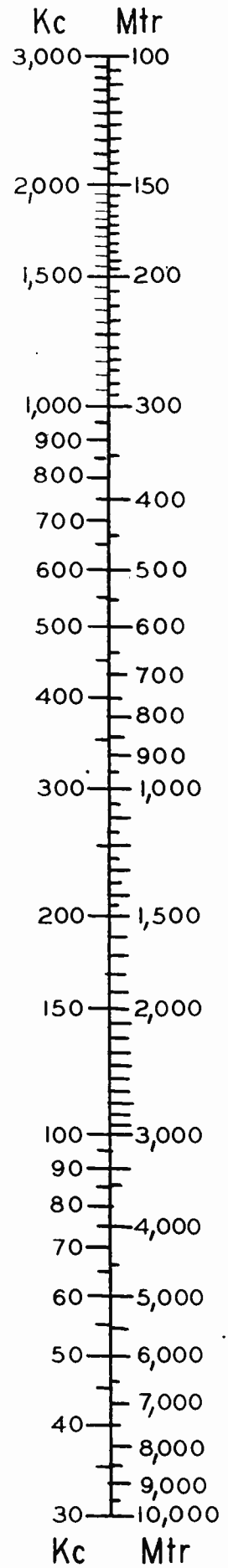
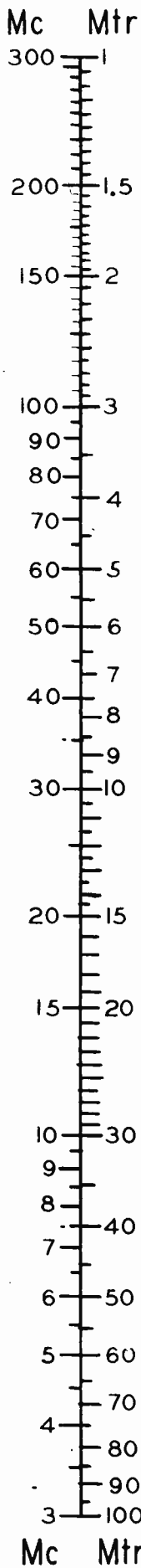
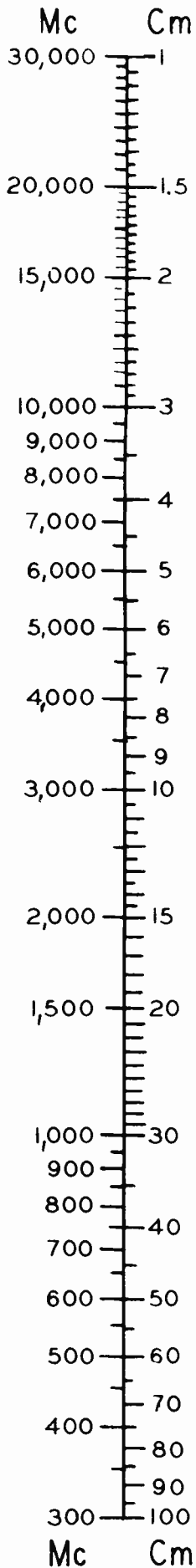

F. S.
7/25/46

COIL DESIGN NOMOGRAM

To use the nomogram, connect the three known values as shown in the key, then read the fourth one. For example, a 1½-inch diameter coil form

26 shows that 250 μh will be ample. A straightedge is laid on the nomogram so that it intersects 1½ on the "d" and 250 on the "L" scale. A light

which will wind 70 turns per inch is needed. The wire table on page 32 gives 72 turns per inch for size 28, which is therefore the size required

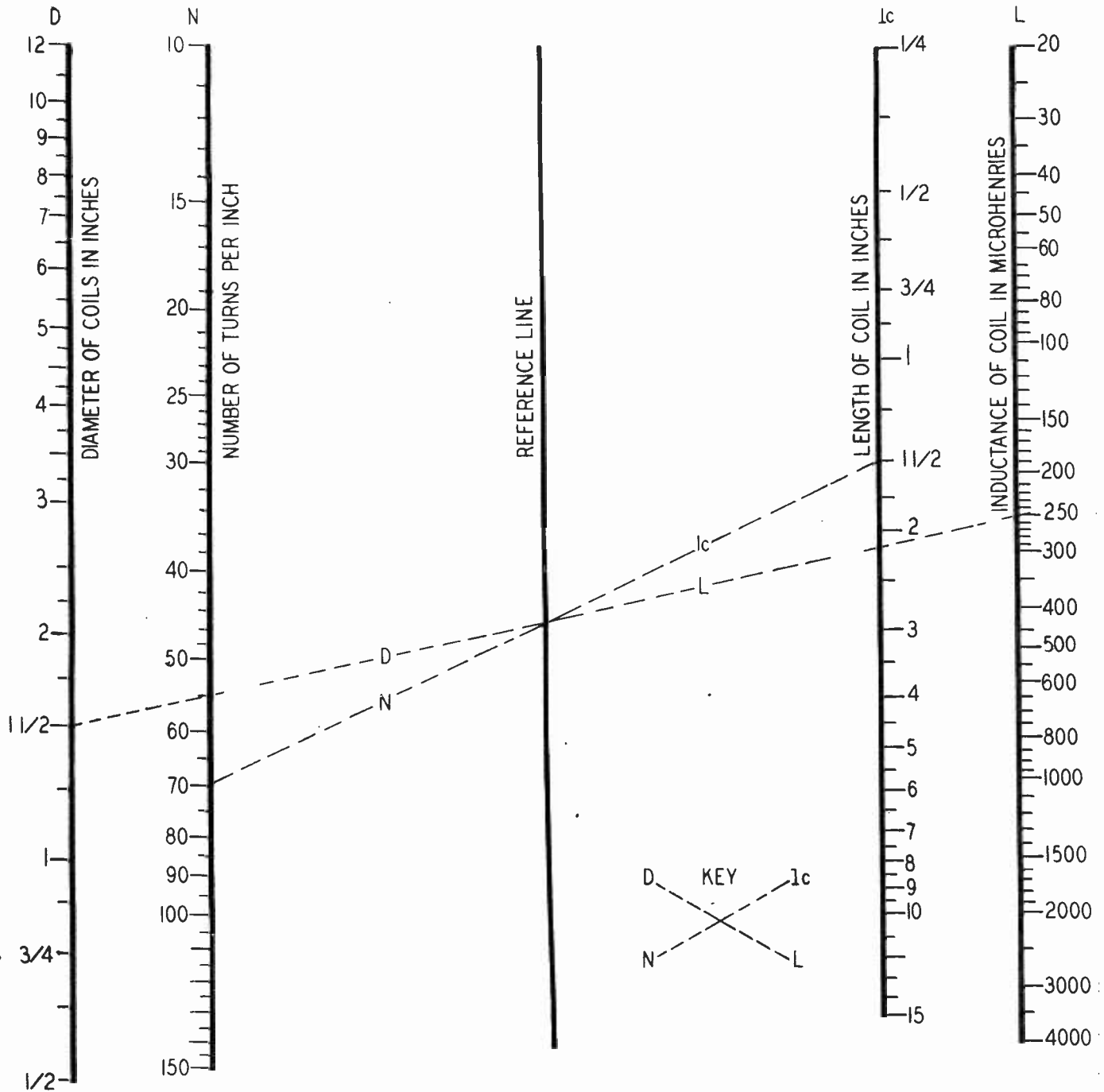

is available, with space enough to wind a coil 1½-inch long. A coil which will tune across the broadcast band with a .00035 (350 μmf) variable condenser is needed. Reference to the inductance-capacity-frequency nomogram on page

mark is made where it crosses the reference line. The straightedge is now placed so that it intersects 1½ on the "l" scale and crosses the reference line at the mark. It will be found to intersect the "n" line at 70. Therefore wire

for the given coil.

This universal chart will serve for the design of single layer coils for the short waves to intermediate frequencies, and can even be used for large transmitting coils.

CAPACITOR MARKINGS

Several Systems of Capacitor Marking have been used in recent years. They are described here.

TABLE I. BASIC THREE-DOT COLOR CODE.

Color	First Dot	Second Dot	Third Dot	Tolerance	Voltage
Black	0	0	none	20%	*
Brown	1	1	0	1%	100
Red	2	2	00	2%	200
Orange	3	3	000	3%	300
Yellow	4	4	0,000	4%	400
Green	5	5	00,000	5%	500
Blue	6	6	000,000	6%	600
Violet	7	7	0,000,000	7%	700
Gray	8	8	00,000,000	8%	800
White	9	9	000,000,000	9%	900
Gold	*	*	divide by 10	5%	1,000
Silver	*	*	divide by 100	10%	2,000
(body)	*	*	*	20% (lowest)	*

*not used.

EXAMPLE: A 0.006- μ f (6,000- μ f) capacitor is marked by three dots in sequence as follows: blue (6), black (0) and red (00).

TABLE II. RMA SIX-DOT COLOR CODE

Color	First Dot	Second Dot	Third Dot	Fourth Dot	Fifth Dot	Sixth Dot
Black	0	0	0	none	*	*
Brown	1	1	1	0	1%	100-v
Red	2	2	2	00	2%	200-v
Orange	3	3	3	000	3%	300-v
Yellow	4	4	4	0,000	4%	400-v
Green	5	5	5	00,000	5%	500-v
Blue	6	6	6	000,000	6%	600-v
Violet	7	7	7	0,000,000	7%	700-v
Gray	8	8	8	00,000,000	8%	800-v
White	9	9	9	000,000,000	9%	900-v
Gold	*	*	*	divide by 10	5%	1,000-v
Silver	*	*	*	divide by 100	10%	2,000-v
(body)	*	*	*	*	20%	500-v

*not used.

EXAMPLE: A capacitor of 0.006- μ f (6,000 μ f) plus-or-minus ten per cent, 800-volts D.C. working voltage, is marked as follows: blue (6), black (0), black (0), brown (one additional zero), silver (10%) and gray (800-v) in that order.

TABLE III AWS SIX-DOT COLOR CODE FOR MICA CAPACITORS

Color	1st Dot	2nd Dot	3rd Dot	4th Dot	5th Dot	Sixth Dot
Black	0	0	0	none	20%	No specified qualities.
Brown	1	1	1	0	*	Specified "Q".
Red	2	2	00	00	2%	Temperature coefficient: plus-or-minus 200 parts/million/C°.
Orange	3	3	000	*	*	Temperature coefficient: plus-or-minus 100 parts/million/C°.
Yellow	4	4	*	*	*	Temperature coefficient: 0 to plus 100 parts/million/C°.
Green	5	5	*	*	*	Temperature coefficient: 0 to plus 50 parts/million/C°.
Blue	6	6	*	*	*	Temperature coefficient: 0 to minus 50 parts/million/C°.
Violet	7	7	*	*	*	*
Gray	8	8	*	*	*	*
White	9	9	*	*	*	*
Gold	*	*	divide by 10	5%	*	*
Silver	*	*	divide by 100	10%	*	*

*not used.

(When the AWS standard is applied to molded paper capacitors, the first dot—always black in a mica condenser

—is silver, as is the fifth dot. The sixth dot indicates operating temperature range: brown, from minus 67 to plus 167 degrees; and black, from minus 67 to plus 185 degrees.)

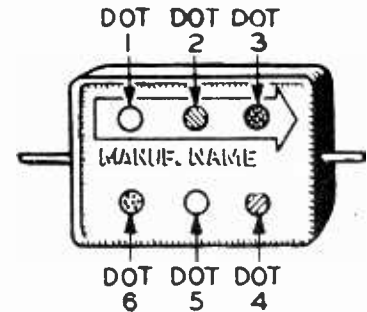

AWS paper capacitor code. First and fifth dots are always silver, sixth black or brown.

EXAMPLES: A 0.00012- μ f (120- μ f) capacitor is marked, to indicate its value, as follows: black (0), brown (1), red (2) and brown (one additional zero).

The fifth dot in the AWS color code indicates the capacitance tolerance in per cent of rated capacitance as previously described. The sixth dot, introducing a new factor, denotes characteristics of design involving Q-factors, temperature coefficients, maximum drift limitations, and production test requirements.

Tubular Ceramic Capacitors

EXAMPLE: A 30- μ f plus-or-minus 5% capacitor with a temperature coefficient of 80 parts per million per degree Centigrade would be marked as follows: end band or dot, red (80 parts/million/C°); second color, orange (3); third color, black (0); fourth color, black (no additional zeros); and fifth color, green (plus-or-minus 5%).

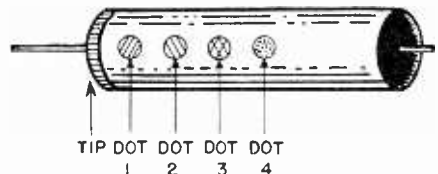

The RMA code for tubular ceramic capacitors.

The symbol (negative) indicates that the capacitance varies inversely with temperature. The temperature coefficient is expressed in micromicrofarads per microfarad per degree Centigrade. Some capacitors are marked with a numeral instead of a color code. For example, N-030 represents a negative temperature coefficient of 0.00003- μ f/ μ f/C°.

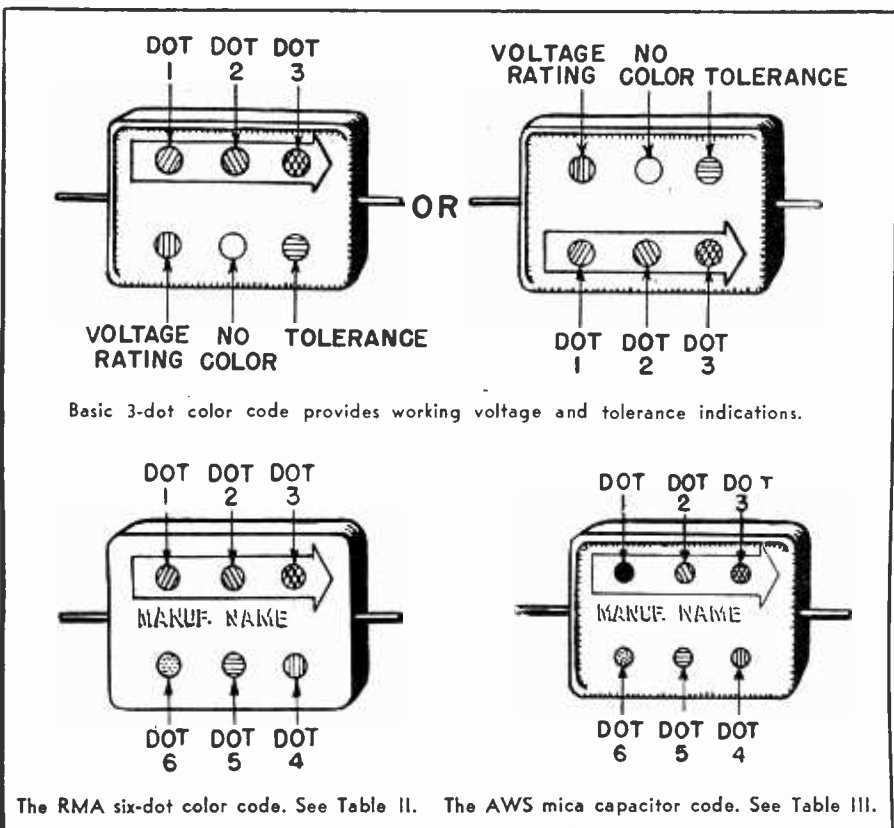

Basic 3-dot color code provides working voltage and tolerance indications.

The RMA six-dot color code. See Table II. The AWS mica capacitor code. See Table III.

LAWS OF THE ATOM

1. A single ATOM is the tiniest particle of any chemical element that can exist by itself and retain the qualities that mark it as that element.

2. All material things in the universe known to our senses are composed of one or more CHEMICAL ELEMENTS.

3. Substances composed of more than one element are known as COMPOUNDS. Atoms of elements are held together in compounds by electrical forces in the outer parts of their structure.

4. The smallest unit of a compound, usually composed of two or more atoms, is known as a MOLECULE.

5. There used to be 92 chemical elements, from hydrogen ($1H^1$) the lightest, to uranium ($92U^{238}$), the heaviest. There are now two new elements, NEPTUNIUM ($93Np^{239}$) and PLUTONIUM ($94Pu^{239}$).

6. When elements are represented, as above, by their chemical SYMBOLS, the subscript number is the atomic number. This is different for each element. The superscript number represents the atomic weight.

7. One of the qualities characteristic of matter is weight or mass. ATOMIC WEIGHT is expressed on a relative scale, as compared with the weight of hydrogen which is taken as one.

8. ATOMIC NUMBER is the measure of the electric charge on the nucleus of the atom's mass.

9. Different samples of the same element, when tested by chemists, are sometimes found to have different atomic weights. Lead which occurs with radium, for example, has a different atomic weight from ordinary lead.

10. In all other ways the two kinds of lead are chemical twins, exactly alike except for weight. Elements which differ in weight only are called ISOTOPES.

11. Uranium has several isotopes. The usual kind, whose atomic weight is 238, was used to produce the two new elements. U-235 was used to make the ATOMIC BOMB.

12. Each of the new elements, neptunium and plutonium, has two isotopes whose atomic weights are 238 and 239.

13. Different elements, quite distinct in chemical behavior, may have the same atomic weight. We have $92U^{238}$, $93Np^{238}$ and $94Pu^{238}$, all with different properties. Such elements are now called ISOBARS.

14. All atoms are composed of standard interchangeable parts. These are PROTONS, NEUTRONS and ELECTRONS.

15. Protons and neutrons make up the NUCLEUS of the atom. The structure of the atom is much like that of the solar system. The nucleus corresponds to the sun at the center. The planets are electrons revolving in their orbits.

16. The proton and the neutron each have a mass about equal to that of a hydrogen atom, which is 1 on the chemist's scale. Each is about 1800 times heavier than the electron.

17. The ELECTRONS, light in weight and some distance away from the heart or nucleus of the atom, revolve around the nucleus much as planets revolve around the sun. They are held in their courses by electric attraction.

18. The proton has a POSITIVE charge of electricity, the electron has a NEGATIVE charge equal and opposite to the positive charge of the proton. The neutron has no charge at all.

19. The difference in chemical properties of the elements is caused by difference in the number of protons in the nucleus. This is the ATOMIC NUMBER.

20. Atomic weight is the SUM of the weights of the protons and neutrons in the nucleus.

21. It is the NEUTRON which figures in the transmutations which give atomic power. Neptunium and plutonium were formed by bombarding uranium 238 with neutrons.

22. Neutrons can PENETRATE to the nucleus of heavy atoms when charged particles would be repelled by charges in the atom.

23. The HYDROGEN atom is believed to have just one proton as its nucleus, with one electron circling around it. Hydrogen's atomic weight and atomic number are each one.

24. Hydrogen has one isotope which is just like ordinary hydrogen except that it is twice as heavy. It is known as "heavy hydrogen" and sometimes as DEUTERIUM. Its compound with oxygen is called "heavy water."

25. The nucleus of HEAVY HYDROGEN contains one proton and one neutron. The atomic number of heavy hydrogen is one, corresponding to one proton. The atomic weight is two, corresponding to the two heavy particles, proton and neutron.

26. HELIUM has two protons and two neutrons in its nucleus. The two protons correspond to helium's atomic number two. The combined weights of protons and neutrons in the nucleus give helium its atomic weight 4. Two electrons, held in their orbits by the two protons, revolve around the nucleus.

27. The VOLUME of an atom is determined by the orbits of its outermost revolving electrons. Only a small fraction of the size of an atom is actually occupied by the protons, neutrons and electrons, just as the space occupied by the sun, the earth and other planets is only a small part of our solar system.

28. In spite of all the unoccupied SPACE, an atom is quite IMPENETRABLE to other atoms and to larger bodies. The electrons revolve millions of times a second, and keep everything out of the space within quite as effectively as though they were everywhere at once.

29. The only things that can get inside an atom are smaller things, FRAGMENTS of other atoms, protons, neutrons or electrons. They must be shot with just the right speed. These fragments of atoms are observed as radiations given off by radio-active elements which are breaking up spontaneously.

30. RADIATION is wave motion, known to us as the electro-magnetic waves used for radio transmission, heat, light, X-rays and cosmic rays. Large numbers of extremely tiny particles in motion together act like waves.

31. Three types of radiation are given off by radio-active substances. ALPHA particles are high-speed nuclei of helium atoms. BETA particles are high-speed electrons. GAMMA rays are electro-magnetic radiations similar to X-rays and light.

32. Of these, only the gamma rays are properly called radiations, and even these act very much like particles because of their short wave-length. Such a "particle" or quantum of gamma radiation is called a PHOTON.

33. In general, the gamma rays are very penetrating, the alpha and beta rays less so. Even though the alpha and beta rays are not very penetrating, they have enormous SPEED.

34. The speed with which atom particles travel is the source of atomic energy. ENERGY is capacity to do work. It is work stored up for future use.

35. If you raise a weight to a height above the ground and suspend it there by some device, the WORK you put into raising it can be stored there indefinitely as POTENTIAL ENERGY. It will be there, ready, whenever you decide to release it.

36. The energy which a moving body has because it is in motion is called KINETIC ENERGY. The kinetic energy of any particle depends upon its mass and the square of its velocity. Energy is conserved by the moving particle until it strikes an object, then work is done.

37. All ENERGY is either potential or kinetic. Either one can be converted into the other. These two conversions are continually occurring.

38. Particles of atomic size have kinetic energy arising from several different kinds of MOTION. All atoms are constantly in motion.

39. If the atoms are so dispersed that the material constituting them is a GAS, that gas will exert pressure on all sides of the container that holds it. If the container is a balloon bag, the imprisoned gas can do work by lifting heavy weights into the air, as in the case of a dirigible.

40. Atoms which compose an element that will combine readily with another element, as hydrogen or carbon will combine with oxygen, have unsymmetrical arrangements of the outer electrons in their systems. These unsymmetrical arrangements tend to set up a sort of strain, which causes CHEMICAL COMBINATION to take place when elements with suitable combining powers are brought together.

41. These unsymmetrical arrangements give rise to FORCES which result in kinetic energy. This energy appears, for example, when carbon and oxygen burn to carbon dioxide, giving off heat, or hydrogen and oxygen explode to form water, again giving off heat.

42. Chemicals combining to form stable compounds give off energy in the process. These are known as EXOTHERMIC REACTIONS. Combinations which absorb energy, forming unstable compounds, are known as ENDOTHERMIC REACTIONS. Explosives, for example, which are highly unstable, are formed by endothermic reactions.

43. Chemical forces, electricity and heat are all forms of energy. Potential and kinetic energy may be distinguished in each case.

44. These energies all arise from motion of the atom as a whole, or motion resulting from attractions and repulsions between the outer PLANETARY ELECTRONS of the atoms' structure.

45. Energy resulting from motion of particles deep within the structure of the atom was unknown until the discovery of RADIOACTIVITY.

46. Radioactive elements undergo SPONTANEOUS breaking up of their atoms, giving off alpha and beta particles and gamma rays. Loss of these particles causes the radio-active elements to change into other elements.

47. The energies shown in these TRANSFORMATIONS are thousands of times greater than the kinetic energies which the molecules of a gas have by reason of their motion when heated. They are thousands of times greater than the energy changes per atom in chemical reactions.

48. The property of matter that connects it with motion is INERTIA. Inertia is opposition to change of motion.

49. One conclusion that appeared early in the development of the theory of RELATIVITY was that the mass due to inertia of a moving body increases as its speed is increased.

50. This increase implied an equivalence between an increase in energy of motion of a body (kinetic energy) and an increase in its MASS.

(Continued on page 46)

RADIO-CRAFT EXPANDED WIRE TABLE

A.W.G. No. (B.S.)	Diam. in mils.*	Diam. in m.m.	Cir. mils	Cross-sectional area		Turns per linear inch**				Turns per Square Inch**				Feet per pound		Current carrying capacity (amperes)			
				Sq. Inches	Sq. m.m.	D.S.C. or D.C.C.	S.C.C.	Enamel	D.C.C.	S.C.C.	Enamel	D.C.C.	S.C.C.	D.C.C.	S.C.C.	Bare	Ohms per 100 ft.	C.M. per amp at 1000	Nearest C.M. at 1500 per amp S.W.G.
1	289.3	7.348	83690	.06573	42.41	—	—	—	—	—	—	—	—	—	.1260	83.7	1		
2	257.6	6.544	66370	.05213	33.63	—	—	—	—	—	—	—	—	—	.1592	66.4	3		
3	229.4	5.827	52640	.04134	26.67	—	—	—	—	—	—	—	—	—	.2004	52.6	4		
4	204.3	5.189	41740	.03278	21.15	—	—	—	—	—	—	—	—	—	.2536	41.7	5		
5	181.9	4.621	33100	.02600	16.77	—	—	—	—	—	—	—	—	—	.3192	33.1	7		
6	162.0	4.115	26250	.02062	13.3	—	—	—	—	—	—	—	—	—	.4028	26.3	8		
7	144.3	3.665	20820	.01635	10.55	—	—	—	—	—	—	—	—	—	.5080	20.8	9		
8	128.5	3.264	16510	.01297	8.36	7.1	7.4	7.6	—	—	—	—	—	—	.6045	16.5	10		
9	114.4	2.906	13090	.01028	6.63	7.8	8.2	8.6	7.4	—	—	—	—	—	.8077	13.1	11		
10	101.9	2.588	10380	.008155	5.26	8.9	9.3	9.6	9.2	80.0	—	—	—	—	1.018	10.4	12		
11	90.74	2.305	8234	.006467	4.17	9.8	10.3	10.7	114	95.5	—	—	—	—	1.284	8.2	13		
12	80.81	2.053	6530	.005129	3.31	10.9	11.5	12.0	144	121	—	—	—	—	1.619	6.5	14		
13	71.96	1.828	5178	.004067	2.62	12.0	12.8	13.5	182	150	—	—	—	—	2.042	5.2	15		
14	64.08	1.628	4107	.003225	2.08	13.3	14.2	15.0	225	183	—	—	—	—	2.575	4.1	16		
15	57.07	1.450	3257	.002558	1.65	14.7	15.8	16.8	282	223	—	—	—	—	3.247	3.3	17		
16	50.82	1.291	2583	.002028	1.31	16.4	17.9	18.9	357	271	—	—	—	—	4.094	2.6	17-18		
17	45.26	1.150	2048	.001609	1.04	18.1	19.9	21.2	450	329	—	—	—	—	5.163	2.0	18		
18	40.30	1.024	1624	.001276	.82	19.8	22.0	23.6	558	399	—	—	—	—	6.510	1.6	19		
19	35.89	.9116	1288	.001012	.65	21.8	24.4	26.4	708	479	—	—	—	—	8.210	1.3	20		
20	31.96	.8118	1022	.0008023	.52	23.8	27.0	29.4	868	625	—	—	—	—	10.35	1.0	21		
21	28.46	.7230	810.1	.0006363	.41	26.0	29.8	33.1	1090	754	—	—	—	—	13.05	.81	22		
22	25.35	.6438	642.4	.0005046	.33	30.0	34.1	37.0	1368	910	—	—	—	—	16.46	.64	23		
23	22.57	.5733	509.5	.0004002	.26	31.6	37.6	41.3	1640	1080	—	—	—	—	20.76	.51	24		
24	20.10	.5106	404.0	.0003173	.20	35.6	41.5	46.3	2140	1260	—	—	—	—	26.17	.41	25		
25	17.90	.4547	320.4	.0002517	.16	38.6	45.6	51.7	2530	1510	—	—	—	—	33.00	.32	26		
26	15.94	.4049	254.1	.0001996	.13	41.8	50.2	58.0	3340	1750	—	—	—	—	41.62	.25	27-28		
27	14.20	.3606	201.5	.0001583	.10	45.0	55.0	64.9	4145	2020	—	—	—	—	52.48	.20	29		
28	12.64	.3211	159.8	.0001255	.08	48.5	60.2	72.7	5250	2310	—	—	—	—	66.17	.16	30		
29	11.26	.2859	126.7	.00009953	.064	51.8	65.4	81.6	6510	2700	—	—	—	—	83.44	.13	31-32		
30	10.03	.2546	100.5	.00007894	.051	55.5	71.5	90.5	8175	3020	—	—	—	—	105.20	.10	33		
31	8.928	.2268	79.70	.00006260	.040	59.2	77.5	101.	1022	—	—	—	—	—	132.70	.079	34-35		
32	7.950	.2019	63.21	.00004964	.032	62.6	83.6	113.	12650	—	—	—	—	—	167.30	.063	36		
33	7.080	.1798	50.13	.00003937	.0254	66.3	90.3	127.	16200	—	—	—	—	—	211.00	.050	36-37		
34	6.305	.1601	39.75	.00003122	.0201	70.0	97.0	143.	19950	—	—	—	—	—	266.00	.039	37-38		
35	5.615	.1426	31.52	.00002476	.0159	73.5	104.	158.	25000	—	—	—	—	—	335.00	.032	38-39		
36	5.000	.1270	25.00	.00001964	.0127	77.0	111.	175.	31700	—	—	—	—	—	423.00	.025	39-40		
37	4.453	.1131	19.83	.00001557	.0100	80.3	118.	198.	39600	6510	—	—	—	—	533.40	.020	41		
38	3.965	.1007	15.72	.00001235	.0079	83.6	126.	224.	49100	6950	—	—	—	—	666.60	.016	42-43		
39	3.531	.0897	12.47	.000009793	.0063	86.6	133.	248.	62600	7450	—	—	—	—	848.10	.012	43		
40	3.134	.0799	9.888	.000007766	.0050	89.7	140.	282.	77600	—	—	—	—	—	1069.00	.009	44		
41	2.75	.0711	7.841	.000006160	.0040	—	—	—	97500	—	—	—	—	—	1323.00	.008	45		
42	2.50	.0633	6.220	.00004885	.0032	—	—	—	122000	—	—	—	—	—	1667.00	.006	45-45		
43	2.25	.0564	4.933	.000003873	.0025	—	—	—	152000	—	—	—	—	—	2105.00	.005	46-47		
44	2.00	.0502	3.910	.000003073	.0020	—	—	—	190000	—	—	—	—	—	2655.00	.004	47		

*A mil is 1/1000 inch **Approximate only—thickness of insulation varies.

to position 8 for large alternating or direct currents, or to position 9 or 10 for smaller direct currents. With current flowing through one of the shunt resistors, the image of the indicator tube should overlap. Adjust the top calibrated dial so that the image appears as it did with no current flow. Read the setting and refer to the proper current chart.

Two current charts are required for position 8 and one each for positions 9 and 10. The charts can be prepared very easily with the aid of variable a.c. and d.c. sources and accurate alternating and direct current meters. Position 8 has an a.c. range of 1 to .15 ampere or a d.c. range of 1 to .05 ampere. The current is limited to a maximum of 1 ampere because of the power rating of the resistor and the large voltage drop. Position 9 has a range of 20 to .5 milliamperes d.c. only; and position 10 has a range of 1200 to 50 microamperes d.c. only.

The current meter may be found useful for approximate measurements if no standard meter is on hand.

Resistance Measurements

To connect the low range ohmmeter circuit of the test unit: Turn on the power supply and indicator circuit, revolve the top calibrated dial to 0 degrees, and turn selector switch Sw4 to position 6. Run a jumper wire from J1 to J4, and connect the test prods to J8 and J5. Short the test prods together and adjust the shadow angle to 0 degrees. Now connect a resistor to the test prods and adjust the top calibrated dial R16 until the green pattern appears as it did with the prods shorted together. Read the number of degrees indicated and refer to the low range resistance chart.

The high range of the ohmmeter circuit of the tester is operated as follows: Rotate the top calibrated dial to 0 degrees and turn selector switch Sw4 to position 5. Run a jumper wire from J1 to J4, and connect the test prods to J2 and J5. Adjust the uncalibrated dial so that the indicating shadow is 0 degrees with the test prods NOT shorted together. Connect a resistor to the test prods, and adjust the top calibrated dial so that the shadow angle returns to 0 degrees. Read the dial setting and refer to the high range resistance chart.

The low range of the ohmmeter circuit is 400 to 500,000 ohms; the high range is 15,000 ohms to 30 megohms. The two resistance charts can be prepared with the aid of a variable resistance and an accurate ohmmeter.

Condenser Tests

To test paper, mica, or variable condensers connect the jumper wire from J1 to J4; turn the selector switch to position 5; plug in the test leads to J2 and J5, and turn the uncalibrated knob so the shadow angle is maximum (about 100°). Contact the prods to the leads of the condenser. The shadow angle of the indicator tube should momentarily be reduced as the condenser charges. If

A MULTIPURPOSE TESTER

(Continued from page 13)

the shadow angle returns to normal, the condenser is good; but if it does not return to normal, the condenser is shorted or leaky. If the indicator tube fails to "blink," either the condenser is open-circuited or the capacity is less than about .001 μ f. Note that the shadow will not be deflected again until the condenser is discharged or the leads reversed.

Electrolytic condensers are tested in a similar manner with a few exceptions. It is necessary to connect the positive terminal of the condenser to J2 and the negative terminal to J5. When the prods are connected to the condenser, the shadow angle of the indicator tube should be decreased for several minutes. If the condenser is good, the shadow angle will slowly increase until it reaches a constant value. After testing any type of condenser, it should be discharged by short-circuiting the condenser leads. A spark can be noticed with any condenser with a capacity of .01 μ f or more.

Capacity Meter

To measure the capacity of condensers, revolve the top calibrated knob to 0 degrees; turn switch Sw4 to position 6, and connect the test leads to J1 and J4. Adjust the uncalibrated knob so that the shadow angle of the indicator tube is 0 degrees with the prods NOT short-circuited together. Connect condenser to the prods and adjust the top knob in order to deflect the shadow angle back to 0 degrees. Read the number of degrees indicated by the knob and refer to the capacity meter chart.

If a stock of condensers of known capacity is available, the capacity meter chart can be prepared by recording the number of degrees rotation required for each capacity. The meter has a range of .0004 to .25 microfarad.

The resourceful experimenter will be

able to think of many additional uses for this multipurpose tester and signal tracer. The circuit does not employ any expensive precision parts, and makes a very interesting and useful project.

List of Parts

Condensers

C1, C2—16 mf 450 V. electrolytic.
C3—.005 mf 600 V. tubular.
C4, C17—.05 mf 600 V. tubular.
C5—.02 mf 600 V. tubular.
C6—25 mf 25 V. electrolytic.
C7, C8, C9, C10, C13, C14, C16, C18—.05 mf 600 V. tubular.
C11, C19, C20—10 mf 25 V. electrolytic.
C12, C15—.0001 mf mica.

Resistors

R1, R5, R7, R14—500,000 ohm carbon.
R2—500 ohm 1 w. carbon.
R3—500,000 ohm volume control with switch.
R4, R13, R22—100,000 ohm carbon.
R6, R24—2,000 ohm carbon.
R8, R21—1 meg. carbon.
R9—10,000 ohm carbon.
R10, R12—50,000 ohm carbon.
R11—250 ohm carbon.
R15, R18—1 meg. potentiometers.
R16—750,000 ohm volume control.
R17—250,000 ohm carbon.
R19—10 meg. carbon.
R20—5 meg. carbon.
R23—10 ohm 10 w. power.
R25—50,000 ohm carbon.

Tubes

1—5Z4, 1—6F6, 1—6J7, 1—6B8 or 6B8-G,
1—6AF6-G, 1—6K7, 1—6H6.

Miscellaneous Parts

1—Power transformer: primary 120 V. A.C.; secondary 6.3 V. @ 3 A., 5.0 V. @ 2 A., and 350-0-350 V.
1—5 inch dynamic speaker with 450 ohm field winding.
1—Output transformer with 7000 ohm primary winding.
5—"MIP" octal sockets.
2—Tuning indicator octal sockets for 6B8-G and 6AF6-G tubes.
1—Metal tube shield for 6B8-G tube.
3—Grid caps.
2—S.P.S.T. Bat-Handle toggle switches.
1—S.P.D.T. Bat-Handle toggle switch.
1—11 position selector switch.
4—Black 1/4" streamlined bar knobs.
3—Dial plates.
1—ICA Precision Vernier Dial (4" diameter, 325°) for R15.
7—Red insulated tip jacks.
4—Black insulated tip jacks.
1—T-2 Tiny Neon Lamp (General Electric).
1—Pilot light assembly with 6.3 V. lamp.
1—Fuse and fuse mount.
1—12" x 7" x 7 1/2" metal cabinet.
1—Chassis.
1—3 ft. 6 wire shielded cable for R.F. tube probe.
Hook-up wire, spaghetti, rubber grommets and other hardware.

NOMOGRAM PRINCIPLES

(Continued from page 25)

city and inductance. The equation is:

$$f = \frac{159}{\sqrt{LC}}$$

where f is the frequency in kilocycles, L the inductance in microhenries and C the capacity in microfarads. This is equivalent to

$$159f = \frac{159}{\sqrt{LC}}$$

When the scale has to be multiplied by a constant, it is simply displaced. Thus $A \times B = 6C$ can be expressed by starting the center scale at 6. In this case, the scale starts at 159 and ends at 15,900 kc, the scale being moved down

slightly on the actual nomogram to permit starting and ending with round numbers. The center line on this nomogram is also a division, or *reciprocal* scale (1/f) and runs in the opposite direction to the other two.

References:

Nomograms, Carl P. Nachord, *General Electric Review*, May, 1944. Page 13.
Nomograms — How to Make and Use Them, R. Howard Cricks, *Electronics and Television & Short-Wave World* (British), November, 1940. Page 495.

Alignment Charts: Construction and Use, Maurice Kraitchik, (D. Van Nostrand Co., New York).

SUPER BARGAINS IN RADIO • ELECTRONIC AND

COMMUNICATION SUPPLIES

Order Today —
Immediate Delivery

PLATE TRANSFORMER

6200 Volt CT — 700
Mils, 110 Volts, 60
Cycles tapped primary. 2 KVA Amer-
tran. Limited quantity. \$39.95

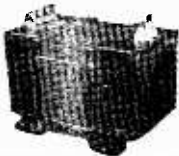

TUBE & SOCKET

JAN 829B/3E29 tube and shielded aluminum socket with built in by-pass condensers. Both for the price of the tube socket. \$6.95

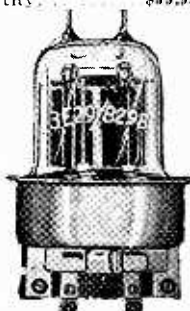

BC-221 FREQUENCY METER

Signal Corps Model BC 221 Freq Meter — a calibrated instrument tunes from 150 to 20,000 KC.; 1000 KC. xtal is used for checking calibrated points — comes complete with tubes, calibration chart and xtal. Very limited quantity. \$59.95



CONDENSERS

Variable Condenser — L. F. Johnson split stator 150 MMF per section, .175 spacing — 7000 Volts. Your cost \$8.95 Johnson edgewound coil; mycalex insulation and mounting, plated, 26 turns at 1/4" spacing — perfect for all ham bands. \$3.95 Sangamo No. G1 mica condenser — .001/6000 Volt working. \$10.95 Sangamo No. G2 mica condenser — .003/8000 Volt working. \$13.95

TRANSFORMERS

Plate Transformer 6200 volts C.T. — 700 mils, 110 volts, 60 cycles tapped primary 2KVA Amertran A few left at \$39.95. 866 Filament Transformer 2 1/2 V. at 10 A. Kenyon — insulated for 10,000 Volts — Pri 110 Volts, 60 Cycles. \$4.25

MISCELLANEOUS

Motor type time delay relay — adjustable to 1 minute, 110 Volt 60 Cy. Hayden motor. \$5.95 Cool that Kilowatt — Duel Blower blows 200 cubic ft. per minute. Deleo 110 Volt, 60 Cy. — slightly used but perfect. Completely noise free. \$15.95 1000 KC Xtal precision AT Cut mounted in standard holder. \$4.95 Antenna change-over relay DPDT, Silver contacts — Leach 110 Volt, 60 Cycle. \$2.50 Veeder-Root Counter No S40 reads 999.9. Your cost \$1.50

We invite all inquiries.
All prices F.O.B. our warehouse New York City, N. Y. Write for our latest bulletin 4 RA.

Export Cable
Address:
Microwave
New York



NIAGARA RADIO SUPPLY
100 Greenwich St., New York 6, N. Y.
Bowling Green 9-7993

RADIOS SERVICED BY OBSERVATION

(Continued from page 21)

which the receiver has been aligned. Attempts to "align" using the high-frequency end of the dial are equally dependent on the correctness of the oscillator trimmer.—Editor)

Shortwave bands can be aligned also in this manner by using the government monitor station at 2.5, 5, 10 and 15 megacycles to set the oscillator trimmers, and the noise level to adjust the r.f. trimmers. Generally, the short wave bands should be aligned first.

A word or two on cut-out cases. These are in no way difficult. Locate the section giving the trouble. Then concentrate on that section. 21—A pair of headphones clipped in through a small condenser to the grid of the first audio tube will indicate whether the trouble is in the audio end of the receiver. If the signal is still coming through the phones, connect them to the grid of the second audio tube, if the set has one. If signal is also in the phones on this stage, go back to the detector. If signal is still heard, the trouble is not in the i.f. or r.f. sections of the set.

Intermittents are a more complicated problem but may be located often by clipping a pair of phones in at different points from detector to output, and waiting till the set stops playing, or fades to a low level. Listening to the phones will indicate whether the fault is before or after the stage in which they are located.

22—If a test oscillator is available, connect it to the antenna and tune in the signal. Turn off the modulation. Turn up the volume control. Any loose connections can easily be heard by probing and tapping.

23—When a suspected open condenser is to be bridged with another one on a cut-out job, touch one side in the usual manner, then holding the other lead with the forefinger and thumb, touch the other terminal with the little finger, thereby charging the condenser slowly through the fingers before completing the connection. This will not cause sudden shock which will often make an intermittent radio start operating normally.

24—If the set is full of birdies, an r.f. or i.f. stage may be oscillating. This can be located best by touching the lead of a lead-pencil to the plate lug of the tube socket. A loud click will be heard when you have located the right one. If it proves to be an i.f. stage, everything apparently normal, put a resistor of as high a value as possible across the primary winding of the i.f. transformer. This will stop the oscillation. Usually 50,000 ohms will take care of it.

Distortion is the cause of many complaints, so some information which may be of some aid in locating the trouble, especially for the beginning serviceman, is included.

Let us go back to locating the defec-

tive section, then the defective stage, and finally the defective part. After a little practice the serviceman will be able to distinguish by ear whether the trouble is in the r.f., audio or speaker. However, touching the first audio tube grid may tell the story. A rattle will indicate speaker trouble. A distorted buzz proves the trouble is in the audio, a clear buzz indicates it is probably in the r.f. section.

If the distortion is traced to the audio amplifier, check all voltages carefully, especially the bias. Be sure it is correct before leaving it. 25—Check the voltage, grid to cathode. If it is resistance-coupled you won't get much indication of voltage, but must have some indication on the output stage. 26—The grid must have some negative voltage. If not, check the coupling condenser. If it is shorted or leaky the power tube may become very hot.

27—A shorted output transformer will cause poor tone. If it has been replaced with another, be sure the load matches the characteristics of the power tube.

28—If you are using the usual 1000-ohm-per-volt test meter, place your leads from grid to ground on all stages, as the grid may be floating. This may clear the tone. If so, replace the grid resistor. If the first audio tube is of the pentode type with a series screen resistor you may not read much voltage. However, turn your voltmeter scales down. This may not increase the deflection, but it will lower the supply voltage to the screen. A high voltage here will cause distortion.

If the distortion trouble has shown up since you have been working on the set, you have probably caused it yourself. Check over the work you have done for defective parts, poor soldering or wrong connections.

R.f. distortion may be due to misalignment or to the wrong bias voltage. Check for both.

If distortion is only on strong signals, disconnect the antenna. If this clears up distortion you can be sure it is due to wrong bias voltage. On the older sets using 24's, etc., voltage under 25 volts on the screen or over 12 volts on the grid will cause the tube to be unstable. It will be necessary to install super-control tubes or a local-distance switch to lessen pickup.

Again check the tubes as to their right positions in sockets. A sharp cut-off type like the 6J7 will not replace a super-control tube of the 6K7 type, where the volume is controlled by the C-bias either manually or with automatic volume control, which includes almost all sets in use today.

Be thorough. Don't skip a stage until you have checked everything. Particularly, don't take it for granted that the tubes are in the right places, even though you may have replaced them in the sockets yourself. Check them again!

TABLE OF REACTANCES

Inductive Reactance

INDUCTANCE IN HENRIES	APPROXIMATE REACTANCE IN OHMS		
	1000 C.P.S.	400 C.P.S.	60 C.P.S.
1 h	6250 ohms	2500 ohms	375 ohms
2 h	12500 ohms	5100 ohms	750 ohms
5 h	31250 ohms	12550 ohms	1900 ohms
10 h	63000 ohms	25000 ohms	3800 ohms
20 h	125000 ohms	50000 ohms	7500 ohms
30 h	190000 ohms	75000 ohms	12000 ohms
40 h	250000 ohms	100000 ohms	15000 ohms
50 h	310000 ohms	125000 ohms	19000 ohms
60 h	380000 ohms	150000 ohms	23000 ohms
70 h	440000 ohms	175000 ohms	27000 ohms
80 h	500000 ohms	200000 ohms	30000 ohms
90 h	570000 ohms	225000 ohms	34000 ohms
100 h	625000 ohms	250000 ohms	38000 ohms

Capacitive Reactance

CAPACITY IN MICROFARADS	APPROXIMATE REACTANCE IN OHMS		
	1000 C.P.S.	400 C.P.S.	60 C.P.S.
.001 MF	160000 ohms	400000 ohms	3000000 ohms
.005 MF	32500 ohms	72000 ohms	520000 ohms
.01 MF	16000 ohms	40000 ohms	265000 ohms
.02 MF	8000 ohms	20000 ohms	132600 ohms
.05 MF	3250 ohms	8000 ohms	53000 ohms
.1 MF	1600 ohms	4000 ohms	26000 ohms
.5 MF	325 ohms	800 ohms	5500 ohms
1.0 MF	160 ohms	400 ohms	2700 ohms
5.0 MF	32 ohms	76 ohms	530 ohms
10.0 MF	16 ohms	40 ohms	250 ohms

Complete Ohm's Law Formulas

Voltage in Volts	Current in Ma	Resistance in Ohms	Power in Watts
KNOWN	KNOWN	$\frac{1000 \times \text{Volts}}{\text{Ma}}$	$\frac{\text{Volts} \times \text{Ma}}{1000}$
KNOWN	$\frac{1000 \times \text{Volts}}{\text{Ohms}}$	KNOWN	$\frac{\text{Volts} \times \text{Volts}}{\text{Ohms}}$
KNOWN	$\frac{1000 \times \text{Watts}}{\text{Volts}}$	$\frac{\text{Volts} \times \text{Volts}}{\text{Watts}}$	KNOWN
$\frac{\text{Ma} \times \text{Ohms}}{1000}$	KNOWN	KNOWN	$\frac{\text{Ma} \times \text{Ma} \times \text{Ohms}}{1,000,000}$
$\frac{1000 \times \text{Watts}}{\text{Ma}}$	KNOWN	$\frac{1,000,000 \times \text{Watts}}{\text{Ma} \times \text{Ma}}$	KNOWN
$\sqrt{\text{Ohms} \times \text{Watts}}$	1000 $\sqrt{\frac{\text{Watts}}{\text{Ohms}}}$	KNOWN	KNOWN

According to Ohm's Law, if two of the three quantities, resistance, voltage or current, are known, the other can be calculated. The power consumed in the circuit can also be computed from these two quantities. The chart above gives at a glance the formula to use when any two of either volts, milliamperes, ohms or watts are known, to find the other two. Since radiomen are usually interested in milliamperes, current is so expressed rather than in the traditional amperes.

Install your aerial

THE VERTROD WAY

As MODERN as the electric refrigerator, compared with the old ice box.

VERTROD—vertical models eliminate poles—insulators—lightning arresters—filters—hanging aerial wires—climbing.

VERTROD—20 models cover all wave reception—FM—AM and Television.

VERTROD—the most perfect scientific development approaching complete freedom from man made static.

The **VERTROD** way (with patented features) is the modern way. At most radio shops.

WRITE FOR FOLDER 401



VERTROD CORPORATION

60 EAST 42nd STREET
NEW YORK 17, N. Y.

Brand New! Just Published! COYNE RADIOMAN'S HANDBOOK

300 pages of the latest Radio facts, tables, diagrams, etc., for on-the-job use. "Quick-as-a-wink" reference index for over 1,200 subjects. The world of radio principles and calculations at your "fingertips". Written by the Coyne Technical Staff and backed by 47 years of experience.

EVERYDAY REFERENCE FOR RADIO WORKERS

Whether you make, repair or maintain radio equipment, you can use this handbook to good advantage. A single day's use could raise you high in the boss' estimation. Quick facts—bring quick promotions. Especially valuable for radiomen running their own shop. Every chart and formula is authentic. Every HOOK-UP pre-tested by COYNE.

SEE IT 7 DAYS FREE

You may have this NEW Radioman's Handbook for examination 7 days free. Look it over leisurely. If you don't think it's the best \$3.25 investment you can make—send it back and you owe nothing. If you keep the book send \$3.25. But see it free anyhow.

SEND NO MONEY! Just a request to see this book 7 days FREE. Mail it today. You take no risk. This book is off the press and quantities are limited. Technical Book Div. Coyne Electrical School 500 S. Paulina St., Dept. 0000, Chicago 12

- Over 300 pages
- 1200 Subjects
- Power Formulas
- Amplifiers
- Coils
- Antenna Data
- Receiving Tubes
- Receivers
- Wiring Tables
- Circuits
- Balance System
- facts you need to get ahead in radio

COYNE ELECTRICAL SCHOOL, Dept. 76-W, Technical Book Div. 500 S. Paulina St., Chicago 12, Ill. I want to see the New Coyne "Radioman's Handbook". Send me a copy for 7 days' FREE examination. If after 7 days I do not want the book I will return it and owe you nothing. If I keep it I will pay \$3.25 within 7 days and the book is mine.

NAME _____ AGE _____
 ADDRESS _____
 TOWN _____ ZONE _____ STATE _____
 If you prefer to pay by postman \$3.25 on delivery, check here. Same FREE Examination and Money-Back Guarantee.

Electromagnetic waves (including radio) travel at the rate of 186,000 miles, or 300,000,000 meters, per second.

RADIO-CRAFT

10 New Books



Each of the books in this new series is crammed full of meaty modern material for immediate, practical application. The books are all set in modern easy-to-read type, carefully printed and well illustrated. Price 50c each, postpaid.

No. 29

HANDY KINKS AND SHORT CUTS. A compilation of practical expedients and methods of overcoming difficulties encountered by every radio man, suggested by readers of RADIO-CRAFT. Here are kinks on antennas, kinks on servicing, kinks for the shop, kinks on power supplies, etc.—arranged by sections for easy reference, and illustrated.

No. 30

UNUSUAL PATENTED CIRCUITS 1944-1946. A digest of electronic circuits, many the result of wartime research, valuable both to the experimenter and to anyone in the electronic field. Divided into five sections: Control Circuits; Power Supplies; Detectors and Amplifiers; Miscellaneous and Foreign Patents. Simplified circuit diagrams illustrate the text.

No. 31

RADIO QUESTIONS AND ANSWERS. Here are the answers to questions most frequently asked of the "Question Box" editor of RADIO-CRAFT. The material selected is well diversified and chosen for practical application to workaday problems. Circuit diagrams are supplied with the answers. **Not ready until Mar., 1947.**

No. 32

ADVANCED SERVICE TECHNIQUE. An up-to-date collection of information on specialized phases of servicing, appealing definitely to the advanced serviceman rather than the beginner. This book is not intended as a *course in advanced servicing*, but strictly a diversified library of ideas, methods, and procedures not likely to be found in other textbooks designed for the professional serviceman.

No. 33

AMPLIFIER BUILDER'S GUIDE. A valuable book for the designer and constructor of sound equipment. Theory and construction of audio amplifiers are treated in separate parts. The theory section while not intended as a complete treatise on the subject contains an unusually wide range of technical data on amplifier design. This is followed up by good solid information on the construction of a variety of audio amplifiers with power outputs from 8 to 30 watts, including a complete wire recorder.



LIBRARY SERIES

50c Each

No. 34

RADIO-ELECTRONIC CIRCUITS. Here is an extensive collection of circuit diagrams with a brief description of each, to serve as a source of inspiration to the experimenter bent on developing further new circuits. Constructional data is purposely limited to allow space for a maximum number of circuits. **Not ready until Mar., 1947.**

No. 35

AMATEUR RADIO BUILDER'S GUIDE. Here is a book for the "ham" who builds his own. Practical, down-to-earth, and devoid of all radio theory, it consists entirely of "How to Build" articles. It is divided into three sections: 1. Receivers 2. Transmitters. 3. Miscellaneous (antennas, converters, and other equipment). The book is packed with usable material from cover to cover. **Not ready until Mar., 1947.**

No. 36

RADIO TEST INSTRUMENTS. Every radio man can use this latest book on building test equipment. The book places more emphasis on the practical side of constructing testers than on classroom theories. Among the instruments described are signal tracers, capacity meters, portable and bench multichesters, signal generators, tube checkers and electronic voltmeters.

No. 37

ELEMENTARY RADIO SERVICING. A book for the radio man who knows little about radio repair. It shows how to get started and keep going. A wide range of essentials is covered in logical sequence: Planning and Equipping the Shop, Systematic Circuit Checks, Signal Tracing Methods, Servicing Midget Receivers and other fundamental servicing topics.

No. 38

HOW TO BUILD RADIO RECEIVERS. Here is a book for the set builder. 13 modern receivers are described—a sufficient variety to appeal to practically every radio fan. The selection includes the following types: Short-wave, broadcast, v. h. f., portable, a.c.-operated, a.c.-d.c. and miniature. Complete coil winding information is given where necessary.

SEE YOUR DEALER.

-----IF HE CAN'T SUPPLY YOU, USE COUPON-----

RADCRAFT PUBLICATIONS, Dept. R-A
25 W. Broadway, New York 7, N. Y.
Kindly send me the volumes (50c each, post-paid) checked, as my dealer cannot supply me.

I enclose \$

My Name

(PLEASE PRINT CLEARLY)

Address

Dealer's Name and Address

- ENTIRE SET OF 10—\$5.00
- No. 29
- No. 30
- No. 31—Ready Mar. 1947
- No. 32
- No. 33
- No. 34—Ready Mar. 1947
- No. 35—Ready Mar. 1947
- No. 36

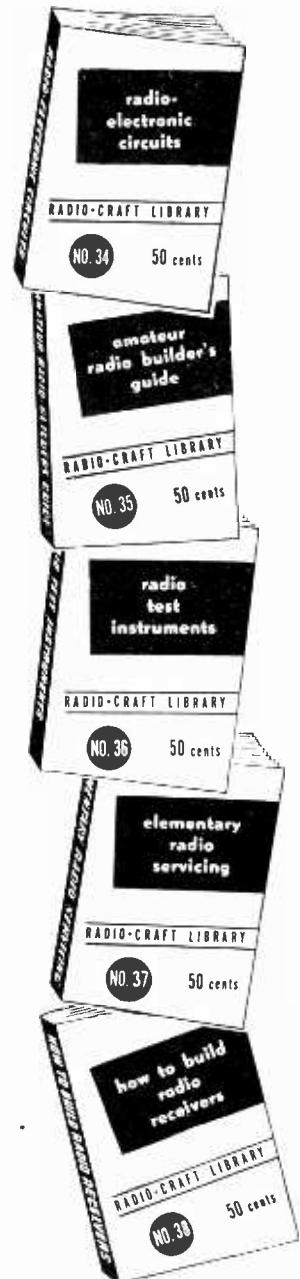

- No. 37
- No. 38

**RADIO
CRAFT**

"TAB"

That's a Buy

PIONEER INSTRUMENT AUTOSYN

BENDIX CK5 and AY101D paired transmitter and Receiver. New g'vii insp. for telemetering or remote signaling operates 24-28V-400cy on 18-24 Volts 60 cycles complete with all gearing. Govt. cost over \$100

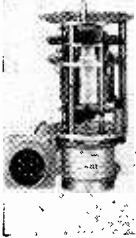

"TAB" special \$2.95.

GE transformers 115 V. 60 Cy pri. all high V. insuld. including chokes—New Navy insp. 115 V. 60 cy pri. 6.3V8A Secondary 1.49
Cased, Sec. 160s V. 2 mca. 5V6A, 6.2V.6A. 2.95
Open Fr. 6.5V8A, 5V3A, 6.526A, 2.5V1.75A. 2.95
830 vct. 125 ma. 6.3V6A, 6.3V1A, 5V3A. 3.50
6.3V8.75A, 6.3V3A, 6.3V.6A, 6.3V.6A, 6.3V6A. 3.95
Auto-Trans 135,160,170,180,1.95-1.73A. 2.95
900Vc.t., 6.3Vc.t., 5Vc.t., 127 Watts. 2.95
10 henries 100ma 200 ohms H.V. ins. 1.40
10 hv 250ma 110 ohms open frame K54J-205. 1.95
10 hv 250ma 100 ohms Cased 68G393. 1.65
2.65 hv 850ma 10.3 ohms K43J232. 2.95
115V60c pri. 250 vct. 25ma. 6.3V1A. Small. 1.25
Thordarson 8 HY 150ma 200 ohm, two for. 1.94
Thord HiFi PP5L6 output 3800 pri; 3, 4, 6, 8, 16, 125, 250, 500 Freq 30/2000 Ocy G'insp. 3.00
S. Dunn Keying relay Vacuum 1500VDC. 4.50
78CCA 10142EL1521 GE Vac. Switch (\$39) 4.50
Molded .01mfd 600V cond 100 for \$6; 1000. 30.00
Assm't pots mfd AB-J 50 to 1 meg ten for 2.50
Kurman adj 1000cy AC source complete. 2.97
WE new 1N26 crystal "K" radar (LP \$9.95). .75
5CP1 JAN insp new with Duo-Dieptal socket 7.50
3BP1 JAN insp new with Duo-Dieptal socket 3.95
Funched chassis 162"x25"x3" -35; 161"x13"x2" .65
Oil cond 3mfd2000VDCWV Wstghe&GD 2 for 5.00

Xtals mtd gtd 2 to 10 mc's active oscil low temp drift 85c each 4 for 3.00
Transformer Raytheon cased 840VCT 110ma. 530VCT/21ma. 5V/3A, 6.3V1A. 6.3V/3A, HV ins (\$28) ea. \$2.50
Two for \$4.50

High voltage strobo-flash transformer 10.00
Time delay relay rectifier filaments 1.49
Condor oil 3mfd 60V 1.20
Aerovox 500mfd2000VDCWV Type R02 (6.10) 1.20
Magnetic dual ckt bkr 8&25amp G'I (\$12) 2.25
Navy sea trunk 12"x2 3/4"x18" used L.N. 3.95
Cond mica .01mfd2500V (LP \$3.40) 2 for. 1.00
National 1MH 300ma RF Chole 10 's: 3 for. .90
GE new UHF Lighthouse tube GL446A 4.95
RCA GE JAN 807 tube, new gtd pcked 1.35
Condor 25mfd1000VAC wks 2 for. .75
Mallory NP1-7 Radio Noise filter .57c; 2 for. .98
Daven 600/600 "T" pad 20 step new G'I 4.95
Cond bath tub oil .5mfd600VWVDC 5 for. 1.00
Dynamic mike unit & int trans to Grid 1.95
TBY Vibrator pack & battery 18.00
CD oil 4mfd 400 WVDC (LP \$59) 6.95
WE Dynamic mike & 50' cable 50/9000 cy. 9.95
Condor 001mfd 800V wks mica (\$32) 3.90
Condor GE oil 3mfd230VAC/1000VWVDC 2 for. 2.50
Condor oil insltors 2mfd2000VWVDC 2 for. 4.25
WE crystal 1N21-22-23 new lead sld. 3 for. 1.50
Socket amphenol UX Safety 4 for. 1.00
Socket amphenol SRTN octal HF 25 for. 1.50
Socket amphenol 49SS8 octal ceramic 10 for. 1.00
Socket amphenol 49SS11L Magnal ceramic 3 for. 1.00
Socket Johnson 50Watt No. 211 B (\$1.90) 2 for. 1.60
Socket Eby Miniature HF mica B & Shield 4 for. 1.00
Socket RCA Differential & Adt ring (\$7.00) 1.15
Socket National 7 Prong ceramic XC-7S; 4 for. 1.00
Socket National 5 Prong ceramic XC-5; 4 for. 1.00
Socket National Octal ceramic CTR-8; 7 for. 1.00
Socket Hammerlund Acorn DHS900; 4 for. 1.00
RCA 808 JAN new (\$7.75) \$2.70 Two for. 5.00
RCA 6AC7 JAN new (\$7.80) .75; 4 for. 2.50
WE 703 Tube UHF; 20Watt to 1000 MC's (\$40) 5.95

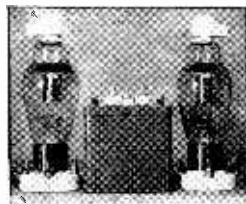

Raytheon 866A filament transformer 115V 60c 60 Cy's. pri. 2.5Vct 11A Sec and Two new 866A tubes Jan. \$5.90 With Millen caps & sockets \$7.00 Raytheon Transformer only \$3.25

Elicor dynamotors new DC Grid over seas packed G'insp Inpt 12V/8A or 24V/4A, output 500V/50ma Inpt same, output 275V/110ma & 12V/3A "TAB" Special each unit \$1.95; Both for \$3.49

\$2 Min. order FOB N.Y.C. Add Postage all orders and 25% deposit. Whitehall 3-3557. Send for catalog 300. Specialists in International Export. School, College & Industrial trade. Buy thru "TAB" and save.

"TAB," Dept. RCX

6A Church Street, New York 6, N. Y.

RADIO HEARING AID

(Continued from page 15)

the plate section of the oscillator coil is short-circuited and therefore the first 1R5 does not convert any frequency or produce any i.f. The 1S5 therefore amplifies at a.f. only. The amplified a.f. appears across the 1-meg resistor located after the primary of the i.f. coil and is applied through an .001- μ f condenser to the third grid of the second 1R5. The second 1R5 is used as an audio-frequency mixer.

The Switch Positions

The fact that the secondary of the first coil is in the input circuit of the 1S5 and that the primary of the second i.f. coil is in the output of the same tube does not impair the performance at a.f. The reactance and mutual inductance of the i.f. coils is infinitesimal at low frequencies. In position 1 the apparatus works as a hearing aid where the 1S5, the second 1R5 and 1S4 all amplify at a.f.

In position 2 the oscillator coil works. The i.f. is applied to the input of the 1S5. In the output, the second i.f. coil applies the i.f. to the diode section of the same tube. The output is fed to the first grid of the second 1R5. The two 50- μ f condensers in the input and output of the 1S5 close the i.f. path to ground. The microphone is still connected and its output is amplified as when switch is in position 1. In this case the 1S5 amplifies at i.f. (radio) and a.f. (microphone). The i.f. signals are also demodulated by the diode section of the 1S5. In this position the apparatus works as radio and hearing aid.

In position 3, the microphone is dis-

connected. The 1S5 amplifies only i.f. (and demodulates). This is the "radio only" position.

The second 1R5 is an audio-frequency mixer. The a.f. rectified by the diode is applied to grid 1, a.f. amplified by the 1S5 to grid 3. In the plate circuit of the second 1R5 we find both signals in amplified form when grids 1 and 3 are both operating. We find only one signal when either grid 1 or grid 3 is working alone.

No definite assembly sketch can be given since the location of the component parts depends too much on their physical shape. The photographs show positions of the parts in the receiver described.

The sensitivity of the radio receiver is better than 400 microvolts r.f. input (broadcast band) for 50 milliwatts a.f. output.

DECIBEL ACOUSTIC SCALE

Level of Sound	Decibels
Threshold of Audibility	0
Low Whisper	10
Suburban Garden	20
Average Home	30
Average Office	40
Motor Car	50
Brisk Conversation	60
Motor Truck	70
Loud Radio Music	80
Pneumatic Drill	90
Boiler Shop	100
Unsilenced Airplane Engine	110
Loud Thunder	120
Threshold of Pain	130

SCALE OF PREFERRED NUMBERS

Use of the preferred number system will become increasingly common in evaluating certain radio parts. In the old system steps were only apparently uniform. For example, resistors were numbered in "uniform" steps of 100, with the result that the 200-ohm was 100 per cent greater than the 100-ohm resistor, while the 1000-ohm was only 10 per cent greater than the 900-ohm resistor.

In the preferred number system, each step increases over the last by the same amount, subject to slight variations to "round off" the values. Thus, beginning with 100 ohms, resistors increase in steps of approximately 20 per cent to 120, 150, 180 and 220 ohms. There is no resistance value in this scale between 820 and 1000 ohms. (See table).

Distance between the steps is governed by the tolerance of the component. A 150-ohm resistor of 10 per cent tolerance may have any value between 150 plus 10 per cent and 150 minus 10 per cent, or between 135 and 165 ohms. The upper limit of a 120-ohm

and the lower limit of a 180-ohm resistor are 135 and 162 ohms respectively. Thus steps of approximately 20 per cent are sufficient to assign values to all resistors in this series and any values between those would be meaningless. For units of 5 per cent tolerance, the values would increase in approximately 10 per cent steps, as shown in the table.

In the table on the next page, the first column shows the preferred values for resistors of 20 per cent tolerance, the second for 10 per cent and the third for 5 per cent resistors. The fourth column shows the older standard values. Note that with only sixteen resistors, the whole range between 50 and 1,000 ohms (taken as an example) can be covered with differences of approximately 20 per cent, while with the old standard, fourteen were used to cover the same range with a much greater proportional difference between many of the values, which follow each other irregularly and illogically.

The preferred number system will come into more general use not only in

the case of resistors, but condensers and very likely chokes, and other components will increasingly adopt the more efficient method. As it is fundamentally a system of numbers, it can be applied to any case where units are

required, and is being discussed in the mechanical trades and the engineering profession. It is therefore well worth the reader's while to familiarize himself with the units, as he is likely to meet them with increasing frequency.

Preferred Values of Resistance			Old Standard Resistance Values	Preferred Values of Resistance			Old Values Standard
±20%	±10%	±5%		±20%	±10%	±5%	
		51	50			27,000	25,000
		56				30,000	30,000
68	68	62		33,000	33,000	33,000	
		68				36,000	
		75	75		39,000	39,000	
		82				43,000	40,000
		91				47,000	
100	100	100	100	47,000	47,000	47,000	
		110				51,000	50,000
		120				56,000	
		130				62,000	60,000
150	150	150	150			68,000	
		160				75,000	75,000
		180		68,000	68,000	82,000	
		200	200			91,000	
220	220	220	200			100,000	100,000
		240				110,000	
		270	250	100,000	100,000	120,000	120,000
		300	300			130,000	
330	330	330	350	150,000	150,000	150,000	150,000
		360				160,000	
		390				180,000	
		430	400			200,000	200,000
		470	450	220,000	220,000	220,000	
		510	500			240,000	250,000
		560	500			270,000	
		620	600	330,000	330,000	300,000	300,000
680	680	680	750			330,000	
		750				360,000	
		820				390,000	400,000
		820		470,000	470,000	470,000	
		910				510,000	500,000
1000	1000	1000	1000			560,000	
		1100				620,000	600,000
		1200	1200			680,000	
		1300				750,000	750,000
1500	1500	1500	1500	680,000	680,000	820,000	
		1600				910,000	
		1800				1.0 Meg.	1.0 Meg.
		2000	2000	1.0 Meg.	1.0 Meg.	1.1 Meg.	
2200	2200	2200	2500			1.2 Meg.	
		2400				1.3 Meg.	
		2700	3000	1.5 Meg.	1.5 Meg.	1.5 Meg.	1.5 Meg.
3300	3300	3300	3500			1.6 Meg.	
		3600				1.8 Meg.	
		3900	4000	2.2 Meg.	2.2 Meg.	2.0 Meg.	2.0 Meg.
		4300				2.2 Meg.	
4700	4700	4700	5000	2.2 Meg.	2.2 Meg.	2.4 Meg.	
		5100				2.7 Meg.	
		5600		3.3 Meg.	3.3 Meg.	3.0 Meg.	3.0 Meg.
		6200	7500			3.3 Meg.	
6800	6800	6800				3.6 Meg.	
		7500				3.9 Meg.	4.0 Meg.
		8200		4.7 Meg.	4.7 Meg.	4.3 Meg.	
		8200				4.7 Meg.	5.0 Meg.
		9100				5.1 Meg.	
10,000	10,000	10,000	10,000			5.6 Meg.	
		11,000				5.6 Meg.	6.0 Meg.
		12,000	12,000			6.2 Meg.	
		13,000		6.8 Meg.	6.8 Meg.	6.8 Meg.	7.0 Meg.
15,000	15,000	15,000	15,000			7.5 Meg.	
		16,000				8.2 Meg.	8.0 Meg.
		18,000				9.1 Meg.	
		18,000				10 Meg.	10 Meg.
22,000	22,000	20,000	20,000			10 Meg.	
		22,000				10 Meg.	
		24,000				10 Meg.	

RISCO SPECIALS Immediate Delivery

VALUE!! VALUE!!

KITCHEN FLUORESCENTS

No extra wiring. Plugs right into your fixture. Underwriters approved parts. Uses 2—

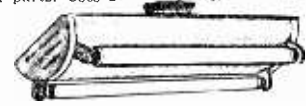

\$4.50

15 or 2-20 watt lamps. Specify size when ordering. Lamps, 80c each.

DETROLA CHANGERS \$15.75

V-M RECORD MIXER CHANGER, \$16.95



ASTATIC L-70 or L-72 Crystal Pickup. Shure Glider Crystal Pickups 2.15 ea. 10 @ 1.95.

PHONO AMPLIFIER 3-tube AC-DC

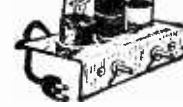

Volume and tone controls. Completely wired. **\$2.95**

PHONO AMP. KIT

With 3 tubes and 5" speaker, 7.95 less tubes or speaker. 5.95 Uses 12SQ7, 50L6, 35Z5.

PORTABLE RECORD CHANGER

KIT complete with tubes. Uses a above V-M changers.



\$37.95

RISCO RECORD PLAYER

Easily Attaches To Any Radio.

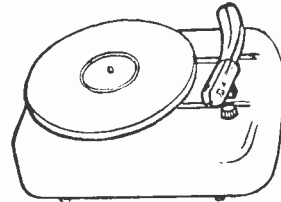

Complete with Volume ctrl. and switch. Plays 10" & 12" Records.

10.95

- 3BP1 Cathode ray tubes, new.....\$2.95
- 5 or 12 prong mounting and cable connectors, set.....1.95
- Little fuse, 3 AG fuse posts......10c
- 3 AG Meter fuses 250 Ma.—500 V......3c
- Alliance Phono Motors & T. T.....3.95
- 100 Asst. Insulated Resistors.....1.95
- Emerson 20-20-150V — Elect. Cord......44c
- 15 Asst. By Pass Cond.—All 600V......89c
- 25 Asst. Mica Cond. Color Coated......89c
- Shure T-17-B Signal Corps Microphones.....1.45
- Signal Corps J-38-Tel. Keys New......49c

RUSH NAME FOR

**FREE BIG
1947
CATALOG**



New Office
414 2nd AVE. at 23rd St.

EXPORT INQUIRIES INVITED.
Send 25% with C.O.D. orders.

RISCO SALES CO.
WHOLESALE RADIO DISTRIBUTORS
224 E. 65th ST., NEW YORK 21, N. Y.

HI-FI AMPLIFIER AND RADIO TUNER

(Continued from page 14)

An octode or pentode converter is used in the first stage of a superheterodyne tuner. The superhet was used because of space limitation, in this case. Standard broadcast r.f. oscillator and i.f. coils are used with a 365- μ f, two-gang variable condenser. Noticeable is the .0004- μ f mica condenser in series with the oscillator coil primary and ground, to assure more uniform band spread. The i.f. signal is amplified at 456 kc, through a 7A7, then detected by a double-diode triode 7C6. One of the diodes is used to supply a.v.c. voltage to the first stage. The radio volume control doubles as diode load. The a.f. signal from the triode plate of the 7C6

is coupled through a condenser and d.p.d.t. switch on back of the tuner volume control, to the 7C7 control grid. One half of the radio volume control switch controls a pilot light used to denote whether the tuner is in or out of the a.f. circuit.

Incorporated is a well filtered full-wave power supply, good for 300 volts at 150 milliamperes—the actual high-voltage current drain being about 115 ma.

A complex power switch is used in order to control the phono motor, mounted on top of the cabinet. By moving the power switch arm one point from the "off" position, power is ap-

plied only to the amplifier and tuner; by moving a step further, the arm ap-



The complete equipment requires little space.

plies power also to the phono motor. A third section of the power switch applies 6.3 volts to a pilot indicator.

The Superamp is a practical and compact unit, and the added radio tuner has been found a very useful auxiliary to the PA system on many occasions.

CONVERSION RATIOS

MULTIPLY	BY	TO OBTAIN
Amperes	1,000,000,000,000	Micromicroamperes
Amperes	1,000,000	Microamperes
Amperes	1,000	Milliamperes
Cycles	.000,001	Megacycles
Cycles	.001	Kilocycles
Farads	1,000,000,000,000	Micromicrofarads
Farads	1,000,000	Microfarads
Farads	1,000	Millifarads
Henries	1,000,000	Microhenries
Henries	1,000	Millihenries
Horsepower	.7457	Kilowatts
Horsepower	745.7	Watts
Kilocycles	1,000	Cycles
Kilovolts	1,000	Volts
Kilowatts	1,000	Watts
Kilowatts	1.341	Horsepower
Megacycles	1,000,000	Cycles
Mhos	1,000,000	Micromhos
Mhos	1,000	Millimhos
Microamperes	.000,001	Amperes
Microfarads	.000,001	Farads
Microhenries	.000,001	Henries
Micromhos	.000,001	Mhos
Micro-ohms	.000,001	Ohms
Microvolts	.000,001	Volts
Microwatts	.000,001	Watts
Micromicrofarads	.000,000,000,001	Farads
Micromicro-ohms	.000,000,000,001	Ohms
Milliamperes	.001	Amperes
Millihenries	.001	Henries
Millimhos	.001	Mhos
Milliohms	.001	Ohms
Millivolts	.001	Volts
Milliwatts	.001	Watts
Ohms	1,000,000,000,000	Micromicro-ohms
Ohms	1,000,000	Micro-ohms
Ohms	1,000	Milliohms
Volts	1,000,000	Microvolts
Volts	1,000	Millivolts
Watts	1,000,000	Microwatts
Watts	1,000	Milliwatts
Watts	.001	Kilowatts
Diam. Circle	3.1416	Circumference Circle
Diam. Circle	.886	Side Equal Square
Inches	2.54	Centimeters

To get units in first column, reverse the process. For example, to get inches, divide centimeters by 2.54.

INSULATING MATERIALS

(At 1 megacycle frequency)

Material	Power Factor	Dielectric Constant
Air	1	
Bakelite	4.5	1.4
Celluloid	4.5	5
Ebonite	2.8	0.5
Electrical fiber	5	5
Formica	4.8	1.1
Glass (window)	8	1.4
Glass (electrical)	4.5	0.5
Lucite	2.6	1.5
Mica	5—8	0.2
Paper	2.5	variable
Nylon	3.6	2.2
Paraffin wax	2.25	0.1
Polystyrene	2.5	.02
Porcelain	7	0.7
Quartz	3.8	.02
Shellac	3.5	0.1
Steatite (commercial)	6	0.2
Steatite (low-loss)	6	0.2*
Varnished cloth	2.5	3
Wood (dry)	2—7	4

*Low-loss steatite has a power factor of approximately 0.2 percent up to 100 megacycles, while that of commercial grades increases with frequency.

SIZE OF TRANSFORMER CORE FOR OUTPUT WATTAGE

Volt-amps Output	Core size (Sq. In.)
25	1.0
50	1.5
75	1.75
100	2.0
150	2.5
200	3.0
250	3.5
350	3.75
500	4.0

These sizes are generously calculated and allow ample regulation.

The number of primary turns in a transformer is calculated from the formula: $N=7.5 \times E$. Thus a core whose cross-section is one square inch would require a primary of about 850 turns on 115 volts ($N=7.5 \times 115$)

A VIBRATOR AMPLIFIER

(Continued from page 8)

ployed, the secondary winding being in two sections to provide as complete coupling as possible.

The entire amplifier and power pack were assembled on a metal chassis 9 inches long by 5½ inches from front to back. A front panel 10 inches by 7 inches was cut from a scrap piece of masonite. This carried the controls, terminals, input and output sockets (these were standard wafer-type tube sockets).

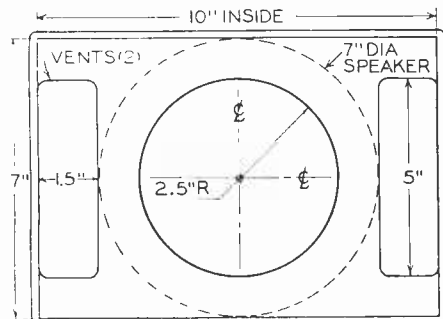

Fig. 2—A front view of the speaker cabinet.

Although the speaker seems housed in a bass-reflex baffle (Fig. 2) there's really not very much bass about it, although music from records sounds quite well-balanced. The speaker box has a volume of 490 cubic inches and with the two vents — one each side of the speaker — the "bass" resonant frequency is about 200 cycles per second, while the natural diaphragm resonance of the speaker is about 150 cycles per second.

The speaker has a 20-ounce Alnico magnet, a voice coil diameter of approximately 1 inch, a very light diaphragm and more than average efficiency. This speaker was chosen because it was the largest speaker (of reasonable efficiency) that would fit in the box.

Type of Microphone

It is very undesirable to produce extra distortion from inter-modulation in the first stage (before the unwanted frequencies are attenuated), so the microphone chosen was of the crystal diaphragm type and was worked into a rather low resistance load (250,000 ohms). Suitable types are the D104 Astatic, the 707A Shure and the VT73 Turner. (This last was—I believe—succeeded by a much better type a number of years ago.) Recently some dynamic microphones were tried and proved quite satisfactory.

On one occasion when a large amplifier broke down, this little job was connected to a pair of Long-horn speakers and used for street advertising. A pair of speakers in parallel gave a load of 5 ohms instead of the usual 3 ohms but this did not seem to matter, and the work was carried on successfully.

New! Complete!

FREE CONCORD Radio Catalog

NEW RADIO SETS

NEW AMPLIFIERS

NEW RADIO PARTS

Electronic Equipment

HAM GEAR

STANDARD LINES! LARGEST STOCK! IMMEDIATE SHIPMENT!

For the newest, the latest, and the best in radio sets, radio parts, amateur kits, and test equipment, mail coupon below for your free copy of Concord's first post-war Catalog. It offers a huge storehouse of everything that's new in radio and electronics . . . including the sensational, talked-about line of exclusive Concord Multiamp ADD-A-UNIT amplifiers. It contains thousands of items . . . all standard lines . . . war-born discoveries and improvements . . . all ready for same-day shipment direct to you from CHICAGO or ATLANTA.

History-Making ADD-A-UNIT Line of Amplifiers

Typical of Concord leadership is the completely revolutionary line of Multiamp ADD-A-UNIT Amplifiers, designed and engineered by Concord, sold only by Concord. Built on entirely new principles, these Amplifiers offer startling innovations not available elsewhere . . . new high standards of flexibility, fidelity, power, economy, and all-round performance almost beyond belief. Mail coupon now for Concord's New Complete Catalog showing full amplifier line . . . and complete assortments of "everything that's new in radio and electronics."

CONCORD
RADIO CORPORATION
 LAFAYETTE RADIO CORPORATION
 CHICAGO 7 ATLANTA 3
 901 W. Jackson Blvd. 265 Peachtree Street

CONCORD RADIO CORPORATION
 901 W. Jackson Blvd., Dept. Ref-7 Chicago 7, Ill.
 Yes, rush FREE COPY of the comprehensive
 new Concord Radio Catalog.

Name.....
 Address.....
 City..... State.....

MILO...
Your "Q" for Quality

Headquarters for
RADIO
and ELECTRONIC Equipment
of NATIONALLY KNOWN PRODUCTS

MILO
MILO
MILO
MILO
MILO

COMPONENT PARTS • RECORDERS
TESTING and SOUND EQUIPMENT
RECEIVING and TRANSMITTING TUBES

Supplying INDUSTRIAL FIRMS
SCHOOLS — AMATEURS
SERVICEMEN, etc.

Trained Sales Technicians to
Expedite Your Orders Efficiently

Radio and Electronics Corp.
200 GREENWICH STREET, NEW YORK 7, N. Y., BEekman 3-2980
Cable Address "MILOELECTRO NEW YORK"

ALL-BAND OSCILLATOR

(Continued from page 18)

equals 150. All i.f. bands can be calibrated this way.

This process should be repeated for (at least) each five degrees of the dial from 100° to 0°. The results are recorded on a graph. The vertical lines represent the number of degrees, and the horizontal lines the frequency. When sufficient points have been marked on the chart, a curved line can be drawn through all the points. This will make it possible to set the oscillator to any desired frequency within the range of the coil and condenser.

The broadcast band can be calibrated easily. Tune the receiver to a station which operates on a known frequency. Then tune the oscillator so that it generates a signal on the same frequency. Record the various frequencies taken from known stations on a chart as was done with the other coils in the set.

The short-wave coils can be calibrated with the aid of harmonics. Set the oscillator to precisely 1000 kilocycles. Then tune in the first harmonic (2000 kc) on the short-wave range of the receiver. Remove the broadcast signal generator coil and insert a short-wave coil which will generate a signal that can be received without touching the tuner of the receiver. The oscillator should then be operating at 2 mega-

cycles, the same frequency as the harmonic originally received. Record this frequency on a chart, and repeat this process using another harmonic. The harmonics from the oscillator, when tuned to 1000 kilocycles, will fall on 2, 3, 4, 5, 6, 7, 8, 9, 10, etc., megacycles.

R.f. stages, i.f. stages, and superheterodyne oscillators can be aligned through the use of the test oscillator and an output meter. The aerial and ground leads are disconnected from the receiver. A lead from the black output jack is connected to the ground post or directly to the chassis. A lead from the red output jack should be connected to the aerial post. In this test the red jack lead should be shielded, to reduce interference from local broadcast stations. An output meter should be connected to the output stage so that the receiver can be accurately aligned by the visual method.

The r.f. oscillator is very useful for calibrating radio equipment. The a.f. oscillator may be used for testing a.f. equipment.

Automatic volume control circuits can be tested by comparing the output reading of the receiver with different a.v.c. tubes. A decrease in reading with a new tube shows that the old one is defective.

The selectivity of tuned circuits can be determined by noting the output reading when the frequency of the oscillator is changed a few degrees on either side of the point of resonance.

The frequency of resonance of a coil and condenser can be determined by opening the lid of the signal generator and placing the coil to be tested near the oscillating coil. A voltmeter should be connected to the meter jacks. When the oscillator is tuned to the frequency of the coil and condenser combination, a current will be induced into the coil. This will cause an increase in the oscillator plate current which will be indicated on the voltmeter.

The largest output from the r.f. oscillator can be obtained by connecting one lead to the chassis and the other through a small condenser (.0001 uf) to the "G" connection of the coil. At low radio frequencies the output will be sufficient to cause a small neon lamp to glow and to be visible on the screen of an oscilloscope. This connection is not used for ordinary tests because the oscillator would lack stability and selectivity.

Parts List

Condensers

- C1, C2—20-20 mf 150 v. electrolytic condenser
- C3—320 mf variable condenser
- C4—3-30 mf low-loss trimmer condenser
- C5—.0001 mf mica condenser
- C6—5 uf 600 v. tubular condenser
- C7, C8, C11, C15—.06 mf 600 v. tubular condenser
- C9—Two insulated wires twisted together
- C10—.002 mf 600 v. tubular condenser
- C13—.005 mf 600 v. tubular condenser
- C16—.05 mf 600 v. tubular condenser

Resistors

- R1—250 ohm 10 watt wire-wound power resistor
- R2—250 ohm 25 watt wire-wound power resistor
- R3—1000 ohm 2 watt carbon resistor
- R4—50,000 ohm carbon resistor
- R5—100,000 ohm potentiometer with switch
- R6—10,000 ohm carbon resistor
- R7—250,000 ohm carbon resistor
- R8—500,000 ohm carbon resistor
- R9—1 meg. or higher resistance potentiometer with switch
- R10—500,000 ohm potentiometer with switch

Tubes

- 1—6J7 radio tube
- 1—6C8-G radio tube
- 1—35Z5-GT radio tube

Miscellaneous Parts

- 1—Audio transformer (secondary not used) or plate coupling choke, (T1)
- 2—S.P.D.T. Bat-Handle toggle switches
- 1—ICA precision vernier dial 4 inch diameter (No. 2169)
- 3—Black pointer knobs
- 1—DeLuxe 0-10 dial plate for R9 tip jacks
- 3—Red large diameter molded Bakelite insulated tip jacks
- 3—Black large diameter molded Bakelite insulated tip jacks
- 1—2.5 mh. r.f. choke
- 3—"MIP" octal sockets
- 1—Amphenol 5-prong socket
- 2—grid caps for 6J7 radio tube and 6C8-G radio tube
- 9—5-prong 1¼" dia., 2¼" high Bakelite coil forms
- 1—¼" red jewelled bracket with miniature base
- 1—Number 40 pilot lamp
- 1—Power cord with plug
- 1—Red test prod with alligator clip
- 1—Black test prod with alligator clip
- 1—Shielded cable with alligator clip
- 1—Penlight cell (size AA)
- 1—8" x 4½" x 1½" metal chassis
- 1—10" x 6" x 7" metal chassis with ventilation louvres on sides and hinged top
- 2—Mounting strips
- 25 ft. hook-up wire, coil wire, rubber grommets, hardware, etc.

The plug-in coil chart is self-explanatory, all information being given.

A THREE-CHANNEL AMPLIFIER

(Continued from page 11)

time restoring the musical equilibrium.

To establish the response curve of which we have just spoken, it is necessary to know that of the ear. That curve has been traced by the physicians and physiologists, who have established it by the average of several thousands of individual cases.

Since the amplifier is destined for the pleasure of one sole listener, it may well happen that the particular ear in question will be very different from the "average ear." Therefore it is infinitely preferable to permit the user to adapt the amplifier response to his own needs and tastes.

With this idea the amplifier here described was conceived. It has three channels, one for each band of frequencies: bass, medium and high, the amplifier for each channel being controllable independently of the others.

Design and Construction

We shall scrupulously avoid the hackneyed description of "the tube A, plate of which is coupled to the grid of tube B through the blocking condenser C, etc.," refusing to consider the reader so benighted that it is necessary to point out that which he can see clearly

in the accompanying schematic drawing. On the other hand, we will devote more time and details to the interesting and unusual features.

The 1-megohm resistors R1 and R2 isolate the three inputs from each other, preventing a mutual short-circuit. The condenser C1 has as its object the short-circuiting of the high and medium notes for its particular input. Therefore the 6F5 stage at the top of the schematic is the "boss" pre-amplifier. Its gain is regulated by the volume control P1. The condenser C2 prevents basses from reaching the grid of the 6F5 directly below the "bass" input. Therefore, only mediums and highs pass. But, as we shall see, the highs will be attenuated further on. This stage constitutes therefore the "medium" pre-amplifier, controlled by P2.

The output of these two stages is applied, through a common volume control P4, a 6C5 and a transformer, to a push-pull stage, using 6A5 triodes. Their low internal resistance permits excellent reproduction of the basses. The negative feedback circuit R4, C4 weakens the high notes, the condensers C4 being of low value (50 μ f). The output transformer has two windings, the higher potential one being tapped

to permit adaption to loudspeakers of different impedances. This arrangement—two 6F5's, 6C5 and two 6A5's—constitute the bass and medium amplifier.

The low-capacity condenser C3 (25 μ f) permits only the highs to pass. To enhance this effect the cathode circuit of the 6J7 is decoupled with a condenser of only 0.1 μ f (across 800 ohms) which reduces the bass and medium notes through degeneration.

This stage constitutes the "high" pre-amplifier. Its gain is also independently controllable, by volume control P3. It is followed by a 6F5 and 6F6.

The output transformer feeds a speaker of a small diameter, intended only for the reproduction of the highs. Under such conditions, this speaker has a marked directional effect. To soften this effect, signals of lower frequencies may be fed (at low level) into the "high" amplifier. This has been done through use of the resistor R.

Note also the milliammeter which permits rapid comparison of the plate currents of the 6A5's, or measurement of the total plate current of the two; a feature which facilitates balancing the push-pull stages and also gives a check on the condition of the apparatus.

PRACTICAL HOME-STUDY

RADIO COURSE

These men used this course to get into good radio jobs



FINEST TRAINING COURSE USED IN MANY SCHOOLS

"The radio training course is the finest up to date easy to understand course. . . . This course outlines practical work. We are using this course in our Topeka High School. It is wonderful." *Henry Ward, Jr., 622 Filmore St., Topeka, Kans.*



WORTH MUCH MORE

"You should get more money for your course. The first week I studied it, I made \$10.00 repairing sets. I built my own test outfit from details given in this course. I have repaired 100 radios to date. . . ." Signed: *Robert C. Hammel, 120 W. 13th, Davenport, Iowa.*



COMPLETED IN 8 WEEKS

"I am very satisfied with the course. When I was at the twelfth lesson I started repairing radios. It took me two months to master your course." From a letter written by *Roger Lanzlois, 1679 Poupart, Montreal, Canada.*



MODERN. UP-TO-DATE

"I have found since taking your course how modern and up to date it really is. There is not one page in the whole course which anyone interested in radio can afford to miss. Your course started me on the road to a well paid job and has repaired me many times." *Charles Alspach, 133 F M St., Reading, Pa.*

AMAZING BARGAIN OFFER

In this large course-manual of 22 practical lessons, you have all the topics covered by the best \$100.00 radio correspondence course. Learn important fundamentals. Speed-up radio servicing. Includes hundreds of circuits, thousands of repair hints, many servicing short-cuts.

RADIO TRAINING FOR HOME-STUDY

This practical home-study course will show you how to repair all types of sets faster and better, tell you how to open your own shop and run the business. The lessons are well illustrated, interesting to read, easy to understand and apply. No special previous knowledge is needed. The early lessons explain important principles. Other lessons cover test equipment, trouble-shooting, circuit tracing, television, and every other important topic of radio and electronics.

SERVICING METHODS SIMPLIFIED

Learn new speed-tricks for radio fault-finding, case histories, servicing short-cuts, extra profit ideas. Included are many large lessons on the use of regular test equipment, explanation of signal tracing, oscilloscope, transmitters, P.A., television, recorders. Let this information save for you enough time on a single job to pay the full price of \$2.50 for the complete course of 22 money-making lessons.

A PARTIAL LIST OF TOPICS COVERED

Circuits, Auto sets, P.A., Tube Characteristics, A.C., Fidelity, Using charts, Amplifiers, Tracking, I.F., Phase, Reactance, Impedance, Modulation, A.V.C., Photo-cell, Review questions, Crystals, Test equipment, Meters, Analyzers, Tube testers, Signal tracing, Oscilloscope, Ohmmeters, Accuracy, Graphs, and hundreds of other topics.



IN MANUAL FORM

\$2.50
COMPLETE

SPECIAL OFFER
READ THE DETAILS

EASY TO UNDERSTAND AND APPLY

The practical lessons making up this course-book are easy to follow and apply to actual radio jobs. Hundreds of radio facts that puzzled you will be quickly cleared up. You will find yourself doing radio repairs in minutes instead of hours—quickly finding the faults or making needed adjustments. Every new radio development of importance and thousands of time-saving radio facts are backed into this complete course-manual.

SATISFACTION GUARANTEED

Use coupon to order the Course for 10-day examination in your own home. Look over the material, read a few lessons, apply some of the ideas. Then decide to keep the lessons at the bargain price of \$2.50 (full price), or return the material and get a cash refund.

NO RISK TRIAL COUPON

SUPREME PUBLICATIONS, 9 S. Kedzie Ave., Chicago 12, ILL.
Ship the complete Radio Course for 10 days use. I must be satisfied or you will refund my money.

- I am enclosing \$2.50, full price. Send postfree.
 Send C.O.D. I am enclosing \$..... deposit.

Name:

Address:

(Use Coupon or Write Order in a Separate Letter)



BUT OUR STOCK IS SHOWING . . .

Years of experience has taught us that there's practically no end to the equipment needed in the radio and electronics field. That's why our warehouses are bulging with one of the most complete selections of nationally advertised radio parts and equipment in the country. We've proven time and again that we have what you want, when you want it . . . because we're distributors for the finest precision equipment available. And our 24-hour delivery service is famous. Try us out—we'll prove it!

- RADIO PARTS
- ELECTRONIC EQUIPMENT
- SOUND EQUIPMENT
- INTER-COM SYSTEMS
- TEST EQUIPMENT

FREE ENGINEERING SERVICE

Let our trained engineers solve your problems...we'll analyze your troubles and send the correct parts. No obligation, of course.

FREE MONTHLY BULLETINS

Have your name put on our mailing list for free monthly bulletins listing hard-to-get items.

Radio Electric
SERVICE CO. OF PENNA., INC.

IN PHILADELPHIA
7th and ARCH STREETS
5133 Market St. • 3145 N. Broad St.
Branches in
CAMDEN, N. J. • ALLENTOWN PA.
EASTON, PA. • WILMINGTON, DEL.

RADIO LABORATORY IN PORTABLE UNIT

(Continued from page 19)

stability with respect to load, because the only coupling between the oscillating circuit and the load is the electron stream flowing through the other elements to the plate. The plate is electrostatically shielded from the oscillating portion by the screen, which is at r.f. ground potential. It is also stable in respect to voltage variations. Any variable condenser which was or could be used to cover the broadcast band with standard coils may be used here. Standard 4-prong plug-in coil forms are used. The coil is wound continuously but is tapped for the cathode connection. Complete information on coil data is given in the table. The 6SK7 is a

Coil Table

(All coils are wound on 1½ in. forms)
I.F. coil (456 kilocycle) No. 26 enamel wire. 170 turns close wound; cathode tap 50 turns from ground.
Broadcast—No. 22 d.c.c. 100 turns close wound; cathode tap 13 turns from ground.
80 Meter—No. 22 d.c.c. 29 turns close wound; tap 2 turns from ground.
40 Meter—No. 22 d.c.c. 16 turns spaced 1¾ inch; tap 1½ inch from ground.
20 Meter—No. 22 d.c.c. 7 turns spaced 1¾ inch; tap 1½ turn from ground.

perfect tube for the job; being single ended, wiring is easy, and one can be assured of complete shielding. Grid condenser and grid leak should be of the smallest physical size procurable and should be fitted with a metal shield. The value of the resistor supplying voltage to the potentiometer is given as 50,000. Actually it should be determined after the voltage from the power-pack is known. For the 6SK7 the voltage at X should be 100 volts, which is the screen voltage given in the tube manual. B-plus and filament voltages are supplied from the power-pack below by two wires plugging into the male receptacle situated at the back of the panel.

As an r.f. and i.f. signal-tracing unit the tester compares not unfavorably with elaborate 3-stage TRF analyzers. For signal tracing the output jack is connected to the input of the audio channel by a short connection. Signals can then be picked up with a shielded test probe.

A word of warning is needed for anyone who thinks that all that is necessary is to pick out the right sized condensers and stick them together. There is a world of difference between an ordinary regenerative set and one that is carefully designed. When used as a service tool one wants no worries as to whether that birdie, whistle, hum or howl is coming from the defective radio or from one's test instrument. Here are a few pointers: 1.—Plate and grid wires must be very short, yet parts must not be crowded. 2.—Half the battle is in constructing strong, neat shields. 3.—Build rigidly and solder carefully. 4.—Three factors in-

fluence the smoothness of going into and out of oscillation; the amount of feedback, grid leak, and antenna coupling. The final setting of the cathode tap on a coil should be such that the detector breaks into oscillation at the recommended screen grid value as given in the tube manual. If it oscillates only at a higher voltage too little feedback is present and the cathode tap should be moved higher on the coil. A low enough value of feedback should be used to ensure smooth regeneration from an almost noiseless condition to slight hiss, loud hiss, whistle (when passing station). If it comes into oscillation with a plop and is not stable (starts squealing if you shake your fist in its face) adjustment of the grid-leak or antenna coupling is indicated. If, however, smooth regeneration cannot be obtained with at least a one-megohm leak, the antenna coupling should be loosened; that is, use a smaller condenser. A tiny trimmer condenser works well in this position.

5.—Another disease from which regenerative sets suffer is fringe howl, noticed when tuning through a station. This is more than a matter of too much regeneration. It means that r.f. signal is getting through into the audio section. The remedy lies in better r.f. filtering.

6.—A good regenerative set should have little or no hum. Methods of elimination are: 1.—More careful shielding, not just of wires but of parts and sections. 2.—Grounding of chassis. 3.—Better power supply. 4.—Ground one side of heaters and by-pass other side through an .01 µf condenser.

To obtain an audio signal for test purposes, plug in broadcast coil, attach antenna to input jack (a small built-in antenna in the top of the cabinet brings in all local stations). Connect output jack to input of audio channel. Tune in a station.

Modulated R.F. or I.F. Signal

As anyone who was ever bothered by interference from a neighbor's radio in the old days knows, a regenerative set can be made to give out a self-modulated r.f. signal. This is done by turning up the regeneration control until the tube breaks into audio oscillation. If the tube merely oscillates smoothly the result is an unmodulated signal. If the regeneration is increased still more the grid becomes more negative until the plate current has been reduced to so low a level that the tube stops oscillating. The grid then becomes less negative and oscillations can again begin, so an audio cycle is repeated and is superimposed upon the fundamental r.f. wave.

It is unnecessary to tell how one uses an r.f. or i.f. signal in locating a fault in a radio. Nor is it necessary to out-

line the alternative method of signal tracing. It hardly needs to be mentioned that when the test instrument is used for signal tracing the apparatus is not used in an oscillating condition. The regeneration control is merely advanced to a position where the apparatus is sufficiently sensitive to pick up a signal, detect and amplify it and pass it on to be registered by the audio channel. Always use a shielded test probe when picking up an r.f. or i.f. signal from a radio.

Diode Vacuum-Tube Voltmeter

To use, the d.c. pocket voltmeter, seen at the right in the photo, is connected to the Diode Rectifier. Refer to the circuit diagram for connections and note that the two ground terminals on the lower part of the panel are used along with the two pin jacks in the upper left corner. This circuit reads peak a.c. volts and while it is not as sensitive as more complicated v.t.v.m.'s, it is a distinct improvement over ordinary a.c. voltmeters. The RMS value of the a.c. voltage under measurement can be determined by multiplying the peak value as read on the meter by 0.71. Most common measurements are peak voltages across filter condensers; to check turns ratios of transformers, and as an audio-frequency output meter across the voice coil of a speaker. The condenser must be a high quality paper 2.0 μ f. It should be noted that this circuit has certain limitations. It is no more sensitive than the meter with which it is used and loads the circuit. As here constructed it has too high

losses to measure r.f. frequencies.

Many possible uses occur to one who has an idle evening with the apparatus. The audio-amplifier becomes a record player, a music booster or a miniature PA system. The broadcast band may be covered, and short-wave coils can easily be wound for foreign reception.

You can also try modulating the suppressor-grid of the 6SK7 with a strong audio signal from a record player or a carbon microphone. The broadcast can be picked up by the kitchen radio. (But not by the neighbor's radio or the federal authorities won't like it.)

A DECIBEL NOMOGRAM

(Continued from page 27)

5—Another useful transformation is that of percentage to decibel loss. Amplifiers are sometimes rated in percentage distortion or noise and sometimes in db down from the rated output. Only two variables are concerned, percentage and decibels. To operate, the ruler is kept fixed against the bottom indication of the left-hand scale at all times. Percentage is read at E, while db down is read at D. A particular amplifier is known to have 2 per cent distortion. How many db down is this? Placing one end of the ruler at 100 volts at the bottom of scale B and the other end at 2 volts (2%) on E, we read —34 db on D. But since we are dealing with power rather than voltage, this reading must be divided by two. The result: —17 db. Distortion is 17 db below output power level.

DYNAMIC HANDFUL

(Continued on page 16)

and the tracer have a common ground.

When testing an a.c.-d.c. set that uses a common positive on the filter block, connect prod C first to one negative of the condenser, use only the one that gives the least amount of hum.

When testing the first r.f. or detector stage of a loop-operated set, an external antenna will be required on the set.

There is no danger of a short circuit because of the blocking condenser. There is no danger of an electric shock because of the wooden cabinet insulating the chassis.

The short test prod is covered with a piece of spaghetti except the very tip, to prevent accidental shorts with the prod itself.

The cabinet was constructed from thin walnut panelwood, but if the serviceman should desire he can build the cabinet out of plywood.

Connections to phone jacks A B C are made after tracer is mounted into the cabinet.

The grid leads on the first tube should be made as short as possible to prevent hum.

When testing audio circuits, the short prod is removed and a shielded wire to which two phone tips are soldered at

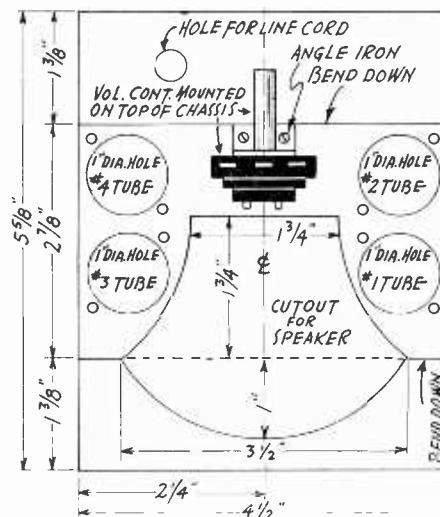

Chassis layout of the compact signal tracer

one end and a pair of alligator clips at the other end should be used. The shielded wire should be plugged in at B and the shield should be plugged in at C.

There are many uses for this tracer that you will find as you become better acquainted with it, the time required to build it will be repaid many times.

By the Millions
By the Hundreds

PAPER TUBULAR CAPACITORS

Good-All condensers are ideal for both general and critical application. The range of values will take care of any need in paper tubular capacitors. Good-All condensers are used by the millions by the government in the V T Fuse and many of the largest Radio Mfrs. in the U. S. . . We specialize in making capacitors to your specifications.

FEATURES:

- Wax impregnated paper tubes plus wax sealed ends protects them from moisture.
- Pigtail terminals perfectly soldered to foils and cannot work loose or pull out.
- Tested before shipment — assuring the highest quality.
- Special type SB of very small physical size and extremely waterproof for such applications as hearing aids, etc.

SEND FOR FREE SAMPLES

GOOD-ALL
ELEC. MFG. CO.
OGALLALA (5) NEBRASKA

MAINTENANCE AND SERVICING OF ELECTRICAL INSTRUMENTS

By JAMES SPENCER, in charge of Instrument and Relay Dept., Westinghouse Elec. Corp., Newark, N. J.

Price \$2.00 postpaid

Check, money order or cash must accompany order.

Instruments

THE MAGAZINE OF

Measurement and Control

Offers a balanced diet of articles and special features appealing to production men as well as to research men — to executives and apprentices.

SUBSCRIBE NOW

Instruments Publishing Co.

1132 Wolfendale St., Pittsburgh 12, Pa.

Enclosed is \$2.00 for which send me Spencer's MAINTENANCE AND SERVICING OF ELECTRICAL INSTRUMENTS.

Enclosed is \$2.00 for which send me Instruments for one year. (Foreign subscriptions, \$7 per year.)

Name

Address

New Direct-Coupled FM-AM

AMPLIFIER MANUAL

By A. C. SHANEY

Chief Engineer, Amplifier Co. of America



For the Layman, Serviceman
Recorder and Engineer

Regardless of whether you are interested in the finest type of phonograph reproduction, high fidelity recording, sound-on-film applications, FM or AM programs, you will find invaluable information in this practical handbook. Written by the leading exponent of direct-coupled amplifiers who has spent more than 10 years improving and perfecting the famous Loftin-White circuit.

Explains the theory and practical application of:

Variable Speed Non-Overloading Push-Pull Expansion; Non Frequency Discriminating Scratch Suppression; Push-Pull Balanced Direct-Coupled Amplification; Push-Pull High-Frequency Equalization; Push-Pull Low-Frequency Equalization; Push-Pull Volume Compression; Automatic Volume Limitation; Automatic Volume Control; Calibrated V. U. Indicator; Audio Spectrum Control; Remote Control

If you are interested in the latest audio developments, you can't afford to be without this complete compilation of authentic articles on Direct-Coupled Amplifiers. 32 pages 8½" x 11". Over 100 diagrams and illustrations.

Priced to Cover Cost of
Printing and Mailing **25c**

Please Send U.S. Stamps or Coin Only

AMPLIFIER CO. of AMERICA
396 BROADWAY NEW YORK, N. Y.

LAWS OF THE ATOM

(Continued from page 31)

51. It was for this reason that Einstein suggested that studies of radioactivity might show the EQUIVALENCE of mass and energy.

52. Einstein's statement is that the amount of energy, E , equivalent to a mass, m , is given by the equation $E=mc^2$ where c is the VELOCITY OF LIGHT.

53. From this equation, one kilogram (2.2 pounds) of matter, if converted ENTIRELY into energy, would give 25 billion kilowatt hours of energy. This is equal to the energy that would be generated by the total electric power industry in the United States (as of 1939) running for approximately two months.

54. Compare this fantastic figure with the 8.5 kilowatt hours of heat energy which may be produced by BURNING an equal amount of coal.

55. Until the atomic power research program, no instance was known of matter being converted into energy without more energy being used to produce the transformation than was released by it.

56. Two axioms of physics stated: (1) MATTER can be neither created nor destroyed; (2) ENERGY can be neither created nor destroyed. For all practical purposes they were true and separate principles until about 1940.

57. It is now known that they are, in fact, two phases of a single principle, for we have discovered that energy may sometimes be CONVERTED into matter and matter into energy.

58. Such conversion is observed in the

phenomenon of nuclear FISSION of uranium, a process in which atomic nuclei split into fragments with the release of an enormous amount of energy.

59. The extreme size of the CONVERSION FACTOR explains why the equivalence of mass and energy is never observed in ordinary chemical combustion.

60. We now believe that the heat given off in such COMBUSTION has mass associated with it, but this mass is so small that it cannot be detected by the most sensitive balances available.

61. Transformation of matter into energy is an entirely different sort of phenomenon than the usual chemical transformations, where the matter is changed into a different form but its MASS persists.

62. From the standpoint of the Laws of the Conservation of Matter and of Energy alone, transformation of matter into energy results in the DESTRUCTION of matter and CREATION of energy.

63. The OPPOSITE transformation, which astronomers believe may be going on in some of the stars, amounts to the destruction of energy and the simultaneous creation of matter.

64. It is difficult for us to imagine the reconciliation of two such different concepts as matter, with its characteristic mass or weight, and energy, which does not have this quality. We shall, perhaps, be forced to think of the stuff of the universe as some such combination of matter and energy as would be symbolized by the coined word "MATTERGY."

—Science Service, Washington

COMMON RADIO ABBREVIATIONS

No standard set of radio abbreviations is in universal use. The reader will note slight differences in every book or magazine he picks up. The table here is the result of a careful survey of the best usage, and the reader should be able to interpret all regular radio abbreviations with its help. It is also a safe guide for the radio writer.

Commonest variations from the list are the hyphenated adjectives, thus: *r-f choke, a-c line*. Many use capital letters for the bulk of the noted abbreviations, and in many cases periods follow one-word terms as well as the parts of two-word abbreviations, which are followed by periods in this table.

Certain terms describing Government agencies, complete pieces of apparatus, methods or systems have already been accepted in practice as abbreviations in capitals without no spacing or periods between them. Examples are: FCC, FM, PA, PM. Another commonly accepted abbreviation is O.K., in capitals with periods.

The only terms likely to cause confusion are those used to denote microhenries and microfarads. The term *micro* is here represented by the Greek μ . In some works, *microhenry* is denoted by mh. Usually in such cases, *millihenry* is abbreviated *Mh*. *Micro-microfarad* may be represented in any one of twelve ways: $\mu\mu f$, $\mu\mu fd$, mmf , $mmfd$, $\mu\mu$, μf and μfd (*picofarad*) and by all the above followed by periods. a.c. — alternating current

a.f. — audio frequency
AM — amplitude modulation
amp — ampere
a.v.c. — automatic volume control
b.f.o. — beat frequency oscillator
cm — centimeter
c.p.s. — cycles per second
c.w. — continuous wave
db — decibel
d.c. — direct current
dx — distance
FM — frequency modulation
h — henry
h.f. — high frequency
i.f. — intermediate frequency
in. — inch
kc — kilocycle
kw — kilowatt
ma — milliamperes
mc — megacycle
meg — megohm
mh — millihenry
mm — millimeter
PA — public address
PM — permanent magnet speaker
r.f. — radio frequency
r.p.m. — revolutions per minute
sec — second
t.r.f. — tuned radio frequency
u.h.f. — ultra high frequency
v — volt
v.h.f. — very high frequency
w — watts
 μf — microfarad
 $\mu\mu f$ — micromicrofarad
 μh — microhenry

In text it is preferable in most cases to spell out the less common or shorter terms in full.

POCKET RADIO CHECKER

(Continued from page 22)

4 x 7 inches and are 3/16 thick. Sides are 3 x 7 x 3/16 inches. For the ends 3/8-inch thick material is used and the two pieces measure 3 x 3 3/4 inches. Meter holes may be cut with a coping saw or circle cutter and then filed smooth. Three holes will have to be made in one end for power input, receptacle and push button.

Making the Shunts

These may be constructed with a fair degree of accuracy and later adjusted to exact values. All the current shunts

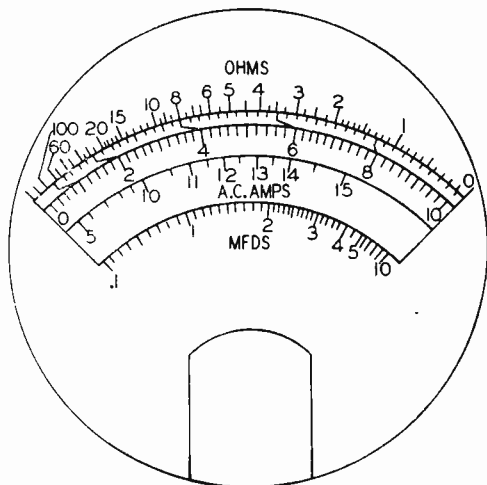

Fig. 2.—Facsimile of the special meter scale.

can be wound on one piece of plastic rod, the ohmmeter and condenser resistors on another. Exact value shunts and resistors can be purchased, thus saving a lot of calibration.

Winding the copper shunts is just as important as is obtaining the correct length of wire. Since copper stretches very easily no attempts should be made to wind tightly. Loosely wound bobbins will therefore be more accurate than a nice looking tight-wound one.

5 feet 3-4/5 inches of No. 20 wire will equal .055 ohm. 5 feet 2 1/2 inches of No. 30 wire will equal .55 ohm. 57 feet 6 inches of No. 30 wire will equal 6.05 ohm. 42 feet 5 1/4 inches of No. 40 wire will equal 45.4 ohms.

Odd value resistors may be made up by series or parallel combinations. 700 ohms in parallel with 800 ohms will make a 370-ohm resistor. The 7800-ohm resistor can be made up with a 7500-ohm and a 300-ohm resistor in series. Multipliers are one watt unless marked otherwise.

Three types of markings are needed on the dial; an ohmmeter scale showing 45, 450 or 4500 ohms at the center point; calibrations for 1, 10, or 100 d.c. ranges and an a.c. marking for making low voltage readings. These dials are available at most supply houses and come in different types for the various meter makes. The correct dial for your meter is ordered by the meter model

number. The original 1-10 dial scale may be used and charts made for a.c., ohms and capacity scales. The scale in Fig. 2 was drawn by the author, and represents several hours' work.

Calibration Check

With the box made, shunts wound and assembly completed, a check for accuracy can be made. Exactness can be compared with a quality multimeter, and any inaccuracies adjusted. A substitution method for checking is possible, if a good standard meter is not obtainable for the calibration, though in most cases it will be possible to borrow a voltmeter, ohmmeter or milliammeter, and check one or more of the scales. If none of these are obtainable, a fairly accurate check of voltages may be made with new batteries of good make, with a bleeder across them to draw a small current. In some cases a voltmeter covering one of the scales may be obtained and a battery voltage measured exactly with it, then used to calibrate other scales.

Precision resistors plus known voltages may be used for checking milliammeter scales (a 500-ohm, 5-watt, and a 50,000-ohm unit will be found very useful). In such cases, low-resistance sources should be used. For example, a 50-volt B battery will probably not maintain its voltage if subjected to a 100-ma drain, where a storage battery will deliver many amperes without drop.

For drains of a few milliamperes, heavy-duty B batteries will be found sufficiently stable.

Resistance scales are checked with precision resistors of known value. Readings of the ohmmeter should compare favorably with the known resistor values. The resistors can be used in the future to check the ohmmeter batteries.

Failure of the meter to show the correct value will indicate that the battery has run down too far to be useful.

The capacity scales may also be checked with the two resistors. A reading of .66 milliamperes should be obtained on the C x 1 range for 50,000 ohms, .13 for 50,000 ohms on C x 10 and .54 for 500 ohms on the C x 100 range. If these three readings are obtained, the scale which accompanies this article will be correct for your meter (based on 1 milliamperes d.c. scale). Since a.c. is measured on the same shunts as d.c., separate calibration is unnecessary. This completes the calibration of the wide range pocket tester. Constant usage will soon make it the handiest piece of test equipment in your shop and its small size makes it a handy instrument for outside jobs, where it can be used to perform a wider variety of jobs than most meters of comparable bulk and weight.

RADIO PARTS SOUND SYSTEMS ELECTRONIC APPARATUS

★ Depend on
RADOLEK ★

Radolek's big Free Profit Guide Catalog and Profit Bulletin supplements keep you abreast of the rapidly changing radio situation. Buying from Radolek means greater values, better service and more profits. Make Radolek your buying headquarters.



RADIO PARTS



SOUND SYSTEMS

FREE
CATALOG

Large Stocks
Fast Service

SEND TODAY!

RADOLEK CO., Dept. RA-46
601 W. Randolph St., Chicago 6, Ill.
Please send your FREE Profit Guide Catalog.

Name.....

Address.....

SAVE AT RADOLEK

Elementary Engineering Electronics

With Special Reference to Measurement and Control

by Andrew W. Kramer

Managing Editor, Power Plant Engineering
Member American Institute of Electrical Engineers

Associate Member Institute of Radio Engineers
This is a PRACTICAL treatment of principles and applications—non-mathematical.

ORDER THIS UNIQUE BOOK NOW

Check, money order or cash must accompany order.

Instruments

THE MAGAZINE OF

Measurement and Control

Offers a balanced diet of articles and special features appealing to production men as well as to research men — to executives and apprentices.

SUBSCRIBE NOW

Instruments Publishing Co.
1132 Wolfendale St., Pittsburgh 12, Pa.

Enclosed is \$2.00 for which send me Kramer's ELEMENTARY ENGINEERING ELECTRONICS.

Enclosed is \$2.00 for which send me Instruments for one year. (Foreign subscriptions \$7.00 per year.)

Name.....

Address.....

MAXIMUM FIDELITY

(Continued from page 3)

reduced greatly over the conventional open-back enclosure.

When a speaker is placed in an enclosure of this type, the back wave of the speaker is added in phase with the front wave through the port in the cabinet, which adds to the acoustic power obtainable at low frequencies. As a matter of fact, the radiation from the port exceeds the radiation from the cone at very low frequencies. This increases the low-frequency response, extending it approximately an octave lower, while at the same time more heavily damping the frequencies above this point. This tends to smooth out the response from the lower limit up.

Damping material is placed in the baffle behind the speaker to absorb the back wave. If this were not done, it would reflect from the back and cancel some of the higher frequencies emerging from the cone. This would give rise to very uneven high-frequency response. The overall effect is an enormous im-

provement in the bass and a clear high frequency response.

provement in the bass and a clear high frequency response. The dimensions given are approximate and there are two ways to vary the box's resonant frequency. The easiest method is to vary the port size by placing a book over part of it while feeding several volts of 60-cycle a.c. into the speaker voice coil from a filament transformer. When the proper size is arrived at, a piece of wood may be screwed over part of the port inside the box. The right position is where the greatest amplitude appears at 60 cycles.

The more difficult method is to move the back of the baffle in or out of the box until the desired result is obtained. For the 15 and 18-inch speakers it would be desirable to use a 30 or 40-cycle source for adjusting the baffle. The source should be a high-quality audio oscillator, with low distortion.

For AM or shellac pressing reproduction, a single speaker with response up to 5000 or 7500 cycles will be adequate.

For FM or transcription reproduction, better results can be obtained with a dual speaker system, with a small high-frequency speaker added to extend the range of the larger unit.

Several coaxial units are available, ranging in price from \$30 to over \$250.

Photo C shows a Jensen 18-inch low frequency speaker, a 14-inch speaker and a Jensen C3 tweeter. This combination is capable of reproducing the range from 30 to over 15,000 cycles.

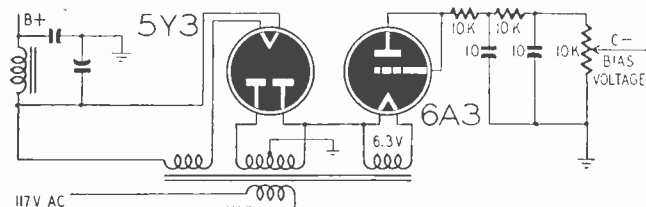

Fig. 5—Simple bias supply which works from the power transformer.

provement in the bass and a clear high frequency response.

The baffle in Photos A and B was built for an 18-inch speaker, but this type of baffle works wonders on any size speaker. Fig. 6 gives the dimensions for all standard sizes. The enclosure

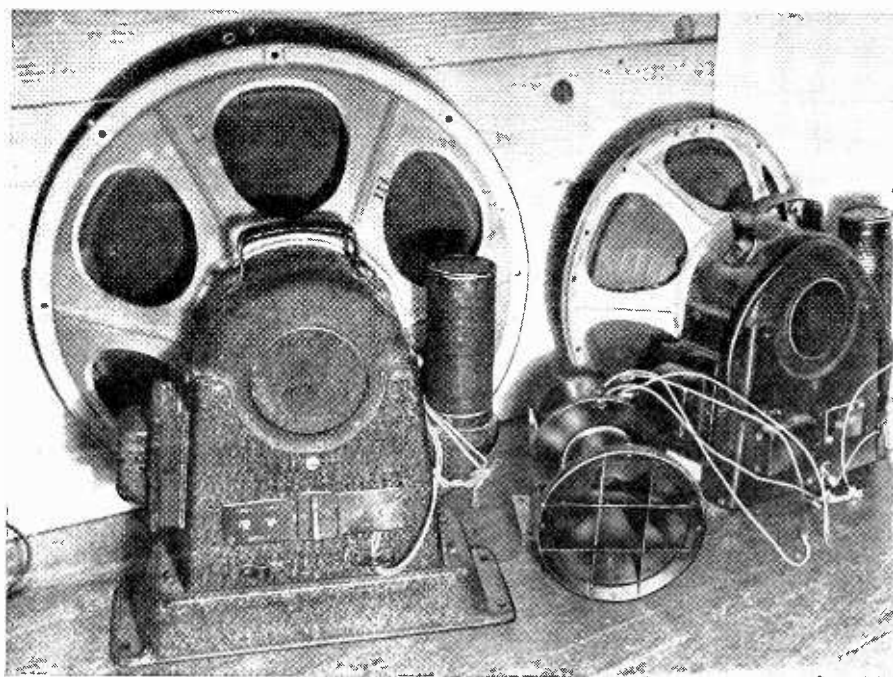
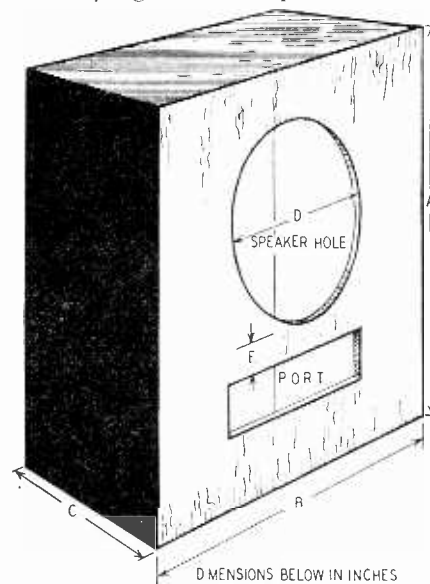

Photo C—A combination of speakers to provide high fidelity from 30 to 15,000 cycles

The best place for a speaker in any room is in a corner facing the longest diagonal. In this position the enclosure is best able to match the room's acoustic impedance. Place the speaker far enough from the turntable so acoustic feedback will not occur from mechanical coupling at low frequencies.



S	A	B	C	D	E	P O R T
8	24	18	11	7	3	1/2 AREA OF SPEAKER HOLE "D"
10	28	22	12	9.5	3	" " " " " "
12	31	24	13	11	3.5	" " " " " "
15	34	26	14	13.5	4	9/16 " " " " " "
18	40	27	14	16	4.5	5/8 " " " " " "

Fig. 6—Correct dimensions of speaker baffle (The first column "S" shows speaker diameter)

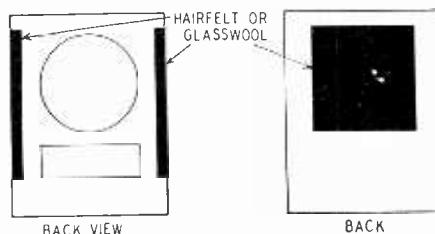

Don't ruin records with worn needles. A regular steel needle will play one side of a 12-inch disc and should not be used further, as it will develop a pronounced flat spot with a sharp cutting edge which will tear up the next record. It will also allow the pickup to chatter in the groove, giving rise to a particularly obnoxious type of distortion.

It is a good investment to purchase a pickup with a built-in permanent stylus. The pressure on the record of these units is usually less than the replaceable-needle types. There is much less acoustical chatter, the hiss is lower and the sapphire stylus is kinder to your records.

In the case of transcriptions, it is necessary to use a light-weight pickup, preferably with sapphire or diamond needles. The one greatest cause of surface noise on records is dust. They should be stored in dustless envelopes.

FREQUENCY MODULATION and AMPLITUDE MODULATION

Push-Pull Direct-Coupled Class "A"

DELUXE AMPLIFIER



MODEL ACA-100DC

Developed for all amplifier applications requiring a wide pass-band and low inherent amplitude and cross-modulation distortion. Particularly adapted for studio monitoring, record evaluation, microphone and speaker measurements, as well as absolute-fidelity amplification of FM and AM radio programs and all types of recording.

SPECIFICATIONS

TUBES REQUIRED:	2-12SC7, 2-12SK7, 2-6SC7, 2-6SJ7, 2-6L6G, 1-5V4G, 1-5U4G, 1-BBR
OVERALL GAIN:	Phono-Radio; 96 DB
NO. OF STAGES:	Five
RATED POWER OUTPUT:	23 Watts
HARMONICS AT RATED OUTPUT:	Less than 1%
HARMONICS AT 1/2 RATED POWER:	0.5%
NOMINAL POWER OUTPUT:	35 Watts
HARMONICS AT NOMINAL POWER OUTPUT:	Less than 5%
PEAK POWER OUTPUT:	39 Watts
HUM AND NOISE LEVEL:	-40 VU
MUSICAL RANGE ± 1 DB:	10 Octaves
NORMAL RESPONSE ± 1 DB:	20 to 20,000 Cycles
CONTROLS:	Radio, Phono, High Frequency, Low Frequency, Expander-Suppressor, Timing, Master Gain Control
HIGH FREQUENCY CONTROL RANGE:	From +13 db to -8 db at 10,000 Cycles
LOW FREQUENCY CONTROL RANGE:	From +14 db to -8 db at 100 Cycles
DIALOGUE FILTER RANGE:	-10 db at 50 Cycles
EXPANSION RATIO:	Adjustable up to 10 db
EXPANDER TIMING CONTROL:	Adjustable from 0.05 to 0.5 seconds
SCRATCH SUPPRESSOR:	Non-Frequency Discriminating
SCRATCH REDUCTION:	10 db
DYNAMIC RANGE:	83 db
INPUT CHANNELS:	Two
INPUT IMPEDANCES:	500,000 Ohms
MINIMUM INPUT SIGNAL:	Phono or Radio Input; 0.02 Volts
OUTPUT TERMINALS:	4/8/16/500 Ohms
BETWEEN TERMINALS:	1/2/6/10/12/83/100/125/150/166 Ohms
LINE VOLTAGE:	105/120 Volts 50/60 Cycles
POWER CONSUMPTION:	150 Watts
SWITCHES:	Expander, Dialogue Filter, Scratch Suppressor, On-Off
DIMENSIONS:	17" x 10" x 10"
NET WEIGHT:	40 Lbs.
SHIPPING WEIGHT:	55 Lbs.
MODEL NO.:	ACA-100 DC
GUARANTEE:	Five Years
LIST PRICE:	\$312.00
NET PRICE:	\$187.20
MATCHED SET OF TUBES. NET PRICE	\$12.07

*Trademark Registered U. S. Patent Office.

AMPLIFIER CORP. of AMERICA
396 Broadway **New York 13, N. Y.**

You can't put the *squeeze* on "Sealdtite" Capacitors

Take a genuine "Sealdtite" capacitor and try to squeeze it. No "soft spots."
Why? Because this Solar capacitor has its high purity paper-and-foil-winding ingeniously molded into a cylinder of solid wax.

No atmospheric moisture can penetrate this protective housing to attack the capacitor element. In genuine wax-molded "Sealdtite" capacitors, there just is no possibility of those twin omens of trouble — soggy cardboard tubes and moisture-filled hollows.

For real reliability, specify Solar "Sealdtites" on your next order.

P.S. If you haven't a copy of our Catalog get one from your Solar distributor, or drop us a penny postcard today.



SOLAR CAPACITOR SALES CORP.

285 Madison Avenue • New York 17, N. Y.

Ⓢ1009

