

POPULAR ELECTRONICS

~~\$1.50~~

SPECIAL
\$1.25

ELECTRONIC EXPERIMENTER'S HANDBOOK

1972 WINTER EDITION

**PLANS
PATTERNS
SCHEMATICS**

- ELECTRONIC AIR FILTER
- RIAA/NAB AUDIO PREAMP
- TOUCH CONTROL SWITCH ● 4-WAY
- HI-FI SPEAKER SYSTEM ● GETTING TO
- KNOW DIGITAL LOGIC ● DYNAMIC
- DIODE TESTING ● PHOTO WASH TEST
- LASER COMMUNICATOR ● MIXING
- AUDIO ● SUBSTITUTION BOX ● REMOTE
- CAMERA SHUTTER RELEASE ● IGNITION
- LOCK ● UJT CIRCUITS ● IMPROVED
- HI-FI BASS RESPONSE ● HOW
- TO GET THE BEST TV
- RECEPTION ● WILD
- GUITAR SOUNDS



Update your Radio/TV skills with these aids

Completely up-to-date, written by experts and easy to follow . . . they are "best sellers" to radio/TV technicians and amateurs alike.

COLOR-TV FIELD-SERVICE GUIDES

Invaluable for servicing Color-TV in the customer's home. Each volume contains 80 diagrams covering over 3,000 chassis sensibly organized with detailed chassis layout charts on one page and specific adjustment procedures on opposite page. Indexed for instant reference.

Vol. 1 No. 20796—\$4.95
Vol. 2 No. 20807—\$4.95
Vol. 3 No. 20847—\$4.95



TRANSISTOR AUDIO AMPLIFIERS

By Jack Darr

Gives you a good, working knowledge of transistor circuits found in audio equipment of all sizes. Shows how the circuits work normally, what changes take place when trouble occurs, and how to service the solid-state equipment. An invaluable guide for all who service transistor circuits. No. 20838—\$5.50



1-2-3-4 SERVICING TRANSISTOR COLOR TV

By Forest H. Belt and Associates

Details the simple 1-2-3-4 servicing method and steps that get transistor Color-TV sets fixed easily and right every time. No. 20777—\$4.95



1-2-3-4 SERVICING AUTOMOBILE STEREO

By Forest H. Belt & Associates

Explains the simple 1-2-3-4 servicing method, shows how easy it is to apply the method to automobile stereo, fm multiplex, and tape cartridge systems. Clear, easy-to-read illustrations, charts and schematics to make servicing easy. No. 20737—\$3.95



STUDY GUIDE FOR CET EXAMINATIONS

By J. A. Wilson, CET and Dick Glass, CET

A comprehensive review of the material covered by the CET (Certified Electronics Technician) examination. It's almost a "must" for gaining a CET designation, for passing a state or local licensing exam, or as a "brush-up" in applying for a position in the electronics field. Includes question-and-answer sections and a 50-question test in each chapter. No. 20834—\$5.95

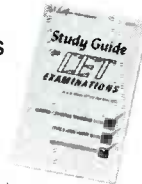

UNDERSTANDING OSCILLATORS

By Irving M. Gottlieb

What you want to know about oscillators . . . how they work, their many personalities and variations, strong and weak points, how they are used in practical applications, how to service them. A most useful text for engineers and technicians. No. 20837—\$4.50



99 ELECTRONIC PROJECTS

By Herbert Friedman

An intriguing, easy-to-follow book for hobbyists as well as those experienced in electronics. Covers sixteen groups of projects, including audio, photography, automotive, remote controls, lamp and motor control circuits, etc., many of which can be built inexpensively. No. 20818—\$3.50



101 QUESTIONS AND ANSWERS ABOUT CB ANTENNAS

By Jim Ashe

Best overall guide to the selection and installation of the proper antenna for your Citizens band radio. An ideal guide for beginners, it also answers questions about how to improve performance and range of already operating equipment and to repair and maintain CB antennas. No. 20749—\$2.95



CITIZENS BAND RADIO HANDBOOK, 4th Edition

By David E. Hicks

Now that two-way radio is available to any citizen, this revised edition answers the many problems and questions of all who use, or plan to use, CB equipment. Covers how to obtain a CB license, operating procedures, equipment, accessories, circuit analysis, servicing data, trouble-shooting hints, etc. No. 20839—\$4.95



SECOND-CLASS RADIOTELEPHONE LICENSE HANDBOOK, 4th Edition

By Edward M. Noll

Information needed to pass the 2nd class FCC radiotelephone exam. Questions and answers are based on the FCC exam for Elements I, II and III. Also covers communications theory and practices, solid-state two-way equipment, FCC Rules and Regulations, operating practices and procedures, reference date, etc. No. 20824—\$6.50

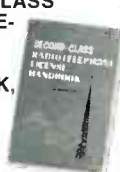

You'll find everything you want to know about Radio or TV in the modern Sams Technical Library. Send for our free catalog.



HOWARD W. SAMS & CO. INC.

HOWARD W. SAMS & CO., INC.

Order from your Electronics Parts Distributor, or mail to Howard W. Sams & Co., Inc., Dept. EX-091, 4300 West 62nd Street, Indianapolis, Indiana 46268.

Send books checked at right. \$_____ enclosed. Please include sales tax where applicable.

Send FREE 1971 Sams Book Catalog.

Name _____ (Please Print)

Address _____

City _____ State _____ Zip _____

- | | |
|--------------------------------|--------------------------------|
| <input type="checkbox"/> 20796 | <input type="checkbox"/> 20834 |
| <input type="checkbox"/> 20807 | <input type="checkbox"/> 20837 |
| <input type="checkbox"/> 20847 | <input type="checkbox"/> 20818 |
| <input type="checkbox"/> 20838 | <input type="checkbox"/> 20749 |
| <input type="checkbox"/> 20777 | <input type="checkbox"/> 20839 |
| <input type="checkbox"/> 20737 | <input type="checkbox"/> 20824 |

CIRCLE NO. 13 ON READER SERVICE CARD

Kit for kit, text for text, dollar for dollar, your best home training buy is NRI

Discover the ease and excitement of learning Television Servicing, Communications, Electronics with equipment designed from chassis up for your education.

After nearly 60 years of training men for successful careers in various fields of Electronics, NRI knows that theory alone is not enough. To properly learn at home, your hands must be trained as well as your head.

Regardless of your educational background, you can learn the Electronics field of your choice the practical NRI way. The NRI color catalog, sent to you free and without obligation, tells you in detail how NRI combines designed-for-learning equipment with "bite-size" texts, so you can use what you build to prove out what you read. Catalog also tells you how to qualify quickly for high-pay jobs in TV-Radio Servicing, Communications, Computer Electronics.

All this is yours when you train at home with NRI

The NRI catalog you get also gives you details about the training kits included, at no extra cost, with the home training program of your choice. Shown below is the



special equipment included in a typical course: educator-acclaimed Achievement Kit, transistorized volt-ohm meter, solid-state radio, even your own custom-designed Color TV set to build and use for years of viewing pleasure. With NRI, Electronics comes alive in the most valuable, practical manner. You experiment with the same professional components and circuits you'll find on the job — not breadboard or hobby kits.

Regardless of manpower needs in other fields, Color TV Servicing continues to need trained men to keep pace with millions of sets being sold every year. You can take your choice of full-time jobs in this or other exciting fields of Electronics, or have a business of your own, or make \$5 to \$7 an hour extra in spare time starting soon after you enroll, fixing sets for friends and neighbors.

And if you choose one of five NRI courses that include FCC License preparation, you must earn your FCC License or NRI refunds your tuition in full! Here's further proof that any ambitious man, regardless of his education, can effectively learn and profit

from the Color TV, Communications or Electronics course of his choice.

Get your hands on more money — fast

Tens of thousands of NRI graduates are proof it is practical to train at home in your spare time . . . proof of why NRI continues to be the country's largest Electronics home-study school. Decide now to reap the rewards of NRI's fast, "hands-on" method of home education. Mail the postage-free card for the new NRI Catalog. No obligation. No salesman will call. NATIONAL RADIO INSTITUTE, Washington, D.C. 20016. In Canada write: NRI Canada, 330 Progress Ave., Scarborough, Ont.

APPROVED UNDER GI BILL

If you served since January 31, 1955, or are in service, check GI line on postage-free card.

MAIL CARD
FOR FREE
CATALOG
NO SALESMAN
WILL CALL

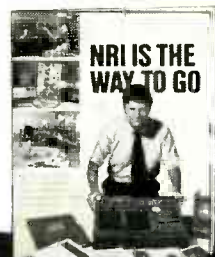



THE 2 MOST IMPORTANT RECORDS IN YOUR ENTIRE COLLECTION!



New Standard in Stereo Testing! The All-New Model SR12 STEREO TEST RECORD
The most complete . . . most sophisticated . . . most versatile Test Disc available today!

The Most Spectacular Sound Exhibition of STEREO FIDELITY Ever Available on one Disc.

Whether you're an avid audiophile who'll settle for nothing but peak performance from his stereo components . . . a casual listener who'd like more insight into the challenging world of stereo reproduction . . . or a professional technician who needs precise standards for lab testing . . . the new MODEL SR12 will be the most important disc in your entire collection. SR12 has been produced by Stereo Review Magazine for music lovers who want immediate answers to questions about the performance of their stereo systems and how to get the best possible sound reproduction. SR12 is the most complete test record of its kind—containing the widest range of checks ever included on one test disc.

MAKE THESE IMPORTANT STEREO CHECKS BY EAR . . . (NO INSTRUMENTS OF ANY KIND REQUIRED)

FREQUENCY RESPONSE — a direct warble-tone check of nineteen sections of the frequency spectrum, from 20 to 20,840 Hz • **SEPARATION** — indicates whether you have adequate separation for good stereo • **CARTRIDGE TRACKING** — devised for checking the performance of your cartridge, stylus and tone arm • **CHANNEL BALANCE** — two broad-band, random-noise signals which permit you to eliminate any imbalances originating in cartridge, amplifier, speakers or room acoustics • **HUM AND RUMBLE** — foolproof tests that help you evaluate the actual audible levels of rumble and hum in your system • **FLUTTER** — a sensitive "musical" test to check whether your turntable's flutter is low, moderate, or high • **PLUS:** Cartridge and Speaker Phasing • Anti-Skating Adjustment • "Gun Shot Test" for Stereo Spread • Multi-purpose Musician's "A" • Equal-tempered Chromatic Octave • Guitar-tuning Tones.

FOR THE ULTIMATE IN STEREO TESTING, 7 CRITICAL TEST EQUIPMENT CHECKS . . .

Attention professionals: Model SR12 is also designed to be used as a highly efficient design and measurement tool. In the following tests, recorded levels, frequencies, etc. have been controlled to laboratory tolerances—affording accurate numerical evaluation when used with oscilloscope, chart recorder, output meter, intermodulation-distortion meter and flutter meter.

- 1,000-Hz square waves to test transient and high-frequency response of phono pickups.
- 500 to 20,000 Hz frequency-response sweep.
- Sine-wave tone-bursts to test transient response of pickup.
- Intermodulation test using simultaneous 400-Hz and 4,000-Hz signals.
- Intermodulation sweep to show distortion caused by excessive resonances in tone arm and cartridge.
- 1,000-Hz reference tones to determine groove velocity.
- 3,000-Hz tone for flutter and speed tests.
- **Sample waveforms** — Illustrating both accurate and faulty responses are provided in the Instruction Manual for comparison with the patterns appearing on your own oscilloscope screen.

FREE 8 Page Instruction Manual includes detailed instructions, charts, tables and diagrams.

Only \$5.98 each

Descriptive Booklet Enclosed includes discussion of the selections on the record, plus a complete description of each selection and the purpose behind its demonstration.

FREE

NOTE — THE STEREO DEMONSTRATION RECORD ONLY IS AVAILABLE IN YOUR CHOICE OF 33 1/3 RPM OR 45 RPM

Both the Model SR12 Stereo Test Record and Stereo Demonstration Record are processed and pressed on a newly developed, improved vinyl. It is permanently anti-static, repels dust and dirt and promotes longer stylus wear. The use of this material is conducive to low surface noise and contributes to the production of full dynamics and frequency range. The record continually looks new, sounds new and wears longer.

RECORDS • Ziff-Davis Service Division
 595 Broadway • New York, N.Y. 10012

My check (or money order) for \$_____ is enclosed.
 Please send:

_____ Stereo Review Stereo Demonstration Records at \$5.98 each, postpaid.

Check one: 33 1/3 RPM 45 RPM

_____ Model SR12 Stereo Test Records at \$5.98 each, postpaid.

(Outside U.S.A. please send \$8.00 per record ordered.) New York State residents please add local sales tax.

EEH-W72

Print Name _____
 Address _____
 City _____
 State _____ Zip _____

PAYMENT MUST BE ENCLOSED WITH ORDER

Copyright © 1971 by ZIFF-DAVIS PUBLISHING COMPANY. All rights reserved.

William Z. H. President; Hershel B. Sarbin, Senior Vice President and Secretary; Philip Sime, Financial Vice President and Treasurer

ELECTRONIC EXPERIMENTER'S HANDBOOK

CONTENTS

AUDIO/STEREO PROJECTS

THE FRISKY FOUR SPEAKER SYSTEM	8	<i>David B. Weems</i>
BUILD A WOOFER GUARD	49	<i>Phil Arthur</i>
BUILD AN AUDIO MULTICOUPLER	65	<i>Don M. Wherry</i>
MODIFY YOUR ELECTRONIC GUITAR SOUND	77	<i>John S. Simonton, Jr.</i>
BUCK UP BASS RESPONSE WITH A SUPER WOOFER	90	<i>Eric Pavlak</i>
WIRE MUSIC	117	<i>Nyle A. Steiner</i>
BUILD A RIAA/NAB PREAMPLIFIER	131	<i>Norman P. Huffnagle</i>

TEST EQUIPMENT PROJECTS

MICRO'LIGN GENERATOR	44	<i>Michael S. Robbins</i>
ELECTRONIC OVERLOAD PROTECTION	74	<i>John L. Keith</i>
MAKE YOUR VTVM A MEGGER TOO	82	<i>James Childs and John Eskridge</i>
BUILD DYNAMIC DIODE TESTER	110	<i>Charles L. Andrew</i>
500/50-KHZ FREQUENCY STANDARD	135	<i>Neil Johnson</i>
"SUPER" SUBSTITUTION BOX	137	<i>Ralph Tenny</i>

USEFUL HOUSEHOLD PROJECTS

BUILD A TRANSCIPITOR	13	<i>Waldo T. Boyd</i>
TC SWITCH—FOR REMOTE CONTROL	21	<i>Jack Bechtold</i>
BUILD THE BUG SHOO	39	<i>Lyman E. Greenlee</i>
BUILD A LOW-COST TIME DELAY RELAY	48	<i>John Stayton</i>
NO SNOW IN JUNE	71	<i>George Monser</i>
REMOTE CAMERA SHUTTER RELEASE	83	<i>A. A. Mangieri</i>
BUILD A PHOTOGRAPHIC WASH TESTER	103	<i>Andre Brosnac</i>
SUPER FLASH	107	<i>Thomas Couch</i>
AUTOMATIC LIGHTNING PROTECTION	113	<i>Howard Phillips</i>
DEHUMMING SMALL RECEIVERS	122	<i>Ronald L. Ives</i>
STAGE LIGHTING CONTROL SYSTEM	128	<i>Gerald Thurow</i>
ELECTRONIC COMBINATION IGNITION LOCK	141	<i>John Beiswenger</i>

EXPERIMENTS & TUTORIAL

BUILD THE DIGITAL LOGIC MICROLAB	25	<i>Don Lancaster</i>
BURNING OUT YOUR CIRCUITS WITHOUT REALLY TRYING	43	<i>Errol J. Queen</i>
LASER BEAM COMMUNICATOR	53	<i>C. Harry Knowles</i>
IC EXPERIMENTAL PROJECTS	91	<i>Don Lancaster</i>
MAKE YOUR OWN SEVEN SEGMENT READOUT	119	<i>David C. Kroop</i>
DESIGN YOUR OWN PRINTED CIRCUITS	124	<i>Alexander W. Burawa</i>
LIGHT-OPERATED BISTABLE SWITCH	140	<i>David C. Conner</i>
TIPS & TECHNIQUES	144	
GETTING TO KNOW THE UJT	146	<i>Frank H. Tooker</i>

WINTER EDITION

1972
POPULAR
ELECTRONICS
**ELECTRONIC
EXPERIMENTER'S
HANDBOOK**

Start Of Something New

The ever-changing tenor of experimental and hobby electronics is again reflected in the editorial content of this HANDBOOK. In particular, this issue contains the most pages the HANDBOOK has ever published involving integrated circuits. For those not too familiar with IC's, one of our authors has written a feature illustrating how a single IC can be used in a variety of small experimental projects (pages 91-102). A second feature tells how integrated circuits perform digital logic functions (pages 25-34). Test equipment projects receive their share of recognition in this issue, and at the request of many readers, the plans for an electrostatic air purifier (of a somewhat unusual volume and design) have been included. Just in case you saw the exhibit, yes, the laser communicator (page 53) is the same one that was featured in the Smithsonian Institute.

OLIVER P. FERRELL
Editor

LAWRENCE SPORN
Publisher

OLIVER P. FERRELL
Editor

LESLIE SOLOMON
Technical Editor

JOHN R. RIGGS
Managing Editor

EDWARD I. BUXBAUM
Art Director

ALEXANDER W. BURAWA
Associate Editor

ANDRE DUZANT
Technical Illustrator

PATTI MORGAN
Associate Editor

JUDITH L. HOGAN
Editorial Assistant

RICHARD J. HALPERN
Advertising Manager

MARGARET DANIELLO
Advertising Service Manager

STANLEY NEUFELD
Associate Publisher

FURMAN H. HEBB
*Group Vice President
Electronics and Photographic*

ZIFF-DAVIS PUBLISHING COMPANY

Editorial, Circulation, and Executive Offices
One Park Avenue, New York, New York 10016
212 679-7200

Midwestern Office

The Pattis Group, 4761 West Touhy Ave.
Lincolnwood, Illinois 60466, 312-679-1100

GERALD E. WOLFE, DICK POWELL

Western Office

9025 Wilshire Boulevard, Beverly Hills, California 90211
213 CRestview 4-0265; BRadshaw 2-1161

Western Advertising Manager, BUD DEAN

Japan: James Yagi

Oji Palace Aoyama; 6-25, Minami Aoyama
6-Chome, Minato-Ku, Tokyo 407-1930/6821

William Ziff, President

W. Bradford Briggs, Executive Vice President
Hershel B. Sarbin, Senior Vice President and Secretary
Stanley R. Greenfield, Senior Vice President
Philip Sine, Financial Vice President and Treasurer
Walter S. Mills, Jr., Vice President, Circulation
Phillip T. Heffernan, Vice President, Marketing
Frank Pomerantz, Vice President, Creative Services
Arthur W. Butzow, Vice President, Production
Edward D. Muhlfeld, Vice President, Aviation Division
Irwin Robinson, Vice President, Travel Division
George Morrissey, Vice President
Sydney H. Rogers, Vice President
Jerry Schneider, Administrative Director,
Ziff-Davis Annuals



Member Audit Bureau
of Circulations

1972 ELECTRONIC EXPERIMENTER'S HANDBOOK, Winter Edition, is published by the Ziff-Davis Publishing Company, One Park Avenue, New York, New York 10016, also publishers of Popular Electronics, Electronics World, Stereo Review, Communications Handbook, Tape Recorder Annual, Stereo Directory & Buying Guide. Copyright © 1971 by Ziff-Davis Publishing Company. All rights reserved.

Cover photo by Conrad Studios.

ELECTRONIC EXPERIMENTER'S HANDBOOK

ELECTRONICS TECHNICIANS:

If you really want
to go places in this
Age of Electronics...

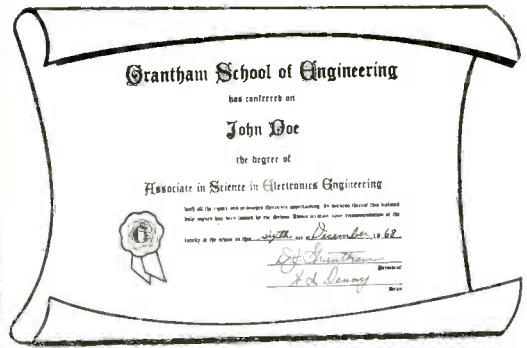

EARN YOUR DEGREE

AND GET INTO ELECTRONICS ENGINEERING!

Advance beyond the technician level. Become an engineer. If you are a high school graduate and have at least one year of experience as an electronics technician, you can earn the Degree of Associate in Science in Electronics Engineering

MOSTLY BY STUDYING AT HOME

while you remain on your present job. Grantham School of Engineering (GSE) offers a home-study program, followed by a two-week class, for the ASEE Degree. This degree is accredited by the Accrediting Commission of the National Home Study Council.

In this college-level program (presented at the same level as resident-college engineering courses), the lessons have been prepared especially for *home study*. They have been rewritten, revised, added-to, revised, expanded, revised, re-oriented, revised, etc., over a period of many years, by home-study experts in the teaching of engineering, with the one objective of providing a *better way* for technicians to learn engineering.

This *accredited* ASEE Degree program includes a review of basic electronic circuits and systems, a thorough coverage of applied engineering mathematics (including algebra, trigonometry, and calculus), classical and modern physics, technical writing, computer science, electrical networks, and semiconductor circuit analysis and design.

We award the *associate* rather than the bachelor's degree because our educational program covers only engineering and engineering-related subjects and does not cover general subjects such as English, History, Foreign Languages, etc. Notice, however, that it is a degree in *engineering* rather than the usual junior-college kind of associate degree.

We Teach Better Because We Specialize

The main purpose of the GSE educational program is to *upgrade* electronics technicians to the *engineering level*. Therefore, as a GSE student, you are not, for example,

studying math with accounting students or studying physics with medical students. Instead, all of the lessons covering all subjects are written for students just like yourself — for electronics technicians upgrading to the engineering level. This method allows electronics engineering examples and applications to be tied in with the study of all subjects in the curriculum.

Since all of our students have backgrounds similar to yours and the same professional objective as yours, we can teach all of the required subjects more directly to the point — the way they should be taught (for maximum advantage) specifically to electronics technicians who are upgrading to the engineering level — not generalized to the extent that they apply equally well to a dozen different professions! So *our way* of teaching electronics engineering is more applicable to *your need*.

For complete details, mail postcard or coupon.

Grantham School of Engineering

1505 N. Western Ave., Hollywood, Calif. 90027

Gentlemen:

I have been in electronics for _____ years. I am interested in the Grantham degree program in Electronics Engineering. Please send me your free bulletin.

Name _____

Address _____

City _____ State _____ Zip _____

CIRCLE NO. 8 ON READER SERVICE PAGE

E-8-71

The FRISKY FOUR SPEAKER SYSTEM



SMALL SPEAKERS GIVE TOP RESPONSE

BY DAVID B. WEEMS

THE IDEA OF USING several small loudspeakers in a single enclosure to obtain full-range sound was popularized by the "Sweet Sixteen" system described in *POPULAR ELECTRONICS* in January 1961. That system consisted of 16 inexpensive replacement-type speakers and utilized close coupling to achieve a fair bass range response.

In the years since the Sweet Sixteen appeared, there has been a revolution in small speaker design. Now some small speakers have a free air resonance that is from one to four octaves below that of the common replacement-type speakers of the same diameter. When a single low

resonance speaker can surpass the bass response range of several replacement types, there is little advantage in using a large number of speakers for good bass response, unless you have some special application in mind.

For conventional direct radiator systems, it is probably easier and less expensive to obtain full bass response with a single woofer. Hence, the number of small speakers used in a system should be limited to a figure which will keep the total cost less than the combined price of a large woofer, mid-range speaker, and tweeter.

The "Frisky Four" speaker system

ELECTRONIC EXPERIMENTER'S HANDBOOK

described here employs four \$3.50 speakers. The price tag makes sense, especially for speakers with rolled-edge suspensions and large (10-oz) magnet assemblies. And four speakers can be housed in a small enclosure that saves space as well as money. Frisky Four somewhat describes the transient response of the speaker system's nimble little cones.

About the System. The enclosure (see Fig. 1), designed to use a room corner for better air loading on the cones, aids the bass response. Another advantage to the triangular enclosure configuration is the absence of parallel walls; internal reflections are reduced and structural rigidity is improved, permitting simplified construction.

Working together, the speakers and

enclosure produce good sound. The system is particularly good for use with low-power amplifiers because its efficiency at low volume levels conserves audio power.

A typical location for the system in your listening room is on a corner table. If such is not available, there are many other possibilities, such as the upper corner of the room. The enclosure can be hung on the wall like a framed picture or even supported by a pole lamp. However, the junction of two walls and the ceiling is an ideal location for maximum bass response. One enclosure in each of two adjacent ceiling corners will give very good stereo coverage. An alternate possibility is a floor corner, but make sure the sound path is not blocked by furniture.

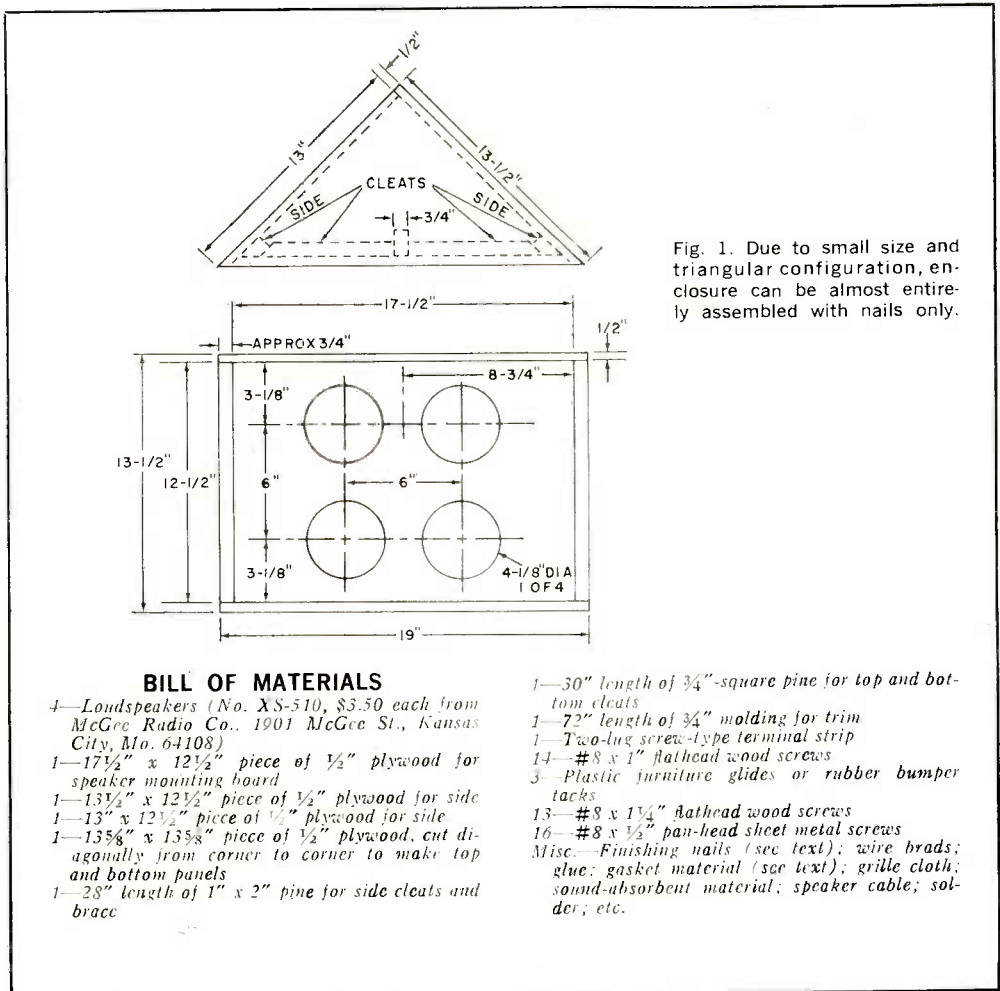

Fig. 1. Due to small size and triangular configuration, enclosure can be almost entirely assembled with nails only.

BILL OF MATERIALS

- 4—Loudspeakers (No. XS-510, \$3.50 each from McGee Radio Co., 1901 McGee St., Kansas City, Mo. 64108)
- 1—17½" x 12½" piece of ½" plywood for speaker mounting board
- 1—13½" x 12½" piece of ½" plywood for side
- 1—13" x 12½" piece of ½" plywood for side
- 1—13⅝" x 13⅝" piece of ½" plywood, cut diagonally from corner to corner to make top and bottom panels
- 1—28" length of 1" x 2" pine for side cleats and brace

- 1—30" length of ¾"-square pine for top and bottom cleats
- 1—72" length of ¾" molding for trim
- 1—Two-lug screw-type terminal strip
- 14—#8 x 1" flathead wood screws
- 3—Plastic furniture glides or rubber bumper tacks
- 13—#8 x 1¼" flathead wood screws
- 16—#8 x ½" pan-head sheet metal screws
- Misc.—Finishing nails (see text); wire brads; glue; gasket material (see text); grille cloth; sound-absorbent material; speaker cable; solder; etc.

Construction. Assembly of the enclosure is quick and easy due to the use of finishing nails and glue on the sides, top, and bottom. Such construction techniques, though not suitable for a large enclosure, are quite adequate for a small box enclosure.

Referring to Fig. 1, cut the sides, top, and bottom panels, and the speaker mounting board to the dimensions given. Notice also that you will have to make several 45° miter cuts, one at the front edge of each side, one at each end of the speaker board, and one for each of the side cleats. To save time, the angled edges of the side cleats can be made with one pass of the saw. Simply set your saw at 45° and rip the length of a 1" × 2" pine stud into two strips of equal thickness. The lengths can be trimmed to the proper dimensions later.

Strike a line on the inside surfaces of the top and bottom plates, spaced ½" in from the front edges, to show the location of the inside surface of the speaker board. Then begin assembling the enclosure by joining the sides at the rear corner. Make sure that the longer wall overlaps the shorter one. Put glue on the surfaces being joined. Then set the short-

er side in a vise, or have someone hold it upright on a solid surface, while you drive in the six-penny finishing nails. Wipe off excess glue after nailing.

Now, glue and nail the top and bottom plates to the walls as shown in Fig. 2. Cut the side cleats to the proper lengths. Glue and nail or screw the cleats in place as in Fig. 3. Three-penny finishing nails are adequate for anchoring these cleats in place if C-clamps are used to apply pressure while the glue sets. Otherwise, you will have to substitute 1" flathead wood screws.

The positions of the side cleats are defined by the lines on the inside surfaces of the top and bottom panels. Seat the cleats behind the lines, leaving space between each cleat and the line to allow for the compressed thickness of the gasket material you plan to use.

Cut a length of 1" × 2" pine to exact length for the center brace. Locate the brace behind the lines the same distance as the side cleats. Then glue and nail it in place by driving two six-penny nails through the top and bottom panels and into the butt ends of the brace.

Trim four ¾"-square lengths of pine to the exact lengths to fit between the



Fig. 2. Liberal bead of white glue between joined members helps to rigidize enclosure and provides air seal. Finishing nails anchor members together.



Fig. 3. Side cleats are miter cut at 45° angles; then glued and nailed to sides, 1/2" in from front.

brace and side cleats, cutting one end of each to 45° as shown in Fig. 4. Glue and nail or screw the cleats to the top and bottom panels. Then sand and stain the enclosure shell.

Assuming that you have already made

the speaker cutouts as shown in Fig. 1, now you must drill about thirteen 1/16" guide holes for mounting the speaker board. Locate a vertical row of three holes about 1 1/4" in from each mitered outside edge of the speaker board, and a vertical row of three holes down the center of the board. Then drill one hole between each vertical row, top and bottom. Mark each guide hole location. Then set the speaker board temporarily in place to check for possible positioning errors. When you are satisfied, remove the speaker board, and apply a coat or two of flat black paint to its front surface and the insides of the cutouts.

Remove sawdust and other debris from your work surface. Set the speaker board face down, and mount the speakers with #8 × 3/4" pan-head screws as shown in Fig. 5. Then, referring to Fig. 6, wire together the speakers. (Note: When wiring the speakers, set the enclosure shell nearby so that you can route the cable that connects the parallel wired pairs *behind* the center brace.)

Now, check the speaker polarity by momentarily touching the contacts of a D cell to the free ends of the wiring. All speaker cones in the system should move in the same direction at contact. Any that move in the opposite direction should be desoldered and the leads transposed and resoldered. Connect the bat-

Fig. 4. Front cleats are mounted on top and bottom plates between center brace and sides.

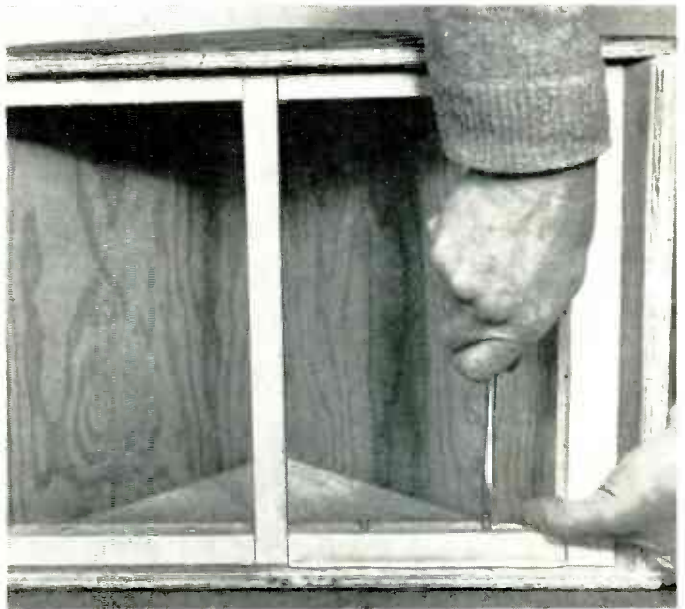



Fig. 5. Fasten loudspeakers to speaker mounting board with #8 x 1/2" pan-head sheet metal screws.

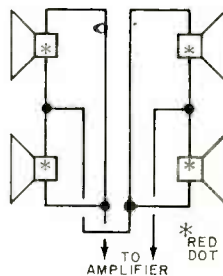

Fig. 6. Parallel-series speaker hookup is required to preserve uniformity and standard impedance. Note carefully red dot orientations. When properly wired, system connects to 8-ohm output.

tery again so that the cones move *outward*; code the wire touching the positive terminal of the battery.

Due to the angled fitting and large area of the speaker mounting board as compared to the small volume of the enclosure, air leaks might present a problem. To obviate any such problems, a gasket should be used. It can be adhesive-backed foam rubber, thin cork, or felt. Or you can run a bead of silicone rubber caulking compound along the outer surfaces of the cleats; this method provides a positive seal even for loose-fitting parts, but it makes access to the speakers difficult—if not impossible.

Another point to seal is the exit hole for the speaker cable. One method is to use a two-lug screw-type terminal strip, located at the center of the bottom plate of the enclosure. Mark and drill two 1/4" holes to accept the solder lugs. Then use the drill bit to ream out one side of the holes so they are large enough to accept both solder lug and screw end. Pass the speaker cable through the holes and solder them to the lugs. Code the screw terminal connected to the wire previously coded. Then glue and screw the terminal strip down, and attach three plastic furniture glides or rubber bumper tacks about 2" from each corner of the bottom plate.

Stuff the enclosure with fiberglass or other sound absorbent material. Begin by lining the top, bottom and sides. Then loosely fill the empty space in the middle with glass wool or cut-up pieces of fiberglass wool.

Attach the speaker board with about four evenly spaced screws and give the system a test run at normal listening volume. You can experiment at this stage by removing or adding stuffing until the sound reproduction meets with your approval. Then install the speaker board with #8 x 1 1/4" flat-head wood screws.

Tack or staple a 12 1/2" x 18" piece of grille cloth over the front of the enclosure. Then select a decorative molding to cover the raw edges of the wood and staples or tacks. Cut the molding to size, stain and finish it to match the enclosure shell, and use small wire brads to affix it in place.

If you are an apartment dweller, limited to low volume levels, you will like the Frisky Four. Some systems, particularly those with large speakers, must be driven at high levels in a large room for maximum enjoyment. This is not a matter of efficiency but of final sound intensity. The Frisky Four, however, sounds good at a low level in a small room like those in apartments. Try one and see for yourself.

BUILD A

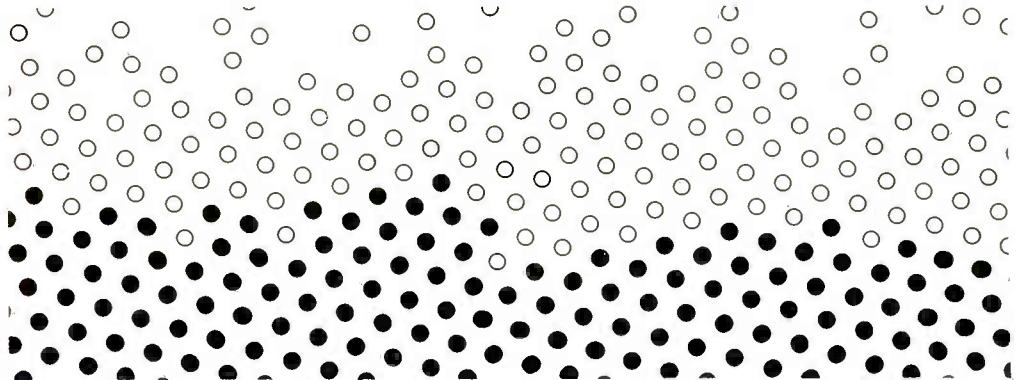

TRANSCIPITOR

GIVES YOU GOOD, CLEAN AIR FOR MANY APPLICATIONS

BY WALDO T. BOYD

HAVE YOU EVER painted a very special piece of equipment, only to have it ruined by dust or bugs while drying? Or have you ever had a delicate biological or chemical experiment spoiled by strange gases and smoke in the air? If you have either of these, or any other, needs for a source of truly clean air, the "Transcipitor" is for you.

This clean-air device uses a high-voltage charge in an enclosed column of moving air to remove dust, smoke, and other particulant matter. The column enclosure can be made from a stack of discarded coffee cans (with the ends removed) or from a length of sheet-metal downspout, topped with a small blower. The electronic "heart" of the Transcipitor is a 10-kV d.c. power supply. Power for the device can be obtained either from a 12-volt battery or a transformer/

rectifier combination operated from the 117-volt a.c. line.

How It Works. A single isolated conductor, connected to the high-voltage source, is run up through the center of the metal column—the latter being grounded. When air moves through the column all particulants receive a charge from the static field within the column. They immediately fly to the grounded column and cling there where they are joined by millions of other particles until there is actually a visible coat of dust on the inside of the column. When the power is turned off, the dust particles fall slowly to the bottom of the column and can be removed easily.

This system is essentially a miniature version of the type used in factory chimneys to remove residue from the smoke.

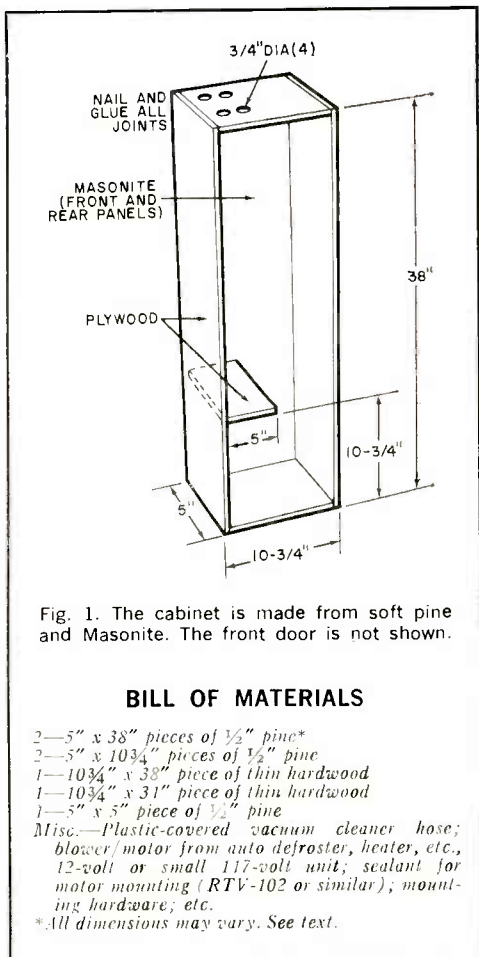

BILL OF MATERIALS

- 2—5" x 38" pieces of 1/2" pine*
- 2—5" x 10 3/4" pieces of 1/2" pine
- 1—10 3/4" x 38" piece of thin hardwood
- 1—10 3/4" x 31" piece of thin hardwood
- 1—5" x 5" piece of 1/2" pine
- Misc.—Plastic-covered vacuum cleaner hose; blower/motor from auto defroster, heater, etc., 12-volt or small 117-volt unit; sealant for motor mounting (RTV-102 or similar); mounting hardware; etc.

*All dimensions may vary. See text.

Cabinet Construction. Dimensions of the case for the Transcipitor are not critical. A layout of the author's prototype is shown in Fig. 1. Any kind of wood (such as pine) can be used for the sides, top and bottom but the front and back panels are of thin Masonite. A 5" shelf, located 10 3/4" from the bottom of the cabinet is attached to the side and rear, with another screw inserted through the front panel when it is put into place.

Four 3/4" ventilation holes are drilled in the top, while the front panel is cut 6" or 7" short to allow air to enter at the bottom. The height of the column (in this case six 1-lb coffee cans, plus the fan) dictates the height of the cabinet. It is best to assemble the column first and then build the cabinet.

If you are going to use coffee cans for the column cut the bottoms out of five of them, but leave the bottom in the sixth for mounting the fan. Stack five cans together, align them as closely as possible and spot solder them together. Wrap tape around the seams to make them airtight.

The fan is mounted on the sixth (top) can. The fan can be salvaged from an old automobile heater or an evaporative cooler, or you can buy one at a surplus supply house. A small 12-volt type is best, but a fan with a 117-volt motor can be used. The fan and motor assembly should be smaller than the top of the coffee can on which it is to be mounted.

Cut a hole in the bottom of the sixth can to fit the fan intake and mount the fan as shown in Fig. 2. Temporarily set this can (and fan) aside.

Stand the 5-can stack up. In the bottom can, drill a series of 3/16" holes about 1/8" apart around the can about 1 1/2" from the bottom. (Most cans have an indentation ring around the can at about



Fig. 2. The small fan is cemented to its hole in top of can. Make sure that the joint is airtight.

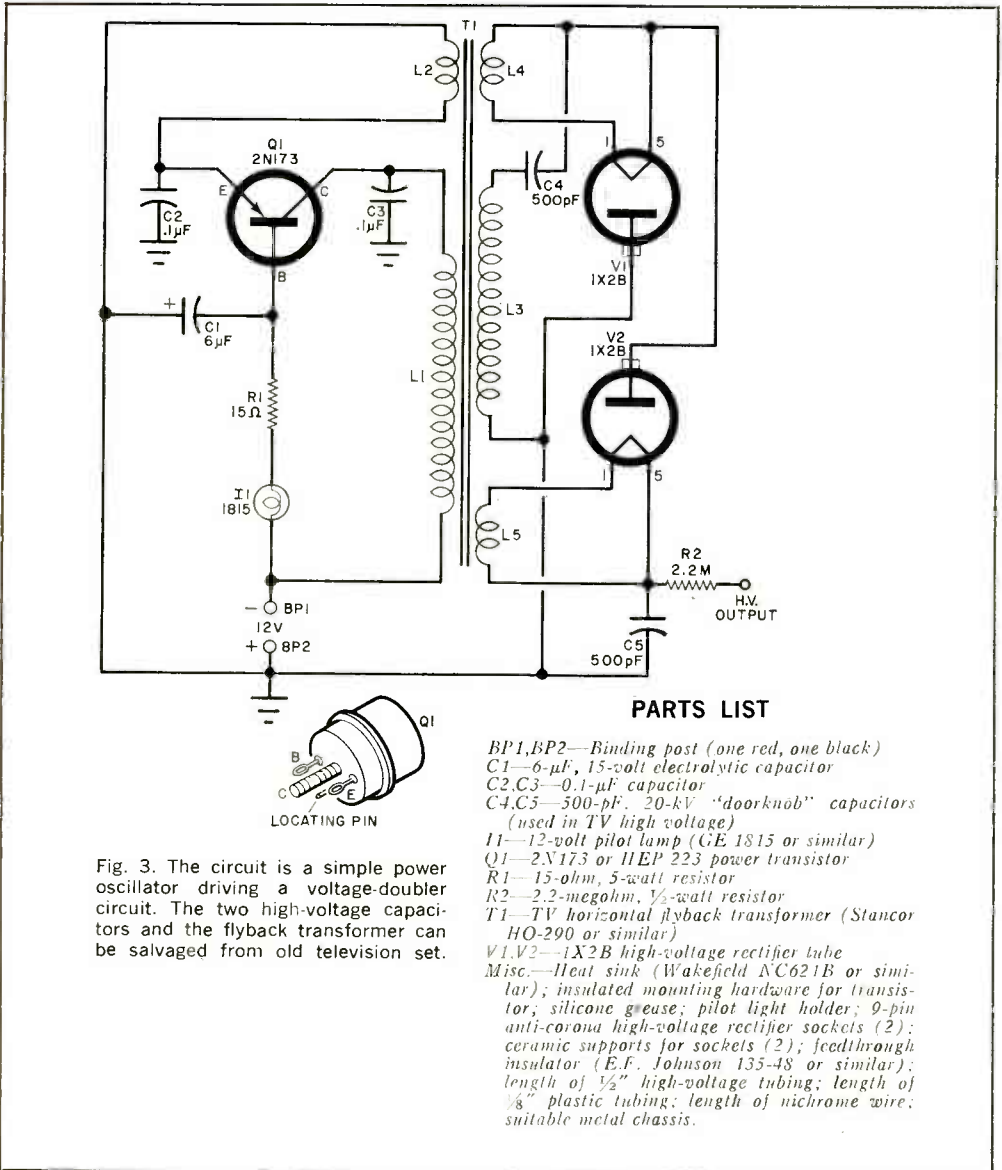

Fig. 3. The circuit is a simple power oscillator driving a voltage-doubler circuit. The two high-voltage capacitors and the flyback transformer can be salvaged from old television set.

that point which you can use as a guide.) Deburr the holes. About 1½" from the top of the can (or in the top indentation ring if it has one), drill four holes 90° apart around the can. Use a thin bit (#43) for these holes. Drill four similar holes in the fifth or top can.

Thread a #6 nylon string through the four holes in the bottom can so that a "crosshair" is created. Make the string tight and apply a little glue on the outside knots to make sure that they hold. Do the same thing on the fifth can. These

crosshairs will be used to support and insulate the high-voltage wire in the center of the column. Do not attach permanently the can with the fan at this time.

Place a plastic lid over the open end of the bottom can and stand the stack in the cabinet.

If you use sheet-metal downspout for the column, make the column as high as six coffee cans and drill all holes in approximately the same places. You will have to mount the fan on a piece of metal and secure this to the column later.

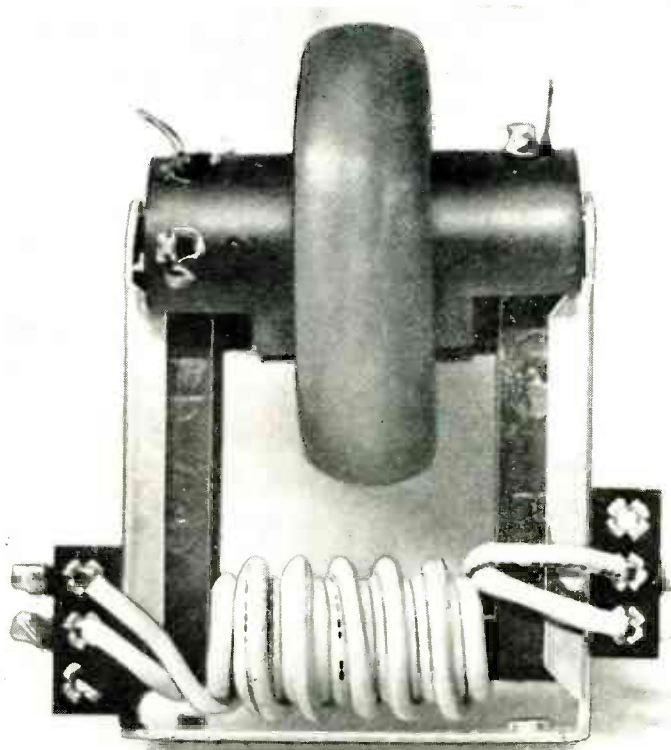

Fig. 4. The two terminal strips are affixed to the side straps of the flyback transformer and support the two ends of new coils ($L1$ and $L2$). Wrap layer of insulating tape around the core before winding the coils.

Power Supply. The circuit for the high-voltage power supply is shown in Fig. 3. For safety, the device is enclosed in a grounded metal container and the high-voltage output is taken through a feed-through insulator.

The supply is a simple transistor oscillator using extra windings on a conventional TV high-voltage horizontal output transformer. Two of these extra coils, a primary and a tickler feedback ($L1$ and $L2$ in Fig. 3), in conjunction with the transistor, form a regenerative feedback network similar to that used in receivers. When the power is turned on, current flows through $L1$ and the transistor. The magnetic field set up by this current generates a voltage in $L2$ that increases the forward bias on the emitter of $Q1$. The collector current through $L1$ then increases. Eventually, the core of the transformer saturates and the magnetic field around $L2$ stops building so that the emitter bias is reduced and the collector current drops. The process is then reversed. The magnetic field set up by the decreasing collector current produces a voltage in $L2$ that drives the transistor

to cutoff. When no current flows through $L1$, there is no voltage across $L2$ and the emitter returns to ground potential. The cycle then repeats. The oscillator frequency is near the upper end of the audible range.

The transistor is biased by $R1$, which is bypassed by $C1$. Capacitors $C2$ and $C3$ protect the transistor from static discharges.

The current through $L1$ varies from zero to about 5 amperes. Because of the turns ratio between $L1$ and $L3$, about 5000 volts a.c. is developed across $L3$. A voltage-doubler/rectifier combination ($V1$ and $V2$ with $C4$ and $C5$) raises the voltage to about 10,000 volts d.c.

Caution. Although the current is low, voltages at the 10-kV level can be very dangerous. Do not, under any circumstances, turn on this high-voltage generator unless the case is completely closed and the high-voltage feedthrough is well in the clear. When the system is turned off for any reason, always discharge the high-voltage terminal using an insulated cable, with one end secured

to ground and the other end held at the end of an insulated rod to touch the terminal.

Power Supply Construction. Remove the insulated filament winding from the flyback transformer. If there is a sponge-rubber pad between the core and the mounting bracket, remove it. Caution: the core is made of a brittle ferrite material in an epoxy binder. Therefore, do not force or twist it in any way. Gently remove the rectifier plate connector lead from the coil. Make sure that you can identify the high-voltage winding terminals.

Solder a two-lug terminal strip to each side of the mounting bracket as shown in Fig. 4. Wrap a layer of insulating tape on the bare horizontal ferrite core, feeding the tape between the core and the mounting bracket. Wind 12 turns of $\#18$ stranded hookup wire in a close layer around the core. This forms $L1$. Solder the ends to the bottom insulated tie points of the terminal strips. If the winding does not pack tightly, remove it, and rewind with a slightly larger wire.

Wind a five-turn coil, using the same gauge wire, on top of $L1$. This forms $L2$. Solder the two ends to the top lugs on the terminal strips. Wind $L2$ in the same direction as $L1$ with the windings spaced evenly across $L1$.

Using the same type of wire originally used for the filament winding (removed in an earlier step), wind the two one-turn coils between the turns of $L2$. These form $L4$ and $L5$ and will be connected to the filaments of the rectifier tubes. Locate one end of the high-voltage winding and connect it to the nearest ground—the transformer mounting bracket will do.

Obtain a metal box, large enough to accommodate the transformer and the rectifier tubes, yet small enough to fit between the metal column and the side of the cabinet. It should be less than 10" high (including the insulator for the high-voltage feedthrough) so that the entire assembly will fit below the shelf in the cabinet.

The transistor is mounted on a heat sink using appropriate hardware and insulating material. Coat both sides of the transistor insulator with silicone heat-conducting grease. The heat sink assem-

bly is mounted at the outside lower end of the rear panel to keep it away from corona discharges set up in the high-voltage section (see Fig. 5). Appropriate holes must be drilled in the rear panel to mount the heat sink and to provide access to the transistor terminals.

The flyback transformer is mounted at one side of the power supply enclosure (see Fig. 6) so that the high-voltage and filament leads face the two rectifier tubes. The tube sockets (of the anti-corona type) for the rectifiers are mounted on ceramic insulators, one on the top and the other on the bottom of the enclosure. Mount the other components as shown in Fig. 6 and wire them, point-to-point, as shown in Fig. 3. Take care to make neat, smooth joints and avoid sharp edges to prevent corona discharges. Resistor $R2$ connects from the rectifiers to the feedthrough insulator.

Checkout. Connect a 2- to 3-volt d.c. source to the battery input terminals,

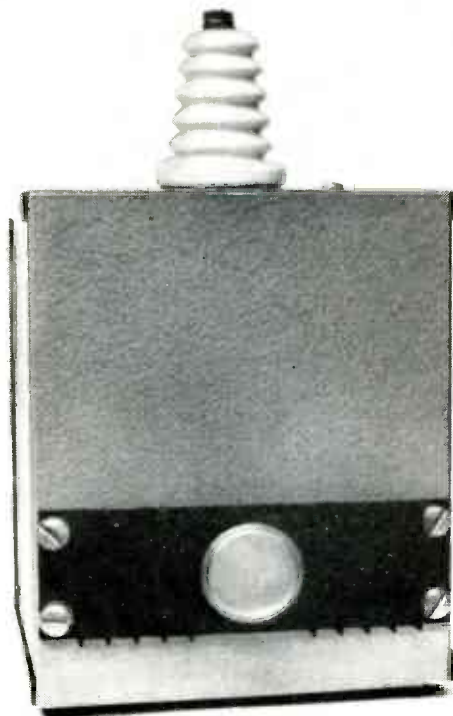
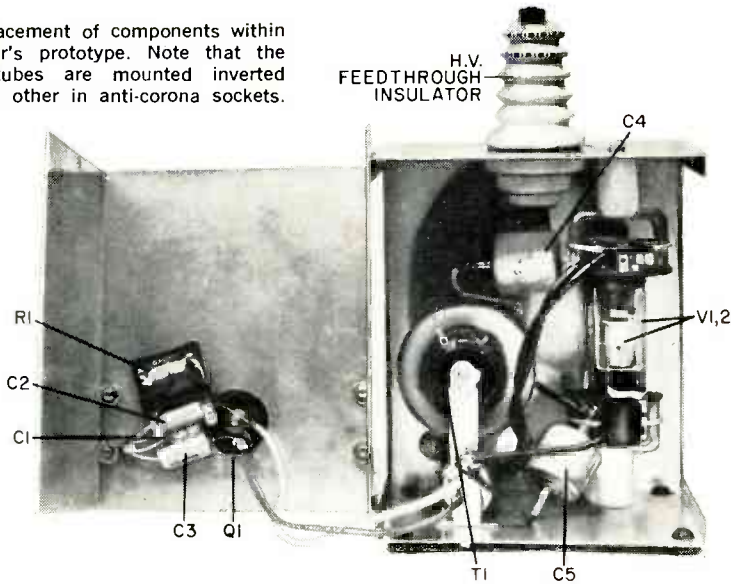

Fig. 5. The transistor is electrically insulated from its heat sink, and the heat sink is attached to the rear of the metal chassis. Make sure that no metal can contact the case (collector) of Q1.

Fig. 6. Placement of components within the author's prototype. Note that the rectifier tubes are mounted inverted from each other in anti-corona sockets.



with positive to ground. A pair of flashlight D cells will do. The circuit will oscillate with this low supply but voltage levels will be down. Try to draw an r.f. arc from the transformer high-voltage terminal using a well-insulated screwdriver. If there is no arc, even a small one, reverse the connections to *L2*. In some cases, it may be necessary to add or remove turns from *L1* to obtain the proper core saturation.

Once you know the oscillator is working, connect 12 volts d.c. to the circuit and, being extremely careful, measure the voltage at the filaments of the rectifiers. It should be between 1.2 and 1.5 volts a.c. Make sure that no part of the voltmeter or your body touches ground when making this measurement! Once filament voltage has been confirmed, shut down the power supply, discharge the high-voltage feedthrough, and assemble the metal enclosure, making sure that it is completely sealed.

As a final check, connect the circuit to a heavy-duty 2- to 12-volt power supply (such as a battery charger) capable of handling 5 amperes. Connect an ammeter in the input lead. With a 2-volt input, the ammeter should indicate about 0.5 ampere. With 12 volts input, current should be about 2 amperes. The reading could go as high as 5 amperes if the circuit is loaded with a high-voltage experiment.

DANGER! There is about 10,000 volts d.c. present on the top of the feedthrough insulator! Treat it with the greatest respect. Don't try to draw arcs with a pencil, and don't short this terminal to ground when the supply is energized. Also, don't touch the transistor case while the supply is operating.

Shut down the power supply, discharge the high-voltage feedthrough, and place the power supply in the cabinet as shown in Fig. 7, with the battery terminals and pilot light facing front.

Mark the point on the metal column that is directly opposite the top of the high-voltage feedthrough. Drill a $\frac{1}{4}$ " hole at this point and deburr it. Obtain a length of high-voltage plastic tubing long enough to go from the top of the feedthrough to the center of the column. For still better insulation, insert another piece of $\frac{1}{8}$ " tubing inside the first one. Feed a length of #22 or smaller wire through this insulator leaving enough at one end to make a connection to the feedthrough and a small loop at the other (column) end, at the center of the crosshairs.

Attach a length of fine nichrome wire (obtained by dismantling an old wire-wound resistor) to the loop of wire at the bottom crosshair (wind the copper wire around the nichrome) and to the crosshair itself for support. Pass the nichrome

wire up through the column and attach the top end to the upper nylon crosshair, making sure that the wire is reasonably straight and does not come near the sides of the metal columns. Cut off loose ends.

(Nichrome wire is used here because the high voltage produces a tiny corona which would ruin copper wire but does not harm the nichrome. Steel wire can be used, but it will eventually rust and disintegrate.)

Do not use any mechanical device to connect the nichrome wire to the high-voltage power supply terminal since this joint will have to be disassembled occasionally so that the column can be removed for cleaning. Replace the plastic cover on the bottom of the column. Place the blower container on top of the column, making sure that the exhaust is toward the front of the cabinet. Secure this can in place by wrapping tape around the seam. Make a wire connection between the metal column and the metal chassis of the power supply at the positive battery input terminal.

The appearance of the stack can be improved by spraying it with paint, but don't get paint in the blower mechanism or on the high voltage leads.

Line Operation. The Transcitor can be operated from a conventional low-voltage d.c. power supply such as that shown in Fig. 8. Mount the transformer on the small shelf in the cabinet and the filter capacitor on a clamp secured to the cabinet wall. A TV power socket is mounted on a small piece of metal and located on the cabinet wall so that power can be applied to the system only when the front panel is in place. A TV "cheater" supplies power to the socket and is mounted on the front panel aligned with its receptacle. The two rectifier diodes are mounted on a heat sink on the rear wall. Wire the power supply point-to-point as shown in Fig. 8.

If the fan motor is of the 12-volt variety, wire it to the power supply. If the motor is 117 volts a.c., connect it in parallel with the input to the power transformer.

Final Assembly. The finished project should now look like the one in Fig. 7. The column, with the fan at the top should just fit snugly within the cabinet.

It may have to be wedged if too loose; or the cabinet top may have to be hollowed out slightly if the fit is too tight. Recheck all wiring, making sure that the metal column is connected to the positive battery input grounded to the supply case. Make sure that the high-voltage feed is in the clear and that all parts attached to the cabinet walls are on tightly.

Obtain a length of flexible vacuum cleaner hose. The hose selected should be plastic rather than cloth to make cleaning easier. Wash the hose thoroughly, inside and out, with a good detergent and then rinse thoroughly. Cut a hole in the front of the cabinet so that the end of the hose and the exhaust on the fan can be mated. It may be necessary to make up some type of size-matching device if the two are greatly different in size. Check all dimensions, and then mount the front panel on the cabinet using a few screws to secure it.

Fig. 7. Coffee-can stack was painted before installation to make a more pleasing appearance. The four top vents provide cooling for power supply.

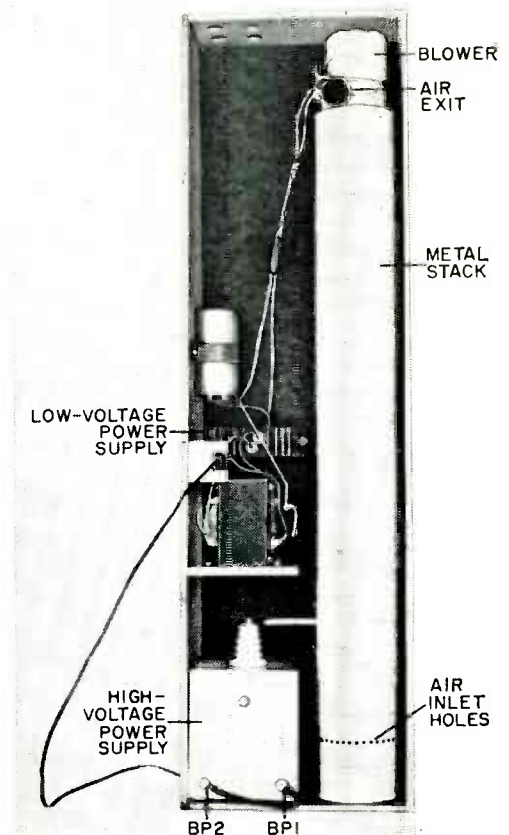

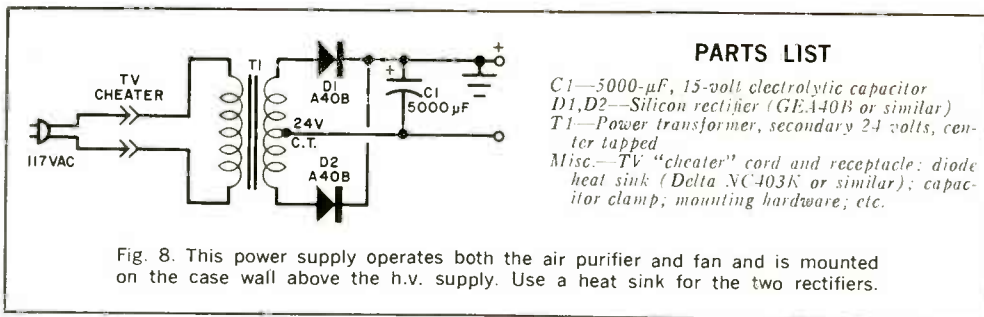

Operation. With the front panel in place and the a.c. or battery supply connected, the blower should start up and moving air should be felt at the outlet. Hold a lighted cigarette or other source of smoke near the ring of holes at the bottom of the column. If everything is working properly, smoke will enter the column, but the air coming out will be clean with no trace of smoke.

For conducting delicate experiments or for drying paint on small items, another cabinet such as that shown in Fig. 9 can be constructed. The vacuum-cleaner hose is coupled to this cabinet; and a small vent in one wall permits the air to escape from the interior. The front door can be constructed with a glass insert and a light bulb can be installed within the cabinet for viewing experiments.

When it comes to removing pollen, dust, etc. from an area such as a large room, the Transcipitor will work—to an extent. It does not have the capacity to handle a very large room; but, in a small room, with windows and doors closed, its effect is quite noticeable.

Every so often, inspect the metal column for dust accumulation. Remove the column from the cabinet, hold it over a paper sack and remove the bottom plastic cover. Shake the column gently to remove dust particles stuck to the sides. Clean the inside walls before reinstalling the column in the cabinet. The stack can be inspected from the outside by shining a flashlight through the bottom array of holes and looking into the other holes. If you can see the dirt, empty the column.

-30-

Fig. 9. The front door is open at the bottom of the cabinet to allow for air intake and observation of the indicator lamp. To prevent operation when the door is open, a TV “cheater” cord and socket are engaged when door is closed.



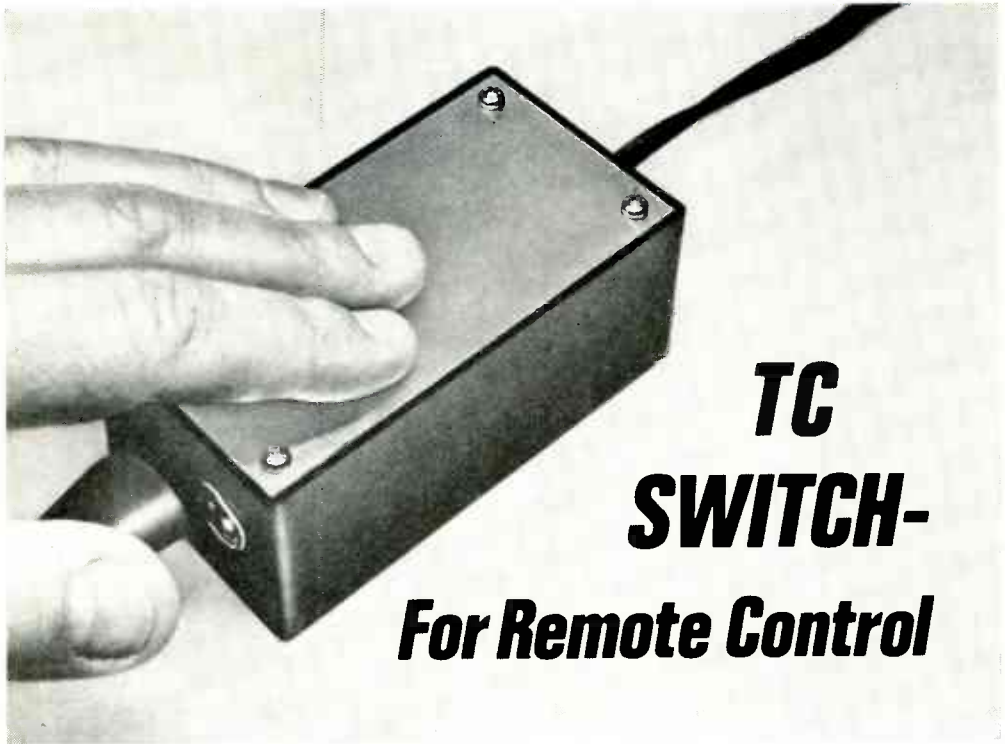

TC SWITCH- For Remote Control

ONE TOUCH, IT'S ON—ANOTHER, IT'S OFF

BY JACK BECHTOLD

WHEN YOUR "lazy streak" gets the upper hand and convenience is the most important thing in the world, that's when you want a "Touch Control Switch." With this handy device you can turn off the television without getting out of bed; you can start the coffee to perking without moving from the dining table; and you can turn on the lights when you come in the house with your arms full of packages.

The Touch Control Switch can be located any place where a wall outlet is available. The appliance or light to be controlled is then plugged into the TC Switch and can be turned on or off with a simple touch of the finger, wrist, elbow, etc. The touch plate can be located remote from the TC Switch itself to make control even more convenient and versatile.

About the Circuit. The circuit of the TC Switch is composed of five main

sections—detector, pulse shaper, switch memory, switch, and power supply. Alternate touches of a metal plate toggle on and off a triac, gated by a flip-flop circuit. The system operates around a multifunction integrated circuit (*IC1* in Fig. 1) which consists of an inverter, two inverter/buffer stages, and a J-K flip-flop.

Referring to the schematic diagram, when the user touches the touch plate, he creates the equivalent of small capacitance *Cb* which forms a series circuit with *C3* to provide a voltage divider across the a.c. line. As soon as the potential across *C3* exceeds the firing voltage of *I1*, *SCR1* triggers into conduction (the SCR is very sensitive, requiring only a few microamperes to trigger it). As long as contact is made with the touch plate, *SCR1* remains conducting on the positive alternations of the a.c. line, producing a low-voltage, half-wave rectified train of pulses across *R4*.

The pulse shaper section generates a

single trigger pulse from the first pulse across R_4 . The positive-going part of this first pulse passes through D_1 and C_4 and appears as a single pulse across R_6 . This pulse then passes through D_2 and is shaped by the inverter and one of the inverter/buffers in IC_1 . This pulse is then used to trigger the switch memory section. Resistor R_5 prevents C_4 from discharging quickly thus permitting only one trigger pulse each time the plate is touched.

The switch memory section is comprised of the flip-flop portion of IC_1 and another inverter/buffer. The flip-flop is operated in the toggle mode with alternate trigger pulses setting and resetting it.

The switch section, consisting of Q_1 , operates as follows: When the flip-flop is in the set state, the output of the inverter/buffer is high, permitting Q_1 to

conduct and supply power to the load connected at SO_1 , the a.c. receptacle. In the "reset" state, no gate current is provided for Q_1 or the load. Since a d.c. voltage is used to gate Q_1 , the triac triggers into conduction very early in the line current cycle. This is essentially zero-crossing switching which generates very little radio-frequency interference (RFI), but C_2 is in the circuit as an added suppressor of RFI.

Low voltage for IC_1 is provided from the a.c. line through C_1 and D_3 , where C_1 stands in for a dropping resistor as a result of its capacitive reactance. Diode D_4 serves as a discharge path for C_1 , and C_6 is the filter to provide a fairly uniform level of d.c. from the rectified a.c. pulses.

Construction. The circuit of the TC Switch is best assembled on a printed

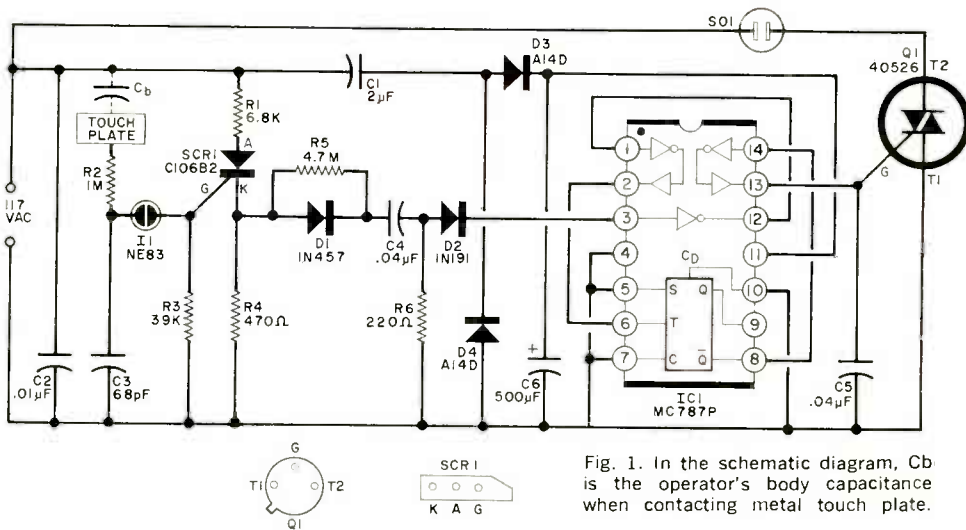

Fig. 1. In the schematic diagram, C_b is the operator's body capacitance when contacting metal touch plate.

PARTS LIST

C_1 —2- μ F, 200-volt non-polarized capacitor
 C_2 —0.01- μ F disc capacitor
 C_3 —68-pF disc capacitor
 C_4 , C_5 —0.04- μ F, low-voltage capacitor
 C_6 —500- μ F, 6-volt electrolytic capacitor
 D_1 —1N457 diode
 D_2 —1N191 diode
 D_3, D_4 —1-ampere rectifier (G.E. A14D or similar)
 I_1 —NE83 neon lamp
 IC_1 —Integrated circuit (Motorola MC787P)
 Q_1 —Triac (RCA 40526 or 40691)

Note: The following are available from Consumer Electronic Specialties, Inc., Box 326, S. Vineland, NJ 08360; PC board, \$2; kit of all parts \$13.50, postpaid. NJ residents add sales tax.

R_1 —6800-ohm
 R_2 —1-megohm
 R_3 —39,000-ohm
 R_4 —470-ohm
 R_5 —4.7-megohm
 R_6 —220-ohm

All resistors
 $\frac{1}{2}$ -watt

SCR1—Silicon controlled rectifier (G.E. C106B2)
 SO_1 —Chassis-mounting a.c. receptacle
Misc.—Bakelite case with aluminum cover (see text); a.c. line cord with plug; Wakefield No. NC209 finned heat sink for Q_1 ; $\frac{3}{8}$ " spacers (4); 4-40 hardware (6 sets); heat-shrinkable tubing and epoxy potting compound (optional, see text); bare and insulated hookup wire; solder; etc.

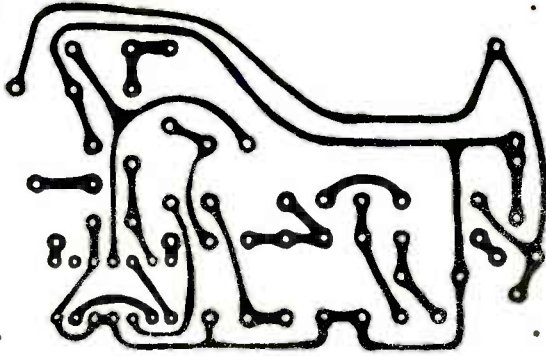
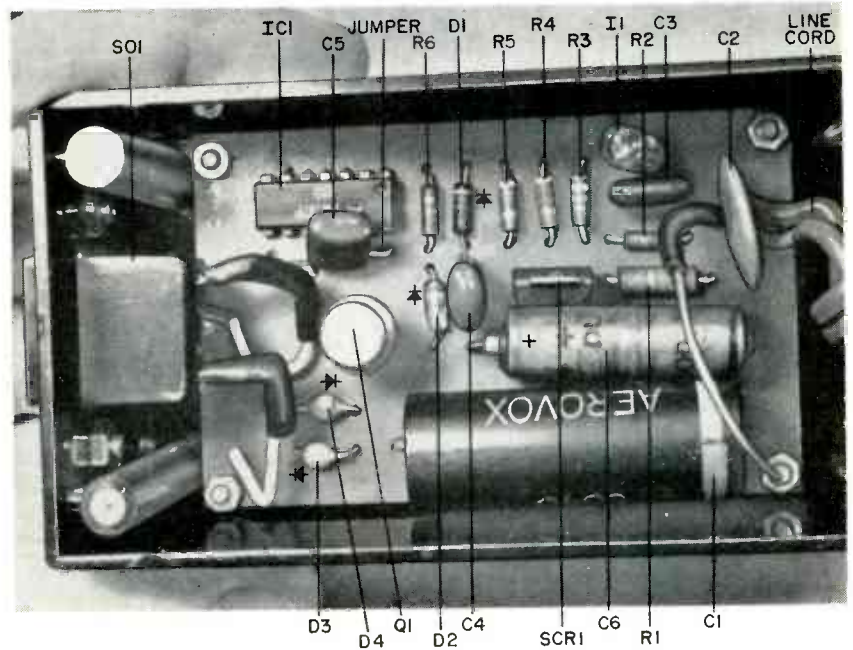

Fig. 2. Full-size etching guide is shown at left. Photo below shows component locations on circuit board and box ends.



circuit board (see Fig. 2 for etching guide and part location photograph) and mounted inside a plastic case that is equipped with an aluminum cover. The metal cover will then serve as a convenient touch plate.

Be very careful when soldering into place the solid-state components to prevent heat damage. Use a low-power soldering iron (not more than 40 watts) and a clip-on heat sink. Also, before mounting *Q1* slip on the finned heat sink specified in the Parts List.

After assembling the circuit, make the rectangular cutout and drill a $\frac{1}{4}$ " hole at opposite ends of the plastic case for the a.c. receptacle and line cord entry, respectively (see Fig. 3). Now feed the free

end of the line cord through the hole, tie a strain relief knot in it, and solder the conductors to the appropriate points on the circuit board. Then solder 2" lengths of hookup wire to the appropriate circuit board holes for the a.c. receptacle. Use $\frac{3}{8}$ "-long spacers and 4-40 hardware to mount the circuit board on the bottom of the case.

Next, mount the a.c. receptacle in place. Cut the leads coming from the circuit board to the appropriate lengths, strip the ends, and solder them to the lugs on the receptacle.

There should be an uninsulated lead still left to connect. This lead goes to the touch plate via one of the hold-down screws used to secure the aluminum cov-

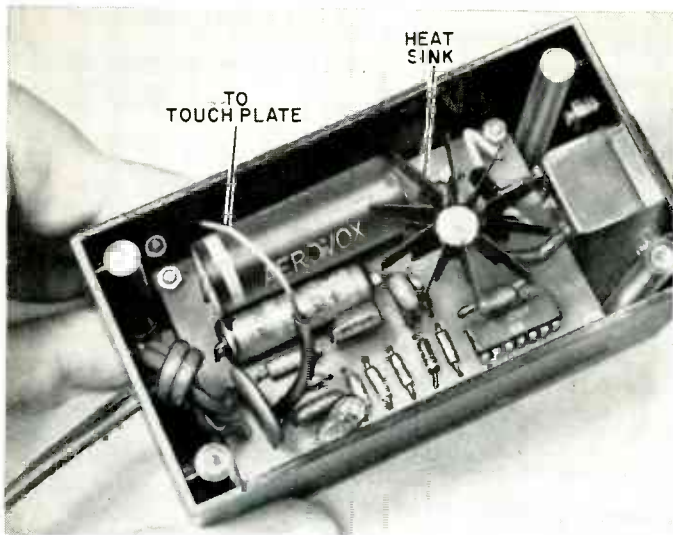

Fig. 3. Heat sink slips onto Q1's case; bare wire end goes to cabinet's metal cover plate.



Fig. 4. Bare wire can be either wrapped around cover hold-down screw or clamped in screw receptacle.

er. Cut this lead to a length of 3" and route the wire to the nearest screw hole, making sure it does not touch any other component or lead (see Fig. 4). Slip on the case cover, and secure it with the screws supplied.

How To Use. Before using the TC Switch, it is a good idea to keep in mind that full line voltage is present at various points in the circuit. For this reason, it is recommended that you not operate

the circuit with the cover of the case removed; if you must, exercise extreme caution. You can obviate any possibility of shock hazard if you epoxy encapsulate the entire circuit board before mounting and slipping heat-shrinkable tubing over the lugs of the a.c. receptacle.

Connect the lamp or appliance you wish to control to the TC Switch via the a.c. receptacle, turn on the appliance, and plug in the line cord of the touch switch. If the appliance immediately goes on, touch the metal plate on the touch switch; the appliance should go off. In the event that the lamp or appliance does not turn on immediately as the line cord is plugged in, touch the touch plate to turn it on. If nothing happens, reverse the line cord at the wall outlet.

For proper operation of the TC Switch, alternate touches of the metal plate should turn the appliance on and off.

The TC Switch, with the parts specified, will handle a maximum load of 150 watts. If you want to control an appliance with a greater drain, you can substitute a higher power triac for Q1. The RCA 40485, for instance, safely handles loads up to 720 watts (be sure to use the appropriate heat sink).

Instead of using the aluminum cover of the case as a touch plate, a remote touch plate can be used. This permits you to use a wall plate, mounted on a commercial wall box. However, make the distance between the project and remote touch plate as short as possible. -30-

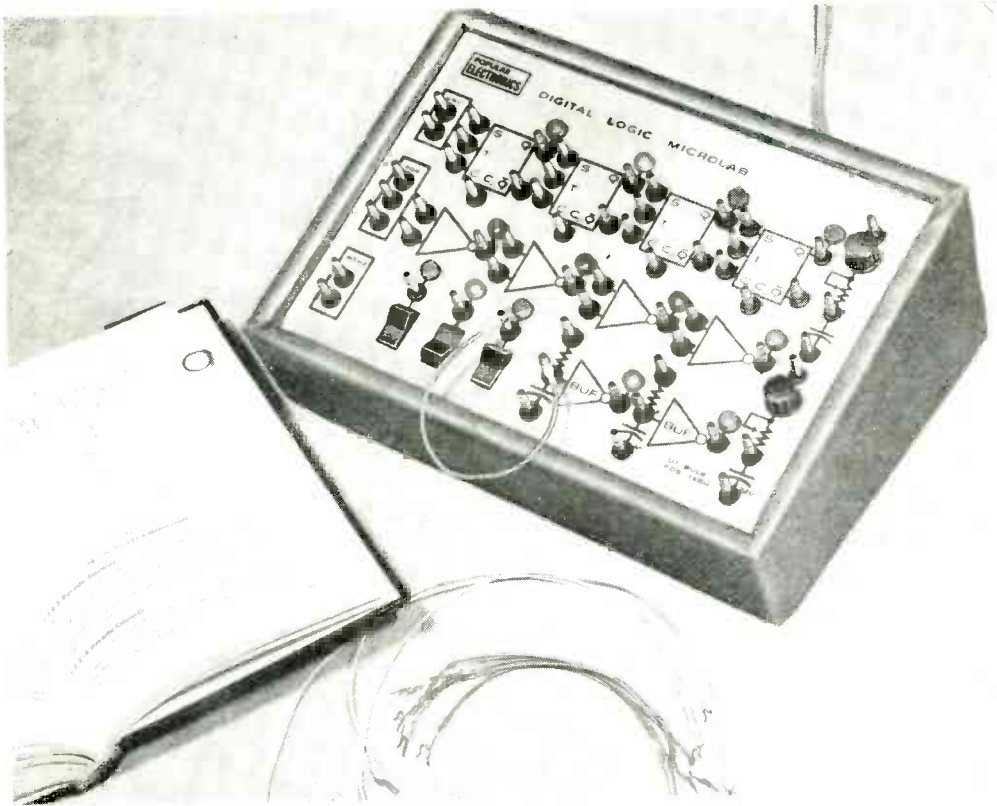

BUILD THE **Digital Logic Microlab**

LEARN HOW DIGITAL CIRCUITS WORK—THE EASY WAY

BY DON LANCASTER

DIGITAL LOGIC is involved in a great number of experimental projects and in instruments used daily in the laboratory. Despite the fact that digital logic circuits are so commonplace, the principles involved are not always too well understood. To remedy this situation, you will want to build a "Digital Logic Microlab"—an advanced breadboarding device that lets you quickly and painlessly verify all the basics of digital logic. It will serve as a teaching aid for yourself and others; and it is an excellent science fair project.

The Microlab can also serve as a universal digital test and debugging instrument, providing such functions as bounceless contacts, state checkers, mon-

itors, precision one-shot time gates, synchronizers, and cycling oscillators. Although the Microlab is designed to use resistor-transistor logic (RTL), to make it compatible with the majority of projects described in these HANDBOOKS, it can easily be adapted to work with diode-transistor logic (DTL), transistor-transistor logic (TTL) or Utilogic® (Signetics Corp.) systems.

The Microlab includes four JK flip-flops, four two-input gates, two buffers, and three bounceless mechanical switches and can be used in over 100 basic logic experiments (see page 33). Each logic block has its own pilot-light readout to indicate the state of its output and the power supply and ground connections for

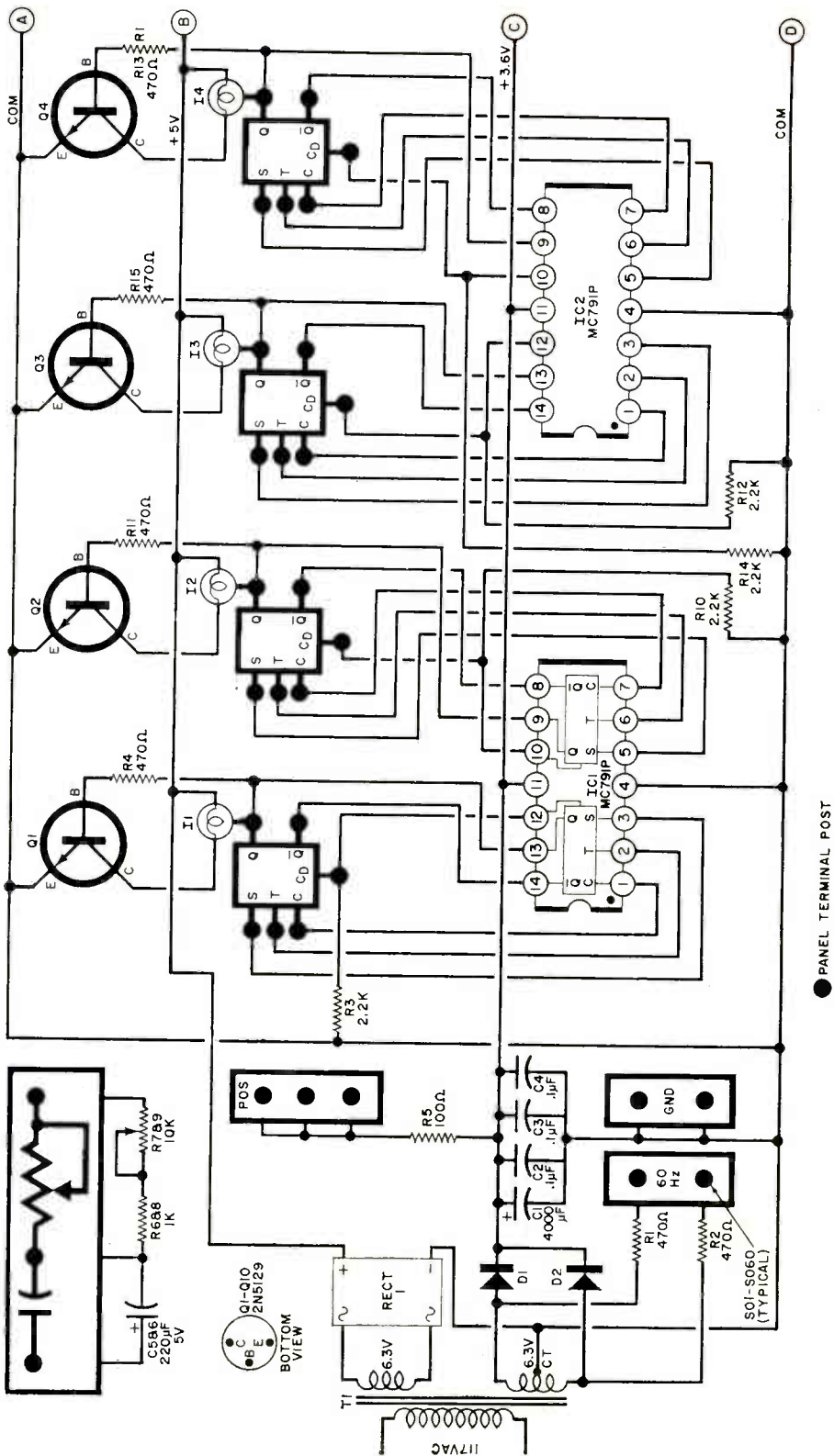
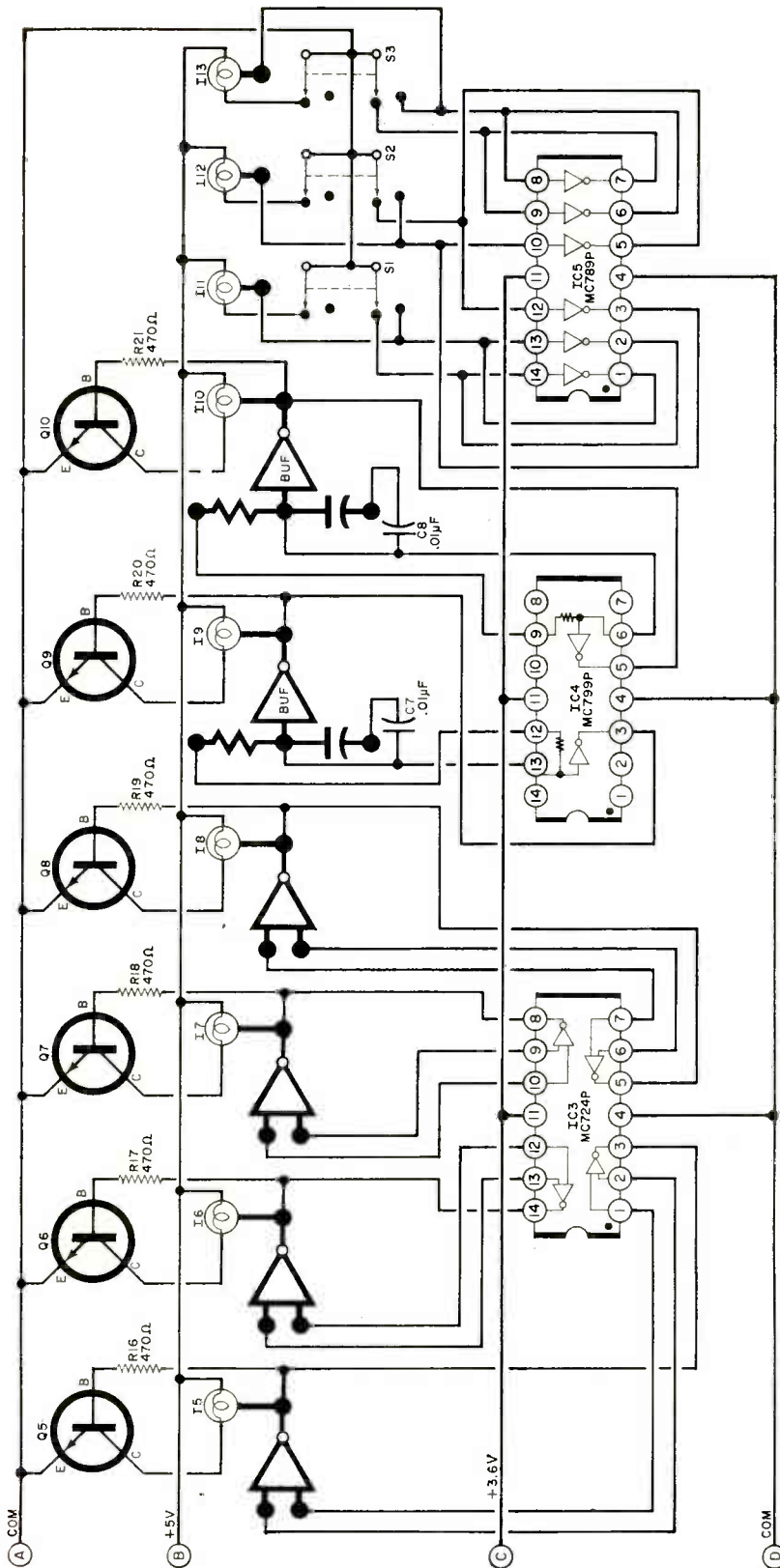

Fig. 1. Complete schematic diagram of Microlab is shown here in two parts; points A, B, C, and D in each half connect to their respective letters. Logic, schematic, and post designations on the front panel—not circuit board—are shown in bold lines. These lines refer to functions inside the IC's and onboard connections.



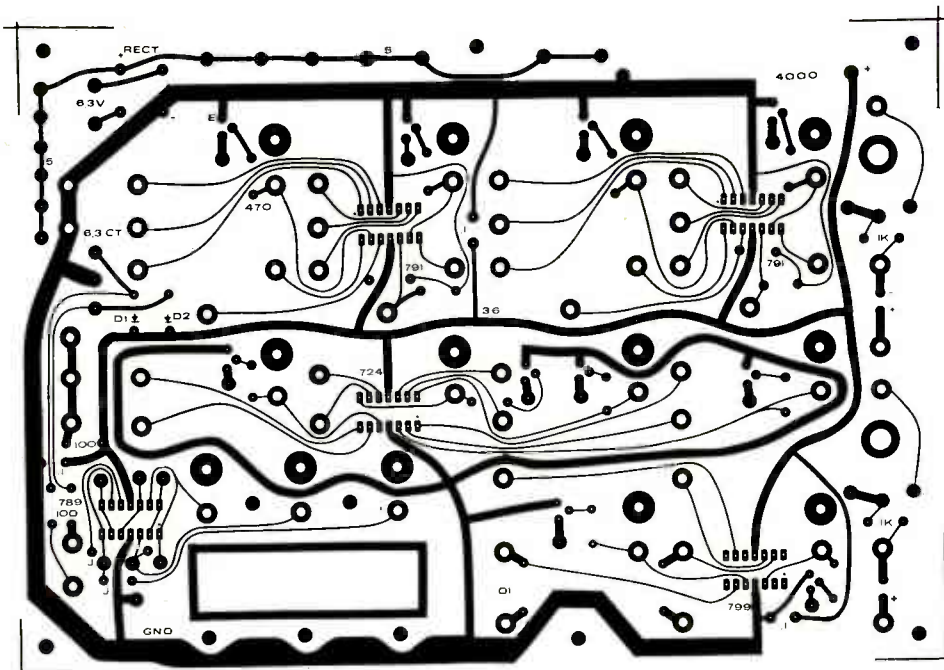

Fig. 2. Foil pattern etching guide is shown here half-size. The best method of obtaining a full-size guide is to use photographic blow-up. However, board is available from the source specified in Parts List if you prefer not to make your own.

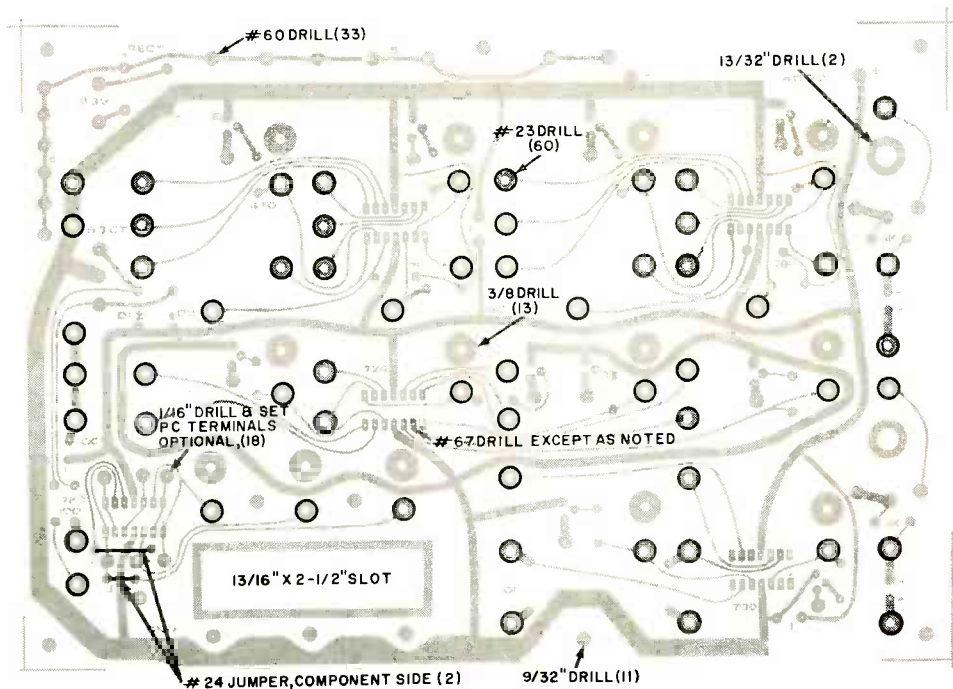

Fig. 3. Circles around solder pads indicate locations of terminal posts. Slot at bottom is to provide clearance for switches. Note jumpers at lower left of illustration.

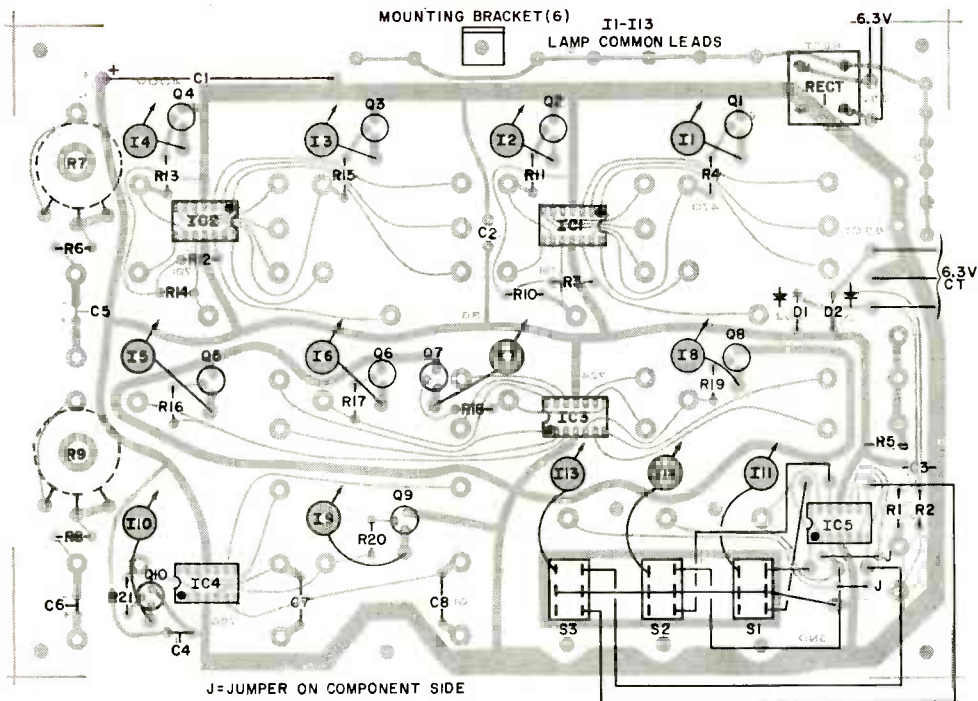

Fig. 4. Be extremely careful when mounting components on circuit board to observe proper lead orientations. Terminal ends of S1-S3 pass through slot in board (lower right) and terminals connect to appropriate points in circuit via wire.

each block are permanently installed and properly bypassed. In using the Micro-lab, all you do is make the logic connections using simple "zip" leads that require no soldering and are easy to attach and remove.

Three types of input signals are available on the front panel: a constant-value positive voltage, the 60-Hz power line that can be properly conditioned for driving the logic blocks, and three conditioning actuators that may be used as either

PARTS LIST

- C1—4000- μ F, 6-volt electrolytic capacitor
- C2-C4—0.1- μ F, 10-volt disc ceramic capacitor
- C5, C6—220- μ F, 6-volt electrolytic capacitor
- C7, C8—0.01- μ F, 50-volt Mylar capacitor
- D1, D2—1-ampere, 25-volt silicon power diode (1N4001 or similar)
- I1-I13—5-volt, 50-mA pilot lamp and color-coded lens (3 green, 4 blue, 2 red, 4 orange)
- IC1, IC2—Dual JK flip-flop (Motorola MC791P)
- IC3—Quad two-input gate (Motorola MC724P)
- IC4—Dual buffer (Motorola MC799P)
- IC5—Hex inverter (Motorola MC789P)
- Q1-Q10—Transistor (National or Fairchild 2N5129, available from New Jersey Semiconductor, 20 Commerce St., Springfield, NJ 07081)
- R1, R2, R4, R11, R13, R15-R21—470-ohm, $\frac{1}{4}$ -watt resistor
- R3, R10, R12, R14—2200-ohm, $\frac{1}{4}$ -watt resistor
- R5—100-ohm, $\frac{1}{4}$ -watt resistor
- R6, R8—1000-ohm, $\frac{1}{4}$ -watt resistor
- R7, R9—10,000-ohm, linear potentiometer
- RECT1—1-ampere, 25-volt diode bridge assembly

S1-S3—D.p.d.t. rocker switch

T1—Filament transformer, secondaries: 6.3 volts at 0.5 amperes, 6.3 volts center-tapped at 0.5 amperes; or two separate transformers.

Misc.—Match-drilled dialplate; 5-fernite terminal posts (Southwest Technical #TP-7563-3G/D or similar, 60 required); vinyl grommets (60); vinyl-clad wood case; heat-shrinkable tubing (2 ft); red lead wire (15 ft); yellow lead wire (9 ft); plated hair pin cotters (Southwest Technical PHPC-43, 80 required); $\frac{1}{2}$ -inch knobs (2); line cord; wire nuts (2); mounting brackets with hardware (6); switch bracket and hardware; epoxy cement; #24 solid wire; sleeving; $\frac{1}{4}$ " nylon nuts or other insulated spacers (7); PC terminals (18, optional); solder, etc.

Note—The following are available from Southwest Technical Products, Box 32040, San Antonio, TX 78216; etched and drilled printed circuit board \pm 997, \$10.50; complete kit of all parts including front panel and vinyl-clad case #997-K, \$29.95; 240-page experimenter laboratory manual #B-1, \$5.50; all prices postpaid. All individual parts are also available.

Fig. 5. Photo shows how to layout and label the front panel.

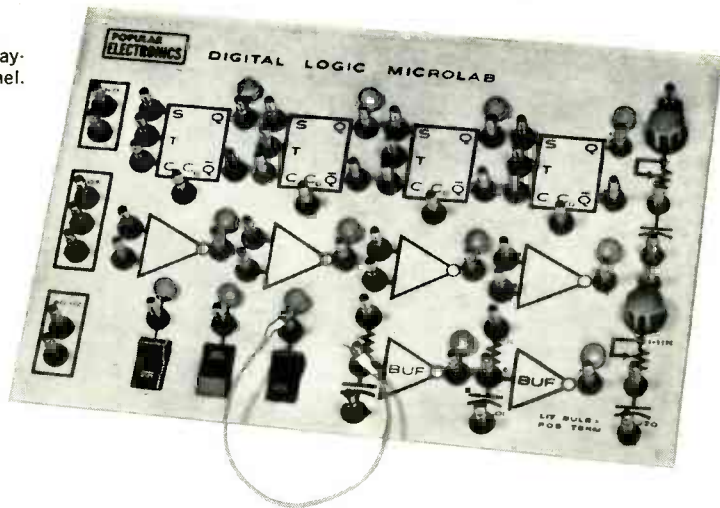

pushbuttons or slide switches. The latter are bounceless and can drive all logic blocks. If desired, certain blocks may be interconnected to form oscillators for driving or test purposes.

Another important feature of the Microlab is that, if you are going to use it as a teaching aide, the entire instrument is "student proof" in that no possible combination of panel connections, however wrong, can damage the circuits.

You can build the Microlab for \$20 to \$30 using the printed circuit boards and complete kits mentioned in the Parts List for Fig. 1. A 240-page experimenter's manual is also available.

What Do the Logic Blocks Do? In general logic blocks perform "yes-no" decisions based upon the presence or absence of "yesses" and "nos" at their inputs. Each block follows a predetermined set of rules and always does the same thing in response to a particular set of input conditions.

There are four types of logic blocks in the Microlab: *two-input gates*, *buffers*, *counting flip-flops* (called JK flip-flops by the computer people), and *inverters*, the latter being inside the unit. The principal components in the blocks are RTL integrated circuits. The outputs of each block are either grounded or at some positive potential (between 1.5 and 3.6 volts), depending on the presence or absence of similar positive or grounded conditions on the inputs.

Two-Input Gate. The logic rule for the

two-input gate states that, if both inputs are grounded, the output is positive; and if either one or both of the inputs is made positive, the output is grounded. If you call ground a "yes" and positive a "no", the two-input gate is a NAND gate. On the other hand, if you call positive a "yes" and ground a "no", you have a NOR gate. The choice is up to you. By combining these gates, all the remaining logic functions can be generated. Two-input gates may also be used to form flip-flops and perform decoding and decision logic.

Buffer. A buffer is an inverting high-power one-input gate and is used where lots of output drive is needed. Its logic rule is simple: if the input is positive, the output is grounded; and vice versa.

A capacitor and resistor are also connected to the buffer's input. If you connect the buffer normally, you simply leave both these components floating. If you connect the resistor to positive and the input to the capacitor, a sudden positive-to-ground transition on the input will produce a brief positive output pulse lasting only several microseconds. This type of pulse is used to reset counting chains or to recognize the beginning, but not the duration, of some event.

Although such an arrangement is seldom used, the resistor can be grounded and a sudden ground-to-positive transition applied to the capacitor. In this case the buffer's output is normally positive and goes to ground briefly for a few microseconds.

Buffers are used as amplifiers to increase drive capability and as reset pulse generators for counters; or, when used in pairs, they may be cross-coupled to form an oscillator or latch.

Counting Flip-Flop. This is the most complex of the logic blocks in the Microlab. Each flip-flop has two outputs, called Q and \bar{Q} , and four inputs, S , T , C , and C_n . The Q and \bar{Q} outputs are complementary. This simply means that, if one is positive, the other is grounded, and vice versa. The inputs are used to make the flip-flop's outputs either change states or stay the way they are.

The C_n input is called a direct input. It is normally left grounded or unconnected. If it is made positive, the flip-flop will immediately go to the state where Q is grounded and \bar{Q} is positive. This is used to initially set the states on a number of flip-flops or to reset a flip-flop. After such a resetting, the C_n input must be returned to ground to allow the other inputs to function.

Inputs S , T , and C are normally used together and are called *clocked* inputs. No matter what happens to the S and C inputs, nothing happens to the outputs until the T input suddenly changes from positive to ground. The rules are as follows:

1. If both S and C are grounded, the output changes state when the T input suddenly goes from positive to ground.
2. If S is grounded and C is positive, and the T input suddenly goes from positive to ground, the outputs are ground at Q and positive at \bar{Q} .
3. If S is positive and C is grounded, and the T input suddenly goes from positive to ground, the outputs are positive at Q and ground at \bar{Q} .
4. If both S and C are positive, nothing happens when the T input goes from positive to ground.

The clocked nature of the JK inputs permits us to set up what the flip-flop is going to do before it actually does it. This is the key to the operation of counters, registers, sequencers, synchronizers, and many other circuits which use clocked flip-flops.

Inverter. The inverter—there are six inside the Microlab—is a low-power buffer. A positive input produces a ground at the output and vice versa. The six inverters are used to make the three con-

ditioning switches bounceless so that they properly drive the T inputs of the flip-flops. Conditioning is accomplished by cascading two inverters to form a set-reset latch whose output is a fast-rise square wave, independent of any contact bounce and noise.

Construction. The Microlab is built in three major parts: a large printed circuit board on which are mounted all of the parts except the power transformer, a front panel that displays the logic symbols and makes available the required connections, and a sloping-front vinyl-clad cabinet.

The schematic is shown in Fig. 1. Since the PC board is so large, a half-

HOW IT WORKS

The Microlab contains five IC's, a dual power supply, and some discrete components. One power supply provides +3.6 volts of filtered, bypassed d.c. for the logic circuits; a current-limited positive voltage reference for the front panel; and a split-phase, current-limited 60-Hz reference. The other supply provides 5 volts of full-wave rectified but unfiltered d.c. to drive the state-indicating pilot lights. Either a single tapped transformer or two filament transformers may be used.

The logic circuits in each IC are brought out to the front panel. For instance, $IC1$ and $IC2$ are dual JK (counting) flip-flops. Each of the four independent flip-flops is brought out to its own symbolic terminal grouping on the front panel. Resistors are added to the C_n inputs so that they may be safely left unconnected.

Each logic block has its state indicated by a pilot light driven by an *npn* silicon transistor having a base-current limiting resistor. When the output terminal is positive, the lamp lights.

The four two-input gates in $IC3$ are also brought out to symbolic terminals on the front panel; as are the two buffers in $IC4$. The 1000-ohm resistors shown in the inputs are internal to the IC, while two capacitors are added as shown. These are useful for pulse and reset generation and for cross-coupling of two buffers to build a high-frequency oscillator.

Hex inverter $IC5$ is used to form three bounceless actuators in conjunction with $S1$, $S2$, and $S3$. This permits direct driving of the T inputs of the flip-flops without erratic triggering. An extra contact on each switch directly controls a pilot light when the post output is positive, saving three driver transistors and three resistors.

Two networks on the right side of the front panel complete the circuit. Each of these consists of a potentiometer, a fixed resistor, and an electrolytic capacitor. They are used with the two-input gates to form either a monostable multivibrator (one network) or an astable low-frequency oscillator (two networks) adjustable over a 10:1 range from several cycles per second to a cycle every second or so. The values have been selected for optimum visual demonstration of logic and count sequences.

size foil pattern is shown in Fig. 2. If you make your own board, match drill it to the front panel so that all 60 terminal posts are correctly registered—within the play of the rubber grommets that insulate the board from the panel if the latter is metal.

Using Fig. 3. as a guide, press fit each terminal post into place on the foil side of the board, making sure that each post is vertical to the board. Press the posts down so that the first ferrule is in contact with the board. Solder them in place. After soldering, turn the board over and either stake or cement (with epoxy) each post in place. Mount the other components in accordance with Fig. 4, using a low-power iron and fine solder. Note that not all of the IC's are mounted the same way. Follow the notch and dot code on each IC body to position it correctly.

The three switches are mounted $\frac{1}{4}$ " below the component side of the board on a suitable standoff bracket. L-brackets are then attached to the component side of the board as shown. These brackets will be used to support the PC board assembly on the case.

Prepare the front panel as shown in Fig. 5. Be sure that the holes in the panel align with the appropriate components—terminal posts, switches, and potentiometers. Drill holes for and mount the 13 pilot light lenses. In the prototype, orange lenses were used for the four IC displays, blue for the two-input gates, red for the two buffers, and green for the three switch indicators. These lenses press fit into place and can be glued for extra security. The holes for the terminal posts should have enough leeway to permit the installation of $\frac{1}{4}$ " grommets. (As noted in the Parts List, a front panel can be purchased.)

Before attaching the PC board to the front panel, wire up the pilot lights. Check that you have enough lead length on each lamp so that it can be fitted into place before mating the board with the front panel. Place a couple of $\frac{1}{4}$ " insulating spacers (nylon nuts are fine) over a few of the terminal posts to keep the board from contacting the metal front panel.

Ease the front panel and PC board together slowly, starting by aligning each grommet on its post and applying only enough pressure to register against the

grommets. As you ease the two components together, apply pressure to each grommet every time around. After several "rounds" of pressure, the board and front panel can be seated together perfectly. The operation is simple; but, if you hurry, a grommet may pop out. If you ever want to separate the board from the panel, simply reverse the procedure (see Fig. 6).

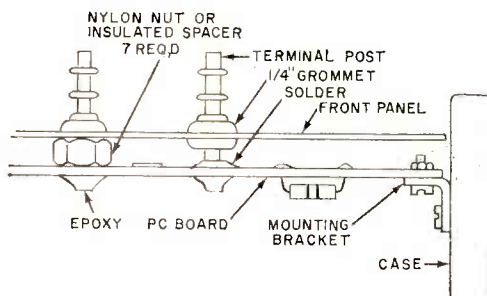

Fig. 6. Nylon spacers prevent circuit board from shorting against metal front panel. Rubber grommets keep terminal posts from contacting panel.

The supporting case is made from wood or particle board and may be covered with vinyl if desired. The PC board and front panel assembly is fitted into the case and secured with wood screws through the L-brackets. The power transformer is then attached to the cabinet interior as desired and wired to the board. Though they are not really necessary, an optional on-off switch and fuse may be added at this time.

Making the Zip Leads. The wires used to make connections on the front panel are called "zip" leads. Each is made of a length of insulated wire (size is not critical but #22 is good), two $\frac{3}{8}$ "-long pieces of heat-shrinkable tubing, and two $\frac{5}{32}$ "-diameter plated hair pin cotters. Unplated hair pin cotters, such as GC Electronics #7378, may be used if they are cleaned carefully before soldering.

For general experimenting, about 40 leads (perhaps 30 red ones 6" long and 10 yellow ones 10" long) will be required. To make a zip lead, cut the wire to the proper length and strip $\frac{1}{4}$ " of insulation from each end. Slip a piece of heat-shrinkable tubing over each end and solder a hair pin cotter to each end. Then

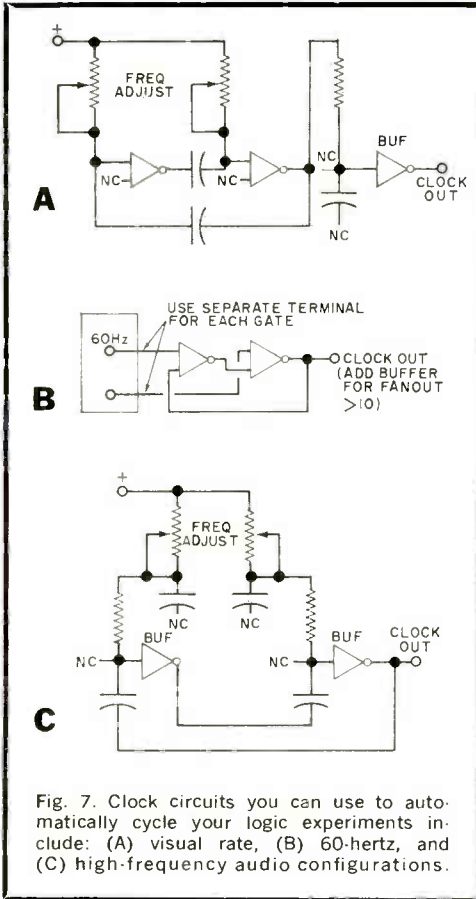
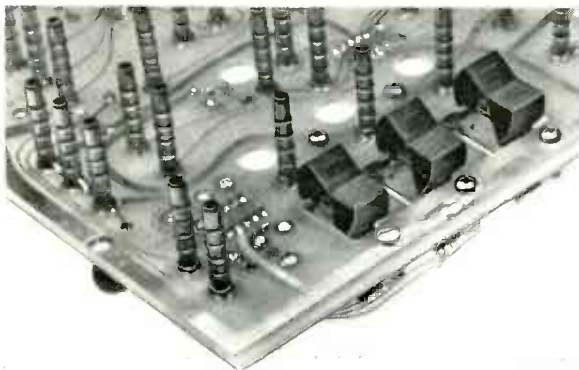

Fig. 7. Clock circuits you can use to automatically cycle your logic experiments include: (A) visual rate, (B) 60-hertz, and (C) high-frequency audio configurations.

slip the tubing over the joint and heat it to shrink it in place. You can do a very neat shrinking job by holding the tubing lightly against the ceramic portion of a screw-in-element soldering iron and rotating slowly.

(Continued on page 38)



OVER A HUNDRED CIRCUITS YOU CAN BUILD WITH THE MICROLAB

GATES AND BUFFERS:

Buffer amplifier, positive pulser, negative pulser, high- or low-frequency astable; logic demonstrators—2-input OR, NOR, AND, NAND, EXOR, EXNOR, positive or negative logic, 3-input OR, NOR, AND, NAND, positive or negative logic, 4-through-8-input OR, NOR, positive and AND/NAND negative logic; binary encoder and decoder; inverter demonstrator.

TYPES OF MULTIVIBRATORS:

RS flip-flop; set-reset latch; edge trimmer latch; monostable multi-, high-, or low-frequency, buffered or load-isolated; half monostable; reset pulse generator; astables, including load isolated, sure start, symmetric, VCO, and negative recovery types; frequency doublers and quadruplers; risetime improvers; squaring circuits; linear amplifier modification.

COUNTERS, REGISTERS, AND SCALERS:

Binary up or down counters, modulo 2,4,8, and 16; synchronous binary 2,4, and 8; shift registers, 1,2,3, and 4 bit; shift register counter, modulo 3,7, and 15; walking ring counters, 2,4,6, and 8, including protected 6 and 8; odd length walking ring counters, 3,5, and 7; factored counters, 2,4,6,8,9,10,12,14, and 16; halfway addition counters, 3,5,6,7,9,10,11,12, 13,14,15; pseudo-random counter sequencers 7 and 15; even-odd reduction modulo 3, 5, and 9; bucket brigade counters, open ended or closed, modulo 1,2,3, and 4; decoded counters, 2,3,4, and 5.

OTHER CLOCKED FLIP-FLOP CIRCUITS:

Sequential pass-ons, 1,2,3, and 4; divide-by-two synchronizer; gated divider; straight synchronizer; one-and-only-one; sequencer; demonstrators, JK, T, D, and RS; type D registers, rings, binary dividers, and sequential pass-ons; disallowed state 2/6 and 2/8 demonstrators.

DECIMAL COUNTERS:

Modulo 10 minimum; inverted M-10-Min; 1-2-4-8; 1-2-4-5; excess 3; 1-2-2'-4; 1-1'-2-5 bi-quinary ring; quibinary ring; halfway addition modulo 10.

DIGITAL TEST INSTRUMENTS, ETC.:

Bounceless pushbuttons; 60-Hz power line clock; visual rate clocks; audio high-frequency clock; state indicators; 0.1-second time base; synchronized 0.1-second time base; power line zero-crossing detector; synchronizers; buffer interface; contact conditioner; heads/tails machine; electronic die; pseudo and random number generators; gated oscillator; counter prescaler; reset pulse generator; signal injector; audio oscillator; electronic siren, door-bell, or panic alarm.

Terminal posts insert through foil side of board, soldered to foil, and exposed to component side.

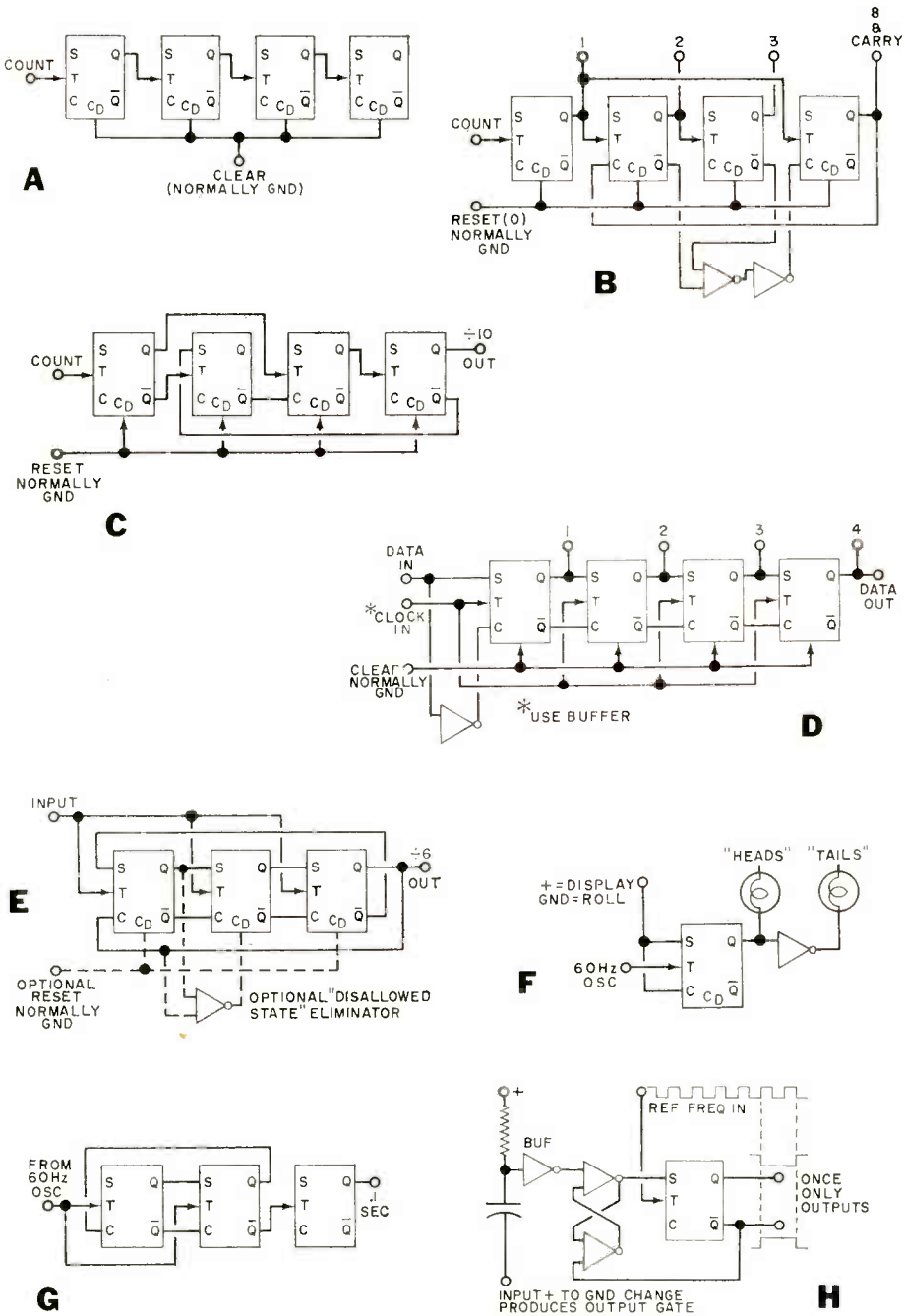
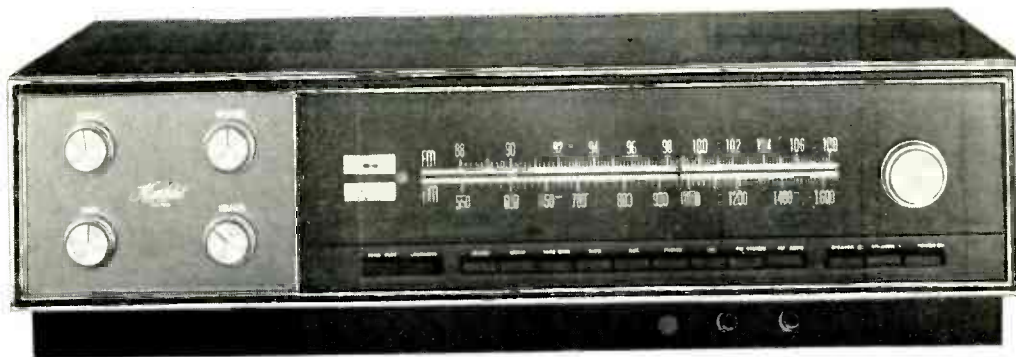

Fig. 9. Some popular digital logic demonstration circuits you can set up are: (A) divide-by-16 binary ripple counter; (B) "1-2-4-8" BCD divide-by-ten counter; (C) "modulo-10 minimum" divide-by-ten scaler; (D) four-stage shift register; (E) divide by six walking ring counter; (F) heads-or-tails "honest odds" coin flipper; (G) 0.1-sec time base (square-wave generator); and (H) "one-and-only-one" synchronizer.

Meet the second generation AR-15 ...new Heathkit AR-1500



In 1967 we introduced the Heathkit AR-15, a receiver that opened new horizons in stereo and FM/ stereo circuitry. Experts agreed it was the most advanced receiver of its kind. Now meet the Heathkit AR-1500 — successor to the AR-15 — with impressive improvements in every critical area!

180 Watts Dynamic Music Power, 90 watts per channel (8 ohm load); 120 watts dynamic music power per channel under 4 ohm load, with less than .2% intermod distortion, less than .25% harmonic distortion. The 14-lb. power transformer and massive output transistor heat sink make this definitive statement on power in the Heath tradition of conservative ratings. Direct coupled output and drive transistors are protected by limiting circuitry that electronically monitors voltage and current.

FM Selectivity greater than 80 dB, better phase linearity, separation and less distortion are made possible by two computer-designed 5-pole LC Filters. The improved 4-gang 6 tuned circuit front-end gives better stability, 1.8 uV sensitivity, 1.5 dB capture ratio, and 100 dB image and IF rejection. Four IC's are used, three in the IF, one in the Multiplex. Patented automatic FM squelch is both noise and deviation activated, fully adjustable for sensitivity.

Vastly Superior AM, an "also ran" with many other receivers, has two dual-gate MOSFETS in the RF and Mixer stages, one J-FET in the oscillator, 12-pole LC Filter in the IF, and broad-band detector. Better overload characteristics, better AGC action, and no IF alignment.

Famous Heath "Black Magic" Lighting hides tuning scales and meters when the AR-1500 is not in use. You'll appreciate such niceties as velvet-smooth single-knob flywheel tuning for FM and AM, function pushbuttons, chrome-plated die cast panel and knobs. And there are outputs for two separate speaker systems, bi-amplification (separable preamps and amps); oscilloscope monitoring of FM multipath. Inputs for phono, tape, tape monitor and auxiliary sources — all with individual level controls.

If you can build a kit, you can build an AR-1500! Ten plug-in circuit boards, two wiring harnesses and extensive use of pre-cut wiring with installed clip connectors make the AR-1500 a kit-builder's dream. Built-in test circuitry uses signal meter to make resistance and voltage checks before operation. Install in the new low-profile walnut cabinet, in a wall or use the black-finish dust-cover included in the kit. The coupon at right is your order blank. Or, if you still can't believe the AR-15 was just a beginning, send for more information on the new Heathkit AR-1500.

Kit AR-1500, less cabinet, 42 lbs., mailable \$379.95
ARA-1500-1, walnut cabinet, 8 lbs., mailable \$19.95



Massive transformer, and output transistors with heat sink across the full length of the back panel, are mute testimony to the power at your command.

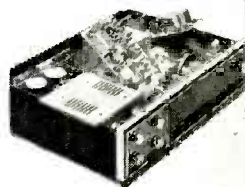

Hinged circuit boards for FM IF, AM IF, Multiplex and Phono Preamp sections — six plug-in boards for all other major circuitry.



Printed plug-in boards for AM and FM IF sections contribute to error-free building. FM circuitry has three LC filters, three IC's. Even the AM has an LC for superior reception.



Completely new AM tuner circuitry mounts easily on printed circuit board — includes two dual-gate MOSFETS and J-FET mixer. FM tuner is preassembled ready to install.

HEATHKIT
Schlumberger

HEATH COMPANY, Dept. 110
Benton Harbor, Michigan 49022

Enclosed is \$ _____, plus shipping.

Please send model (s) _____

Please send FREE Heathkit Catalog.

Name (print) _____

Address _____

City _____ State _____ Zip _____

Prices & specifications subject to change without notice.
*Mail order prices, F.O.B. factory. HF-249R

CIRCLE NO. 9 ON READER SERVICE CARD

How to Use. The manual prescribed in the Parts List gives many of the experiments you can perform with the Micro-lab. Many of the drawings are in logic block form and ready for instant breadboarding. Generally, you set up an experiment using a logic diagram and the zip leads and then put the circuit through all its possible states in one of several ways.

For instance, you can use the positive and ground reference posts and, by changing zip leads, cycle the circuit. Or you can use the actuators, either as slide switches or by rocking them with two fingers, as pushbuttons.

For automatic experimenting, you can drive the circuit from one of the "clocks" shown in Fig. 7. Figure 7A shows how to use the two RC networks to build a variable low-frequency oscillator that can cycle an experiment at an easy-to-watch, adjustable rate. Figure 7B shows how to build a 60-Hz power-line driven oscillator, which is useful for time bases, heads-tails and random-number circuits, and other cases where you want to cycle the logic faster. Finally, Fig. 7C shows how to create a high-frequency oscillator by cross-coupling the two buffers. This high-speed cycling circuit is most useful when you have an oscilloscope to observe the resulting waveforms or are cycling or testing an external digital instrument.

Several small numbers appear next to terminals on the front panel. These tell you either how much drive is available if the terminal is an output or how much drive is needed if the terminal is an input. For instance, the two-input gate has 13 units of drive available at its output and needs 3 units of drive at either of its inputs. With this gate, you can drive, say, two T inputs (5 units each) and an S input (3 units); but three T inputs (totalling 15) would be too much. Any time you run out of drive capability, run the output through a buffer. Either buffer output is powerful enough (77 units) to drive every input on the board simultaneously. Each of the three switches can put out 13 units of drive power. Use a buffer if you simultaneously (synchronously) drive all four T inputs.

Figure 8 shows some of the more popular digital demonstration circuits. Figure 8A is a binary ripple counter that counts to 16 and then repeats; B is a 1-2-4-8 decimal or divide-by-10 counter;

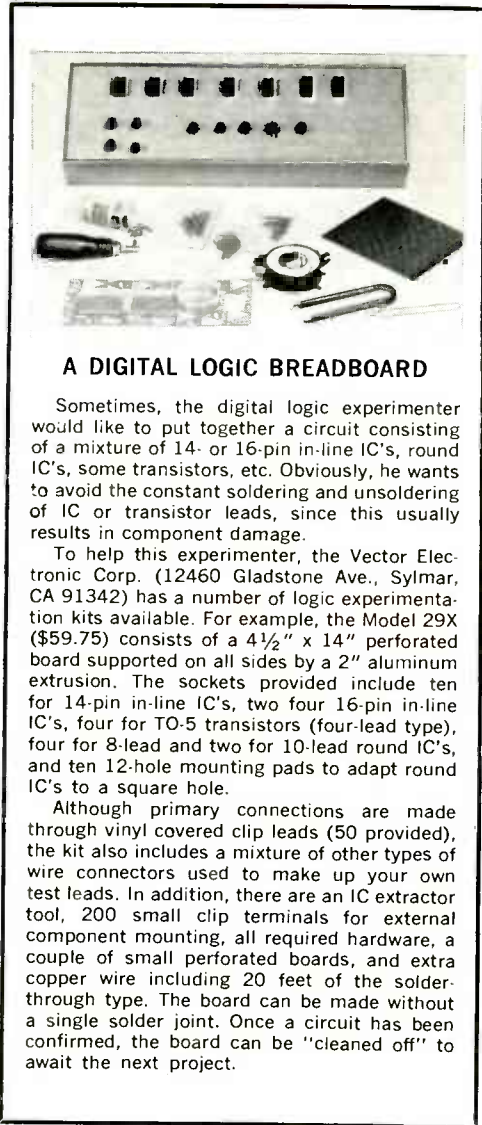

A DIGITAL LOGIC BREADBOARD

Sometimes, the digital logic experimenter would like to put together a circuit consisting of a mixture of 14- or 16-pin in-line IC's, round IC's, some transistors, etc. Obviously, he wants to avoid the constant soldering and unsoldering of IC or transistor leads, since this usually results in component damage.

To help this experimenter, the Vector Electronic Corp. (12460 Gladstone Ave., Sylmar, CA 91342) has a number of logic experimentation kits available. For example, the Model 29X (\$59.75) consists of a 4½" x 14" perforated board supported on all sides by a 2" aluminum extrusion. The sockets provided include ten for 14-pin in-line IC's, two four 16-pin in-line IC's, four for TO-5 transistors (four-lead type), four for 8-lead and two for 10-lead round IC's, and ten 12-hole mounting pads to adapt round IC's to a square hole.

Although primary connections are made through vinyl covered clip leads (50 provided), the kit also includes a mixture of other types of wire connectors used to make up your own test leads. In addition, there are an IC extractor tool, 200 small clip terminals for external component mounting, all required hardware, a couple of small perforated boards, and extra copper wire including 20 feet of the solder-through type. The board can be made without a single solder joint. Once a circuit has been confirmed, the board can be "cleaned off" to await the next project.

C is a modulo-ten minimum-hardware decimal counter; D is a four-stage shift register; E is a walking-ring divide-by-six counter useful in digital clocks and as an electronic die; F is an honest-odds, heads-or-tails coin flipper; G is a 0.1-second time base and square-wave oscillator; H is a one-and-only-one synchronizer that can be used with the time base to get one precise 0.1-second gate under random command every time you flip the switch; I is a divide-by-3 counter; J is a divide-by-five counter; and K is a 15-state pseudo random-sequence generator.

-30-

Build the Bug Shoo

*Greaseless,
odorless
mosquito
repellent*

BY LYMAN E. GREENLEE

THROUGH OBSERVATION and scientific study of the habits of mosquitoes, certain facts have been compiled leading to the design of an electronic repellent for the little beasties. It has been determined that the male mosquito is attracted by a humming noise at a frequency of about 2000 Hz. But the male mosquito does not sting; it is the female of the species that creates all the discomfort.

The female mosquito is said to be repelled by the same sound that attracts the male. And since it is the female mosquito you want to ward off, having a device that will "repel" her is mighty handy. The trick is to ward off the female without attracting too many male mosquitoes, and the "Bug-Shoo," a simple cigarette-package-size device, has proven itself to be quite effective since female mosquitoes usually avoid the male "humming" area.



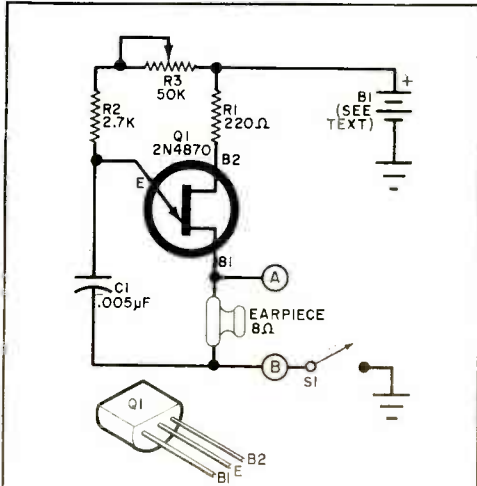

Fig. 1. Simple UJT relaxation oscillator makes up repeller; output is from earpiece.

PARTS LIST

- B1*—9-volt transistor or 22.5-volt miniature battery (see text)
C1—0.005- μ F disc capacitor
Q1—Transistor (Motorola 2N4870 or HEI 310)
R1—220-ohm, $\frac{1}{2}$ -watt resistor
R2—2700-ohm, $\frac{1}{2}$ -watt resistor
R3—50,000-ohm miniature P.C. potentiometer
S1—S.p.s.t. slide or miniature toggle switch
1—8-ohm miniature earpiece (from transistor radio)
1— $3\frac{3}{4}$ " x $2\frac{1}{8}$ " x $\frac{1}{8}$ " aluminum utility box
Misc.—Brass shim stock; 22-gauge aluminum (or old money clip) for pocket clip; 2-56 machine hardware; 1"-square piece of fiber paper insulator; perforated phenolic or Bakelite board; hookup wire; solder; etc.

About The Circuit. A simple UJT relaxation oscillator (see Fig. 1) is the heart of the Bug-Shoo. Unijunction transistor *Q1* is the active element in the circuit, while capacitor *C1* and the combined resistances of *R2* and potentiometer *R3* form the frequency-determining RC network. Potentiometer *R3* provides control over a wide frequency range.

Resistor *R1* is the B2 load for *Q1*. The output transducer for the Bug-Shoo is an inexpensive miniature earpiece with an impedance of 8 ohms. Power for the circuit is not critical and can be anywhere between 9 and 22 volts, using a small transistor radio battery.

Construction. Due to the simplicity of the circuit, assembly is best performed

as shown in Fig. 2 on a piece of Bakelite or perforated phenolic board. The board should measure no more than $1\frac{3}{4}$ " x $1\frac{1}{2}$ " if you wish the entire project to fit inside a $3\frac{3}{4}$ " x $2\frac{1}{8}$ " x $1\frac{1}{4}$ " metal utility box. You can assemble the circuit on the board by drilling holes for and routing cross-connecting wiring under the board. Control *R3* also mounts to the underside of the board.

Next, machine the top half of the utility box so that the opening of the earpiece and control slot for *R3* are accessible from the outside. Then mount the circuit board with 2-56 machine hardware and $\frac{1}{4}$ "-long spacers. Switch *S1* mounts near the board with 6-32 screws.

If you are using a miniature 22.5-volt battery for *B1*, you can mount it in place as follows. Make an indentation (centered $\frac{3}{8}$ " in from one end of the bottom half of the utility box) to accommodate the negative contact of the battery. Then cement a 1"-square piece of black fiber paper on the opposite wall of the half section (see Fig. 3). Solder the free end of the positive hookup wire to a $\frac{1}{2}$ "-square piece of brass shim stock and wedge the shim between the positive contact of the battery and fiber paper. (If

AN EXPERIMENTAL DEVICE

The Bug-Shoo is an experimental device. As such, it makes an excellent research project. The fact that sounds attract or repel mosquitoes has been proved in laboratory experiments. Recordings have been made of the mating calls of mosquitoes, and playbacks of these recordings have proved effective in luring mosquitoes into traps where they could be conveniently destroyed.

Just because you are wearing the Bug-Shoo, there is no absolute guarantee that you will not be attacked and stung by mosquitoes. But then the application of greasy or odorous "repellents" or powders is no guarantee against stings either. One method works about as well as the other, but the Bug-Shoo is not gooey, greasy, or smelly.

There are a number of outstanding patents on devices of this nature. The most important are U.S.A. Patents 1,700,450; 1,870,778; 2,922,999; and 2,928,204. There is a British Patent (705,921) that is worth reading and an Italian Patent (426,491) on repelling mosquitoes with ultrasonic sound. There are several books and papers on this subject available in major libraries.

—Lyman E. Greenlee

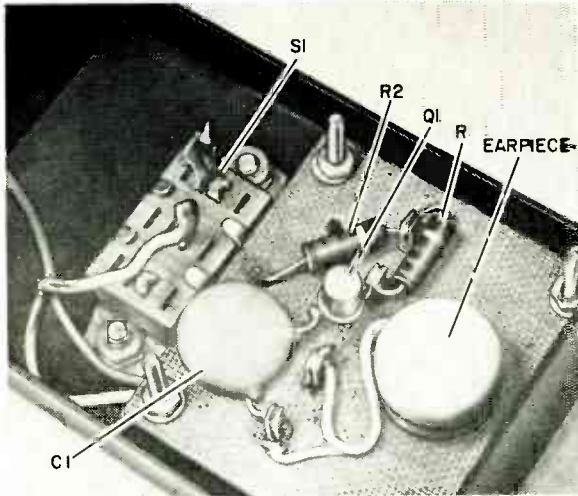

Fig. 2. All components except switch and battery are on circuit board. Interconnecting wiring is routed on bottom of board; earpiece is cemented in place.

If you have difficulty in achieving efficient operation always try a different earphone. Some earphones work much better than others and the author has found surprising differences in earphone sensitivity and audio output.

you use a 9-volt battery, there is no need to dimple the side or use fiber paper; the usual snap-on connector will serve as a wedge.) The battery can then be held in place with a small L bracket and 2-56 machine hardware.

Finally, bolt to the outside surface of the bottom of the utility box a pocket clip. The clip can be made from an old money clip or from 22-gauge aluminum stock. Assemble the box.

Use. You can "tune" the Bug-Shoo oscillator by ear or by comparison with the output signal heard from a loudspeaker from an audio generator. A frequency between 2000 and 2500 Hz seems to work best as a repellent. However, it is inter-

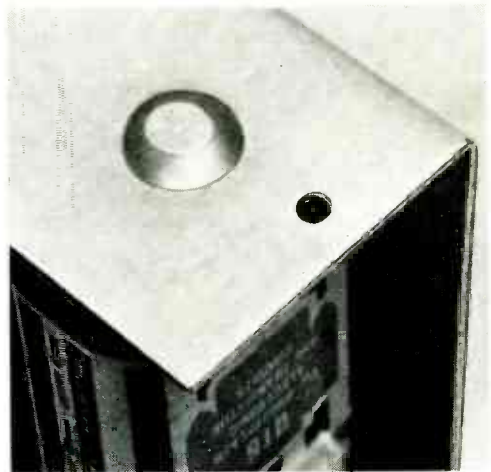

Fig. 3. For installation of 22.5-volt battery, one side of chassis box must be dimpled to accept negative contact (above). Positive pole connection consists of brass shim (left), insulated from box with fiber paper. Small L-bracket holds battery in upright position. Note the wire connected to shim.



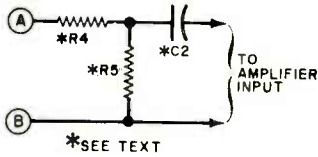

Fig. 4. Optional add-on allows Bug-Shoo to be used with amplifier for larger area coverage. Points A and B connect to respective points in main schematic diagram.

esting to note that *all* mosquitoes seem to be repelled by a high frequency, above 10,000 Hz. If you set $R3$ so that the oscillator produces the highest pitched squeal you can hear, and then turn it just slightly into the ultrasonic range, the sound will be unnoticeable to you but will be detected by mosquitoes. But your dog might hate you!

The Bug-Shoo's observed effective range is 3' or more. Hence, it is not recommended for beach use where most of your epidermis (that's skin in case you don't know what epidermis is) is exposed as a succulent meal for a passing female mosquito. You should use the Bug-Shoo when you are fully clothed from the waist down and want to protect your upper body.

If you want greater coverage from the Bug-Shoo, you can connect it to an audio amplifier. In this case you will need an add-on circuit as shown in Fig. 4; points A and B indicate the connections to be made to the basic oscillator circuit in Fig. 1. In the add-on circuit, capacitor $C2$ can have any value between 0.05 and 0.1 μF . Resistors $R4$ and $R5$ serve as a volume reducing pad for the input signal to the amplifier. For a 10:1 reduction in signal amplitude, try using 10 ohms for $R4$ and 100 ohms for $R5$.

By using an amplifier with your Bug-Shoo, it is possible to increase greatly the area of coverage against mosquito attacks. But there is a practical limit to the coverage area—especially if there are a lot of dogs in the vicinity. —30—



For carrying convenience, you can fashion pocket clip from 22-gauge aluminum stock and bolt it to rear of chassis box. An old money clip can also be used if available.

BURNING OUT YOUR CIRCUITS WITHOUT REALLY TRYING

BY ERROL J. QUEEN

THE AGE OF SEMICONDUCTORS brought with it the many advantages of subminiaturization, cool operation, and improved performance in everything from sophisticated FM tuners to electronic light dimmers. Diodes and transistors are not without problems, however; as I recently discovered.

I am an audio-visual enthusiast and take great pains to put on semi-professional slide shows for friends and relatives who visit us frequently. A Kodak Carousel projector is connected through a Sound Synchronizer to a transistorized tape deck and amplifier. The Synchronizer unit receives trip signals from one track of the stereo tape, in turn changing the slides in coordination with pre-recorded commentary and music. Colored lamps light the projection screen prior to the show's beginning; and by means of a light dimmer, the room lights and colored spots are slowly dimmed as the first slide comes on.

Recently, in redecorating our family room, I made the mistake of having acrylic wall-to-wall carpeting put in. I was unaware of its highly electrostatic nature, particularly on cool winter evenings. Sparks can play havoc with apparatus containing semiconductors.

When my wife or I walked across the room and then touched any metal surface, an intense spark was created. While not dangerous because of the infinitesimally low current, the voltage was probably near 100,000 volts with sparks as long as an inch and a half. We even found that we were able to locate metal surfaces behind the wall plaster (such as plumbing and conduits) by walking about and probing with a finger until a spark jumped into the wall. My wife insisted that perhaps there were treasures buried beneath the floor and asked that I crawl along the carpeting as a human treasure locator!

The electrostatic nature of acrylic (and also nylon rugs) was such that

within a week I saw sparks fly into my FM tuner, lamp dimmer, and FM-AM clock radio. Each in turn suffered semiconductor damage, which was costly and emotionally disconcerting. At that point, I felt I would have to make a serious decision—sell the carpeting at a tremendous loss, or sell the semiconductor equipment at a loss of dollars and pleasure. I searched the catalogs and concluded that tube-type tuners and clock radios were rapidly becoming a thing of the past—what with their problems of size, heat, and lack of demand.

My problems were finally resolved when I called in the firm which sold the carpeting. They recommended one of several available sprays, which, when applied, reduce the charge buildup on such fibers. Powders are also available for the same purpose. Finally, a humidifier in the room or house is an excellent method of reducing static changes.

If you own or plan to buy transistorized radios, amplifiers, tuners, tape decks, light dimmers, or other appliances, make sure your carpeting is static-free.

-30-



I made an excellent human treasure locator!

Low-cost
signal
source
for
a.f./i.f./r.f.

MICRO'LIGN GENERATOR

A PROBLEM often encountered upon completion of a kit- or magazine project-built radio receiver for AM broadcast reception is getting it properly aligned. Sure, you can tune the receiver by ear, but to get it to track properly, the intermediate frequency (i.f.) should be as close to 455 kHz as possible. For the casual hobbyist, a signal generator is usually a luxury. However, the "Micro'Lign" generator, an inexpensive, easy-to-build, accurate a.f./i.f./r.f. signal source, fills the need nicely.

The Micro'Lign is "on frequency" as soon as it is assembled so there is no need for test or calibration equipment to make it work properly. The output of the generator is a 500-Hz audio tone and a 455-kHz i.f. signal, both rich in harmonics. (The i.f. harmonics are usable to beyond 30 MHz.) The 455-kHz output, modulated at 500 Hz is used in AM broadcast-band work for i.f. alignment,

and modulated signals at 910 kHz and 1365 kHz are for r.f. alignment. The 500-Hz signal is also useful for troubleshooting the audio stages of a receiver or other audio circuits.

How It Works. The r.f. oscillator ($Q3$ circuit in Fig. 1) is a variation of the Hartley or Colpitts circuit, but it uses a Clevite Transfilter, $XTAL$, in place of the usual coils and capacitors. The Transfilter is a piezoelectric device consisting of a plated ceramic disc. The disc has natural mechanical vibration modes which can be induced by applying a voltage to the plated terminals.

Transistor $Q3$ amplifies the signal produced by the vibrating disc in $XTAL$ and feeds it back in the proper phase to sustain oscillations. Initial oscillations are caused by the sudden application of voltage to the circuit when power switch $S1$ is closed. The Transfilter oscillator

then produces the 455-kHz "r.f." signal and its harmonics.

Audio for amplitude modulation is produced by the astable multivibrator circuit consisting of transistors $Q1$ and $Q2$. A voltage divider made up of resistors $R1$ and $R2$ is used to supply audio and the oscillator voltage from $B1$ to $Q3$. The use of the divider insures that $Q3$ will oscillate even on the audio half-cycles when $Q1$ is cut off.

Construction. To keep construction simple, it is suggested that you use a printed circuit board for parts mounting. You can make your own board from the full-size etching guide provided in Fig. 2, or you can buy one already etched and drilled from the source given in the Parts List.

In assembling the circuit, notice that all components, with the exception of the Transfilter, mount on the top of the

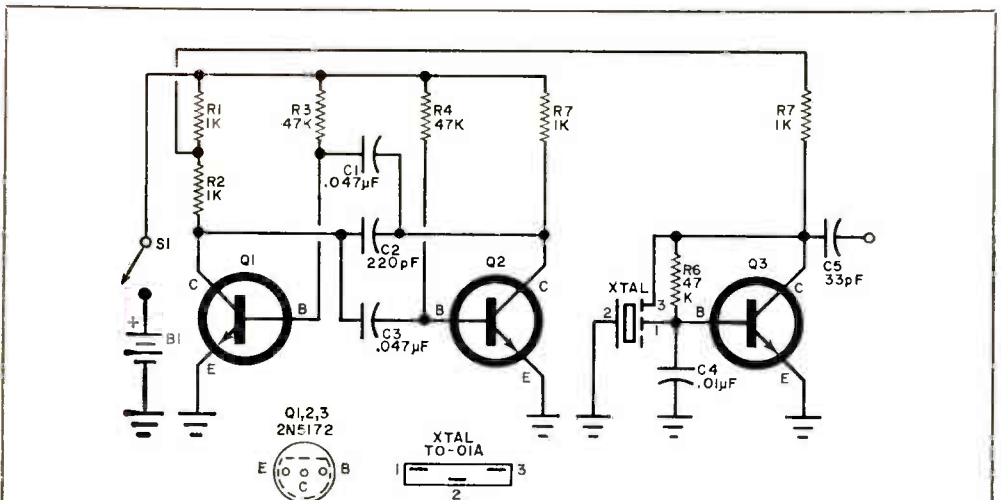

Fig. 1. Generator consists of crystal-controlled r.f. oscillator $Q3$ and $Q1/Q2$ multivibrator which provides amplitude modulating signal.

PARTS LIST

$B1$ —9-volt transistor battery
 $C1, C3$ —0.047- μF , 10-volt disc capacitor
 $C2$ —220-pF disc capacitor
 $C4$ —0.01- μF , 10-volt disc capacitor
 $C5$ —33-pF disc capacitor
 $Q1, Q2, Q3$ —2N5172
 $R1, R2, R5, R7$ —1000-ohm, $\frac{1}{4}$ -watt resistor
 $R3, R4, R6$ —47,000-ohm, $\frac{1}{4}$ -watt resistor
 $S1$ —S.p.s.t. printed-circuit-type slide switch
 $XTAL$ —Transfilter (Clevite Corp. No. 10-01A)
 1 — $2\frac{1}{4}$ " x $1\frac{1}{2}$ " x $1\frac{3}{8}$ " box (LMB No. M100)

Misc.—Printed circuit board; battery connector; miniature alligator clips (2); hardware: hookup wire; solder; etc.

Note—A complete kit of parts (including Transfilter, battery, printed circuit board, chassis box, and all components) is available for \$7.95, postpaid, from Kits Industries, Inc., 3546 Dakota Ave., Minneapolis, M.N. 55416. Clevite Transfilter is available from Semiconductor Specialists, Inc., P.O. Box 66125, Chicago, IL 60666, or from Kits Industries for \$1.75. Printed circuit board is available separately from Kits Industries for \$2.

circuit board (see parts placement photo in Fig. 2). The transfilter mounts on the foil side of the board. It must be mounted as close as possible to the board and carefully soldered with a miniature soldering iron.

The ground connection can be made to the chassis by soldering it to a #6 solder lug mounted between the switch tab and chassis.

The slide switch holds the small circuit board in place inside the chassis box by bolting the switch to the front of the box after bringing out the signal and

ground leads from the board as shown in the photo on the first page of this article. This allows you to mount the battery directly behind the circuit board. Then place a piece of sponge rubber or other insulating material between the battery and bottom of the circuit board. Finally, solder alligator clips onto the output leads, and assemble the box.

How To Use. Connect the output lead clips of the Micro'Lign together to form a loop, and place the loop near the ferrite rod antenna of an AM broadcast receive-

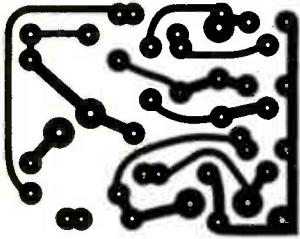
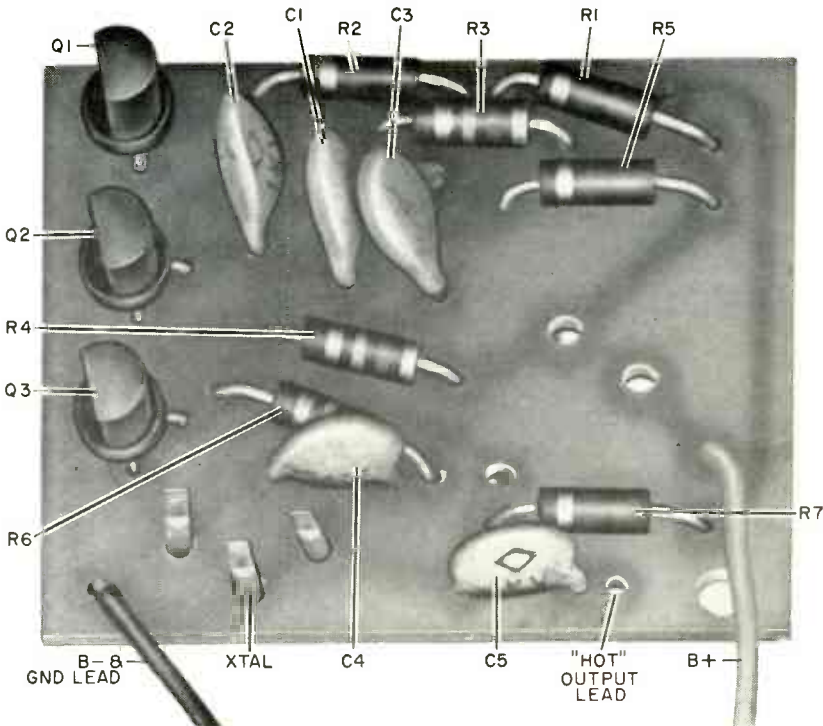
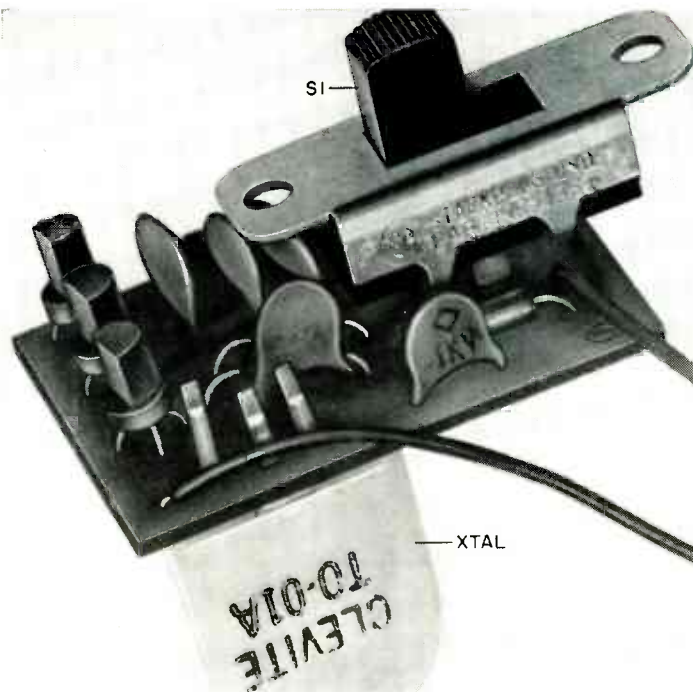

Fig. 2. Actual size printed circuit etching guide is shown at left. Photo below shows component placement (except S1) on board.





Special Clevite Transfilter must be seated on circuit board from foil side; switch S1 mounts on top (component side) of board.

er. Tune the receiver to its lowest frequency (535-540 kHz, if the dial markings go that low). Turn on the receiver.

With the receiver volume turned up, you should hear the 500-Hz tone coming from its speaker. However, if you do not hear the tone, or the tone is too low in volume, move the Micro'Lign's loop closer to the antenna; if too loud, move the loop farther away. Now, adjust the i.f. transformer slugs to obtain the loudest note. Move the Micro'Lign away from the receiver until the note volume diminishes, and adjust the slugs again for maximum volume. Do this until you hear no perceptible change in the level of the note.

After peaking the i.f. transformers, turn off the Micro'Lign. Tune in a station at the low end of the receiver dial and adjust the oscillator coil slug and the setting of the station selector until

you hear the broadcast on the correct dial setting. Now, tune in a station at the top end of the receiver dial, and adjust the oscillator trimmer capacitor and the setting of the station dial until the station comes in at the proper dial setting. Repeat this procedure at the low and high ends of the dial until no further change is noted.

Again, turn on the Micro'Lign. Tune in the generator's signal at 910 kHz on the receiver dial. Move the Micro'Lign away from the receiver until you can barely hear the signal. Adjust the antenna trimmer capacitor for maximum volume level.

The Micro'Lign can also be used as a signal injector for troubleshooting the audio and i.f. stages in both tube and transistor type receivers. It can even be used to trace troubles in high quality amplifiers.

-30-

Build a LOW-COST TIME DELAY RELAY

BY JOHN STAYTON

AN INEXPENSIVE, semi-variable time delay relay is a handy item to have around if you do a lot of experimenting. While solid-state timers give excellent results, they are often more precise than required and prohibitively expensive for

After some specified time, depending on the characteristics of *K2*, the thermal relay's contacts close and supply power to the heater of *K1*. Then, when *K1*'s time delay has elapsed, its contacts open and break the circuit that latches *K3*

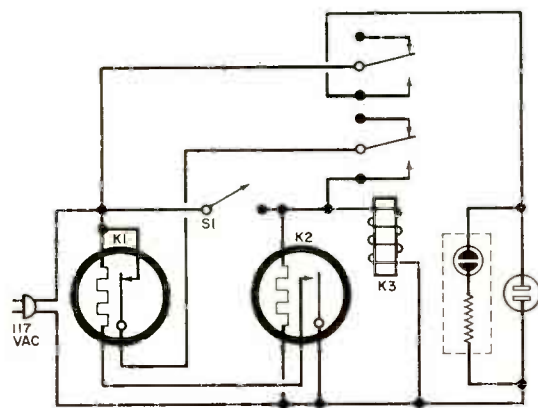

Thermal relays *K1* and *K2* are selected to give desired delay time. Depending on the relays, delay can be between 4 seconds and 6 minutes.

PARTS LIST

- K1*—S.p.s.t. normally closed 117-volt thermostatic relay
- K2*—S.p.s.t. normally open 117-volt thermostatic relay
- K3*—D.p.d.t. 117-volt electromagnetic relay with 10-ampere contacts
- S1*—S.p.s.t. normally open momentary-action push button switch
- Misc.—Neon lamp assembly with built-in current-limiting resistor; chassis- or line-cord-mounting a.c. receptacle; sockets for *K1* and *K2*; chassis; line cord and plug; hardware; wire; solder; etc.

simple experimenting and occasional use. However, commonly available and inexpensive thermostatic delay relays can be arranged in a circuit to provide the time delay or delays you would normally require.

Keeping in the low price range, it was found that a maximum of only three minutes could be obtained from any given thermal relay. However, with two thermal relays, as in the schematic diagram, you can obtain anywhere from four seconds to six minutes of delay time.

Circuit operation is easy to follow. When pushbutton switch *S1* is momentarily depressed, electromagnetic relay *K3* energizes, simultaneously delivering power to the heating element of thermal relay *K3* and the a.c. outlet. The indicator lamp lights up whenever the a.c. receptacle is "live."

closed. Relay *K3* deenergizes, and the delay cycle ends. The variable feature is not built in; it is actually a function of a combination of delay times selected for *K1* and *K2*.

Since the circuit is so simple, it can be laid out as desired during construction. The prototype shown here was built on a $5\frac{1}{4}'' \times 3'' \times 2''$ metal utility box to conserve space. Although the a.c. outlet is shown mounted to the rear of the box, it could just as easily have been located at the end of any desired length of twin-conductor power cable.

In use, the delay relay's power cord is plugged into an a.c. outlet, and the appliance to be operated connected via the a.c. receptacle. The delay relay is capable of handling up to 1000 watts; so a fairly high load can be safely controlled.

-30-

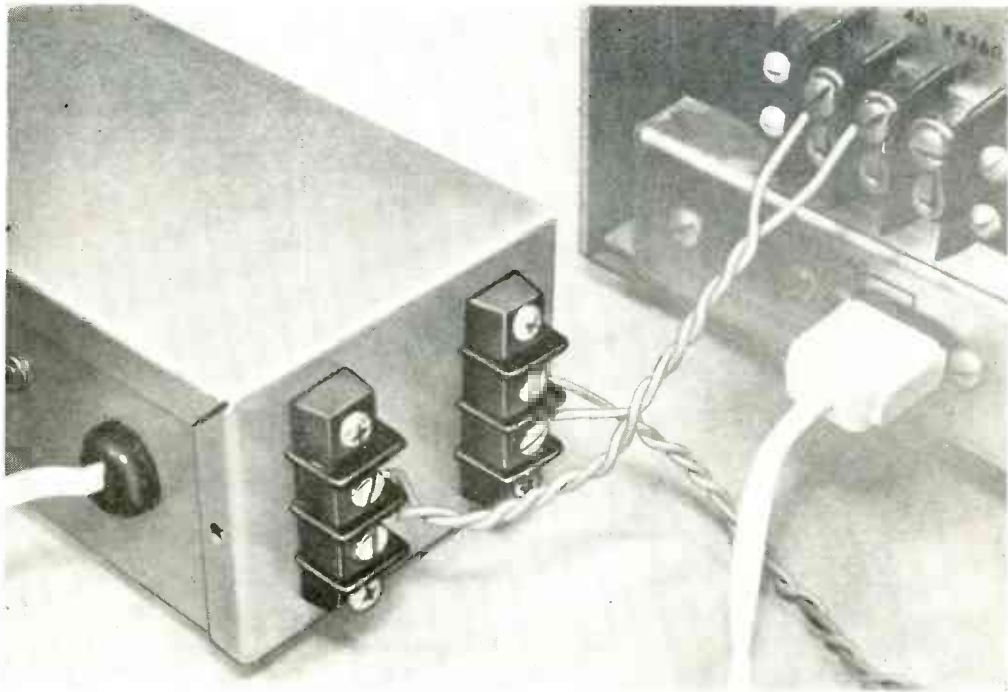

Build a WOOFER GUARD

SAFETY FIRST FOR SPEAKER CONES

BY PHIL ARTHUR

MANY DIRECT-COUPLED solid-state output amplifiers produce a loud "thump" every time you turn them on or off. Worse still, if their output circuits fail, the full supply voltage (on the order of 37.5-42 volts d.c.) could be delivered to your speaker systems, causing serious damage if not detected in time.

The turn-on/turn-off thump is a result of the supply voltage's being suddenly applied or removed from the output stages of the amplifier. If of sufficient amplitude, these voltage transients can "pop" speaker cones, irreparably damaging your speaker systems. The way to eliminate the thump is to delay the output signal (and, consequently, the transient) until the output voltage is at a safe level for the speakers—especially the woofers which are most prone to damage by the low frequency of the transient.

The other big hazard connected with direct-coupled outputs—short-circuit failures that deliver full supply voltage to the speakers—can be dealt with by the

same delay circuit. Since such a delay circuit is voltage sensitive, it would actuate long before the voltage available at the output could attain a damaging level.

The "Woofers Guard" was designed to allow hi-fi buffs to operate their systems with complete safety. Placed between the output terminals of any direct-coupled power amplifier and the speaker systems, it quite literally "guards" the speakers from damage.

About The Circuit. The Woofers Guard is composed of two circuits: a timer which prevents turn-on and turn-off transients from reaching the speakers, and a voltage sensing circuit that "samples" the output voltage of the amplifier to determine whether or not to complete the circuit to the speakers. Resistor *R8*, potentiometer *R9*, and capacitor *C2* in Fig. 1 form an *RC* timing circuit.

Resistor *R8* and potentiometer *R9* allow capacitor *C2* to charge up to about 1.2 volts when voltage is applied to the

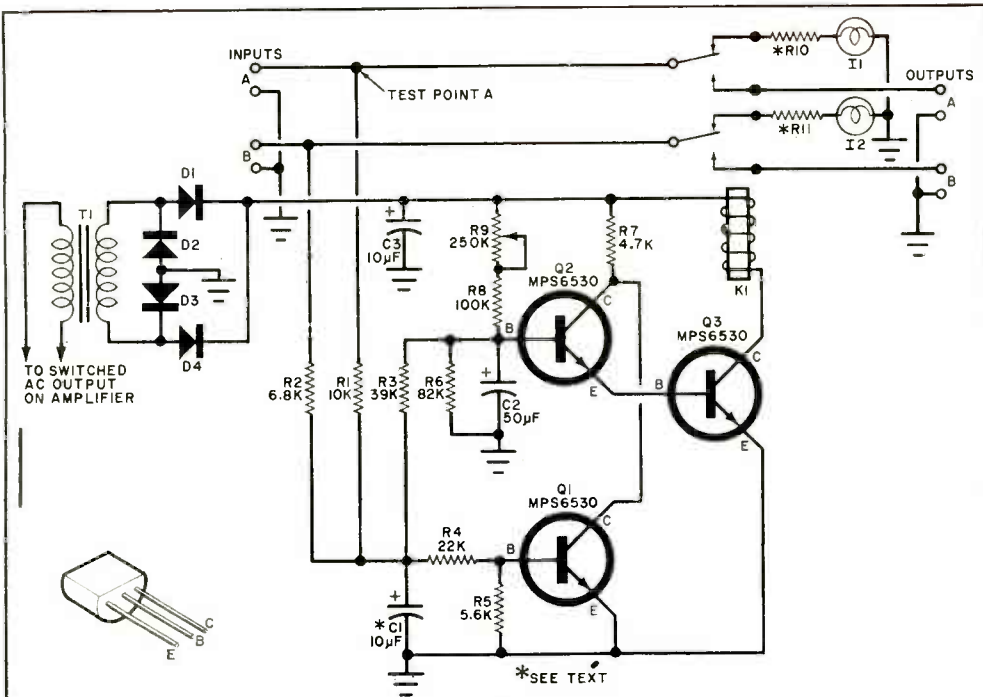

Fig. 1. Any high-level audio signal or constant d.c. voltage detected by amplifier circuit Q1-Q3 causes relay K1 to be deenergized.

PARTS LIST

- C1—10- μ F, 50-volt electrolytic capacitor (see text)
 C2—50- μ F, 15-volt electrolytic capacitor
 C3—10- μ F, 50-volt electrolytic capacitor
 D1-D4—100-volt, 0.5-ampere diode
 I1, I2—Optional indicator lamp (see text)
 K1—D.p.d.t., 24-volt, 600-ohm relay (Allied Electronics No. 41D4659 or similar)
 Q1-Q3—Bipolar transistors (Motorola MPS6530, HEP 721, or similar)

- R1—10,000-ohm
 R2—6800-ohm
 R3—39,000-ohm
 R4—22,000-ohm
 R5—5600-ohm
 R6—82,000-ohm
 R7—4700-ohm
 R8—100,000-ohm
 R9—250,000-ohm, linear-taper potentiometer
 R10, R11—Optional dropping resistors for I1 and I2 (see text)
 T1—24-volt, 0.5-ampere filament transformer
 Misc.—Aluminum utility box; rubber grommets for I1 and I2; a.c. line cord with plug; screw-type barrier blocks; hookup wire; solder; hardware; etc.

All resistors
 1/2-watt

circuit. Since transistors Q2 and Q3 are arranged in a Darlington-pair configuration, the transistors are cut off until the charge across C2 exceeds the sum of Q2's and Q3's emitter-to-base junction voltage (approximately 0.6 for each transistor, or a total of about 1.2 volts). As soon as 1.2 volts is exceeded, Q2 and Q3 will immediately go into conduction and cause K1, the relay, to be energized which completes the circuit between the amplifier and speaker systems. Now, if a component in the amplifier fails and the amplifier applies a positive or negative voltage, with respect to ground, to the output, the sensing circuit goes into ac-

tion and reverses the process just outlined, disconnecting the speakers from the amplifier output circuits.

Resistors R1 and R2 serve to isolate the Woofer Guard, preventing it from interfering with the normal operation of the amplifier. Capacitor C1 prevents the sensing circuit from going into action on loud music (high-voltage) passages.

If a positive voltage with a sufficient time duration appears at the output of the amplifier, a portion of this voltage will bias Q1 into conduction and cause the collector voltage of Q2 to decrease. This decrease, in turn, cuts off Q3 and

causes *K1* to deenergize and disable the circuits between amplifier and speaker systems.

If a negative voltage is applied to the input of the Speaker Guard circuit, a portion of this voltage would be fed, through *R3*, to the base of *Q2*, biasing both *Q2* and *Q3* into cutoff. Again, with these two transistors cut off, *K1* will be deenergized.

The power supply for the Speaker Guard consists of a simple bridge rectifier and a small-value filter capacitor (*D1-D4* and *C3*). Capacitor *C3* prevents *K1* from "chattering" prior to being fully energized.

The *I1/R10* and *I2/R11* circuits are optional features that provide a visual indication of which output circuit is defective in the event of an amplifier failure. The operation of these circuits is as follows: If channel A malfunctions and supplies the full supply (42 volts) to the Woofer Guard, the voltage-sensing circuit deenergizes *K1* as described above, disconnecting the speaker systems. The relay contacts are now in the positions shown, applying the supply voltage to *I1* through *R10*, indicating that Channel A is malfunctioning.

The values of resistors *R10* and *R11* must be calculated for your given amplifier. Since power supply voltages differ from amplifier to amplifier, you will have to use Ohm's Law to compute the values: $R = E/I$, where *E* is the amplifier's supply voltage minus the voltage rating of

the lamp, and *I* is the current rating of the lamp.

To show how the values of *R10* and *R11* are computed, assume that *E* is 42 volts and the lamp is rated at 6 volts at 40 mA. Plugging these figures into the Ohm's Law equation, we get: $R = E/I = (42 - 6)/0.04 = 900$ ohms. Then, to obtain the power rating of the resistor, use the power formula: $P = E^2/R = 36^2/900 = 1.44$ watts. Hence, we would use a 900-ohm, 2-watt resistor for the lamp voltage dropper in each channel.

Construction. Due to the simplicity of the circuit, all components (except *T1* and *K1*) can be easily mounted on a small piece of perforated phenolic board as shown in Fig. 2. The board is held in place with #6 hardware and $\frac{1}{2}$ " spacers.

Notice that input and output connections are made to separate screw-type barrier blocks. Make sure that, when wiring the blocks up, you do the job correctly. (Note: If your amplifier has one channel that can be switched to reverse the phase, check to make sure that the grounds in each channel are common to each other. If they are not, run separate ground wires for each channel through the Woofer Guard, and do NOT GROUND either of these wires to the chassis of the Woofer Guard or operating the phase reversal switch can damage your amplifier.)

When soldering to the diodes and transistors, exercise caution to prevent heat

Fig. 2. Except for relay, jacks, and transformer, all components mount on small piece of perforated phenolic board; use small L brackets for board mounting.

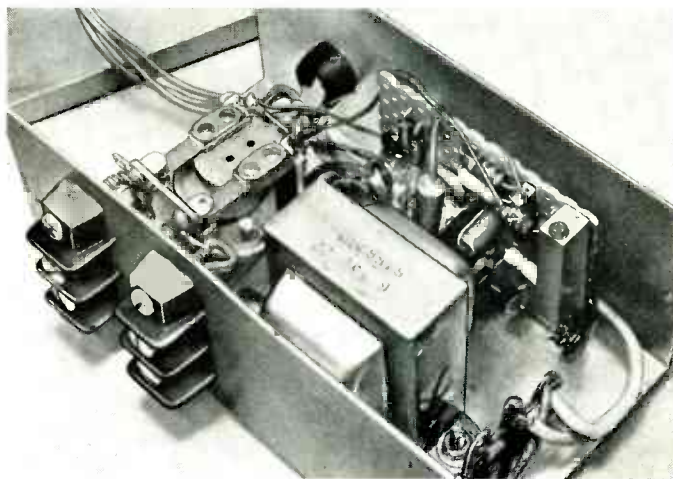

damage to these components. Use a low-wattage soldering iron, and apply the heat only long enough to get the solder to flow, while protecting the component lead with a heat sink. Also, make sure that electrolytic capacitors, diodes, and transistors are installed in the proper lead orientation.

Test and Adjustment. Without the speakers and amplifier connected to the Woofer Guard, plug in the guard's line

cord and adjust the setting of **R9** to obtain approximately a 2-second delay before the relay contacts close. Time the delay from the instant the power cord is connected until the contacts close.

To test the voltage-sensing circuit, momentarily touch the positive contact of a 9-volt transistor battery to test point A in the Woofer Guard circuit; the negative contact goes to the COMMON input terminal. The relay should immediately deenergize. Then, by momentarily touching the battery contacts to the same points in the Woofer Guard circuit in the opposite direction, the relay should again almost immediately deenergize.

HIRSCH-HOUCK LABORATORIES

Project Evaluation

Tested on the laboratory workbench, it was found that the relay in the Woofer Guard dropped out with as low as ± 3 volts d.c. applied to the inputs. It seemed a little sluggish at this low voltage (perhaps 0.5-second operating time), but at 5 volts or more, it operates in about 0.1 second. The release time after dropping out is on the order of 2 seconds.

Low-frequency audio signals were tried to determine what would trip the Woofer Guard. A sine wave of 10 volts r.m.s. at 5-6 Hz was capable of tripping the circuit, but a 9-volt peak-to-peak square wave of any frequency up to 50 kHz would also trip it. This is consistent with the static operation (d.c.) of the device, since it operates on both polarities; the square wave appears to the Woofer Guard as a d.c. input of about 4.5 volts.

The Woofer Guard was then connected between an Acoustic Research receiver and a pair of 8-ohm speakers. It trips on the muting "thump" if the volume setting on the amplifier is somewhat above the normal listening level, or if any great amount of bass boost is used. The only way the Woofer Guard was made to trip when fed with program material was to play the amplifier at very high levels, preferably with bass boost.

The Woofer Guard protects only the woofer in a speaker system, but the tweeter in many cases is more vulnerable. Even though few amplifiers have direct-coupled outputs, there is always the chance that the blocking capacitor will break down and place half of the supply voltage in the amplifier across the speaker system. The Woofer Guard should take care of such a situation nicely.

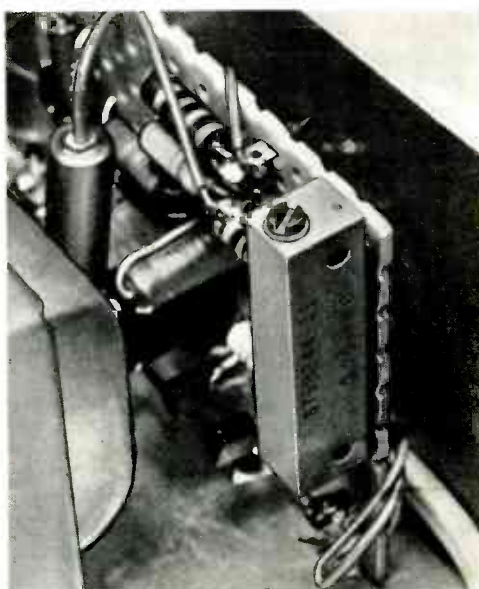

Long block shown in foreground is special trimmer potentiometer. You can substitute commonly available printed circuit type pot of appropriate value.

Now, assemble the Woofer Guard's case and connect it to your amplifier outputs and speaker systems. In use, you might notice that the Woofer Guard disconnects your speaker systems on high-level, low-frequency notes (about 70 watts r.m.s./channel below 20 Hz). If you find this annoying, you can replace **C1** with a 20- μ F capacitor. -50-



EXCLUSIVE DEVELOPMENTAL PROJECT

LASER BEAM COMMUNICATOR

AUDIO MODULATE OUR LOW-COST LASER

BY C. HARRY KNOWLES

COMMUNICATING by means of a laser beam is as fresh and new as the tomatoes picked from your garden tomorrow morning. The mere idea of being able to transmit information on a beam of coherent laser light suggests all sorts of possibilities for secret, non-jammable, interference-free communications. And it is possible today!

Communications by laser beam offers several advantages over conventional radio links. Neither atmospheric lightning nor airborne electrical noise affects laser communications though they can completely ruin radio communications. On

the debit side, however, laser performance is degraded, over any reasonable distance, by heavy fog, rain, snow, or terrestrial heat.

Unlike radio, in which the signal is "sprayed" out over a wide area, a laser beam communications system operates on a line-of-sight basis and the beam is tight enough to provide excellent privacy. Of course, obstructions cannot be permitted to interrupt the beam but conventional optical mirrors can be used to bend the light beam around obstructions.

Two approaches to laser communications are described in this article. The

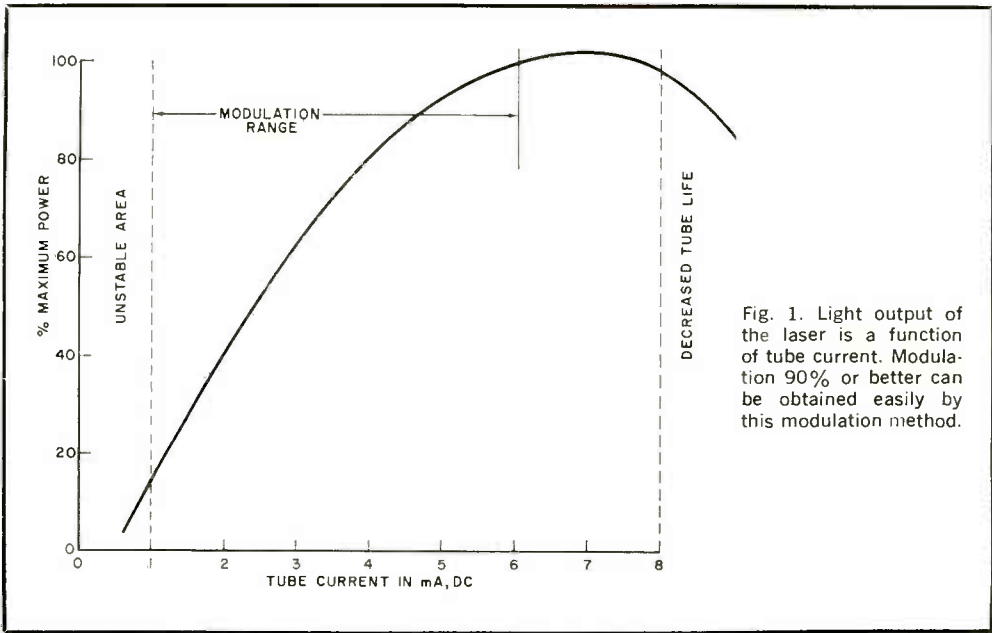

Fig. 1. Light output of the laser is a function of tube current. Modulation 90% or better can be obtained easily by this modulation method.

first involves only a simple addition to the basic laser described in the 1971 EXPERIMENTER'S HANDBOOK, Spring Edition. This system has a range of about 100 ft, and can be used for experimenting within a room and provides a "breadboard" for use in understanding modulated laser action. It also makes an excellent science fair project.

The second approach uses a modulation and receiving scheme similar to the

first but it operates through conventional low-cost telescopes to achieve a range of several miles (depending on atmospheric conditions).

Laser Modulation. The light output of a gas laser such as the 0.5-mw helium-neon type described in our previous article is a function of the current flowing through the laser tube (see Fig. 1). At very low currents, the laser becomes unstable and

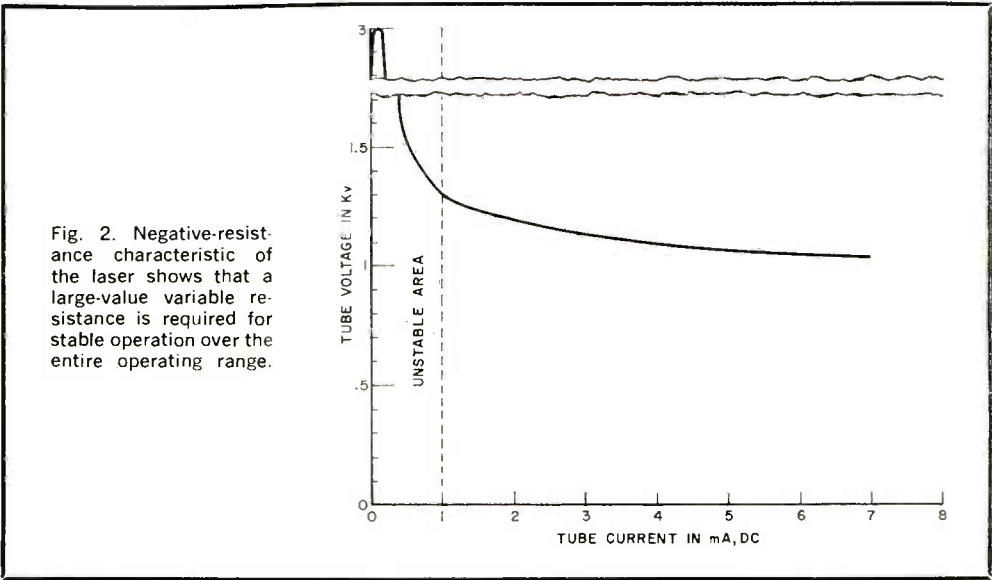

Fig. 2. Negative-resistance characteristic of the laser shows that a large-value variable resistance is required for stable operation over the entire operating range.

tends to turn itself off. The light output increases reasonably linear with tube current up to approximately 5 mA. Above that, the light output drops drastically and tube life is decreased. If the current is centered on the middle of the linear portion of the curve and varied about that point, the light output can be made to swing in a linear fashion and very high modulation levels can be obtained.

The voltage-current curve in Fig. 2 shows that the laser tube has a negative resistance characteristic (voltage decreases as current increases). Stable, linear operation thus depends on the use of a ballast resistor. When the tube is operating at 5 mA, approximately 1100 volts are required. At this point, the negative dynamic resistance is about 30,000 ohms. As the current is decreased the required voltage rises until, at about 1 mA, it is approximately 1300 volts. Here the negative resistance is 80,000 ohms. Therefore, the ballast resistor must have an effective value well above 80,000 ohms to keep the tube operating.

A basic modulator circuit, using a pentode with a large dynamic resistance, is shown in Fig. 3. The pentode is in series with the laser tube and forms a simple amplitude modulator. The dynamic resistance of the pentode is a function of the applied audio signal on its control grid. A potentiometer in the cathode circuit of the pentode determines the basic operating resistance of the tube and, hence, the operating point of the laser. Once the latter point (located on

the curve in Fig. 1) has been set by the bias potentiometer, an audio input to the pentode causes the laser current to fluctuate about the operating point and the emitted light is amplitude modulated.

Almost any type of audio driver can be used to generate the input audio signal to the pentode.

Basic Modulator. The circuit for converting the original laser project into a light-beam transceiver is shown in Fig. 4. A photograph of the finished project is shown in Fig. 5. A complete vacuum-tube system is used simply because a high resistance device is required and the tube that will do the job is inexpensive and readily available. In addition, the +175 and 6.3-volt sources required by the pentode can be used elsewhere in the circuit.

The modulator circuit can be divided into two portions. The transmitter (V1) consists of the pentode modulator driven by the triode half of the tube acting as a microphone preamplifier. Potentiometer R4 provides modulation level control. The three gas tubes in series (I1-I3) are 200-volt breakdown lamps which chop off the high-voltage spikes that trigger the laser. Although the operating plate voltage of the tube is below its maximum rating, a much higher voltage spike is used to trigger the laser. The three gas lamps limit this spike to 600 volts. Unlike semiconductors, a vacuum tube can withstand an overvoltage for a short time. The trigger spike here lasts only about one millisecond so no damage can be done to the tube. If you can't locate the gas tubes called for in the Parts List, use any combination of conventional neon lamps that add up to approximately 600 volts.

The receiving portion of the modulator consists of a three-stage conventional audio amplifier driven from the output of the solar cell. Unlike a conventional light-dependent resistor, a solar cell generates a voltage that is a function of the amount of light striking the photosensitive surface.

Construction. If you built the original laser project, the same metal chassis may be used. Drill or punch holes for two 9-pin and one 7-pin tube sockets. These may be located on the top of the chassis,

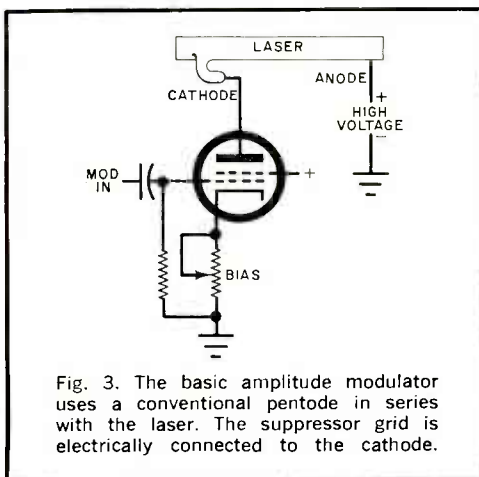

Fig. 3. The basic amplitude modulator uses a conventional pentode in series with the laser. The suppressor grid is electrically connected to the cathode.

next to the laser tube. (Be sure to remove the laser tube when doing mechanical work on the chassis.) On the wall opposite the high-voltage laser power supply, mount the three potentiometers ($R6$, bias; $R4$, modulation level; and $R12$, receiver volume), the microphone

input jack ($J1$), and the photocell input jack ($J2$) (see Fig. 5). Mount power transformer $T2$ on the outside of the chassis using the same mounting hardware as were used for the original 600-volt transformer. (It was $T1$; now it is $T3$.)

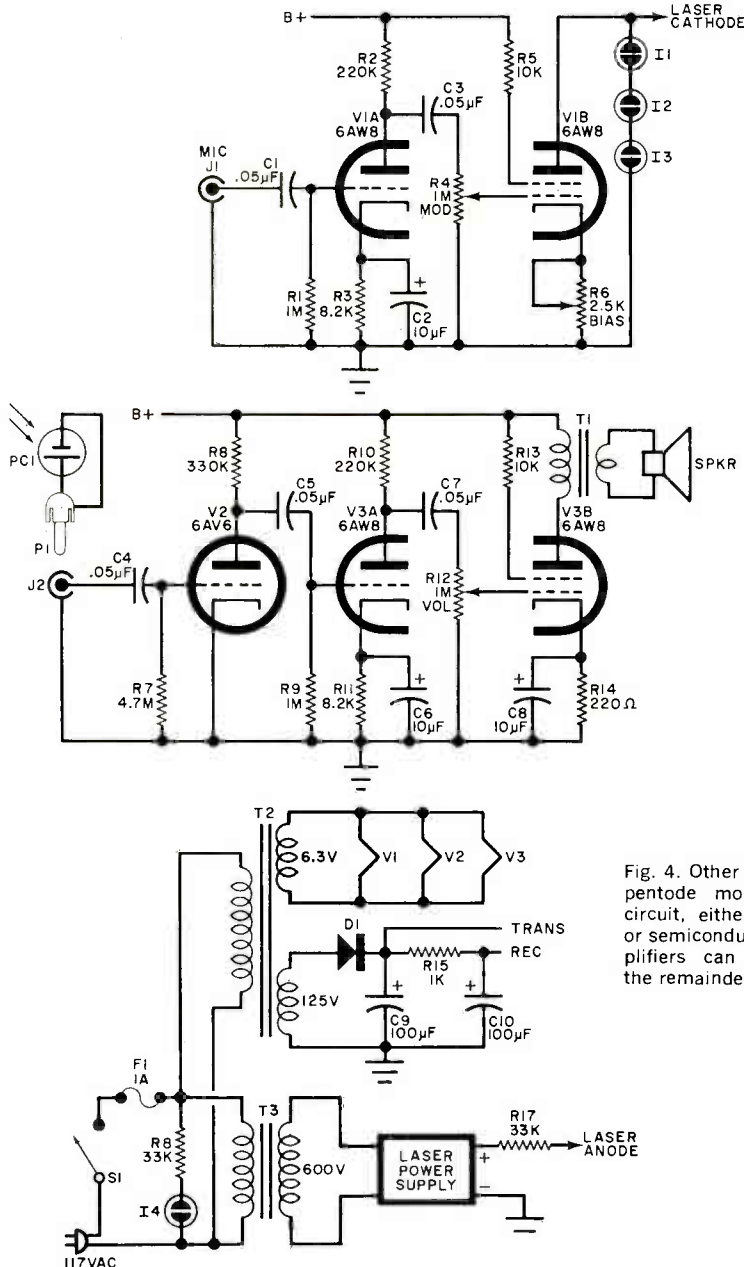

Fig. 4. Other than the basic pentode modulator (V1B) circuit, either vacuum-tube or semiconductor audio amplifiers can be used for the remainder of the circuit.

Once all the components are installed, wire up the circuit point-to-point (using terminal strips as required) following the circuit shown in Fig. 4. Of course, it is not necessary to use vacuum tubes for the microphone amplifier. You can use the 6AU6 pentode for the laser driver and, for the amplifier, any one of several commercially available transistor amplifiers. The author used one of the new RCA IC kits—the KC4000 microphone pre-amplifier—in one model and found that it worked fine. The solid-state receiver consisted of a KC4000 microphone preamplifier for the photocell pre-

amplifier and a KC4003 1/2-watt audio amplifier to drive the speaker.

The receiving photocell in this simple light communicator is mounted at one end of a dark plastic tube. (A cleaned out container of Polaroid print coater works very well.) If you use a cardboard tube, paint the interior a dull black before installing the cell. For testing and experimentation, make up a microphone cable with a phono connector at one end. Use a phone jack to make the connection to the earphone output of a conventional transistor radio. The radio is silent when the earphone jack is plugged in and produces a non-tiring audio signal for testing.

PARTS LIST ONE-WAY COMMUNICATOR

- C1,C3-C5,C7—0.05- μ F capacitor
 - C2,C6,C8—10- μ F, 15-volt electrolytic capacitor
 - C9,C10—100- μ F, 250-volt electrolytic capacitor
 - D1—Silicon rectified diode (1N4001 or similar)
 - F1—1-ampere fuse and holder
 - 1L—13—200-volt breakdown lamp (Signallite A-259 or similar)
 - 14—NE-2 neon lamp
 - J1,J2—Phono jack
 - P1—Phono plug
 - PC1—Solar cell (Solar Systems 11LC)
 - R1,R9—1-megohm
 - R2,R10—220,000-ohm
 - R3,R11—8200-ohm
 - R5,R13—10,000-ohm
 - R7—4.7-megohm
 - R8—330,000-ohm
 - R14—220-ohm
 - R15—1000-ohm
 - R16—33,000-ohm
 - R4,R12—1-megohm potentiometer
 - R6—2500-ohm potentiometer
 - S1—S.p.s.t. switch
 - Spkr—3.2-ohm speaker
 - T1—5000-to-3.2-ohm output transformer
 - T2—Power transformer; secondaries, 6.3 volts at 2 amperes and 125 volts at 50 mA (CTC PA8421 or similar)
 - T3—Power transformer; secondary 620-650 volts at 50 mA
 - V1,V3—6AV8A
 - V2—6AV6
- Misc.—Laser power supply, laser, nine-pin socket (2), seven-pin socket, multi-lug terminal strip, mounting hardware, insulated wire, microphone, speaker, etc.
- Note—The following are available from Metrologic Instruments Inc., 143 Harding Ave., Bellmawr, NJ 08030: laser model 205, 0.3 to 0.7 mW power output, 2.0 milliradians beam divergence, multimode. \$50.50, postpaid; or laser model 215, 0.5 to 1.0 mW output, 0.8 milliradians divergence, single mode. \$70.50, postpaid; model 60-141 power supply kit complete with PC board, all components and transformer, \$18.50, postpaid; model 60-203 complete one-way communicator (except laser and its power supply) including chassis, PC boards, microphone, solid-state 1-kHz oscillator, amplifiers, speech compressor, power supply, solar cell, speaker, and instruction book, \$74.25, postpaid (this kit is convertible for telescope transmission and reception).

All resistors
1/2-watt

Testing. Place the volume, modulation, and bias potentiometers in their minimum resistance positions. Connect up the speaker, photocell, and radio and turn on the power. The laser tube will start to blink at a low level until the modulation pentode warms up. Once the tube is hot, the laser will operate at its full brightness. A slight increase in the resistance of R6 should cause the laser beam to dim slightly. This shows that the bias control is operating properly. Now set the control for full brightness. Increasing the volume control should produce some hum in the speaker. If conventional room light is allowed to fall on the sensitive face of the solar cell, it will produce a distinctive hum. This is the reason the solar cell should be mounted in a dark tube.

Separate the laser and the solar cell by a few feet and aim the beam at the receiver. Alternatively, aim the laser beam at a mirror so that it is reflected back to the cell. (The beam must be aimed straight down the cell tube and not at the interior wall.)

With the laser beam shining on the solar cell at full brightness, turn on the radio, tune to a station, and plug in the earphone jack. On the laser chassis, turn up the receiver volume control and note that, as the hand is passed through the laser beam, a thump is heard in the speaker.

Slightly reduce the bias control to dim the laser a little, and turn up the modulation control slightly. These two controls interact somewhat so you will have to "juggle" them for best modulation.

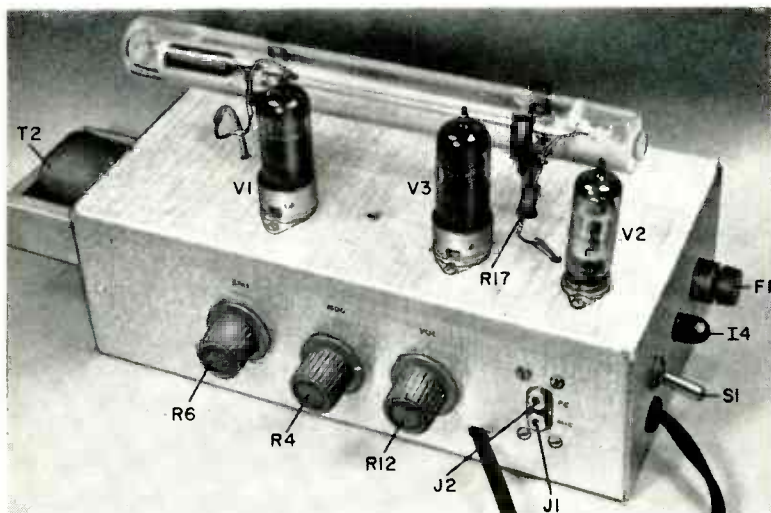

Fig. 5. The prototype was built on the original laser chassis (Spring '71 EEH). Any other layout will do as long as the pentode modulator is as close as possible to the laser.

Make sure that the radio volume is turned up sufficiently.

Once the communicator is working, you can experiment with the controls and the circuit (always retaining the pentode as the laser modulator) to increase your understanding of laser communications.

Optical Systems. Depending on how you want to use it, the laser communicator can be set up with any one of three optical systems. The simplest, which can be used for point-to-point communications around a room (to a total of 100 ft round trip), is as described above, without any lenses. To improve the reception somewhat, a simple lens can be placed in the beam path at the receiver end to reduce the size of the diverged beam.

The second type of optical system, requires the use of a set of binoculars, one eyepiece for the transmitter and the other for the receiver. Simple toy telescopes may also be used. The range for this type of system is a few hundred feet.

For communicating over greater distances, a reasonably high-power telescope is necessary. Such a telescope, attached to the laser communicator, acts like a high-gain antenna on a conventional radio system. In both cases the transmitted and received signals get a boost from the "antenna." And in both cases, the telescope or antenna is used for both transmitting and receiving through a simple mechanical switching process.

How far can you transmit using a telescope? It depends on a number of factors, the most important being beam divergence and atmospheric conditions. As the beam travels along its path, it tends to enlarge (diverge). This means that, although the beam leaving the laser is quite small (1 millimeter in the Spring 1971 EEH laser), it does enlarge considerably—though not as much as a comparable beam of conventional light. Using a telescope improves this condition considerably.

Atmospheric disturbances of the laser beam cause it to wander.

As the beam of light is projected over a long distance, it may encounter various forms of air turbulence, such as localized temperature changes. In each of these turbulences, the density of the air changes and each change in density acts as a prism as the beam passes through it, changing the beam's direction slightly. The amount of wander can be as much as several feet per mile. In the still, relatively even temperature of morning, before the sun has had a chance to warm up the air, beam wander may be as little as a few inches per mile.

In using a reflector telescope such as that described later in this article, the beam should be collimated as closely as possible to the distant receiver, allowing for thermal refractive variations for the time of day and the atmospheric conditions. If the air is still and of an even temperature, the beam will wander only a few inches per mile. In this case, also,



Internal layout of the prototype transceiver (above) showing the laser power supply mounted on one wall with the rest of the components occupying the remaining space. The internal arrangement of the telescope electronics (shown below) shows the modulator tube and its associated components arranged within its smaller metal enclosure.

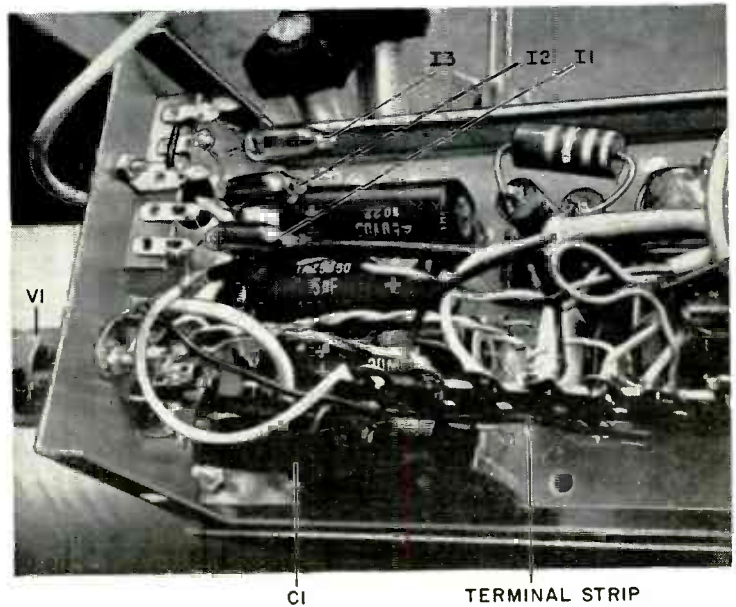

the beam may be focussed so that at the receiver, the beam diameter has diverged only about one foot per mile. If the atmosphere is clear, there is little absorption by airborne particulants (smoke, dust, etc.); and the overall result is that

about 3 to 5% of the transmitted beam power is obtained at the receiver. This extremely high efficiency is one of the many attractive features of laser communications that will help make it the system of the future.

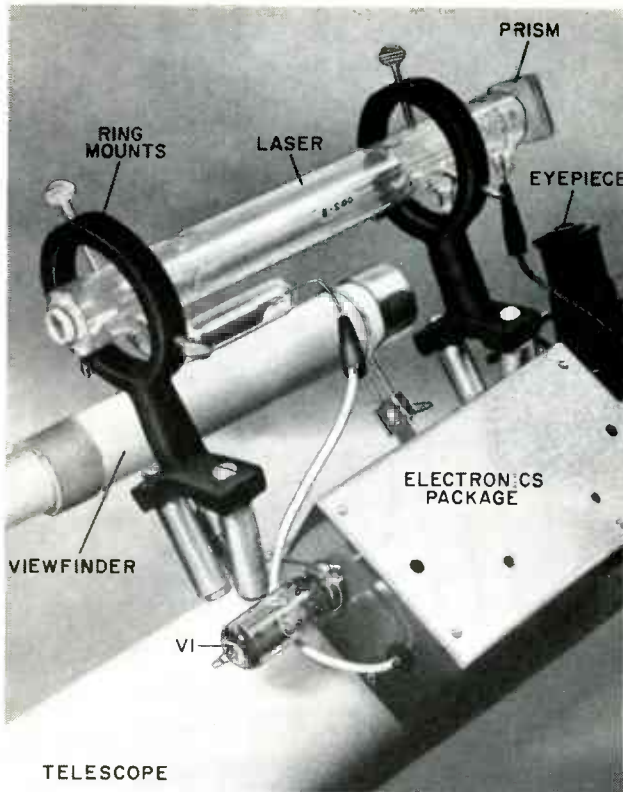

The complete telescope system can communicate as far as a 12-inch target can be clearly seen via the telescope. At night, this target will have to be illuminated. In good visibility, range can be very great but is dependent on certain conditions (see text). To assist distant communications, an optional 1-kHz audio oscillator is used to modulate the transmitter, and both ends must be "juggled" until the received audio tone is at a maximum. To get around opaque objects, a large-size front-surface mirror (not a ladies compact mirror) may be used to reflect the laser beam.

Note: Since this article was prepared, a solid-state modulator and receiver have been developed. For further details contact Meirologic Instruments Inc., 143 Harding Avenue, Bellmawr, New Jersey 08030.

Reflector Telescope Construction. A telescopic system is shown in Fig. 6. The laser tube is supported by a pair of viewfinder ring mounts attached to the telescope tube. The laser is positioned within the mounts so that the light-emitting end is almost directly over the telescope eyepiece. (Check your laser tube to make sure whether the light beam comes out of the anode or the cathode. Some models are one way; some the other.)

Make up an L-shaped length of heavy bus bar with the long side about 2½" — the other about 1" long. Cement (with epoxy) the short end of the bus bar to the relay armature so that it swings back and forth as the relay is energized and de-energized. Position the relay about 90° from the telescope eyepiece so that when the long end of the bus bar is placed through a slot cut in the telescope tube and with the relay energized (talk position) the end of the bus bar is out of the beam path. With the relay de-energized (listen position) the wire should be in the beam path. Remove the telescope eyepiece to watch this.

Fig. 6. Complete telescope communicator showing the use of semiconductor audio amplifiers. Any neon lamps may be used for I1, I2, or I3 if their breakdown totals up to about 600 volts.

PARTS LIST TELESCOPE COMMUNICATOR

C1—0.1- μ F capacitor
 C2—10- μ F, 250-volt electrolytic capacitor
 C3,C4—100- μ F, 25-volt electrolytic capacitor
 D1-D5—Silicon rectifier diode (1N4003 or similar)
 F1—1-ampere fuse and holder
 I1-I3—200-volt breakdown lamp (Signallite A259 or similar)
 I4—NE-2 neon lamp
 J1—Phono jack
 K1—117-volt relay
 P1—Octal plug
 P2—Phono plug
 P3—2-lead plug
 R1—33,000-ohm, 2-watt resistor
 R2—470,000-ohm, ½-watt resistor
 R3—10,000-ohm, ½-watt resistor
 R4—2500-ohm potentiometer
 R5,R6—1-megohm potentiometer
 R7—1000-ohm, ½-watt resistor
 R8—33,000-ohm, ½-watt resistor
 S1—Normally open s.p.s.t. pushbutton switch
 SO1—Octal socket
 SO2—2-lead socket
 T1—Power transformer; secondaries, 6.3 volts at 2 amperes, 125 volts at 50 mA (CTC PA8421 or similar)

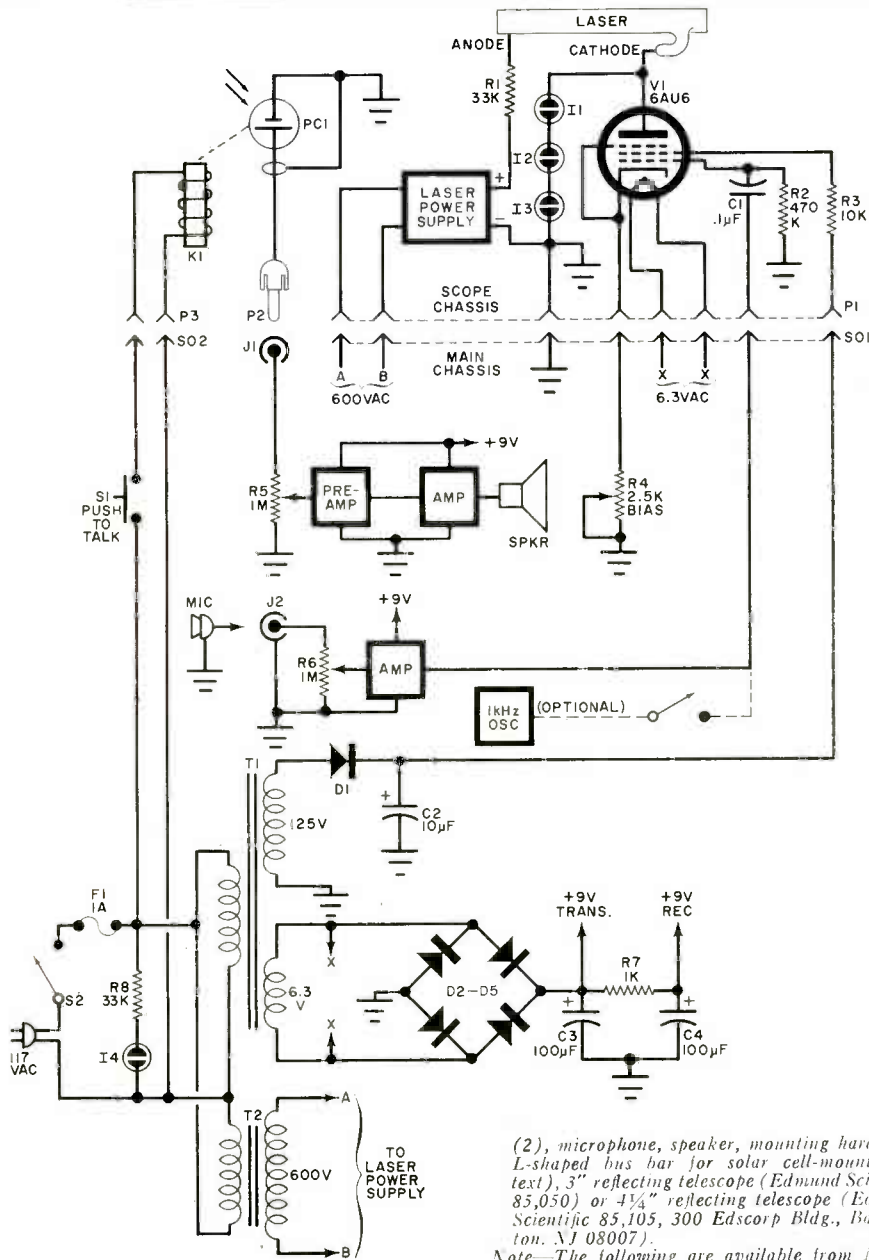

T2—Power transformer; secondary 620-650 volts at 50 mA

V1—6AU6 tube

Pre-Amp—Microphone preamplifier (RCA KC 4000 or similar)

Amp.—Half-watt amplifier (RCA KC4003 or similar)

Misc.—5½" x 3" x 2" two-piece metal enclosure, main chassis, laser, laser power supply, 7-pin socket, multi-lead terminal strip, 90° plastic prism, lengths of multi-lead and coaxial cable, 2" ID telescope viewer mounting rings

(2), microphone, speaker, mounting hardware, L-shaped bus bar for solar cell-mount (see text), 3" reflecting telescope (Edmund Scientific 85,050) or 4¼" reflecting telescope (Edmund Scientific 85,105, 300 Edscorp Bldg., Barrington, NJ 08007).

Note—The following are available from Metrologic Instruments Inc., 143 Harding Ave., Bellmawr, NJ 08030: a kit to convert from one-way to telescope reception and transmission, model 60-204, \$24.50, postpaid, including deflection prism and tube mount, solar cell and solenoid, laser ring mounts, telescope mounting kit (for 3" to 6" tubes), and instruction book; 4¼" metal tube reflecting telescope with stand, model 60-205, \$94.50 or 4¼" metal tube telescope without stand, model 60-206, \$67.50 transportation charges collect. (These telescopes are complete with lenses and are suitable for astronomy).

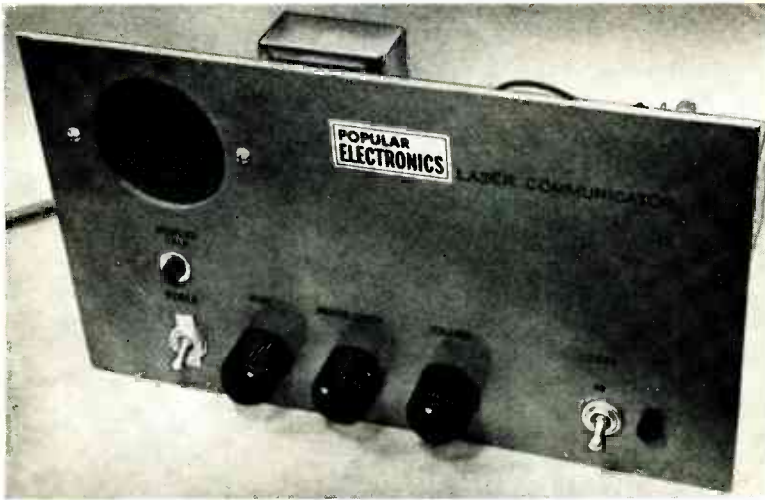

The main chassis for the telescope communicator mounts the relatively heavy power supplies (except for the laser), all controls, and is connected to the telescope electronics via a multi-lead flexible cable. Microphone plugs into the rear.

On the solar cell called for in the Parts List of Fig. 4, the black side is the sensitive area. Cement the shiny side of the cell to the bus bar and then slide the cell and relay assembly into position. Make sure that the cell switches cleanly in and out of the beam path as the relay is operated. The two leads from the solar cell are taken out of the same slit and terminated on a two-lug terminal strip mounted near the relay.

Mount the empty half of the two-piece electronic chassis on the telescope tube, just below the two laser mounting rings, drilling mating holes in both chassis and telescope tube. Use short mounting hardware so as not to interfere with the beam path. Recheck all mechanical work and tighten the telescope tripod screws.

To keep weight to a minimum, only the modulator pentode and the laser power supply are mounted in the chassis on the telescope. This is necessary to reduce the possibility of oscillation in the circuits.

Mount the power supply on the inside of the chassis, using an insulated spacer (about $\frac{1}{4}$ ") at each corner. Be sure that the high-voltage end is far enough from the metal to avoid arcing. The seven-pin tube socket for the pentode is mounted at one end, while a multi-lug terminal strip supports the ends of the wiring. A $\frac{1}{2}$ " grommeted hole should be provided for the incoming cable.

The circuit for the scope-mounted electronics is shown in Fig. 7. Only the relay, solar cell, and laser are external to the chassis. The circuit above *SO1* is mounted at the scope. The lower portion is built in a larger conventional chassis.

Once again, either vacuum-tube or semiconductor amplifiers may be used. The latter save quite a bit of work. Connections between the two chassis are made with multi-lead cable, with the exception of a small coaxial cable for the solar cell leads. Make the connections long enough to allow plenty of space between the telescope and the other chassis. The cables may be taped at intervals to keep them from separating.

When all electronic work is finished, attach the second half of the chassis to the one on the telescope. The cable should be placed where it will not interfere with scope operation.

Fully open the ring mount thumb-screws and slide the laser into position as described above. Tighten the thumb-screws gently to avoid damaging the tube. Attach the plus side of the high-voltage supply to the laser anode and the negative side to the cathode.

Make up a phono connector to connect the solar cell leads to *J1*. Connect the two leads to the relay.

Setup. Connect the far end of the multi-

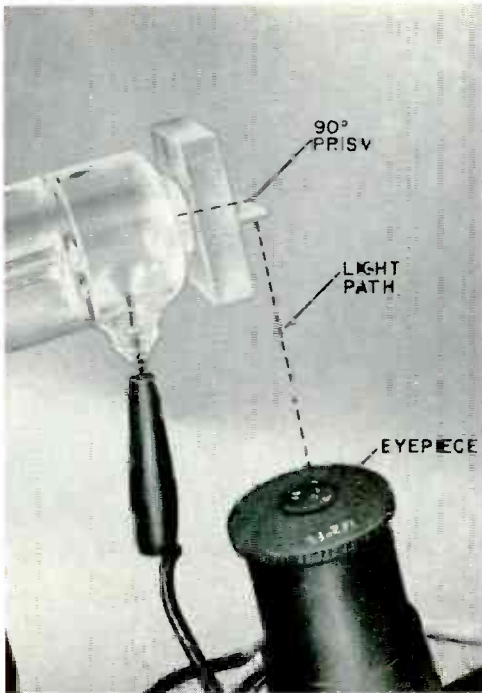

A small 90° prism is cemented to a plastic block to aim the laser light at the telescope eyepiece. The plastic block is press fit to the laser end.



The transmit-receive relay is mounted to the telescope tube with the solar cell and rod passed inside through a hole cut in the telescope tube wall.

lead cable to the main chassis, along with the solar cell and microphone connectors. (You can substitute a radio for the microphone for testing.) The push-to-

talk button may be temporarily shorted to keep the solar cell out of the beam path during the following optical alignment.

Three commercial IC audio kits were used for all stages except the pentode modulator. Power supplies are mounted under the chassis. Telescope cable termination is on rear apron.

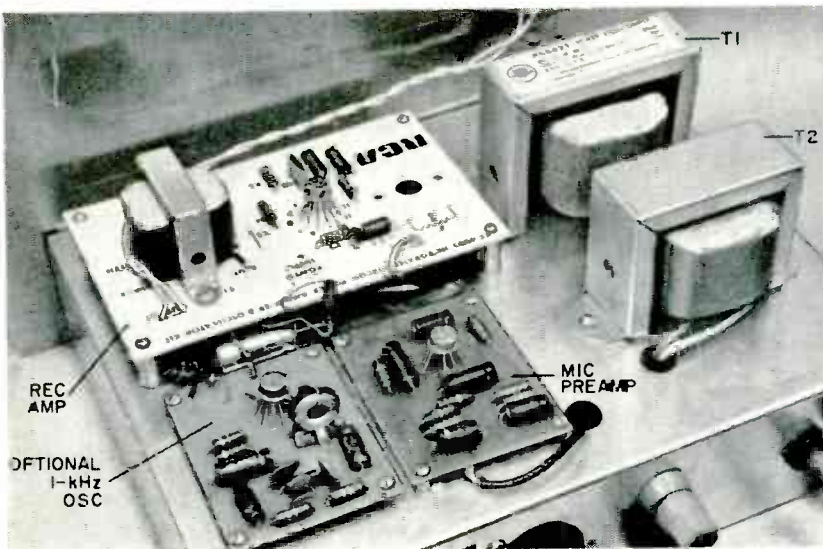

View looking into end of telescope shows how the solar cell, in transmit condition, is out of beam path from laser to diagonal. In the receive mode, the cell enters the beam path between diagonal and eyepiece. Make sure that sensitive side of solar cell faces the diagonal.

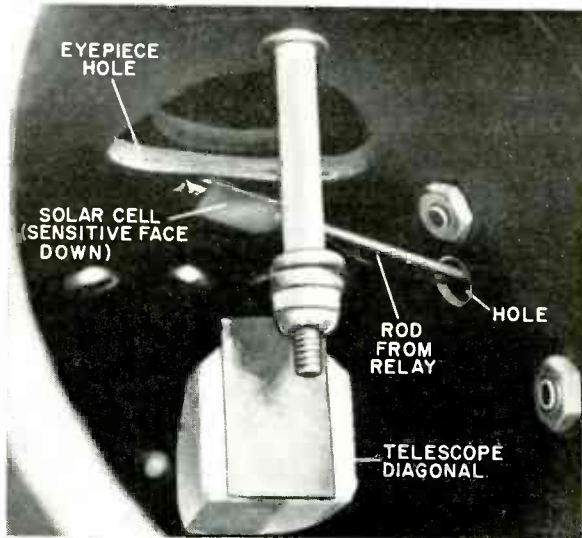

In the simple transceiver, the solar cell is mounted within a tube having a dark interior—in this case, it's a clean Polaroid print coater. Cell is affected by ambient light so that it must be shielded during use. Any method of mechanical mounting may be used to position the cell correctly.

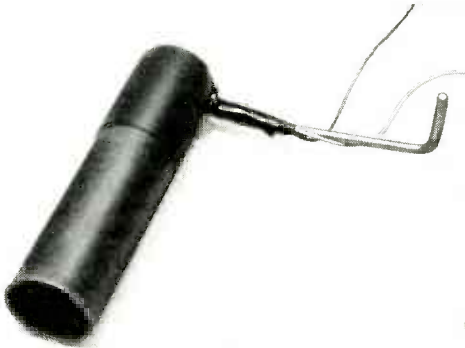

It is assumed that the telescope optics have been set up as described in the telescope operating manual.

On the main chassis, set bias control R_4 , volume control R_5 , and modulation control R_6 to minimum resistance. Plug in the 117-volt line cord and turn on the power. The laser tube will blink a few times until V_1 warms up. After the laser starts to glow at full power, allow the entire system to stabilize for a few moments. Adjusting the bias control should cause the laser glow to diminish a little. Set this control for maximum laser brilliance.

Place the 90° plastic prism over the protuberance at the laser exit hole and adjust the prism so that the laser beam is reflected down the telescope eyepiece. Aim the telescope at a wall and keep adjusting the prism—and if necessary the position of the laser—until a red circle

with the diagonal mirror shadow centered in it, is clearly visible on the wall. At this point, the laser has been properly set up and should not be moved.

If you have to keep looking at the laser beam, a pair of blue sunglasses may be worn to reduce the red glare.

To test the system, aim the telescope at a distant mirror and reflect the beam back to a duplicate solar cell that has been connected to the main chassis. You can also use the second telescope of the communications system if you have built it at this time.

With the light beam shining on the solar cell, make sure that the radio is playing at a reasonable volume and turn up the laser volume control R_5 . If artificial light falls on the solar cell, a hum will be heard; so for best reception keep the ambient light dim. Slowly adjust the bias control (R_4) until the laser dims a little. Then bring up slightly the modulation control (R_6) until music is heard from the main chassis speaker. Since R_4 and R_6 are interlocking in their action, you will have to adjust them together to get the desired results. If R_4 is set for too low a beam level and R_6 is set too high, modulation peaks may extinguish the laser. The automatic power supply will retrigger the laser, but the controls should be adjusted to prevent the dropout. Once clean modulation has been obtained, the radio can be replaced by the microphone and R_6 adjusted for this type of input.



Build an AUDIO MULTICOUPLER

ISOLATE TAPE RECORDER INPUTS AND MINIMIZE LOADING

BY DON M. WHERRY

WHEN YOU record "live" or "off-the-air" on magnetic tape, situations are sometimes encountered which require equipment that is not commonly available. This can occur when more than one tape recorder is being fed from a single pickup. The usual approach here is simply to parallel the recorders somewhere in the pickup line, and forget it.

However, this arrangement has two definite drawbacks. If the input to one of the recorders becomes open-circuited, the input signal levels to the remaining

recorders increase. On the other hand (and more disastrously), if one of the recorder inputs becomes short-circuited, the result is a zero or near-zero input level to the remaining recorders. In any parallel-fed, direct-from-the-pickup system, either or both of these problems is likely to develop with annoying regularity.

To prevent such occurrences, it is necessary to isolate each recorder input line from the other input lines in the system. This can be accomplished with the simple

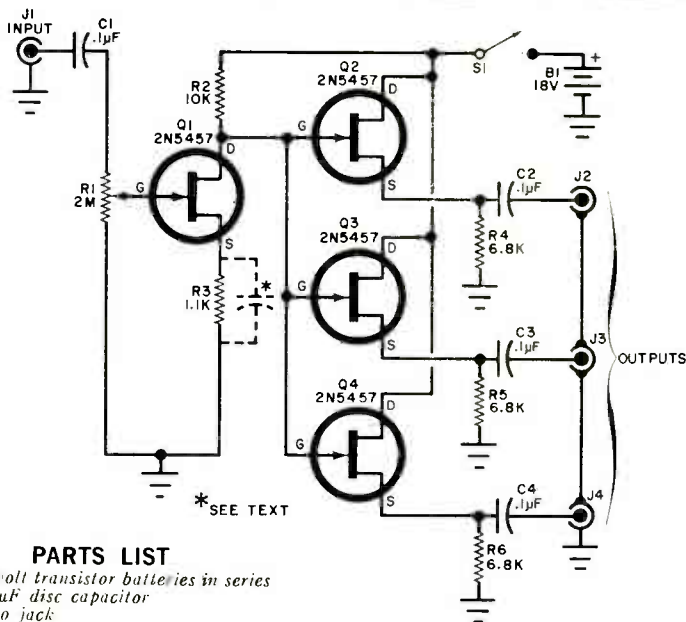

PARTS LIST

- B1*—Two 9-volt transistor batteries in series
C1-C4—0.1- μ F disc capacitor
J1-J4—Phono jack
Q1-Q4—2N5457 field effect transistor
R1—2-megohm audio-taper potentiometer
R2—10,000-ohm, $\frac{1}{2}$ -watt resistor
R3—1100-ohm, $\frac{1}{2}$ -watt resistor
R4-R6—6800-ohm, $\frac{1}{2}$ -watt resistor
S1—S.p.s.t. slide or toggle switch
Misc.—Electrolytic capacitor, 50- μ F, 15-volt (optional, see text); aluminum utility box 5" x 4" x 3"; printed circuit board or perforated phenolic board and flea clips; #6 hardware; U-bracket for batteries; hookup wire; solder, etc.

Fig. 1. Multicoupler circuit is designed to independently feed signals from single source to several tape recorders. Failure of any one stage has no effect on others.

and inexpensive "Audio Multicoupler" described in this article. In addition to satisfying the isolation requirement, the Multicoupler provides 8-10 dB of gain, depending on the tape recorder load, and operates flat 12-100,000 Hz \pm 1 dB. The noise figure is good, too—more than 70 dB below the rated output when a battery supply is used. And all of this comes in a 5" x 4" x 3" package.

About The Circuit. As shown in Fig. 1, the Audio Multicoupler consists of a single FET input stage and three (or more) discrete FET output stages, the latter operated in a source-follower configuration. Hence, not only is each output line isolated from the others, the input and outputs are also isolated from each other.

The program source, connected to the Multicoupler via *J1*, can be a microphone,

tuner, turntable, or tape recorder. The signal developed by the program source undergoes amplification in the *Q1* stage, and is then passed through source-follower stages *Q2*, *Q3*, and *Q4* and out to the individual recorders.

Each of the output channel stages is driven by the same amount of signal current, and each is "live" whenever a signal is applied to the input. Potentiometer *R1* controls the output signal level in all channels simultaneously. This control is adjusted for the least sensitive recorder in the system; then the recording level controls on the other recorders are used to adjust for undistorted recordings.

With a high-impedance load, the Multicoupler has a gain of more than 10 dB, which drops as the load approaches 3300 ohms. Lower impedance loads should be avoided, since distortion increases as the

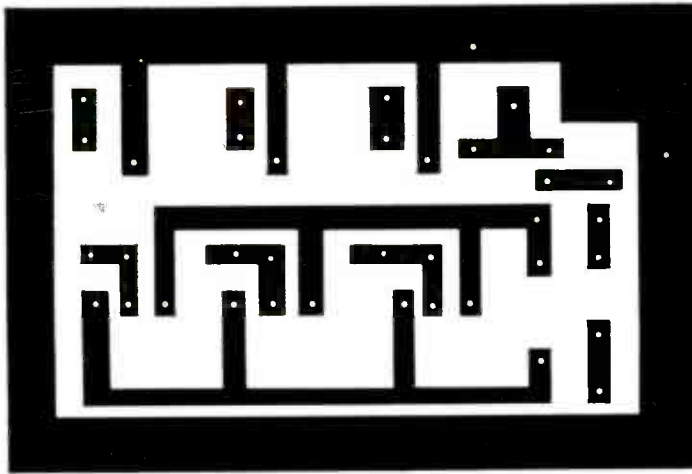
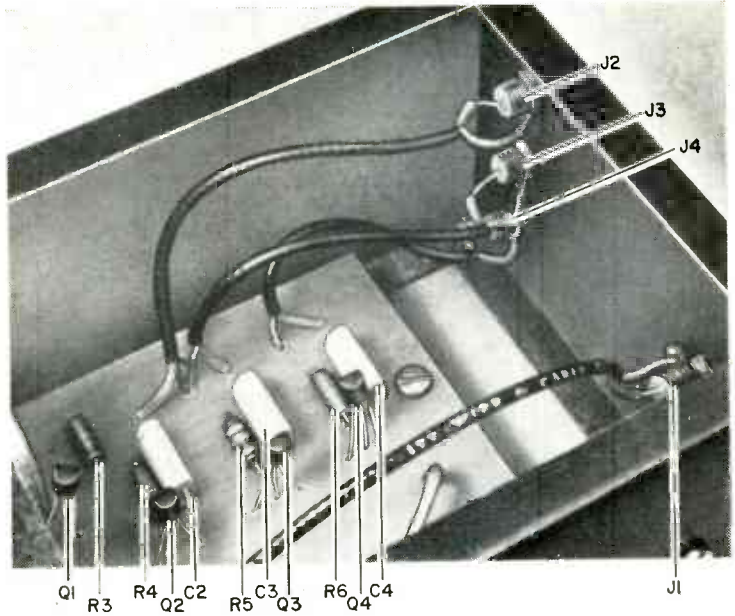

Fig. 2. Actual-size printed circuit board etching guide is shown directly above. At top, components are shown mounted to board and on side of box.

load is reduced below 3300 ohms. However, you can obtain a lower impedance output by dividing R_4 , R_5 , and R_6 and taking your output from the lower tap. While this procedure will reduce gain, adding a $50\text{-}\mu\text{F}$, 15-volt electrolytic capacitor across R_3 will restore the lost gain.

If you wish more than three output channels, simply add the required number of stages ($Q_2/R_4/C_2$) as shown.

However, limit the total number of stages to six for practical purposes.

Construction. The Audio Multicoupler is best assembled on a printed circuit board, the full-size etching guide and components placement diagram for which are shown in Fig. 2. If you wish, however, the circuit can also be assembled on a piece of perforated phenolic board with the aid of flea clips for parts mounting.

HIRSCH-HOUCK LABORATORIES Project Evaluation

The "Audio Multicoupler" has every bit of the frequency response claimed by the author, but the response seems to fall off a bit at 100 kHz. However, in the audio range, the frequency response is flat. The

results of tests performed on the Audio Multicoupler are as follows: gain is 8.7 dB at 1000 Hz; maximum output is 4.65 volts; and output impedance is 1200 ohms. Referenced at 1000 Hz, outputs of 0.1, 0.3, 1.0, 2.0, 3.0, and 4.0 volts produced total harmonic distortions (THD's) of 0.082%, 0.19%, 0.58%, 1.22%, 1.8%, and 2.5%, respectively.

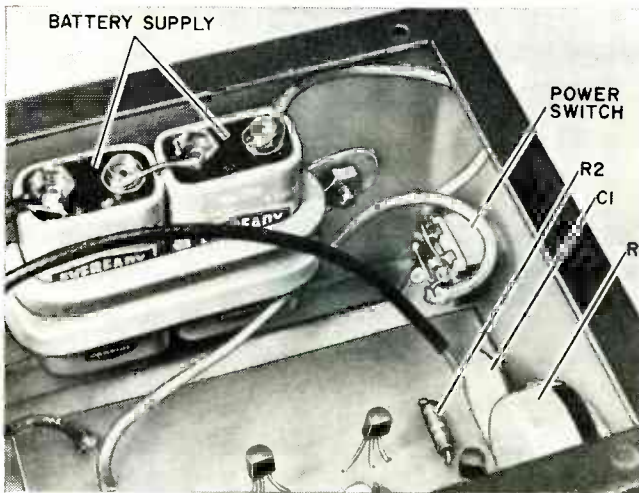
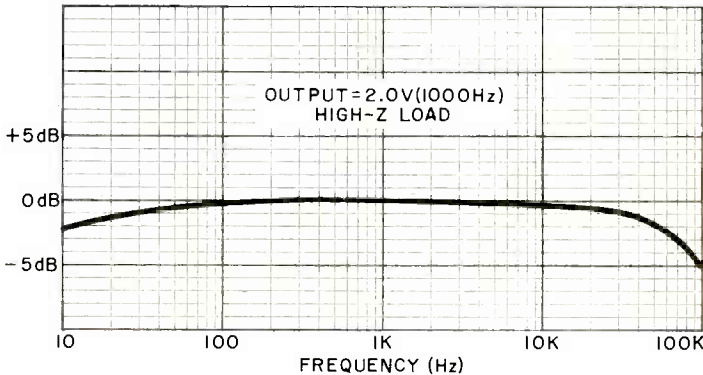
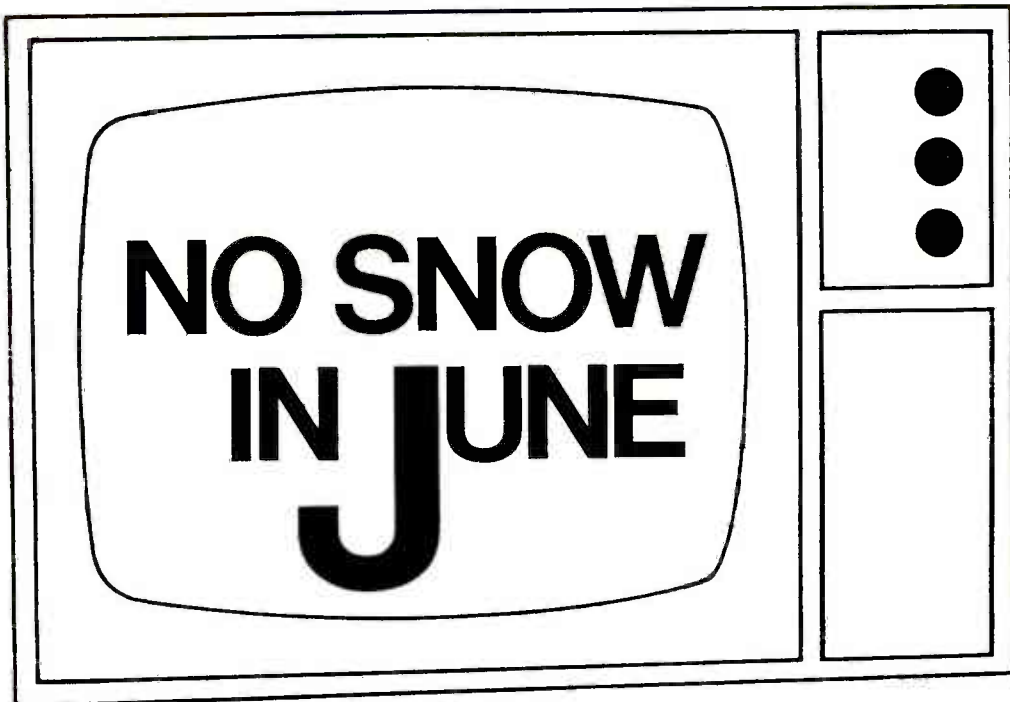

Fig. 3. Two 9-volt transistor batteries, connected in series, can be mounted to box with U brackets or small drawer pull.

Whichever method of assembly you choose, mount the completed circuit board inside a 5" × 4" × 3" aluminum utility box (see Fig. 3). Mount input and output phono jacks on the back panel, and if a battery supply is used, mount the two 9-volt batteries to one side of the circuit board. Then mount the switch

and potentiometer on the box front.

Interconnect the outboard components with the appropriate points on the circuit board, using shielded cable between the input and output jacks and their board connections. Then assemble the utility box, and you are ready to make multiple magnetic recordings. -30-



MATCH YOUR TV ANTENNA TO RECEIVER
FOR BEST POSSIBLE PICTURE

BY GEORGE MONSER

GOOD TV RECEPTION is not obtained by accident; it is carefully sought for and designed into your antenna system. You can get the best antenna and lead-in cable money can buy, but if the antenna is not impedance-matched to the cable and/or the cable is not matched to the TV receiver, you might just as well be using outdated "rabbit ears." This is especially true for color TV reception—and not just in the "fringe" reception areas.

Everything in your TV receiving system must be just perfect, and the only way you can make sure that it is to do the job right—the first time. But do not think that you have to be a TV antenna/transmission line expert to set up a receiving system. With the help of the information provided in this article, you can set up the best possible antenna system.

The Loss Factor. Nothing is perfect. No matter whether it is an automobile en-

gine or an electronic circuit, every system suffers from some type of loss which reduces its efficiency. While you cannot completely eliminate receiving system losses (known as signal attenuation), you can limit them to an acceptable level.

To demonstrate how loss becomes a critical design factor, consider a 300-ohm folded dipole antenna (tuned or cut to any TV channel) connected to a length of 300-ohm twin-lead cable. Very little loss would occur between the antenna and cable for the channel to which the antenna is tuned. But for all other channels in the TV band, the loss might be as high as 3-4 dB; and over the complete band, an average loss of 2 dB would be typical, enough to cancel the characteristic 2-dB gain of the folded dipole (favorably oriented) antenna.

Now, consider a resonant 300-ohm folded dipole, reflector, and several director array (representative of most commercial TV receiving antennas). An estimated 2-dB loss would occur at the

antenna/cable connection due to the lowering of the dipole's impedance. (The effect of placing a reflector and directors in close proximity to the folded dipole is to lower the 300-ohm characteristic impedance of the dipole to about 70-100 ohms). But since this antenna array provides 6-10 dB of gain, a 2-dB loss, severe in our first case, can usually be acceptable, particularly in good reception areas.

For both cases cited above, the cable lead-in loss, assuming about 40' of twin-lead at VHF, amounts to between 0.6 and 1 dB. Hence, the total loss in antenna signal strength is 3 dB. This means that only 50% of the antenna signal power would be delivered to the TV receiver.

Reducing the Losses. The choice of improving the antenna-to-transmission line match basically involves inserting an impedance-matching transformer between antenna and line. The drawing in Fig. 1 illustrates the makeup of one type of



Fig. 1. Transformers are cut to specific lengths for individual channels or for multichannel band.

transformer you can use. It is easy to fabricate and consists of two lengths of 300-ohm twin-lead cable.

The decision of whether to fabricate your own transformer as opposed to buying one that is commercially made should depend on the end results. Tests made with both types show that at the 70-MHz frequency of channel 4, the commercial ferrite-core balun *lowers* the signal level by about 2 dB, while the quarter-wave, twin-lead homebrew transformer *improves* the signal level by 1.5 dB.

Lead-in attenuation, the other loss (amounting to less than 1 dB) can be slightly reduced, but not without considerable effort. Here, two possibilities exist: transition from the antenna to a homebrew 600-ohm open-wire lead-in and back to 300 ohms at the TV receiver; or transition from the antenna to homebrew

1"-diameter, 77-ohm coaxial line and back to 300 ohms at the receiver. Neither of these alternatives will yield a line loss less than 0.3-0.5 dB, which hardly seems worthwhile by itself. However, if a choice were to be made, it would probably be easier to stay with a balanced line and use 600-ohm open line. (Fig. 2 illustrates how this can be accomplished

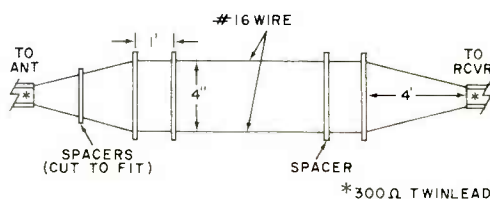

Fig. 2. Insulator spacers support gradual tapers when matching 600-ohm open line to 300-ohm cable.

with #16 wire and a wire separation of 4" to yield a line loss of about 0.25 dB/100' at 88 MHz, or less than 0.15 dB for a typical 40' run.)

You may be wondering when and where it is advantageous to use these methods for improving signal transfer. As a general rule, they should be employed in "fringe" reception areas to improve weak TV channel reception. When making your own transformer or transformers, refer to the Table for the proper quarter-wave transformer lengths to use for each TV channel in the VHF spectrum. The lengths listed were computed assuming standard 300-ohm twin-lead cable with a phase factor of 0.84, which is typical for polyethylene-jacketed twin-lead.

Now, take three practical examples to show how to improve TV reception. In the first example, suppose you have a good quality commercial antenna array and wish to improve reception on Channel 4 by inserting a transformer section between the antenna and a 300-ohm twin-lead line. Select the transformer length section from the Table; in this case, 36" is indicated. Cut two pieces of twin-lead cable to *exactly* 36" (plus about 1/2" extra at each end). Strip away 1/2" of insulation from each end of both cables. Then, connect the lengths of twin-lead in parallel with each other (see Fig. 1).

TRANSFORMER SIZES	
VHF Channel	Transformer Length (inches)
2	43
3	40
4	36
5	32
6	29
7	14
8	13.6
9	13.1
10	12.8
11	12.4
12	12.0
13	11.7

Insert the transformer section between the antenna and twin-lead lead-in cable. This should yield an improvement of 1.5 dB in signal strength and a noticeable improvement in Channel 4 fringe-area reception.

For our second example, suppose you use the same antenna and want the best possible reception. Rather than running 300-ohm twin-lead cable, try using lower loss 600-ohm open line. This can be done fairly easily by following the instructions detailed in Fig. 2. At both the antenna and TV receiver, the line must be tapered gradually to the 600-ohm spacing of the open line. When completed, the installation should yield about a 2-dB improvement in signal reception, slightly better than in the first example.

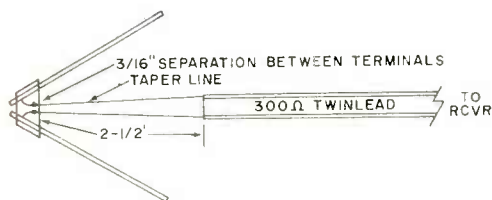

Fig. 3. Gradual taper matches 300-ohm twin-lead cable to 150-ohm impedance of Pyramidal Antenna.

As a final example, assume you are planning to erect the Pyramidal TV/FM Antenna ("Build The 'Pyramidal' TV/FM Antenna," WINTER 1971 EXPERI-

MENTER'S HANDBOOK). This antenna's impedance is about 150 ohms, which means that 300-ohm twin-lead cable is reasonably ideal to use. However, for the ultimate match, you should insert a tapered section of line between the antenna connecting terminals and the 300-ohm twin-lead lead-in cable as shown in Fig. 3 to improve reception by about 0.5 dB.

The added complication of tapering the line in the last example might not be

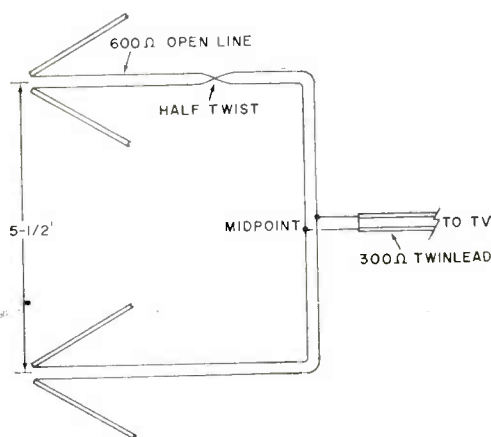

Fig. 4. Open line matches two Pyramidal Antennas to 300-ohm cable. Note half twist in 600-ohm line.

justified, considering that this antenna has a nearly flat gain characteristic of 10 dB for all VHF TV channels.

Finally, suppose that even 10 dB of gain is not enough to provide quality fringe-area reception. You could stack two Pyramidal antennas as shown in Fig. 4 to obtain 13 dB overall gain. Here, the individual antenna connecting point impedances can be tapered to 600 ohms and then paralleled, providing an ideal match to the 300-ohm twin-lead cable line to the receiver. In the illustration, the center-to-center spacing between the antennas is 5'. Of course, the antennas could just as easily be placed side by side to yield the same resultant gain; but erection on a single mast is usually easier to implement.

Now that you have been apprised of good receiving system basics, you can start designing your own system. And with the warm weather here, what better time is there to tackle the job? -30-



ELECTRONIC Overload Protection

CURRENT LIMITER FOR YOUR SEMICONDUCTORS

BY JOHN L. KEITH

ELECTRONICS experimenters are finding more and more uses for the latest microminiature solid-state devices—and with good reason. These components simplify circuit design and construction, making it possible for the experimenter to build projects that were formerly too complex and expensive to duplicate. There is one great care the experimenter must exercise, however: most semiconductor devices are extremely current sensitive. Exceed the rating just a little bit, and the device may be permanently damaged. To prevent such occurrences, try the electronic overload protector described here.

When connected between the power

supply and the experimental circuit, the overload protector automatically limits the current drawn by the circuit to a value consistent with the known ratings of the semiconductor devices you are using.

The protector, whose circuit is shown in Fig. 1, operates on the principle of a shunt current meter. The load current must flow through one of the range resistors, *R8-R10*. The voltage drop across the resistor is then applied through potentiometer *R11* to the base of *Q1*. The use of *R11* makes each range continuously variable.

With no overload condition, *Q1* conducts slightly, allowing *Q2* to conduct

PARTS LIST

D1, D2—1N34A diode
 D3—1N2069 diode
 I1—327R incandescent pilot lamp (28 volts at 40 mA)
 K1—S.p.d.t. relay, 5500-ohm at 2.9-mA winding
 Q1, Q2—2N508 transistor (see text)

K1—680-ohm
 R2—220-ohm
 R3, R5—220,000-ohm
 R4—82,000-ohm
 R6—9100-ohm
 R7—10,000-ohm (see text)
 R8—20-ohm
 R9—10-ohm
 R10—5-ohm
 R11—5000-ohm linear taper potentiometer
 S1—S.p.s.t. slide or toggle switch
 S2—Momentary-action, push-to-close switch
 S3—Three-position, non-shorting rotary switch
 7—Five-way binding posts or banana jacks for contacts 1 through 7
 1—metal utility box
 Misc.—Rubber grommet for I1; hardware; hook-up wire; solder; etc.

All resistors
 1/2-watt

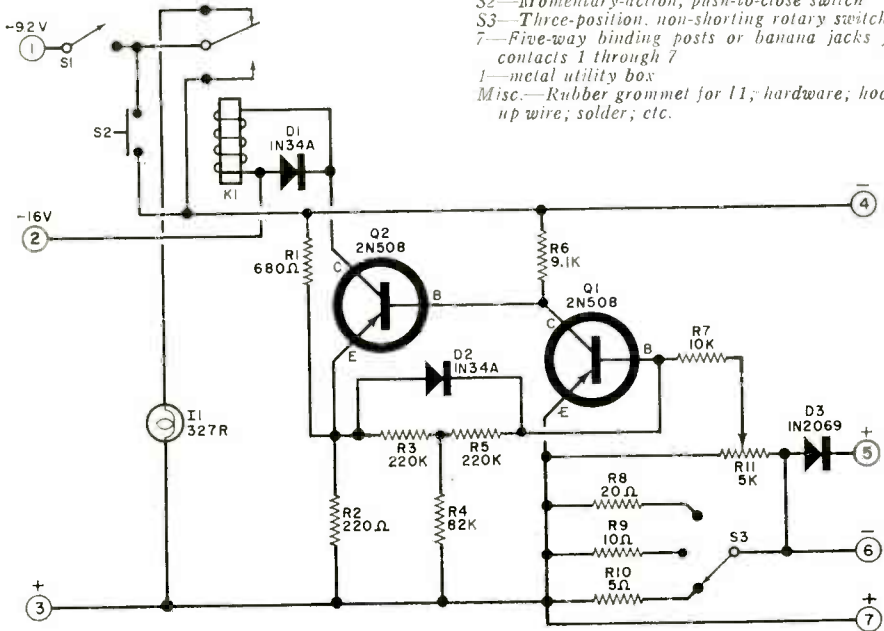
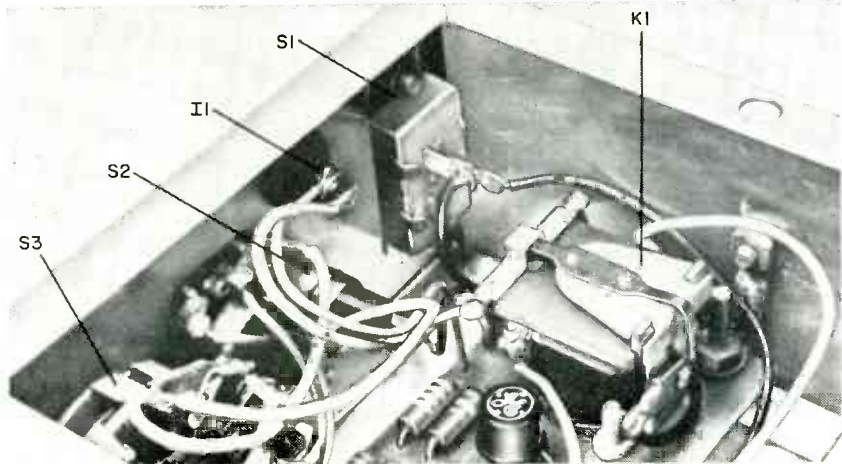

Fig. 1. Input power is applied via contacts 1 and 2; separate 16-volt supply for K1 via 2 and 3; load via 4 and 5. Load current is measured as voltage drop between 6 and 7 and converted to current with Ohm's Law.

Switches S1-S3, potentiometer R11, and indicator lamp I1 mount directly to front panel of utility box. Load connectors, also on front panel, can be five-way binding posts.



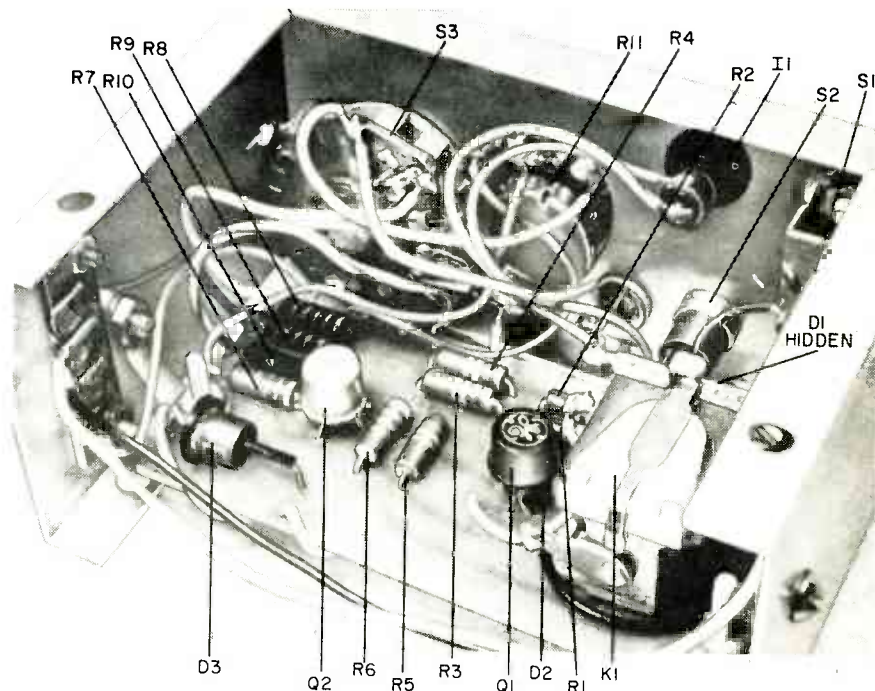

Fig. 2. Although printed circuit board construction is shown, circuit is simple enough to be assembled with point-to-point wiring. Terminal strip at left is for power inputs.

heavily and energize relay *K1*. Emitter-to-base negative feedback is used as temperature compensation.

When an overload occurs, *Q1* becomes forward biased, lowering the *Q2* bias and deenergizing *K1*. This action disables the output circuit. Then when reset switch *S2* is momentarily depressed, bias is restored to *Q1*, *Q2*, and the output. If the overload still exists, *Q2* will remain cut off, and *K1* will not energize. But if the overload is removed, *Q1* conducts and energizes *K1* when *S2* is depressed.

The three ranges chosen provide accurate current control in steps of 10-25 mA, 20-50 mA, and 40-100 mA at 9 volts d.c. Also provided are connections for measuring the voltage drop across the range resistors (contacts 6 and 7). This voltage can be converted, by Ohm's Law, to current and indicated on a graph.

Although designed for 9-volt operation, the overload protection circuit can be used with other input voltages to provide corresponding output voltages. Just be sure to take into account the change of current flowing through the range resistors with the new voltage.

The construction and layout of the electronic overload protection circuit are not critical. While the original prototype shown in Fig. 2 was assembled with the aid of a printed circuit board, the circuit is simple enough to permit point-to-point wiring. Almost any general-purpose transistor should work satisfactorily, provided that the one employed as the shunt

VOLTAGE TO CURRENT RELATIONSHIPS			
RANGE SWITCH POSITION			
VOLTS	A	B	C
0.2	10 mA	20 mA	40 mA
0.3	15 mA	30 mA	60 mA
0.4	20 mA	40 mA	80 mA
0.5	25 mA	50 mA	100 mA

amplifier has high enough gain, and the transistor for relay control has a V_{CBO} of 16 volts or more. If the transistor (*Q2*) gain is too low, the value of *R7* might have to be reduced to 4700 ohms.

For your convenience, the table gives the voltage-to-current specifications for the three settings of range switch *S3*. This table can be cut out or copied and pasted to the enclosure.



MODIFY YOUR ELECTRONIC GUITAR SOUND

VARY "ATTACK" TIME WITH THIS DELAY UNIT

EVERY MUSICAL instrument owes its unique sound to a certain combination of inherent characteristics. For instance, the number of harmonics produced, combined with their magnitudes and phase relationships, play an important role in creating the instrument's distinctive sound.

Another important characteristic is attack time—the speed with which sound is built up after a tone is initiated. Reed instruments such as the clarinet produce sounds which can be described as "soft" because they have a relatively slow attack caused by the time it takes for the reed to build up to its maximum vibration. On the other hand, instruments such as the guitar have a very rapid attack because maximum amplitude vibration is started as soon as the string is plucked or struck.

By changing an instrument's attack, we can make it sound different and, at the same time, not like any other instrument. That is what the "Attack Delay Unit" (ADU) does for the guitar. By slowing down the guitar's attack, a brand new sound can be obtained. The effect

can also be produced by recording a guitar passage on tape and then running the tape backwards through the player. Instead of sharp, clean tones, a hard-to-describe "whoop" is heard for each note played. Although the note is on pitch, it doesn't sound like it belongs to any known musical instrument.

Using the ADU, attack can be delayed for a very short period so that only the sound of the pick hitting the string is eliminated or it can be delayed so that the music builds up over the length of a run. A foot control switch makes it easy to delay particular notes selectively.

Construction. The circuit of the ADU, shown in Fig. 1, is fabricated on a printed circuit board whose foil pattern is shown in Fig. 2. Once the board has been made (or purchased), install the components as shown in Fig. 2. Be sure to install the semiconductors and electrolytic capacitors correctly. Use a heat sink (such as long nose pliers) on the transistor and diode leads while soldering to avoid possible thermal damage. Also, use a low-power (35 watts) soldering iron.

Connect sufficiently long leads to the various external connection pads before mounting the board in the chassis.

Almost any type of metal chassis may be used as long as it will hold the PC board, the power transformer, and the associated rectifier and will permit the installation of four switches on the front and three phone jacks on the back.

The choice of switches for S_2 , S_3 , and S_4 should be made carefully. During use, it may be necessary to manipulate these

switches rapidly in various combinations so they should have large paddle-type handles and operate with a light pressure. Any type of s.p.s.t. switch may be used for power switch S_1 .

Mount the power transformer (T_1) and a seven-lug terminal strip at one end of the chassis and drill a hole in the wall for the line cord. Put a grommet in this hole. Build up the power supply and attach the positive lead to S_1 . Do not ground either side of the a.c. to the chas-



Fig. 2. The actual size foil pattern is shown at the left, while component installation is illustrated below. The PC board is mounted on four spacers, and the power supply is mounted elsewhere in the cabinet. Alternatively, the ADU can be built in an existing amplifier console, with the control switches readily accessible to user.

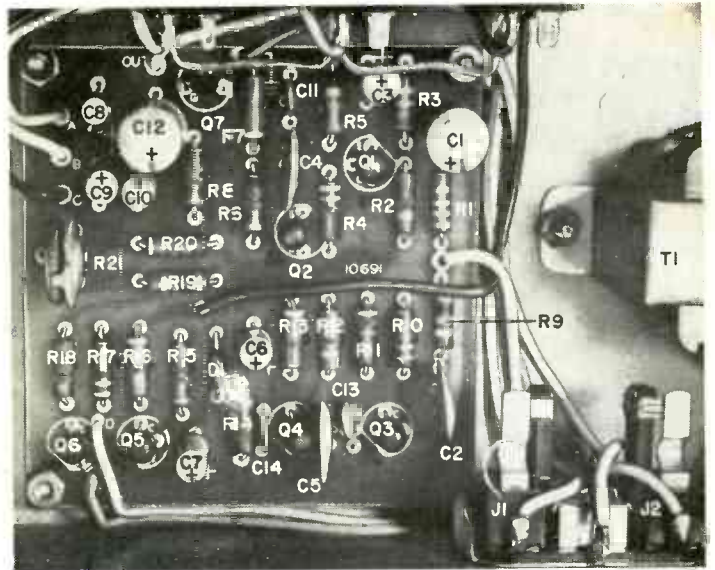

HOW IT WORKS

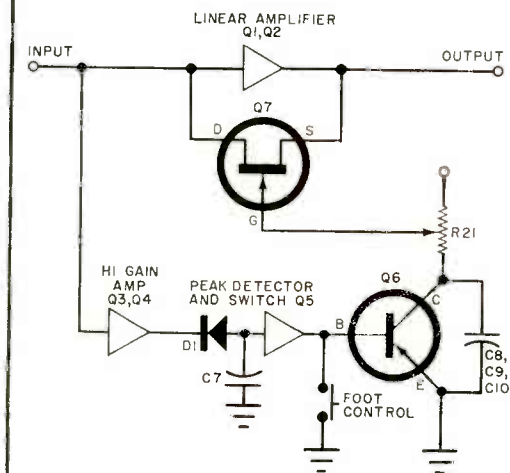

With no signal input, transistor $Q6$ is turned on and acts as a short circuit around the switch-selected capacitors $C8$, $C9$, and $C10$. The gate bias of FET $Q7$, in this case, is such that the FET is turned on and its low source-to-drain resistance results in a large amount of feedback for the linear amplifier formed by $Q1$ and $Q2$. Since this amplifier is designed for unity gain with no feedback, for all practical purposes, no input signal passes through it.

When there is an input signal, it is amplified by high-gain amplifier $Q3$ and $Q4$ and then rectified by peak detector $D1$. The resulting d.c. voltage appearing across $C7$ turns on $Q5$, which then turns off $Q6$ and allows the selected capacitor to charge. As the capacitor charges, the bias on $Q7$'s gate changes to increase its source-to-drain resistance. The increase in resistance around the linear amplifier loop decreases the feedback and causes the gain to go from nearly zero to approximately unity. The time required for this to take place depends on the capacitance value selected. Trimmer potentiometer $R21$ acts as a threshold control and sets the bias on the gate of $Q7$ when $Q6$ is on.

When the foot control switch is closed, the base of $Q6$ is shorted to ground, allowing the selected capacitor to remain charged. This holds the linear amplifier at unity gain and defeats the attack delay.

sis. Mount the three capacitor-selector switches ($S2$, $S3$, and $S4$) on the front wall and three phone jacks ($J1$, input; $J2$, foot control; and $J3$, output) on the rear wall.

Mount the PC board on four $\frac{1}{4}$ " insulated spacers so that $R21$ will be accessible from the side. Wire the complete circuit as shown in Fig. 1. Put four rubber feet on the chassis bottom to keep it from slipping around when in use.

Setup. Prepare the unit for operation

by running a short length of cable from the output of the ADU to your amplifier input and plugging the instrument output into the ADU input. For the time being, do not use the foot control switch. Turn the ADU on and set the delay to 4.

Since a certain minimum signal is required to operate the delay unit, the instrument's gain should be turned up almost all the way and the volume adjusted by using the amplifier's control.

The only thing that needs adjustment in the ADU is potentiometer $R21$. At one

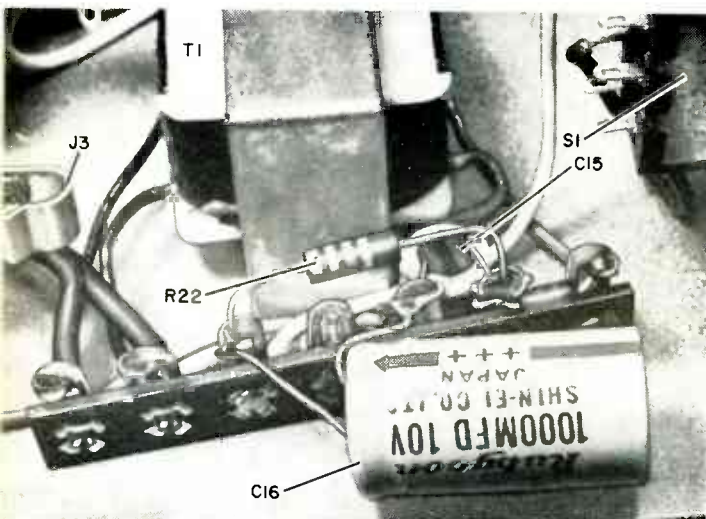

The power supply is built up on a seven-lug terminal strip which also carries the input a.c. line cord. The arrangement is not critical, but make sure that neither side of the power line makes electrical contact with the chassis.

When obtaining switches for the delay selection, remember that they may be operated a considerable number of times, in various orders, and possibly in a hurry. Pick switches with long handles and smooth operation.

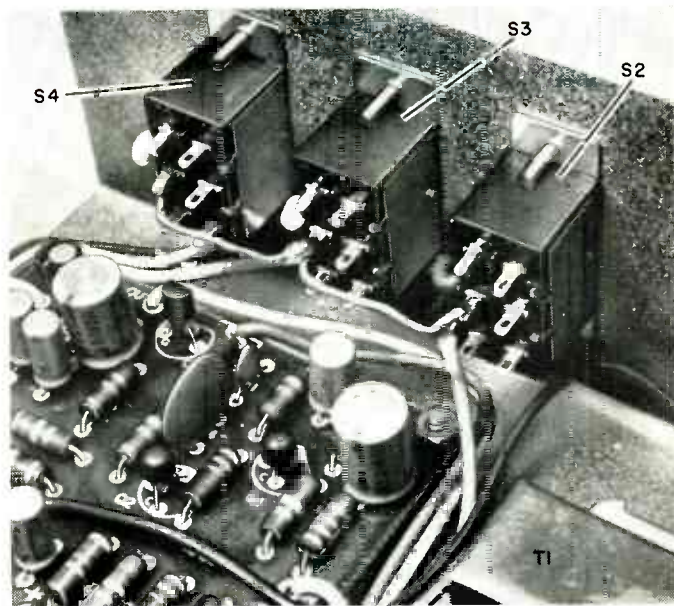

end of this pot's rotation, there is little or no delay in the instrument attack; with the opposite setting, there is no sound for an instant and then the volume will come up full. Between these two extremes, are a variety of settings which can be selected strictly as a matter of personal taste. Ideally there should be very little or no sound when the note is first struck, followed immediately by a noticeable increase in volume with a smooth glide to maximum.

Operation. The three delay switches on the ADU can be used singly or in combinations to yield up to seven different delays. The numbers above the switches represent some arbitrary unit of delay (which varies with the setting of $R21$) and may be added together to get the longer delays. For instance, if the "2" and "4" switches are down, the attack delay is 6 times longer than if only the "1" switch is down.

Since the ADU requires a short, no-signal dead time for the circuits to reset, all strings on a guitar must be silenced before the next chord or note is struck. If single notes are being played, just lifting the finger from the finger board will ordinarily accomplish the deadening, but for chords with open strings, it is necessary to deaden the strings with the palm of the strumming

hand. The resetting time is actually very short (on the order of a tenth of a second) so very rapid runs can be played with the delay still occurring on each note.

The foot control switch is a single-pole, single-throw type and can be housed in a

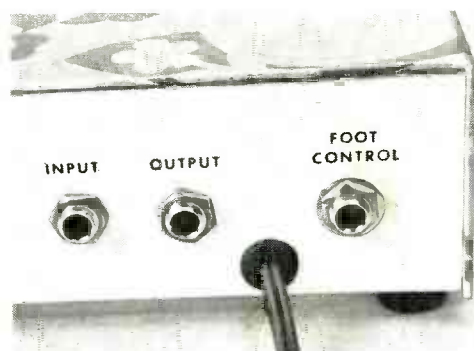

Phone jacks for input, output, and foot control are located most conveniently on back of chassis. Colorful vinyl cloth was used to cover prototype.

sturdy case of metal or a block of wood. The switch can be a push-on/push-off type but experience has shown that a spring-loaded, normally closed switch works best. With this arrangement, selective delay can be accomplished by pressing the switch when delay is desired and releasing it to sustain a note. -30-

MAKE YOUR VTVM A MEGGER TOO

MEASURE UP TO 50,000 MEGOHMS

BY JAMES CHILDS AND JOHN ESKRIDGE

BBUILT RIGHT into your VTVM is a megger that can measure extremely high resistances (to 50,000 megohms). To make use of this megger function, all you have to do to the basic meter is add a resistor and a pin or banana jack. The modification simply provides a convenient voltage source for measuring very high resistances; it does not interfere with the normal operation of your meter.

The megger modification comes in handy for all sorts of jobs. It greatly simplifies the detection of leakage in non-electrolytic capacitors, between coil and transformer windings, and between conductors of transmission lines.

The filtered d.c. for the megger is obtained from the positive side of the filter capacitor, through load resistor $R1$ which is also used as a current limiter, in your VTVM as shown in the schematic diagram. Load resistor $R1$ is the megger modification resistor that must be added to the VTVM's circuit. Its value must be

calculated on the basis that it will pass no more than 1 mA if the ground lead of the meter is accidentally shorted to $J1$ (the pin or banana jack that is used in the modification). This value is usually between 50,000 and 75,000 ohms, depending on the amplitude of the $B+$ voltage in your particular meter and derived by Ohm's Law ($R1 = B+/0.001$).

The first step in measuring an unknown resistance is to measure the source voltage at $J1$ with the positive d.c. probe of the meter. Then unknown resistor Rx is placed between $J1$ and the probe to provide a circuit from $B+$ through Rx and into the input of the meter. At this point, the meter is measuring the voltage drop across input impedance Rm of the meter, which is typically 11 megohms.

If Rm and its voltage drop Em are known, you can calculate total current It . The voltage drop across Rx can be calculated by subtracting meter voltage Em from source voltage Es to obtain Ex , the voltage dropped across the resistance being measured.

With total current through and the voltage drop across Rx known, calculate the value of Rx by using Ohm's Law ($Rx = Ex/Ix$), or from the equation: $Rx = [Rm (Es - Em)]/Em$.

Most VTVM's have unregulated power supplies, but since the resistances being measured are very high, the loading effect on the power supplies will be negligible. Also, since current through Rx is very low, the voltage drop across the current-limiting resistor, $R1$, can be ignored.

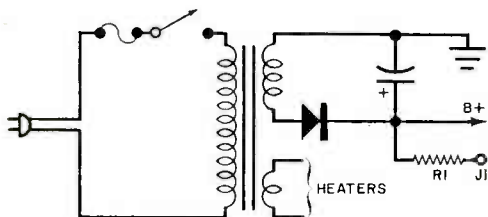

Two small parts, $R1$ and $J1$, are all that have to be added to basic VTVM to provide megger function.

-30-

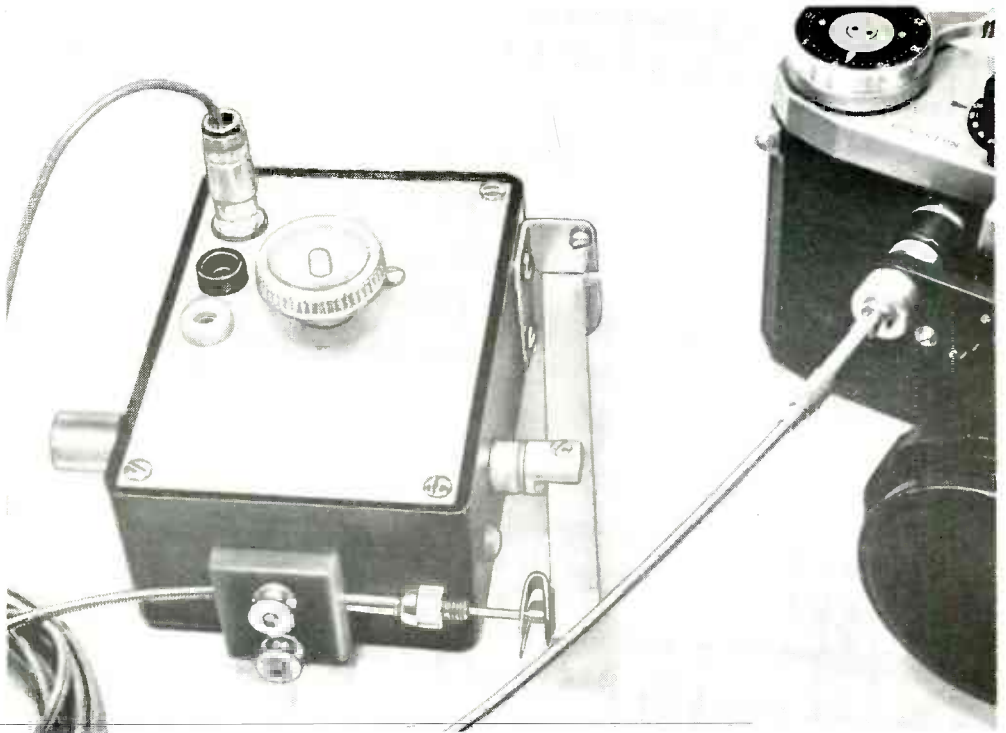

REMOTE CAMERA SHUTTER RELEASE

VARIABLE SOLENOID CONTROL CIRCUIT
TRIGGERS HUNDREDS OF FEET AWAY

BY A. A. MANGIERI

IF HE IS planning wildlife or surveillance shots—or just some tricky setups in his studio—the serious camera buff knows that he has to have a remote shutter release system. Such a system need not be elaborate or expensive. In fact, the electrically operated shutter release described here is compact, easily constructed using ordinary tools, and contains a minimum of components. The system includes stroke and trip-force adjustments to match the requirements of most cameras.

Either of two control circuits can be used. One provides for more or less direct electrical operation from distances up to 50 feet. The second uses a transistor amplifier for truly remote control from hundreds of feet away.

About the Circuit. Both shutter release circuits are shown in Fig. 1. One is a simple series loop including a battery, *B1*, solenoid force control, *R1*, and solenoid, *K1*. Battery polarity in the circuit is important only when an external battery charger is used (through jacks *J1* and *J2*).

Since up to 2.5 amperes of current flows through the circuit, it is necessary that the trip cable between *PL1* and trip switch *S1* be two-conductor lamp cord. This cable actually forms part of the series loop, connecting *R1* to *K1*, and carries the full tripping current.

The power booster circuit (Fig. 1B) employs a single transistor to amplify the signal delivered to solenoid *K1*. It is inadvisable to try to trip the solenoid

PARTS LIST

B1—Four 1.5-volt, 500-mA-hr nickel-cadmium cells in series (Eveready No. B11500)
J1, J2—Banana jack (one red, one black)
J3—Phono jack
K1—6-volt d.c., 1.6-ohm solenoid (Dormeyer No. B24-755-A-1)
PL1—Phono plug
Q1—30-watt, 60-volt, 3-ampere npn silicon power transistor (Motorola HEP245)
R1—3-ohm, 5-watt midgeet potentiometer
R2—200-ohm, 5-watt miniature potentiometer
R3—4.7-ohm, 1-watt resistor
S1—S.p.s.t. normally open, momentary-action pushbutton switch
1—4" x 2 $\frac{1}{8}$ " x 1 $\frac{1}{16}$ " plastic or Bakelite case with aluminum cover
Misc.—1" x 1" x $\frac{1}{4}$ " Bakelite (2); Amphenol No. 3-12 shell and No. 78-B blank insert; sheet aluminum; #24 two conductor juke box cable (or lamp cord—see text); D cell holder (see text); 4 $\frac{1}{4}$ " x $\frac{3}{8}$ " x $\frac{3}{16}$ " steel strip for shutter actuator arm; control knob; #6 machine hardware; hookup wire; solder; etc.

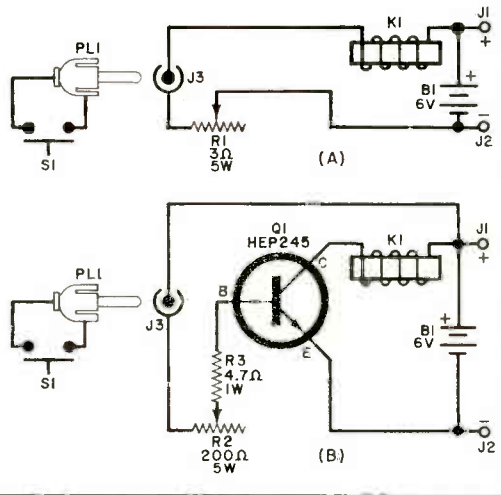

Fig. 1. Circuit in (A) is used for short runs where line voltage drop is minimal; (B) circuit provides current gain through *Q1* for long runs.

from a distance of more than 50 feet through a simple series loop. The cable resistance would probably reduce the current flow enough to prevent energization of *K1*. Hence, in the booster circuit, only biasing current for transistor *Q1* is routed through the trip switch/cable assembly. This allows the use of inexpensive and less cumbersome juke box cable.

Both circuits have provision for varying the solenoid actuating force. Potentiometer *R2* accomplishes this by varying the bias on the base of *Q1*. Polarity of the battery in this circuit is critical. Not only must it match the coding of the charger jacks, it must also conform to the requirements of the transistor.

Construction. Referring to Fig. 2, lo-

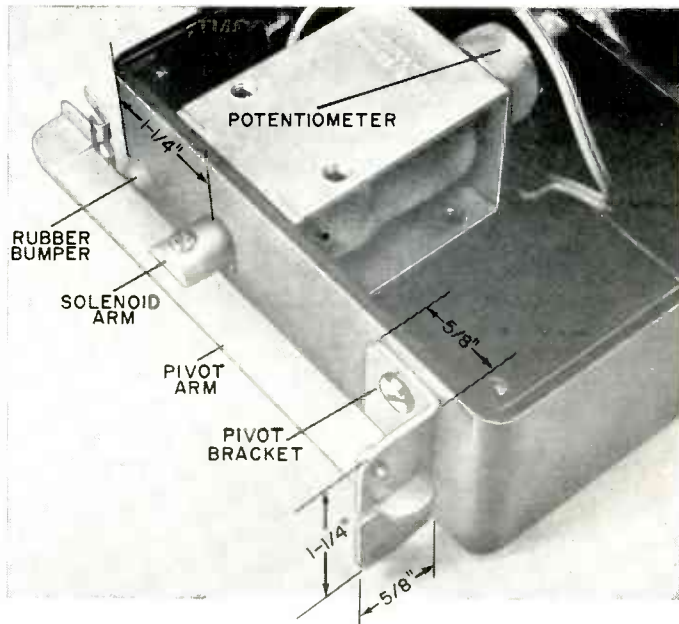
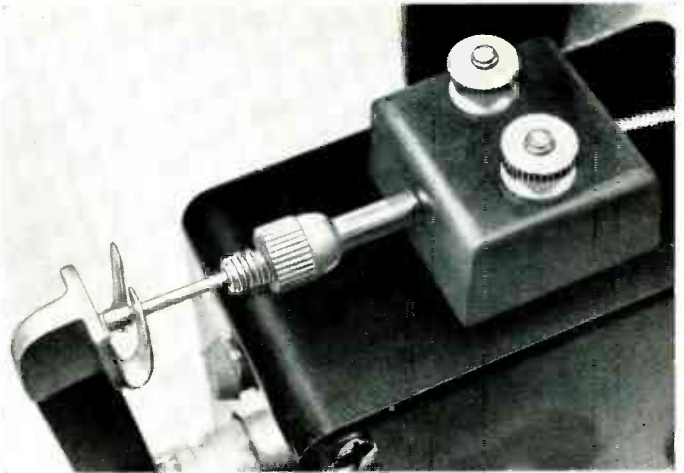

Fig. 2. Mechanical linkage between solenoid and pivot arm requires fabrication of several small metal parts. Note location of potentiometer *R2* under housing of solenoid coil.

Fig. 3. Plunger consists of two blocks of Bakelite, machined to provide friction fit. Plunger retainer (far left in photo) can be soldered or brazed to pivot arm; if aluminum is used for pivot arm, use machine screw, washer, and nut.



cate and drill the exit hole for the arm of the solenoid, centering it between the two sides of the box. Then drill the mounting holes for the solenoid and actuating arm pivot bracket, and for the potentiometer (located directly opposite the exit hole for the solenoid).

Now, mount the potentiometer and solenoid in their respective locations. Use washers between the solenoid frame and wall of the box to align the solenoid arm with the exit hole. Attach a small rubber bumper (or a spot of silicone rubber compound) about $\frac{1}{2}$ " in from the end of the box and centered as shown. Then mount the pivot bracket in place with #6 machine hardware.

Drill and tap two 6-32 holes through the upright leg of the pivot bracket, start two #6 screws into the holes, and notch the bracket. Now, set the pivot arm into the notches in the solenoid arm and pivot bracket. Secure it to the solenoid arm with hardware, and test the movement to make sure that the pivot arm does not bind in either notch. Then place a piece of steel wire across the pivot point, route the ends of the wire under the previously started screws, and tighten down the screws. This wire is not a spring; it merely retains the arm in the pivot. Hence, it should not bind the arm.

Firmly clamp the two Bakelite blocks so that they align exactly with each other. Then, at the interface and exactly centered, carefully drill a hole large enough to accommodate (with slight binding pressure) the barrel at the plunger end of your shutter release cable.

Remove the Bakelite blocks from the clamp and, holding them mated together, drill two #8 holes through the blocks. Then drill two holes through the wall of the box in line with the holes in the blocks. (Locate the holes as close as possible to the push pad on the pivot arm with the plunger fully in but without depressing the cable release button. Loosely bolt down the block/cable assembly with #8 hardware. This allows for later stroke adjustments. If the cable release has a very short barrel, position the blocks to provide the required stroke for your particular camera.) Details for attaching the block/cable assembly to the box are shown in Fig. 3.

Now, referring to Fig. 4, fashion an L bracket out of 22-gauge aluminum. Cut up a D-cell holder to make the NiCad

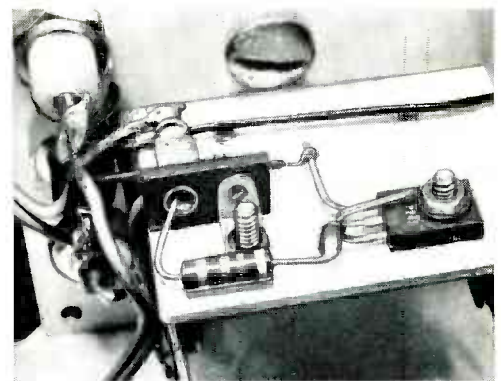

Fig. 4. Electronic components are wired together on L bracket secured to front plate of the box.

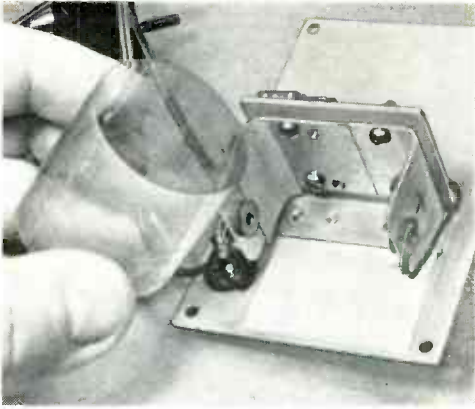

Fig. 5. Cut-down D cell holder, bolted to L bracket, and sheet plastic or card stock provide convenient method of connecting batteries to circuit.

battery holder (see Fig. 5). Mount the holder to the L bracket. Then, as shown in Fig. 4, mount the components on the opposite side of the bracket. The transistor mounts with a 4-40 screw, which also secures one point of the battery holder. Place the copper pad (collector) of the transistor against the metal bracket and tighten the screw gently.

Install charging jacks *J1* and *J2* and phono plug *PL1* on the front panel. Use shoulder fiber washers to insure that the jacks and plugs are insulated from each other. Then assemble the box.

Make the trip switch assembly from an Amphenol No. 3-12 shell and No. 78-B blank insert. Depending on which of the two circuits you plan to use, route the lamp cord or juke box cable through the side of the shell (see Fig. 6), lining the entry hole with a small rubber grommet to prevent the metal from cutting through the cable insulation. The momentary-action pushbutton switch mounts in the top hole in the shell. Connect and solder the conductors of the cable to the switch lugs, and press-fit the blank insert onto the shell. Then, at the other end of the trip switch cable, solder on a phono jack.

How To Use. With the shutter release mounted firmly next to your camera, and before loading the camera, make trial adjustments of the stroke length by moving the cable release in the clamp blocks and depressing the plunger by hand. Use

just enough stroke movement to trip the camera with the plunger fully in.

Set the force control potentiometer for maximum resistance (minimum force) and plug in the trip switch cable. Advance the force control in small steps,



Fig. 6. Amphenol shell accommodates remote actuating switch. Cable should be routed through a grommet-lined hole.

depressing the trip switch momentarily each time, until the shutter trips. Do *not* hold down on the pushbutton more than a moment as this only wastes battery power. -30-

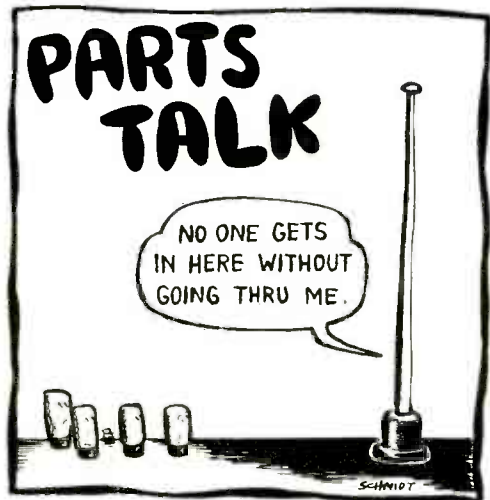

The Music Goes 'Round and 'Round



See Reds, Blues, Greens Dance to Your Beat
With This Ever-Entertaining *knight-kit*® Color Organ!

The colorful way to a bright new musical world. Our exclusive easy-to-assemble kit connects to the speaker leads of ANY audio equipment or amplifier. Get new excitement from your old favorites and a really different sight AND sound experience from new music. Special "lens" for 3-dimensional effect, walnut-veneer vinyl-clad case. Intensity controls for red/green, and Master control. Stop in and see music "in color"—there's a store near you!

39.95

Science Fair® P-Box Kits—America's Favorite

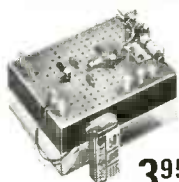

2-Transistor AM Radio. Earphone.



Wireless AM Mike. Broadcast to 20 ft.

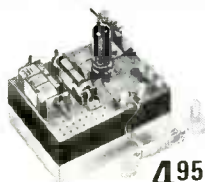

Single-Tube AM Radio. Low-voltage DC.

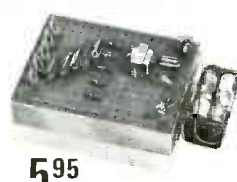

"Gooflylite" Fires 5 lamps in sequence or random.

The unique kits that make use of their own package. Pre-punched P-Box becomes kit chassis, clear-plastic cover protects wiring.



FREE
Kit/Parts
Catalog



2725 W. 7th St., Dept. EEH-2
Fort Worth, Texas 76107

I enclose check money order for these postpaid kits:

Name (print) _____
Street _____
Apt. # _____ Route _____ Box _____
City _____ State _____ Zip _____

- Free Kit & Part Catalog
- Color Organ @ 39.95 ea.
- 2-Tr. Radio @ 3.95 ea.
- AM Mike @ 3.95 ea.
- 1-Tube Radio @ 4.95 ea.
- Gooflylite @ 5.95 ea.

CIRCLE NO. 1 ON READER SERVICE CARD

BUCK UP BASS RESPONSE WITH A SUPER WOOFER

BY ERIC PAVLAK

ONE OF THE BEST methods of getting good bass response from your stereo system is to use a super-powerful woofer in addition to your regular speaker systems. Since the very lowest bass notes, those under 100 Hz, are non-directional, a single super woofer setup will serve both stereo channels. Consequently, your regular speaker systems can have less than full bass response and still be quite satisfactory.

A super woofer, for best results, should be powered by a separate amplifier. This provides several distinct advantages over systems connected by an LC crossover network. For one thing, the independent bass amplifier (actually, it can be any amplifier with very good bass response) can be adjusted without interfering with the main amplifier. So, the volume level of the super woofer can be set in relationship to the rest of the system without introducing resistance in series with any of the speakers—a resistance that would prevent good speaker damping.

Also, a separate amplifier allows the lowest bass to be increased without upsetting the balance of the rest of the system. And it permits the use of steep-sloped filters of 18-dB/octave that would

otherwise be impractical. One further advantage of using a single super woofer is that no phasing problems exist.

The amplifier for the super woofer should be coupled to both the right and left channel outputs of your regular amplifier. For this, you will need a circuit like that shown in the schematic diagram. This circuit is simpler than an electronic crossover network with active elements and it introduces less distortion than a passive filter which uses both capacitive and inductive elements.

Crosstalk introduced by this adapter circuit is minimal. Signal level is adjusted by control *R6*. When assembling the circuit, mount it inside a shielded box. Parts placement is not critical, but be sure to use shielded cable between the circuit output and the input of your super woofer amplifier.

The super woofer itself can be as big as your listening room will allow and as expensive as your budget can take. Several 12" or 15" woofers can also be used; or, better yet, you can use one of the horn-type woofers available from Altec or Klipsch.

The best place in a room to set the super woofer is in a corner. And since only the lowest frequency sounds are to be radiated, it matters little if furniture or thin draperies are located between the super woofer and listener. But be wary of standing waves which can result when large, flat surfaces are directly opposite the speaker.

A super woofer is just the thing to improve weak bass systems. Adding one is relatively simple and inexpensive yet it can provide really thunderous lows without mid-bass thumping or booming. —30—

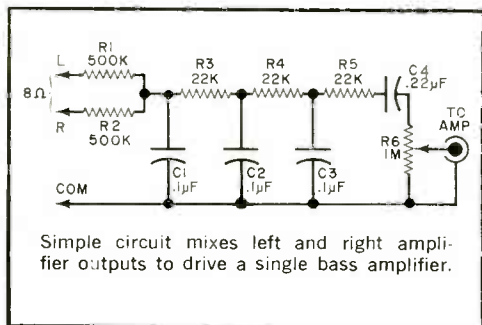



IC EXPERIMENTAL PROJECTS

BY DON LANCASTER

TWO-TONE ALARM

HAVE YOU EVER needed an audio tone source that was really loud, absolutely distinctive, or even downright annoying? If so, this Alarm is for you.

The circuit of the Alarm automatically switches the audible output from 500 to 1000 Hz five times a second, producing a "twee-dell, twee-dell" sound

Presented here is a series of simplified integrated circuit projects demonstrating some of the applications of readily available IC's. The projects themselves can be used for classroom or Science Fair demonstrations or they can be repackaged and put to more constructive uses. Included are a Two-Tone Alarm, 100-kHz Frequency Standard, Signal Injector, and Shift Register (not shown above).

that can't be missed anywhere and positively can't be ignored. By adding an optional potentiometer to the circuit, the sound level can be changed from a high tweet to a low growl.

The Alarm can be set to run continuously or it can be turned on with a local switch or a remotely operated contactor. There are two outputs; a low-level one which can be amplified in any audio amplifier and a high-level one that can be used to drive a conventional speaker directly.

You can use the Alarm as a panic button, a novelty audio device, an electronic doorbell, a selective call, a Science Fair multivibrator demonstrator, a burglar alarm, or as a signalling device for high-noise industrial environments.

Construction. A schematic diagram of the Alarm is shown in Fig. 1. While it is not essential, a printed circuit board greatly simplifies the assembly. If you want to make your own, use the foil pat-

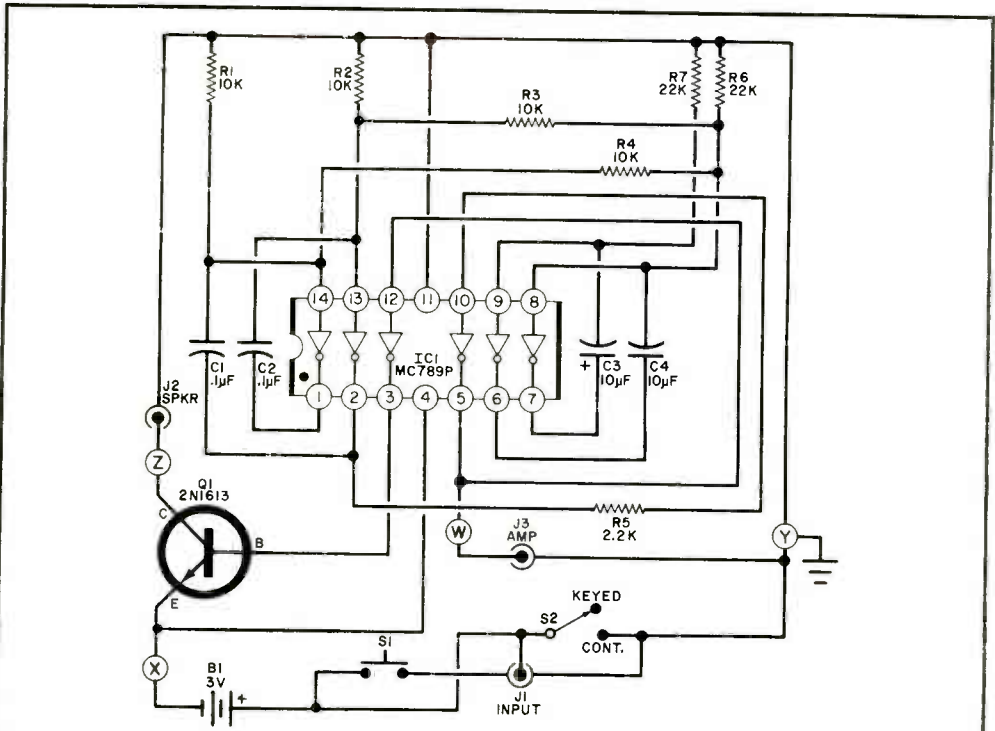

Fig. 1. The circuit is essentially a pair of audio oscillators that interact with each other to produce the strange sound. Note that the positive side of the battery is grounded to the chassis to ease the wiring.

PARTS LIST

- B1—D cell (2)
- C1,C2—0.1-µF, 10-volt disc ceramic capacitor
- C3,C4—10-µF, 10-volt electrolytic capacitor
- IC1—MRTL hex inverter (Motorola MC789P)
- J1-J3—Phono jack
- Q1—2N1613 npn medium-power transistor (or similar)
- R1-R4—10,000-ohm, ¼-watt resistor
- R5—2200-ohm, ¼-watt resistor
- R6,R7—22,000-ohm, ¼-watt resistor

- S1—S.p.s.t. normally open pushbutton switch
 - S2—S.p.s.t. slide switch
 - Misc.—PC terminals (4), 3" x 4" x 5" case, mounting hardware, battery holder (Keystone 176), PM speaker and enclosure (optional), wire, solder, etc.
- Note—The following are available from Southwest Technical Products, Box 32040, San Antonio, Texas, 78216: etched and drilled circuit board, \$1.50; complete kit of all parts including prepunched, vinyl-clad case, but less batteries and speaker, \$6.90, postpaid in U.S.A.

HOW IT WORKS

The integrated circuit used here is called a hex inverter and contains six separate inverting amplifier stages. Two of these stages are combined with R6, R7, C3, and C4 to form a 5-Hz astable multivibrator (square-wave oscillator). Two more inverters are combined with R1 through R4 and C1 and C2 to form a second astable multivibrator that can operate at either 500 or 1000 Hz, depending on the state of the 5-Hz multivibrator and feedback through R3 and R4.

The remaining inverters provide load isolation, while transistor Q1 provides enough drive to handle a permanent-magnet speaker.

Power for the Alarm is obtained from two D cells. Any other medium-current d.c. supply with a voltage from 1.5 to 6 volts can be used. Switches S1 and S2 and jack J1 are all in parallel to energize the Alarm. To simplify the assembly, the case is connected to the keyed positive supply level (PC terminal Y).

tern and drilling details shown in Fig. 2. Mount the parts as shown in Fig. 3. The integrated circuit polarity is identified by a notch (between pins 1 and 14) and a dot. In the illustrations it is shown from the top. Be sure to orient it properly and use a small soldering iron and fine solder when installing it. Also, be careful about the polarities of electrolytic capacitors C3 and C4.

Assemble the Alarm in a 3" x 4" x 5" metal box. The battery holder is mounted on the bottom with pop rivets or #6 hardware. The PC board goes on the top using spacers and hardware.

Fig. 2. Actual-size foil pattern for the Two-Tone Generator. The IC is oriented so that pin 1 is adjacent to the small dot on the foil pattern. After fabrication, the board can be drilled as shown below, and PC terminals can be used at the four lettered locations. The board is supported by spacers at each corner location. Component location is shown in Fig. 3.

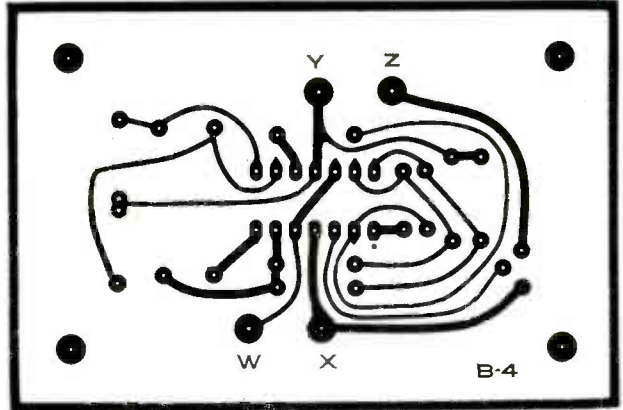
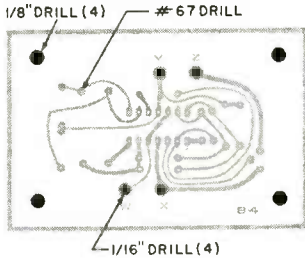

Operation: To test the Alarm, either connect the amplifier output (*J3*) to a suitable amplification system or attach a low-impedance (4-, 8-, or 16-ohm) speaker to the speaker jack (*J2*). The Alarm should operate immediately.

To vary the output sound, add a 500- or 1000-ohm potentiometer in series with *S1*.

Capacitors *C1* and *C2* determine the frequency of the lowest note, while *C3* and *C4* determine the switching rate. The difference between the highest and lowest notes is determined by *R3* and *R4*. You can experiment with any of these values to get different audio results.

Volume should be more than enough

for most applications. If you want more, however, try using a higher supply voltage (up to 6 volts). You can also use an output matching transformer or a high-efficiency horn-type speaker.

100-KHZ STANDARD

A STABLE, accurate source of 100-kHz reference square waves has many applications—most of which are adequately filled by the “100-kHz Standard” described here. For the ham or SWL, it is a must for receiver calibration, providing a “birdie” every 100 kHz and, if desired, it can be adjusted to

Fig. 3. Although the alarm can be built in almost any type of case, the prototype was built within a small metal enclosure. Install the components on the PC board as shown at left and mount batteries on other side.

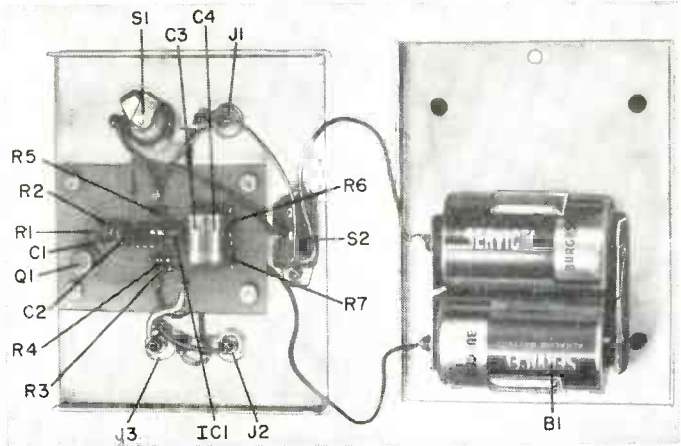

zero beat against WWV for optimum accuracy.

For general experimental and laboratory work, the Standard can be used as a top-notch calibrator for oscilloscopes and r.f. generators, since it has a very accurate frequency and excellent rise time (about 12 nanoseconds) for probe compensation.

In work involving digital IC's, the unit is a handy high-frequency clock source. For example the frequency can be divided to obtain ultra-precise time gates for an electronic counter. Or, the gate input can be used to start and stop the gate output making available a train of

10- μ sec pulses that can be fed to the counter to measure the velocity of a bullet and perform other experiments in the laboratory.

About the Circuit. The 100-kHz standard employs a crystal and a single integrated circuit (XTAL and IC1 in Fig. 4) in a very simple circuit. Three outputs are provided: CW (J3) for 100-kHz square waves all of the time; RF (J2) for wide-spectrum narrow (10- μ sec) period spikes for receiver calibration; and GATED (J4) for the 100-kHz square waves only when a separate GATE INPUT (J1) is grounded. Appli-

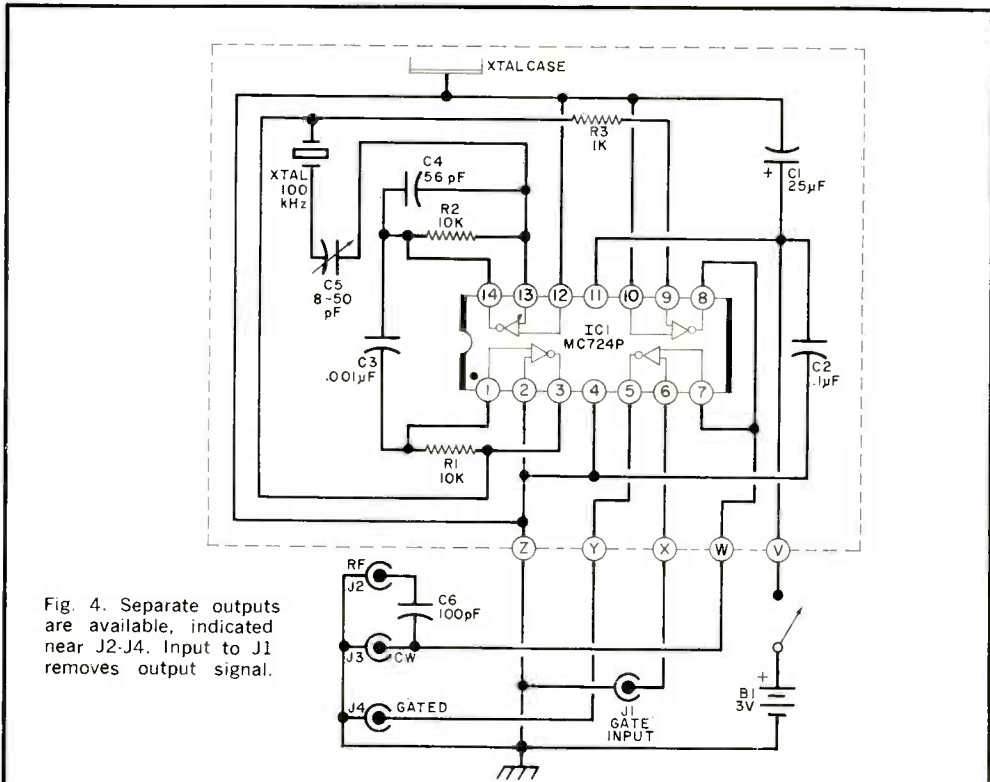

Fig. 4. Separate outputs are available, indicated near J2-J4. Input to J1 removes output signal.

PARTS LIST

- B1—1.5-volt D cell (2)
- C1—25- μ F, 6-volt electrolytic capacitor
- C2—0.1- μ F disc capacitor
- C3—0.001- μ F, 50-volt Mylar capacitor
- C4—56-pF mica capacitor
- C5—8-50-pF screwdriver-adjustable trimmer capacitor
- IC1—Quad two-input-gate integrated circuit (Motorola MC724P)
- J1-J4—Phono jack
- S1—S.p.s.t. switch

- XTAL—100-kHz parallel resonant crystal, specified into 32-pF load
- Mis.—Printed circuit board (see text); crystal holder and rivets; hardware for C5 if needed; 5" x 4" x 2 1/2" vinyl-clad case; Keystone No. 176 battery holder; #6 hardware; hookup wire; solder; etc.
- The following items are available from Southwest Technical Products Corp., Box 32040, San Antonio, TX 78216: etched and drilled printed circuit board No. 173C for \$9.85; complete kit of parts, including pre-punched case, but less batteries, No. 173b \$2.15; postpaid in U.S.

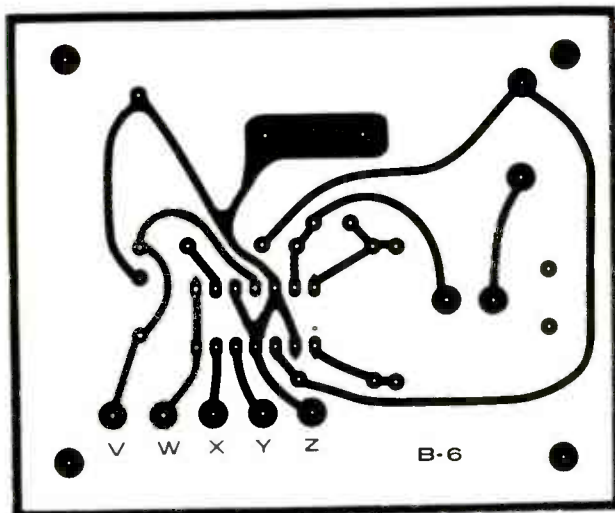

Fig. 5. Full-size printed circuit etching guide at left should be copied exactly as shown. Exercise caution to avoid short circuits between close proximity IC pin solder pads.

cation of +1.4 volts d.c. to the GATE INPUT removes the output signal.

In addition, an internal trimmer capacitor, *C5*, is provided to allow shifting the frequency approximately 100 Hz on either side of the crystal frequency to provide compensation for crystal tolerance, variations in supply voltage and temperature, and zero beating with WWV. A buffer stage between the oscillator and the outputs insures minimum loading.

Integrated circuit *IC1* consists of four two-input gates, two of which are biased into the class A region to act as linear amplifiers with resistors *R1* and *R2*. These amplifiers are cross-connected to each other through capacitors *C3* and *C4* and the crystal to form a feedback loop.

A third gate and *R3* provide an isolating buffer stage. The output of this gate goes to *J3* directly, and to *J2* through capacitor *C6* to provide only the sharp leading and trailing edges for the calibrator output.

The fourth gate is the only one in which the second input is used. This stage is used for gating the CW output and, in turn, provide a gated output signal.

The crystal specified is a 100-kHz parallel-resonant type into a 32-pF load. When *C5* is set to 32 pF, the operating frequency will be the same as the characteristic frequency of the crystal. Increasing the capacity of *C5* decreases the

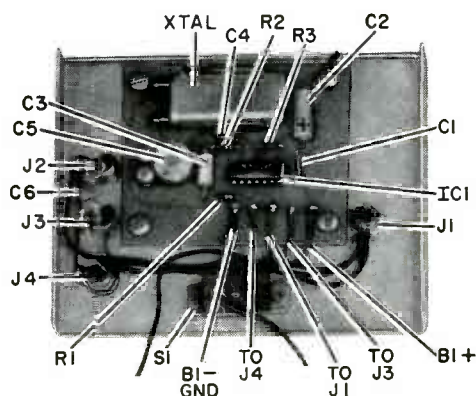

Fig. 6. Photo shows component locations on circuit board and front panel. Notch on *IC1* is to left.

crystal's operating frequency, and vice versa. This feature allows the user to "pull" the oscillator frequency to exactly 100 kHz.

Construction. A printed circuit board is recommended for this project. You can buy one already etched and drilled (see Parts List), or you can make your own by carefully following the etching guide provided in Fig. 5.

The first step in assembling the circuit is to rivet the crystal clip to the component side of the PC board in the appropriate location. Then mount the components on the board as shown in Fig. 6. Use a low-power, small tip soldering iron to solder the leads of *IC1* to the foil pat-

tern, and apply heat just long enough to get the solder to flow.

Next, mount the circuit board to the front panel with ≈ 6 hardware and four $\frac{1}{2}$ "-long spacers. Interconnect the jacks, switch, and circuit board.

For a housing, you can use either the pre-punched vinyl-clad one specified in the Parts List or a 5" \times 4" \times 3" metal utility box. In either case, the batteries should be mounted to the rear of the case, and an access hole to $C5$ should be drilled. (Note that both sides of $C5$ must be "floating," precluding the use of a conventional panel-mounting variable capacitor; so do not attempt to substitute this component.)

How To Use. Calibration of the 100-kHz Standard is needed only for very exacting applications since the normal operating frequency of the standard will usually be well within a 99.9-100.1-kHz range. To calibrate, use either an electronic counter or a communications receiver tuned to a high-frequency WWV transmission. Adjust $C5$ with an insulated alignment tool to obtain either a 100 kHz reading on the counter or a quiet "chuffing" zero-beat note from the receiver speaker.

The circuit should operate properly with all good-quality 100-kHz parallel-resonant crystals. However, older surplus or odd cut crystals might require a shift in the values of capacitor $C4$

and, rarely, $C3$ for proper starting and clean operation. If you are using non-standard crystals, you might have to experiment to get the best results. Also, crystals with other frequencies can be used for special applications, up to 8 MHz or so.

For powering the standard, you can use batteries or any power supply capable of delivering 1.5-6 volts of relatively clean d.c. Supply voltage has a slight effect on the operating frequency; so, be sure to calibrate your 100-kHz Standard at the voltage you will be using.

IC SIGNAL INJECTOR

THE SIGNAL INJECTION technique, most electronics technicians agree, is the quickest way to troubleshoot radio receivers and audio equipment. Using a signal injector, he can check an entire unit with only one hookup—no matter how complex the receiver or amplifier. Time-consuming voltage or ohmmeter checks are required only when the faulty stage is located.

Whether you plan to use it on the job

IC EXPERIMENTER'S POWER SUPPLY

The low-voltage power supply whose schematic is shown here can be used with any and all of the "IC Experimenter's Corner" projects presented in this series. Note that the supply has full-wave rectification and very good filtering to supply a stable d.c. voltage source for

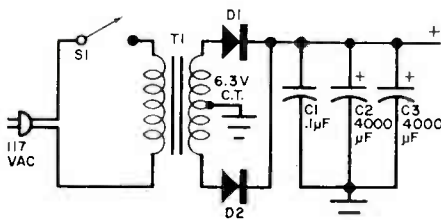

the IC projects. Output voltage from the supply is approximately 3.6 volts d.c.

The power supply can be assembled by any conventional method, including point-to-point wiring. Very few components are used and they are relatively small in size. Hence, the supply can be fit inside any of the enclosures suggested for the various projects.

PARTS LIST

- C1*—0.1- μ F disc capacitor
 - C2, C3*—4000- μ F, 15-volt electrolytic capacitor
 - D1, D2*—25 PIV, 1.5-ampere silicon diode
 - S1*—S.p.s.t. slide or toggle switch
 - T1*—6.3-volt, center-tapped filament transformer (Stancor No. P-6134 or similar)
 - 1—line cord with plug
 - Misc.—Hardware, hookup wire, solder, etc.
- Note—A kit of parts for the power supply is available at \$4.50 postpaid from Southwest Technical Products Corp., Box 32040, San Antonio, TX 78216.

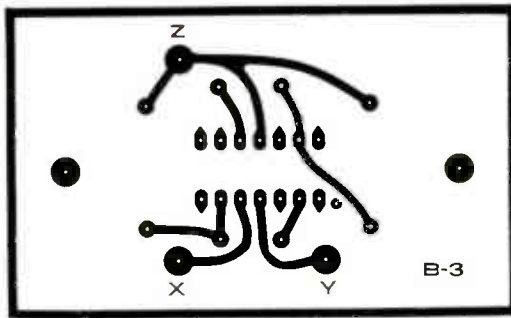

Fig. 8. Actual size circuit board etching guide is designed to accommodate components not mounted on front panel of the project. Isolated dots locate mounting holes.

or at home to keep your own equipment in working order, you will find many uses for the "IC Signal Injector" described here. This Injector is basically a battery-powered 1000-Hz multivibrator that generates square waves. The amplitude of the output square waves is continuously variable and is great enough, with the amplitude control wide open, to drive or test a loudspeaker. The Injector also provides a wide band-width r.f. signal which is extremely useful in testing AM receivers.

Construction. As you can see from the schematic diagram in Fig. 7, the circuit of the IC Signal Injector is very simple. However, since it does employ an integrated circuit with closely spaced pin leads, it is essential to use a printed circuit board. You can obtain a prepunched and etched board from the source listed in the Parts List, or you can make your own with the aid of the etching guide provided in Fig. 8.

Install the components on the board as shown in the photo in Fig. 9, paying particular attention to the orientation of the indexing groove on IC1. Use a low-wattage, fine-pointed tool when soldering component leads to the foil pattern on the PC board, and apply heat only long enough to allow the solder to flow.

Next, mount R3, C3, S1, and J1 and J2 on the front panel. Use 3/8"-long spacers and #6 machine hardware to fasten the circuit board to the front panel in the position shown, and interconnect with hookup wire all components and the circuit board.

Battery B1, two 1.5-volt D cells connected in series, can be mounted to the rear panel of the enclosure with a dual-

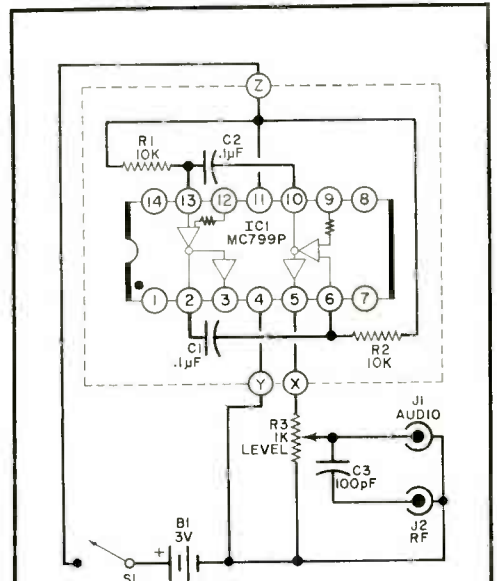

Fig. 7. One-IC circuit provides both audio and r.f. tracing signals; each output signal is continuously variable in amplitude.

PARTS LIST

- B1—Two 1.5-volt D cells in series
- C1, C2—0.1- μ F, 10-volt disc capacitor
- C3—100-pF disc capacitor
- IC1—MC799P or HEP571 dual-buffer integrated circuit (Motorola)
- J1, J2—Phono jack
- R1, R2—10,000-ohm, 1/4-watt resistor
- R3—1000-ohm linear-taper potentiometer
- S1—S.p.s.t. slide or toggle switch
- Misc.—Keystone #176 battery holder; control knob; 5" x 4" x 2 1/2" case; spacers; #6 machine hardware; hookup wire; solder; etc.
- Note—The following items are available from Southwest Technical Products Corp., Box 32040, San Antonio, TX 78216: etched and drilled printed circuit board, \$1.78; complete kit of parts, including prepunched vinyl-clad case but less batteries, \$7.30, postpaid in U.S.A.

HOW IT WORKS

Integrated circuit *IC1* in Fig. 1 is a dual inverting buffer. Each input has two outputs, one low- and the other high-level. The low-level outputs are cross-coupled to each buffer input through capacitors *C1* and *C2* and charging resistors *R1* and *R2* to form an astable multivibrator.

One high-level output is tied to level control *R3* and AUDIO jack *J1* as a 1000-Hz signal. Internal isolation between low- and high-level outputs prevents heavy loads—or even short circuits—from stalling or radically shifting the operating frequency of the multivibrator.

Capacitor *C3* couples only the high-frequency energy (derived from the harmonic-rich leading edges of the square waves generated by the multivibrator) of the audio waveform to RF jack *J2*. At *J2*, there is available a series of impulses that can be used for signal injection and other AM radio receiver work.

cell holder. However, if you plan to use another type of d.c. supply (see sidebar), make the hookup wires connected to *S1* and ground on the circuit board as long as necessary.

How To Use. To test the IC Signal Injector, close *S1* and connect a small 3.2- or 8-ohm loudspeaker to the AUDIO jack on the front panel. Rotate LEVEL control fully clockwise; you should hear a 1000-Hz tone coming from the speaker. An

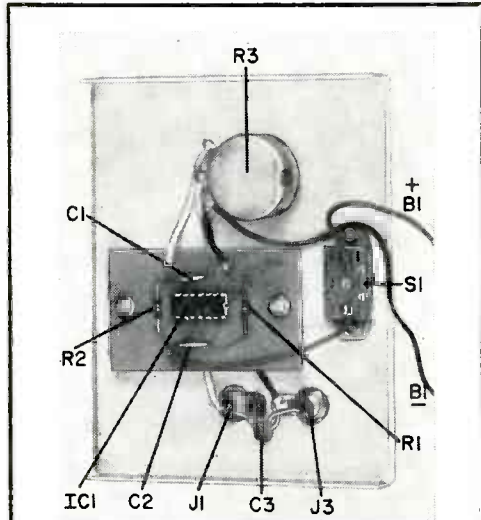

Fig. 9. Pay particular attention to location of notch on *IC1* during assembly of project. Mount *C3* between *J1* and *J2*.

alternate test method would be to connect the audio output of the injector to an audio system, setting the LEVEL control as needed, and listen for the tone.

The output from the RF jack on the injector is rich in harmonics to allow the checkout of the front ends in most receivers, including those that operate in the standard AM broadcast spectrum. For example, assume you want to troubleshoot a faulty AM transistor radio receiver. First check the receiver's battery under load with a voltmeter. If it checks out good, proceed to your signal injection tests:

First inject the audio signal into the speaker, directly across the speaker terminals. If you hear the tone, the speaker is in operating order. Then, stage by stage, work back toward the front end of the receiver until the signal ceases to be heard from the receiver, at which time you will have located the faulty stage. (Note: when injecting into the audio circuits, use the audio output; for the i.f. and r.f. stages, use the r.f. output.) You should end up at the antenna input if the receiver is in perfect operating order.

If you wish to change the audio frequency of the tone, you can change the values of *C1* and *C2*. Higher capacitance values decrease the signal frequency, and vice versa.

Current drain for the IC Signal Injector is on the order of 80 mA at 3 volts d.c., assuring long life from a battery supply, especially if you use heavy-duty alkaline cells. If you prefer a built-in power supply, however, you can build your own by referring to the schematic diagram shown in box above. Or, you can use any good bench supply capable of delivering 1.6 to 6 volts d.c. at about 100 mA for full-load operation.

THE SHIFT REGISTER

HAVE YOU EVER wondered how computers and electronic calculators perform arithmetic operations, or how they

move data and numbers about? A unique circuit known as a "shift register" is responsible for these operations. The shift register is an electronic device that stores numbers, commands, words or locations when programmed to do so. Later, it "plays back" the stored information, either all at once or bit by bit until the register is empty or is back where it started from.

If you would like to experiment with the shift register, you can make one of your own at very little cost, using the instructions provided here. Your project can then be used as an entry in a science fair, a teaching aid, or simply as an interesting device for studying digital integrated circuits and computer logic.

This shift register employs three IC's and four transistors, arranged to form a "four-bit, serial-in/serial-out parallel-read" system. The functions provided are *enter*, *recirculate*, *compliment*, *shift*, and *clear*. The same project also demonstrates "walking ring counters" and "disallowed subroutines."

Shift Registers in General. Almost all digital computers and computer circuits are made up of simple elements that can have only two states: *on* and *off*, voltage and no voltage, or, most commonly, 1 and 0. The 1 or 0 represented at any time in a single element is called a *bit* (for binary digit). A string of related bits is a *word* (sometimes referred to as a *byte*). A word can represent a number (in binary, octal, binary coded decimal, decimal, or any other coding system), an address (a specific location or element in the machine), or an instruction (such as a "multiply" command).

A computer or calculator gets its words from a program on tape, cards, discs, drums, or a programmer (the person operating the computer). It then stores all the words it needs and later manipulates them as instructed.

The length of a word is simply the number of bits required to make up the word. The longer the word, the more accurate it can be. For example, for six-place accuracy using binary coded decimal (BCD) numbering, 25 bits are needed in each word.

The words are often stored in shift registers. A shift register comprises a number of stages, each of which can store one

HOW THE SHIFT REGISTER WORKS

CLEAR: With the clear command fed in, the register automatically resets to indicate 0000, regardless of the previous states. This operation empties the register, preparing it for its next use.

ENTER: The register places a selected 1 or 0 into the first stage on a shift command. All other 1's and 0's in the register then move one stage to the right. This is how a register is "filled" or "loaded."

```
Start with 0000
Enter a 1 1000
Enter a 1 1100
Enter a 0 0110
Enter a 0 0011
```

With each digit entry, a shift command must be initiated.

RECIRCULATE: The register shifts the word one stage to the right with each command received, with the last stage passing its 0 or 1 back to the first stage. This condition "marches" out a word bit by bit for outside use. When finished, the word ends up in its initial position if you shift exactly the number of stages in the register. This is how a word can be used but still retained.

```
Start with 0011
Shift to get 1001
Shift to get 1100
Shift to get 0110
Shift to get 0011
```

The binary word has gone "once around," one bit at a time appearing at the farthest right stage for outside use.

COMPLIMENT: This is a "trick" that is sometimes used to change a register into a counter. To compliment a register, the opposite of what is in the last stage gets passed back to the first stage, with all other stages passing their 0 or 1 one position to the right as usual. Eight shift commands are required to get the register back to where it started in a four-stage register.

```
Start with 0011
Shift for 0001
Shift for 0000
Shift for 1000
Shift for 1100
Shift for 1110
Shift for 1111
Shift for 0111
Shift for 0011
```

At this point, the register is back to where it started, taking eight shift commands to get it there. Hence, a divide-by-eight counter, called a "walking ring counter," is obtained.

bit; 25 stages are needed to store a 25-bit word, and so on. There are several ways to get information into and out of a shift register, and there are several types of shift registers. For those of interest here, information is put in and taken out one bit at a time. This type is known as a "serial-in/serial-out" register.

The *shift* operation takes place when it is desired to move the stored word. On a shift command, every bit moves one—and only one—element to the right as the first element accepts a new bit from outside. (The sidebar on page 99 summarizes how this operation takes place.) The input can be an outside *enter* command, or the output *recirculated*, or the opposite of the output known as the *complement* for special counter circuits.

Some shift registers, including this one, also have provision for a *clear* instruction that puts all 0's in the register.

A shift register can be built with a train of conventional JK clocked flip-flops as shown in Fig. 10. Assuming that a *clear* command is first fed into the circuit, all stages are reset to a 0 condition. Upon receipt of a *shift* command, each stage passes its 0 one stage to the right, and the first stage accepts a new input.

Shift registers are then a means of accepting, storing, and later providing digital words when given the proper commands. In the *recirculate* mode, a shift register can march its word around bit by bit, produce one bit at a time as an output, and end up with the word right back where it started, ready for another use.

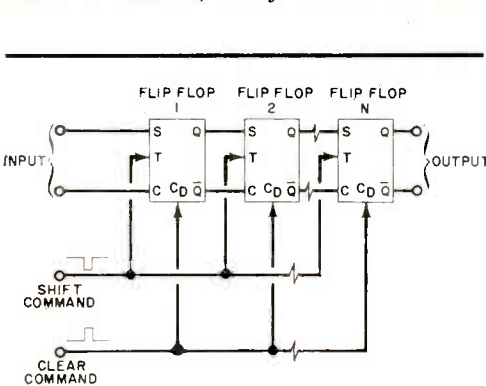

Fig. 10. Shift register is basically string of JK flip-flops connected in cascade. Any number of JK flip-flops can be connected in the manner shown.

PARTS LIST

- C1—0.1- μ f disc capacitor
 - C2—100- μ F, 6-volt electrolytic capacitor
 - I1-I4—X-1490 panel lamp
 - IC1—Dual two-input gate integrated circuit (Fairchild μ L914)
 - IC2, IC3—Dual JK flip-flop integrated circuit (Motorola MC7901)
 - Q1-Q4—2N4400 transistor (or Motorola MPS6554)
 - R1-R6—470-ohm, $\frac{1}{4}$ -watt resistor
 - S1—S.p.s.t. slide switch
 - S2—S.p.s.t. normally-open snap-action pushbutton switch
 - S3—Dual s.p.s.t. snap-action pushbutton switch; one pair of normally closed, other pair of normally open contacts
 - S4—Two-pole, three-position non-shorting rotary switch (Mallory No. 3223J)
 - S5—D.p.d.t. slide switch
 - Misc.—Printed circuit board (see text); dialplate: $3\frac{1}{2}$ " x 4" x 5" case; $\frac{3}{4}$ " metal or fiber spacers (3); $\frac{3}{8}$ "-inner diameter rubber grommets for mounting lamps on front panel (4); #24 insulated wire for circuit board jumpers; control knob; \approx 6 hardware; hookup wire; solder; etc.
- Note—A metal photo aluminum dial plate is available for \$3 postpaid in U.S. from Reill's Photo Finishing, 4627 N. 11 St., Phoenix, AZ 85014. The following items are available from Southwest Technical Products Corp., 219 W. Rhoads, San Antonio, TX 78216: Etched and drilled printed circuit board, \approx 172c, \$1.90; complete kit of parts including prepunched vinyl-clad case and dialplate, \approx 172c, \$9.75 postpaid in U.S.

How It Works. Four JK flip-flops, IC2 and IC3 in Fig. 11, are used as the storage elements. These flip-flops are cascaded, with the first stage being driven from a source selected by switch S4. The source of the input data can be from switch S5 (*enter*), the output (*recirculate*), or the opposite of the output (*complement*).

A shift command is delivered to the toggle, or T, input of each stage from the bounceless pushbutton circuit made up of IC1 and S3, which moves each bit one stage to the right for each shift command received. The clear operation is accomplished when S2 delivers a positive voltage to the CD input of each stage, forcing the register into the 0000 condition.

The condition or state of each stage is indicated by lamps I1-I4. A lighted lamp indicates a "1" state, while an extinguished lamp indicates a "0" state.

Construction. A printed circuit board is a must for this project. The PC board can be purchased, etched and drilled (see Parts List), or you can make your own by following the actual size etching guide provided in Fig. 12.

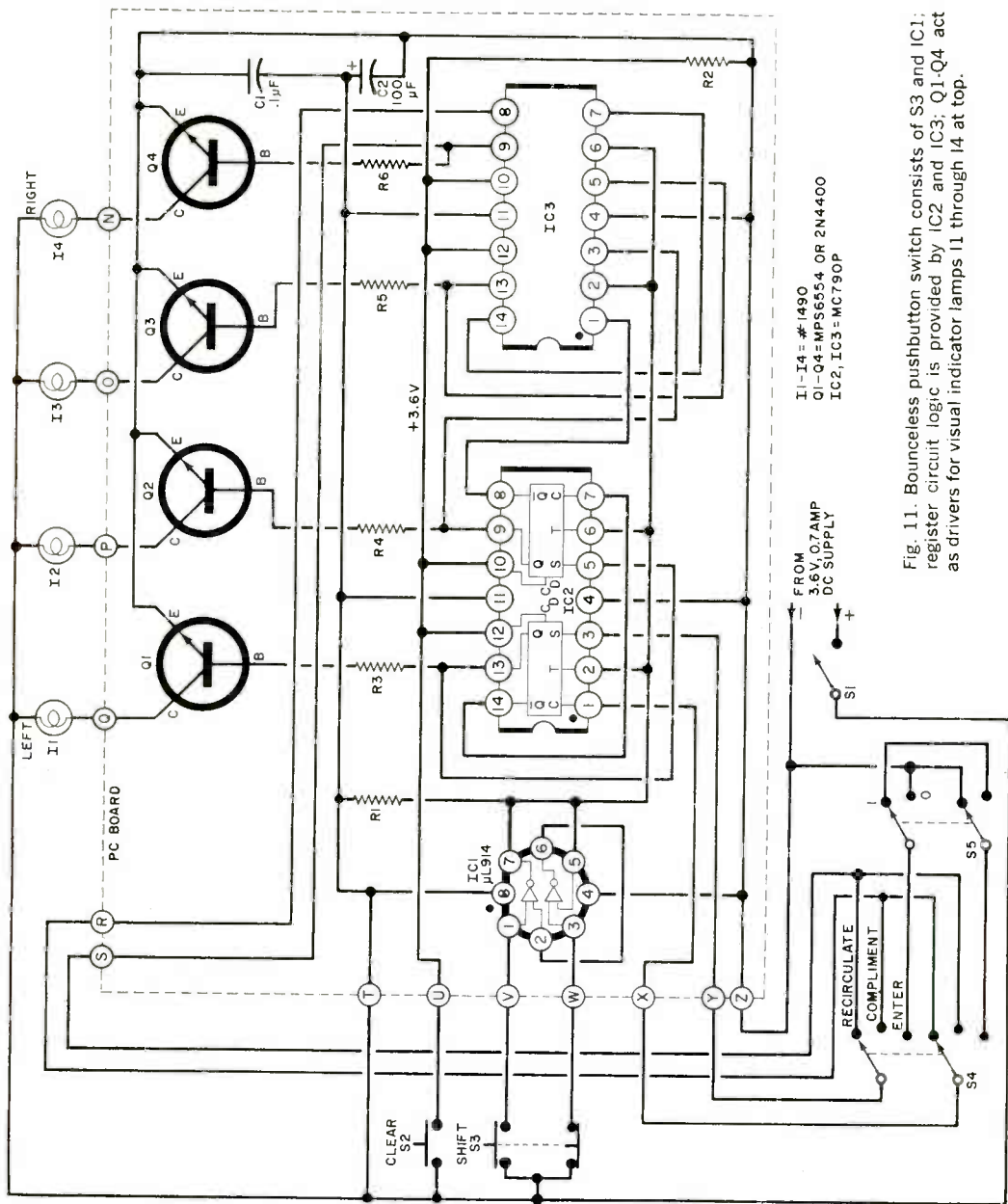

Fig. 11. Bounceless pushbutton switch consists of S3 and IC1; register circuit logic is provided by IC2 and IC3; Q1-Q4 act as drivers for visual indicator lamps I1 through I4 at top.

Component placement on the circuit board is shown in Fig. 13. When mounting components on the board, notice that IC1 is identified by a flat and color dot near lead 8, while IC2 and IC3 are identified by a dot-and-code notch. Also take careful

note of the lead orientations of transistors Q1-Q4. Use fine-grade solder and a small pencil soldering iron. The lamps mount on the dialplate by press fitting them into 3/8" rubber grommets as shown in Fig. 13. The hookup

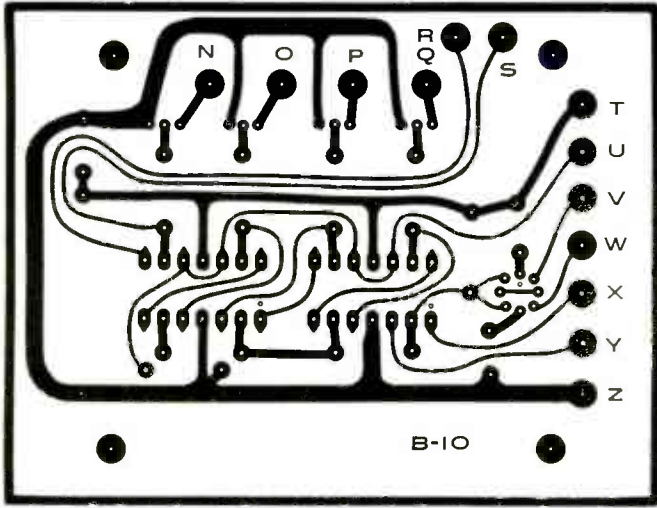

Fig. 12. In actual size printed circuit board etching guide, lettered contacts indicate off-the-board component connections.

wires are soldered directly to the contacts on the lamps, saving the price of individual lamp sockets. Next, the circuit board mounts on the front panel with the aid of three spacers. (Note: bend the lugs of *S*₄ so that they do not interfere with or touch the circuit board.

Once the components are mounted on the front panel and the circuit board is in place, interconnect with hookup wire, re-

ferring back to Fig. 11 as needed. Then mount the assembly in the vinyl-clad metal box provided with the kit of parts, or mount it in an aluminum utility box with dimensions at least 5" × 4" × 3½", and construction is complete.

When using the shift register, bear in mind that the circuit requires 3.6 volts at 700 mA, with less than 700 mV of ripple peak-to-peak.

-30-

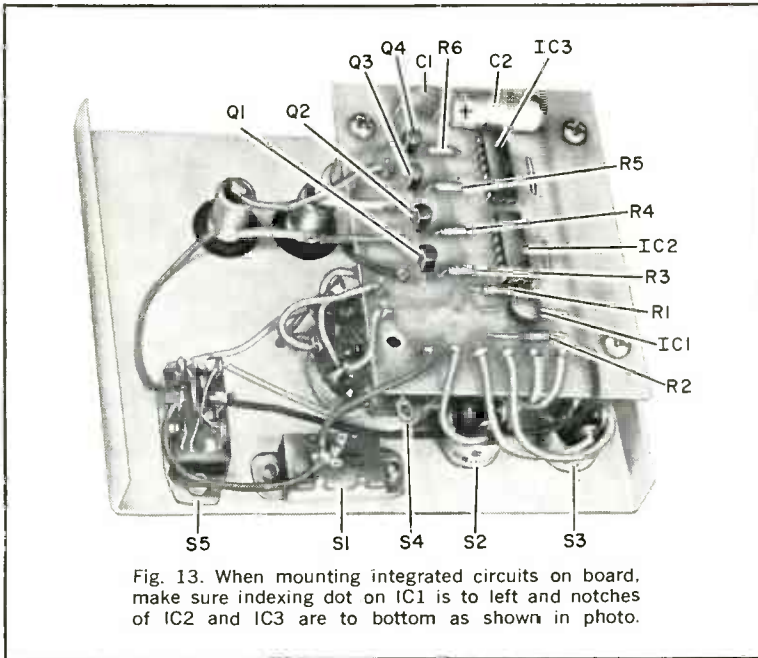
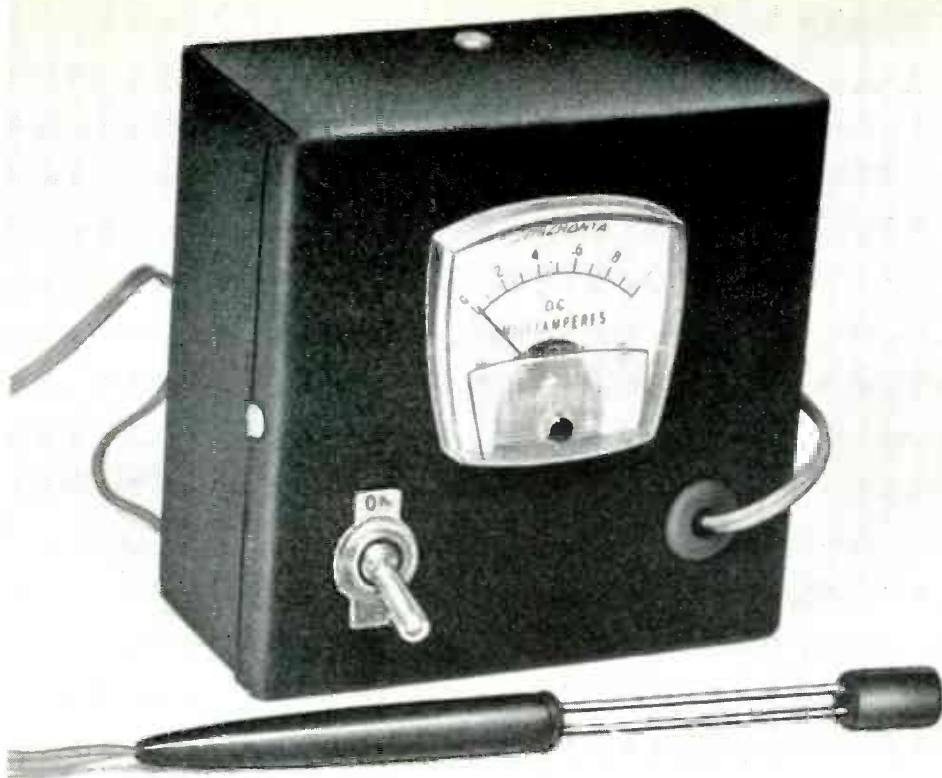

Fig. 13. When mounting integrated circuits on board, make sure indexing dot on IC1 is to left and notches of IC2 and IC3 are to bottom as shown in photo.



BUILD A PHOTOGRAPHIC WASH TESTER

FOR BETTER DEVELOPING AND PRINTING

BY ANDRE BROSNAK

AFTER a hypo bath, photographic film and paper require a thorough wash in running water to remove any residual sodium thiosulfate (the hypo chemical). There are several ways of checking the wash water to make sure that the cleansing process is complete. Some of these are complicated and some are too expensive; but now you can build your own photographic wash tester which gives good indication of the amount of hypo left in the wash water, at a cost of only \$8 or less.

The principle of the wash tester's operation is simple and is based on the fact that the electrical conductance of the wash water increases with increasing strength of hypo in the wash. A comparison of meter readings for the wash water and for plain tap water enables the photography buff to determine exactly when the wash is complete.

The circuit (see Fig. 1) of the photo-

graphic wash tester is very simple, consisting of a series circuit loop. It is self-powered by battery *B1*. Power is applied and removed by switch *S1*. Meter *M1* is the visual indicator, and resistor *R1* is used to limit the flow of current around the loop to a safe value.

When the probe is immersed in the wash and *S1* is closed, *M1*'s pointer will deflect upscale by an amount proportional to the amount of hypo solution in the bath. If the hypo concentration is high, the pointer deflects to a high upscale position. As the solution becomes less and less concentrated, the meter pointer will move downscale until it reaches the preset reference.

The first step in assembling the wash tester is to machine the chassis box. Then mount the meter movement, power switch, terminal strip, battery holder, and rubber grommet as shown in Fig. 2.

Referring to Fig. 1, wire together the

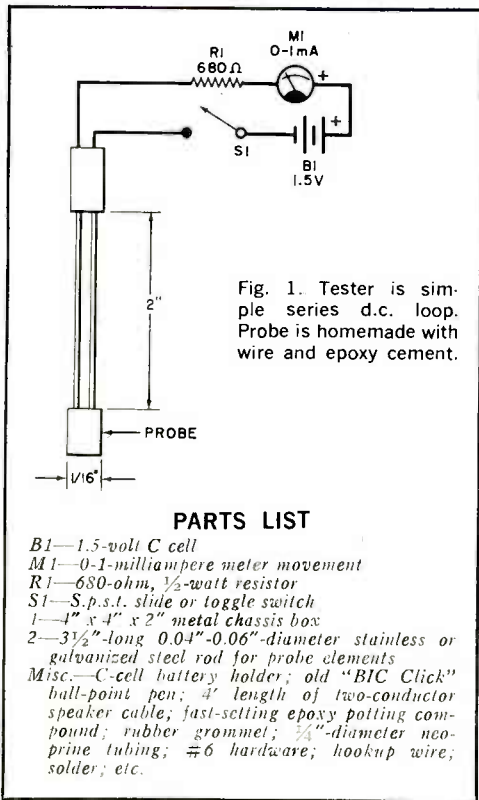

PARTS LIST

- B1—1.5-volt C cell
- M1—0-1-milliampere meter movement
- R1—680-ohm, 1/2-watt resistor
- S1—S.p.s.t. slide or toggle switch
- 1—4" x 4" x 2" metal chassis box
- 2—3 1/2"-long 0.04"-0.06"-diameter stainless or galvanized steel rod for probe elements
- Misc.—C-cell battery holder; old "BIC Click" ball-point pen; 4' length of two-conductor speaker cable; fast-setting epoxy potting compound; rubber grommet; 1/4"-diameter neoprene tubing; #6 hardware; hookup wire; solder; etc.



Taped-end neoprene tubing serves as the form when assembling the probe elements with hard-set epoxy.

the 3 1/2"-long sensor rods (see Parts List) into the tubing, keeping them spaced 1/16" apart. Pour epoxy potting compound into the tubing and allow sufficient time for the compound to set. Then peel off the neoprene tubing.

Solder one end of a two-conductor cable to the free ends of the sensor rods. Seal this end of the sensor assembly with epoxy potting compound as described above.

Remove and discard the ink cartridge, return spring, operating button, and bottom half of an old ballpoint pen. Feed the free end of the two-conductor cable through the top half of the pen shell, and epoxy cement the sensor probe element assembly to the shell.

Finally, connect the free ends of the sensor cable to the appropriate points in the circuit. Assemble the chassis box, and the tester is ready to use.

To use the wash tester, first immerse the sensor probe in plain tap water. Set power switch S1 to the ON position. Wait about 45 seconds, and mark the position on the meter face where the pointer comes to rest. The mark represents the reference point for your tests.

Now, as you use the tester to monitor your wash, continue to wash the film or paper with the probe immersed in the wash water until the meter pointer deflects to your mark. At this point, the wash will be complete, and you can proceed to the next step in your processing.

chassis mounted components. Make sure that no component interferes with the others and that the meter movement is connected with the proper polarity.

Next, assemble the sensor probe as follows. Cut a 1/2" length of 1/4"-inner-diameter neoprene tubing to size. Seal one end with masking tape. Then insert

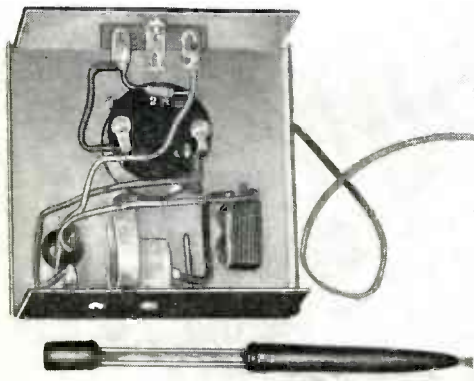

Fig. 2. Neat, open layout is facilitated by simplicity of circuit. Batteries are at bottom of case.



WORLD'S BRIGHTEST INCANDESCENT LAMP FLASHER

BY THOMAS COUCH

FLASHING LIGHT systems are one of the most popular types of projects found in electronics experimenters' publications. But wait a minute! No matter how many flashers you may have seen or built, you are in for a surprise when you build the "Super Flash". It uses only a 117-volt, 6-watt lamp, but the amount of light emitted is practically blinding! In fact, an ordinary D26 Christmas-tree lamp was found to deliver slightly more than 500 foot candles in one flash. Because of this extreme brightness, it is recommended that the Super Flash *not* be used indoors where a person might stare at it at close range.

Although this new approach to flashers was designed for use with a disabled vehicle on a dark roadway, it can also be used as a boat light, a pier or dock indicator, or a sure-to-be-seen obstruction light.

Construction. The circuit for the Super Flash is shown in Fig. 1. The prototype was built in a 5" × 4" × 3" metal enclosure, though any type of construction can be used. If you use the metal enclosure, drill a hole in one end large enough to accommodate the two-pin bayonet socket. If you are going to use the Fresnel lens, also drill the four holes required to mount the lens retainer ring.

The two power transistors are mounted in sockets, each socket supported by a pair of insulated standoffs. The two sockets and the transformer are mounted on one long wall as shown in the photograph. Arrange the sockets so that the terminals are facing you and are accessible.

The dual potentiometers, along with a two-lug terminal strip (non-grounded) are mounted on the other half of the chassis. Arrange these parts so that,

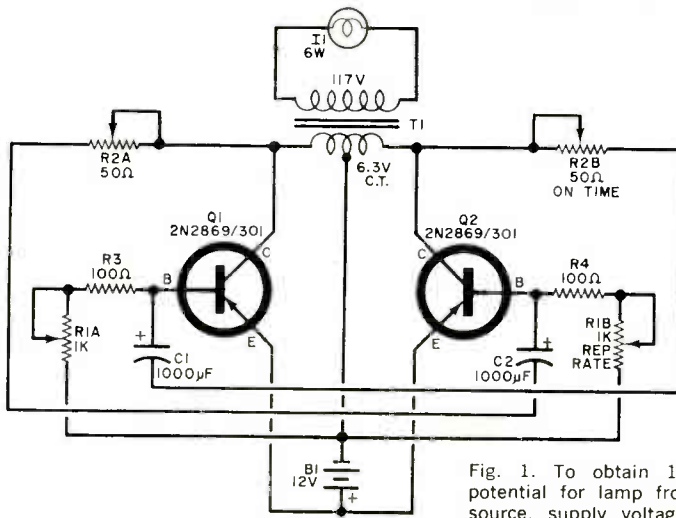

Fig. 1. To obtain 117-volt driving potential for lamp from 12-volt d.c. source, supply voltage is converted to a.c. via oscillator and stepped up.

PARTS LIST

- C1,C2—1000- μ F, 50-volt electrolytic capacitor
 I1—117-volt, 6-watt incandescent lamp. Chicago
 Miniature 6S6, or similar
 Q1,Q2—2N2869/301 power transistor
 R1—1000-ohm, linear-taper, dual potentiometer
 R2—50-ohm, linear-taper, dual potentiometer
 R3,R4—100-ohm, 1-watt resistor
 T1—Filament transformer, 117-volt primary,
 6.3-volt, 1.5-amp CT secondary (Chicago
 Stancor P-3064 or similar)

Misc.—5" x 4" x 3" metal enclosure, 2-pin bayonet socket, power transistor socket (2), insulated standoff with mounting hardware (4), terminal strip, length of twin-conductor lead with cigarette-lighter attachment, Fresnel lens (optional).

Note—A clear Fresnel lens, with gasket and retaining ring, is available at #2826 for \$5.00 from Gordon S. Anderson, Mfg. Co., Mabbittsville County Rd., RD #1, Millbrook, NY 12545.

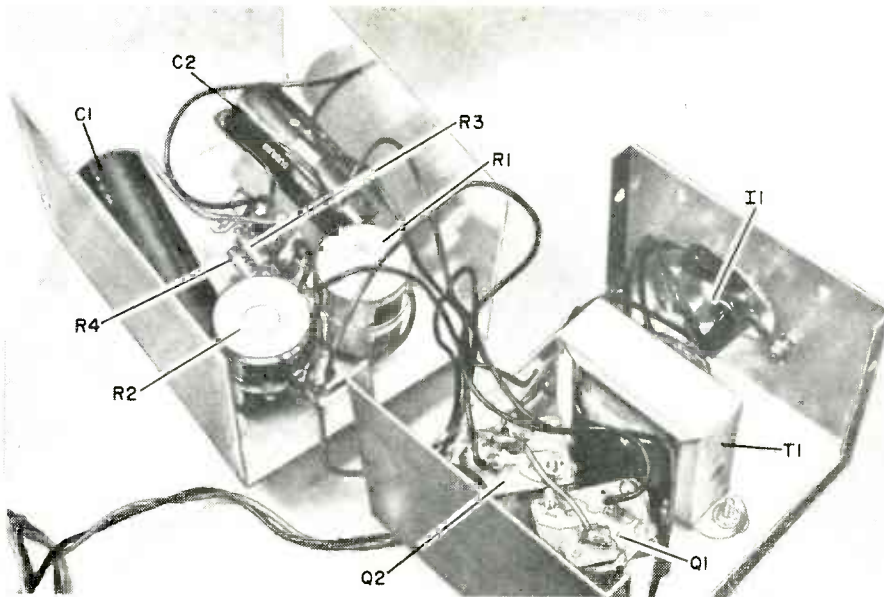

Due to simplicity of circuit, point-to-point wiring, using stranded hookup wire, is best for assembling project. Mount controls on front, lamp and lens assembly to top of chassis box.

With aid of standard phenolic sockets and insulated spacers, mount transistors to rear of chassis below transformer T1 as shown.

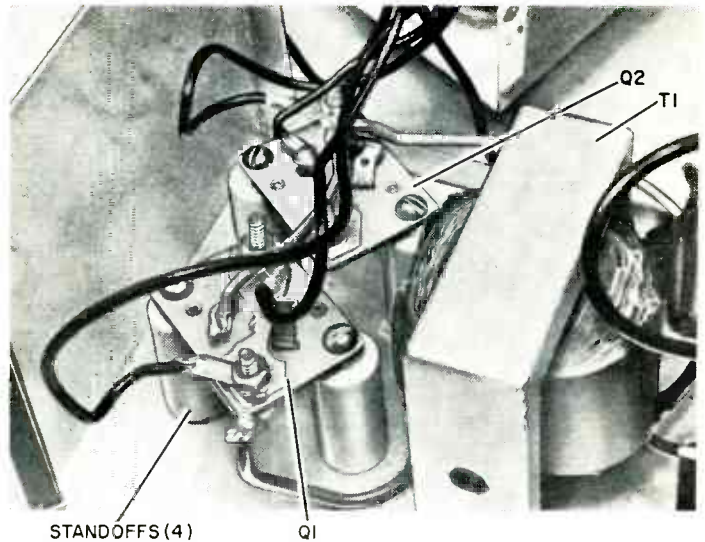

The Fresnel lens assembly bolts to the top of the chassis box with four sets of #6 machine hardware.

when the two halves of the metal enclosure are fitted together, the potentiometer metal shells do not contact the transistor socket terminals.

Once these parts have been assembled, wire the circuit in accordance with Fig. 1. Note that *T1* is wired "backwards." That is, the center-tapped low-voltage winding is used as the primary, while the 117-volt winding is used as the secondary. To avoid component damage, make sure that no part of the electrical circuit is connected to the metal chassis.

Power for the Super Flash is obtained from an external 12-volt vehicle battery capable of delivering 2 amperes. A length of two-conductor cable is terminated in a conventional cigarette-lighter plug. Be sure that the proper connections are made to the plug. On a negative-ground vehicle system, the center pole of the cigarette lighter is positive.

If you want to test the flasher on your workbench, use a low-impedance 12-volt d.c. power supply capable of delivering 2 amperes.

Insert the 6-watt lamp in the socket and mount the Fresnel lens. Do not use a lamp with a power rating any higher than 6 or 7 watts as the load may keep the circuit from oscillating.

With the lamp installed, connect up the power. Do not stare at the lamp when it is operating as a very bright flash of light
(Continued on page 145)



BUILD

Dynamic Diode Tester

SORTING OUT THOSE UNIDENTIFIED DIODES

BY CHARLES L. ANDREW

TAKE A QUICK LOOK in your electronics storage cabinet. Got some diodes there that you can't readily identify? Are they signal diodes, rectifiers, or zeners? Silicon or germanium? Which end is which? Many of these questions can be answered by the "Dynamic Diode Tester." The Tester is easily built and works in conjunction with an oscilloscope to identify clearly all your diodes as well as many other types of semiconductors. It will even test capacitors and light-sensitive devices for certain characteristics.

As the schematic in Fig. 1 shows, the Tester is very simple. To use it, all you have to do is attach it to your scope, plug a diode into the test terminals, manipulate a knob and a pushbutton, and the diode characteristics are clearly displayed on the CRT screen.

About the Circuit. The a.c. voltage applied to the device to be tested is deter-

mined by potentiometer *R1*, while resistor *R2* limits the applied current to a safe value. Resistor *R3* acts as a shunt to provide the vertical input to the scope. Thus the voltage across the device is applied to the horizontal terminals and the current to the vertical terminals; and the VI characteristic is displayed on the screen.

For best results, a d.c. scope should be used. With an a.c. scope, the display is usable, but it may shift as *R1* is adjusted.

Diode *D1* is used to determine whether or not the test diode is properly connected to the test terminals. It is normally shorted out by pushbutton *S2*.

Construction. The prototype Tester was built in a 5" × 2½" × 1½" plastic box with a metal cover as shown in the photos. All components were mounted on the metal cover, with *R2* and *R3* wired point-to-point to the proper locations. Any

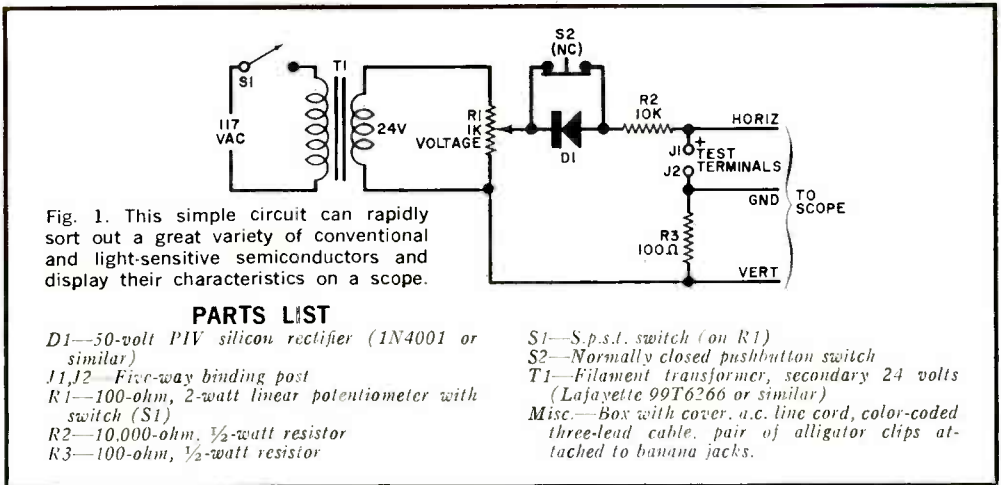

other type of construction may be used. A short length of color-coded, three-wire cable is used to make connections to the scope terminals.

Operation. Connect the three leads from the tester to the proper terminals on the scope. Then set the scope horizontal input to the "external input" position. With *R1* at a minimum, center the dot on the CRT screen.

In all cases, an open circuit between

the test terminals is indicated by a horizontal line on the scope, while a short circuit shows up as a vertical line. In either case, the length of the line is determined by the setting of *R1*.

Connect a rectifier diode that is known to be good to the Tester terminals without regard for the polarity. Observe the scope as *R1* is slowly adjusted to give a higher applied voltage. The dot should slowly extend into a short horizontal line (adjust the scope horizontal gain if nec-

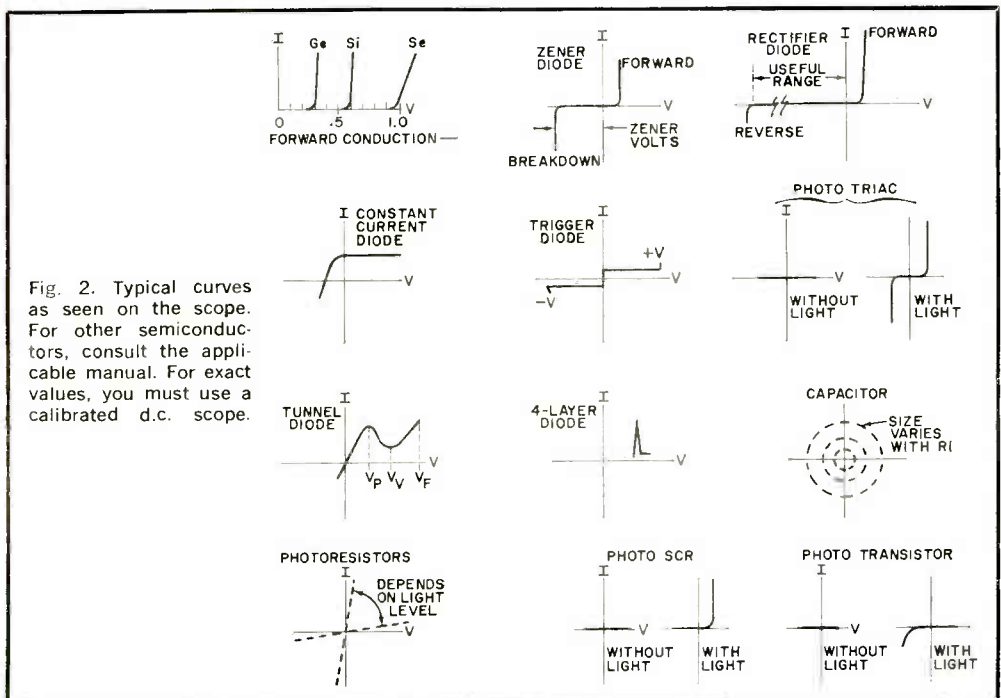

essary); and then the trace should suddenly take a sharp 90° vertical turn. This is the forward conduction curve and it should be on the upper right-hand side of the display. If it is, the diode lead connected to the positive terminal on the tester is the cathode. If the vertical portion is on the lower left portion of the trace, going down, reverse the diode. To check that you are observing the forward conduction curve, depress *S2* and note that the vertical trace remains while the horizontal trace disappears. If the diode is connected backwards, the horizontal trace remains and the short vertical trace disappears.

Advance voltage control *R1* and note the reverse conduction, if any. In case of a zener diode, for example, as *R1* is advanced, there will be a sudden drop in the trace at the zener voltage point, creating a step-like curve. In the case of most power rectifiers, the tester may not have enough voltage to produce the reverse breakdown.

Calibration. The Tester was designed primarily as a simple means of identification. To obtain rating information, you must have a d.c.-coupled scope and calibrate its horizontal axis by applying known voltages to the horizontal input and adjusting the gain control of the Tester to obtain a specific number of volts per division. Once this has been done, do not reset the gain control or calibration will be destroyed. Since most forward conduction values will not exceed about one volt, it is best to set the scope dot to the right side of the screen.

Since the Tester provides only 24 volts r.m.s., the reverse breakdown voltage of most rectifiers is not reached. If you

The complete tester is assembled on the metal cover of the plastic cabinet. Point-to-point wiring is used and a three-conductor cable connects to scope.

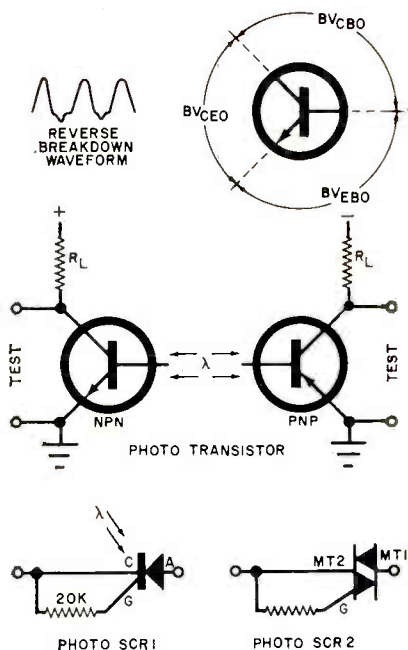
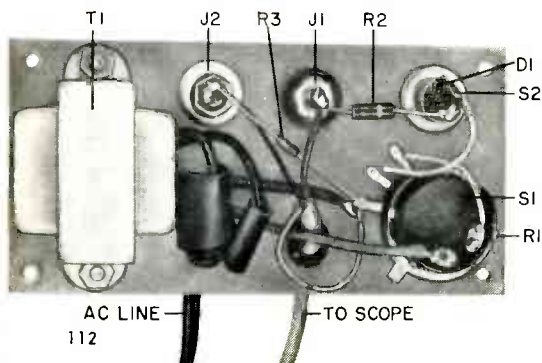

Fig. 3. Reverse breakdown of transistors can be determined, as well as the operation of several types of light-sensitive semiconductors. The two circuits at the bottom show how to wire these semiconductors.

want to know the exact value of reverse breakdown, the secondary voltage value of *T1* must be increased.

Some typical curves for common semiconductors are shown in Fig. 2. No current or voltage values are given except for those that are used to identify the semiconductor itself. Note that capacitors can be tested for condition—not for value—by obtaining a circle on the scope. The size of the circle is determined by the setting of *R1*. Voltage-current curves for other devices may be obtained from various handbooks.

Breakdown voltages of transistors may be determined as shown in Fig. 3. Set the scope sweep so that it displays two or three 60-Hz sine waves (when such a signal is applied to the vertical input). With the transistor properly connected, increasing *R1* will produce a half sine wave. A further increase in *R1* produces a small negative bump, indicating reverse breakdown. (The transistor is not damaged by this test.) The a.c. voltage (peak) is then measured to determine the breakdown value. Remember that the maximum voltage is 24 volts r.m.s. so some transistors will not show the reverse breakdown.



AUTOMATIC LIGHTNING PROTECTION

DON'T *zap* YOUR ANTENNA SYSTEM

BY HOWARD PHILLIPS

MOST HAMS FORGET, on occasion, to ground their antennas—or never even bother to provide a grounding facility—when they are not operating their rigs. These oversights or lack of foresight can have grave consequences before or during an electrical storm, causing a lot of good equipment to go up in smoke. There is no substitute for connecting an antenna to the earth ground common to the communications equipment for good protection against lightning damage.

Regardless of the quality of your present antenna grounding system, the automatic lightning protection system described here can reduce the possibility of your equipment's sustaining serious damage from lightning or static charge

buildup. The operation of the system is automatic in the sense that turning on and off your transceiver is all that is required. So, you cannot forget to ground your antenna, since you are not likely to forget to turn off your transceiver when you are finished using it.

Lightning Effects. There are three basic effects of electrical storm activity that can cause damage to communications equipment.

First is static charge buildup on the antenna. This is not caused by a direct lightning "hit" on the antenna but by the same conditions which produce lightning. Static charge buildup occurs when an ungrounded antenna accumulates a large d.c. charge as a result of its coming

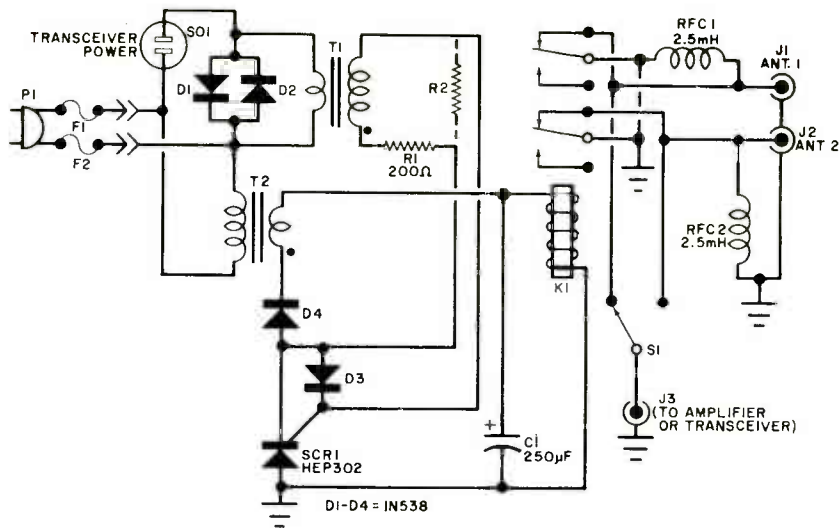

Fig. 1. Lightning protector features switching facilities for two antennas. Use fused plug for supplying power to obtain maximum lightning protection.

PARTS LIST

C1—250- μ F, 50-volt electrolytic capacitor

D1-D4—1N538 diode

F1,F2—250-volt, 5-ampere fuse

J1-J3—Coaxial connector (Amphenol No. SO-239)

K1—9- or 12-volt a.c. or d.c. relay with 250-volt, 5-ampere d.p.d.t. contact arrangement

P1—117-volt fused male plug (fuses F1 and F2)

R1—200-ohm, $\frac{1}{2}$ -watt resistor

R2—Lead resistor (see text)

RFC1,RFC2—2.5-mH, 20-mA radio-frequency choke

S1—S.p.d.t. switch with 250-volt, 5-ampere contacts

SCR1—150 PIV, 3-ampere silicon controlled rectifier (Motorola HEP302 or similar)

SO1—117-volt a.c. chassis-mounting receptacle

T1,T2—24-volt, 1-ampere filament transformer

Misc.—Metal utility box; hookup wire; solder; machine hardware; etc.

in contact with partially ionized air. The charge builds up a high d.c. potential between ground and the ungrounded antenna parts. The damage which can result is caused by over-voltage applied to the transmission line or to components in the front end of a transceiver.

The damage resulting from static buildup can be prevented by grounding all parts of the antenna system either directly or through a radio frequency choke (RFC). The RFC provides a low-resistance discharge path for the d.c. charge but does not affect normal antenna operation. The static charge buildup is greatest during the early stages of a storm, before any rainfall occurs. Consequently, equipment damage can occur before clouds or other storm symptoms appear.

The second effect of an electrical storm

which can cause equipment damage is important when lightning strikes nearby but misses hitting the antenna. In this case, high transient voltages can be induced in the antenna and transmission line. These transient voltages have a short duration but can be the cause of extensive damage due to their r.f. effect. A RFC to ground offers no protection against these r.f. voltage transients. The only effective protection is good, direct earth grounding.

The third and final effect is that of the direct hit by lightning. This, of course, is the most damaging of the effects discussed. A direct earth ground is the best possible protection against the damage to the antenna system caused by a direct hit, but some damage can occur even when the antenna is connected directly to ground.

About The Circuit. Shown in Fig. 1 is the schematic diagram of the automatic lightning protection system. Notice that there is a facility (switch *S1*) to switch into the circuit either of two antennas. Jacks *J1* and *J2* should be r.f. coaxial type connectors.

Radio frequency chokes *RFC1* and *RFC2* provide protection against damage from static charge buildup on either antenna. Relay *K1* shorts both antennas directly to ground when the transceiver, connected to a.c. receptacle *SO1*, is turned off or when a power failure occurs.

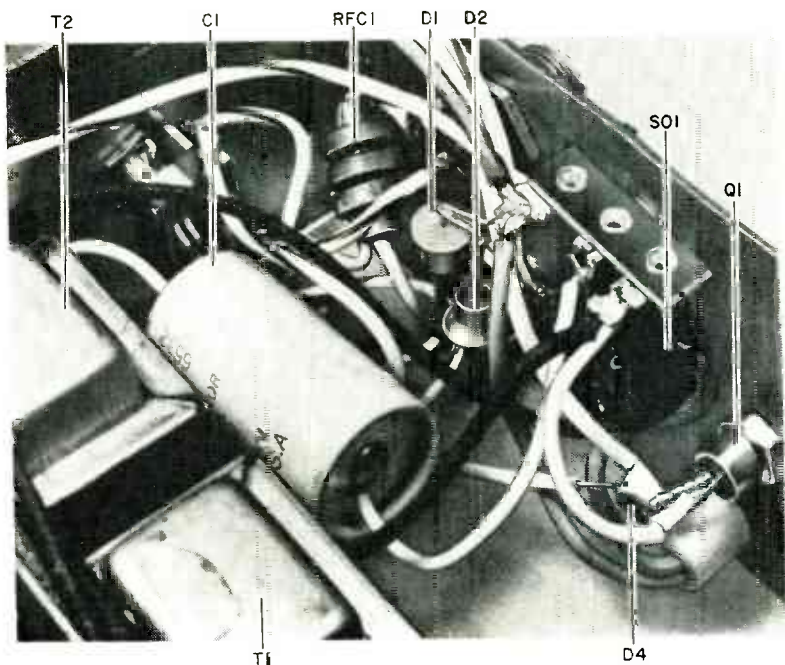
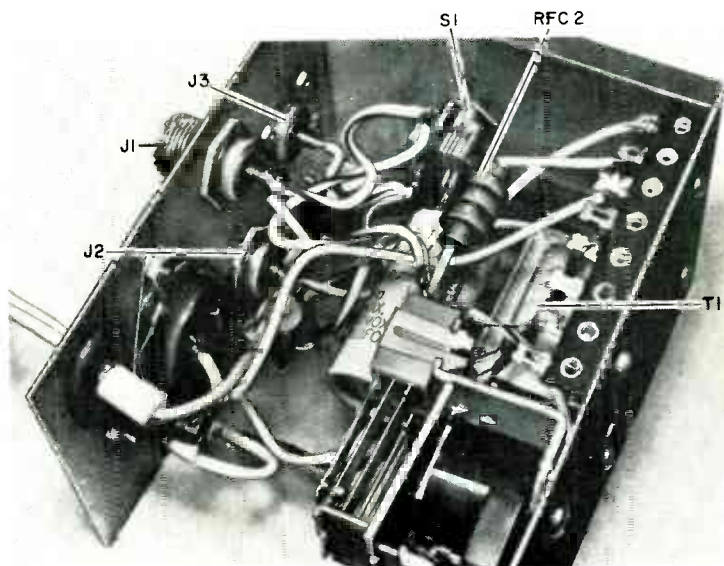

Fig. 2. Component mounting is best accomplished if ends of chassis are bent slightly outward during machining and chassis wiring.



The current threshold detector circuit made up of *D1*, *D2*, and *T1* controls the power delivered to the solenoid of *K1*. The voltage drop across monitoring diodes *D1* and *D2* is on the order of 1.5 volts peak-to-peak and is independent of the power required by the transceiver. The square-wave voltage drop across the diode pair is coupled through transformer *T1* to silicon controlled rectifier *SCR1*.

Resistors *R1* and *R2* form a voltage divider which determines the amplitude of the triggering signal delivered to the gate of *SCR1*. The value of *R2* depends on the sensitivity of *SCR1* and the power required by the transceiver when turned off (some transceivers contain a heating element which operates continuously).

When the transceiver is turned on and the voltage applied to the gate of *SCR1* is sufficient, the SCR turns on and voltage is applied to the coil of *K1* through rectifier diode *D4*. Diode *D3* insures that excessive reverse bias is never applied to the gate of *SCR1*. The transformer phase relationships, indicated by the dots in the schematic diagram, are required to provide d.c. power to *K1*'s solenoid.

The voltage applied to *K1* is half-wave rectified d.c. with some ripple content (*C1* provides filtering). Because of voltage drops across *D4* and *SCR1*, the relay voltage is typically between 5 and 20 volts, depending on the d.c. resistance of the relay coil. Hence, a 9- or 12-volt relay will work well. An a.c. or a d.c. coil can be used, since the ripple content of the voltage is low enough to prevent relay "chatter."

Construction. Component placement in the metal utility box is shown in Fig. 2. To facilitate machining and project assembly, it is suggested that you bend outward the ends of the utility box. Then parts mounting and connection can be quickly accomplished.

Leads carrying r.f. power should be kept as short as possible so that the transmission line standing wave ratio (SWR) will not be adversely affected. Also, the relay should not be mounted too close to the transformers unless the transformers have reasonably good magnetic shielding.

The phasing of the transformers need not be known during assembly since no component damage will result from a

wiring error. If the assembled project will not unground the antennas when transceiver power is turned on, the leads from any pair of the four transformer lead pairs can be reversed to provide proper phasing.

The anode (mounting stud) of *SCR1* is at ground potential in this project to obviate the need for special insulating hardware. A fused power plug is recommended because it provides more protection from damage due to over-voltage which can be caused by a hit by lightning on the power line.

A special note is in order here. The circuit shown schematically in Fig. 1 should first be wired without *R2*. When the turned-off transceiver is plugged into *SO1*, *K1* should not unground the antennas. If it does, a potentiometer can be connected across the secondary of *T1* to determine the value of *R2* required to cause *K1* to trip only when the transceiver is turned on.

Checkout and Use. If both an amplifier and a transceiver are to be used, the amplifier output should be connected to the lightning protector via *J3*. Standing wave ratio measurements should be made with the project in and out of the antenna system to insure that the quality of construction is adequate. There should be no detectable difference between your SWR readings.

The antenna-switching capability of the lightning protector is more than adequate to handle any 1-kW transmitter. With proper construction techniques, the antenna switch can be used to switch any transmitting antenna operating in the frequency range between 3.5 and 30 MHz.

The project provides more than adequate protection against damage from static charge buildup on the antennas, even when the transceiver is switched on. When the transceiver is off, full protection against voltage transients on the antennas is automatically provided and the antennas are automatically grounded via the relay contacts. So some protection—although not complete—against damage caused by direct lightning hits is also provided.

Antenna ungrounding requires 117-volt a.c. line power to trip *K1*. Consequently, a power failure insures that the antenna will automatically be grounded. —30—

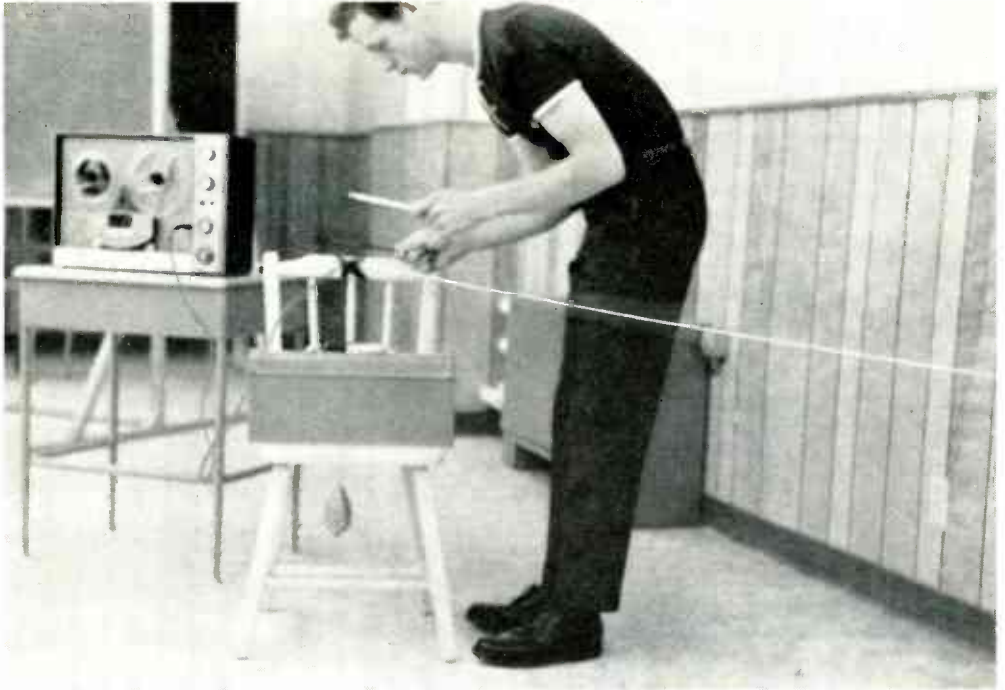

WIRE MUSIC

LATEST THING
ON THE MUSIC SCENE

BY NYLE A. STEINER

WIRE MUSIC! What is it? Well, the sound is like nothing you ever heard before; and the way it's produced is like nothing you ever saw before. Yet, Wire Music is a fascinating way of adding zest and "newness" to your music scene.

Wire Music is the amplified sound picked up from a long (about 30 ft) piece of taut steel wire which is set in vibration in one of a number of ways—plucking, stroking, etc. It may sound crazy but the whole thing is easy and inexpensive to set up; and the result provides a whole new musical experience—one you won't want to miss, even if you're just curious.

The first step in setting up a Wire Music instrument is to wind your own magnetic pickup. Use a small permanent magnet and #30 to 36 enameled copper wire. Fashion a bobbin from two cardboard discs, using the magnet as the

crosspiece and gluing the cardboard in place (see drawings). Then wind the bobbin nearly full with the enameled wire.

Scrape away about $\frac{1}{2}$ " of the enamel on the free ends of the wire, and solder to these wires the conductors of a length of shielded audio cable. Tape insulate the exposed wires and connections, and securely tape the shielded cable to the winding body to provide a strain relief.

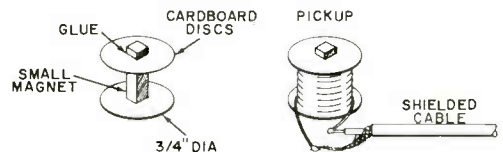

Bond cardboard discs to magnet with epoxy cement. Tape cable to pickup coil winding.

At the other end of the shielded cable, connect a plug that is compatible with the microphone input jack to your tape recorder or amplifier.

The wire which is used to produce the musical sounds should be about #30 steel. (It can be heavier or lighter, depending on the pitch of the sound you wish.) This wire must be magnetic (ferrous) if it is to drive the magnetic pickup effectively. The thin steel wire used in hobby crafts to string Indian beads is an excellent choice.

String this wire between two points that are about 28'-30' apart. Almost any solid supports will do. For example, one

end of the wire can be anchored to a wall-mounted conduit and the other end weighted and hung over the back of a weighted chair. If the wire is hung or wrapped around a metal object, however, be sure to insulate the object with electrical tape to eliminate a sound of static whenever the wire is touched.

Mount the magnetic pickup at the weighted end of the strung wire. Make sure that the magnet core of the pickup is within $\frac{1}{8}$ "- $\frac{3}{16}$ " of the wire.

The tension weight on the wire can be any object weighing several pounds (a single-jack hammer, a power transformer, or even a pail of lead sinkers).

The tension of the wire should be adjusted until it gives a crisp and lively echoing sound when it is plucked. If the tension is too loose, the sound will be "muddy;" if too tight, you run the risk of breaking the wire.

The instrument can produce an astonishing range of sounds, depending on the methods used to play it. The sounds generated range from a compelling, penetrating throb to those of a very subtle nature full of pleasant harmonics.

It would be futile to attempt to enumerate all of the methods of play possible. This is because, like all musical instruments, much depends on the taste and artistry of the performer. However, among the basic approaches you can try are plucking with your fingers to obtain a bright, pulsating echo and using a violin bow to stroke the wire near the pickup to produce a great variety of sounds.

A three cornered file produces a recognizable musical note when one of its corners is struck against the wire. The pitch of the note here will depend on the length of the wire between where it is struck and the pickup. Hence, definite pitches and melodies can be played if the wire is marked at the proper intervals with paint. The file can also be slid up and down the length of the wire for glissando effects. Or it can be rubbed violently across the wire in the same manner as a violin bow to produce a very powerful, penetrating sound.

An amazing new miniature torch brazes, welds, solders and heats with surprising precision. You solder any appliance electrical part. You weld auto parts, braze household devices and toys easily, with professional accuracy, at half the normal cost. The Little Torch welds any size metal from tiny .002" wire to 16 gauge steel. Is economical to use, easy to operate—an invaluable addition to your home and workshop tools. Send for your FREE brochure telling all about the Little Torch, today. Complete the coupon below and mail now. No obligation.

Tescom
CORPORATION

Instrument

2633 S.E. 4th St.
Minneapolis, Minn. 55414

FREE
BROCHURE

Tescom Corporation, 2633 S.E. 4th St.
Mpls., Minn. 55414

Gentlemen: Please forward my FREE brochure telling more about the Little Torch at once. I understand I am not obligated to buy.

Name _____

Address _____

City _____

State _____ Zip Code _____

CIRCLE NO. 16 ON READER SERVICE CARD



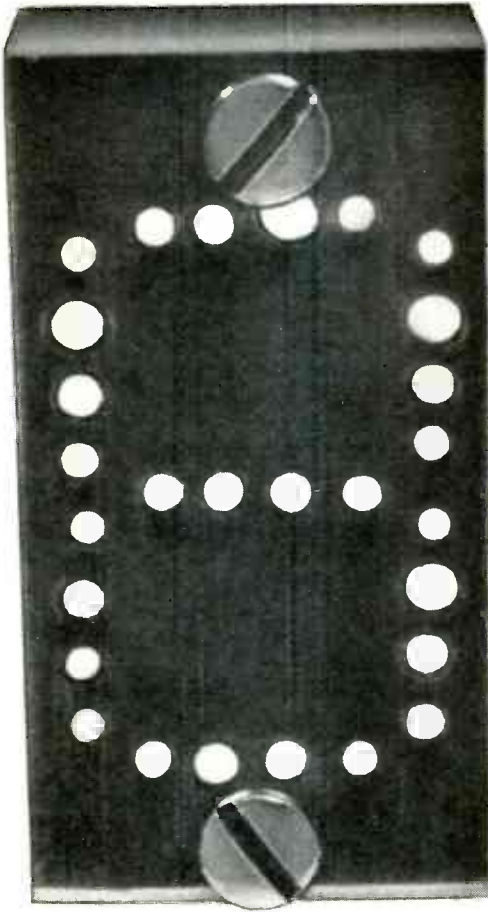

MAKE YOUR OWN Seven Segment Readout

EASY TO CONSTRUCT
AND THEY LOOK GREAT

DIGITAL READOUT devices are becoming ever more popular and everybody has his own idea of what is the best type of readout device—incandescent lamps, Nixie® tubes, Numitrons, 7-segment displays, and so on. The basic simplicity and low cost of the 7-segment display make it particularly popular (see “Third-Generation DCU,” 1970 SPRING EXPERIMENTER’S HANDBOOK) and many experimenters have designed and made their own display units. One such unit is described here. It is easy to construct and, when properly finished off, gives a very professional appearance to your digital readout. All you need is a block of some opaque material, a couple of drill bits, a piece of translucent plastic sheet for the faceplate, and a little time. You can make a single or multiple display.

Construction. If you intend to make more than one readout stage, it is suggested that you make a drilling guide with a hole arrangement like that shown in Fig. 1A. You can use heavy card stock, sheet plastic, or even thin metal for the guide. When making the guide try to keep the hole centers on straight lines and spaced about $\frac{1}{8}$ " apart to produce a neat, symmetrical layout. Note also that hole centers for the optional circuit board and translucent faceplate mounting screws should be shown.

The opaque material can be either Bakelite or aluminum stock (unless you have access to a drill press with a 200 r/min speed, avoid using plastic). Although the Bakelite or aluminum can consist of a solid block, it is better if you use two separate pieces, one measuring $2\frac{1}{2}$ " \times 1" \times $\frac{3}{8}$ " for the light guides

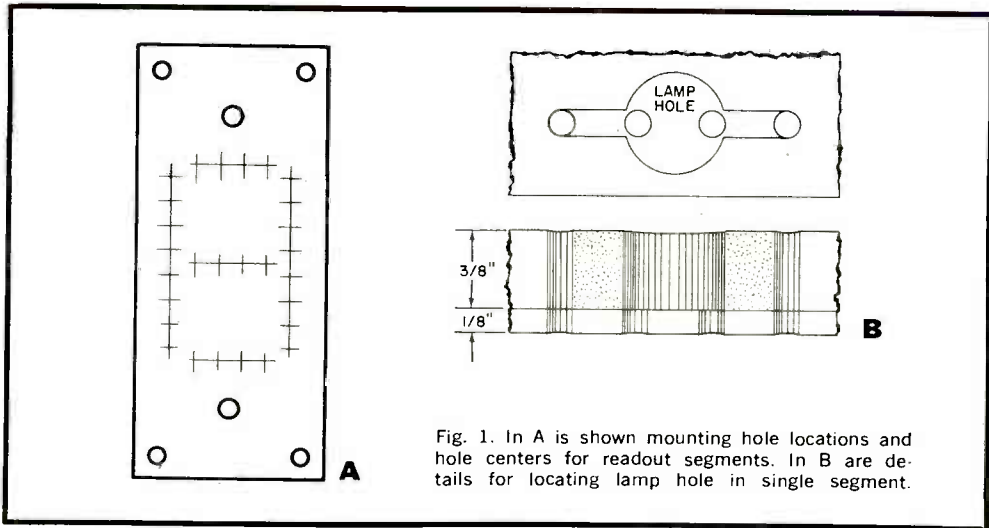

Fig. 1. In A is shown mounting hole locations and hole centers for readout segments. In B are details for locating lamp hole in single segment.

and another measuring $2\frac{1}{2}'' \times 1'' \times \frac{1}{8}''$ for the numeral mask. If more than one readout stage is required, multiply in both cases the 1" dimension by the number of stages desired.

Now, place the two pieces of opaque material squarely together and clamp them solidly in a vise to prevent them from shifting position with respect to each other. Use a file to groove one end of the blocks to serve as guides during assembly.

Working carefully with your drilling guide and a sharp center punch, mark the hole centers for each stage. The 28 holes that make up the seven segments

of each readout and the four circuit board mounting holes should be drilled all the way through both blocks. Use a $\frac{1}{16}''$ drill for the segment holes and a $\frac{1}{8}''$ drill for the mounting holes. Keep all holes as close as possible to right angles to the surface. Countersink the mounting holes.

Loosen the vise and remove the thinner block and temporarily set it aside. Retighten the vise on the thicker block. Use an appropriate size drill to bore the lamp holes through the block (back up the exit hole side of the block with wood to prevent chipping and flaking). There should be exactly seven of these new

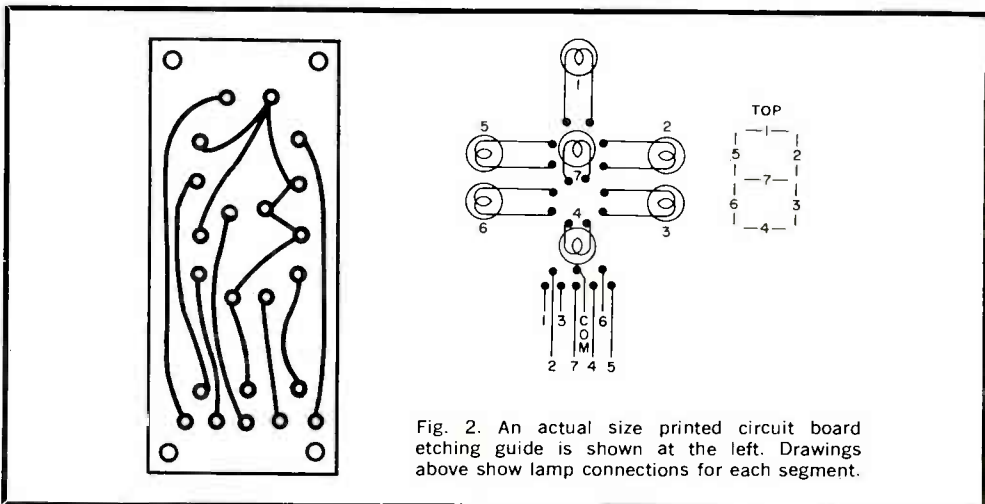

Fig. 2. An actual size printed circuit board etching guide is shown at the left. Drawings above show lamp connections for each segment.

Assembled seven-segment module is shown at right. Note use of metal spacers to support circuit board away from the lamps.



holes per decade, and each should be centered in a grouping of four $\frac{1}{16}$ " holes (see Fig. 1B).

Next, remove the solid material between the unconnected holes. This is best accomplished with the aid of a "saw-type" drill bit or a hacksaw equipped with a tungsten carbide blade.

If you used Bakelite for the blocks, spray a coat or two of metallic aluminum or white paint into the holes of both blocks and the inner surface of the thinner block. If aluminum was used, just spray a coat of velvet black paint on the front surface of the $\frac{1}{8}$ "-thick block. In both cases, when the paint dries, carefully remove any that obstructs the passage of light through the segment holes.

Wiring. To simplify the wiring process, make the optional printed circuit board, using the actual-size etching guide at the left in Fig. 2. The center drawing shows how to wire the lamps to the circuit board and the board to the DCU, while the final drawing shows the numeral segment/lamp layout.

Now, mate the two blocks together, carefully observing your register marks. Then use flat-head machine hardware and spacers of appropriate length to bolt together the blocks and circuit board/lamp assembly.

Mount the translucent faceplate to the front of the assembly. (This faceplate can be homemade from $\frac{1}{16}$ "- $\frac{1}{8}$ "-thick

transparent plexiglass—any color will do, including clear. To make it translucent, rub one surface with No. 00 emery cloth and fine-grade steel wool. This will produce a velvety-smooth finish.) When you mount the faceplate, place the dull side against the numeral mask. —30—

ANOTHER SUPERB VALUE

from **Olson**
Electronics



ONLY
\$12

**DELUXE
TRANSISTOR
CHECKER**

Compact, self-contained, self-powered dynamic transistor checker. Test may be made "in circuit" or out of circuit. Identifies and checks PNP and NPN types, plus power. Complete with instruction manual, service tips and transistor drawings.

Olson Electronics, Dept. SU, 260 S. Forge St.,
Akron, Ohio 44308

- I enclose \$12, plus \$1 for postage and handling. Send me the TE-199 Transistor Checker.
- Send me the next seven issues of the Olson Catalog, without cost or obligation. **FREE**

Name

Address

City

State Zip

CIRCLE NO. 12 ON READER SERVICE CARD

DEHUMMING SMALL RECEIVERS

PERK UP YOUR SHORT-WAVE LISTENING

BY RONALD L. IVES

DO YOU LISTEN to the short-wave bands through a veil of a.c. hum? Such hum troubles are commonly generated in the d.c. power supply. Though a comparative rarity, hum can also originate in the filament circuit. Efficient d.c. filtering and a simple redesign can drastically reduce this a.c. hum to a very low level.

Most power supplies in modestly-priced or inexpensive shortwave receivers use a half-wave rectifier and a "brute-force" filtering circuit. A few receivers do use a full-wave rectifier, but on occasion even these receivers are subject to certain a.c. hum problems.

Troubles in a.c. hum can also be caused by a cold solder connection and before delving into the circuit of the receiver itself, it is always best to check the tubes for heater-to-cathode leakage.

And, while you have the receiver open, carefully inspect underneath the chassis for any evidence of corrosion or leakage around the filter capacitors.

Reducing Rectifier Hum. Hum that can be traced back to the rectifier can be reduced by two expedients. If the receiver is small and inexpensive, the most effective method of reducing the hum is to

replace the half-wave rectifier with a packaged bridge rectifier. The typical half-wave rectifier seen in many low-cost

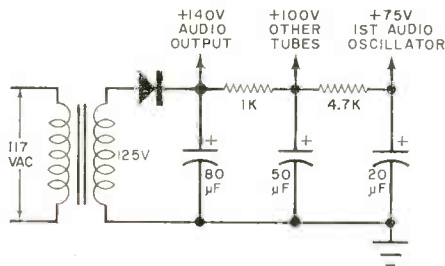

Half-wave rectification and RC filtering are hallmarks of most inexpensive receiver power supplies.

receivers is shown in Fig. 1. The circuit for a modified full-wave bridge rectifier is shown in Fig. 2. Choose the specific rectifier to have a rated input voltage (rms) slightly higher than the nominal output voltage of the power transformer.

This substitution will change the a.c. hum ripple frequency from 60 Hz to 120 Hz and will thereby double the effectiveness of each filter component. Check the results after the substitution and, if the

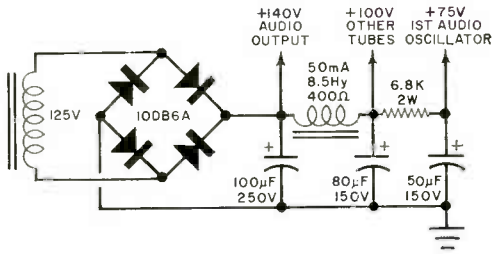

Full-wave bridge rectification and LC filtering remove most of the a.c. ripple from the d.c. output.



Pointer shows filter resistor to be removed and replaced with filter choke mounted to side of chassis.

hum level is now tolerable, the job is done.

Further hum reduction might be obtained by increasing the capacitance of one or all of the active filter elements. Try shunting the electrolytic filter capacitors, one at a time, with other capacitors of equivalent value. Note the results and if the tests indicate that larger value filter capacitors are called for, they should be installed up to the point of space limitations.

Oddly enough, many short-wave receivers use a resistive element in the filter in preference to an inductance whose

higher reactance would vastly increase the effectiveness of filtering. A 1-henry filter choke has a reactance at 120 Hz of about 750 ohms. A tremendous reduction in a.c. hum is possible through the substitution of a choke having an inductance in excess of 7.5 henrys for the resistor. For most small receivers, a Stancor C-2318 (12 H at 30 mA) or C-1515 (30 H at 50 mA) or the equivalent of other manufacturers will be more than adequate.

Replacement of the resistive filter element by an inductive element (choke) has another advantage. Audible hum consists not only of the fundamental ripple frequency, but also of its harmonics, of which those at 240 and 360 Hz are possibly more important. Obviously, a resistive filter element has the same reactance at all frequencies. An inductive filter element, however, has a reactance proportional to the frequency and a 1-H choke which has a reactance of 750 ohms at 120 Hz has a reactance of about 1500 ohms at 240 Hz and 2,250 ohms at 360 Hz.

-30-

**SOLDERING +
DESOLDERING +
RESOLDERING =**

SOLDERABILITY
ELEMENTARY TO ELITE
WORLD'S MOST PRACTICAL SOLDER HANDLING TOOLS

SOLDAPULL™ • **SOLDAVAC™**

Desoldering Tools



● LIGHT WEIGHT, PORTABLE ● SELF-CLEANING ● FAST, VACUUM ACTION

SOLDASIP™ RESOLDERING TIPS **ERSA™** SOLDERING TOOLS



One tip applies, removes solder ● EXPERT CRAFTSMANSHIP ● FAST SOLDERING CYCLES

LONER™ SOLDERING INSTRUMENT IN A CLASS BY ITSELF FOR YOU ALONE

EASY KNOB CONTROL ELECTRONICALLY CONTROLLED



TEMPERATURE SETTING

Send for our FREE 12 page
SOLDERABILITY manual.



EDSYN
15954 ANHIMTA STREET
VAN NUYS, CALIFORNIA 91406
PHONE (213) 989-2324
TELEX NO. 65-1469 EDSYMEK VAN

idle rest™
THERMAL GUARD
SOLDERING INSTRUMENT
HOLDER



with
LONER

● U.S. and Foreign Patents Applied For.
Ads in EEM, MAS, EBG, AE, TR, and
EPAC Catalogs

CIRCLE NO. 6 ON READER SERVICE CARD

DESIGN YOUR OWN PRINTED CIRCUITS

FROM DIAGRAM TO BOARD IS SIMPLER THAN YOU THINK

BY ALEXANDER W. BURAWA

THE PRINTED CIRCUIT board undoubtedly ranks among the most important developments in the history of electronics. The PC method of construction, compared to point-to-point wiring, has many advantages and they become more apparent with increasing circuit complexity. The PC board reduces construction and assembly time (and generally costs), virtually eliminates wiring errors, is easy to trace and troubleshoot, and provides neater, more compact, lighter weight modular assemblies.

Unfortunately, many experimenters and hobbyists avoid using the PC board for a misguided reason—they think that designing their own is beyond their capabilities. The fact is, however, that designing a printed circuit board is a great deal easier than designing a circuit. All you have to do is master a few simple techniques. With a little practice, the techniques outlined here will allow you to design PC boards that are every bit as professional as those produced commercially.

Discussion in this article is purposely limited to the techniques that can be employed by *anyone* interested in electronics. The materials required are basic dime-store items: tracing and opaque paper, a straight-edge rule with sixteenth-inch divisions, pencils, a compass, and a protractor. Three optional items

that really save time and paper are graph paper with ten divisions/inch, a large sheet of heavy-duty clear acetate, and a grease pencil.

Preliminary Layout. Many electronic components are manufactured in standard sizes. So, it is to your advantage to make up a template that shows mounting hole locations and minimum area required for these components. If you wish to make such a template, you can copy the drawing shown in Fig. 1. Put it on heavy clear acetate and carefully perforate the acetate at the hole locations.

Now, assume that the circuit you want to mount on a PC board is the one shown in Fig. 2. First, decide which of the components will *not* be mounted on the board. Break the connecting lines to these components, and insert a letter or numeral designation at the breaks. Examples of components that should not be mounted on a PC board are primary controls and switches (because of their frequency of use), power relays and heavy transformers (because of their weight), and high-power or high-current semiconductors (which generate excessive heat). These components should be mounted on a strong accompanying chassis that is capable of quickly conducting away excessive heat.

Next, redraw the schematic diagram

so that only the conductor pattern, as viewed from the *underside* of the board, remains (see Fig. 3). If possible, keep the input-to-output flow from right to left, and route the ground or signal reference conductor so that it encircles the circuit. Make sure you include a dot or circle for *each* connection to be made to the pattern (including the connections for the off-the-board components). *Never* have more than one component lead connected to a given point in the conductor diagram. Then letter in the schematic part number between the connection points, preferably on a tracing paper overlay to avoid confusion. Identify polarities of electrolytic capacitors and diodes, lead orientation for transistors and the indexing tabs or dots and pin numbers of IC's.

Bear in mind that, to avoid the need for jumper wires to complete a circuit, you can route conductors between connection points of resistors, large capacitors, and most diodes. *Never* route conductors between transistor leads. And try to limit the number of conductors inside the pin outlines of IC's to a maximum of three side-by-side, and then only for the conductors specifically related to the IC. If a jumper is unavoidable, plan it so that it does not bridge a component; route it around components as necessary, or even on the underside of the board.

Once you are satisfied that your conductor pattern layout is correct, a good idea is to "breadboard" your circuit exactly as laid out to determine whether or

not you will have to deal with feedback, crosstalk, hum and noise, etc. If the design is troublesome, now is the time to find out; otherwise what you do from here on will be fruitless.

If you experience any of the problems enumerated above, you have two choices: you can start fresh with an alternate conductor pattern design; or, you can try the less drastic step of shielding sensitive components or assemblies with metal barriers, or isolating troublesome circuits on separate circuit boards. In very extreme cases, a combination of the two methods might be called for, such as in the two channels of a stereo pre-amplifier that are first mounted side-by-side on a single PC board. If metal shields are used, when they are mounted in place with either hardware or solder they must touch only the common ground or signal reference conductors. They must *not* touch conductors that are not common to each other.

Once you are satisfied that the circuit will operate as designed, you can proceed to make the full-size drawing of the etching guide you will use to make the PC board.

Making the Etching Guide. Tape down on your work surface a clean sheet of graph paper. Then over this, tape a sheet of good quality tracing paper. Vellum is best—it is expensive but well worth it since it does not crack or tear easily and readily takes a pencil line.

Now, make sure you have several pen-

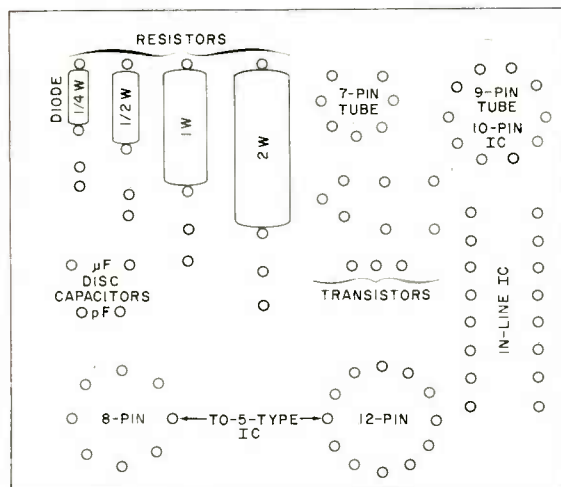

Fig. 1. Template guide, shown actual size, gives minimum hole spacing for most commonly used components. Most signal and low-current diodes fit into 1/4-watt resistor slot; other silicon diodes fit into 1/2- or 1-watt resistor slots. Eliminate one dot in upper right drawing for nine-pin tubes.

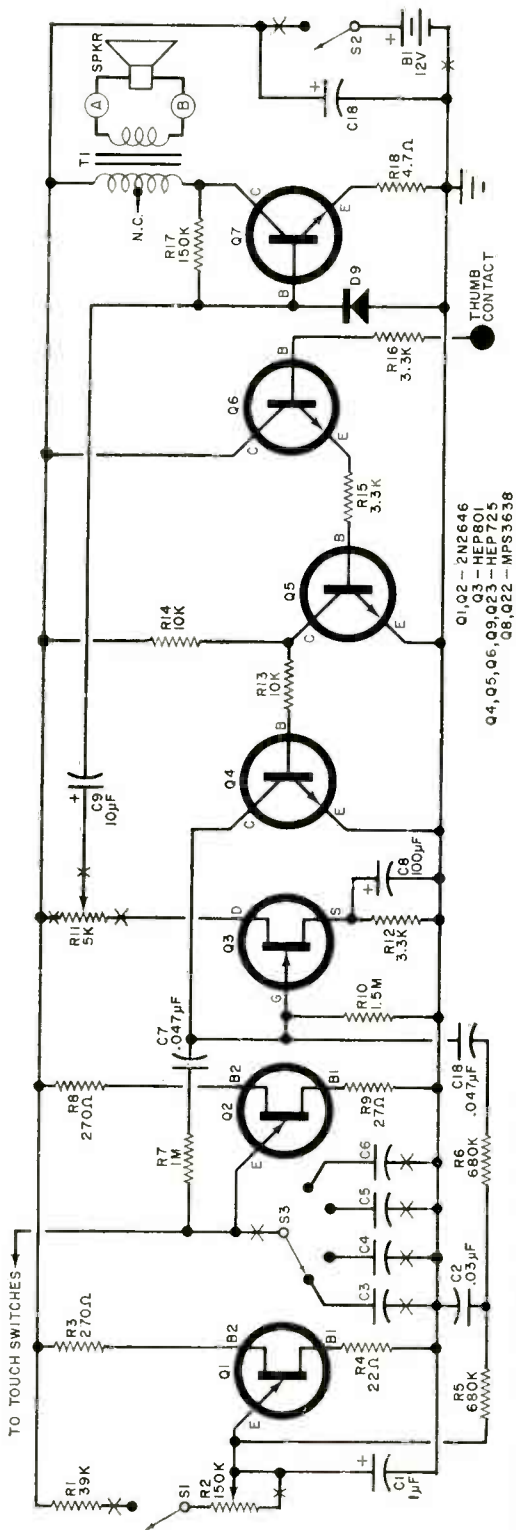

Fig. 2. Shown at left is sample circuit. Off-the-board components are shown by small X marks; you can break lines at these points and insert letters.

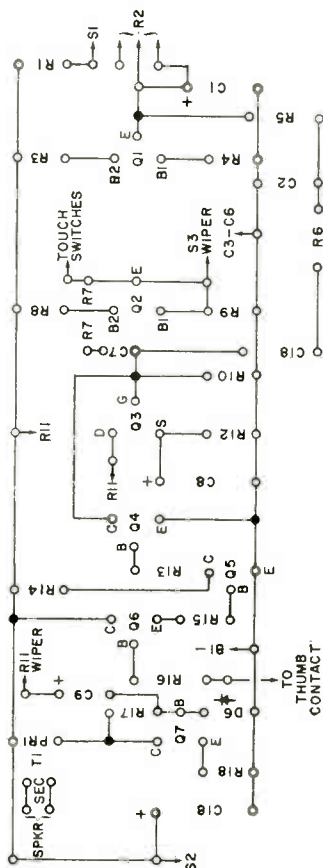

Fig. 3. Drawing above is conductor pattern diagram of sample circuit shown at left.

cils, your rule, component sizing template, and protractor handy. By consolidating your materials close at hand, you will work faster and more efficiently and make fewer errors.

Begin your etching guide layout by striking the top and right border lines perpendicular to each other and about 6" long. If you have succeeded in routing the ground or signal reference conductor around all other conductors, strike two more lines, each spaced $\frac{1}{4}$ "- $\frac{3}{8}$ " in from and parallel to the border lines. If not, make these new lines at least $\frac{3}{8}$ " in from the border lines to allow for circuit board mounting without the hardware touching the foil.

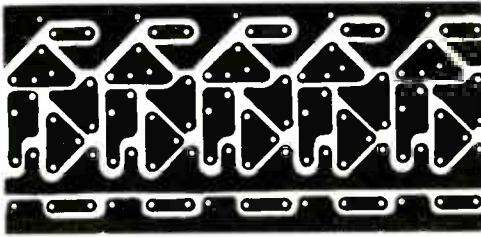
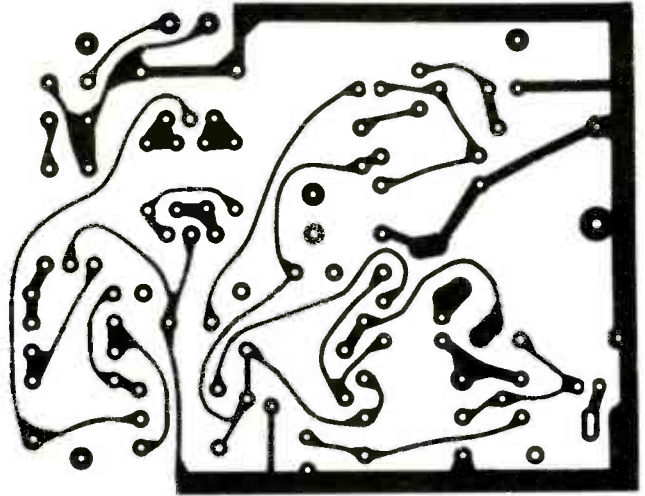

Fig. 4. Examples of both minimum-width conductor (above) and "area etch" (left) etching guides are shown. Note differences in amount of copper (blackened-in portions) in guides.

Now, using your template and/or rule, start filling in hole locations and foil patterns in the same sequence as in your conductor pattern diagram. Condense the areas on which the components are to be mounted for maximum space utilization. However, do not be afraid to assign a component more space than it requires if you want to preserve symmetry of the layout or to prevent thermal problems.

The foil pattern can be any thickness from $\frac{3}{32}$ " to as wide as you want, within the limits of the circuit board size required. Another basic rule to remember is to space conductors no closer together than $\frac{1}{16}$ " (except for inline IC's, where spacing can be as small as $\frac{1}{32}$ " between the two rows of pins). If the conductors are to be less than $\frac{1}{8}$ " wide, plan to have solder pads that are a
(Continued on page 152)

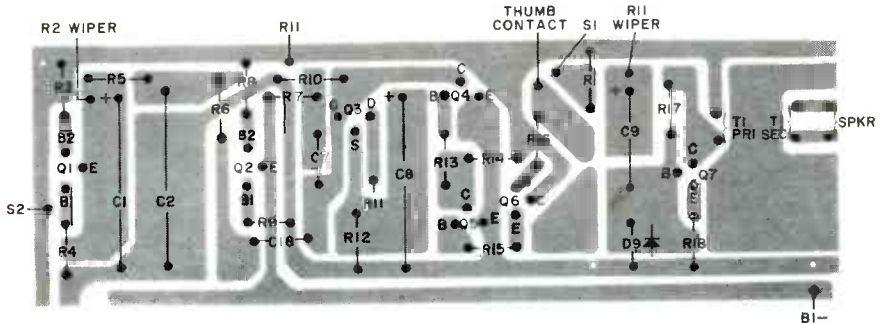

Fig. 5. Viewed from conductor side of board, foil pattern is in grey. Area etch technique was used here, but minimum-width conductor would have served just as well.

STAGE LIGHTING CONTROL SYSTEM

CONVENTIONAL COMPONENTS
ACHIEVE PROFESSIONAL EFFECTS

BY GERALD THUROW

LITTLE THEATRE groups and other "amateur" production organizations are notoriously short on funds and one thing they usually need but can't afford is a good stage lighting system. If you are reasonably good at electrical construction projects, you can be a real hero coming to the rescue by building them a solid-state light control system. If you use silicon controlled rectifiers (SCR's) the job is easy and the cost is low.

The dimmer system shown in the photos in this article is built around ten General Electric \$13 Triacs. It is a 120-

volt, 15,000-watt system consisting of ten individual 1500-watt units. It has a portable control console which can be used in the front of the house, while the dimmers are mounted backstage. The Triacs are pre-assembled SCR variable-voltage circuits with complete linear dimming ranges, zero sets, RFI suppression and isolated heat sinks.

Of course, any type of Triac or SCR dimmer, whose output is varied with a control potentiometer, may be used. Some of these dimmers may be purchased at your local hardware or electri-

Take a group of commercially available light dimmers, make only a small circuit change, package them neatly, and you have a professional looking control system that can make the lighting on any stage similar to that in big-time theatres.

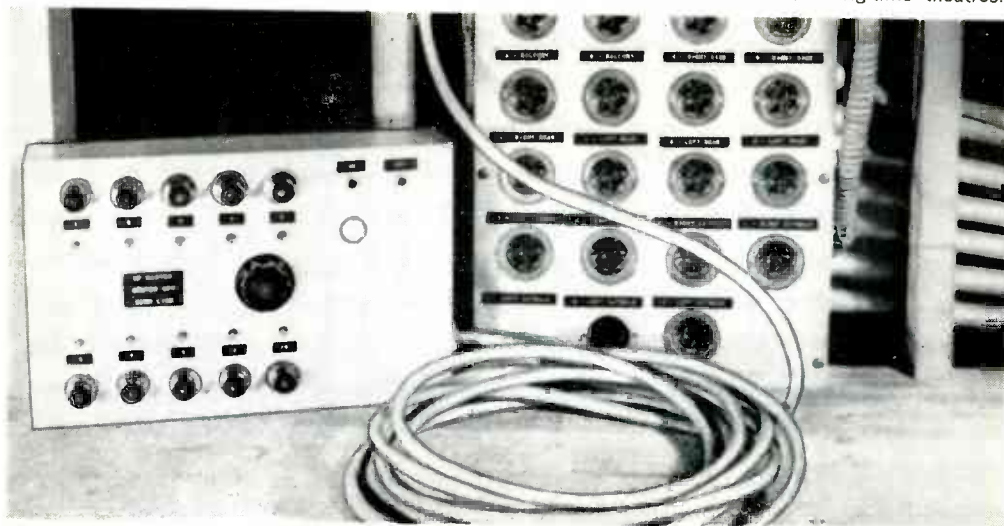

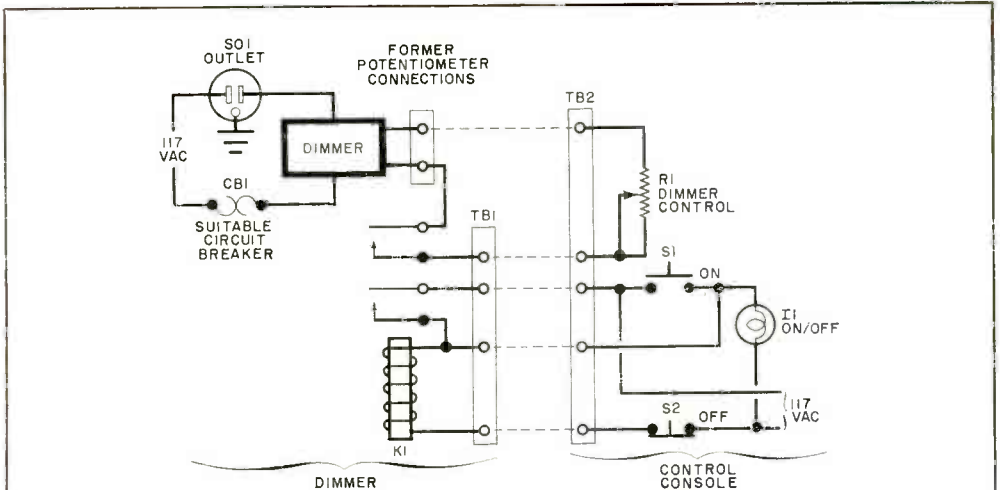

Fig. 1. Each dimmer stage is coupled to the remote control console via a multi-lead cable—preferably shielded to reduce electrical noise. Almost any number of dimmers may be used, all to one console.

PARTS LIST

- CBI—Suitable circuit breaker*
- Dimmer—Wattage as required, modified per text*
- I1—Indicator lamp with holder*
- K1—Relay to suit power source*
- R1—Potentiometer removed from dimmer*
- S1—Normally open s.p.s.t. pushbutton switch*

- S2—Normally closed s.p.s.t. pushbutton switch*
- SO1—Three-pin electrical outlet*
- TB1, TB2—Multiterminal barrier strip (or similar)*
- Misc.—Interconnecting power cable, shielded pair cable, chassis for dimmer and relay, chassis for control console, knobs, press-type lettering, etc.*



When mounting a number of dimmers in one chassis, make sure that sufficient heat sink area is provided to enable each to operate at a safe temperature.

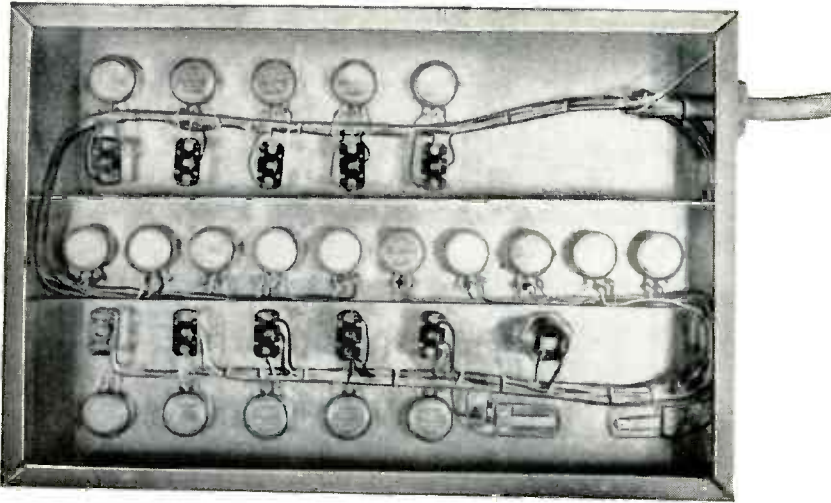

Fig. 2. Example of a typical control console showing dimmer potentiometers and on-off switches. Each control covers different lighting function.

cal store. Others are available through catalogs. Select the dimmers that will handle the contemplated load. The total cost of the system will depend on the type and number of dimmer units you have to buy. The 15,000-watt system shown here is about \$200.

Typical Circuit. Since the variations and complexity of the systems that can be built are practically endless, we will describe in detail only the basic one-dimmer, one-control circuit. The first step in constructing such a system is to locate the dimming control potentiometer on the unit you are using. Remove the potentiometer from the circuit and wire the two leads that formerly went to the potentiometer to two terminals of a barrier (or similar) strip. If you want remote turn-on/turn-off control, obtain a 117-volt d.p.s.t. a.c. relay to be mounted in the cabinet backstage with the dimmer. Wire the system as shown in Fig. 1. External connections to the relay are made to other terminals on the barrier strip.

The dimmer control and on-off controls (with a pilot light indicator) are mounted in the control console as shown in Fig. 2. The control potentiometer is connected to the remote dimmer through a shielded pair, while the other wiring can be made with conventional multilead power cable. Just make sure that the wire is large enough to handle the relay

coil current. Of course, if you have some low-voltage d.c. relays and a suitable power supply, these can be used instead of the 117-volt a.c. relay.

Obviously tandem potentiometers can be used to control two or more dimmers simultaneously or individually and more relay contacts can be used to switch more than one dimmer.

Connections between the control console and the dimmer must follow local electrical codes for safety. Mark the outlet of each dimmer with the maximum load it can tolerate. This will prevent damage through accidental overload. —30—

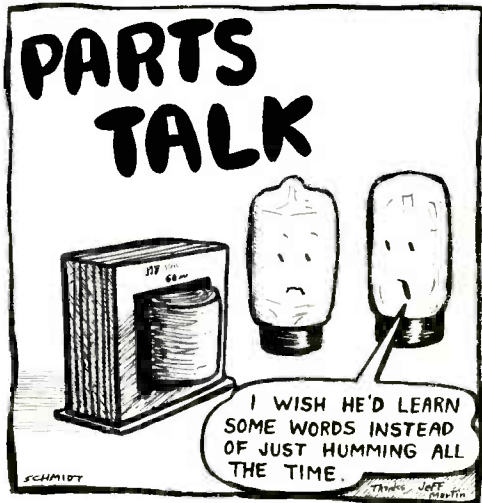

BUILD A RIAA/NAB PREAMPLIFIER

IC OP AMP

SIMPLIFIES

CONSTRUCTION—

GIVES IDEAL CHARACTERISTICS



BY NORMAN P. HUFFNAGLE

BECAUSE OF ITS UNIQUE properties, the integrated circuit operational amplifier (op amp) is ideal for use as a preamplifier stage for a hi-fi system. And the Fairchild μ A739C IC, containing two high-quality op amps that share a common power supply and package, is an excellent choice for a really simple project. Even though its two op amps are in close proximity to each other, interchannel separation is quite good, and there is roughly 94 dB of separation.

The μ A739C IC is the heart of the "RIAA/NAB Preamplifier" project described here. Aside from the project's value as a preamp, it also enables you to become acquainted with the ability of the operational amplifier to be completely controlled by the circuit in which it is used: an "ideal" amplifier.

About The Circuit. Shown in Fig. 1 is the schematic diagram of the preamplifier. Switch *S1* is in the phono mode (RIAA) position. In this position, *S1* selects the roll-off characteristic impedance to match either phono cartridge or magnetic tape head inputs; input impedance is 47,000 ohms to match it to

most cartridges currently on the market. Output impedance of the preamp is 10,000 ohms. Resistors *R7-R10* and capacitors *C9* and *C10* supply d.c. bias to the negative inputs of the op amps.

Since the two op amps are identical, discussion of the operation of only one op amp applies equally to both. In channel A, *C1* and *R1* form the input network. The circuit made up of *C5*, *C7*, and *R5* form the RIAA feedback gain network and establish the roll-off curve. In the NAB mode (*S1* set to the alternate position), *C3* and *R3* perform the roll-off function. Capacitor *C11* is a high frequency oscillation limiter, and *C13* is the output coupling capacitor for channel A.

The open circuit gain of the μ A739C IC (*IC1*) is on the order of 20,000, or 86 dBV. Since most preamplifiers achieve a gain of only 1000 (60 dBV), the μ A739C can be treated as though it has infinite gain.

Construction. The original prototype of the RIAA/NAB Preamplifier (shown in the photos) employed a perforated board and push-in solder terminals. However, because of the close proximity of the

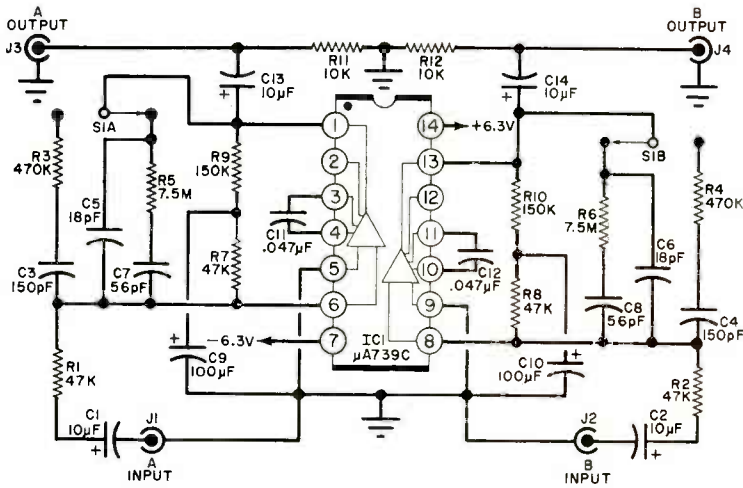

Fig. 1. Identical op amps in IC1 have same outboard circuitry. Note that positive and negative d.c. power is needed for proper circuit operation.

PARTS LIST

C1,C2,C13,C14—10 μ F, 15-volt electrolytic capacitor
 C3,C4—150-pF disc capacitor (see text)
 C5,C6—18-pF disc capacitor
 C7,C8—56-pF disc capacitor
 C9,C10—100- μ F, 3-volt electrolytic capacitor
 C11,C12—0.047- μ F disc capacitor
 IC1—Integrated circuit operational amplifier (Fairchild μ A739C, Motorola MC1303L, or Signetics E5003A)
 J1-J4—Phono jack

R1,R2,R7,R8—47,000-ohm
 R3,R4—470,000-ohm (see text)
 R5,R6—7.5-megohm
 R9,R10—150,000-ohm
 R11,R12—10,000-ohm
 S1—D.p.d.t. slide or toggle switch
 Misc.—Perforated board and push-in solder terminals (or optional printed circuit board); two contact screw-type barrier block; #6 solder lug; spacers (4); metal utility box; #6 machine hardware; hookup wire; solder, etc.

pins on IC1, it is suggested that you use a printed circuit board for assembly. An actual-size etching guide and a parts location drawing are given in Fig. 2.

If you use the printed circuit board for assembly, you should encounter no crosstalk problems. However, if you use any other type of assembly technique,

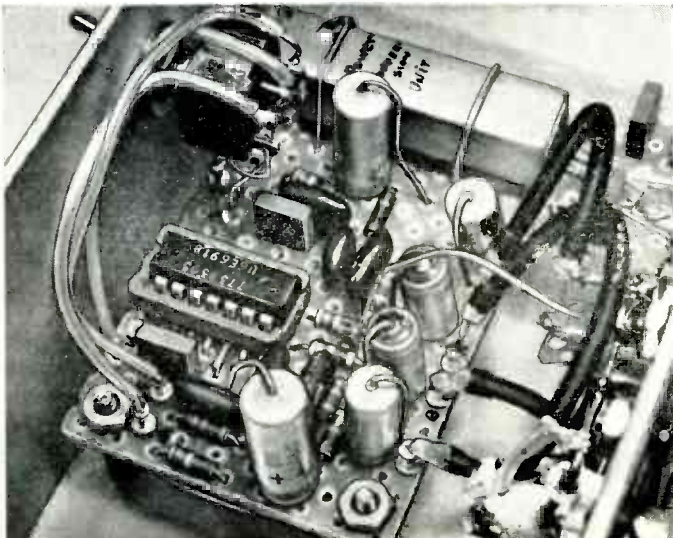

Original prototype was wired on perforated board and incorporated IC socket. Oblong box (at top) housed a power pack.

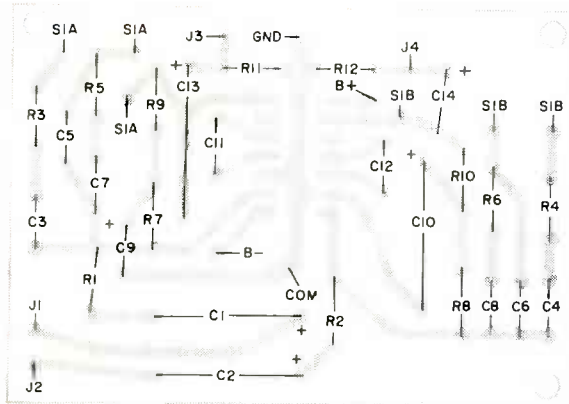
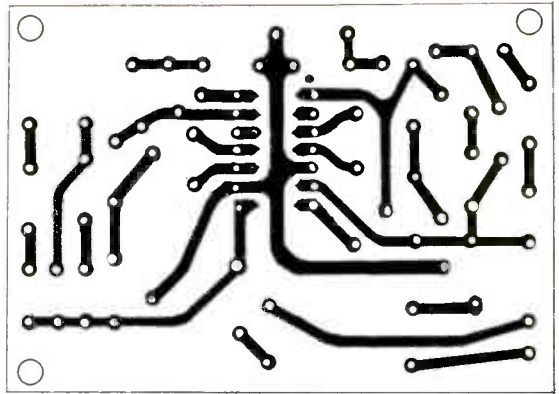

Fig. 2. An actual size printed circuit etching guide is shown above; at left is guide to component placement and orientation as viewed from the top of the board. Note: align pin 1 of integrated circuit with hole located directly below R11.

you will have to locate and orient the components to insure good isolation between the channels. When laying out the components, make sure to observe the indexing guide for *IC1* and the polarities of the electrolytic capacitors.

The integrated circuit requires both positive and negative supply voltages, each referenced to ground, for proper operation. Hence, it is a good idea to incorporate into your project the optional power pack shown in schematic diagram form in Fig. 3. Note that the power pack will accept a.c. potentials between 6.3 and 12.6 volts and d.c. potentials between 12 and 20 volts. For the a.c. source any filament transformer rated at about 0.5 ampere will suffice, while any good d.c. supply including batteries will work well for the d.c. source.

The preamp circuit is best housed inside a metal utility box to minimize the possibility of induced hum and/or noise. Neither the preamp circuit nor the power pack generate much heat; so a small box can be employed.

In Use. If while using the RIAA/NAB Preampifier you notice that insufficient gain is available in the tape (NAB) position, you can substitute 100-pF capacitors for *C3* and *C4* or 500,000-ohm resistors for *R3* and *R4*; don't change both resistors and capacitors. Either substitution will alter the roll-off curve, raising it everywhere, but the slope will remain unchanged.

A second problem you might encounter is increasing gain at frequencies below 20 Hz. To rectify this situation, you can

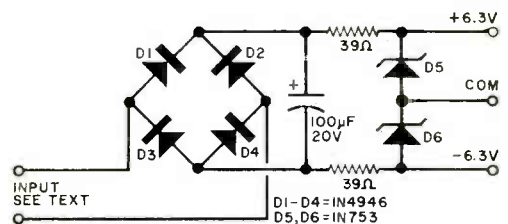
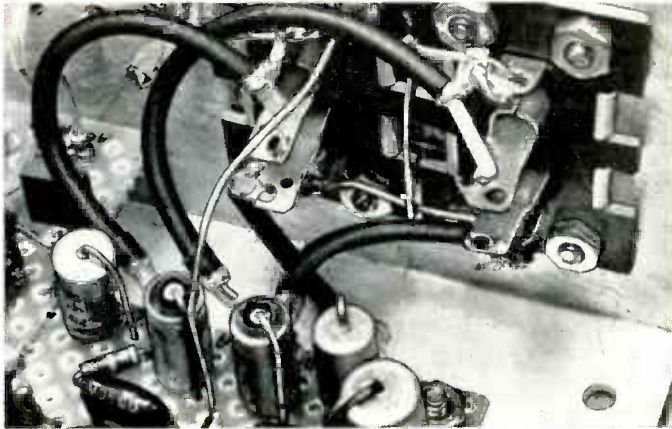
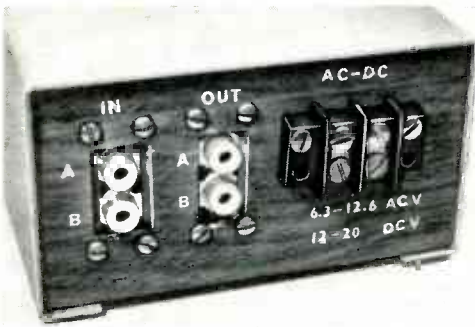

Fig. 3. Optional power pack to provide positive and negative voltages can be wired point-to-point.

Use shielded cable to interconnect the circuit board with the input and output jacks as shown in photograph at right.



Connectors for input and output signals and power should be located on the rear apron of the metal cabinet as shown below.



parallel C_3 and C_4 with 5.6-megohm resistors. Gain will be limited to about 61.5 dB, but roll-off will be unaffected.

If at all possible, it is recommended that you use a tone control circuit (using FET circuitry) between the preamp and input of the amplifier. This serves to isolate the preamp from the amplifier and eliminate objectionable feedback oscillations that may occur in the power amplifier that has local feedback. -50-

HIRSCH-HOUCK LABORATORIES

Project Evaluation

The equalization provided by the preamplifier for both RIAA and NAB characteristics is quite good from 60 to 20,000 Hz, coming within ± 3 dB of the ideal. It appears, however, that the feedback drops off at the lower frequencies so that the gain rises to about +11 dB at 20 Hz, relative to 1000 Hz. This is undesirable for phono use, since it can be expected to amplify greatly any rumble.

The gain of the preamp is not particularly high, requiring 9.7 mV at 1000 Hz for a 1-volt output for phono; the output clips at 2.5 volts, corresponding to an input of less than 25mV. This latter is not really a bad situation, since most amplifiers can be driven well with less than 200 mV on their auxiliary (AUX) inputs. So, the dynamic range of the preamp is okay for use with all but high-output cartridges—greater than 7mV.

For some reason, a lower gain was chosen for tape than phono, with 38 mV needed at 1000 Hz input for a 1-volt output on NAB. With tape head outputs normally being in the low millivolt range,

it is difficult to understand how the preamp can be used with a tape deck. However, we did use it as a phono preamp, and it sounded fine with a Shure V-15 Type II cartridge. The noise output of the preamp is about 53-54 dB below 1 volt and is normally subsonic. Crosstalk is about 55 dB down at 1000 Hz, and harmonic distortion is less than 0.1% up to the 1-mV output and did not increase significantly up to 2 volts.

Operating the preamp from an EICO Model 1020 d.c. power supply at 12 volts, the minimum rated operating potential, a current drain of only 5 mA was noted. The zener diodes in the optional power pack drew rapidly increasing current above 12 volts so that the drain increased to 33 mA at 15 volts. Obviously, when operating the preamp from a battery supply, a 12-volt battery would be most economical and should provide long life even if the preamp is inadvertently left on continuously.

In listening tests, we found, not unexpectedly, that it is not possible to use amplifier bass boost without inducing acoustic feedback. With proper equalization, in the amplifier itself, there was no such difficulty.

500/50-kHz FREQUENCY STANDARD

ACCURATE CALIBRATION FOR YOUR RECEIVER

BY NEIL JOHNSON

THE CRYSTAL CALIBRATOR is the most versatile test instrument available to hams and SWL's for accurately checking the calibration of their receivers. Most available crystal calibrators operate on a fundamental frequency of 100 kHz with multiple markers obtained from the 100-kHz spaced harmonics of the fundamental.

The main problem here is that the markers are inflexibly placed at predetermined intervals. So if you have to set your receiver dial in the HF range between 20 and 30 MHz where the markers are close together, it is often difficult to determine whether your receiver is set to 20.1 or 20.2 MHz. Conversely, on the low end of the spectrum, the markers may be too far apart for adequate coverage. Therefore, if you could obtain a frequency standard capable of delivering markers at both 50- and 500-kHz intervals, you might have a more useful instrument. The secondary "Frequency Standard" described here is designed with that philosophy in mind.

About the Circuit. The "Frequency Standard" is basically a conventional

crystal calibrator with one major advantage—it can split the fundamental frequency as desired. The crystal oscillator stage (*V1* in schematic diagram) employs a tetrode vacuum tube in an electron-coupled configuration. This type of design provides good frequency stability so that changes in output loading have little effect on the input circuit.

There are no reactive elements in either the plate or screen-grid circuits. As a result of eliminating any trace of a resonant load, the fundamental frequency and its harmonics are free to appear at the output of the stage.

Stages *V2A* and *V2B* serve a dual purpose. With *S1* open, they act as a straight amplifier. By closing *S2*, a feedback loop from the screen grid of *V2B* to the grid of *V2A*, through *C7* and *S1*, connects the two stages in a multivibrator configuration. Again, the use of a tetrode for *V2B* allows either high- or low-impedance loads to be connected to the frequency standard with no ill effects on the circuit.

The typical multivibrator, being basically an unstable circuit, is excited with a crystal-stabilized signal from *V1*. With

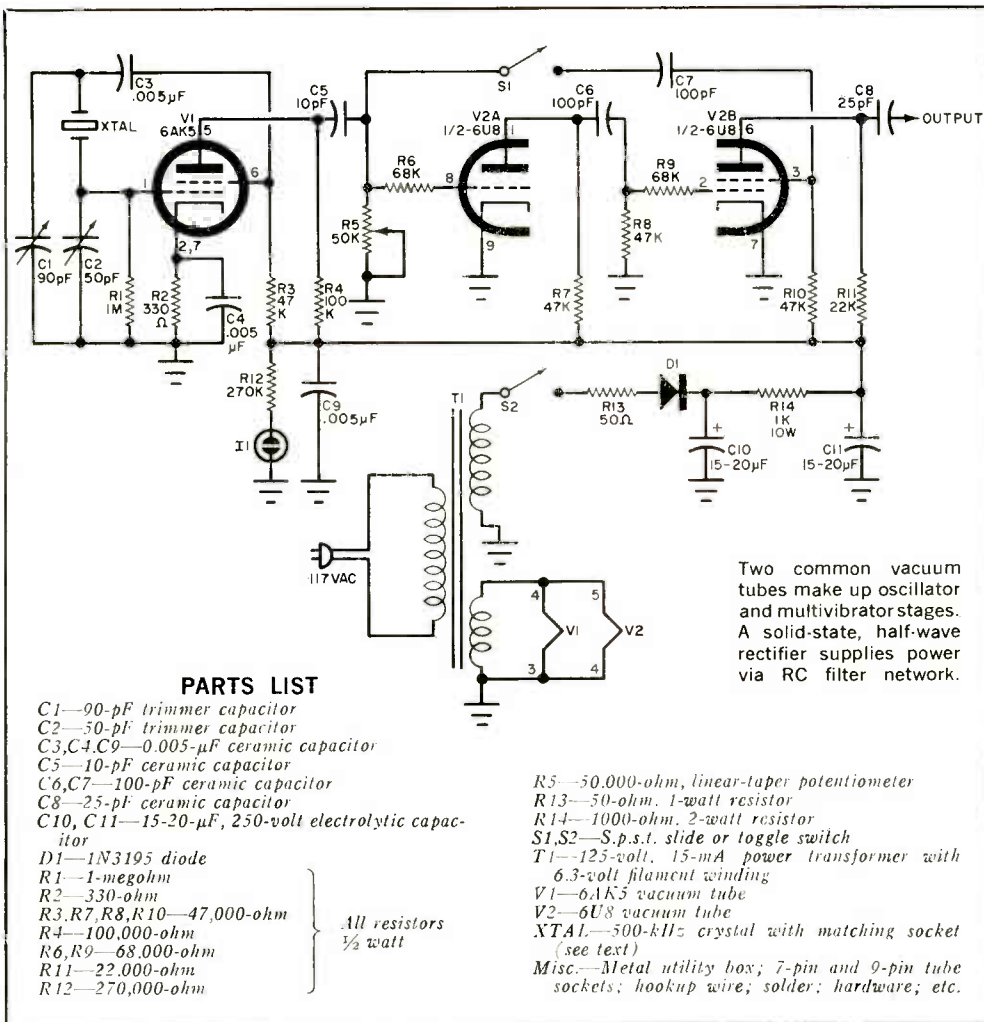

R5 set at approximately mid-range, an uncontrolled oscillation of about 50 kHz is obtained. However, by injecting the 500-kHz signal from *V1* into the multi-vibrator, a very stable 50-kHz signal appears at the output.

The frequency standard also features an instant-on type of design. Switch *S2* in the power supply controls only the B+ to the three stages. Heater power is applied at all times when the line cord is plugged into an a.c. outlet.

Construction. Because of the relative simplicity of the circuit, almost any method of assembling and mounting it inside an appropriate size cabinet will do. The cabinet, however, should be

metal and vent holes should be drilled in it at the rear and top to provide adequate convection cooling for the tubes.

Switches *S1* and *S2* should be easily accessible and clearly marked to show which positions they are set to and the functions they perform. For *S2*, you have the added convenience of indicator lamp *I1* to indicate when the B+ is applied to the plates of *V1* and *V2*.

When selecting the crystal, try to obtain one that is right on 500 kHz. If you buy from surplus parts suppliers, it is worth noting that the FT-241 variety are generally too far off frequency—especially on the harmonics—for your purpose. A better choice would be the HC-6U
 (Continued on page 153)

“SUPER” SUBSTITUTION BOX

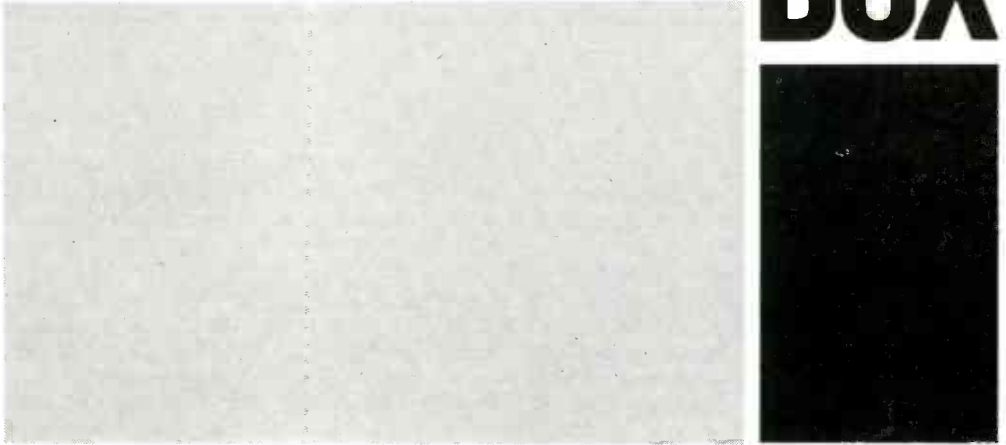

BY RALPH TENNY

MORE POSSIBILITIES WITH LITTLE EFFORT

THE POPULAR Heathkit Model IN-37 resistor substitution box gives the user a choice of 36 resistance values ranging between 15 ohms and 10 megohms. However, with a simple, inexpensive modification, this same substitution box can be made to provide more than 200 different value choices—all using only 36 resistors!

It is best to perform the modification on a new IN-37 still in kit form, substituting parts as you assemble the kit. But an assembled substitution box that

has already seen considerable service can be modified as well.

The schematic diagram shown in Fig. 1 (used with the permission of Heath Company) is the standard circuit representation of the IN-37 and uses the circuit designations employed in the IN-37 Instruction Manual. The first changes that must be performed can be summarized as follows (see Fig. 2):

First, replace slide switch *C* with a Stackpole No. SS-31 slide switch. Wire

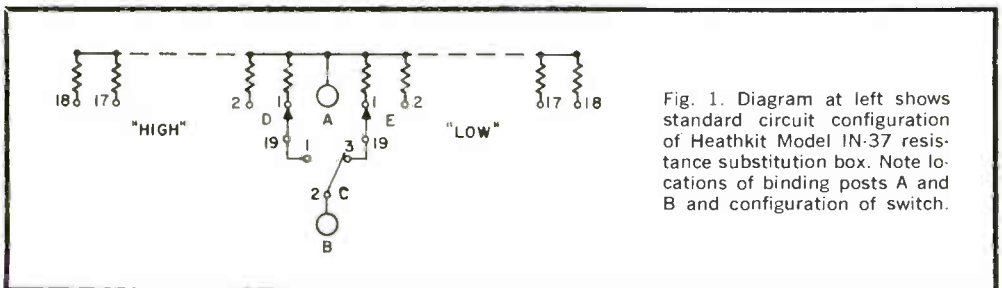

Fig. 1. Diagram at left shows standard circuit configuration of Heathkit Model IN-37 resistance substitution box. Note locations of binding posts A and B and configuration of switch.

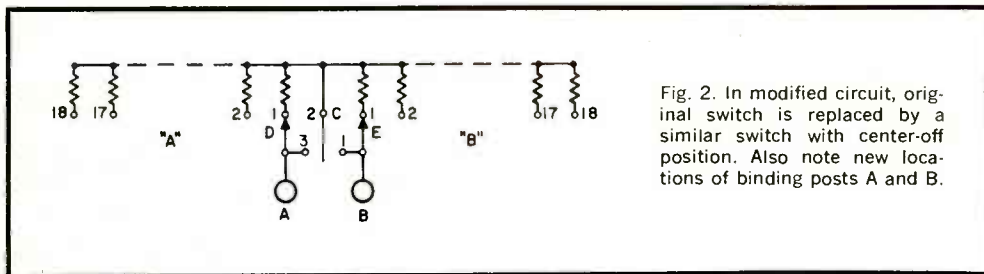

Fig. 2. In modified circuit, original switch is replaced by a similar switch with center-off position. Also note new locations of binding posts A and B.

the new switch to have a center-off position: Connect binding post A to lug 3 on the switch and binding post B to lug 1. Finally, connect lug 2 on the switch to the common buss where binding post A was originally connected.

This change now permits a selection of 360 resistance values, but only about 120 of these are significantly different in value from the others. These values are selected as follows: The standard 36 values are selected in the manner outlined in the Heath manual. Slide the newly installed switch to the center-OFF position. Then dial the extra values. For example, set the selector switches to 15 and 15K, respectively. Move the LOW selector from 15 to 10K, and you are set up to select any one of 18 values between 15K and 28K.

This process can be repeated for any resistor on the HIGH selector, but 1 megohm is about the upper limit for practical use. After all, 1 megohm plus 10,000 ohms is only a 1% change! The lines drawn in Fig. 3 further illustrate possible combinations of switch settings between 15,000 ohms and 1 megohm.

A second modification can be performed on the IN-37 to allow you to select more than 240 useful values between 1000 ohms and 1 megohm in addition to the usual ones. To make the modification, first perform the changes already outlined with reference to the slide switch. Then eliminate the 68-ohm, 680-ohm, 6.8-k, 68-k, 680-k, 6.8-megohm, and 10-megohm resistors in the original instrument. Substitute 10-ohm, 56-ohm, 560-ohm, 5.6-k, 56-k, 560-k, and 5.6-megohm resistors, respectively, for the resistors eliminated.

Mount the resistors on the selector switches in the order shown in Fig. 4. When you are finished with the wiring, each switch should contain half of the

resistors less than 10,000 ohms and half above 10,000 ohms.

The center-OFF, or A + B mode, is especially versatile. It now lets you select many small values of resistance around a single value.

One final modification finishes the project. You must redo the front panel of the substitution box so that the switches indicate the proper values selected. To do this, first mask off both ends of the panel and the center area around the switches with 3-M "Magic Mending" tape. Trim the tape around the position locator dots, permitting the dots to show after the panel is repainted.

(Continued on page 152)

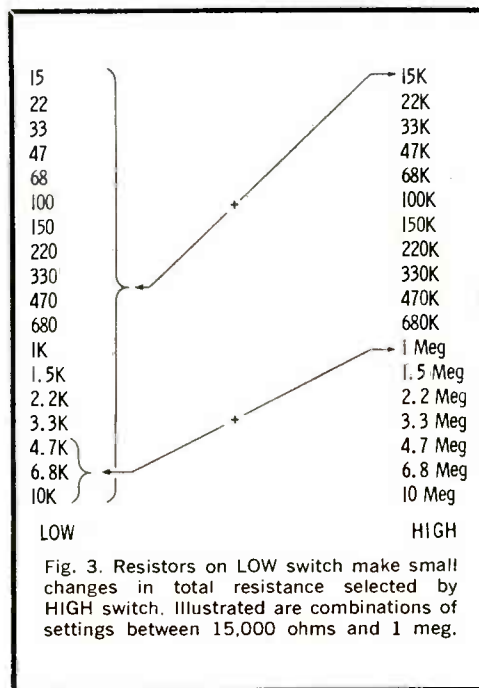

Fig. 3. Resistors on LOW switch make small changes in total resistance selected by HIGH switch. Illustrated are combinations of settings between 15,000 ohms and 1 meg.

Electronics experimenters! Hobbyists!

There's more for you in **Popular Electronics**

More construction projects—

up to 6 per issue—more than 60 per year—all lab tested for accuracy and “workability.” Many with actual size PC foil patterns and IC diagrams. “How-to-build-it,” “How-it-works” instructions guarantee success.

More challenge—

with more sophisticated projects than ever before such as lasers, desk calculators, mini-computers, and there's much more on the way!

More diversity—

from the very sophisticated to the just-plain-fun, and everything in between. Stereo and hi-fi components. Highly sen-

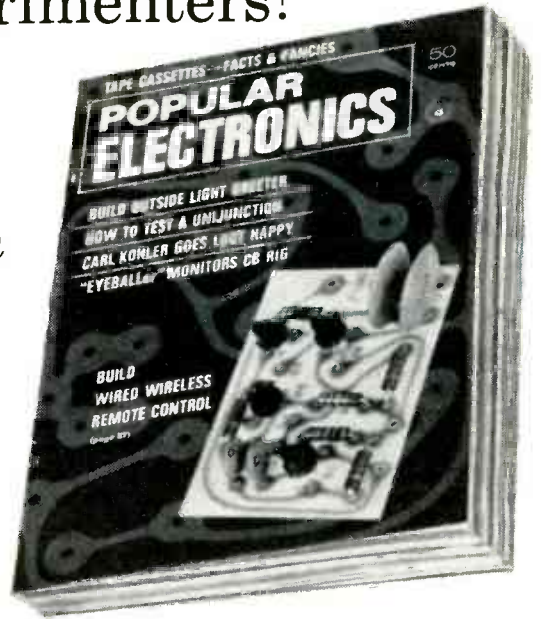

sitive testing gear. Electronic instrumentation and music synthesis. Useful items for home, car, shop. Electronic games and puzzles. Communications equipment.

More information—

On the latest developments in electronics with state-of-the-art and tutorial features on space electronics, satellite broadcasting, telemetry, laser holography. On careers in electronics. On new products. Available books and literature.

And it's all available now
at **HALF-PRICE** to readers of
the *Experimenter's Handbook!*

**ONE FULL YEAR of
POPULAR ELECTRONICS, ONLY \$3.00!**
(That's *HALF* the regular, \$6 one-year rate!)

*So don't delay!
Use the coupon today and get MORE!*

Clip and mail to: **POPULAR ELECTRONICS**
P.O. Box 1096 / Flushing, N.Y. 11352

O.K., POPULAR ELECTRONICS! Please enter my
subscription for one year at the **HALF-PRICE** rate
of only \$3.00. 0543

name _____
Please Print

address _____

city _____

state _____ Zip _____

Light-Operated Bistable Switch

BY DAVID C. CONNER

A SWITCH that can be operated by a light beam from remote locations of up to 30 feet is a handy device to have around the house or in the workshop. Such a switch, especially if it can be operated under wide ambient light extremes, is used to turn appliances on and off, silence the audio on a TV receiver during commercials, and serve as a remote switch in a garage or basement. You can readily see how much of a work saver and safety provider a light-operated remote switch can be.

As shown in the schematic diagram, the remote switch described here is a simple device, employing a pair of light-dependent resistors (*LDR1* and *LDR2*) which provide on and off bias for a simple transistor amplifier (*Q1*). The amplifier load is a relay which is energized or de-energized depending on the conduction state of the transistor. The relay has a double-throw contact arrangement so that an appliance or device can be connected to either the normally open or normally closed contacts, depending on the operating condition desired. (These contacts will handle up to 1 ampere of current at 117 volts ac. If higher power is required for a particular device, *K1* can be used as a control relay to drive an appropriately rated power relay.)

In operation, illumination of *LDR2*

causes *Q1* to conduct sufficient current to energize *K1*. Once *K1* is pulled in, it remains energized even after the light is removed from *LDR2* because the solenoid of the relay is normally biased near its pull-in point during its de-energized period. Hence, although the energizing current must exceed a certain level, the holding current is within the biasing current range.

Now, by illuminating *LDR1*, the bias condition at the base of *Q1* changes, causing the transistor to conduct less heavily—this time sufficiently below the holding current of *K1* to allow it to drop out. Again, the situation is such that the normal standby current through *Q1* and *K1* allows the relay to remain de-energized

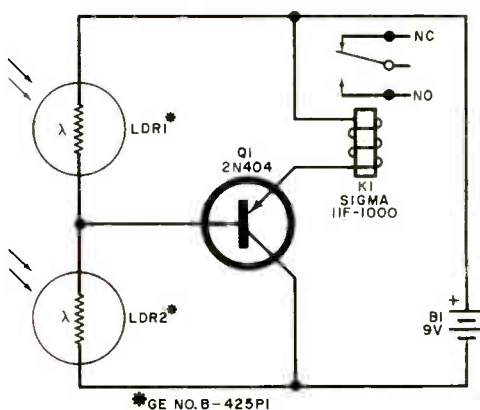

Relay *K1* closes and opens when *LDR2* and *LDR1*, respectively, are illuminated. Sufficient current is normally available to latch *K1* in desired state.

even after the light is removed from *LDR1*.

Background changes from total darkness to full brightness will not cause false operation of the remote switch since the resistance ratio between *LDR1* and *LDR2* will not change and, as a result, the biasing scheme is unaltered. However, the amount of light reaching both *LDR*'s must be the same at any given time for this to be true.

When assembling the remote switch, bear in mind that the *LDR*'s must be physically separated so that they can be illuminated selectively (by a flashlight, for instance). Experimentally, a separation of about 7 inches provided reliable operation at distances up to 30 feet. —30—

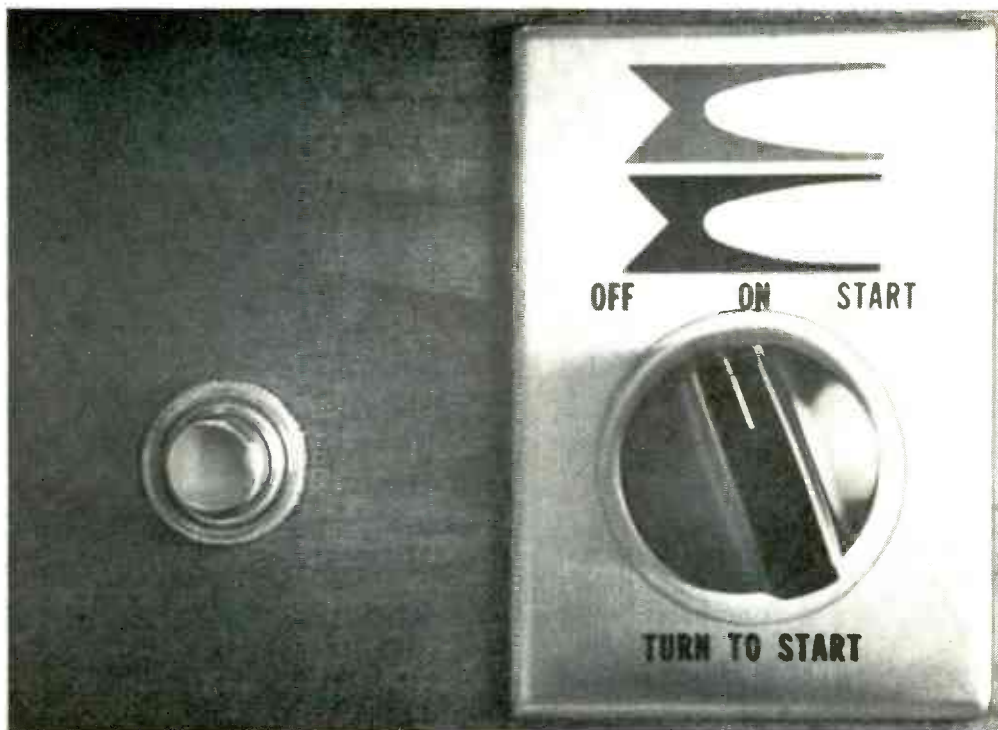

ELECTRONIC COMBINATION IGNITION LOCK

SURE-FIRE PROTECTION FOR YOUR BOAT

BY JOHN BEISWENGER

DURING THE PAST FEW YEARS, there have appeared in print a wealth of anti-theft/anti-intruder lock projects for the home and automobile. But as one boat owner so aptly put it: "Doesn't anyone know or care that boats get stolen, too?" Well someone does know and has done something about eurtailing boat thefts by designing an "Electronic Combination Ignition Switch" just for marine engines.

Aside from providing theft protection, the electronic combination switch saves a lot of frustration if you have a knack for forgetting rarely used boat keys or drop your keys into the drink. The reason is that there just aren't any keys to remember or guard. The lock works essentially like a mechanical combination lock.

Inexpensive and easy to build, the lock is designed to operate with any manual or electric start outboard motor that includes, as an accessory, the conventional off/on or off/on/start switch characteristic of most such systems. The lock is also designed to operate positive ignition engines, such as the inboard and inboard/outboard types.

About The Circuit. The Electronic Combination Ignition Lock is, as mentioned above, very similar in operation to its mechanical counterparts. Numbers must be "dialed in" in a set sequence to "open" the lock. (The lock does not actually open; instead, it actuates a battery of relay contacts.)

In the schematic diagram (Fig. 1), the combination for the prototype lock

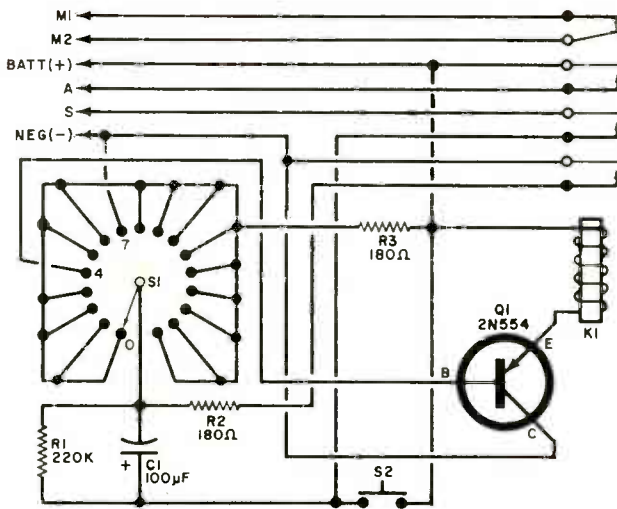

Fig. 1. Combination sequence is 7-4. Simple rewiring of S1 allows selection of any other two-digit combination desired.

PARTS LIST

C1—100- μ F, 15-volt electrolytic capacitor
 K1—4-p.d.t. 12-volt d.c. relay with 5-ampere contacts (Potter & Brumfield No. GA17D or similar)
 Q1—2N554 or IEP-230 transistor (Motorola)
 R1—220,000-ohm, $\frac{1}{2}$ -watt resistor

R2, R3—180-ohm, $\frac{1}{2}$ -watt resistor
 S1—17-position non-shorting rotary switch (Malory No. 31117) or similar
 S2—S.p.s.t. momentary-action pushbutton switch
 1— $2\frac{1}{4}$ " x $2\frac{1}{4}$ " x 4" aluminum utility box
 Misc.—Hardware, switch knob, hookup wire, solder, etc.

is 7-4, in that order. Any attempt to open the lock by feeding in a 4-7 combination will meet with frustration. Switch S1 is the combination dial; with it, the operator enters his combination. After each number, in its proper sequence, is dialed, momentary-action pushbutton switch S2 must be depressed to "program" the actuating circuit consisting of transistor Q1 and relay K1.

When 7 is dialed into the lock and S2 is momentarily closed, capacitor C1 charges up to approximately the supply voltage level. Then, when S1 is dialed to position 4 and S2 is again depressed, the charge on C1 is applied to the base of Q1, triggering into conduction the transistor, which energizes relay K1.

The operator has approximately ten seconds in which to dial in the second

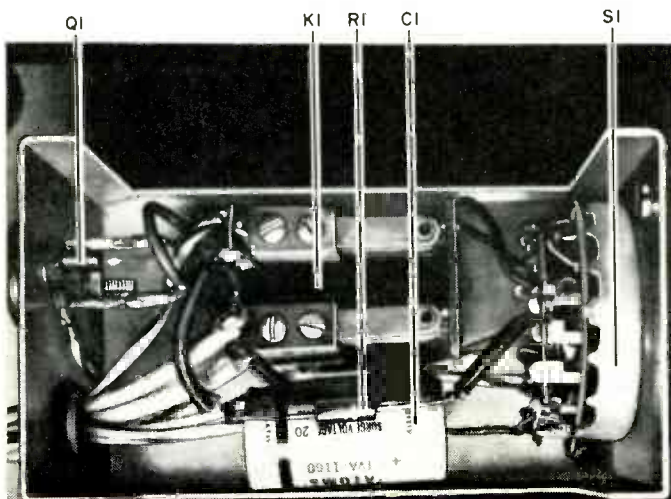

Fig. 2. After mounting components in small utility box or under dashboard, try to waterproof circuit to prevent relay and switch contact corrosion.

number after actuating the first to have the lock open. Any longer delay, including the depressing of *S2*, will allow the charge across *C1* to bleed off through *R1*, resulting in an insufficient potential to trigger on *Q1*.

As *Q1* conducts heavily and *K1* energizes, the top relay contacts open; the second, third, and fourth, in descending order, close to complete various functions. The lowest contacts supply a negative bias to the base of *Q1* via position 4 of *S1* continuously. The next set of contacts puts *S2* directly into the start solenoid circuit. The remaining set of closed contacts supplies power to the boat's accessories. The top contacts simply open the grounding circuit of the boat's motor magnetos. (Note: If the boat motor is an inboard or inboard/outboard type, eliminate the top contacts and let the second set of contacts supply power to the ignition and accessories.)

Now, to "close" the lock, all you need do is switch *S1* out of position 4. This will remove the bias from *Q1* and allow *K1* to deenergize immediately, shutting down all systems.

How To Install. Since the project is so simple, the only construction information necessary is shown in Fig. 2. This is only a suggested layout; if you wish, you can use your own ingenuity to house and mount the circuit. One thing, however, is worth pointing out: Do not put numerals at the knob pointer locations for *S1*'s positions. Plan to count the clicks instead. This will preserve the security of your lock combination if someone is watching you open it.

Now, referring to Fig. 1, connect the ground lead of your boat's magneto ground wire to the uppermost contacts of *K1* (if used). The remaining system wires connect to the other contacts on *K1* as indicated by the original key switch terminal markings. —30—

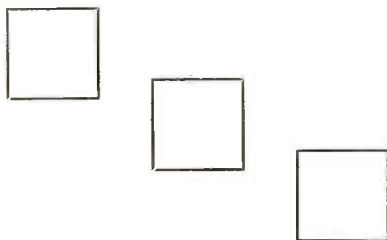

Every record you buy is one more reason to own a Dual.

If you think of your total investment in records—which may be hundreds, even thousands of dollars—we think you'll agree that those records should be handled with the utmost care.

Which brings us to the turntable, the component that actually handles your precious records and tracks their impressionable grooves with the unyielding hardness of a diamond.

For many years serious music lovers have entrusted their records to one make of automatic turntable Dual. In fact, nearly all professionals, including record reviewers, use a Dual in their own stereo component systems.

If you'd like to know why, just write. We'll send you an article from a leading music magazine that tells you what to look for in record playing equipment. We'll also send you a series of independent test reports on Dual.

When you read them, you'll know why Dual has made an impression on the experts and none on their records.



United Audio Products, Inc.
120 So. Columbus Avenue, Mt. Vernon, New York 10553.
Exclusive U.S. Distribution Agency for Dual

CIRCLE NO. 17 ON READER SERVICE CARD

tips & techniques

MECHANICAL PENCIL SOLDER HOLDER

For easy soldering in tight places, a draftsman's mechanical chuck pencil can come in handy. You simply load the chuck pencil with a 6" length of #16 solder. The chuck jaws, when the button is released, will grasp the solder and hold it firmly in place to form a working bit. Leave the solder bit straight, or bend it as required by the job. When the exposed solder is consumed, simply depress the chuck button until a convenient length of solder slides out. Keep a stock of 6" lengths of solder handy.

—Martin J. Leff

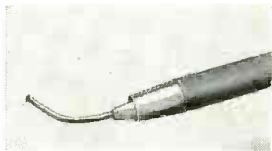

BRACKETS END SNARLED POWER CORDS

When storing Heathkit test equipment, it is often difficult to keep the power cord from sprawling all over the place. To solve this problem, you can drill two holes about half way through each end of the carrying handle and secure L brackets to the ends with self-tapping screws, or you can secure double-L brackets under the handle, anchoring them in place with the handle's mounting screws. To prevent the sharp edges of the brackets from chafing through the insulation of the power cord, slip some heat-shrinkable tubing over the brackets and shrink the tubing for a snug fit. Finally, wind the power cord around the handle as shown in the photo.

—Stephen LaFleur



REPAIRING DAMAGED PAINT FINISH

If the finish on one of your projects becomes marred during or after assembly, you can repair it quickly and easily. All you need is a small artist's paint brush and an aerosol spray paint of the same type and color as the one you used on the project originally. Spray a small amount of paint on the brush, and carefully work over the marred surface, using short, light strokes. Apply as many coats of paint as you feel are needed, but allow adequate drying time between each application. With a little practice and patience, you'll be surprised at how good a job you can do.

—Frank H. Tooker

TEMPLATE SPEEDS HOLE DRILLING

Orienting the mounting holes for irregularly shaped components, such as tuning capacitors, on a chassis can be time-consuming if you use ordinary measuring techniques. A much quicker and more direct approach is to line up the edges of a sheet of paper with the sides of the component, locate the holes through the paper by touch, and punch through the paper with a pencil as shown in the photo. Make sure the paper stays put as you punch the holes. Then flip the paper "template" over and mark the drilling points on the chassis.

—Robert E. Kelland

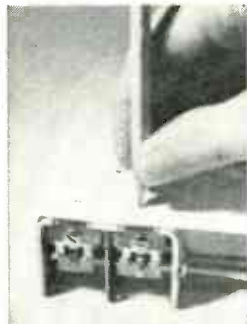

WANTED

THE RARE OR UNUSUAL TOOL YOU HAVE BEEN SEARCHING FOR

SPECIALISTS
IN TOOLS FOR
INTEGRATED
CIRCUITRY

24 HOUR
DELIVERY ON
MOST ITEMS

MORE THAN
5000 ITEMS

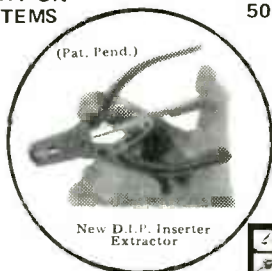

New D.I.P. Inserter
Extractor



FREE 1971
(160 Page)
CATALOG AND SUPPLEMENT

TECHNI-TOOL, INC.

1216 ARCH ST., PHILADELPHIA, PA.

(215) LO 8-4457

19107

CIRCLE NO. 15 ON READER SERVICE CARD

SUPER FLASH

(Continued from page 109)

is developed. Since the ability of the human eye to see a signalling device such as this is directly proportional to the amount of time that the lamp remains on, the on time can be set by adjusting dual potentiometer R2. Dual potentiometer R1 is adjusted to determine the flashing rate.

Almost any type of 6- or 7-watt, 117-volt lamp can be used with the Super Flash. However, don't use a Christmas-tree lamp that has its own built-in thermal flasher since it has a mind of its own about when it will go on and off. The best type of lamp (such as a 6S6) to use is that normally used on appliances where quite a bit of mechanical vibration is normally expected.

You may wonder why the lamp doesn't burn out rapidly. At each flash, the lamp is subjected to a considerable overvoltage and would indeed burn out if the duration of the power were for an appreciable length of time. The flashes are



Ferrule of bayonet socket protrudes through a hole in top of box and is fastened with machine screws.

so short, however, that the lamp has a chance to cool down between them. The brightness of the flash is due to the fact that a lamp rated at 117 volts delivers an increase in light of approximately 30% for every additional volt above its rating.

—30—

EXAMINE ANY OF THESE FINE NEW BOOKS ON 10-DAY FREE TRIAL!



ELECTRONICS PROJECTS & HOBBY BOOKS

- 125 One-Transistor Projects—192 pps.—\$3.95
- 104 Easy Projects for the Electronics Gadgeteer—\$3.95
- 64 Hobby Projects for Home and Car—192 pps.—\$3.95
- 104 Simple One-Tube Projects—192 pps.—\$3.95
- Electronic Hobbyist's IC Project Handbook—160 pps.—\$3.95
- Simple Transistor Projects for Hobbyists & Students—\$4.95
- Radio Control Handbook—New 3rd Ed.—320 pps.—\$5.95
- Radio-Electronics Hobby Projects—192 pps.—\$3.95
- TV, Radio & Hi-Fi Hints & Kinks—256 pps.—\$4.95
- 104 Easy Transistor Projects You Can Build—224 pps.—\$3.95

BASIC ELECTRONICS

- Basic Electronics Problems Solved—192 pps.—\$4.95
- How to Read Electronic Circuit Diagrams—210 pps.—\$3.95
- How to Use Your VOM-VTVM & Oscilloscope—192 pps.—\$3.95
- Beginner's Guide to TV Repair—176 pps.—\$3.95
- Fire and Theft Security Systems—176 pps.—\$4.95
- Electronics Self-Taught with Experiments & Projects—\$4.95

AMATEUR RADIO

- CB Radio Operator's Guide—224 pps.—\$3.95
- Amateur Radio Advanced-Class License Study Guide—\$3.95
- Ham Radio Incentive Licensing Guide—160 pps.—\$3.95
- 104 Ham Radio Projects for Novice & Technician—\$3.95
- VHF Ham Radio Handbook—176 pps.—\$3.95
- Extra-Class License Study Guide—224 pps.—\$4.95
- General-Class License Study Guide—320 pps.—\$5.95
- Novice-Class License Study Guide—160 pps.—\$3.95
- IC Projects for Amateur & Experimenter—\$3.95

COMPUTERS, BROADCAST, AUDIO & HI-FI

- Computer Circuits & How They Work—192 pps.—\$4.95
- Beginner's Guide to Computer Programming—384 pps.—\$6.95
- Computer Technician's Handbook—480 pps.—\$7.95
- CATV System Engineering—3rd Edition—Hardbound \$12.95
- The Man Behind the Mike—288 pps.—Hardbound \$7.95
- How to become a Radio Disc Jockey—256 pps.—\$7.95
- Guide to Radio-TV Broadcast Engineering Practice—Hardbound \$12.95
- Servicing Modern Hi-Fi Stereo Systems—236 pps.—\$4.95
- Handbook of Magnetic Recording—192 pps.—\$4.95
- Installing & Servicing Home Audio Systems—256 pps.—\$4.95
- Tape Recording for Fun & Profit—224 pps.—\$4.95
- Audio Systems Handbook—192 pps.—\$4.95
- Electronic Musical Instruments—192 pps.—\$4.95
- Servicing Electronic Organs—196 pps., 8 1/2 x 11—\$7.95

SEMICONDUCTORS & TEST EQUIPMENT

- Understanding Solid-State Circuits—192 pps.—\$4.95
- 1972 Popular Tube Transistor Substitution Guide—\$2.95
- Semiconductors From A to Z—272 pps.—\$4.95
- Electronic Test & Measurement Handbook—224 pps.—\$4.95
- The Oscilloscope: 3rd Edition—256 pps.—\$4.95
- How to Use Test Instruments in Electronics Servicing—\$4.95
- 99 Ways to Use Your Oscilloscope—192 pps.—\$4.95
- Working With the Oscilloscope—164 pps., 8 1/2 x 11—\$4.95
- How to Use Vectorscope Oscilloscopes & Sweep-Marker Generators—\$4.95

SERVICING COLOR TV, RADIO & APPLIANCES

- Beginner's Guide to TV Repair—176 pps.—\$3.95
- 199 TV Tough-Dog Problems Solved—256 pps.—\$4.95
- Jack Darr's Service Clinic No. 2—176 pps.—\$3.95
- Major Appliance Repair Guide—288 pps.—\$4.95
- Home-Call TV Repair Guide—144 pps.—\$2.95
- How to Repair Solid-State Imports—160 pps.—\$4.95
- Small Appliance Repair Guide—224 pps.—\$4.95
- 101 TV Troubles—From Symptom to Repair—224 pps.—\$4.95
- How to Repair Home & Auto Air Conditioners—208 pps.—\$4.95
- How to Fix Transistor Radios & Printed Circuits—\$4.95
- Easy Way to Service Radio Receivers—176 pps.—\$3.95
- On the Color TV Service Bench—192 pps.—\$4.95
- Color TV Servicing Manuals. Separate volumes on RCA, Zenith, Motorola, Philco, Magnavox, G.E. Sylvania, Admiral, Japanese. Each 8 1/2 x 11, 196 pps.—\$4.95.

SEE THESE HELPFUL BOOKS AT YOUR PARTS DISTRIBUTORS'. OR CLIP THIS AD and order on FREE 10-DAY Trial, or attach payment and save postage. Fully guaranteed or money back! EX-91



TAB BOOKS

BLUE RIDGE SUMMIT, PA. 17214

CIRCLE NO. 14 ON READER SERVICE CARD

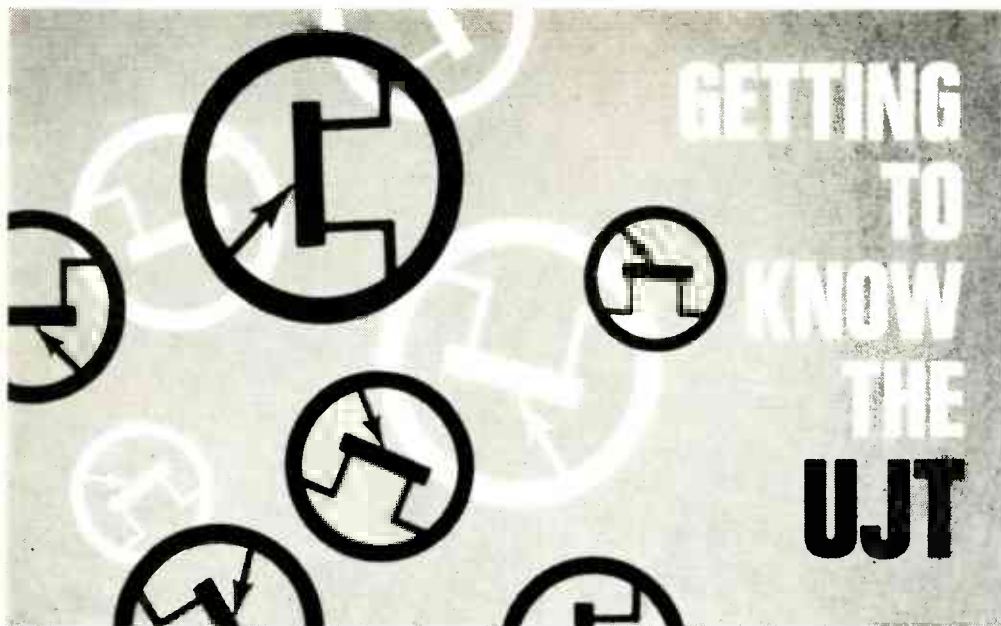

AN ALL-ROUND SIGNAL GENERATOR:
SAW-TOOTH, SQUARE-WAVE, SINE-WAVE

BY FRANK H. TOOKER

ALMOST EVERYONE who has an interest in electronics is aware of the existence of a device called the unijunction transistor, or UJT. (If he remembers it from its very beginning, he might recall that it was originally referred to as a "double-base diode.") The UJT is used most often in circuits requiring a positive-going spike pulse and, occasionally, as a generator of sawtooth waveforms.

However, the UJT is actually much more versatile than these two uses would imply. It can also be used to generate square waves and, believe it or not, sine waves having quite pure waveforms. It behooves the serious electronics experimenter to learn more about all of these uses—and to do so, he will need to know more about the UJT itself.

How the UJT Works. The UJT can be represented by a circuit approximation consisting of two resistances in series, with a diode connected at their junction as in Fig. 1. (Also shown in the figure is the accepted schematic symbol and base diagram for the UJT. Note that in

both cases the leads are identified as E, B1, and B2 for emitter, base-1, and base-2.) The resistance approximation is a *passive* representation of the UJT. In simple terms, this means that a pair of resistors and a diode connected as shown will *not* operate as a unijunction transistor. The approximation is simply a means by which operation of the UJT can be explained.

In the majority of applications, the

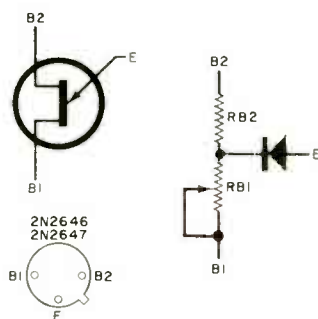

FIGURE 1

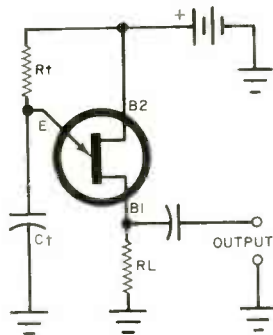

FIGURE 2

emitter is the control electrode of the UJT. The magnitude and polarity of a potential applied to the emitter determine whether or not the UJT will fire. With the emitter circuit open (diode non-conducting), resistance $RB1$ is maximum, and the sum of $RB1$ and $RB2$, called interbase resistance, is between 5000 and 10,000 ohms for the 2N2646 and 2N2647 (two typical, useful UJT's).

Resistance $RB1$ is shown variable be-

cause current flow in the emitter circuit causes a decrease in the ohmic value of this resistance. The greater the current flow, the lower the resistance. Hence, a UJT exhibits negative resistance, a characteristic that can be thought of as amplification. What actually happens inside the UJT is that current flowing into the E-to-B1 circuit "pulls" current carriers from the B2 area, increasing the circuit's conductance.

The supply voltage, usually applied through a series resistor, is connected across the interbase resistance, B1 to B2, with B2 positive with respect to B1. To fire the UJT, a positive potential (called the peak-point voltage) is applied to the emitter.

The ratio of $RB1$ to the interbase resistance is called η (Greek eta), or the intrinsic standoff ratio. The peak-point voltage is this ratio times the supply voltage plus the potential hill of the diode (about 0.5 volt). The voltage required for firing the UJT varies with the supply—in the same direction.

UJT Relaxation Oscillators. The schem-

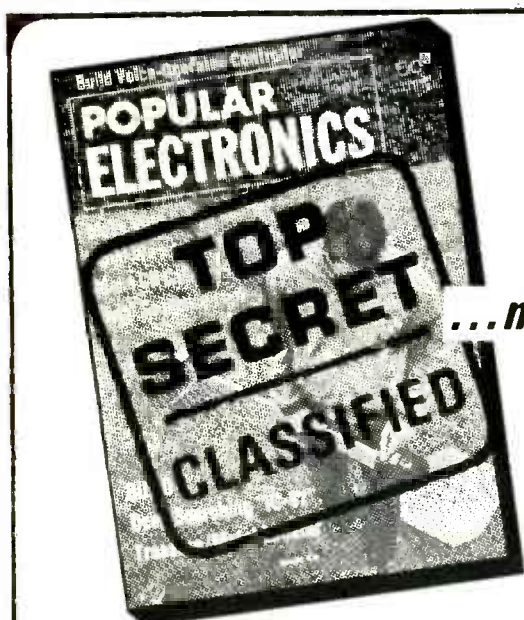

There's certainly nothing top secret about the classified pages in Popular Electronics Magazine. They're wide open to the searching eyes of every buyer who's in the market for the product or service that he knows can be found in Popular Electronics' Electronics Market Place.

The more than 371,000 buyers of Popular Electronics, largest readership of any electronics magazine in the world, are your guarantee of knowing that your ad is being read by people who are constantly looking for and buying electronics products. It is these people to whom you MUST direct YOUR advertising as do the many key advertisers appearing in this issue and in each issue throughout the year.

...not by a long shot it isn't!

No doubt about it—there's a vast market of buyers searching the classified advertising pages of Popular Electronics and it's important that your ad be exposed to this prime buying audience. Prove to yourself that the leading electronics magazine MUST ALSO be the leader in sales responses to the many classified ads presently enhancing its pages—it makes a great deal of sense—give it a try.

There's complete rate information for your convenience in the classified section of this issue. Or, if you'd like a little personal service, it's right up our alley. Just write to

HAL CYMES

Classified Advertising Manager

ZIFF-DAVIS PUBLISHING COMPANY

One Park Avenue • New York, New York 10016

atic diagram in Fig. 2, or some variation of it, is probably familiar to most experimenters. It is the one most commonly used circuits for relaxation oscillators by circuit designers.

Referring to the diagram, capacitor C_t charges up through resistor R_t at a rate determined by the RC time constant of these two components. The larger these values, the slower the charging rate. During the charging interval, the emitter junction is reverse biased, and the only current flowing in the emitter circuit is due to leakage (similar to the I_{co} of a bipolar transistor). Emitter leakage for the 2N2646 is a maximum of $2 \mu A$, and for the 2N2647, only $0.2 \mu A$.

When the potential across C_t reaches the value of peak-point voltage for the particular UJT being used in the circuit, the emitter junction goes suddenly into conduction. Using the UJT approximation shown in Fig. 1, R_{B1} promptly drops to a much lower value and C_t in Fig. 2 discharges abruptly through load resistor R_L , producing a spike pulse of voltage across the output terminals.

Capacitor C_t does not discharge to zero potential. Rather, it is discharged to a value determined by the series resistance between the emitter and ground and the magnitude of the discharge current. The actual value to which C_t discharges is termed the "valley voltage." When C_t discharges to this value, the emitter junction of the UJT becomes reverse biased again; then C_t begins to recharge, and the cycle repeats. The

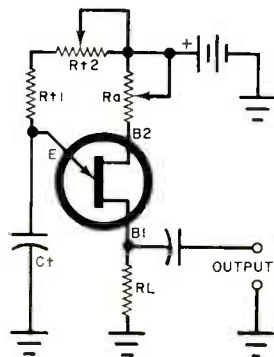

FIGURE 3

charge-discharge action of C_t produces a sawtooth waveform signal.

When It Doesn't Work. The operation of a UJT relaxation oscillator involves more than just raising the potential across timing capacitor C_t to the firing level. A certain value of current, called the "peak-point emitter current," is required to fire the unijunction transistor. This current must be supplied through timing resistor R_t (see Fig. 2). If the current through R_t is too low, capacitor C_t will charge to a value that is below the peak-point voltage, and operation will cease. The UJT will not fire. This need for sufficient emitter current becomes important when R_t must have a large value to operate the UJT at a very low repetition rate.

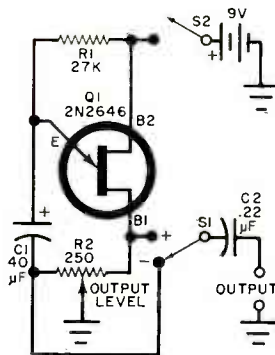

FIGURE 4

The peak-point emitter current for the 2N2646 is about $5 \mu A$; for the 2N2647 it is only $2 \mu A$. It is important to bear in mind that even though the 2N2647 is 2.5 times better than the 2N2646, if an electrolytic capacitor is used in the circuit, the leakage current of the capacitor has the same effect as an identical increase in the peak-point emitter current of the UJT. Consequently, care must be exercised in choosing a capacitor with the lowest leakage or the value of the 2N2647 might be lost.

Characteristics vary from one UJT to another, even for those with the same type number. Thus, if the relaxation oscillator is to have a definite repetition rate, the value of timing resistor R_t

should be made adjustable to allow you to "trim" the circuit to the desired frequency or repetition rate.

The circuit shown in Fig. 3 has trimming facilities. Varying the resistance of R_a varies the interbase voltage, thereby altering the peak-point voltage and, thus, the repetition rate. The value of potentiometer R_a in such a circuit should be limited to a maximum of 5000 ohms.

Negative-Pulse Generator. Pulses obtained at the B1 terminal of a UJT are positive-going. Negative-going pulses can be obtained from the B2 terminal when a resistor is connected between B2 and the positive side of the battery. Negative pulses can also be obtained from a resistor connected in series with the lower end of the timing capacitor.

The circuit shown in Fig. 4 provides a choice of either positive or negative pulses, depending on the setting of $S1$. Adjusting the setting of level control potentiometer $R2$ adds resistance to one of the two circuits, while it subtracts an equal amount of resistance from the other circuit. So, when $R2$ is set for maximum amplitude of a negative output pulse, resistance in the positive side of the circuit is zero, and vice versa. This gives the circuit maximum efficiency, providing maximum pulse amplitude in either direction.

The repetition rate of the circuit with the component values shown is about one

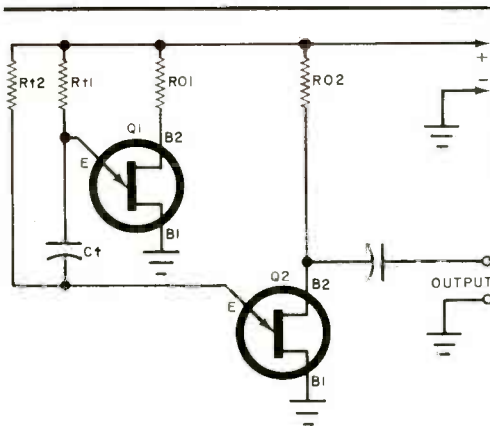

FIGURE 5

versatile new 14-Piece, 1/4" Sq. Drive socket wrench set drives fasteners 7 different ways



REVERSIBLE RATCHET — Precision made, long life, fully enclosed mechanism. Short handle swing for close quarter work.

UNIQUE SPINNER/EXTENSION — 5-3/4" over-all. Plastic (UL) handle with 1/4" sq. drive socket insert for ratchet. Use also as regular nutdriver.

2" DRIVE EXTENSION — Fits on ratchet or either end of spinner/extension.

RUGGED, HEAT TREATED, ALLOY STEEL SOCKETS — Nine for hex sizes 3/16" thru 1/2". Two dual purpose for hex and square sizes 1/4" and 5/16".

FREE STICK-ON INITIALS personalize the sturdy plastic case and help prevent loss or mix-up.

REQUEST
BULLETIN N770

No. 1001 SET

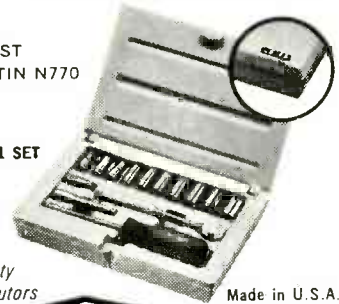

*nationwide availability
through local distributors*

Made in U.S.A.



XCELITE, INC. • 54 BANK ST., ORCHARD PARK, N.Y. 14127
Send Bulletin N770 on 1/4" Square Drive Socket Wrench Set.

name _____
address _____
city _____ state & zone _____

CIRCLE NO. 18 ON READER SERVICE CARD

pulse in every two seconds. This rate was selected to provide a useful instrument for checking experimental hookups

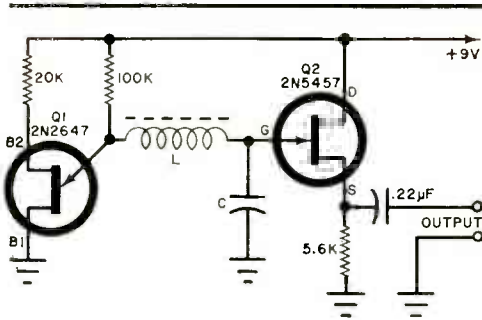

FIGURE 6

of JK flip-flops, SCR's, SCS's, and other pulse-operated devices.

Square-Wave Generator. The circuit of a square-wave generator (actually a dual-UJT multivibrator) is shown in Fig. 5. This circuit generates excellent square waves within the frequency range of efficient operation of the unijunction transistors.

When the power is applied to the dual-UJT circuit, both emitters are made positive with respect to ground through resistors $Rt1$ and $Rt2$. One UJT fires promptly, bringing both ends of the timing capacitor, Ct , to a value well below the peak-point voltage. This UJT remains conducting while Ct charges through the timing resistor of the other UJT circuit.

As soon as the second UJT's emitter becomes sufficiently positive with respect to ground, it suddenly conducts, driving the emitter of the first UJT negative and causing it to stop conducting. With the second UJT conducting and the first cut off, Ct starts charging in the opposite direction, through the timing resistor of the first UJT. Now, when the emitter of the first UJT becomes sufficiently positive, it fires, and the second UJT cuts off. The alternate-stage fire/cutoff cycle is self repeating whenever power is applied to the circuit, and the output of the system is a train of rectangular pulses.

Sine-Wave Generator. Sine waves are

produced by allowing a UJT circuit to charge and discharge a capacitor through an inductance. When the charge-discharge period is equal to the resonant frequency of the LC circuit, sine waves are generated across the capacitor. A schematic diagram of a UJT sine-wave generator is shown in Fig. 6.

The tuned circuit of the generator is made up of inductor L and capacitor C . Field effect transistor $Q2$ operates as a source follower to prevent loading down the tuned circuit; this stage is not otherwise essential to the operation of the oscillator as a sine-wave generator. The circuit shown has operated well up to 50,000 Hz.

The output of the sine-wave generator is obtained across $Q1$'s source resistor. The waveform here is cleanest when the ratio of inductance to capacitance is high.

Modulate a Relaxation Oscillator. A UJT relaxation oscillator can be frequency modulated by applying the modulating signal across a resistor in the B2 circuit as shown in Fig. 7. The waveform of the modulating signal can be sine, sawtooth, square, triangular, or irregular.

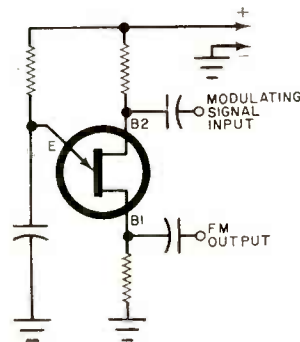

FIGURE 7

A practical example of a modulated UJT oscillator is shown in Fig. 8. This circuit is known as a "bell-tone" oscillator. In operation, $Q2$ and its associated components make up a relaxation oscillator which, when unmodulated, has an operating frequency of about 700 Hz. Unijunction transistor $Q1$ and its as-

sociated components make up a low-frequency astable multivibrator. The wave-form of the $Q1$ setup is not as good as that of the circuit in Fig 5, but it

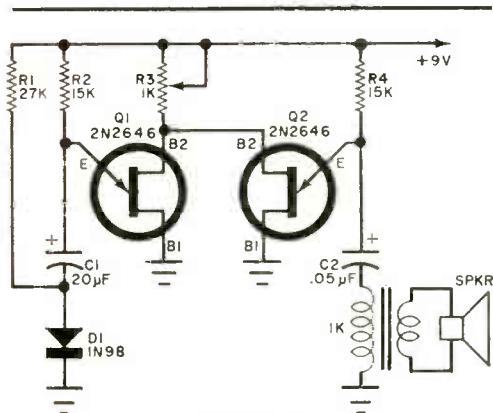

FIGURE 8

serves the purposes of the bell-tone oscillator well.

In the multivibrator, $C1$ charges through $R2$, while diode $D1$ is maintained in a forward conducting state by the charging current and the current through $R1$. When $Q1$ fires, reverse bias is applied to $D1$, and the diode appears as an open circuit. Transistor $Q1$ remains conducting while capacitor $C1$ discharges through resistor $R1$. At the end of this interval, $D1$ begins conducting again, $Q1$ cuts off, and the cycle repeats. The result is a rectangular signal across $R3$.

Since the B2's of $Q1$ and $Q2$ are tied together, each time $Q1$ fires, its B2 signal decreases the interbase voltage of $Q2$ and causes an increase in $Q2$'s operating frequency. As $Q1$ conducts and cuts off, the pitch of the sound heard from the loudspeaker rises and falls sharply, giving the sound a distinct bell-like quality. The speaker is preferably a small one, such as a 3" replacement type, to provide "tinny" reproduction. When working with the circuit, adjust potentiometer $R3$ to obtain the most pleasing sound.

-30-



Convert today! 4-CHANNEL SOUND



EV STEREO-4

compatible four channel

\$59.95

Enjoy the new 4-channel stereo records and 4-channel FM right now... and enhance the sound of your present stereo library. Just add this EVX-4 stereo decoder from Electro-Voice plus a stereo pair of speakers and amp to your present stereo system. Hear it today!

ELECTRO-VOICE, INC., Dept. 914EH
615 Cecil Street, Buchanan, Michigan 49107
In Europe: Electro-Voice, S.A., Lyss-Strasse 55,
2560 Nidau, Switzerland

Electro-Voice
a GULTON subsidiary

CIRCLE NO. 7 ON READER SERVICE CARD

INJECTORALL

NEW PHOTO-ETCH PRINTED CIRCUIT KIT FOR BEGINNER OR PROFESSIONAL!

You can make professional printed circuits first time, every time, with INJECTORALL'S new 650 photo-sensitive printed-circuit kit. Kit 650 is complete and uses a photographic method for producing professional quality printed circuits. No dark room needed. No need to depend on commercially made boards. Contains:

- two sensitized copper-clad boards • photographic test negative • ultra-violet light source. Plus — exposure glass, clamps, developer, etchant, trays, resist remover, drill and complete instructions. Materials are included to make negatives of magazine circuits. Ideal for solid-state and integrated circuits. Only \$10.80.



Available at all major distributors or write direct.
INJECTORALL ELECTRONICS CORP.,
Glen Cove, N.Y. 11542

CANADA: Canadian General Electric Ltd., Ontario.

CIRCLE NO. 10 ON READER SERVICE CARD

through the circuit board. Make these holes *small* since their only purpose is to serve as guide markers for drilling.

Your completed etching guide should look like the one shown in Fig. 5. Note that the guide employs the "area etch" technique. The minimum-width technique could just as easily have been employed.

From your etching guide, you can now determine exactly how large a copper-clad board is needed for your project. A good idea is to add about $\frac{1}{8}$ " to the length and width dimensions. -30-

FREQUENCY STANDARD

(Continued from page 136)

crystal mounting with matching socket.

You might have to experiment with grid resistors *R6* and *R9* to find the optimum values for proper operation of the multivibrator circuits. But the values shown in the schematic diagram and specified in the Parts List will be adequate in most cases. If not, start with the values specified and work from there.

How To Use. With both switches set to the off position, plug the line cord into an a.c. outlet. The heaters of both tubes should begin to glow. Now, close *S2*, leaving *S1* open, and tune your receiver to WWV on 2.5, 5, 10, or 15 MHz. Loosely couple the output of the frequency standard to your receiver's antenna and adjust *C1* to approximately midrange. Vary *C2* until the output of the frequency standard zero beats with the WWV signal. If necessary, touch up *C1* to obtain zero beat.

Remove the antenna lead from your receiver, and connect the output lead of the frequency standard in its place. Tune your receiver across the 3.5-4.0-MHz band; you should hear two markers, one at each end of the band. Now, close *S1* and again tune across the 3.5-4.0-MHz band, listening for markers. If you do not hear eleven markers (one at 3.5 MHz and every 50 kHz apart as you go up the band), adjust *R5* until you do. Since the setting is somewhat broad, adjust *R5* midway between its upper and lower drop-off settings. -30-

Hey!

Hams, Engineers, Hobbyists

MARK LIKE MAGIC



Any surface * * * * *
can be marked with
DATAK'S
DRY TRANSFER
titles and symbols.
The results are
professional,
it looks like the
finest printing!

Write for your **FREE**
SAMPLE and Catalog,
listing hundreds of
letter sheets and
symbol sets.

Order from your distributor or directly from:

THE DATAK CORPORATION

* From $\frac{1}{2}$ " K-64 $\frac{1}{4}$ " letters and numerals . . . \$1.50
Also available #9581 professional title set for electronic equipment . . . \$5.95

85 Highland Ave. / Passaic, New Jersey 07055

CIRCLE NO. 2 ON READER SERVICE CARD

ELECTRONIC EXPERIMENTER'S HANDBOOK WINTER 1972

READER SERVICE NO.	ADVERTISER	PAGE NO.
1	Allied Radio Shack	87, 88, 89
3	Cleveland Institute of Electronics	155, 156, 3rd Cover
2	Datak Corporation, The	153
4	EICO Electronic Instrument Co., Inc.	4th Cover
5	Edmund Scientific Co.	154
6	Edsyn	123
7	Electro-Voice, Inc.	151
8	Grantham School of Engineering	7
9	Heath Company	35, 36, 37
10	Injectorall Electronics Corp.	151
11	Lafayette Radio Electronics	69, 70
	National Radio Institute	1, 2, 3
12	Olson Electronics	121
13	Sams & Co., Inc., Howard W.	2nd Cover
14	Tab Books	145
15	Techni-Tool, Inc.	144
16	Tescom Corporation	118
17	United Audio Products, Inc.	143
18	Xcelite, Inc.	149

KEEP PACE WITH SPACE AGE! SEE MOON SHOTS—LANDINGS, SPACE FLIGHTS, CLOSE-UP!

AMAZING SCIENCE BUYS

for FUN, STUDY or PROFIT



VISUAL EFFECTS PROJECTOR SET

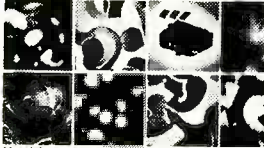

Dazzling, avant-garde visual effects. Fantastic variety. Incredibly beautiful. Special package offer contains all necessary apparatus. Color, floating, expanding, fiery bursts of color like "Symphony of Spheres," "Chronicle Starburst," "Cosmos (al Starburst)." Features: 35mm 300 W. fan cooled projector—produces big image at short distance. Accepts two 4" diam. wheels. (Dry) Kaleidoscope & Hexidoscope—2 cylindrical accessories. (6" Colored Cloud & 5" Hexidoscope w six internal mirrored walls). Complete instructions. Stock No. 71.212GD \$79.50 Ppd. DELUXE SET (with Kaleidoscope Lens) Stock No. 71.250GD \$99.50 Ppd.

NEW 18" BLACK-LIGHT STROBE

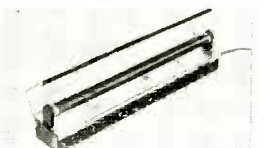

Stock No. 71.480GD \$42.95 Ppd.

It's a versatile strobe... and it's blacklight! Adjustable flash rate from as slow as 1 flash per second to a continuous glow beyond visual flicker perception (11,500 flashes a minute)—can be used as reg. light source. Top quality, solid state unit has hi-polish reflector, long lamp life. Ideal for parties, blacklight posters, combos, decoration and experiments. Includes 18" black-light tube, 4 1/2" h. cord. Approx. 3 X 5 1/2 X 18".

See moon shots, orbits, stars, craters!

NEW 3" ASTRONOMICAL REFLECTOR TELESCOPE

60 to 180X
DE-LUXE FEATURES
AT ECONOMY PRICE



- Amazingly priced Apollo Space Explorer brings the wonders of the universe up close. 3" aluminum & overcoated 4 1/2" mirror. Resolves theoretical limits of resolution & definition. 60X standard size 1 1/4" O.D. eyepiece. 1 1/2" F.L. 1X adjustable Barlow. 6X inverter telescope, high impact plastic fork mount w positive locking. 3/16" hardwood tripod. Included FREE: 272p. Handbook, Star Chart, Instructions. Best value ever!
- Stock No. 80.162GD \$59.50 Ppd.
REC. 3" REFLECTOR TELESCOPE Stock No. 85.050GD \$34.50 Ppd.
4 1/2" ASTRONOMICAL REFLECTOR TELESCOPE Stock No. 85.105GD \$94.50 Ppd.
6" ASTRONOMICAL REFLECTOR TELESCOPE Stock No. 85.086GD \$239.50 F.O.B.

INFRA RED SENSOR ALARM KIT

Make a sensor alarm w new low cost experimental kit. When infra red hits solid state sensor's A.S.C.R. light activated Silicon Controlled Rectifier it actuates the integrated circ. tone generator. Oscillators then amplified into loud speaker. Incls. 16ohm 2 1/2" dia. spkr., perf. blk. batt. clip & holder, 2 1/2" dia. plastic fiberoptics light pd. w infra red filter, wire, resistors, capacitors, transistor, NPN Regs., 4 AA cells, not incl. Instrs, w exps. & apps.

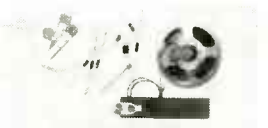

Stock No. 41.595GD \$6.95 Ppd.

PSYCHEDELIC LIGHTING HANDBOOK



100 information packed pages! Fully explains latest in psychedelic lighting equipment, techniques, developments. Covers all facets of psychedelic light-show production including strobes, black lights, projectors, crystals, organic slides, mirrors, color organs, polarized color, light boxes, Musicvision, etc. Shows how to "psychedelize" parties, musical groups, shows. 8 1/2" x 11" loose-leaf paper for 3 ring binder. Stock No. 9100GD \$3.00 Ppd.

NEW LIGHT-EMITTING-DIODE KIT



Stock No. 41.597GD \$5.95 Ppd.

Bargain kit ideal for economical experimenting with amazing L.E.D.s. Includes solid state monochromatic lamps that use low voltage DC, last up to 1MM hrs. Used in card-type readers, character recognition, hi-speed detectors. All kinds of electrical applications. Kit incl's: 3 L.E.D.s; gallium arsenide (MLED 600, MV 50, MLED 930); 2 visible red emitting (4000 A); 1 infra-red emitting (9000 A); 6 resistors; 1 20mm plastic fibre optic light pipe; instrs.

NEW! ELECTRONIC DIGITAL COMPUTER KIT!

Solve problems, play games, predict weather with this actual working model of giant electronic brains. Amazing new fun way to learn all about computer programming, logic, decimal, binary systems, laws of Sets—even do your own programming after completing simplified 116 page instructive booklet. Includes step-by-step assembly diagrams. Circuits easily changed. Resistor from illuminated control panel. Req. 2 "D" batt. (not incl.). Best model we've seen—for home, school, industry.



No. 71.434GD (11" X 12 1/2" X 4") \$31.50 Ppd.

ASTRONOMICAL TELESCOPE KITS



Stock No. 70.006GD \$52.50 FOB

Grind your own mirror for powerful telescopes. Kits contain fine annealed pyrex mirror blank, tool, abrasives, diagonal mirror, and eyepiece lenses. Instruments you build range in value from \$75 to hundreds of dollars. 4 1/2" DIAMETER—3 1/2" Thick Stock No. 70.003AV \$10.75 Ppd. 6" DIAMETER—1 1/2" Thick Stock No. 70.004AV \$13.95 Ppd. 8" DIAMETER—1 1/2" Thick Stock No. 70.005AV \$21.50 Ppd. 10" DIAMETER—1 1/2" Thick Stock No. 70.006AV \$52.50 FOB

Order by Stock No.—Check or M.O.—Money-Back Guarantee
EDMUND SCIENTIFIC CO., 300 EDCORP BLDG., BARRINGTON, N.J. 08007

WRITE FOR GIANT FREE CATALOG "GD"



Completely new 1972 edition. New items, categories, illustrations. 128 easy-to-read pages packed with 1000 unusual items, dozens of electrical and electronic parts, accessories. Enormous selection of Astronomical Telescopes, Microscopes, Binoculars, Magnifiers, Magnets, Lenses, Lasers, Prisms. Many new surplus items, for hobbyists, experimenters, workshops, factory. Write for catalog "GD." include Zip.

BLACK-LIGHT MIGHTY MITES

Relatively small (12") fixtures give surprisingly bright black light. Mirror-finished reflector makes instant starting 8-watt, high-intensity bulb look like 30-watt. Up to 5,000 hours of safe, long-wave (3660A) black-light to really turn-on parties, light & theatrical shows, psychedelic decors, holiday decorations. Shockproof end-caps remove for safe, easy replacement of bulb and starter. Stands upright or horizontal. Aluminum case.

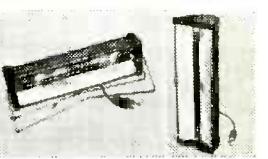

Stock No. 71.274GD \$14.95 Ppd.
DELUXE OUTDOOR INDOOR MODEL Stock No. 71.293GD \$19.95 Ppd.

AMAZING NEW Wankel Engine KIT!

Thrill to the fun of building your own see-through motorized model of revolutionary pistonless type engine, rights for which GM recently paid \$20 million! Only engine experts think economical—by modifying to meet new pollution standards. Replaces piston, cylinder, crank assemblies with rotating discs sections removed for firing chambers. Smaller than conventional fewer parts, greater reliability, same speed w less horsepower. Feat: flashing plugs, rubber fan belt, stick-shift on-off switch. Req. 2—1.5V batt. (not incl.).



No. 71.424GD (4 1/2" 5" x 9") \$6.75 Ppd.

EDMUND SCIENTIFIC CO. ORDER BY STOCK NUMBER • SEND CHECK OR MONEY ORDER • MONEY-BACK GUARANTEE
300 EDCORP BLDG. BARRINGTON, NEW JERSEY 08007

CIRCLE NO. 5 ON READER SERVICE CARD

How to get into one of today's hottest money-making fields—servicing 2-way radios!



He's flying high. Before he got his CIE training and FCC License, Ed Dulaney's only professional skill was as a commercial pilot engaged in crop dusting. Today he has his own two-way radio company, with seven full-time employees. "I am much better off financially, and really enjoy my work," he says. "I found my electronics lessons thorough and easy to understand. The CIE course was the best investment I ever made."



Business is booming. August Gibbemeyer was in radio-TV repair work before studying with CIE. Now, he says, "we are in the marine and two-way radio business. Our trade has grown by leaps and bounds."

More than 5 million two-way transmitters have skyrocketed the demand for service men and field, system, and R & D engineers. Topnotch licensed experts can earn \$12,000 a year or more. You can be your own boss, build your own company. And you don't need a college education to break in.

HOW WOULD YOU LIKE to earn \$5 to \$7 an hour...\$200 to \$300 a week...\$10,000 to \$15,000 a year? One of your best chances today, especially if you don't have a college education, is in the field of two-way radio.

Two-way radio is booming. Today there are more than five million two-way transmitters for police cars, fire trucks, taxis, planes, etc. and Citizen's Band uses—and the number is growing at the rate of 80,000 per month.

This wildfire boom presents a solid gold opportunity for trained two-way radio service experts. Most of them are earning between \$5,000 and \$10,000 a year more than the average radio-TV repair man.

Why You'll Earn Top Pay

The reason is that the U.S. doesn't permit anyone to service two-way radio systems unless he is licensed by the FCC (Federal Communications Commission). And there aren't enough licensed experts to go around.

This means that the available licensed expert can "write his own ticket" when it comes to earnings. Some work by the hour and usually charge at least \$5.00 per hour, \$7.50 on evenings and Sundays, plus travel expenses. Others charge each customer a monthly retainer fee, such as \$20 a month for a base station and \$7.50 for each mobile station. A survey showed that one man can easily

maintain at least 15 base stations and 85 mobiles. This would add up to at least \$12,000 a year.

How to Get Started

How do you break into the ranks of the big-money earners in two-way radio? This is probably the best way:

1. Without quitting your present job, learn enough about electronics fundamentals to pass the Government FCC License. Then get a job in a two-way radio service shop and "learn the ropes" of the business.

2. As soon as you've earned a reputation as an expert, there are several ways you can go. You can move out, and start signing up your own customers. You might become a franchised service representative of a big manufacturer and then start getting into two-way radio sales, where one sales contract might net you \$5,000. Or you may be invited to move up into a high-prestige salaried job with one of the same manufacturers.

The first step—mastering the fundamentals of Electronics in your spare time and getting your FCC License—can be easier than you think.

Cleveland Institute of Electronics has been successfully teaching Electronics by mail for over thirty years. Right at home, in your spare time, you learn Electronics step by step. OUR AUTO-PROGRAMMER® lessons and coaching by expert instructors make everything clear and easy, even for men who thought they were "poor learners."

Your FCC License... or Your Money Back!

By the time you've finished your CIE course, you'll be able to pass the FCC License Exam with ease. Better than nine out of ten CIE graduates are able to pass the FCC Exam, even though two out of three non-CIE men fail. This startling record of achievement makes possible our famous FCC License Warranty: you'll pass the FCC Exam upon completion of your course or your tuition will be refunded in full.

Find out more. Mail the bound-in post-paid card for two FREE books, "How To Succeed In Electronics" and "How To Get A Commercial FCC License." If card has been detached, use coupon below.

ENROLL UNDER NEW G.I. BILL

All CIE courses are available under the new G.I. Bill. If you served on active duty since January 31, 1955, or are in service now, check box on card for G.I. Bill information.

CIE Cleveland Institute of Electronics

1776 East 17th Street, Cleveland, Ohio 44114

Please send me without cost or obligation:

1. Your 44-page book "How To Succeed In Electronics" describing the job opportunities in Electronics today, and how your courses can prepare me for them.
2. Your book on "How To Get A Commercial FCC License."

Name _____ Age _____

(PLEASE PRINT)

Address _____

City _____ State _____ Zip _____

Accredited Member National Home Study Council **EH-11**

CIRCLE NO. 3 ON READER SERVICE PAGE

Be creative—and thrifty too!

Save up to 50% with EICO Kits and Wired Equipment.

NEW "TREASURE HUNTER" KIT

Finds metals, pipes several inches underground. EICO TH-30 Solid State Treasure Hunter locates iron, steel, tin, gold, silver, copper etc. Beep pitch increases as you near object.

Battery operated. \$29.95.



NEW "BULLHORN" KIT

Carries your voice up to 400 feet. EICO BH-16 Solid State Bullhorn. 2½ lbs. light, is perfect for all outdoors, camping, sports. Battery operated. \$15.95.



NEW EICOCRAFT

The electronic science project kits for beginners, sophisticates, educators. 42 kits to date.



8 NEW EICOCRAFT KITS

Automotive "LIGHTGUARD" • "VARIVOLT" DC Power Supply • "MOODLITE" Light Dimmer Control • "VARASPEED" Motor Speed Control • "LIGHTSHOW" Sound/Lite Translator • "ELECTRIC FIESTA" Audio Color Organ • "SUPER MOODLITE" Remote Control Light Dimmer • "ELECTROPLATER" From \$2.50 to \$14.95.

NEW "FLEXI-CAB"

Build your own custom designed cabinet in minutes! Give your EICOCRAFT and other projects that finished professional look with decor-styled FLEXI-CAB vinyl clad steel cabinets. Fast, easy, push-together assembly. 3-sizes from \$3.49.

COLOR IMAGES

Electronic Art in Motion.

"CHROMA-CUBE"

Classic white 18" Cube features a fantastic audio-responsive light display.

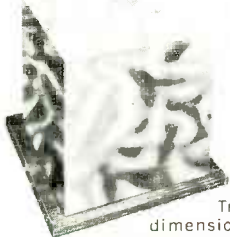

"CELESTIAL LITES"

Constantly flowing color images move in rhythm to music. 24" x 24" x 6".

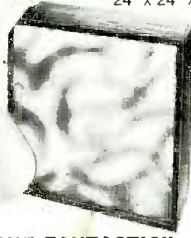

"LIGHT FANTASTIC"

Translucent dome provides 3-dimensional world of ever changing light patterns in response to music. 38" high.

NEW Cortina2 STEREO KITS

The lowest-priced component quality high fidelity!



EICO 3780 50-Watt Silicon Solid State FET AM-FM Stereo Receiver. Kit \$109.95, Wired \$169.95



EICO 3080 50-Watt Silicon Solid State Stereo Amplifier. Kit \$69.95, Wired \$109.95



EICO 3300 Silicon Solid State FET AM-FM Stereo Tuner. Kit \$69.95, Wired \$109.95

NEW SOLID STATE TEST INSTRUMENTS

The first and only solid-state test equipment guaranteed for 5 years!



EICO 240 Solid State FET-TVM. Kit \$59.95, Wired \$79.95.
EICO 379 Solid State Sine/Square Wave Generator. Kit \$69.95, Wired \$99.95
EICO 242 Solid State FET-TVOM. Kit \$69.95, Wired \$94.50.
EICO 150 Solid State Signal Tracer. Kit \$49.95, Wired \$69.95.
EICO 330 Solid State RF Signal Generator. Kit \$59.95, Wired \$89.95

FREE 1971 EICO CATALOG

Send me FREE catalog describing the full EICO line of 200 best buys, and name of nearest dealer.

Name _____
Address _____
City _____ State _____ Zip _____

EICO Electronic Instrument Co., Inc. 283 Santa Monica Boulevard, Los Angeles, CA 90001
www.americanradiohistory.com

NOW YOU CAN SEE THE MUSIC YOU HEAR

Sound n' Color

Color Organs, Translators, Strobes



COLOR ORGANS

The new dimension to music pleasure.

EICO all electronic solid-state Audio-Color Organs transform sound waves into moving synchronized color images.

MODEL 3450 Giant (30" x 12" x 10") 4-Channels. Kit \$79.95, Wired \$109.95.

MODEL 3445 (24" x 12" x 10") 4-Channels. Kit \$64.95, Wired \$99.95.

MODEL 3440 (10" x 15" x 16") 3-Channels. Kit \$49.95. Wired \$79.95. Other models to choose, from \$19.95 and up.

TRANSLATORS

The electronics you need to create audio-stimulated light displays.



MODEL 3460 1 Channel. Kit \$24.95, Wired \$39.95.

MODEL 3465 3 Channel. Kit \$49.95, Wired \$69.95.

STROBE LITES

Burst of white light flash in cadence of each beat of audio.

Model 3470 Adjustable Rate. Kit \$29.95, Wired \$39.95.

Model 3475 Audio Actuated. Kit \$39.95, Wired \$59.95.



AUTOMOTIVE

EICO 889 Solid State Capacitive Ignition System.

Boost gas mileage up to 25%, life of points, plugs to 100,000 miles; Kit \$29.95, Wired, \$39.95.



EICO 888 Solid State Universal Engine Analyzer. Tunes and troubleshoots your car/boat engine, the totally professional way. Kit \$54.95, Wired \$79.95