

1991 **ELECTRONICS** **HOBBYISTS** **handbook**™

DOZENS OF PROJECTS AND KITS

- **BUILD A MINI GEIGER COUNTER**
Find and measure nuclear radiation!
- **STEREO AMPLIFIER**
Its 20 watts per channel packs a punch.
- **WHEEL OF FORTUNE**
Create your own version of the popular TV game show.
- **ELECTRONIC SLOT MACHINE**
Realistic slot-machine action.
- **LIGHTNING BOLT STROBE LIGHT**
A brilliant xenon strobe turns your basement into a disco!
- **QUIZ MASTER**
Add a touch of professionalism to quiz games.
- **PHOTO STROBE TRIGGER**
You can take better pictures today!
- **CAR BATTERY/ALTERNATOR MONITOR**
Keep tabs on your car's charging system so you don't get stranded.



HIGH-TECH FUN

- **COLOR ORGAN**
Add 3 channels of colored lights to your music
- **SOUND SYNTHESIZER**
Make sound effects—or even music!
- **SIMULATED LASER**
Experiment safely with laser concepts.
- **SUPER BURGLAR CHASER**
Protect yourself with a powerful blast of sound.
- **INSANITY ALARM**
You can hear it—but can you find it?
- **BATTERY TESTER KIT**
Is that drawer-full of batteries good?
- **TELEPHONE AMPLIFIER**
Now everyone can hear the conversation.
- **ELECTRONIC HOLD BUTTON**
Place any call on hold.
- **AC OUTLET TESTER**
Are your outlets working?
- **METAL LOCATOR**
Find buried treasure!
- **MOISTURE DETECTOR**
Get an early warning to a flooded basement.
- **ULTRASONIC PEST REPELLER**
Keep pests away without chemicals!



\$3.50 U.S.
\$3.95 CAN

FREE

2 ROLLS 35mm Film

*Rave Reviews
from the
Photo Magazines*

Try this Exciting New Film!
"While (this film) has sharpness
and fine grain competitive with
other films of its speed, its main
forte is color reproduction.
Nuances of color
are held in the
prints; You can see the
difference between
cherry red and tomato red"
Photographic Magazine

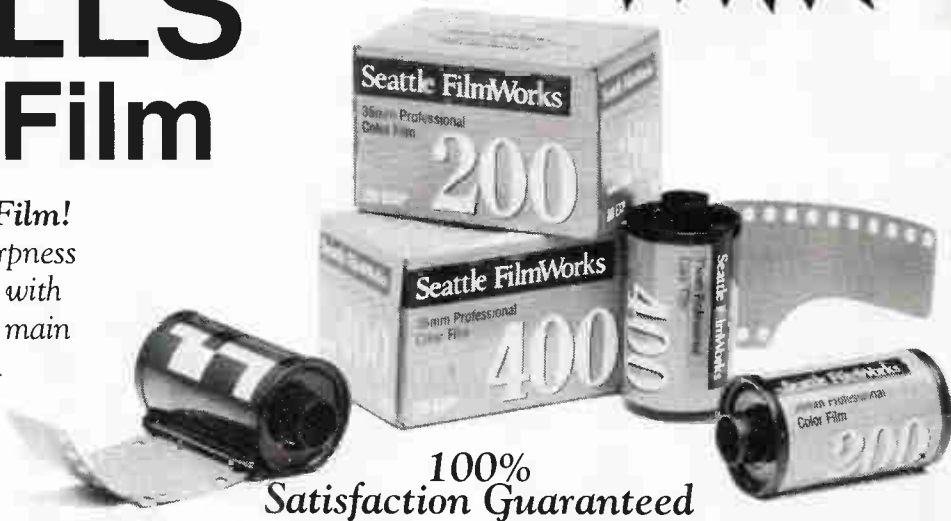

**100%
Satisfaction Guaranteed**

Now you can try the 35mm film *Photographic Magazine* calls the best 200 ASA print film in the World! For Free. To introduce you, we'll send you two rolls Free. Fine grain, rich color, wide exposure latitude — perfect for everyday shots. Shoot in bright or low light — indoors or outdoors. And you can order prints, slides, or both, from the same roll — without the high cost of slide film! Try this remarkable film today.

**Prints or
Slides
from
the same
roll**

SEND ME 2 ROLLS FREE!

Rush me two 20-exposure rolls of your highly acclaimed 35mm film, one each at 200ASA and 400 ASA. Enclosed is \$2.00 for shipping. Limit 2 rolls per household.

FIRST NAME

LAST NAME

ADDRESS

CITY

STATE

ZIP

Mail to: Seattle FilmWorks
1260 16th Ave. W.
P.O. Box 34056
Seattle, WA 98124-1056

24526

©1991 Seattle FilmWorks. Free film offer does not include developing. Process SFW-XL.



1991 **ELECTRONICS**

HOBBYISTS

handbook TM

Popular
Electronics[®]

EDITORIAL	2
KIT-BUILDING HINTS	52
ORDER FORM	96

SKILL LEVEL 1

MOISTURE DETECTOR	12
TELEPHONE AMPLIFIER	22
INSANITY ALARM	31
ELECTRONIC TELEPHONE HOLD BUTTON	33
FANTASTIC SIMULATED LASER	42
BATTERY TESTER	44
CAR BATTERY AND ALTERNATOR MONITOR	63
METAL LOCATOR	71
PHOTO STROBE SLAVE TRIGGER	73
INFRARED REMOTE-CONTROL TESTER	75
SPACE-AGE SOUND MACHINE	77
POOR MAN'S LIE DETECTOR	89
BATTERY-OPERATED BLACK LIGHT	93

SKILL LEVEL 2

SUPER LED FLASHER	10
AC OUTLET TESTER	14
SUPER BURGLAR CHASER	19
3-CHANNEL COLOR ORGAN	24
0 - 12-VOLT, 1-AMP VARIABLE POWER SUPPLY	28
10-NOTE SOUND SYNTHESIZER	40
TIC-TIC-BOOM!	57
BUILD YOUR OWN GEIGER COUNTER	59
20W + 20W STEREO AMP	65
ULTRASONIC PEST REPELLER	69
120VAC SHIMMERING LIGHT	82
13.8VDC 2 AMP REGULATED POWER SUPPLY	83
PROXIMITY ALARM	85

SKILL LEVEL 3

WHEEL OF FORTUNE	4
ELECTRONIC SLOT MACHINE	36
QUIZ MASTER	47
LIGHTNING BOLT STROBE PROBE	54
LIGHT SEQUENCER	79

As a service to readers, **1991 Popular Electronics Electronics Hobbyists Handbook** publishes available plans or information relating to newsworthy products, techniques and scientific and technological developments. Because of possible variances in the quality and condition of materials and workmanship used by readers, we disclaim any responsibility for the safe and proper functioning of reader-built projects based upon or from plans or information published in this magazine.

Since some of the equipment and circuitry described in **1991 Popular Electronics Electronics Hobbyists Handbook** may relate to or be covered by U.S.

patents, we disclaim any liability for the infringement of such patents by the making, using, or selling of any such equipment or circuitry, and suggests that anyone interested in such projects consult a patent attorney.

1991 Popular Electronics Electronics Hobbyists Handbook is published annually by Gernsback Publications Inc. All rights reserved. Printed in U.S.A. Single copy price \$3.50, Canada \$3.95 (includes G.S.T. Canadian Goods and Services Tax regulation No. R125166280). ©Copyright Gernsback Publications Inc., 1991.

Larry Steckler
EHF, CET

Editor-in-Chief and Publisher

EDITORIAL DEPARTMENT

Brian C. Fenton
Handbook Editor

Carl Laron
Editor

Teri Scaduto
Associate Editor

Robert A. Young
Associate Editor

John J. Yacono
Associate Editor

Byron G. Wels, K2AVB
Associate Editor

Kathy Terenzi
Editorial Assistant

Marc Spiwak
Editorial Associate

Fred Blechman

Joseph J. Carr, K4IPV
Marc Ellis

Len Feldman

Jeffrey K. Holtzman

Don Jensen

Charles D. Rakes

Marc Saxon

Contributing Editors

PRODUCTION DEPARTMENT

Ruby M. Yee
Production Director

Karen S. Brown
Production Manager

Marcella Amoroso
Production Assistant

Janice Box
Editorial Production

ART DEPARTMENT

Andre Duzant
Art Director

Injae Lee
Illustrator

Russell C. Truelson
Illustrator

Jacqueline P. Cheeseboro
Circulation Director

Michele Torrillo
P-E Bookstore

BUSINESS AND EDITORIAL OFFICES

Gernsback Publications, Inc.
500-B Bi-County Blvd.
Farmingdale, NY 11735
1-516-293-3000
Fax: 1-516-293-3115
President: Larry Steckler
Vice President: Cathy Steckler

Advertising Sales offices listed on page 100

Cover photography by Nick Koudis

Composition by
Bri-Ter Editorial and
Mates Graphics

 The
Audit
Bureau
of Circulation



The publisher has no knowledge of any proprietary rights which will be violated by the making or using of any items disclosed in this issue.

Editorial

KIT BUILDING IS ALIVE AND WELL AND LIVING IN POPULAR ELECTRONICS!

We hear it all the time: "No one wants to build electronic kits anymore." We answer, "Balderdash!"

It's true that electronic projects aren't as popular as they once were. There are a lot of reasons for that. There are a lot more diversions for the technically inclined hobbyist -- computers, for example. Also, with today's robotic manufacturing, very little human labor goes into producing a finished product, so kit building doesn't offer the economic advantages that it did in the past.

Other complaints that project builders have are that parts are sometimes hard to come by. Large manufacturers don't want to sell small quantities of parts to individuals. And rarely are all parts available from a single source.

Well, we at *Popular Electronics* have done something to answer all those complaints. We've teamed up with *The Electronic Goldmine*, one of the leading suppliers of small electronic kits to bring you thirty fun and useful projects. Every project shown in this issue is available as a complete kit, from a single source, and at a reasonable price.

Projects range from simple ones that are perfect for first-time kit builders, to more complex kits for the experienced hobbyist. And, since we provide complete schematics, printed-circuit patterns, and the theory behind the circuit operation, you can adapt the circuits to meet your own needs.

We feel we've given our best effort to encourage the resurrection of electronic kit building. Now it's up to you to pick up this magazine, pick out a kit (or two), pick up your soldering iron, and put kit building back on the map!

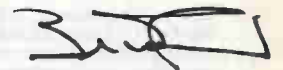

Brian C. Fenton
PE Handbook Editor

SELECT 5 BOOKS for only \$4.95

(values to \$127.70)

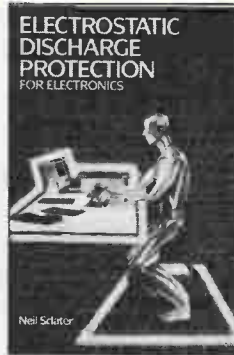
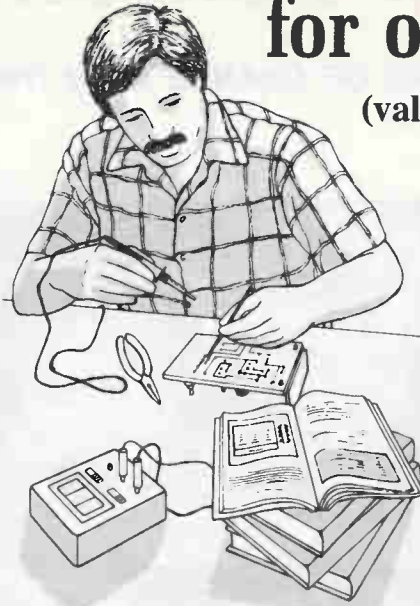

3329 \$29.95
Counts as 2

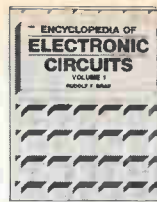

1938 \$60.00
Counts as 3



2867P \$18.95



2987P \$16.95



3360 \$29.95
Counts as 2



3445 \$21.95



2995 \$25.95

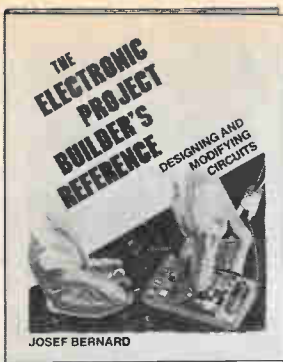

3260 \$22.95



10010P \$19.95



3321P \$16.95



2826P \$16.95

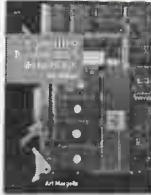

3279 \$36.95
Counts as 2



3031P \$17.95

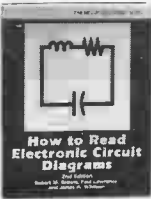

2880P \$14.95



3267P \$16.95



3342 \$25.95
Counts as 2



3205 \$24.95



2707P \$17.95



2800P \$16.95



2613P \$17.95

Your most complete source for electronics books for over 25 years.



3258 \$27.95
Counts as 2



3107P \$18.95



2865P \$14.95



3219 \$27.95
Counts as 2

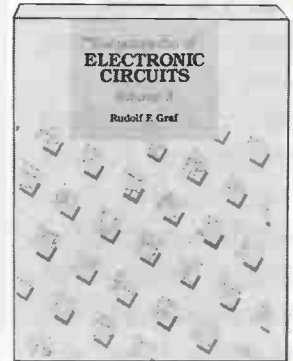

3138 \$60.00
Counts as 3

Membership Benefits • Big Savings. In addition to this introductory offer, you keep saving substantially with members' prices of up to 50% off the publishers' prices. • **Bonus Books.** Starting immediately, you will be eligible for our Bonus Book Plan, with savings of up to 80% off publishers' prices. • **Club News Bulletins.** 15 times per year you will receive the Book Club News, describing all the current selections—mains, alternates, extras—plus bonus offers and special sales, with scores of titles to choose from. • **Automatic Order.** If you want the Main Selection, do nothing and it will be sent to you automatically. If you prefer another selection, or no book at all, simply indicate your choice on the reply form provided. You will have at least 10 days to decide. As a member, you agree to purchase at least 3 books within the next 12 months and may resign at any time thereafter. • **Ironclad No-Risk Guarantee.** If not satisfied with your books, return them within 10 days without obligation! • **Exceptional Quality.** All books are quality publishers' editions especially selected by our Editorial Board.

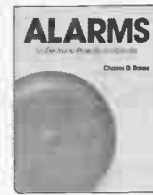

2996P \$13.95

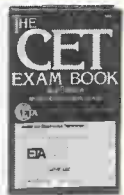

2950P \$13.95



3270 \$32.95
Counts as 2



2926 \$25.95



1897P \$15.95



2883P \$17.95



ELECTRONICS BOOK CLUB

Blue Ridge Summit, PA 17294-0810

Please accept my membership in the Electronics Book Club and send the 5 volumes listed below, billing me \$4.95. If not satisfied, I may return the books within ten days without obligation and have my membership cancelled. I agree to purchase at least 3 books at regular Club prices during the next 12 months and may resign any time thereafter. A shipping/handling charge and sales tax will be added to all orders.

Name _____

Address _____

City _____

State _____ Zip _____ Phone _____

Valid for new members only. Foreign applicants will receive special ordering instructions. Canada must remit in U.S. currency. This order subject to acceptance by the Electronics Book Club. PEX491

All books are hardcover unless number is followed by a "P" for paperback.

(Publishers' Prices Shown)
©1991 ELECTRONICS BOOK CLUB

RUSH POSTAGE-PAID CARD FOR YOUR FREE CATALOG!



**CHECK
ONE**

Please send my free catalog
on NRI training in:

Every NRI course features practical,
hands-on training with state-of-
the-art equipment you keep.

Only NRI gives you the
training *and* the
equipment for career
advancement, part-
time earnings, or
even a business of
your own.



For G.I. Bill approved
courses, check here

- Microcomputer Servicing
- Computer Programming
- TV/Video/Audio Servicing
- Telecommunications
- Industrial Electronics & Robotics
- Digital Electronics Servicing
- Radio Communications (FCC)
- Cellular Telephone Technology
- Security Electronics
- Electronic Music Technology
- Basic Electronics
- PC Systems Analysis
- PC Software Engineering Using C
- Desktop Publishing & Design
- Bookkeeping and Accounting
- Paralegal
- Fiction/Nonfiction Writing
- Building Construction & Remodeling
- Air Conditioning, Heating, & Refrigeration
- Electrician
- Locksmithing
- Small Engine
- Automotive Servicing

Name Age
(Please Print)

Street *(No P.O. Box numbers please)*

City State Zip

Accredited Member, National Home Study Council



NO POSTAGE
NECESSARY
IF MAILED
IN THE
UNITED STATES

BUSINESS REPLY MAIL
FIRST CLASS MAIL PERMIT NO. 10008 WASHINGTON, D.C.

POSTAGE WILL BE PAID BY ADDRESSEE



McGraw-Hill Continuing Education Center
4401 Connecticut Avenue, NW
Washington, D.C. 20077-3543



5 sure steps to a fast start as a high-paid computer service technician

1. Choose training that's right for today's good jobs

Jobs for computer service technicians will almost double in the next 10 years, according to the latest Department of Labor projections. For you, that means unlimited opportunities for advancement, a new career, or even a computer service business of your own.

But to succeed in computer service today, you need training—complete, practical training that gives you the confidence to service any brand of computer. You need NRI training.

Only NRI—the leader in career-building, at-home electronics training for more than 75 years—gives you practical knowledge, hands-on skill, and real-world experience with a powerful AT-compatible computer you keep. Only NRI starts you with the basics, then builds your knowledge step by step until you have everything you need for a fast start as a high-paid computer service technician.

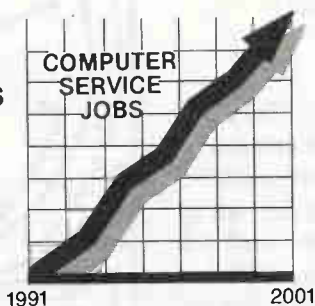

Plus, now you train with and keep the latest in diagnostic hardware and software: the R.A.C.E.R. plug-in diagnostic card and QuickTech diagnostic software, both from Ultra-X. Using these state-of-the-art diagnostic tools, you learn to quickly identify and service virtually any computer problem on IBM-compatible machines.

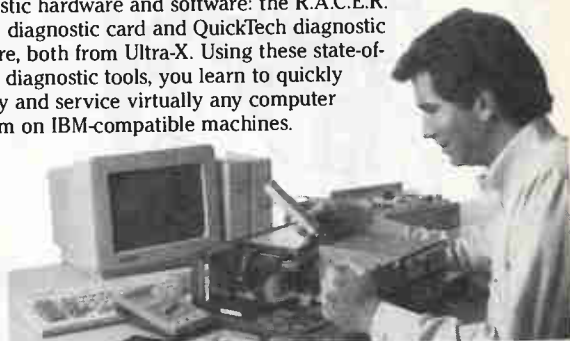

4. Make sure you've always got someone to turn to for help



Throughout your NRI training, you've got the full support of your personal NRI instructor and the entire NRI technical staff. Always ready to answer your questions and help you if you should hit a snag, your instructors will make you feel as if you're in a classroom of one, giving you as much time and personal attention as you need.

5. Step into a bright new future in computer service—start by sending for your FREE catalog today!

Discover for yourself how easy NRI makes it to succeed in computer service. Send today for NRI's big, 100-page, full-color catalog describing every aspect of NRI's one-of-a-kind computer training, as well as training in robotics, TV/video/audio servicing, electronic music technology, security electronics, and other growing high-tech career fields.

If the coupon is missing, write to: NRI School of Electronics, McGraw-Hill Continuing Education Center, 4401 Connecticut Avenue, NW, Washington, DC 20008. R.A.C.E.R. and QuickTech are registered trademarks of Ultra-X, INC.



2. Go beyond "book learning" to get true hands-on experience

NRI knows you learn better by doing. So NRI training works overtime to give you that invaluable practical experience. You first read about the subject,

studying diagrams, schematics, and photos that make the subject even clearer. Then you do. You build, examine, remove, test, repair, replace. You discover for yourself the feel of the real thing, the confidence gained only with experience.

3. Get inside a powerful computer system

If you really want to get ahead in computer service, you have to get inside a state-of-the-art computer system. That's why NRI includes the powerful new West Coast 1010 ES computer as the centerpiece of your hands-on training.

As you build this fully IBM AT-compatible micro from the keyboard up, you actually see for yourself how each section of your computer works. You assemble and test your computer's "intelligent" keyboard, install the power supply and high-density floppy disk drive, then interface the high-resolution monitor. But that's not all.

You go on to install a powerful 20 megabyte hard disk drive—today's most-wanted computer peripheral—included in your course to dramatically increase the data storage capacity of your computer while giving you lightning-quick data access.



Now—
AT Compatible!

NRI Schools

McGraw-Hill Continuing Education Center
4401 Connecticut Avenue, NW, Washington, DC 20008

CHECK ONE CATALOG ONLY

- | | |
|--|--|
| <input type="checkbox"/> Microcomputer Servicing | <input type="checkbox"/> Computer Programming |
| <input type="checkbox"/> TV/Video/Audio Servicing | <input type="checkbox"/> PC Systems Analysis |
| <input type="checkbox"/> Telecommunications | <input type="checkbox"/> PC Software Engineering Using C |
| <input type="checkbox"/> Industrial Electronics/Robotics | <input type="checkbox"/> Desktop Publishing & Design |
| <input type="checkbox"/> Basic Electronics | <input type="checkbox"/> Bookkeeping & Accounting |

Name _____

Address _____

City _____ State _____ Zip _____

Accredited Member, National Home Study Council

9-051

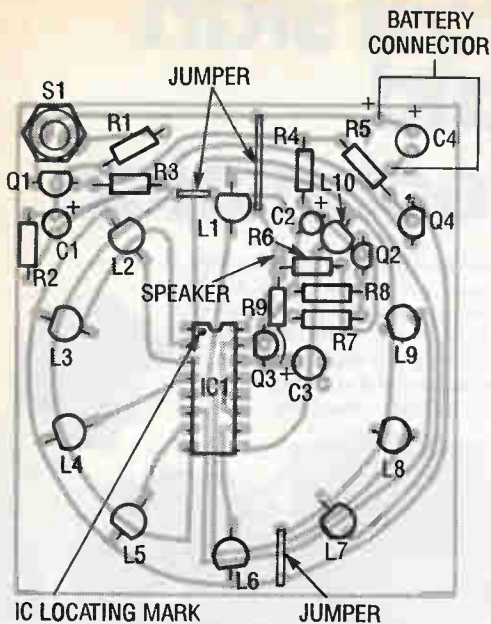

Figure 2. The kit is not difficult to build, but because so many polarized components are used, you have to be extra careful!

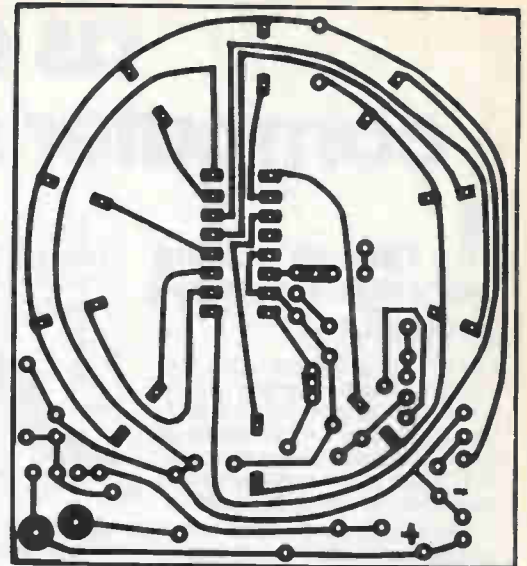

Figure 3. This Full-sized foil pattern is provided for those who would like to make their own PC board. That's definitely not a job for a beginner!

IC1, a 4017 CMOS Johnson counter, which is often called a divide-by-10 counter.

As IC1 receives pulses on its input pin, it shifts the output pulse to each of its ten output pins. Each output pin has an LED connected to it that lights when the output is pulsed. (That occurs at one-tenth of the input frequency, thus the name "divide-by-10" counter.) If the LEDs are arranged in a circular pattern, a lighted ball will appear to be "spinning" around a circle as the LEDs are lighted in sequence. The speaker, which also receives pulses from Q3, clicks as each LED lights.

Transistor Q4 turns the LEDs off when transistor Q1 turns off. If it did not, the LED that is on when the circuit stops oscillating would stay on until the battery was removed or exhausted. As you can observe, when C1 discharges, Q1 and Q2 turn off, and no more pulses reach pin 14 of IC1. The IC now keeps "high" whichever output was originally "high" when the pulses discontinued. The LED will "fade out"

PARTS LIST

C1,C3	10 μ F Capacitor
C2	1 μ F Capacitor
C4	47 μ F Capacitor
IC1	MC14017BCP
L1-L10	Jumbo Red LEDs
Q1,Q3,Q4	..	2N3904 Transistor
Q2	MU10UJT Transistor
R1,R5	33K Resistor
R2	2.2 Meg Resistor
R3	82K Resistor
R4	47K Resistor
R6	2.2K Resistor
R7	390 ohm Resistor
R8	100 ohm Resistor
R9	680 ohm Resistor
S1	Pushbutton Switch
Misc.	Speaker, PC Board, 9V Snap, IC Socket, Wire, Faceplate

NOTE: A complete kit of parts for the Wheel of Fortune is available as kit C3806 for \$14.98 from the Electronic Goldmine, P.O. Box 5408, Scottsdale, AZ 85261 (Phone 602-451-7454). See page 96 for complete ordering information

after several seconds by the action of Q4, as stated above. It's still good practice, however, to remove the battery (or to install

an ON/OFF switch) if you don't plan to use the wheel for a while.

ASSEMBLY INSTRUCTIONS

1. Building the Wheel of Fortune is not difficult if you're careful. Follow the parts-placement diagram in Figure 2, the schematic in Figure 1, and the parts list as we proceed. As with all of the kits presented in this issue, be sure to use a low-wattage iron and 60/40 rosin-core solder.
2. Not all LEDs are mounted in the same way! Mount each with the flat side facing the direction shown on the parts-placement diagram. Neatness counts! These LEDs should be mounted perpendicular to the board surface so that the finished face will have an attractive appearance. The capacitors used in this circuit are polarized. Make sure you mount them in the proper direction. Also observe the correct mounting direction of the four transistors. Be sure to use an IC socket for

IC1. When you install the IC, make sure the notch is in the direction indicated.

- Three jumpers are needed on the circuit board. Left-over resistor leads will work fine for those.
- Connect the speaker with insulated leads. For a neater job, twist the wires together along their length. Do the same with the battery snap.
- Punch out holes on faceplate and cut out.
- Connect a fresh 9-volt alkaline battery to the snap, push the switch, and the wheel should "begin to spin" after C1 charges (which takes a couple of seconds).

IF IT DOESN'T WORK

First, double check all of your soldering work. Make sure you used rosin-core solder. Make sure you didn't "bridge" any adjacent traces, that all solder is shiny and well rounded. If any solder joints look "cold," reheat the joint and add solder if it appears to need some.

Make sure that the flat sides of all LEDs are facing the direction shown on the parts layout. Check to make sure that IC1 has been installed in the proper direction. There are two different types of locating marks in common use. The first is a notch at one end of the IC. If you look at the IC with the notch on the top and at the far end, pin 1 will be at the far end on the left. The other marking convention in common use is a small dot or a slight indentation at pin 1.

Also check all transistors for

the correct orientation of their flat sides and re-check the polarity direction of capacitors C1, C2, C3, and C4.

Re-check all resistors to make sure the right value is installed at each location. Finally, make sure the battery snap is installed correctly and (we should have probably mentioned this

first) make sure that your battery is good!

If your kit still doesn't operate properly -- even after you've double-checked all of the instructions -- and if you bought the kit from The Electronic Goldmine, return the kit according to their return policy, which is detailed on page 96. Ω

48 HOUR SHIPPING

ELENCO & HITACHI PRODUCTS AT DISCOUNT PRICES

48 HOUR SHIPPING

Hitachi RSO Series

(Portable Real-time Digital Storage Oscilloscopes)

VC-6023 - 20MHz, 20MS/s	\$99/mo*
VC-6024 - 50MHz, 20MS/s	\$120/mo*
VC-6025 - 50MHz, 20MS/s	\$136/mo*
VC-6045 - 100MHz, 40MS/s	\$125/mo*
VC-6145 - 100MHz, 100MS/s	\$200/mo*

RSD's from Hitachi feature roll mode, averaging, save memory, smoothing, interpolation, pretriggering, cursor measurements. These scopes enable more accurate, simpler observation of complex waveforms, in addition to such functions as hardcopy via a plotter interface and waveform transfer via the RS-232C interface. Enjoy the comfort of analog and the power to digital.

LEASING AVAILABLE

For all Hitachi Scopes - Call for details
* Based on 24 months except V-1150, VC-6045, VC-6145 (36 months)

Hitachi Portable Scopes

DC to 50MHz, 2-Channel, DC offset function, Alternate magnifier function

V-525 - CRT Readout, Cursor Meas.	\$1,025
V-523 - Delayed Sweep	\$995
V-522 - Basic Model	\$895
V-422 - 40MHz	\$795
V-223 - 20MHz delayed sweep	\$695
V-212 - 20MHz	\$425

HITACHI COMPACT SERIES SCOPES

This series provides many new functions such as CRT Readout, Cursor measurements (V-1085/1065/665), Frequency Ctr (V-1085), Sweeptime Autoring, Delayed sweep and Trigger Lock using a 6-inch CRT. You don't lose the compactness in terms of performance and operation.

V-660 - 60MHz, Dual Trace	\$1,195
V-665 - 60MHz, DT, w/cursor	\$1,345
V-1060 - 100MHz, Dual Trace	\$1,425
V-1065 - 100MHz, DT, w/cursor	\$1,050/mo*
V-1085 - 100MHz, DT, w/cursor	\$1,250/mo*
V-1100A - 100MHz, Quad Trace	\$1,250/mo*
V-1150 - 150MHz, Quad Trace	\$1,150/mo*

20MHz Elenco Oscilloscope

\$375

MO-1251

- Dual Trace
- Component Tester
- 6" CRT
- X-Y Operation
- TV Sync
- 2 P-1 Probes

FREE DMM
with purchase of
ANY SCOPE

SCOPE PROBES
P-1 65MHz, 1x, 10x **\$19.95**
P-2 100MHz, 1x, 10x **\$23.95**

Elenco 35MHz Dual Trace

Good to 50MHz **\$495**

MO-1252

- High Luminance 6" CRT
- 1mV Sensitivity
- 6KV Acceleration Voltage
- 10ns Rise Time
- X-Y Operation • Z Axis
- Delayed Triggering Sweep
- Includes 2 P-1 Probes

All scopes include probes, schematics, operators manual and 3 year (2 yrs for Elenco scopes) world wide warranty on parts & labor. Many accessories available for all Hitachi scopes. Call or write for complete specifications on these and many other fine oscilloscopes.

B + K TEST EQUIPMENT

All Models Available

Call for special price

Digital Capacitance Meter

CM-1550B

\$58.95

9 Ranges
.1pf-20,000.0pf
5% basic acy.
Zero control w/ Case
Big 1" Display

Digital LCR Meter

LC-1801

\$125

Measures:
Coils 1uH-200H
Caps. 1pf-200uF
Res. .01-20M

Multimeter with Capacitance & Transistor Tester

\$55 CM-1500B

Reads Volts, Ohms, Current, Capacitors, Transistors and Diodes / with case

FLUKE MULTIMETERS

All Models Available

Call for special price

Quad Power Supply

XP-580

\$59.95

2-20V @ 2A
12V @ 1A
5V @ 3A
5V @ 5A

Fully regulated and short circuit protected

Triple Power Supply

XP-620

Assembled \$65
Kit \$45

2to 15V @ 1A,
-2 to -15V @ 1A
(or 4 to 30V @ 1A)
and 5V @ 3A

All the desired features for doing experiments. Features short circuit protection, all supplies

AM/FM Transistor Radio Kit

with Training Course

Model AM/FM 108

\$26.95

14 Transistors • 5 Diodes
Makes a great school project

True RMS 4 1/2 Digit Multimeter

M-7000

\$135

05% DC Accuracy
1% Resistance
with Freq. Counter and Deluxe Case

Soldering Station

Temperature Controlled

SL-30 **\$99**

Digital Display
Temp Range:
300F-500F
Grounded Tip
Overheat Protect

Color Convergence Generator

SG-200

\$69.95

Finest in the industry
10 rock steady patterns

Four-Function Frequency Counters

F-100 120MHz
\$179

F-1000 1.2GHz
\$259

Frequency, Period, Totalize, Self Check with High Stabilized Crystal Oven Oscillator, 8 digit LED display

Digital Triple Power Supply

XP-765

\$249

0-20V at 1A
0-20V at 1A
5V at 5A

Fully regulated, Short circuit protected with 2 limit control, 3 separate supplies
XP-660 with Analog Meters \$175

GF-8016 Function Generator

with Freq. Counter

\$249

Sine, Square, Triangle
Pulse, Ramp, 2 to 2MHz
Freq Counter: .1 - 10MHz

Function Generator

Blox

\$9600

\$28.95

Provides sine, triangle, square wave from 1Hz to 1MHz
AM or FM capability

XK-500 DIGITAL / ANALOG TRAINER

A complete main-lob for building, testing, prototyping analog and digital circuits
Elenco's Digital / Analog Trainer is specially designed for school projects, with 3 built-in power supplies includes a function generator with continuously variable, sine, triangle, square wave forms. All power supplies are regulated and protected against shorts.

POWER SUPPLIES

- Variable Power Supply
- +1.25 to 20VDC @ 5 Amp
- +1.25 to 15VDC @ 1 Amp
- -1.25 to -20VDC @ 5 Amp
- -1.25 to -15VDC @ 1 Amp
- +1.2VDC @ 1 Amp
- -12VDC @ 1 Amp
- +5VDC @ 1 Amp
- -5VDC @ 1 Amp
- -20VDC General tapped @ 15VAC
- All 1 Amp

ANALOG - SECTION

- Function Generator Sine, Triangle, Square wave forms
- Frequency adjustable in five ranges from 1 to 1000Hz
- Fine frequency adjust
- Amplitude adjust
- DC offset
- Modulator FM-AM

DIGITAL - SECTION

- Eight data switches
- Two no bounce logic switches
- Eight LED readouts TTL buffered
- Clock frequency 1 to 1000Hz
- Clock amplitude 500V square wave

BREADBOARDS

- 2 Breadboards, each contains 340 tie points (total 1,020)

Learn to Build and Program Computers with this Kit

Includes: All Parts, Assembly and Lesson Manual

Model **MM-8000**

\$129.00

Starting from scratch you build a complete system. Our Micro-Master trainer teaches you to write into RAM, ROMs and run a 8085 microprocessor, which uses similar machine language as IBM PC.

Robotics Kit for above (MM8010) 71.95

Wide Band Signal Generators

SG-9000 **\$129**

RF Freq 100K-450MHz AM Modulation of 1MHz Variable RF output
SG-9500 w/ Digital Display & 150MHz built-in Counter **\$249**

\$139.95 Assembled
\$119.95 Kit

WE WILL NOT BE UNDERSOLD!
UPS Shipping: 48 States 5%
(\$3 Min \$10 Max) Shipping
IL Res., 7% Tax FAX: 708-520-0085

C & S SALES INC.

1245 Rosewood, Deerfield, IL 60015
(800) 292-7711 (708) 541-0710

15 Day Money Back Guarantee
2 Year Warranty

WRITE FOR FREE CATALOG

CIRCLE 6 ON FREE INFORMATION CARD

PE HOBBYIST HANDBOOK

9

SUPER LED FLASHER

PUT THE 555 TIMER IC TO WORK IN A FUN PROJECT!

There's something about flashing LEDs that seems to say "high tech." Yet flashing LEDs can also be an excellent educational tool. With this circuit, you'll learn how to use one of the most popular timer-circuit ICs available, the 555. And you'll find that education can be lots of fun! You'll be able to use the finished kit in all sorts of projects. For example, you can create an attention-getting warning notice that nobody will be able to miss, or just spruce up model cars or spacecraft.

How It Works

The Super LED Flasher Kit is actually two complete LED flasher circuits on one circuit board. To understand how it works, we need only to look at one of these LED flashers because the other is identical. As you can see in the schematic diagram in Figure 1, the first LED flasher is made up of IC1 and

LEDs D1 and D2. IC1 is a 555 timer IC configured as an astable (free-running) multivibrator with its output on pin 3.

The frequency of the 555's oscillation is controlled by R2, R3, and C1. (After you build the circuit and are sure that it's operating correctly, you might want to experiment with changing the values of those components to see what effect they have on the circuit's operation.) For more information on the 555, you might want to refer to the classic book, *555 Timer Cookbook*, by Walter G. Jung, published by Howard W. Sams & Co., Inc.

Resistor R1 limits the input voltage to a low enough level to prevent damage to the IC. As the 555 IC oscillates, the output of pin 3 goes high (+) then low (-). When the output is high, it supplies current to D1, which lights up. When it is low, pin 3 sinks current and D2 lights up. This happens because LEDs are polarity-sensitive (like all other diodes,

they permit current to flow in only one direction) and we have connected one lead of each LED to the respective polarity needed to light that LED. Each LED is made up of a special semiconductor PN junction that converts electrons directly, and efficiently, to photons (light).

The second LED flasher, made up of IC2 and LEDs D3 and D4, operates in the same way as the first LED flasher.

ASSEMBLY INSTRUCTIONS

1. Assemble the circuit following the parts-placement diagram in Figure 2 along with the schematic diagram and the Parts List. Be sure to use the right solder: 60/40 rosin-core only!
2. Observe the flat-side location of LEDs for correct mounting per parts layout. Install all resistors per color code and parts layout.
3. Observe the locating mark (a notch at one end, or a "dot" at pin 1) on ICs for correct mounting. Use IC sockets for mounting the 555 timers.
4. Capacitors C1 and C4 are also polarized. Be sure to install them in the direction that is shown in the parts-placement diagram.
5. The LEDs must also be mounted as shown in Figure 2, as they, too, as explained above, are polarized components.

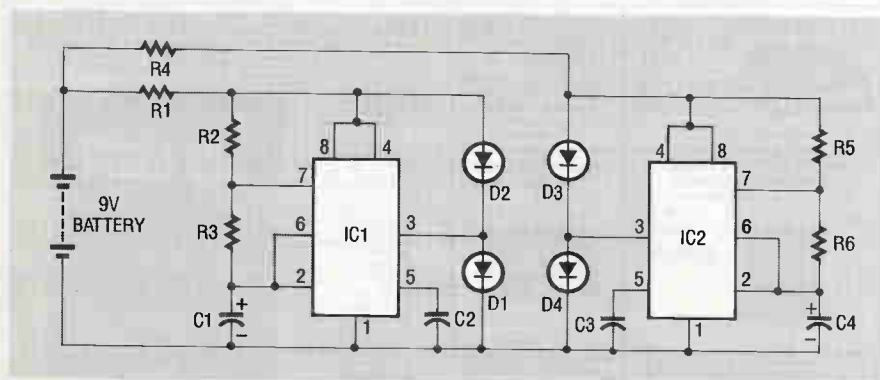

Figure 1. The Super LED Flasher Kit consists of two identical flasher circuits that are based on the 555 timer IC.

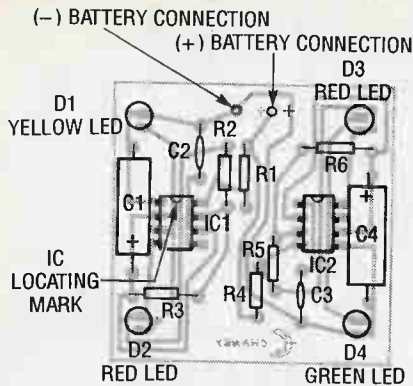

Figure 2. Follow the parts-placement diagram carefully when building your kit and you'll have little trouble.

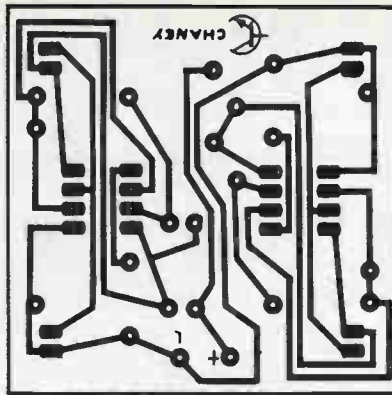

Figure 3. If you prefer to etch your own board, use this full-sized foil pattern of the PC board.

PARTS LIST

- C1, C4 4.7 μ F Electrolytic Capacitor
- C2, C3 .. 330 pF Disc Capacitor
- D1 Yellow LED
- D2, D3 Red LED
- D4 Green LED
- IC1, IC2 555 Timer IC
- R1, R4 100 ohm Resistor
- R2, R5 82K Resistor
- R3, R6 33K Resistor
- Misc 9V Snap, IC Sockets and PC Board

NOTE: A complete set of parts for the Super LED Flasher is available as kit C4407 for \$6.25 from The Electronic Goldmine, P.O. Box 5408, Scottsdale, AZ 85261 (Phone 602-451-7454). See page 96 for complete ordering information.

TROUBLESHOOTING HINTS

This is an excellent project for beginners to try, and shouldn't present any problems even for first-time builders -- as long as you practice soldering *before* trying to build the flasher and pay attention to device polarity. How-

ever, mistakes *do* happen, and here are some hints to help you find them. First of all, verify that you used the correct solder for the kit. Then re-check all resistors to make sure you installed the correct parts in the right places. Check to make sure that C1 and C2 have been installed with polarity as shown on parts layout.

Check to make sure that all LEDs have their flat sides facing toward the outside edge of board. Check for solder bridges by comparing the foil pattern to the actual foil side of PC board. Resolder all cold solder joints.

Check to make sure that the battery snap has been installed correctly and that the battery is good. Also be sure that IC1 and IC2 have been installed with their locating marks in direction shown on parts layout. Note: IC1 mounts in the opposite direction of IC2!

If your kit still does not operate, re-check all assembly instructions. If everything is correct, and you purchased the kit from The Electronic Goldmine, return the kit per their repair policy. Ω

DISCOVER EXPERIMENT LEARN ADVANCE ELECTRONICS LASERS CAD-CAM HOME STUDY HEATHKIT HOMWORKS!

Now you can learn beginning to advanced electronics at home, with the same courses used today in the world's top colleges and tech schools, and pay a lot less! You'll learn just what you want, when you want, at your own pace. The complete story is in our free catalog, HomeWorks by Heathkit. Order yours today, call toll-free:

1-800-44-HEATH
(1-800-444-3284)

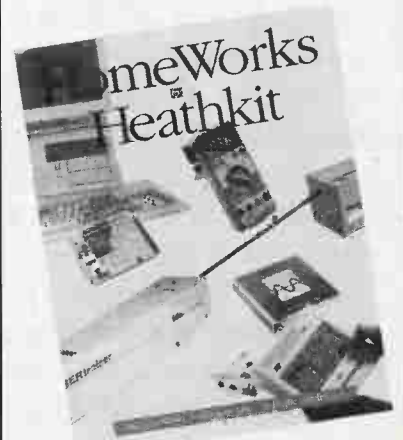

YES! Please send me a FREE copy of the HomeWorks by Heathkit Catalog.

Send to: Heath Company, Dept. 117-040
Benton Harbor, Michigan 49022

Name _____

Address _____

City _____

State _____ Zip _____

FD 240

Bull Data Systems, Inc.

CIRCLE 7 ON FREE INFORMATION CARD

MOISTURE DETECTOR

**YOUR BEST DEFENSE AGAINST WATER DAMAGE IS
KNOWING WHEN THE WATER IS THERE.**

A basement can certainly be a big selling point for a house. Basements can provide storage space that's a necessity for most suburbanites. Unfortunately, unless your house is relatively new, your basement probably can't be used for storage because it leaks whenever you have a good rain..

While there are waterproofing treatments that can work, in most cases, a leaky basement will always be leaky. But that doesn't mean it can't be used for storage! A good dehumidifier can take care of the high summertime humidity and some slight seepage. For major seepage, you'll have to get to work yourself to protect your stored items. But this Moisture Detector Kit can help you out by providing an audible warning when moisture is present. That's your signal to get moving!

The schematic of the moisture detector is shown in Figure 1. It uses 2 transistors and a piezoelectric transducer to sound an alarm tone when water is present.

Transistor Q1 forms a crystal-controlled oscillator, using a portion of piezoelectric transducer XDC -- which contains two piezoelectric crystal regions -- as the crystal. The transducer has three separate leads. One lead goes to each of the crystals, and the third lead is common to both.

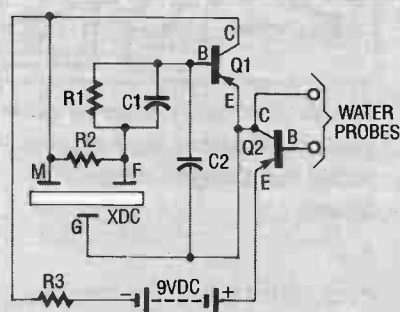

Figure 1. When water is between the probes, transistor Q2 is biased "on" just as if a resistor was placed on. That, in turn, turns Q1 on, which sounds the piezoelectric transducer.

The smaller internal crystal region sets the frequency of operation and the larger element is driven by Q1 (when it is biased "on") to provide the loud tone output. To turn the PNP transistor Q1 (used as an oscillator) "on" we need to turn on the PNP transistor Q2 (used here as a switch). To turn it "on" with the biasing

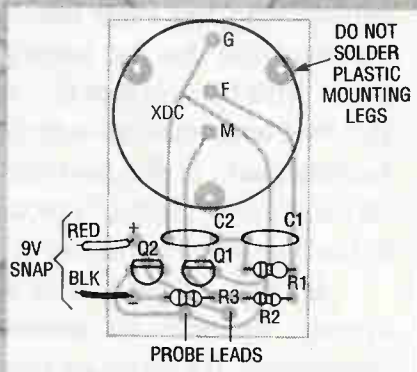

Figure 2. Be sure to mount the transistors and transducer in the directions indicated in this parts-placement diagram.

that is normally connected, we need only connect a resistor from the collector of Q2 to the base, which gives the base a negative (-) bias. The "resistor" we use is the water that you're trying to detect. In other words, when water

PARTS LIST

C1,C2 ..	0.1 μ F Mylar Capacitor (104K)
Q1,Q2	2N3906 Transistor
R1	6.8K Resistor
R2	33K Resistor
R3	200 ohm Resistor
XDC	Piezoelectric Transducer
Misc.	9V Snap, PC Board

NOTE: A complete set of parts for the Moisture Detector is available as kit C4486 for \$6.25 from The Electronic Goldmine, P.O. Box 5408, Scottsdale, AZ 85261. See page 96 for complete ordering information.

contacts the probes, it is the same as placing a resistor between the base and collector leads of Q2. That turns Q2 on, which, in turn, turns on Q1. The result when water touches the probe is that the transducer emits a loud tone.

ASSEMBLY INSTRUCTIONS

1. Building the moisture detector is not difficult if you follow the parts-placement diagram in Figure 2, the schematic in

Figure 1, and the Parts List. In fact, it makes for a good first project!

2. Be sure to mount the transistors with the correct orientation. Then mount the rest of the components, including the piezoelectric transducer XDC. Be careful not to bend the pins on the transducer when you insert it into the board!
3. Use two pieces of wire (the cut-off leads from the resistors) for the water probes. Solder each lead into hole on PC board and

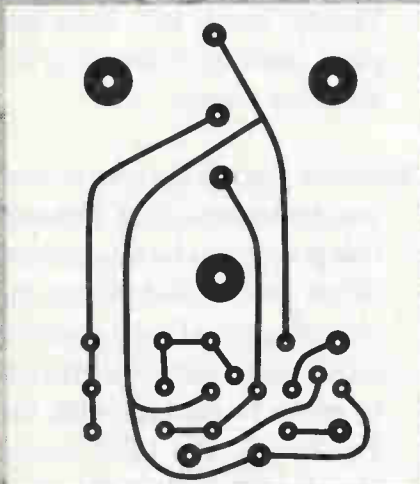

Figure 3. The full-sized foil pattern for the moisture detector.

bend them over. Use leads that are long enough. You'll want them to extend outside the case in which you'll mount the detector. You can shorten the leads later.

4. To test the unit, simply connect a fresh 9-volt battery to the snap and insert probes into a small drop of water. The unit should produce a piercing tone until the water is removed.
5. After you've verified that the circuit works, you'll want to

mount the circuit board and battery in a plastic box into which you've drilled two holes for the probe leads to extend out the side. Bend the leads down so they are both in even contact with the floor when the box is set down. Make sure several holes are drilled in the top of the box to allow sound waves to escape.

6. When no moisture is present, (thus, the transducer is not sounding) the current drain on the battery is in the microampere range because Q2 is not conducting. However, the battery will eventually wear out. You should make it a habit to test the unit periodically. Also, replace the battery with a new one every couple of months -- and especially during your rainy season -- just to be sure.

PROBLEMS?

Since this is a beginner-level kit, experienced builders should have no problems the first time it's hooked up. There are a few general things to look for if your detector doesn't work. First, make sure that you mounted the correct valued resistors in their correct places. Also double check the transistor mounting, and the polarity of the battery snap -- and whether your battery is any good! Study your construction technique.

When you get it all working, you should mount it where water first seems to enter your basement for the earliest possible warning. Ω

DIGITAL VIDEO STABILIZER ELIMINATES ALL VIDEO COPY PROTECTIONS



While watching rental movies, you will notice annoying periodic color darkening, color shift, unwanted lines, flashing or jagged edges. This is caused by the copy protection jamming signals embedded in the video tape, such as Macrovision copy protection. Digital Video Stabilizer: RXII completely eliminates all copy protections and jamming signals and brings you crystal clear pictures.

- FEATURES:**
- Easy to use and a snap to install
 - State-of-the-art integrated circuit technology
 - 100% automatic - no need for any troublesome adjustments
 - Compatible to all types of VCRs and TVs
 - The best and most exciting Video Stabilizer in the market
 - Light weight (8 ounces) and Compact (1x3.5x5")
 - Beautiful deluxe gift box
 - Uses a standard 9 Volt battery which will last 1-2 years.

WARNING :
SCO Electronics and RXII dealers do not encourage people to use the Digital Video Stabilizer to duplicate rental movies or copyrighted video tapes. RXII is intended to stabilize and restore crystal clear picture quality for private home use only.

(Dealers Welcome)

To Order: \$49.95 ea + \$4 for FAST UPS SHIPPING
1-800-445-9285 or **516-568-9850**
 Visa, M/C, COD M-F: 9-6 (battery not included)
 SCO ELECTRONICS INC.
 Dept CPEB 581 W. Merrick Rd. Valley Stream NY 11580
 Unconditional 30 days Money Back Guarantee

CIRCLE 15 ON FREE INFORMATION CARD

CABLE TV DESCRAMBLER

How You Can Save Money on Cable Rental Fees



1 Unit 5+
 Jerrold SB w/Tri-Bi.....\$99.....\$70
 SuperTri-Bi (TBM).....\$109.....\$75
 Jerrold 450 combo.....\$189.....\$139
 Scientific Atlanta.....\$109.....\$75
 SA 8536.....\$250.....\$195
 Pioneer.....\$109.....\$79
 Oak KN12 (w/VS).....\$109.....\$65
 Hamlin MLD 1200.....\$89.....\$59
 Tocom.....\$169.....\$129
 Stargate converter.....\$89.....\$69
 Panasonic TZPC145.....\$99.....\$79

US Cable will Beat Anyone's Price Advertisd in this Magazine!

30 Days Money Back Guarantee
 Free 16 page Catalog

Visa, M/C, COD or send money order to:
US Cable TV Inc. Dept. KPEB
 4100 N. Powerline Rd., Bldg F-4
 Pompano Beach, FL 33073

1-800-445-9285

For Our Record

I, the undersigned, do hereby declare under penalty of perjury that all products purchased, now and in the future, will only be used on Cable TV systems with proper authorization from local officials or cable company officials in accordance with all applicable federal and state laws. FEDERAL AND VARIOUS STATE LAWS PROVIDE FOR SUBSTANTIAL CRIMINAL AND CIVIL PENALTIES FOR UNAUTHORIZED USE.

Date: _____

Signed: _____

No Florida Sales!

CIRCLE 14 ON FREE INFORMATION CARD

AC OUTLET TESTER

VERIFY THAT YOUR AC OUTLETS ARE WORKING WITH SOUND AND LIGHT.

We've become quite accustomed to electrical outlets that work. And why not? They usually do. In fact, when an outlet fails, we're more likely to blame the appliance that's plugged into it than the outlet itself. The simple circuit that we'll build here will let you quickly test that an outlet is supplying power. While you could use any standard electrical lamp for the same purpose, building this circuit has a couple of advantages. First, it's more rugged than a light bulb, and gives you an audible indication that your outlet is working. Second, and more important, it's a good way to get started in building line-powered devices. It will boost your confidence and, we hope, teach you respect for the possible dangers of the 120-volt power line.

The AC Tester consists of a rectifier circuit and a multivibrator circuit. As shown in the schematic of Figure 1, the AC voltage is half-wave rectified by diode D1 and stored in capacitor C1. Resistor R1 is used to limit the current through D1 to a safe value. The voltage stored across C1 supplies IC1 operating power. The IC, the versatile 555 timer, is configured here to operate as a

multivibrator whose operating frequency is determined by C2, R2 and R3. The output of IC1, on pin 3, is coupled to a piezoelectric speaker (SPK), which gives an indication of the presence of AC. An LED (L1) also lights up when AC is present.

BUILDING THE TESTER

1. Follow the schematic, the parts-placement diagram (Figure 2) and the Parts List as you assemble the tester using rosin-core solder.
2. Start off by installing capacitors C2 and C3. They are not polarized, so they can mount in either direction. Mount diode D1 with its cathode (the end

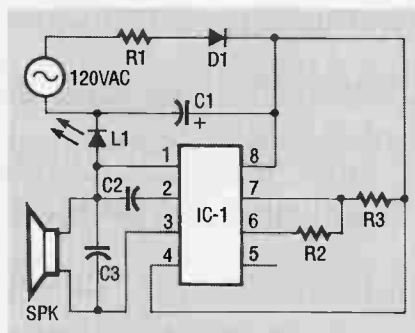

Figure 1. The AC tester uses half-wave rectified 120 volts AC to power a multivibrator circuit that produces aural and visual indication of power.

with the band) in direction indicated. Then install all resistors.

3. Install L1, the LED, making sure that the cathode (the flat side) is mounted in the proper direction. Also install C1, noting that it, too, is polarized and can mount in only one direction. Install a socket for the IC, and attach the AC line cord. Install the piezoelectric speaker SPK. Use left-over leads from resistors to attach its "ear holes" to the board. Finally, install IC1. Note that pin 1 must be mounted in the direction shown.

4. Before you test the unit, be sure you understand that **120-volt line power can be dangerous!** When you are ready to test the unit, plug the AC line cord into an AC outlet **being careful not to come in contact with the PC board.** The LED should glow brightly and a high pitched tone should be heard.
5. Remember to use extreme caution when using a kit that connects to the AC line. **Never** use it outside or near water. **Always** mount the entire kit inside a wooden or plastic (insulated) box to prevent any contact with the AC voltage.

TROUBLESHOOTING HINTS

If your kit doesn't work the first time, double check your construction techniques. Most problems are due to poor soldering. Did you use rosin-core sol-

Mail This Card Today!

Discover Your Career Potential In The
Fast Growing Field Of High-Tech Electronics!

YES! Please send your independent study catalog. (For your convenience, CIE will have a representative contact you - There is no obligation.)

Name _____

Address _____

City _____ State _____

Zip _____ Phone () _____

Check for G.I. Bill details Age _____

Active Duty Veteran

Choose From Thirteen Different Programs.

I'm most interested in (please check only one):

- | | |
|--|---|
| <input type="checkbox"/> Electronics Technology with Laboratory | <input type="checkbox"/> Electronics Technology with Digital Laboratory |
| <input type="checkbox"/> Electronics Technology | <input type="checkbox"/> Electronics Technology with Digital and Microprocessor Lab |
| <input type="checkbox"/> Broadcast Engineering | <input type="checkbox"/> Electronics Engineering Technology |
| <input type="checkbox"/> Electronics Communications | <input type="checkbox"/> Automotive Electronics |
| <input type="checkbox"/> Industrial Electronics | <input type="checkbox"/> Associate in Applied Science in Electronics Engineering Technology |
| <input type="checkbox"/> Electronics Engineering | |
| <input type="checkbox"/> Electronics Technology and Advanced Troubleshooting | |
| <input type="checkbox"/> Computer Operation and Programming | |

AHB02



NO POSTAGE
NECESSARY
IF MAILED
IN THE
UNITED STATES

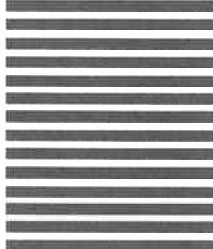

BUSINESS REPLY MAIL
FIRST CLASS MAIL PERMIT NO. 8685 CLEVELAND, OHIO
POSTAGE WILL BE PAID BY ADDRESSEE

CIE
CLEVELAND INSTITUTE OF ELECTRONICS INC
1776 E 17TH ST
CLEVELAND OH 44197-9846



CIE Gives You The Training You Need to Succeed... At Your Own Pace...& In Your Own Home!

Discover Your Career Potential In The
Fast-Growing Field Of High-Tech Electronics!

If you're anxious to get ahead...and build a *real* career...you owe it to yourself to find out about the Cleveland Institute of Electronics!

CIE can help you discover your career potential in the fast growing field of high-tech electronics. A career that will challenge and excite you every day...reward you with a powerful feeling of personal accomplishment...and deliver a level of financial security you may have only dreamed of before!

As the leading school in home-study electronics, CIE has helped over 150,000 students in the U.S.A. and over 70 foreign countries get started in this exciting field. To find out how CIE could be helping you...read on...then send for a CIE catalog TODAY!

A Growing Need For Trained Professionals!

The career opportunities shown here are only a few of the challenging, high-paying careers you could enjoy as an electronics technician.

You could be the "brains" behind the scenes of an exciting TV broadcast...trouble-shoot life-saving medical equipment...design exotic new aeronautics systems...CIE's job-oriented programs offer you the quickest possible path to the career of your dreams! And CIE also features military and union re-training, to build on what you already know.

Dozens Of Fascinating Careers To Choose From!

Even if you aren't sure which career is best for you, CIE can get you started with core lessons applicable to *all* areas of electronics. As you advance, CIE makes job opportunities available to you through the bimonthly school paper, *The Electron*.



Data Communications



Automotive Electronics



Avionics



Computer-Assisted Manufacturing



Consumer Electronics



Military Electronics

Personal Training From A Renowned Faculty.

Unlike the impersonal approach of large classroom study, CIE offers you one-on-one instructional help 6 days a week, toll-free. Each CIE lesson is authored by an independent specialist, backed by CIE instructors who work directly with you to answer your questions and provide technical assistance when you need it.

Practical Training... At Your Own Pace.

Through CIE, you can train for your new career while you keep your present job. Each course allows a generous completion time, and there are no limitations on how fast you can study. Should you already have some electronics experience, CIE offers several courses which start at the intermediate level.

"State-Of-The-Art" Facilities & Equipment.

In 1969, CIE pioneered the first electronics laboratory course, and in 1984, the first Microprocessor Laboratory. Today, no other home study school can match CIE's state-of-the-art equipment. And all your laboratory equipment is included in your tuition cost. There is no extra charge—it's yours to use while you study at home and on the job after you complete your course!

Earn Your Degree To Become A Professional In Electronics!

Every CIE course you take earns you credit towards the completion of your Associate in Applied Science Degree, so you can work towards your degree in stages. And CIE is the only school that awards you for fast study, which can save you thousands of dollars in obtaining the same electronics education found in four-year Bachelor's Degree programs!

Send For Your Catalog Today!



CIE World Headquarters

Cleveland Institute of Electronics, Inc.
1776 East 17th St., Cleveland, Ohio 44114

YES! Please send me your independent study catalog (For your convenience, CIE will have a representative contact you—there is no obligation.)

Print Name _____

Address _____ Apt # _____

City/State/Zip _____

Age _____ Area Code/Phone No. _____

Check box for G.I. Bill bulletin on educational benefits: Veteran Active Duty

Mail This Coupon Today!

AHB01

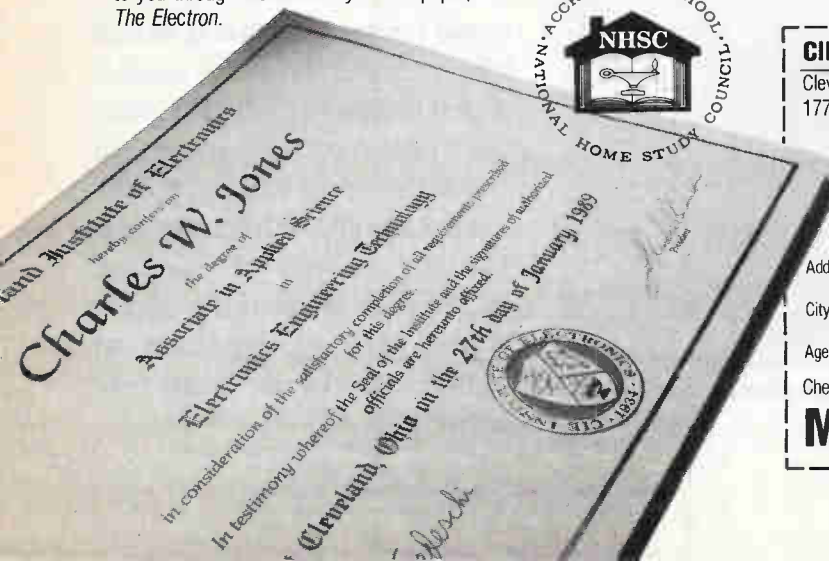

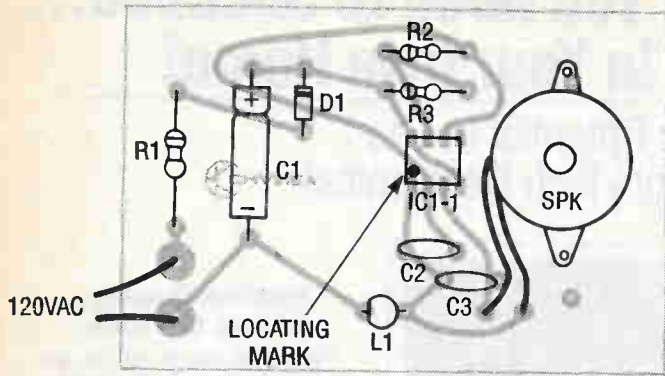

Figure 2. Follow this parts-placement diagram as you build the tester. Be sure to note that many of the components are polarized!

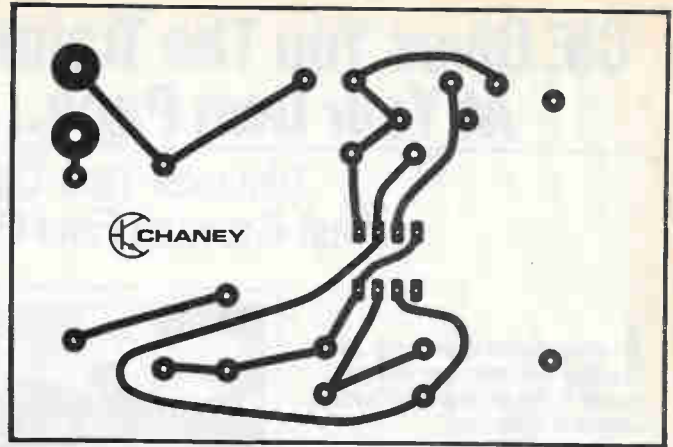

Figure 3. The foil pattern of the AC tester. Use it to etch your own board or to verify that you don't have any solder bridges.

der? Look for solder bridges by comparing actual foil on PC board to foil pattern in Figure 3. Check for cold solder joints and reheat and suspect connections.

Recheck all resistors to ensure that the proper values were installed in the correct places. Also check to make sure that the IC is installed in the right direction. Do

the same for the LED and polarized capacitor.

If you can't get your kit to operate, and you bought it from the Electronic Goldmine, you're not out of luck. Simply return it to them according to their repair policy.

One of the best uses we've

PARTS LIST

C1	50 μ F Electrolytic Capacitor
C2,C3 ..	.047 μ F Disc Capacitor
D1	1N4003 Diode
IC1	555 Timer IC
L1	Jumbo Red LED
R1	3.9K, 1 watt Resistor
R2	2K, 1/4 watt Resistor
R3	4.7K, 1/4 watt Resistor
SPK	Piezoelectric Speaker
Misc.	PC Board, AC Line Cord, IC Socket

NOTE: A complete set of parts for the AC tester is available as Kit C4485 from The Electronic Goldmine for \$6.20. Turn to page 96 for complete ordering information.

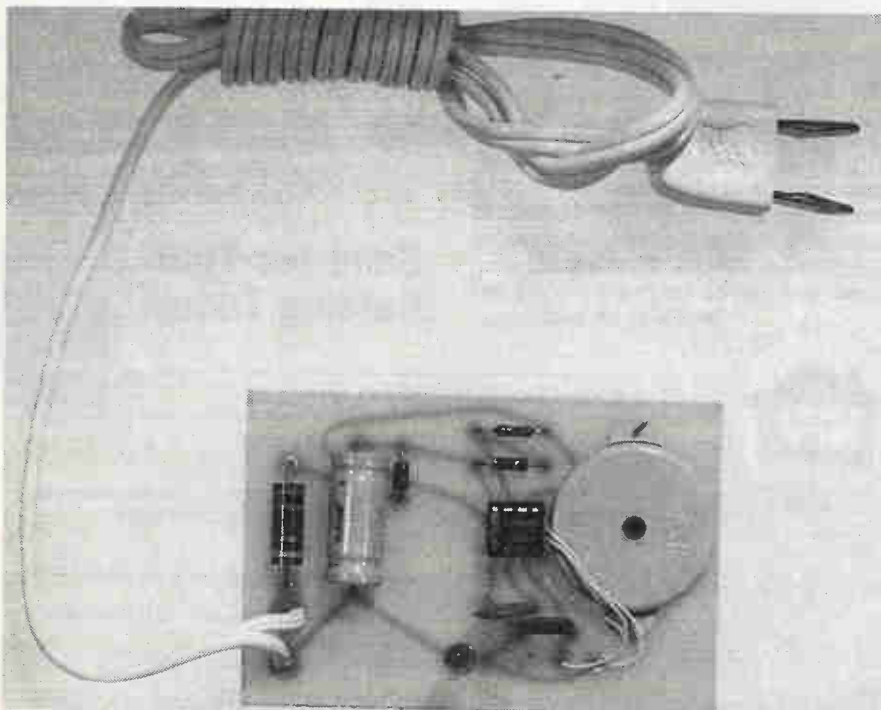

Here is a photograph of the completed kit. Note its size compared to the power cord!

found for the AC tester is to find which circuit breakers control which outlets in our house. That used to require two people: one to switch the circuit breaker, and the second to yell, "That's the one! The light just went off!" Now, we just have to operate the circuit breaker while we keep an ear out for the sound of our handy new tester. Ω

SUPER BURGLAR CHASER

GET THE UPPER HAND ON BURGLARS WITH THE ELEMENT OF SURPRISE!

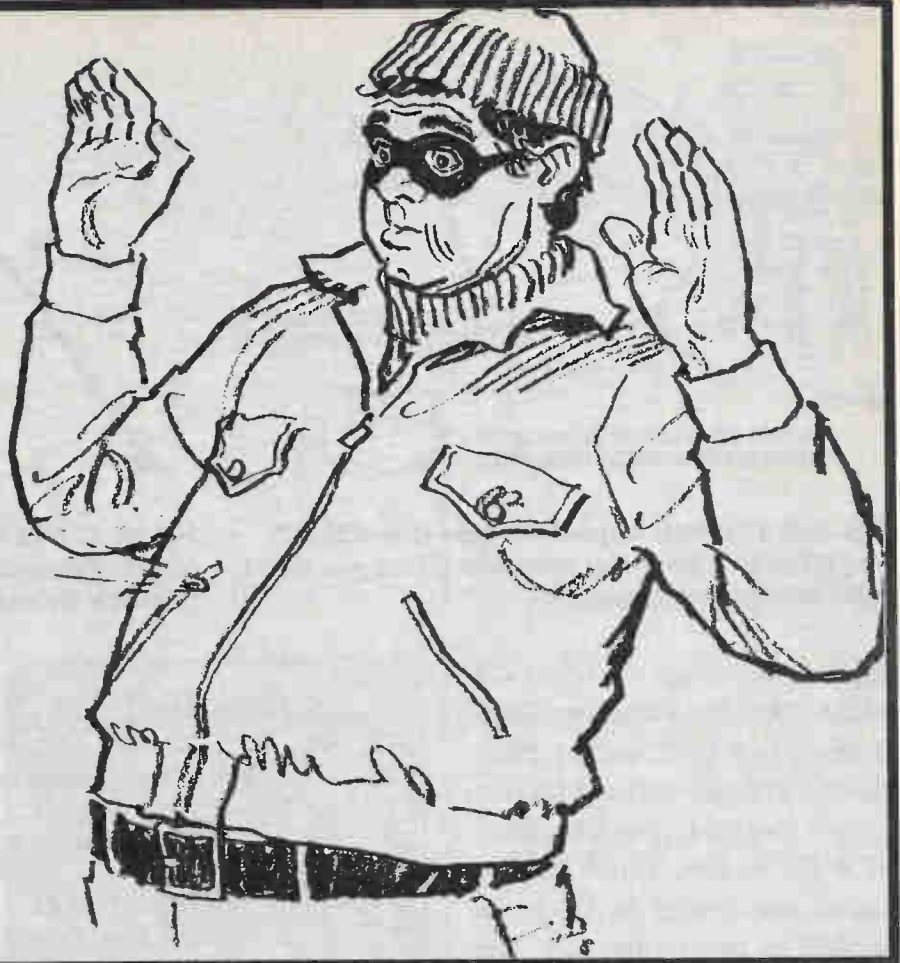

Burglars are burglars because they figure it's an easy way to make a living. Understanding that fact is the key to defending yourself against burglary -- just make it a little more difficult for the burglar, and he's likely to go on in search of an easier target. The Super Burglar Chaser makes a great accessory for any alarm system. It creates brilliant flashes of white light and a loud, irritating sound from a metal horn buzzer. When a burglar encounters all of the attention-getting sound and light, he'll be off and running in no time!

The sound from the chaser comes from buzzer called BZ in the schematic of Figure 1. The horn, of course, is just an electro-

mechanical buzzer, which creates a noise when 6 volts DC is applied to its terminals. The strobe portion requires all of the other circuitry, and it operates as follows: Transformer T1 is connected to Q1, R1, and R2 to form a blocking oscillator. This creates

a 6-volt AC signal on the primary of T1. Because of T1's large ratio of turns from primary to secondary, the 6-volt AC signal is stepped up to a level of over 200 volts AC!

The AC is rectified by D1, and the resultant DC voltage is

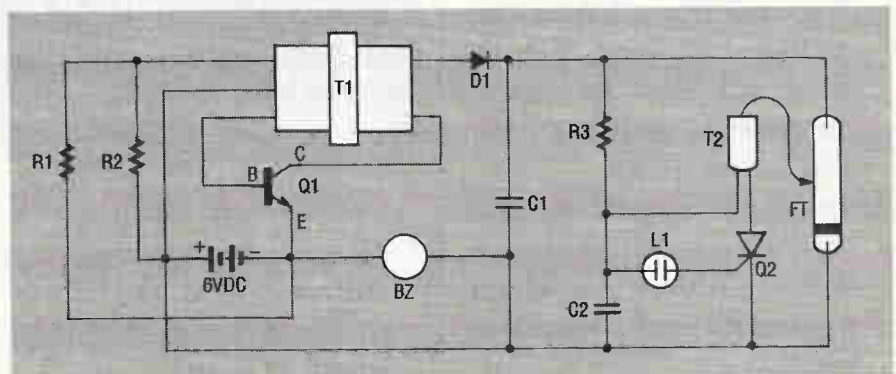

Figure 1. The schematic makes it obvious that the circuit is not very complex. However, high voltages are present in the circuit, so be careful not to touch any exposed contacts.

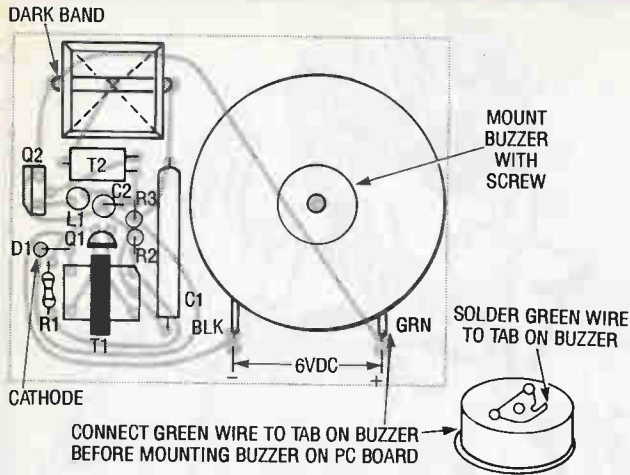
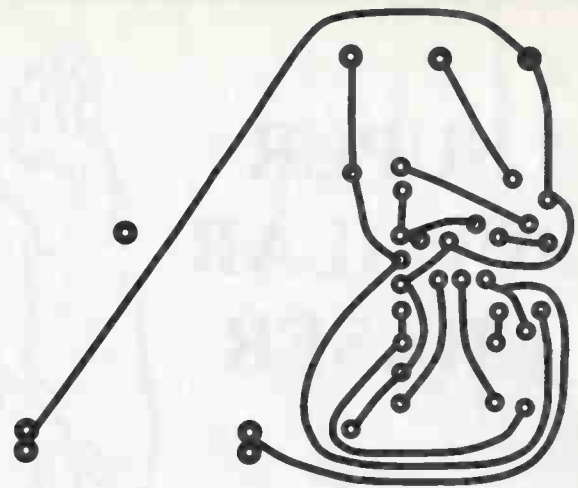

Figure 2. The Parts Layout. Be sure to install R2 and R3 before installing capacitor C1, or you won't have enough room to work.

Figure 3. This is the full size foil pattern for the burglar chaser. Use it to make your own board or to check for solder bridges.



applied to storage capacitor C1 and the neon relaxation oscillator made up of R3, C2, and L1. Each time C2 charges up to a sufficient level it ionizes L1, which causes SCR Q2 to fire, which in turn causes the charge on C2 to be applied to the trigger coil. The trigger coil converts the 200 volts into the 4000-volt pulse that is needed to fire micro xenon strobe tube/reflector FT. The cycle repeats itself after the strobe tube flashes.

ASSEMBLY INSTRUCTIONS

1. Follow the parts-placement diagram in Figure 2 along with the Parts List. Verify that you have all the necessary components, and that your solder is rosin-core.
2. Install resistors R2 and R3 before capacitor C1, as you will find it difficult to install resistors R2 and R3 after C1 is installed.
3. Install SCR Q2, being sure to observe that its beveled edge is

Parts List

BZ	Metal Horn Buzzer
C15 µF 250 volts Capacitor
C2022 µF Green Cap (223 K5K)
D1	1N4007 Diode
FT	Micro Strobe Tube/Reflector
L1	Neon Lamp
Q1	C1740 SW Transistor
Q2	106 SCR
R1	200 ohm Resistor
R2	820 ohm Resistor
R3	10 meg Resistor
T1	Inverter Transformer
T2	4 KV Trigger Coil
Misc.	Wire, PC Board

NOTE: A complete set of parts is available as kit C4654 for \$18.70 from The Electronic Goldmine. See page 96 for complete ordering information.

4. Install diode D1 with cathode next to board at point shown.
5. Install transistor Q1 with its flat side mounted in the direction shown (towards transformer T1).
6. Notice the hole marked by an "X" on the parts layout (under the flash tube). You must solder a short piece of wire (cut from a resistor) so that it protrudes up about 1/8 inch above the circuit board on the component side. This wire must press into the hole at the bottom of the reflector assembly to conduct the triggering voltage from T2 to the strobe tube FT. Use other pieces of wire (cut from a resistor) to connect the tube to PC board. Observe the dark band around one end of FT when installing. This denotes the cathode, and it should go to the correct point on the circuit board.
7. After assembly, connect a fresh 6-volt lantern battery to proper points. The unit should emit flashes of brilliant light, and the buzzer should emit a loud sound. After the initial test,

you'll want to hook the burglar chaser to your alarm system -- and hope you never have to use it. You'll want to mount the burglar chaser where the burglar -- and your neighbors -- are most likely to see it and hear its racket.

TROUBLESHOOTING HINTS

Assuming that you used good construction techniques and the proper solder, and that you don't have any solder bridges or cold solder joints (the main cause of most electronics construction problems for beginners and pros alike), the first place to look for possible problems is with the in-

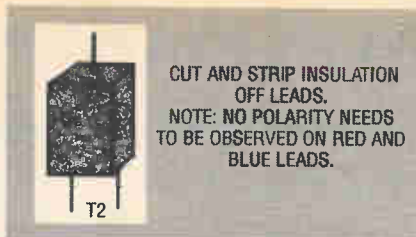
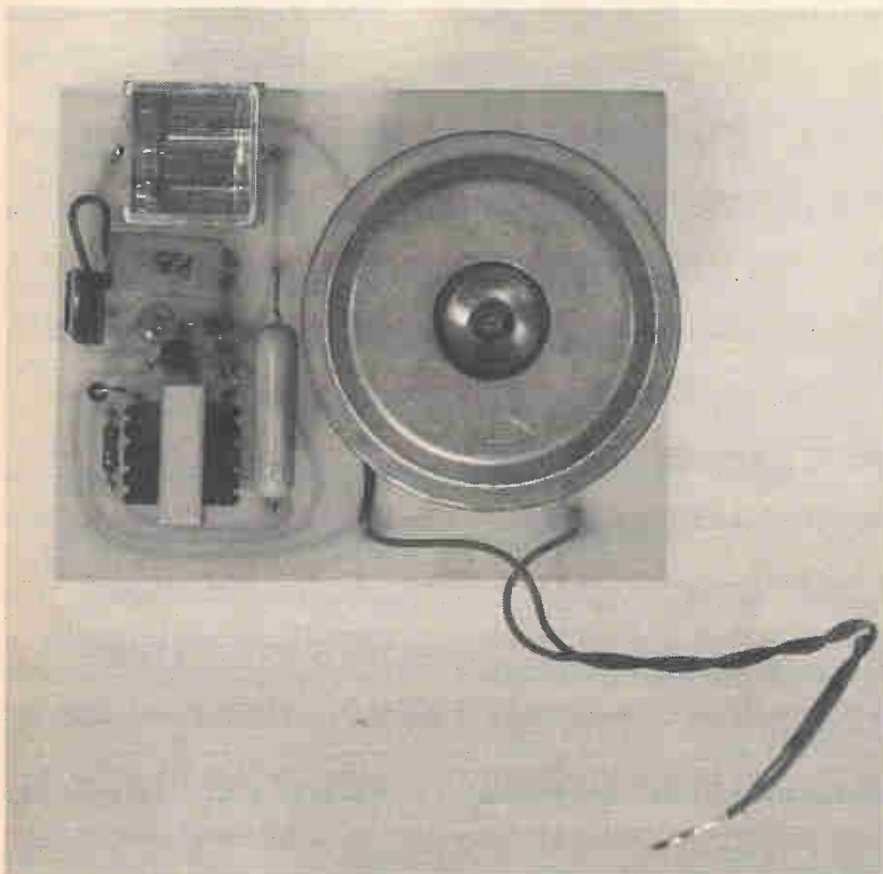

Figure 4. Trigger-coil mounting instructions. Cut and strip the insulation off leads. before mounting, and note that no polarity needs to be observed on red and blue leads.

correct installation of the polarized components.

Make sure that Q1 is installed correctly, and that that battery polarity is correct. The flash tube also mounts in one direction only. Then check all resistors to make sure that you installed the correct values at the correct place. Ω



The completed burglar chaser is shown here before being connected to a lantern battery and being installed in a case. It's certainly a good idea to use an insulated case for the project, but be sure to leave ample openings to let the sound from the buzzer and the light from the flash tube to escape.

LASERS

HELIUM NEON LASER KIT

≈ 5 mW, 633 nm
Red Output
12 VDC operation.
Kit includes
Commercial made
Laser Tube and Power Supply.
Requires Final Assembly into a Project case that you supply.
This Laser Kit is C.D.R.H. approved.

Cat. #
HNKD-10
\$59.00

VISIBLE LASER MODULE

<p>2 mW MODULE Cat. # VLM-2 \$150.00</p>	<p>5 mW MODULE Cat. # VLM-5 \$195.00</p>
--	--

Output: 2 or 5 mW @ 670 nm (Red) C.W.
Spot Size: Inside 1 square inch @ 50 feet
Input Power: 5 to 10 VDC @ 60 mA
(A 9-Volt Battery will run the VLM for 5 hours)
Dimensions:58" dia. x 1.13" long

LASER PEN

DANGER
LASER RADIATION
AVOID DIRECT EXPOSURE TO BEAM!
MAX. OUTPUT: 5 mW
CLASS II LASER PRODUCT

Enhance any presentation with this 5mW Laser Pointer. Fits in shirt pocket. One year limited warranty.
Cat. # LP-5 **\$190.00** BATTERY INCLUDED

FOR FAST SERVICE: Call to ship COD.
Add \$8.00 for S & H — AZ Residents add 6.5% tax.

FREE CATALOG CALL, WRITE, OR FAX TODAY!

MEREDITH INSTRUMENTS

P. O. Box 1724 • 6403 N. 59th Ave. • Glendale, AZ 85301
Phone: (602) 934-9387 FAX: 602-939-3369

CIRCLE 11 ON FREE INFORMATION CARD

Be an FCC LICENSED ELECTRONIC TECHNICIAN!

Earn up to \$30 an hour and more!

Learn at home in spare time. No previous experience needed!

No costly School. No commuting to class. The Original Home-Study course prepares you for the "FCC Commercial Radio-telephone License". This valuable license is your "ticket" to thousands of exciting jobs in Communications, Radio-TV, Microwave, Computers, Radar, Avionics and more! You don't need a college degree to qualify, but you do need an FCC License. **No Need to Quit Your Job or Go To School** This proven course is easy, fast and low cost! **GUARANTEED PASS** — You get your FCC License or money refunded. **Send for FREE facts now. MAIL COUPON TODAY!**

COMMAND PRODUCTIONS
FCC LICENSE TRAINING, Dept. 204
P.O. Box 2824, San Francisco, CA 94126
Please rush FREE details immediately!

NAME _____
ADDRESS _____
CITY _____ STATE _____ ZIP _____

TELEPHONE AMPLIFIER

NOW EVERYONE CAN HEAR THE CONVERSATION!

You don't have to go out and buy an expensive speaker phone to let the whole family listen in on phone calls. Our Telephone Amplifier is as simple to build as it is to use. It amplifies the incoming voice so that everyone in the room can hear what's being said (although they'll still have to take turns talking). The sensitive, large induction coil picks up the voice from the receiver and provides reliable performance. The compact phone amplifier is a great accessory for your home or office.

As you can see from the schematic diagram shown in Figure 1, the Telephone Amplifier is surprisingly simple. It uses one transistor (Q1) and one IC (IC1) to provide an output from a speaker that is loud enough so that other people can hear the phone conversation. The telephone conversation is inductively picked up by the coil. The tiny signal is coupled by capacitor C1 to transistor Q1. Resistors R1 and R2 provide the biasing for Q1. Transistor Q1, NPN type, amplifies the signal to a level high

speaker, and capacitor C7 prevents low-frequency distortion.

ASSEMBLY INSTRUCTIONS

1. Assemble the phone amplifier according to the parts-placement diagram in Figure 2, using the Parts List and the schematic to help you. Make sure you have all the necessary parts on hand before beginning construction, and use only 60/40 rosin-core solder.
2. Observe the polarity of capacitors C1, C4, C5, C6, and C7, and the flat side of transistor Q1, and install accordingly. Look for the IC locating mark on IC1, and install it as shown. Remove the insulation from the ends of the telephone pickup wire and solder the wire to the PC board. Install resistors R1 and R2 as shown on the parts layout.
3. For full volume performance, the speaker must be mounted in a plastic or wooden case that has holes cut to allow the sound to escape. The pickup coil cannot be mounted in the same box, because it must be located at least 8 inches away from the speaker. Only the PC board, speaker, and 9-volt battery should be mounted in the case.
4. Attach a fresh 9-volt battery to the snap, and place the telephone pickup coil directly under telephone ear piece, as shown in Figure 3.

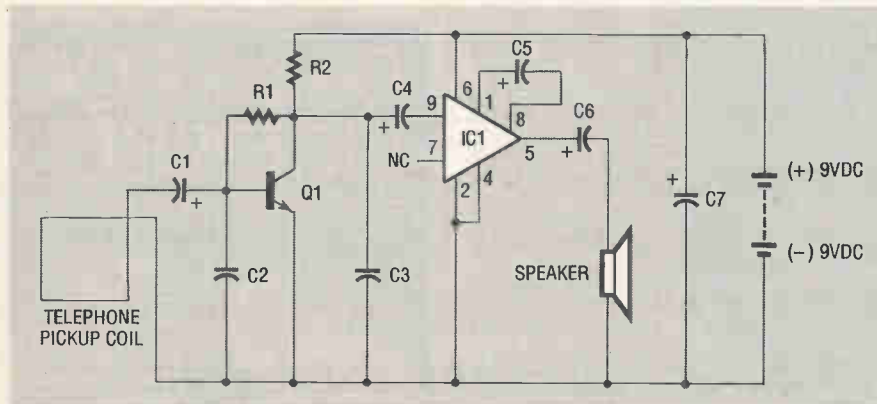

Figure 1. The telephone signal is picked up by L1, is amplified by Q1, and finally by op-amp IC1.

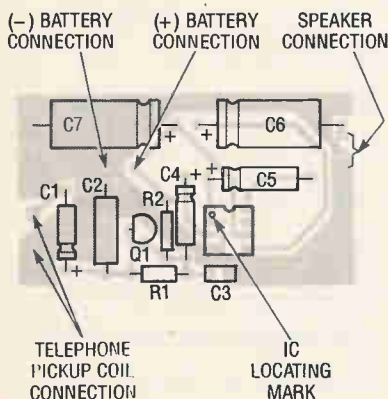

Figure 2. The Parts Layout for the Telephone Amplifier.

enough to drive IC1, an LM386 operational amplifier. That higher level signal is coupled by capacitor C4 to the input pin of IC1. Capacitors C2 and C3 provide filtering and reduce the feedback. Capacitor C5 sets the gain of IC1 to a level high enough to drive the small speaker (SPK). Capacitor C6 is used to couple the signal from the output of IC1 to the

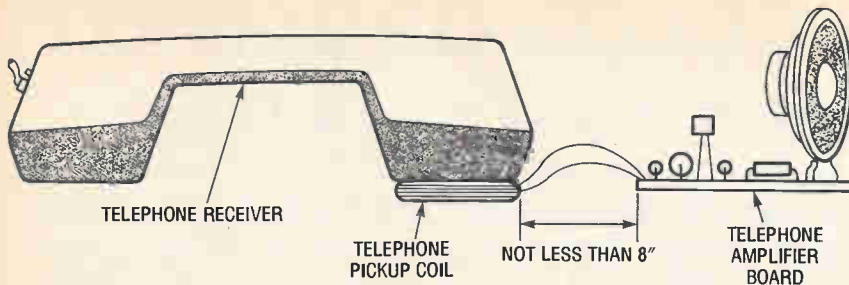

Figure 3. Telephone Hookup Instructions. There must be a distance of at least eight inches between the telephone amplifier board and the telephone receiver.

5. Dial a number that you know has a recorded messages, such as the Temperature or Time numbers, and adjust the location of the coil for optimum performance as the recorded message is playing.
6. To carry on a conversation in normal use, simply direct your voice at the transmitter portion of the telephone receiver. You may find it necessary to speak a little louder or to move closer to the transmitter for the most effective performance.

TROUBLESHOOTING HINTS

First of all, make sure that the solder used to build the kit was rosin core -- not acid core, which could cause irreparable damage by allowing high voltages to be conducted to various points where it should not be.

Recheck all resistors against the parts layout (Figure 2) and look

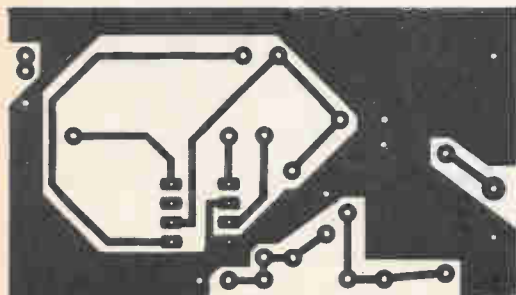

Figure 3. Foil pattern of PC board.

PARTS LIST

C1, C4, C5 1 μ F Electrolytic Capacitor
 C2 0.47 μ F Mylar Capacitor
 C3 0.001 μ F Mylar Capacitor
 C6, C7 100 μ F Electrolytic Capacitor
 IC1 LM386 IC
 Q1 PN2222A Transistor
 R1 10K Resistor
 R2 7.5K Resistor
 Misc. PC Board, 9V Snap, Speaker, Pickup Coil, IC Socket

NOTE: A complete set of parts for the Telephone Amplifier is available as kit C4727 for \$11.90 from The Electronic Goldmine, P.O. Box 5408, Scottsdale, AZ 85261. See page 96 for complete ordering information.

for solder bridges by comparing the actual foil on your PC board to the foil pattern shown in Figure 4. Next, check for cold solder joints and reheat them, adding solder to any suspect connections.

Make sure that the battery snap has been installed with polarity as shown in the parts-placement illustration.

Check to make sure that IC1 is installed correctly and that Q1 has been installed with its flat side in the direction shown. Ω

ATTENTION! ELECTRONICS TECHNICIANS

EARN YOUR B.S.E.E. DEGREE

THROUGH HOME STUDY

Our New and Highly Effective Advanced-Placement Program for experienced Electronic Technicians grants credit for previous Schooling and Professional Experience, and can greatly reduce the time required to complete Program and reach graduation. No residence schooling required for qualified Electronic Technicians. Through this Special Program you can pull all of the loose ends of your electronics background together and earn your B.S.E.E. Degree. Upgrade your status and pay to the Engineering Level. Advance Rapidly! Many finish in 12 months or less. Students and graduates in all 50 States and throughout the World. Established Over 40 Years! Write for free Descriptive Literature.



COOK'S INSTITUTE

OF ELECTRONICS ENGINEERING

4251 CYPRESS DRIVE
JACKSON, MISSISSIPPI 39212

CIRCLE 8 ON FREE INFORMATION CARD

FREE Catalog

All the tools & test equipment you need for hobby or work!

Electrical, electronics, computers, communications, sound systems -- all the tools, meters and other equipment you need to do a professional job!



Top technicians and field service personnel prize their Jensen tool kits. Our new 232-page Master Catalog will show you why. You'll discover hard-to-find items, the latest high-tech developments, soldering stations, wire & cable accessories and many more quality products you want and need. **Send for your free copy today!**



JENSEN TOOLS INC.

7815 South 46th St.,
Phoenix, AZ 85044-5399
Phone: (602) 968-6231
FAX: (800) 366-9662

CIRCLE 10 ON FREE INFORMATION CARD

3-CHANNEL COLOR ORGAN KIT

ENJOY WATCHING THE MUSIC AS YOU LISTEN!

With the soaring popularity of audio/video surround-sound systems, it seems as if people are just beginning to realize that sound and sight belong together. But we've known that for some time. Those of us who were around in the 1960's might remember the popularity of psychedelic light shows at rock-and-roll concerts. To bring the feeling home -- along with the lava lamp -- there was the color organ.

The three-channel color organ kit that we'll show you how to build uses three separate filter stages to light standard 120-volt lamps in response to a music (or other audio) input. The filter circuits, each made up of a resistor-capacitor network, respond to different frequencies or tones in the music, so that low-frequency, or

bass, tones will light one light, midrange tones will light a second lamp, and high-frequency or treble tones will light a third lamp. The affect is a colorful display (if colored bulbs are used) that pulsates in time to the music.

As shown in the schematic diagram of Figure 1, AC line power is brought into the circuit board through F1, a protective 5-ampere fuse. One side of the AC line is connected to one side of each AC outlet. The other side of the AC line is connected to each SCR or Silicon Controlled Rectifier. Each SCR is, in turn, connected to the other side of each AC outlet.

The SCR can be thought of as a device that contains an ON/OFF switch between its anode (A) lead and its cathode (C) lead.

When an SCR is turned ON it will light the lamp plugged into its associated AC outlet.

To turn the switch on, a positive (+) potential needs to be applied to the gate (G) lead. In a DC circuit, the SCR will remain on once it is turned on; however, in an AC circuit the SCR will stay on only as long as a positive level appears on the gate lead.

In this circuit, an audio signal is brought into the circuit from your stereo speaker by transformer T1. This transformer is known as an Audio Output transformer, and it has a ratio of 500 ohms impedance on the primary to 8 ohms impedance on its secondary. When you build the kit, however, you are required to connect T1 in reverse so that the 8-ohm side is connected to your speaker and

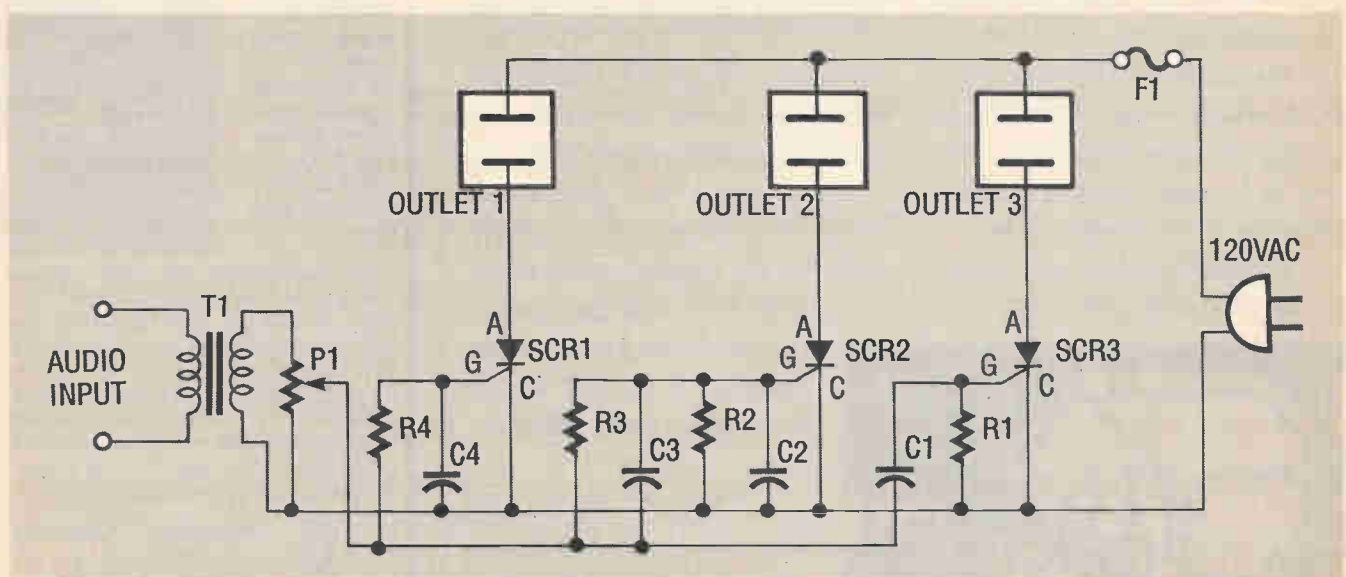

Figure 1. The schematic of the color organ shows how the three outlets are controlled by three SCRs. The R-C filter circuits determine what audio frequencies will turn on the SCRs.

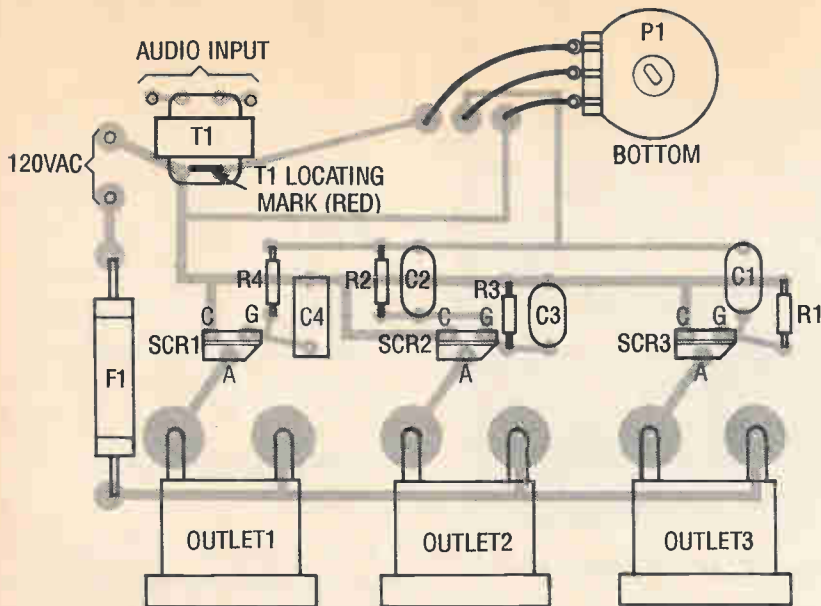

Figure 2. Be sure to mount the SCRs as shown here.

PARTS LIST

C1,C2,C3	0.1 μ F Capacitor
C433 μ F Capacitor
P1	10K Potentiometer
R1	1K Resistor
R2,R3	2K Resistor
R4	4.7K Resistor
SCR1-3	106 SCR
T1	Audio Transformer
Misc.	AC Outlets, Line Cord, Fuse, Wire,
PC Board	

Note: A complete set of parts for the 3-Channel Color Organ is available for \$12.98 as kit C4530 from The Electronic Goldmine, P.O. Box 5408, Scottsdale, AZ 85261. See Page 96 for complete ordering information.

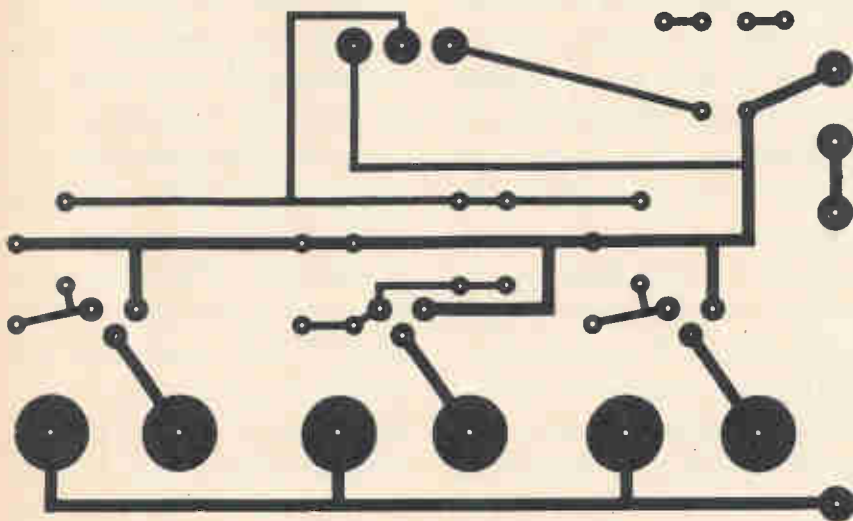
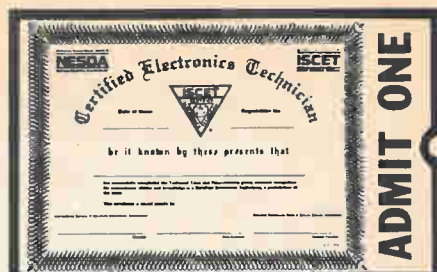

Figure 3. Here is the full-sized foil pattern, which can be used to make your own printed-circuit board.



Your Ticket To SUCCESS

Over 28,000 technicians have gained admittance worldwide as certified professionals. Let your ticket start opening doors for you.

IS CET offers Journeyman certification in Consumer Electronics, Industrial, Medical, Communications, Radar, Computer and Video. For more information, contact the International Society of Certified Electronics Technicians, 2708 West Berry Street, Fort Worth, TX 76109; (817) 921-9101.

Name _____
 Address _____
 City _____
 State _____ Zip _____

Send material about IS CET and becoming certified.

Send one "Study Guide for the Associate Level CET Test." Enclosed is \$10 (inc. postage).

AMAZING SCIENTIFIC & ELECTRONIC PRODUCTS

LASERS AND SCIENTIFIC DEVICES

VRL2K	3mw Vis Red Laser Diode System Kit	\$159.50
LLIS1K	Laser Beam "Bounce" Listener Kit	\$199.50
LHC2K	Visible Simulated 3 Color Laser Kit	\$44.50
LC7	40 Watt Burning Cutting Laser Plans	\$20.00
RUB4	Hi Powered Pulsed Drilling Laser Plans	\$20.00
LGU40	1 to 2mw HeNe Vis Red Laser Gun Assembled	\$199.00
LLS1	Laser Lite Show - 3 Methods Plans	\$20.00
SD5K	See in the Dark Kit	\$299.50
EML1K	Electromagnetic Coil Gun Kit	\$69.50
MCP1	Hi Velocity Coil Gun Plans	\$15.00
LEV1	Levitating Device Plans	\$10.00
EH1	Electronic Hypnotism Techniques Plans	\$10.00

HIGH VOLTAGE AND PLASMA DISPLAY DEVICES

HVM7K	75,000 Volt DC Variable Output Lab Source Kit	\$149.50
IDG3K	Ion Ray Gun Kit, project energy without wires	\$69.50
NIG9K	12W/115 VAC Hi Out Neg Ion Generator Kit	\$34.50
EMA1K	Telekinetic Enhancer/Electric Man Assembled	\$99.50
LG5K	Lightning Display Globe Kit	\$54.50
BTC1K	Worlds Smallest Tesla Coil Kit	\$49.50
BTC3K	250KV Table Top Tesla Coil Kit	\$249.50
BTC5	1.5 Million Volts Tesla Coil Plans	\$20.00
JL3	Jacobs Ladder - 3 Models Plans	\$15.00
GRA1	Anti Gravity Generator Plans	\$10.00
PFS20	Plasma Fire Saber Assembled	\$69.50
DPL20	Dancing Plasma to Music and Sounds Assembled	\$79.50

SECURITY AND PROTECTION DEVICES

ITM10	100,000 Volt Intimidator up to 20' Assembled	\$129.50
IPG70	Invisible Pain Field Blast Wave Gen Assembled	\$74.50
PSP4K	Phasor Sonic Blast Wave Pistol Kit	\$59.50
LIS10	Infinity Xmr, Listen in Via Phone Assembled	\$199.50
TAT30	Automatic Tel Recording Device Assembled	\$24.50
VWPM7K	3 Mi. FM Auto Tel Transmitter Kit	\$49.50
FMV1K	3 Mi. FM Voice Transmitter Kit	\$39.50
HDD1K	Homing/Tracking Beeper Transmitter Kit	\$49.50

EASY ORDERING PROCEDURE TOLL FREE 1-800-221-1705 or 24 HRS ON 1-603-673-4730 or FAX IT TO 1-603-672-5406

VISA, MC, CHECK, MO IN US FUNDS. INCLUDE 10% SHIPPING. ORDERS \$100.00 & UP ONLY ADD \$10.00. CATALOG \$1.00 OR FREE WITH ORDER.

INFORMATION UNLIMITED
 P.O. BOX 716, DEPT. PE, AMHERST, NH 03031

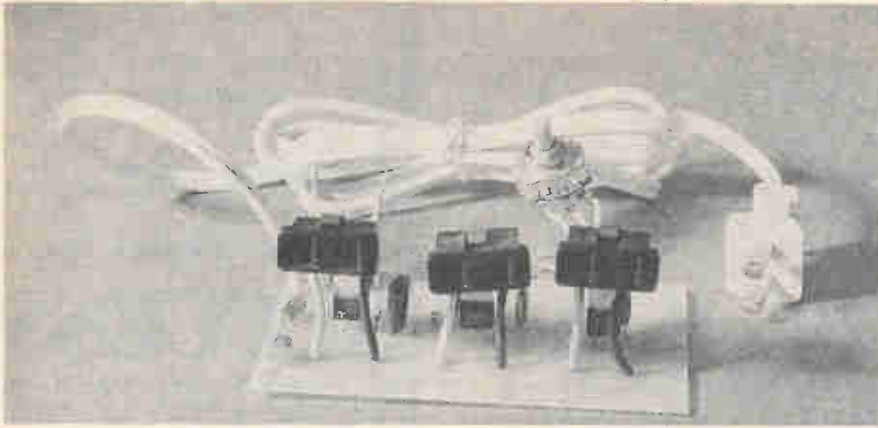

Here is the finished kit before being mounted in an appropriate insulated enclosure.

the 500-ohm side is connected to potentiometer P1. When connected in that configuration, T1 will "step up" the audio signal to a level that is high enough to turn on the SCRs.

Potentiometer P1 is used as a level or sensitivity control. The signal from its wiper lead is applied to each R-C filter stage. Since each SCR has a different R-C (resistor/capacitor) filter in front of its gate lead, each will respond to different frequencies. The greater the capacitance in the filter, the lower the frequency that the SCR will respond to. This allows for a different and exciting display from each song as the different frequencies are applied to different SCRs, thus lighting the different lamps.

ASSEMBLY INSTRUCTIONS

1. CAUTION: Be extremely careful when using a kit that connects to the AC line. **Never** use it outside or near water and always mount the entire kit in a wooden or plastic (insulated) box to prevent you from coming in contact with the AC voltage.

2. Assemble the PC board following the parts layout of Figure 2 and the Parts List.
3. Make sure SCR1 - SCR3 and T1 are installed exactly as shown on the parts layout.
4. Connect lamps of your choice (up to 200 watts total) to outlets. Use different-colored lights in each outlet -- red for base, green for midrange, and white for treble, for example.
5. Connect the audio input across the speaker leads -- there's no need to disconnect your speaker -- and plug the AC line cord in. Adjust your stereo to the desired listening level and then adjust color organ control for desired effect. Your amplifier must be capable of at least 2 watts output to drive the color organ. Do **not** exceed 25 watts of input power to color organ as you will damage the input transformer. If you must use it at higher levels, install some sort of limiting resistor in series with the input to the transformer -- a value of 100 ohms to 200 ohms at 1 watt would work.
6. Always be careful when operating this unit as it operates

from 120 volts AC. While the kit is not dangerous, any AC-operated equipment contains potentially dangerous voltage. Mount the completed unit in a plastic or wooden case to prevent contact with unit when power is on.

TROUBLESHOOTING HINTS

If you have problems with your kit, first be sure that you used the proper solder to build the kit: 60/40 tin/lead rosin-core solder. The solder is available at electric/electronic supply shops.

Next check all the resistor color codes along with the parts-placement diagram and the parts list. Verify that all SCRs have been mounted with their beveled edges as shown.

Make sure that T1 has been mounted with its red mark toward the inside of the board.

Be sure that your input signal is high enough. The best way to determine if a low input signal is the problem, is to supply a signal that you know is high enough. Disconnect the leads that normally go to your speaker and momentarily connect a 9-volt transistor battery across the leads. (Make sure that P1 is adjusted to the high sensitivity position when you do that). The lamps --or at least one of the lamps-- should flash. If this does not work, readjust P1 to the other direction and try again. If it still does not work, you have made an assembly error or you have a cold solder joint. Unplug the unit and reheat and add solder to any suspect connections. Ω

A Goldmine of Electronics Books from **TAB**

EXPERIMENTS

HOMEMADE LIGHTNING: Creative Experiments in Electricity by R. A. Ford. Demonstrate for yourself some of the greatest electrostatic discoveries of the past 150 years. Each of these tested, safe, and inexpensive projects includes thorough instructions and working illustrations. 208 pp., 163 illus. #3576H \$23.95

THE TALKING TELEPHONE AND 14 OTHER CUSTOM TELEPHONE PROJECTS by Steve Sokolowski. Take a fascinating journey through the world of telecommunications, digital electronics, speech synthesis, and control circuitry. 304 pp., 328 illus. #3571H \$25.95

HOMEMADE HOLOGRAMS: The Complete Guide to Inexpensive, Do-It-Yourself Holography by John Iovine. Produce simple white-light-reflection and transmission holograms of people, computer graphics, and solid objects. 208 pp., 110 illus. #3460H \$22.95

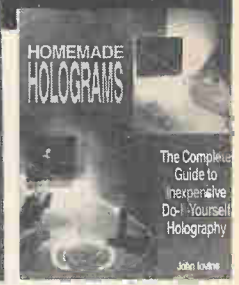
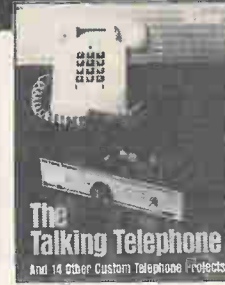
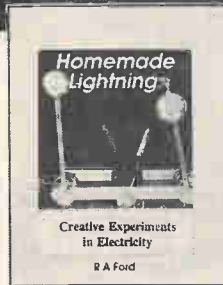

PROJECTS

CIARCIA'S CIRCUIT CELLAR—Vol VII by Steve Ciarcia. Build a gray-scale video digitizer, trainable infrared master controller, an intelligent serial EPROM programmer, the Circuit Cellar AT computer, and lots more. 224 pp., 100 illus. #10010P \$19.95

GORDON McCOMB'S GADGETEER'S GOLDMINE! 55 Space-Age Projects by Gordon McComb. Build a fiberoptic communications link, portable He-Ne laser pistol, laser alarm system, solar battery charger, and much more. 400 pp., 250 illus. #3360H \$29.95

GORDON McCOMB'S TIPS & TECHNIQUES FOR THE ELECTRONICS HOBBYIST by Gordon McComb. Build, test, and use common electronic devices. You get detailed drawings, schematics, and other illustrations for clarification and support. 300 pp., 180 illus. #3485H \$27.95

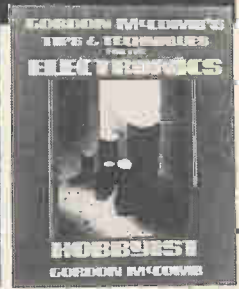
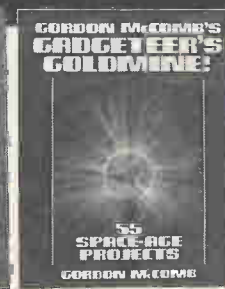
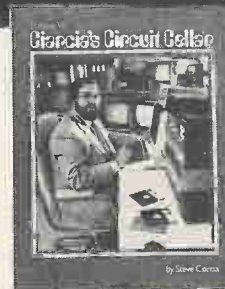

TROUBLESHOOTING TIPS

SECRETS OF RF CIRCUIT DESIGN by Joseph J. Carr. Discover the basics of receiver operation, the proper use and repair of components in RF circuits, and principles of low-frequency to microwave radio signal propagation. 416 pp., 175 illus. #3710H \$32.95

LENK'S VIDEO HANDBOOK: Operation and Troubleshooting by John D. Lenk. Zip through color-circuit checks, digital video circuit checks, 8mm flying erase head troubleshooting, and any other possible operation, repair or adjustment procedure. 416 pp., Illustrated #10018H \$39.95

MAINTAINING AND REPAIRING VCR'S—2nd Ed. by Robert L. Goodman. This money-saving guide shows you how to maintain and repair VHS HQ machines, 8mm, and camcorders. 352 pp., 370 illus. #3103H \$27.95

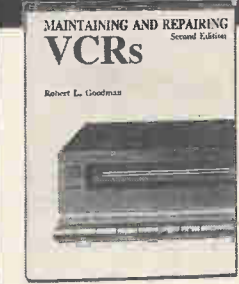
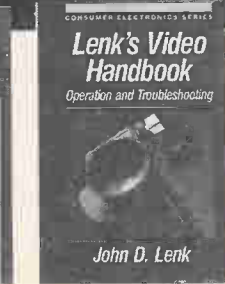
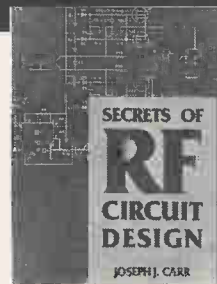

HANDY REFERENCES

To Order Call Toll Free

OLD TIME RADIOS! RESTORATION AND REPAIR by Joseph J. Carr. Get all the detailed instructions you need to build or repair old-time home, auto, amateur, shortwave, and CB radio sets. 256 pp., 200 illus. #3342H \$25.95

DESIGN & BUILD ELECTRONIC POWER SUPPLIES by Irving M. Gottlieb. Discover new advances such as electronic and synchronous rectification, resonant-mode switching, current-mode control, and the MCT thyristor. 180 pp., 98 illus. #3540H \$26.95

THE ENCYCLOPEDIA OF ELECTRONIC CIRCUITS—Vol. 3 by Rudolf F. Graf. "A truly encyclopedic work, giving schematics that encompass virtually the entire spectrum of electronics technology. . . This is a well worthwhile book to have handy." —Modern Electronics 768 pp., 1000 illus. #3348P \$29.95

1-800-822-8158
(in PA, AK, and Canada call 1-717-794-2191)

or fax your order: 717-794-2080

or mail coupon to:

TAB BOOKS, Blue Ridge Summit, PA 17294-0840

CUT ALONG DOTTED LINE

Please add applicable state and local sales tax (in Canada add \$5.00 shipping and handling).

Check or money order enclosed made payable to TAB BOOKS.

Charge my VISA Mastercard American Express

Acct. No. _____ Exp _____

Signature _____

Please send me the book(s) below:

Book # _____ Price _____ Book # _____ Price _____

Book # _____ Price _____ Book # _____ Price _____

Name _____

Address _____

City/State/Zip _____

Satisfaction Guaranteed—If you are not completely satisfied, return the book(s) for a complete refund. Orders subject to credit approval. Prices subject to change.

HH41



0 - 12 VOLT, 1-AMP VARIABLE POWER SUPPLY

POWER ALL OF YOUR PROJECTS WITH THIS VERSATILE , HEFTY POWER SUPPLY!

They say that variety is the spice of life -- but it can also make life more difficult, particularly when you have a variety of electronic devices, each of which has different power requirements. This Variable Power Supply provides a reliable power source for devices that run on anything from 0 to 12 volts DC. It provides a hefty 1-amp, filtered output. Different colored LEDs indicate the output voltages, so there's no need for meters.

This project is somewhat complex for beginners and, because it is powered by 120 volts AC, even experienced electronics hobbyists should use caution when building it. For those readers who know and follow standard AC precautions, we're sure that this power supply will be one of the most useful, and often-used, projects that you build!

THEORY OF OPERATION

The 0 - 12 volt DC Variable Power Supply uses an IC voltage regulator and heavy-duty transformer to provide a reliable DC power supply. Looking at the schematic shown in Figure 1, you can see that line power is brought into the primary of the transformer

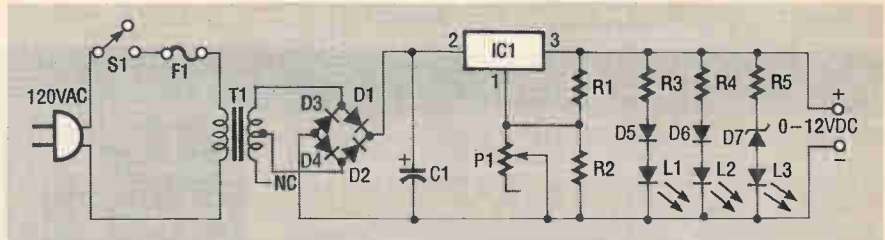

Figure 1. As you can see from the schematic, the Variable Power Supply is connected to 120VAC power. Be sure to exercise caution when building and using the power supply.

PARTS LIST

- C1 470 μ F, 40V Electrolytic Capacitor
- D1 - D6 1N4004 Diodes
- D7 7814 Zener Diode
- F1 Pigtail Fuse
- IC1 LM317T Regulator
- L1 Red LED
- L2 Yellow LED
- L3 Green LED
- P1 10K Potentiometer
- R1 270 ohm Resistor
- R2 4.7K Resistor
- R3 - R5 1.5K Resistor

- S1 Slide Switch
- T1 Power Transformer
- Misc. AC Line Cord, Wire, PC Board, Heat Sink, Nuts and Bolts

NOTE: A complete set of parts for the 0 - 12VDC 1 Amp Variable Power Supply is available as kit C5177 for \$18.95 from The Electronic Goldmine, P.O. Box 5408, Scottsdale, AZ 85261. See page 96 for complete ordering information.

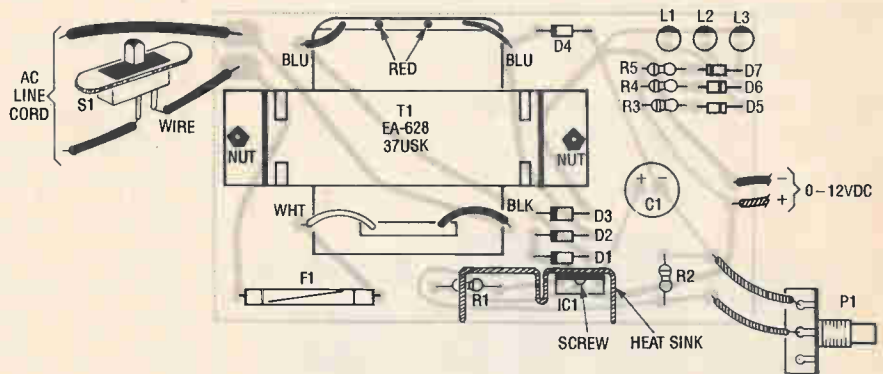

Figure 2. Parts-placement diagram. Note that the heat sink gets hot in normal use. Be careful not to touch it! Also, provide ventilation holes in the case or box for cooling.

through switch S1 and fuse F1. The function of S1 is to turn on the power supply, and the function of fuse F1 is to protect the power supply if a "short" develops either inside the supply, or in the circuit at its output terminals.

The transformer T1 consists of a primary winding with many turns and a secondary winding with few turns of wire. These are wound around an iron-based metal core. The purpose of the transformer is to take in 120-volts AC on the primary and transform it to about 28-volts AC on the secondary. This 28 volts AC is "bridge" rectified by diodes D1 - D4. The resulting output is a DC voltage with a 120-Hz ripple or "hum" component. To smooth or eliminate this hum, the circuit uses a large filter capacitor C1.

The filtered DC is then fed to the input (pin 2) of the LM317T voltage regulator, IC1, which keeps the voltage at its output constant (pin 3) regardless (within limitations) of the input voltage. Pin 1 of the LM317T is the adjustment pin. Varying the voltage on pin 1 (via P1) allows the output voltage to be varied.

Diodes D5 - D7 and LEDs L1 - L3 give an approximate indication of the output voltage. Each LED/diode path has a limiting resistor to limit the current to a level that is safe for the LED.

ASSEMBLY INSTRUCTIONS

1. Carefully examine the parts-placement diagram shown in Figure 2 and refer to the Parts List and the schematic as you go along.

2. Make sure that diodes D1 - D7 are installed with cathode bands in directions shown on the parts placement diagram. Note that Zener diode D7 mounts in the opposite direction of diodes D5 and D6.
3. Be sure to observe polarity when installing electrolytic capacitor C1, and the flat side guide (cathode) when installing LEDs L1 - L3.
4. Install all resistors according to the parts layout, and install potentiometer P1 using a pair of twisted wires.
5. Mount the tap on IC1 to the heat sink using a screw. Notice that the tab of IC1 mounts directly to the heat sink; no insulator is needed. After IC1 is mounted to the heat sink, install IC1 on the PC board as shown. As shown in Figures 2 and 3, one side of the heat sink is not used; this side sits on top of resistor R1.
6. Mount power transformer T1 observing the color code on the leads. Note that the red leads on the secondary are not used and can be cut off. Use nuts and bolts to secure T1 to PC board.
7. Install line cord, fuse, and switch as shown.

TROUBLESHOOTING HINTS

Check that all diodes were installed with the cathode bands oriented in directions shown in Figure 2. Recheck each resistor against the parts layout. Make sure that tab of Q1 faces the inside of the printed-circuit board. Make sure that the blue wires on the secondary of T1 have been

FREE CATALOG

Call (800) 992-9943

Over 35,000
Electronic Components

Call Today for Your
FREE SUBSCRIPTION

If You Order Today,
WE SHIP TODAY!!



**MOUSER
ELECTRONICS**

(800) 992-9943

Stocking Locations Across America.

CIRCLE 12 ON FREE INFORMATION CARD

LEARN VCR CLEANING/MAINTENANCE/REPAIR

EARN UP TO \$1000 A WEEK, WORKING
PART TIME FROM YOUR OWN HOME!



THE MONEY MAKING OPPORTUNITY OF THE 1990'S

IF you are able to work with common small hand tools, and are familiar with basic electronics (i.e. able to use voltmeter, understand DC electronics) . . .

IF you possess average mechanical ability, and have a VCR on which to practice and learn. . . then we can teach **YOU** VCR maintenance and repair!

FACT: up to 90% of ALL VCR malfunctions are due to simple MECHANICAL or ELECTRO-MECHANICAL breakdowns!

FACT: over 77 million VCRs in use today nationwide! Average VCR needs service or repair every 12 to 18 months!

Viejo's **400 PAGE TRAINING MANUAL** (over 500 photos and illustrations) and **AWARD-WINNING VIDEO TRAINING TAPE** reveals the **SECRETS** of VCR maintenance and repair—"real world" information that is **NOT** available elsewhere!

Also includes all the info you'll need regarding the **BUSINESS-SIDE** of running a successful service operation!

FREE INFORMATION

CALL TOLL-FREE 1-800-537-0589

Or write to: Viejo Publications Inc.
5329 Fountain Ave.

Los Angeles, CA 90029 Dept. PEH

CIRCLE 17 ON FREE INFORMATION CARD

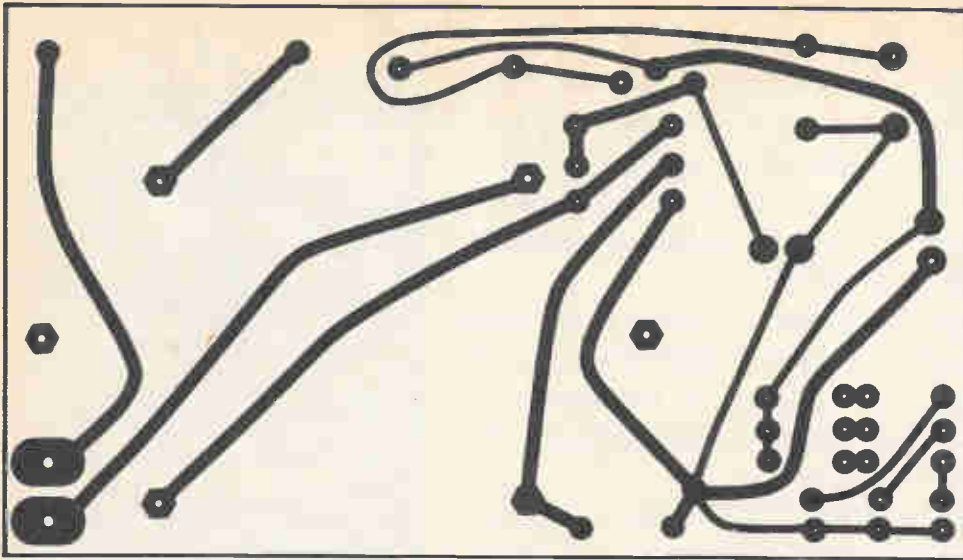
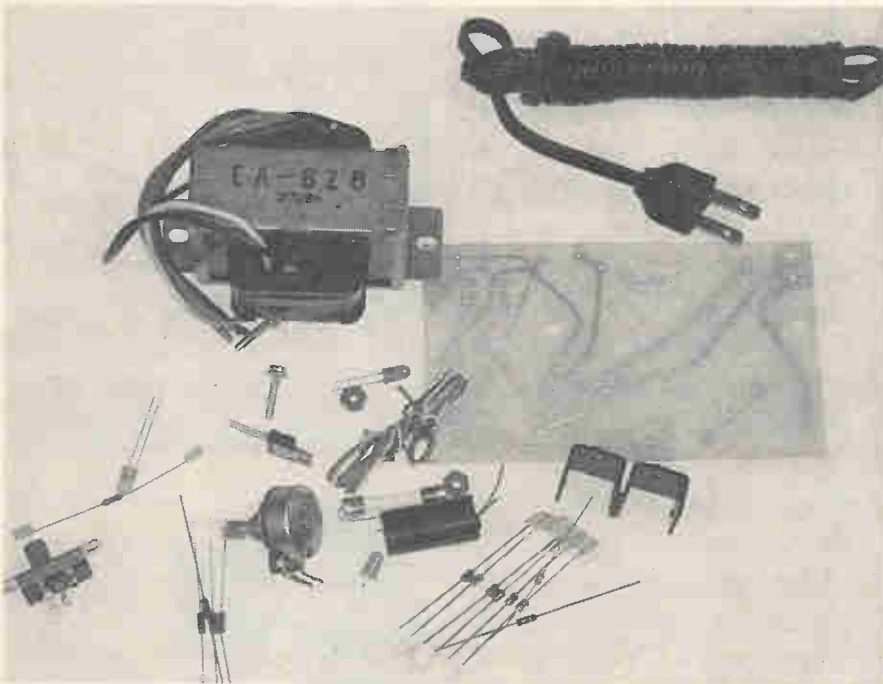
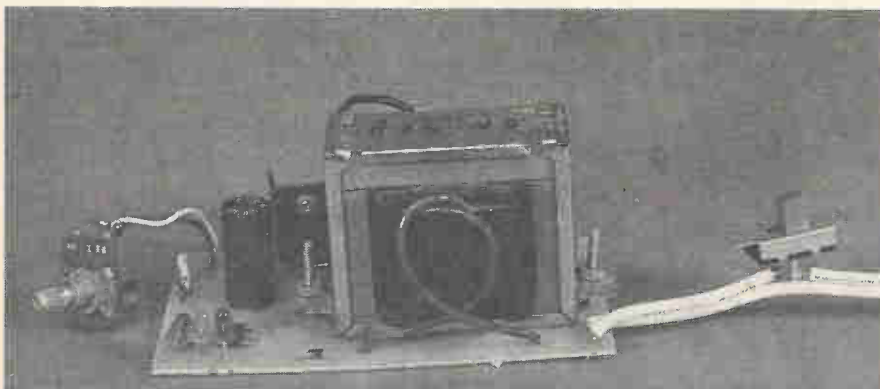

Figure 4. You can use this full-sized foil pattern to etch your own PC Board for the variable power supply.



Although the complete kit doesn't contain many parts, you shouldn't be misled into thinking that it can't do a lot!



The finished kit before installation in a case. Note how power-switch S1 is installed.

properly connected to the board.

Check the polarity of C1, and make sure that all LEDs are installed correctly.

Look for cold solder joints and reheat any suspect connections.

USING THE POWER SUPPLY

After rechecking assembly for good soldering and component placement, plug in the line cord. Now, slowly turn the potentiometer. If the LEDs glow in order (red, yellow, green), your unit is functioning properly.

Because the unit connects to the AC line, be careful when working with it. Mount the sup-

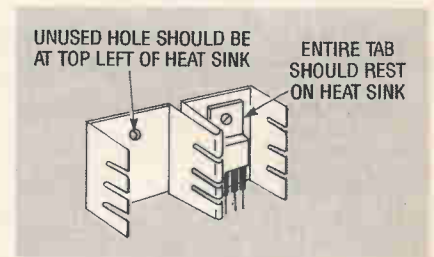

Figure 3. This is how the heat sink/voltage regulator should look when properly mounted.

ply in a plastic or wood case to prevent contact with the 120VAC.

The approximate output voltages indicated by the LEDs with a normal load connected are:

- 0 - 2 Volts:** No LEDs glowing;
- 3 volts:** Only red LED glowing;
- 5 volts:** Red LED glowing, and yellow barely glowing.
- 8 volts:** Red LED and Yellow LED at normal brilliance.
- 10 volts:** Red and yellow LEDs glowing and green barely glowing.
- 12 volts:** All LEDs glowing at normal brilliance. Ω

INSANITY ALARM

*DRIVE YOUR FRIENDS CRAZY
-- ELECTRONICALLY!*

No, the Insanity Alarm doesn't go off whenever a crazy person sits next to you on the subway. Instead of warning you that someone's insane, it actually "drives people insane." In reality, the device is quite harmless. When you set it in an inconspicuous spot exposed to ambient light, it remains completely silent. But as soon as the light is turned off, it emits a high-pitched, irritating tone. When your friends turn the light back on to look for the culprit, the Insanity Alarm keeps quiet again! It's as easy to build as it is fun to use.

THEORY OF OPERATION

The Insanity Alarm uses a fixed-frequency piezoelectric buzzer element in conjunction with a cadmium-sulfide (CDS) cell and the two-transistor circuit shown in Figure 1 to provide a unique effect. Whenever light reaches the CDS photo-electric cell, the kit is silent. But when there is no light striking the cell, transistor Q1 turns on, and the kit emits a high-pitched tone.

The first item to study to understand how this kit works is the three-terminal fixed-frequency piezoelectric buzzer element. It consists of a piezoelectric disk that oscillates at the fixed frequency of 3.137 kHz. The oscillations necessary to produce the sound are created by the arrangement of transistor Q2, capacitors C1 and C2, and resistors R1 through R3. Transistor Q1 is used as a switch. It is forward biased "on" by R4; however, the CDS Cell turns Q1 "off" when the light is striking it.

A CDS photo cell is made from material known as cadmium sulfide, a semiconductor material that changes resistance when the light strikes it. The greater the amount of light, the lower the resis-

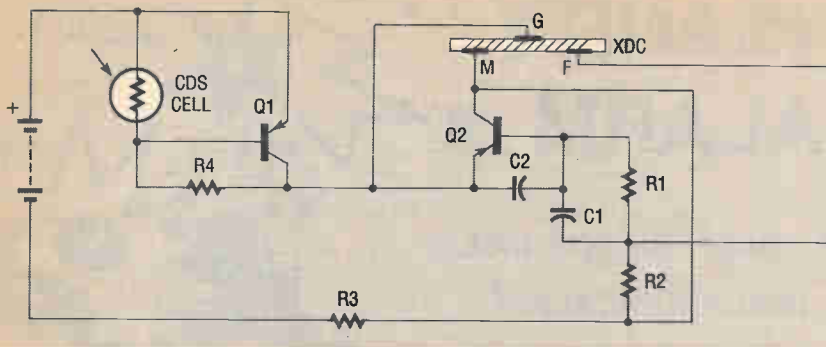

Figure 1. The simple schematic of the Insanity Alarm makes it obvious that you won't go crazy trying to assemble it.



The completed board is hardly bigger than the battery that powers it. You'll have no trouble hiding it!

tance. That low resistance conducts positive voltage to the base of PNP transistor Q1, keeping it turned "off" when the light shines on the CDS Cell. As soon as the light is removed, the CDS Cell provides a resistance over 100K. That causes Q1 to turn "on," which then allows positive voltage to reach the emitter lead of

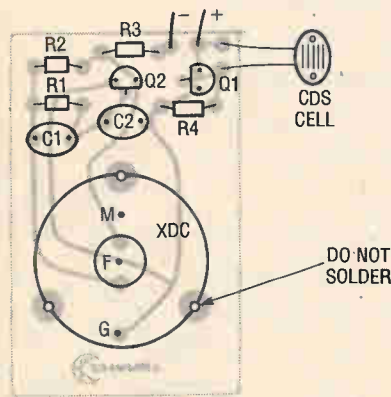

Figure 2. Parts-placement diagram for the Insanity Alarm.

Q2, which then begins to oscillate. That then causes the piezoelectric element (transducer) to produce the loud tone.

ASSEMBLY INSTRUCTIONS

1. Assemble the Insanity Alarm by following the parts layout (Figure 2), parts list, and schematic. Use only 60/40 rosin-core solder. Never use acid-core solder.
2. Carefully solder all the components, observing the flat-side guides on Q1 and Q2.
3. Install the transducer XDC

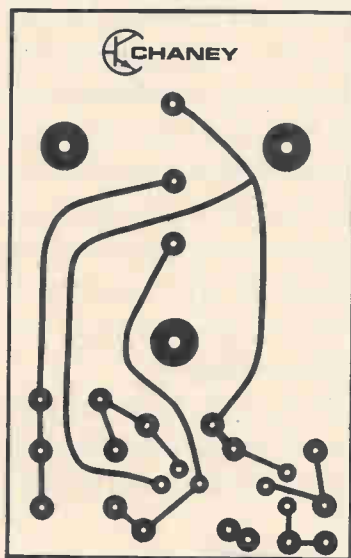

Figure 3. Full size foil pattern can be used for making your own board.

PARTS LIST

C1, C2047 Disc Capacitor
Q1, Q2	2N3906 Transistor
R1	6.8K Resistor
R2	33K Resistor
R3	200 ohm Resistor
R4	75K Resistor
XDC	Piezoelectric Transducer
Misc.	CDS cell, 9-volt snap, and PC Board

NOTE: A complete set of parts for the Insanity Alarm is available as kit C6240 for \$6.98 from The Electronic Goldmine, P.O. Box 5408, Scottsdale, AZ 85261. See page 96 for complete ordering information.

carefully to prevent bending of the three small pins. Solder the pins of XDC only - not the plastic mounting legs.

4. After assembly, check all parts placements and soldering. Place the unit under a light and connect a fresh 9-volt battery. The unit should be silent until the CDS cell is covered or the light is turned off.

TROUBLESHOOTING HINTS

First of all, make sure that you used the right solder. Then check to make sure that Q1 and Q2 are mounted with their flat sides as shown, and recheck all resistors against the parts-placement diagram. Make sure that the snap was connected with polarity as shown. Is your battery good?

Temporarily remove the CDS cell, and the unit should produce a loud tone. If it does not, you have probably made an assembly error or have a cold-soldered joint. Ω

Don't you hate it when you're in the middle of a phone conversation and something comes up that requires your immediate attention? You can put the phone down while you deal with the situation at your end of the line -- with the person at the other end over-hearing every word. Or you can hang up and call them back a few minutes later. We have a better solution: Invest an evening at your workbench, and about five dollars, and build a hold button for your telephone. The tiny device -- it's small enough to be mounted inside the phone! -- provides both convenience and privacy by allowing you to place the receiver back on the hook, without breaking the connection,

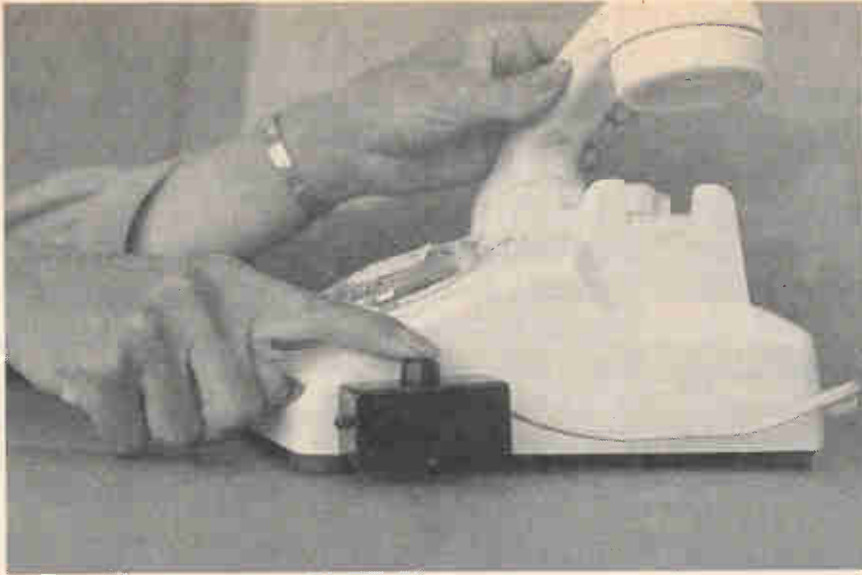

ELECTRONIC TELEPHONE HOLD BUTTON

BUILD THIS CONVENIENT ADD-ON FOR ALL YOUR PHONES

until you're ready to pick up the conversation again. (You can even pick it up at a different extension!)

THEORY OF OPERATION

The Telephone Electronic Hold Button uses a Silicon Con-

trolled Rectifier (SCR) and a simple circuit, shown in Figure 1, to provide a useful phone accessory. The standard phone has a set of contacts inside the phone that "hold" or cause a relay or electronic circuit in the telephone company's central office to make your connection to the other party on the line. The Telephone Electronic Hold Button electronically "holds" the central-office relay, allowing

you to hang up the phone's handset. Normally, hanging up the handset would open the circuit to the central office, disconnecting you from the other party.

The Electronic Hold Button works by putting an electronic switch in parallel with the phone's own switch. That electronic

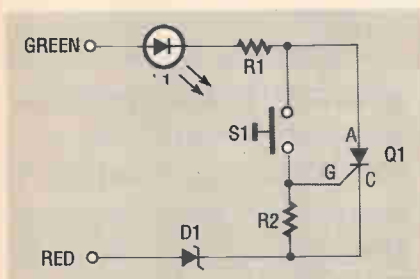

Figure 1. The Telephone Electronic Hold Button is an easy project to build, even for beginners.

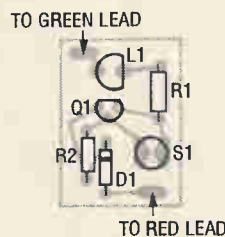

Figure 2. Make sure to study the proper orientation of L1, Q1, and D1, and install them exactly as shown here.

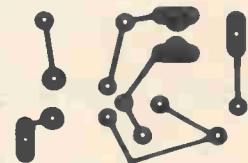

Figure 3. You can see from this full-size foil pattern that the Electronic Hold Button is tiny and unobtrusive.

switch is known as an SCR. In a DC circuit, the SCR switches on between the cathode lead (C) and the anode lead (A) when a positive (+) level is momentarily connected to its gate lead (G). As you can see in the parts-placement diagram (Figure 2), the Electronic Hold Button uses normally open (N.O.) pushbutton switch S1 to accomplish that, since a (+) level appears on the green lead going to the phone line and (-) appears on the red lead. Resistors R1 and R2 are used as current limiters.

LED L1 indicates that the party is on hold by lighting up when S1 is pressed. A LED is a PN junction of a special semiconductor material that converts electrons directly into photons (visible light). Diode D1 is a zener that not only serves to prevent reverse polarity to the SCR (in case the kit is incorrectly connected), but also is used to provide a 6-volt DC voltage drop from the central-office voltage.

Once the device is attached to your phone, the red LED will light to signify that you have a call on hold. Simply picking up the handset will reconnect the call. You'll be able to put a call on hold on an upstairs phone, run downstairs to answer the front door, and then resume your conversation on a downstairs extension!

ASSEMBLY INSTRUCTIONS

1. Build the Telephone Electronic Hold Button according to the parts-placement diagram in Figure 2, the Parts List, and the schematic. Make sure to use

only 60/40 rosin-core solder. If you use acid-core solder, the device will be conducting high voltage to various points where it should not, and that can cause irreparable damage.

2. Install LED L1 with its flat side exactly as shown in Figure 2. Install SCR Q1 and Zener diode D1, orienting the band on D1 and the flat side on Q1 exactly as shown.
3. After assembly, connect the red lead to the red-lead terminal on the inside of the phone or on the phone jack. Next, connect the green lead to the green-lead terminal on the inside of the phone or on the phone jack.
4. Test your Electronic Hold Button by calling a friend and placing the call on hold. To do so, first depress pushbutton S1 and continue to hold S1 down while replacing the phone's handset. If the red LED glows, the call has been placed on hold. The call will remain on hold until you pick up the handset again either at the

phone with the hold button or any extension connected to the same line.

5. In some cases, if you are close to the phone company's office, you might notice that the red LED stays on even after you have taken the calling party off hold and have hung up after the completion of your conversation. That does not present a problem since the line will release and the LED will go out after a delay of about 15 seconds.

TROUBLESHOOTING HINTS

This kit is so easy to build that it shouldn't present any problems -- even for first-time kit builders! If, however, your hold button doesn't work the first time, make sure that Q1 has been installed with flat side as shown, and that the flat side of LED is facing the direction as shown in Figure 2. The cathode of D1 also must face the direction shown.

The operation of the kit can be verified by connecting the (+) terminal of two 9-volt batteries connected in series to the green lead and the (-) terminal to the red lead. Depress S1 and the LED should light up and remain on, even after S1 is released. Remove the batteries after your test.

Check for cold solder joints and reheat them, adding solder to any suspect connections.

When you've verified that everything works correctly, you will want to install it permanently. It's small enough to fit inside of most telephones, or you might want to install it in a separate case for greater flexibility.Ω

PARTS LIST

D1	7814 Zener Diode
L1	Red LED
Q1	C103B SCR
R1	820 ohm Resistor
R2	1K Resistor
S1	N.O. Pushbutton Switch
Misc.	Wire, PC Board

NOTE: A complete set of parts for the Telephone Electronic Hold Button is available as kit C5176 for \$5.00 from The Electronic Goldmine, P.O. Box 5408, Scottsdale, AZ 85261. See page 96 for complete ordering information.

Enter A World Of Excitement with a Subscription to Popular Electronics®

Get the latest electronic technology
and information monthly!

Now you can subscribe to the magazine that plugs you into the exciting world of electronics. With every issue of Popular Electronics you'll find a wide variety of electronics projects you can build and enjoy.

Popular Electronics brings you informative new product and literature listings, feature articles on test equipment and tools—all designed to keep you tuned in to the latest developments in electronics. So if you love to build fascinating electronics, just fill out the subscription form below to subscribe to Popular Electronics... It's a power-house of fun for the electronics enthusiast.

EXCITING MONTHLY FEATURES LIKE:

- CONSTRUCTION**—Building projects from crystal sets to electronic roulette
- FEATURES**—Educational training on digital electronics, Ohm's Law, Antennas, Communications, Antique Radio, Simplified Theory
- HANDS-ON-REPORTS**—User test comments on new and unusual consumer products
- SPECIAL COLUMNS**—Think Tank, Circuit Circus, Computer Bits, DX Listening, Antique Radio, Amateur, Scanner Scene

PLUS: ALL OUR GREAT DEPARTMENTS!

You'll get 12 exciting and informative issues of Popular Electronics for only \$18.95. That's a savings of \$16.45 off the regular single copy price. Subscribe to Popular Electronics today! Just fill out the subscription order form below.



FOR FASTER SERVICE CALL TODAY
1-800-435-0715
(7:30AM-8:30PM)
EASTERN STANDARD TIME

Popular Electronics® SUBSCRIPTION ORDER FORM

P.O. Box 338, Mt. Morris IL. 61054

YES! I want to subscribe to Popular Electronics for 1 Full year (12 Issues) for only \$18.95. That's a savings of \$16.45 off the newsstand price.

Payment Enclosed Bill me later
Please charge my: Visa Mastercard

Acct. #

Signature _____

Exp. Date _____

PLEASE PRINT BELOW:

NAME _____

ADDRESS _____

CITY _____

STATE _____

ZIP _____

Allow 6 to 8 weeks for delivery of first issue. U.S. Funds only.
In Canada add \$5.00 Postage. All Other Foreign add \$7.50 Postage.

AHH91

BUILD YOUR OWN ELECTRONIC SLOT MACHINE

***YOU'LL BE THE BIG WINNER WITH THIS
EXCITING ELECTRONIC SLOT MACHINE!***

Anyone who's ever been to Las Vegas knows how mesmerizing the slot machines can be -- with their spinning displays, flashing lights, bells, and buzzers -- and how expensive they can be. This Electronic Slot Machine provides all the fun, and none of the risk. The device features sound effects, digital readouts, and a flashing LED. Three different symbols "roll" and "come up" one at a time. And when you hit three of a kind, a special "winner" note sounds. This is one one-armed bandit that won't steal your hard-earned pay!

THEORY OF OPERATION

The slot machine's realistic action is provided by seven ICs and three displays, as illustrated in Figure 1, the schematic diagram. Two 555 CMOS timer ICs generate pulses. IC1 is used to generate the clock pulses for the entire electronic slot machine. The pulses are coupled from the output (pin 3) to the clock inputs of IC4, IC5, and IC6, the display-driver ICs.

The displays are common-cathode seven-segment LED types. They are wired to display three different symbols, an "L,"

a "7," and a "bar." When all three displays show the same symbols, IC7 (a 4023 triple 3-input NAND gate) decodes a winner and sends a signal to pin 5 of IC3. That IC is a 4001 CMOS NOR gate and it functions to turn on IC2, a 555 timer IC. IC2 actually produces the winner tone on its output, pin 3.

Transistors Q4 - Q12 are used to drive the common cathode displays. An LED is used to indicate the clock pulses, and a variable resistor is provided for each of these functions. Trimmer resistor P1 controls the overall clock rate, P2 controls the "winner" tone, and P3 controls the display brilliance.

ASSEMBLY INSTRUCTIONS

1. Study the Parts-Placement Diagram in Figure 2, as well as the the Parts List and the schematic before you begin to build the Electronic Slot Machine. Be sure that you have all proper components on hand, and use only 60/40 rosin-core solder. If you've never built a kit before, this is not a good one to start with. Try one of the other, simpler projects presented in this magazine.

2. Install the IC sockets, and line up the IC locating marks when mounting IC1 - IC7. Install transistors Q1 - Q12, observing the direction of their flat sides, and mounting them as shown in Figure 2.
3. Be sure to observe the polarity on electrolytic capacitors C1, C3, C4, C5, and C6 when installing them. There's no need to observe the polarity on capacitors C2, C7, and C8.
4. Install diodes D1 through D6, observing the direction of the cathode band on each one as shown in the parts-placement diagram. Mount the jumbo red LED with flat side (cathode) in direction shown in Figure 2.
5. Install displays DISP1 - DISP3 with the decimal points in the proper direction, and observe polarity when installing the 9-volt snaps.
6. Install trimmer resistors P1 - P3 as shown in Figure 2. Install the pushbutton switch PB.
7. Install resistors R1 through R31.
8. Install all jumper wires using bare wire as illustrated in Figure 2. Wire the speaker to the printed circuit board at points shown.
9. After rechecking the assembly, carefully, connect a fresh 9-

volt alkaline battery to the snap. The LED should begin flashing. (You should be able to vary its rate with P1.) Depress pushbutton PB and, while holding it down, the displays will begin to "roll" (flashing the symbols "7," "-", and "L"). Release PB and each digit will stop one at a time. When all the symbols have stopped, the speaker will go silent -- unless all the symbols are the same. If that's the case, you have won, and the speaker sounds a special "winners beep"!

10. Trimmer resistor P1 adjusts the roll speed and the speed of "winner beep" sound. Trimmer resistors P2 and P3 adjust the pitch of the "winner beep" sound and the brightness on the displays, respectively. When setting P3, keep in mind that the brighter the display, the faster your battery will drain.

TROUBLESHOOTING HINTS

Recheck all resistors against the parts layout and Parts List.

Look for solder bridges by

comparing the actual foil on your PC board to the foil pattern in Figure 3. Check for cold solder joints and reheat, adding solder to any suspect connections.

Make sure that the battery snap has been installed with polarity as shown, and that your battery is good.

Check to make sure that all ICs have been installed with their locating marks in direction shown in the parts-placement diagram. Recheck the LED to make sure that its flat side is facing the direction shown.

Make sure that polarity was

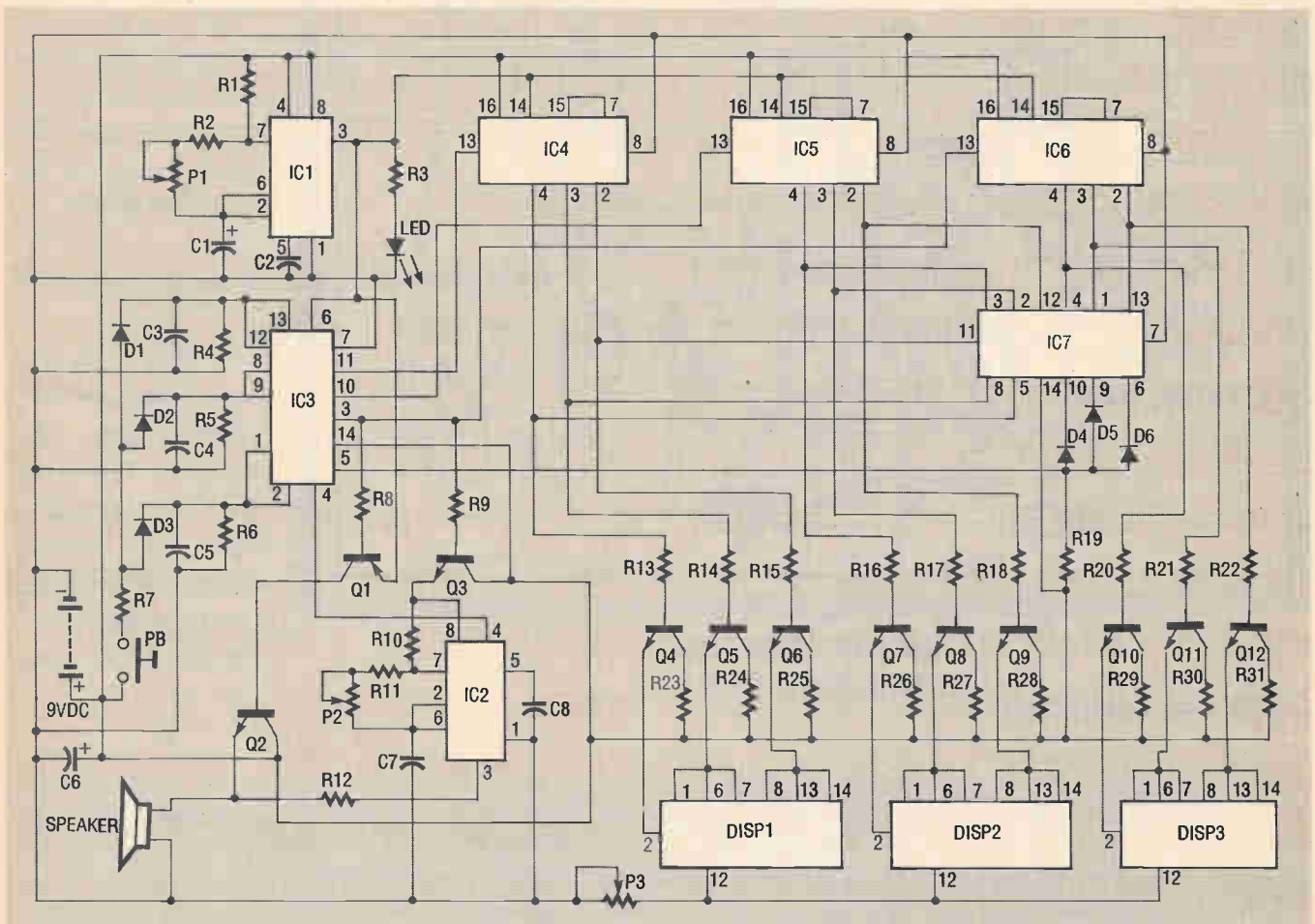

Figure 1. Seven ICs and three displays give the Electronic Slot Machine excitement and a real-life feel. When all three symbols are the same, a "winner" tone is sounded by an oscillator built around IC2, a 555 timer.

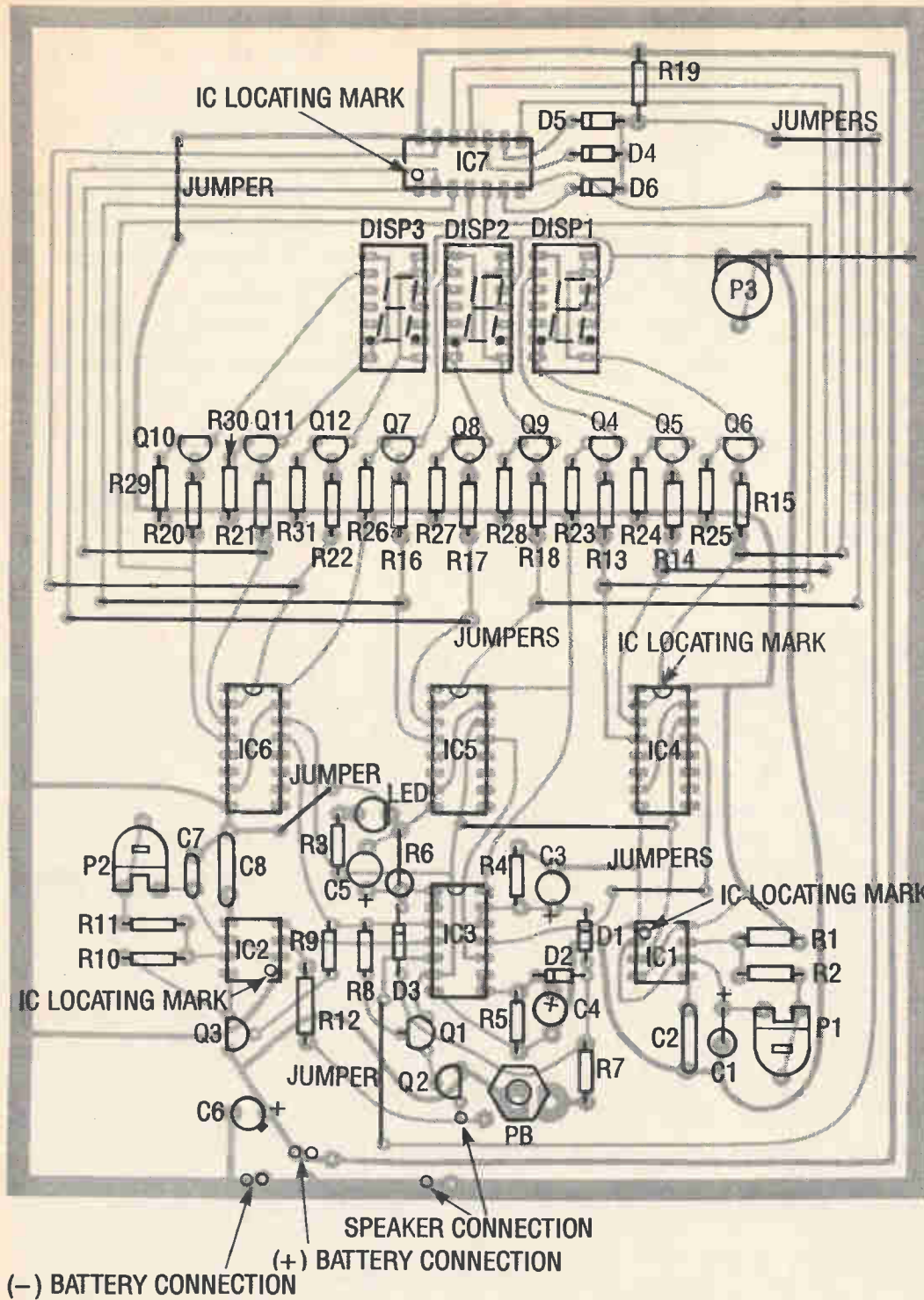

Figure 2. As you follow the parts-placement diagram, be sure to observe the IC locating marks and the polarity of the electrolytic capacitors and the diodes. Mount your components in the direction shown.

observed on all electrolytic capacitors as shown in the parts-placement diagram. Also, make sure the polarity (cathode band) on each of the diodes is correctly oriented. And make sure that all transistors have their flat sides facing in the direction shown.

PLAYING THE SLOTS

You should have "slots of fun" playing this slot machine. To keep your fun to the maximum, the battery should be removed from the snap when the unit is not being

PARTS LIST

C1 22 μ F Capacitor
 C2,C801 μ F Capacitor
 C3-C6 10 μ F Capacitor
 C71 μ F Capacitor
 D1 - D6 1N4148 Diode
 DISP1 - DISP3 SEC3010RE Display

IC1,IC2 555 Timer IC
 IC3 4001 CMOS IC
 IC4 - IC6 MC14017BCP IC
 IC7 4023 CMOS IC
 LED Jumbo Red LED
 P1, P2 .. 50K Trimmer Resistor
 P3 200 ohm Trimmer Resistor
 PB Pushbutton Switch
 Q1 2N3906 Transistor

Q2+Q12 239904 Transistor
 R1,R3,R9,R10,
 R11,R13 - R18,
 R20 - R22 1K Resistor
 R2 200 ohm Resistor
 R4 470K Resistor
 R5 650K Resistor
 R6 390K Resistor
 R7 33K Resistor

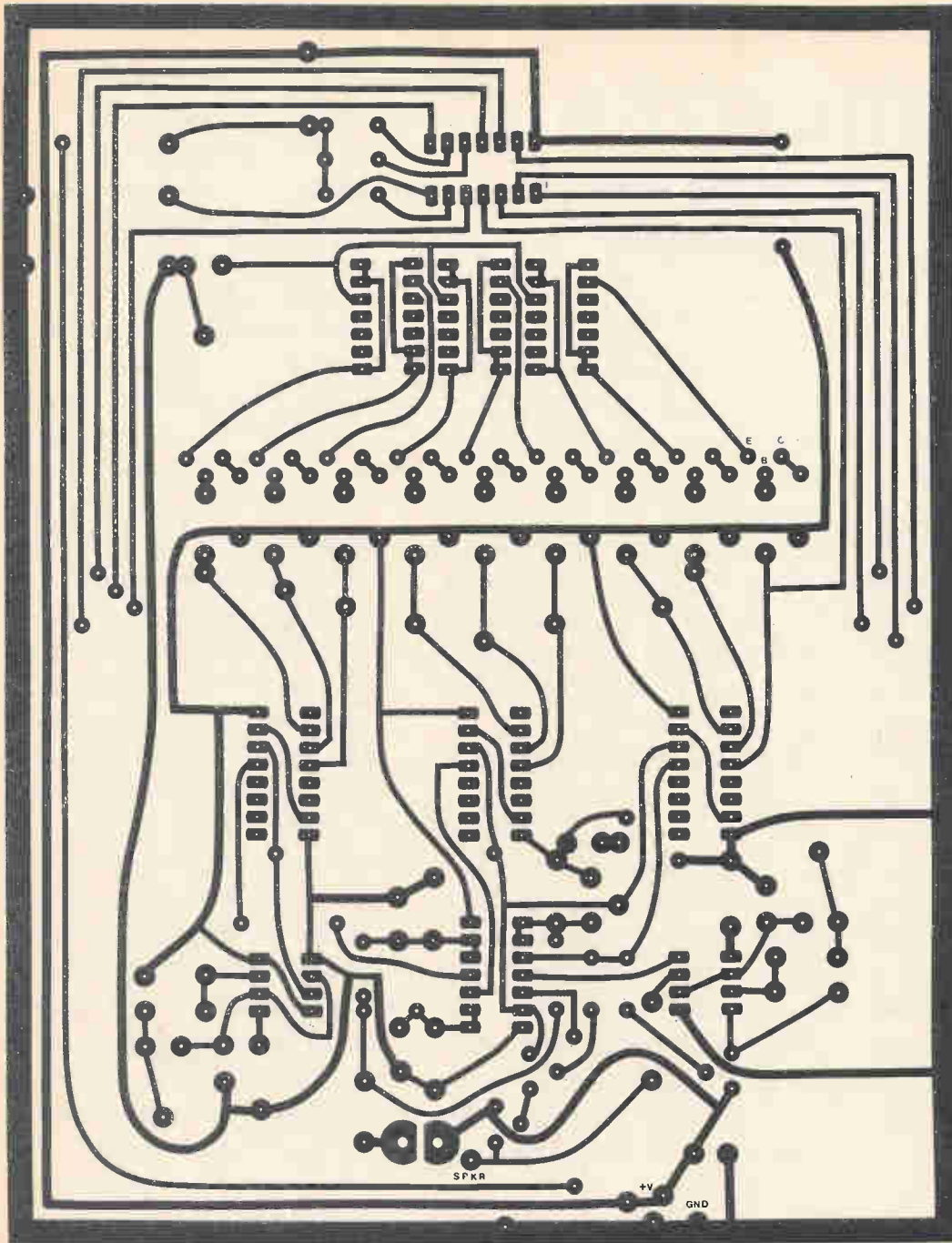

Figure 3. You can use this full-size foil pattern to make your own printed circuit board for the Electronic Slot Machine.

- R8 10K Resistor
- R12 100 ohm Resistor
- R19 2.2K Resistor
- R23,R26,R29 560 ohm Resistor
- R24,R25,R27,
- R28,R30,R31 150 ohm Resistor
- Misc. PC Board, Speaker, IC
- Sockets, 9V Snaps, Insulated
- Wire, Bare Wire

NOTE: A complete set of parts for the Electronic Slot Machine is available as kit C7423 for \$37.50 from The Electronic Goldmine, P.O. Box 5408, Scottsdale, AZ 85261. See page 96 for complete ordering information.

used. The Electronic Slot Machine requires a large current to light the bright displays, which drains a battery's capacity quickly. Therefore, a second set of battery terminals is provided on the PC board so that a second 9V battery can be added for longer life. For extended usage, the slot machine can be operated from a 9-volt DC adapter or from six alkaline "D" cells connected in series. We've found that this game can be quite addictive. And we think that you'll definitely want to consider adding some provision for longer playing time!

Since your playing results won't always be favorable, you will definitely want to install the slot machine in a sturdy case -- it's sure to get a lot of use (and perhaps even abuse from the losers).

Use a red bezel to enhance the display's visibility, and mount the speaker up front to generate the maximum excitement. Best of all, as you play, just think how much you're cheating the realone-armed bandits! Ω

10-NOTE SOUND SYNTHESIZER

**AMAZE YOUR FRIENDS WITH
HIGH-TECH SOUND EFFECTS**

Sound effects are always fun to play around with. You can use strange sounds to give your video soundtracks a high-tech feel, to play practical jokes on your friends, or to bring a Halloween costume to life. You don't have to spend a lot of money on a fancy store-bought synthesizer to get in on the fun. With the 10-Note Sound Synthesizer the fun starts as you build it yourself. Once it's up and running, you're sure to come up with all sorts of ways to use its robot and computer noises and "space war" sound effects. The sound synthesizer has ten adjustable notes, variable pitch and speed, and individual or flowing notes, so you can use it to create an endless variety of sounds.

THEORY OF OPERATION

As you can see in the schematic (Figure 1), three IC's are used to produce the computer and robot sounds. IC1 is a 555 timer that is used to generate clock pulses. It is configured here as an astable multivibrator. The frequency of the clock pulses is set by trimmer potentiometer P1, a variable resistor. Those clock pulses are coupled to the input of IC3 (a 4017 CMOS Johnson

counter) on its clock input pin 14. Each clock pulse causes IC3 to shift a "high" to each of its output pins in sequence. A variable trimmer resistor, which can be adjusted to set a different frequency for each note, is connected to each of IC3's output pins. One side of each of the trimmers is connected to pin 5 (the control voltage pin) of IC2.

IC2, another 555 timer IC, is used to create the tone; the overall pitch of the tone can be varied by P2. As the output sequences from the 4017, that tone, which is changed in frequency by each output shift, is applied to a small speaker from pin 3 of IC2. An LED, which flashes with each clock pulse, is connected to pin 3 of IC1. Switch S2 is used to vary the sound between "flowing" and distinct notes.

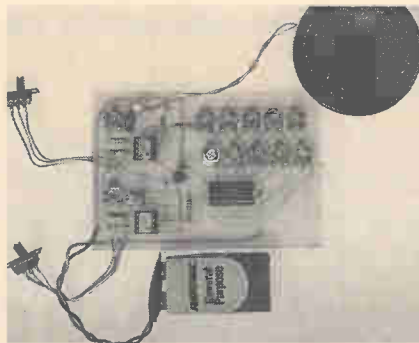

The completed synthesizer is shown here before being installed in a case.

ASSEMBLY INSTRUCTIONS

1. Follow the schematic (Figure 1) and the parts-placement diagram shown in Figure 2, and refer to the Parts List as needed. Be sure to use only 60/40 rosin-core solder -- do not use acid-core solder!
2. Install all resistors, and then the capacitors. Don't forget to observe the polarity of the capacitors when indicated. Orient the IC's as shown in the Figure 2, using the locating marks to place them correctly. Depending on the type of IC, the locating mark will either be a notch on the lower-left side, or a small dot on lower-left corner, or possibly both. The LED should be installed with the flat side (cathode) as shown in Figure 2.
3. You can use left-over pieces of leads, cut from resistors, to install the jumpers in three places, as shown in Figure 2.
4. Connect a fresh 9-volt battery to the battery snap and adjust P3 through P12. Because potentiometers interact with each other, those 10 adjustments can produce a tremendous variety of sounds.
5. Potentiometers P1 and P3 are used to vary the overall sounds; P1 adjusts speed and P2 adjusts pitch. Switch S2 switches from individual to flowing notes.

TROUBLESHOOTING HINTS

If your kit doesn't work when you first turn it on, check your construction techniques. Make sure you used the right solder,

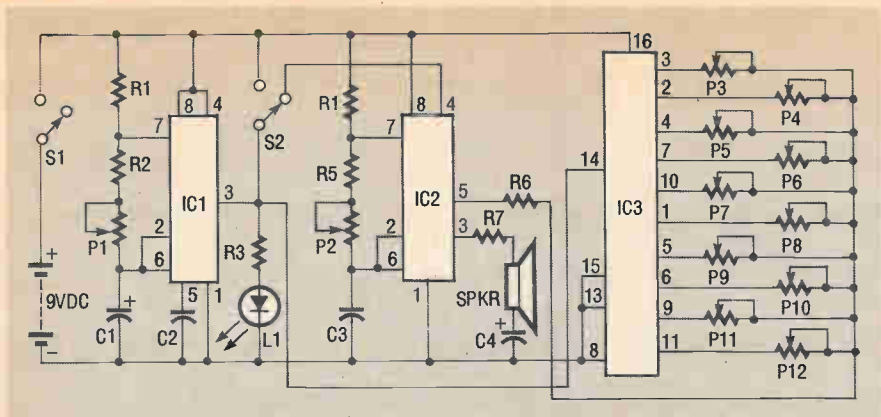

Figure 1. The schematic of the 10-note sound synthesizer, which is built around two 555 timers and a 14017 divide-by-10 counter (IC3).

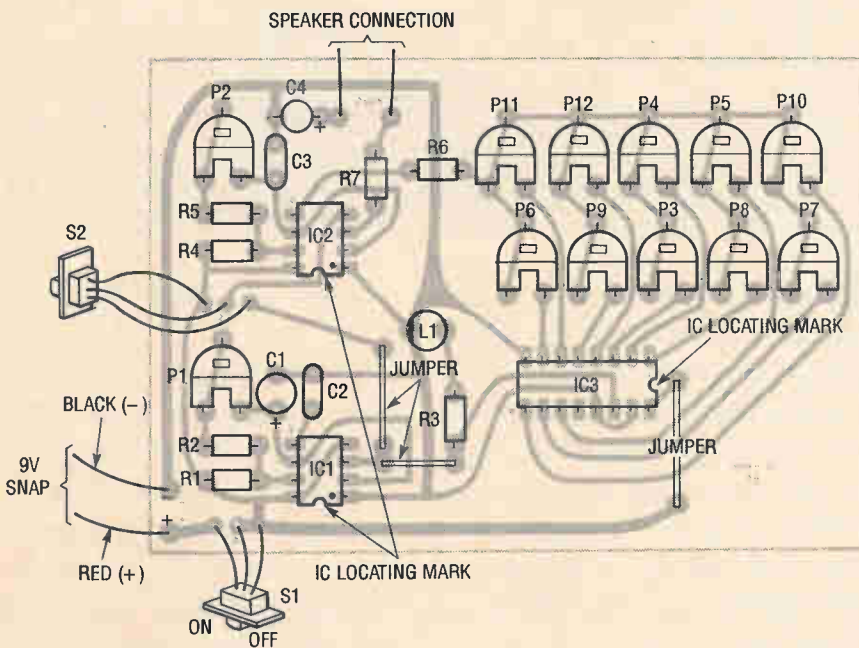

Figure 2. Follow the parts placement diagram carefully.

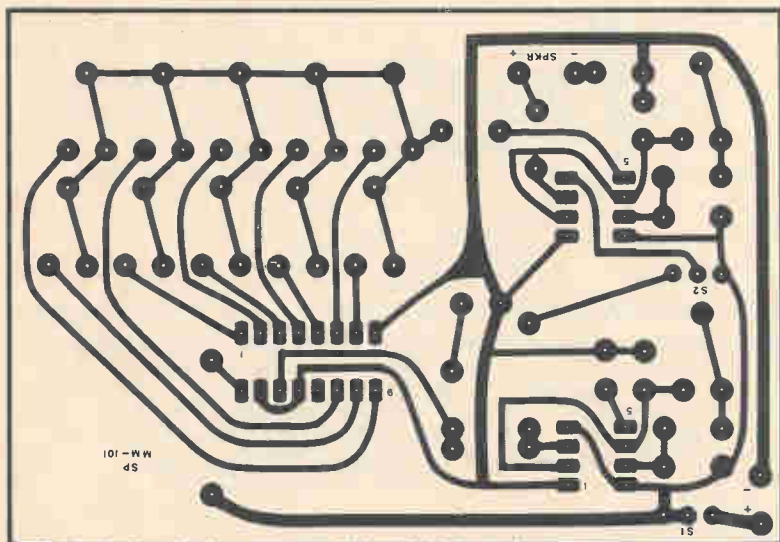

Figure 3. Full-size foil pattern of the PC Board.

PARTS LIST

C1	22 μ F	Electrolytic Capacitor
C2	0.01 μ F	Capacitor
C3	0.1 μ F	Capacitor (104K)
C4	10 μ F	Capacitor
IC1, IC2	555	Timer IC
IC3	4017	IC
L1	Red	LED
P1-P12	5K	Trimmer Resistor
R1, R3, R4	1K	Resistor
R2	200-ohm	Resistor
R5	4.7K	Resistor
R6	100-ohm	Resistor
R7	15-ohm	Resistor
S1, S2		SPDT Switch
Misc.	9V Snap, Speaker, IC Sockets, Wire, PC Board	

NOTE: A complete set of parts for the 10-Note Sound Synthesizer is available as kit C4722 for \$15.00 from The Electronic Goldmine, P.O. Box 5408, Scottsdale, AZ 85261. See page 96 for complete ordering information.

and that your solder connections are bright and shiny, not "cold." Make sure you don't have any solder bridges across traces. Use the foil pattern in Figure 3.

If your soldering is okay, carefully examine your parts placement. Check all resistors against the parts-layout diagram, and double check that each IC has been installed correctly and that the polarity is correct on all electrolytic capacitors.

Make sure that the battery snap has been installed with polarity as shown.

With the virtually unlimited sounds the synthesizer can produce, you'll find more uses than you imagined. Perhaps it's time to get started building a second?

FANTASTIC SIMULATED LASER

**BUILD A SAFE,
INEXPENSIVE LASER
LOOK-ALIKE!**

If real lasers are beyond the scope of your budget and your electronic project-building skills, try out this Fantastic Simulated Laser. Even beginners can assemble it with ease, and at less than \$10, it won't put too big a dent in anyone's wallet. The device emits a bright, pulsating light from a Stanley LED, unique for its high output power and focusing ability. The Simulated Laser will project a one-foot-diameter red circle from ten feet away in a darkened room. And, if

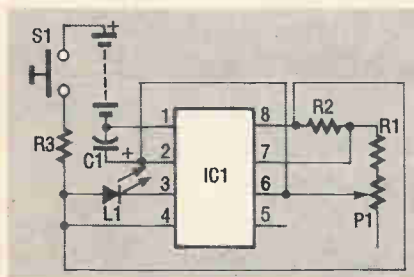
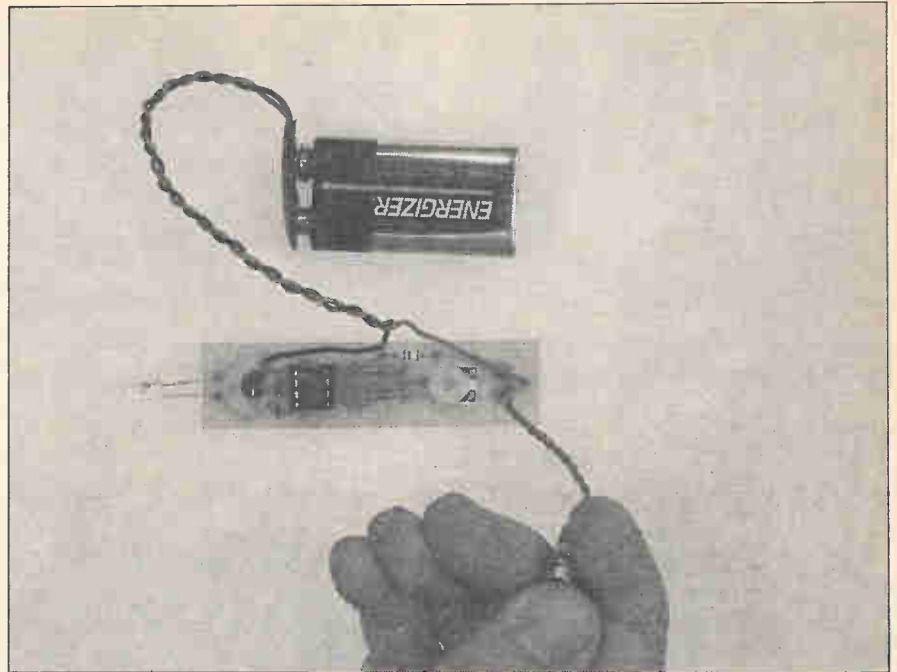

Figure 1. As you can see from the schematic diagram, the Fantastic Simulated Laser is a simple circuit, appropriate even for beginners.



you add a magnifying lens, you can project a very precise, intense circle up to 30 feet away. You can use the Fantastic Simulated laser in science-fair projects, stage productions, and just for fun. Although it emits a bright, laser-like light, the device cannot actually do the same things that a real laser can.

THEORY OF OPERATION

As shown in the schematic (Figure 1), the Fantastic Simulated Laser uses a 555 timer IC to power an ultrabright LED. The output is a pulsing red light that can be projected using lenses. An ultrabright Stanley LED capable of 300-millicandela (or mcd, a

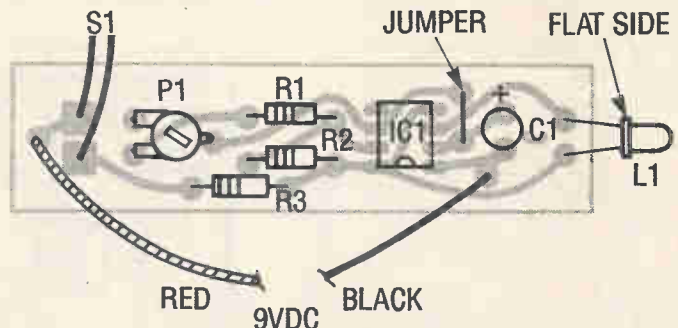

Figure 2. Make sure to orient the flat side of L1, and the notch on IC1, in the direction shown in the parts-placement diagram above.

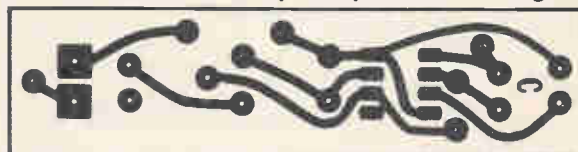

Figure 3. This is a full-size foil pattern of the PC board for the Simulated Laser.

unit of luminous intensity) output is tied to pin 3 of the 555 timer IC. That IC has been configured as an astable multivibrator. The frequency of this multivibrator is controlled by R1, R2, C1, and P1. You can vary the frequency by adjusting P1, which changes the output from a slow blinking to a fast pulsating light. Resistor R3 is used to limit the current flowing into the circuit to a safe value, to prevent the LED and the IC from burning out. Switch S1 applies power to the circuit when its button is pressed.

ASSEMBLY INSTRUCTIONS

1. Follow the parts layout shown in Figure 2, and refer to the Parts List and the schematic, as you assemble your Simulated Laser. Be sure to use only 60/40 rosin-core solder.
2. Observe polarity when installing electrolytic capacitor C1. Leave the leads of LED L1 full length, and observe the flat side location when installing. Bend L1 over after installing, so it faces forward as shown in Figure 2.
3. Carefully install trimmer resistor P1 as shown. Do not bend the pins on P1 too sharply, as they may break.
4. Install resistors R1, R2, and R3.
5. Install the jumper (use left-over wire lead cut from resistor) and the IC socket. Next, install switch S1 using insulated wire. Do not use excessive heat or solder, as S1 could be damaged. Finally, install the 9-volt snap, observing polarity. Recheck all connections and then install IC1 with its locating mark facing in the direction shown.
6. Connect a fresh 9-volt alkaline battery to the snap, and adjust P1 to the desired pulsation of red light. Experiment with magnifying lenses if a smaller diameter light is desired. The best results are obtained in a semi-darkened room. Remove battery when not in use.

PARTS LIST

C1	1 μ F Electrolytic Capacitor
IC1	555 Timer IC
L1	Stanley Ultrabright Red LED
P1	50K Trimmer Resistor (9265-9)
R1, R2	4.7K Resistor
R3	47 ohm Resistor
S1	N.O. Pushbutton Switch
Misc.	9-volt Snap, PC Board, IC Socket

NOTE: A complete set of parts for the Fantastic Simulated Laser is available as kit C6394 for \$8.00 from The Electronic Goldmine, P.O. Box 5408, Scottsdale, AZ 85261. See page 96 for complete ordering information.

TROUBLESHOOTING HINTS

First, make sure that you used rosin-core solder when you built the kit.

Check all resistor values against the Parts List and the parts-placement diagram. Also make sure that the flat side of the LED is in the direction shown. Check IC1 to make sure that its locating mark is in direction shown. Check the polarity of the snap. Is your battery good?

Look for cold solder joints and reheat any that look suspect, adding solder if necessary. Also check for solder bridges by comparing the foil side of your actual PC board to the foil pattern shown in Figure 4. Ω

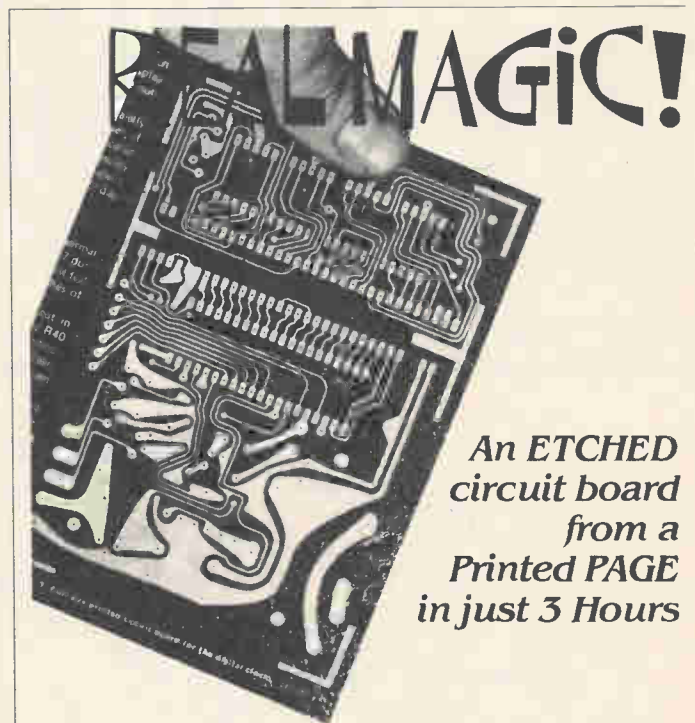

An ETCHED circuit board from a Printed PAGE in just 3 Hours

The ER-4 PHOTO ETCH KIT gives you the tools, materials and chemicals to make your own printed circuit boards. The patented Pos-Neg™ process copies artwork from magazines like this one without damaging the page. Use the circuit patterns, tapes and drafting film to make your own 1X artwork. Or try the Direct Etch™ system (also included), to make single circuit boards without artwork. The ER-4 is stocked by many electronic parts distributors, or order direct, postpaid.

ER-4 PHOTO ETCH KIT (NJ and CA residents add sales tax) \$38.00
DATAK'S COMPLETE CATALOG lists hundreds of printed circuit products and art patterns. Also contains dry transfer letter sheets and electronic title sets for professional looking control panels. **WRITE FOR IT NOW!**

DATAK Corporation • 55 Freeport Blvd, Unit 23 • Sparks, NV 89431

CIRCLE 19 ON FREE INFORMATION CARD

1991 PE HOBBYIST HANDBOOK

BATTERY TESTER

USE THIS HANDY TESTER TO SORT THAT DRAWER-FULL OF BATTERIES!

If you glance through the "Troubleshooting Hints" for just about any of the projects featured in this magazine, you'll see something like "Is your battery good?" Unfortunately, batteries often aren't good, and that problem affects all of your battery-operated devices -- flashlights, personal stereos, portable TV's, lap-

top computers, remote-control units, toys, etc. It's no wonder that a battery tester is such a handy device to have around. This do-it-yourself model is easy to build (even for beginners), inexpensive, accurate, and faster than many store-bought models. It's easy to use, too. You can calibrate it to test the five battery types that you

use most frequently. You select the battery voltage to be tested simply by rotating the selection switch and connecting the clip leads to the battery. If the battery is good, the green LED lights. You can even test the battery under load by pressing the load switch.

THEORY OF OPERATION

The Battery Tester uses four transistors and two LEDs to indicate the condition of any battery you want to test. Looking at the circuit shown in Figure 1, you will see two transistors, Q3 and Q4, connected in what is known as a Darlington configuration. This Darlington configuration has extremely high gain. Its purpose is to light green LED L2 when a small positive potential appears on the base of Q3. Transistors Q1 and Q2 form a direct-coupled DC-amplifier circuit. The output of this stage drives the red LED L1. Rotary switch S1 is used to select different ranges (which have been previously set by adjusting trimmer resistors P1 through P5).

If you connect a battery to the input test leads, you can see that the positive (+) voltage goes through the selected contacts of S1 to the biasing resistors R3, R4, and R5. The negative (-) voltage of the battery under test goes to the ground or common lead of the circuit and the (+) voltage to one side of P1 through P5.

Depending on the position of S1, a particular trimmer resistor (wiper lead) is selected. That lead goes through the contact on S1 to resistor R1 and into the base of the NPN transistor Q1. If the

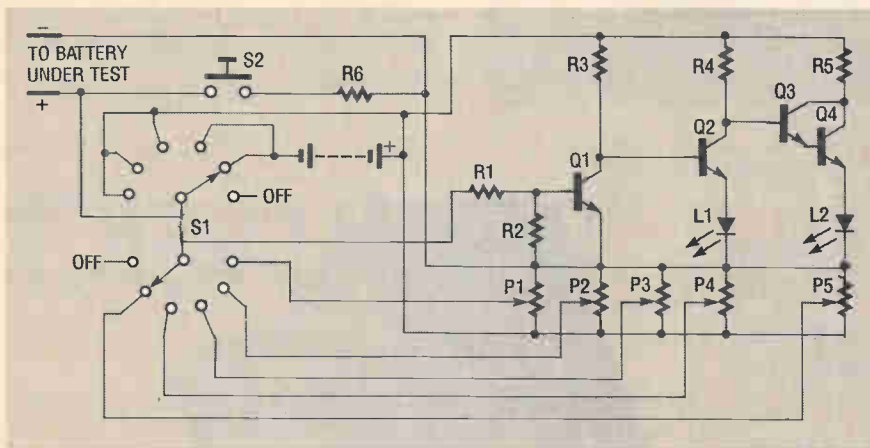

Figure 1. The schematic for the Battery Tester shows transistors Q3 and Q4 connected in a high-gain Darlington configuration.

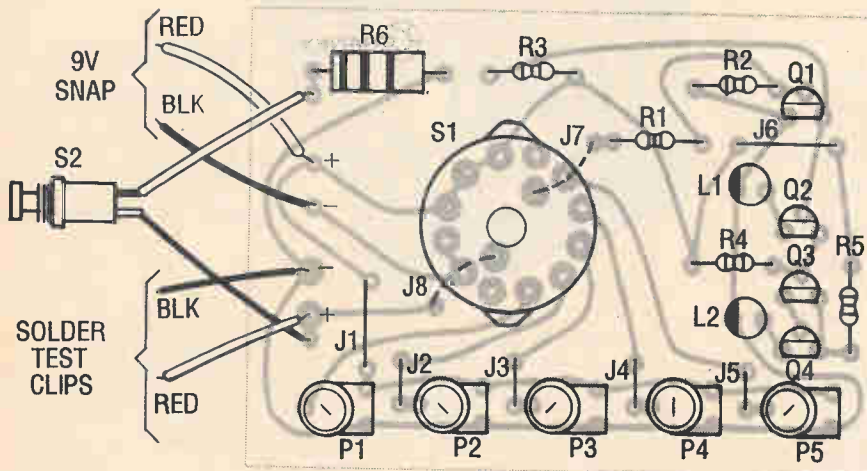

Figure 2. Make sure that you install the LEDs and transistors Q1 through Q4 with their flat sides facing the directions shown here in the parts-placement diagram.

battery is good enough, (+) voltage goes to the base of Q1, turning it on. This turns Q2 off, which then allows Q3 to turn on. That causes Q4 to turn on and light green LED L2.

If the battery is weak, Q1 will not turn on, which will cause Q2 to be biased on by R3, which in turn lights red LED L1. When Q2 is on, it biases the base of Q3 negative, causing Q3 to be turned off. That prevents L2 from turning on.

The circuit operates in the same manner for all ranges except the first two, where a 9V battery has been added by S1 to be in series with the input voltage to allow for testing of very low voltage batteries. That is because at voltages below 2 volts DC, LEDs will not light and the circuit would be unable to test a low voltage (<2-volt) battery without the additional internal-battery voltage. A load resistor has also been included; it allows the battery under test to be connected to a load to give a better indication of its condition. That load resistor

PARTS LIST

J1 - J6 ..	Bare Wire Jumpers
J7, J8	Insulated Wire Jumpers
L1	Red LED
L2	Green LED
P1 - P5 ..	5K Trimmer Resistor
Q1 - Q4	2N3904 Transistor
R1	100K Resistor
R2, R3	33K Resistor
R4, R5	470 ohm Resistor
R6	12 ohm 1W Resistor
S1	2 pole, 6 position NS Rotary Switch
S2	N.O. Pushbutton Switch
Misc.	9V Snap, Test Clips, Wire, Nut, PC Board

NOTE: A complete set of parts for the Battery Tester is available as kit C6414 for \$6.95 from The Electronic Goldmine, P.O. Box 5408, Scottsdale, AZ 85261. See page 96 for complete ordering information.

is connected across the battery when normally open (N.O.) switch S2 is depressed.

ASSEMBLY INSTRUCTIONS

1. Assemble the Battery Tester

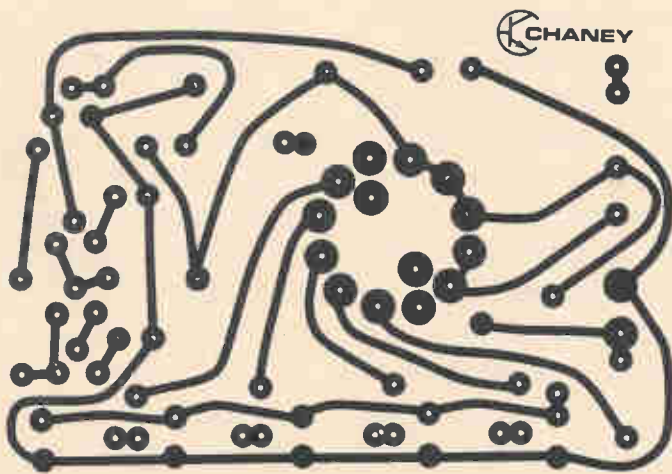

Figure 3. Compare your PC board to this full-size foil pattern to check for solder bridges.

following the parts-placement diagram shown in Figure 2, the Parts List, and the schematic. Be sure to use only 60/40 rosin-core solder.

2. Install trimmer resistors P1 through P5, bending leads as necessary to enable each trimmer resistor to be soldered in place.
3. Install transistors Q1 through Q4, placing the flat side of each transistor as indicated in Figure 2 for correct mounting. Next, install LEDs L1 and L2, also observing the flat sides for correct mounting. Then install S1.
4. Next install all resistors as shown. Install wire jumpers J1 through J6 using short pieces of bare wire. Install insulated wire jumpers J7 and J8 on foil pattern of PC board.
5. Install pushbutton switch S2 using insulated wire. Now install the battery snap, observing polarity as shown on parts layout.
6. Finally, construct the battery test leads as shown on the parts layout. Solder the red clip to one wire and the black clip to the other wire.

CALIBRATING THE TESTER

After assembly, it is necessary to calibrate your project for accurate testing of the five battery types you've selected. The first step is to rotate the shaft of rotary switch S1 to the fully counter-clockwise (off) position. Attach a fresh 9-volt battery to the snap. Now turn the shaft of S1 one "click" (position) clockwise.

S1 Switch Position	Battery to Test	Calibration Trimmer
1	(off)	--
2	1.5V	P5
3	3V	P4
4	6V	P3
5	7.5V	P2
6	9V	P1

Table 1. This is a sample setup for the Battery Tester. Yours might be different, if you select different battery voltages to test.

Attach the clip leads to any new battery from 1.2 to 2 volts that you normally use and that you know is good. Adjust the knob of P5 until both red and green LEDs light up. Now turn the knob of P5 slightly clockwise until only the green LED lights. That completes the calibration of the first switch setting.

Now turn the shaft of S1 one more "click" and repeat the

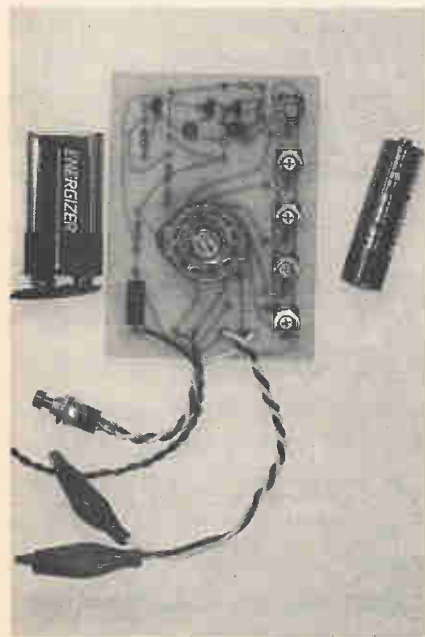

Figure 4. This is how the completed Battery Tester should look.

above calibration procedure by connecting the clip leads to another battery you commonly use (in the range of 2V to 3V). This time adjust P4. Repeat the procedure for each of the three remaining positions of S1. For each position of S1, connect clip leads to a new battery that you wish to test and adjust the appropriate potentiometer. The table shows a typical setup for the Battery Tester.

Batteries of any voltage up to 12 volts can be tested by initially calibrating your unit for those batteries. After all switch-position settings have been calibrated, it is a good idea to put a dab of glue between the trimmer knob and the substrate to lock the knob in that position.

After calibration, the tester is used by selecting the correct position of S1 and then attaching the clip leads to the battery to be tested. If the green LED lights, the battery is good. If the red LED lights, it is bad. If both LEDs light up, it is weak. If the green LED lights, but you are still not sure

about the quality, momentarily depress the load-test switch S2. If the red LED now comes on, the battery is weak and should be replaced. Note: The internal 9-volt battery is only used on the first two ranges so it need not be disconnected from the snap. However, S1 should be turned to the first (off) position when the tester is not being used.

Your tester, when properly calibrated, is extremely accurate and can test batteries faster than other testers costing much more.

TROUBLESHOOTING HINTS

First make sure that you used the correct solder to build the kit. Check all resistors against the parts layout for correct placement. Make sure that transistors Q1 through Q4 have their flat sides all facing the same direction, as shown on the parts layout.

Re-check the jumpers that were installed on the PC board. Check to make sure that LEDs L1 and L2 have their flat sides facing the direction shown. Check to make sure that the battery snap is connected with polarity as shown.

Compare the foil pattern (Figure 3) to the actual foil of your PC board, looking for solder bridges. Check for cold solder joints and reheat any suspected connections, adding more solder if needed.

If your kit still does not operate, re-check all assembly instructions. If everything is correct, and you bought the kit from The Electronic Goldmine, you can return the kit per their repair policy as outlined on page 96. Ω



QUIZ MASTER

***BUILD THE PERFECT JUDGE
FOR YOUR NEXT CONTEST!***

If your school, organization, or family ever holds "Jeopardy"-style quiz tournaments, scholastic challenges that pit one team against another, or other question-answer contests, you've probably found yourself in need of an accurate, impartial way to determine which contestant got the answer first. The Quiz Master provides perfect judging every time.

Up to eight players each have their own answer button to press, corresponding to the four Red Team and four Green Team LED's on the master control board. As soon as the first contestant who thinks that he knows the answer presses the button, a loud tone sounds, all other contestants are locked out, and the contestant's indicator LED lights on the control board so that it's obvious who buzzed in first.

The control board also features two selectable "time out" periods, each adjustable from 3 to 15 seconds, setting specified time intervals in which the player must answer before the "time's up!" tone sounds. The Quiz Master is

great for use at school -- or at home, where the whole family can play along with "Jeopardy" each night.

This challenging electronic construction project is intended for experienced kit builders with excellent soldering skills. If you haven't built many projects, hone your skills on some of the easier projects in this magazine before you attempt the Quiz Master.

THEORY OF OPERATION

The Quiz Master uses eight silicon controlled rectifiers (SCRs), several relays and transistors, and an IC to provide an electronic way to judge who "buzzed in first." The eight SCRs form the heart of the circuit, which is depicted in Figure 1. The anode of each SCR has a positive (+) bias on it by way of an LED and a negative (-) bias on each cathode. As soon as a contestant depresses his or her switch button (S4 - S11), a positive bias is applied to the respective SCR gate. That bias latches the contestant's SCR on, which in turn lights up

the appropriate LED on the master control board. At the same time, the action of the SCR latching on turns on the answer buzzer (BZ) and locks out all other contestants. The lockout occurs because relay K2 contacts operate to remove the availability of a bias voltage to the gates of the other SCRs.

The other circuitry consists of a timer circuit and a "time's-up" tone-generating circuit. The timer circuit consists of transistor Q1, capacitor C1, resistors R1 - R3, and trimmer resistors P1 and P2. Depending on the adjustment of the trimmer resistors and the selection switch S3, a specific time period can be set. The time's-up tone-generating circuit is made up of IC1, transistors Q2 and Q3, and the associated resistors and capacitors. The "on" time of the tone can be set by P3. Relay K1, which is operated by the timer circuit, serves to reset the entire unit for the next question.

ASSEMBLY INSTRUCTIONS

1. Carefully examine the parts-placement diagram (Figure 2) and the schematic before and during construction. Make sure you have on hand all the necessary parts, as shown in the Parts List. Use only 60/40 rosin-core solder.
2. Relays K1 and K2 cannot be interchanged, so take care to install the correct relay at each location. Install the IC socket and trimmer resistors P1 - P3 as shown.
3. Install all resistors per the color code and the parts layout.

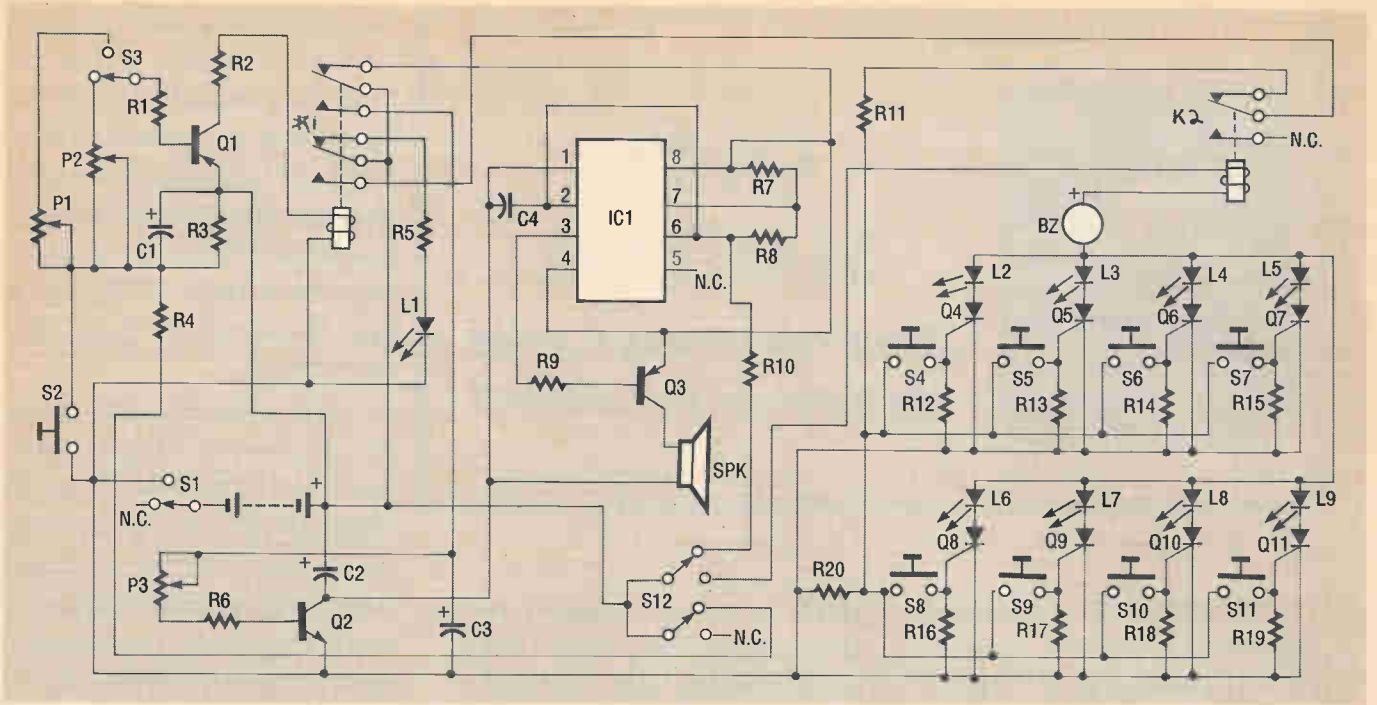

Figure 1. As you can see from the schematic, the Quiz Master is not a project for beginners.

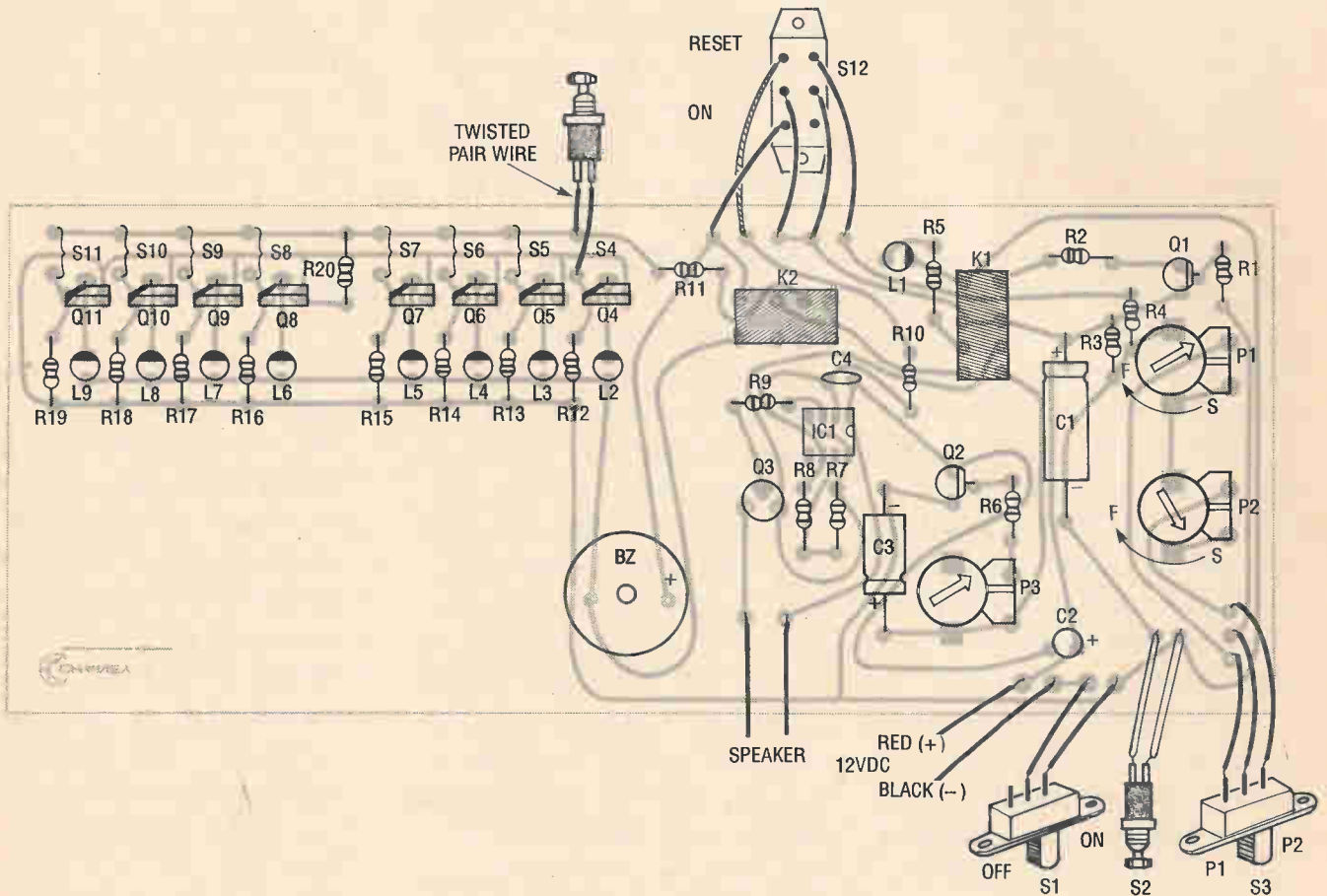

Figure 2. Carefully examine the parts-placement diagram as you assemble the Quiz Master.

4. Install piezoelectric buzzer BZ observing the polarity, which is marked on the back of the buzzer.
5. Also observe the polarity of capacitors C1 - C3 as you install them. Install C4; its polarity isn't crucial to its proper placement.
6. Observe the flat sides of transistors Q1 and Q2 when installing them, and install Q3 with its metal tab facing the direction shown in Figure 2. Next, install SCRs Q4 - Q11 with beveled edges in the direction shown.
7. Install all LEDs according to the colors indicated in the Parts List, with the flat side (cathode) of each facing the direction indicated on the parts layout by a darkened half moon.
8. Use two pieces of wire to connect speaker SPK to the printed-circuit board at the points shown. Next, use insulated wires to connect switches S1 - S3 and S12 as shown. The wires can be longer than those shown in the parts-placement diagram, but the switches **must be wired exactly as shown**. If S12 is wired incorrectly, it will result in various malfunctions!
9. Install the battery snap, observing the proper polarity. Cut eight 12-foot lengths of twisted-pair wire and use it to connect switches S4 - S11 to the PC board. In Figure 2, S4 is shown as an example of the correct wiring. Next, install IC1 into the IC socket, being careful to observe the IC locating marks (a notch at one end or a "dot" at pin 1).

PARTS LIST

BZ	Piezoelectric Buzzer
C1	1000 μ F Electrolytic Capacitor
C2	10 μ F Electrolytic Capacitor
C3	50 μ F Capacitor
C4	0.01 μ F Disc Ceramic Capacitor
IC1	555 Timer IC
K1	RZ-5-C DPDT Relay
K2	1B00 SPDT Relay
L1	Yellow LED
L2 - L5	Red LEDs
L6 - L9	Green LEDs
P1 - P3	5K ohm Trimmer Resistors
Q1	2N3906 Transistor
Q2	2N3904 Transistor
Q3	B714 Transistor
Q4-Q11106 SCR
R1	270 ohm Resistor
R2	82 ohm Resistor
R3	15K Resistor
R4,R12	- R1947 ohm Resistor
R5,R6 ..	470 ohm Resistor
R7,R9 ..	4.7K Resistor
R8	33K Resistor
R10,R11,R20	.. 100 ohm Resistor
S1,S3 ..	SPDT Slide Switch
S2,S4 - S11 N.O. Pushbutton Switch
S12	DPDT Slide Switch
SPK	Small Speaker
Misc.	PC Board, IC Socket, Battery Snap, Battery Holder, Wire

NOTE: A complete set of parts for the Quiz Master is available as kit C6419 for \$87.95 from The Electronic Goldmine, P.O. Box 5408, Scottsdale, AZ 85261. See page 96 for complete ordering information.

TESTING THE QUIZ MASTER

After assembly has been completed, place the Quiz Master on a non-conductive surface. Separate contestant switches S4 -

S11 and insert eight fresh "AA" alkaline batteries into the battery holder. Connect the battery holder to the snap. Adjust P1 - P3 so that the arrows are pointing in the direction shown on the parts layout, and adjust the handle of S12 to the on position.

Turn the unit on by switching the handle of S1 to the "on" position. The yellow LED should light. Move the handle of S3 to the P1 position. Depress the button on S2, and the yellow LED should extinguish. In about 2 or 3 seconds, a short tone (the "time's up" tone) should be heard and the yellow LED should light up again. If the LED went out only during the time you held down S2's button, you have the handle of S12 in the wrong position. Move it to the other position.

Place S3 in the P2 position and depress the button on S2. This time, 15 seconds will elapse before the "time's up" tone sounds and the yellow LED lights again. During this time period, depress one of the contestants' answer buttons. You will notice that the corresponding LED will light up and the "on board" buzzer will emit a tone. To reset the contestant answer tone and LED, simply operate the "reset" switch S12. Note: When the handle of S12 is moved to the "reset" position and then back to the "on" position, it resets the "on board" buzzer tone, the contestant LED, and the answer "time's up" speaker tone, and resets the Quiz Master for the next question.

To complete the testing of your Quiz Master, test all of the

contestant buttons (S4 - S11) in the same manner. If the unit performs correctly, you can install it on a mounting base or in the case of your choice. Switches S1, S2, S3, and S12 should be mounted in a box. Do not leave them laying loose, as you will need to operate them quickly during a contest.

TROUBLESHOOTING HINTS

If you have problems, first, make sure that the solder used was 60/40 rosin-core solder. Then recheck the orientation of all components. Check the resistors, comparing them to the color code and the parts layout. Make sure that the IC has been installed with the locating mark in the direction shown. Check to see that the flat sides of all LED's and transistors, and the beveled edges of all SCR's, are mounted facing the directions shown in Figure 2. Make sure that polarity was observed on all electrolytic capacitors and on the battery snap, as shown. Are your batteries good?

Compare your PC board to the foil pattern shown in Figure 3. Check for solder bridges. Reheat any cold solder joints and add solder to any suspect connections.

USING THE QUIZ MASTER

It's a good idea to become familiar with the operation of the Quiz Master before a contest, so that the contest can run fairly and without delays. We've outlined some of the facts that will help

Figure 3. Use this full-size foil pattern to etch your own printed-circuit board.

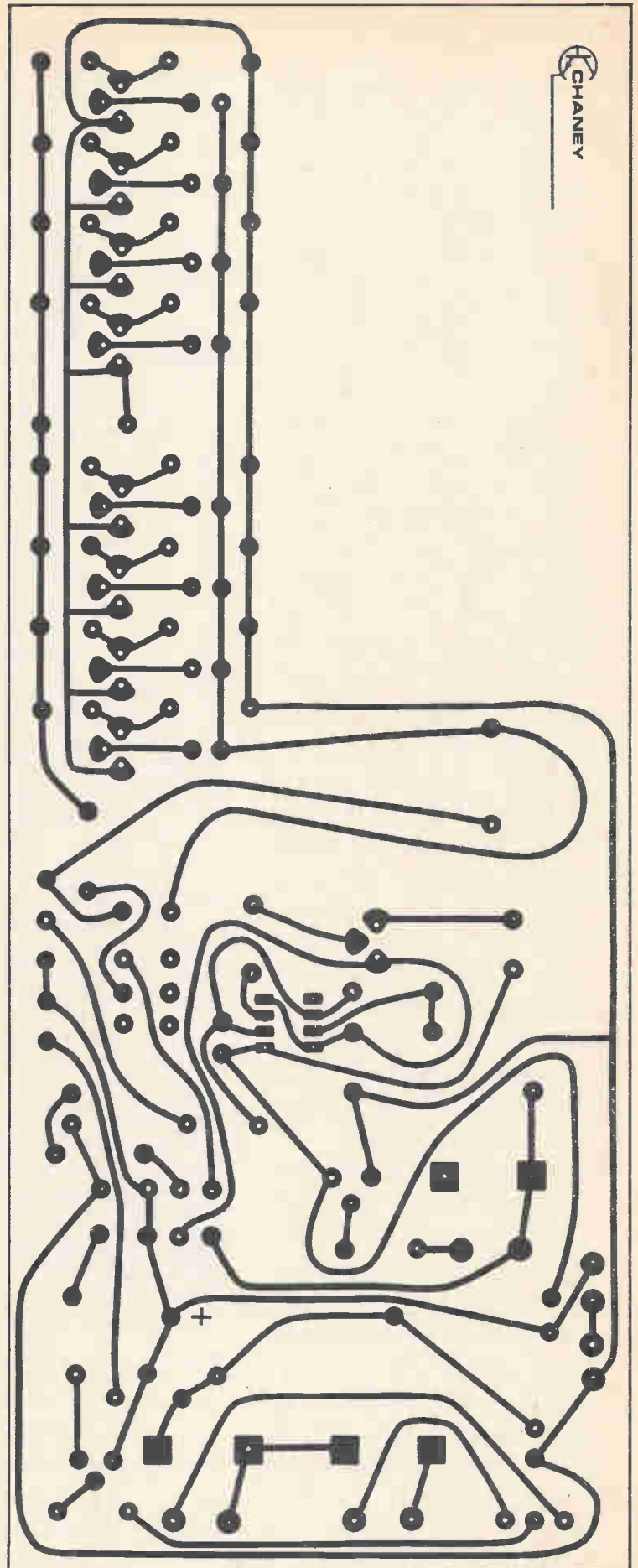

you use the Quiz Master most effectively.

When asking a question, always have S12 in the "on" position and depress S2 at the desired instant to start the "time out" interval.

You should select time intervals **before** the start of the contest by adjusting P1 and P2. You can select either of the time-out intervals by using S3 before depressing S2. Typically, you would leave S3 in one position or the other; however, you might want to speed things up at a particular stage of the contest.

When a contestant answers by depressing his or her button, the corresponding LED will light up and the "on board" buzzer will sound, notifying all other contestants that someone has buzzed in first. Only one LED will light up. The judge or instructor calls on the appropriate player and moves the handle of S12 to the "reset" position and then back to "on." If the judge is too quick in operating the "reset" switch handle, a short beep may be heard in the speaker. Practice operating the handle at the proper speed. If the judge does not operate the reset switch S12, the Quiz Master will automatically "time out" and the "time's up" tone will be heard even if a contestant's button has been depressed.

Always make sure to operate S12 from "on" to "reset" and then back to "on" after a contestant has pressed his or her button.

If none of the contestants has depressed an answer button

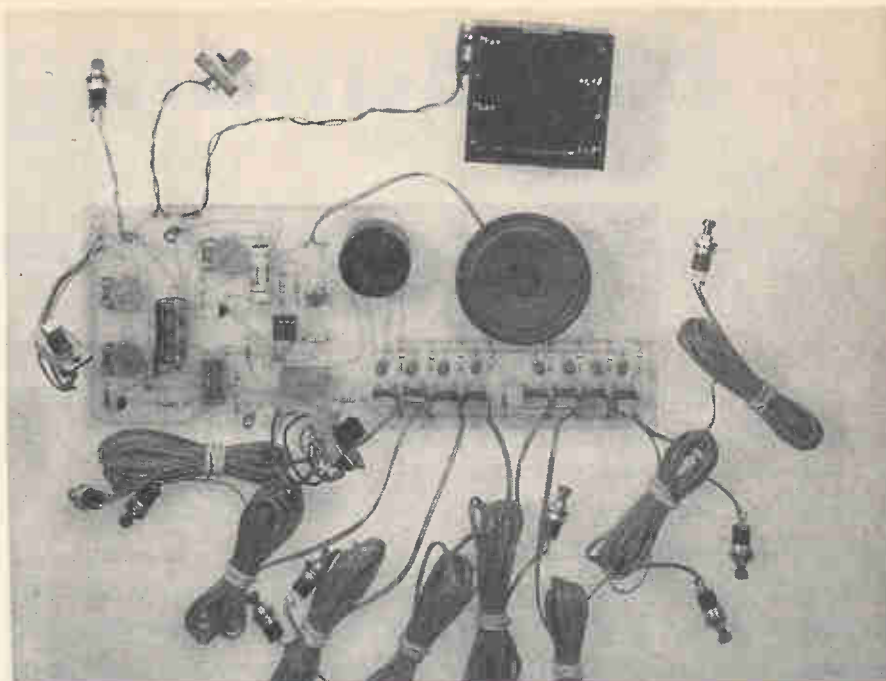

The completed Quiz Master ready to be installed in a suitable case.

1 2 3 4		1 2 3 4	
GREEN TEAM		RED TEAM	
NAMES	CORRECT ANSWERS	NAMES	CORRECT ANSWERS
1.		1.	
2.		2.	
3.		3.	
4.		4.	

Figure 4. Design your own label to identify the contestants, using ours as a guide.

(no one knows the answer), the "time's up" tone will sound and the Quiz Master will automatically reset itself after the yellow LED comes back on. At that point, you can ask another question and depress S2 again to start the process again. Note: P3 adjusts the "time's up" tone from a very short beep to a longer (1.5-second) tone.

It is typical to divide the

contestants into two teams -- the Red Team and the Green Team -- but that is not necessary. You can make up a label using Figure 4 as a guide to help the judge keep track of the individual players' names and their correct answers.

Always remember to turn off the Quiz Master when the contest is over. It is also a good idea to always have a spare set of batteries on hand. Ω

Kit-Building Tips

READ THIS BEFORE YOU START BUILDING THE PROJECTS!

Any of the projects in this magazine that are said to be "good for beginners" are designed to be easy enough that even someone who has never used a soldering iron should have no trouble putting them together. That's because soldering is easy! But if you don't take the time to learn the basic principles and methods of soldering **before** you begin, you're going to have trouble! Here are some practical pointers to help

you get started in electronic-project building.

SOLDERING TECHNIQUES

Figure 1 shows a four-step approach to soldering terminals and printed-circuit boards. Begin with a wet sponge. Heat the soldering tip, wipe it off on the sponge, and apply solder to the cleaned tip. That is known as "tinning" the tip; it inhibits oxi-

dation. For terminal lugs (Figure 3a) and relatively thick or wide PC foils (Figure 3b), place the soldering tip against the foil (or terminal) and against the component's lead. Then apply solder. Apply heat long enough to allow the solder to flow evenly and uniformly over the joint. Then remove the iron and be sure not to move the component until the solder cools.

For hairline traces, the rec-

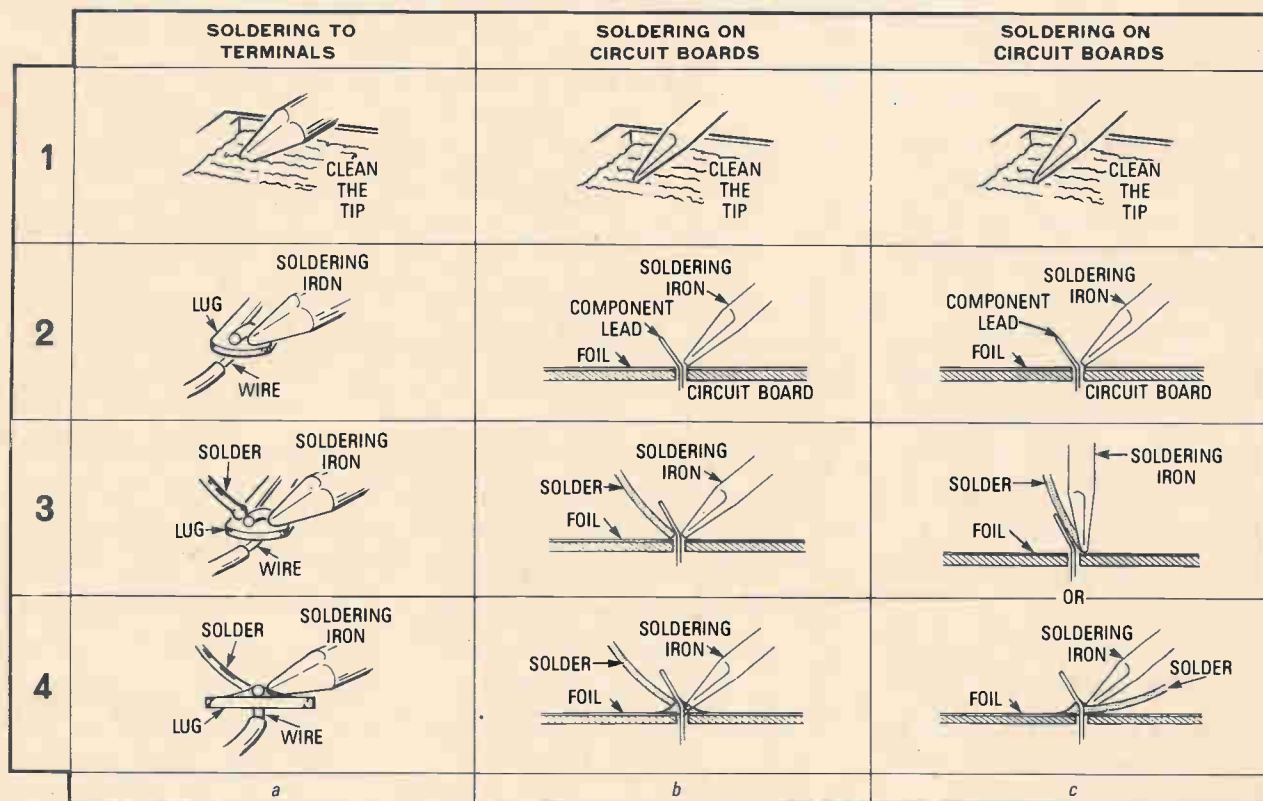

Figure 1. Although the usual practice is to heat the material to which solder will be applied (as shown in a and b), when soldering hairline printed-circuit traces, the heat is applied to the solder (c).

ommended technique (Figure 3c) is to place the solder against the component lead and the foil and then squash the iron down on the solder until there is a good flow. (That way there is less chance of overheating which causes a hairline trace to lift off the PC board.)

When soldering conventional components such as resistors and capacitors, it's a good idea to bend their leads to keep them from moving when the soldering iron is removed. You'll find it's well worth the extra time.

If you soldered the joint correctly, it will be smooth and shiny (Figure 2). If not, it will be what is known as a "cold" solder joint. Cold solder joints, which are characterized by either a crystalline, grainy texture or by blobs and uneven solder flow, are poor conductors. Two examples of cold solder joints are shown in Figure 3.

Integrated circuits (ICs) require special care when soldering. Typically, they have closely placed pins on 0.100-inch centers, and it's easy to "bridge" across two or more pins if just a bit of excess solder is applied, or if the tip of the soldering iron spans two pins or traces. To avoid the problem, use extra-thin solder (usually called "wire gauge"), a small soldering pencil, and extra care.

OOPS!

Occasionally you will bridge a solder gap or make a cold joint. Usually, it's nearly impossible to salvage the connection, or even to avoid further damage, unless

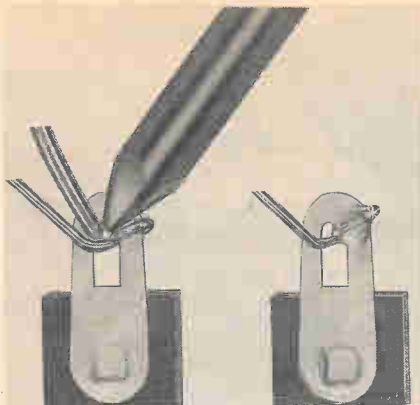

Figure 2. This is how a properly soldered terminal connection should look.

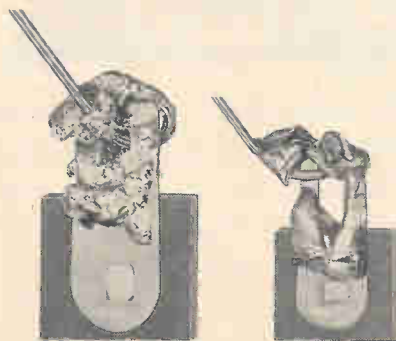

Figure 3. Two examples of cold solder joints. Either one can create problems in your circuit.



Figure 4. Solder-removal braid is available in several widths.

the solder is removed first.

There are two ways to remove unwanted solder so that you can start over. You can use solder-removal braid, which absorbs molten solder. It is available under

several brand names (see Figure 4), and comes in different widths tailored for "wicking" everything from hairline traces to old-fashioned terminal lugs. Alternately, you can use a "solder-sucker" -- a device that uses a vacuum to literally suck the solder off a connection.

TIME TO GET STARTED

For all of the projects in this magazine, it is recommended that you use a low-wattage soldering iron and high-quality, 60/40 rosin-core solder. 60/40 refers to the tin/lead ratio. Because solder contains lead, make sure to **avoid breathing the fumes as you apply it.** Never use acid-core solder. Acid-core solder will actually destroy your project!

Happy project building!

KIT BUILDING

All of the projects presented in this magazine have been thoroughly engineered so that with proper assembly they will work the first time. All the parts are provided; with most of the kits, you need only supply a battery, and a case or cabinet. To get the most out of this magazine, and to achieve the most success in building the projects, we recommend that you follow some basic pointers. First, use a low-wattage soldering iron and high-quality, rosin-core solder. The only other tools you'll need to have on hand are a pair of wire cutters and, in some cases, a screwdriver and needle-nose pliers.

--continued on page 91



LIGHTNING BOLT STROBE LIGHT

*BUILD A BRILLIANT,
DAZZLING STROBE*

You don't have to go to a disco to see an exciting strobe-light show. In fact, one of the most impressive strobe displays you're ever likely to see is one that an experienced electronic hobbyist can build at home. The Lightning Bolt Strobe Light features a powerful xenon tube that has uses a 3-1/2-inch long flash-tube. It produces flashes of blinding white light, much stronger than the standard strobes sold in stores. A control allows you to vary the flash rate from from 30 to 400 flashes per minute. That high rate is much faster than most strobes, and creates a fabulous "freeze action" effect!

THEORY OF OPERATION

The Lightning Bolt Strobe Light operates from standard 120VAC, the standard line voltage out of a wall outlet. As is shown in Figure 1, that voltage is brought into the circuit board through the line cord. One side of the line cord goes to the fuse F1, which limits the current entering

the circuit board to a safe amount (in this case, 1 amp maximum). The other side of the line cord goes to the "on/off" switch S1, which lets current flow into the circuit when it is in the "on" position, and prevents the flow of current into the circuit when it is in the "off" position.

The next stage of the circuit is a power resistor, R1, which is in series with the input to the rest of the circuit. R1 limits the amount of current applied to the voltage doubler stage, which is comprised of C1, C2, C3, D1, D2, C4, C5, and C6. Capacitors C1, C2, and C3 are connected in parallel and form an equivalent capacitor of 30 μ F at 160V. Capacitors C4, C5, and C6 are connected in se-

ries and form an equivalent capacitor of about 53 μ F at 480V. Diodes D1 and D2 not only change the incoming AC voltage to DC (rectify the voltage), but also complete the voltage doubler stage, which converts the incoming 120VAC to the approximately 300 volts required by the xenon strobe tube.

The next stage of the circuit is the neon relaxation oscillator and trigger stage. This stage is made up of R2, P1, C7, L1, Q1, T1, and T2. As the storage capacitor (made up of C4, C5, and C6) reaches its full capacity charge, the voltage divider made up of R2 and P1 applies voltage to capacitor C7. As C7 charges up, it reaches a threshold voltage level,

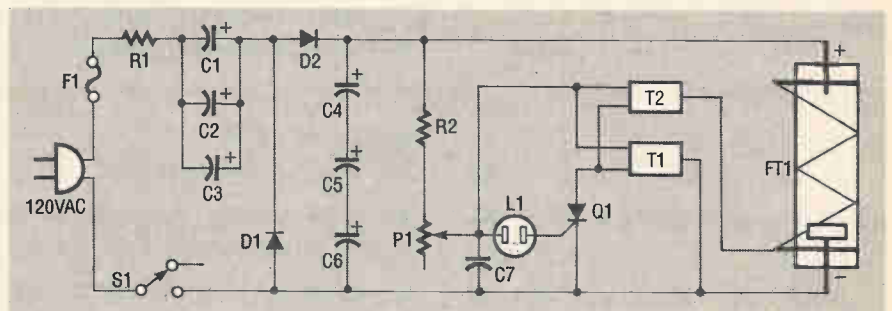

Figure 1. The schematic of the Lightning Bolt Strobe Light.

PARTS LIST

C1,C2,C3...	10 μ F 160V Electrolytic Capacitor
C4,C5,C6...	160 μ F 200V Electrolytic Capacitor
C7	0.5 μ F 250V Mylar Capacitor
D1, D2 ..	1N4004 Diodes
F1	1 Amp Pigtail Fuse
FT1	Giant Xenon Strobe Tube
L1	Neon Lamp
P1	10 Meg Potentiometer
Q1	106D1 SCR
R1	20 ohm 10 Watt Power Resistor
R2	270K 1/4 Watt Resistor
S1	Slide Switch
T1, T2 ..	Red Trigger Coil
Misc.	Line Cord, Wire, PC Board

NOTE: A complete set of parts for the Lightning Bolt Strobe Light is available as kit C6431 for \$34.95 from The Electronic Goldmine, P.O. Box 5408, Scottsdale, AZ 85261. See page 96 for complete ordering information.

which causes the neon lamp L1 to ignite. When L1 ignites, a positive pulse is applied to the gate of

SCR Q1. When Q1 has a positive pulse on its gate, it fires (causes a short from anode to cathode). That firing action discharges most of the energy stored in C7 into trigger transformers T1 and T2 (which have secondaries connected in series to develop over 8 KV). Those trigger transformers are known as auto transformers. They have the characteristic that a small level of primary voltage produces a tremendously high level of secondary voltage (in this case, 8 KV). That voltage is very high, but it is at an extremely low current level (microamps). The frequency of the 8-KV pulses is determined by the setting of P1 and the value of C7. Since C7 is a fixed capacitor, only the setting of P1 adjusts the flash rate in this circuit.

The final stage is made up of the xenon strobe tube FT1. The strobe tube is basically a glass envelope from which all air and impurities have been removed (a vacuum) and replaced by xenon

gas. The tube has three elements: the cathode (-), the anode (+), and the trigger lead. The tube operates as follows: 200 volts or greater is applied at the correct polarity by the storage capacitors C4, C5, and C6. As soon as an 8-KV pulse is applied from the secondary of T2 (trigger wire) to the trigger lead of FT1, the xenon gas ionizes (or conducts) producing a brilliant white explosion (flash). When the xenon gas inside FT1 ionizes (flashes), it discharges the storage capacitors C4, C5, and C6. The cycle then repeats itself until the power is removed from the circuit board by turning "off" S1 or removing the line cord.

ASSEMBLY INSTRUCTIONS

1. Assemble the Lightning Bolt Strobe Light following the parts layout shown in Figure 2, the Parts List, and the schematic.
2. Make sure that the solder you use is 60/40 rosin-core only.
3. Install diodes D1 and D2 with their cathode bands oriented in direction shown on the parts layout. Install pigtail fuse F1 and power resistor R1.
4. Install C1, C2, and C3 with polarity as shown. Then install C4, C5, and C6 with polarity as shown.
5. Install R2, L1, and C7 as shown; you need not observe their polarity. Install SCR Q1 with its beveled edge facing the direction shown in Figure 2.
6. Use insulated wire to install potentiometer P1 to PC board.
7. Install slide switch S1 by connecting the center lead to the PC board using a piece of

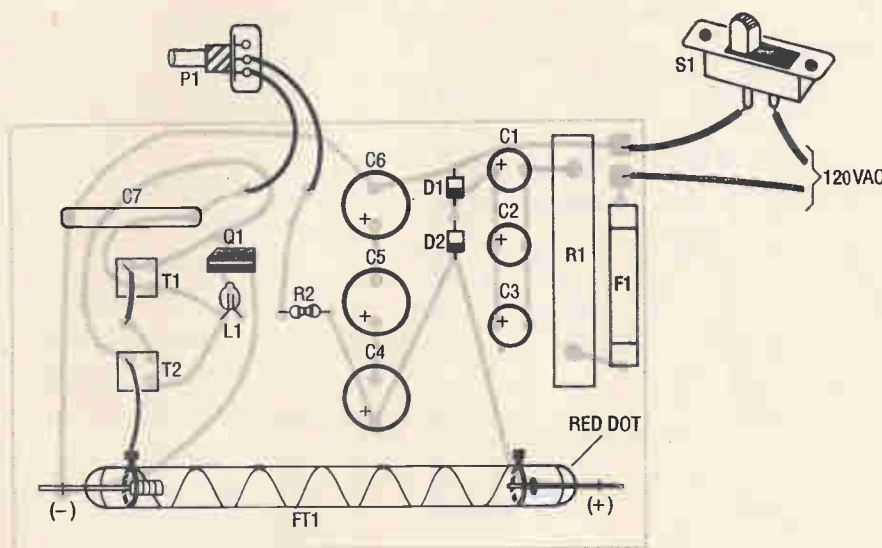

Figure 2. As you can see from the parts-placement diagram, the Lightning Bolt Strobe Light uses 120VAC power. Be sure to observe the proper safety precautions when building and using it!

insulated wire. Now, connect one of the outer terminals of S1 to one lead of the line cord. Connect the other lead of the line cord to the PC board as shown in the parts-placement diagram. Install T1 and T2 as shown in Figures 2 and 4, connecting the wire from top lead of T1 to the PC board.

7. Install strobe tube FT1 by first soldering a bare wire post (use left-over leads cut off from C7) into the anode (+) and cathode (-) mounting holes on the PC board. **Do not bend the lead on FT1 as that will crack the tube seal and release the xenon gas (causing permanent damage to the tube).** After the posts have been soldered in, form a loop to hold the leads on FT1 (Figure 3). After you have made the loops around the leads of FT1, you may now solder in the tube. The next step is to connect a wire from the top of trigger

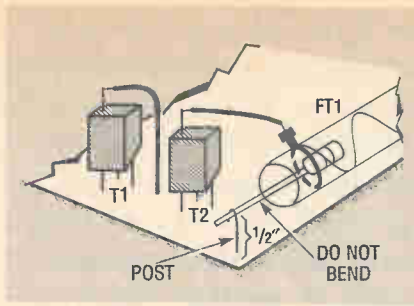

Figure 4. Loop Post Formation. Be extra careful not to bend the lead on FT1, as that will crack the tube seal and release the xenon gas!

coil T2, loop it around the trigger terminal of the strobe tube, and solder it. Now, take the thin wire that extends from the trigger terminal of FT1 and wrap it 3 or 4 times around the connection you just soldered. Re-solder the connection again. These exacting steps are necessary because the tremendous heat that FT1 generates can actually melt solder.

8. After assembly, place the strobe on an insulated surface and plug the line cord into the wall

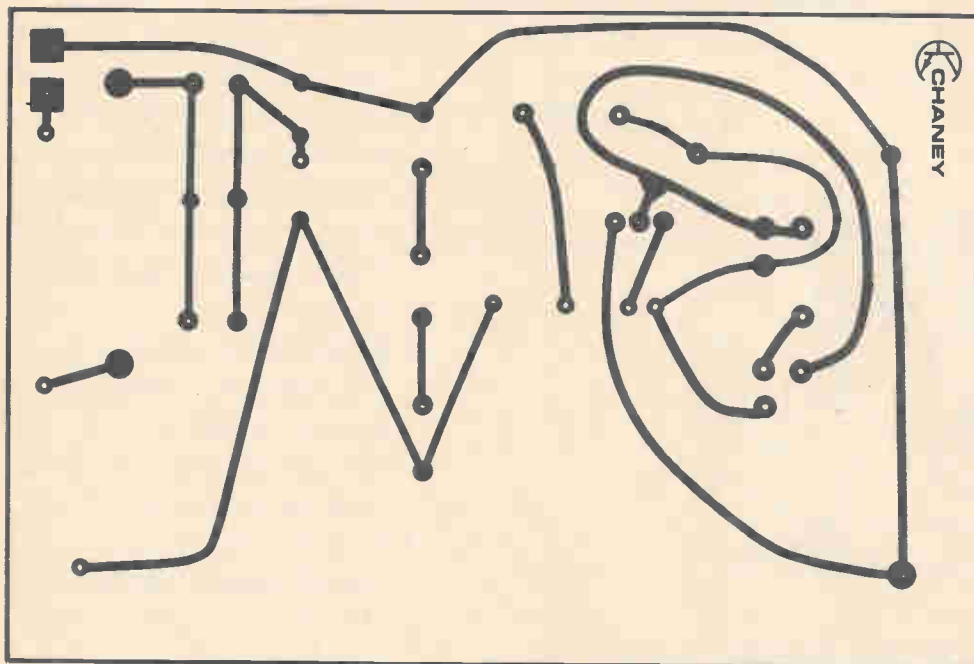

Figure 3. You can use this full-size foil pattern to etch your own printed-circuit board, or to check your solder traces.

socket. Turn S1 on, and the Lightning Bolt Strobe Light should begin to flash. Adjust P1 to vary the strobe's flash rate from slow to fast. If the strobe works properly, install it in a ventilated, insulated case to prevent exposure to the hazardous AC voltages present on circuit board. Always observe all AC safety precautions with this kit and any kit that operates from the AC line. **Avoid contact** with the strobe light when it's plugged into the AC line; **never use it near water**; and **use it only when it is in an insulated plastic or wooden case.**

9. One final note of caution: This project produces tremendous amounts of heat from the strobe tube and it must not be operated continuously for more than 5 minutes on high speed or more than 30 minutes at slow speed. Failure to observe these precautions will shorten the

strobe tube life and may cause damage to the other components, the case, etc., from the excessive heat produced. A rest period of 10 minutes is recommended before another five-minute high-speed operation.

If you have problems, make sure that the trigger coil top lead is connected to the strobe tube. Also make sure that Q1 has been installed with its beveled edge as shown. And don't forget to handle the xenon strobe tube carefully! Ω

Tic... Tic... Tic... Tic... Tic... Tic...

Tic... Tic... Tic... Tic... Tic...

BOOM!

WHO SAID TIMER CIRCUITS HAVE TO BE DULL?

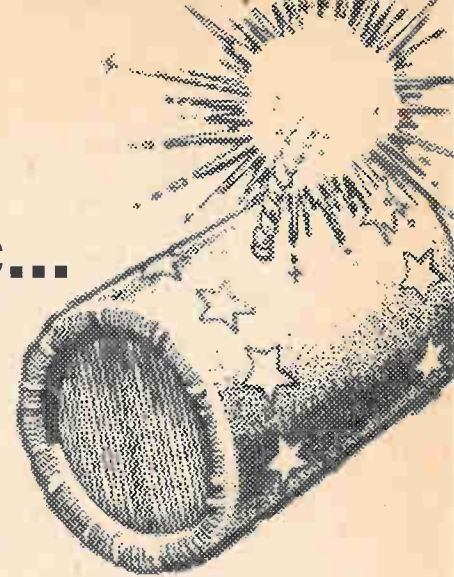

How much time does each team have to come up with an answer when you play Trivial Pursuit? Do your chess games drag on interminably? You just might need to build Tic Tic Boom!, an analog to a time bomb that can be used as a timer for quiz games or other "beat the clock" contests. It emits the familiar, anxiety-provoking ticking of a count-down timer -- and, at the end of the count, it lets you know your time is up with a resounding "BOOM"! (Actually, with the component values we have chosen, it's more of a scream than a boom, but...)

The complete schematic of

the Tic Tic Boom! kit is shown in Figure 1. One section of the circuit is a timer that regulates the circuit's overall operating interval. A second timer circuit, which we'll call the sub-interval timer, keeps you informed of the passage of time with gentle "tic tics." Finally, after a set time delay, a continuous oscillator circuit indicates that you've run out of time by emitting a screaming loud sound.

With switch S1 in the off position as shown, battery voltage is applied across timing-capacitor C1, which stays charged while the rest of the circuitry has no power supplied to it. Transis-

tor Q1, and thus transistors Q2 through Q4, are kept in an off condition as long as C1 has sufficient charge on it.

When switch S1 is turned to the on position, battery voltage is applied to all of the circuit, and capacitor C1 begins to discharge through R1 and P1. In the meantime, transistors Q6 and Q7 act as an astable multivibrator with a time period (sub-interval) defined by R7, R8, and C3. A click is heard in speaker SPK, indicating the sub-interval duration.

At the end of the timing period of interval timer Q1 - Q3, C1 is discharged, causing Q1 and Q2 to conduct. That provides a positive (+) voltage to the gate of SCR Q3, which turns fully on, connects Q4 to the (-) terminal, and allows the "Boom" oscillator, made of Q4 and Q5, to run and drive speaker SPK to let you know that the time interval is over. Potentiometer P1 can be used to lengthen or shorten the time interval.

ASSEMBLY INSTRUCTIONS

1. Assemble Tic Tic Boom! on a printed-circuit board, following

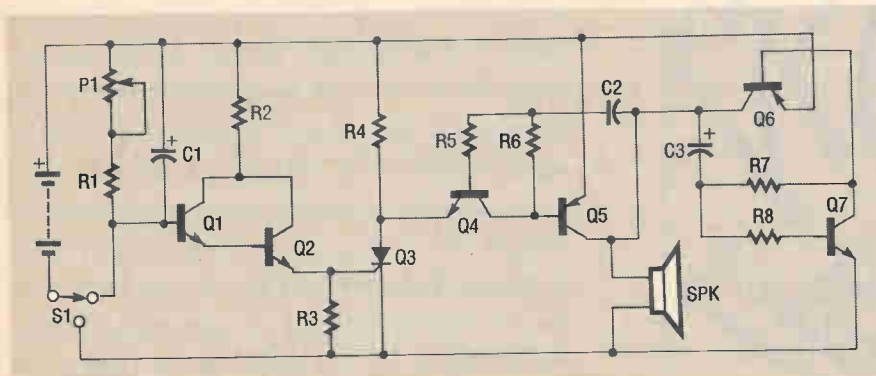

Figure 1. The "tics" are created by the astable oscillator circuit made up of Q6, Q7, and associated components. The circuit will tic for a duration determined by the discharge of C1. When C1 is discharged, transistors Q1 and Q2 turn on, thus turning on the "boom" oscillator made up of Q4 and Q5.

PARTS LIST

C1100 μ F Electrolytic Capacitor
 C2 0.0047 μ F Mylar Capacitor
 C3 1 μ F Electrolytic Capacitor
 P1 2 meg Trimmer Resistor
 Q1,Q2,Q4,Q7.. 2N3904 Transistor
 Q3 106 SCR
 Q5, Q6 2N3906 Transistor

R1 1 meg Resistor
 R2 10K Resistor
 R3 33K Resistor
 R4 200 ohm Resistor
 R5 2.2K Resistor
 R6 220K Resistor
 R7 2.2 meg Resistor
 R8 7.5K Resistor
 S1 SPDT Slide Switch

SPK Small Speaker
 Misc. PC Board, 9-volt Snap,
 Wire

NOTE: A complete kit of parts for the Tic Tic Boom project is available for \$9.95 from The Electronic Goldmine. See ordering information on page 96.

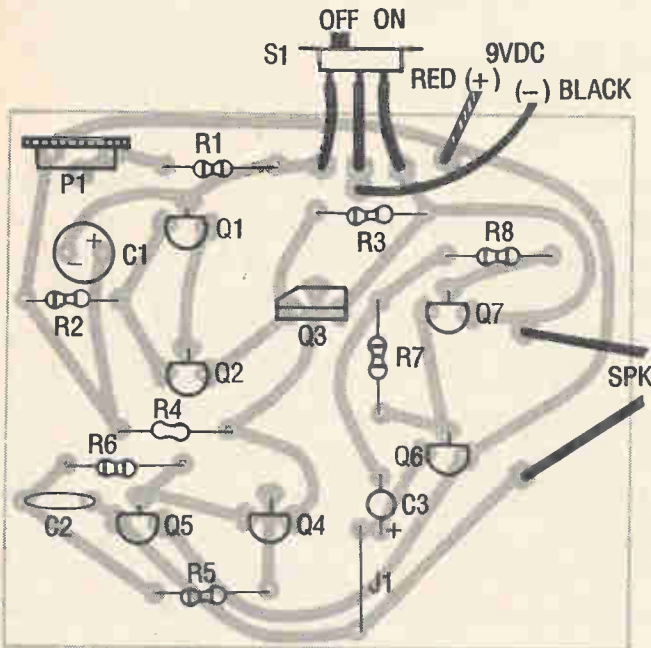

Figure 2. Follow this parts-placement diagram for proper assembly. Be sure to install all polarized components correctly!

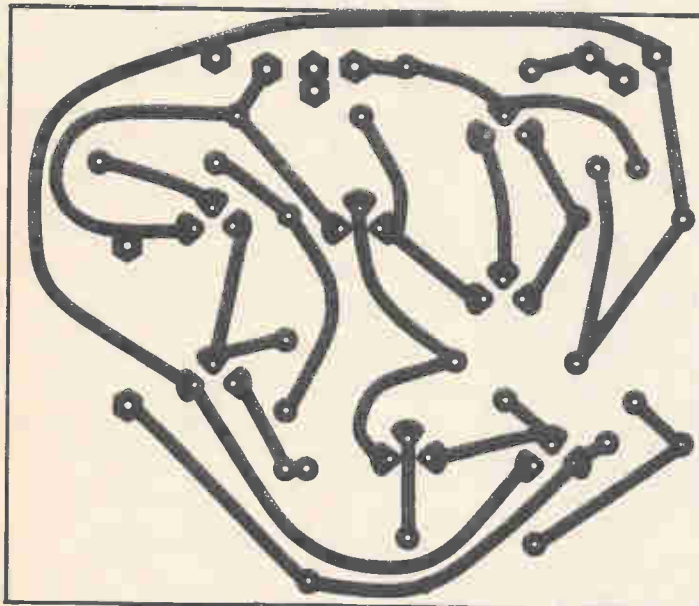

Figure 3. The foil pattern is provided here, full sized, for those readers who wish to etch their own circuit boards.

the schematic (Figure 1), the parts-placement diagram (Figure 2), and the Parts List. Be sure to use only 60/40 rosin-core solder. You can etch your own board using the foil pattern in Figure 3, or buy a complete kit that includes the board as indicated in the Parts List.

2. Be careful to double-check the orientation of transistors Q1, Q2, Q4, Q5, Q6, and Q7 when mounting them. Also take care to follow the parts-placement diagram when installing the SCR, Q3 -- its beveled edge should help you line things up correctly. Capacitors C1 and C3 are polarized, so be sure you keep that in mind as well. Finally, the battery snap should be installed with the polarity as shown or you'll really have troubles!
3. Install jumper J1 using left-over wire lead (cut off from resistor).
4. After all components have been installed, recheck your work, looking for such common pitfalls as poor soldering, solder bridges, and incorrect parts placement.
5. With slide switch S1 in the off position, and the control knob on trimmer resistor P1 tuned to the counter-clockwise position, connect a fresh 9-volt alkaline battery to the battery snap. Turn S1 to the on position, and the kit should tick like a clock for a period of up to approximately 70 seconds. It should then automatically switch to a loud steady scream. Adjust P1 to change the time-delay period (between the start of ticking and the screaming sound). This period can be adjusted anywhere from about 25 seconds up to about 70 seconds.(you may want to experiment with different values for P1 to vary the timing characteristics.

--continued on page 62

A Geiger counter is a fascinating instrument to use, and if you suspect that you're being exposed to dangerous levels of radiation, it provides a way to track the source. Unfortunately, many Geiger counters are quite high priced. One exception is this Geiger counter with meter that you can build for yourself if you have a fair amount of experience in electronic kit building. (We'd recommend that beginners hone their skills with some easier projects before attempting to build the Geiger Counter.) The finished counter features a sensitive, thin-walled Geiger Mueller (GM) tube and a piezoelectric speaker that emits clicks in direct proportion to the radiation level. The unit detects three kinds of radiation -- Beta, Gamma, and Alpha -- all of which are quite harmful. You can use the Geiger counter to detect radiation emitted by the radium dials on old watches and clocks, background radiation -- and, of course, nuclear fallout.

THEORY OF OPERATION

As illustrated in the schematic (Figure 1) the Geiger Counter with Meter uses a two-transistor circuit and a sensitive alpha-window Geiger Mueller (GM) tube to detect radiation. The

Build Your Own GEIGER COUNTER

**DETECT BETA , GAMMA , AND
ALPHA RAYS WITH THIS
INEXPENSIVE GEIGER COUNTER**

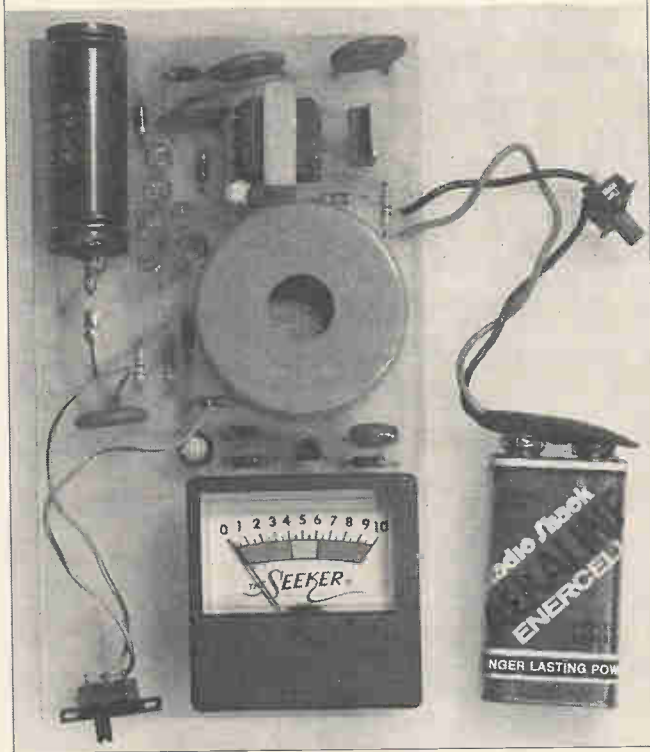

first transistor, Q1, is a PNP power transistor used in conjunction with a ferrite transformer to form a blocking-type oscillator. This oscillator is a fixed-frequency type, and the feedback to sustain oscillations is from capacitor C1. Because of the turns ratio of T1, the small AC voltage produced on its primary is converted to a large AC voltage on its secondary. That high-voltage AC is

applied to the voltage tripper stage, which consists of capacitors C2, C3, and C4 and diodes D1, D2, and D3. The resultant voltage is now over 800 volts and it is regulated by neon lamps L1 - L6. Diode D4 rectifies the high voltage and applies it to the cathode lead of the GM tube. The positive (+) bias on the GM tube is applied to the anode by way of load resistors R4 and R5. Each time a radioactive particle strikes the GM tube, it causes the gas inside to ionize. This ionization of the gas creates a pulse, which drives the piezo speaker and is also coupled by diode D5 to the base of Q2. Transistor Q2 is a PNP type and is used to "integrate" the pulses in conjunction with capacitor C6. That produces a DC voltage level, which is in proportion to the quantity of pulses arriving at the base of Q2. The collector of Q2 is connected through resistor R8 to the (+) terminal of the meter. The other side of the meter goes directly to (-) of the battery.

ASSEMBLY INSTRUCTIONS

1. Carefully follow the parts-placement diagram shown in Figure 2, and refer to the Parts List and the schematic as needed. Use only 60/40 rosin-core solder. **Do not** remove

GM1 from the bag until instructed to do so (step 8), and **do not** remove the red protective cap from the end of

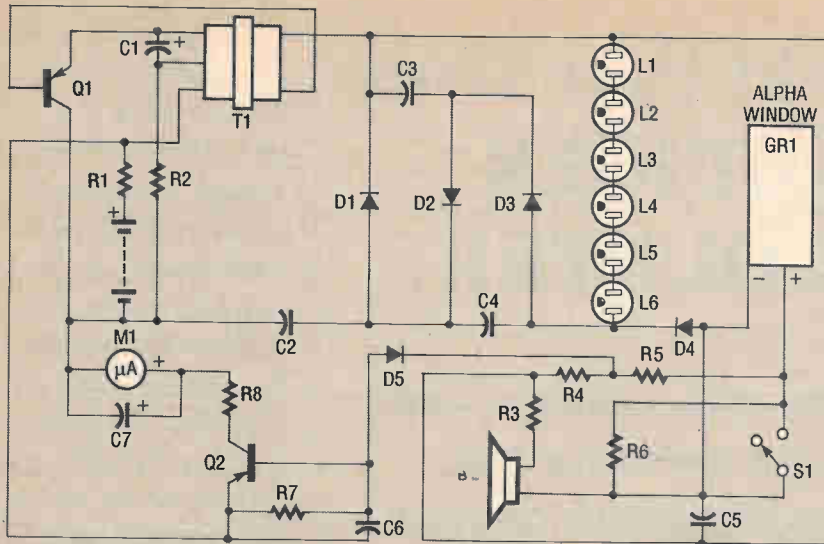

Figure 1. The schematic of the Geiger Counter shows a two-transistor circuit with an alpha-window Geiger Mueller (GM) tube.

PARTS LIST

BZ	Blue Piezo Buzzer
C1	4.6 μ F Electrolytic Capacitor
C2 - C4	0.005 μ F 1KV Disc Capacitor
C501 μ F 1KV Disc Capacitor (103M)
C61 μ F 100V Mylar Capacitor (104K)
C7	33 μ F Electrolytic Capacitor
D1 - D5	1N4007 Diodes
GM1	Alpha Window Geiger Mueller Tube
L1 - L6	Neon Lamps
M1	0-200 microamp "Seeker" Meter
Q1	02-GE PNP Power Transistor
Q2	2N3906 Transistor
R1	47 ohm Resistor
R2, R3	3.9K Resistor
R4, R5	4.7 Meg Resistor
R6	220K Resistor
R7	27K Resistor
R8	18K ohm Resistor
S1	SPDT Slide Switch
T1	Blue Inverter Transformer
Misc.	PC Board, 9-volt Snap, Bare Wire, Insulated Wire, Extra Slide Switch

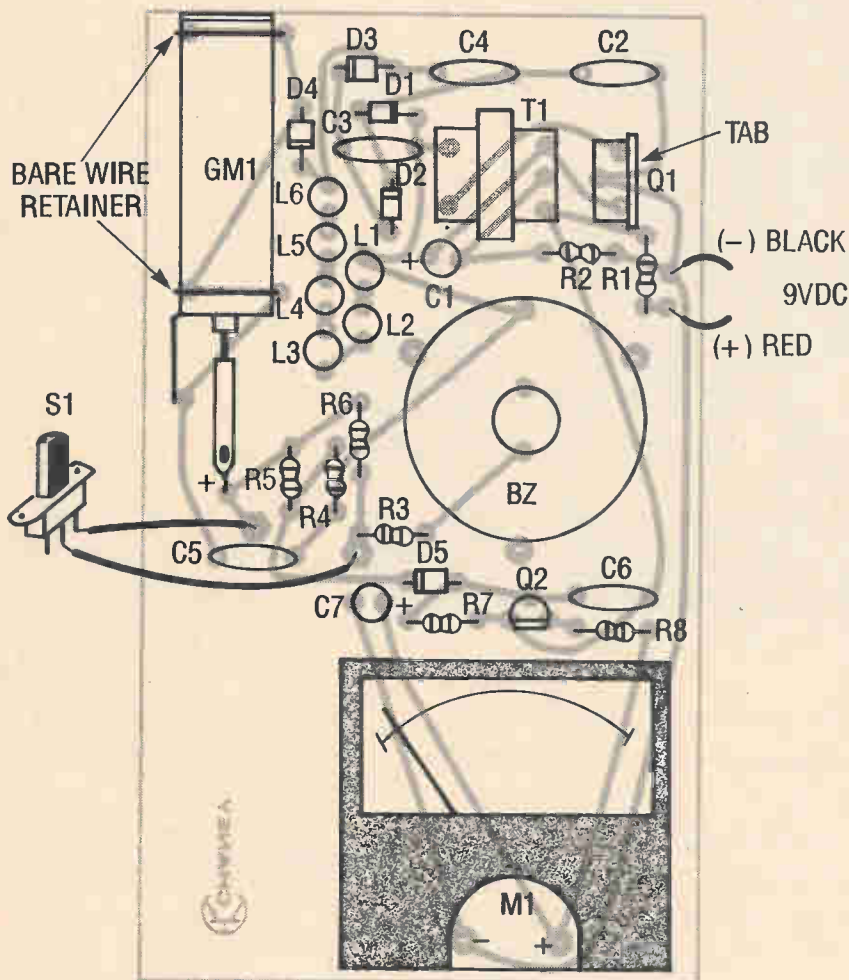

Figure 2. Follow this parts-placement diagram as you construct the Geiger Counter. Keep in mind that the finished project will produce about 800V at very low current -- enough to give you a shock, although not a hazardous shock. Install the completed kit in wood or insulated plastic case.

A complete set of parts for the geiger counter is available for \$79.95 as kit C6432 from The Electronic Goldmine, P.O. Box 5408, Scottsdale, AZ 85261. See page 96 for complete ordering information.

the tube until the moment the tube is to be installed. The alpha window is made up of a very

fragile piece of mica that will break if you touch it. Mica is the only substance that can be used in alpha-sensitive GM tubes, and the tube will give years of service if the alpha window is not disturbed.

2. Install all resistors as shown on the parts layout. Next, install diodes D1 - D5 observing cathode band location.
3. Install electrolytic capacitors C1 and C7, observing polarity. Next, install capacitors C2 - C6 (no polarity needs to be observed).
4. Install inverter transformer T1 and neon lamps L1 - L6. Then install power transistor Q1 with its tab facing in the direction shown in Figure 2. Next, install transistor Q2 with the flat side facing direction shown.
5. Now, install piezo buzzer BZ, being careful that each pin goes into correct hole on the PC board. Solder the pins only -- the plastic feet are for support only.
6. Use insulated wire to connect slide switch S1 as shown. Install the 9-volt snap, observing polarity as shown. If you would like, an "on/off" switch can be installed in series with one lead of the battery snap.
7. Install meter M1 as shown, making sure to push the leads on M1 directly into the PC board and soldering them.
8. Now, **carefully** remove the

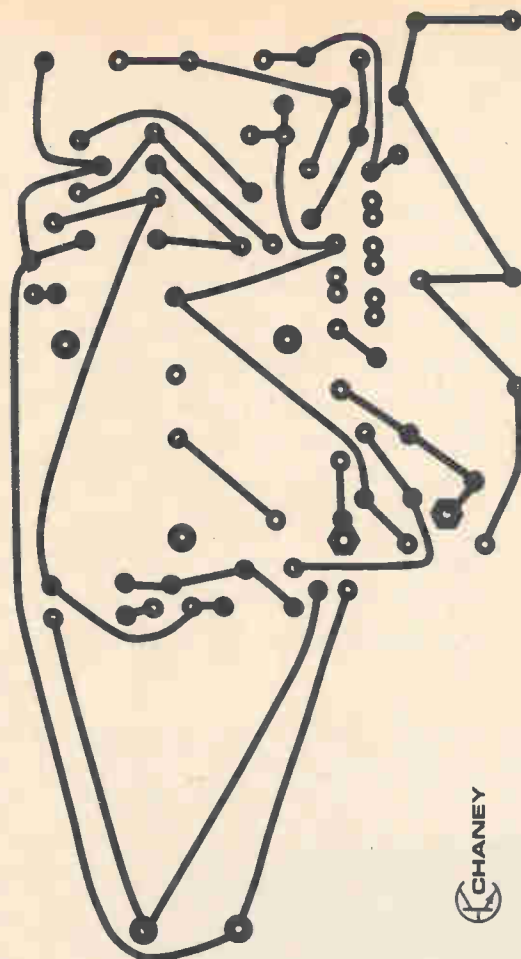

Figure 3. The full-sized foil pattern for the geiger counter.

Geiger Mueller tube from its protective package. Grasp the main part of the tube and **carefully** remove the red end cap. Lay the tube on the PC board and install retainer bare wires along the grooves in GM1. Next, **carefully** solder the positive (+) terminal lug to the PC board using a short piece of bare wire. Solder the ground wire from GM1 to PC board at point shown in Figure 2. **CAUTION: Make sure that you do not touch the alpha-mica window at the end of the tube or you will puncture the tube, destroying it.** To test your Geiger Counter, place it

on an insulated surface and connect a fresh 9-volt alkaline battery to the snap. (If you have installed an "on/off" switch, turn it on.) You should see the neon lamps glow and you should start hearing random clicks (background radiation level) from BZ. If you do not see the lamps glow, you have made an assembly error (see Troubleshooting Hints).

9. You can select "sound" or "mute" (reduced volume level) on S1 and you can see the relative level of radiation detected on the meter.

10. Normal background radiation varies depending on location but, in general, you can expect it to be within the range of about 12 to 40 clicks per minute.

11. Your Geiger Counter with Meter is **extremely** sensitive and will detect the radiation from standard camping lantern mantles if they are placed near the alpha window of GM1. You can also use it to detect radiation from old luminous watch dials. (The use of radium on watch and clock dials was banned years ago, so modern watches use a non-radioactive luminous paint.) Of course, the kit can also detect radioactive minerals, isotopes, smoke detector chambers, and X-rays. Just make sure to be careful not to touch or allow anything to come in contact with the alpha window on GM1, as once it gets punctured the tube is

permanently destroyed. Turn off the unit, or remove the battery, when not in use.

12. CAUTION: The Geiger Counter produces about 800-volts at very low current. It will shock you if you touch the underside of the PC board when the unit is on, or right after it has been turned off. Because of the very low current, it is not a hazardous shock, but you should avoid contact with it. After assembly, you should install the completed Geiger counter in a plastic (insulated) or wooden case.

solder to any suspect connections.

Make sure that the battery snap has been installed with polarity as shown -- and that your battery is good. Make sure that polarity was observed on all electrolytic capacitors, and that the cathode bands on all diodes are in the right direction, as shown in Figure 2. Check to see that the metal tab on Q1 is facing the right direction, and that Q2 has its flat side in the direction shown.

Are the neon bulbs lighting up? If so, the high-voltage portion of the kit is working properly, and isolates the problem to

Tic Tic BOOM!
Continued from page 58

TROUBLESHOOTING HINTS

If your circuit doesn't work as expected, first make sure that you used rosin-core solder, such as is available at electronics-supply stores. Acid-core solder will destroy the kit!

Recheck all resistors to make sure that each is the correct value and is installed in the right place.

Look for solder bridges by comparing the actual foil on your PC board to the foil pattern (Figure 3). Also re-check for "cold" solder joints and reheat, adding solder to any suspect connections.

Make sure that the battery snap has been installed with polarity as shown. Is your battery good? Check it in another circuit to be sure. (The battery tester shown elsewhere in this issue is a good way to check it!)

Make sure that polarity is correct on all electrolytic capacitors as shown, and that the flat sides of all transistors are facing in the direction indicated. Check the orientation of the SCR also.

If your project still does not operate, recheck all assembly instructions. If you purchased a kit from the Electronic Goldmine, you may want to return it according to their repair policy.

NOTE: as your battery grows weaker, the time delay periods will become longer. If your unit ticks, but does not switch to a steady scream, it indicates that the battery voltage has dropped too low and must be replaced. Ω



The Geiger Mueller Tube. Be sure to handle it very carefully!

TROUBLESHOOTING HINTS

First of all, make sure that the solder used to build the kit was rosin-core. Acid-core solder causes high voltages to be conducted to various points where it should not be, and the project will be destroyed. Next, re-check all the resistors against the parts layout.

Look for solder bridges by comparing the actual foil on your PC board to the foil pattern shown in Figure 3. Check for cold solder joints and reheat them, adding

the GM tube, load resistors, Q2 and the meter circuit.

If your kit still does not operate, recheck all assembly instructions. If everything is correct, and you purchased the kit of parts from The Electronic Goldmine, you can return your kit per their repair policy. However, the company does not replace the GM tubes for free for any reason, because all tubes are fully tested before being placed in their protective packaging. The cost of a replacement tube is \$45.00! Ω

CAR BATTERY AND ALTERNATOR MONITOR KIT

KEEP YOUR FINGER ON THE PULSE OF YOUR CAR WITH THIS HANDY DEVICE!

There are two reasons that those indicator lights on your dashboard are known as “idiot lights.” First, they remind “forgetful” drivers that they left their lights on and ran down their battery, or ran out of gas. Second, the indicators themselves are not very smart -- actually, they’re generally quite inaccurate. You can get much more accurate readings on the state of your car’s electrical system with this Car Battery and Alternator Monitor. Its green LED lights if your alternator is working properly. If the red LED comes on,

however, the alternator is malfunctioning and your battery’s energy is being drained. This electronic diagnostic device is sure to come in handy!

THEORY OF OPERATION

The Car Battery and Alternator Monitor is a simple voltage comparator in which a car battery serves as the battery for operation. Knowing that the battery voltage is higher with the alternator operating properly (or lower when the alternator is inoperative or disconnected), we can get an indication of the alternator’s operation by setting the input voltage to the comparator appropriately. The input voltage to the comparator is set by adjusting potentiometer P1. P1 must be adjusted so that so that the green

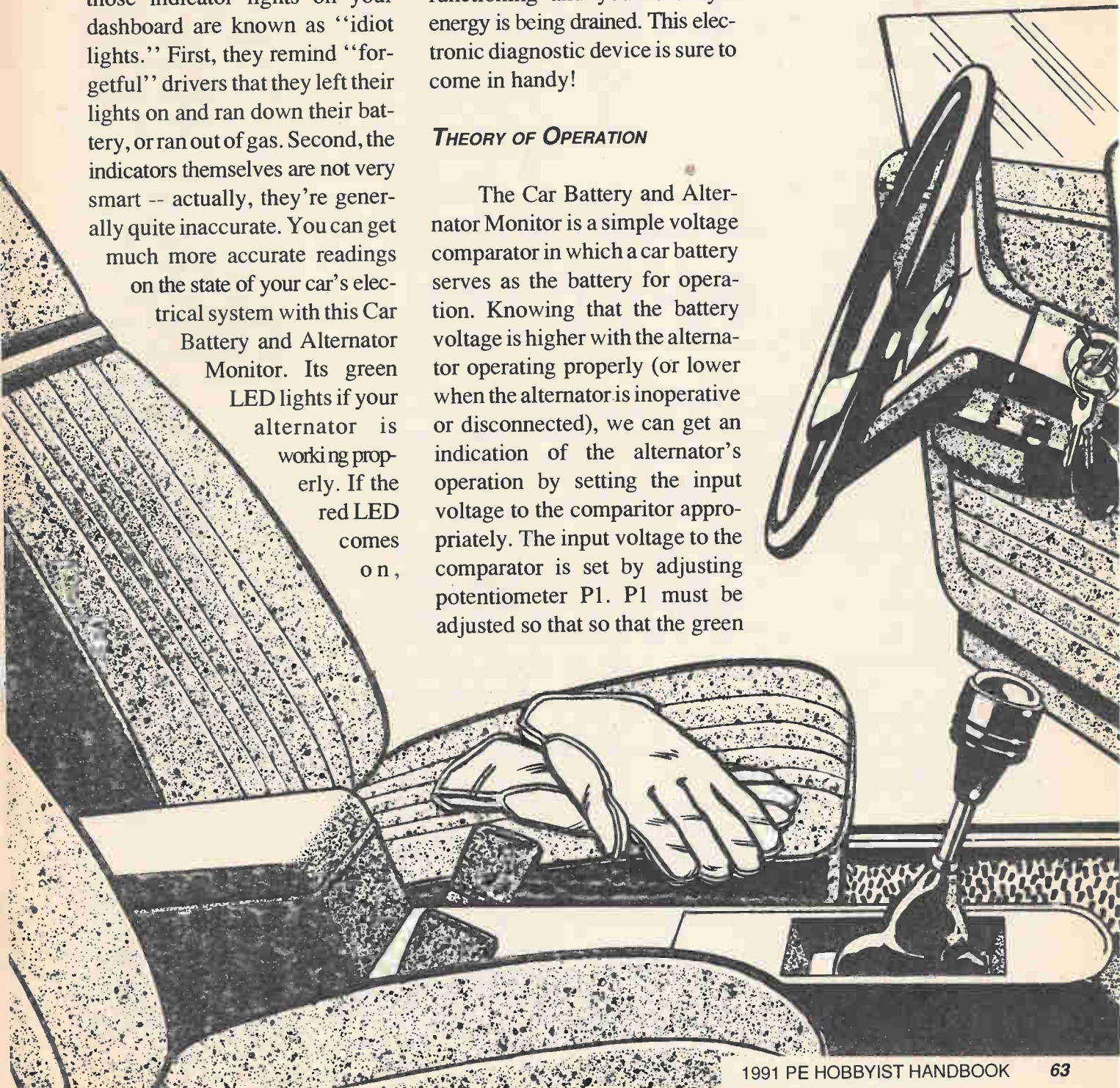

LED L2 is on when the alternator is operating properly and red LED L1 is on when the alternator is inoperative.

The circuit operates as follows: When the alternator operates properly, the battery voltage is higher and P1 is set so that transistor Q1 is causing Q2 to be off. That results in Q3 and Q4 being fully on, or, in other words, applying current to green LED L2. If the battery voltage is lowered (alternator inoperative), the transistor Q1 is turned off. That allows transistor Q2 to turn fully on, applying current to red LED L1, indicating trouble. Once Q2 is on, it causes Q3 and Q4 to go out of conduction:

ASSEMBLY INSTRUCTIONS

1. Assemble the Car Battery and Alternator Monitor following the parts layout shown in Figure 2, the Parts List, and the schematic. Use only 60/40 rosin-core solder.
2. Observe the flat-side mounting guide on LEDs L1 and L2 and transistors Q1 - Q4 when installing these components.
3. Install trimmer resistor P1 and resistors R1 - R5.
4. Connect the white wire to (+) on the PC board,

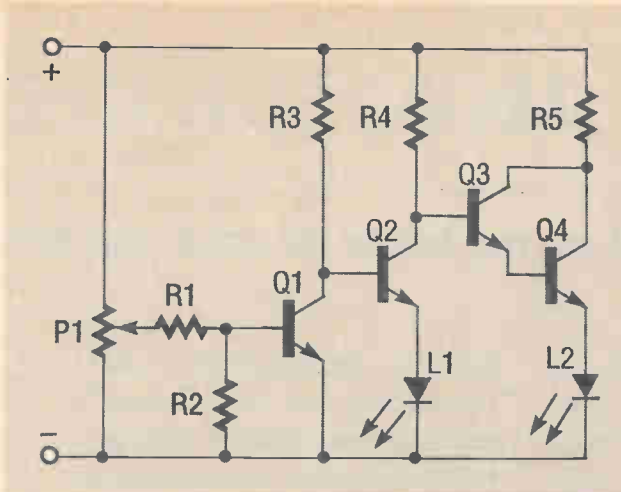

Figure 1. The schematic for the Car Battery and Alternator Monitor shows a simple voltage comparator. The car's battery powers the circuit.

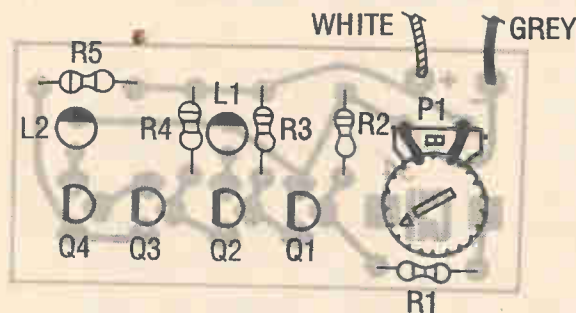

Figure 2. When assembling the monitor, make sure to orient the components exactly as shown in the parts-placement diagram shown here.

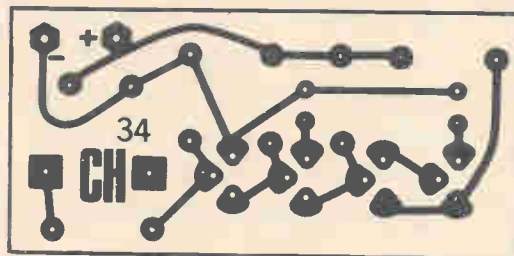

Figure 3. Experienced kit builders might want to try their hands at etching their own PC board.

PARTS LIST

L1	Red LED
L2	Green LED
P1	2.5K Trimmer Resistor
Q1 - Q4	2N3904 Transistor
R1	100K Resistor
R2, R3 ..	33K Resistor
R4, R5 ..	470ohm Resistor
Misc.	PC board, Wire

NOTE: A complete set of parts for the Car Battery and Alternator Monitor is available as kit C6388 for \$5.00 from The Electronic Goldmine, P.O. Box 5408, Scottsdale, AZ 85261. See page 96 for ordering information.

and the gray wire to (-) on PC board.

5. For laboratory calibration: Connect the gray wire to (-) and the white wire to (+) on a power supply set for 13.0 volts DC (measured with a digital voltmeter), and slowly adjust P1 until both the red and the green LEDs light up. Without re-adjusting P1, raise the voltage of the power supply to 13.8 volts DC. The green LED should be on and the red off.

6. For field calibration: Connect the gray wire to the (-) terminal on your car battery and connect the white wire to the (+) terminal on the battery. With the car off and all accessories off, adjust P1 so that the red and green LEDs are both on.

7. After calibration, drip glue or wax onto the knob and the PC board to permanently set P1.

8. Now the kit is ready to be mounted in a box or case, and the wires can be attached to (+) and the ground to (-). NOTE: You can leave the Car Battery and Alternator Monitor connected to a car battery continuously, as the current drain is extremely small. Also, the device should be mounted inside the passenger compartment, as best accuracy is obtained at normal

--continued on page 68

If you've been looking for a stereo booster amp for your car's sound system, but have been put off by high prices, look no further. This little beauty provides two separate high-power amps on one printed-circuit board. Each has its own level control and puts out 20 watts RMS. A red LED indicates that the power is "on." The 20W + 20W Stereo Amp features low-distortion circuitry, runs on 12-volts DC, works with any speakers capable of handling at least 20 watts -- and costs only about \$20! This project is somewhat difficult for beginners, but intermediate-level electronic hobbyists will find it well worth the effort.

THEORY OF OPERATION

The 20W + 20W Stereo Amp consists of two complete, separate 20-watt RMS bridge-type amplifiers. Each amplifier works the exact same way, so we will look at the operation of channel A only. If you look at the schematic in Figure 1, you will notice that the input signal source is brought into the amplifier through the voltage divider network, which is made up of R1, R2, and P1. Resistor R1 provides a load impedance between the signal source and ground. Resistor R2

20W + 20W STEREO AMP

**ITS TWO AMPS EACH OUTPUT AN
INCREDIBLE 20 WATTS RMS!**

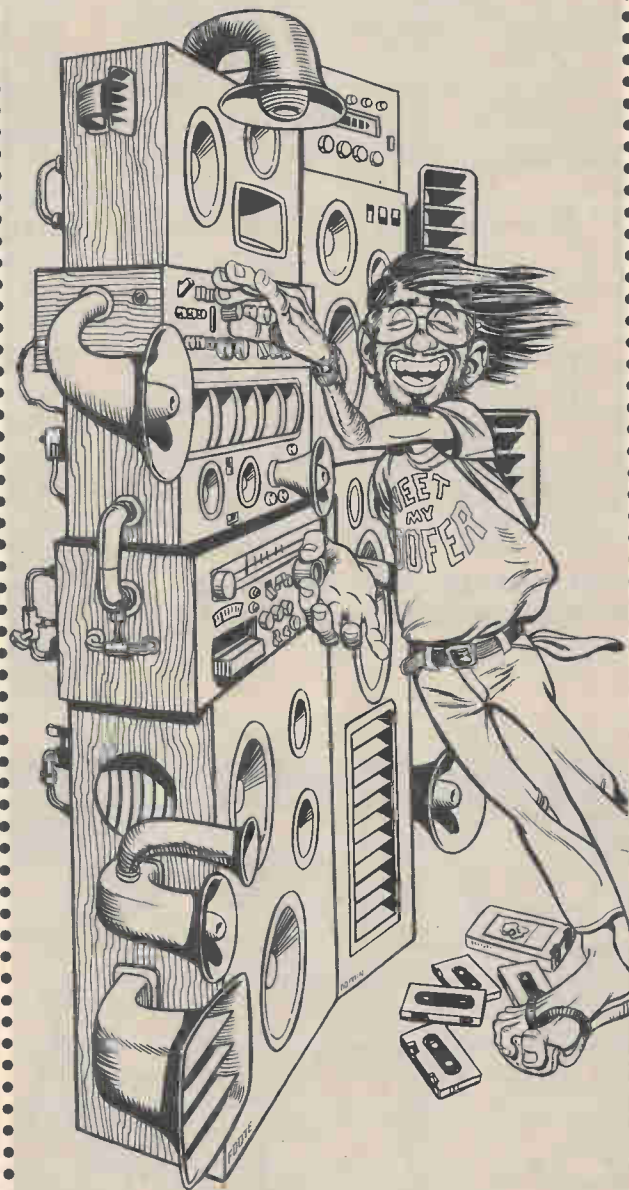

couples that signal, reduces it, and brings it to potentiometer P1. As the shaft of P1 is rotated clockwise, less resistance is placed between the input capacitor C1

and R2. As the resistance of P1 is reduced, the level of the signal becomes greater at the wiper terminal of P1 (indicated on the schematic by an arrow).

The signal is coupled by capacitor C1 to the non-inverting (+) input (pin 1) of internal amplifier (A) of IC1, where the signal is greatly amplified. Capacitor C2 couples the (+) input of the other (B) internal amplifier of IC1 to ground. That causes the input signal, which is referenced to ground, to be coupled to both amplifiers since both the inputs and outputs of IC1 (A) and IC1 (B) are connected in a bridge configuration. Notice that the output of IC1 (A) from pin 10 is connected to one side of the speaker and the output of IC1 (B) from pin 8 is connected to the other side of the speaker. That is why the speakers used cannot have one side connected to ground. Resistors R6 and R7 set the gain of the amplifier. Resistors R9 and R10 and capacitors C9 and C10 provide frequency stability and prevent oscillation. Capacitors C6 and C7 provide "bootstrapping," which prevents distortion at low frequency. LED L1

lights up by way of a series resistor connected to the anode to +12VDC when power is applied. Keep in mind that the LEDs have

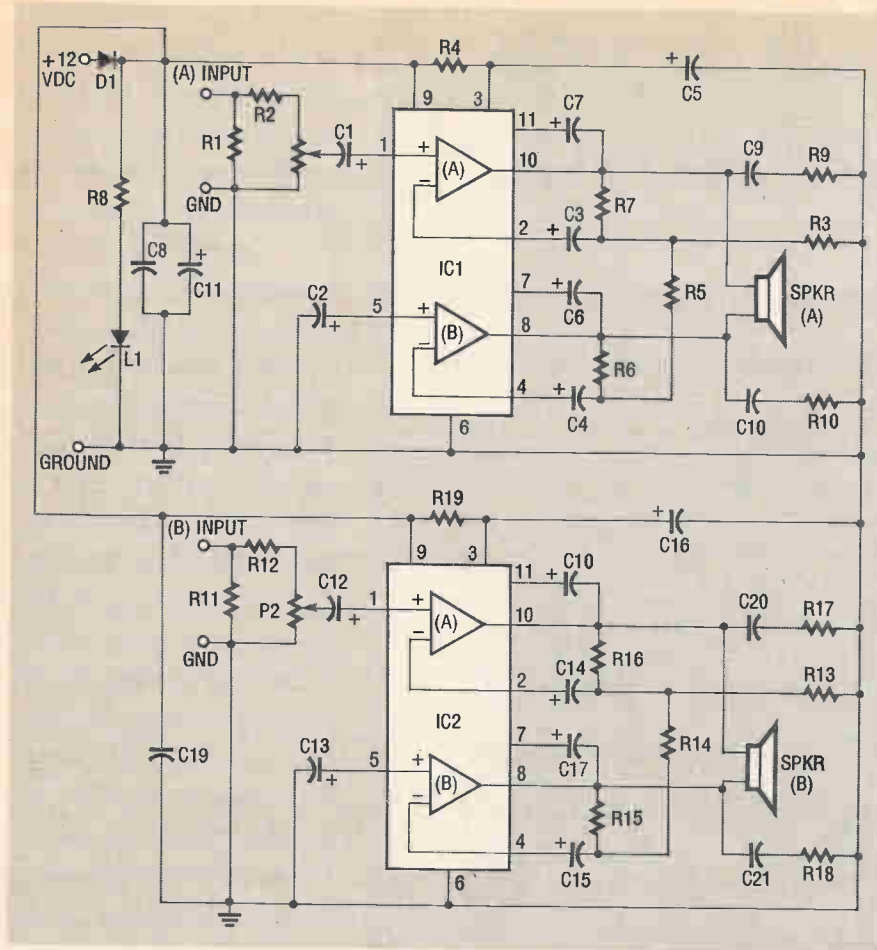

- PARTS LIST**
- C1,C2,C12,C13 4.7 μ F Electrolytic Capacitor
 - C3,C4,C5,C6, C7,C14,C15 .. 100 μ F Electrolytic Capacitor
 - C16,C17,C18,C8, C9,C10,C19,C20, C21 0.47 μ F Mylar Capacitor
 - C11 3300 μ F, 25V Electrolytic Capacitor
 - D1 3 Amp Rectifier
 - L1 Red LED
 - R1, R11 .. 47 ohm, 1 watt Resistor
 - R2, R12 .. 33K, 1/4 watt Resistor
 - R3,R5,R13,R14 12 ohm, 1/4 watt Resistor
 - R4,R19.. 120K, 1/4 watt Resistor
 - R6,R15.. 2K, 1/4 watt Resistor
 - R7,R16.. 1K, 1/4 watt Resistor
 - R8 680 ohm, 1/4 watt Resistor
 - R9,R10,R17,R18 3 ohm, 1/4 watt Resistor
 - P1,P2 50K Dual Potentiometer
 - IC1, IC2 NEC70001AB Amplifier
 - Misc. Heat Sink, Screws/Nuts, PC board, Hex nuts and wire
- NOTE: A complete set of parts is available as kit C6442 for \$19.95 from The Electronic Goldmine, See page 96 for information.**

Figure 1. As you can see from this schematic, two identical and completely separate high-power amps are built around IC1 and IC2, NEC70001AB amplifier IC's.

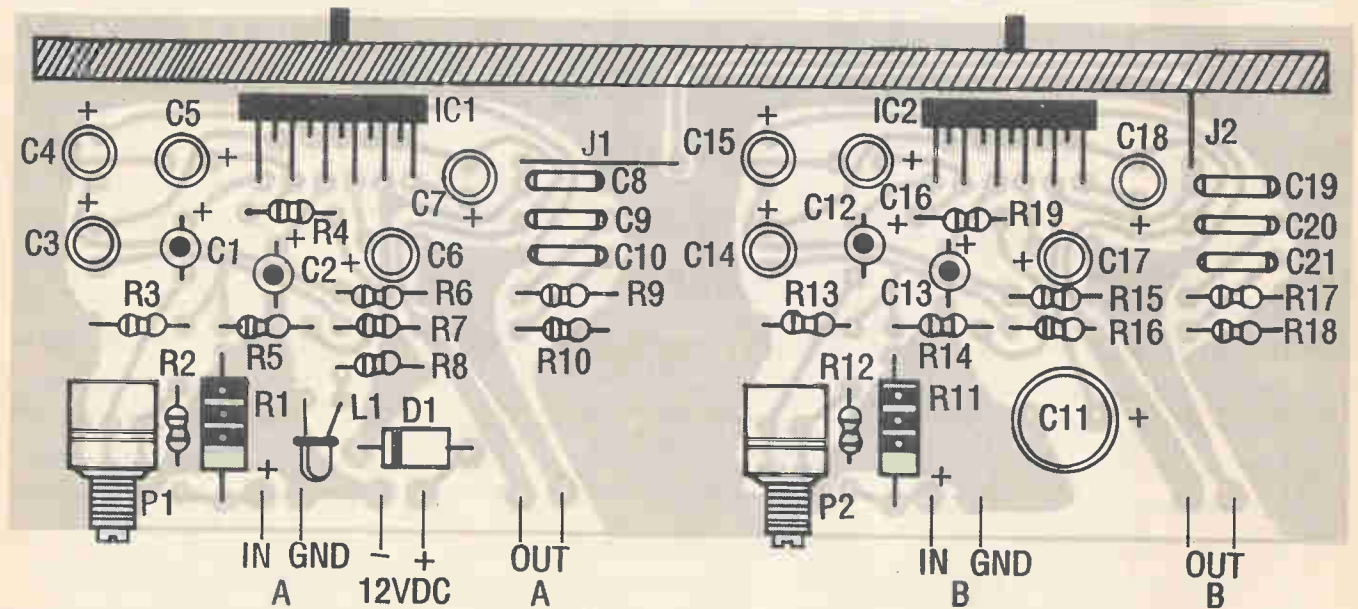
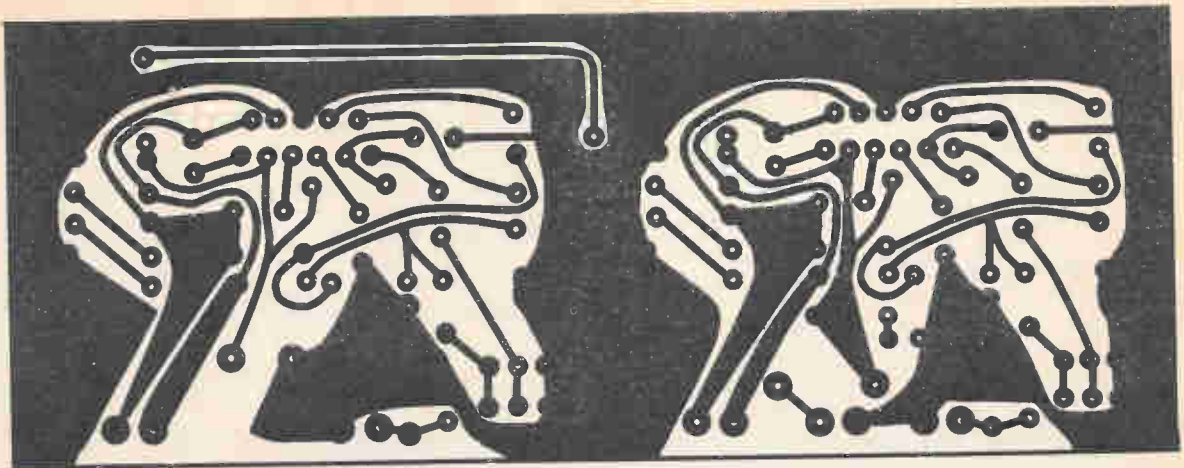

Figure 2. This is the parts-placement diagram for the Stereo Amp. Note that the tab of each IC mounts directly to the bar with no insulation needed.

Figure 3.
Full-size foil
pattern for
the PC
board.



a polarity and will not light up if they are installed backwards. The heat sink is provided to cool IC1. Power for both IC1 and IC2 is brought in through D1 (to protect amplifiers from reverse polarity). Capacitor C11 provides additional power supply line filtering.

This booster is capable of producing 20 watts RMS output out of each channel. Many manufacturers give peak power ratings, which are misleading for an amplifier. Therefore you should always try to obtain the RMS output capability when comparing power amplifiers.

ASSEMBLY INSTRUCTIONS

1. Assemble the Stereo Amp using the parts-placement diagram in Figure 2, the Parts List, and the schematic to guide you. Be sure to use only 60/40 rosin-core solder; acid-core solder could irreparably damage your project!
2. First install all electrolytic capacitors, following the Parts List and the parts layout, being careful to observe the correct polarity on each capacitor and to install P1 and P2 as shown.
3. Install D1 with the cathode band going toward potentiometer P1 as shown. Next, install LED L1 with its flat (cathode) side going toward P1. You may now bend L1 over, so that it faces the front of the board as shown.
4. Install all six mylar capacitors as shown (no polarity needed). Next, install all resistors per the Parts List and the parts layout.
5. Cut bare wire into two pieces and install jumpers J1 and J2.
6. Mount each IC on heat-sink bar by using a screw and nut (do not tighten yet). Note that the tab of each IC mounts directly to the bar -- no insulator is needed. Carefully insert each IC into the appropriate place on PC board and solder. Now you may tighten the screw and nut on each IC. Make sure that the bar does not touch the jumper J2! If it does, you have mounted the ICs on the bar incorrectly; remove the screws and nuts, rotate the bar 180 degrees, and re-install the ICs to the bar.
7. Finally, cut insulated wire into 3-inch lengths and install it on

the PC board. Use these short lengths to jumper (connect) to your speaker wires, battery, etc.

TESTING AND CHECKOUT

To test out your 20W + 20W Stereo Amplifier, connect any 20-watt (or greater power), 4- to 8-ohm, two-lead speaker to each output. **NOTE: Make absolutely sure that the speakers you use are not grounded.** This booster amplifier uses a bridge configuration, which requires the use of two-lead speakers -- one-lead-and-ground types will "short out" the booster amp.

Connect the output of your signal source (tape player, radio, etc.) to channel A (left) input and channel B (right) input. **NOTE: It is okay to reference the input signals to ground - just not the output of the booster amp.**

Connect 12VDC to the booster amp at points shown. Adjust level of signal source to 1/4 turn or less, and then adjust each channel's level control on the booster amp (P1 and P2) to the desired level, without distortion. **NOTE: If the signal level coming in is too high, just a slight**

adjustment of P1 and P2 will bring the booster amp to full output. Turning these controls up more will cause distortion. The signal begins to clip (distort) above 20 watts/channel.

TROUBLESHOOTING HINTS

If you have any problems,

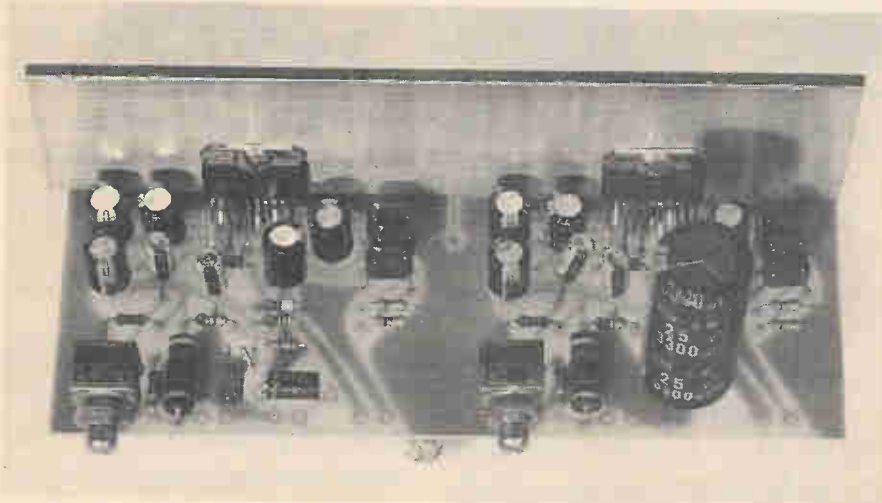

The completed 20W+20W amplifier. Note how the IC's are mounted to the heatsink Be sure that the heatsink doesn't touch J2!

SPECIFICATIONS

Frequency Response: (-3dB points) 40Hz to 20KHz
 Maximum Distortion: 1%
 Efficiency: 60% (typical)
 Thermal Shut-Down Temperature: .. 145 degrees Centigrade
 Maximum Output: (3.2 ohm load) 22 watt RMS/Channel
 Voltage Range: 8 to 18VDC

first -- as with all of the kits described in this issue, make sure that the solder used to build the kit was rosin core.

If you do not hear an amplified output out of your speakers, check with a voltmeter to see that 12 volts DC is being applied with the polarity as shown. Also check that the input signal is being applied at correct points and the

signal source is turned on!

Make sure that speakers with sufficient power-handling capabilities are connected to correct points, and that all soldering and parts placement is correct.

If you hear distortion, check to see if the input level from signal source is too high. The level control P1/P2 may also be ad-

justed too high, or your power supply might be providing less than 12 volts.

Another possible source of distortion might be the source of the signal that you are trying to amplify.

Since the amplifier puts out a significant amount of power, you should be sure that your speakers can handle it. Ω

Alternator Monitor Continued from page 64

temperatures (not at the excessive heat found under the hood of car).

- The LED indicators are simple to interpret. With the engine on, when the green LED is on, that indicates that the alternator and the voltage regulator are functioning properly. With the engine on, when the red LED is on that indicates a bad alternator, regulator, or battery. If both the red and the green LEDs are on, it usually indicates that the fan belt is too loose.

TROUBLESHOOTING HINTS

First of all, make sure that the solder used to build the project was rosin-core. Then, check your parts placement. Recheck all resistors according to the color code and the parts layout. Recheck both LEDs to make sure that their flat sides are facing the direction shown on the parts layout. Make sure that all transistors have flat sides facing direction shown. Check to make sure that the conducting wires are at the proper battery terminals.

Look for solder bridges by comparing the actual foil on your PC board to the foil pattern shown in Figure 3. Check for cold solder joints and reheat them, adding solder to any suspect connections.

If your Car Battery and Alternator Monitor still does not operate, go back again and double-check all of the assembly instructions. Ω

ULTRASONIC PEST REPELLER

HERE'S A NON-TOXIC, ENVIRONMENTALLY-SAFE WAY TO STAY BUG-FREE!

We've had our share of barbecues, beach parties, and camping trips ruined by pesky mosquitoes each summer. And it seems that a couple of local field mice find our kitchen a warm and cozy spot to spend the winter. Because we don't like to spray pesticides on our skin, or put out poison or traps in our kitchen, we just had to learn to live with our unwanted "guests."

If you've experienced similar pest problems, you might find a solution in this Ultrasonic Pest Repeller. It provides a safe way to keep insects and small rodents away. It emits low-intensity ultrasonic sound waves that repel insects and rodents but are above the hearing range of people, dogs, cats, and birds. The only thing you hear from the Ultrasonic Pest Repeller is a slight buzzing noise that's not at all offensive. Insects and rodents hear the sound differently, and do not like to be anywhere near the source of the sound.

The Pest Repeller is a good project for intermediate-level kit

builders. Beginners might want to try their hand at some of the easier projects in this magazine first.

THEORY OF OPERATION

The Ultrasonic Pest Repeller uses two transistors and one IC (a 555 timer IC) to produce a pulsating ultrasonic frequency. Looking at the schematic in Figure 1, you can see that transistors Q1 and Q2 are connected in a direct-coupled oscillator. The frequency of that oscillator is set by capacitor C1. The oscillator output is taken from the emitter of Q2 to pin 7 of IC1. Transistor Q1 is an NPN transistor, and Q2 is a PNP transistor. The signal on pin 7 of IC1 causes the output signal appearing on pin 3 to be modulated or varied by the audio frequency developed by Q1 and Q2. The IC itself is connected as an astable multivibrator with a frequency determined by C3. Capacitor C3 sets the basic frequency to be well above the human hearing range (ultrasonic), and the combined

modulated ultrasonic frequency appears on pin 3 of IC1, where it is coupled by capacitor C4 to the piezoelectric transducer.

ASSEMBLY INSTRUCTIONS

1. Assemble the Ultrasonic Pest Repeller according to the parts-placement diagram (Figure 2), the Parts List, and the schematic. Use only 60/40 rosin-core solder. Do **not** use acid-core solder!
2. Orient the IC locating mark, the flat side of Q1 and Q2, and polarity on C2 as indicated on the parts layout when installing those components.
3. Connect XDC by first installing two pieces of bare wire (the pieces left-over from resistor already installed) into the correct positions and solder. Next, lay XDC flat on the PC board with the ceramic surface on top. Then, carefully bend wires over to touch XDC, and cut off the excess (see Figure 2). Make sure that the longer wire does not touch the edge of disc. Finally, solder each bare wire to the disc using a very small amount of solder. The long lead should be soldered to the ceramic surface and the short lead to the brass surface.
4. Install the jumper wire as shown on the parts layout.

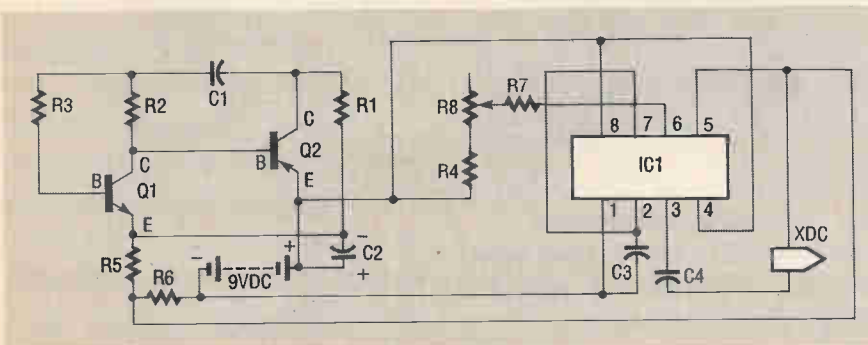

Figure 1. The schematic shows transistors Q1 and Q2 connected in a direct-coupled oscillator.

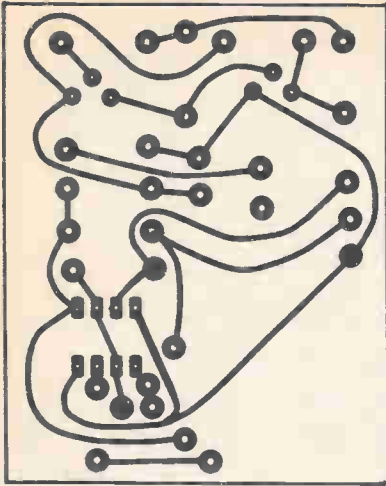

Figure 2. Follow the parts-placement diagram carefully when constructing your Ultrasonic Pest Repeller.

PARTS LIST

C1,C2 ..	0.1 μ F Mylar Capacitor
C2	1 μ F Electrolytic Capacitor
C3	0.001 μ F Mylar Capacitor
IC1	555 timer IC
Q1	2N3904 Transistor
Q2	2N3906 Transistor
R1	4.7K Resistor
R2	3.3 meg Resistor
R3,R6 ..	10K Resistor
R4,R5 ..	100 ohm Resistor
R7	18K Resistor
R8	5K Trimmer Resistor
XDC	Piezoelectric Transducer Disc
Misc.	IC Socket, 9-Volt Snap, PC Board

NOTE: A complete set of parts for the Ultrasonic Pest Repeller is available as kit C6350 for \$9.00 from The Electronic Goldmine, P.O. Box 5408, Scottsdale, AZ 85261. See page 96 for complete ordering information.

longer operating periods or continuously "on" use, you will need to use a filtered 9VDC

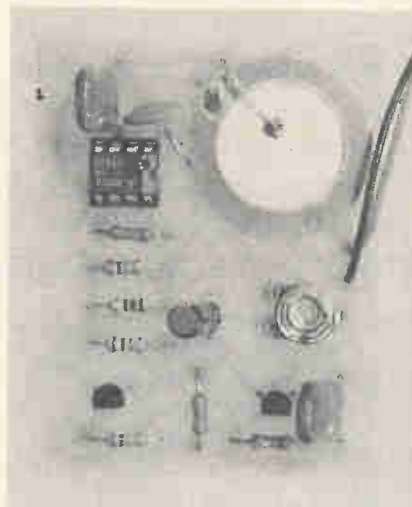

The completed pest repeller circuit board is shown here Note how the transducer is soldered using cut resistor leads.

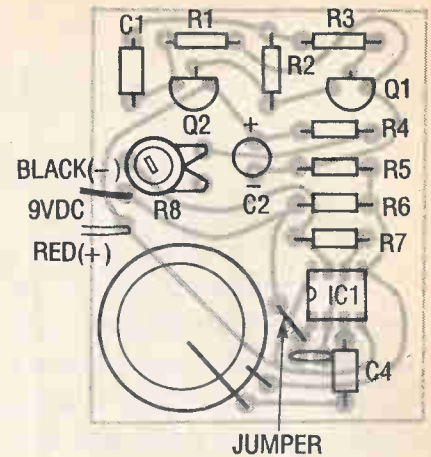

Figure 3. The foil pattern is full sized, so it can be used for etching the printed-circuit board for the Ultrasonic Pest Repeller.

adapter (available at your local electronics-supply store).

TROUBLESHOOTING HINTS

Make sure that the solder you used was rosin core solder! Then compare your project to the parts layout and check that the resistors are in the right positions, that Q1 and Q2 have been installed with the flat sides facing the direction shown, and that the IC is oriented correctly.

Next, compare your PC board to the foil pattern shown in Figure 3. Look closely for solder bridges. Check for cold solder joints and reheat, adding solder to any suspect connections.

Make sure that the battery snap has been installed with polarity as shown on the parts layout. Is your battery good?

If your Ultrasonic Pest Repeller still does not operate, and you purchased the complete set of parts from The Electronic Goldmine, you can return your kit per their repair policy. Ω

METAL LOCATOR

FIND THE GOLD IN THEM THAR HILLS!

Treasure hunting isn't limited to gold prospectors. We often see people combing the beaches with metal detectors, searching for loose change and jewelry that has fallen from the pockets of sunbathers. You can build your own metal detector -- without having to spend too much of your own silver -- and join in the fun and profitable treasure-hunting hobby.

This Metal Locator is easy to build, too, even for beginners. Its transistorized circuit uses a unique detection coil that is wound directly on top of a printed circuit board; no coil forms are required. The Metal Locator indicates that it has detected metal by a shift in tone that is transmitted to a standard portable AM radio. (You probably have an old transistor radio lying at the bottom of your kitchen drawer. If you do, this project should pay for itself in no time!)

THEORY OF OPERATION

The metal locator uses a one-transistor oscillator and your AM radio to detect metal. As shown in Figure 1, transistor Q1 is a PNP transistor that is connected as an oscillator. Resistor R1 provides the correct base bias and capacitors C3 and C4 and the search coil

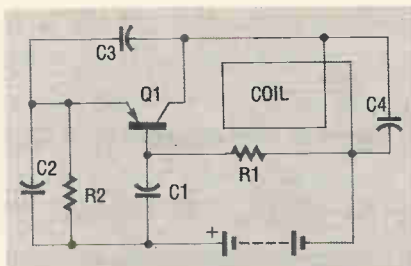

Figure 1. As you can see from this simple schematic, the Metal Locator is a good project for beginners.

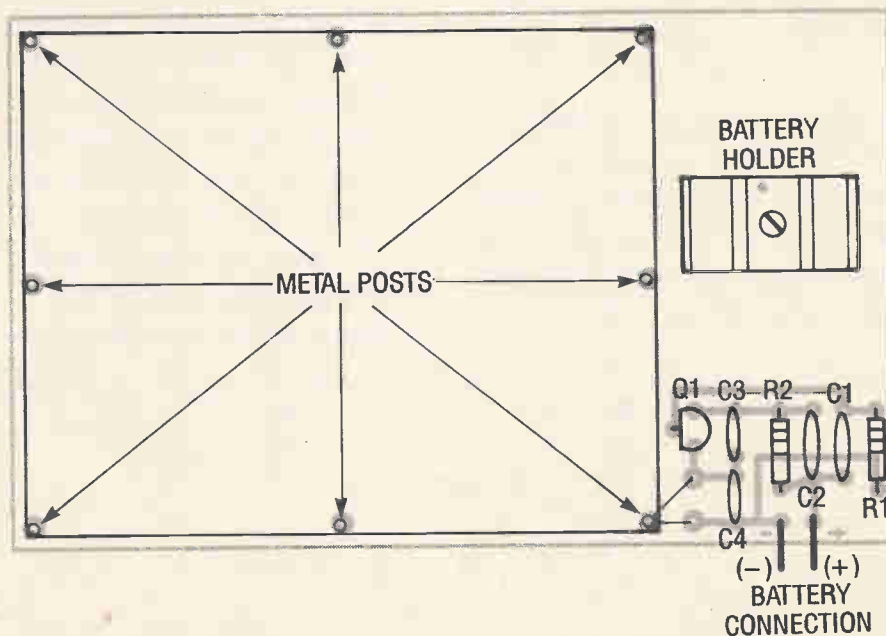

Figure 2. Parts-Placement Diagram. Be sure to install Q1 with its flat side facing the direction shown.

determining the frequency of oscillation.

Capacitors C3 and C4 are fixed in value, but the search coil is an inductor, which varies in inductance (and thus varies the oscillator frequency) as metal is brought near it. The oscillator

frequency is rich in harmonics and its output falls within the AM broadcast band. The metal detector works by combining its output with the local oscillator inside the AM radio. The resulting net output of the radio is a low-frequency audio tone that changes -- gets

PARTS LIST

- C1,C20.01 μ F Capacitor (103)
- C3,C40.001 μ F Capacitor
- Q12N3906 Transistor
- R147K Resistor
- R2100 ohm Resistor
- Misc.9-Volt Snap, 8 pins, Battery Holder, Screw, Nut, Wire, PC Board

NOTE: A complete set of parts for the Metal Locator is available as kit C4515 for \$5.95 from The Electronic Goldmine, P.O. Box 5408, Scottsdale, AZ 85261. See page 96 for complete ordering information.

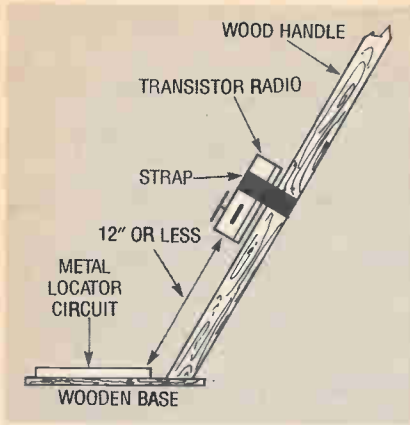

Figure 3. Mount the completed circuit on a wooden base and attach a wooden handle. Strap the AM radio to the handle, making sure that it is no more than 12 inches away from the circuit. Keep the wooden base parallel to the ground and swing the Metal Locator back and forth in a sweeping motion to search for metal.

higher or lower -- as metal is brought near or taken away from the search coil. Commercial metal detectors use two oscillators, so they don't require an AM radio. This Metal Locator provides an

inexpensive alternative to an expensive commercial metal locator.

ASSEMBLY INSTRUCTIONS

1. Assemble the metal detector following the parts layout shown in Figure 2, the Parts List, and the schematic. Be sure to use only 60/40 rosin-core solder. As with every other project in this magazine, using acid-core solder will destroy your work!
2. Solder the eight pins in, and then bend the pins outward slightly -- they will be used to hold the coil of wire. Wrap 16 turns of enameled wire (sometimes called "magnet wire") around the pins. Scrape the enamel off the ends of the wire so that it can be soldered to the PC board. Install the resistors and capacitors. Install Q1 with its flat side facing the direction shown on the parts placement diagram. Be sure to
3. watch for the correct polarity as you install the battery snap.
3. Mount the completed unit on a thin wooden base for stability. The Metal Locator is easiest to use if a wooden handle is attached to the base. Figure 3 shows the recommended configuration. The AM radio should be strapped to the handle no further than 12 inches from the metal-locator circuit for proper operation.
4. With the battery connected to the Metal Locator and the radio turned on, a "squeal" should be heard at several dial positions. Select the loudest and adjust the volume. The pitch will change when metal is detected.
5. Now you're ready to give it a try for real. Practice with purposely buried coins (don't go to deep) so that you'll know what it sounds like to find the real thing. The most important thing to remember is that you must be patient!

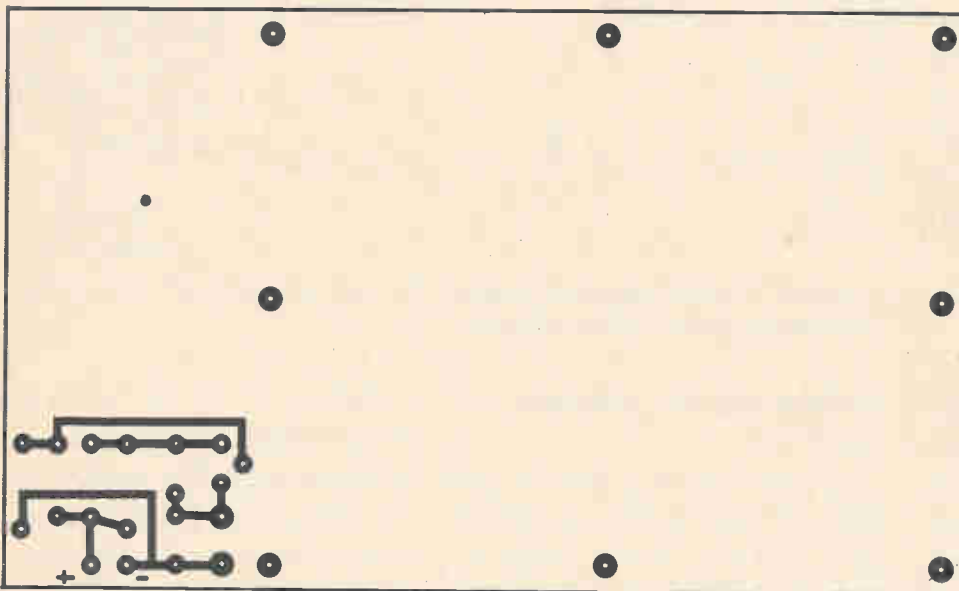

The full-size foil pattern for the metal locator is shown here for those who want to make their own board. Perforated construction board is also a good alternative for this project.

TROUBLESHOOTING HINTS

Double-check the placement of all components., especially Q1.

Make sure that the insulation has been scraped or sanded off the ends of the search coil. (Measure the resistance across the search coil with an ohmmeter. It should be very low resistance.

Finally, compare your printed-circuit board with the foil pattern shown in Figure 4. Check for cold solder joints and reheat, any you suspect. Ω

Even with the introduction of supposedly "idiot-proof" do-everything cameras, good flash photography hasn't gotten any easier. Using a single flash usually results in the main subject being washed out, with the surrounding area or background remaining underexposed. Turning up the room lights usually doesn't help the exposure too much; they're simply not bright enough.

For good, bright, even lighting, professional studio photographers use multiple strobes. That's fine if you take your pictures in a studio. But what about those flash shots at your annual family get-together?

You can achieve near-professional results without using the professional's expensive, specialized strobes. Using standard strobes and this easy-to-build slave-trigger you can turn night into day. You need simply to connect the output leads of this circuit to the shutter cord of any strobe you want to use as the slave. When the main strobe is triggered, the slave circuit will sense it (up to 50 feet away) and cause your slave strobe to flash simultaneously. There is no limit to the number of strobes you can use, although you'll need to build a separate kit for each one.

As shown in the schematic diagram in Figure 1, the Photo Strobe Slave Trigger Circuit uses a solar cell and a SCR or Silicon Controlled Rectifier to flash any strobe of your choice when you trigger your "master" strobe. The tiny solar cell produces a very small voltage when its surface

Build This PHOTO STROBE SLAVE TRIGGER

*TURN ANY PHOTO STROBE INTO A USEFUL SLAVE
STROBE WITH THIS LIGHT-ACTIVATED
SLAVE TRIGGER!*



has light on it. When you trigger your master strobe, the tiny voltage (about 0.6 volts) is converted to a higher value by transformer T1. Thanks to the large turns ratio of T1, its output is high enough to trigger the SCR (Q1), causing it to turn on.

A strobe connected to Q1 will fire in precise synchronization with your master strobe when the SCR is triggered. The best part about using the solar cell is that the remote strobe is activated without wires!

ASSEMBLY INSTRUCTIONS

1. Assemble the circuit following the parts-placement diagram in Figure 2 along with the Parts List. Double check your work using the schematic, and be sure that you use 60/40 rosin core solder only.
2. Install solar sensor B1 with colored lead (on some cells it is colored blue, on others it is red) in the direction shown for correct polarity.
3. Bend the metal mounting ears on T1 under the device, as they're not used for mounting the transformer in this project. Insert T1's wire leads into the PC board and solder.
4. Install Q1 with its bevelled edge in the direction shown.
5. Connect the hookup wire to your shutter cord as indicated in the parts-placement diagram, and insert shutter cord into "slave" strobe. Turn the "slave" strobe on, and when the ready lights come on, fire your "master" strobe. Both the master and slave strobes should

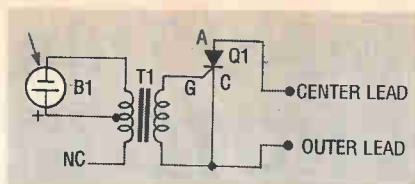

Figure 1. The voltage produced when light hits the solar cell (B1) is stepped up by transformer T1 so that it can trigger the SCR (Q1) which, in turn, triggers the slave unit.

PARTS LIST

B1	Solar Cell
Q1	106 SCR
T1	Coupling Transformer
Misc.	PC Board, Wire, Case, etc.

A complete set of parts for the Photo Strobe Slave Trigger is available as kit C6436 for \$7,49 from the Electronic Goldmine, P.O. Box 5408, Scottsdale, AZ 85261. See page 96 for complete ordering information.

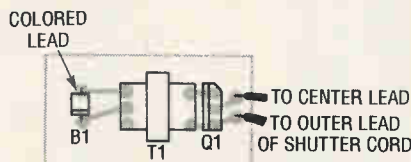

Figure 2. Follow this parts placement diagram when building the slave trigger. As you can see from this figure and the foil pattern below, the trigger is quite small, which gives you many mounting options. (You may even be able to mount it inside your slave strobe!)

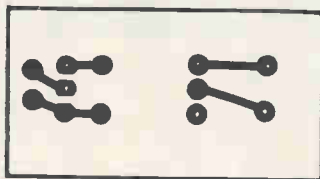

Figure 3. Full-size foil pattern for the Photo Strobe Slave Trigger.

flash at the same time.

6. If your Photo Strobe Slave Trigger Kit did not fire the strobe, double-check your work, using our "Troubleshooting Hints" section as a guide.
7. After you build the slave trigger and test its operation, you may want to mount it in a case for protection and for neatness. The circuit board is so small that it will easily fit in a standard 35-mm film canister. You'll just have to make sure that a hole is provided to allow light to strike sensor B1. Even with the hole, you'll want to try several test flashes to determine the maximum distance for reliable operation.

TROUBLESHOOTING HINTS

If you have any problems with the kit, first make sure that the solder used to build the kit was rosin core. If acid core solder was used, the kit won't work! In fact, it will be destroyed.

Look for solder bridges by comparing actual foil on PC board to the foil pattern (Figure 3). Also check for "cold" solder joints and reheat and that seem suspect, adding solder as you do. Also check to make sure that the SCR is mounted with its beveled edge as shown on parts layout.

If your kit still does not operate, even after double-checking all of the assembly instructions, you may not be out of luck. If you purchased the kit from The Electronic Goldmine, you have the option to return it per their repair policy. Ω

INFRARED REMOTE-CONTROL TESTER

Now you can "SEE" THOSE
INVISIBLE SIGNALS!

You might not be able to see it, but it directly influences what you see -- every time you hit a button on your TV's remote control. The remote controls for your stereo, VCR, CD player, etc., all use infrared light.

But what do you do when you hit the button and nothing happens? Is it your handheld remote or is it your equipment that's to blame? If you can't see the infrared light, how can you be sure that it's there? Our Infrared Detector, which detects most types of invisible infrared waves using a simple sensor, provides a way to test your remote-control units. And it won't cost you much in terms of either time or money!

The Infrared Detector circuit, whose schematic is shown

in Figure 1, uses a sensitive PN type solar sensor that is connected directly to a Darlington amplifier made up of transistors Q1 and Q2. Biasing is provided by R1 and P1, a variable resistor that serves as a sensitivity control. The collector lead of Q1 is the output lead of the Darlington amp, and it is connected to a red LED and the primary of transformer T1. The function of T1 is to convert the low-voltage output signal to a level high enough to drive a small piezo disc. That disc makes a clicking sound when the sensor picks up an infrared signal that is varying in frequency or amplitude.

The infrared sensor will also pick up visible light and visible light may interfere with normal

performance, so we'd recommend using it in a darkened room. That will extend its range considerably.

ASSEMBLY INSTRUCTIONS

1. Before you begin, make sure that you have on hand all the necessary components, as noted in the Parts List. Use only 60/40 rosin-core solder. Assemble the Infrared Detector according to the parts-placement diagram in Figure 2 and the schematic.
2. Install solar sensor S1 with the colored lead (-) in direction shown. Then install resistor R1 per the parts layout.
3. Observe the flat-side orientation of transistors Q1 and Q2 when installing. Also install jumbo red LED L1 with its flat side in direction shown.
4. Install trimmer resistor P1 and transformer T1. Be sure to note the proper polarity when installing the 9-volt snap.
5. To install piezo disc BZ, first cut a piece of bare wire in half, and then install one end of each piece into the PC board. Lay

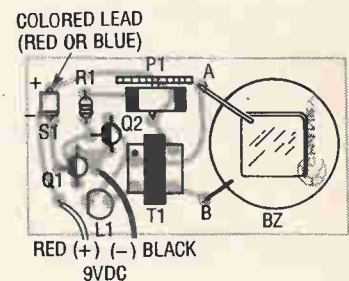

Figure 2. Follow this parts-placement diagram carefully when assembling the Infrared Detector. Be sure to face the flat edges of Q1, Q2, and L1 as shown.

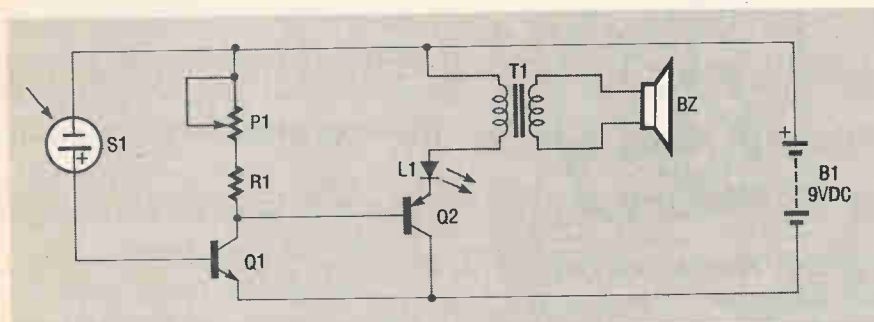

Figure 1. This is a good project for beginners, as you can see from the simple schematic shown here.

BZ on the PC board in position shown on the parts layout, then **carefully** bend over pieces of bare wire and cut them to match the layout. Next, solder each piece of bare wire to the disc at point shown. Use only a small amount of solder, and try not to use excessive heat. **Do not** allow bare wire piece A to touch the brass disc. The brass disc may be a little tarnished, but

PARTS LIST

BZ	Piezo Disc
L1	Jumbo Red LED
P1	2 meg Trimmer Resistor
Q1	2N3904 Transistor
Q2	2N3906 Transistor
R1	270 ohm Resistor
S1	Solar Sensor
T1	Yellow Dot Transformer
Misc.	PC Board, 9-volt Snap, Bare Wire

NOTE: A complete set of parts for the Infrared Detector is available as kit C6441 for \$5.95 from The Electronic Goldmine, P.O. Box 5408, Scottsdale, AZ 85261. See page 96 for complete ordering information.

that does not affect the performance in any way. If you wish, you may brighten it by rubbing a pencil eraser over the disc.

TROUBLESHOOTING HINTS

First of all, check your construction techniques. Make sure that you don't have any cold solder joints or solder bridges.

Check your battery; is it good? Make sure that the battery

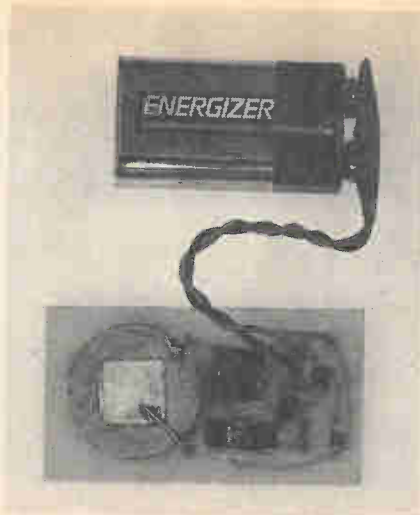

The completed infrared detector. Note how the piezoelectric disc is soldered to the board using bare wire.

snap has been installed with polarity as shown.

Recheck the jumbo red LED to make sure that its flat side is facing direction shown on the parts layout (Figure 2). Make sure that the flat sides of transistors Q1 and Q2 are properly oriented. Finally, check to make sure that solar sensor S1 has been installed with its correct polarity as indicated by its colored lead.

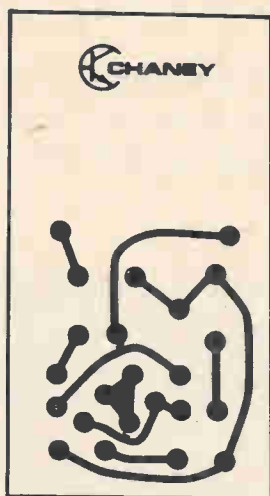

Figure 3. You can use this full-size foil pattern to etch your own printed circuit board for the Infrared Detector.

USING THE INFRARED DETECTOR

After re-checking assembly for accuracy, connect a fresh 9-volt battery to the snap. Set the detector so that the sensor does not face directly at any light source. The sensitive sensor detects the infrared content of all light sources. Adjust P1 until L1 just extinguishes.

Your Infrared Detector Kit is now ready to test infrared controllers, infrared LEDs, etc. Simply aim your remote control at the sensor (from a distance of three inches or less) and press each button. You should notice that L1 will flash and BZ will emit a clicking sound. Pressing the remote control's "record" button alone typically will not cause an response on the Infrared Detector; but most other buttons will. To test infrared LEDs, bring the LED near the sensor and turn on and off the power source to your infrared LED. You should observe L1 flashing and BZ clicking at the rate you are turning the infrared LED on and off. If you just leave the power to the infrared LED on, L1 will stay on (will not flash), and BZ, the piezoelectric buzzer, will not click.

For longer range, place your infrared kit in a darkened room and set P1 fully counter-clockwise (L1 should be off in darkness). Now you can detect a good infrared controller from up to 10 feet away, and sometimes farther, depending on your remote control's output power.

Remember to remove the battery from the snap when you're not using the detector. Ω

SPACE-AGE SOUND MACHINE

MAY THE FORCE BE WITH YOU!

Part of what makes the *Star Wars* and *Star Trek* movies so exciting are the special effects and sound effects -- especially the ones used in the high-tech laser-type weapons. Now you can create similar effects at home with this easy-to-build Phasor Sound and Light project. Even beginners can build the device, which produces the type of sound you've seen in those space-age movies. It features a control that varies the frequency of the sound. You can use the Phasor Sound and Light in science projects or place it in models, robots, or toy phasor guns.

THEORY OF OPERATION

Our space-age sound device uses a 556 dual-timer IC to produce phasor sounds. That IC is

actually two 555 timer ICs in one 14-pin package, as shown in the schematic (Figure 1). Each timer inside the 556 is connected in an astable multivibrator mode.

The first timer has its frequency set by R1, R2, and C1. Its output appears on pin 5 and is coupled through C2 and R5 into the trigger input of the second timer. The second timer has an adjustable frequency controlled by P1, R6, and C3.

In the second timer, the first frequency mixes with the second frequency, producing the phasor-like sounds. The output of the second timer, which has the two signals mixed together, is brought from pin 9 through a limiting resistor R7 to the input of Q1. The function of that PNP germanium power transistor Q1 is to amplify

the signal to the level needed to drive the speaker. The green LED, L1, converts electrons directly into visible photons (light) in time with the pulses from the speaker. The purpose of resistor R8 is to limit the current through the LED to a safe level.

ASSEMBLY INSTRUCTIONS

1. Assemble the Phasor Sound and Light device according to the parts layout in Figure 2, the Parts List, and the schematic. Be sure to use only 60/40 rosin-core solder. If acid core solder is used, the device will be conducting voltage to various points where does not belong, and the kit will be destroyed.
2. Install capacitor C1 observing

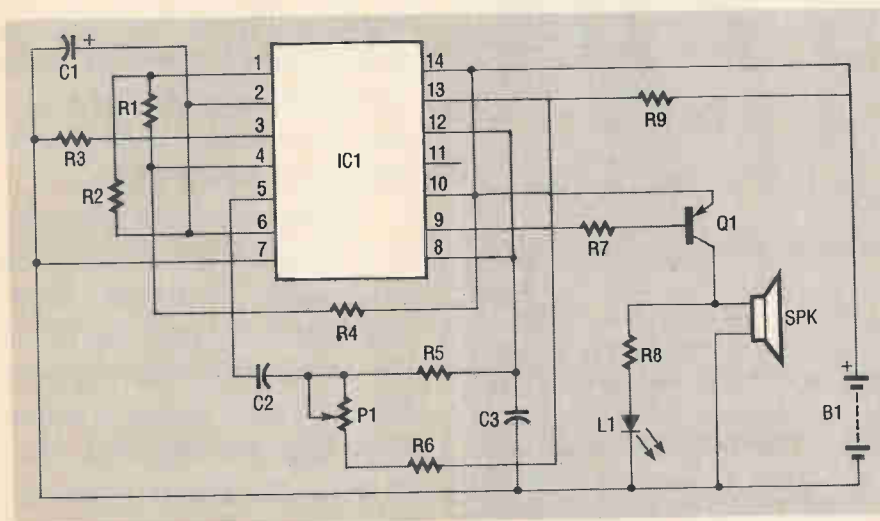

Figure 1. At the heart of the schematic for the Phasor Sound and Light device is IC1, a 14-pin, 556 dual-timer IC.

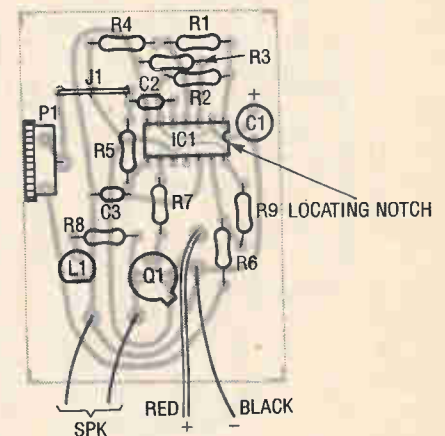

Figure 2. Follow this parts-placement diagram as you assemble the Phasor Sound and Light device, making sure to orient the IC locating notch in the direction shown.

- polarity as shown in Figure 2.
3. Install L1 with its flat side facing the direction shown, and install transistor Q1 with its tab (which indicates the emitter lead) in direction as shown.
 4. Next install all resistors. Check the color code (see page 52) and the parts-placement diagram for correct installation. Install disc capacitors C2 and C3.
 5. Now install jumper J1, using a piece of left-over wire lead (from a resistor or capacitor) at the location shown.
 6. Finally, install trimmer resistor P1, the speaker, the IC socket, and the battery snap. Observe polarity on the battery snap.
 7. After assembly, re-check all components for correct placement and good soldering techniques. Then install IC1 into the socket, observing the locating notch on the IC for correct orientation.

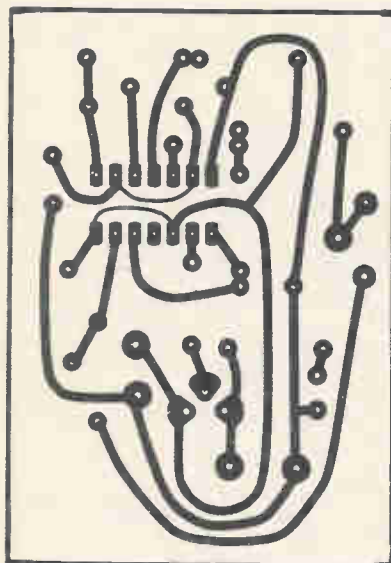
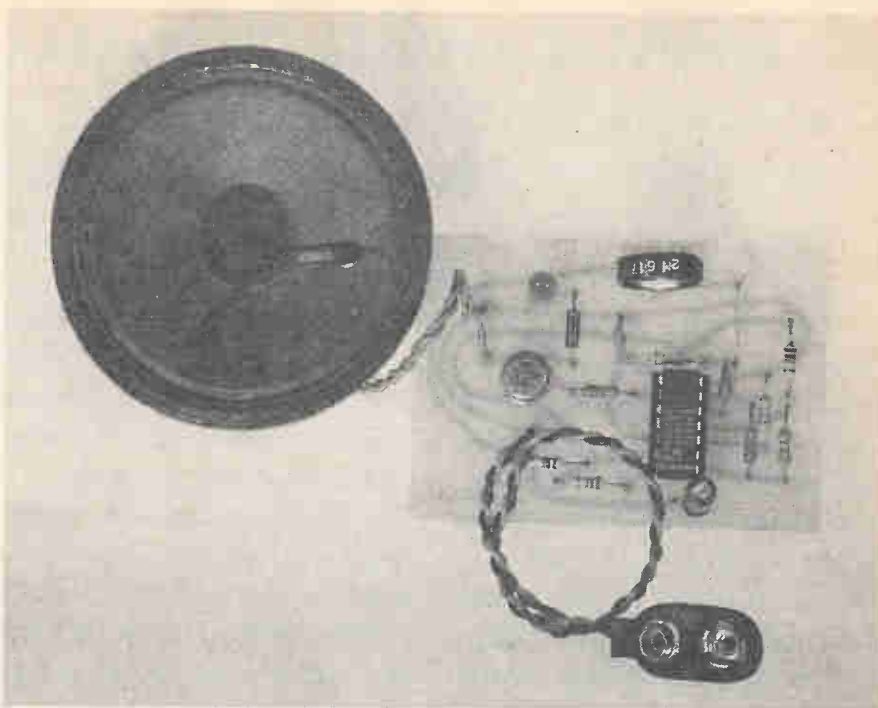

Figure 3. Experienced project builders might want to use this full-size foil pattern to etch their own printed-circuit boards.



The finished board, ready to be packaged in a futuristic "space weapon." We have to admit, it sounds better than it looks!

8. Connect a fresh 9-volt battery to the battery snap, and adjust the sound with resistor P1.

TROUBLESHOOTING HINTS

First of all, make sure that the solder used to build the kit was rosin-core solder. Check all the resistors against the color code and parts layout. Check the polarity of capacitor C1 against the parts layout.

Look for any solder bridges by comparing the foil pattern shown in Figure 3 to the actual foil of your PC board. Re-solder any connections that look as if they may be cold solder joints, adding just a little solder.

Make sure battery snap has been installed correctly and that your battery is in good shape. Check to make sure that the IC has been installed with its locating notch in the direction shown. If the LED is not lighting, check to make sure that its flat side is facing in the direction indicated on the parts-placement diagram. Ω

PARTS LIST

C1	1 μF Radial Electrolytic Capacitor
C2, C3	..	0.01 μF Disc Capacitor
IC1	556 Dual Timer IC
L1	Green LED
P1	2 Meg Trimmer Resistor
Q1	B714 PNP Transistor
R1	82K Resistor
R2, R5	..	33K Resistor
R3, R7	..	4.7K Resistor
R4, R6, R9	...	1K Resistor
R8	100 ohm Resistor
Spk	Small Speaker
Misc.	PC Board, 9-volt Snap, IC Socket, Insulated Wire

NOTE: A complete set of parts for the Phasor Sound and Light is available as kit C6406 for \$6.95 from The Electronic Goldmine, P.O. Box 5408, Scottsdale, AZ 85261. See page 96 for complete ordering information.

Light sequencers first became popular in advertising displays and then caught on for use in discos, on billboards, for special effects, at parties, and even as Christmas decorations.

You can make your own "chaser" displays with our 120-volt Light Sequencer. It controls ten outputs, each of which can light up to 200 watts of 120-volt AC lamps. Standard incandescent lightbulbs are used to create sequencing effects that are anything but standard. Customize your sequencing display by selecting the bulbs to use and by adjusting the speed of the sequencing. The effects are sure to be fabulous!

THEORY OF OPERATION

The schematic of the Light Sequencer is shown in Figure 1. It uses two IC's and 10 SCR's to create an AC sequencer. The first IC, a 555 timer IC, is used to provide clock pulses for IC2. The IC is configured as an astable multivibrator, and has its output on pin 3.

Capacitors C1 and C4, along with resistor R2, and potentiometer P1, control the frequency of the pulses. IC2 is a 4017 Johnson counter. With each incoming clock pulse on pin 14, the Johnson counter shifts a high signal level to each one of its ten output pins in sequence. Each output pin is resistively coupled to the gate lead on an SCR. When the respective output pin on the 4017 is high and the positive half of the AC cycle is on the anode lead of the SCR, it turns on. The lamp that is connected to its anode lights.

LIGHT SEQUENCER

CHASER LIGHTS CAN BRIGHTEN YOUR PARTIES AND YOUR CHRISTMAS DISPLAYS

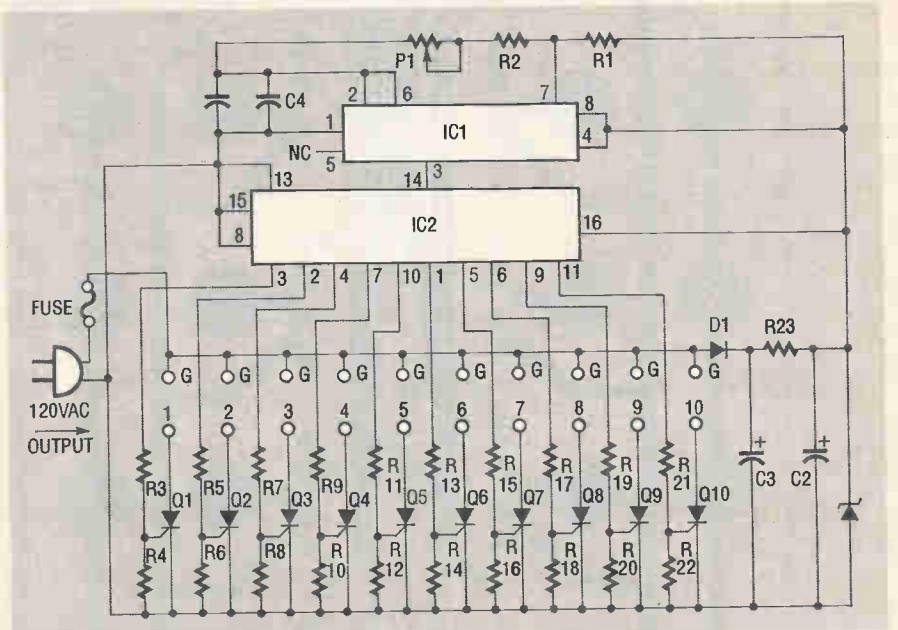

Figure 1. Two ICs and 10 SCRs provide the sequencing effect.

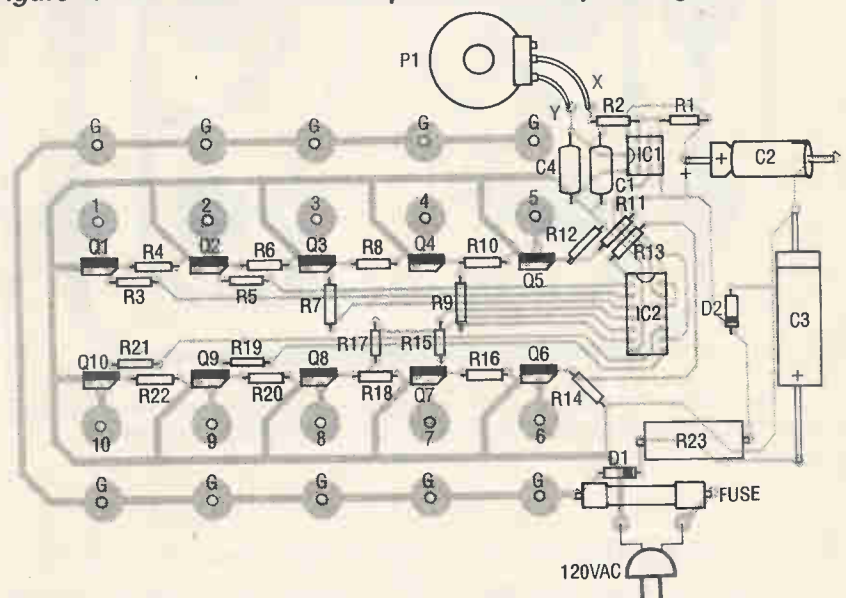

Figure 2. The Parts Layout. Be sure to use standard household light bulbs in your sequencer.

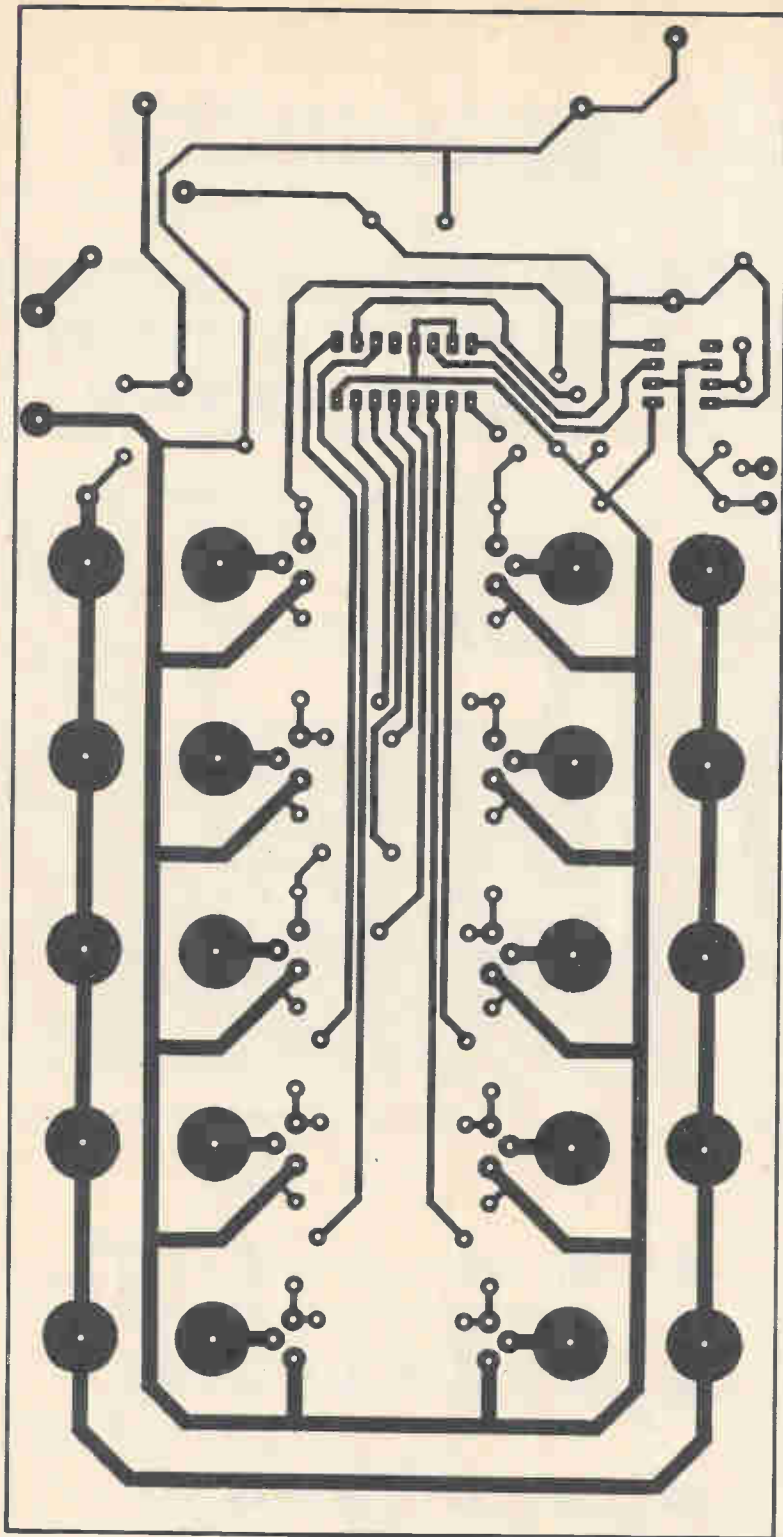

Figure 3. This is a full-sized foil pattern for the 120VAC Light Sequencer.

Power is brought into the PC board by the line cord, and the circuit is fuse-protected. Diode D1 changes the AC to pulsating,

which is smoothed by C2 and C3. R23 limits the current, while Zener diode D2 limits the DC voltage to 6VDC.

PARTS LIST

C1,C4 0.1 μ F Capacitor
C2 100 μ F Capacitor
C3 47 μ F, 350V Electrolytic Capacitor
D1 1N4007 Diode
D2 6V Zener (M747814)
IC1 555 Timer IC
IC2 4017 CMOS IC
P1 500K Potentiometer
Q1-Q10	.. 106 SCR
R1 560 ohm Resistor
R2,R4,R6, R8,R10,R12,R14, R16,R18	
R20,R22	100K Resistor
R3,R5,R7, R9,R11,R13, R15,R17,R19,	
R21 2.2K Resistor
R23 15K 7 watt Resistor
Misc. PC Board, Pigtail Fuse, AC Line Cord, IC Sockets

NOTE: A complete set of parts for the 120VAC Light Sequencer is available as kit C4725 for \$28.95 from The Electronic Goldmine, P.O. Box 5408, Scottsdale, AZ 85261. See page 96 for complete ordering information.

ASSEMBLY INSTRUCTIONS

1. Assemble the Light Sequencer according to the parts layout (Figure 2), Parts List, and schematic (Figure 1). Use only 60/40 rosin-core solder -- never use acid-core solder, which will destroy the project to a point beyond repair.
2. Install capacitors C2 and C3 observing their polarity. Install capacitors C1 and C4, whose polarity is not crucial. Observe the direction of the cathode bands when installing diode D1

and Zener diode D2. Install the IC sockets.

3. Install resistors R1 - R23 following the color code and the parts layout. Observe the IC locating marks when mounting IC1 and IC2 into the IC sockets. Wire the speed-adjust potentiometer, P1, as shown in Figure 2.
4. Observe the beveled edges when installing SCR's Q1 - Q10, making sure that the edge is placed as shown in the parts layout. Install pigtail fuse and the AC line cord on the PC board at the points shown on the parts layout.
5. Connect standard 120VAC lamps (your choice of wattage up to 200 watts) to each output pad. You can use any combination of lamps as long as the wattage does not exceed 200 watts. For instance, between G and 1, you might install one lamp or a set of

lamps. Again, make sure the total wattage of the lamps connected does not exceed 200 watts or the SCRs will be damaged! The only light bulbs that can be used in the Light Sequencer are standard incandescent bulbs. Those are resistive type bulbs without any transformers. In other words, use only the standard resistive type light bulbs intended for normal household use. Do not use fluorescent bulbs, transformer-driven bulbs, or strobe lights!

6. Plug the unit in and adjust speed control P1 to the desired speed. Note that on certain lower speed settings of the potentiometer the sequencer may "skip" an output. That does not indicate a malfunction in your Light Sequencer. Simply change the speed setting.
7. Remember to **be extremely cautious** when building and

using a device that connects to the AC line. **Never** use it outside or near water and always mount the entire kit inside a wooden or plastic (insulated) box to prevent any contact with the AC voltage.

TROUBLESHOOTING HINTS

If you experience any problems first make sure that you used only rosin-core solder to build the project. Then recheck the placement of all the resistors against the color code and the parts-placement diagram of Figure 2.

Next, examine your printed circuit board. Look for solder bridges by comparing the actual foil on your PC board to the foil pattern shown in Figure 3.

Check for cold solder joints and reheat, adding solder to any connections that don't have a nice, smooth, and shiny appearance.

Make sure that the two ICs have been installed with their locating marks facing the direction shown in the parts-placement diagram, and that you were careful when installing any polarized electrolytic capacitors. Also, make sure that the polarity (cathode band) on all diodes are in direction shown.

Check to make sure that all SCRs are mounted with beveled edge facing the direction shown on parts layout and in the photograph to the left.

Make sure that you have connected only resistive-type lamps to the output pins, and that the wires used to connect them are insulated and not touching ground or metal objects. Ω

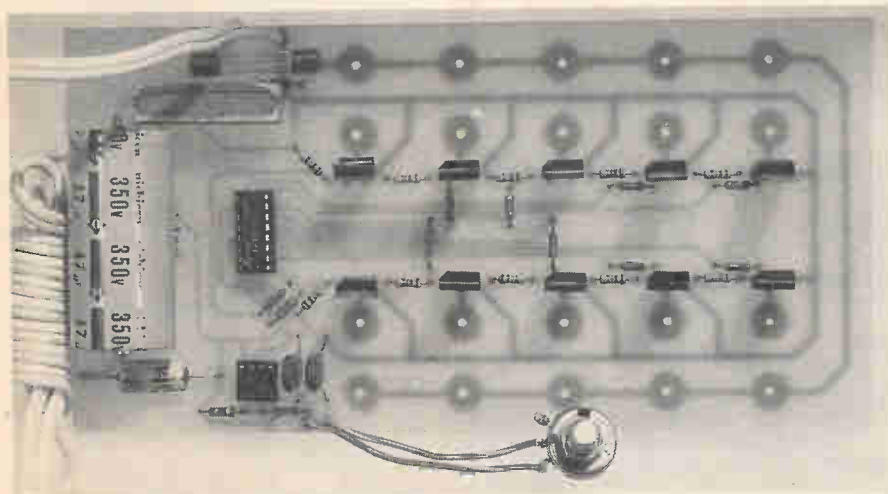

The completed board ready to drive the lights of your choice. For maximum flexibility, you might want to connect standard 120-volt AC chassis-mount sockets to the pads. After initial testing, you must install the board in an insulated enclosure to minimize the possibility of coming in contact with the AC voltage. You should also label the enclosure to indicate that only standard lamps should be connected to the outlet -- no strobes or other lights!

120VAC SHIMMERING LIGHT

SET AN EERIE ATMOSPHERE WITH BLINKING, SHIMMERING LIGHTS!

You can turn any ordinary household light bulb into one that shimmers or blinks with this easy, inexpensive project. Use it at

the line cord, it is full-wave rectified by diodes D1 and D2. That changes the AC to DC, and a portion of that DC voltage is

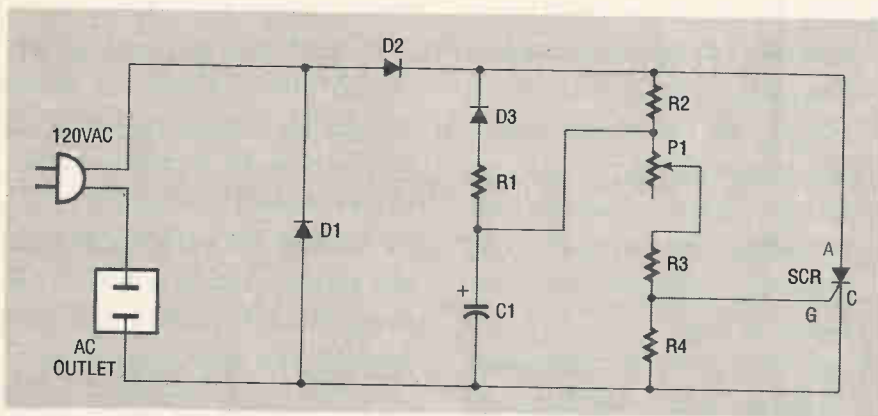

Figure 1. As you can see in the schematic, the Shimmering Light is an easy project to build.

parties instead of candlelight, or create eerie effects for Halloween parties or plays. Or just use it to learn about SCRs! It works on any incandescent light up to 200 watts, and runs on standard 120 volts AC.

Figure 1 shows the schematic for the Shimmering Light. The circuit uses a Silicon Controlled Rectifier (SCR) to cause an ordinary lamp to shimmer. Note that one side of the lamp is connected directly to 120VAC, and the other side of the lamp goes to the cathode of the SCR. As AC voltage is brought into the circuit through

PARTS LIST

C1	10 μ F, 100V Capacitor
D1 - D3		1N4004 Diode
P1	100K Potentiometer
R1, R3	..	2K Resistor
R2	18K Resistor
R4	1K Resistor
SCR	106 SCR
Misc.	Line Cord, AC Outlet, Wire, PC Board

NOTE: A complete set of parts for the Shimmering Light is available as kit C4737 for \$5.00 from The Electronic Goldmine, P.O. Box 5408, Scottsdale, AZ 85261. See page 96 for complete ordering information.

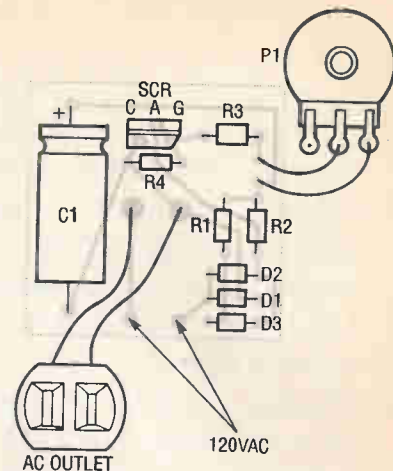

Figure 2. The Parts Placement Diagram illustrates the use of an SCR to make the lamp shimmer, and a potentiometer to adjust the shimmering effect.

applied to capacitor C1 through R2. Diode D3 blocks the (+) DC voltage, so that only the voltage from the path of R2 charges C1. With C1 having a (+) charge on it, the SCR fires, blinking the lamp and causing C1 to discharge through the path of R1 and D3. That forms an oscillator, which has a frequency determined by the setting of potentiometer P1 (since the other components have fixed values).

Remember to use **extreme caution** when using a device that connects to the AC line. **Never** use it outside or near water and always mount the entire kit inside a wooden or plastic (insulated) box to prevent any contact with the AC voltage.

ASSEMBLY INSTRUCTIONS

1. Follow the parts layout, and consult the Parts List and schematic as you build the Shimmering Light. Make sure

--continued on page 88

13.8VDC 2 AMP REGULATED POWER SUPPLY

If you service car accessories -- such as CB's, car stereos, and car tape decks -- or if you ever want to use those devices at home, then you'll be able to put this 13.8VDC 2 Amp Regulated Power Supply to use. This deluxe, heavy-duty regulated power supply transforms standard 120VAC to 13.8 volts DC, which is what your car's alternator outputs and what is generally used to power your 12-volt car accessories. The Regulated Power Supply features output regulation, fused input and output, a neon "on" indicator, a heavy-duty transformer, and high-capacitance filtering.

The Regulated Power Supply is designed for those who already have some kit-building experience. In particular, you should have a thorough understanding of AC safety precautions and be a skillful solderer before taking on this project.

THEORY OF OPERATION

As shown in Figure 1, the 13.8VDC 2 Amp Regulated Power Supply consists of step-down transformer T1, a full-wave rectifier bridge (D1 - D4), and a filtering regulator circuit made up of C1, C2, R1, R2, R3, D5, and Q1. When 120-volts AC is provided, the neon-lamp assembly L1 lights up, and transformer T1 changes 120-volts AC to about 28-volts AC. The rectifier bridge, D1 - D4, rectifies the AC into pulsating DC, which is then filtered by C1. Capacitor C1 acts as a storage capacitor. Zener diode

**USE YOUR 12-VOLT AUTOMOTIVE ACCESSORIES
IN YOUR HOME!**

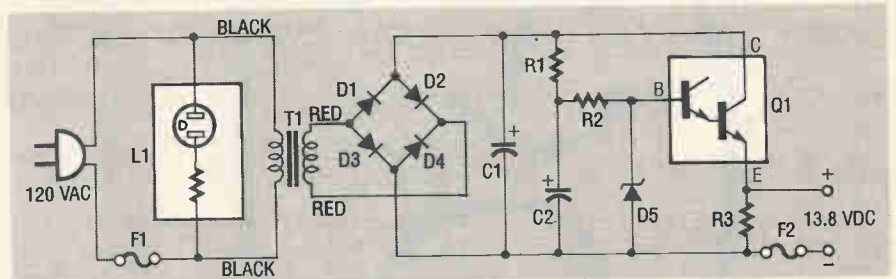

Figure 1. Regulated Power Supply . Although straightforward, this is not a project for complete beginners. Make sure to take proper precautions when using projects powered by 120-volts AC.

D5 keeps the voltage constant across the base of the Darlington regulator Q1, causing constant voltage across resistor R3 and the (+) and (-) output terminals where the load is connected. Fuse F2 is used to open ("blow"), if the

current through the output terminals is too high. That not only protects the power supply circuit, but also the circuit that you're powering with the supply. More important, it also helps to prevent a possible fire.

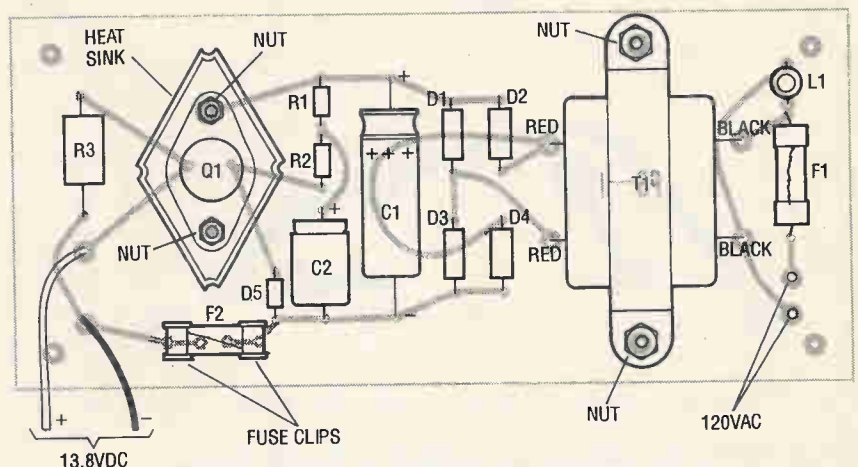

Figure 2. The parts-placement diagram. Be sure to orient all components exactly as shown.

ASSEMBLY INSTRUCTIONS

1. Carefully follow the parts-placement diagram (Figure 2), the Parts List, and the schematic as you assemble your Regulated Power Supply. Make sure to use only 60/40 rosin-core

PARTS LIST

C1	3300 μ F 35V Electrolytic Capacitor
C2	50 μ F 25V Electrolytic Capacitor
D1 - D4	..	HR050 3 Amp Rectifier
D5	1N4744 Zener Diode
F1	Pigtail Fuse
F2	2-1/2 Amp "Snap In" Fuse
L1	Neon Lamp Assembly
Q1	PMD12K40 Darlington Power Transistor
R1, R2	100 ohm 1/2 watt Resistor
R3	270 ohm 1 watt Resistor
T1	Power Transformer
Misc.	PC Board, Fuse Clips, Heat Sink, AC Line Cord, Screws, Nuts, Wire

NOTE: A complete set of parts for the 13.8VDC 2 Amp Regulated Power supply is available as kit C6381 for \$24.95 from The Electronic Goldmine, P.O. Box 5408, Scottsdale, AZ 85261. See page 96 for complete ordering information.

solder. If you use acid-core solder, your project will be ruined!

2. Observe polarity when mounting electrolytic capacitors C1 and C2. Install rectifiers D1 - D4 and Zener diode D5 observing direction

--continued on page 88

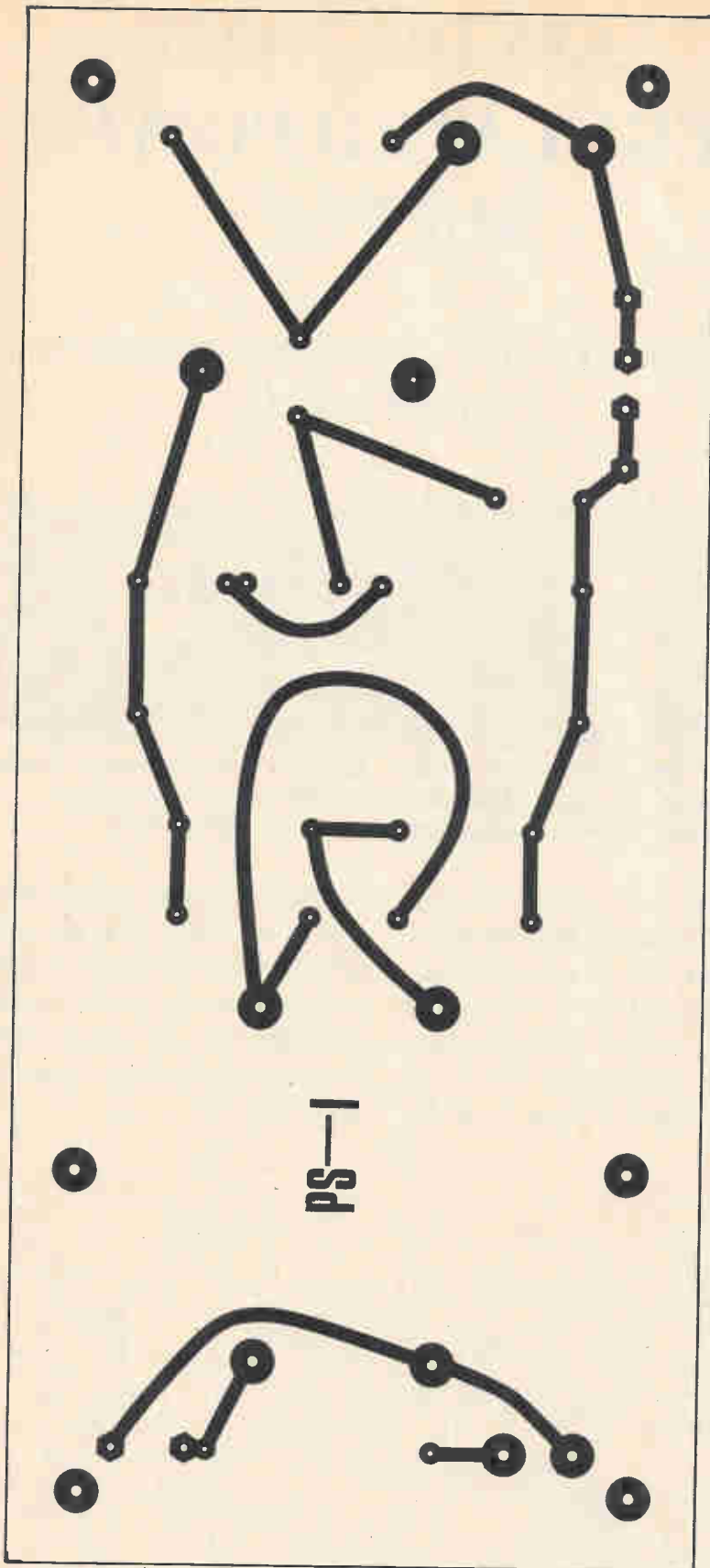

Figure 3. This is the full-size foil pattern of the PC Board.

PROXIMITY ALARM

THIS HANDY LITTLE DEVICE PROVIDES "HANDS-OFF" PROTECTION AT HOME OR WHEN YOU TRAVEL!

Working on the "body capacitance" principle, this Proximity Alarm actually senses human touch, and sets off a piercing tone as soon as it someone grasps the object under protection.

You can hang the Proximity Alarm around the inside of a motel-room doorknob before going to sleep, and if someone touches the outside doorknob, the alarm will go off instantly! Or use it around your bedroom doorknob to make sure that your younger siblings don't snoop around in there.

At the heart of the Proximity Alarm is a custom IC, which contains several oscillators and an amplifier. The schematic is shown in Figure 1. The low-frequency audio-signal oscillator is used to supply an input to the amplifier. That signal is the audio tone that is amplified, and then

supplied to the speaker by the amplifier.

The high-frequency oscillator is purposely set to be very unstable. It is dormant or "off" until the resistor-and-capacitor (RC) network is changed. The resistance (R) in this case is made up of R2 and P1. As the resistance of P1 is decreased, the unit becomes more sensitive (more unstable), and less capacitance (C) is needed to cause the oscillator to oscillate.

The capacitance required is provided by C2 and by any capacitance introduced via of the antenna loop. When you come near that loop, your inherent body capacitance causes the high-frequency oscillator to begin to oscillate, which then causes the low-frequency oscillator to be "switched on" internally. Once the alarm is sounding, the IC is designed so that it "latches" or

stays on until the power to it is switched off.

ASSEMBLY INSTRUCTIONS

1. Assemble the Proximity Alarm according to the parts-placement diagram (Figure 2) and the schematic. Make sure that you use only 60/40 rosin-core solder.
2. Observe the polarity when installing C1. Bend the tabs over on P1 before soldering it.
3. Do not plug IC1 into the IC socket until the socket has been soldered in. When installing IC1 into the socket, observe the IC locating mark (a dot on the lower left corner) and install the IC as shown in the parts-placement diagram.
4. After all components have been installed, it is necessary to connect the ground plate and the antenna. The ground plate should be connected by a three-foot-long piece of insulated wire. One end of the wire should be soldered to one side of the ground plate (either side works) and the other end of the wire should be connected to the appropriate location on the PC board, as shown on the parts layout. The antenna wire is more critical than the ground-plate wire. The antenna wire cannot exceed nine inches in total length. First, cut off a piece of insulated wire nine inches

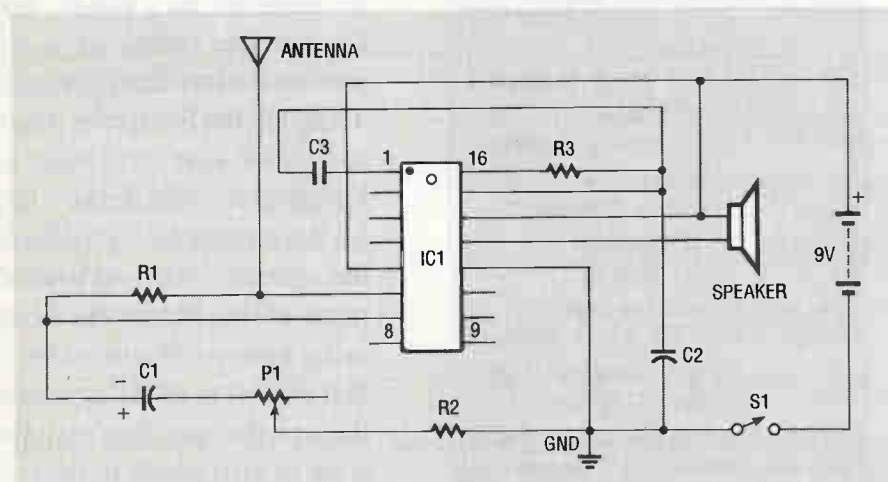

Figure 1. As shown in the schematic of the Proximity Alarm, pins 2 - 4 and 8 - 11 of IC1 have no connection, and are not used.

long. Next, twist both bare ends together. The antenna is now finished, and the bare wire end can be connected to the appropriate location on the PC board.

5. After the assembly is finished, recheck all parts for correct placement and good soldering. Make sure that there is no solder bridge where the IC socket has been soldered in.
6. To test your Proximity Alarm, set the PC board on a wooden table and move the ground plate approximately three feet away from the PC board. Set SPDT switch S1 to the "off" position, and rotate trimmer resistor P1 fully clockwise. Connect a fresh 9-volt battery to the snap, and slide S1 to the

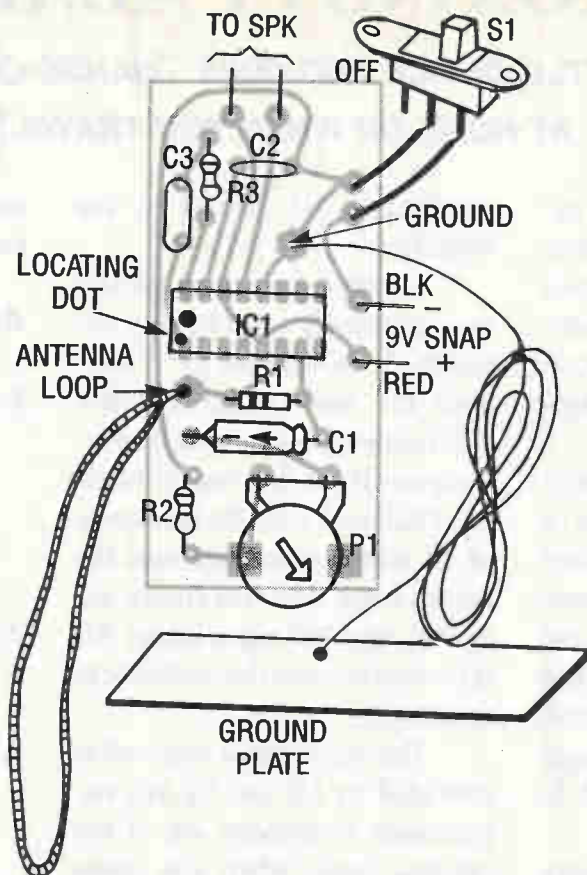

Figure 2. Parts Layout. Use a three-foot-long piece of insulated wire to connect the ground plate, and a wire no longer than nine inches for the antenna loop.

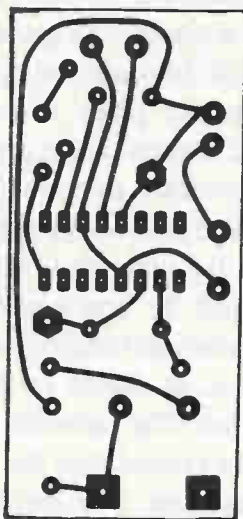

Figure 3. This is the full-sized foil pattern for the Proximity Alarm. You can use it to etch your own printed-circuit board.

PARTS LIST

C1	1 μ F Axial Capacitor
C2	27 pf Silver Mica Capacitor
C3	0.1 μ F Mylar Capacitor
IC1	CM1001N IC
P1	50K Trimmer Resistor
R1	75K Resistor
R2	200 ohm Resistor
R3	100K Resistor
S1	SPDT Switch
Spk	Small Speaker
Misc.	IC Socket, Battery Snap, Ground Plate, Wire, PC Board

NOTE: A complete set of parts for the Proximity Alarm is available as kit C6358 for \$14.00 from The Electronic Goldmine. See page 96 for information.

"on" position, being careful not to touch the antenna loop. At this point, the unit should be silent. If the unit is not silent, recheck that P1 is fully clockwise and turn S1 "off" and "on" again. With the unit silent and S1 in the "on" position, grasp the antenna loop with your hand (use your whole hand and not just your fingers). The unit should emit a loud tone, which can only be silenced by turning S1 to the "off" position. If the alarm did not sound, do the following: Grasp the antenna loop again or adjust P1 to a higher sensitivity position (counter-clockwise). If those procedures do not work, you have probably made an

assembly error, have a cold solder joint, or have a weak 9-volt battery.

7. After the alarm is tested, it can be mounted in a plastic box. Do not use metal, as it will prevent the unit from operating. To install the Proximity Alarm in a plastic case, drill holes for the speaker. Also, make a hole for the lever of S1 and holes for the antenna-loop and ground-plate wires. Mount the board using a piece of foam rubber so that the lever of S1 protrudes through the case. You may also want to drill a hole in the case so that P1 can be adjusted by a screwdriver.

Make sure that trimmer resistor P1 is not adjusted too high or the unit will not reset. Make sure that only a nine-inch wire is used for the antenna. Then you're ready to use it!

USING THE PROXIMITY ALARM

Simply hang the proximity alarm on the inside of any door-knob (wood doors only) and turn S1 to the "on" position. When anyone grasps the outside knob assembly, the alarm should sound. NOTE: Make sure that the ground plate is resting on the floor.

If your application is to protect other objects or to detect a person walking up to an area, a straight piece of wire with a test clip can be installed in place of the antenna loop. You can experiment with attaching the clip to different objects or metal plates to detect people. We have not provided additional information on this, because you must experiment with different settings of P1 and different ground plate locations to use your unit in this manner. NOTE: It is entirely possible that the inherent capacitance of many objects that are connected to the antenna clip in this mode will be so high that the alarm will sound at all settings of P1 and never be silent. The inherent capacitance must be considered, and it does not indicate a defective alarm. The correct test of the alarm is provided in step 6 of the Assembly Instructions. All other applications require experimentation on your part to determine the limitations and abilities of the Proximity Alarm. Ω

Popular Electronics REPRINT BOOKSTORE

- | | |
|--|--|
| <input type="checkbox"/> 221 Popular Electronics (1991 back issues) \$4.00
Write in issues desired _____ | <input type="checkbox"/> 107 Radio-Electronics (1987 back issues) . \$5.25
Write in issues desired _____ |
| <input type="checkbox"/> 220 Popular Electronics (1990 back issues) \$4.50
Write in issues desired _____ | <input type="checkbox"/> 106 Radio-Electronics (1986 back issues) . \$5.50
Write in issues desired _____ |
| <input type="checkbox"/> 119 Popular Electronics (1989 back issues) \$4.75
Write in issues desired _____ | |
| <input type="checkbox"/> 118 Hands-On Electronics (1988 back issues) \$5.00
Write in issues desired _____ | REPRINTS REPRINTS |
| <input type="checkbox"/> 117 Hands-On Electronics (1987 back issues) \$5.25
Write in issues desired _____ | <input type="checkbox"/> 169 Think Tank (133 Circuits) \$3.50 |
| <input type="checkbox"/> 116 Hands-On Electronics (1986 back issues) \$5.50
Write in issues desired _____ | <input type="checkbox"/> 169A Think Tank Vol. 2 \$3.00 |
| <input type="checkbox"/> EH91 Experimenters Handbook (1991) . . . \$4.50 | <input type="checkbox"/> 168 Fact Cards (#34-66) . . . \$4.00 |
| <input type="checkbox"/> EH90 Experimenters Handbook (1990) . . . \$5.00 | <input type="checkbox"/> 168C Fact Cards (#67-99) . . . \$3.50 |
| <input type="checkbox"/> EH88 Experimenters Handbook (1988-89) \$5.50 | <input type="checkbox"/> 168D Fact Cards (#100-132) . . . \$3.50 |
| <input type="checkbox"/> EH87 Experimenters Handbook (1987) . . . \$6.00 | <input type="checkbox"/> 167 Designing With IC's \$4.00 |
| <input type="checkbox"/> HH91 Popular Electronics Hobbyist Handbook (1991) . . . \$5.00 | <input type="checkbox"/> 166 Collected Works of Mohammed Ulyses Fips (62 pages, April Fools Collection) . . . \$5.00 |
| <input type="checkbox"/> HH90 Popular Electronics Hobbyist Handbook (1990) . . . \$5.50 | <input type="checkbox"/> 165 How to Repair CD Disc Players \$5.00 |
| <input type="checkbox"/> HH89 Popular Electronics Hobbyist Handbook (1989) . . . \$6.00 | <input type="checkbox"/> 164 Modern Electrics (April 1908) . . . \$3.00 |
| <input type="checkbox"/> 126 Radio-Electronics Annual 1986 \$6.00 | <input type="checkbox"/> 163 Receiving Satellite TV \$5.00 |
| <input type="checkbox"/> 211 Radio-Electronics (1991 back issues) . \$4.00
Write in issues desired _____ | <input type="checkbox"/> 162 Build Your Own Satellite TV Receiver \$5.00 |
| <input type="checkbox"/> 210 Radio-Electronics (1990 back issues) . \$4.50
Write in issues desired _____ | <input type="checkbox"/> 161 Descrambling (Feb. 1984) . . . \$3.00 |
| <input type="checkbox"/> 109 Radio-Electronics (1989 back issues) . \$4.75
Write in issues desired _____ | <input type="checkbox"/> 160 New Ideas - 42 Circuits \$3.50 |
| <input type="checkbox"/> 108 Radio-Electronics (1988 back issues) . \$5.00
Write in issues desired _____ | <input type="checkbox"/> 159 Low Frequency Receiving Techniques
Building and using VLF Antennas . . . \$5.00 |
| | <input type="checkbox"/> 158 Electro Importing Co. Catalog (Circa 1918) . . . \$5.95 |
| | <input type="checkbox"/> 157 All About Kits \$2.00 |
| | <input type="checkbox"/> 156 How To Make PC Boards \$2.00 |
| | <input type="checkbox"/> 155 IBM Typewriter To Computer \$2.00 |
| | <input type="checkbox"/> 154 How To Repair VCR's \$3.50 |
| | <input type="checkbox"/> 150 Pay TV Decoder (1981) \$3.00 |

To order any of the items indicated above, check off the ones you want. Complete the order form below, include your payment, check or money order (DO NOT SEND CASH), and mail to Popular Electronics, Reprint Department, P.O. Box 4079, Farmingdale, NY 11735. Please allow 4-6 weeks for delivery.

If you need a copy of an article that is in an issue we indicate is unavailable you can order it directly from us. We charge 50¢ per page. Indicate the issue (month & year), pages and article desired. Include payment in full, plus shipping and handling charge. Make checks payable to Gernsback Publications, Inc.

ARTICLE _____		
PAGES _____	MONTH _____	YEAR _____
TOTAL PAGES _____	@50¢ each	TOTAL PRICE _____

MAIL TO: Popular Electronics
Reprint Bookstore, P.O. Box 4079, Farmingdale NY 11735

All payments must be in U.S. funds

SHIPPING CHARGES IN USA & CANADA		
\$0.01 to \$5.00	\$1.25	\$30.01 to 40.00 . . . \$5.00
\$5.01 to \$10.00	\$2.00	\$40.01 to 50.00 . . . \$6.00
\$10.01 to 20.00	\$3.00	\$50.01 and above . . . \$7.50
\$20.01 to 30.00	\$4.00	

Total price of merchandise \$ _____

Sales Tax (New York State Residents only) \$ _____

Shipping Charge (see chart) \$ _____

Name _____ Total Enclosed \$ _____

Address _____

City _____ State _____ Zip _____

HB91

Shimmering Light
Continued from page 82

to use only 60/40 rosin-core solder.

2. Observe the beveled edge for the correct installation of the SCR. Install D1 - D3 according to the direction of cathode bands. Observe polarity on C1 when installing. Check the proper orientation on the parts-placement diagram shown in Figure 2.
3. After assembly, carefully plug the lamp of your choice (up to

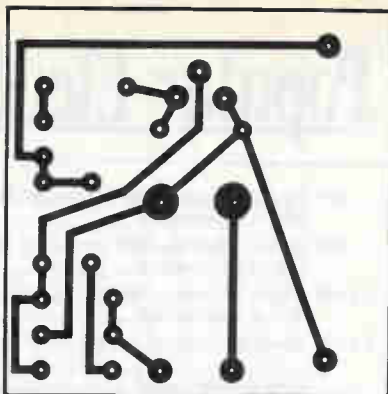
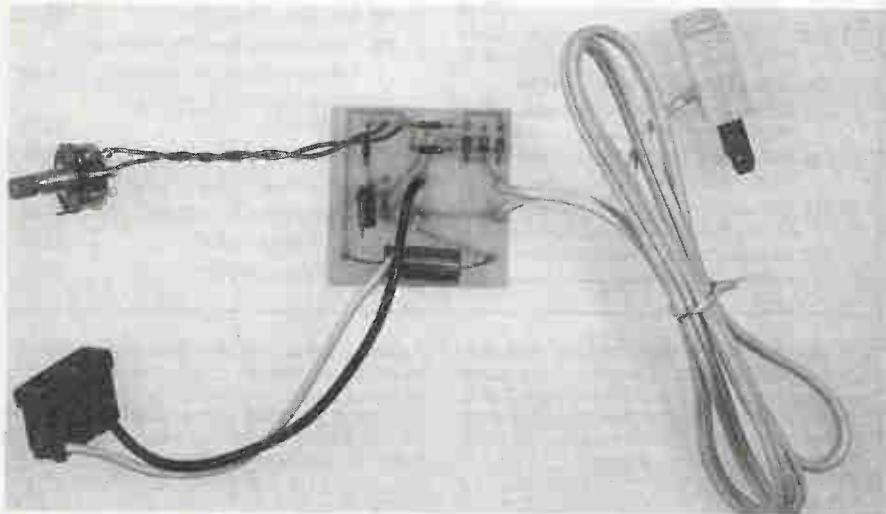

Figure 3. You can use this full-size foil pattern to etch your own PC board for the Shimmering Light.

Next, check all resistors against the parts layout shown in Figure 2. Make sure that all the diodes have cathode bands ori-



200 watts) in AC outlet, and then plug the Shimmering Light device into AC. Adjust P1 for desired blinking or shimmering effect.

4. **CAUTION:** Because this unit operates from 120VAC, use extreme care when using, and mount it in a plastic or wooden box.

TROUBLESHOOTING HINTS

First of all, make sure that the solder used to build the kit was rosin-core.

ented in the direction shown.

Make sure that C1 has been installed with polarity as shown, and that the SCR's beveled edge is facing direction shown on the parts layout.

Check for cold solder joints and reheat them, adding solder to any suspect connections.

Make sure that your lamp switch has been turned on and make sure that only incandescent lamps, less than 200 watts rating, are connected to the outlet (fluorescent types will not work). Ω

Power Supply
Continued from 84.

of cathode bands, as shown on the parts layout.

3. Mount power transformer T1 on the PC board using screws and nuts. Solder black leads and red leads to locations shown in Figure 2.
4. Install all resistors according to the color code and the parts layout. Install the fuse clips and the indicator lamp assembly L1. Solder in pigtail fuse F1. After the fuse clips have been installed, snap fuse F2 into the clips.
5. Lay the heat sink over the holes on the PC board and then insert the leads of power transistor Q1 through the heat sink and the PC board. Now use screws and nuts to mount Q1 and the heat sink. After tightening the nuts, solder the base and emitter leads of Q1 to the PC board. Finally, solder the AC line cord to the PC board as shown.
6. After assembly, recheck all components for correct placement and good soldering. Make sure that the PC board is on a wood or other insulated surface and plug in the AC cord. The red lamp L1 should light up. Use a voltmeter to measure the output. It should indicate 13.8-volts DC. If the unit tests okay, mount the entire kit inside a wooden or plastic (insulated) box. Remember to **use extreme caution when using a project that connects to the AC line. NEVER use it outside or near water.** Ω

POOR MAN'S LIE DETECTOR

**GET TO THE TRUTH OF
THE MATTER WITH THIS
FUN CIRCUIT**

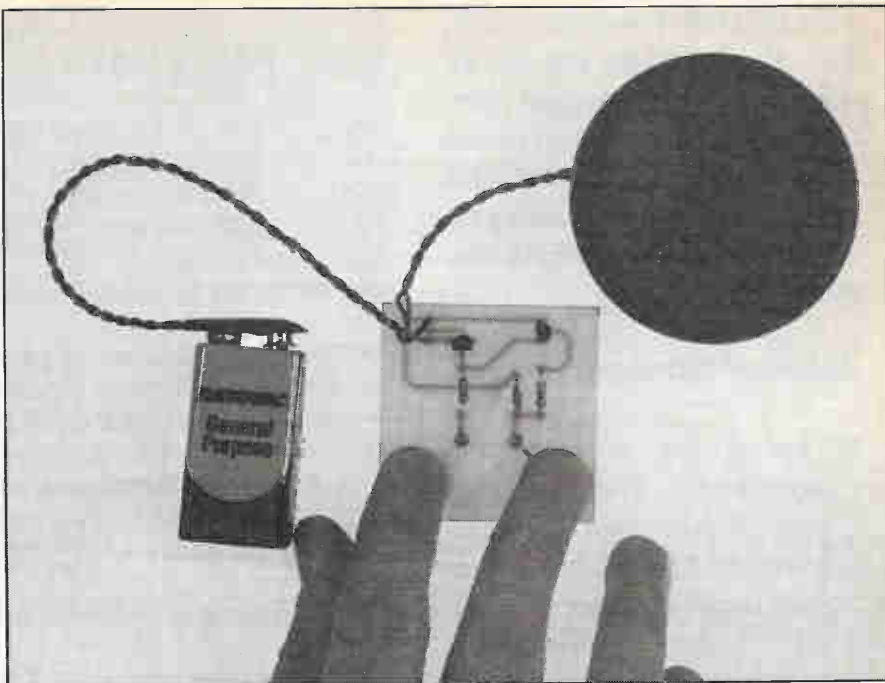

We don't put much faith in lie-detector (or polygraph) tests, simply because lie detectors don't always work. The underlying theory is that lying can produce measurable changes in bodily functions. For example, your heart rate will often increase, your body temperature may go up, and you may start to sweat a little. (Any sort of test seems to have that effect on us!) "Professional" liars have found ways to beat polygraph tests by learning how to control how their body reacts.

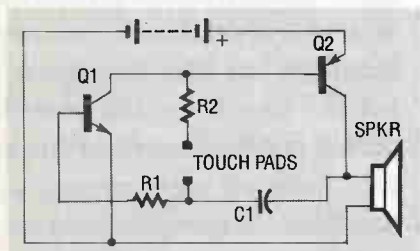

Figure 1. The "Poor Man's Lie Detector" is a simple circuit that sounds a tone that depends on the resistance across the touch pads.

This "Poor Man's Lie Detector" isn't meant to be able to sniff out the liars among you. But it can be a great source of fun for party games and the like. It produces a tone that varies in pitch depending on skin resistance, one of the factors that is assumed to change when you lie.

THEORY OF OPERATION

The circuit, whose schematic is shown in Figure 1, uses a two-transistor direct-coupled oscillator that has a frequency determined by C1, R2, and the (skin) resistance across the touch pads. Since C1 and R2 are fixed values, only the skin resistance across the touch pads can vary the sound of the oscillator. To sustain oscillations, C1 feeds a portion of the output from Q2 back to the input of Q1 through resistor R1.

Transistor Q1 is an NPN type and transistor Q2 is a PNP type. The output of Q2 is fed into a

small speaker. The kit relies on the fact that the human skin conducts electricity. Actually, it is not a great conductor, but it conducts well enough that at high voltage we can receive dangerous shocks.

The Skin Resistance Monitor operates from low voltage (9

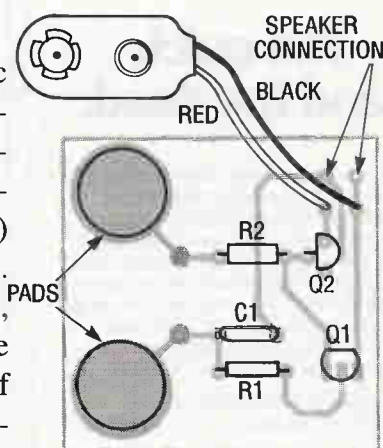

Figure 2. The parts-placement diagram shows just how easy this circuit is to build. Make sure you connect the pads to the other side of the board by using short cut resistor leads.

volts DC) and is completely safe. The other principle that the kit relies on is that as you get nervous, you perspire, which causes salt to be added to your skin. This lowers the resistance, causing the monitor to produce a higher frequency tone.

ASSEMBLY INSTRUCTIONS

1. Install the resistors and capacitor C1. Then install Q1 and Q2 with their flat sides going in direction shown on parts layout in Figure 2. Install all other remaining components. Connect the touch pads on top of the board to the bottom of board (through the solder pads) using pieces of

PARTS LIST

C1 0.01 μ F Capacitor (103)
 Q1 2N3904 Transistor
 Q2 2N3906 Transistor
 R1 4.7K Resistor
 R2 82K Resistor
 Misc. PC Board, Speaker, 9V Snap, Wire

NOTE: A complete set of parts for the Skin Resistance Monitor is available as kit C4657 for \$6.50 from The Electronic Goldmine, P.O. Box 5408, Scottsdale, AZ 85261. See page 96 for complete ordering information.

left-over wire leads from resistors. Be sure to solder on both sides of the board!

2. After connecting a fresh 9-volt battery, rest your index and adjacent finger on the pads (one on each pad). A tone should be heard. Now, moisten your fingers and touch the pads -- a very high-pitched tone will be heard. This will give you an idea of the unit's range.

TROUBLESHOOTING HINTS

Since the majority of problems that kit builders have is due to poor soldering, go back and check your work. Make sure you have no cold solder joints, and that you created no solder bridges. Use the foil pattern in Figure 3 as you look for solder bridges.

If your soldering checks out OK, check all the resistors for correct installation. Double check to make sure Q1 and Q2 are the correct types, and have their flat sides facing the direction shown on parts layout. Also check the

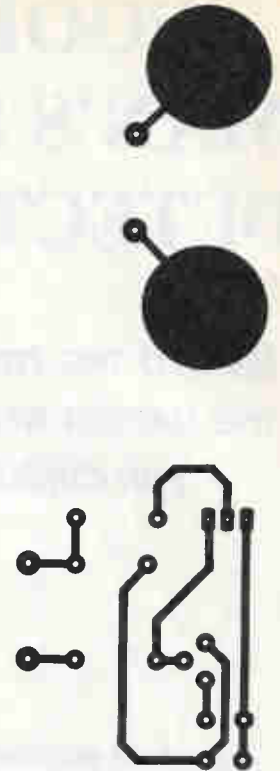

Figure 3. Foil Pattern of PC Boards. Note that this is a double-sided board.

battery connector, and the battery itself. Make sure that touch pads have wire jumpers connecting the top side pads to the bottom of the PC board.

USING THE "LIE DETECTOR"

When you get everything up and running, it's time to have fun. In actual operation, do not have the subject moisten his fingers as you did for testing. Just have the person rest his fingers on the pad at a constant pressure and ask questions, or compare your relative skin resistance to his. As one becomes nervous, the skin resistance will decrease, causing the frequency of the tone to go higher. Now, what questions are you going to ask? Ω

There are two kinds of heart attack victims.

The quick and the dead.

When you're having a heart attack, getting to the hospital quickly can mean the difference between life and death. If you feel the symptoms, don't take chances—get to the hospital. New life-saving therapies are now available. But they have to be given early. For more information write us at: American Heart Association, 7320 Greenville Avenue, Box 14, Dallas, TX 75231.

You can help prevent heart disease. We can tell you how.

American Heart Association

This space provided as a public service.

Kit-Building Tips Continued from page 53

Be sure to pay attention to the skill level for each project, as indicated in the table of contents. Skill level 1 means that a project is suitable for complete begin-

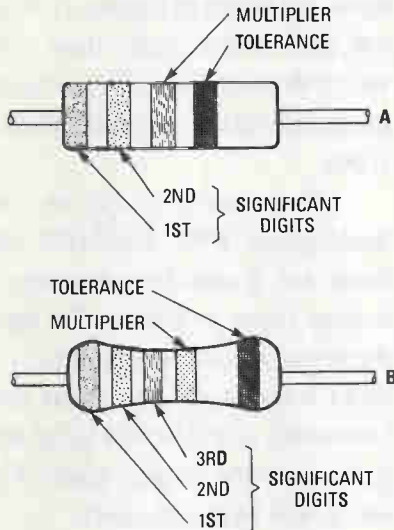

Figure 5. The arrangement of bands on both a regular (A) and a high-precision (B) resistor body. The precision resistor has more digits to specify its value more accurately.

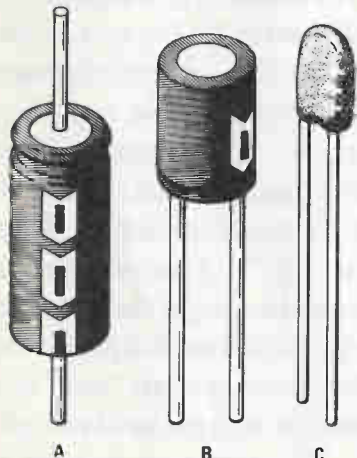

Figure 6. Polarized capacitors have their polarity clearly marked. Shown are axial-lead (A), radial-lead (B), and tantalum (C) types.

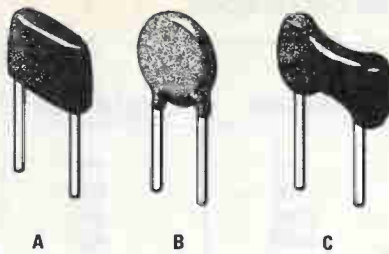

Figure 7. Some popular non-polarized capacitors include epoxy-dipped (A), disc (B), and metal-film (C) types.

ners with no previous knowledge of electronics or kit-building experience. Projects labeled skill level 2 are aimed at those who have built kits before, know how to solder well, and know AC safety precautions. If a kit is labeled skill level 3, don't try to build it unless you've built several kits before, can solder perfectly, and understand the basic AC safety precautions. By building the kits that are within your level of ex-

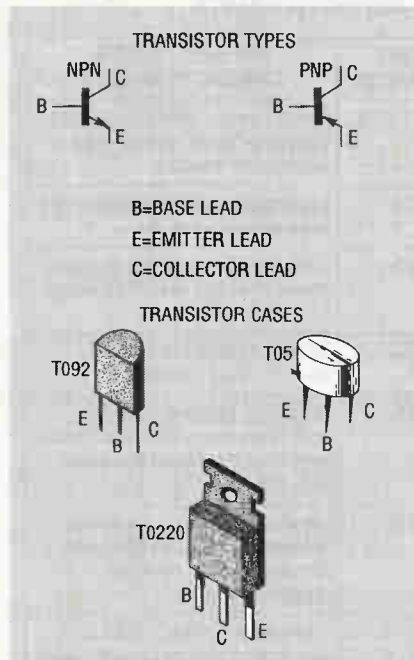

Figure 8. Different transistor types. Be careful when installing these -- it's easy to get them backward!

SPECIAL FROM ETT

□ **PCP101—PRACTICAL DIGITAL ELECTRONICS HANDBOOK ... \$9.95.** Introduces digital circuits, logic gates, bistables and timers, as well as microprocessors, memory and input/output devices. Special section on digital test gear projects.



□ **PCP102—INTRODUCING DIGITAL AUDIO ... \$9.95** Shows what is involved in the digital part of audio signals, particularly in the newest devices such as CD, DAT and sampling. Bridges the gap of understanding for the technician and enthusiast.

□ **PCP103—PRACTICAL MIDI HANDBOOK ... \$9.95.** Covers all MIDI based equipment you can use—keyboards, drum machines, sequencers, effects units, mixers, drum pads and guitars. Also a section on computer music that covers software and more.



□ **PCP104—ELECTRONICS BUILD & LEARN, Second Edition ... \$9.95.** You start by assembling a circuit demonstrator that is then used to build and investigate a variety of useful circuits including oscillators, multi-vibrators, bistables and logic circuits.

□ **PCP105—MAKE MONEY FROM HOME RECORDING ... \$10.00.** Now that you've spent all that money on all that recording gear, wouldn't it be nice to get some of it back? Well here's the book that can show you how.



□ **PCP106—SYNTHESIZERS FOR MUSICIANS ... \$10.00.** All current popular forms of synthesis explained; LA, additive, phase distortion, FM and sampling. Get the sounds you want from your synth. Written especially for musicians.

MAIL TO: Electronic Technology Today, Inc.
P.O. Box 240
Massapequa Park, NY 11762-0240

SHIPPING CHARGES IN USA AND CANADA

\$0.01 to \$5.00	\$1.25	\$30.01 to \$40.00	\$5.00
\$5.01 to 10.00	\$2.00	\$40.01 to \$50.00	\$6.00
\$10.01 to \$20.00	\$3.00	\$50.01 and above	\$7.50
\$20.01 to \$30.00	\$4.00		

SORRY, No orders accepted outside of USA and Canada

Total price of merchandise	\$	
Shipping (see chart)	\$	
Subtotal	\$	
Sales Tax (NYS only)	\$	
Total Enclosed	\$	

Name _____
Address _____
City _____ State _____ Zip _____

TABLE 1—THE RESISTOR COLOR CODE

COLOR	SIGNIFICANT FIGURE VALUES	MULTIPLIER	TOLERANCE
BLACK	0	1	—
BROWN	1	10	1%
RED	2	100	2%
ORANGE	3	1000	3%
YELLOW	4	10000	4%
GREEN	5	100000	—
BLUE	6	1000000	—
VIOLET	7	—	—
GREY	8	—	—
WHITE	9	—	—
SILVER	—	0.01	10%
GOLD	—	0.1	5%

pertise, you won't get frustrated and, more important, you will be gaining the experience and skills needed to go on to more difficult projects.

IDENTIFYING PARTS

One of the best things about building electronic projects is that you are always learning. However, if you've never built any-

thing before, that learning process can be difficult. That is, if you don't have people like us showing you the basic tips and tricks.

Being able to identify components is one of the first skills you should try to hone. Let's start with resistors. Figure 5 shows typical fixed resistors. Notice how resistors have bands of color around them that tell you their values and tolerance. Table 1 gives

TABLE 2—CAPACITOR CHARACTERISTICS

TYPE	TYPICAL VALUE RANGE	TYPICAL TOLERANCE	APPLICATIONS & CHARACTERISTICS
Aluminum Electrolytic	0.68—200,000 μ F	- 10%— + 75%	Power-supply filtering, bypass, coupling. Used where large values are needed.
Tantalum Electrolytic	.001—1000 μ F	5—20%	Bypass, coupling, decoupling. Very stable, long life
Ceramic	1pF—2.2 μ F	5—30%	Transient decoupling, bypass. Value changes with frequency and temperature.
Mica	1pF—1 μ F	1—30%	Timing, Oscillator, and AF circuits. Very stable.
Polypropylene	1pF—10 μ F	2—10%	Blocking, bypass, coupling, and timing circuits. Filter, noise suppression. Good for audio through UHF
Polyester (Mylar)	.001—10 μ F	5—20%	Blocking, filtering, transient suppression. Good for audio. Small size with medium stability.
Paper	.001—10 μ F	10—20%	General purpose. Large size, low cost, medium stability, and poor moisture characteristics.
Polystyrene	51pF—0.15 μ F	1—5%	Timing and tuned circuits. Small capacitance change with temperature. Excellent stability. Good in audio circuits.

the definition of what those colored bands mean.

Capacitors come in a variety of shapes and sizes. Higher-value capacitors are polarized, meaning that they can be hooked up in only one direction. Figure 6 shows some typical polarized capacitors.

Non-polarized capacitors also come in a variety of packages, as shown in Figure 7. There are even more types than what we've shown! Table 2 gives some more details on various capacitor types.

Transistors come in two basic types: PNP and NPN. But there are a dazzling number of device types available. To build the projects in this magazine, you don't have to worry about that. However, you do have to be able to identify the correct leads. Figure 8 will help you there.

The most complex devices used in the projects you'll build here are ICs or integrated circuits. However, they are the easiest to use!

It's important to realize that if you install an IC backward, you will destroy it! It's easy to identify the IC's correct orientation. Pin 1 is marked in one of two ways -- and sometimes both! Sometimes, a notch at one end of the IC indicates that pin 1 is at the "top left." (That assumes that you are looking at the IC from the top, with the notch at the far end.) Other times, a small "dot" or indentation by a pin indicates pin 1.

The best way to learn the basics of electronic construction and circuit operation is to get busy. Get out your soldering iron and start building these projects! Ω

“Every thing old is new again,” according to the old song, and that’s certainly true in the 1990’s for 1960’s memorabilia. If you’ve come across

some 60’s-style psychedelic posters, you’ll need a black light to appreciate them fully.

This Battery-Operated Black Light comes in handy for more than just looking at old Grateful Dead posters. You can use it to find fluorescent minerals, detect insects that glow under black lights, and read “invisible” fluorescent inks. The Battery-Operated Black Light is so easy to build that you’ll have plenty of free time left to create your own psychedelic artwork, using fluorescent paints.

THEORY OF OPERATION

The Battery-Operated Black Light uses a “U”-shaped, unfiltered, black-light tube, which requires approximately 250VAC to operate. The glow from the tube is a light-purple color, not the darker purple glow that you see from filtered black-light tubes. The light-purple glow that is emitted will cause invisible fluorescent inks to glow brightly, fluorescent minerals to glow, and some insects (such as scorpions) to glow.

BATTERY-OPERATED BLACK LIGHT

THIS PROJECT DESERVES “GLOWING” PRAISE!

To create the 250 volts AC from a 6-volt battery (from which the kit operates), the circuit uses a one-transistor blocking oscillator that drives a ferrite inverter transformer, as shown in the schematic in Figure 1. The simple circuit illustrated in this schematic is all that’s needed to build the Battery-Operated Black Light.

A blocking oscillator is one that turns itself off after one or more cycles. In this circuit, it consists of C1, P1, Q1, R1, and T1. The oscillations are sustained because the base of Q1 is connected to one of the windings on T1.

Transformer T1 is a step-up

fed to T1, which, because of its large turns ratio, converts the low-voltage signal into a high-voltage alternating current, which is coupled through resistor R2 to the black-light tube. Resistor R1 and trimmer resistor P1 limit the current flowing through the circuit.

As the control on P1 is rotated, more current flows in the circuit, producing a brighter light output. Of course, the more current that flows, the faster the battery will wear out.

ASSEMBLY INSTRUCTIONS

1. Assemble the Battery-Operated Black Light following the schematic and the parts placement diagram in Figure 2. Before you start, carefully read the Parts List to be sure you have on hand all the parts you’ll need. Be sure to use only 60/40 rosin-core solder.
2. Connect bare wires tightly around black-light tube FTB at the places shown and solder it. (The purpose of those wires is to hold the tube firmly in place -- they are not part of the circuit). Next,

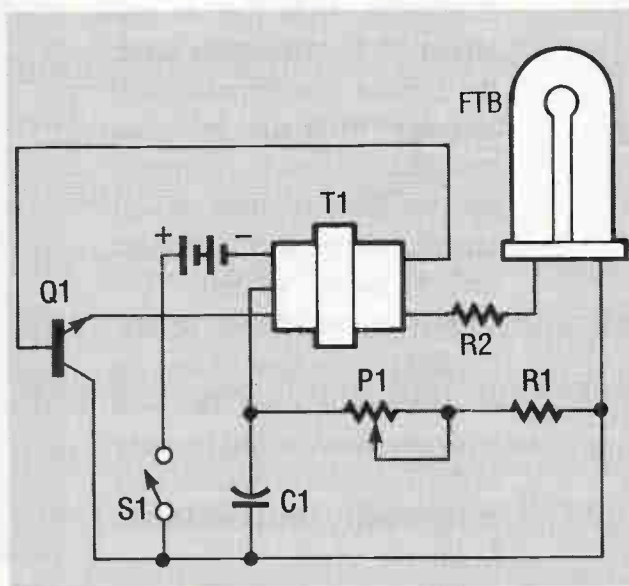

Figure 1. The simple circuit illustrated in this schematic is all that’s needed to build the Battery-Operated Black Light.

PARTS LIST

C1	1 μ F Electrolytic Capacitor
FTB	FTB8T6 Black-light Tube
P1	2.5K Trimmer Resistor (252C)
Q1	C1740 SW Transistor
R1	330 ohm Resistor
R2	1K Resistor
S1	Slide Switch
T1	Inverter Transformer
Misc.	PC Board, Wire, Bare Wire

NOTE: A complete set of parts for the Battery-Operated Black Light is available as kit C6356 for \$13.95 from The Electronic Goldmine. See page 96 for complete ordering information.

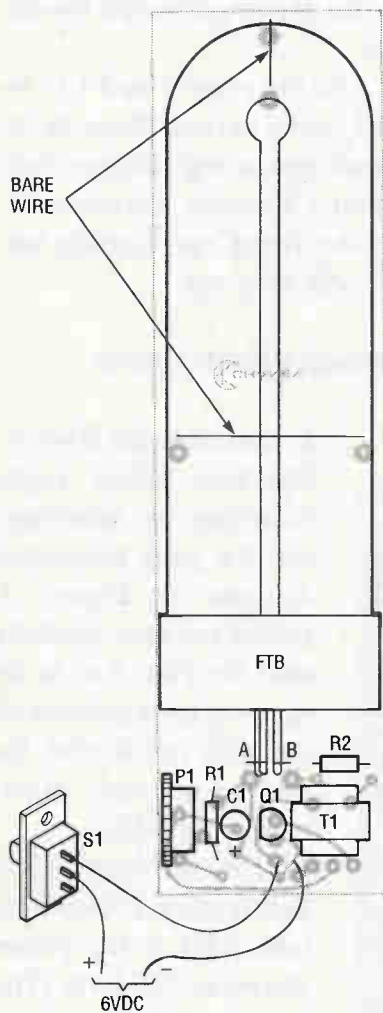

Figure 2. Parts Placement Diagram. Be sure to mount Q1 with its flat side facing C1, as shown.

connect wire from the pad marked "A" on the parts layout to the left-side terminals of FTB (wrap the wire around the two terminals on the left side and solder). Next, repeat the process on the right-side terminals of FTB and connect to the pad marked "B" on the parts layout.

3. Observe the polarity on capacitor C1 and the flat side on Q1, and install them precisely as shown in Figure 2, with the flat side of Q1 facing C1.
4. Be careful not to bend the leads on inverter transformer T1 when installing it onto the PC board, as the leads can break off if bent too sharply.
5. After installing the rest of the components, re-check your layout for good solder joints and correct parts placement.
6. Connect a source of 6VDC to the PC board and the switch terminal as shown. Turn slide switch S1 on and adjust trimmer resistor P1 for desired brightness. Note that as you adjust P1 for a brighter level, the current consumption will increase. With that in mind, possible choices for batteries are as follows: one 6-volt lantern battery, four "D"-size cells in series, or four "C" cells connected in series. Penlight cells should not be considered for use. They will wear out too quickly because of the high current requirements of the Battery-Operated Black-Light.

7. NOTE: It is normal for a blackening to occur near the base of the tube.

TROUBLESHOOTING HINTS

First, make sure you used rosin-core solder to build the kit. Next, make sure that the flat side of Q1 faces the direction shown. Check resistors against the parts layout for correct placement.

Make sure that you have securely attached the wires from the PC board to the FTB tube. Also check for cold solder joints.

Make sure that the battery power is applied with the correct polarity as shown. Do not exceed 6 volts DC.

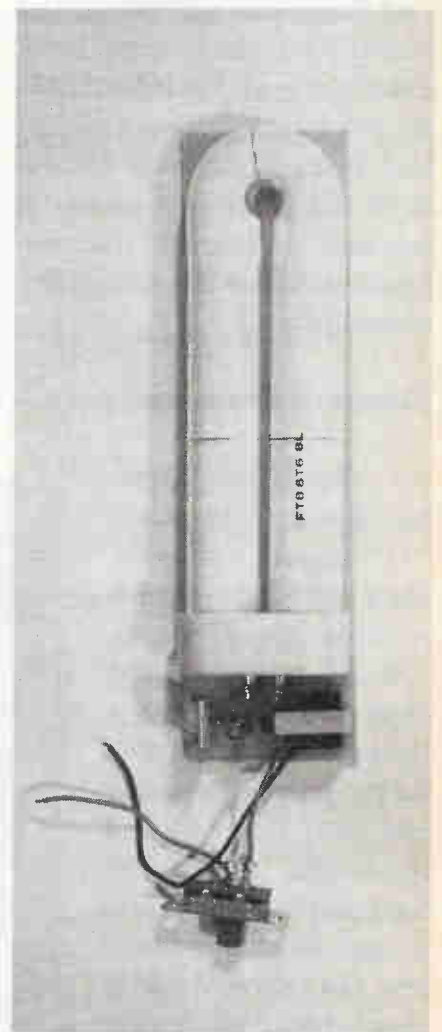

The completed PC board before being installed in a case. Note the two wires that hold the tube securely in place.

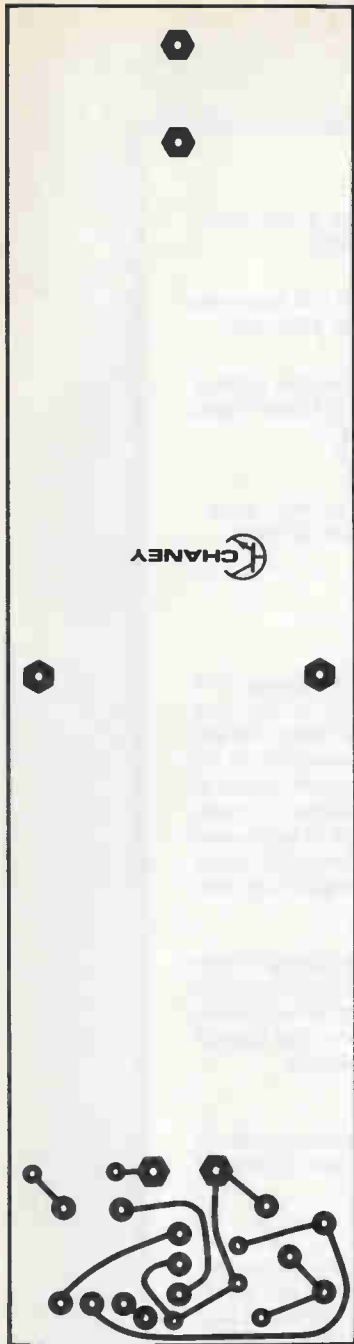

Figure 3. Foil Pattern of PC Board. This is a full-sized pattern for the Black Light

USING YOUR BLACK LIGHT

The black-light tube used in this project generates a wide spectrum of light. Normal fluorescent tubes only supply a limited spectrum and will not produce the "fluorescent effect" that your tube will. The tube requires sev-

eral hundred volts for proper operation; the purpose of T1 and the associated circuitry is to produce that high voltage from a low-voltage battery. The voltage produced by the Battery-Operated Black Light will shock you if you touch certain points on the PC board, so be careful if the power is on and you have not yet mounted the unit in a case. Note that, although the kit produces high voltage, it is at a very low current, so it is not considered dangerous or hazardous. Also note that all fluorescent tubes are made of glass and are fragile. If yours breaks, discard the tube immediately and avoid touching the broken glass.

The best results are obtained by using your black light in the dark. You can search outdoors for minerals that glow under black light. You can buy invisible fluorescent inks to write secret messages that can only be read in black light. You can draw or paint pictures using fluorescent colors or paints available from art stores. Another use is discovering insects that glow under blacklight. Also, your blacklight will attract most insects.

The high-priced black lights used by prospectors to find minerals have a very expensive UV filter over the black-light tube. That filter allows only UV light to escape. The kit of parts sold for this project (see Parts List) does not come with a UV filter as the cost would then be prohibitive. The Black Light will produce some normal spectrum light, so the color is purple instead of totally black. Ω

SPECIAL FROM ETT

□ **PCP107—DIGITAL LOGIC GATES AND FLIP-FLOPS ... \$10.00.** Establishes a firm foundation for the user who wants to design and troubleshoot digital circuitry and wants to know more than a few rules of thumb. No background beyond a basic knowledge of electronics is assumed.

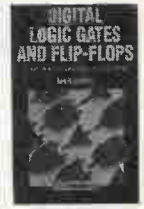

□ **PCP108—COMPUTERS AND MUSIC ... \$9.95.** Helps you learn the basics of computing, running applications programs, wiring a MIDI system and using the system to good effect. In fact, just about everything you need to know about hardware and programs.

□ **PCP109—EVERYDAY ELECTRONICS DATA BOOK ... \$10.00.** Presents the essential theory of electronic circuits and also deals with a wide range of practical electronic applications. Info is presented in the form of a basic electronics recipe book.

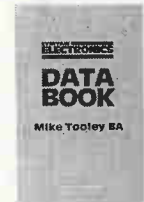

□ **PCP110—ELECTRONIC POWER SUPPLY HANDBOOK ... \$10.00.** All types of power supplies are covered, starting with cells and batteries, on to rectified supplies and linear stabilizers, to modern switch-mode systems, IC switch-mode regulators, DC-DC converters and inverters.

□ **BP285—BEGINNERS GUIDE TO MODERN ELECTRONIC COMPONENTS ... \$6.50.** Basic functions of resistors, capacitors, inductors, diodes (including Zeners and Varicaps), transistors, Thyristors, optoelectronic devices, op-amps, logic IC's, speakers and microphones, and meters are all described. Sort of a beginners bible of electronics.



MAIL TO: Electronic Technology Today, Inc.
P.O. Box 240
Massapequa Park, NY 11762-0240

SHIPPING CHARGES IN USA AND CANADA

\$0.01 to \$5.00	\$1.25	\$30.01 to \$40.00	\$5.00
\$5.01 to 10.00	\$2.00	\$40.01 to \$50.00	\$6.00
\$10.01 to \$20.00	\$3.00	\$50.01 and above	\$7.50
\$20.01 to \$30.00	\$4.00		

SORRY, No orders accepted outside of USA and Canada

Total price of merchandise	\$ _____
Shipping (see chart)	\$ _____
Subtotal	\$ _____
Sales Tax (NYS only)	\$ _____
Total Enclosed	\$ _____

Name _____
Address _____
City _____ State _____ Zip _____

ORDERING INFORMATION

TERMS

USA

We accept Visa/MasterCard, Checks and Money Orders for payment of your order.
NOTE: Personal checks are held for clearance and will delay your order.

CANADA MEXICO

We accept Visa/MasterCard and Money Orders drawn on U.S. banks in U.S. funds only (personal checks not accepted). Please include extra shipping (\$5.00 Minimum).

ALL OTHER FOREIGN COUNTRIES

We are sorry, but due to the greater amount of paperwork, we have a \$50 plus shipping minimum order to Foreign Countries (except Canada and Mexico). Only Money Orders drawn on U.S. banks in U.S. funds or Visa/MasterCard are accepted.

PHONE ORDERS

Call area code (602) 451-7454 for placing your order. Please have Visa/MasterCard number handy.
For your added convenience, place your order on our 24 hour FAX order line at (602) 451-9495.

C.O.D. AND OPEN ACCOUNT

We are sorry, but we do not accept C.O.D. or Open Account orders.

SHIPPING

Please include \$3.00 shipping to cover up to 5lbs. to anywhere in the Continental U.S.A. We ship by UPS surface, therefore, we must have a street address. If you live outside of the Continental U.S.A., or must have your order shipped to a P.O. box, you must include a minimum of \$5.00 shipping. Hawaii, Alaska, Canada and Mexico orders must include at least \$5.00 for shipping. If shipment of your order costs more than \$5.00, we will still send you your order, but we will attach a note telling you how much more you need to remit to us. UPS surface takes between 4 and 8 working days (M-F) to deliver your package after we give it to them. If your order is for a large quantity, please add additional shipping. We normally process all orders paid for by Visa/MasterCard, Money Orders or Cashiers Check (not personal checks) within 3 days after receipt of the order. If you have paid for your order with a personal check, it may take up to 18 days for our bank to clear your check.

RUSH SERVICE

If you would like same day shipment, and you have paid for your order with Visa/MasterCard, Money Orders or Cashiers Check, please include **\$10.00** extra *RUSH* charge (in addition to the \$3.00 shipping charge). We will then process your order within 24 hours and ship it out via UPS blue label rush shipping (up to 3lbs.) Normally, blue label arrives anywhere in the Continental U.S.A. within 3 working days. On large quantity orders, our rush service costs more than \$10.00, so please call for actual costs if this applies.

RETURNS

Kits may be returned within 30 days only if they have not been opened. Parts may be returned within 30 days if they are in original condition. No adjustments whatsoever can be made after 30 days. All returned items are subject to a 15% restocking fee.

A NOTE ABOUT OUR KITS

Kits cannot be returned for any credit adjustment or refund once they have been opened. We do, however have a repair service. If your kit fails to operate, you may return it to us with a check for \$8.00 and we will repair your kit and return it by UPS to you. All requests for repairs must be made within 30 days of your original order date and the \$8.00 amount must be included with your returned kit (our actual costs are much higher than \$8.00 - we offer this as a service to you).

SEND ORDERS TO: THE ELECTRONIC GOLDMINE
P.O. BOX 5408
SCOTTSDALE, AZ 85261



CALL PHONE ORDERS IN: (602) 451-7454
PLEASE HAVE
VISA/MASTERCARD READY
FAX ORDERS (602) 451-9495



The Electronic Goldmine, Inc. disclaims any implied warranties of merchantability and fitness, arising in connection with the sale of any product described in this magazine. In no event shall The Electronic Goldmine, Inc. be liable for any claim for incidental or consequential damages arising out of or in connection thereof with the manufacture, sale, delivery, or use of any product in this magazine. Specifications, prices, and availability of items are subject to change without notice. We cannot be responsible for typographical errors.

GET THE LATEST ADVANCES IN ELECTRONICS

WITH A SUBSCRIPTION TO

Radio **Electronics**®



ENJOY THE WORLD OF ELECTRONICS EACH MONTH!

Now you can subscribe to the best electronics magazine. The only one that brings you articles on—electronics projects, technology, circuit design, communications, new products and much more.

Radio-Electronics looks to the future and shows you what new video, audio and computer products are on the horizon. What's more you'll find helpful, monthly departments such as Video News, Equipment Reports, Hardware Hacker, Audio Update, IC Spotlight, Drawing Board. All designed to give you instruction, tips, and fun.

Radio-Electronics gives you exciting articles like:

- How to Choose the Right Battery
- Build a Solid State Disk Drive
- Build a Video Frame Grabber
- Microwave Technology
- VCR Repairs You Can Do
- The Sound Retrieval System
- Digital Circuit Simulation
- Display of the Future
- How to Fight Electrostatic Discharge
- Build R-E's Digital Dashboard
- Audio Amplifier Cookbook



FOR FASTER SERVICE CALL TODAY
1-800-999-7139

DON'T DELAY SUBSCRIBE TODAY!

Just fill out the order card in this magazine and mail it in today.

ELECTRONICS MARKET PLACE

FOR SALE

FREE lists, new merchandise, discounted prices! New York surplus electronics warehouse now open to the public! Electronics, computer products, fans, motors, power supplies, switches, transformers, speakers, semiconductors, etc. **ELECTRONIC COMPONENTS TRADING CORP.**, 44 V Jefryn Blvd., Deer Park, NY 11729. 1 (800) 942-9439, NY (516) 242-7733.

BUSINESS OPPORTUNITIES

LET the government finance your small business. Grants/loans to \$500,000 yearly. Free recorded message: (707) 449-8600. (KS3)

BUY BONDS

AC/DC VOLTAGE RESISTANCE DIODE TEST **KELVIN 200** **\$39.95**

LOW BATTERY Warning
ACCURACY +/- 0.5%
CONTINUITY TEST/BUZZER
TRANSISTOR CHECKER
CAPACITANCE CHECKER

Stock No. 990091

KELVIN Electronics
7 Fairchild Ave., Plainville, NY 11803
(516) 349-7620 1(800) 645-9212

VISA MC



Motion Control System **159.00**

Includes Computer, Monitor, Keyboard, Power supply, 4 Motors, and Software.
Call or Send for **Free Robotics Catalog**

Silicon Valley Surplus 415 261-4506
4222 E. 12th St. Oakland Ca 94601
Serving you since 1963
8 am to 4 pm PST



GET OUT OF THE DARK.

Open your eyes and see just how many subjects are covered in the new edition of the Consumer Information Catalog. It's free just for the asking and so are nearly half of the 200 federal publications described inside. Booklets on subjects like financial and career planning; eating right, exercising, and staying healthy; housing and child care; federal benefit programs. Just about everything you would need to know. Write today. We'll send you the latest edition of the Consumer Information Catalog, which is updated and published quarterly. It'll be a great help, you'll see. Just write:

**Consumer Information Center
Department TD
Pueblo, Colorado 81009**

U.S. General Services Administration

Cable TV Descramblers

If you find a better deal, we'll better our deal.

*Jerrold *Tocom *Hamlin *Oak
*Scientific Atlanta *Zenith
Ask about our extended warranty program.

COD, Visa, M/C welcome.
Free Call - Free Catalog.

Video Tech **800-562-6884**
2702 S. Virginia St., Ste. 160-304
Reno, NV 89502.



CABLE TV DESCRAMBLERS! BARGAIN HEADQUARTERS!



•JERROLD™ •TOCOM •HAMLIN
•OAK •ZENITH
•SCIENTIFIC ATLANTA

6 month warranty! We ship C.O.D.!
Lowest retail/wholesale prices!

FREE CATALOG:
Global Cable Network
1032 Irving St. Suite 109
S.F., CA 94122
NO CALIFORNIA SALES!!!

ORDER TODAY! 800-327-8544

CABLE TV "BOXES"

Converters - Descramblers
Remote Controls - Accessories

★ Guaranteed Best Prices ★
★ 1 Year Warranty - C.O.D.'s ★
★ Immediate Shipping ★
★ FREE CATALOG ★

Call or Write
TRANS-WORLD CABLE CO.
12062 Southwest 117th Court, Suite 126
Miami, Florida 33186
1-800-442-9333



BEST BY MAIL

Rates: Write National, Box 5, Sarasota, FL 34230

BOOKS-CATALOGS-MAGAZINES

ROBOTS! FULLY ASSEMBLED and kits, robot arms, PC interfaces, motor sensors. \$30.00 to \$80,000.00. Catalog \$5.00 refundable with order. HTO, PO Box 3084, RSF, CA 92067.

BUSINESS OPPORTUNITIES

BUMPERSTICKER PRINTER. Cheap, simple, portable. Free details. Bumper, POB 22791(PY), Tampa, FL 33622.

JOB MARKET TOUGH? Consider Professional Retirement Counseling. Complete Details: New Careers, 3871 Piedmont Ave., Oakland, CA 94611.

ELECTRON TUBES OVER 3000 TYPES IN STOCK!

Also capacitors, transformers
and parts for tube type equipment.
Send \$2.00 for 26 page catalog.

ANTIQUE ELECTRONIC SUPPLY

6621 S. Maple Ave., Tempe, AZ 85283
PHONE: 602/820-5411 FAX: 602/820-4643

VISIBLE LASER DIODES !!!

Our new **Pocket Laser™** includes all drive electronics, heatsink & collimating optics. All parts mount on a PCB only 1.40" x 1.78"! The laser will run over 5 hours on a single 9v alkaline battery. Red Laser beam (670nm) is visible 150' away! (CA. Residents add 6.5% P/H add \$2.50)
Beam Diameter: 4.5mm **DEALER INQUIRIES WELCOME**
3mW (TOLD9200) Pocket laser: \$99.95 / Laser Diode only: \$64.95
5mW (TOLD9201) Pocket laser: \$119.95 / Laser Diode only: \$87.95
5mW (TOLD9211) Pocket laser: \$139.95 / Laser Diode only: \$99.95
SECURICOM: P.O. Box 5227 CHATSWORTH, CA. 91313-5227

Now Tax Free For College



U.S. Savings Bonds

A public service of this publication.



Getting high before takeoff.

If the thought of flying doesn't scare you, how about the thought of flying with a pilot who's addicted to cocaine?

According to a series of articles by a Pittsburgh newspaper, drug addiction among airline pilots is not at all uncommon.

The newspaper's series was the result of a phone tip from a frustrated doctor.

He told of a pilot who'd been rushed to the hospital near death from an overdose of cocaine.

A survey of the area's hospitals proved this was not an isolated incident.

Upon further investigation, reporters learned that screening flight personnel for drug use was forbidden. And that the FAA medical exams didn't mandate blood and urine analyses so drug use couldn't be detected.

They learned scores of pilots were receiving treatment for drug abuse.

The newspaper's story brought the problem to the attention of the public.

The public was outraged. And demanded immediate reform.

As a result, several reforms were initiated. Among them, the development of more extensive FAA medical exams.

Reforms that may never have occurred if it hadn't been for a couple of reporters pursuing a story.

To learn more about the role of a free press and how it protects your rights, call the First Amendment Center at 1-800-542-1600.

If the press didn't tell us, who would?



A public service message of The Ad Council and The Society of Professional Journalists.

ADVERTISING INDEX

POPULAR ELECTRONICS Hobbyist Handbook magazine does not assume any responsibility for errors that may appear in the index below.

Free Information No.	Page
—	Amazing Concepts 25
—	Antique Electronic Supply 99
6	C&S Sales 9
—	CIE 17
—	Command Productions 21
8	Cook's Institute 23
19	Datak 43
—	Electronic Tech. Today ... CV3,95
—	Electronics Book Club 3
—	Global Cable Network 99
7	Heathkit 11
—	Iscet 25
—	Kelvin 99
10	Jensen 23
11	Meredith 21
12	Mouser 29
—	NRI Schools 21
—	National Mail Order 99
—	P.E. Reprint Bkst 87
14	SCO Electronics 13
—	Seattle Film Works CV2
—	Securicom 99
—	Tab Books 27
—	Silicon Valley Surplus 99
—	Trans World 99
—	Video Tech 99
15	U.S. Cable 13
17	Viejo Publications 29

ADVERTISING SALES OFFICE

Gernsback Publications, Inc.
500-B Bi-County Blvd.
Farmingdale, NY 11735
1-(516) 293-3000
President: **Larry Steckler**
Assistant to the President: **Christina Estrada**

For Advertising ONLY
516-293-3000
Fax 1-516-293-3115
Larry Steckler
publisher

Arline Fishman
advertising director
Denise Haven
advertising assistant
Kelly McQuade
credit manager

Customer Service/Order Form
1-800-435-0715
1-800-892-0753
7:30 AM - 8:30 PM EST

SALES OFFICES

EAST/SOUTHEAST
Stanley Levitan, Eastern Sales Manager
259-23 57th Avenue
Little Neck, NY 11362
1-718-428-6037, 1-516-293-3000
Fax 1-718-225-8594

MIDWEST/Texas/Arkansas/Okla.
Ralph Bergen, Midwest Sales Manager
540 Frontage Road—Suite 204
Northfield, IL 60093
1-708-446-1444
Fax 1-708-446-8451

PACIFIC COAST/Mountain States
Marvin Green, Pacific Sales Manager
5430 Van Nuys Blvd. Suite 316
Van Nuys, CA 91401
1-818-986-2001
Fax 1-818-986-2009

Electronics Paperback Books

GREAT PAPERBACKS AT SPECIAL PRICES

BP248—TEST EQUIPMENT CONSTRUCTION \$5.95. Details construction of simple, inexpensive, but extremely useful test equipment. AF Gen, Test Bench Ampl, Audio Millivoltmeter, Transistor Tester and six more.



BP267—HOW TO USE OSCILLOSCOPES AND OTHER TEST EQUIPMENT \$6.95. Mastering the oscilloscope is not really too difficult. This book explains all the standard controls and functions. Other equipment is also described.

BP265—MORE ADVANCED USES OF THE MULTIMETER \$5.95. Use these techniques to test and analyze the performance of a variety of components. Also see how to build add-ons to extend multimeter capabilities.



BP256—INTRO TO LOUDSPEAKERS AND ENCLOSURE DESIGN \$5.95. We explore the variety of enclosure and speaker designs in use today so the reader can understand the principles involved.

BP263—A CONCISE INTRO TO dBASE \$6.95. The dBASE series of programs are probably the best known database programs for microcomputers. This book is designed to help you get started working with them.



BP260—CONCISE INTRO TO OS/2 \$5.95. If you are a multitasking PC user and want to get the most out of your computer, then you must learn its OS/2 operating system. This book shows you just how to do that, quickly and easily.



BP249—MORE ADVANCED TEST EQUIPMENT CONSTRUCTION \$6.95. Eleven more test equipment construction projects. They include a digital voltmeter, capacitance meter, current tracer and more.



BP245—DIGITAL AUDIO PROJECTS \$5.95. Practical circuits to build and experiment with. Includes A/D converter, input amplifier, digital delay line, compander, echo effect and more.

BP247—MORE ADVANCED MIDI PROJECTS \$5.95. Circuits included are a MIDI indicator, THRU box, merge unit, code generator, pedal, programmer, channelizer, and analyzer.



BP257—INTRO TO AMATEUR RADIO \$6.95. Amateur radio is a unique and fascinating hobby. This book gives the newcomer a comprehensive and easy to understand guide to the subject.



PCP102—INTRODUCING DIGITAL AUDIO \$9.95. Covers all kinds of digital recording methods—CD, DAT and Sampling. Bridges the gap between the technician and the enthusiast. Principles and methods are explained.

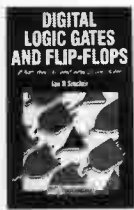

PCP107—DIGITAL LOGIC GATES AND FLIP FLOPS \$10.00. Thorough treatment of gates and flip-flops for enthusiasts, student and technicians. Only a basic knowledge of electronics is needed.

BP251—COMPUTER HOBBYISTS HANDBOOK \$8.95. A wrapup of everything the computer hobbyist needs to know in one easy to use volume. Provides a range of useful reference material in a single source.



PCP108—COMPUTERS AND MUSIC \$9.95. Explains the basics of computers and music with no previous knowledge of computers needed. Covers types of music software and explains how to set up your own computer music studio.

- BP195—INTRODUCTION TO SATELLITE TV**..... \$9.95. A definitive introduction to the subject written for the professional engineer, electronics enthusiast, or others who want to know more before they buy. 8 x 10 in.
- BP190—ADVANCED ELECTRONIC SECURITY PROJECTS**.....\$5.95. Includes a passive infra-red detector, a fiber-optic loop alarm, computer-based alarms and an unusual form of ultrasonic intruder detector.
- BP235—POWER SELECTOR GUIDE**.....\$10.00. Complete guide to semiconductor power devices. More than 1000 power handling devices are included. They are tabulated in alpha-numeric sequence, by technical specs. Includes power diodes, Thyristors, Triacs, Power Transistors and FET's.
- BP234—TRANSISTOR SELECTOR GUIDE**.....\$10.00. Companion volume to BP235. Book covers more than 1400 JEDEC, JIS, and brand-specific devices. Also contains listing by case type, and electronic parameters. Includes Darlingtons transistors, high-voltage devices, high-current devices, high power devices.
- BP99—MINI-MATRIX BOARD PROJECTS**.....\$5.50. Here are 20 useful circuits that can be built on a mini-matrix board that is just 24 holes by ten copper-foil strips.
- BP82—ELECTRONIC PROJECTS USING SOLAR CELLS**.....\$5.50. Circuits with applications around the home that are powered by the energy of the sun. Everything from radio receivers, to a bicycle speedometer, to timers, audio projects and more.
- BP117—PRACTICAL ELECTRONIC BUILDING BLOCKS—Book 1**.....\$5.75. Oscillators, Timers, Noise Generators, Rectifiers, Comparators, Triggers and more.
- BP184—INTRO TO 68000 ASSEMBLY LANGUAGE**.....\$6.95. The 68000 is a great new breed of microprocessor. Programming in assembly language increases the running speed of your programs. Here's what you need to know.

BP179—ELECTRONIC CIRCUITS FOR THE COMPUTER CONTROL OF ROBOTS \$7.50. Data and circuits for interfacing the computer to the robot's motors and sensors.

- BP239—GETTING THE MOST FROM YOUR MULTIMETER**..... \$5.95. Covers basics of analog and digital meters. Methods of component testing includes transistors, thyristors, resistors, capacitors and other active and passive devices.
- BP97—IC PROJECTS FOR BEGINNERS**.....\$5.50. Power supplies, radio and audio circuits, oscillators, timers, switches, and more. If you can use a soldering iron you can build these devices.
- BP37—50 PROJECTS USING RELAYS, SCR'S & TRIACS**.....\$5.50. Build priority indicators, light modulators, warning devices, light dimmers and more.
- RADIO—100 RADIO HOOKUPS**.....\$3.00. Reprint of 1924 booklet presents radio circuits of the era including regenerative, neutrodyne, reflex & more.
- BP42—SIMPLE LED CIRCUITS**..... \$5.50. A large selection of simple applications for this simple electronic component.
- BP127—HOW TO DESIGN ELECTRONIC PROJECTS**.....\$5.75. Helps the reader to put projects together from standard circuit blocks with a minimum of trial and error.
- BP122—AUDIO AMPLIFIER CONSTRUCTION**.....\$5.75. Construction details for preamps and power amplifiers up through a 100-watt DC-coupled FED amplifier.
- BP92—CRYSTAL SET CONSTRUCTION**..... \$5.50. Everything you need to know about building crystal radio receivers.
- BP45—PROJECTS IN OPTOELECTRONICS**..... \$5.50. Includes infra-red detectors, transmitters, modulated light transmission and photographic applications.

BP185—ELECTRONIC SYNTHESIZER CONSTRUCTION \$5.95. Use this book to learn how to build a reasonably low cost, yet worthwhile monophonic synthesizer and learn a lot about electronic music synthesis in the process.

CHECK OFF THE BOOKS YOU WANT

ELECTRONIC TECHNOLOGY TODAY INC.
P.O. Box 240, Massapequa Park, NY 11762-0240

Name _____
Address _____
City _____ State _____ Zip _____

SHIPPING CHARGES IN USA AND CANADA

\$0.01 to \$5.00	..	\$1.25
\$5.01 to 10.00	..	\$2.00
\$10.01 to \$20.00	..	\$3.00
\$20.01 to \$30.00	..	\$4.00
\$30.01 to \$40.00	..	\$5.00
\$40.01 to \$50.00	..	\$6.00
\$50.01 and above	..	\$7.50

SORRY No orders accepted outside of USA & Canada

Number of books ordered

Total price of merchandise \$ _____
Sales Tax (New York State Residents only) \$ _____
Shipping (see chart) \$ _____

All payments must be in U.S. funds

Total Enclosed .. \$ _____

HHB91

Countersurveillance

Never before has so much professional information on the art of detecting and eliminating electronic snooping devices—and how to defend against experienced information thieves—been placed in one VHS video. If you are a Fortune 500 CEO, an executive in any hi-tech industry, or a novice seeking entry into an honorable, rewarding field of work in countersurveillance, you must view this video presentation again and again.

Wake up! You may be the victim of stolen words—precious ideas that would have made you very wealthy! Yes, professionals, even rank amateurs, may be listening to your most private conversations.

Wake up! If you are not the victim, then you are surrounded by countless victims who need your help if you know how to discover telephone taps, locate bugs, or “sweep” a room clean.

There is a thriving professional service steeped in high-tech techniques that you can become a part of! But first, you must know and understand Countersurveillance Technology. Your very first insight into this highly rewarding field is made possible by a video VHS presentation that you cannot view on broadcast television, satellite, or cable. It presents an informative program prepared by professionals in the field who know their industry, its techniques, kinks and loopholes. Men who can tell you more in 45 minutes in a straightforward, exclusive talk than was ever attempted before.

Foiling Information Thieves

Discover the targets professional snoopers seek out! The prey are stock brokers, arbitrage firms, manufacturers, high-tech companies, any competitive industry, or even small businesses in the same community. The valuable information they filch may be marketing strategies, customer lists, product formulas, manufacturing techniques, even advertising plans. Information thieves eavesdrop on court decisions, bidding information, financial data. The list is unlimited in the mind of man—especially if he is a thief!

You know that the Russians secretly installed countless microphones in the concrete work of the American Embassy building in Moscow. They converted

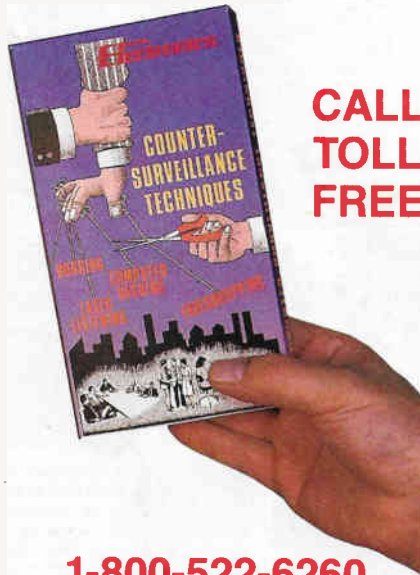

**CALL
TOLL
FREE**

1-800-522-6260

**HAVE YOUR
VISA or MC CARD
AVAILABLE**

what was to be an embassy and private residence into the most sophisticated recording studio the world had ever known. The building had to be torn down in order to remove all the bugs.

Stolen Information

The open taps from where the information pours out may be from FAX's, computer communications, telephone calls, and everyday business meetings and lunchtime encounters. Businessmen need counselling on how to eliminate this information drain. Basic telephone use coupled with the user's understanding that someone may be listening or recording vital data and information greatly reduces the opportunity for others to purloin meaningful information.

The professional discussions seen on the TV screen in your home reveals how to detect and disable wiretaps, midget radio-frequency transmitters, and other bugs, plus when to use disinformation to confuse the unwanted listener, and the technique of voice scrambling telephone communications. In fact, do you know how to look for a bug, where to look for a bug, and what to do when you find it?

Bugs of a very small size are easy to build and they can be placed quickly in a matter of seconds, in any object or room. Today you may have used a telephone handset that was bugged. It probably contained three bugs. One was a phony bug to fool you into believing you found a bug and secured the telephone. The second bug placates the investigator when he finds the real thing! And the third bug is found only by the professional, who continued to search just in case there were more bugs.

The professional is not without his tools. Special equipment has been designed so that the professional can sweep a room so that he can detect voice-activated (VOX) and remote-activated bugs. Some of this equipment can be operated by novices, others require a trained countersurveillance professional.

The professionals viewed on your television screen reveal information on the latest technological advances like laser-beam snoopers that are installed hundreds of feet away from the room they snoop on. The professionals disclose that computers yield information too easily.

This advertisement was not written by a countersurveillance professional, but by a beginner whose only experience came from viewing the video tape in the privacy of his home. After you review the video carefully and understand its contents, you have taken the first important step in either acquiring professional help with your surveillance problems, or you may very well consider a career as a countersurveillance professional.

The Dollars You Save

To obtain the information contained in the video VHS cassette, you would attend a professional seminar costing \$350-750 and possibly pay hundreds of dollars more if you had to travel to a distant city to attend. Now, for only \$49.95 (plus \$4.00 P&H) you can view *Countersurveillance Techniques* at home and take refresher views often. To obtain your copy, complete the coupon below or call toll free.

RADIO-ELECTRONICS VIDEO OFFER		HHB
500-B Bi-County Blvd. Farmingdale, NY 11735		
Please rush my copy of the Countersurveillance Techniques Video VHS Cassette for \$49.95 plus \$4.00 for postage and handling.		
No. of Cassettes ordered _____		
Amount of payment \$ _____		
Bill my <input type="checkbox"/> VISA <input type="checkbox"/> MasterCard		
Card No. _____		
Expire Date _____ / _____		
Signature _____		
Name _____		
Address _____		
City _____ State _____ ZIP _____		
All payments in U.S.A. funds. Canadians add \$4.00 per VHS cassette. No foreign orders. New York State residents add applicable sales tax.		