

**ELECTRONICS
HOBBY-THEORY
PROJECTS**

THE FUN WAY TO LEARN ELECTRONICS

VOLUME XI

\$3.95

ELECTRONICS HANDBOOK

WPS 36286

IN CANADA \$4.50

**ALL
NEW**

PROJECTS YOU CAN BUILD TONIGHT!

**CHOOSING THE RIGHT CABINET
FOR YOUR PROJECT**

IC TESTBENCH

**WORKBENCH
PROJECTS**

**ANTIQUA
RADIO**

**POWER
SUPPLY
BASICS**



**A VOICE IN
THE OUTBACK**

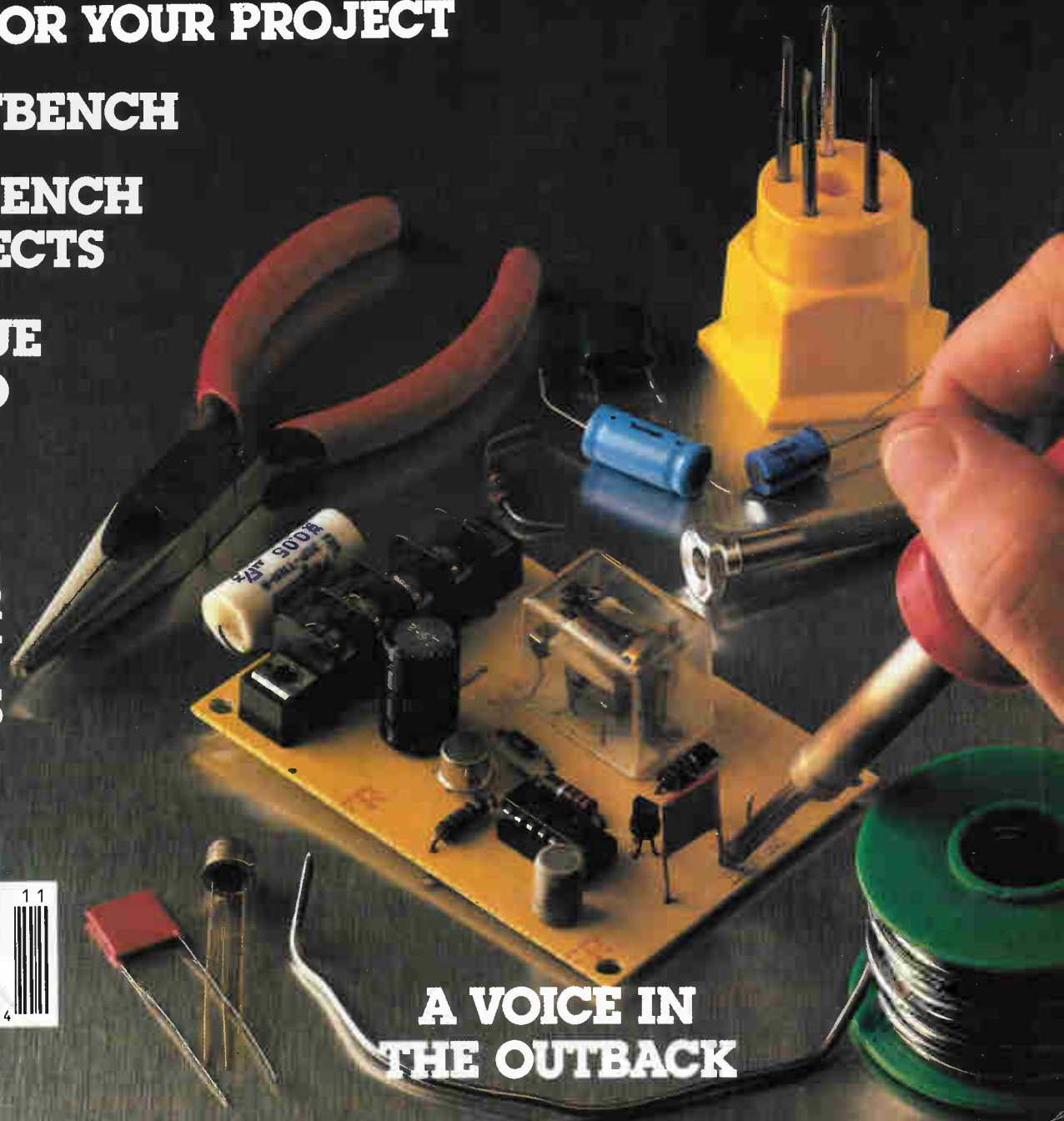

**Lab Test
ELECTRONICS
HANDBOOK
For Yourself**

Get switched on

In case you're not all that familiar with us, we're not a publication for electrical engineers and other wizards. No way, **ELECTRONICS HANDBOOK** is expressly for people who like to build their own projects and gadgets—and maybe get a little knee-deep in tape, solder and wire clippings in the process.

In fact, we have a sneaking suspicion that our readers like us because they think we're just as bug-eyed and downright crazy over great new project ideas as they are. And I guess they're right!

ELECTRONICS HANDBOOK thinks of you who dig electronics as the last of a special breed. It's more than just the "do-it-yourself" angle—it's also the spirit of adventure. In this pre-packaged, deodorized world, building your own stereo system, shortwave receiver, darkroom timer or CB outfit is like constructing a fine-tuned little universe all your own. And when it all works perfectly—it really takes you to another world.

IF YOU'RE NEW TO ELECTRONICS YOU GET A "BASIC COURSE"!

It gives you a complete, ground-floor lowdown on a variety of important electronic subjects. For example—Understanding Transistors...How Radio Receivers Pull In Signals...Cathode Ray Tubes Explained...How Capacitors Work...Using Magnetism In Electronics, and much, much more!



Of course, we can't make you a master electrician overnight. But we can show you the fundamentals of repair plus maintenance tips.

TRY A FEW ISSUES AND EVALUATE OUR...

- **HOW-TO-DO-IT HELP** Tips and pointers that add up to money saved. For example—tuning up your tape player...all about radios ...whys and hows of turntables...care and feeding of speakers.
- **EXCITING DISCOVERIES.** Whatever your particular interest in electronics, you'll be entering a world of discovery in the pages of the **ELECTRONICS HANDBOOK**

With NRI hands-on training, you can experience the rewards of a career in computer programming

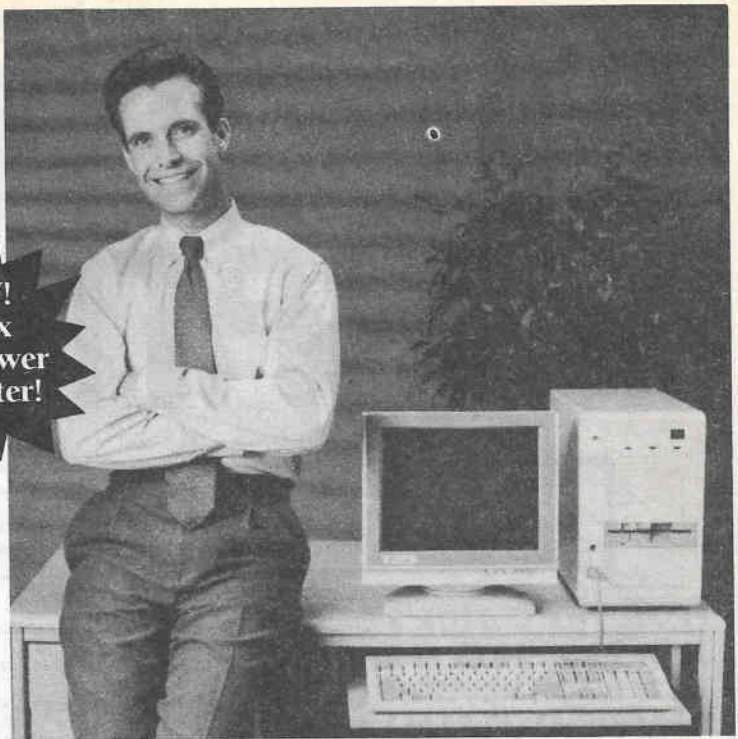

**NEW!
386sx
mini-tower
computer!**

Now you can get the practical training and experience you need to succeed in computer programming, today's top-growth computer career field.

NRI at-home training gives you real-world programming skills in four of today's hottest computer languages: BASIC, Pascal, C, and COBOL. You get hands-on training that now includes a powerful 386sx/20 MHz mini-tower computer, modem, and programming software ... all yours to train with and keep! Best of all, NRI gives you the programming know-how you need to succeed on the job, in a new career, or in a business of your own.

Job opportunities for the skilled computer programmer will increase by 71.7 percent over the next 10 years according to Bureau of Labor Statistics forecasts. And now, with NRI training, you can be one of the increasing number of computer programmers using their skills to build a top-paying career — even a business of their own — in this professionally and financially rewarding high-tech field.

▼ The only programming course that includes a powerful 386sx-based computer system and programming software you keep

Right from the start, NRI training gets you actively involved in the challenge of real-world programming. You learn how to create the kinds of full-featured, powerful programs today's employers and clients demand.

And, unlike any other school, NRI lets you experience first-hand the power of an IBM PC/AT-compatible, 386sx-based computer system, complete with modem, a full megabyte of RAM, disk drive, and monitor — all yours to train with and keep!

Plus you explore the extraordinary capabilities of not one or two but four in-demand computer languages. You learn to design, code, run, debug, and document programs in BASIC, Pascal, C, and COBOL. In the process you become uniquely prepared for the wide variety of programming opportunities available today.



▼ No previous experience necessary

Immediately, you start getting the money-making job skills you need to secure a future in computer programming — no matter what your background. NRI's unique Discovery Learning Method guides you swiftly from computer novice to computer professional with step-by-step lessons covering program design techniques used every day by successful PC programmers.

You'll find no heavy textbooks to plow through. No night classes to attend. Instead, NRI's at-home, step-by-step training covers all the bases, guiding you

from the important fundamentals to real-world methods and techniques. Backed up throughout your course by your experienced NRI instructor, you quickly gain the skills you need to handle a wide variety of programming tasks with confidence. You even use your modem to "talk" to your instructor, meet other NRI students, and download programs through NRI's exclusive programmers network, PRONET.

▼ Send today for your FREE catalog

Now you can experience the professional and financial rewards of a career in computer programming. See how NRI at-home training gives you the know-how, the computer, and the software you need to get started in this top-paying field. Send today for your FREE catalog!

If the coupon is missing, write to us as the NRI School of Computer Programming, McGraw-Hill Continuing Education Center, 4401 Connecticut Avenue, NW, Washington, DC 20008.

SEND FOR YOUR FREE NRI CATALOG TODAY!

NRI Schools

McGraw-Hill Continuing Education Center
4401 Connecticut Avenue, NW, Washington, DC 20008



Check one free catalog only

- | | |
|---|--|
| <input type="checkbox"/> Computer Programming | <input type="checkbox"/> Programming in C++ with Windows |
| <input type="checkbox"/> Microcomputer Servicing | <input type="checkbox"/> Desktop Publishing & Design |
| <input type="checkbox"/> PC Applications Specialist | <input type="checkbox"/> Bookkeeping and Accounting |

Name _____ Age _____
(please print)

Address _____

City _____ State _____ Zip _____

Accredited Member, National Home Study Council

22-032



ELECTRONICS HANDBOOK

CONTENTS

FROM THE EDITOR'S DESK	6
NEW PRODUCTS PARADE	8
NEW BOOK REVIEWS	12
CLASSIFIED FLEAMARKET	17
UNDERSTANDING ELECTRICITY	18
A VOICE IN THE OUTBACK	26
PASSIVE ALARM CIRCUIT	37
POWER SUPPLY BASICS	39
IMPEDANCE MISMATCH	49
CHOOSING THE RIGHT CABINET	53
ANTIQUE RADIO (DYNAMIC SPEAKERS)	66
MAKING PCB's THE EASY WAY	69
MEDICAL ELECTRONICS	73
SOLID STATE UPDATE	76
STINGRAYS WITH A CHARGE	79
THE CATALOG CORNER	82
AUDIO TAPE NOISE LIMITER	86

WORKBENCH PROJECTS

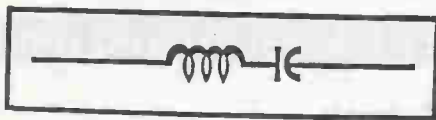

31

LED ELECTRICAL CIRCUIT TESTER
FUNCTIONAL CAPACITANCE VERIFIER
AUDIBLE INDICATOR FOR HF PULSES
A SIMPLE LOGIC PROBE
CAPACITOR TESTER
THE TELEPHONE LINE PROTECTOR
TV ANTENNA PROTECTOR

IC TESTBENCH

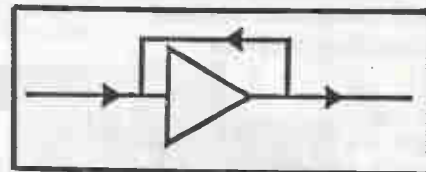

59

MINI-MICRO METRONOME
TAKING THE COUNT
NINE VOLT NEON LAMP
DO-IT-YOURSELF LOGIC
SIMPLE TRIAC TESTER
PULSE DELAY CIRCUIT
IN-CIRCUIT RESISTANCE VERIFIER
HOME/AUTO BURGLAR ALARM
SQUARE WAVE CONDITIONER

SELECT 5 BOOKS for only \$4⁹⁵

(values to \$155.75)

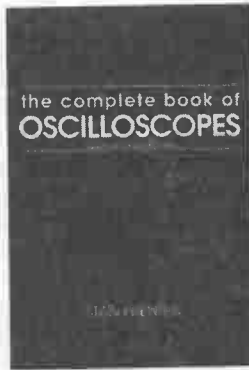
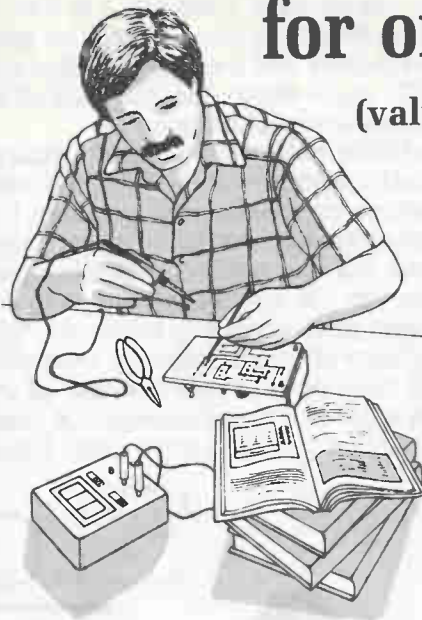

3825 \$26.95

Your most complete source for electronics books for over 25 years.

Membership Benefits • Big Savings. In addition to this introductory offer, you keep saving substantially with members' prices of up to 50% off the publishers' prices. • **Bonus Books.** Starting immediately, you will be eligible for our Bonus Book Plan, with savings of up to 80% off publishers' prices. • **Club News Bulletins.** 15 times per year you will receive the Book Club News, describing all the current selections—mains, alternates, extras—plus bonus offers and special sales, with scores of titles to choose from. • **Automatic Order.** If you want the Main Selection, do nothing and it will be sent to you automatically. If you prefer another selection, or no book at all, simply indicate your choice on the reply form provided. You will have at least 10 days to decide. As a member, you agree to purchase at least 3 books within the next 12 months and may resign at any time thereafter. • **Ironclad No-Risk Guarantee.** If not satisfied with your books, return them within 10 days without obligation! • **Exceptional Quality.** All books are quality publishers' editions especially selected by our Editorial Board. (Publishers' Prices Shown)



3589 \$27.95



3669 \$27.95



3677 \$34.95
Counts as 2

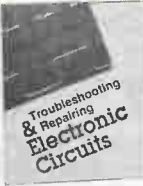

3258 \$28.95
Counts as 2



3671 \$29.95



045904-5 \$29.95



3414 \$39.95
Counts as 2



3710 \$32.95
Counts as 2



3627 \$29.95
Counts as 2



3374P \$16.95



2947P \$13.95



2981P \$18.95



3485 \$27.95



2980P \$19.95



2790P \$15.95



2613P \$17.95



2883P \$18.95



2867P \$18.95

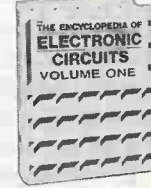

1938 \$60.00
Counts as 3



2925P \$10.95



3632 \$18.95



3922 \$26.95

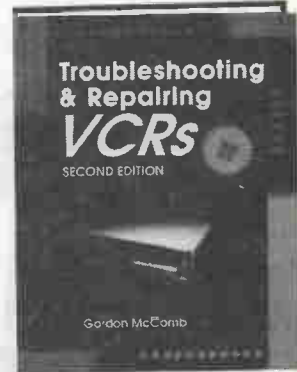

3777 \$32.95
Counts as 2



585928-9 \$24.95



3550 \$34.95
Counts as 2

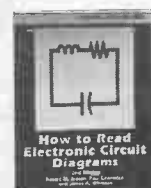

2880P \$14.95



3345 \$39.95



3540 \$26.95



9290 \$36.00
Counts as 2

ELECTRONICS BOOK CLUBSM
Blue Ridge Summit, PA 17294-0810

Please accept my membership in the Electronics Book Club and send the 5 volumes listed below, billing me \$4.95. If not satisfied, I may return the books within ten days without obligation and have my membership cancelled. I agree to purchase at least 3 books at regular Club prices during the next 12 months and may resign anytime thereafter. A shipping/handling charge and sales tax will be added to all orders.

Name _____

Address _____

City _____

State _____ Zip _____ Phone _____

Valid for new members only. Foreign applicants will receive special ordering instructions. Canada must remit in U.S. currency. This order subject to acceptance by the Electronics Book Club. CEHB492

All books are hardcover unless number is followed by a "P" for paperback.

OUR CHANGING WORLD

For those of us who became interested in electronics in the days of vacuum tubes and transistors, today's integrated circuits (ICs) are nothing short of miraculous. Entire circuits that once required dozens of discrete components, together with considerable construction and "debugging" time, are now available in a postage-stamp-size package. Obtaining a desired circuit function, such as amplification or a logic gate, today involves little more than selecting an appropriate IC and adding a few external components (such as capacitors and resistors) together with a voltage source. All the hard work has already been done! ICs are, in effect, little "package" of amplification, voltage regulation, detection, timing, inverting, and similar useful functions.

The nature of electronic circuit design and construction has changed. Circuit design is much more of a "cookbook" procedure, requiring far less complex math, voltage and current measurements, attention to parts layout and placement, and so on, than in previous years. Designing with IC devices is largely a matter of "chaining" appropriate ICs and the functions they perform together to create working electronic devices. Moreover, the availability of inexpensive and versatile "breadboard" design tools makes experimentation with ICs and circuit prototyping merely a matter of inserting ICs and other components into holes and connecting them with "plug-in" wires. Circuit construction now takes minutes rather than hours of careful soldering. I feel old when I contemplate that many younger electronics enthusiasts have never known the "joy" of trying to solder parts mounted on a so-called "perfboard," or the smell of a fried transistor that was inadequately heat-sunk during soldering. (If you are one of those younger people, take it from me—you haven't missed a thing!)



Don Gabree,
—Publisher

WANTED: PROJECTS

How would you like to find your home-brew project in the next issue of the **ELECTRONICS HANDBOOK**? It's up to you! Build your project for yourself...It should have a real purpose. Then, if you think it is good enough to appear in the **ELECTRONICS HANDBOOK**, let us know about it.

Write us a short letter describing your project. Tell us what the project does. Provide us with a legible schematic diagram and a few black-and-white photographs of the project...photos are important. After we have read your letter, we'll let you know, one way or the other, whether we would like to purchase your article describing the project. Send your letter to:

**DON GABREE, PUBLISHER
C&E HOBBY HANDBOOKS
P.O. BOX #5148
NORTH BRANCH, N.J. 08876**

ELECTRONICS HANDBOOK

PUBLISHER
AND
EDITORIAL DIRECTOR
Don Gabree
SECRETARY/TREASURER
L. M. Gabree
ASSOCIATE EDITOR
Holly Love
CONTRIBUTING AUTHORS
Homer Davidson
Walter Sikonowiz
Tony Lee
Steve Sokolowski
Hugh Gordon
William R. Gross
William R. Hoffman
Ralph Hubscher
Ron C. Johnson
Joe O'Connell
Jeff Orthober
Glenn Rawlings

ISSN 0897-7631

ADVERTISING SALES
C&E Hobby Handbooks
P.O. Box #5148
North Branch, N.J. 08876
(201) 231-1518

Published by C&E Hobby Handbooks, Inc. Editorial and Business address, P.O. Box #5148, North Branch, N.J. 08876 (908) 231-1518. PERMISSIONS: Material in this publication may not be duplicated or reproduced in any form without permission. Requests for permission should be directed to — Don Gabree, C&E HOBBY HANDBOOKS, INC. P.O. Box #5148, North Branch, N.J. 08876 (908) 231-1518.

EDITORIAL CONTRIBUTIONS must be accompanied by return postage and will be handled with reasonable care; however, the publisher assumes no responsibility for the return or safety of manuscripts, artwork or photographs. All contributions should be addressed to: PUBLISHER, C&E HOBBY HANDBOOKS, P.O. Box #5148, North Branch, N.J. 08876.

As a service to readers, C&E HOBBY HANDBOOKS publishes available plans and/or information relating to products, techniques of scientific and technological developments. Because of possible variances in the quality and condition of materials and workmanship used by readers, C&E HOBBY HANDBOOKS disclaims any responsibility for the safe and proper functioning of reader-built projects based upon or from plans and/or information published by C&E HOBBY HANDBOOKS.

Second Class Entry applied for. Copyright © 1992 by C&E HOBBY HANDBOOKS, INC.

AMAZING SCIENTIFIC & ELECTRONIC PRODUCTS

LASERS AND SCIENTIFIC DEVICES	VRL2K	3mw Vis Red Laser Diode System Kit	\$159.50
	LLIS1K	Laser Beam "Bounce" Listener Kit	\$199.50
	LHC2K	Visible Simulated 3 Color Laser Kit	\$44.50
	LC7	40 Watt Burning Cutting Laser Plans	\$20.00
	RUB4	Hi Powered Pulsed Drilling Laser Plans	\$20.00
	LGU40	1 to 2mw HeNe Vis Red Laser Gun Assembled	\$199.00
	LLS1	Laser Lite Show - 3 Methods Plans	\$20.00
	SD5K	See in the Dark Kit	\$299.50
	EML1K	Electromagnetic Coil Gun Kit	\$69.50
	MCP1	Hi Velocity Coil Gun Plans	\$15.00
HIGH VOLTAGE AND PLASMA DISPLAY DEVICES	LEV1	Levitating Device Plans	\$10.00
	EH1	Electronic Hypnotism Techniques Plans	\$10.00
	HVM7K	75,000 Volt DC Variable Output Lab Source Kit	\$149.50
	IOG3K	Ion Ray Gun Kit, project energy without wires	\$69.50
	NIG9K	12V/115 VAC Hi Out Neg Ion Generator Kit	\$34.50
	EMA1K	Telekinetic Enhancer/Electric Man Assembled	\$99.50
	LG5K	Lightning Display Globe Kit	\$54.50
	BTC1K	Worlds Smallest Tesla Coil Kit	\$49.50
	BTC3K	250KV Table Top Tesla Coil Kit	\$249.50
	BTC5	1.5 Million Volts Tesla Coil Plans	\$20.00
SECURITY AND PROTECTION DEVICES	JL3	Jacobs Ladder - 3 Models Plans	\$15.00
	GRA1	Anti Gravity Generator Plans	\$10.00
	PFS20	Plasma Fire Saber Assembled	\$69.50
	DPL20	Dancing Plasma to Music and Sounds Assembled	\$79.50
	ITM10	100,000 Volt Intimidator up to 20' Assembled	\$129.50
	IPG70	Invisible Pain Field Blast Wave Gen Assembled	\$74.50
	PSP4K	Phasor Sonic Blast Wave Pistol Kit	\$59.50
	LIST10	Infinity Xmtr, Listen in Via Phone Assembled	\$199.50
	TAT30	Automatic Tel Recording Device Assembled	\$24.50
	VWPM7K	3 Mi. FM Auto Tel Transmitter Kit	\$49.50
FMV1K	3 Mi. FM Voice Transmitter Kit	\$39.50	
HOD1K	Homing/Tracking Beeper Transmitter Kit	\$49.50	

EASY ORDERING PROCEDURE TOLL FREE 1-800-221-1705
or 24 HRS ON 1-603-673-4730 or FAX IT TO 1-603-672-5406
VISA, MC, CHECK, MO IN US FUNDS. INCLUDE 10% SHIPPING. ORDERS
\$100.00 & UP ONLY ADD \$10.00. CATALOG \$1.00 OR FREE WITH ORDER.

INFORMATION UNLIMITED
P.O. BOX 716, DEPT. HB, AMHERST, NH 03031



ATTACH LABEL HERE

NEW ADDRESS HERE

PLEASE PRINT

NAME _____

ADDRESS _____

CITY _____ STATE _____

DATE _____ ZIP _____

V11

FROM THE EDITOR'S DESK

Ask The Editor, He Knows!

Got a question or a problem with a project—ask The Editor. Please remember that The Editors' column is limited to answering specific electronic project questions that you send to him. Personal replies cannot be made. Sorry,

he isn't offering a circuit design service. Write to:

The Editor
C&E HOBBY HANDBOOKS INC.
P.O. Box #5148
North Branch, N.J. 08876

The Tube Lives

First, I'd like to tell you that Vol. 8 of **Electronics Handbook** was terrific. I built your triple-output regulated DC power supply, and it works great. Also, your new Solid State Update column is a great idea, and I'm sure it won't be long before some other magazine borrows the concept. Keep up the good work!

Now for the important stuff. A friend of mine and I have made a bet that we'd like you to settle. He says the vacuum tube is dead; I say it isn't. Who's right? There is a large pizza and a six-pack riding on this bet, fellas, so don't let me down.

— Neil Vance, Tacoma, WA

As you obviously surmised, Neil, flattery is a good way to ensure that a letter gets published. Your comments regarding Vol. 8 are certainly appreciated. For the benefit of anyone else who might like to build our triple-output regulated power supply, please note that back issues of Vol. 8 are still available.

Now, let's settle your bet. As far as I'm concerned, until my Aunt Amanda gets rid of her 1953-vintage Dumont television receiver, the vacuum tube still lives. But that argument isn't likely to win you a pizza, so let's take a more careful survey of current applications for the vacuum tube. First of all, let's not forget that the ubiquitous CRT, or cathode-ray tube, is found in millions of television sets, computers, and oscilloscopes. Maybe in ten or twenty years some flat-screen technology such as the LCD will supplant the CRT, but probably not in all applications. So, simply

*from evidence based on the CRT, I'd say that you've won your bet. But your buddy may cry foul, saying that by **vacuum tube** he meant anything but a CRT, so we'll press on with our analysis.*

Because of their power-handling capability, vacuum tubes are still favored as generators of RF energy. When you reheat a slice of pizza in your microwave oven, you're making use of a magnetron tube. When you listen to a shortwave radio broadcast, you're hearing a signal that in all likelihood was amplified by high-power vacuum tubes. Perhaps these applications may one day be taken over by solid-state devices, but it won't be any day soon.

Vacuum tubes can also be found in some musical-instrument amplifiers, and here's why: solid-state amplifiers generate both even and odd harmonics when overdriven, but tube amps generate only the even harmonics. As a result, tube amps don't sound as harsh when overdriven by a frenzied guitarist, and are thus preferred by picky guitar players like Chuck Berry and others. Perhaps the most famous tube amps are those made in England by Marshall.

Tube amplifiers are also favored by certain highbrow audiophiles, but I remain skeptical of their reasoning. (Remember, these are the same fellows who replace conventional speaker cable with half-inch-thick, coaxial transmission line made from oxygen-free copper and claim to hear an improvement in sound, when all the laws of physics militate against such a claim, and unbiased ears, like mine, can't hear the slightest

bit of difference.) In any event, tube-style stereo amplifiers don't sound significantly different from well-designed solid-state amps. The fact that tube amps produce only even-order harmonics when overdriven has little bearing here, since hi-fi amps don't get overdriven the way musical-instrument amps do. But as long as certain golden-eared audiophiles cling to their tube amps, the vacuum tube will never die.

As a final example of the viability of tubes, we should note that vacuum tubes are once again making their presence felt in, of all places, digital electronics. No, we're not returning to the days of the UNIVAC, when tube-based computers filled entire rooms, generated prodigious quantities of heat, and broke down every couple of hours. These new tubes are nothing like the short-lived, heat-producing glass bottles of yore. To be precise, the new tubes are vacuum microelectronic devices, which are fabricated using equipment and materials similar to those employed in the semiconductor industry. Research is being carried out at the Naval Research Laboratory in Washington, D.C., the Lawrence Livermore National Laboratory, The Amoco Technology Co., and a variety of other places. Two methods have shown the greatest promise. The first of these is the so-called thermionic IC, in which optical lithography is used to form metallic cathode, anode, and gate structures on a sapphire substrate. The scheme works well, but because it relies on thermionic emission of electrons, power consumption is high. The second



approach replaces the hot cathode with a field emitter, a cold source of electrons. This has the beneficial effect of reducing power consumption and allowing denser, submicron geometries to be used. Researchers are currently at the stage where they are able to fabricate discrete vacuum microelectronic devices, but it won't be long before they start producing integrated circuits based on this technology.

Why bother with vacuum microelectronics at all? Speed is the answer. Vacuum microelectronic devices have the potential to switch at faster rates than the semiconductor devices currently in production. They could find application in computers, high-definition TV, and military electronics. The latter seems an especially promising application, since vacuum microelectronic devices are not as sensitive to high temperatures and radiation as semiconductors ICs.

Obviously, vacuum-tube technology is far from dead. You've won your bet, Neil. Now go claim that pizza.

TV Cable Capacitance

I'm new to electronics, so maybe you can help me out on what's going on with coaxial TV cable. I've been told that I can get better reception of weak TV signals, with less noise pickup from electronic motors, microwave ovens, etc. If I use shielded coaxial cable between the TV antenna on top of our house and our TV set.

Fair enough, I also understand the shield (outside) of the cable will keep the inside wire conductor from picking up local interference which can cause problems with the weak TV signals. But I see that this coax cable has so many pF (picofarads) of capacitance per foot. And I need almost a hundred feet of leadin cable. Now won't all that extra capacitance weaken the already-small TV signals more than the pickup of local interfering

electrical disturbance? —**Waymon Arden, Denver, Colorado.**

Shielded (coax) TV leadin cable may lessen pickup of local interference. Its total capacitance (number of feet times the capacitance per foot) will also cut down on the weak signals from distant TV stations. Why not try using standard (flat wire, 300-ohm) leadin cable first? You may find there's little or no local interference, and you'll be spared the trouble and signal loss of coax leadin.

If you find you are getting interference, then you can go to coax. Weak signals from distant TV stations can also be improved if you get an antenna amplifier and mount it right on the TV antenna mast.

What is "Transistor" Sound?

I hear stereo fans talking about "transistor" sound and also about "tube" sound. I thought that transistors, and in the old days, tubes, just reproduce whatever sounds are fed to them. In other words, don't transistors (and tubes) just amplify signals? The lovers of Tube sound claim that tubes make "sweeter" music and that transistors make harsher, more "grainy" sounds. What's the real story? —**Raymond Whitney, Evanston, Illinois.**

Transistor sound is today largely a matter of wishful thinking on the part of some audio fanatics. It is true that many early transistor amplifiers (in the Sixties) produced sound that had more distortion than the best tube amplifiers produced. That was because transistor designs were new, and in addition there weren't any transistors available at reasonable prices that could handle much power. Today that's all changed because plenty of high-powered transistors are available at reasonable prices. In addition, engineers have learned how to design amps which produce much lower distortion

than the best tube amplifiers.

Anyone who claims he can hear the difference between a good transistor amplifier and a tube amp which has similar specifications is pulling his own leg. There are plenty of such audio nuts around, by the way. They really believe what they say, but they're never taken a real blindfold test to prove it.

Up with LPs; Down with CDs!

Why are record markers in such a hurry to push aside the LP record? It's given us the music we want, when we want it (to quote RCA) for nearly 40 years.

Even though many people won't admit it, most people can't tell the difference between the same music played on an LP and on a CD particularly when it's played at rock music volume levels. They just want to keep up with "the latest." I'm not going CD for a long time. Instead I shall upgrade my present (good) stereo system. I can't see spending \$14-18 on a CD when I can get the same thing on LP for \$6-8. *Long live vinyl discs*, is my motto!

I'm tired of hearing people praising the CD to the skies, and claiming LPs are no good. We record collectors must stand together and fight to save the LP record. Join with me in this fight. Time is running out! Don't let the LP recording become the next endangered species. If you would like to make people aware of this by wearing a red and black "Save the Record" silk-screened shirt, join me and many others. To get your shirt; (\$12 postpaid.) State your size, S,M,L, or XL.

—L.A. Schwartz, Glendale, CA.

If you agree with Mr. Schwartz, and want to show your support of his viewpoint you can send your \$12 to him at Suite 458, 249 N. Brand St. in Glendale 91209.

NEW PRODUCTS PARADE

SINGLE BOARD COMPUTER

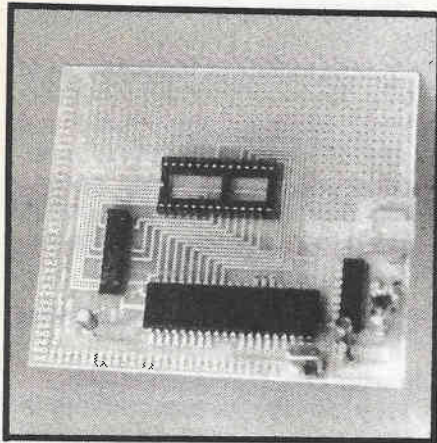

Suncoast Technologies, Spring Hill, Florida introduces an economical version of the Single Board Computer. The 70691C is an 8051 based computer engine designed for hobby use. With the addition of a large prototyping area, the 70691C is a very versatile piece of electronic hardware.

Completely assembled and tested, the 70691C computer board contains the popular 8051 microcontroller chip with its standard 128-byte internal memory. Also included is the circuitry for RS-232 communication between the 8051 and its host computer. Using a standard 4-conductor module type telephone linecord, the 70691C easily connects to the host computer's serial interface, using a 24-pin female connector (Interface Cable Optional) — \$4.95 plus shipping and handling.

Designed to address an 8K out-board EPROM, the 70691C provides the means for the beginner hobbyist to understand complex computer theory, an area of inexpensive experimentation with interfacing more elaborate circuitry to the 8051.

Operating from a standard 5 volt DC, the 70691C draws only 100mA of current, thus allowing the use of the available prototype area for the construction of a small Power Supply. A preassembled and tested 5 volt DC Power Supply is also avail-

able from Suncoast Technologies for \$5.95 plus shipping and handling (less 12VAC 500 mA transformer.)

With 14 programmable Input/Output Ports (16, if RS-232 communication is not needed), the 70691C is the Single Board Computer of choice for the hobbyist needing an assembled and fully tested computer engine.

Priced at only \$49.00 plus \$2.50 shipping/handling (\$3.50 for Canadian shipping), the 70691C is an economical means of bringing that microcontroller idea of yours to life. The kit is also available without the RS-232 Interfacing Circuitry for \$41.00 plus \$2.50 shipping/handling (\$3.50 Canada).

For more information and/or details about the 8051 Single Board Computer, write to **Suncoast Technologies (EH)**, P.O. Box 5835, Spring Hill, FL 34606.

HANDY WIRE CUTTER



From HMC, an inexpensive 5-inch flush wire cutter for electronic/electric assembly and repair applications. It features tempered high-carbon steel blades that are precision ground to deliver a unique light-touch shearing action for cutting soft wire to 20 gauge. The cushioned full-length molded handles are

securely anchored to the steel shank and are contoured to provide the sensitive feel so important to wire cutters. This flush cutter's extra-thin profile, due to its non-protruding spring, allows for snag-free manipulation in tight areas, making it ideal for the electronics hobbyists who are involved with PC board assembly.

For more details contact **HMC (HUB Material Company)**, 33 Springdale Avenue, Canton, MA 02021 (617) 821-1870 and ask about their Model M170 "shears".

RUST REMOVER

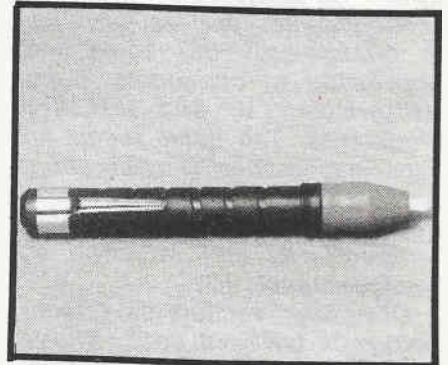

Pro Motorcar Products introduces a new multipurpose tool, the **ELIMINATOR** Glass Fiber Rust Remover, which brushes away rust and get into areas that other tools can't reach.

The **ELIMINATOR** brush has a narrow tip composed of glass fibers, each smaller than a human hair. The glass fibers combine to produce a concentrated scrubbing power of hundreds of pounds per square inch.

In less than a minute, the **ELIMINATOR** brush can clean out all surface rust, wax, and film. The **ELIMINATOR's** glass fibers also get into hard to reach corners, grouting, tooling and engraving. The glass fibers provide a new and better way of cleaning electrical contacts and connectors, deglossing parts before gluing, preparing parts for soldering or welding.

The **ELIMINATOR** brush comes with two additional glass fiber

cartridges, which are stored inside the handle, readily available for use. The price for the ELIMINATOR brush is \$6.95 post paid.

To order, or for further information, contact **Pro Motorcar Products, Inc., 22025 US 19 North, Clearwater, Florida 34625, (800/323-1090).**

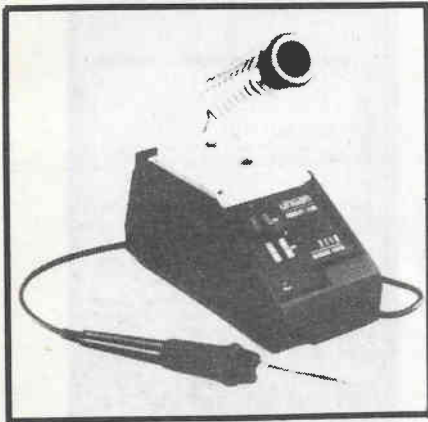

HIGH CAPACITY SOLDERING STATION

The **Ungar Model 2110** is a high capacity, ESD-safe station that performs virtually all soldering tasks. Its 60-watt, 24-volt micro handpiece has zero crossover, closed loop electronic control of the ceramic heating element over a temperature range of 550 F to 850 F. Features include a soft-touch cool-grip handle, burn-resistant cord, and replaceable long-life ceramic heater. The soldering iron comes standard with a thermal thrust, high capacity soldering tip which is used to handle thick multilayer boards, heavy ground planes and other difficult tasks. An optional tip retainer allows the soldering iron to accept standard micro tips for general purpose soldering. Easily calibrated at the station without disassembly, this CMOS-safe unit is fully grounded from tip to plug. (tip temperature ± 10 F). The station comes complete with static-dissipative power unit, on/off switch, power-on LED indicator, sponge, iron holder, soldering iron tip, 3-wire

cord and a 1-year warranty. A complete selection of soldering tip shapes and sizes is available to meet the demands of any soldering application.

For further information or answers to questions, contact **HMC, 33 Springdale Avenue, Canton, MA 02021, Phone (617) 821-1870, FAX (617) 821-4133.**

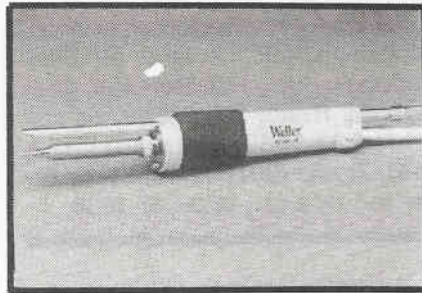

FUME EXTRACTOR SOLDERING IRON

These new soldering irons remove harmful fumes at the source while you solder. Designed to be used with existing fume removal systems, these irons have an adjustable stainless steel exhaust tube with a 3/16" diameter for precise positioning over the work area. They also have a cushioned grip for increased comfort. Two models are available. Model TC201FE plugs into Weller WTCPS or WTCPR soldering stations and comes with a PTA-7 tip. Model EC120FE plugs into Weller EC1001 or EC2001 soldering stations and comes complete with an ETA tip. Both irons come complete with 7 feet or 3/16" vinyl tubing.

For more information, call or write to **Contact East, Inc., 335 Willow Street, North Andover, MA 01845, (508) 682-2000, FAX (508) 688-7829.**

LINEAR AMPLIFIER PROTECTOR

Ameritron announces the new ICP-120 or ICP-240 InRush Current Protector for linear amplifiers... \$79.00.

Here is the best investment in protection and long term amplifier reliability you will ever make: the Ameritron InRush Current Protector. It works with any and all linear amplifiers, it protects both expensive tubes and costly power supply components from excessive current at turn-on, and its cost is less than a single repair bill. Installation is a cinch: simply plug your amplifier's AC cord into the Ameritron InRush Current Protector box, then plug the protector's plug into the wall socket.



The Ameritron ICP-120/ICP-240 step-starts your amplifier through a high power current limiting resistor. The resistor is then shorted with a relay to give a start-up sequence that is easy on the tube and power supply components. This stops damaging inrush current, allows your cold tube to warm up slowly, and maximizes life. Excessive inrush current to cold tube filaments is the leading cause of tube failures. The second most common failure is shorted diodes caused by high charging current to filter capacitors. Both of these problems are eliminated with the Ameritron ICP-120/ICP-240. All Ameritron amplifiers have this critical protection. Now you can add the protection to your own amplifier without complicated

NEW PRODUCTS PARADE

wiring. Momentary high voltage "spikes" can also cause damage to your amplifier. The Ameritron In-Rush Current Protector has built-in varistors to absorb these spikes before they cause damage. Many amateurs are unconsciously aware of "turn-on" wear to amplifiers and seldom use them. Install an Ameritron InRush Current Protector, and you can enjoy switching on your amplifier anytime desired and using it to your heart's content! Works with nearly all linear amplifiers. Ameritron ICP-120 for 120 volts up to 12 amps; ICP-240 for 240 volts up to 20 amps continuous.

To order, contact any Ameritron dealer. For more information or for the location of your nearest Ameritron dealer contact **Ameritron, 921 Louisville Road, Starkville, MS 39759, telephone (601) 323-5869; FAX: (601) 323-6551; or toll free at 800-647-1800.**

POCKET ROLL-UP ANTENNA

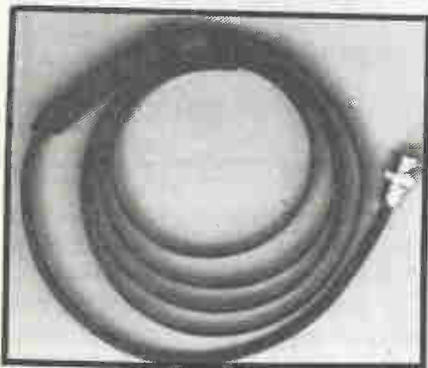

MFJ Enterprises, Inc. announces the new MFJ-1730 Pocket Roll-up "J" 2-Meter Antenna...\$14.95.

MFJ's new 1730 2 Meter half-wave vertical J antenna is ideal for traveling, vacationing, and motel use. You can roll up this half-wave 2 Meter gain antenna, stick it in your pocket, and go! Using the MFJ-1730 is a cinch: just hang it in a convenient spot, plug the handy BNC connector into your handheld, and enjoy base station performance almost anywhere!

The MFJ-1730 Roll-up antenna really adds big-time performance to your handheld. It is omni-directional and does not need an awkward ground plane. Works indoors and outdoors. Works with all 2 Meter handhelds. Good gain characteristics. Class half-wave "J" design.

It comes with MFJ's one full year unconditional guarantee.

For more information or to order, contact any MFJ dealer or **MFJ Enterprises, Inc., P.O. Box 494, Mississippi State, MS 39762, or call (601) 323-5869, Fax: (601) 323-6551, Telex: (601) 323-6551, or order toll-free at 1-800-647-1800.**

SCIENTIFIC CALCULATORS

For a follow-up to their HP-42S (reviewed in a previous issue of the "Handbook"), Hewlett-Packard now introduces two new scientific calculators: the HP 48S and the HP 32SII RPN.

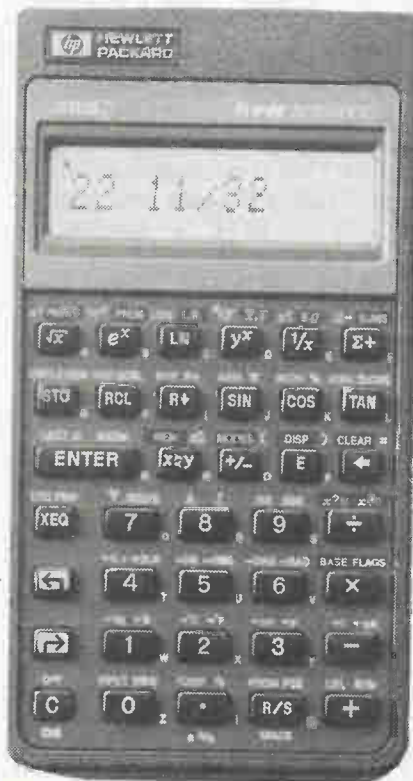

The HP 48S is part of the HP 48 family of high-end calculators aimed at students and professionals who solve complex problems. It contains all the features of the HP 48SX with the exception of the RAM/ROM memory-card slots.



The HP 32SII features HP's RPN entry system combined with algebraic-formula entry and evaluation and the HP Solve application. Its scientific functions include fraction-math, unit conversions, complex arithmetic, base-conversion statistics and numeric integration. For more information and/or details on these two new scientific calculators, contact: **Hewlett-Packard Co., 3000 Hanover Street, Palo Alto, California 94304, P.O. Box 10301, or Hewlett-Packard Company, 1000 Northeast Circle Boulevard, Corvallis, Oregon 97330-4239, Telephone (503) 757-2000.**

RADIO SHACK CIRCUIT BREADBOARD

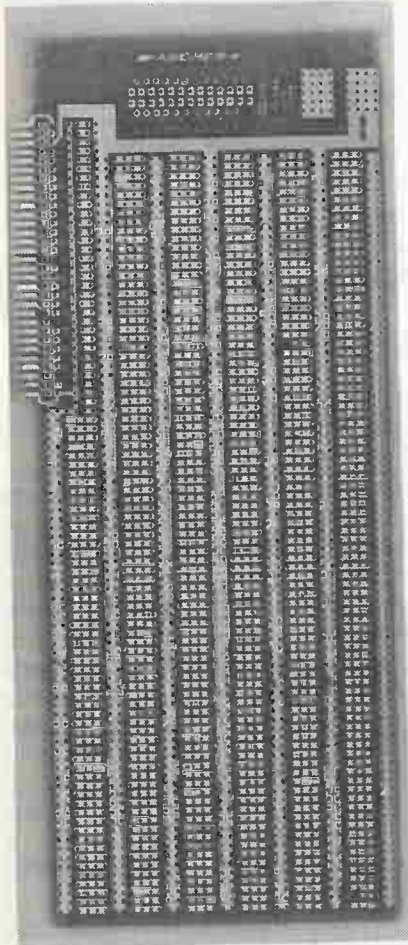

Radio Shack is now offering the new Archer Experimenter's Plug-In CaRD (Cat. No 276-1598) designed for use by technicians, students and hobbyists to breadboard digital and analog circuits. Its unique bus grid design allows easy access to power and ground hook-up points.

Made of sturdy epoxy glass composite material, the board has a card-edge compatible with XT style microcomputer expansion bus connectors. In addition, it has an input/output port designed to hold a right-angle DB25 connector. It measures 3&7/8 x 10&1/16 inches.

Board holes are plated-thru for electrical continuity and measure 0.042" in diameter spaced 0.100" on centers.

The Archer Experimenter Plug-in card sells for \$29.95 at over 7000 Radio Shack stores and participating dealers nationwide.

For further information, check your local Radio Shack outlet or write to **Radio Shack, 700 One Tandy Center, Fort Worth, Texas 76102, (817) 390-3300.**

MAGNETIC SENSING PROBE



By sensing the presence of magnetic fields, the "Lil Devil" Mag-Probe lets you test any electrical/electronic device for current or "glitches" without the use of schematics. It detects residual magnetism and/or transient current pulses as fast as 10 milliseconds and identifies north and south poles in AC and DC-powered solenoids, relays and any other device that uses a coil. You can safely and easily identify and separate electrical and mechanical problems accurately and inexpensively. With this trouble-shooting instrument, there's no need to refer to a schematic of the device being tested. Just place the probe tip close to the coil in the device. The LED in the Mag-Probe's handle lights if the device is energized. If

the LED stays unlit, the device is de-energized. Unlike an oscilloscope or voltmeter, the Mag-Probe operates without making a direct electrical connection. Two models are available. The standard sensitivity model tests large and standard-sized solenoids and relays. The high sensitivity model tests the full range, from the largest to sub-miniature devices, including most reed relays.

For more information and/or details, contact **HMC (Hub Material Company.) P.O. Box #526, Canton, MA 02021 (617) 821-1870.**

THIRD HAND



A **Third Hand**, offered by Jensen Tools Inc., has two adjustable arms anchored in a heavy base to prevent movement. Firm alligator jaws hold small parts to free the user's hands for soldering and fine adjustment work. This is an extremely versatile tool that can be adjusted to almost any position. It is a good value from Jensen at \$13.92 (subject to quantity discounts).

The **Third Hand** is featured in Jensen's 1992 Master Catalog. The catalog guarantees complete satisfaction and offers free shipping to any location in the Continental U.S.A. For a free copy, write or call Jensen Tools Inc., 7815 S. 46th., Phoenix AZ 85044. (602) 968-6231.

NEW BOOK REVIEWS



THE TALKING TELEPHONE by Steve Sokolowski

Anyone who's ever had the urge to supercharge his home telephone system will welcome author Steve Sokolowski's new book, *The Talking Telephone*. In it, Steve describes fifteen telephone-enhancement projects ranging in complexity from simple to advanced. Three of the most complicated projects incorporate National Semiconductor's Digitaltalker voice synthesizer chips, which are relatively inexpensive (\$27) and readily available. One speech project replaces a telephone's bell with a voice that shouts "Hello!" or some other attention-getting phrase. Feeling more ambitious? Well, Steve also presents a circuit that verbally announces the digits you dial, thereby providing immediate confirmation of a correctly dialed number. Such a project would be especially useful to a visually handicapped person. The third and final speech-related project shows how to make the Digitaltalker speak complete phrases by stringing together words contained in the Digitaltalker's ROM chips.

Not interested in speech? Well, maybe you'd like to replace your phone's annoying bell with something more soothing and pleasant. Four of the projects do just that. You can take your pick from among an English-style telephone ringer, a two-tone

ringer, an electronic ringer, and a melody ringer. The latter is particularly interesting, in that it is based on a chip capable of playing twelve different tunes.

Other worthwhile projects include a phone sentry (which screens out unwanted calls), a flip-flop hold button, and a music-on-hold adapter. Also included are three projects that provide digital displays of the number you've dialed. Though essentially similar, these three projects differ in complexity and the nature of the display they provide. Finally, for anyone who has been trying to stave off the unauthorized use of a telephone, the author presents an ingenious digital telephone lock that will foil even the most determined interloper.

In addition to the main projects just discussed, the book contains a collection of telephone-circuit building blocks which the reader can incorporate into his own designs. These circuits include a surge suppressor, polarity guard, common-ground converter, off-hook detector, ring detector, tone detector, phantom power supply, and universal telephone interface.

Since most readers are apt to know little or nothing about the theory of telephone communication, the author thankfully provides in his first three chapters a detailed introduction to telephone circuits and systems, including digital telephony. He also provides practical construction hints and advice on making printed circuits. (By the way, each project is accompanied by PCB artwork.) All things considered, Steve Sokolowski has done an outstanding job of making the mysteries of the telephone accessible to all of us.

The Talking Telephone, 337 pages, softcover: \$16.95, hardcover: \$25.95. TAB Book Co., Blue Ridge Summit, PA, 17214-9988. Telephone 1-800-822-8138.



ELECTRICAL WIRING by Arthur C. Seale, Jr.

You're a typical electronics enthusiast. You've studied circuit theory, you're hip to the fine points of solid-state theory, and your friends all say you're a wizard when it comes to repairing electronic equipment. So there's no reason why you couldn't do the electrical wiring in your own home, right? Perhaps, but remember that for safety's sake, your wiring must conform to the National Electrical Code, and a qualified inspector must verify that it does. You can't just run wires willy-nilly through the walls. So before you start, you'd better bone up on the proper techniques of electrical wiring. To do that, you might want to check out Arthur Seale's new book, which does an excellent job of explaining all aspects of electrical wiring.

The book begins by explaining the nature of the electrical power system, including generation, transmission, and distribution. It progresses to Ohm's Law (easy for you) and such mundane matters as splices (perhaps not so easy, until you've had a bit of practice). The importance of proper grounding is stressed, along with the need for ground fault circuit interrupters (GFCIs) to protect against electrical shocks. We also learn how to set up an electrical service entrance panel.

Since this is a book on electrical wiring, much of the discussion is about wire. We learn how to select the right type and gauge of wire for a particular branch circuit, based upon the anticipated current that the circuit will carry. We also learn about the myriad kinds of electrical hardware available, including conduit, connectors, couplings, and boxes to house switches and outlets. Metallic and non-metallic hardware is available, and we learn where each is best used. The book devotes ample space to the actual business of running wires and making connections. It shows the proper way to use wire-nut connectors and crimp connectors. And we see illustrations of the various kinds of switches and receptacles that are available.

Special attention is given to outdoor home wiring, which must be waterproof, and outdoor security lights, motion detectors, etc. The author even discusses wiring in connection with outdoor pools and hot tubs. The book's coverage extends beyond electrical power per se to include consideration of the wiring associated with security and alarm systems, television antennas, telephones, and cable TV. The book concludes with advice on fishing wires through walls (easier said than done, I'm afraid).

To answer the question that was posed at the beginning of this review: Yes, you can do your own electrical wiring, with a minimum of hassle, provided you've done some study in advance, and Arthur Seale's book is an excellent source for the information you'll need.

Electrical Wiring, 274 pages, softcover: \$19.95. Howard W. Sams & Co., 11711 N. College Ave., Carmel, IN, 46032. Telephone 1-800-257-5755.

PC POWER PROTECTION by Mark Waller

The biggest threat to the well-being of your computer is the electrical power that you feed it.

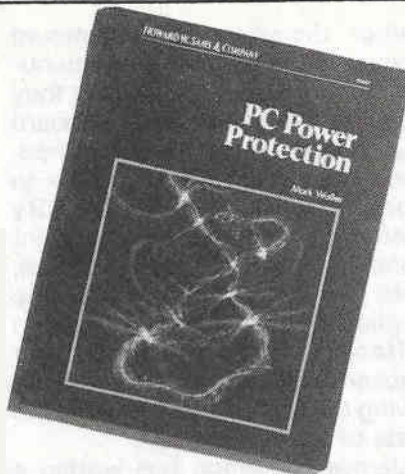

The danger lies not with the 120-volt, 60-Hz sine wave that your power outlet supplies, but with all the garbage that accompanies it. The switching on and off of motors and other inductive loads impresses high-voltage, short-duration transients on the normal line voltage. Nearby lightning strikes do much the same thing, but with far greater fury. Transient voltages and other power-line aberrations can do two things to your computer: they can destroy it outright, or they can cause it to lose valuable data. Neither outcome is a pleasant one, and so it makes sense to do as much as possible to ensure that power-line aberrations never reach your computer. **PC Power Protection** offers advice on how to do exactly that.

The book opens with an introduction to basic electrical principles, and then proceeds to document the various kinds of power-line aberrations that can wreak havoc on a computer: impulses, noise, drop-outs, surges, and sags. According to a survey published by IBM in 1972, the typical business can expect an average of two such disturbances per day. Not all of these will be killers, but such statistics point up the need for adequate power protection.

Author Mark Waller goes on to discuss how lightning, motors, and other culprits can induce power-line transients and noise,

and how improper electrical grounding in a power-distribution system can exacerbate the deadly effects of these power-line disturbances. He next discusses computer power supplies, both linear and switch-mode, and shows how these two types of supply differ in their susceptibility to transients and noise.

Having established the need for PC power protection, the author proceeds to show how it can be accomplished. Transient suppressors and power-line filters are the cheapest and least effective means of protection, but for the hobbyist who uses his computer only infrequently, they are probably sufficient. The problem with surge suppressors is that, after a sufficiently strong jolt, they may fail—and do so without warning, leaving the user with a false sense of security.

Better protection can be obtained, albeit at a higher price, with a so-called power conditioner, which is essentially a shielded isolation transformer that very effectively eliminates spikes and noise. In the opinion of the author, the power-line conditioner provides all the protection the average user will ever need, particularly if used in conjunction with a surge suppressor. But a power-line conditioner will not protect against the absence of power, which may be either momentary (in which case, it's called a dropout) or longterm (i.e., either a brownout or a blackout). To guard against the loss of voltage, you need an uninterruptible power supply, or UPS. Such a device uses a battery and an inverter to generate AC power for the computer when line voltage is low or absent. The UPS is a worthwhile investment primarily for businesses that use computers.

PC Power Protection, 220 pages, softbound: \$19.95. Howard W. Sams & Co., 11711 N. College Ave., Carmel, IN, 46032. Telephone 1-800-257-5755.

NEW BOOK REVIEWS

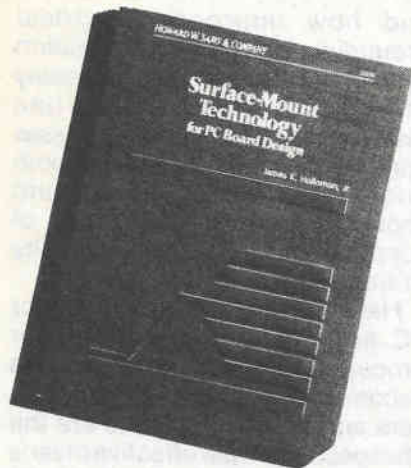

SURFACE-MOUNT TECHNOLOGY FOR PC BOARD DESIGN

By James K. Hollomon, Jr.

Electronic devices keep getting smaller and smaller. Today, camcorders fit in the palm of your hand; a television set takes up no more room than a notebook in your shirt pocket. It's a trend we all seem to take for granted, but how is it done? Some of the credit goes to large-scale integration, which packs transistors with ever-increasing density onto IC chips. But that is just part of the magic. At the board level, a relatively new phenomenon called surface-mount technology has changed the way components are packaged. The new surface-mount packages have leads that are spaced more closely; consequently, the packages themselves are smaller. Furthermore, the leads are no longer inserted into holes in the PC board; instead, they rest flat against the surface of the board, thus allowing components to be mounted on both the top and bottom of the board. The net result of the adoption of surface-mount techniques is to reduce circuit-board area by as much as 60%.

James Hollomon's new book is a professional guide to PCB fabrication using surface-mount technology. After reviewing the advantages and disadvantages of surface-mount technology, the

author discusses surface-mount components and the new manufacturing methodologies that they demand. New strategies of board layout and design are required, and the author covers these in considerable detail. Quality assurance, always an important consideration in PCB fabrication, gets good coverage too. Specific applications of surface-mount in different types of equipment appear throughout the book, thus giving the reader a feel for what the state of the art is today.

James Hollomon has written a comprehensive, 500-page reference on the techniques of PCB design and manufacture using surface-mount technology. The book is heartily recommended to engineers, manufacturers, and anyone else interested in high-density circuit fabrication. *Surface Mount Technology for PC Board Design* costs \$49.95 and is published by **Howard W. Sams, Division of MacMillan Computer Publishing, 11711 North College, Suite 141, Carmel, IN, 46032. Telephone 1-800-257-8247.**



IC TIMER COOKBOOK By Walter G. Jung

The introduction of the 555 timer by Signetics in 1972 was a watershed in the history of circuit design. Although the data sheet said simply that you could use it as a monostable or astable multivi-

brator, clever engineers soon found dozens of other uses for the device. In fact, it got to be so that you couldn't pick up an issue of *Electronic Design* or *EDN* without finding yet another application for the 555 timer. Author Walter Jung has compiled all those diverse applications into one handy reference book.

The book begins with a discussion of timer ICs—not just the venerable 555, but the XR-L555, the ICM7555, the 556, the 558, the 322, the 3905, and the 2240, too. The relevant design equations are presented along with a discussion of circuit operation. After that, we are treated to a whole slew of timer applications—too many for me to list all of them, but here are some highlights: one-shots, ramp generators, square-wave oscillators, time-delay circuits, function generators, burglar alarms, switch debouncers, edge detectors, flashers, tone generators, logic probes, a capacitance meter, a pulse generator, burst generators, and an A/D converter. Careful descriptions accompany each circuit, making this book useful as a textbook or as a reference.

No technical library is complete without something on timers, and this second edition of the *IC Timer Cookbook* is as good a reference as you're likely to find. It costs \$17.95 and is published by **Howard W. Sams, Division of MacMillan Computer Publishing, 11711 North College, Suite 141, Carmel, IN, 46032. Telephone 1-800-257-8247.**

DESIGNING, BUILDING & TESTING YOUR OWN SPEAKER SYSTEM, 3rd Ed. by David B. Weems

Back in the Dark Ages of high fidelity, the fifties and sixties, speaker design was something of a black art, practiced by wizards with names like Kloss, Klipsch,

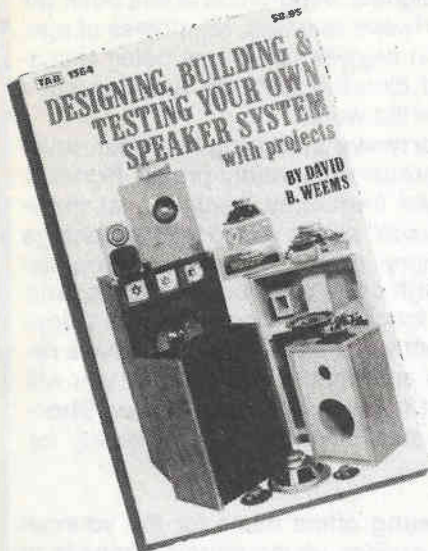

and Bose. Gradually, however, authors like David Weems began to spread the word that speaker design wasn't such a scary thing, and that even amateurs could build their own speaker systems and achieve good results, too. Today, many people enjoy building their own speaker systems, and it's a safe bet that a goodly percentage of those people got their inspiration from **Designing, Building & Testing Your Own Speaker System**, a classic that's now in its third edition.

The book begins with a discussion of drivers and their characteristics, such as frequency response, transient response, impedance, compliance, and damping. It then surveys the various types of enclosures currently in use, with particular emphasis on the closed-box (acoustic-suspension) and ported-box (bass-reflex) types, since these are the easiest to design and build. The design approach employed by the author is a graphical one. Once you've chosen a woofer and obtained its resonant frequency, Q, and compliance from the manufacturer's data sheet, you consult a few graphs and charts to find the right internal volume for your enclosure. You then build a box having the

required volume, such that the ratio of depth:width:length equals 0.62:1.0:1.62, or thereabouts. This eliminates unwanted resonance of the air in the box. Choose a compatible tweeter, and perhaps a midrange driver as well, build a crossover network, put it all together and—voila!—you've got a speaker system that sounds as good as a store-bought system costing two or three times as much. Suspicious because it all sounds so easy? Well, don't be. After you've read this book, you'll be building speakers like a pro.

Designing, Building & Testing Your Own Speaker System, 224 pages, softcover: \$16.95, hardcover: \$24.95. TAB Book Co., Blue Ridge Summit, PA, 17214-9988. Telephone 1-800-822-8138.

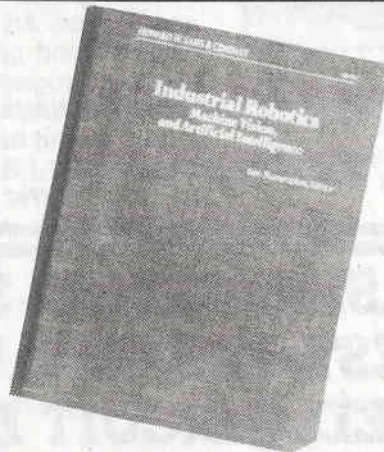

**INDUSTRIAL ROBOTICS,
MACHINE VISION, AND
ARTIFICIAL INTELLIGENCE**
Ken Stonecipher, Editor

Robotics is a fast-paced, highly innovative field in which ideas deemed revolutionary today may be passé tomorrow. When progress occurs so rapidly, it is sometimes difficult for workers in the field to keep up with the latest advancements. The book **Industrial Robotics, Machine Vision, and Artificial Intelligence** was written in an attempt to make the latest research available to newcomers as well as established workers in the field of industrial robotics. It is

not a textbook. Rather, it surveys work currently being done in various areas of industrial robotics, and directs the interested reader to books and research papers which further explain the subject. As such, this is a book that will primarily appeal to persons already familiar with robotics and computer science.

Chapter 1 describes the components that make up a robotic system, things like hydraulic actuators, electric motors, pneumatic actuators, and jointed arms. Chapter 2 describes the components of a typical machine-vision system: hardware such as cameras, and software designed to recognize images. Chapter 3 goes on to describe how two-dimensional images are analyzed, and Chapter 4 does the same for three-dimensional images.

Sensors and their use are covered in Chapter 5. Examples of the application of various sensors in an assembly-line robot are presented. Chapters 6 and 7 discuss artificial intelligence, by which is meant the ability of a machine to emulate human thought—specifically, by making inferences, learning new types of behavior, and recognizing patterns. The final chapter discusses applications of artificial intelligence in manufacturing.

Because the level of presentation is fairly advanced, this is not a book that will appeal to the hobbyist eager to learn about robotics. However, readers with experience in robotics or computer science will come away with a better understanding of how robotics is transforming industry today.

Industrial Robotics, Machine Vision, and Artificial Intelligence, 312 pages, softbound: \$39.95. Howard W. Sams & Co., Division of Macmillan Computer Publishing, 11711 N. College Ave., Carmel, IN, 46032. Telephone 1-800-257-5755.

SHORTWAVE LISTENERS GUIDE FOR APARTMENT/CONDO DWELLERS

By Ed Noll

Shortwave Listener's Guide for Apartment/Condo Dwellers

Edward M. Noll, W3FCJ



Shortwave Listener's Guide
for Apartment/Condo Dwellers



Willis Tower
Chicago, Illinois



Radio Regency
Columbus, Ohio



Radio Canada Broadcast Centre
Toronto, Ontario



Radio Station
Chicago, Illinois



Radio Station
Chicago, Illinois



Radio Station
Chicago, Illinois

A starter book about shortwave program listening with instructions for effective use of indoor antennas and accessories. You will learn where and when to listen for those signals that permit you to enjoy program content from remote corners of the world despite the limitations of your location.

Instructions help you to layout thin hook-up wire into effective antennas. Accessory items can be added to further boost weak signals. Information in this book will be helpful to all shortwave listeners, regardless of age, who are interested in enjoying programs being broadcast in English and directed to North America each evening from all over the world.

The hobby of **Shortwave Listening** has been revolutionized by numerous reasonably-priced Portable Receivers with digital frequency displays that make tuning easy. This "Guide" allows you to take advantage of a Receiver's Memory positions in planning your listening schedule. High cost, poor performance, and poor location are no longer valid excuses for not enjoying this rewarding hobby. For those of you who have retired and now live in apartments and condos, you will find the selectivity of modern Receivers makes **Shortwave Listening** a stimulating hobby...especially for Senior Citizens.

Shortwave Listening offers much for the younger generation also. It provides young people a means to evaluate different cultures, languages, music, news, geography and world politics. Shortwave Receivers are now being used extensively at all levels of High School and College. Any student can set up a **listening post** at home and enjoy good night-time reception and weekend programs.

SHORTWAVE LISTENER'S GUIDE (\$9.95) plus shipping and handling (\$3.00 USA \$8.00 Overseas)
Contact MFJ Books, P.O. Box #494, Mississippi State, MS 39762.

L2000 LASER/COPIER SHEETS THE EASIEST, FASTEST WAY TO: MAKE PRINTED CIRCUIT BOARDS OR LABEL ENCLOSURES

The procedure is simple, Just:

- Print pattern with a laser printer or plain paper copier to a sheet of L2000
- Iron pattern from the L2000 to board or enclosure
- Remove L2000 to find printed circuit pattern transferred to board and ready to etch!!!
- Enclosures can have any graphic design or label you wish. Why use amateurish label tapes?
- 8 1/2 x 11 L2000 Laser/Copier Sheets come with complete instructions and are fully guaranteed. Available only from:

**THUMB ELECTRONICS
P.O. BOX #344
MARYSVILLE, MI 48040**

- L2000 Laser/Copier Iron-on Resist Sheets are priced: 5 sheets for \$4.00 or 10 sheets for \$7.00 plus \$1.50 Shipping & Handling

CLASSIFIED FLEAMARKET



Digital Compass Kit

The perfect assembly project for school or for that budding electronic hobbyist.

The Digital Compass is a hand held device that senses all eight compass headings by lighting the appropriate LED.

By making use of the highly advanced Dinsmore Sensor, your compass kit can also provide accurate headings for your car or boat.

Kit comes complete with ALL parts, compass sensor, PC Board (2x3.5in), memory chip and assy. instructions (Less Housing & 9V Battery).



\$26.50

Suncoast Technologies
P.O. Box 5835
Spring Hill, FL 34606

VHS-VCR Repair Solution Sets I, II, III, IV, V, VI. Each contains 150 symptoms and cures, Cross Reference Chart, Free Assistance \$11.95 each. All six \$59.95. **Eagle Electronics, Box "D", 52053 Locks Lane, Granger, IN 46530.**

Design Tesla Coils! Any size, any power, quickly and easily on your IBM computer. Fantastic, fully graphic program! Only \$29.95. **W.C.N., 3283 Belvedere, Riverside, CA 92507**

ALL ABOUT CRYSTAL SETS. Theory and construction of crystal set radios. \$7.95 ppd USA. **Allabout Books, Dept. "H", Box #14155, Fremont, CA 94539.**

ALL ABOUT METERS. A Learn-by-doing history of the development of electrical meters. Build seven simple meters using common hardware. \$7.95 ppd USA. **Allabout Books, Dept. "H", Box #14155, Fremont, CA 94539.**

ELECTRONICS HANDBOOK

V11

P.O. Box #5148, N. Branch, N.J. 08876

- Yes. Enter my subscription — 4 issues ONLY \$15.00**
(Canada \$18.00...Foreign Postage add \$8.00...U.S. Funds)
- Payment enclosed. (Payable to: C&E Hobby Handbooks)**

PLEASE PRINT

NAME: _____

ADDRESS: _____

CITY: _____

STATE: _____ **ZIP** _____

**Lab Test
ELECTRONICS
HANDBOOK
For Yourself**

UNDERSTANDING

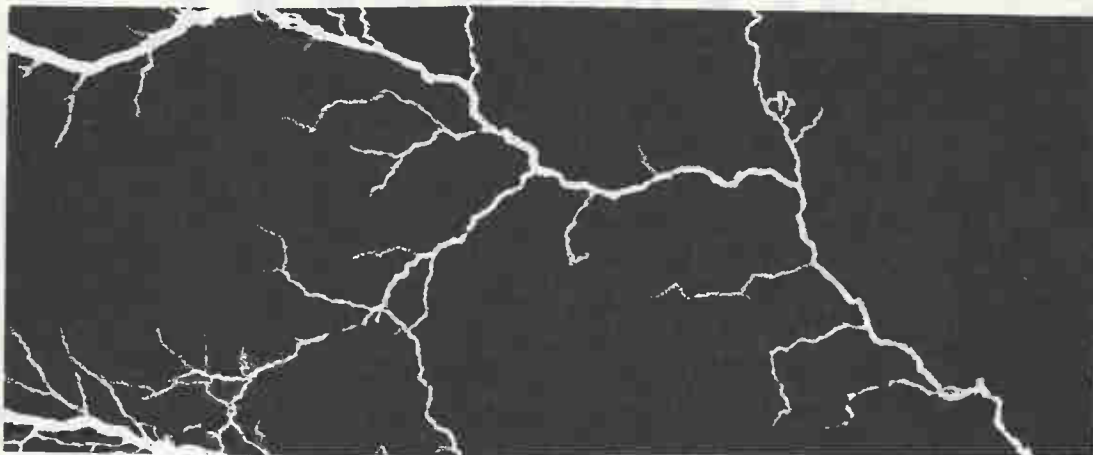

ELECTRICITY

By Ron C. Johnson, C.E.T.

PART III

Well, here we are again in this land of great potential, charging upwards, full power. Though significant currents continue to oppose our forces I remain steadfast in my resistance to their rise. In fact, I charge you...

Sorry. Just practicing my speech for the Electronics Club electrons, I mean elections, next week. Where were we?

Ah, yes! Last issue we learned about Scientific Notation, Engineering Units, and the resistor color code before we looked at series and parallel circuits. This time we'll put series and parallel together as well as looking at some practical aspects of meters, how they work and how to use them.

Alright then! Let's get series, I mean serious.

SERIES AND PARALLEL

Up to this point we have been learning about the very basic concepts of electricity and how we deal with the quantities involved. As we get into series-parallel networks we are finally talking about some practical aspects of the field, We can actually apply some of this stuff to real life situations. Here is an example.

Those of you who have an interest in stereo

equipment have probably run into the situation where a number of speakers were to be connected together to one power amp output. The power amp specs say that the amp is rated to drive into eight ohms. How should the speakers be connected to provide the correct load to the amp? This is an important consideration, (often ignored), and the consequences of doing it wrong range from inefficient operation, to distortion, to outright damage to the amp.

We don't worry about the technical reasons why it is

so critical to keep the load resistance close to the specified value, our job is make sure it is done.

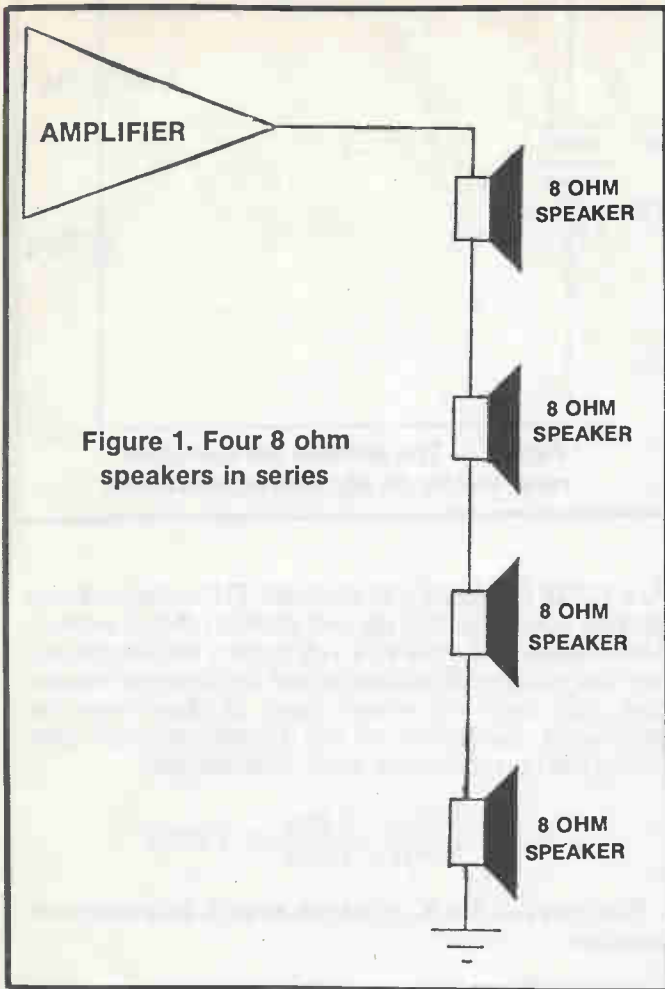

Let's assume that the available speakers are all eight ohms and that we have four of them to connect. Obviously, one of them connected to the amp by itself would be easy. To connect four is a little more complex. Connected all in series, (Figure 1), they would be additive as we saw in the last issue's segment. The total resistance would be:

$$8\Omega + 8\Omega + 8\Omega + 8\Omega = 32\Omega$$

This is obviously too much.

On the other hand, if they were all connected in parallel (Figure 2) the equivalent resistance seen by the amplifier would be:

Adding conductances in parallel

$$G_T = 1/R_T = 1/8\Omega + 1/8\Omega + 1/8\Omega + 1/8\Omega = 4/8\Omega = .5 \text{ Siemens}$$

or

$$R_T = 2\Omega$$

And this is much too low.

Now let's mix the two up. In Figure 3 we see a series-parallel combination where the two speakers in series are connected in parallel with two other speakers in series. Each brand of two speakers will have:

$$8\Omega + 8\Omega = 16\Omega$$

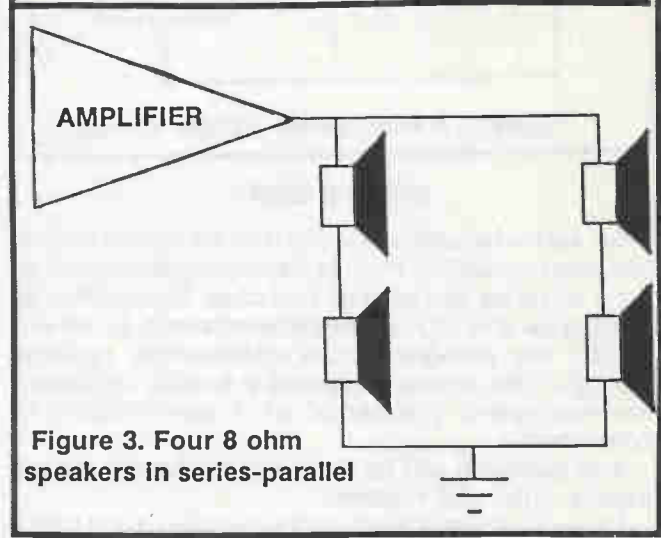
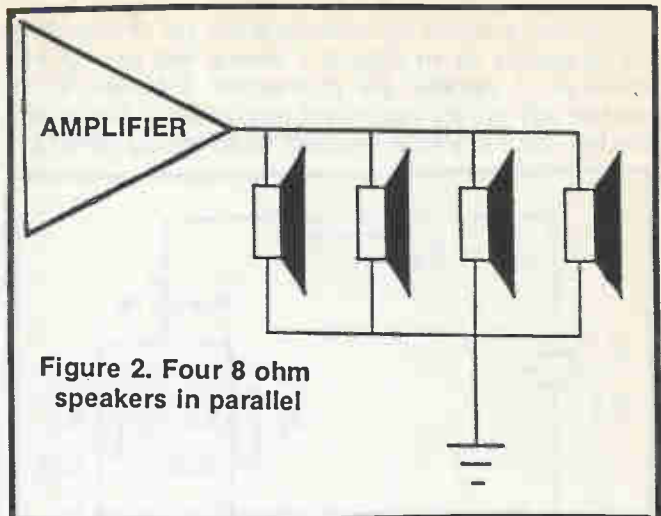

If we redraw the diagram substituting the equivalent 16Ω resistances we now have them in parallel (Figure 4). Combining them we get

Again adding conductances

$$G_T = 1/R_T = 1/16\Omega + 1/16\Omega = .125 \text{ Siemens}$$

and

$$R_T = 8\Omega$$

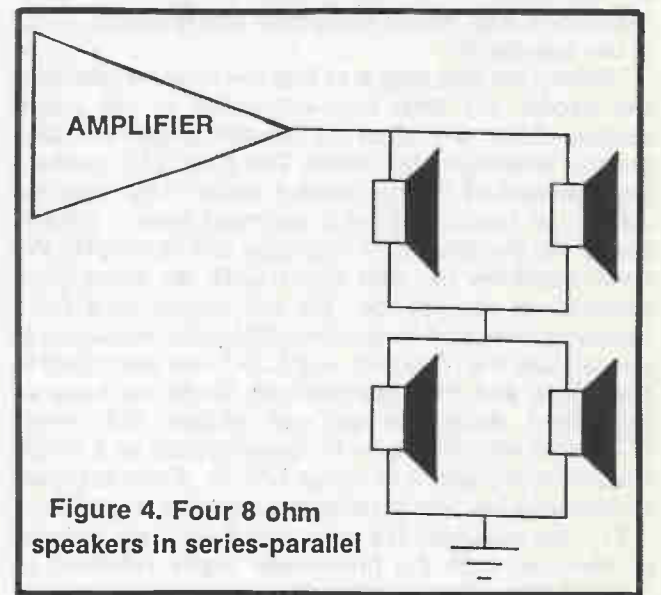

The same could be accomplished by configuring the speakers as in Figure 5 where two sets of 8Ω speakers in parallel are connected in series. Each parallel set has an equivalent resistance of 4Ω. When the two equivalents are added together we get 8Ω.

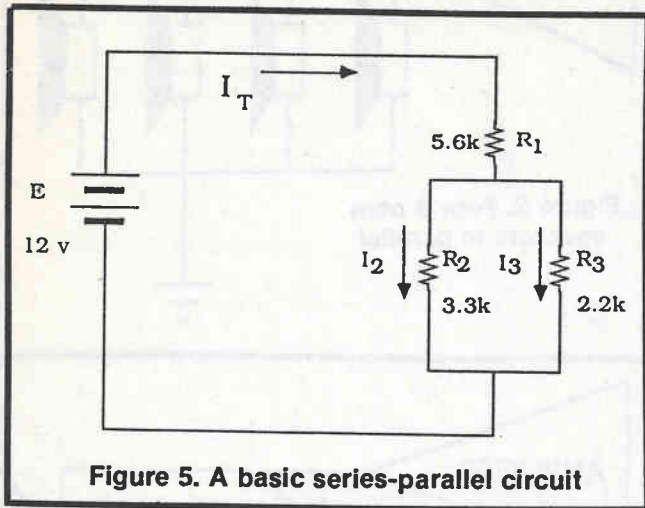

Figure 5. A basic series-parallel circuit

SOME THEORY

So series-parallel networks can be useful and, in fact, most practical circuits have complex combinations of series and parallel branches. Quite often we need to be able to analyze these networks so we can predict the voltages across components, currents through them, power dissipated in specific devices or the equivalent resistance of a combination of components.

And most of it can be done with the help of our old friends, Ohm and Kirchoff.

Figure 5 shows a basic series-parallel circuit with a DC voltage source. The total current flowing out of the voltage source is I_T . All of this current flows through R_1 . It then splits and some flows down through R_2 and some through R_3 . We will call these currents I_1 and I_2 respectively.

The sixty-four thousand dollar question is: How much will flow through each resistor? Also, how do we calculate R_T , I_T , the power dissipated in each resistor... Okay, so it's more than one question. What is the approach?

Usually the first step is to find the total resistance in the circuit: the total load presented to the power source. This will allow us to determine the total current flowing in the circuit. The trick is to combine the resistances in the correct order. Any time the current in the circuit splits we must have a parallel section in the circuit. In this case it is R_2 and R_3 . We can't combine R_1 with them until we know their equivalent resistance. So we either add their conductances and then convert back to resistance or we can use the "product over sum" rule described in the Rules and Formula section. Once we have an equivalent resistance we can redraw the circuit (Figure 6) with the $R_2 - R_3$ combination as a single resistor and place it in series with R_1 . From there we simply add the two resistances together to get R_T .

Try this example. It's easy and it will help you get comfortable with the procedure. Again referring to Figure 5 let's make R_1 a 5.6 kΩ resistor, R_2 a 3.3 kΩ and

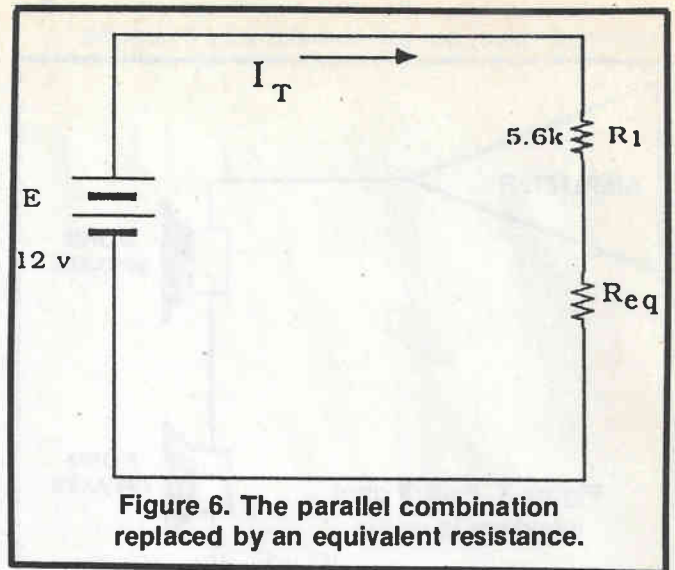

Figure 6. The parallel combination replaced by an equivalent resistance.

R_3 a 2.2 kΩ. (These are all standard EIA resistor values so you could set this up and confirm that it works.) The voltage source is a 12 volt battery but practically any low voltage DC source would do for experimentation. We said we would have to determine the equivalent resistance of the parallel branch first. Using the "product over sum" rule we get

$$R_{eq} = \frac{3.3k\Omega \times 2.2k\Omega}{3.3k\Omega + 2.2k\Omega} = 1.32k\Omega$$

We then put the R_{eq} in series with R_1 and add them together.

$$R_T = R_1 + R_{eq} = 5.6k\Omega + 1.32k\Omega = 6.92k\Omega$$

We could now redraw this again as a simple series circuit: a voltage source, one resistance and a current carrying path. But let's just calculate the total current flowing out of the voltage source:

$$I_T = E / R_T = 12v / 6.92k\Omega = 1.73 \text{ mAmps}$$

So now we know the source voltage, the total resistance in the circuit and the total current drawn from the supply. The purpose of our analysis will determine where we go from here. We could find the total power dissipated in the circuit using $P = I_T \times E$ and the information we have so far. Quite often though we want to know how the current splits through R_2 and R_3 . There are a couple of ways of finding this. We know one way using the tools we already have. You can check out the Rules and Formulas section for another way called current divider rule.

Take a look at Figure 6, again, where we have redrawn the circuit diagram showing the $R_2 - R_3$ parallel combination as an equivalent resistance. We have seen this circuit before and know how to find the voltage across R_{eq} . V_{Req} would be equal to R_{eq} times the current through it since R_{eq} is the equivalent resistance of the parallel section and I_T flows into that combination.

If V_{Req} is across R_{eq} then that same voltage is across the parallel combination of R_2 and R_3 which means that each resistor has the same voltage, V_{Req} across it. To determine the current through either one of those resistors we just use Ohm's Law:

$$I_{R2} = V_{Req} / R_2$$

and

$$I_{R3} = V_{Req} / R_1$$

These two values of current should add up to I_T which was calculated before. (Just for practice, go ahead and calculate these currents and check).

All of this brings up some rules which, while they are not absolutely necessary to know, can be useful in this process of circuit analysis.

I know, more rules and formulas, but they are pretty simple and can help streamline your analysis technique.

KCL

No, this doesn't stand for Kentucky Cooked Lizard. Actually Kirchoff had two good ideas. Kirchoff's Current Law states that the algebraic sum of all the currents entering and leaving a node will equal zero. What this really means is: "what goes in has to come out." A node is an electrical connection of two or more components. If current flows in from one branch the same amount has to flow out somewhere. In our previous example the current, I_T flowed into Node A, where R_1 connects to R_2 and R_3 . The same amount of current—the total of I_2 and I_3 —must equal I_T . Another way of calculating how much flows in each branch (Current Divider Rule) is shown in the Rules and Formulas section along with a method of finding the voltage across a resistor in a series circuit (Voltage Divider Rule).

METERS

Probably most of you have had an opportunity to use a meter at one time or another. Perhaps you have one of your own. Our purpose here is not to cover the use of meters as much as to talk about how meters relate to this subject of series-parallel circuits. Even so, we'll take a general look at meters as a way of introduction.

We could categorize meters in several ways. We could differentiate between, analog and digital meters, bench meters and portables, specialty meters versus general purpose, or high accuracy versus economy units.

For our purposes let's talk about functions. The basic meter we are considering measures voltage, current and resistance, the quantities we have been dealing with in this series. In addition to DC values most meters of this type will measure alternating currents and voltages. Older units were called VOM's (Volt Ohm Meter) while others were TVM's (Transistorized Volt Meters), VTVM's (Vacuum Tube Voltmeters), and more recently DVM's (Digital Voltmeters). In all cases, though, the same quantities were measured. Before the advent of digital technology and the availability of digital displays,

bench and portable test meters used various kinds of electromechanical meter movements for indication. Many were excellent pieces of test equipment considering the delicacy of their meters movements, difficulty of interpreting scales and limited specifications. (More on that later.)

Digital meters, which have replaced analog for most applications, have benefited, not just by their solid state displays but also by the improved technology used in their input sections. In addition to being more rugged, generally, they can fit more functions in a smaller package and give better specifications.

We'll take a look at some actual products and their use in another segment.

The important concept that must be understood is that although the equipment available is generally very good, meters do have an effect on the circuit they measure. Figure 7 shows a simple series circuit with two resistors, R_1 and R_2 and a 20 volt source. Let's imagine that you have been asked to measure the voltage across R_2 with the meter shown. If the meter was perfect it could be connected across R_2 and it would indicate the voltage dropped there. We could predict what that voltage should be by using voltage divider rule to calculate it.

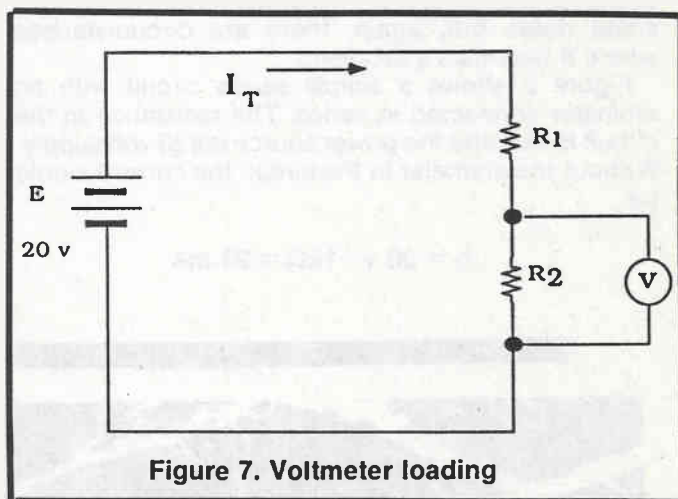

Figure 7. Voltmeter loading

A perfect or ideal meter would look like an infinite resistance and so would draw zero current from the circuit and consequently have no effect on it. However, meters are never ideal. Such is life. In reality meters have an internal resistance which, while very high, is a finite value. So in order to use our own meter intelligently we need to know under what conditions it will "load down" the circuit. If it loads down the circuit it will give significantly erroneous readings.

For example, digital meters often have an input resistance specification of over $1M\Omega$ which is very high—much higher than most analog VOM's. If R_1 and R_2 in Figure 7 were 100Ω resistors we could calculate V_{R2} to be 10 volts. If the meter ($1M\Omega$) were connected across R_2 we would have to consider a $1M\Omega$ resistor to have been connected across R_2 . We would then recalculate V_{R2} based on an R_{eq} of 100Ω in parallel with $1M\Omega$. In this case the change in R_{eq} would be negligible.

But what if R_1 and R_2 were $1\text{M}\Omega$ each?

In that case V_{R_2} should still be 10 volts, because the ratio of the resistors is still the same, but now R_{eq} would be a $1\text{M}\Omega$ resistor in parallel with a $1\text{M}\Omega$ meter resistance which would equal $500\text{k}\Omega$. Using the voltage divider rule and the equivalent resistance we would get:

$$V_{R_2} = (500\text{k}\Omega / 1.5\text{M}\Omega) \times 20\text{volts} = 6.67\text{volts}$$

So the meter would read 6.67 volts even though it should be reading 10 volts. This is a case where the meter is loading down the circuit. Sometimes this is difficult to avoid but at least being aware of the problem helps to understand why you are getting unexpected readings. This will happen when measuring voltages across high values of resistance.

A similar situation can come up when measuring current. We have been saying that we always talk about the current "through" a component so it makes sense that in order to measure current we have to break into the circuit and route the current through the meter. Ideally the meter, when measuring current, would have zero resistance, thereby contributing nothing to the total circuit resistance. Practically speaking, the resistance of an ammeter is very low, usually just a few ohms. This presents no problems in some cases but, again, there are circumstances where it becomes a problem.

Figure 8 shows a simple series circuit with an ammeter connected in series. The resistance in the circuit is $1\text{k}\Omega$ and the power source is a 20 volt supply. Without the ammeter in the circuit the current would be:

$$I_T = 20\text{ v} / 1\text{k}\Omega = 20\text{ mA}$$

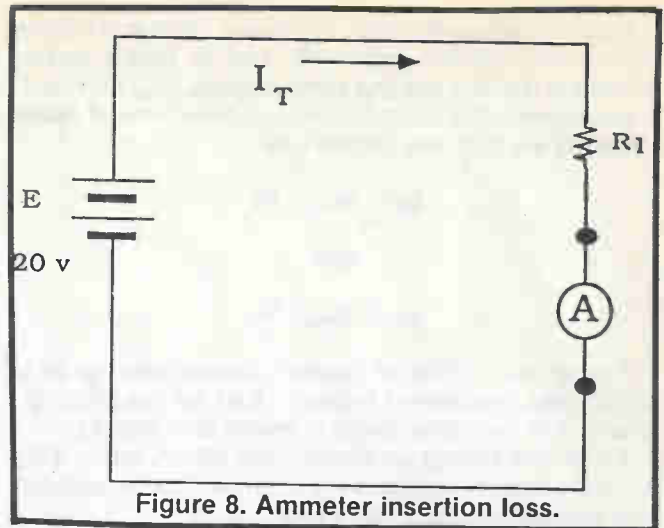

Figure 8. Ammeter insertion loss.

With the ammeter in the circuit we are adding 10Ω to the total resistance. Ten ohms is small compared to the $1\text{k}\Omega$ resistor and will make practically no difference to the total current. On the other hand, if the circuit resistance was 20Ω (which would give a current of 1 amp) adding the ammeter to the circuit would change the total resistance to 30Ω instead of 20Ω . This would limit the current to 667 mA instead of 1 amp so the meter would be affecting the operation of the circuit.

Again we must be aware that when connecting an ammeter in series with a circuit which has a low total resistance that the meter will affect the circuit noticeably.

Well, that about wraps it up for this issue. Next time we'll talk about ideal and practical DC energy sources before we move on into some basics of Alternating voltage and current.

Hope we didn't load down your circuits. ■

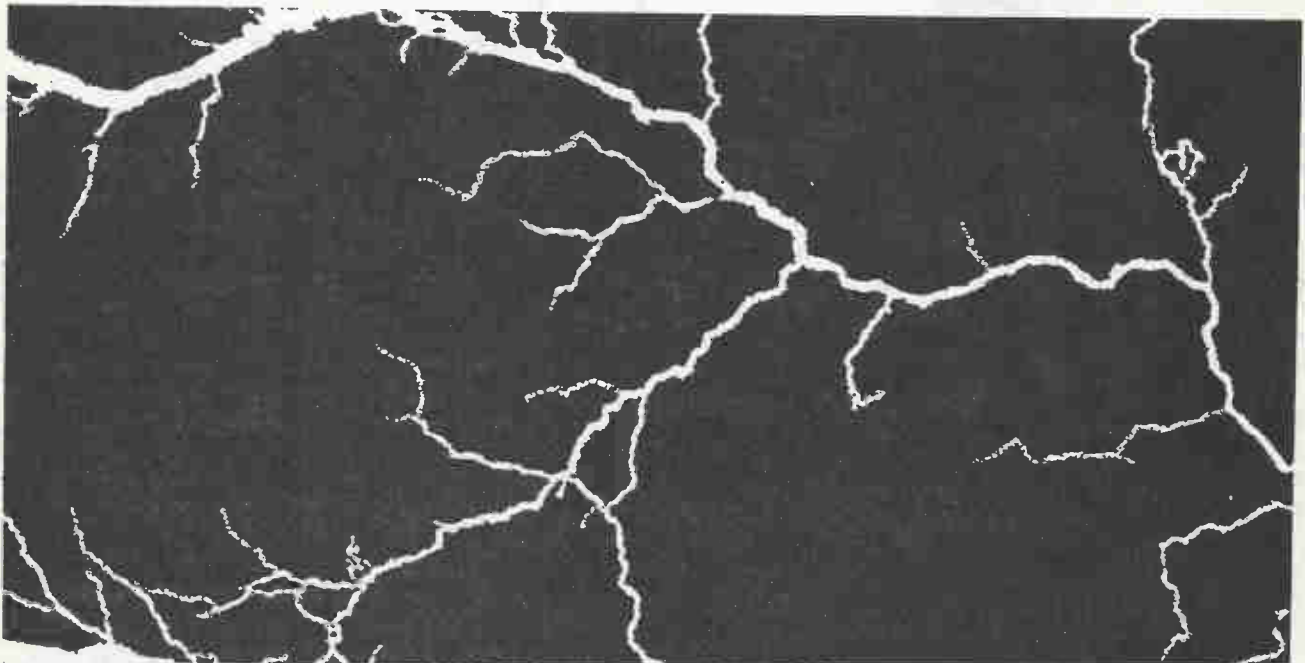

UNDERSTANDING ELECTRICITY

SOME USEFUL RULES AND FORMULAS

In last month's segment we talked about how to calculate equivalent resistances. We said that resistances in series are just added together but to determine the equivalent resistance or resistors in parallel the simplest way was to use conductances. So:

$$G_T = 1/R_T = 1/R_1 + 1/R_2 + \dots + 1/R_N$$

where G_T is conductance in Siemens, S, and N is the number of resistors.

This will calculate the equivalent resistance for any number of parallel resistors. But if you have just two resistors in parallel it may be simpler to use what is called the "product over sum" method. (This is just a derivation of the conductance method.)

$$R_{eq} = \frac{R_1 \times R_2}{R_1 + R_2}$$

If you have more than two resistors in parallel, any two can be reduced to an equivalent which can then be combined with the third.

In the case where resistors of the same value are in parallel the value of the resistors divided by the number of resistors will give the equivalent:

$$R_{eq} = R/N$$

Voltage Divider Rule

Kirchoff tells us that around any loop the voltage rises must equal the voltage drops. Last issue we calculated the total resistance in a series loop and found the total current. We then multiplied the value of a particular resistor times the current to find the voltage drop across that resistor. Voltage divider rule is just a quicker way to do the same thing.

Given a series circuit with two resistors (R_1 and R_2) we can find the voltage across either one by using the following formula:

$$V_{R1} = E \times R_1 / (R_1 + R_2)$$

or

$$V_{R2} = E \times R_2 / (R_1 + R_2)$$

What the formula is saying is that the voltage across the resistor will be proportional to the ratio of that resistor to the total resistance of the circuit.

Current Divider Rule

Current divider rule is used to determine how much current splits down the branches of a parallel circuit and as in VDR it uses a ratio. In this case, however, the current through a resistor in one branch is proportional to the ratio of the resistance of the other branch to the total resistance.

$$I_{R1} = I_T \times R_2 / (R_1 + R_2)$$

and

$$I_{R2} = I_T \times R_1 / (R_1 + R_2)$$



If You're Serious About a Future in Electronics, Ensure that Future with the Best Educational Training Available.

FREE!

SEND FOR YOUR CIE HOME
STUDY COURSE CATALOG AND
RECEIVE A FREE 24-PAGE CIE
ELECTRONICS SYMBOL HANDBOOK!

Includes hundreds of the most frequently
used electronic symbols. Published by
CIE exclusively for our students and
alumni. Yours free when you
request a CIE Course Catalog.

electronics

If you want to learn about electronics, and earn a good income with that knowledge then CIE is your best educational value.

CIE's reputation as the world leader in home study electronics is based solely on the success of our graduates. And we've earned that reputation with an unconditional commitment to provide our students with the very best electronics training.

Just ask any of the 150,000-plus graduates of the Cleveland Institute of Electronics who are working in high-paying positions with aerospace, computer, medical, automotive and communication firms throughout the world.



They'll tell you success didn't come easy...but, it did come....thanks to CIE. And today, a career in electronics offers more opportunities and greater rewards than ever before.

CIE's COMMITTED TO BEING THE BEST....IN ONE AREA....ELECTRONICS.

CIE isn't another be-everything-to-everybody school. We teach only one subject and we believe we're the best at what we do. Also, CIE is accredited by the National Home Study Council. And with more than a 1,000 graduates each year, we're the largest home study school specializing exclusively in electronics. CIE has been training career-minded students like yourself for nearly 60 years and we're the best at our subject ELECTRONICS ... BECAUSE IT'S THE ONLY SUBJECT WE TEACH!

CIE PROVIDES YOU WITH A LEARNING METHOD SO GOOD, IT'S PATENTED.

CIE's Auto-programmed lessons are a proven learning method for building valuable electronics career skills. Each lesson is designed to take you step-by-step and principle-by-principle. And while all CIE lessons are designed for independent study, CIE's instructors are personally available to assist you with just a toll-free call. The result is practical training... the kind of experience you can put to work in today's marketplace.

LEARN BY DOING...WITH STATE-OF-THE-ART FACILITIES AND EQUIPMENT.

In 1969, CIE pioneered the first Electronics Laboratory course and in 1984, the first Microprocessor Laboratory course. Today, no other home study school can match CIE's state-of-the-art equipment and training. And all your laboratory equipment, books, and lessons are included in your tuition. It's all yours to use while you study at home and for on -the -job after graduation.

PERSONALIZED TRAINING....TO MATCH YOUR BACKGROUND.

While some of our students have a working knowledge of electronics others are just starting out. That's why we've developed twelve career courses and an A.A.S. Degree program to choose from. So, even if your not sure which electronics career is best for you, CIE can get you started with



core lessons applicable to all areas of electronics. And every CIE course you take earns you credit towards completion of your Associate in Applied Science Degree. So you can work toward your degree in stages or as fast as you wish. In fact, CIE is the only school that actually rewards you for fast study, which can save you thousands of dollars.

SEND TODAY FOR YOUR CIE COURSE CATALOG AND WE'LL SEND YOU A FREE 24 PAGE CIE ELECTRONICS SYMBOL HANDBOOK!

FINANCIAL AID AVAILABLE TO QUALIFIED INDIVIDUALS.

WHY CHOOSE CIE FOR YOUR TRAINING?

- 150,000 successful graduates from every country around the world.
- Only CIE rewards you for fast study. CIE offers an Associate Degree program based on actual study time used. The faster you complete your degree the less your overall tuition.
- State-of-the-art laboratory equipment is yours to keep and it comes assembled, ready for hands-on experiments.
- Approved for educational benefits under the G.I. Bill for veterans and other eligible persons.
- Upon graduation, CIE offers free preparation to pass the Certified Electronics Technician Exams.

YES! I want to get started. Send me my CIE school catalog including details about the Associate Degree Program. (For your convenience, CIE will have a representative contact you -> there is no obligation.)

Name: _____

Address: _____

City: _____ State: _____

Zip: _____ Age: _____

Phone No. (_____) _____

Check box for G.I. Bulletin Benefits

Veteran Active Duty



CLEVELAND INSTITUTE OF ELECTRONICS
1776 East 17th Street
Cleveland, Ohio 44114
(216) 781-9400



A school of thousands.
A class of one.
Since 1934.

AFW04

A VOICE IN THE OUTBACK

By Tony Lee

In this era of momentous electronic breakthroughs in communications and medical science, it might be understandable that we could forget that not many years ago, people in many parts of the world struggled to survive.

While it is true that some of these people still struggle to overcome their adversities, it is worth noting here, the part that early radio communication and the indomitable perseverance of pioneers in radio communication, like John Flynn, Alf Traeger and others led the way to a new world of hope and development in the Australian "Outback".

John Flynn, the founder of the Australian Flying Doctor Service, envisaged a "Mantle of Safety" over the entire outback—a sunburnt, inhospitable region covering an area of 5,000,000 square miles.

In 1918, he knew little of aviation and still less about radio communication but he was quick to realize that without a radio network in the outback, it would be virtually impossible to administer medical assistance to the isolated cattle and sheep stations (ranches), and other outposts.

In those days, it wasn't uncommon for a ranch hand to travel two or three hundred miles on horseback to summon help, only to find the doctor out of town attending another patient at another far-flung outpost.

In many cases, medical advice alone would have been sufficient to prolong the life of a sick child until professional help arrived. But health and safety were not the only concern of Flynn. On his frequent visits to the outback, he saw the crushing effect of isolation and loneliness on the outback community. Women in particular suffered from deprivation and fear when their menfolk were away for weeks or months at a time, mustering or driving stock to the railhead.

Quite often, calls for medical help arose from nothing more than a debilitating aberration. Sturdy, healthy bush men broke down. Some found escape in alcohol, others in suicide...all for the sound of a human voice!

Radio telephony was in its infancy in the early twenties. Throughout Europe and Britain, there were only six radio telephone stations in operation. Some outback Australian towns had telegraph offices, and telephone lines had been installed along railroad tracks but for long-distance communication; the transmission of a message was agonizingly slow and tedious.

When a young ranch-hand sustained serious internal injuries when he was thrown from his horse, he was taken in a buckboard the forty-seven miles to an outpost telegraph office. The operator could not contact the nearest doctor 250 miles away so he tapped out a

message to a Perth doctor through 2,283 miles of telephone wire.

Because of the inferior batteries of that period, messages had to be relayed through several telegraph stations at the maximum permissible speed of 25 words a minute. The recipient listened to the telegraph sounder and recorded the message in long-hand. No priority was given to emergency messages over regular telegrams.

Joe Flynn's plan was to establish a radio network across the outback, using base stations attached to hospital and aerial transport facilities. Each base or mother station would reach out to a number of isolated habitations installed with transceivers.

He reviewed the state-of-the-art as it was at that time and three major systems emerged, each at a different state of development. Communication began with the electric telegraph which relied on miles of wire to transmit and receive messages, and used a Morse key, a sounder and a battery.

Simple though it was, the installation of wires connecting hundreds of outlying communities was not a viable proposition. But much progress had been made in the field of radio telegraphy. Although it still depended on Morse code as the means of transmitting and receiving a message, the system dispensed with wires which proved a quantum leap forward in the search for the ideal "outback" communication service.

The earliest designs employed spark transmission. Hertz, Marconi and others had demonstrated how the low-voltage primary winding of an induction coil could produce a high-tension spark in the secondary coil. This in turn could produce electro-magnetic waves in an aerial coil which radiated out from the aerial like the ripples from a stone thrown into a pond.

A receiver at some distance away could pick up the signals by using an aerial of similar length. Later experiments enabled the receiver to be tuned to the same

wavelength using adjustable aerial coils, and this was further refined with an adjustable condenser.

The spark-gap transmitter was later replaced by the far more efficient oscillator design which employed Lee De Forest's triode, the first amplifying vacuum tube invented, and Edwin Armstrong's regenerative circuit. Not only did it produce a purer tone for Morse reception compared with the staccato buzz of a spark gap, but it required far less input power to achieve a greater transmission range. This was indeed another step forward of major significance.

The third and unquestionably the most important development was the radio telephone, capable of voice transmission but fraught with obstacles.

In 1918, the radio (or wireless) telephone was limited to the armed forces, some merchant shipping and a few amateur experimenters. The 'wireless' enthusiasts had reported to Flynn that equipment was available with a range of 300 miles. Sadly, this was not the case. The best portable equipment developed by the R.A.F. had a range of only thirty miles.

Another published report stated: "There are now on the market some very compact machines, capable of transport on the backs of two horses!" This was certainly not what Flynn had in mind. His goal was to provide the outback folk with a long-range, low powered sturdy, cheap set, easy to operate and easy to maintain. He was ahead of his time.

The first Atlantic broadcast by radio telephony in 1915 used 300 vacuum tubes! The apparatus was clumsy and fragile, prone to breakdown and consumed enormous power, and electric power was one commodity the "outback" folk didn't possess. A "portable" radio telephone of that era required the equivalent of six car batteries to power it. It also needed a stable high-tension supply for its continuous carrier wave to ensure reliable transmission.

Joe Flynn had to contend with all these issues and decide on the best approach. If he was to gain support and raise funds for his ambitious program, he would need to demonstrate the practicality of it. His immediate objective therefore was to set up a mother station capable of servicing several outposts.

Because of the complexity of radio telephony, he opted for radio telegraphic equipment for the outposts and radio telephony at the base station.

It would be difficult enough for the amateur operators at the homestead (ranch-house) to send Morse code, let alone receive it. This made sense since it would enable the Flying Doctor or other personnel to speak directly to a patient using headphones or a loudspeaker, and give comfort and advice.

Flynn had made many friends amongst the wireless fraternity, many of whom were amateur radio operators and backyard hobbyists. It wasn't long after Marconi sent his first Morse signal across the Atlantic that the "backyarders" were communicating with each other across the length and breadth of Australia. Perhaps it was Australia's geographical isolation that placed it in the forefront of communication development.

Flynn had made many friends amongst the wireless fraternity, many of whom were radio operators and

backyard hobbyists. It wasn't long after Marconi sent his first Morse signal across the Atlantic that the "backyarders" were communicating with each other across the length and breadth of Australia. Perhaps it was Australia's geographical isolation that placed it in the forefront of communication development.

Whatever the reason, tribute must be paid to the amateurs who, with the restrictions placed on them by the "professionals", made such strides in the 100-Meter band. While the professionals grappled with their medium and long wavebands of 300 to 3000 Meters, using massive power to achieve the greatest distance, the shortwave brotherhood with their low-power, less complex home-made equipment, were getting remarkable results. Max Howden, a "ham" operator in Melbourne was the first to send a radio signal to be picked up in England.

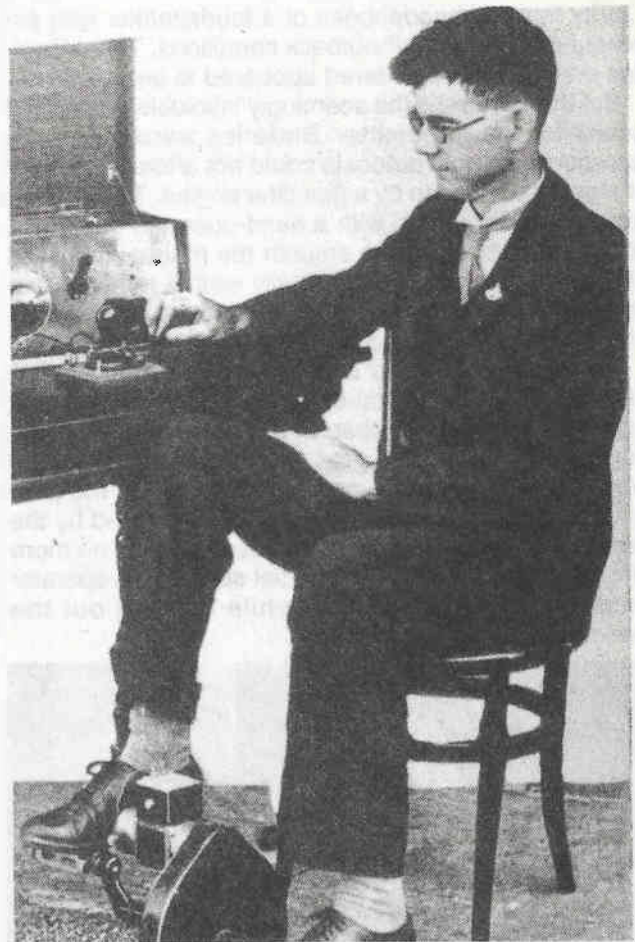

Alf Traeger about 1930, demonstrating his pedal generator and transceiver. The equipment can be seen in the Flying Doctor Museum at Alice Springs in Central Australia.

Amateurs around the world were in contact with each other well before the professional stations, notwithstanding the limitation imposed of 25 Watts maximum output. With clever aerial arrays and transmitting at night when the Heavyside layer supposedly comes closer to Earth, they achieved maximum range.

But in the early 1920's, the wireless devotees could not provide Flynn with a transceiver suitable for outback conditions.

The problems relating to portability, power supply and reliability seemed insurmountable. And then Flynn met Alf Traeger, a gifted young electrical engineer and holder of an amateur radio operators license. He joined forces with Flynn and together they made several sorties to the outback, with Flynn's battered Dodge truck weighed down with radio apparatus, aerial masts and spare parts. But their experiments were unsuccessful and Traeger returned to his workshop in Adelaide.

First he made extensive modifications to the receiver and came up with a low-powered design using only two vacuum tubes. The low voltage batteries were lightweight and had a life expectancy of at least four months. Clarity through headphones or a loudspeaker was excellent under "normal" outback conditions. The difficulties previously encountered appeared to be resolved.

Clarity through headphones or a loudspeaker was excellent under "normal" outback conditions. The difficulties previously encountered appeared to be resolved.

But there was still the seemingly insoluble problem of power for the transmitter. Batteries were out of the question and most outposts could not afford the luxury of a generator driven by a gasoline engine. Traeger had already experimented with a hand-operated generator, using a quartz crystal to smooth the manual input but although it performed reasonably well, it required two operators; one to crank the generator, the other to operate the Morse key and adjust the receiver.

And then came the breakthrough he had been searching for—the pedal-operated generator that was to give a voice to the outback. He built an oil-filled gearbox to which he attached the cranks and pedals from a bicycle. At the top of the gearbox he mounted the generator which supplied the twenty watts required by the transmitter. It was a resounding success. With no more effort than riding a bicycle on a flat surface, an operator could generate the power while tapping out the message.

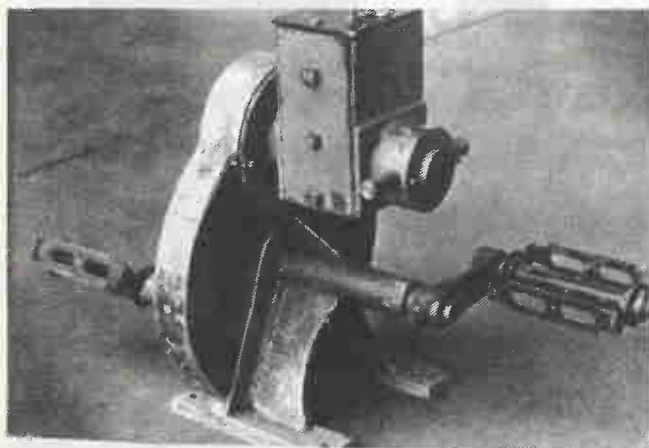

Above: the pedal radio generator, developed by Alf Traeger, which solved the power problem at remote habitations in the early twenties.

Armed with six sets of radio tranceivers and pedal generators, Traeger set out for Cloncurry, a remote town in far-north Queensland, to establish the first radio network for the Flying Doctor Service—an area of 90,000 square miles.

There was no time to lose before the wet season set in, and with the help of the newly appointed radio operator, Harry Kinzbrunner, he installed the base station at Cloncurry. A Lister gasoline engine in a shed at the back of the small church ran the generator for the 200 watt telephony transmitter, which was installed in the vestry. After carrying out some tests, he left Kinzbrunner at the base station and headed for the first outpost, Augusta Downs Station 180 miles north of Cloncurry.

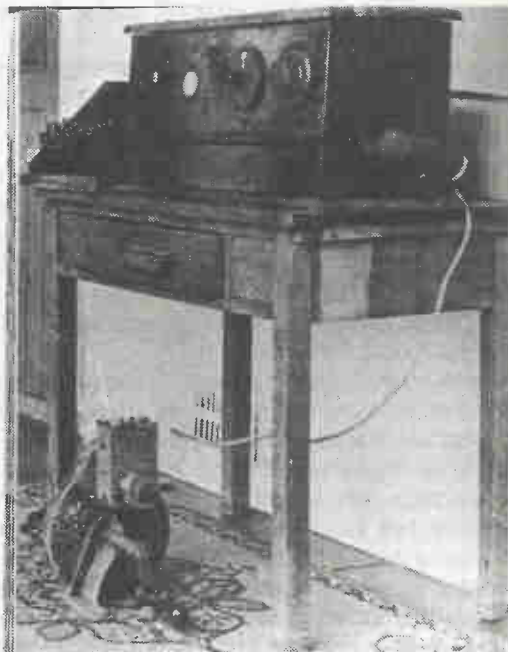

Traeger's complete "outback" transceiver. Note the keyboard on the left of the cabinet. It dispensed with the need to learn and transmit Morse code.

Accompanied by George Scott (a Patrol Padre from the Inland Mission) as his assistant, Traeger installed the pedal radio, as it became known, and erected the sixty-foot aerial mast. Then he taught the wife of the station manager to use the Morse key and operate the controls.



The little girl waits with the pedal generator while her mother jots down a message from the "Flying Doctor." The photo was taken in the early 1940's after the radio telephone had replaced radio telegraphy.



The expression says it all! A visiting "Flying Doctor" immunizes a child on a cattle station.

Ten days of preparation and Traeger was ready to contact Kinzbrunner who was standing by. The excited family and ranch-hands crowded around the tranceiver; Mrs. Rothery waiting with her hand on the Morse key. She turned nervously to Traeger and asked, "What shall I send?" "Try sending 'Hello Harry,'" he suggested. The story goes that Kinzbrunner received the message: "Hell OHell OHarry!" It caused much amusement among the outback community but it was an historic moment and one that Flynn would have been proud of.

Unfortunately, he was on a world tour at the time; financed by his aviation and radio friends. But before he left, he agreed that it would be advisable to instruct the womenfolk on the operation of the radio equipment because they seldom left the homestead and were often left alone with the children.

Traeger went on to install the other five pedal radio's at outposts hundreds of miles apart, and it was after leaving the fourth that tragedy struck. Sister Gilbert, a nurse working on one of the most remote outposts in Australia—Birdsville, became ill. She and her colleagues had been teaching themselves Morse code for weeks prior to Traeger's visit but when they went to use the transmitter, they found it defective.

They drove Sister Gilbert to the nearest telephone—250 miles away and called Cloncurry. But the weather conditions made it too hazardous for flying so they drove the 150 miles to Cloncurry where she was operated on but died soon after. The rigors of the journey along bush tracks had taken its toll; 400 miles of heat and dust...

Nevertheless, the pilot project proved a huge success and the first Flying Doctor aircraft, appropriately named "Victory" went into service. News of the incredible pedal radio spread through the outback in a very short time and orders came pouring in from far and wide.

It wasn't long before the radio network was being used for other purposes as Flynn had intended. Outback communities could listen to talks, music and news broadcasts besides the essential medical advice. In fact, the outback folk often received news from America and Britain before the city newspapers got it!

But Alf Traeger wasn't content to rest on his successes. While constructing, installing and servicing the equipment, he was forever trying to improve the efficiency and reliability of it.

Between bickering with the bureaucrats at the Post Office about not keeping up with written specifications on each outpost station (even though they were all the same), and teaching the ladies to send Morse code, he was, in his own words, "Running around the country like an agitated ant!"

Many of the pedal radio operators were not proficient at sending clearcut, unambiguous messages which caused considerable hardship for the base radio operator who had to decipher them or ask for a repeat.

Traeger thought long and hard about the problem and the feasibility of building an "automatic Keyboard." Using the principle of a typewriter, he cut the lettered key bars to correspond to the dots and dashes and intervals of Morse code. When the keys were pressed,



The "outback" radio network enabled the establishment of the "School of the Air," the world's largest classroom. These children on a cattle ranch chat with their teacher and classmates hundreds of miles away.

they energized a relay which opened or closed the transmission circuit.

Whether a portable typewriter was modified for the prototype of his ingenious invention, is not clear but it worked very efficiently, if rather slowly. Operators no longer had to learn the tedious Morse code and laboriously tap out messages.

By 1934, Traeger had built and installed approximately seventy of his keyboards but by then, he was busily converting telegraphic stations to telephony and they were swiftly phased out from then on.

The Flying Doctor Service now provides a "Mantle of Safety" across the vast interior of Australia, using the most up-to-date single sideband radio transmission equipment available.

The old pedal generators have long been supplanted by electrical power or generators that can charge batteries or directly power the tranceiver. The compact, low-maintenance SSB tranceivers can now be found in several thousand outposts scattered over the conti-

ment. And there are now a dozen or more base stations to service them.

There is no place in Australia where the Flying Doctor Service can't reach a sick or injured person within two hours. Only the old-timers can reminisce about the days when the women-folk had to travel several hundred miles by camel through floods, dust storms, torrential rains and incessant heat to have their babies.

Thanks are due to the founder, John Flynn and his many helpers and advisers, not the least Hudson Fysh, the aviation pioneer and co-founder of Qantas Airways; Harry Kauper, chief engineer of the Australian Broadcasting Commission; and the intrepid band of amateurs, the unsung hero's of short wave communication development. But above all, Alf Traeger who was awarded the Order of the British Empire for his "unstinting contribution" to the Flying Doctor Service. Almost up to his passing in 1980 at the age of 85, he continued working in his Adelaide factory, advancing the science of communication. ■

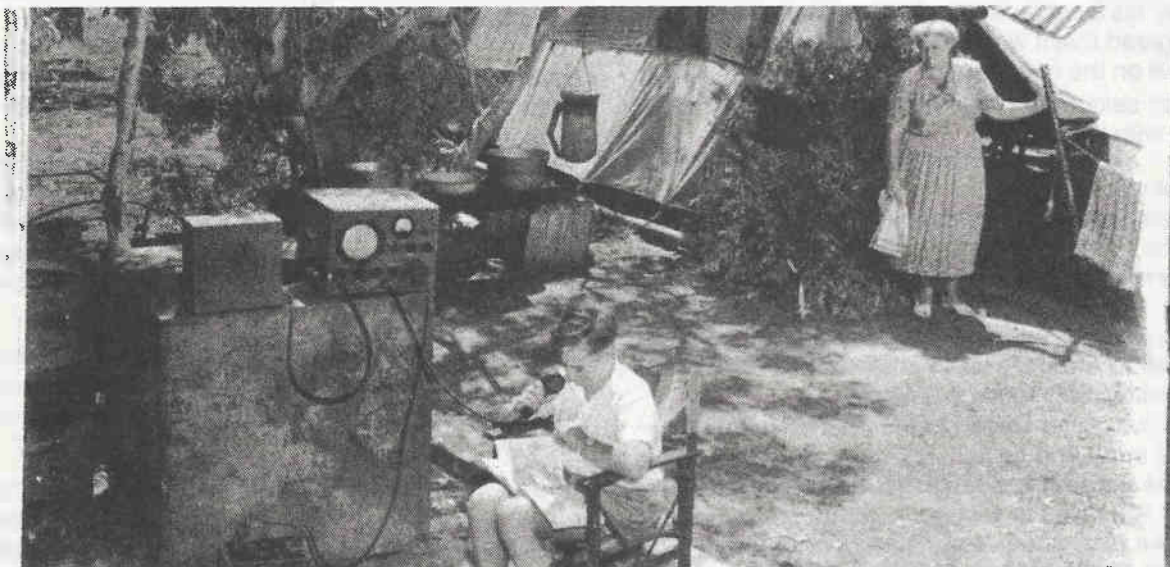

The "Flying Doctor" radio network is now used for many purposes. An early photo of an isolated well-borers camp shows a pupil "attending" the School of the Air...the worlds largest classroom. Mom looks on with pride.

WORKBENCH PROJECTS

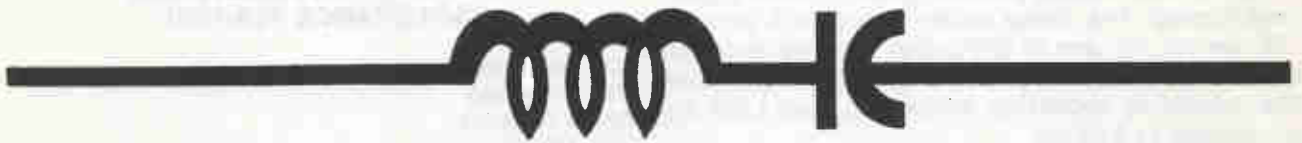

With any electronics assembly and/or project construction, it is important that you understand how the various parts of the circuit work together and the objective of each component before you start gathering the components together and assembling them. With any project that requires Integrated Circuits (ICs) or transistors, be careful to observe precautions about overheating their leads. If possible, use sockets designed for the IC chip required, instead of soldering directly into the chip's wire leads. If you don't have sockets available, be sure to protect the IC and/or transistor lead wires by using long-nose pliers as a "heat-sink" when soldering these leads.

LED ELECTRICAL CIRCUIT TESTER

Typically, this kind of electrical power tester will use Neon lamps to indicate completed circuits or faulty circuits...why not LEDs? You can build this tester in a minimum of space. Wiring is simple but you must remember that you will be applying 120 volts to the circuit, therefore, it is prudent to encapsulate the completed circuit in silicone, such as caulking.

The "hot" lead will be a golden brass color, "neutral" will be chrome colored and the ground pin is u-shaped, usually with a green screw.

To test your device, plug it into a receptacle that you want to test. The receptacle is good if L1 and L2

light. If nothing lights, there is no power. Check for wiring errors or an open ground if some other combination of LEDs light.

This tester will trip GFCI outlets if used to test them, since the LEDs draw more than 6mA through the ground.

PARTS LIST FOR LED ELECTRICAL CIRCUIT TESTER

R1, R2, R3—15K ohm, 2 watt resistors.

L1, L2—Green LEDs.

L3—Red LED.

Misc.—Suitable enclosure.

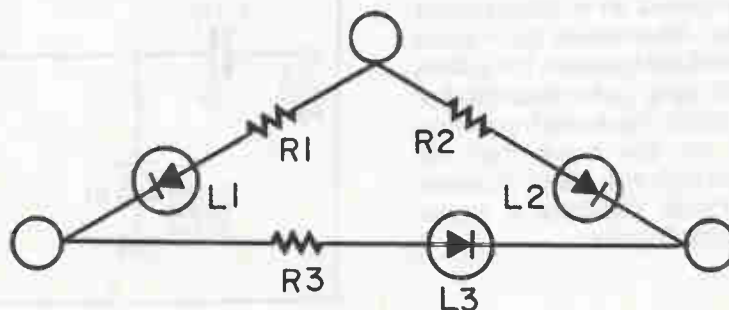

FUNCTIONAL CAPACITANCE VERIFIER

There are often situations in which a capacitor needs to be checked in order to ascertain whether it is functioning or not. The circuit shown here gives a quick indication of the condition of the capacitor, by using its most basic property i.e. the ability to block dc voltages. The ubiquitous 555 timer is used to provide a train of non critical positive pulses. These pulses pass through the device under test, onto a bi-color LED sensor. In case of difficulties locating this LED, two standard separate LED's are fine. The pulse characteristics appearing across the dual LED are interpreted as follows:

- 1) Capacitor OK:-Negative and positive pulse train illuminates both colors.
- 2) Capacitor S/C:-Positive pulse train only illuminates one color.
- 3) Capacitor O/C:-No pulse output hence neither LED lit.

The circuit functions over a wide range of capacitance, typically 100pF to 1000pF. ■

PARTS LIST FOR FUNCTIONAL CAPACITANCE VERIFIER

- IC1—555 Timer (any type)
- R1—10K ohms
- R2—4.7K ohms
- R3—100 ohms
- C1—1000pF
- C2—10nF
- LED—Bi-color (single) or two separate LED's (any color)

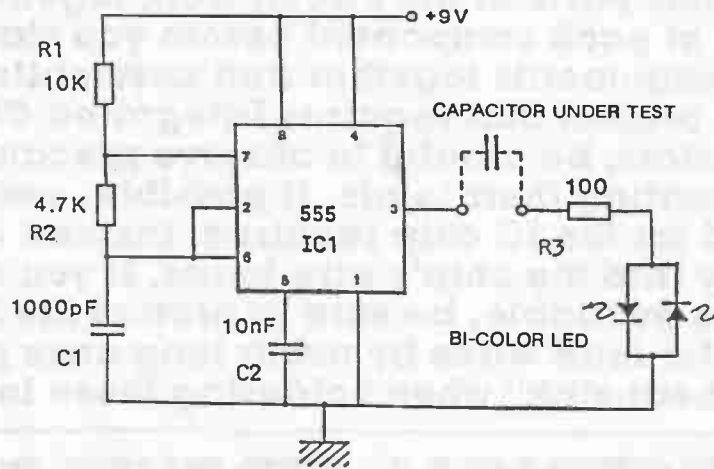

AUDIBLE INDICATOR FOR HF PULSES

PARTS LIST FOR AUDIBLE INDICATOR FOR HF PULSES

When experimenting with high frequency pulses just outside the audio frequency band, e.g. 20kHz to 50kHz used commonly for ultrasonic range finding and motion detectors, a simple verification is often needed for the presence of such pulses. An oscilloscope is a nice luxury, however failing to come up with the funds, a much easier option is available. The circuit albeit simple, provides an audible output in the presence of HF pulses. Alternatives such as an LED indicator cannot differentiate between HF pulses and a latched high state and using just a loudspeaker will not give an indication outside the audio frequency band. This circuit works on the basis that the capacitor blocks any latched high signals and passes pulses only. The clamp diode provides a signal capable of activating the piezo buzzer. ■

- C1— .01uF Capacitor
- D1— 1N4148 silicon signal diode (or Equiv.)
- SPKR— Miniature Piezo buzzer or audible warning device

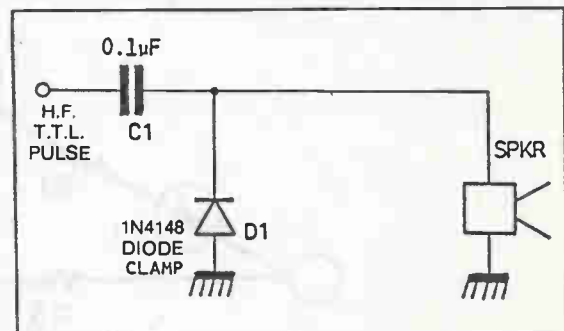

A SIMPLE LOGIC PROBE

Here is a quick and simple logic probe that works great with low speed digital signals. It can be built with a few simple parts: one chip, a bi-polar (two element) LED, a capacitor and a few resistors. The schematic shows a quad two input Nand gate chip but any HC or HCT chip that contains several inverters or inverting gates will work fine. (HCT chips are HCMOS chips that have inputs compatible with TTL logic levels. Using an HCT chip will allow this probe to work with most types of TTL and CMOS logic.)

The circuit is pretty simple. Gate "A" of U1 senses and buffers the signal under test. The input resistors, R1 and R2, limit the input current and pull it down so it is stable when not in use. Gates "C" and "D" of U1 provide the current to drive the bi-polar LED. One "sources" the current while the other "sinks" the current depending on the logic level of the input. The 220 Ohm resistor, R3, limits the LED current to about 23 milliAmps so the gates and the LED do not burn up. (For you techno-buffs, this method of driving a load is similar to the idea behind "H-Bridge" motor drivers but on a smaller scale.) The capacitor in the circuit, C1, helps supply the switching currents for the CMOS gates and helps suppress noise.

The logic indication goes as follows: When a "High" is applied to the input, the LED is red. When a "Low" is applied to the input, the LED is green. When a slowly changing signal is applied to the input, the LED will

alternate red and green. When a signal above 50 Hertz is applied to the input, the LED will flash red and green very quickly and the color will appear to be some shade of yellow. The particular shade of yellow will depend on the duty cycle of the input signal. Mostly high or mostly low signals will show a slightly discolored red or green, respectively.

As shown in the schematic this probe is intended to be used with logic on a +5V supply only. The input will draw very little current from the circuit under test, but the appropriate logic levels must be maintained to ensure proper operation. The LED is similar to the XC-5491 available from your local Radio Shack store as part #276-012. This circuit could also be constructed with one of the three leaded two element LEDs or even two separate LEDs by tying one of the anodes to the output of Gate "C", the other anode to the output of gate "D" and the common cathode through the 220 Ohm resistor to ground. ■

PARTS LIST FOR SIMPLE LOGIC PROBE

- C1**—1 uf to 10 uf
- LED1**—DualColor or Bi-Polar LED similar to Radio Shack part #276-012
- R1**—1000 Ohms
- R2**—22,000 Ohms
- R3**—220 Ohms
- U1**—74HC00 or 74HCT00 (see text)

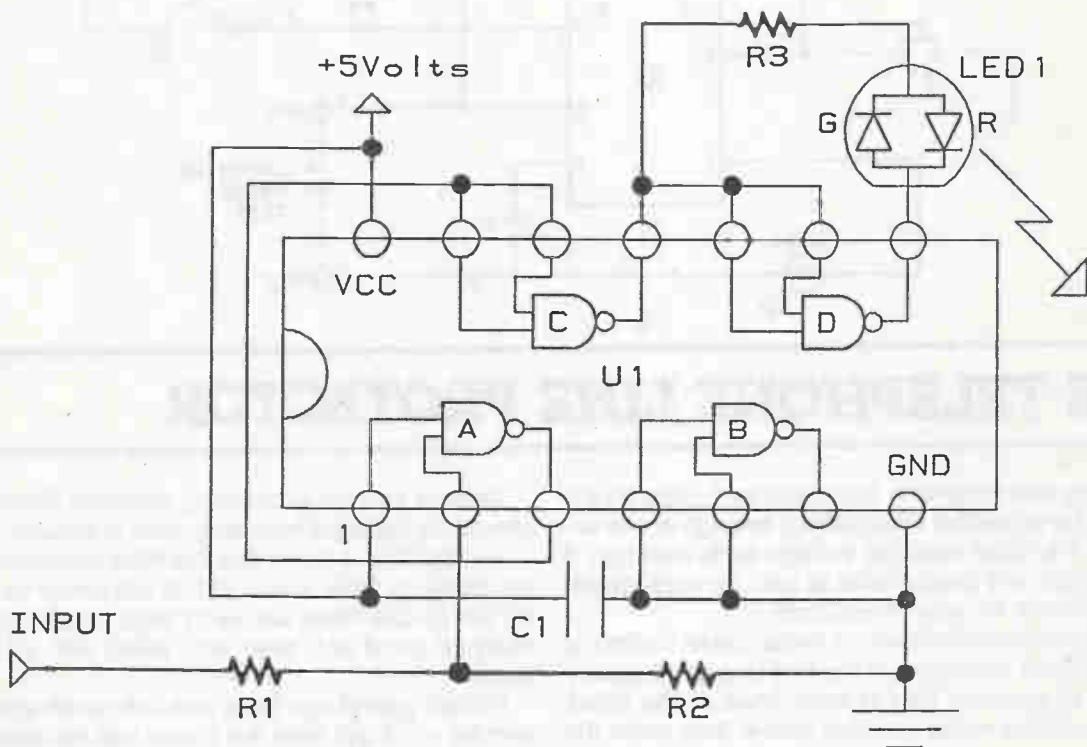

CAPACITOR TESTER

Here is a simple little device that can be used in conjunction with a watch or clock, capable of measurements in seconds, that will measure the value of any electrolytic or tantalum capacitor.

With the capacitor to be tested connected to the binding posts (watch polarities), press and release S1; then time how long LED1 remains on. Multiply the time by the appropriate scale factor and divide by 1.1. You now have the capacitance in microfarads. For example, suppose S2 is in position B and LED1 has remained on for 11 seconds. The capacitance is then equal to:

$$\frac{11 \text{ seconds} \times 10 \text{ (scale factor)}}{1.1} = 100\mu\text{F}$$

When testing an unknown capacitor, always start at position A. If the time interval LED1 stays on is too short to be accurately measured on your watch, move S2 to the next position. Every time you move S2 to a

lower position, you increase the time interval the LED1 will remain on by a factor of ten.

The circuit theory is quite simple. The 555 timer IC is set up as a one shot. When S1 is depressed, the timing cycle is started and LED1 is turned on until the timing cycle is completed.

PARTS LIST FOR CAPACITOR TESTER

- BP1, BP2**—Binding Posts
- C1**— .01uF Capacitor
- IC1**—LM555 Timer
- LED1**—Light Emitting Diode
- R1, R6**—10,000-ohm, ¼ Watt, 5% Resistors
- R2**—100,000-ohm, ¼ Watt, 5% Resistor
- R3**—1,000,000-ohm, ¼ Watt, 5% Resistor
- R4**—10,000,000-ohm, ¼ Watt, 5% Resistor
- R5**—1,000-ohm, ¼ Watt, 5% Resistor
- S1**—Normally open mini SPST momentary switch. (Radio Shack #275-1547 or Equiv.)
- S2**—Single Pole 12 position rotary switch. (Radio Shack #274-1385 or Equiv.)

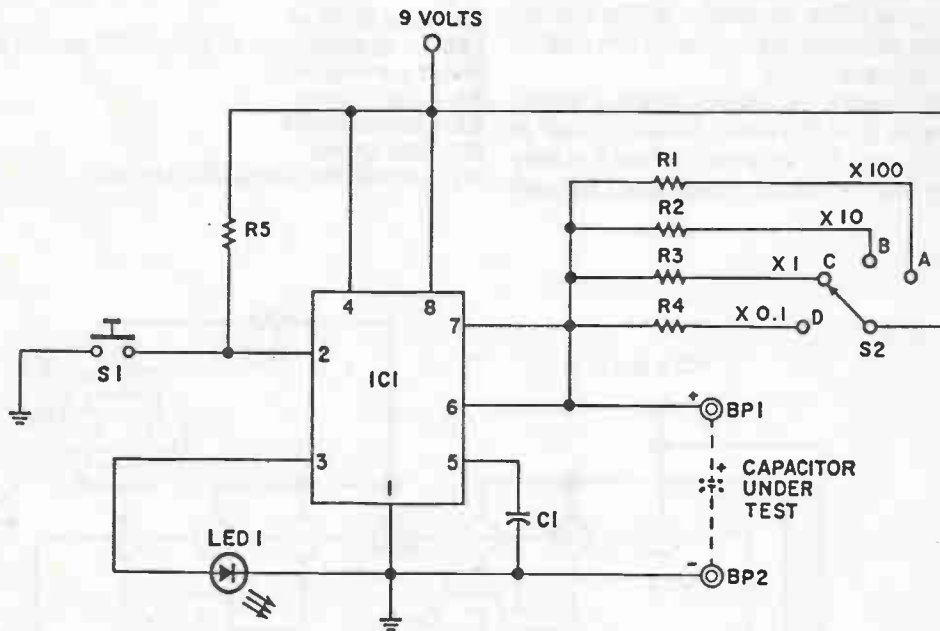

THE TELEPHONE LINE PROTECTOR

Lightning hits telephone lines and even though the lines may be protected by arrestors, enough of the energy from the strike may get through to do damage. It is both simple and inexpensive to gain an extra measure of protection for your phone lines.

As shown in the schematic, a Metal Oxide Varistor is connected from each wire of the line to a good electrical or earth ground. This is best done at the block where the phone wires connect where they enter the building.

Should you be protecting multiple lines, a MOV should be installed from each wire to ground.

An important point is that the MOV used here is rated the same as those used on 110 volt power as voltages on the phone lines are fairly high. Also, the ground must be good and solid, and wired with #16 wire or larger.

Protect your phone lines with this circuit and the only shocks you'll get from the phone will be what may be said over it!

THE TELEPHONE LINE PROTECTOR

SCHEMATIC OF TELEPHONE PROTECTOR

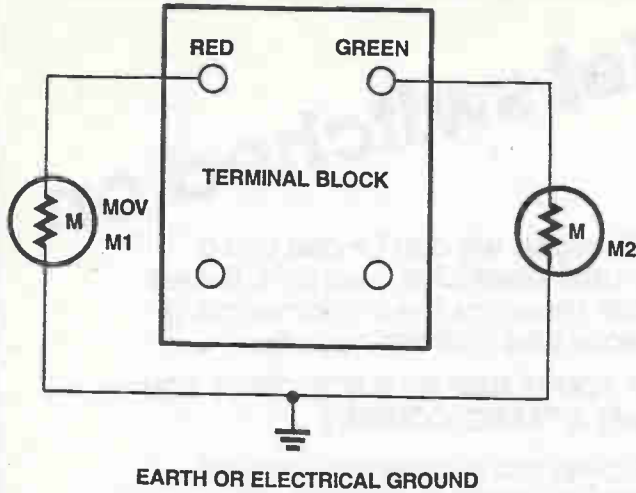

PARTS LIST FOR THE TELEPHONE LINE PROTECTOR

M1,2— Metal Oxide Varistor. Radio Shack #276-568 or equivalent.

TV ANTENNA PROTECTOR

So much has been said about lightning protection of power lines that any other avenue of lightning entry is virtually ignored. One of these is not a good idea to ignore, and that is lightning protection for your TV antenna.

Most antennas that mount outside on any kind of metal mast should be mounted with the mast grounded to an earth ground and with a lightning arrestor on the lead before it enters the house. Normally the arrestor used has an air gap that arcs over with a lightning strike. Air gap arrestors will pass surges of thousands of volts before they arc over and short the strike to ground.

A better way to handle the surges is to use a Metal Oxide Varistor that shorts surges above 170 volts to ground. A problem exists in that the MOV has the characteristic of capacitance, and connecting it to RF may weaken, distort, or totally eliminate the incoming RF signal.

As you can see in the schematic, the coil L1 is in series with the MOV. This coil behaves like a resistance in excess of 75 ohms at even the lowest TV frequencies but will pass the surge energy to the MOV without any delay or attenuation. This device must be built in a metal box for shielding and grounding purposes, and the box must be grounded to an earth or electrical ground with a wire of at least #16 gauge or heavier. Someday, this inexpensive little protector may save your TV from destruction.

PARTS LIST FOR TV ANTENNA PROTECTOR

X1,2— Type F connectors. Radio Shack 278-212 or equivalent.

L1— 10 turns of #22 solid wire on 1/2" form or 6 turns on 3/4" dia. toroid core.

M1— Metal Oxide Varistor. Radio Shack 276-568 or equivalent.

SCHEMATIC OF TV ANTENNA PROTECTOR

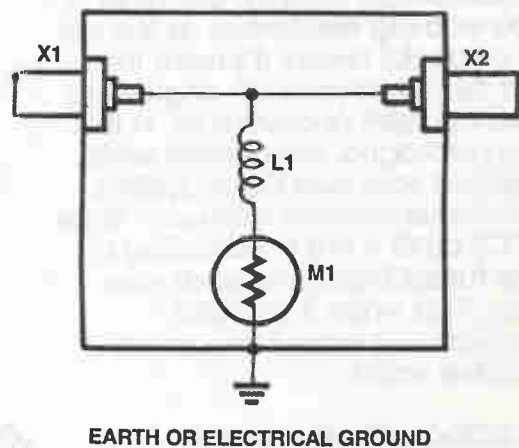

THE FUN WAY TO LEARN ELECTRONICS

Get switched on

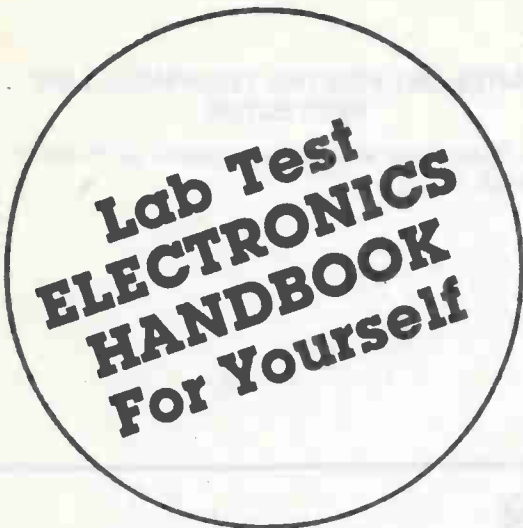

In case you're not all that familiar with us, we're not a publication for electrical engineers and other wizards. No way, **ELECTRONICS HANDBOOK** is expressly for people who like to build their own projects and gadgets — and maybe get a little knee-deep in tape, solder and wire clippings in the process.

In fact, we have a sneaking suspicion that our readers like us because they think we're just as bug-eyed and downright crazy over great new project ideas as they are. And I guess they're right!

ELECTRONICS HANDBOOK thinks of you who dig electronics as the last of a special breed. It's more than just the "do-it-yourself" angle — it's also the spirit of adventure. In this pre-packaged, deodorized world, building your own stereo system, shortwave receiver, darkroom timer or CB outfit is like constructing a fine-tuned little universe all your own. And when it all works perfectly — it really takes you to another world.

ELECTRONICS HANDBOOK knows the kinds of projects you like — and we bring 'em to you by the truckload!

Of course, we can't make you a master electrician overnight. But we can show you the fundamentals of repair plus maintenance tips.

IF YOU'RE NEW TO ELECTRONICS YOU GET A "BASIC COURSE"!

It gives you a complete, ground-floor lowdown on a variety of important electronic subjects. For example — Understanding Transistors...How Radio Receivers Pull In Signals...Cathode Ray Tubes Explained...How Capacitors Work...Using Magnetism in Electronics, and much, much more!

TRY A FEW ISSUES AND EVALUATE OUR...

- **HOW-TO-DO-IT HELP.** Tips and pointers that add up to money saved. For example — tuning up your tape player...all about radios ...whys and hows of turntables...care and feeding of speakers.

- **EXCITING DISCOVERIES.** Whatever your particular interest in electronics, you'll be entering a world of discovery in the pages of the **ELECTRONICS HANDBOOK**

ORDER TODAY



"PLUG IN"

to the excitement and satisfaction of

ELECTRONICS HANDBOOK

Yes. Enter my subscription — 4 issues **ONLY \$15.00**
(Canada \$18.00...Foreign Postage add \$8.00...U.S. Funds)

Payment enclosed. (Payable to: C&E Hobby Handbooks)

PLEASE PRINT

NAME: _____

ADDRESS: _____

CITY: _____

STATE: _____

ZIP _____
V11

PASSIVE ALARM CIRCUIT

By James C. Work

The AL-08 Alarm is a Passive type Auto Alarm System that can be expanded into Home and Workshop security. Its features include Key and Door activation, On and Off Chirp, Fixed or variable Entry/Exit Time Delay, Glass and/or Motion Detector capabilities. Armed LED Indicator Output and Automatic Reset.

The heart of the circuit uses a 74C221 (U1) Dual Non-retriggerable Monostable Multivibrator (One-Shot) and a 73C73 (U2) Dual J-F Flip-Flop. For the remainder of our discussion we will reference the schematic diagram.

Both IC's contain a Clear (CLR) input which is active low, therefore, a high must be present to allow the IC's to function. The circuit is active through the Accessory (ACC) input. With the ignition in the off position a high level is present via the pull-up resistor R6 which provides a 12V (BATT) level to U1A pin 3 and U2B pins 6 and 7, allowing them to be active. Once the ignition is switched to "ACC" or "On" from the "Off" position a 0V to 12V transition occurs at the point marked "ACC" on the schematic. This applies voltage to the base of Q1 through the current limiting resistor R8, thus turning on the transistor and sending the 12V level to ground and disabling the circuit. R7 is a pull-down resistor which holds the base of Q1 to ground.

With "ACC" in the "Off" position, the alarm is armed by opening a door. Note that there are two door triggers on U1A. If you use the existing door switch in your vehicle, you may note that on one side of the switch (when the door is in the closed position) a 12V level occurs. Once the door is opened a 0V level occurs. If this is the case with your vehicle then you will use the 12V to 0V input (pin 1) of U1A. If the pin switch reads 0V (Door closed) then 12V (Door open) use the 0V to 12V input (pin 2). NOTE: USE ONLY ONE OF THE DOOR INPUTS.

The 2.2M resistors (R2, R4) and the 0.47uF capacitors (C1, C2) are used to eliminate the effects of switch bounce oscillation and will create approximately one second delay for U1A's output to respond to the change of the door input transition.

The 220K resistors (R1, R3) at the inputs are used for pull-up and pull-down resistors for the proper

logic needed at the unused input. Let's take a look to see what happens once the door goes from closed to open, assuming the 12V to 0V (pin 1) is being used.

Assuming that the ignition key is in the "Off" position and a high is present on pin 3 of U1A (CLR), as the door is opened the input makes a 12V to 0V transition. The One-Shot's output (pin 13) Q changes from 0V to 12V, approximately one second after the door transition occurs. (Note: the output to input delay is created from the RC time constant $R4 \times C2$).

The output level remains high for approximately 20 seconds, if you use the RC FIXED time constant which contains R5A and C3 of U1A (pins 15 and 14). To use the variable time constant replace R5A with the resistor combination R5b and R5B.

During this transition a high will also be present on U2A clock line (pin 1) and will proceed to charge C4 through R9 thus holding J (pin 14) and CLR (pin 2) of U2A at a high state. Once the time constant runs out, U1A pin 13 high state returns to a low state. On this high to low transition U2A's clock triggers the output Q (pin 12) to a high which proceeds through CR1 to the base of Q2, thereby supplying the BATTERY voltage to +S (+ Siren). At the same time UA2 pin 12 is also providing a high level to the clock (pin 5) of U2B. Keep in mind that the output of UA2 occurred at the high to low transition of U1A's output so the output of U2A will remain at a high level only as long as U2A's CLR (pin 2) remains high. This will remain high as long as C4 discharges through R9. This RC time constant of R9 and C4 creates the "ON" and "Off" chirp.

Once the clear line of U2A is at a low level, its output pin 12 changes from high to low turning Q2 off. This high to low state triggers the Clock line of U2B thus changing the output of U2B (pin 9) to a high level. Once U2B has been triggered, it will remain in this state until "ACC" clears it.

The output of U2B pin 9 provides a high level to the LED OUTPUT and to U1B's B input (pin 10) and CLR (pin 11), thus enabling this part of the IC. Now the alarm is armed and ready to be triggered.

The next time the door is opened U1A and U2A will perform the same sequence of events, only this time the alarm will be activated for approximately five minutes. At the output of U2A pin 13 (Q not) is tied to

pin 9 of U1B through a resistor R10 (we will discuss this later), once U2A is triggered again, pin 13 goes from a high to a low transition (don't forget you are going through your door delay again) thus triggering U1B's output to go through CR2 and once again turning on Q2. This time Q2 will remain on for the period of the RC time constant ($R11 \times C5$) of U1B (pin 7 and 6).

Approximately 5 minutes later U1B will time out and reset itself. Note the purpose of CR1 and CR2 is to prevent sinking the current from one part of the circuit to another. The instant trigger is activated simply by pulling GLASS input from a high level at U1B pin 9 to a low level. R10 is used to prevent an excessive loading to U2A pin 13.

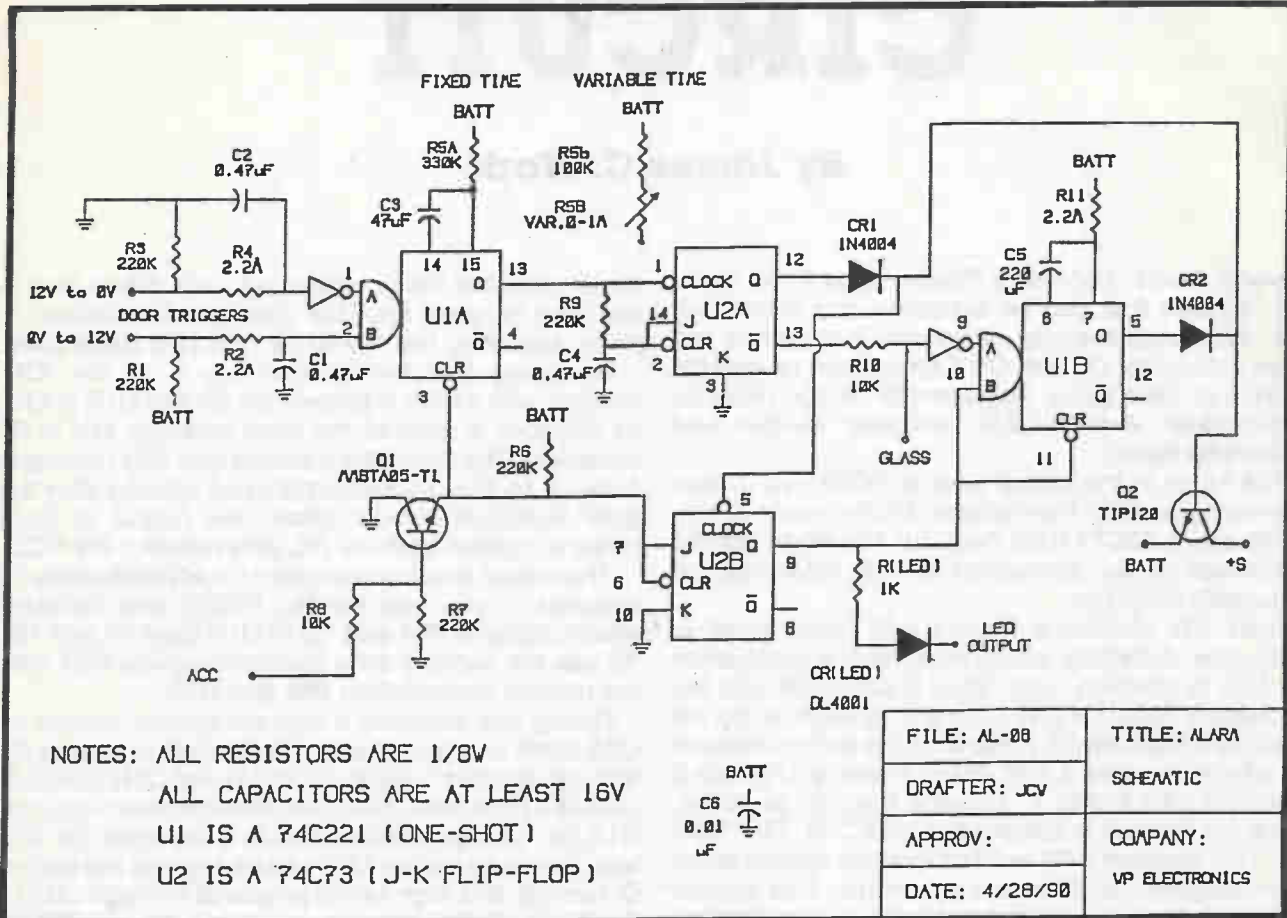

PARTS LIST FOR PASSIVE ALARM

SEMI-CONDUCTORS

- U1—74C221 One Shot
- U2—74C73-J-K Flip Flop
- Q1—MMBTA05-T1 NPN Driver
- Q2—TIP120KS NPN Darlington 60V 5A
- CR1, CR2—1N4004 Diodes

CAPACITORS

- C1, C2—0.47uF, 63V Axial
- C3—47uF, 25V Min. Alum. Elect., Radial
- C4—0.47uF, 50V Min. Alum. Elect., Radial
- C5—100uF, 25V Min. Alum. Elect., Radial
- C6—0.01uF, 50V

RESISTORS

- R1, R6, R7, R9—220K, 1/8W, 5%
- R2, R4, R11—2.2M, 1/8W, 5%
- R3—220K, 1/8W, 5%
- R5A—330K, 1/8W, 5%
- R5b—100K, 1/8W, 5%
- R5B—0 to 1M Adj. Pot., 6MM Dia. Cermet
- R8—10K, 1/8W, 5%
- R10—10K, 1/8W, 5%

Suggested source for parts to construct the "Passive Alarm Circuit" is Digi-Key Corp., Highway #32 South, Box #667, Thief River Falls, MN 55701.

The author has circuit boards available, plus assembly instructions with board drawings. Send \$6.50 (Money-Orders only) to:

WP Electronics
 P.O. Box #908
 Gardner, MA 01440

Add \$4.00 for each additional circuit board (Includes shipping & handling).

Note: All resistors are 1/8W
 All capacitors are at least 16V
 U1 is a 74C221 (One-Shot)
 U2 is a 74C73 (JK Flip-Flop)

POWER SUPPLY BASICS

By Steve Sokolowski

Power supplies have been an intricate part of electronics products since the first electron tube was invented in the 1800's but very few authors have taken the time to tackle the seemingly complex chore of explaining just how to convert a large AC voltage into a form that is more palatable to the more conventional electronic components used in today's super computers, space shuttles and let's not forget the tiny LCD televisions that can easily fit into a shirt pocket. No matter what the nature of your project, some sort of outside energy is needed to excite microscopic particles called electrons, more affectionately called "Little Joe Electron" by my high school electronics teacher (Mr. G.E. Brown). By applying a force, Little Joe will either be attracted or repelled by the source of energy. With enough Little Joes' flowing from the negative to the positive supply, an electrical current is said to be present. This current is measured in Amperes. (Amp, milli-Amps, micro-Amps). The more electrons flowing within a conducting medium with the least amount of resistance, the higher the current.

If enough force is present within a conducting path of little or no resistance, another form of energy is created. This secondary energy is called HEAT. And heat IS AN ENEMY to delicate electronic components. To control the obvious destruction of parts, we must have some means of governing the amount of energy created by an electronic circuit. This circuit is called a "Power Supply" and power supplies are what this feature is all about.

Power Supply Basics

In broad terms, a power supply is a circuit that takes the normally available AC (alternating current) household line voltage and transforms it into a DC (direct current) voltage usually of a lower value (if working with transistorized circuits). Power suppliers are the "silent partners" of all electronic projects. Every circuit requires some sort of "energy" to fulfill its intended function. The power supply does just that.

A Typical Power Supply

A power supply is a circuit that can come in a variety of sizes and shapes. From a small 5 volt ½ Amp unit to devices that can deliver voltages in excess of tens of thousands of volts with a deadly current of 100 Amps or more. No matter how complex the supply is, it can be broken down into five functional blocks: The AC input, the transformer, the rectifier, the filter and the regulator. Figure 1 illustrates a typical power supply in a form called a block diagram. For any power supply to function, we need a primary voltage source. Here, this voltage can be obtained from the standard household AC outlet. Due to differences in wiring and your location within the United States, this voltage can range anywhere from 105 to 125 volts. Even with this 20 volt variation, a power supply can operate efficiently as long as the input voltage remains at some reasonable value. If the input AC voltage drops too low, the supply might not be able to sustain its rated DC output voltage and current to the load (electronic circuit).

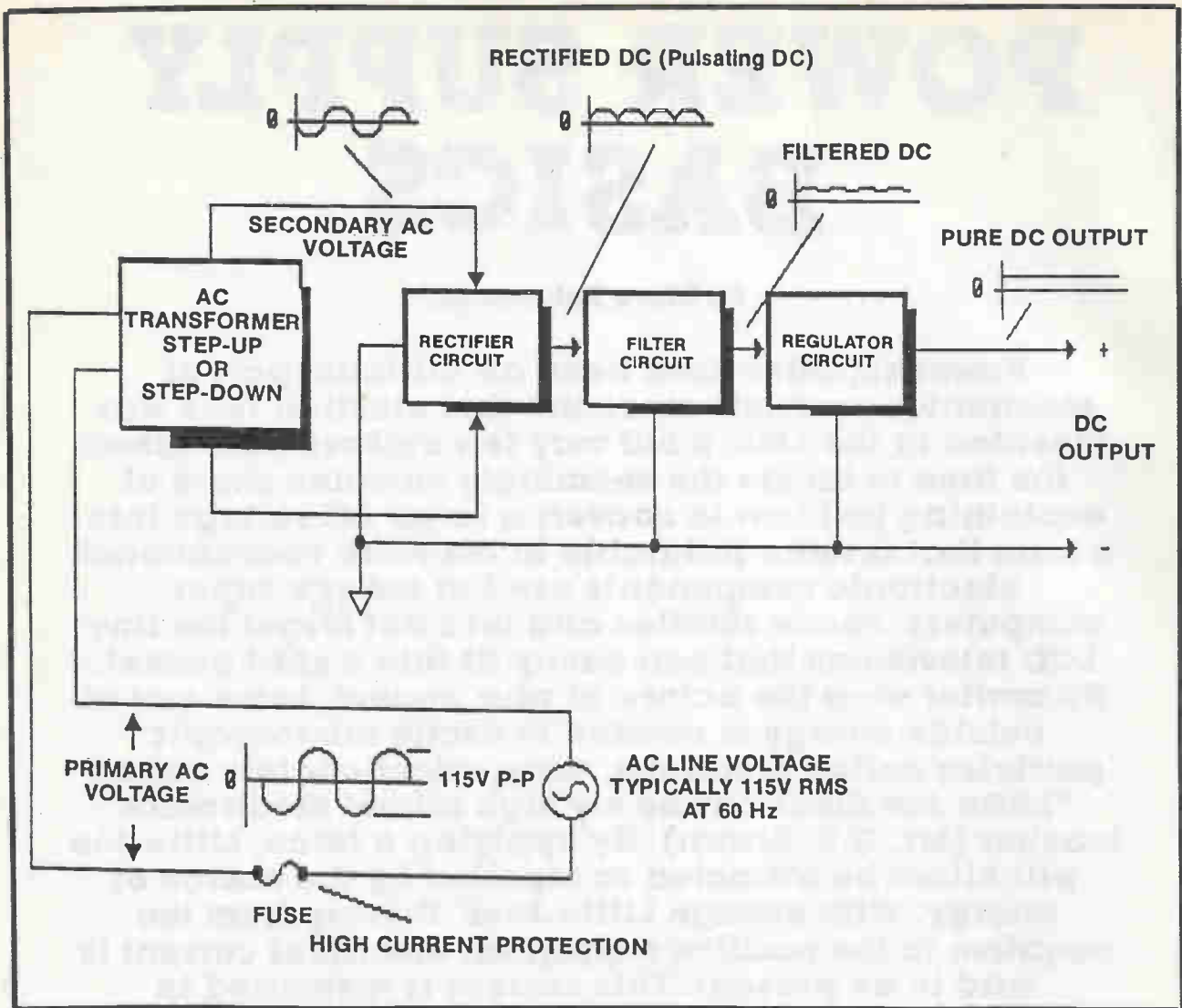

FIGURE 1

Conversely, if the AC input voltage is too high, the power supply will produce an output DC voltage that is higher than needed. Subsequently, this higher voltage can easily destroy electronic parts because the suggested operating voltage has been exceeded.

At the primary AC voltage input line, you will notice a device called a "fuse." A fuse is a component that is placed in series with one side of the input AC voltage line. Here any excessive flow of "Little Joe" Electrons caused by a short circuit placed across the load will generate *heat* as mentioned above. This heat will literally melt a small fine wire located within the fuse at a predetermined current. Hence, if the fuse "opens", all AC voltage flow will be abruptly halted and power to the circuit will be broken until the fuse is replaced.

Fuses have the unhealthy reputation of being thrown away after each and every high current surge. One way to save a few dollars and to provide maximum protection to the circuit, is to replace the standard fuses with a device called a "circuit breaker." These components are basic switches that will automatically open with the presence of excessive current flow. If we take a look inside a circuit breaker, we will see a "trip sensor" connected in series with the breaker's switch. As long as the current flow is well

within the rated value of the breaker, the internal switch will remain closed. Thus providing a path for electrons to flow. If, on the other hand, the current flow exceeds the rated value, the trip sensor will open the breaker's contacts, thus disrupting the flow of current. The breaker's contacts will remain open until an outside force (your finger) re-sets the sensor. Once re-set, the circuit breaker will, again, silently protect your valuable investment until the next surge of unwanted high current.

Transformers

A transformer is a device that converts the high AC voltage into an even higher or lower AC voltage. By using the principle of "magnetic coupling", NO direct connection is made between the input and output voltage. A transformer of this type can be called an "Isolation Transformer." The AC input voltage (placed on the transformer's PRIMARY windings) is isolated from the usually lower AC output voltage (secondary winding), thus preventing a *deadly* shock hazard.

For a transformer to make use of the phenomenon called magnetic or inductive coupling, a varying

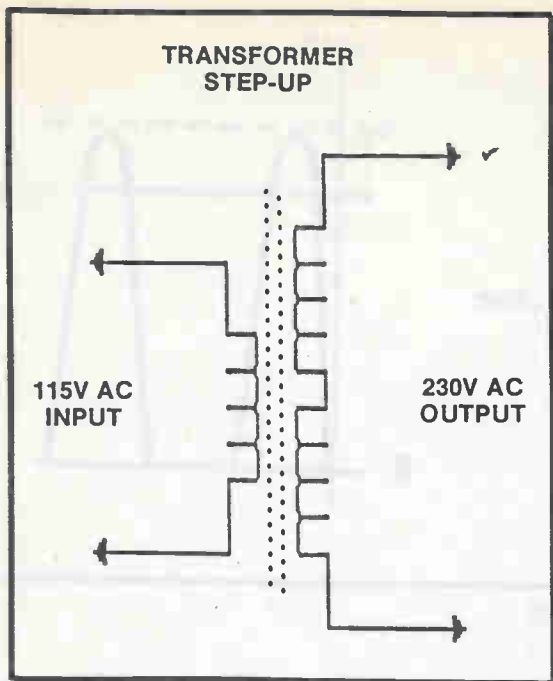

FIGURE 2

voltage, like the one found in an AC voltage must be placed on the primary winding of the device. Here the voltage swing from positive 57V to negative 57 volts creates strong magnetic fields. It is this field that induces an alternating current in the secondary winding of the transformer. Just how strong this induced voltage is depends on the number of copper wire turns in the windings. If the number of turns on the secondary of the transformer is greater than the number in the primary windings, the inductive coupling will induce a voltage that is GREATER than that found in the primary. This transformer is said to be a "STEP-UP" transformer (See Figure 2). If the number of wire turns in the secondary is LESS than

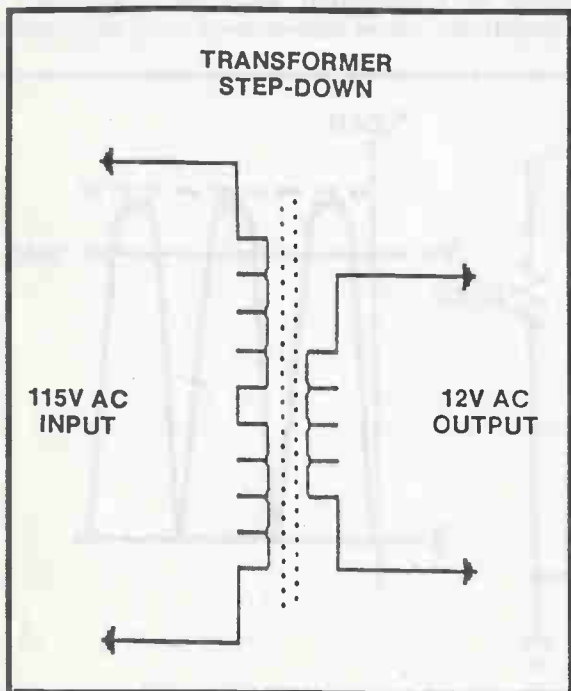

FIGURE 3

that found in the primary, the induced voltage will be LESS than that in the primary. This transformer is said to be a "STEP-DOWN" transformer (See Figure 3). If the number of turns in the primary is equal in number to the secondary, the voltage at the secondary will be equal to the primary. What good is this? This transformer isolates the deadly AC primary voltage from the secondary. Remember earlier, we mentioned "Isolation Transformers?" Well, this is how it is accomplished. Figure 4 illustrates the electronic schematic of an "Isolation Transformer."

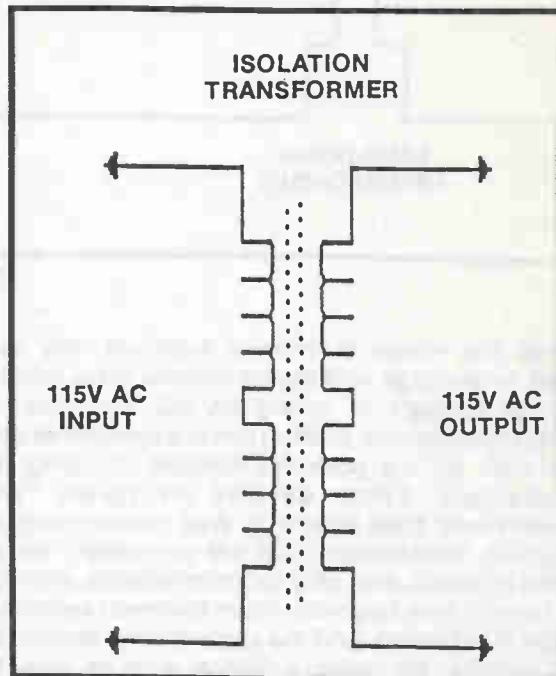

FIGURE 4

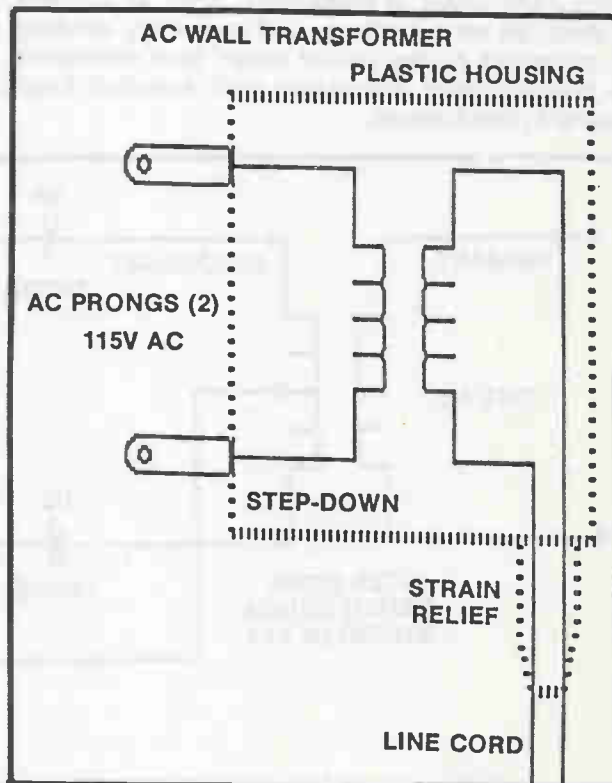

FIGURE 5

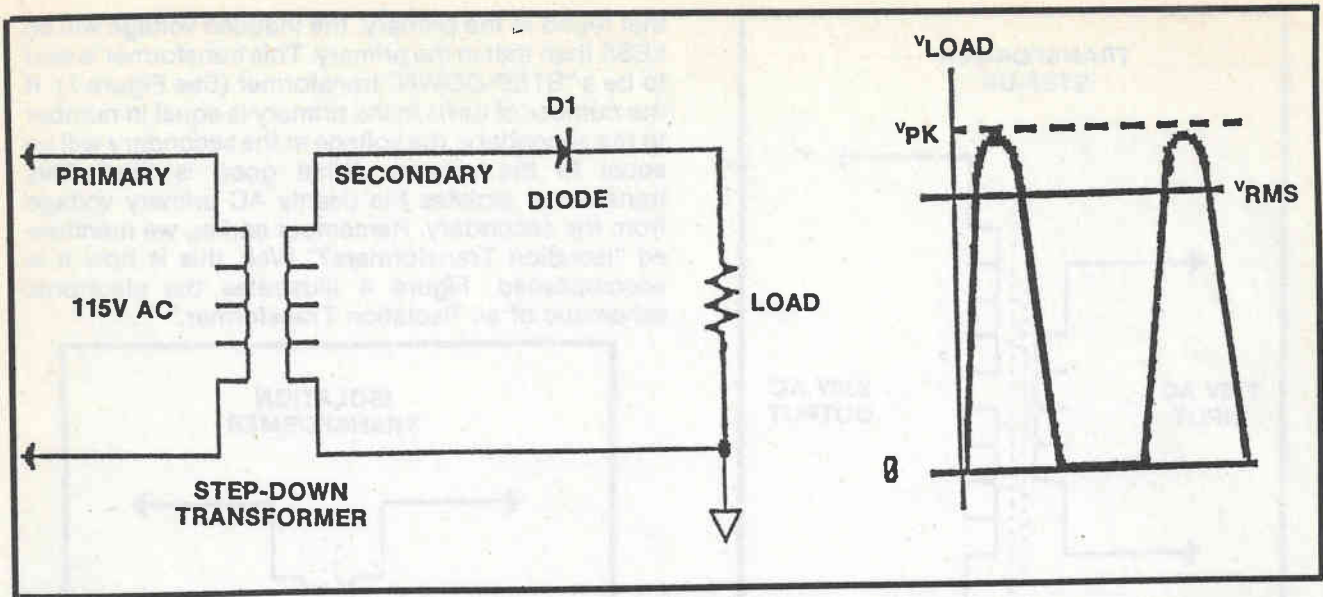

FIGURE 6

Since the novice electronics hobbyist may have limited knowledge relating to transformers and the potential dangers of wiring an AC line cord, we strongly recommend making use of a device that does away with all the potential dangers of using line transformers. These devices are called "Wall Transformers" (See Figure 5). Wall transformers are step-down transformers that are completely encapsulated in plastic with only two connections showing. One being a twin lead wire where the lower secondary voltage is delivered. And the second is the familiar AC male prongs. By using a device such as this, the potential danger that might be encountered in wiring a line transformer is eliminated. Also, all soldered connections on the primary and secondary windings are protected by the plastic cover, thus eliminating the shock hazard associated with standard board mounted transformers.

Wall transformers come in a variety of output voltages and current ratings. Depending on the amount of current required, pricing of these devices also vary widely. Surplus electronic suppliers sell wall transformers for as little as \$1.95. Surely, your safety is worth \$1.95? We think it is. Make use of Wall Transformers wherever possible.

Rectifiers

After the AC input voltage is brought down to a lower level by a step-down wall transformer, the next step is to somehow convert the AC voltage into a raw form of DC (Direct Current) signal. Even though the voltage output of the rectifier varies greatly, the polarity of the signal remains the same. Thus the term "pulsating DC."

Stages of rectification are often composed of semiconductor diode networks or solid state bridge

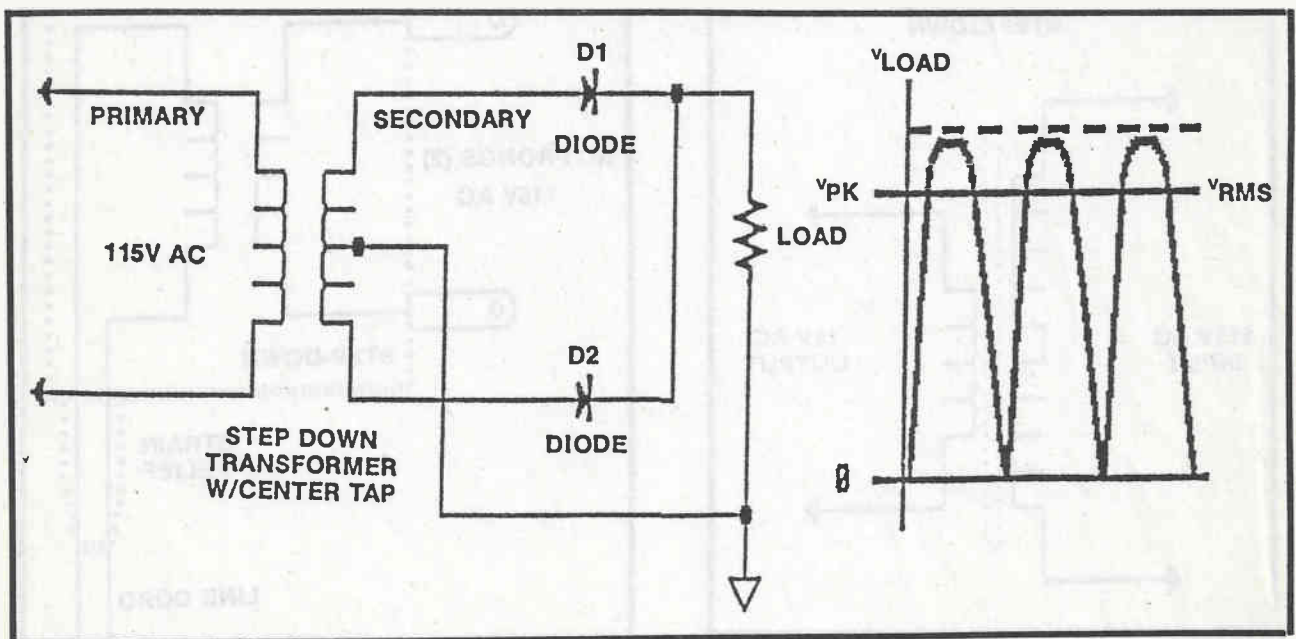

FIGURE 7

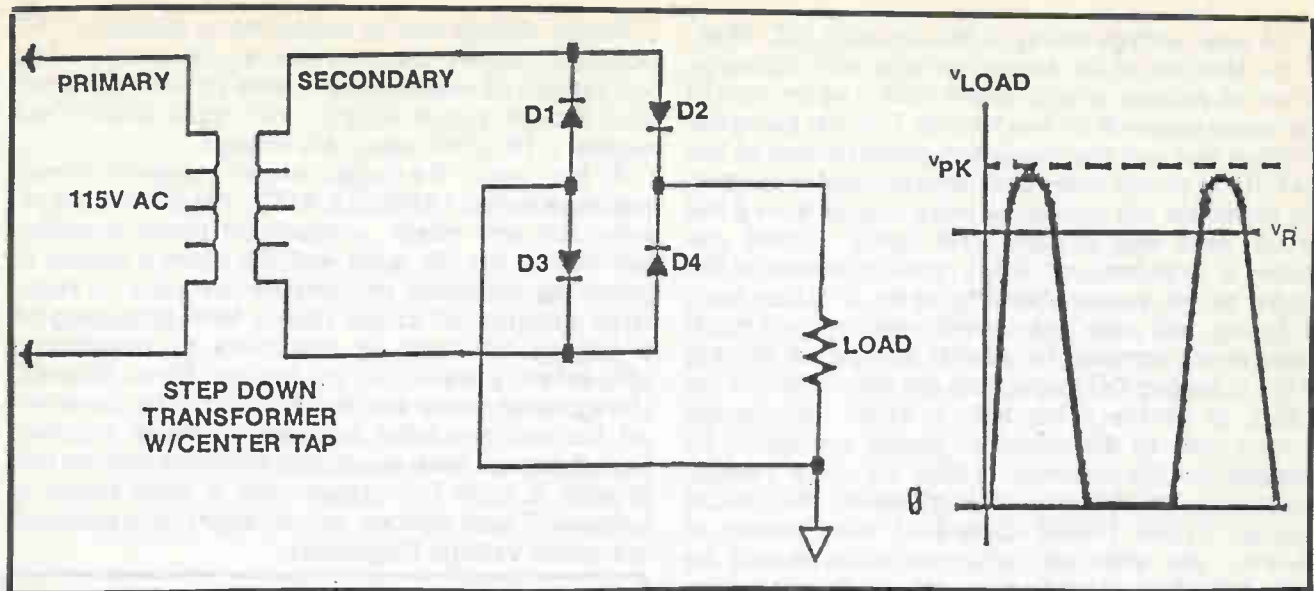

FIGURE 8

rectifiers. There are three basic classifications of rectifier circuits used in power supplies. The HALF WAVE (Figure 6), the FULL WAVE (Figure 7) and the BRIDGE shown in Figure 8.

The simplest of the three is the Half wave rectifier since the circuit requires only one diode and no center tap on the transformers secondary winding. The principal disadvantage of the half wave rectifier is that only one half of the available secondary voltage is rectified. Rectifying only half of the signal produces gaps in the output voltage (See accompanying wave form at Figure 9). These gaps produce an output voltage that has a lower average value and a higher amount of AC ripple riding at the output. With a high AC ripple content at the output, heavier filtering will be required, thus increasing its overall cost. Because of the high ripple content, Half wave rectifiers will not be found in commercial power supplies.

Full wave rectifiers provide a significant advantage over its predecessor (See Figure 7). With the wiring arrangement as shown in Figure 7, two diodes are used instead of one. Two diodes are allowed to conduct on BOTH halves of the secondary AC signal. The resultant waveform can be seen in Figure 7. As you can see, the number of DC pulses has been increased by a factor of two. With almost no time delay between the conduction of the first and second diode, the AC ripple content of the output is greatly reduced. Also, a power supply using the full wave configuration can provide a steadier DC voltage output and it can also support heavier loads. The main drawback of using the full wave is the use of the center-tapped transformer. This circuit requires a ground reference point and it is provided by the center tap.

Constructing center-tapped transformers is an expensive proposition, and its cost is a reflection of its manufacturing complexities. Even the price of wall-mounted transformers, making use of center taps, are quite expensive. So, for our needs, let's skip full-wave rectifiers and go right to the last classification of rectifiers; the "Bridge."

By focusing your attention on Figure 8, you can see that the bridge rectifier provides, not only full wave rectification of the secondary AC voltage, but it also furnishes its own ground reference without the need of an expensive center-tapped transformer. The FULL secondary AC voltage applied to the bridge will appear as pulsating DC at its output. As an example, if an AC signal of 12 volts is applied to the bridge, you can expect an output of a pulsating 12 volts. Bridge rectifiers are the choice of equipment designers. You can find them in the more expensive unregulated power supplies and in almost all types of regulated supplies.

When choosing rectifiers of any power supply design, two important factors must be considered; the forward current and the peak inverse voltage (it used to be called Peak Reverse Voltage PRV). The forward current is the maximum current that can flow through the diode in its forward biased (conducting state) direction without causing harm. This forward current value of the device should be equal to the maximum expected load plus another 50% for safety sake. Many circuits that you will be building will, without a doubt, operate well under 1 Amp. To provide a pulsating DC output with a current under 1 A, the 1N4401 diode is my choice. With a PIV (Peak Inverse Voltage) rating of a whopping 500V at 1 Amp, the 1N4001 diode will perform in virtually any power supply circuit that you can think of. And best of all, the diode can be purchased for about \$.02 each.

Filters

Filter capacitors used in power supplies have the function to smooth out the pulsating DC signal to a somewhat steady DC output. Even with heavy capacitor filtering, the effects of AC ripple can still be seen in the output. Even with a capacitor with a value in excess of 1500uf (1500 micro farads) can not eliminate all the undesired ripple associated with any of the three rectifier classifications. Basically, a filter capacitor is an energy storage device that will charge

to the peak voltage rating of the pulsating DC. Then, in the absence of an applied voltage, will discharge slowly to provide energy to the load. The amount of discharge depends on two factors. The first being the physical size and the amount of current drawn by the load. If the circuit requires a large amount of current, the capacitor will discharge more rapidly than if the circuit used less current. This heavy current use causes a large amount of AC ripple to appear at the output of the supply (See Figure 9). A lighter load, obviously, will draw less current, resulting in a much lower ripple content. To provide substantial filtering of the pulsating DC, capacitors are often wired to the output in parallel. This will, in effect, double the surface area of the capacitor plates, increasing its capacitance. For example, a filter capacitor needed for a supply must have a value of 3000uf (3000 micro farads). If two 1500uf capacitors were placed in parallel, the effective capacitor value would be 3000uf. Adding capacitors in parallel to achieve as pure a DC voltage as possible has its drawbacks.

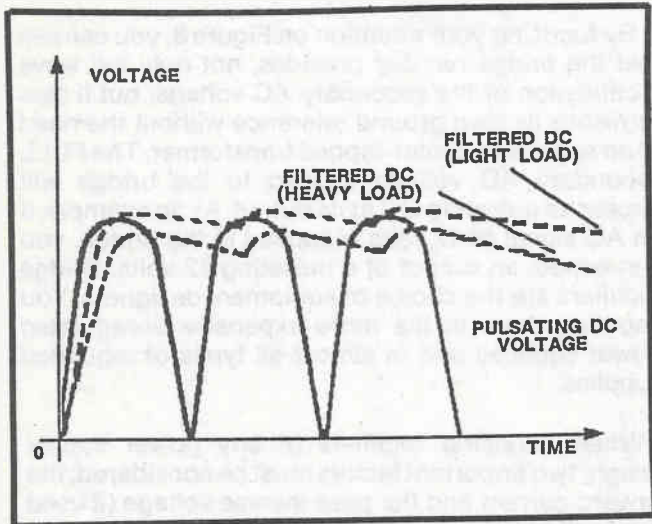

FIGURE 9

Capacitors in the range of 1500 to 3000uf are relatively large in size. And the larger the capacitor, the higher the price tag. Using capacitors with a value of 10,000uf or more can become dangerous. As mentioned earlier, capacitors are energy storage devices. Even if the power is disconnected from a capacitor of this size, electrical energy IS STILL PRESENT. This energy potential can easily create serious shock hazards to the user. To reduce the possible shock risk, a high value resistor called a "bleeder resistor" should be added in parallel to the filter capacitor. A 1 to 2 meg ohm (1,000,000 to 2,000,000 ohm) resistor is used to bleed the excess electrical energy stored by a charged capacitor, to ground, helping to eliminate any shocking experience.

Choosing a capacitor to be used as a filter, select a capacitor with a working voltage that is about 50% above the peak voltage that will be encountered by the component. For example, say a bridge rectifier delivers a pulsating DC of 12V, the filter capacitor should be rated on or about 15 volts. Higher voltage capacitors can also be used without any adverse effects on circuit performance.

Ripple voltage can be measured by placing an AC voltmeter across the now filtered DC output. The voltage can be read directly in volts. In a well designed and filtered power supply, the ripple should not exceed 0.1% of the input AC voltage.

At this stage, the output of our imaginary power supply is called UNREGULATED. For driving lamps, solenoids and relays, unregulated power supplies, will handle the job quite well but when it comes to powering amplifiers or computer circuitry, unregulated voltages will create havoc, from producing an annoying AC hum in amplifiers to developing unwanted pulses on computer Data Busses. Unregulated power supplies should not be considered. For well regulated, inexpensive power supplies, manufacturers have developed miniature circuits that provide a pure DC output over a wide range of voltages. These devices, as you might have guessed, are called Voltage Regulators.

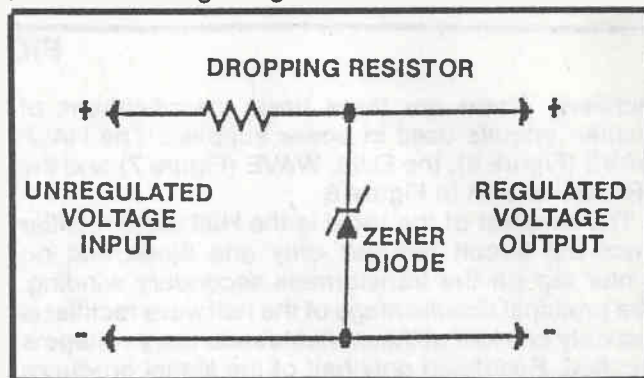

FIGURE 10

Regulators

Voltage regulators are devices that allow a precise control and adjustment of the DC voltage output. By adding an inexpensive regulator to a power supply's output, AC ripple can be almost completely eliminated. Enough so that the output can be considered to be equal to the DC output of a standard 9 volt transistor radio battery.

This simplest form of voltage regulator is the Zener diode with a current limiting resistor in series, as shown in Figure 10. The unregulated voltage from the output of a filter is delivered to the resistor-Zener circuit. Often called a "clamping" circuit. As with any electronic component, Zener diodes come in a variety of voltage and current ratings. For a particular voltage output, any Zener diode with a rating less than the unregulated input voltage can be used in the design. The series resistor will dissipate the extra voltage and help reduce the unregulated voltage to the desired level. The value of this resistor depends on the voltage drop across it. This drop can be considered to be the difference between the unregulated voltage and the regulated voltage desired (Zener diode voltage). Also, the current required by the circuit must be taken into consideration. For example, let's take an unregulated 12V power supply. We need this circuit to be reduced to 10 volts. With this example, the series resistor must be able to withstand a voltage drop of 2 volts across it. If the maximum load current is to be 1 Amp, then by using Ohms law, the value of the resistor has to be 2

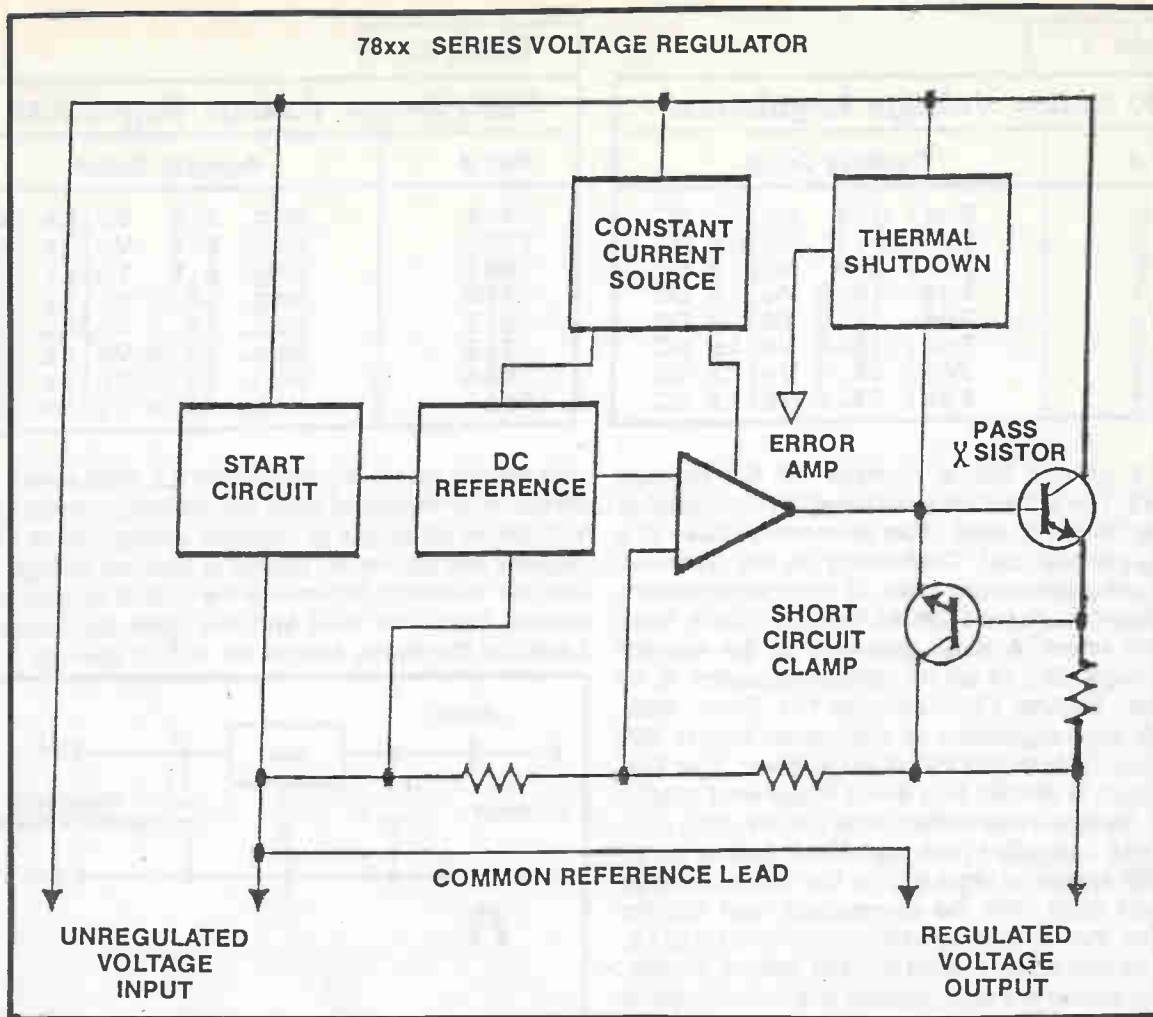

FIGURE 11

volts/1 amp or 2 ohms. The power dissipated by the resistor is also related to the amount of current drawn by the circuit. In this example, the power dissipated by the series resistor will be $(1 \text{ amp} \times 1 \text{ amp}) \times (2 \text{ ohms})$ or current squared, times resistance. We come up with an answer of 2 (Watts). By adding a safety factor of 50% to the wattage value we just calculated, the Zener's series resistor should be 2 ohms with a wattage rating of 3 Watts.

As with any electronic component or circuit, there are drawbacks. If the load were to be disconnected, the full load current would be impressed across the Zener, blowing it out. Zeners don't cost that much but accidental removal of the load should not place any component in a position of over-stress or inevitable destruction. To eliminate this, let's take a look at integrated circuit type voltage regulators.

IC Regulators

Integrated circuit voltage regulators, such as those in the 7800 and the 7900 series family are excellent alternatives to Zener circuits. Internal regulator circuitry compares the output voltage to an internal reference (See Figure 11). Any difference between the two will create an error voltage that causes the current flow of the IC to change at the output transistor. By making use of this scheme, the error amplifier keeps track of all output loads across the IC

and then makes the appropriate corrective action to keep the output voltage at a constant level.

Voltage drops and loading current are also important in the choice of IC voltage regulators. The unregulated input voltage must exceed the regulated DC output by several volts if IC regulators are to function properly.

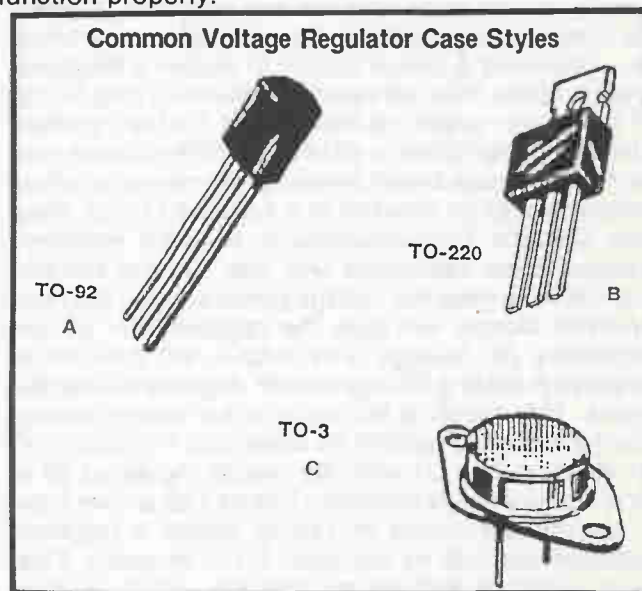

FIGURE 12

Table 1	
7800 Series Voltage Regulators	
Part #	Regulated Output
7805	Pos. 5.0 Volts DC
7806	Pos. 6.0 Volts DC
7808	Pos. 8.0 Volts DC
7810	Pos. 10.0 Volts DC
7812	Pos. 12.0 Volts DC
7815	Pos. 15.0 Volts DC
7818	Pos. 18.0 Volts DC
7824	Pos. 24.0 Volts DC

Table 2	
7900 Series Voltage Regulators	
Part #	Regulated Output
7905	Neg. 5.0 Volts DC
7906	Neg. 6.0 Volts DC
7908	Neg. 8.0 Volts DC
7910	Neg. 10.0 Volts DC
7912	Neg. 12.0 Volts DC
7915	Neg. 15.0 Volts DC
7918	Neg. 18.0 Volts DC
7924	Neg. 24.0 Volts DC

Table 1 and 2 list a number of IC Voltage Regulators. These devices can be easily purchased in any Radio Shack or mail order electronic house at a surprisingly small cost. Depending on the type and manufacturing procedure used, IC voltage regulators can withstand currents from as little as 100mA to as much as 5 amps. A dead giveaway to the current handling capability of an IC voltage regulator is its case style. Figure 12 illustrates the three most commonly used regulators on the market. Figure 12A shows a regulator in a TO-92 configuration. This TO-92 case style is similar to a small three lead plastic transistor. Its small size reflects that it can supply only small 100mA currents to the load. On the other hand, Figure 12B shows a regulator in the larger TO-220 case. When used with the appropriate heat sinking capabilities, the TO-220 can deliver currents up to 1A, with 500mA the more typical current output. Finally, Figure 12C shows the ever popular diamond shape of the TO-3 regulator. Regulators of this type can deliver up to and exceeding 5A of continuous current. But for the hobbyist, TO-3's delivering 1.5A will more than satisfy your needs.

Negative Voltage Output

Once a transformer, rectifier, filter and regulator are assembled to form a single output regulated power supply, several other features can be added to make the circuit more versatile. For example, sometimes you may need a power supply to deliver a Negative voltage rather than the standard positive. The polarity of the power supply is determined by the rectified network. If the diodes in all of the rectifier circuits that we have discussed were reversed, the normal positive voltage would be inverted to a negative output. Also note that the filter capacitor(s) must be reversed. *Otherwise the capacitors will heat up and literally explode.* In a negative voltage power supply, the now reversed diodes will pass the negative half of the secondary AC voltage. The output, will produce a negative pulsating DC signal with negative AC ripple. Figure 13A shows a typical positive power supply using a half wave rectifier for simplicity. The output of D1 is filtered by C1 with the results regulated by a 7800 series voltage regulator. Figure 13B shows how to convert the circuit in 13A to deliver a negative output. Note that, in this case, D1 is reversed. This feeds negative voltage to filter C3, which is also reversed. The only abnormal thing about this circuit is

that we use an IC regulator from the 7900 series of IC chips. Any regulator with the starting number 79xx will deliver an output of negative voltage, while a 78xx number will deliver an output of positive voltage. The last two numbers determine the output voltage of the device. Both the 7800 and the 7900 regulators are basically the same, except for output polarity.

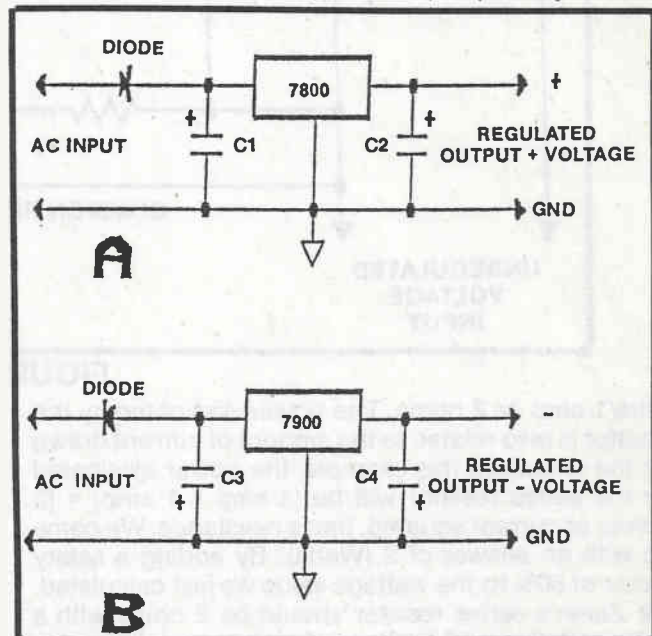

FIGURE 13
Multiple Voltage Outputs

There will be times that a circuit design requires two or more different voltages. A second output voltage can easily be added to a power supply by tapping into the filtered DC to provide an unregulated voltage for the second regulator. Figure 14 depicts a simple multi-output power supply. Here, a common unregulated voltage is filtered by the usual capacitor. From here, the voltage splits up into two branches. Branch one feeds a voltage to the input of a 7805 positive voltage regulator, while the other voltage is branched to the input of the 7812 regulator. At the outputs, the 7805 will deliver a regulated +5 volts, while the 7812 will output a regulated +12 volts. To provide a multiple output, the filtered DC output must be higher than the highest desired regulated output.

For supplies requiring both a negative and positive output, the circuit in Figure 15 can be considered. By using a half wave rectifier, D1 will pass the negative

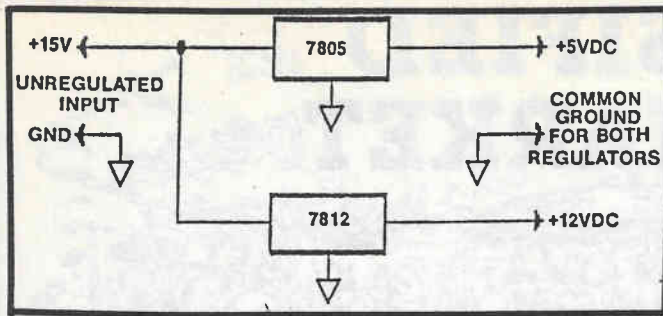

FIGURE 14

half of the secondary AC voltage, while D2 will pass only the positive half. Since D1 delivers a negative voltage, filter capacitors C1 and C2 must be connected to the circuit to reflect this polarity. Note that the negative terminals of both C1 and C2 are connected to the 7900 voltage regulator. Capacitors C3 and C4 are fed a positive voltage from D2 so the positive terminals are both connected to the 7800 series voltage regulator. With this arrangement, a

power regulator that is ideally suited for variable supplies. Figure 16 is a schematic of an adjustable power supply using the common LM317 regulator.

The ADJ or the center pin is connected to a voltage divider network formed by R1 and potentiometer R2. As the value of R2 increases, the reference voltage on the ADJ pin also rises, this in turn, will raise the output voltage. The output voltage from the LM317 can be varied from 1.25 volts up to the limit set by the value of R2. For the proper values of the components used in Figure 16, check the regulator's application notes for the equations you'll need to determine the values. Voltages below 1.25V can not be obtained because of the minimum voltage required across R1 to maintain the correct bias that the LM317 needs for normal operation.

The LM317 comes in the TO-3 diamond shape case style and it was designed to deliver upwards of 1.5 amps of load current. Due to its high current potential, a TO-3 type heat sink is highly recommended.

To use, just connect a voltmeter across the two output pins, while under load conditions, adjust R2

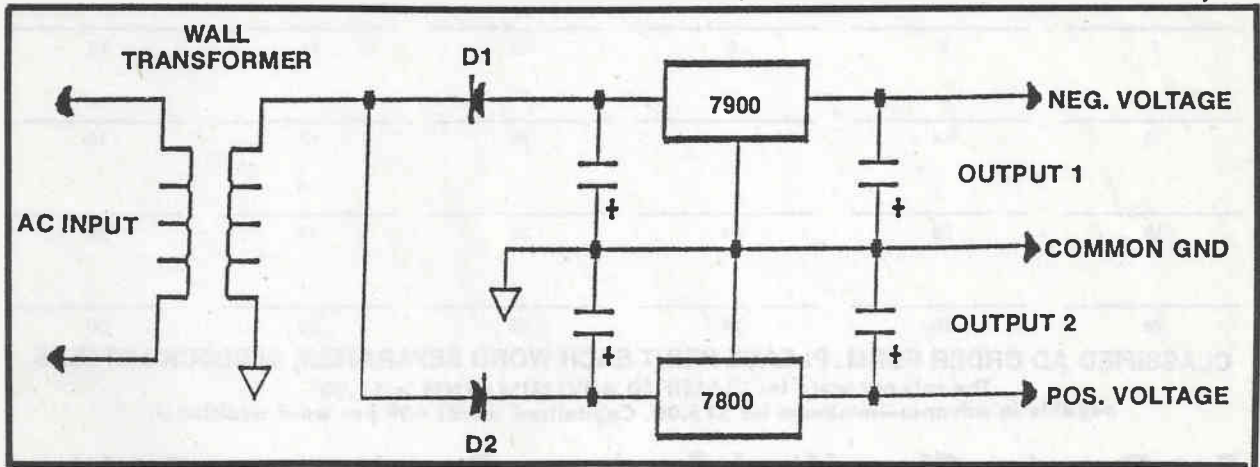

FIGURE 15

negative voltage determined by the 7900 IC used will be present at output 1, while a positive voltage, again determined by the 7800 IC used, will be present at output 2. As stated before, the input pulsating DC voltage must be at least 2 volts higher than the highest output regulated voltage.

Variable Voltage Regulators

So far, we've discussed voltage regulators with a fixed output voltage level. Variable voltage regulators also exist. The LM317 is an example of an adjustable

until the desired voltage level is indicated on the meter. For the novice electronics hobbyist, it is a good idea to get into the habit, when connecting any project to an adjustable power supply, to adjust the potentiometer voltage output down to 0V, or in the case of the LM317, to read 1.25V on the meter. It would be one heck of a mistake if you connect a project designed to operate at 5 volts, to a power supply that has been adjusted to 30 or more volts. Oh! what pretty smoke. ■

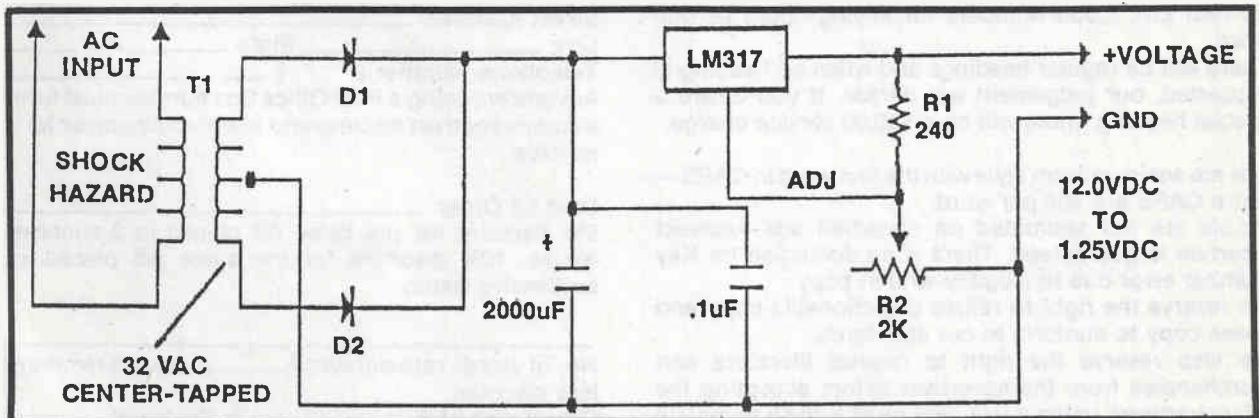

FIGURE 16

CLASSIFIED FLEAMARKET



NO CHARGE FOR ZIP CODE...NO CHARGE FOR CAPITALIZING FIRST WORD...ADDITIONAL WORDS IN CAPS—40¢
 To run your own classified ad, put one word on each of the lines below and send this form along with your check

1	2	3	4	5	6
7	8	9	10	11	12
13	14	15	16	17	18
19	20	21	22	23	24
25	26	27	28	29	30

CLASSIFIED AD ORDER FORM. PLEASE PRINT EACH WORD SEPARATELY, IN BLOCK LETTERS.
 The rate per word for CLASSIFIED ADVERTISEMENTS is \$1.00
 payable in advance—minimum ad \$15.00. Capitalized words 40¢ per word additional.

For Greater Classified Savings...Results...and Profits...

DISPLAY RATES:

1"×2" (\$125), 2"×2" (\$225), 2"×3" (\$300), 2"×4" (\$400)

CLASSIFIED AD REQUIREMENTS

Minimum ad 15 words—Please remember to be sure to count your name and address—Count each Abbreviation (B.J. Jones = 3 words), Initial (W. Main Street = 3 words), Single Figure (P.O. Box 3333 = 3 words) or Groups of Figures (10 x 12, 35mm, F.O.B., etc = 1 word). Your Zip and State are one word each, there is no charge for your ZIP. Code numbers for keying count as one word.

There will be regular headings and when no heading is requested, our judgement will decide. If you desire a special heading, there will be a \$10.00 service charge.

Ads are set in uniform style with the first word in CAPS—Extra CAPS are 40¢ per word.

Proofs are not submitted on classified ads—correct insertion is guaranteed. There is no deduction for Key Number error due to illegibly written copy.

We reserve the right to refuse objectionable copy and revise copy to conform to our standards.

We also reserve the right to request literature and merchandise from the advertiser before accepting the ad. Advertisers using a P.O. Box must furnish complete name and address for our records.

C&E HOBBY HANDBOOKS

Call (201) 231-1518 or write to:
 L. M. Gabree, P.O. Box #5148, North Branch, N.J. 08876

MAIL TO: C&E HOBBY HANDBOOKS—CLASSIFIED,
 P.O. BCX #5148, North Branch, N.J. 08876

Your Name _____

Firm Address _____

Street Address _____

City _____ State _____ Zip _____

Telephone Number () _____

Advertisers using a Post Office Box number must furnish a complete street address and telephone number for our records.

Date Of Order _____

5% discount for the same Ad placed in 3 successive issues. 10% discount for the same Ad placed in 6 successive issues.

No. of words rate per word _____ equals remittance, less discount.

Remittance of \$ _____ is Enclosed.

V11

DON'T GAMBLE WITH IMPEDANCE MISMATCH

By Hugh Gordon

All Bill wanted was to have a single extension speaker in his workshop. He decided to connect it to his stereo and reasoned that one channel would be enough. So, using a simple 'Y' connector, he tapped onto the rear of the left, channel speaker upstairs, fed the lead down through the floor and over to his bench. To the lead, he connected an old speaker he'd had around for years. Now, he could enjoy the music right where he worked.

But not for long. It came with the suddenness of switching off a lamp. The sound stopped. Not even a hint of static could be heard from his extension speaker. Bill ran upstairs to check the stereo. The left channel was dead.

At the service shop, he nearly cried as the technician told him with a voice of doom, "The large scale integrated circuit that drives the left channel is burnt out. It'll cost you about eighty dollars."

What caused such a catastrophe? Bill had severely mismatched the impedance on that channel.

Attention must be paid to matching impedance. When properly matched, two things happen:

1. Maximum power is delivered to the load, which, in this case, was a speaker or a set of speakers.
2. The optimum design current flows through the output transistors whether they are discrete or included in an IC.

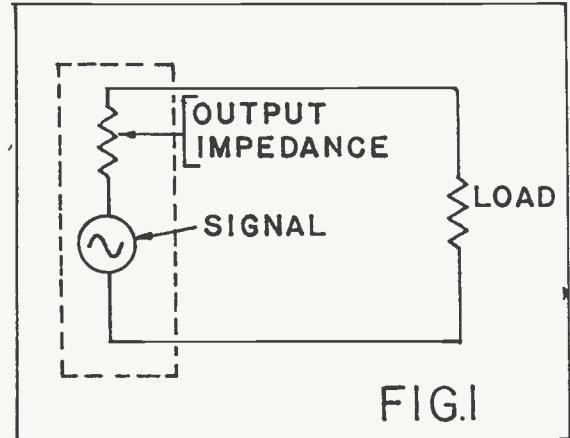

FIG.1

Changing load impedance that upsets the matching can produce different results, depending upon the design of the final output stage. Sometimes people create a mismatch and get away with it. Then, they tell a friend. Result: their friend may have a sudden surprise.

Let's examine the effect of changing load impedance from its design value.

All sources driving a load have an internal resistance or impedance, expressed in ohms. A simple and familiar source is a dry cell or battery. It

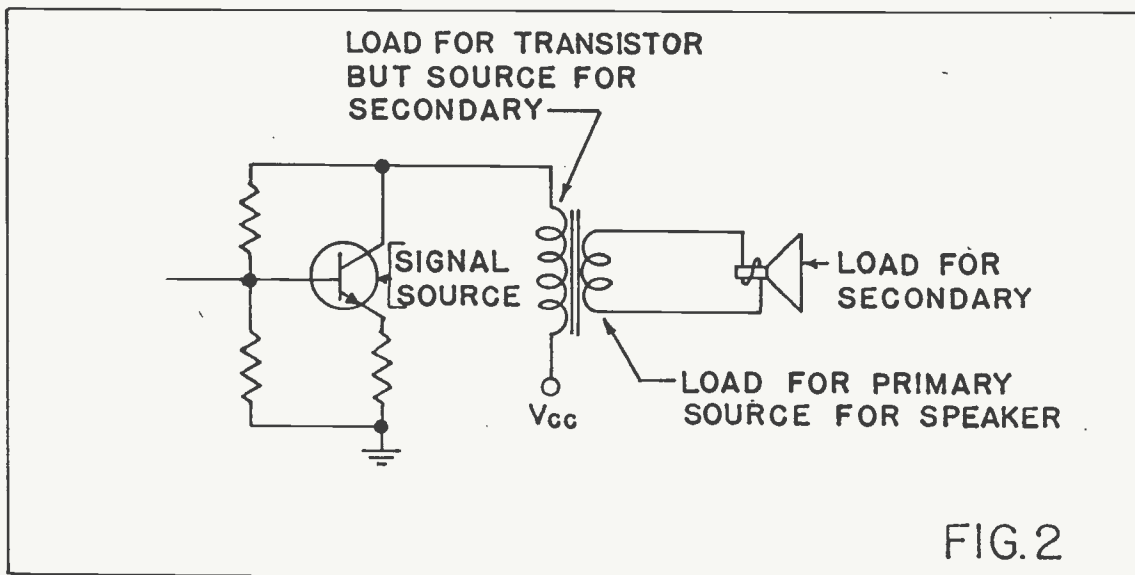
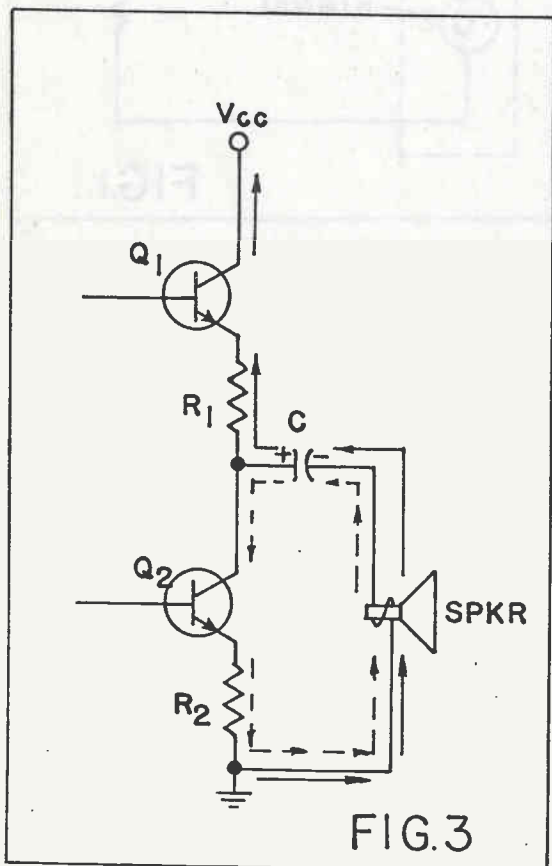

FIG.2

has an internal resistance, which is a result of the electrode materials and the chemicals used. It's very small, but you can observe its effect. As the cell ages, its internal resistance increases. This is observable in a flashlight when the lamp becomes dim as the battery ages.

A transistor amplifier stage also has internal 'resistance', although when dealing with AC signals, it is referred to as impedance. In Figure 1, the simplified equivalent circuit of an output transistor is shown within the dotted lines. The output impedance indicates the opposition to the AC signal between the emitter and collector. The load shown with a resistor symbol, represents the speaker.

Impedance is defined as the total opposition to AC current flow offered by a device or circuit at a particular frequency. Impedance is a combination of resistance, inductive reactance and capacitive reactance, and is analyzed using phasors or vectors and complex Math. Since impedance is frequency sensitive, it varies as frequency changes.



Amplifier stages have both an input and output impedance. With load or impedance matching of an amplifier to speaker, the output impedance is the important factor.

There are two basic output amplifier designs, and each exhibits its own impedance matching characteristics.

One design uses a transformer to couple the output stage to the speaker, while the other uses no transformer but couples either directly or through a large value capacitor to the speaker.

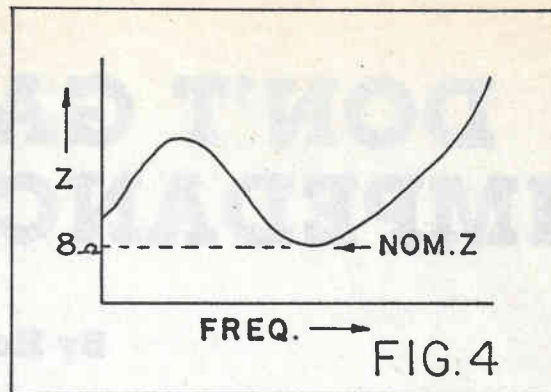

The transformer-coupled stage is not as common as it once was but is still seen in older car radios, portable radios and public address systems. A simplified schematic is shown in Figure 2. This is single-ended, but the reaction to a load impedance is similar to the push-pull design.

The transistor is the source of the signal while the speaker is the final load. The transformer couples the transistor to the speaker as well as matching the different impedances.

The primary of the transformer is the load for the signal source (or transistor), while the secondary acts not only as the load for the primary but the signal source for the speaker. The speaker, then, is the load for the secondary windings.

To be properly matched, the impedance of the primary windings should be the same as the output impedance of the transistor *and* the impedance of the secondary windings should be the same as the rated impedance of the speaker.

How is this accomplished?

Well, it's really up to the designer, but a brief explanation here will help you understand the process. You must be aware, however, that for simplicity, transformer efficiency, which is a result of its various AC losses, is not being considered. We'll leave that up to the engineers designing the equipment.

Recall the formula: $N_p/N_s = \sqrt{Z_p/Z_s}$? Sometimes it is expressed as $(\frac{N_p}{N_s})^2 = \frac{Z_p}{Z_s}$. In this formula, N_p/N_s is the turns ratio of the transformer and Z_p/Z_s is the impedance ratio required of the transformer.

Now, if the output impedance of the transistor is 1000 ohms and the speaker impedance is only 8 ohms, the match is obtained by application of the formula. Inserting the values above for the impedances, where Z_p is the transistor output impedance and Z_s is the speaker impedance, we have:

$$\frac{N_p}{N_s} = \sqrt{\frac{Z_p}{Z_s}} = \sqrt{\frac{1000}{8}} = \sqrt{125} = 11.2$$

This tells us that the turns ratio of the transformer, neglecting losses, should be 11.2 to 1 for a proper match. Or, that the primary windings should have 11.2 times as many turns as the secondary. Although we have ignored the various losses that would be considered by a design engineer, you can see the approach.

Using a transformer which can handle the currents involved and which has the correct turns ratio will properly match the output transistor's impedance with the speaker impedance.

The second circuit is the common transformerless type which gives superior sound reproduction, especially if no capacitor is included in the output circuit. A typical transformerless circuit which includes the coupling capacitor is shown in Figure 3. The coupling capacitor has been included to simplify the explanation of the circuit. Here, transistors Q1 and Q2 are connected in the common-collector configuration to provide the low output impedance needed to match the speaker.

These two transistors work together to supply a signal to the speaker. The inputs to Q1 and Q2 are 180 degrees out of phase so that as Q1 is conducting, Q2 is either cut off or almost cut off. To reduce crossover distortion, the output transistors are usually operated with a small amount of bias current which flows continuously.

When a positive-going signal is applied to Q1, a negative-going signal is applied to Q2. This causes Q2 to be cut off while Q1 conducts. The signal current then flows in the path shown by the solid arrows—from ground, up through the speaker, C1, R1, and Q1, charging C1 in the process to the polarity shown.

When the signal reverses, and Q2 is positive-going, Q2 will conduct, while Q1 is cut off. The signal current now will flow in the direction of the dotted lines, from C1, through Q2, R2 and the speaker.

Thus, both halves of the signal are produced.

Speakers are rated at a *nominal* value of impedance, expressed in ohms, with typical common values being 4 and 8 ohms. However, because a speaker reacts somewhat as an inductor, where impedance varies with frequency, the actual impedance of the speaker may often be three to five times its nominal value, and seldom is exactly 4 or 8 ohms.

Figure 4 illustrates a typical graph of speaker impedance vs frequency. The nominal impedance chosen by the manufacturer is usually at the low dip in the graph. This curve can effectively be flattened by good speaker cabinet design and a proper crossover network.

Nevertheless, all amplifiers should be terminated with a speaker of the correct nominal impedance. To vary far from this value could have disastrous results.

There are two types of mismatch and each has a different effect. Mismatching by connecting a lower than recommended load impedance would imply that you have either connected a speaker with too low an impedance or perhaps paralleled speakers. For example: connecting two 8-ohm speakers in parallel produces a total of 4-ohms, and connecting this combination to an 8-ohm tap on your amplifier, mismatches downwards.

Should you lower the impedance with a transformer-coupled amplifier, Figure 2, the impedance of the output transformer primary windings is also lowered because of the reflection of impedance through the transformer. This has the effect of decreasing the AC signal voltage seen across the primary windings and hence also across the collector-emitter of the transistor. Power output to the speaker is reduced.

Should the load impedance be reduced to the extreme value of zero ohms, there will, of course, be no output.

The other type of mismatch is when you increase the load impedance above the design value. If you do that in the transformer-coupled circuit, the impedance of the transformer primary increases. Then, the AC signal voltage across the primary as well as across the transistor also increases, even though the power output to the speaker again decreases. It may even be possible, in some circuits, for the signal voltage across the transistor to reach a value large

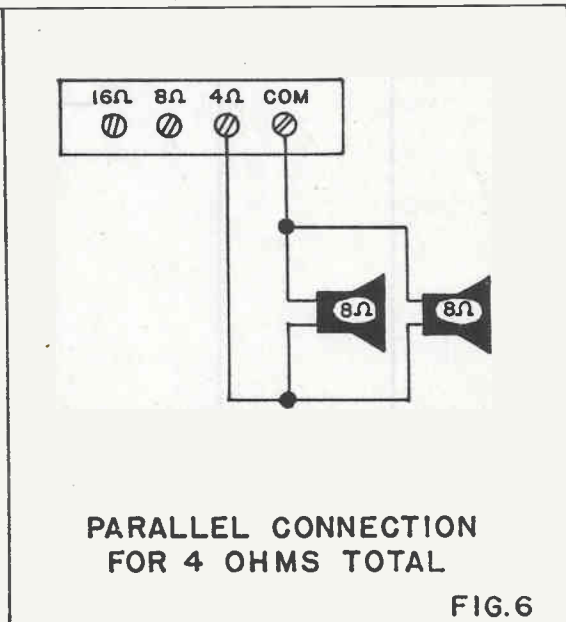
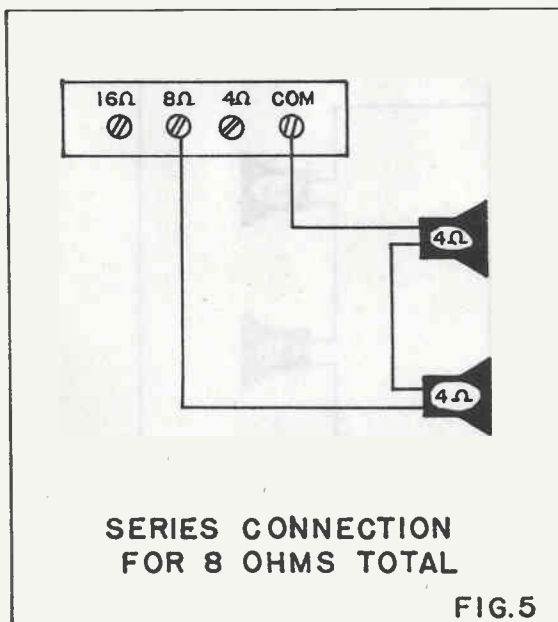

enough to damage the output transistor, especially if the speaker was disconnected and the set turned on.

In some older car radios that use a transformer-coupled output, a shorting speaker jack is used. Pull the speaker plug and the transformer secondary is shorted, effectively providing a load impedance of zero ohms, thus protecting the output stage should the set be turned on with the speaker disconnected.

Impedance mismatching in a transformerless circuit has just the opposite effect. Lowering the impedance of the speaker will result in an appreciable increase in collector current. The output transistor (or transistors) has a low output impedance, in the order of about 8 ohms, and, with an 8-ohm speaker in series with it, the total impedance seen by the signal is 16 ohms. Now, should you reduce the speaker impedance to 4 ohms, the total impedance drops to just 12 ohms, a change of 25%.

As the collector current increases, the power dissipation in the transistor also increases, for power is proportional to the square of the current. Double the current and power dissipation increases by four times! This extra power can sometimes generate so much heat that the poor overworked transistor or IC quickly burns out. Unless, of course, it's your lucky day and the fuse goes first.

Should you increase total impedance in the transformerless circuit, all you do is effectively lower the collector current and the speaker power output, but there will normally be no damage to a well-

designed output circuit.

Should you still want to connect a load impedance that differs from its design value, here are two rules for you to follow:

1. Transformer-coupled amplifier: never increase the load impedance.
2. Transformerless or direct-coupled amplifier: never decrease load impedance.

However, it is more advisable to try to match the impedances as closely as possible. In many instances you won't know what type of amplifier output stage is in your set. Don't chance guessing. It could be like playing a game of Russian Roulette. Although some of you may have connected speakers in such a way that opposes the rules above and had no nasty surprises, you're probably reaping the benefits of good design by an engineer who included a large safety factor.

If you really must connect multiple speakers to a system that is not designed for these additions, try to connect them in such a way, series, parallel, or series-parallel, so the sum of the impedance equals the value needed for that amplifier.

Figures 5, 6 and 7 show three possible multiple speaker arrangements. There are many more. Be aware, however, that power delivered from the amplifier divides between the speakers proportionately to their individual impedance. For example: assuming 20 watts is delivered from the amplifier, then each speaker in Figure 5 or 6 would receive 10 watts and those in Figure 7 only 5 watts. ■

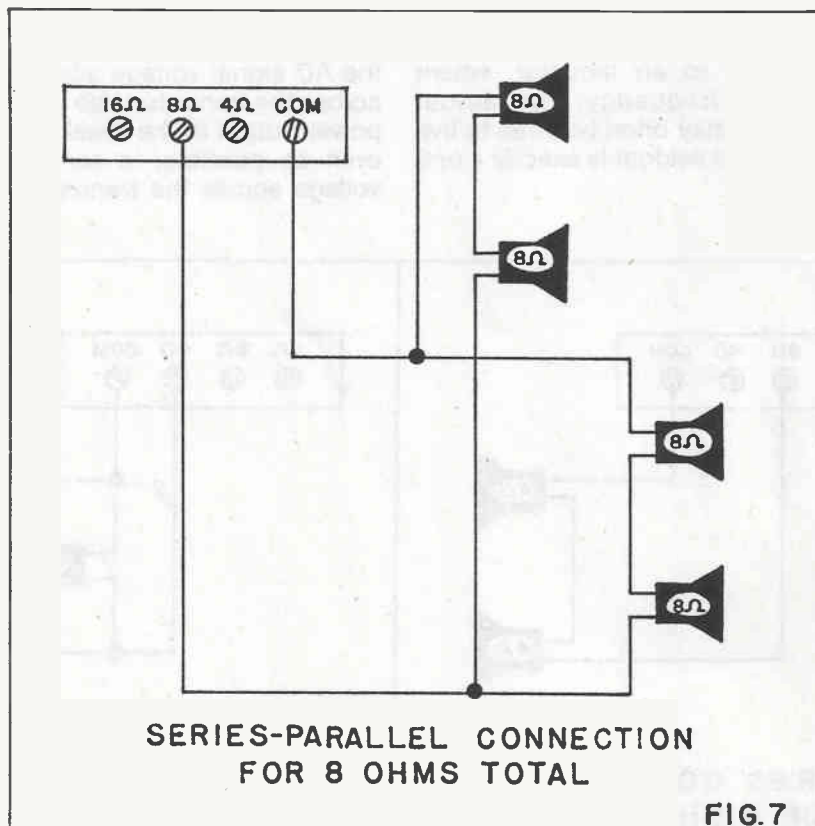



CHOOSING THE RIGHT CABINET

By Holmer L. Davidson

Today, there are many different kinds of cabinets that can be used to enclose your favorite electronic project.

They are available at reasonable prices, in various sizes and shapes, (Figure 1) from numerous electronic parts suppliers.

Small projects are usually built in plastic cases, since they are easier to drill and otherwise adapt to the project. Large electronic projects, however, may be enclosed in large plastic, metal or a combination plastic and metal cabinet.

A Touch of "Class"

Unfortunately, we often take the easy way out by purchasing a cheap plastic case. If you take a little extra time and select a metal or a plastic case with a metal front cover, the project can look like a commercially constructed unit. It's amazing how a polished aluminum front panel dresses up an electronic project. Just add a few decals, letters and numbers and you are in business, you have a finished project that you can be proud to show your friends (Figure 2).

Choosing The Cabinet

When choosing a good cabinet, a good rule of thumb is to spend as much for the cabinet as the total cost of the project. This may sound a little steep, but in the long run you end up with a professional looking project. Select a cabinet that is large enough to hold

all components without stacking them on top of one another. Sometimes when the parts are all jammed together, you end up with shorted components that



Figure 1: Project cabinets and enclosures come in many sizes and shapes. Plastic, metal front panels and plastic sides and all metal cabinets.



Figure 2: Dress up that front panel and make it look professional with decals, rub-on letters and numbers. Here the test instrument case has a plastic body with satin finish metal front panel.



Figure 3: Select a cabinet big enough for all parts. Here parts are jammed together in a project case that is too small.

provide unreliable and/or intermittent operation. (Figure 3).

Make sure the cabinet is shock proof. Do not choose a plastic cabinet when real high voltage or power line shock hazards are built in. Do not choose a plastic cabinet for electronic projects that may have RF radiation, such as generators or high voltage test equipment. Keep battery operated projects in the plastic cabinets.

Choose a metal or metal front cabinet for a professional appearance. Plastic cabinets with aluminum thick front panels are easy to drill and make a finished project look good. Admittedly, they cost a few more bucks, but they are worth it. In choosing a cabinet for your favorite project, make sure it's big enough. Take a peek inside a commercial test instrument and note all the room around the various components (Figure 4). Next, choose a cabinet that is safe and shock proof. Last, choose a cabinet with a professional looking finish. It's worth it!

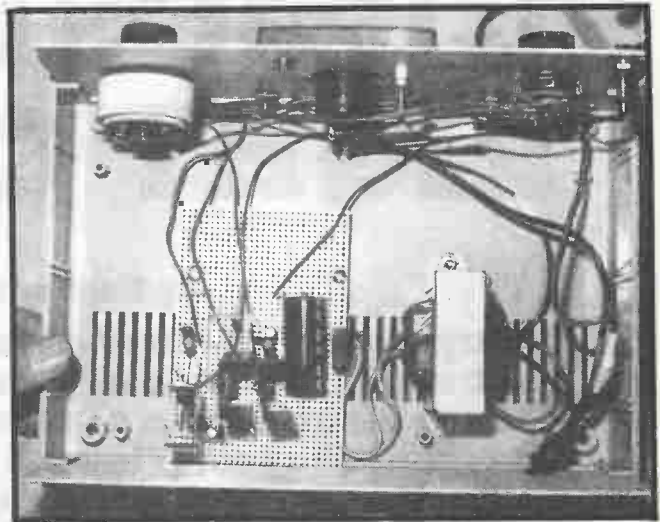

Figure 4: This cabinet is large with plenty of room around the components and plastic standoffs to mount the pc board.



Figure 5: Plastic project cases may come with metal or plastic front covers.

Plastic Cabinets

The plastic cabinets are usually cheap, easy to work with and frequently electronic suppliers have them for sale. Plastic cases and boxes come in sizes from 2½ inches up to 8 inches in length. Some of the plastic enclosures have metal aluminum covers, while others



Figure 6: With this ABS plastic cabinet, a metal satin-aluminum front panel was purchased extra for one dollar.

have screw mounted plastic covers (Figure 5). You will find some plastic boxes with internal slots for mounting a pc board.

The typical cabinet is low in price, can be drilled or large holes can be cut to make a quick project. Select the plastic high-style pro case for projects like RF or infrared transistors, garage door transmitters or any RF project. Some of these deluxe plastic enclosures are made of polycarbonate material which is impact resistant and can be dropped without breaking.

The deluxe plastic case may come in two sections where the top half lifts off and is bolted to the bottom section. Some are made for special test instrument enclosures. They are flame retardant and come in a variety of different colors. The ABS instrument enclosures have front and rear matching panels. Integral pc board mounting standoffs and two sets of vertical mounting slots for front and rear subpanel pc boards are provided.



Figure 7: This large metal grey painted cabinet comes with plastic ends and feet.

For a dollar bill you can purchase a satin finish aluminum front panel that gives your project the professional touch (Figure 6). This panel is easy to drill and parts mount solidly on the front panel. When the switch or control clicks on you know it's solid, and the parts will stay in place. Nothing dresses up the cabinet more than a satin aluminum finished panel.

Metal Cabinets

Although metal cabinets or enclosures may be more difficult to work with, and may take a little longer to put together, they give a professional finished appearance. Metal cabinets come in pressed, cast and bent metal units (Figure 7). The metal enclosure may have plastic sides and metal front and back panels. Of course, the metal cabinet also costs more than any other cabinet.



Figure 8: You can order out manufactured test instrument enclosures, just like the commercial test instruments from Global Specialties and Elenco Electronics.

The first metal cabinets had a black crinkled finish. Some still do. It may appear with a slanted front, recessed front panel, desk top console and/or a perforated cabinet. We recommend a metal cabinet for your favorite test instrument. Not only do they have a professional appearance, they stand up longer and are quite durable.

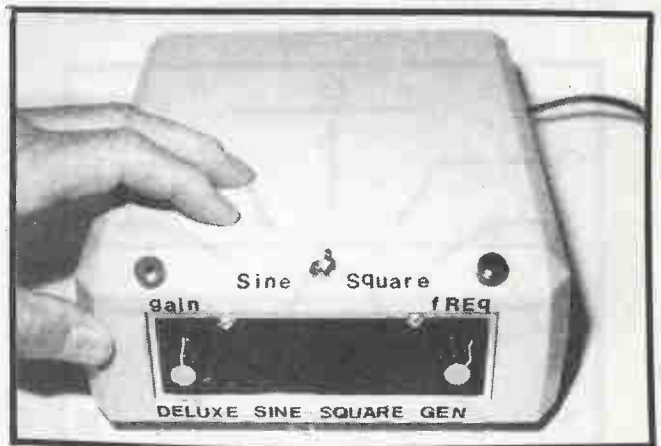

Figure 9: You can pick up surplus cabinets from \$1 to \$5.00. Some have colored plastic cabinets with a few control holes stamped in them.



Figure 10: Dress up the front panel with decals or rub-on letters and lines. Prepare the front panel, drill, mark and spray on clear art spray to prevent scratches.

Test Instrument Cabinets

Commercial test instrument cabinets may be purchased from some test equipment manufacturers. Many of these cabinets are exact units that the manufacturer uses for their test instruments. Some cabinets have plastic cases with satin aluminum front panels, while others have a solid aluminum brush anodized finish, front and back panels included. Small grey plastic impact probe cases are available. Both **Global Specialties** and **Elenco Electronics** have project cabinets at fairly reasonable prices (Figure 8).

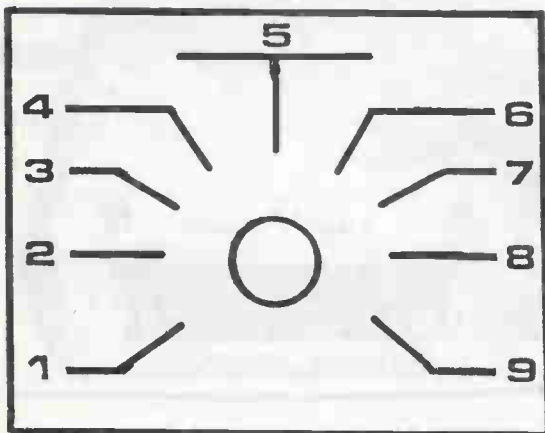
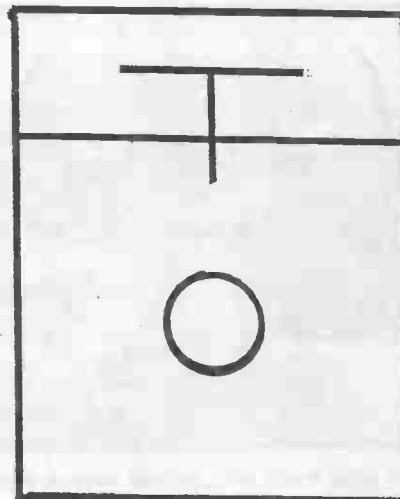

Figure 11: Lay out the switch and control decals with rub-on lines found at electronic part stores. These are the same lines and numbers found in pc board layout kits. Make a few different ones and copy what you want or need on a photocopy machine.

Surplus Cabinets

Brand new cabinets with a few blemishes may be purchased in the surplus electronic parts market. You can pick up project boxes or factory enclosures for only a few dollars (a fraction of their original value). Of course, many of these cabinets were designed for manufactured test instruments and electronic projects. Some cabinets have smoked gray dizeles, that will show up LED's or pilot lights, when mounted behind the front panel (Figure 9). A lot of the cabinets have control mounting holes. You can usually purchase these surplus cabinets from \$1.00 to \$5.00 each.



Letter and number the front panel with rub-on letters and numbers, that come in black or white to show up nicely on dark or black cabinets.

Layout The Front Panel

Before drilling the new cabinet, lay out the front panel on a piece of white typing paper. Make a rough sketch where each control or component will stick through the front panel. Center and balance up each hole with a ruler. Mark cross ("X") where each hole will go. Scotch tape the layout sheet over the front panel. This will help prevent scratching and marring the satin aluminum and plastic finish. No matter how careful you are in drilling the cabinet, scratches often appear.

Drilling The Cabinet

Start with a 1/8 inch drill when starting holes in the front cabinet. Then enlarge the hole with a larger drill bit. Sometimes when starting with a large drill bit it may leave a ragged hole or pull the cabinet out of your hands. The cabinet or front panel may run up the drill bit and whirl around dangerously, if not held securely while drilling.

A drill press is ideal for all cabinets and front piece drilling. Use a block of wood covered with a cloth to drill those slick finished front panels. After drilling a couple of holes, tap the panel to dislodge small metal pieces that may mar the front panel. Of course, a hand drill will do a nice job but hold the cabinet or front panel securely when drilling. Plastic and metal enclosures have a tendency to spin up the drill bit when it completes the penetration.

Dress Up The Front Panel

Make that front panel look like a commercially manufactured unit by dressing up the front panel. Letter all components with rub-on transfer lettering. You can purchase small, medium and large letters, with numbers, for any front panel. Pick them up at electronic wholesale parts houses, stationery, hobby and art stores. They come in plastic sheets. Prepare the front panel before mounting any parts.

Make those dial decals out of direct etching dry transfer lines and numbers. Black solid transfer lines can be placed directly upon the aluminum or plastic front panel. Variable control decals can be made up directly on the metal surface. Use a razor blade to trim the ends squarely. Rub on numbers can be placed on the control decal (Figure 10). These control decals can be placed on a white piece of typing paper and copied with a photocopy machine. Likewise, decals found in various electronic magazines can be copied and glued on the front panel.

Keep all numbers and letters as square as possible. Keep lettering in line by lightly drawing a horizontal pencil line or a layer of scotch tape. Seat the "rub on" numbers and letters up to the line or tape edge to keep them level. After the front panel is completed, spray on 3 or 4 coats of clear art coat finish. This prevents damage to the lettering and protects the front panel (Figure 11). Now, mount those front controls and meters.

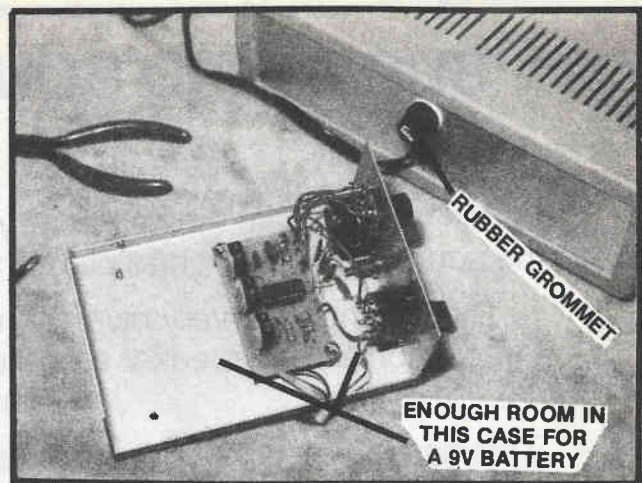

Figure 12: Place rubber grommets in metal or plastic holes for power cords. Prevent shorts and shocks with grommets.

Conclusion

Here are some constructive hints that may make project building a lot easier and a lot more fun. When choosing the right cabinet, make sure you have plenty of room to mount those parts. Dress up your project with a nice cabinet or enclosure. Start all holes with a small drill bit. Prepare the front panel with a sheet of typing paper scotch-taped to the front panel. Use extreme care when drilling or mounting parts on the front panel to prevent nicks and scratch marks.

Dress up that front panel with rub-on letters and numbers. Finish the front panel "dress-up" after drilling all holes and before mounting parts. Spray several coats of clear finish on the front panel for protection. Place rubber grommets in holes where power cords come through metal or plastic (Figure 12). **Play it safe and shock proof.** Mount plastic or rubber feet on the finished project. Above all, make your project shine and look professional—it's worth it. ■

LIST OF ELECTRONIC PARTS SUPPLIERS WITH CABINETS AND ENCLOSURES

- | | |
|--|---|
| All Electronics Corp.
P.O. Box 567
Van Nuys, CA 90408 | Global Specialties
P.O. Box 1405
New Haven, CT 06505 |
| Circuit Specialists, Inc.
P.O. Box 3047
Scottsdale, AZ 85271-3047 | Hosfelt Electronics, Inc.
2700 Sunset Blvd.
Steubenville, OH 43952 |
| D. C. Electronics
P.O. Box 3203
Scottsdale, AZ 85271-3203 | Mouser Electronics
P.O. Box 699
Mansfield, TX 76063 |
| Digi-Key Corp.
701 Brooks Ave.
P.O. Box 677
Thief River Falls, MN 56701-0677 | Elenco Electronics, Inc.
150 W. Carpenter Ave.
Wheeling, IL 60090 |
| Radio Shack Stores
(locally) | |

SURROUND SOUND DECODER KIT

Watch your favorite movie the way it was meant to be seen. Experience the sounds of Navy fighter planes and the thunderous roar of the crowd.

By building your very own "Surround Sound Decoder" (with noise reduction & rear speaker amplifier) you can experience the sense of being there.

This easy-to-assemble kit contains all the parts (less AC Transformer & Housing) printed circuit board and step-by-step instructions to build this exciting electronic project.

The "Surround Sound Decoder" is the perfect classroom construction project that will provide years of enjoyable television viewing.

\$39.95

Plus \$1.50 S/H

SUNCOAST TECHNOLOGIES
P.O. BOX #5835
SPRING HILL, FL 34606



THE 80 TUNE COMPUTER



The 80-Tune Computer is a project which is not only easy to build but also fun to use. Its uses are many and are limited only by the imagination of the builder. This is an excellent beginner's project because of its simplicity. A masked microprocessor (special Integrated Circuit, or IC) does all the work.

Any of the 80 songs can be selected by the telephone-style keypad. A push of the *Play* button makes the selection. The *Stop* button resets the microprocessor. The selected tune will start each time the *Play* button is pushed as long as power is on and no *Reset* (or *Stop*) occurs.

80 TUNE COMPUTER SONG LIST

- | | | |
|--------------------------|-------------------------|--------------------------|
| 0 AMERICA | 27 IN HEAVEN IS NO BEER | 53 BUCKLE OOWN WINSOCKI |
| 1 ANCHORS AWEIGH | 28 JIMMY CRACK CORN | 54 CHARGE |
| 2 BATTLE HYMN REPUBLIC | 29 JINGLE BELLS | 55 DEAR OLD NEBRASKA U. |
| 3 CAISSONS GO ROLLING | 30 KING OF ROAD | 56 THE EYES OF TEXAS |
| 4 CALL TO COLORS | 31 LA CUCATACHA | 57 ABOVE CAYUGA'S WATERS |
| 5 CAVALRY CHARGE | 32 LONE RANGER | 58 FIGHT ON USC |
| 6 OIXIE | 33 MODEL T | 59 GO, NORTHWESTERN |
| 7 HAIL BRITANIA | 34 THE OLD GREY MARE | 60 HAIL PURDUE |
| 8 YANKEE DOODLE OANDY | 35 POPEYE | 61 HEY LOOK ME OVER |
| 9 LA MARSEILLAISE | 36 RAINDROPS | 62 HOLD THAT TIGER |
| 10 MARINE HYMN | 37 SAILORS HORNPIPE | 63 ILLINOIS LOYALTY |
| 11 REVEILLE | 38 SAN ANTONIO ROSE | 64 INDIANA, OUR INDINA |
| 12 STARS & STRIPES | 39 SEE THE USA | 64 1M A JAYHAWK |
| 13 TAPS | 40 OUT TO THE BALLGAME | 66 IOWA FIGHT SONG |
| 14 WILD BLUE YONDER | 41 TIJUANA TAXI | 67 LOVE YA BLUE |
| 15 ALOUETTE | 42 TWO BITS | 68 MICHIGAN STATE FIGHT |
| 16 AHLVEUEHCIN ROMA | 43 WADASHI CANNONBALL | 69 MINNESOTA HOUSLR |
| 17 CAMPTOWN RACES | 44 SAINTS GO MARCHING | 70 NITTANY LION |
| 18 CANDY MAN | 45 WOODY WOOPECKER | 71 NOTRE DAME FIGHT |
| 19 CHATTANOOGA CHOO-CHOO | 46 YELLOW ROSE OF TEXAS | 72 OLE MISS |
| 20 CLEMENTINE | 47 ACROSS THE FIELD | 73 OH, BRAVE ARMY TEAM |
| 21 UALLAS THEME | 48 AGGIE WAR HYMN | 74 OH WISCONSIN |
| 22 EL PASO | 49 ARKANSAS FIGHT SONG | 75 WRECK FROM GA. TECH |
| 23 THE ENTERTAINER | 50 RE SHARP | 76 ROLL ON TULANE |
| 24 JOYLY UUUU FELLOW | 51 UOUMEH BOUNEH | 77 THE VICTORS |
| 25 FUNERAL MARCH | 52 BOW DOWN WASHINGTON | 78 WASHINGTON/LEE SWING |
| 26 HAVA NAOLAH | | 79 YEA ALABAMA |

Complete plans to build the "80-Tune Computer" \$2.95

U1 Custom Microprocessor \$9.00

PCB Printed Circuit Board \$4.95

Add \$2.00 for postage & handling

For each combination of the above items, send check or money order (U.S. funds) to: C&E Hobby Handbooks, Inc.

P.O. Box #5148, North Branch, N.J. 08876

Payment enclosed. to: C&E Hobby Handbooks

PLEASE PRINT

V11

NAME: _____

ADDRESS: _____

CITY: _____

STATE: _____

ZIP _____

Foreign Postage add \$8.00...U.S. Funds

IC TESTBENCH

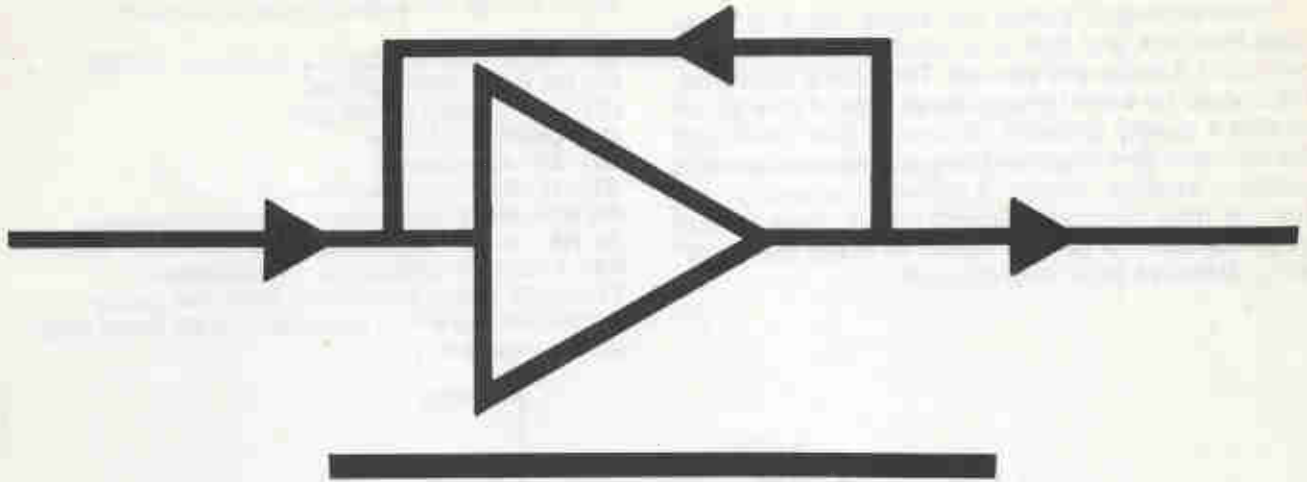

We have said before but it bears repeating. For the beginning project builder, it would be wise to polish your skills on some of the simpler projects in this issue before you tackle the projects in this section.

For those of you who feel ready to try some of the following projects, we offer some suggestions and precautions. Unless you are using a commercially made breadboard, it would be wise to invest in some sockets, whose holes will accommodate the IC pin spacings for the particular ICs which you are planning to use. Through the use of sockets, solder connections can be made without the danger of damage to the IC and voltage and input signal tests can be performed without the IC being exposed to their hazards.

When debugging a circuit, or testing for signals and/or voltages, prior to firing up your project for the first time, it is important that you remember to NEVER apply an input signal to an IC unless the circuit is powered up. Damage will almost certainly occur. Also, in those projects which require a separate input signal, such as a clock source, which is not an integrated part of the circuit you're building, it's a good idea to use a power switch which is capable of controlling the supply to both circuits. This will minimize the possibility of applying a signal to a non-powered chip, both in turning the circuit on and turning it off. If you don't use this method, remember to remove the input signal before turning off the power to the IC circuit...Have fun, and use caution!

MINI-MICRO METRONOME



Transforming IC pulses into sound, this tiny ticker goes both tick *and* tock at a rate of about 2 seconds per tic to 6 tocks per second. The timing capacitor, C1, should be a low leakage mylar type of about 2- μ F or else a quality tantalum of about 4.7- μ F. Although the reversed flow of current through the transformer's primary winding causes a different sound in the speaker from the positive-going inrush, diode D3 and potentiometer R5 can be added to make the "tock" more definitive in its sound quality.

PARTS LIST FOR MINI-MICRO METRONOME

- C1**—2 to 5- μ F low-leakage mylar or tantalum capacitor, 15 VDC
- C2**—2.2 to 10- μ F electrolytic capacitor, 15 VDC
- D1, D2, D3**—1N4148 diodes
- IC1**—4011A quad NAND gate
- Q1**—2N4401 transistor
- Q2**—2N4403 transistor
- R1**—47,000-ohm, 1/2-watt resistor
- R2, R3**—500,000-ohm linear-taper potentiometers
- R4, R6**—10-ohm, 1/2-watt resistors
- R5**—1,000-ohm linear-taper potentiometer
- T1**—audio output transformer 1000-ohm center-tapped primary/8-ohm secondary (Radio Shack #273-1380 or equivalent)

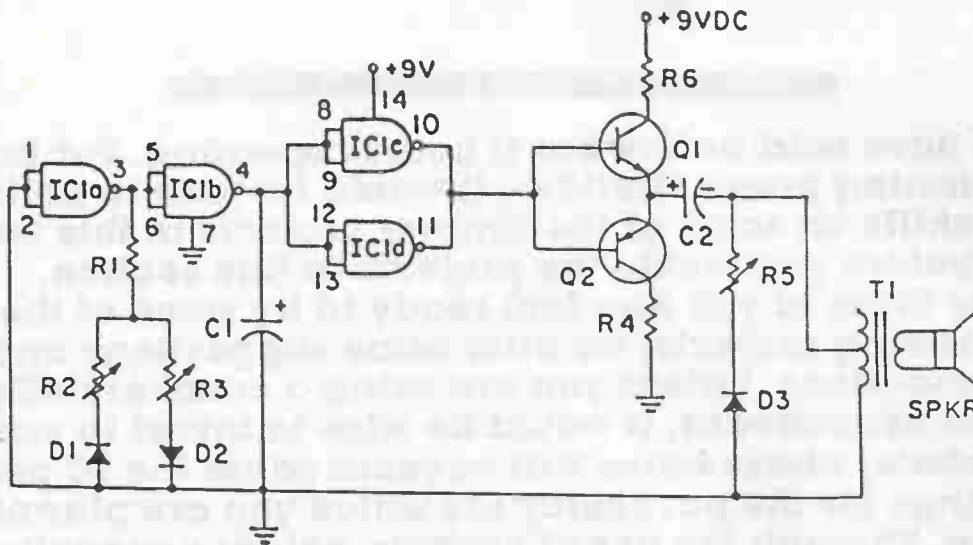

TAKING THE COUNT



The type 4026 and its companion 4033 CMOS counter-decoders are so versatile and useful, that the IC experimenter should make their acquaintance without delay. What they do is to count incoming pulses (positive-going) and *directly* drive those seven-segment LED (or other) digital indicators. The 4026 and the DL-750 display provide a particularly happy pair as no interfacing drivers or current-limiting resistors are needed for voltages in the 5 to 8 volt supply range.

For an introduction to this most useful IC, connect as shown below. Reset the display to "0". Using a bounceless push-button switch, step through the

digits one-by-one. The display makes a good teaching aid for the pre-school set, letting them "learn their numbers" by pushing the switch five times for "5," etc.

PARTS LIST FOR TAKING THE COUNT

- IC1**—4001 AE quad NAND gate
- IC2**—4026 decade counter
- LED**—DL-750 7-segment common cathode display or equivalent
- Q1 through Q7**—2N4401 transistors
- R1 through R10**—1,000-ohm, 1/2-watt resistors
- S1**—SPDT slide switch
- S2**—SPST momentary-contact push-button switch

TAKING THE COUNT

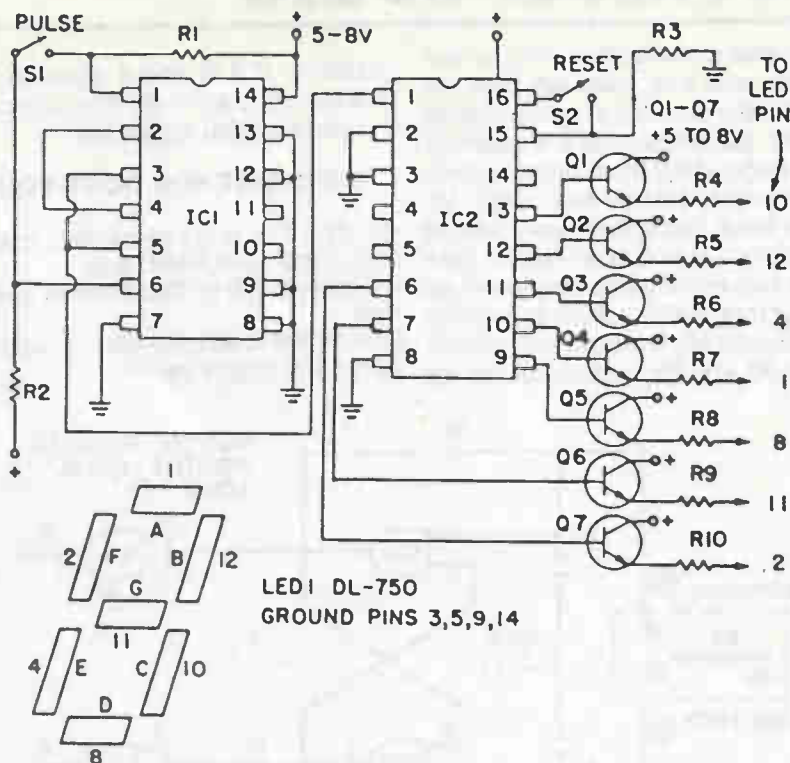

NINE VOLT NEON LAMP



High voltage, sufficient, at any rate, to power a type NE-2 neon bulb, can be obtained via an interstage transformer with the high-turns side feeding the lamp. (The transformer used here is one with windings of 75 ohms and 1000 ohms impedance.) One kHz or higher frequencies from the pulse generator are stepped up and rectified as shown. (Possibly other transformer combinations could be obtained to fire the lamp directly.)

PARTS LIST FOR NINE VOLT NEON LAMP

- C1—0.01 to 0.1- μ F ceramic capacitor, 15 VDC
- C2—10- μ F electrolytic capacitor, 25 VDC
- C3—0.47- μ F ceramic capacitor, 400 VDC
- D1—1N4002 diode
- IC1—4011A quad NAND gate
- Q1—2N4401 NPN transistor
- Q2—2N4403 PNP transistor
- NE—NE-2 neon lamp
- R1—500-ohm, $\frac{1}{2}$ -watt resistor
- R2—10,000-ohm linear-taper potentiometer
- R3, R4—10-ohm, $\frac{1}{2}$ -watt resistors
- R5—10,000 to 22,000-ohm, 2-watt resistor
- T1—audio output transformer 1,000-ohm primary/75 ohm secondary

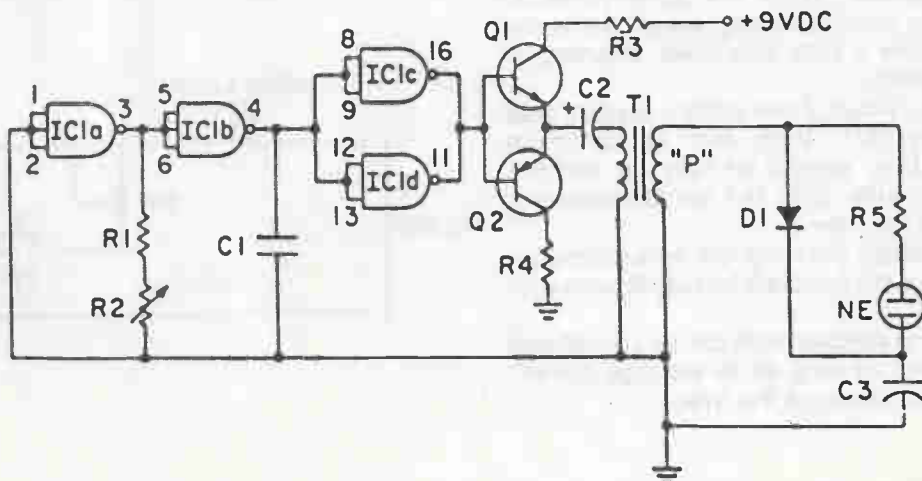

DO IT YOURSELF LOGIC



Sometimes the integrated circuits taken for granted are not always available, and one must fall back on more basic components. We do not go quite as far as discrete transistors here, but show how a frequency divider flip-flop can be improvised from simple gates. The following divide-by-two circuit was used for dividing a 60 Hz square wave, but should work well at other frequencies. A 7400 or 74LS00 quad NAND gate was selected, with the two extra gates employed as buffers to keep the input toggle clock from appearing when the flip-flop was biased off. If the cut-off resistor R3 is the same value as R1 and R2, a lock-out will be

obtained. If it is about doubled, then the circuit will function, but will hold one output high (or low) when the clock signal drops out.

PARTS LIST FOR DO-IT-YOURSELF LOGIC

- C1, C2—0.01 to 0.1- μ F ceramic capacitors, 15 VDC
- IC1—7400 quad NAND gate
- R1, R2—50,000 to 100,000-ohm, 1/2-watt resistors (see text)
- R3—50,000 to 200,000-ohm, 1/2-watt resistor (see text)
- S1—SPDT toggle switch

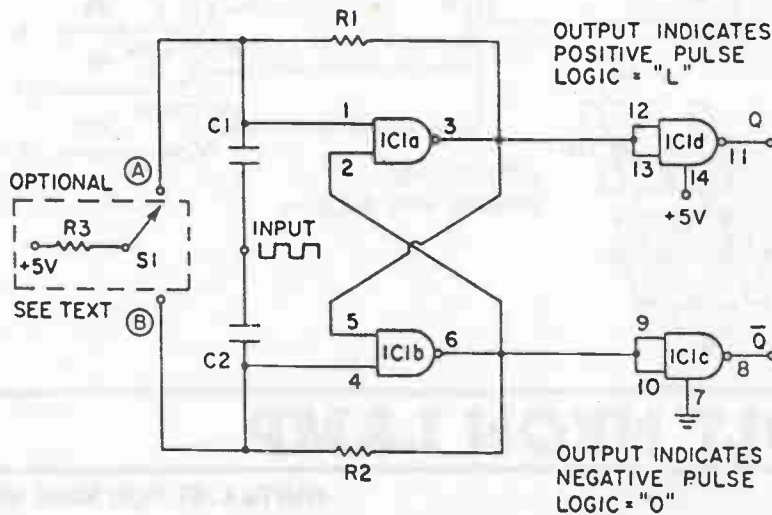

SIMPLE TRIAC TESTER



A triac, often used in lamp dimmers, interfaces, and AC control circuits, can't be checked directly with an ohmmeter like a diode. An ohmmeter would show a good triac as open or very high resistance between terminals MT1 and MT2; open or high resistance from the gate to MT2, and as two diodes in "reverse parallel" from the gate to MT1. Therefore, those measurements would not show accurately whether a triac was open, shorted, or conducting properly.

In this simple circuit, closing PB1 applies gate current, set by Rv1. With Rv1 at minimum resistance, the triac should be fully on and the neon lamp lit brightly. With Rv1 set to maximum, the lamp will be very dim.

If the triac is **open**, the lamp will never come on and if it is **shorted**, the lamp will be fully lit even with PB1 open.

A standard incandescent bulb can be substituted for the neon lamp as long as its wattage doesn't exceed the power rating of the triac.

PARTS LIST FOR SIMPLE TRIAC TESTER

- 110 Vac neon lamp
- Rv1—2M Ohm control pot
- PB1—normally open momentary pushbutton

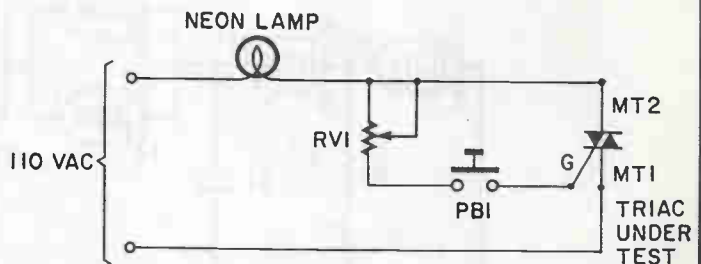

PULSE DELAY CIRCUIT



This circuit is useful for clock and digital applications. It can be used to delay a clock pulse by as much as one pulse width (or any part of one pulse). The output pulse can be no longer in duration than the spacing between input pulses.

The length of the delay and the pulse width are varied by changing the R1/C1 time constant. Op amplifier A1, half of a 1458 dual op amp, inverts the input pulse and charges up capacitor C1. Time constant R1/C1 sets the Delay time. The slower capacitor C1 discharges, the longer the delay time will be, but it must discharge fully before the input pulse goes low.

Op amp A2 inverts the signal again, forming a narrow pulse whose width depends on time constant R1/C1. The output of A2 charges C2 to widen the pulse. C2 must discharge fully before the input pulse

goes high again. Op-amp A3 squares off and inverts the widened pulse. The output of A3 is inverted, and is then delayed compared to the input signal.

Transistor Q1 inverts the output of A3, buffers it, and adjusts its level to (almost) the level of the power supply. Note that the input signal can be any voltage which is less than the supply voltage. Thus this circuit can also function as a level shifter.

PARTS LIST FOR PULSE DELAY CIRCUIT

- A1, A2—1458 Dual Op-amp
- A3—741 Op-amp
- D1, D2—1N914 Diodes
- Q1—2N3906 PNP Transistor
- C1, C2—0.1 uf Capacitors
- R1, R2—variable, try R1 = 27K, R2 = 22K Ohms
- R3, R4—1K Ohm

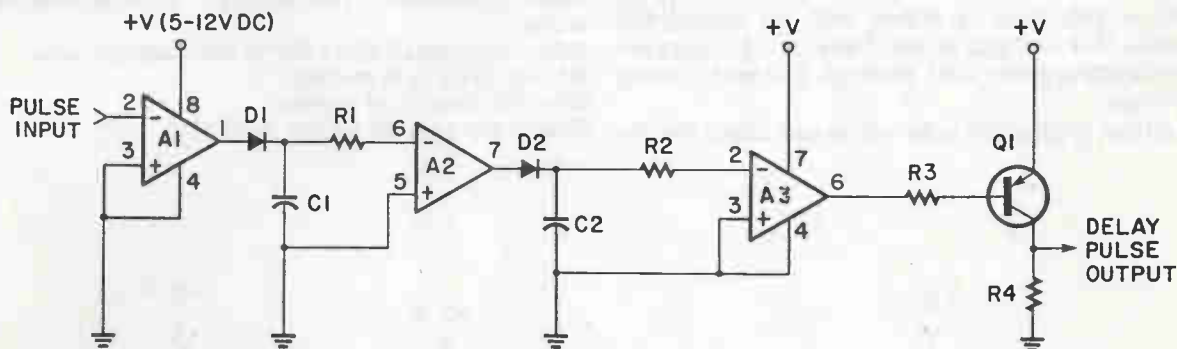

IN-CIRCUIT RESISTANCE VERIFIER

Simple low dc voltage audible testers are commonly used for checking the continuity of wiring, giving an audible indication of continuity. There are applications, however, where both low resistance paths (e.g. PCB tracks, transformer windings, etc) and high resistance paths (greater than a few kilo ohms) have to be verified. The circuit shown allows such paths to be checked using the well known 555 timer IC. Varying resistances applied across the test probes cause a resultant change in output frequency from the speaker.

PARTS LIST FOR IN-CIRCUIT RESISTANCE VERIFIER

- IC1—555 Timer (any type)
- R1—5K ohms
- R2—3K ohms
- C1—0.1uF
- C2—0.01uF
- SPKR—Miniature replacement speaker (any Type)

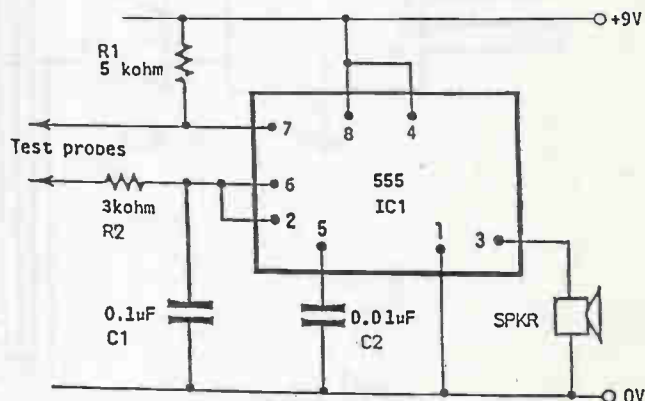

HOME/AUTO BURGLAR ALARM



This alarm circuit uses four common digital IC's to monitor up to nine switch inputs. A switch closure will actuate the siren and indicate the input number on the display. Inputs could be "limit switches" and/or "photoswitches" for windows and doors, or, for car use, "pin" switches for the doors and trunk and a mercury switch for motion detection. This circuit was originally designed to monitor liquid high level using float switches, so the alarm will turn off when the input is reset. Add a latch circuit to the inputs or the siren relay to keep the alarm on.

IC1 is a 10-to-4 encoder, producing a BCD output for each input. The inputs, are "active low", so the alarm is actuated by the closing of switches connected to the power supply common (-). IC2 inverts IC1's output to drive IC3 and IC4. IC3 is a BCD-to-7 segment decoder/driver for the display, and IC4 is a 4 input NOR gate. The LED display indicates which input is active, with R1 setting the brightness. IC4's output is low if any of it's inputs are high, energizing relay CR1 through IC2 and turning on the siren.

This circuit is ideal for automotive use, since the car

chassis is the common, and only one wire need be run to each switch. Using the CMOS equivalents of the IC's will allow you to use the car's 12 VDC instead of 5 volts, although some "pin-outs" will be different. The siren and relay will operate with a 12 volt supply, and the LED display can be omitted or the pull-up resistor R1 increased. The circuit as shown requires 5 volts at 500 mA.

PARTS LIST FOR HOME/AUTO BURGLAR ALARM

- IC1—74147 Decimal-to-BCD encoder, CMOS =40147
- IC2—7406 Hex Inverter/Buffer, CMOS=4049
- IC3—7447 BCD-to-7-segment decoder/driver, CMOS=4055
- IC4—7425 Dual Quad input NOR gate, CMOS=4002
- DIS1—ECG-3080 1" LED display, 7 segment common anode
- CR1—Magnecraft W171-DIP-9 DIP package relay
- R1—47 Ohm, 1/2 W resistor
- R2—100 Ohm, 1/4 W resistor
- Siren—Mura SC-58 8 Ohm, 6-12 VDC

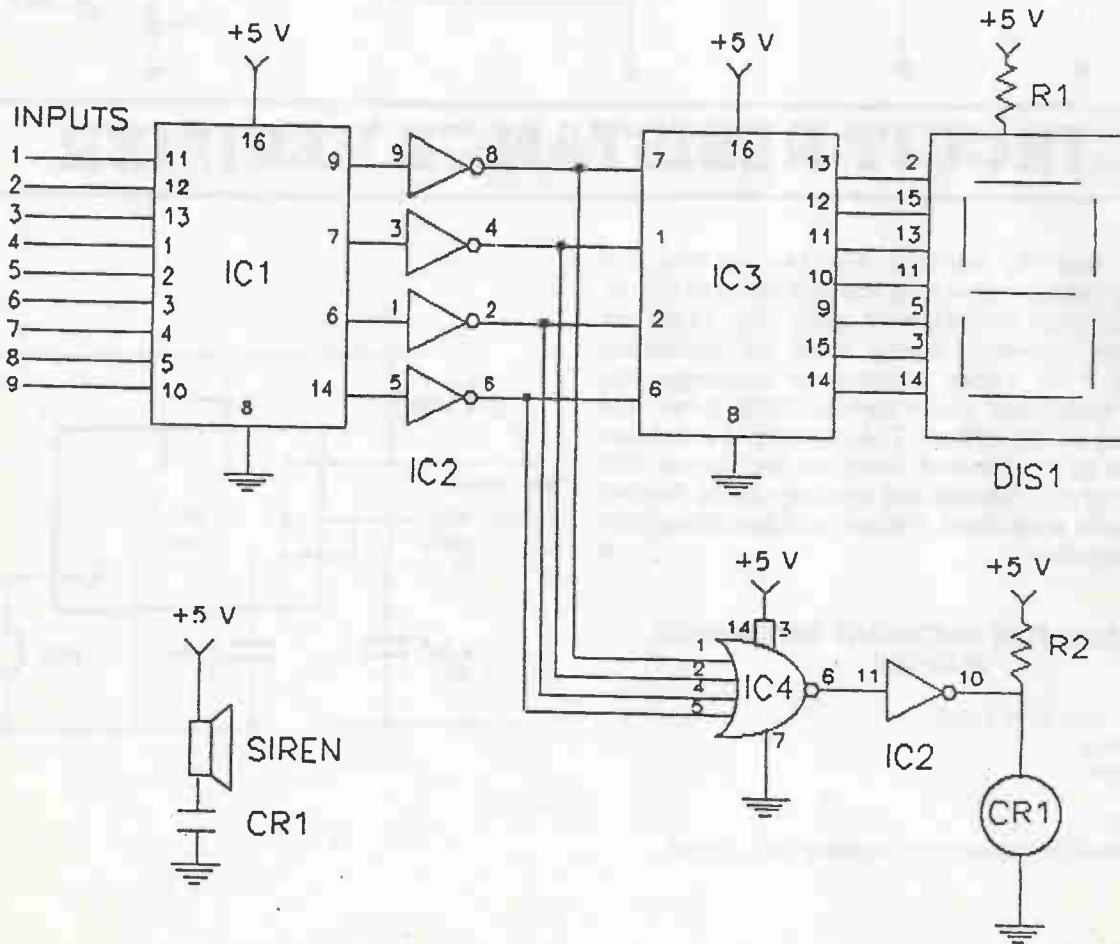

SQUARE WAVE CONDITIONER



Here is a circuit that is very simple to build but very effective and precise in its operation. The 1 Hz Square Wave Generator will fill the bill for every hobbyist or professional who needs a precision 1 Hz signal source.

Here is a circuit that is very simple to build but very effective and precise in its operation. The 1 Hz Square Wave Generator fill the bill for every hobbyist or professional who needs a precision 1 Hz signal source. This circuit is compatible with TTL and CMOS. It is a square wave with a precise 50-50 duty cycle, whose accuracy is tied to the 110 VAC 60Hz household electrical system, close enough indeed to supply pulses for a clock. The beautiful part about it is that the 555 timer section is not operating as a divide by two but as a voltage divider, whose positive and negative cycle is very precise. The 60Hz output at pin #3 is fed to the 7490, which is set up as a divide by 10. This output, now 6Hz at pin #12, is fed to a 7492 set-up in the divide by 6 mode. The output of this stage is a perfect 1Hz square wave, suitable for any TTL or CMOS circuit needing a 1Hz signal.

This circuit is not entirely original. The author originally built a programmable up-down counter and clock, using the 74190, 7447 and 555. It was almost impossible to use a 555 time base that was not susceptible to ambient temperature changes. I needed a precise 1Hz square wave. Having a copy of Don Lancaster's TTL Cookbook, I found a circuit for a "single-ended power-line conditioner" but the duty

cycle was not exactly 50%. However, the Bugbook Reference Series, by Howard Berlin, had exactly what I needed. I, therefore, combined the two circuits and...Voilla!!! A beautiful 1Hz generator with a perfect 50-50 duty cycle. Needless to say, my counter-clock works beautifully. I have timed it over an 8-hour period with a commercially sold Digital Clock and it kept time to the second. The uses for this circuit are far-reaching and almost endless. It is actually the same effect as a "Schmitt-Trigger".

Here is how it works: In the "Square Wave Conditioner" section, the 555 is set up as "Schmitt Trigger". The two internal comparator inputs (pins #2 and #6) are tied together and externally biased at $\frac{1}{2} V_{cc}$, through R1 and R2. Since the upper comparator at pin #6 will trip at $\frac{2}{3} V_{cc}$ and the lower comparator will trip at $\frac{1}{3} V_{cc}$, the bias provided by R1 and R2 is centered within these two thresholds.

A sine-wave input of sufficient amplitude to exceed the reference levels causes the internal flip-flop to alternately set and reset, producing a square wave output. As long as R1 equals R2, the 555 will automatically be biased for any supply voltage in the 5 to 15 volt range. A scope readout reveals that the square wave is out of phase with the 60Hz sine wave. However, by 180 degrees, which presents no problem at all.

Hopefully, this "project" will help some hobbyists, especially beginners, along the road of "Digital Electronics".

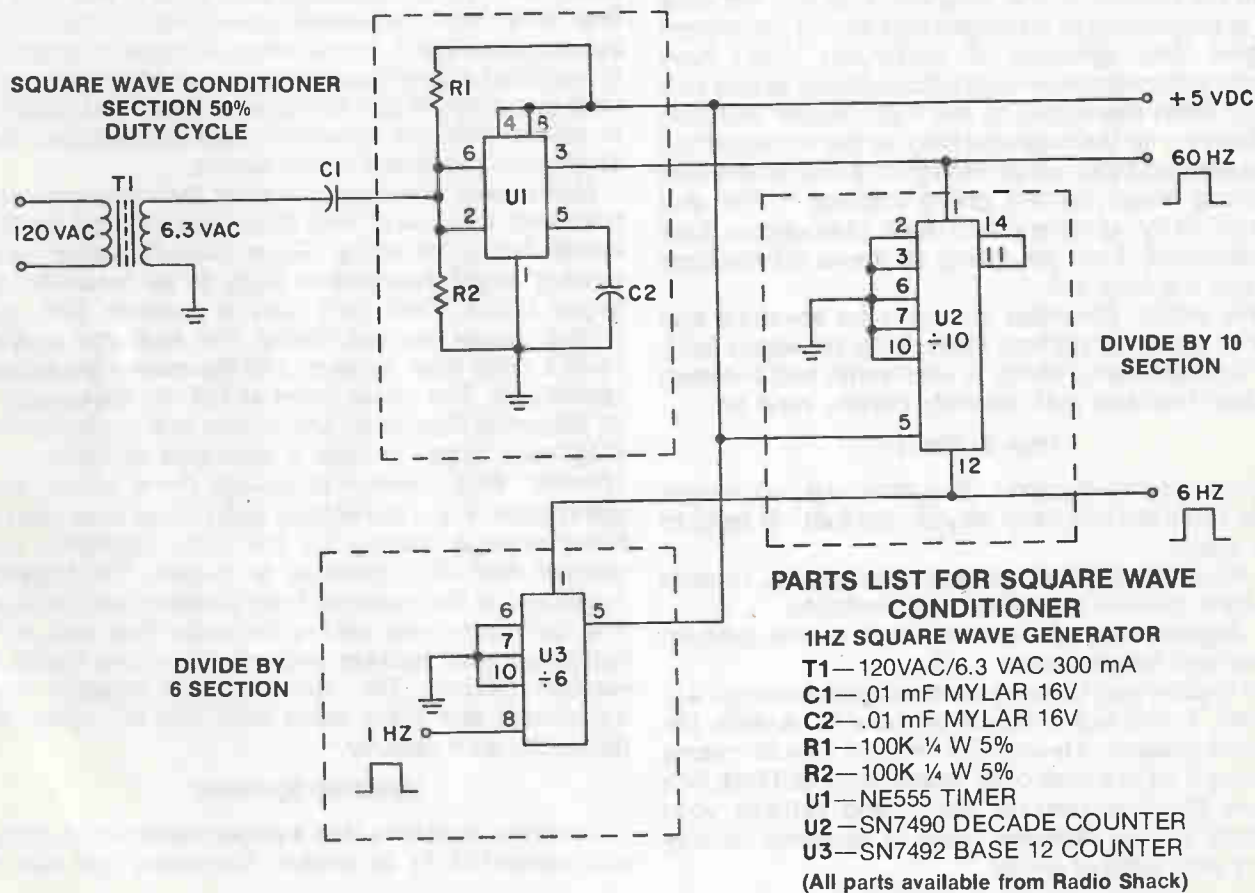

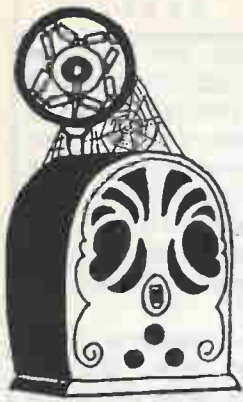

ANTIQUE RADIO

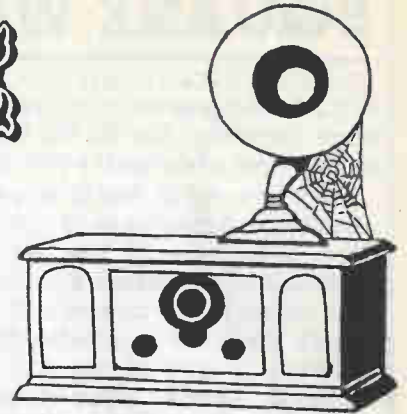

DYNAMIC SPEAKERS

Put these old-time speakers back in action

One of the most important parts of any radio is the loudspeaker, and old-time radios had speakers which were quite different from the speakers of today. (Editor's Note: although a loudspeaker really consists of two main parts, the *speaker driver* and the *speaker enclosure*, when we talk about a loudspeaker we are usually referring just to the *driver*.)

Modern speakers have just two connections, which go to the voice coil. The magnetic field that the voice coil is suspended in is created by a strong permanent magnet. But speakers of yesteryear didn't have permanent magnets—magnetic materials at that time hadn't been developed to the high degree that they are today—so the magnetic field for the voice coil had to be created by an electro-magnet; a coil of wire with a strong direct current going through it. For that reason early speakers had four (sometimes five) connections. Two (or three) of these connections went to the *field coil*.

This article describes the old-type speakers and how to repair or replace them. To learn about field-coil loudspeakers, which is what radio had between the late Twenties and the early Forties, read on.

How to Do It

Since electro-dynamic speakers are no longer made there are two basic ways to get that old radio to play again.

1. Have the original speaker repaired, i.e., replace the cone or have a new field coil installed.
2. Replace the old speaker with a new modern permanent magnet type.

To enable you to make an intelligent choice, I will present a detailed account on how to replace the original speaker. Having the original rebuilt means sending it off to a mail order repair shop. But first, let's review the loudspeaker story, and refresh your memory on the different types of speakers usually found with antique radios.

Early Speakers

First of all, there are two basic types of speakers found in radios made between 1920 and 1950. The first radios only used headphones, sometimes called earphones. Headphones limited the number of persons that could listen to a radio at one time. They were reasonably sensitive, worked with crystal radio sets, or with 1-tube battery-operated radios. The basic design of an earphone consisted of two coils of fine wire, with laminated cores inside the coils, surrounded by a horse-shoe-shaped magnet. Suspended a few thousandths of an inch above the coils was a very thin, soft iron diaphragm that vibrated in unison with the received audio frequencies. The diaphragm produced sound waves.

Quite soon, someone mounted the earphone on a horn and the sound was then loud enough for the whole family to enjoy. Soon manufacturers were making larger headphone units to be mounted on larger horns. Distortion was a problem with the limited power handling ability. The next step was to build a cone type speaker, and the center-pin driven reproducer. The above types all fall into the category of Magnetic Speakers. Meanwhile out in California, Magnavox began to build a horn-type dynamic loud speaker. This speaker produced more power and better tone. Since the battery sets of that time used a 6-volt storage battery for the tube filaments, the speaker field also operated on 6-volts. The biggest drawback to the dynamic horn speaker was its size. The consumer was asking for radio that was self-contained with speaker and set all hidden inside a wooden cabinet. The dynamic cone speaker was introduced about the same time that AC operated radios became popular.

Dynamic Speakers

Dynamic Speakers had a paper cone with a voice coil cemented to its center. The voice coil was a

cylinder of paper from 1/2 to 2-inches in diameter, depending on the power handling design of the speaker. One or more layers of insulated magnet wire was wound on the voice coil and ultimately connected through an impedance matching transformer to the audio output stage of the radio receiver. Centered inside the voice coil was a soft iron pole piece which in turn was surrounded by a field coil wound with thousands of turns (except in car radio speakers) which when connected into the radio high-voltage circuit produced a magnetic force in the pole piece. This speaker was called an electro-dynamic speaker. The illustration shows this kind of speaker, plus a typical circuit diagram using an electro-magnetic (EM) speaker. It took a lot of electrical power to magnetize the pole piece, so when more efficient permanent magnets were developed manufacturers began to make PM dynamic speakers.

The EM dynamic speakers used in auto radios, at this time, had only 4 or 6-ohms resistance, and it took 1 to 1.5 amperes to excite the field. If you remember the automobiles that had 6-volt ignition systems you

will also remember that they were never too good in winter.

When the PM (permanent magnet) speaker was introduced, auto radio manufacturers were the first to use them. Later they were used in portables and house radios. Alnico V was the magnet used most successfully in speakers. Generally speaking, a larger magnet will permit the speaker to handle more power. Thus a small 4-inch speaker may have a half-ounce magnet while a 15-inch speaker may have a 2-to 3-pound magnet. Replacing a PM speaker is no problem since replacements are readily available at all radio parts stores.

Replacing an EM or field coil speaker is a much bigger problem. To start with, the field coil had a certain amount of inductance and therefore it acted as a filter choke in the "B" power supply circuit. The resistance of the field coil was also the resistance that determined the "B" supply voltage supplied to the tubes in the radio. So when replacing an EM speaker with a PM we have a couple of important factors to consider. The first factor is physical size. Whenever

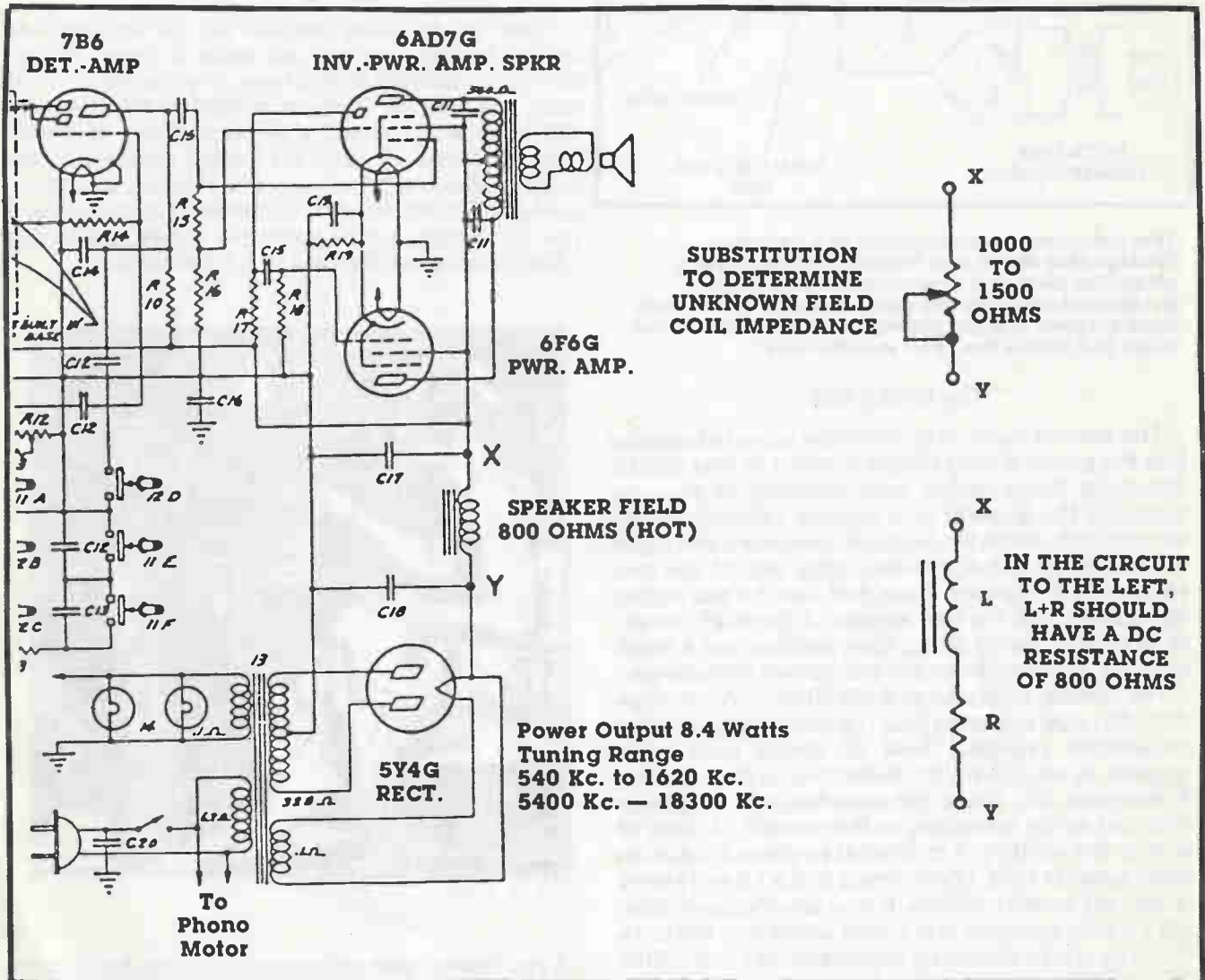

When you want to substitute a modern speaker for an old one that had a speaker field coil, you need to replace the lost impedance in the circuit. Unlike this schematic of a Zenith Model 7S681/2 many old-time schematics don't always include the value of the coil. Determine this with the top circuit and replace it with the bottom one.

possible, always use the largest PM speaker that will fit the allotted space. The larger speaker will reproduce bass notes more efficiently than a small speaker. If you use a smaller-than-original size speaker, you will have to make an adapter board with the proper size hole for your new speaker and make it large enough to cover the old hole. Without going into acoustic theory, I would advise you to never leave an opening around the speaker cone. To produce the same amplitude and frequency tone range as the radio did when new, you should try to return the set to its original baffle condition.

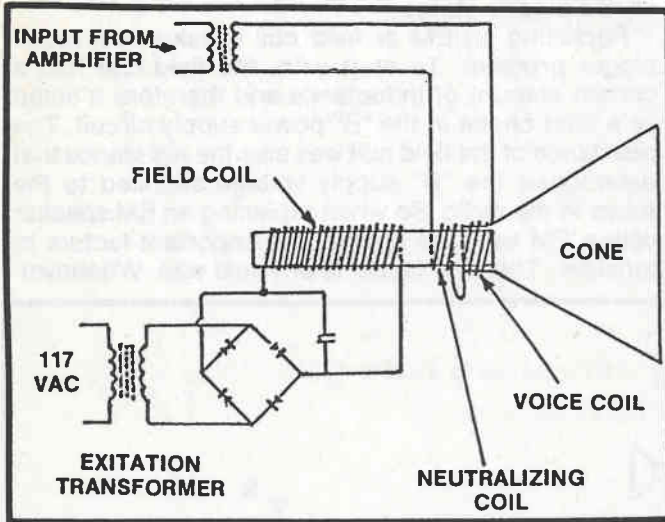

This schematic representation of a dynamic loudspeaker shows how the parts relate to each other. The field coil energizes the core (now permanent magnets are used) so that it is a steady field magnet. The fluctuating magnetic field on the voice coil moves the cone over the core.

The Choke Coil

The second factor is to introduce some inductance into the power supply circuit in place of that lost by removing the speaker field winding. If you are replacing the speaker in a console radio, you may have room to leave the field coil connected and place the coil in an out of the way spot. Mount the new speaker in the proper place and use the old output transformer with the new speaker. If there isn't room, as in a table model radio, then you can use a small inductor and resistor to get the correct impedance.

The rectifier tube changes the 60 cycle AC voltage into 120 cycle pulsating DC. The filter capacitors and inductance (speaker field or choke coil) work together to smooth out the pulsations so the net result is hum-free DC. Since the inductance of a speaker field coil varies according to the number of turns of wire in the winding it is difficult to place a value on every speaker field. I have found that a 1.5 to 2 Henry choke will usually suffice. If you salvage parts from old TV sets, you may find a filter choke that will work fine. The choke should be capable of carrying 150 to 200 milliamperes of current.

Since the choke will usually have less resistance than the field did, you must add resistance in series with the choke coil. The total resistance of the choke and resistor in series must equal the speaker field

resistance. If this isn't done all the "B" voltages will be too high. Higher than original "B" voltages can lead to blown out capacitors, overloaded resistors, and tubes being operated beyond their ratings. For example, if the speaker field measures 750-ohms and your choke coil measures 150-ohms, you will need a 500-ohm resistor in series with the choke coil. Use a 25-watt, 500-ohm wire-wound power resistor. If the resistance value had turned out to be a non-standard value you could have used an adjustable, wire-wound resistor.

If, after you replace the EM speaker in the manner we just described, the hum level is higher than normal, then you will have to put additional filtering in the power supply. Try a 20 uF., 450-volt DC capacitor connected between the junction point of the choke coil and resistor, and "B-." There will be special cases in which the speaker field will have a tapped winding. Use what you have learned and use two resistors if necessary. Remember to connect one of the choke leads to the same point the field coil connected to i.e., the rectifier filament or cathode.

Figuring the Value

There will be some cases where the speaker field coil is burned out and no value is listed on the schematic drawing or you have no schematic. In this case, use a power rheostat of 1000 to 1500-ohms at 100 watts and connect it in place of the field coil. Adjust the rheostat until the voltage readings on the audio output tube plates are normal, and then connect a choke-resistor combination in the circuit. If you don't have a schematic that shows the proper tube voltages use the data in a tube manual.



If you follow these suggestions, you should have no problem replacing the Electro-dynamic speaker in your radio with a permanent magnet type. ■

MAKING PCB's THE EASY WAY

By Mike Giamportone

Here is a fast and relatively easy way to accomplish one of the more difficult parts of any electronic project construction. If you are looking for a technique to give your project a unique professional look...read on.

This article will explain exactly how you can make your own PCB's and/or enclosure labels at a relatively low cost.

All that is required is a L2000 Laser/Copier Iron-on Resist Sheet and follow the procedure explained here and your on your way...

Do all your project enclosures look the same? Would you like each one of your project enclosures to look unique, and express your creativity? Maybe you're tired of those amateurish-looking label tapes that eventually peel off. More than likely, you have seen a design that would dress up a project nicely, but lacked an acceptable way to apply it.

Do you find creating very populated printed circuit boards intimidating? How about ones with traces running between IC pads? Are you finding that rubbing a pattern down to make a PCB, time consuming, costly, or frustrating?

Well, here may be the answer to your prayers, L2000 Laser/Copier Iron-On Resist Sheets. This new product will give you the quickest and easiest way to make a printed circuit board or label an enclosure. Using the latest in iron-on resist sheets, you too can craft electronic projects like a professional. All that is required is a L2000 sheet, household iron, and use of a laser printer or plain paper copier.

There are just a few simple steps to make PCBs or great looking enclosures using L2000 sheets. Copy the desired pattern onto the special plastic sheet with either a laser printer or copy machine. Tape the copied pattern to your board or enclosure, and iron in place. Remove the sheet to find your pattern transferred to the metal surface. For a PC board, it would be ready for etching, that quick! By making several patterns at a time, you can select one whenever needed from your files. This will save even more time and effort especially when building multiple circuits or enclosures.

The process starts when the laser printer or copier applies a copy of the selected artwork to the sheet, and

heat fuses it in place. This is done with toner, the machine's dry powder ink. When the L2000 sheet is reheated by ironing, it releases the toner that now bonds to the metal surface. In the case of a PCB, the ink becomes resist.

Resist is any acid-proof material used to protect parts of the board, when submersed in the copper-eating etchant. Once soaked in the etchant, all exposed copper is removed from the board. This leaves only the copper under the resist. After rinsing, the resist is then removed to uncover the copper traces and pads, comprising our printed circuit.

Making your own iron-on resist patterns begins by washing your hands to remove body oils that will interfere with any resist and etchants. Handle the laser sheets and the board or enclosure to be labeled, by the edges only. If your sheet seems dirty or mishandled, clean it with a little rubbing alcohol and dry with a clean paper towel before use.

When using a computer to generate the printed circuits or other artwork, you should print the artwork flipped, or as a mirror image. This will give you the proper pattern when ironed onto the new surface. Most printed circuit making programs, like PCBoards*, do this by printing the foil (lower) layer as it appears from the component (upper) side. This will be the mirror image needed when printed. If your PCB program does not print the reverse image of the foil pattern, build your foil pattern on the component, or upper layer.

If you are using a computer graphics program to dress up an enclosure, (Like First Publisher, Printmagic, Deluxe Paint, Printmaster, and many others),

you can flip or invert the artwork to get the mirror image desired. Not all graphic or PCB programs will print the reverse view. In these cases, treat your art as you would ready-made work.

In the cases when your artwork is not the mirror image or ready-made artwork, follow these steps: Make a paper copy of the pattern to check darkness and quality before using the L2000. Take your design or even if it is a hand drawing, and copy it to a laser sheet. Then put this copy in the top of a copy machine, ink-side up. Put a clean sheet of paper on top of the L2000 sheet to prevent a dirty copy machine lid from adding to your final artwork. Copy this flipped image onto another sheet of L2000. Making a second copy this way, gives you the mirror image needed. This is what has to be done with a foil-side PC pattern normally supplied in plans or construction articles.

Clean the intermediate sheet used to make the mirror image with acetone (nail polish remover) or similar solvent, dry, then wipe with rubbing alcohol. When working with flammable liquids, wear rubber gloves, protective glasses, and do so only in a well ventilated area away from flames or sparks. If the laser sheet becomes slightly cloudy after cleaning, it can be reused and has no effect on its performance.

When using a copy machine, be sure it is a plain paper type using dry toner. This type of copier is commonly used by libraries, most offices, print and copy shops. If the machine can copy to a transparency or overhead projector sheet, it will work just fine for making L2000 Laser/Iron-On Resist patterns.

Load the L2000 sheets where single paper sheets are fed. This is usually on top of the paper feed tray and where single sheets of paper are placed to make two-sided copies. In the few cases where there is no place for single sheets, place the L2000 on top of the stack of paper in the feed tray. If using a laser printer, turn the paper feed knob to allow the laser sheets to pass straight through, rather than route it back toward you. This produces flatter, better looking patterns. Experiment with darkness whenever possible. The darker the pattern, the more resist that gets applied to prevent undercutting while etching.

Applying the artwork made with L2000 starts by preparing the board or enclosure you will be putting the design onto. Cut the blank PC board to size, or drill the enclosure/lid as needed. Thoroughly clean the metal surface with a plastic scouring pad, scouring powder, and plenty of water.

This is very important since the fine scratches will help the toner adhere. Scrubbing should be done in a circular motion and until entire surface is polished evenly. Aluminum enclosures and lids will require a little more effort since the metal is harder. Rinse well, dry with a clean paper towel, and handle by the edges from now on.

Trim the plastic pattern to the same size as the metal surface. With two pieces of tape, secure the design with the toner side toward the surface to be marked. The plastic must lay flat. Drag your fingernail lightly over the plastic. If it feels rough where the pattern is, you taped the sheet on upside-down.

To insulate the board/pattern assembly from the cool

table top, place it plastic side up, on an old magazine. Cover it, with a sheet of paper towel. This assures maximum heat transfer from the iron to the metal surface. This is essential to properly remelt the toner.

Preheat a household iron for several minutes at 290 degrees F. or on cotton/linens. Once fully warm, place it squarely on the assembly while under paper towel. Allow the iron to heat the assembly for 20 seconds. Then move the iron around the entire surface with medium pressure for about 30 seconds. Remove the iron, turn off and let cool. Never leave the hot iron unattended.

Allow the assembly to cool COMPLETELY before removing the plastic. Peel the plastic from one corner slowly. You will find any minor toner deficiencies in the original artwork vanished when the toner remelts. If any of the ink did not transfer, or the pattern is not completely black, just draw in with a resist pen. Sanford brand "Sharpie" permanent markers are the same as resist markers. "Sharpies" are available at most department or office-supply stores and come in several tip sizes. They cost about half as much as other resist pens.

Scrape any unwanted resist off with a razor or knife. If you made a circuit board, it is now ready for etching. This type of resist is very tough. But after etching, it can be removed in the normal manner using scouring powder and water, or solvent.

Enclosures require additional heating to bake the toner staunchly in place. Put the metal lid/enclosure in a 350 degree preheated oven for 5 minutes. The artwork will be just about impossible to get off after this. To further protect the metal and artwork, spray a very light coat of quick-drying clear enamel on the metal while it is still warm. This not only protects and weathers the art, but gives a bright luster to the entire piece. Additional coats may be applied after the previous one dries. Heavy coats may remelt the toner and ruin the artwork.

ADDITIONAL TIPS

Some hobbyists prefer to add one step before ironing resist artwork, by etching their printed circuit boards for one to three minutes before applying the pattern. This makes the copper more sensitive and adhesion easier. This is usually not needed and only necessary if you find the resist not adhering well to your boards.

By warming and agitating the etchant, you can speed the etching process. This prevents undercutting of the resist. Even though this type of resist is tougher than dry transfer (rub downs) and other resists, it is a good idea to keep etching time to a minimum.

Print all dot-matrix PC patterns in the 2 times mode. Then reduce the circuit pattern in a copy machine by 71% and then again another 71% to get the proper size pattern before copying to a sheet of L2000. The result will be a cleaner, better looking pattern.

Any sheet, paper or synthetic, that passes through a copy machine or laser printer has to withstand the high temperatures used to fuse the toner to it. L2000 Iron-On Resist Sheets are designed specifically for this and are not just "coated" as other sheets may be. The new

(Continued on page 72)

TANDY TECHNOLOGY CENTER



Tandy Corporation is creating tomorrow's technology today in its new Tandy Technology Center in Fort Worth.

The new seven-story, 270,000 square foot Center provides a unique work environment designed specifically for the needs of Tandy's Information Services and Tandy Electronics Research and Development Groups.

"The Center is where much of the technology that drives our business is housed," said John V. Roach, Chairman and CEO of Tandy Corporation. "We've built the best technical facilities in the world to recruit, retain, and motivate the people who will help us win technically in the 1990's."

Tandy Information Services (TIS), which occupies three floors, controls Tandy Corporation's inventory, payroll, sales data, accounting, networking, and telecommunications. Tandy Information Services played a major role in designing and installing Tandy's Point-of-Sale (POS) system used by Radio Shack, McDuff Electronics and Appliances®, and VideoConcepts® retail outlets. It is the largest POS system of its kind in the nation. The TIS mainframe does more than 300 jobs per hour, issuing about 120 million instructions per second. One outstanding feature is the NASA-style "command center", with banks of computers constantly monitoring TIS functions.

Floors five, six, and seven house the Tandy Electronics Research and Development Groups, which design Tandy's new consumer and computer products, and produce technical publications. Research and Development is vital to Tandy's efforts to maintain its competitive edge in the technology marketplace. It is also essential to insure that Tandy customers continue to receive the highest quality consumer electronics and personal computer products.

For years, R&D has kept Tandy on the leading edge of developments in audio, video, telephony, personal computers, and magnetic media technology. Now, Tandy continues to lead with its developments in Multimedia Personal Computing and digital recording. Earlier this year, Tandy Corporation became the first manufacturer to unveil fully-configured Multimedia Personal Computer systems and hardware products. This technology combines text, graphics, sound, and animation to create an exciting new computing environment. Tandy R&D teams are developing new products based on Digital Compact Cassette (DCC) technology. DCC adds a new dimension to sound by combining the quality of digital recording with the convenience of a compact cassette.

All R&D floors have multiple laboratories dedicated to the research, development, and testing of new products. The labs are flexibly designed to meet any space, power, communications, signal, or safety requirements that are needed. All floors, in both the R&D and Tandy Information Services departments, are raised to accommodate more than two million feet of phone and data cables.

The Tandy Technology Center provides a totally flexible, productive, energy efficient work environment. Offices and work zones are equipped with motion sensors that turn off lights and temperature controls when no movement is detected for a specific time. Interior walls may be dismantled, so offices can be moved or created as the need arises. Sensitive computer equipment is protected from power surges by special, color coded outlets designed to provide a clean source of electrical power.

Construction began January 9, 1990 on a 4-acre site adjacent to Tandy's headquarters in downtown Fort Worth. The building is surrounded by an attractive, fully landscaped, multi-tiered park; a 400 seat outdoor amphitheater for musical or theatrical performances; and an aesthetically pleasing, tree-lined parking lot. The central core features a glass-domed atrium with an arboretum that gives the Center's 600 employees a pleasant view and a relaxing break environment.

The first floor houses the Lewis Kornfeld Conference Room, named in honor of the former president of Radio Shack®. This attractive, acoustically designed room includes a theater presentation area with rear screen projection, sophisticated electronic communication equipment, and worldwide satellite conferencing capabilities.

A satellite transmitter dish, atop the building, is used by the Tandy Satellite Television Network for sales and training seminars and to pass news and information to employees at 250 company downlink locations nationwide. "As Tandy continues to grow and expand its operations globally, this state-of-the-art satellite network will be the key communications vehicle for the corporation," said Roach.

To maintain its prominent leadership role in the consumer electronics and personal computer industries, Tandy Corporation traditionally looks to the future. Carroll Leu, vice president of Tandy Information Services says, "The work performed in the Center concentrates on the development and application of tomorrow's technologies. The new Tandy Technology Center represents our commitment to the future."

Radio Shack, McDuff, and VideoConcepts are registered service marks used by Tandy Corporation.

MAKING PCB'S THE EASY WAY

material does not get old and deteriorate in performance like coated plastics. If past experiences with iron-on resist have been disappointing, try the latest. The 8^{1/2}" x 11" L2000 Sheets carry a 30 day warranty and come with complete instructions.

Give your enclosures a new look. Save time and money by ironing resist artwork to your circuit boards. Inexpensive, yet simple enough for the beginner electronic enthusiast to use, L2000 Iron-On Laser/Copier Resist Sheets are the latest innovation for labeling enclosures and making printed circuit boards. ■

L2000 Laser/Copier Iron-on Resist Sheets are sold by Thumb Electronics, P.O. Box 344, Marys-

ville, MI 48040. Costs for L2000 are \$1.20 each plus \$1.50 shipping and handling up to 4 sheets. Quantities of 5 sheets more are 80¢ each plus \$1.75 shipping and handling. For technical assistance inquires, or any remark requiring a reply, please send a Self Addressed Stamped Envelope.

*PCBoards is an easy-to-run, menu-driven computer program to generate single or double sided printed circuit artwork for under \$100. PCBoards, 2110 14th Ave. South, Birmingham, AL 35205
1-205-933-1122.

MEDICAL ELECTRONICS

A CAREER OPPORTUNITY

By George Williamson CBET

For those readers who have the aptitude and would enjoy working with a variety of sophisticated equipment with the satisfaction that they are helping people, "Medical Electronics" may be a career worth looking into for a future livelihood.

Much of the equipment used in medicine today is state-of-the-art or close to it. In this mix of technology you can find RF, Analog, Digital and Microprocessor circuitry, sometimes all in one device. If you are interested in a career that offers great variety, "Medical Electronics" may be for you. Rarely do you work on the same type of equipment repeatedly. The exception to this may be in "field service." As a "field service" technician or representative, you may be restricted to the repair of one type of equipment. This is the position held by the author when he first entered the area of "Medical Electronics" for a future career. It involved considerable travel, much of it local but it also provided an excellent opportunity to gain much valuable experience. It will require transportation, usually your own vehicle. Some companies provide one, others pay you to use your own. It is not uncommon to drive as much as 10,000 to 15,000 miles per year, in some cases much more.

Planning Your Time

Field service requires careful planning of your time and you must carry an adequate supply of critical parts, especially those that are prone to breakdown or failure. The office or home that you will be working from is invariably too far away to waste time on constant trips for replacement parts. Ideally, you should not have to pick up additional stock of repair parts more than once a week. In some cases, as a "field service technician," you will have to fly to destinations for on-site repairs. This means having tools, test equipment and supplies portable enough to be transported on a plane, therefore, it is not uncommon to see a "Tech" wheeling a stack of suitcases with a collapsible baggage cart. Usually the repairs done in the field are at the "board" level. The defective circuit is located and replaced. The defective board is then returned to a service center for repairs. In some cases, the boards are disposed of when they are not repairable.

Field Service Technicians usually have at least a minimum of test equipment. A small but reliable

Digital Multimeter would be essential. You will soon learn various tricks of testing to get the maximum use from your DMM. Other equipment may be added to your tool kit as necessary, such as a reliable oscilloscope. You will soon learn that you must be resourceful. It is a do-it-yourself job. The boss and/or extra manuals and parts are usually too far away to help. Field service is for "self-starters." If you enjoy traveling, this may be the place to start your career in "Medical Electronics."

Hospital Service

Hospital service is a totally different area of medical electronics, devoted to people who work in hospitals in various capacities. Unlike field service, the technician is usually only minutes away from his work. Usually called "Biomedical technicians," the people who maintain the medical electronic equipment in hospitals usually receive above average pay for their technical skills. "Biomedical Engineering" is a real challenge. Most biomedical technicians work on a very broad range of equipment. Their workshops will have much more test equipment than carried by the field service technicians. They sometimes have to troubleshoot to the component level. The well-equipped workshop will have service manuals for all of the equipment used in the hospital and, of course, a supply of parts to cope with unexpected emergencies. You will have access to most of this sophisticated test equipment, such as Digital Multimeters, Oscilloscopes, Signal and Function generators and Safety Testers. The "Safety Tester" is of primary importance. This instrument is used to test every electronic device allowed into the hospital. It checks each device for electrical leakage. Leakage above 100 microamperes could be hazardous, especially to patients with heart problems. All electrical and electronic devices must, therefore, be checked thoroughly as a protection for the patients. Another electronic device that is used frequently in today's modern hospital is the "Simulator," which will produce waveforms that mimic various signals that

are picked up by a monitor from the patient. Most common is the signal produced by the heart. This is the EKG signal, sometimes called the ECG, an abbreviation for Electrocardiogram. This signal is normally picked up by pad electrodes that are placed on the patient in a proper configuration. There are several ways to place leads on a patient and each has its special purpose. Each combination of 3 leads is one configuration. For example, a 12-lead configuration will have Lead #1, Lead #2, Lead #3, AVR, AVL, AVF, V1, V2, V3, V4, V5, and V6. An electronic machine switches through all 12 lead configurations as the test progresses. A 12-lead EKG gives the most comprehensive picture available of the patients' heart function.

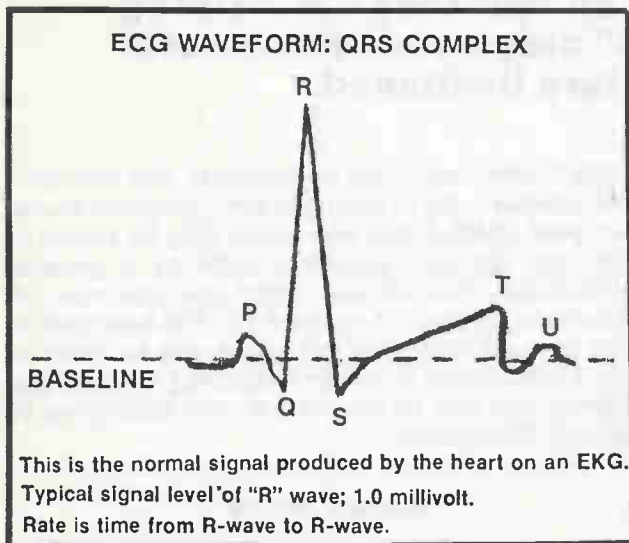

Simulators are connected to the monitor with cables and take the place of the patients' signals. Besides the EKG signals, simulators can produce blood pressure signals, respiration signals and temperature signals. Most of the technician's testing will involve either the "Safety Analyzer" or "Simulators."

Defibrillator Test Load

This relatively simple device shows how much energy is released by a "Defibrillator" under test. Other test instruments include ESU testers, Laser

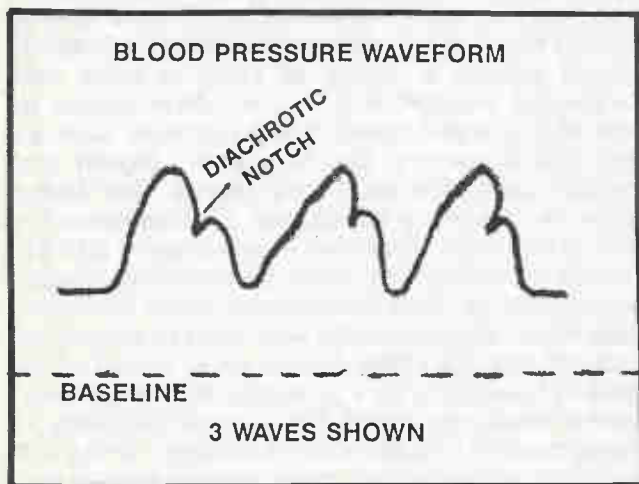

Power Meters, Ultrasound Power Meters, Tachometers for testing centrifuges and Thermometers for testing incubators and baby warmers.

Monitors

The Biomedical Technician will work on a variety of monitors, mostly for monitoring a patient's heart. They also monitor a patient's temperature and blood pressure, respiration, blood oxygenation and other parameters. A considerable portion of the technicians' time is spent maintaining monitors. These monitors can be simple little boxes with lights to indicate functions or very large and complex systems that monitor multiple functions. Many monitors will have a CRT screen that will display the information recorded, including waveforms. The more sophisticated heart monitors will detect and flag arrhythmias, which are defects in the heartbeat. This enables doctors to detect problems with their patients easier and quicker.

Transducers

All monitors connect to the patient with a transducer, which connects a non-electrical device or a person to an electrical device. An example of a transducer would be the strain gauge blood pressure transducer. This device has a metal membrane that is thin and sensitive to the pressure of blood pushing a water column against it. The shift in the mechanical position of the membrane is converted to electrical signals in the strain gauge and relayed to the monitor.

Defibrillators

When a patient has a heart stoppage (cardiac arrest), the Defibrillator is used to shock it back into action, typically delivering a burst of energy at 3120 volts. Needless to say, it is extremely important that this device is functioning properly.

Infusion Devices

These devices deliver controlled amounts of fluids intravenously to a patient. A needle is inserted into a vein, typically on the hand and tubing is connected to it. Control of the fluid going into the patient is critical, since these devices are used for intravenous feeding, fluid replacement and administering drugs. As a Biomedical technician, you will test these devices for proper operation. You will also be called upon to repair them when they are defective.

Incubators and Warmers

These are obviously used to keep babies, usually new-born, at a correct temperature for proper growth and health. Your job will require you to verify the correct operation of these devices periodically.

Laboratory Equipment

Most hospitals today have a wide range of laboratory equipment to be periodically checked and maintained and you will usually be called upon to service at least some of it. They can vary from "Tube Rockers" to "Centrifuges" to sophisticated analyzers. They can all be yours to work on.

Electrosurgical Units (ESUs)

These devices are used instead of scalpels and knives to make incisions in surgery. Radio frequency energy is used and the ESU can be set to coagulate small blood vessels as the surgeon makes the incision. You will be required to periodically test the output for accuracy. You may also be called upon to repair the ESU if it fails to function properly.

Nurse Call Systems

These are really "Paging" or "Intercoms" systems and are frequently the responsibility of the Biomedical technician for proper operation and maintenance. The newer systems are computerized and quite sophisticated.

Computers

Many Biomedical departments are maintaining computers on site. Computers are everywhere and are used extensively in hospitals today, ranging in size from laptop units to huge mainframes. An expertise in computer technology is certainly a plus.

Some other devices that you might work with include: Anesthesia machines, Analyzers, Blood Gas Machines, Electrocardiographs, Electroencephalographs, Echocardiographs, CAT-scan equipment, Magnetic Resonance Imaging equipment, X-Ray machines, Gamma Cameras, Linear Accelerators, Lasers, Ophthalmoscopes, Fundus Cameras, Slit Lamps and Microscopes.

Training will be a part of your life. As new equipment is introduced, the manufacturers will provide inservice training on site for qualified technicians with additional training and technical support at their offices.

Most employers are looking for technicians with at least a 2-year Associates degree in Electronics or in Biomedical Engineering. For the better (more advanced) positions or to progress to Clinical Engineering, a 4-year degree is required. Clinical Engineering is above Biomedical Engineering and involves more of the medical application. Clinical Engineers work very closely with the doctors and nurses who use this sophisticated equipment, assisting them to get the maximum use from the equipment. They are also frequently involved in supervising Biomedical departments or in Research and Development.

Salary ranges from entry level positions can be as low as \$5.00 per hour or as high as \$10.00 per hour, depending, to a great extent on the applicants experience and qualifications. Trained technicians can attain annual incomes of \$40,000 or more. Clinical Engineers can exceed \$60,000 per year.

Medical Electronics is an interesting and rewarding career. Maybe it is a career for you.

About the author: George Williamson is a Certified Biomedical Engineering Technician. He first became interested in electronics in 1959 and has worked in the Biomedical Engineering department of a major medical center for the past 12 years. ■

DIGITAL COMPASS KIT

The perfect assembly project for school or that budding electronics hobbyist.

The "Digital Compass" is a hand-held device that senses all eight compass headings by lighting the appropriate LED.

By making use of the highly advanced Dinsmore Sensor, your compass kit can also provide accurate headings for your car or boat.

Kit comes complete with ALL parts, compass sensor, PC Board (2x3½ in.), memory chip and assembly instructions (Less Housing & 9V battery).

\$26.50

Plus \$1.50 S/H

SUNCOAST TECHNOLOGIES

P.O. BOX #5835

SPRING HILL, FL 34606

SOLID STATE UPDATE

Each month, the manufacturers of solid state components release literally hundreds of new devices. While we cannot report on all of these, we do intend to feature some of the devices that are most likely to interest our readers. For further information on any of these solid-state components, write directly to the manufacturers. They can provide you with data sheets and application notes at no charge.

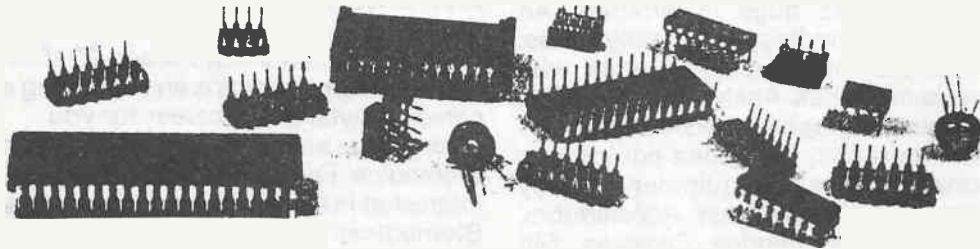

3B20 TORQUE TRANSDUCER CONDITIONER

The 3B20 from Analog Devices is a complete, low-cost signal-conditioning module for torque transducers. It provides AC sensor excitation and produces simultaneous high-level voltage and current outputs. Torque transducers (strain gages with transformer coupling for excitation and response) eliminate the need for slip rings or other unreliable connections in applications where physical contact between the sensor and its associated electronics is difficult.

The 3B20 provides AC excitation of 2 to 10 V rms at frequencies from 1 to 10 kHz. Input spans range from 1.5 mV to 150 mV rms and are compatible with most torque transducers and four-arm bridges. Outputs of ± 10 V and 4-20/0-20 mA are simultaneously available, with an overall accuracy of 0.1% and a drift of 0.01%/°C.

Housed in a 3.2" \times 0.7" \times 3.3" module, the 3B20 can be plugged into a 4-, 8-, or 16-channel backplane, also available from the manufacturer. Address inquires to Analog Devices, 70 Shawmut Rd., Canton, MA, 02021.

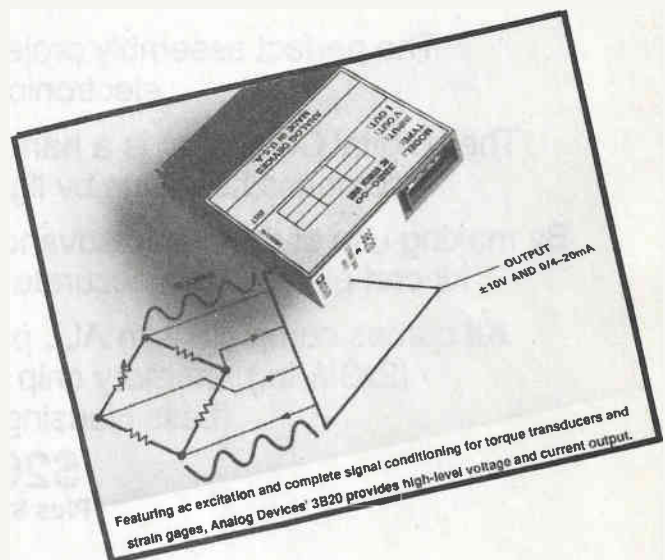

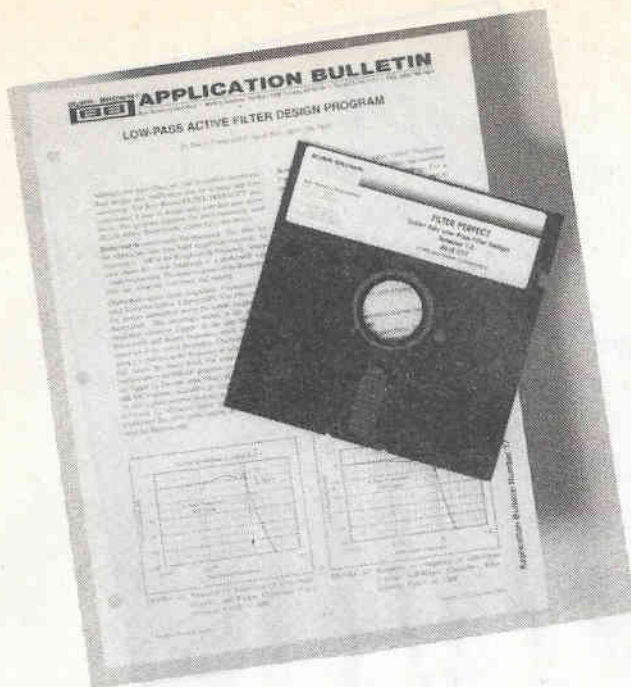

FILTER DESIGN SOFTWARE

Filter design can be a tedious, mathematically daunting task for beginner and expert alike. But now, the folks at Burr-Brown have come up with a program called FILTER PERFECT™ that allows the user to design unity-gain, low-pass active filters with a minimum of effort. The program comes on a DOS-compatible 5¼" disk together with an application note describing its operation. Butterworth, Chebyshev, or Bessel response can be selected. The menu-driven program guides the user in choosing the type of filter, number of poles (up to 7), etc., and automatically calculates resistor and capacitor values. Capacitors selected by the program are standard values; resistors are exact or nearest 1% values depending on the selected mode of operation. FILTER PERFECT™ is available free of charge from **Burr-Brown Corp., P.O. Box 11400, Tucson, AZ, 85734**. It can also be downloaded as "FILTER 1" from the company's BBS: (602) 741-3978; (3/12/2400, 8, N, 1).

RF DATA BOOKS

Motorola, one of the nation's largest manufacturers of semiconductor products, has just published an enlarged and updated version of its RF Data Book. This new data book, officially designated DL110/D Rev. 4, consists of two volumes containing the latest and most complete listing of standard products offered by the RF Products Division of Motorola Semiconductor. The book should be a valuable addition to the bookshelf of every engineer, technician, experimenter, and ham radio operator. A total of 84 new products are represented by data sheets as well as application notes. Coverage is given to RF devices of all kinds, including small-signal transistors (both bipolar and field effect), power FETs, and power bipolar devices.

To obtain a copy of the Motorola RF Data Book, call Motorola Literature Distribution at (602) 994-6561 and ask for DL110/D. Alternatively, you can make a written request to **Motorola Inc., Literature Distribution Center, P.O. Box 20924, Phoenix, AZ, 85063**.

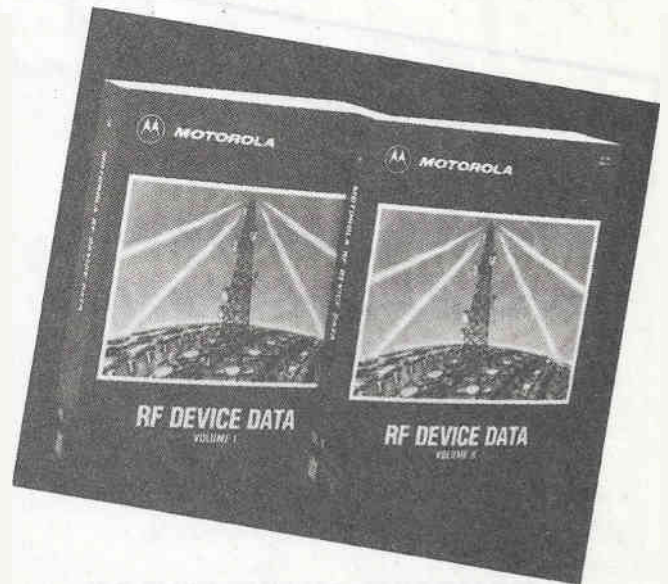

POWER SCHOTTKY RECTIFIERS

Conventional p-n junction rectifiers have two characteristics which limit their efficiency: forward voltage drop (about one volt), and reverse recovery time. In low-power applications, these characteristics are of little consequence, but in high-power circuits, they result in wasted power. For that reason, designers of high-power rectifier circuits choose Schottky-barrier rectifiers rather than conventional p-n types. In a Schottky rectifier, the forward voltage drop is reduced and the reverse recovery time is nil, which makes the Schottky diode an ideal candidate for use in switch-mode power supplies at frequencies as high as several MHz. Motorola has just announced the MBR-16035CT series of common-cathode, dual Schottky rectifiers, which can be paralleled for higher current output. Specs include 40 millijoules avalanche energy, high dV/dt capability, and a 160-amp current rating. **Motorola Inc., 5005 E. McDowell Rd., Phoenix, AZ, 85008**.

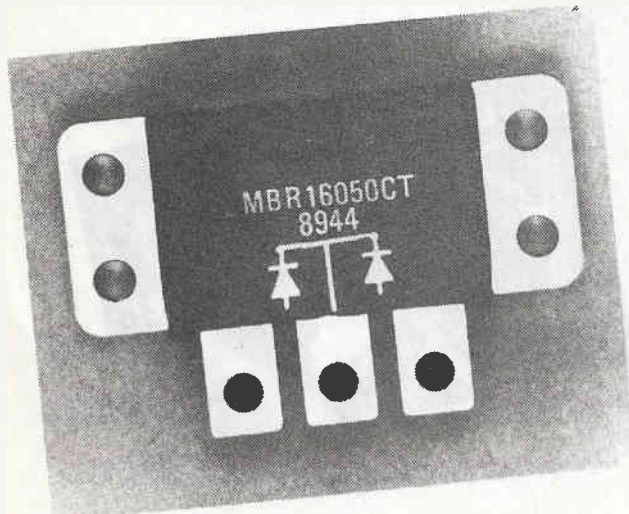

DATA BOOK SUPPLEMENT

Burr-Brown, a leading supplier of linear ICs to industrial and military customers, has announced the availability of a new Integrated Circuits Data Book Supplement, Vol. 33B. The new publication contains over 650 pages of complete product descriptions, applications tips, performance graphs, specifications, and ordering information for the company's broad line of high-performance linear integrated circuits.

Burr-Brown's Integrated Circuits Data Book Supplement gives designers more than 60 new high-performance products, including high-speed op amps, instrumentation amps, isolation amps, D/A and A/D converters, voltage-to-frequency converters, digital-signal-processing circuits, and DC/DC converters.

Circuit designers and engineers can obtain a free copy of Vol. 33B from any Burr-Brown sales office or by calling 1-800-548-6132. You can also write directly to **Burr-Brown Corp., P.O. Box 11400, Tucson, AZ, 85734.**

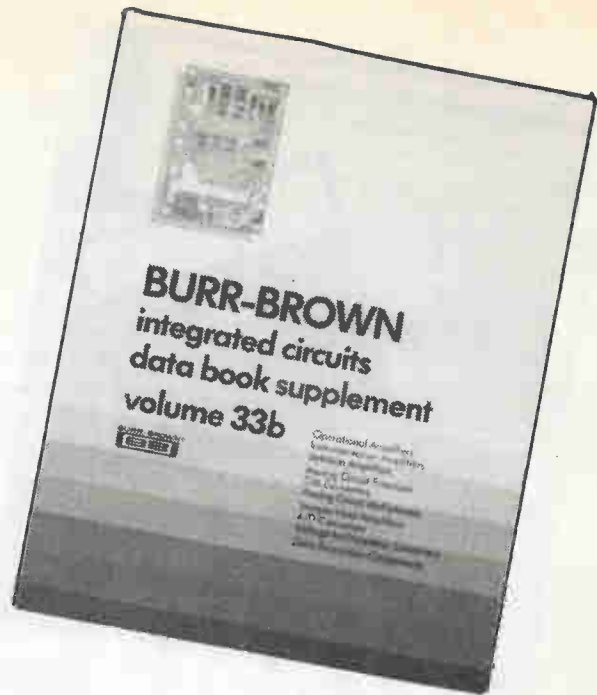

LOW VOLTAGE DC-DC CONVERTERS

Here's good news for builders of portable, battery-operated equipment: Maxim has announced the availability of a family of six low-voltage DC-DC converters, designated MAX654 through MAX659. These devices are intended to provide a simple, compact solution to the problem of generating a regulated +5V or +3V output from a low-voltage source such as a single-cell battery. The MAX654/6/7 feature a guaranteed 1.15V start-up, and continue to function as the input voltage drops below 1 volt. The new family of converters can supply up to 450 mA (MAX658) of output current with few external components, achieving a typical conversion efficiency of up to 75%. Special features include a comparator output which goes low when the input drops below 1.15V, and a "Power Ready" output signal. In standby mode, the quiescent current drain is 80 microamps. For further information and a data sheet, write to **Maxim Integrated Products, 120 San Gabriel Dr., Sunnyvale, CA, 94086.**

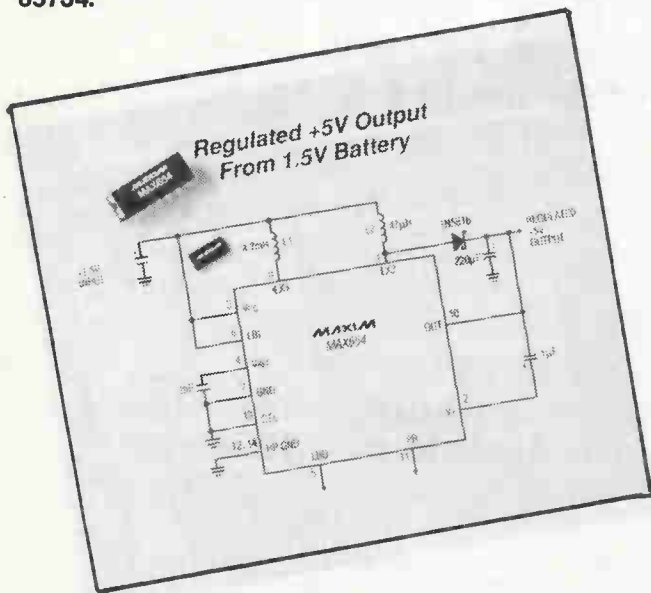

AUTOMOTIVE SMART-SENSOR

Operating from an automotive battery power supply between +9 and +30V., Analog Devices' AD22001 monolithic five-channel comparator automatically detects the failure of headlamps, indicators, and other lights. The device improves safety by continuously monitoring the condition of up to five lamp filaments, whether on or off, and also by testing the in-line fuse in two series circuits. Packaged in a space-saving 20-pin DIP and consuming only 300 mW of power, the AD22001 replaces complex, less reliable discrete designs and costs only \$2.00 in automotive OEM quantities. The AD22001's five comparators operate by detecting a very small threshold voltage, nominally 1.75 mV, across a small shunt resistor in series with the lamp being monitored. A length of standard copper track on the circuit board can serve as the shunt resistor, minimizing power dissipation and component count. More information can be obtained from **Analog Devices Inc., 804 Woburn St., Wilmington, MA, 01887.**



Analog Devices' AD22001 monolithic five-channel comparator automatically detects the failure of automotive lamps and fuses.

SIXTH SENSE GIVES STINGRAYS A CHARGE

Courtesy Ian Bruce, Senior Technical Marketing Engineer, ANALOG DEVICES, INC.

Isolation Amplifiers allow investigation of animal "Sixth Sense." Generating very low-level signals to mimic animal electric fields requires careful design and isolation for success.

Engineers in everyday life aren't generally requested to investigate the sex lives of fish. They are, however, often required to generate, simulate or transmit low-level signals across large distances in harsh environments. The following short article describes an unusual and demanding application for digitally synthesizing very low-level signals in salt water.

Researchers have discovered that stingrays, sharks and related animals possess a "sixth sense," they are able to perceive electric fields. To discover if they use this ability to detect potential mates required precisely simulating the tiny nanovolt-per-meter field generated by these animals under water. This article explains how scientists, using Analog Devices' AD210 isolation amplifier and the AD 7845 digital-to-analog converter, designed equipment to generate, isolate and transmit such signals.

It may not be animal magnetism, but stingrays and other fish do seem to have an attraction for one another that is truly electric. Researchers have shown that sharks, rays and skates (known collectively as Elasmobranchii) possess a sixth sense: they are able to perceive electric fields. Small receptors called Ampula of Lorenzini can detect the minute electric field generated by all animals, including humans. Sharks use this ability to hunt and capture their prey.

Researchers believe that other elasmobranch behaviors can be attributed to electric field detection, including mating. Romantic male stingrays are thought to find a "relationship with potential" by sensing a potential difference. Female rays, buried in sand during the mating season, produce a characteristic electric field associated with their respiration. An electro-chemical voltage exists between the mucus membranes in the animal's mouth and surface membranes distributed around the gills (the mouth is at a negative potential with respect to the gills). The distribution of the gill membranes produces a complex, multi-pole field around the ray, and the field intensity varies as its mouth opens and closes. Male

rays in the area sense this and, their interest sparked, come like a flash to the buried female.

To test this theory, Dr. Timothy Tricas, Research Associate at Washington University School of Medicine, designed a system that could record then replay the electric calls of female rays. With the help of Scott Michael, graduate of the University of Nebraska, he located a colony of Round Stingrays that mate in shallow water near Baja Kino off the Mexican Gulf coast.

The experiment presented a number of interesting technical challenges common to applications where complex, low-level signals are being reproduced. Rays generate a very weak, dc electric field modulated with a fundamental frequency just below one Hertz. The mean intensity is only 500 nV/m (by comparison, the mean field intensity of the earth at sea level varies between 100 and 300 V/m, and can rise to 10,000 V/m during electric storms). Mimicking female Round Stingrays requires accurately reproducing this low level signal in seawater at a depth of several meters, and in such a way that the complex spatial domain of the field is retained.

The harmonic bio-electric calls generated by

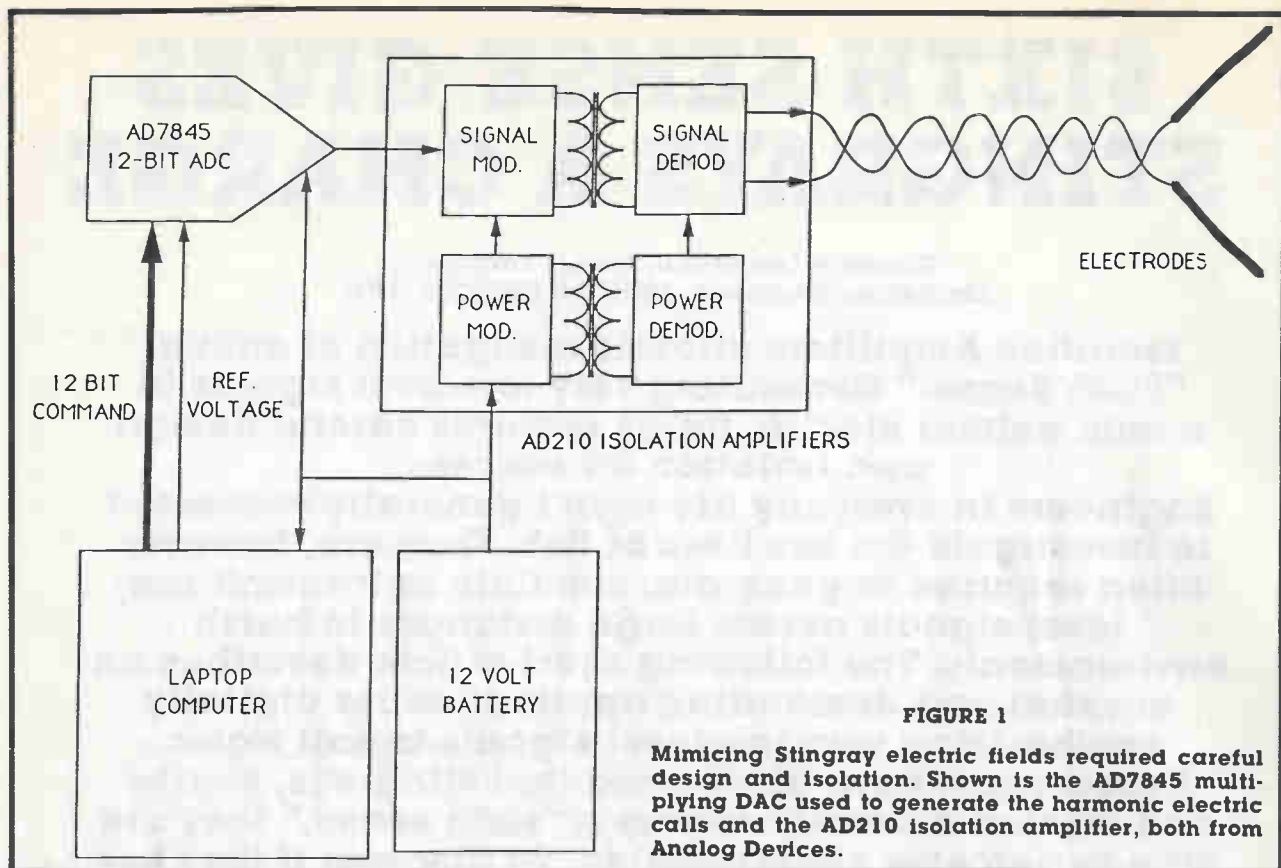

FIGURE 1

Mimicing Stingray electric fields required careful design and isolation. Shown is the AD7845 multiplying DAC used to generate the harmonic electric calls and the AD210 isolation amplifier, both from Analog Devices.

female rays were stored on the hard disk of a Compaq laptop computer. For playback, the PC was connected to a plug-in digital-to-analog interface card, which in turn was connected to Analog Devices'

isolation amplifiers. All of the equipment was enclosed in a water-tight plastic enclosure designed especially for the project (see Figure 1). Sealed connectors linked the output of the isolation

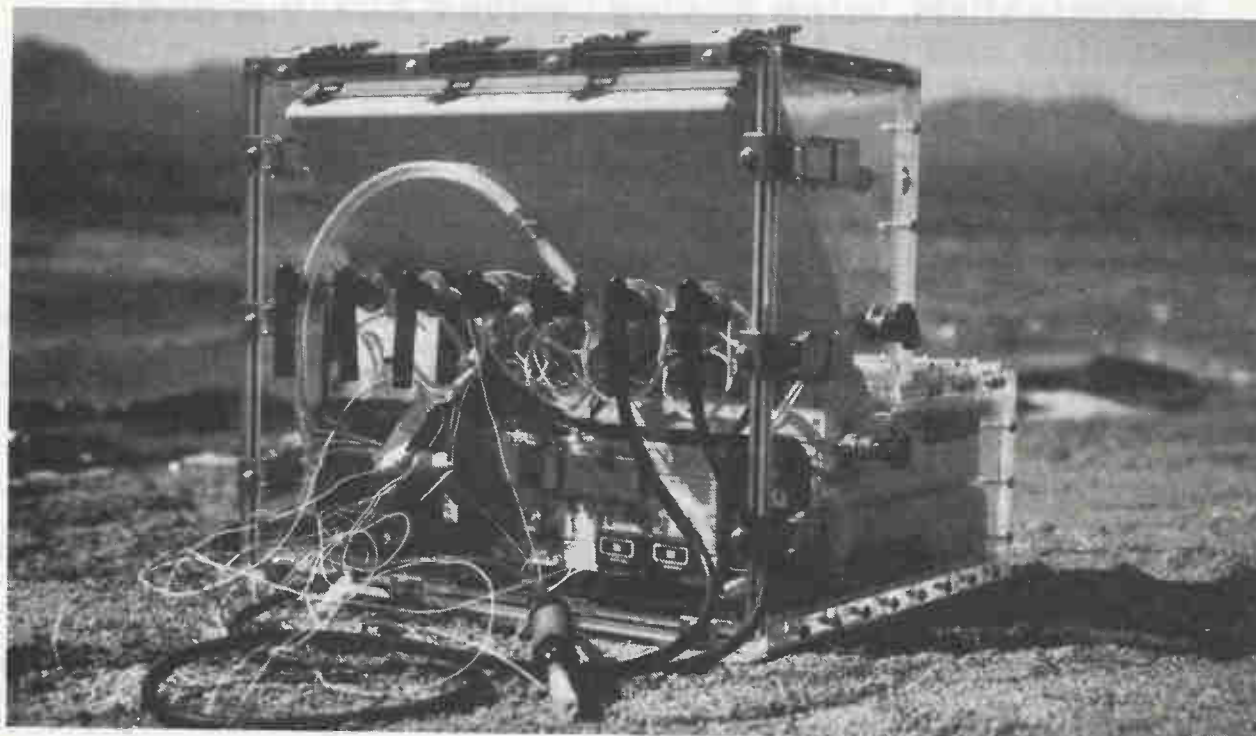

FIGURE 2

The computer and its associated equipment is shown housed in the water-tight plastic enclosure at the Mexican experimentation site. Visible are the blue Analog Devices' AD210 isolated amplifiers.

amplifiers to remote silver electrodes.

To better understand what properties of the electric field "turn-on" male rays (do they like their fields to come on strong and heavy, or are they more interested in racy, fast signals?) both amplitude and frequency were varied. Frequency control was maintained by the computer, and the intensity of the field was varied using multiplying digital-to-analog converters (DACs). Multiplying DACs have two input variables: a digital word corresponds to the playback of the female ray from the computer, and an analog reference voltage determines signal output magnitude or intensity. Using Analog Devices' AD7845 12-bit DACs, the output current to the isolation amplifiers could be controlled accurately in the 4- to 8-uA range. This produced electric field intensities in the nV/m range near the electrodes.

uA output significantly, and the computer's calls would have been unrequited.

The output of the isolation amplifier was fed to a pair of remote silver wire electrodes which are the substitute for the electro-chemical membranes of the ray. To enhance the realistic orientation of the electric field, the wires were formed and separated by a dielectric plastic sheet. All cabling was buried from view. There were no visual, audible or olfactory clues to the presence of the hidden electrodes; they could only be sensed by the electric field they generated.

Dr. Tricas conducted his experiments in the Spring of 1990, and the results have been filmed for a National Geographic special that will air in 1992. Male rays that passed within a few meters of the buried electrodes were attracted by the emitted electric field, and tried in vain to unearth possible mates. Interestingly, female rays were also attracted by the

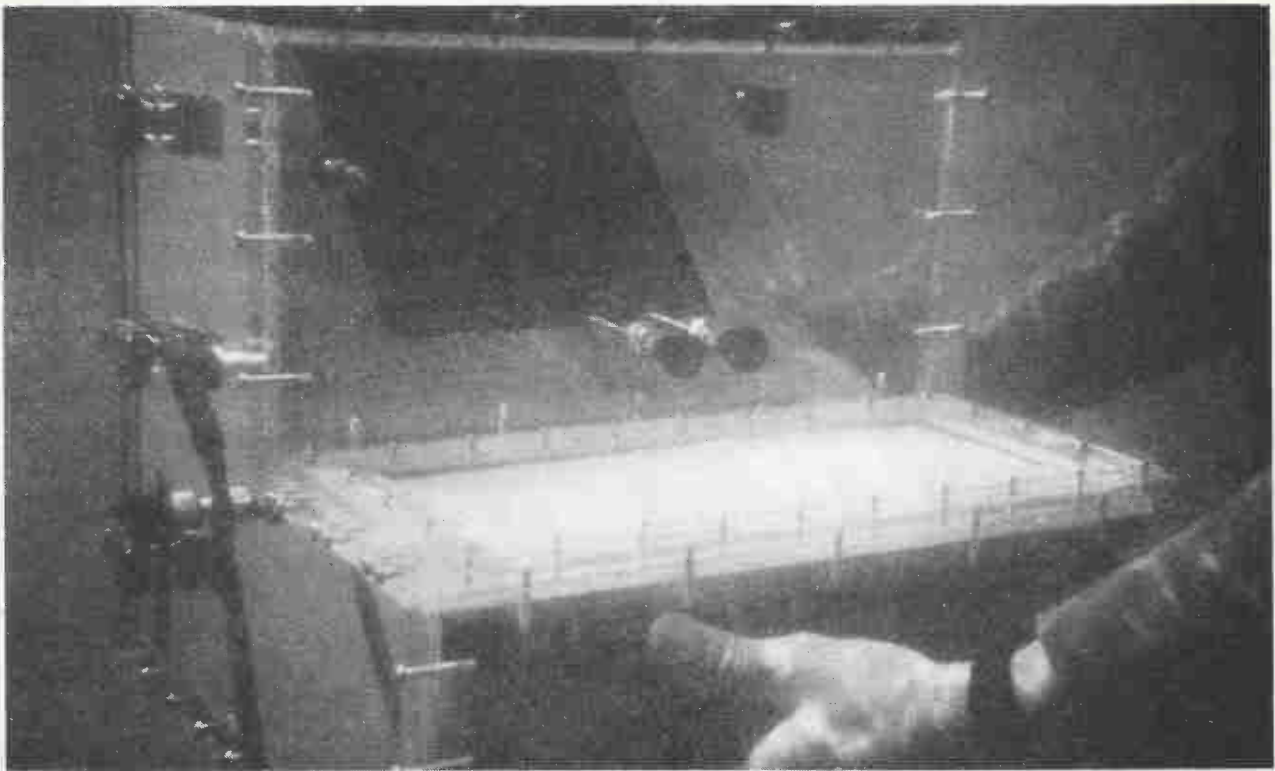

FIGURE 3

The computer is submerged to several meters and ready for connection to the electrodes.

Isolating the output signal from the battery power supply and ground was essential. Analog Devices' AD210 isolation amplifier was chosen because it combines high 2,500 V isolation, low ± 25 ppm/ $^{\circ}$ C gain drift and 120 dB common mode rejection in a small, 2.1" \times 1.0" \times 0.35" package. It could also operate directly from the unregulated 12-V PC battery. Isolation amplifiers galvanically isolate both the signal and the power supply, interrupting ground loops and leakage paths, and rejecting common-mode voltage signals. Without such isolation, noise and common-mode signals would have distorted the

signals, and buried themselves close to the electrodes.

More research is required as to how elasmobranchii and other animals use their sixth sense. Researchers speculate that electric fields generated by animals moving through the earth's magnetic field may be used to detect heading. In ancient China it was believed that catfish had precognition of impending earthquakes; scientists now know that prior to quake activity there are large variations in the earth's electric field, which some animals may be able to detect. ■

THE CATALOG CORNER

If you live in a relatively remote area that doesn't have ready sources for electronic parts, you can send away to numerous supply houses, who have good catalogs of electronic parts and assemblies...many of them real bargains.

Following are several catalogs that we have recently received in the mail, with brief descriptions and comments. Most of these suppliers send out new catalogs every four to six months, with many of the items repeated and new ones added, plus some new "specials"...usually on the first couple pages and the last few pages of each issue.

WINFRED M. BERG, INC.

Raise your right hand if you enjoyed tinkering with an erector set as a kid. Ahhh, just as we expected: there are a lot of you out there. And we'll bet that you still enjoy building complicated electromechanical contraptions. If that's true, you'll flip when you see the latest catalog from Winfred M. Berg, Inc. Berg is one of the world's largest manufacturers of precision mechanical components, and their 544-page catalog is filled with over 58,000 devices. For example, they have gear-drive chains, pulleys, sprocket gears, drive belts, timing belts and pulleys, O-rings, spur gears of metal and plastic, anti-backlash gears, miter and bevel gears, worm gears, racks and pinions, gearboxes, pawls and ratchets, lead screws, shafts, and bearings. A special section of the catalog contains reference data for designers. **Winfred M. Berg Inc., 499 Ocean Ave., East Rockaway, NY, 11518.**



JDR MICRODEVICES

Judging by this company's name, JDR Microdevices, you'd probably expect them to carry semiconductors, and you'd be right. JDR sells a wide variety of micro chips: TTL and CMOS logic, linear devices like op amps and voltage regulators, microprocessors, RAM chips, and various other ICs and discrete devices. In fact, you could probably find most of the parts for any project in this magazine in the JDR catalog.

But parts are not the only things that JDR sells. The company also sells build-it-yourself computers, PC clones that run standard IBM-compatible software, but don't cost nearly as much as the ones sold by Big Blue. JDR has cases, keyboards, monitors, motherboards, disk drives, and various plug-ins like disk controllers and serial-port adapters—in short, everything you'll need to build your own computer. If all this sounds interesting, write to **JDR Microdevices, 2233 Branham Lane, San Jose, CA 95124.**



ALLIED ELECTRONICS

Allied Electronics is one of the grand old names in the electronic business, a company that's been around for more than half a century. Today, Allied is a subsidiary of Hall-Mark Electronics, one of the largest industrial distributors of electronic components. Allied's new catalog is the size of a big-city telephone directory: 772 pages filled with every kind of electronic component you could imagine. Naturally, we're not going to list them all here, but consider, if you will, the following list of semiconductor manufacturers whose products are available through the Allied catalog: Motorola, Texas Instruments, Siemens, Dallas Semiconductor, CKE, Xicor, GE, RCA, Collmer Semiconductor, NTE, and General Instrument. In addition to semiconductors, Allied stocks resistors, capacitors, switches, test equipment, batteries, connectors, and more. Get your copy by writing to **Allied Electronics, 401 E. 8th St., Fort Worth, TX, 76102.**

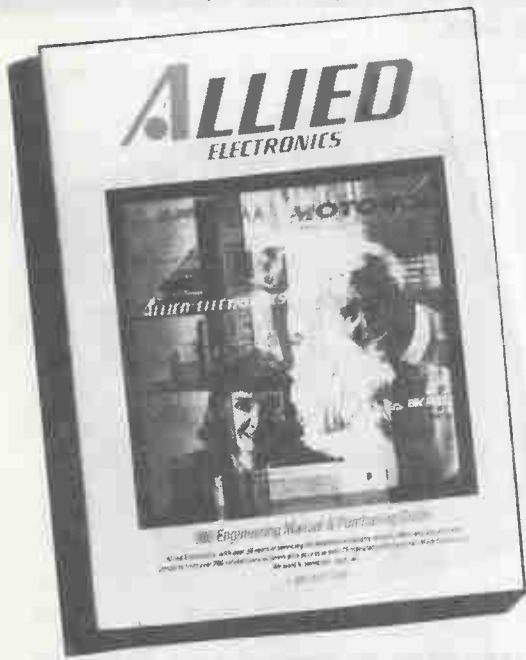

EXTECH INSTRUMENTS

Extech Instruments has just issued a colorful new catalog that's filled with a wide variety of electronic instruments, and while some of these devices will only interest the industrial user, there's plenty here for the hobbyist and experimenter. For example, they've got digital thermometers as well as thermometer adapters, which will allow a DMM to measure temperature. An assortment of thermocouple probes is also featured. If you need to measure pH, as often happens in PCB production, you'll be pleased with Extech's selection of bench-mount and portable digital pH meters and pH probes. Perhaps you'd like to measure the conductivity or rate of flow of a solution. Again, Extech has instruments that can do it. Digital multimeters are always essential for the electronics enthusiast, and Extech offers several models, including a 4-½ digit DMM with .05% DC accuracy for the remarkable price of \$129. **Extech Instruments, 150 Bear Hill Rd., Waltham, MA, 02154.**

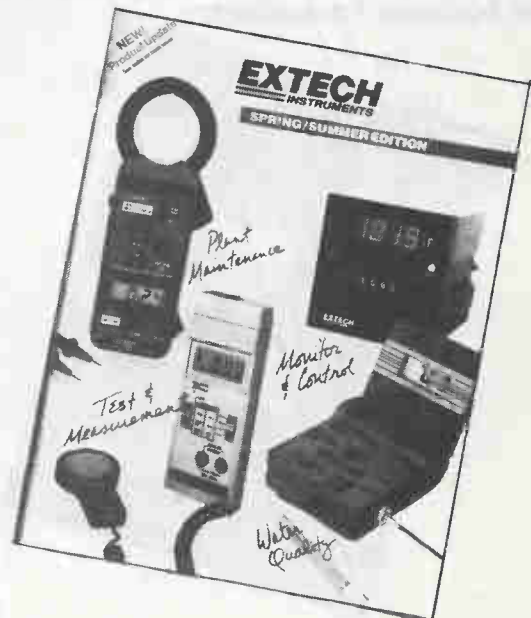

FORDHAM RADIO

Company names can sometimes be deceiving. Take Fordham Radio for example. Perhaps when this company was founded it specialized in the sale of radios, but today Fordham offers all kinds of electronic equipment. Featured prominently in Fordham's latest catalog is a wide variety of electronic test gear, some of it bearing the Fordham brand name, the rest bearing the names of such well-known manufacturers as B&K Precision, Hitachi, Simpson, Global Specialties, VIZ, and Fluke. In addition to test gear, Fordham also offers an excellent selection of tools like soldering irons, pliers, PBC drills, wrenches, screwdrivers, and so on. The Fordham product line is rounded out by an interesting array of consumer electronic items like video equipment, speakers, radar detectors, telecommunications products, and exercise machines. Oh, by the way, Fordham also sells radios. **Fordham Radio, 260 Motor Parkway, Hauppauge, NY, 11788-5134. Toll-free telephone 1-800-695-4848.**

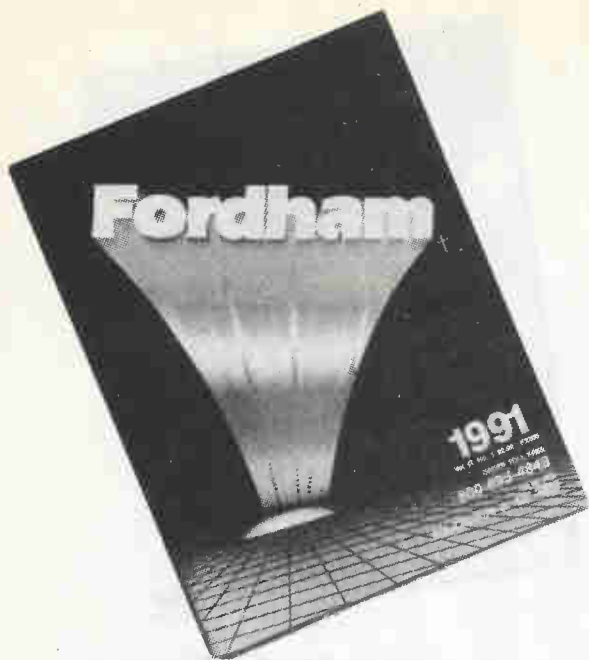

HEATH HOME AUTOMATION

In the seventies, the big craze in consumer electronics was CB radio; in the eighties, it was personal computers. What's in store for us in the nineties? Home automation...and you don't need a crystal ball to make such a prediction. Just take a stroll through your neighborhood hardware store or building-supplies center. You'll find aisle after aisle of gadgets designed to turn lights on and off automatically, detect intruders, and remotely control your appliances. The home of the future promises to be a smart home, bristling with sensors and controls and electronic readouts. This vision of the future has not been lost on the folks at Heath. Heath's catalog of home automation products contains such items as command consoles, alarm systems, an electronic barking dog alarm, motion sensors, a video intercom system, various remote-control devices, and energy-saving automatic thermostats. For more info, contact **Heath Company, Benton Harbor, MI, 49022-8589. Toll-free telephone 1-800-253-0570.**

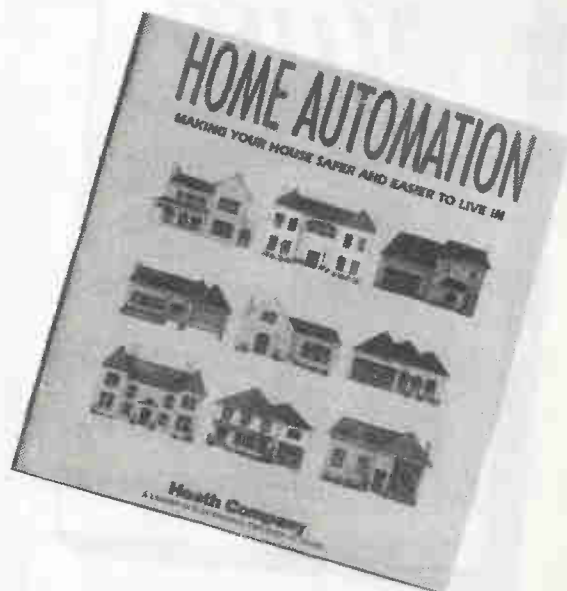

AMATEUR ELECTRONIC SUPPLY

Through the years, amateur radio has proved to be an egalitarian hobby, attracting participants from every walk of life. Some hams—like Senator Barry Goldwater, actor Marlon Brando, and King Hussein of Jordan—are world-famous, while others, like those of us who compile this column, work in relative obscurity. But whether famous or not, all hams share the desire to communicate with friends around the world. They also share a common problem: the difficulty of obtaining good equipment. That problem can be overcome by getting your hands on the latest catalog from Amateur Electronic Supply. The folks at AES stock a huge inventory of transceivers, antennas, keyers, packet-radio equipment, and test gear. They carry products by Ten-Tec, Kenwood, Cushcraft, Icom, Hy-Gain, MFJ, Yaesu, and hundreds of other manufacturers. And they offer substantial discounts on many items. **Amateur Electronic Supply, 5710 W. Good Hope Rd., Milwaukee, WI, 53223. Phone toll-free 1-800-558-0411.**



EDLIE ELECTRONICS

There are essentially three methods by which an item may find its way into the Catalog Corner. First, a company may send us a catalog in the hope that it will strike our editorial fancy. Second, we may request a copy of a catalog that seems particularly interesting. Third, blind luck may intervene, which is what happened here. In this instance, Edlie Electronics sent a copy of its catalog to an electronics enthusiast—let's call him Mr. X—who then passed the catalog on to a friend, Mr. Y, who later loaned it to us. The result of this conspiracy of fate is that Edlie now gets some free publicity. We think you'll like the Edlie catalog. Its 130 pages contain such neat things as test instruments, books, kits, semiconductors, alarm systems, tools, audio and video accessories, chemicals, printed-circuit supplies, and cabinets. Lots of bargains, too. **Edlie Electronics, 2700 Hempstead Turnpike, Levittown, L.I., NY, 11756-1443. Phone toll-free 1-800-645-4722.**

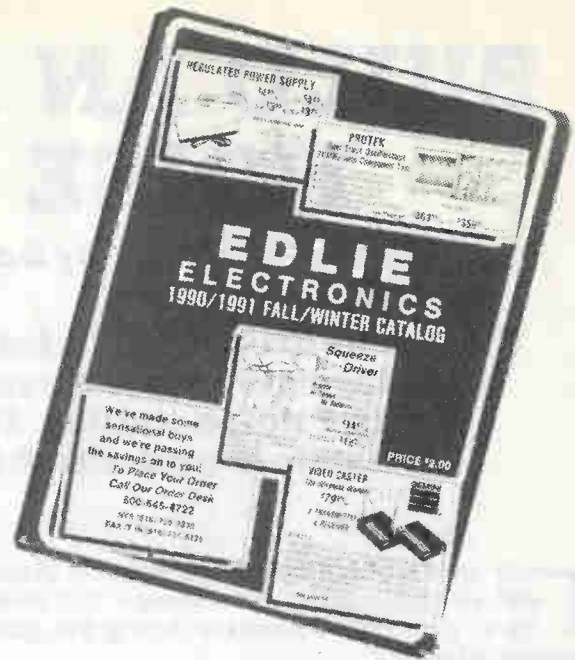

BANANAS NEWS

Bananas News is a tabloid-size periodical devoted to electronic musical equipment of all kinds. Despite the whimsical title, these guys don't monkey around. Each issue is jam-packed with the latest information on hundreds of pieces of electronic musical equipment. More than just a catalog, Bananas News is filled with technical tips and gossip that will appeal to anyone with an interest in electronic music. Whether you're a musician, sound-recording engineer, audiophile, or computer-music experimenter, there is sure to be something that will interest you in this catalog. For example, the latest issue of Bananas News features DAT tape decks, mixers, keyboards, amplifiers, multitrack tape decks, microphones, signal processors, headphones, guitars, speakers, music software, MIDI controllers, computers, pianos, electronic drum sets, and CD players. To get a copy of Bananas News, just write to **Bananas At Large, 1504 Fourth St., San Rafael, CA, 94901, or telephone 415-457-7600.**



EDUCALC

There is a tendency, we suspect, among some segments of society to view the calculator as the less capable and less glamorous cousin of the computer, but we beg to disagree. Computers and calculators are different beasts entirely, and simple comparisons between the two are relatively meaningless. It makes more sense to think of the calculator as a special-purpose computer which has been optimized for certain kinds of tasks, such as scientific or business calculations. Just as computers have become more powerful over the years, so too have calculators. If your calculator is more than five years old, it could be worth your while to upgrade. The folks at EduCALC have a catalog that is chock full of the hot new machines from Hewlett-Packard, Texas Instruments, and other manufacturers. Books, software, and accessories are included, and they'll even burn custom ROMs for you, too. **EduCALC, 27953 Cabot Rd., Laguna Niguel, CA, 92677. Toll-free telephone 1-800-633-2252.**

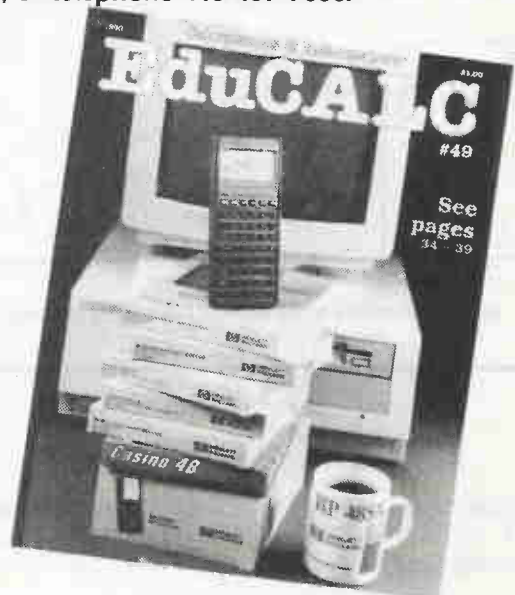

BUILD AN AUDIO TAPE NOISE LIMITER

By Darren Yates

Sick of hearing that "hiss" during the quiet passages of your favorite music cassette? Then remove it with this tape noise limiter. It uses only three common transistors and can be built in a couple of hours.

Tape noise is one of the major drawbacks of audio and video cassettes. Even though it is always there, it is only noticeable during the quiet passages of music.

Even on many video cassettes, the audio quality can be quite bad with that "hiss" easily heard on many tapes.

With many "passive" noise removers (i.e. ones that use no transistors or ICs), capacitors and resistors are used to make simple filters which remove most of the high frequencies that make up most noise.

The problem with these, however, is that they act all the time and reduce the clarity of the speech or music, even when the noise cannot be heard through it.

The circuit we present here is also known as a voltage-controlled filter and only works when the signal level drops below a preset level where noise becomes noticeable. It adjusts itself to cut the high frequencies, when there is no sound to be heard (other than noise) and then turns itself off when the speech or music, we want to hear, returns allowing all those juicy high frequencies to pass through again.

When the quiet passages occur, Q3 is turned on and the filter is brought into action. Figure 1 shows its response. Notice that all the frequencies below 3.3kHz are allowed to pass whereas the frequencies above 3.3kHz are progressively cut, the higher in frequency we go.

This type of filter is known as a low-pass filter because it allows low frequencies to pass unimpeded, and progressively blocks the higher ones.

Now, let's have a look at the circuit diagram in Figure 2, and see how we make the transistor switch work at the right time.

At the input to the circuit, some of the signal is taken by the 1uF capacitor and coupled via a level control VR1 to the base of transistor Q1. VR1 allows you to set the signal level at which the filter should come on. It also sets how hard the filter works, whether it reduces the high frequencies either a little or a lot.

Transistor Q1 is set up as an amplifier with a gain of about 180. It amplifies the signal so that we get a signal level of a few volts.

The signal is then coupled via a 4.7uF capacitor to two diodes and another 4.7uF capacitor. These components form a voltage rectifier and doubler. It takes the AC signal and turns it into a DC voltage twice its original value. Since it works on the principle of the more signal input, the more DC voltage, we have the means now to control the switch and make it cut in at the right time.

We now feed this DC voltage into the base of transistor Q2. This transistor acts as an inverter, so that when we get a voltage at the base of Q2, we get no volts at its collector, and when we get no volts at the base, we get volts at its collector.

The base of the transistor "switch" Q3 is connected to this collector point of Q2.

If we get a DC voltage at the base of Q2, we know that we have a reasonably loud signal at the input, so we don't want the filter to cut in. (This is because we won't hear the noise anyway!)

This voltage causes Q2 to turn on and the voltage at its collector drops to about 0.2 volts. Because the base of Q3 only has 0.2 volts across its base-emitter junction, it doesn't turn on and so the filter stays off, just as we want it to.

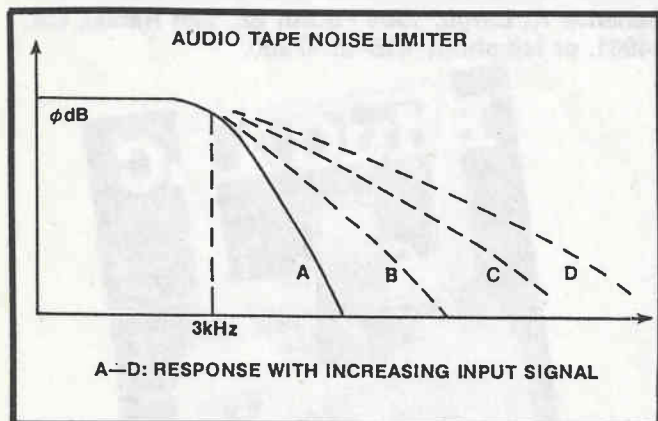

FIGURE 1

How It Works

The main part of the filter is the 4.7K resistor and the 0.01uF capacitor. Transistor Q3 operates as a voltage-controlled switch.

AUDIO TAPE NOISE LIMITER

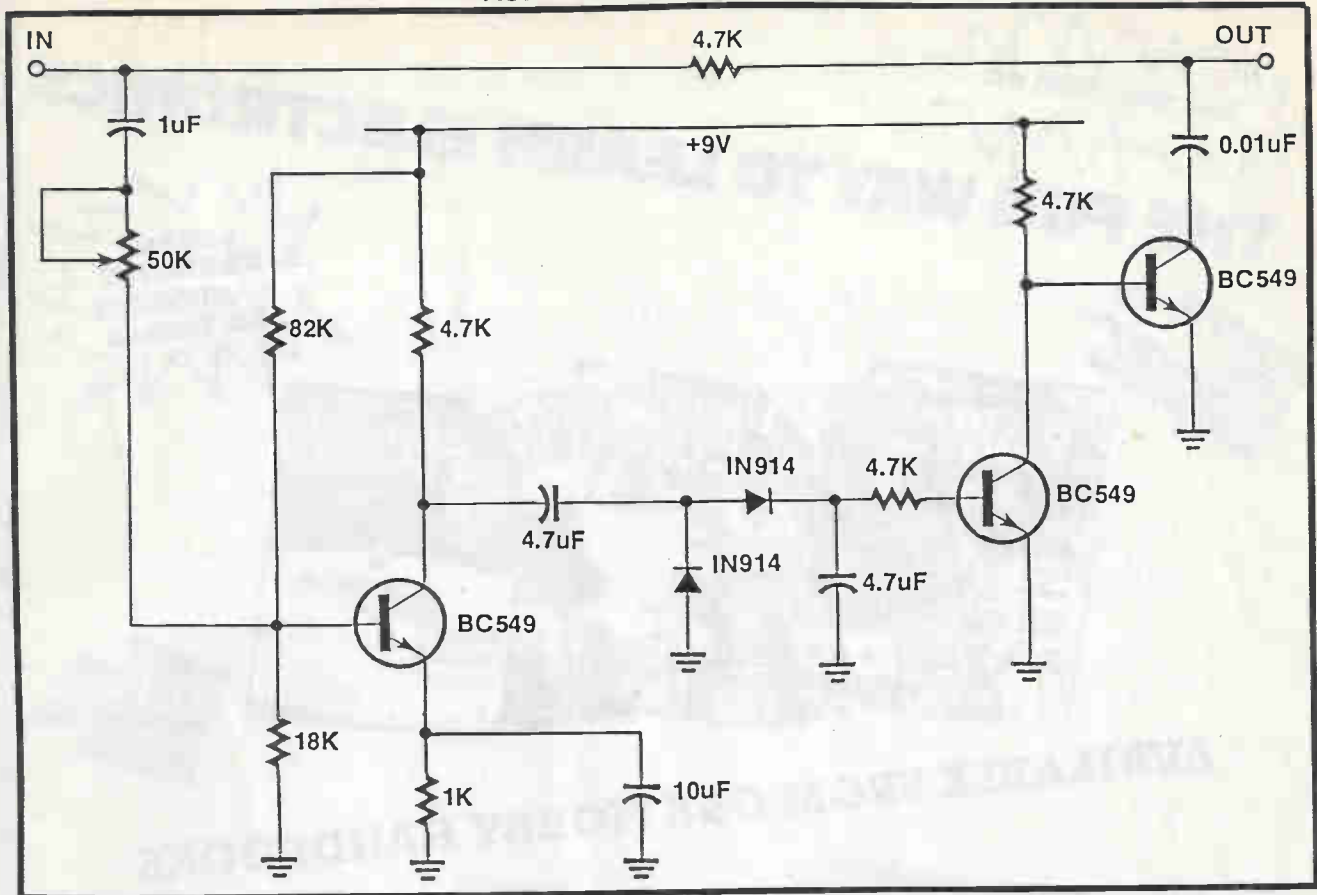

FIGURE 2

When the voltage at the base of Q2 disappears, we now have little or no signal coming through. This is when we are likely to notice noise. Because there is no voltage at its base, Q2 turns off and its collector now goes to nearly 9 volts. But because we can only have 0.6 volts across the base-emitter junction of Q3, it now turns on hard, bringing the filter into play—just as we want.

When you build this, use either a piece of veroboard or if you have the facilities, make your own printed board. Make sure that your 9 volt power supply is well regulated otherwise AC hum can leak through into the circuit and be heard at the output.

When you install the circuit, fit it between the cassette deck or video recorder and your audio amplifier using either phono plugs or small jack plugs. Now play a tape or video that has a number of

quiet passages. When they occur, adjust VR1 to give what you think is the best result.

All you need do now, is enjoy the fruits of your labor and listen to relatively noise-free sound. ■

PARTS LIST FOR AUDIO TAPE NOISE LIMITER

- 3—BC549 NPN Transistors (2N5818 or Equiv.)
- 2—IN914 signal diodes
- 1—10uF electrolytic capacitor (16VW)
- 2—4.7uF (16VW) electrolytics
- 1—1uF (16VW) electrolytic
- 1—0.01uF metalized polyester
- 1—50K ohms linear pot.
- 1—82K ohms (1/4W) 5%
- 1—18K ohms
- 2—4.7K ohms
- 1—1K ohm



ELECTRONICS HANDBOOK V11

P.O. Box #5148, N. Branch, N.J. 08876

- Yes. Enter my subscription — 4 issues ONLY \$15.00
(Canada \$18.00...Foreign Postage add \$8.00...U.S. Funds)
- Payment enclosed. (Payable to: C&E Hobby Handbooks)

PLEASE PRINT

NAME: _____
 ADDRESS: _____
 CITY: _____
 STATE: _____ ZIP _____

Get switched on

THE FUN WAY TO LEARN ELECTRONICS

SECRETS OF RADIO:
Phase and Frequency Facts,
AVC, Superhet Circuitry,
Power Supplies, Antennas

Lab Test
**C&E HOBBY
HANDBOOKS**
For Yourself!



**NEWEST
SOLID STATE
TECHNIQUES:**
Thermistors, Op Amps,
IC Learning Aids

AVAILABLE FROM C&E HOBBY HANDBOOKS

**LEARN ABOUT
ELECTRONS:**
Electricity and Magnetism,
Inductance and Capacitance



**ALL ABOUT
COMMUNICATIONS:**
Low Frequencies,
Short waves, FM, TV,
Microwaves, Satellites

- ★ RESERVE YOUR COPIES OF FUTURE ISSUES...
- ★ ORDER COPIES OF BACK ISSUES...
- ★ MAIL THIS COUPON FOR DETAILS...

**TO: ELECTRONICS HANDBOOK
P.O. BOX #5148
NORTH BRANCH, N.J. 08876**

FROM: (Please Print)

Name: _____

Address: _____

City & State: _____

Zip: _____

CONSTRUCTION QUICKIE

SOLID STATE RELAY

By Joe O'Connell

Solid state relays are reliable alternatives to their old-fashioned electromechanical counterparts. Because they have no moving parts, solid state relays are silent, longer lasting, more compact, non-arcing, and don't produce as much electrical noise. For these reasons, solid state relays are becoming more popular in applications where standard relays were previously used or couldn't be used because of their drawbacks.

It's possible to buy solid state relays already assembled and packaged, but it's cheaper to make your own. The circuit shown here uses a low voltage DC input to control AC power with a triac. The power handling capacity depends only on what size triac you use and how well it is heatsunk. For any input voltages, use a value of R given by $R = \text{input voltage} \times 50$.

The triac driver opto-isolator makes the circuit quite simple. It has an LED input which will operate over a 15 to 50 mA current range so the exact value of R is not critical. Similar opto-isolators accept input

currents as low as 5 mA. The capacitors suppress high frequency noise that might otherwise trigger the triac. For overvoltage protection, add a low voltage zener diode and fuse as shown in the schematic. The triac driver opto-isolator can be either the standard MOC3010 or the MOC3031 which incorporates zero-crossing circuitry. Use the zero-crossing driver if the load you are controlling is sensitive to line noise or if it has a large transformer-input power supply.

This relay is suitable as an extension switch for controlling large loads. It can be located right next to the device being controlled, with thin DC control wires run to a remote battery and switch. This allows you to avoid long high-power wiring runs that cost more to install, develop a voltage loss, and are governed by electrical codes. Because the low voltage control circuitry is electrically isolated from the 120 Vac, the relay is ideal when safety is important. One of the frequent uses of low voltage relays is switching lights, heaters, and fans from in or near showers and pools. ■

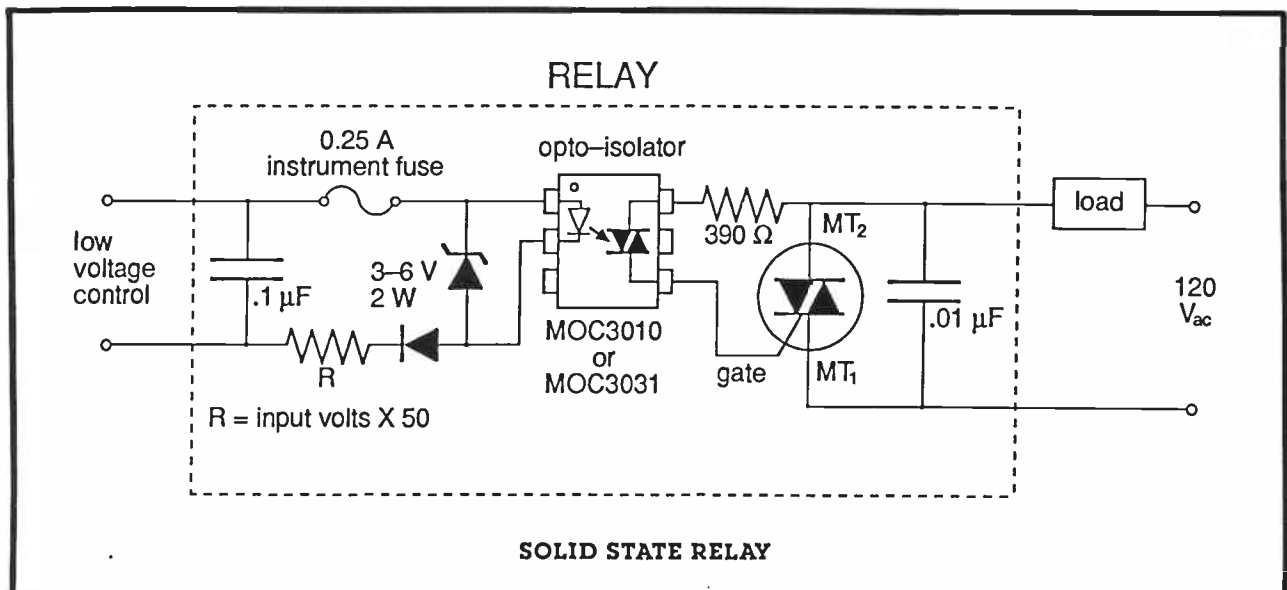

Build your own Surge-Protector, Function Generator, Amplifier, Laser Printer...

"I can't believe how easy it is to build my own electronic devices. This book shows me how to do it step-by-step."



The Modern Electronics Manual

Newly revised and enlarged, now with more than 550 pages, shows you how to successfully build and repair electronic appliances and equipment. Useful projects, easy-to-follow repair instructions, detailed instructions for correctly using test equipment, up-to-date techniques and the latest in electronics know-how.

Dozens of practical, money saving projects

With detailed assembly instructions, schematics, circuit layouts and parts lists, you'll build projects in areas ranging from telecommunications, stereos and computers, test and repair tools, to radio and TV. And you won't spend valuable time searching for parts, because our "Sources of Electronic Components and Supplies" provides you with an updated list of local and mail-order suppliers.

Do-it-yourself repair techniques

Professional hints, tips and shortcuts will make repair easy and efficient. Learn money saving maintenance tricks and repair techniques. You'll feel confident about troubleshooting problems. You'll know when to call for service and when you can fix equipment yourself.

Timely supplements offer you brand new projects and up-to-date information.

Experts in their fields work out new and interesting assembly instructions for one-evening projects and keep you on top of what's new. Your knowledge of electronics grows continuously. You'll benefit from the latest developments and ideas, be able to build or repair more on your own, have fun and save more money. Supplements are sent 4-5 times a year. No-risk guarantee, you pay upon approval.

Convenient, easy to access information in one, comprehensive source

You won't need to search for books, magazines and manufacturer's brochures. The sturdy three ring binder with index tabs organizes the material so that you'll find what you need quickly.

Free circuit layouts on acetate save time and improve results!

The hardest part of many electronics jobs is in the planning, because drawing your own circuit layouts can be time consuming and inaccurate. The Modern Electronics Manual provides clear acetate circuit layouts for every project. Just place the layout over a photosensitive copper circuit board, expose it to light and etch your own printed circuit.

Then attach the components, plug it in and use it!

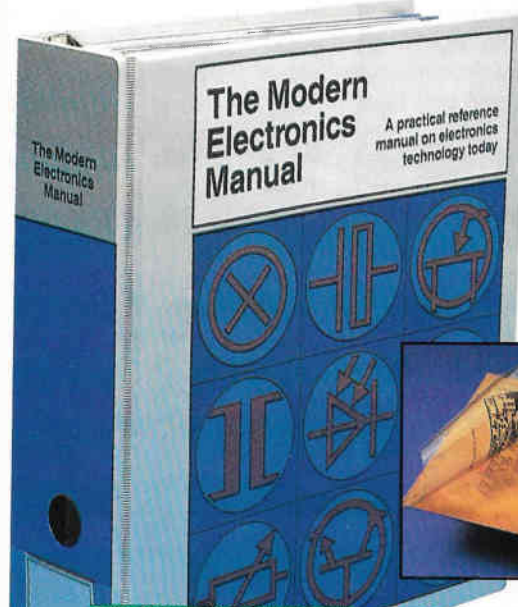

FREE!
Circuit Layouts
on Acetate

MONEYBACK GUARANTEE:

There's no risk in trying The Modern Electronics Manual to see if it's right for you. If you are not delighted, simply return the manual after the 15-day trial period and receive a prompt refund.



97 Indian Field Rd.
Greenwich, CT 06830

YES, please send me The Modern Electronics Manual for only \$49.95 plus \$5.00 shipping and handling. I understand that if I am not completely delighted, I may return the manual within 15 days and receive a prompt refund. Updates will be sent 4-5 times a year, they are up to 120 pages each and cost 25¢ per page. Cancel anytime.

Visa MasterCard Check enclosed Bill me
Card # _____ Exp. date _____
Signature _____
Phone _____ Signature and number are required for all orders.
Name _____
Address _____
City _____ State _____ Zip _____

Sorry, orders from foreign countries can only be accepted if they are prepaid in US currency. Shipping and handling cost \$15.00 per international shipment. \$10.00 to Canada.

400014

**CALL 1-800-222-WEKA
FOR FASTER SERVICE**