



BK-10

TRANSISTOR APPLICATIONS

More than 50 Practical Circuits
using
RAYTHEON CK722 TRANSISTORS.

Complete How-To-Do-It Instructions.

PRICE 50¢

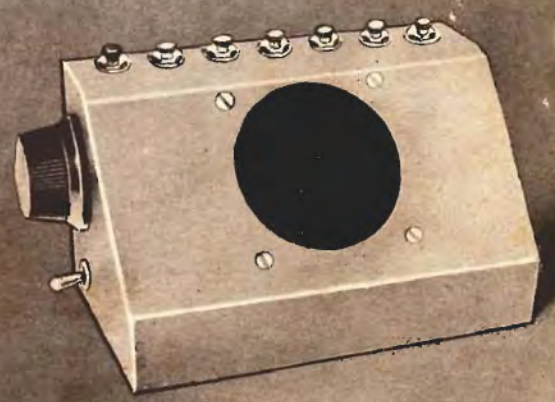
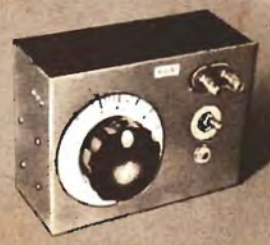
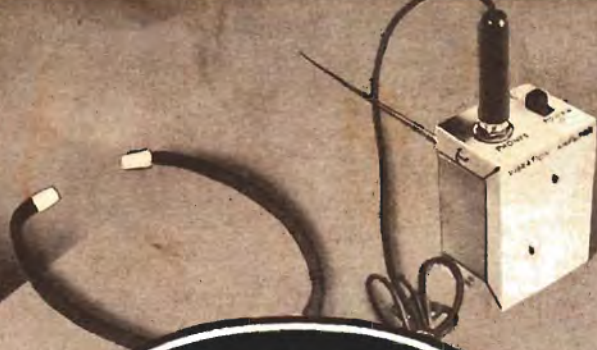

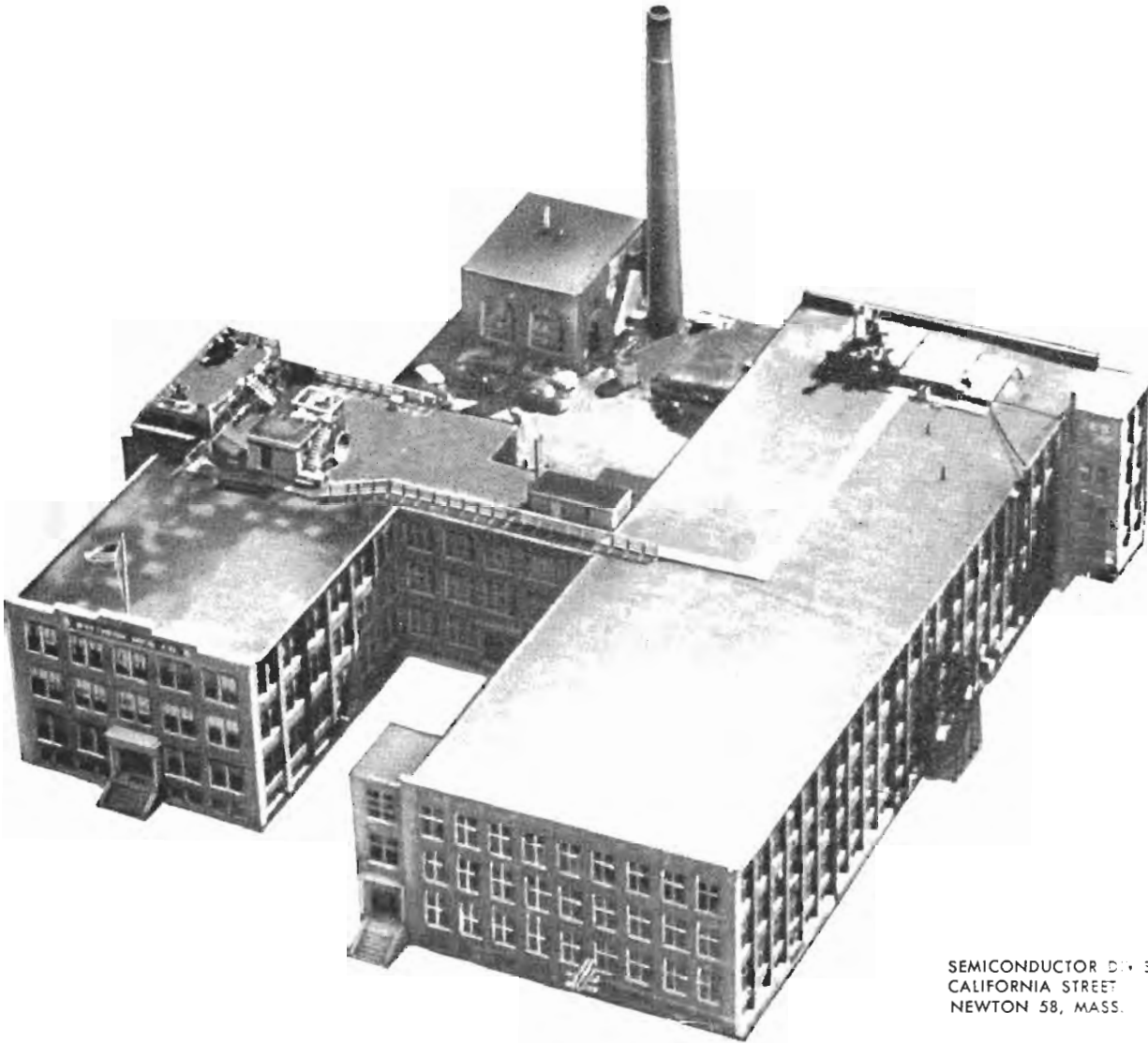

SEMICONDUCTOR DIVISION
CALIFORNIA STREET
NEWTON 58, MASS.

THE HOME OF RAYTHEON TRANSISTORS

This multimillion dollar plant is the largest in the world devoted exclusively to the production of semiconductors. Three times the size of former facilities it meets the demand for Raytheon Transistors brought about by Raytheon leadership in transistor design and development.

Raytheon produced the first commercial transistors for hearing aids — the transistors that have revolutionized the hearing aid industry.

In the computer industry and in the newest and finest portable and automobile radios the new Raytheon RF Transistors are proving equally valuable and important.

Today, there are several million Raytheon Transistors in use —

More In Use Than All Other Makes Combined



TRANSISTOR APPLICATIONS

This book is a practical guide to the fascinating new world of Transistors, prepared especially for the interest and enjoyment of engineers, technicians and hobbyists who have been eager to experiment with Transistor circuits. It fills the need for a source of circuits that will help the builder to study the many facets of Transistors — their properties, performance and adaptability.

Emphasis has been placed on practical applications. Basic Transistor theory is discussed in many of the articles, such as the article, "Build This Transistor Receiver" on page 3. It contains a wide variety of circuit diagrams plus detailed procedures and parts lists to assist the builder in every step.

Raytheon Transistors and other components needed for these projects are available through Raytheon tube suppliers who can lend valuable assistance in many ways.

A great deal of information contained in this Raytheon Transistor Book has been made available through the courtesy of two leading publications in the electronics field — RADIO-ELECTRONICS and RADIO AND TELEVISION NEWS. We wish to express our sincere appreciation to them for their cooperation.

Credit is accorded RADIO-ELECTRONICS for the articles originating on pages 7, 9, 11, 22, 25, 29, 31, 35, 37, 43, 52, 59, 61, 63, 73, 75, 77, 91, 95, 97, 99, 100 and the articles "Transistor Dot Maker" on page 80, "Transistor Oscillator Powered by Light" on page 36 and "Noise Generator" on page 100.

Credit is accorded RADIO AND TELEVISION NEWS for the articles on pages 3, 12, 15, 17, 19, 24, 27, 33, 38, 41, 45, 56, 81, 83, 85, 87, 89 and the articles "Transistor Oscillator" on page 36, "Transistor Wireless 'Mike'" on page 80 and "A Transistor Bridge Null Detector" on page 100.

TABLE OF CONTENTS

Build This Transistor Receiver	3
Regenerative Transistor Receiver	7
Transistor Regenerative Receiver	9
Transistor Radio Uses No Power Supply	11
Transistorize Your Audio Amplifiers	12
A Transistor Vibration Amplifier	15
Transistor Guitar Amplifier	17
The Transistor D.C. Amplifier	19
Low Noise Transistor Preamplifier	22
Transistor Clipper Amplifier	23
A Transistor Phase Inverter	24
Build This Transistor Hearing Aid	25
A Transistorized Audio Oscillator	27
Junction Transistors for High Frequency Oscillators	29
Transistor Toy Oscillator	30
Transistor Phono Oscillator	31
A Subminiature Code Practice Oscillator	33
Transistor Oscillator Produces Subharmonics	35
Transistor Oscillator is Powered by Light	36
Transistor Oscillator	36
IF-RF Crystal Oscillator Uses Junction Transistor	37
Miniature Audio Frequency Test Oscillator	37
A Universal Counter	38
Transistor Operated Photocell Relay	41
Transistor Control Relay	43
A Transistor Timer	45
Radio Control Circuit	47
A Self-Powered Transistor CW Monitor	49
Transistor Keying Monitor	52
A Transistorized Audio Filter for Amateur Reception	53
Transistor Band Spotter	56
Transistor-Varistor Modulator	59
Transistor AM Test Oscillator	61
Heterodyne Frequency Meter Uses Pair of Transistors.....	63
A General Purpose Transistor Voltmeter	64
Miniature Audio Frequency Meter	67
Transistor Audio Frequency and Voltage Standard	70
Transistorized Voltmeter	73
Pistol Grip Signal Tracer	75
Demonstration Transistor Circuits	77
Transistor Wireless "Mike"	80
Transistor Dot Maker	80
A Transistor Metronome	81
A Transistorized Applause Meter	83
Transistorized Moisture Detector	85
A Transistor "Electric Organ"	87
A Transistor Sine-Wave Clipper	89
Two Transistorized Metal Locators	91
Transistorized Commercial Killer	95
Electronic Headphone	97
A Transistorized Geiger Counter	99
A Transistor Bridge Null Detector	100
Noise Generator	100

TECHNICAL DATA

CK721	107
CK722	110
CK727	113
Pertinent Data on Other Raytheon Transistors	116

Pertinent Data on Raytheon Semiconductor Diodes
inside back cover

BUILD THIS TRANSISTOR RECEIVER

By
ROBERT K. DIXON

Receiving Tube Division
Raytheon Manufacturing Company

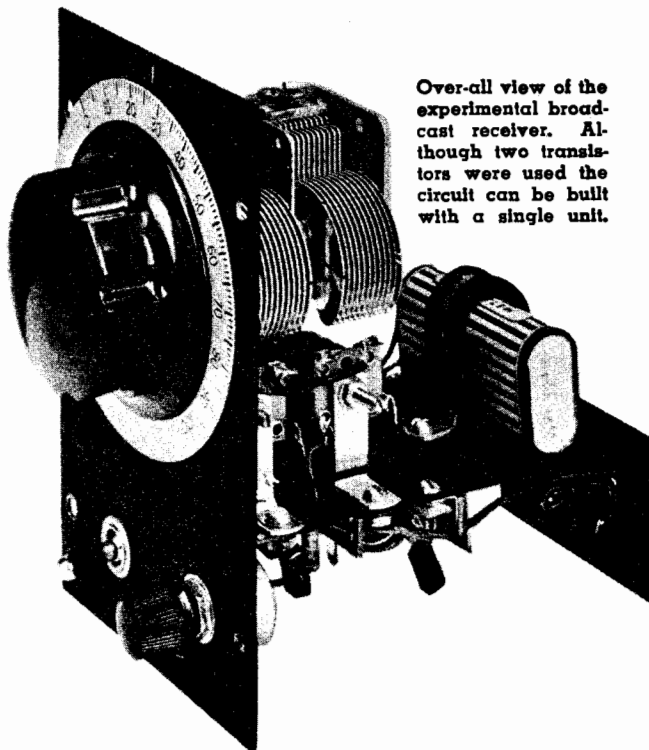

Over-all view of the experimental broadcast receiver. Although two transistors were used the circuit can be built with a single unit.

ABOUT four years ago, the transistor was first announced. Since that time, a considerable amount of effort has gone into the design and production of transistors and much has been written about them.

Transistors are semiconductor devices capable of acting as amplifiers, oscillators, and performing other functions now performed by vacuum tubes and with greater efficiency. The basic material in most transistors today is germanium and the devices are made in two different types: the point contact, which was the original, and the junction.

A semiconductor is any material which is neither a good conductor nor a good insulator, thus its name. Germanium has a simple atomic structure with the inter-atomic spacings in the crystals forming relatively straight corridors or paths. The basic lattice of the crystal has eight atoms per cell, four of which form the corners of a small cube while the other four are wholly within the cube. There are relatively large spaces between the atoms. In this pure form germanium is basically a stable material and does not exhibit a surplus or deficiency of electrons.

By the introduction of certain selected elements, the germanium can be made to exhibit an excess of electrons and thus become a negative or "n" type material, or by the introduction of other impurities or chemical elements there may be a deficiency of electrons and the material will be considered a positive or "p" type material.

If electrical pressure is applied to a piece of "n" type germanium material, current flow will exist by virtue of the free electrons existing therein. Similarly, if electrical force is applied to the positive type material, conduction appears by virtue of the phenomenon

called hole conduction. The application of electrical potential causes electrons to move from the negative end toward the positive end, the presence of holes facilitating the electron flow.

The point-contact transistor consists

EDITOR'S NOTE: Obviously no attempt has been made to "miniaturize" this unit. It is more important to familiarize oneself with the design and limitations of transistors. Miniaturization is then not too difficult a task.

of a block or crystal of material such as germanium with two properly spaced pointed electrodes making contact with the surface of the germanium. In many respects, it resembles the well-known crystal diode with the exception of the additional electrode. During manufacturing, the position of the two point contact electrodes (including the relative spacing of these elements) is adjusted for proper operation of the transistor as an amplifying device.

Fig. 1. Internal construction of the (A) point contact and (B) junction transistor.

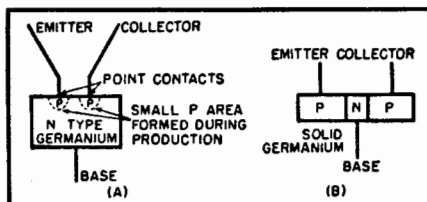

The basic block of germanium is normally "n" type in the point-contact device. Small areas of the germanium adjacent to the pointed electrodes are converted to "p" type material during production. (See Fig. 1A.)

Junction transistors consist of a block of material in which "n" and "p" type materials are arranged in alternate layers. The end sections can be either "n" or "p" material with the center zone being the opposite type. (See Fig. 1B.)

The point-contact transistor finds wide application in switching circuits and oscillator circuits at frequencies normally not possible with the junction type units. The point-contact transistor has inherently higher noise output than the junction units.

The junction transistor, on the other hand, is a more efficient amplifier while operating at low voltages. They are extremely rugged and have exceptionally long life. The normal noise voltage generated in a junction type is lower than that of the point-contact type transistor. Since the electrons travel somewhat slower through the germanium material in transistors than in a vacuum and due to the high internal capacities of junction transistors as we know them today, operation is normally limited to the lower frequencies.

This article deals with a "p-n-p" junction transistor recently announced by the Raytheon Manufacturing Com-

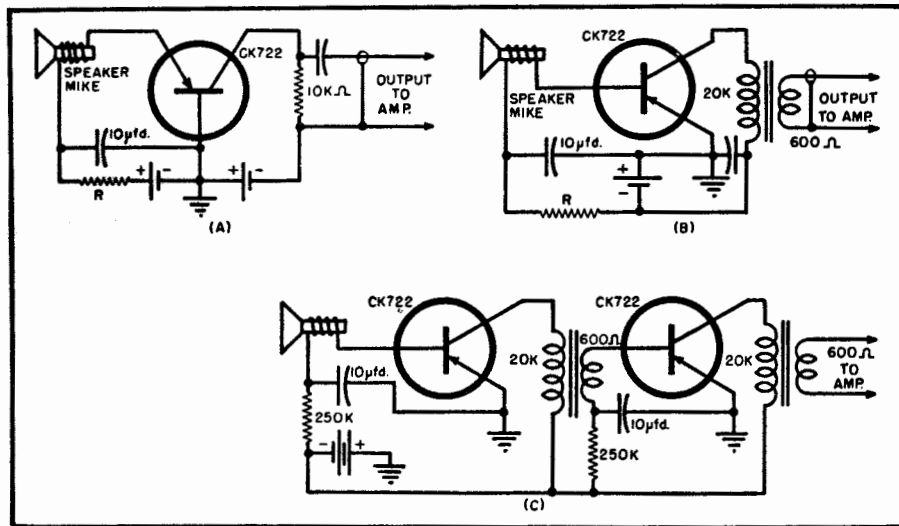

Fig. 2. Microphone preamplifiers using transistors. (A) grounded base, (B) grounded emitter, and (C) a two-stage, transformer-coupled amplifier. See text for details.

MECHANICAL DATA

CASE: Plastic and Glass
BASE: None (0.016" tinned flexible leads,** Length: 1.5" min. Spacing: 0.08" center-to-center)

TERMINAL CONNECTIONS: (Red dot is adjacent to lead 1)
 Lead 1 Collector
 Lead 2 Base
 Lead 3 Emitter

WEIGHT: 0.025 ounce
MOUNTING POSITION: Any

ELECTRICAL DATA

RATINGS—ABSOLUTE MAXIMUM VALUES:

Collector Voltage	-20 volts
Collector Current	-5 ma.
Collector Dissipation (at 30°C)	30 mw.
Emitter Current	5 ma.
Ambient Temperature	50 °C

AVERAGE GAIN CHARACTERISTICS—GROUNDED EMITTER: (at 30°C)

Collector Voltage	-1.5 volts
Collector Current	-0.5 ma.
Base Current	-20 μa.
Current Amplification Factor	12
Power Gain*	30 db
Noise Factor # (1000 cycles)	22 db

* Source: 1000 ohms; Load: 20,000 ohms
 # At -1.5 volts (-1.0 ma.) to the collector.
 ** Socket types: Cinch Nos. 14148 & 14273 or equivalent.

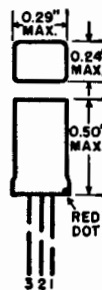

Table 1. Tentative data on the Raytheon CK722 germanium junction transistor.

pany, identified as the CK722. The characteristics and ratings of the CK722 are shown in Table 1. It is extremely rugged and when operated at normal ratings has exceptionally long life.

Basically, the "p-n-p" junction transistor may be compared to the vacuum tube with the emitter resembling the cathode, the base resembling the grid, and the collector resembling the plate. There are several basic differences, however, which are outstanding.

In the "p-n-p" junction transistor,

conduction is accomplished in a solid instead of in a vacuum. The collector is operated with a negative bias instead of the customary positive voltage applied to the plate. Another outstanding difference lies in the input impedance. The vacuum tube has almost infinite input impedance over a considerable range of frequencies. The transistor, on the other hand, is a current-operated device and has a rather low input impedance in the grounded base or grounded emitter connection which is analogous to the

grounded grid and grounded cathode type amplifiers.

The graphic symbol for the "p-n-p" junction transistor is shown in Fig. 3. Since the transistor is a three-terminal device, several combinations of connections may be used, namely, the grounded emitter, the grounded base, and the grounded collector.

Fig. 5 is a typical set of characteristic collector curves for the CK722. These curves may be compared to the plate characteristics of a pentode amplifier except that instead of grid voltage we use various values of base current. A load line of 1000 ohms has been drawn in and examination of the curve will show that operation is linear over almost the full range from zero to maximum collector current. The slow increase in collector current with increasing collector voltage at any fixed value of base current is typical of junction transistors and is indicative of the high collector resistance.

An additional characteristic which is little known but of considerable importance is the "Zener" effect. If the transistor is operated with positive base current so that normally there is no collector current, the collector voltage can be increased to a point where conduction will occur. This is the "Zener" point and may be an important consideration in operation of transistors. "Zener" current flowing during the peak a.c. voltage cycle could cause excessive limiting and consequently high distortion in an amplifier.

Many applications for the CK722 junction transistor will become apparent to the experimenter. Since junction transistors had up to now been available on only a limited basis, very little application and circuit work has been done.

Three basic type circuits immediately suggest themselves. These are: switching circuits, oscillator circuits, and amplifier circuits.

We shall discuss in some detail, the CK722 as a small-signal, low-voltage amplifier.

The small size and relatively high efficiency at low operating voltage coupled with the absence of any heater voltage make the transistor ideally suited for preamplifier use. A further advantage is the fact that transistors are not microphonic, thus no special precautions in mounting need be taken.

Fig. 2 includes several suggested circuits for transistors used as microphone preamplifiers. The microphone

Fig. 3. Equivalent graphic circuits. (A) Graphic symbol of CK722 "p-n-p" junction transistor. (B) Common base amplifier, with low input impedance and high output impedance. Requires two batteries. (C) Common emitter circuit having medium input impedance and high output impedance. Permits single battery operation. (D) Common collector with high input impedance and low output impedance.

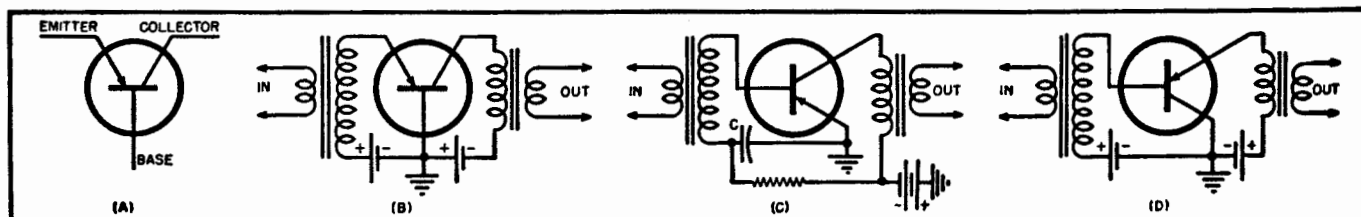

may be a small 2 or 3 inch dynamic speaker. Notice that it is directly connected to the transistor without use of an impedance matching transformer. With a voice coil impedance of 8 ohms and with R adjusted for a collector current of 100 microamperes, the sensitivity will be approximately equal to a good carbon mike with much better fidelity and less noise. The circuit of Fig. 2B may be used to eliminate the need of a tapped battery, however, the gain will be slightly less. If a long shielded cable is required, a transformer should be used instead of a resistor load in the collector of the transistor as in Fig. 2B. This can be a small plate-to-line transformer of 2000-600 ohms impedance.

Because the operating current is low, battery life is good. The supply for the transistor can be obtained from the standard high voltage plate supply of the amplifier and, in fact, this circuit has the advantage of supplying a more constant current to the transistor. The important factors in these circuits are the low input impedance of the emitter, on the order of 100 ohms with the grounded base connection, and the high output impedance of the collector, on the order of 500,000 ohms. With grounded emitter connection, the input impedance of the base is a function of other operating parameters so no value can be given for it.

Several stages of transistor amplifiers can be cascaded and the use of coupling transformers will assure maximum gain. Plate-to-line transformers may be used as shown in Fig. 2C. Resistance coupling can be used but with some loss in gain (approximately 6 db). Large coupling condensers must be used to obtain good low frequency response because of the low impedance levels.

Push-pull operation of transistors is entirely feasible, permitting greater power dissipation with consequent greater power output. Class A operating efficiencies on the order of 50 percent are obtainable while class B operating efficiencies to nearly 80 percent are possible. Matched units should be used in this application and degeneration can be applied to improve performance.

The audio amplifier type operation lends itself admirably to a simple broadcast receiver. To investigate this application more thoroughly, such a receiver has been built. For those interested in duplicating it, a description follows:

Transistor Receiver

One or two transistors may be used in this receiver (Fig. 4). The first unit is utilized as a detector/amplifier. The second transistor is connected as a grounded emitter amplifier.

The first unit is capable of delivering adequate earphone volume so that the second stage can be eliminated if it is desired to reduce the cost of the receiver. Although the experimental receiver shown has been built on

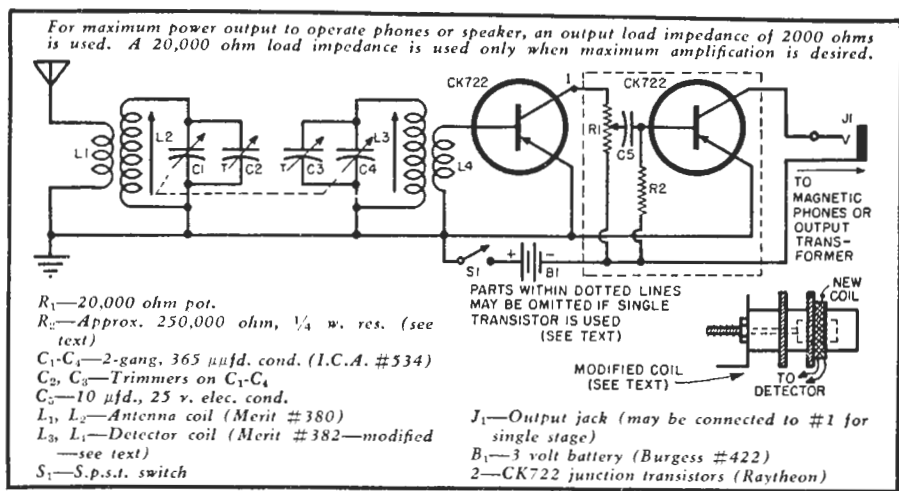

Fig. 4. Diagram of transistor receiver. A single unit may be used if desired. See text.

metal, obviously it could be built using a wooden case without affecting its performance.

In the Boston area where this receiver has been operated, the two tuned circuits have given more than adequate selectivity to separate the local stations. An antenna of 50 feet and a good ground made possible reception of stations over approximately a 15 mile radius. The importance of a good antenna and ground, particularly in an area somewhat remote from high power broadcast stations, cannot be overemphasized.

The two circuits are coupled through mutual coupling existing by physically placing the coils close together, one inch separation center-to-center is recommended. The detector coil must be modified to connect to the transistor detector/amplifier. The antenna coil portion of the Merit type 382 should be carefully removed. It can be slid off the end of the form without damage to the coils after unsoldering the leads. The wire from this antenna coil may be used to scramble wind 50

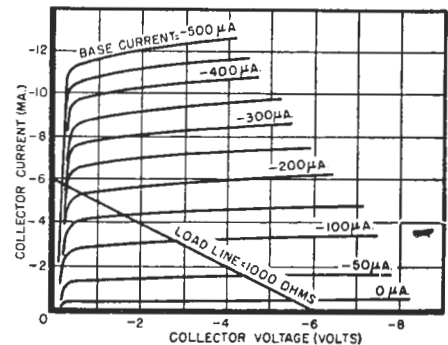

Fig. 5. $I_c/E_c/I_b$ curves for the CK722.

turns on the 382 form, tight against the first pi of the tuning coil. (See Fig. 4). This detector coil can be cemented in place with a good coil dope, such as Amphenol 912.

The amplifier is connected in the grounded emitter type circuit. The advantages of this circuit are that only one battery is required and that it has a higher input impedance than the

Over-all view of the experimental transistor receiver showing accessory headphones.



Transistor Receiver

grounded base circuit. The value of R_2 should be chosen so that the collector current is about 1 milliampere. The collector current of the detector/amplifier transistor will depend on the strength of the received signal but will average about 200 microamperes with a strong signal.

Battery life with only one transistor will probably equal the shelf life of the battery. With two transistors, the life will depend on average hourly use but should be at least 100 hours for two penlight type cells.

If magnetic phones are used, they may be connected directly in the collector of either transistor. Low im-

pedance phones or a speaker will require the use of a matching transformer. A load impedance of 2000 ohms in the output stage is correct for the voltage and current indicated.

Alignment is perfectly straightforward but should be done carefully in order to realize maximum sensitivity. Any good service oscillator or signals from broadcast stations may be used to accomplish the alignment. The collector current of the first transistor is a good indication of resonance. The parallel trimmers are used to line the set up on the high frequency end and the slugs on the low frequency end.

The output power of this receiver is about 1.5 milliwatts and is sufficient for adequate earphone volume. An efficient speaker can be connected to the output circuit and adequate volume will be obtained in a quiet location.

However, the addition of a class B output stage to drive the loudspeaker is recommended.

The receiver, as originally built and as shown in the photos, included a CK705 germanium rectifier and several parts associated with this rectifier. The junction transistors were used as straight audio amplifiers. Tests proved that the diode was not essential and in fact provided no advantage, so the receiver has been modified to the circuit of Fig. 4.

BIBLIOGRAPHY

Doremus, John A.; "Point-Contact and Junction Transistors," *Radio-Electronic Engineering Edition of RADIO & TELEVISION NEWS*, April 1952.

Reich, Dr. Herbert J.; "Transistors and Transistor Circuits," *Electrical Manufacturing*, November, December 1952.

Proceedings of the IRE, Vol. 40, November 1952.

Under chassis view of the transistor receiver designed around the CK722 transistor.

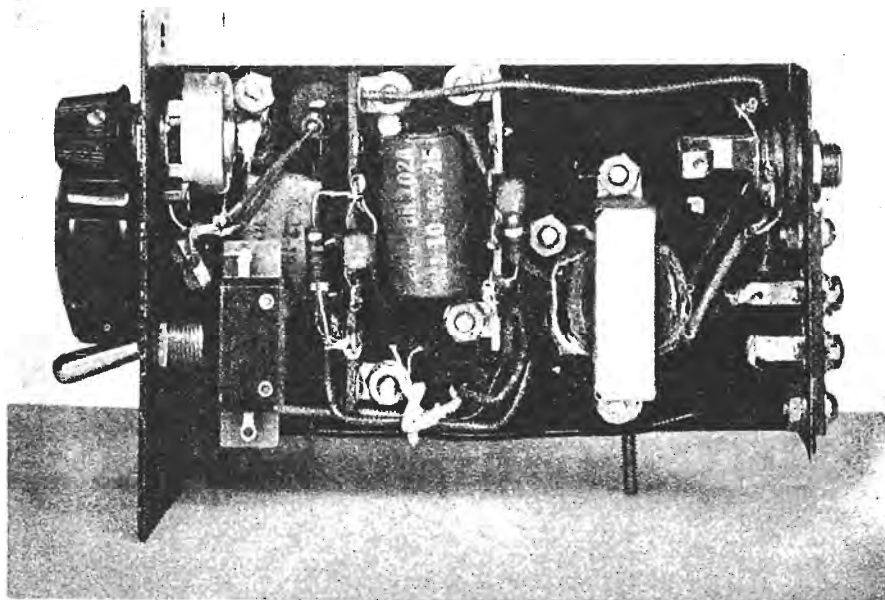

REGENERATIVE TRANSISTOR RECEIVER

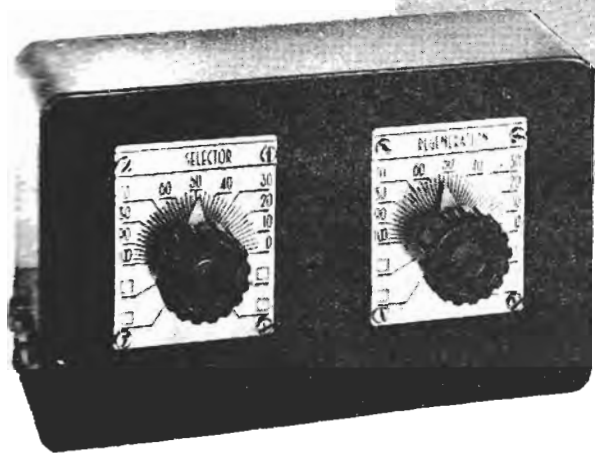

This sensitive and selective unit contains regenerative detector and audio amplifier

By DR. WILLIAM H. GRACE, JR.

THIS compact regenerative receiver has given more than ample ear-phone volume on broadcast stations located several hundred miles away. When used with a 60-foot outside antenna, stations well beyond 1,000 miles have been repeatedly heard right through the numerous superpowered N. Y. C. locals. This indicates its sensitivity and selectivity. The receiver makes a reliable receptor for emergency use during power failure should a sudden air attack occur. Though built for use with earphones, many of the local broadcasting stations can be received at moderate room volume on a 10-inch PM speaker with a suitable matching transformer.

Construction

A black bakelite meter case was used for the cabinet, the outside dimensions being 3.75 x 6.25 x 2 inches. The set is built within the cabinet rather than on a separate panel. This construction simplifies the assembly and permits mounting the smaller components on a little shelf directly above the trimmer capacitor. This small variable capacitor is the regeneration control and provides the necessary capacitance feedback for oscillation. The shelf is suspended by small-sized L-brackets, very easily attached by hex nuts to the projecting machine screws that hold the dial plates in position on the front of the panel. This idea works nicely and eliminates the drilling of extra holes in the cabinet.

The circuit is a standard grounded-emitter type with the first transistor

acting as a regenerative detector and the second as a transformer-coupled audio amplifier (Fig. 1). Both transistors are Raytheon junction type CK 722, that operate satisfactorily on only 4.5 volts.

Crystal triodes are durable and have a long life if reasonable precautions are taken to prevent burnouts. The negative side of the battery must be connected to the collectors as indicated in the diagram.

The antenna requirements of any practical emergency receiver must be flexible. Thus, two separate antenna connections have been provided. On the left side of the cabinet are 3 phone-tip jacks. The two nearest the rear are for antenna connections, the third is for ground. In series with J1 and the main tuning capacitor (C3), is C1, one of the antenna coupling capacitors. The J1 connection is used only with a short, 20- or 25-foot antenna, plus a ground connection. It is often possible to obtain good results with J1 connected to the shell of a floor lamp or table lamp, the shell of a telephone box, or to one side of an a.c. outlet. No ground connection is made if any of the above antenna substitutes are used. This precaution is necessary because of the possibility of a short in C1. There will be only a very slight loss in volume by so doing. Capacitor C2 is in series with J2; this connection is used when a longer outside antenna (60 to 100 feet) is available. Two 3-foot lengths of flexible wire, phone tips at one end and alligator clips at the other, furnish the actual connection from set to antenna

and ground. Of course, the greatest volume and best dx will be obtained with an efficient outside antenna as high above ground as possible.

Inductor L1 is a standard Ferri Loopstick coil; and L2 is approximately 5 turns of No. 30 enamel wire, wound directly over the cardboard covering of the Ferri coil. The constructor should experiment with a greater or lesser number of turns on L2. In general, a few turns more than 5 will give greater volume and less selectivity, while fewer turns result in slightly lessened volume but increased selectivity. Incidentally, if oscillation is not obtained, reverse the leads to L2; this is the same as reversing the leads to the tickler coil in a regenerative tube receiver. The coil is mounted in the upper right-hand corner of the cabinet, rear view. The projecting dial plate screw again becomes useful.

The choke prevents r.f. from entering the audio circuit. Smooth regeneration will not take place if this choke is omitted. I found it convenient to mount the choke on the under side of the shelf just to the right of the trimmer capacitor.

The audio transformer is connected backward, that is, the high impedance winding is in the collector circuit. This is done to satisfy the impedance requirements of the transistors which can be considered to be opposite to tube triodes in respect to input and output impedances. The colored wire leads shown in the diagram are for the UTC type SSO-2 subsubbouncer transformer. In conventional circuits using trans-

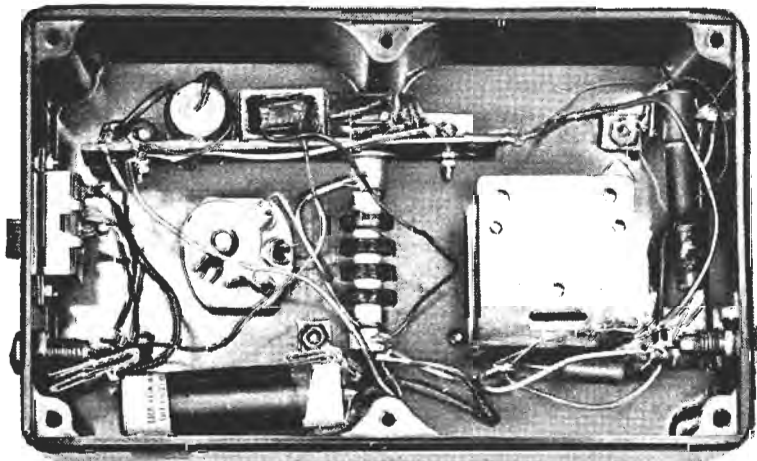

Internal view. The transistors are near the ends of the mounting strip.

former coupling with transistors, a base resistor is indicated from the base to the minus side of the battery. But with the particular CK722 used in this case no advantage seemed to be gained. The builder should experiment with this connection. The exact value of this resistor can best be found by test; any value between 220,000 ohms and 2 meg-ohms may prove suitable.

Both transistors, C5 and C6, and the audio transformer were mounted directly on the shelf. Capacitor C6 could well be of greater value, but the value suggested does work satisfactorily. If better base response is desired, shunt this capacitor with one of equal value. The objection to using a larger value, say 5 μf is that the actual physical size of such a capacitor prevents getting it into the cabinet.

The battery switch and the phone output jacks are mounted at the right side of the cabinet, front view. Any type of battery switch may be used; a sliding type was chosen because it happened to be at hand. It is a good precaution to mount the switch so that the ON position is as obvious as possible. In this way there will be less chance of forgetting to turn off the set.

The battery requirements of this receiver are easily met by 3 penlite cells. The cells are taped together edgewise, connected in series to furnish 4.5 volts. The minus lead from the battery goes to one switch terminal, the positive lead to ground. The cells are soldered, as far as their leads are concerned, directly into the circuit since they will seldom need replacement because of the

very low current drain of the two transistors. The total drain for both transistors is about 1 ma, hence the cells should last almost their normal shelf life with average use. A convenient way to anchor the cells is with two more L brackets fastened again to the two projecting machine screws from the dial plates. Small pieces of folded cardboard wedge the three cells to prevent them from slipping sideways.

Capacitor C3 is a miniature 365- μf tuning capacitor. A standard broadcast capacitor could be used, but I found the smaller one easier to mount.

Operation

With only two controls the operation of the receiver is simplicity itself. The left-hand knob controls the frequency; the right-hand knob controls the volume, by varying the degree of feedback. It is comparable to the operation of any other regenerative-type of tuner. No other volume control was used in the circuit. If still greater volume is required it would be an easy matter to add a second stage of audio amplification. In this case a separate volume control would be necessary, and space on the front of the cabinet has been provided for this control just between the two dial plates.

Regeneration

Failure to obtain regeneration may be due, in the majority of instances, to incorrect coil connections. Fig. 2 shows the exact method of connecting L1 and L2. If there is any doubt as to which is the start of the winding on the Ferri

Loopstick and which is the ending, the following may prove helpful. Using a sharp knife, remove the cardboard covering protecting the coil winding. The starting and ending lead will now be visible. Care must be taken in doing this, or the coil winding will be damaged.

Another common cause of failure to obtain regeneration is due to the actual variation in the transistors themselves. Some CK722's are good oscillators and good rectifiers, others are not as efficient as detectors, and still others do not seem to oscillate or regenerate at all. Fortunately, a large percentage of those tested perform very well. We should realize that these transistors were not designed for regenerative purposes. CK722 transistors were built as low-power audio amplifiers and are for low-frequency purposes. However, they will work very nicely over most of the broadcast band as r.f. rectifiers. When a particularly good one is found it acts as a very sensitive detector just at the point of oscillation. In fact, when operated under the conditions described the sensitivity is remarkable and regeneration is fairly stable.

About the only other common or likely cause for lack of regeneration is a gross error in the circuit hookup. Worn-out dry cells will also produce poor results.

This receiver is very simple to construct, using the minimum number of parts and but two transistors. It will prove an interesting introduction to the transistor field for anybody interested

Parts for regenerative receiver

1—14 μf , 1—.001 μf , mica or ceramic capacitors; 2—1 μf , miniature, paper capacitors; 1—50 μf , trimmer capacitor with 1/4-inch shaft; 1—365 μf , miniature, tuning capacitor; 1—transformer, primary impedance 10,000 ohms, secondary impedance 90,000 ohms, (UTC 550-2 subsubouncer); 1—Ferri-Loopstick, bracket mounting type; 1—coil, 5 to 7 turns of No. 30 enameled wire; 1—r.f. choke, 2.5 mh; 2—Raytheon CK722 transistors; 1—case, 3.75 x 6.25 x 2 inches (Waldon utility case, model BC-138; panel, BB-137); 5—phone-tip jacks; 3—penlite cells; 1—s.p.s.t. switch; 6—small L brackets; 2—phone tips; 2—alligator clips.

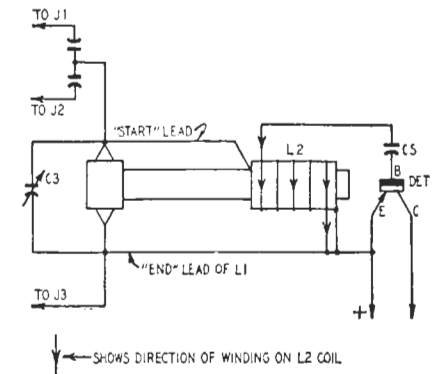

Fig. 2—Diagram of L1-L2 connection.

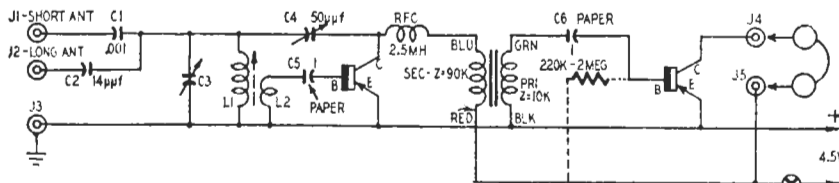

Fig. 1—Schematic of the 2-transistor radio. Circuit is grounded-emitter.

in these modern devices. The performance of this little rig proved ample reward for the few hours needed for its assembly. END

Transistor REGENERATIVE Receiver

By EDWIN BOHR

NOTE

Use of a CK 705 Germanium Diode in place of the IN34 is recommended

REGENERATION "soups up" the performance of transistor receivers. Simple transistor radios without regeneration are just crystal detectors followed by audio amplification. There is no r.f. amplification, and sensitivity and selectivity are always poor. In contrast, the regenerator has high gain and sharp selectivity.

You or your friends may have attempted to build a transistor regenerator and found it did not work. Several factors make the design of a workable transistor regenerator different from the vacuum-tube equivalent.

First, the transistor must be able to sustain r.f. oscillation throughout the entire broadcast band. Whether or not this can be done successfully depends upon the design of the feedback and tuning circuits. Unlike vacuum-tube oscillators, transistor oscillators are not inherently self-starting. Tubes draw heavy current when they are first turned on and shock their circuits into oscillation. The transistor circuit must have starting features built into it. Furthermore, the transistor must be made d.c. stable or it may lock itself into a condition of inoperation.

Fig. 1 is the successful regenerative transistor circuit. Feedback is from collector to emitter. The emitter circuit impedance is very low, unsuitable for a parallel-tuned circuit. This is the reason the tuning capacitor and coil are placed in the collector circuit. Here the impedance is moderately high. The tickler winding feeds the emitter.

With tubes, detection or demodulation takes place in the tube. The grid

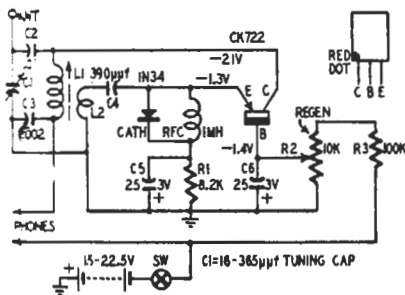
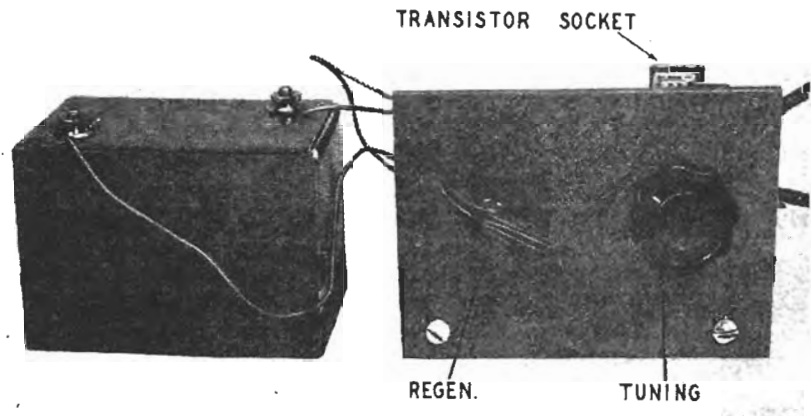
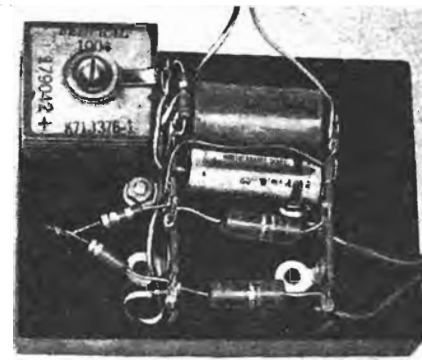
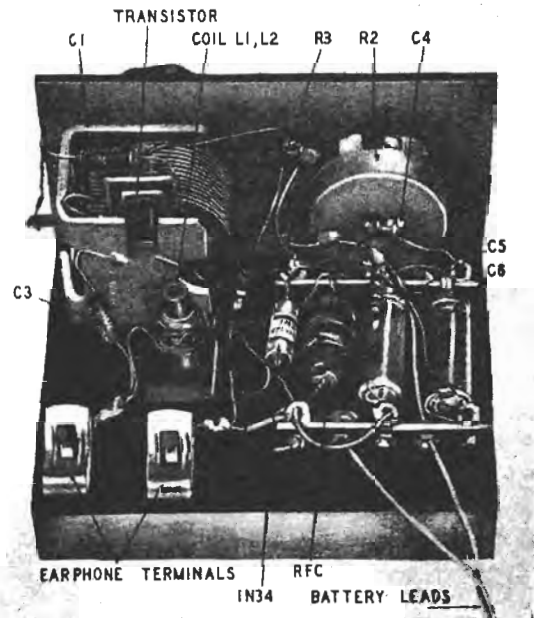

Fig. 1—Regenerative transistor circuit.

Single-transistor receiver features high gain and sharp selectivity



Top, a.c. power supply for receiver. 100 ma selenium rectifier and components are mounted on a bakelite chassis.



Center, with only two controls, operation is simple. Low current drain insures long battery life.

Right, layout of the regenerative receiver. Mounting strips permit neat arrangement of parts.

rectifies the r.f., charging a grid-leak capacitor. The voltage across the grid-leak follows the modulation, placing an audio signal on the grid. Unfortunately, this scheme of things will not work with the junction transistor.

The reason it does not work is simple. To cause enough collector current to flow for r.f. oscillation, the emitter

must have a constant bias current flowing through it. This emitter-current flow ruins the emitter's effectiveness as a detector-rectifier. This means the signal must be detected by something other than the transistor. The problem of allowing the transistor to oscillate and still detect the signal can be solved by using a separate rectifier (a1N34).

Let us get a complete picture of the circuit operation by following an r.f. signal through the detector. The signal, arriving from the antenna, is fed into L2 by transformer action from L1. The signal then passes through C4. This capacitor prevents the d.c. emitter bias from shorting to ground through the tickler coil (L2). It also blocks the audio signal that will be developed by the 1N34. C4 and R1 provide an action without which most transistors will not oscillate past a frequency of 600 or 700 kilocycles.

From C4 the r.f. flows both to the 1N34 and to the emitter. The r.f. choke RFC prevents the r.f. signal from bypassing to ground. The r.f. that reaches the emitter is amplified in the transistor and is fed back into L1. This feedback gives r.f. amplification by reducing the r.f. resistance of the tuning circuit.

Part of the r.f. signal reaches the 1N34 and is rectified by it and charges C5. The charge on C5 then varies with the modulation frequency and amplitude. This audio voltage flows easily through the r.f. choke (RFC) and varies the emitter current. From here, it is amplified in the transistor, flows through the tuned circuit and into the earphones.

Some will ask why the 25- μ f capacitor (C5) does not shunt all the audio to ground. The answer is the low impedance of the emitter. For all but the very highest audio frequencies, the emitter impedance is lower than the shunt reactance of C5. Therefore the emitter absorbs the audio power. Experiment will bear this out. Try low values for C5—say .05 to 0.5 μ f—and the audio amplification will be very low. The same thing results if the 1N34 is disconnected. Without the 1N34 rectifier, detection will take place only with the regeneration control rotated all the way to ground. Then the set will not regenerate!

Potentiometer R2, in the base circuit, controls the emitter bias and r.f. gain. Capacitor C6 bypasses audio and r.f. around the potentiometer. Here, 25 μ f is a good bypass value because of the higher impedance of the base.

Capacitor C2 isolates the battery voltage from the tuning-capacitor plates.

Construction

The small size of the transistor and its socket makes wiring difficult. Two wires are about all that can be soldered to the tiny terminals on the socket. This makes it necessary to mount the receiver components on terminal strips onto which the many connections can be soldered. From these terminal strips, wires are run up to the transistor socket. None of the lead lengths are critical.

A metal front panel is very necessary. Without the panel, hand capacitance effects make tuning extremely difficult.

The electrolytic capacitors may have any rating of 3 volts or higher. Any commonly used voltage rating will do for the paper and ceramic capacitors.

Capacitor values may vary 50% from those specified. The resistors may be $\frac{1}{2}$ watt or larger.

The tuning coil is a modified *Ferri-Loopstick*. The extra-high Q of the loopstick is responsible to a large extent for the easy oscillation of the circuit through the entire broadcast band. Every CK722 we have used oscillated easily. None of the other coils experimented with worked nearly as well.

To modify the loopstick, first remove the cardboard sleeve that covers the winding. The short antenna supplied with the coil is discarded. Remove 5 turns of wire from the free end of the coil. When this is done, L2 is wound directly over the loopstick winding. L2 is 7 turns of about No. 22 wire (the exact size of the wire is not important). A single twist of the free ends keeps the coil from unwinding. Push the iron core into the coil until it extends an equal distance from each end of the coil.

When the receiver is put in operation it will be necessary to slide the core out slightly to adjust the tuning range. The length of antenna connected to the receiver also changes the tuning range. The slug will compensate for this too.

Operation

After the set is wired, check off all parts and connections against the diagram. Make sure the electrolytics are wired properly—positive side to ground.

Plug in the CK722 transistor before the battery is connected. Connecting the battery backward can damage the transistor. Be sure the negative battery terminal is fastened to the earphones and 100,000-ohm resistor, R3.

With the earphones and battery connected, a "rushing" sound should be heard in the phones. The lack of this sound does not indicate a bad transistor. The only possible reason for the sound not being heard is that something is wired wrong. This sound is the noise generated by all transistors.

For a voltage check of the circuit, typical voltages are shown on the diagram. These measurements were made using a 10,000-ohms-per-volt meter with the regeneration control in mid-position.

The rushing sound is heard at any setting of the control regardless of whether or not the set is regenerating. However, the loudness of the rushing will increase slightly with clockwise rotation of the regeneration control.

Connect an antenna 25 feet or longer to the stator terminal of the tuning capacitor. When tuning, have the regeneration control advanced all the way. This does not give best reception but each station that is passed—even one too weak to be heard—will sound a tweet or whistle.

At some settings—usually near the center of the dial—the receiver tends to motorboat at critical regeneration. Weak stations come in better just below critical regeneration; strong stations, above this point.

A good antenna and ground reduce the tendency to motorboat; and the detector will pass over critical regeneration with a single "plop" sound.

The regeneration control setting affects the tuning slightly. On the high end of the dial, moving the control may detune the station, making a tuning readjustment necessary.

If it is impossible to pick up a station at either extreme of the tuning capacitor, the iron core can be adjusted in the coil to bring in the station.

Power supply

A small a.c. power supply for the receiver is shown in Figure 2. Do not use a direct earth ground with the power supply. Two .001- μ f capacitors

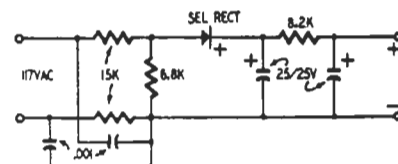

Fig. 2—Schematic of a.c. power supply

in the diagram are not shown in the picture—they were added later. Any ordinary receiving type selenium rectifier will work. A 100-ma rectifier was in the parts box. This is the reason for the large unit pictured. The resistors can be any wattage. We made the 6,800-ohm resistor from two smaller ones because they were at hand, not for more power.

(The reader can make a much safer supply with a 12.5-volt filament transformer and a small germanium rectifier. The present job—if used—should be enclosed and treated with caution.—Editor)

From a small country town, in two weeks of listening with a 25-foot antenna, 12 stations were recorded. The nearest powerful station was more than 100 miles away. No ground was used.

The regenerator circuit is a good starting point for experimentation. With a hearing-aid battery, padder type tuning capacitor, and a smaller regeneration control, the circuit will shrink to shirt-pocket size.

The radio is a real performer considering its very small power consumption. The audio gain is much better than some vacuum-tube circuits operating on this low voltage. In the same location mentioned, a transistor radio without regeneration was able to pick up just two stations—and it was almost impossible to separate them. With regeneration many more stations were received, all with good selectivity.

Parts list for receiver

Resistors: 1—8,200, 1—100,000 ohms, $\frac{1}{2}$ watt; 1—10,000 ohms, potentiometer (linear).
Capacitors: 1—16-365 μ f, variable; 1—390 μ f, ceramic; 1—.01 μ f, 200 volts, paper; 2—25 μ f, 3 volts, electrolytic.
Miscellaneous: 1—CK722 transistor and socket; 1—1N34; 1—1-mh r.f. choke; 1—Ferri-Loopstick; 1—battery, 15-22 $\frac{1}{2}$ volts; 2—Fahnstock clips; 1—antenna wire (25 feet or more); 1—metal front panel; 1—bakelite chassis; 2—mounting strips.

Parts list for a.c. power supply

Resistors: 1—6,800, 1—8,200, 2—15,000 ohms, $\frac{1}{2}$ watt.
Capacitors: 2—.001 μ f, 200 volts, paper; 2—25 μ f, 25 volts, electrolytic.
Miscellaneous: 1—selenium rectifier, 25 ma min.; 2—mounting strips; 1—bakelite chassis. END

TRANSISTOR RADIO

uses NO POWER SUPPLY

NOTE

Use of a CK 705 Germanium Diode in place of the IN34 is recommended

Here's what many have looked for--something for nothing

By WILLIAM H. GRACE, JR.

RECENT statistics on the sales of crystal receivers plus the sales of radio parts for such sets to hobbyists indicate that there may be approximately a quarter of a million such receivers in use throughout the world. One manufacturer reports sales of 50,000 crystal sets during 1954. The reasons are cheap and dependable reception, good fidelity, low initial cost and next to no upkeep expense. The main disadvantage of crystal receivers is the low sound volume in the headphones or speaker. This deficit could be remedied by a stage of tube or transistor audio amplification but this requires some external source of power. The circuit described in this article provides a stage of transistor audio amplification of moderate gain without requiring any external power source of a conventional type whatever. I originated the circuit several years ago while experimenting with standard audio circuits and it has proven itself practical and effective.

This circuit comes as close to giving something for nothing as you are apt to see in a long time. Because of this characteristic, it seemed to be just naturally wedded to a crystal receiver. If you live in a location where a crystal receiver will provide a good signal, this battery-less transistor amplifier will almost double the volume. The crystal tuner (see diagram) is the conventional tuned-primary-tuned-secondary affair used for years by crystal experimenters and before that by ship-to-shore stations in the days of spark transmitters. A 1N34 germanium diode is used as a detector-rectifier. Any suitable type of diode may be substituted in place of the 1N34, and one of the newer gold-bonded silicon types having lower front and

higher back impedances might well prove superior to the germanium ones.

The audio stage requires but two additional parts, a Raytheon CK722 or similar junction transistor, and a fixed capacitor whose actual value appears not too critical. Almost any value be-

greater will be the usable d.c. from the carrier and the greater the gain.

The polarity of the diode is most important. If it is reversed, there will be no amplification. The polarity shown in the diagram is correct for use with the CK722 or other transistors of the p-n-p type. These transistors require a negative collector. If a transistor of the n-p-n type is used, the diode will have to be reversed because, in this case, the collector will have to be biased positively.

The amount of amplification or gain from an amplifier of this type is not equal to that of one using an external source of d.c. power plus proper emitter bias, but sufficient gain is obtained on strong local signals to produce very high headphone volume. In strong field-strength areas moderate speaker volume can be realized with only the single stage of audio. Various modifications of the circuit, such as using transformer-coupled arrangements, proved successful. I found it practical to take the rectified carrier d.c. from a frequency other than the one that furnishes the signal current. Test various types of transistors in this basic circuit; the resulting gain depends to a considerable extent upon the characteristics of the particular transistor used. However, the CK722 type will function well and is among the least expensive of the models now available to the builder. This "something-for-nothing" circuit is almost foolproof. END

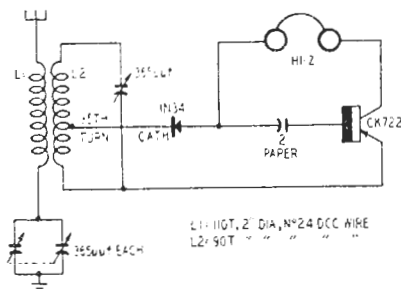

Schematic of the battery-less amplifier.

tween .05 and 5 μ f will suffice. I used a miniature 2- μ f paper capacitor because it was at hand and functioned satisfactorily. The operation of the amplifier is extremely simple. It depends upon the fact that the output of the diode consists of two separate components—the modulated signal current and the rectified carrier d.c. This d.c., useless in the ordinary crystal receiver, is applied to the collector of the transistor and powers the audio stage. In other words, the rectified carrier current is put to work in the collector circuit to increase the signal current from the diode.

If your crystal set has an output of around 100 microamperes (measured across the phone jacks), worthwhile amplification will be obtained from this system. If an output of 500 or more microamperes can be obtained, considerably greater volume will result. The louder the signal to begin with, the

Parts for battery-less amplifier

1—high-impedance headphones; 1—CK722 transistor; 1—1N34 crystal; 1—2- μ f capacitor (see text); 1—365- μ f tuning capacitor; 1—2-gang tuning capacitor, 365 μ f each; 1—primary coil (L1), 110 turns, 2-inch diameter, No. 24 d.c.c. wire; 1—secondary coil (L2), 90 turns, 2-inch diameter, No. 24 d.c.c. wire, tapped at 35th turn from the low end.

TRANSISTORIZE YOUR

Another interesting application for transistors. Details for constructing several amplifiers are also included.

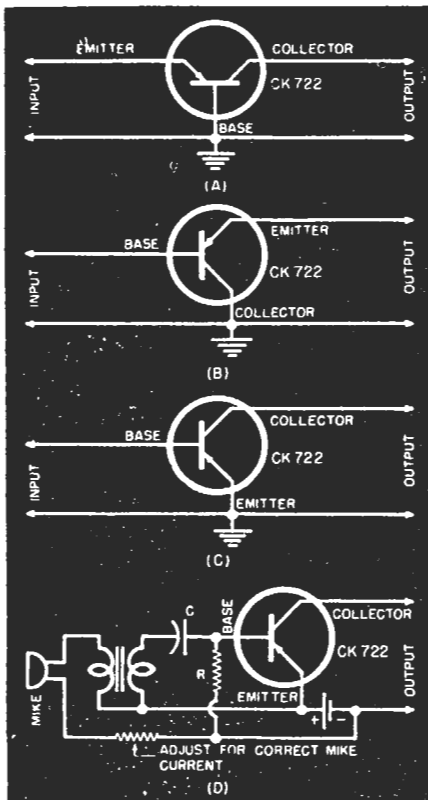

Fig. 1. Typical transistor circuits. (A) grounded base, (B) grounded collector, (C) grounded emitter, (D) carbon mike input.

WE HAVE used electron tubes for so many years that we seldom give any thought to the power required for operation until we find that portable, battery operation is desirable for some new project. However, the engineer or experimenter who builds a junction-transistor amplifier suddenly realizes how much simpler it is to design and assemble for there is no complicated power supply and there are fewer components for each stage of amplification. Furthermore, the operating power is unbelievably low so that small batteries of standard flashlight cell sizes last so long that there is no advantage in using a.c. power sources. This, in time, makes possible very small and compact equipment for which there are many uses. Even though parts of an equipment, such as a portable amateur transceiver, require tubes, the use of transistors where applicable in the circuit, will help to reduce size and weight. As an example, the audio preamplifier might use transistors while the modulator and r.f. stages of the transmitter would use tubes. Likewise, the same transistor amplifier could be used for the audio amplifier for receiving, by using suitable switching.

Other uses for small battery-operated transistor amplifiers are: hearing aids, portable receivers, portable intercoms and variations thereof, portable recorders, record players, sound measuring equipment, etc. In these applications junction transistors provide, in addition to long life and ruggedness, a freedom from microphonics never achieved with tubes even though

tremendous improvements have been made in the CK500 subminiature tube series produced during recent years for hearing aid use and other critical applications.¹

In a recent issue of this magazine² there appears a discussion of transistors and some description of their uses. This present article will discuss the use of junction transistors in audio amplifiers in an effort to indicate to each reader the methods to be used in designing amplifiers for his particular needs.

Junction transistors such as the Raytheon type CK722, may be used in any of three basic circuits. The grounded-base circuit is shown in Fig. 1A. This circuit utilizes the transistor emitter as the signal input element and the collector as the output element. Input impedance is low, output impedance is high, and gain is fairly good. This circuit also exhibits less variation with temperature than the grounded-emitter circuit to be discussed below. For the type CK722 junction transistor, typical input impedance is 1000 ohms, typical output impedance is 100,000 ohms or better and average power gains of 20-22 db can be obtained.

The grounded-collector circuit shown in Fig. 1B provides less gain (about 12 db for CK722) and has less power output capabilities than either grounded-base or grounded-emitter circuits. The lower power output obtainable with this method of connection is due to the limitations on emitter circuit power imposed by the manufacturer's ratings. Grounded-collector circuits are used when high input impedance is required for this may be one or two hundred thousand ohms depending upon the value of load impedance used. For example, a 10,000 ohm load will provide 150,000 or 200,000 ohms' input impedance with type CK722 but this may drop to 50,000 ohms or less if the load is dropped to 1000 ohms.

In contrast to the grounded-base or grounded-collector circuits for which two batteries or a tapped battery are needed, the grounded-emitter circuit requires but one battery and is thus particularly desirable for compact, lightweight, portable amplifiers. It provides typical input and output impedances with CK722 of about 1000 and 40,000 ohms respectively and gives the highest gain, averaging 30 db for this type. The grounded-emitter circuit is more susceptible to tempera-

ture variations although under about 125° Fahrenheit, the temperature effects are usually not serious. Gain decreases as the temperature increases and the higher the temperature the faster the gain decreases for additional increases in temperature.

Let us assume that we wish to design a small portable amplifier using type CK722 *p-n-p* junction transistors to be used by police to listen in on suspects. Because but one battery is required, a grounded-emitter circuit will be used. The first problem is to design the input stage for which carbon, dynamic, and crystal mikes are available. Carbon mikes require operating current from the battery so are not desirable for low battery drain. Fig. 1D shows a possible connection.

Dynamic microphones may be obtained with various impedances, 500 ohms not being unusual. The mismatch would not be critical with microphone impedances as low as 100 ohms. Furthermore, the average dynamic microphone puts out more power for a given sound pressure than crystal microphones except some of the old large types having high capacity. Because our transistor amplifier is really a power amplifier, this is important, for by using the microphone giving the most power, we can obtain desired amplifier performance with a minimum number of transistors. Fig. 3A shows the input amplifier stage using a dynamic microphone directly coupled to the transistor without an input transformer. Fig. 3B shows a variation of this circuit which is equally satisfactory. If a dynamic or magnetic microphone with an impedance appreciably different from 1000 ohms is used, a matching transformer may be employed as indicated in Fig. 3C to give better over-all gain than if the mike is poorly matched to the CK722. Resistor *R* is adjusted for minimum noise and best gain and should result in a collector (output) current of no more than 0.5 milliampere. *R* will probably be at least 100,000 ohms for CK722 but will depend upon the battery voltage to be discussed later. Condenser *C* must be large enough to pass the lowest frequencies which must be amplified. This condenser *must* be used to allow the base voltage and therefore the collector current to be correctly adjusted by *R*.

Except for the large, high capacity types mentioned previously, the aver-

AUDIO AMPLIFIERS

By **CHARLES W. MARTEL**
Raytheon Manufacturing Company

age crystal mike will give at least 10 db less power than a dynamic microphone and, in addition all crystal microphones have high impedances which will not match the relatively low input impedance of the grounded emitter CK722 unless coupled through a step-down transformer. The circuit will be identical to that of Fig. 3C except that the transformer primary impedance should be as high as possible (several hundred thousand ohms) and the secondary impedance should be about 1000 ohms. An inter-stage transformer of the type used to couple the voice coil of a loudspeaker microphone to the input tube grid may be used "in reverse" to obtain a reasonably good impedance match.

With the input circuit determined, the next step is to add transistor stages to obtain the desired gain. The user of this amplifier will listen-in with a small receiver similar to those used for hearing aids or by amateurs so a total gain of 60 to 80 db should be sufficient and will therefore require at least three and probably four stages of transformer coupling is used to obtain maximum gain. Resistance coupling may be employed but at least one additional amplifier stage will be needed for the gain-per-stage with resistance coupling will average about 5 db less than that obtained with transformer coupling. Except for the output circuit to be discussed later, Fig. 2A shows a transformer-coupled amplifier and Fig. 2B a resistance-coupled amplifier using the input circuit of Fig. 3A. The primary and secondary impedances of the inter-stage transformers should match reasonably well the output and input impedances respectively for CK722 in the grounded-emitter circuit as indicated in a preceding paragraph.

In both Figs. 2A and 2B resistor R in each stage is adjusted for the collector current giving best gain, lowest noise, and lowest distortion but no more than 0.5 ma. should be needed per stage. A suitable value for R is usually in the range of 200,000 to 250,000 ohms. Also for both circuits, C must be large enough to give desired frequency response and because it is in series with the input impedance (about 1000 ohms) of the CK722, it must be several microfarads for good low frequency gain. Small size electrolytic condensers are on the market and it is suggested that a 10 or 20 μ fd. unit be used. The lowest available voltage ratings are ample, for the maximum voltage in the circuit is two or three volts depending upon the battery used. In the resistance-coupled circuit, R_L must be a compromise between matching the output impedance of the transistor and causing too low

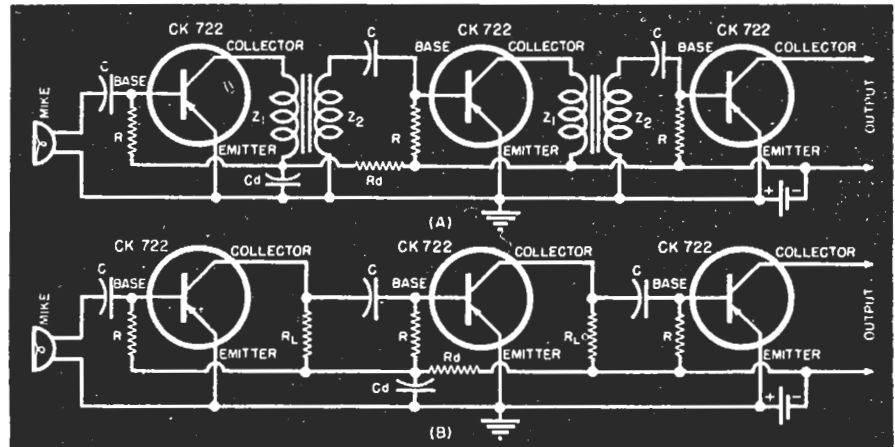

Fig. 2. (A) Transformer-coupled and (B) resistance-coupled amplifiers using transistors.

a voltage at the collector because of the voltage drop in R_L resulting from collector current. 10,000 ohms is about right for CK722.

Note that in each of these circuits (Figs. 2A and 2B) a decoupling filter comprised of R_d and C_d is shown. This is necessary for unless the battery is of extremely low impedance there will be positive feedback resulting from the fact that the battery impedance is common to all stages. It may even be found necessary to add decoupling filters in other stages depending upon the total number in the amplifier, the total gain, etc. Experience has shown that most batteries will cause feedback in a high-gain transistor amplifier for even though the battery impedance is low, it is appreciable compared to the relatively low impedances of the transistors. C_d must be a fairly high capacity if R_d is to be kept small enough to not drop the operating voltages too greatly. For example R_d of 500 ohms and C_d of 40 μ fd. or more might be satisfactory but final values can be determined by trial and will depend upon the frequency range of the amplifier as well as the gain, number of stages, etc. In general, the time constant ($C_d R_d$) should be greater than $1/f$ for the lowest frequency passed by the amplifier. (In computing this time constant C_d must be expressed in farads, R_d in ohms, and f in cycles per second.)

Now we come to the output where we wish to operate a small earphone requiring 2 or 3 milliwatts for suitable output. Because we are dealing with a power amplifier operated from a low voltage supply, the output signal will have a voltage swing of only a few volts, never more than the theoretical limit of twice the supply voltage. Crystal phones are of high impedance and depend on larger voltage swings so are not desirable because they re-

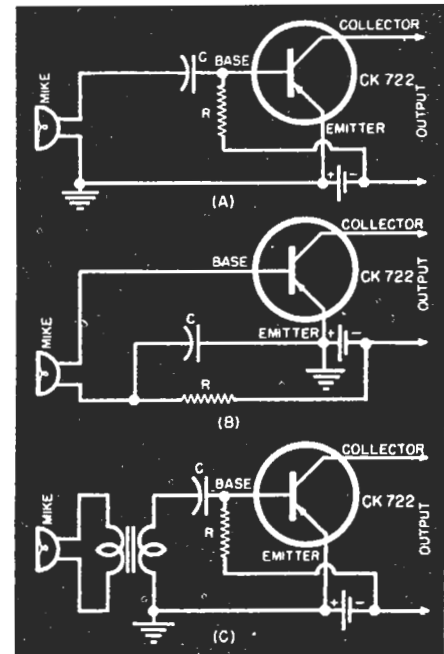
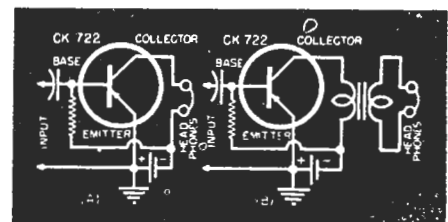

Fig. 3. (A) Dynamic microphone input circuit. (B) Variation of circuit in (A). (C) Transformer-coupled dynamic mike input.

quire a matching transformer. Magnetic phones are readily available with impedances of a few thousand ohms and may be used without transformer

Fig. 4. (A) Direct-coupled output and (B) transformer-coupled output. See text.



coupling as indicated in Fig. 4A. Of course, the d.c. resistance should not be too high or the voltage drop will reduce the collector operating voltage to too low a value. Low impedance phones are fully as satisfactory if there is no objection to using a matching transformer as in Fig. 4B. The approximate load impedance to match the output transistor is found with sufficient accuracy for experimental use by dividing the d.c. voltage at the collector by the d.c. collector current.

A word about transformers. There are many types of transformers with a variety of impedance combinations suitable for use in the circuits discussed. However a small tapped transformer such as UTC types R-27, R-28, R-33, R-38A, R-59, *Thordarson* types S62, S86, S87, S88, and similar universal types are relatively inexpensive, small, and provide impedance ratios from a few hundred to several thousand times so that optimum coupling can usually be obtained for interstage use as well as for input and output requirements. A mismatch of two to one in the lower level stages may be used without appreciable loss of gain.

The next item in designing this amplifier is that of battery voltage. Three volts is a desirable supply voltage although 1.5 will suffice in many cases. Even higher voltage may be used when larger output power is required. The maximum collector current rating for type CK722 is 5 ma. so with 3 volts supply less the drop in the output transformer or earphone, we can still put 8 or 10 milliwatts in and easily obtain several milliwatts of audio output power. The input resistor in the final stage should be adjusted to give the lowest collector current which will result in sufficient output power to drive the phone for there is no need for using more battery current than necessary. The CK722 transistor has a maximum collector dissipation rating at room temperature of 30 milliwatts which means that with obtainable efficiencies you can if you desire more power output (up to about 20 or 25 milliwatts), operate the final stage at its maximum collector current rating of 5 ma. and a collector voltage of about 10 volts. If this is done, it will save battery power if the stages preceding the output stage are operated from a separate 1.5 or 3 volt battery rather than through a dropping resistor connected to the total available supply voltage.

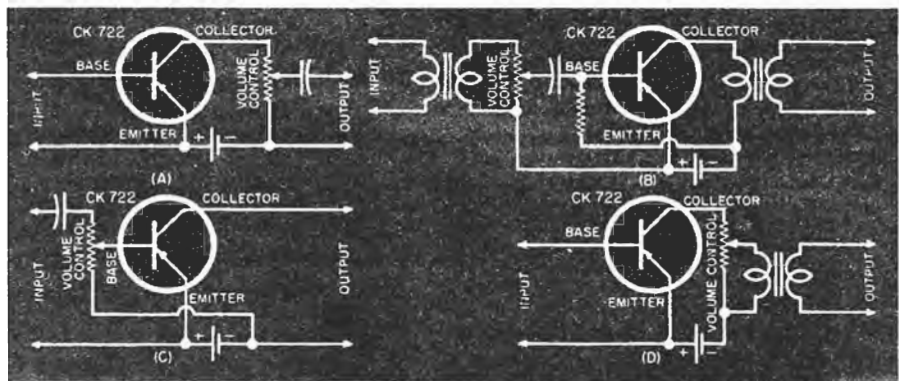

Fig. 5. (A) Volume control for resistance coupling. (B) Volume control for transformer coupling. (C and D) Unsatisfactory volume control circuits. See text.

Although some amplifiers may be usable without a volume control, it is usually necessary that means be provided to adjust the volume to accommodate variations in signal input, changes resulting from battery aging, etc. The volume control problem is not quite as simple as with tubes but one good method for resistance-coupled circuits is illustrated in Fig. 5 where the resistance portion of the control becomes the load for the transistor and the arm of the control supplies the signal to the following stage. The control may be used in any convenient amplifier stage but ordinarily it is well to put it at the "front" of the circuit to aid in preventing overloading of following stages on strong signals. Fig. 5B shows a volume control circuit suitable for use with transformer coupling. In this circuit, the resistance of the control should be at least 10 times (more if possible) the impedance of the transformer secondary.

The volume control cannot be connected in a manner which would vary the base bias, and thus the collector current, so Fig. 5C is a volume control circuit which is *not* satisfactory. Fig. 5D shows another method which is *not* satisfactory because it would vary both collector current and load impedance. Even the insertion of a condenser between volume control arm and transformer primary would not make the circuit desirable because the load impedance would vary with changes in the volume control setting.

Although we assumed that we were designing a transistor amplifier for a particular purpose the reader should understand that this was to give some

indication of how to proceed with the design of an amplifier for a typical application. There are infinite combinations of components which may be used and after one has gained some experience in building transistor amplifiers he can readily work out variations such as the use of loudspeakers for both pickup and reproduction as in intercoms, combinations of different transistor circuits such as a first stage using a crystal mike directly coupled to the high input impedance grounded-collector circuit, followed by grounded-emitter stages for maximum gain, and other combinations designed to meet particular ideas and requirements. Also transistors may be used in push-pull class A, class B, and other conventional circuits for greater output so there is no end to the possibilities which may be investigated and employed by those interested in the advantages in small size, lightweight, and low battery drain obtained by using transistors. Negative feedback in a grounded-emitter circuit may be obtained by an unbypassed resistor in the emitter lead and offers another line of investigation for the experimenter. Negative feedback over more than one stage is possible, as with tubes, but not always as easily accomplished. For example, tertiary windings on transformers appear most promising in transformer-coupled amplifiers for which negative feedback is desired. It is very desirable that the investigator have available an audio signal generator and oscilloscope for use in observing the effect of changes in transistor circuits and operating conditions.

REFERENCES

1. ———; *General Radio Experimenter*, March 1952, page 3.
2. Dixon, Robert K.: "Build This Transistor Receiver," *RADIO & TELEVISION NEWS*, February 1953.

A TRANSISTOR VIBRATION AMPLIFIER

By LOUIS E. GARNER, JR.

Transistorized and simplified version of a circuit first described in Jan. 1953 issue.

THE extremely small power requirements of transistors make it quite advantageous to "transistorize" portable equipment wherever practicable. This is true not only of hearing aids and portable radios, but also of most types of portable test and measuring equipment.

In an earlier article, the author described a small vibration-pickup amplifier built around a used hearing aid ("A Vibration-Pickup Amplifier," January, 1953 RADIO & TELEVISION NEWS). A "transistorized" version of a vibration pickup and amplifier is shown in Fig. 1, together with the headphones used as an accessory.

No attempt was made, in designing this transistorized version, to exactly duplicate the performance of the earlier unit. Rather, the instrument shown in Fig. 1 was designed for a somewhat different application. Where the earlier unit was used primarily to check for mechanical movements and vibrations in clocks, this instrument is designed for checking sounds in heavier mechanical equipment, specifically, to aid an automobile mechanic in diagnosing troubles. Because of this, only one transistor is used (two tubes were used in the earlier version), and less gain is provided.

Circuit Description

The circuit used in the transistor vibration amplifier is quite simple and straightforward, as can be easily seen by reference to the schematic diagram given in Fig. 2. A conventional single-stage grounded-emitter amplifier circuit is employed.

In operation, mechanical vibrations picked up by the probe are converted into electrical signals by a piezoelectric crystal (an ordinary phono crystal cartridge). These signals are, in turn, applied to the primary winding of T_1 .

A piezoelectric crystal has a high output impedance. The transistor amplifier stage has a low input impedance. Hence, in order to match these two impedances to insure maximum signal transfer, a transformer (T_1) having a stepdown turns ratio is employed.

The signal appearing across the secondary winding of T_1 is applied to the base-emitter circuit of the transistor

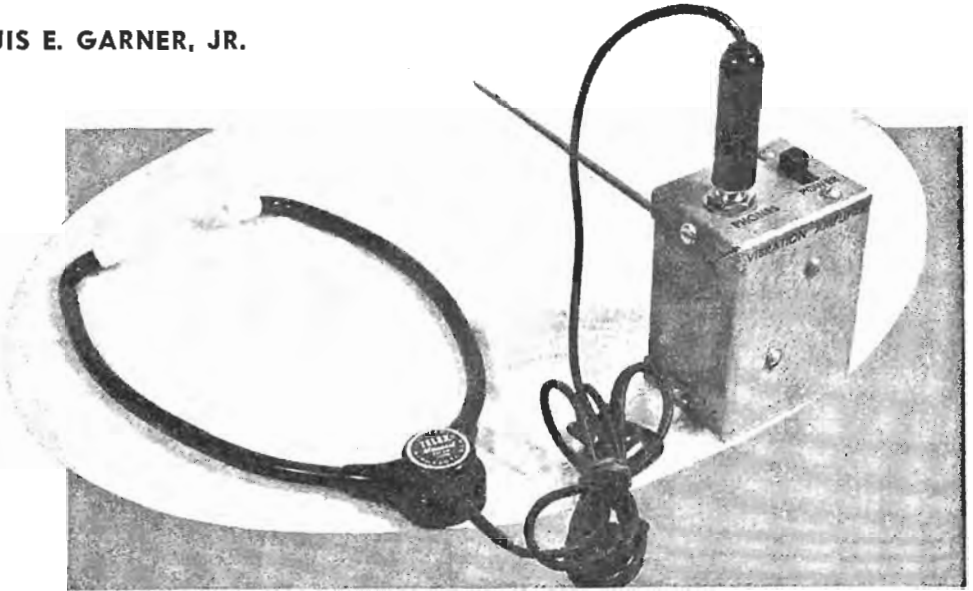

Fig. 1. Over-all view of transistorized vibration pickup and its amplifier.

through coupling condenser C_1 . A fairly large capacity condenser is used here to prevent loss of signal level at medium and lower frequencies, which might otherwise occur due to introducing a comparatively high impedance in series with the low input impedance of the transistor.

R_1 serves as the "base return" resistor, and, by providing a d.c. path between the power source and the base, establishes the base "bias" current. The value of this resistor determines the "bias" current flow and hence the operating characteristics of the stage.

The collector current also varies with the size of R_1 , as collector current is directly proportional to base current.

The audio signal is amplified by the transistor stage and the amplified signal appearing in the collector circuit is applied to the headphones. Since magnetic headphones are used, they also serve to complete the d.c. path for collector current flow.

A hearing-aid type battery, B_1 , serves as the power supply, and a s.p.s.t. slide switch, S_1 , as the power switch.

No provision has been made for a gain control, as it is not needed with a single stage of amplification.

Construction Hints

Both the pickup probe and the amplifier itself are assembled in a small Bud "Minibox." These small aluminum boxes may be obtained with either a gray hammerloid or an etched aluminum finish.

The general parts arrangement used by the author is apparent from the interior photograph given in Fig. 4. Layout is not critical, however, and a somewhat different arrangement may be used by the builder, if desired.

In the author's model, the small transformer and the battery are held

in place by two "Z" brackets, fastened in place by a single machine screw and nut. Connections to the battery are made by soldering leads directly to the terminals. Scotch electrical tape is used over the battery terminals to prevent accidental shorts.

Another builder might prefer to devise a small socket arrangement so that the battery may be installed and removed without soldering.

The transistor has been wired directly into the circuit in the model shown. Where this is done, special care must be taken to avoid overheating the transistor leads. Like most semiconductor devices, the transistor is particularly sensitive to heat, and may be easily damaged by excessively high temperatures.

As an alternative, a socket might well be used for the transistor. An ordinary 5-pin subminiature tube socket is employed (only three of the pin positions are required).

Once the unit is completed, labels may be made up by using standard decals, obtainable through most wholesale parts distributors. In the author's model, black decals were used. After the decals were attached, three coats of clear plastic were applied to protect both the decals and the finish of the case.

Some builders may prefer to omit the labels, however, since they add nothing to the performance of the unit.

Assembling the Probe: A detailed cross-sectional view of the probe assembly is given in Fig. 3 and this sketch is, to some extent, self-explanatory. A few comments are appropriate, however.

The probe itself is made up from an ice pick. The metal point is removed from the handle and the blunt end heated in a gas flame until it changes

color. This process removes the temper and permits a standard die to be used for threading the end.

Choose a die size that is appropriate for the diameter of the ice pick point used. This will vary somewhat with different ice picks. A 10-32 die was used by the author.

The sharp end of the ice pick should be rounded slightly by using a grinding wheel. This is done to prevent the point from digging into or scratching the surfaces against which it is held. *Do not remove the temper from the point by heating, however.*

Only that portion of the probe which is to be treated should be re-tempered. For best results, the rest of the probe should be kept in its original state.

When assembling the phono cartridge and probe point as shown in Fig. 3, note that the probe point and its mounting nut bear against the case of the crystal cartridge, not against the needle chuck!

In operation, the case tends to vibrate around and against the crystal, with the inertia of the crystal resisting this movement. This provides the necessary bending and twisting motion to operate the crystal so that an electrical signal is produced.

Parts Substitutions: Since so few parts are required for this unit, and these are all standard, the prospective builder should not find it necessary to make substitutions. A number of substitutions are permissible, however.

First, a case different from the one employed by the author might well be used. In choosing another case, keep in mind that it should be fairly rigid—for this reason, a plastic case is not generally recommended.

Another transformer might well be substituted for T_1 . Use any transformer capable of matching a high impedance to the low input impedance of the transistor. A certain amount of mismatch will not cause difficulty. In choosing another transformer, make sure that its physical size is such that it will fit easily into the case chosen.

If preferred, a somewhat smaller condenser may be used in place of C_1 . The author used a 10 μ fd. condenser because of its ready availability. An 8, 4, or even a 2 μ fd. condenser should give equally satisfactory results.

A toggle or rotary switch might be substituted for the slide switch used in the author's model.

Either an open or a closed circuit jack may be used as J_1 , although an open circuit jack will prevent accidental current drain when the headphones are removed (should the switch be in the "on" position). As an alternative, the headphones could be wired permanently in place and no jack provided.

Circuit Modification

Only a moderate amount of gain is provided by the single amplifier stage used in the author's model. This is sufficient, however, where the unit is used on equipment having vibrations of large amplitude.

For some types of work, the builder may prefer an amplifier providing more gain.

One simple technique for increasing the gain of the unit is to substitute a Raytheon type CK721 transistor ("p-n-p" type) for the CK722 shown in the schematic diagram (Fig. 2). The connections are the same, and it should not be necessary to change any parts values.

Where even greater gain is desired, a two-, or even three-, stage amplifier may be used. In such cases, it will be necessary to provide a gain control to prevent overload on strong input signals.

For general information on multi-stage transistor amplifiers, as well as suggested gain control circuits, refer to Charles W. Martel's article "Transistorize Your Audio Amplifiers" (March, 1953, RADIO & TELEVISION NEWS).

The builder may find that a tone control will be desirable for some applications. Such a control may be added by connecting a .05 μ fd. condenser in series with a 25,000 ohm rheostat, and connecting the entire assembly between the collector and emitter leads of the transistor. This forms a simple, but effective, "losser" type tone control circuit.

Using the Unit

To use the transistor vibration amplifier, plug a pair of magnetic headphones into the output jack (J_1) and turn the unit "on."

The case is held in the hand and the pointed probe held firmly, but lightly, against the machinery or equipment being checked. Experiment with both the angle at which the probe touches the machinery as well as the exact point at which contact is made.

This technique often enables the user to distinguish between different types of vibration sounds, and to pick out those signals of particular interest.

If the builder has assembled a unit using two or more amplifier stages, and has provided a gain control, this control should be set for minimum gain when the probe is first placed in position. The gain is then gradually

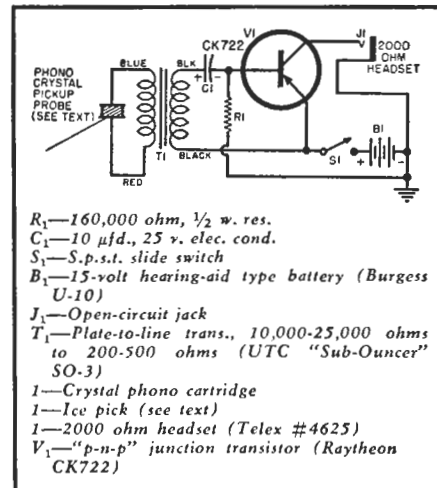

Fig. 2. Diagram of vibration pickup unit.

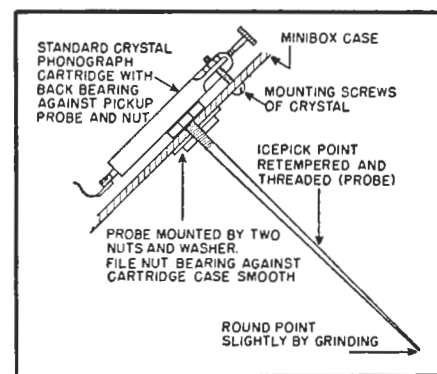

Fig. 3. Mechanical details for assembling the probe. See text for full instructions.

increased, without moving the probe, until the desired signal level is finally reached.

This last technique is used for two reasons. (1) to prevent "blasting" due to high signal levels, and (2) to prevent accidental signal overload, with resulting distortion and changes in signal quality. A distorted signal is difficult to properly interpret.

Applications

Although primarily designed for lis-
(Continued on page 101)

Fig. 4. Interior view of unit. Layout may be altered to suit needs of the builder.

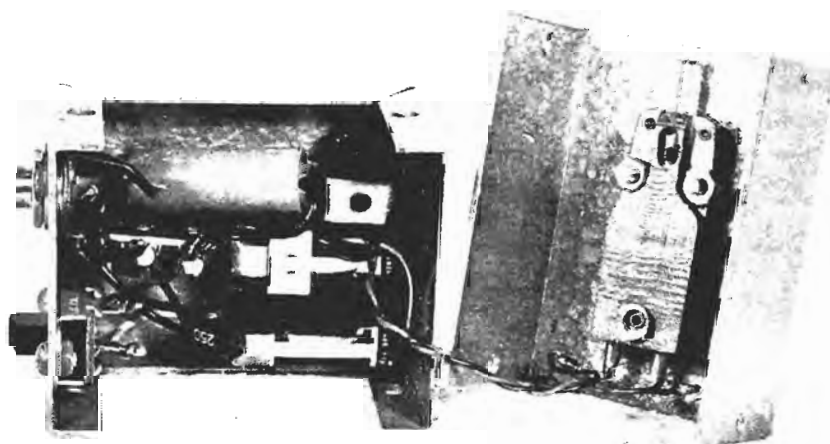

TRANSISTOR GUITAR AMPLIFIER

By LOUIS E. GARNER, JR.



Fig. 1. Over-all view of transistor amplifier, guitar, pickup microphone, and cable. Amplifier is housed in a sloping front panel wall baffle instead of a "cabinet."

This multistage unit uses four transistors, operates from a single 6-volt battery, and will withstand heavy portable use.

A GUITAR amplifier provides an interesting construction project for the experimenter or technician who wishes to "try his hand" at building a multistage, transistor-operated audio amplifier. Such an amplifier is shown in Fig. 1, together with the guitar with which it is used and the pickup microphone and cable.

Interior top and bottom chassis views of the amplifier itself are given in Figs. 3 and 4, respectively.

Although the amplifier shown cannot be considered as a substitute or replacement for a conventional vacuum-tube amplifier because of its low power output (a fraction of a watt), it does offer several advantages over conventional amplifiers for some applications.

First, its small size and light weight make it an ideal instrument for portable use—even a small child can carry it without difficulty. Secondly, since the power supply is self-contained (a battery), the instrument may be used wherever desired—at picnics, lawn parties, weiner roasts, or at similar outdoor functions.

Another advantage is its low maintenance cost. Except for an occasional battery replacement, the amplifier should seldom, if ever, require any adjustment or servicing. It certainly will never require replacement tubes!

Another, perhaps less apparent, advantage of the transistor amplifier over a conventional vacuum-tube amplifier is its over-all ruggedness. With

no tubes to shake out of their sockets, or tube elements to loosen and become microphonic, the amplifier can withstand a considerable amount of "jouncing" in the trunk of an automobile or on the floor of a station wagon.

The transistor guitar amplifier is fairly easy to assemble and wire. The average technician will find that it makes an excellent "week-end" construction project.

Circuit Description

As can be seen by reference to the schematic diagram of Fig. 2, the complete amplifier consists of a two-stage "voltage amplifier" followed by a push-pull output stage.

A Brush "Vibromike" vibration microphone is used on the guitar, with a shielded cable connected between the mike and the input jack (J_1) of the amplifier. The signal obtained from this mike appears across R_1 , which serves as the "Gain" or "Volume" control.

In designing transistor-operated audio amplifiers, it is important that the signal level be controlled in such a fashion as to avoid changing either the base "bias" current or the collector current of any transistor stage.

C_1 serves as a blocking condenser to prevent the comparatively low d.c. resistance of the primary of T_1 , acting as a shunt across R_1 . T_1 , in turn, is used to match the high microphone and "Gain" control impedance to the low input impedance of the transistor

amplifier. Thus, a stepdown turns ratio is used in this transformer.

The a.c. signal appearing across the secondary of T_1 is coupled through d.c. blocking condenser C_2 to the base of the first CK721 transistor amplifier stage. R_2 serves as the "base return" resistor and establishes the "bias" current for this stage, being returned to the negative terminal of the power source, B_1 .

An amplified signal appears across the primary of transformer T_2 . This transformer is used to perform a function similar to that of T_1 . Where T_1 serves to match the high microphone impedance to the low input impedance of the transistor amplifier stage, T_2 is used to match the comparatively high output impedance of one amplifier stage to the low input impedance of the succeeding stage. Because of the differences in impedances, different turns ratios are required, and hence different transformer types are used for T_1 and T_2 .

Condenser C_3 and resistor R_3 perform functions similar to C_2 and R_2 , respectively.

The second CK721 transistor stage provides additional amplification, with the output signal appearing across the primary of T_3 .

Transformer T_4 performs two jobs. It acts to match the high output impedance of the second CK721 stage to the low input impedances of the push-pull output stage while, at the same time, providing two signals having a 180° phase difference to properly drive the two output transistors.

C_4 and C_5 serve as d.c. blocking condensers, while resistors R_4 and R_5 are the "base return" resistors for the two CK722 transistors used in the output stage.

A conventional push-pull audio-output transformer, T_4 , is used to match the output stage to the 6" PM loudspeaker used.

The tone control is conventional and consists of C_6 and R_6 , connected across the primary winding of T_4 . As the resistance of R_6 is reduced, C_6 becomes more and more effective in bypassing the higher frequency components of the amplified audio signal. This type of tone control circuit is commonly called a "losser" tone control.

A small 6-volt radio "A" battery is used as the power source for the entire amplifier. A rotary type switch, S_1 , is used in the "A—" lead as the "Power" switch.

The guitar amplifier circuit points up an important feature of transistor

amplifier circuits in general. Although "grounded-emitter" amplifier stages are used throughout, the common "chassis" ground is to "A-." Thus, the "type" of transistor amplifier circuit (*grounded base, grounded emitter, and grounded collector*) is determined by the method of applying the input signal and the location of the output load, rather than the location of chassis ground. *In general, chassis or circuit ground may be made at any point in a transistor amplifier stage, regardless of type.*

In this respect, the guitar amplifier may be considered analogous to a vacuum-tube amplifier in which "B plus" and plate return leads are connected to ground, with "B minus" and the tube cathodes above ground potential.

Construction Hints

A sloping front speaker wall baffle has been used as the "cabinet" of the guitar amplifier. Rubber tack feet have been added to the "top" of the baffle, which then becomes the base of the cabinet. A small handle was also added to facilitate carrying the unit. These modifications are readily visible in the photographs.

Both the loudspeaker and the battery power supply are mounted directly in the baffle, with a small clamp provided for holding the battery in place. The rest of the amplifier circuit is assembled and wired on the small aluminum chassis visible in Figs. 3 and 4.

Layout and parts location are not too critical, although standard good wiring practice should be followed. The input and output signal leads should be kept well separated.

No provision is made by the manufacturer for mounting the "Sub-Ouncer" transformers (T_1 and T_2) and it becomes necessary for the builder

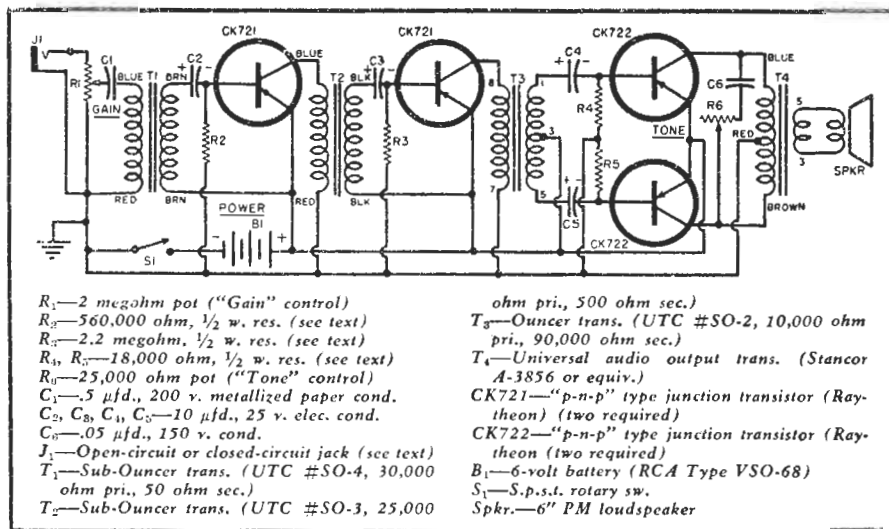

Fig. 2. Complete schematic diagram of the multistage transistor-operated amplifier.

to use his ingenuity in mounting these units. The author employed small "Z" brackets, clearly visible in Fig. 3.

Both the primary and secondary leads of transformers T_1 and T_2 , as well as the primary leads of transformer T_4 are identified by color-coded leads. All other transformer connections are identified by numbered terminals. The proper connections to use in each case are indicated in the schematic diagram (Fig. 2).

As far as the output transformer is concerned, however, the proper secondary leads to use should be chosen for the particular loudspeaker employed. Although the author used terminals 3 and 5 (as shown in Fig. 2), some other pair of terminals might give better results with a different speaker.

Either an "open" or a "closed" circuit jack may be used for the input (J_1), at the discretion of the builder. For many applications, a closed cir-

cuit jack is preferred, as it reduces the possibility of noise and hum pickup should the "Gain" control be turned up with the "mike" unplugged.

In the author's model, the transistors have been soldered directly in place, but sockets may be provided if desired. Ordinary 5-pin, subminiature tube sockets are suitable, with only three of the pins being used.

Should the builder prefer to solder the transistors in place, special care should be taken to avoid overheating the leads. Transistors are, in many respects, more susceptible to heat damage than are conventional germanium diodes, and many technicians have probably, at one time or another, damaged at least one germanium diode while removing it or installing it in a circuit.

Do not cut the transistor leads too short. Use a clean, well-tinned hot soldering iron and complete each joint quickly. (Continued on page 105)

Fig. 3. Top chassis view showing amplifier in baffle "cabinet."

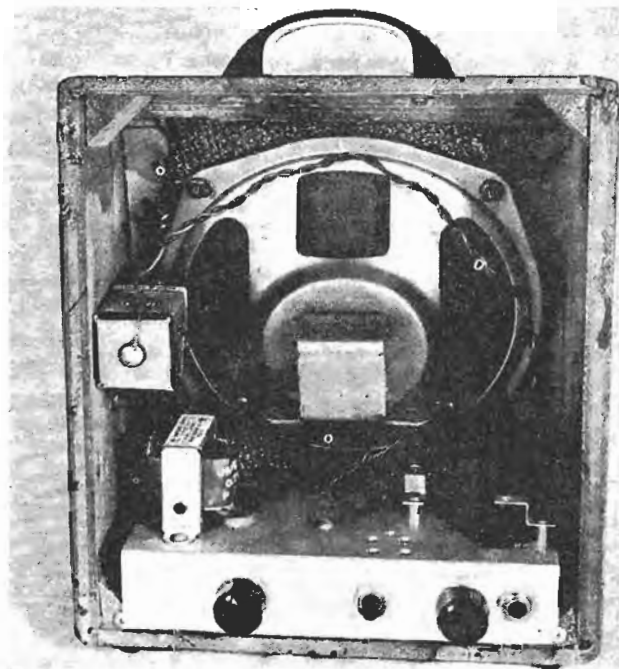
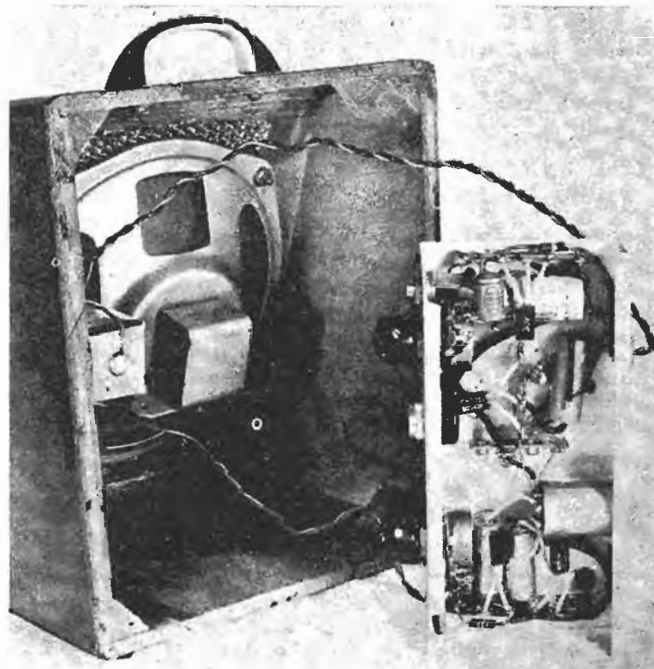

Fig. 4. Amplifier pulled out to show the under chassis wiring.



THE TRANSISTOR D. C. AMPLIFIER

By

HERBERT F. STARKE

Receiving Tube Division
Raytheon Manufacturing Company

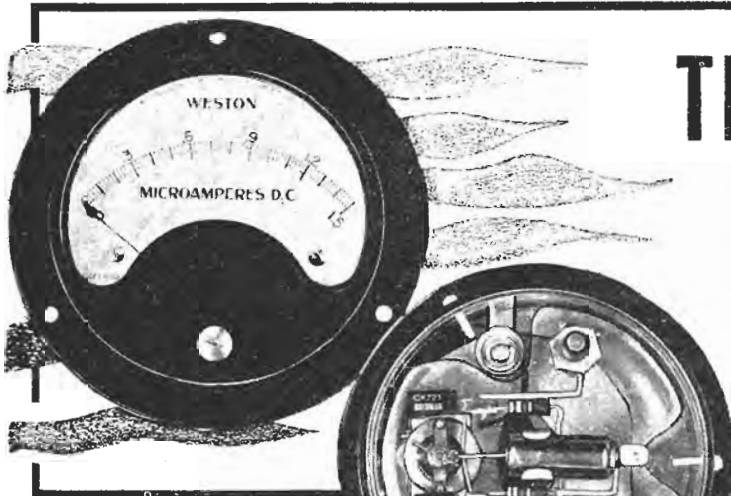

Fig. 1. Front view of the Weston Model 643 with the scale marking changed to 1.5 microamperes, full-scale. Rear view showing the meter movement remounted on Lucite back. Cell (Mallory RM-401) is outside with resistors, transistors, etc. shown mounted inside case.

A new and interesting application of transistors in the instrumentation field. Increased sensitivity is obtained.

THERE appears to be no sensible reason why transistors should not find their way very quickly into various applications associated with the field of measurement and electronic instrumentation. In view of a definite trend toward miniaturization and low power consumption in this as well as other fields, transistorized versions of familiar laboratory devices should constitute an early, logical step in the development of transistor applications. With this idea in mind, the writer undertook to determine what could be done to increase the sensitivity of a small d.c. meter with a simple and compact circuit using components small enough to permit mounting on the back of the meter.

Several years ago it was thought that the desired result might be achieved with subminiature tubes but a critical survey of the requirements turned out to be rather discouraging. A 20 microampere, 2000 ohm meter may be thought of as having a transconductance of 500 micromhos and if this is to be translated back to the input of a tube circuit, the circuit transconductance must also be 500 micromhos if the device is to introduce a voltage drop no greater than that of the meter alone. For either single-ended or balanced circuits, this means, in practical terms, a tube transconductance of at least 1000 micromhos which becomes very difficult with subminiature tubes operating at low filament currents and "B" voltages.

Fundamentally, the meter is a power device and if we wish to increase its effective sensitivity we must supply power amplification. A 20 microampere, 2000 ohm meter requires 0.8 microwatt for full-scale deflection

and if (a.) 2 microamperes at 20,000 ohms, i.e., the same voltage drop is desired the power gain must be 10 db or (b.) 2 microamperes at 2000 ohms (for the same circuit resistance) requires a power gain of 20 db. These gains are of the sort that may be readily achieved in one stage using junction transistors, a single cell, and a few resistors, with the entire package being of a size that can be mounted in back of the meter case or, for that matter, partly inside the case. (The word "partly" is included only because it does not seem very practical to periodically open a meter case for the purpose of replacing a cell.)

Fig. 2 represents the first attempt at a circuit showing promise of obtaining at least a ten-fold increase in current sensitivity. The evolution to Fig. 3, with the elimination of four resistors out of six, requires some explanation. This, in turn, depends upon the temperature characteristics of the transistors and the need for a high degree of zero stability in the meter amplifier under consideration.

Under certain circuit conditions, transistors make better thermistors than thermistors. That is to say, the temperature coefficient of the cut-off current of the transistor is nearly double the temperature coefficient of resistance of the thermistor. In a circuit intended to be highly responsive to temperature changes (such as the basic form shown in Fig. 4) these coefficients would combine to produce an over-all coefficient on the order of 12% per degree Centigrade provided, of course, both elements were associated with the same thermal circuit. Since in Fig. 4 these effects appear in amplified form in the collector circuit,

it should not be particularly difficult to obtain full-scale deflection on a 20 microampere meter for a temperature change of one degree Centigrade with operating collector currents on the order of 150 or 200 microamperes.

In the case at hand, however, it is desired to make the temperature response as low as possible because here temperature response is the same as zero drift. In a d.c. amplifier using transistors in a grounded emitter circuit (necessary here because the grounded base circuit has current amplification less than unity) the direct first-order cause of collector current drift is the temperature coefficient of the cut-off current and the two are related according to:

$$I_c = (I_{c0} + \alpha I_b) / (1 - \alpha)$$

where:

I_c = collector current

I_b = base current

I_{c0} = cut-off current (the collector-to-base current with open emitter)

α = short-circuit current amplification (grounded base).

The foregoing points immediately, of course, to a balanced circuit which allows us to proceed at once to an examination of second- and third-order effects upon zero drift and response. In the circuit of Fig. 2, if the transistors can be matched for cut-off current, temperature coefficient of the cut-off current, and α , the residual zero-drift over the ordinary range of "room temperature" ($28 \pm 6^\circ\text{C}$) should be very small. In addition, it is quite likely that a transistor of higher-than-average cut-off current can be paired with one of lower-than-average temperature coefficient and *vice versa*. This latter technique could resolve itself into a simple matching of collector currents (at either a fixed or zero base current) with a maximum permissible mis-division of the collector-to-collector load as the sole criterion of temperature behavior, although the effectiveness of the test would be greatly increased if the original balance were followed by checking the shift in zero caused by shorting the input (base-to-base). This, in turn, results in the elimina-

tion of the electrical zero adjustment as shown in Fig. 3 which, as a design feature, would be somewhat more practicable with a meter having a greater range of adjustment of the mechanical zero.

The choice of battery capacity, collector current, and load resistors are all interrelated. If these are chosen with an eye to convenience in the matter of battery replacements, the use of the *Mallory* RM-12 (also RM-1200) with collector currents of 75 to 100 microamperes will result in operation requiring a new battery only once a year without the inclusion of an "on-off" switch. Collector currents below 100 microamperes, on the other hand, will show some increase in sensitivity with rising temperatures. This can be circumvented by at least two methods: (1.) Choose an operating collector current high enough (about 200 microamperes) so that any small further increase in current amplification is largely offset by compensating changes in other transistor parameters or (2.) use a temperature sensitive meter shunt as shown in Fig. 6. Proper proportions of *R* and *T* will allow the use of rather low collector currents without causing an unduly large response error over a reasonable range of operating temperature.

Since some degree of matching appears to be inevitable, it seems logical to use only those transistors whose open-base collector currents fall within the desired range. This leads to the elimination of the base resistors and, while the circuit of Fig. 3 seems almost too good to be true, its performance may be seen in Fig. 5 which shows voltage gain, current gain, and power gain as functions of source impedance. These plots, which are typical for the CK721, point out immediately the chief operational defect of the circuit: it cannot measure either current or voltage accurately unless the source impedance is much higher (for current) or much lower (for voltage) than the base-to-base impedance at the transistor input. This means (oddly enough) that the meter is virtually useless for quantitative measurements at the point which gives maximum power gain. This involves an operational concept which is somewhat unusual but it should not trouble us too much if we recall that the original objective was to realize a substantial increase in the current sensitivity of a microammeter with an absolute minimum of components.

Although the meter is of some potential value as a millivoltmeter for use with thermocouples, bolometers, and other low impedance sources, an extra word of caution may be interjected at this point: If the designer elects to use the same meter for current and voltage measurements, the most careful matching of transistor characteristics will be necessary; otherwise there may be a substantial zero shift in going from a high source impedance (0.1 or 1 megohm) to a low impedance (10 or 100 ohms) and *vice versa*.

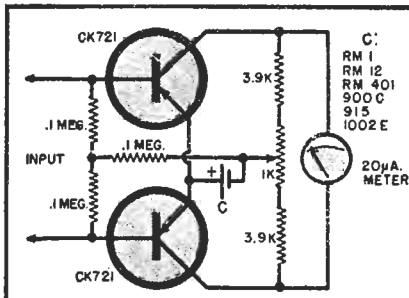

Fig. 2. An early circuit using six resistors, a condenser, two transistors.

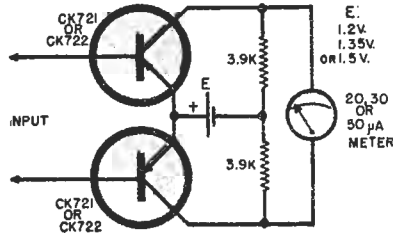

Fig. 3. A simplification of the circuit of Fig. 2 eliminating four of six resistors.

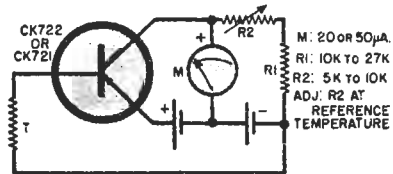

Fig. 4. Basic temperature-sensitive circuit.

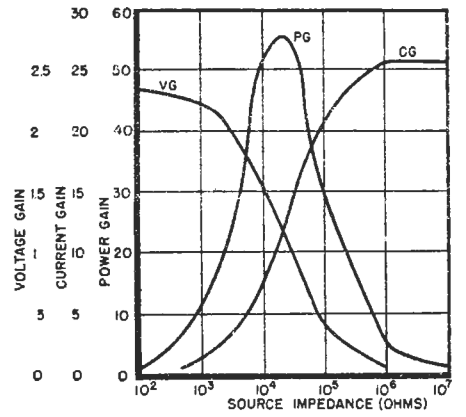

Fig. 5. Performance of the circuit of Fig. 3 shown graphically. Voltage gain, current gain, and power gain are shown as functions of source impedance. All of the values are expressed as factors, not in db.

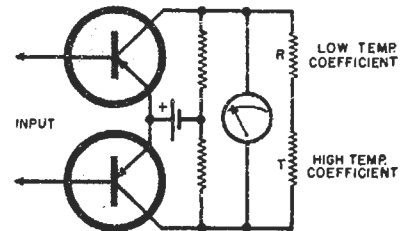

Fig. 6. Temperature-sensitive meter shunt.

The curves shown in Fig. 5 are intended to illustrate only one particular operating point using typical CK721's, which were matched in *alpha*. With a battery current of 150 microamperes (in the open-base circuit) the corresponding collector current of 75 microamperes to each transistor yielded characteristics as indicated in Table 1.

The resulting high input impedance leads, in this case, to rather serious errors if the current source impedance falls very much below 1 megohm. If this is too high for the application at hand, the only remedy is to operate at higher collector current with the im-

	α	R_c	R_b	R_e
#1	.966	2.7 meg.	1900 ohms	335 ohms
#2	.966	2.8 meg.	1740 ohms	340 ohms

Table 1. Matched transistor characteristics.

CELL	CAPACITY (ma. hours)
1002-E (Eveready)	1000
RM-1000 (Mallory)	1000
RM-1200 (Mallory)	3600
915 (Eveready)	800
RM-401 (Mallory)	800
RM-625 (Mallory)	250

Table 2. Life expectancy, in milliamperes-hours, of various available battery cells which could be used in the construction of transistorized d.c. amplifiers for meters.

Fig. 7. Front and rear view of Weston Model 301 with the scale marking changed to .5 microampere, full-scale. All parts, including RM-1000 cell are mounted outside.

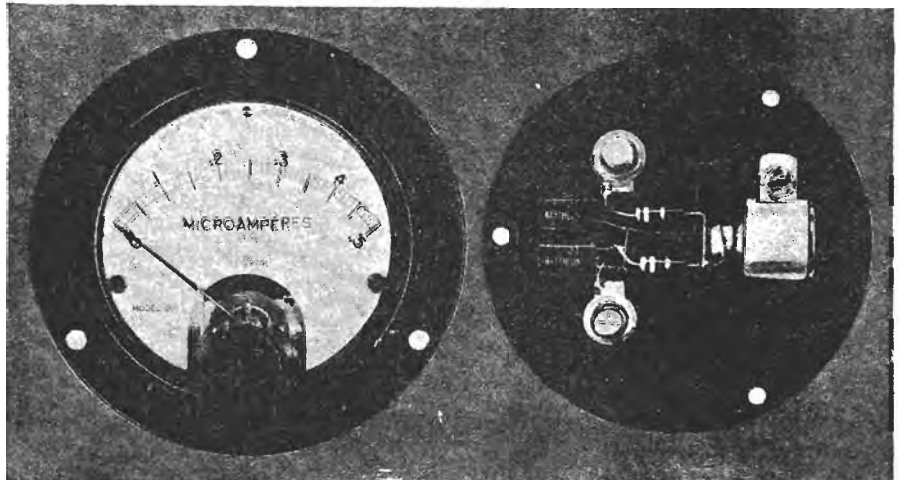

pedance scale shifting to the right by a factor of ten for approximately a doubling of current. The power curve is not the product of the voltage gain and current gain curves because the signal voltages and currents were computed from E_o/R_o while the power input was computed from $E_i^2/4R_o$. All points were for constant output power at full-scale meter deflection: 20 microamperes, 1850 ohms, 37 millivolts, 0.74 microwatt. This treatment may appear rather unorthodox but is more indicative of circuit performance in the face of a basic concept of good instrumentation (which postulates that the power expended in the measuring system must be small compared to the total power in the circuit being measured) than other presentations that could be used.

The parenthetical remark indicates more clearly why the circuit fails (in a usage sense) at maximum power gain because at this point the impedances are matched and the two powers are equal.

In the early months of transistor history, much was made of the fact that here, for the first time, was a device that could be regarded as a current amplifier. In the intervening years, however, very little has appeared in the form of practical devices making use of this important and interesting property. This being so, it may be permissible to emphasize the current-amplifying properties of the present device and gloss over its rather mediocre performance as a voltage amplifier.

From a source impedance, then, on the order of 50,000 ohms or more (depending upon the operating point chosen) the current gain of the circuit is approximately the grounded-emitter current amplification of the transistor multiplied by the shunting effect of the load resistors across the meter:

$$CG = [\alpha / (1 - \alpha)] [R_L / (R_L + R_m)] \text{ approx.}$$

where:

CG = the current gain (expressed as a factor)

R_L = collector-to-collector load

R_m = meter resistance.

The foregoing neglects the further shunting effect of the collector resistance because this will be at least several hundred-thousand ohms.

Interesting and informative comparisons may be made between the d.c. transistor amplifier and its vacuum tube counterpart. In a d.c. vacuum-tube voltmeter of the balanced cathode-follower variety, the "bottom" tube usually functions mainly as a balancing tube, to stabilize zero in the face of changes in contact potential and emission with changes in cathode temperature. While the balancing transistor is even more necessary in the transistor amplifier (although for a different reason) the second transistor is active dynamically and does not "shunt down" circuit sensitivity as is often the case with balanced tube circuits. Also, it is usually the prac-

tice to ground the lower grid of the tube circuit because of troublesome ground capacitances and currents while the transistor circuit, being a relatively low impedance circuit containing very little in addition to the meter movement, need not be grounded and can therefore be operated at a considerable impedance to ground. The "bottom" transistor, then, is at the bottom only on paper and actually there is no necessity to designate "high" or "low" terminals at the input nor to provide a polarity-reversing switch (except as a convenience) at the indicating meter.

Certain types of laboratory and service instruments would appear to be logical candidates for improvement, through transistorization, in one or more of the following particulars: Instrument size and weight; number of components; manufacturing costs; performance; etc. For example, the volt-ohm-milliammeter class of instrument (as exemplified by the *Simpson Model 260* and the *Triplet Model 630-A*), which at present uses a 50 microampere movement can offer 200,000 ohms-per-volt and 1.5 to 5 megohms at center-scale in the same instrument size at slightly higher cost. For this purpose, the CK722, with a current gain of 10 or 12 should be adequate. Or, conversely, the performance of the d.c. vacuum-tube instrument (of the balanced cathode-follower type referred to before) can be approximately equalled in a smaller instrument of the same or possibly lower cost.

While much of the foregoing also applies, of course, to a.c. amplifiers and instruments, it will be understood that the present discussion is confined to d.c. This is partly because there is such a glaringly obvious discrepancy between the power supply requirements of d.c. instruments (particularly battery-operated instruments) and what may and should be possible with transistors. In this class of instrument with its plethora of batteries, including separate "A" batteries, "B" battery, coupling batteries and bucking battery, it is not unusual for the weight and bulk of the power supply to exceed 75% of the total. Further, if the designer attempts to reduce this percentage substantially, the usual result, on meters used only intermittently, is a considerable loss of time in servicing operations. To this may be added the difficulty of maintaining fresh stocks of several types of batteries in the usual situation where most of the available instruments require different battery types.

Among the d.c. instruments which are often battery operated may be mentioned: photometers, densitometers, pH meters, spectrophotometers, infrared amplifiers, strain gauge amplifiers, mass spectrograph leak detectors, etc. While most of these require the sort of input impedance which can only be realized from electrometer tubes, there appears to be no reason why the remaining stages cannot

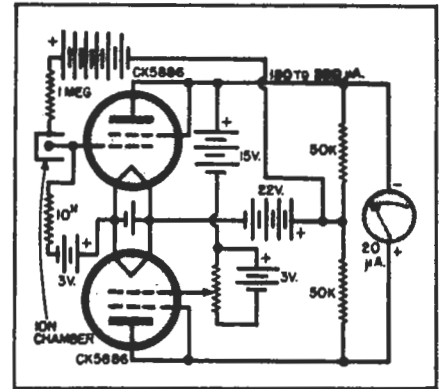

Fig. 8. Simplified schematic of the "Zeus" type radiation meter which has a full-scale sensitivity of 25 milliroentgens per hour.

be taken over by transistors. In fact, in the type of circuit using a large negative feedback, it is possible that the transistor stages can be operated single-ended because the temperature drift of the first transistor, i.e., the second stage, will be reduced in proportion to the gain of the electrometer input stage. In this type of hybrid (tube and transistor) operation, coupling batteries, where required, and the meter stage battery will be single cells, one of which is already present in the form of the electrometer tube filament battery.

A fair example of a simple conversion to a combination circuit may be seen in Figs. 8 and 9. The former is a simplified schematic of the familiar "Zeus" type of radiation meter with a full-scale sensitivity of 25 milliroentgens per hour and using five batteries (not counting the ion chamber battery which is not part of the amplifier proper). The addition of two transistors not only reduces the number of batteries to two but also increases over-all sensitivity at lower plate current to the electrometer tubes. The temperature characteristics of the transistors are not particularly important in this application since there is an electrical zero adjustment and instruments of this type are frequently checked for this setting.

(Continued on page 104)

Fig. 9. Circuit amplified by using transistors which helps eliminate three batteries while increasing instrument sensitivity.

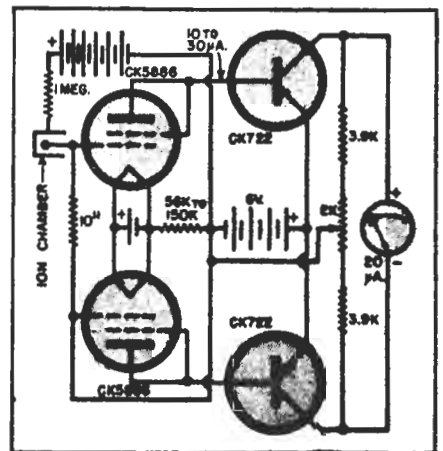



*The new CK727 insures
both quiet operation
and high voltage gain*

By RUFUS P. TURNER*

low-noise transistor preamplifier

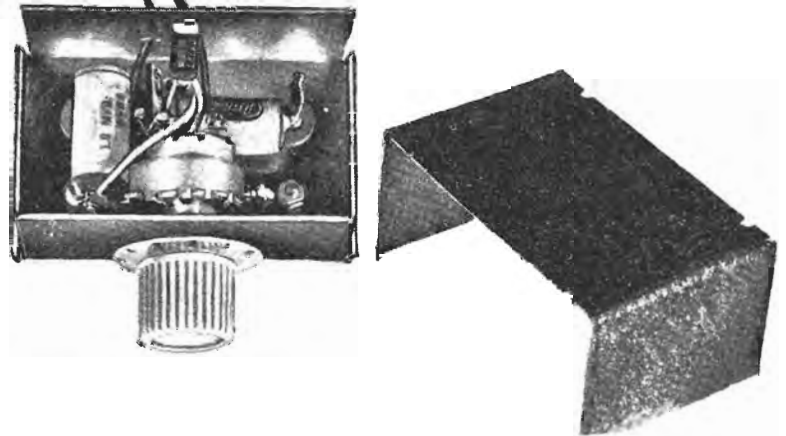

ALTHOUGH the junction transistor in the common-emitter circuit always has offered attractive possibilities as a high-gain, single-stage, nonmicrophonic, single-battery, voltage preamplifier, there has been some objection to its use because of the inherent high noise level of the transistor. When operated ahead of a main amplifier having high voltage gain, this noise voltage has appeared

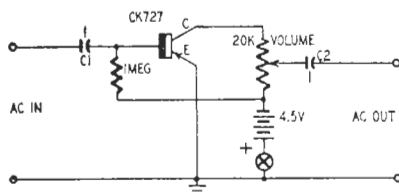

Fig. 1—Common-emitter preamplifier.

as an annoying hiss in the final output.

The new Raytheon CK727 p-n-p transistor has a lower noise factor (18 db maximum in the common-emitter circuit with 1.5 volts collector potential) than previous high-alpha units. In other respects, the room-temperature characteristics of this new transistor are similar to those of the CK721 in the 1.5-volt common-emitter circuit, except for a collector resistance in the CK727 of 1 megohm, base resistance of 800 ohms, and cutoff current of $5 \mu\text{a}$.

*Author, *Transistors, Theory and Practice*.

Fig. 1 shows a common-emitter preamplifier circuit which I found optimum for my particular requirements. This resistance-capacitance-coupled arrangement is designed to operate into a high impedance, such as an a.c. vacuum-tube voltmeter or the grid circuit of an amplifier, which will allow full use of the preamplifier voltage gain.

For the transistor tested, voltage gain at 1,000 cycles is 93. The maximum 1,000-cycle input-signal voltage before rounding of the positive peaks of the output signal is 10 millivolts. Output voltage is 0.93 volt across 1 megohm connected to the amplifier output terminals. The measured input impedance at 1,000 cycles is 7,500 ohms (output impedance of the signal generator used was 600 ohms, resistive). The noise voltage, measured with a vacuum-tube a.c. millivoltmeter at the amplifier output terminals, was 3 millivolts with the input terminals short-circuited. This is 49.8 db below maximum signal-voltage output.

Fig. 2 shows the frequency response of the single-stage amplifier when worked into a 1-megohm load resistor connected to the output terminals. Response is constant from 500 to 5,000 cycles, and is 1.66 db down at 50 cycles and 3.75 db down at 50 kc. It is 1.29 db down at 20 kc. This curve was plotted with a constant 10-mv input signal and with the amplifier gain control set at maximum output.

A single 4.5-volt battery powers the

amplifier. Since the current drain is only 100 microamperes d.c., this can be a miniature battery, for example three 1.5-volt penlight cells connected in series. The battery switch can be operated by the volume-control potentiometer. I used small metallized-paper 1- μf coupling capacitors for C1 and C2. For compact installations, however, these components may be miniature tantalum electrolytic capacitors. If the latter are used, the positive

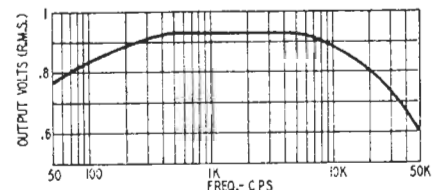

Fig. 2—Amplifier frequency response.

terminal of C1 must be connected to the top a.c.-input terminal, and the positive terminal of C2 to the top a.c. output terminal.

It is a comparatively simple matter to build this preamplifier into a test probe, microphone case, stethoscope pickup, or similar accessory requiring high voltage gain with few components, freedom from the power line, and a simple circuit. Its low power drain (around 500 microwatts d.c.) makes it economical to operate for long periods and prevents the mortal sin of forgetting to turn it off. **END**

TRANSISTOR CLIPPER AMPLIFIER

By

ROBERT W. MALOY
 4705 Del Monte
 San Diego 7, California

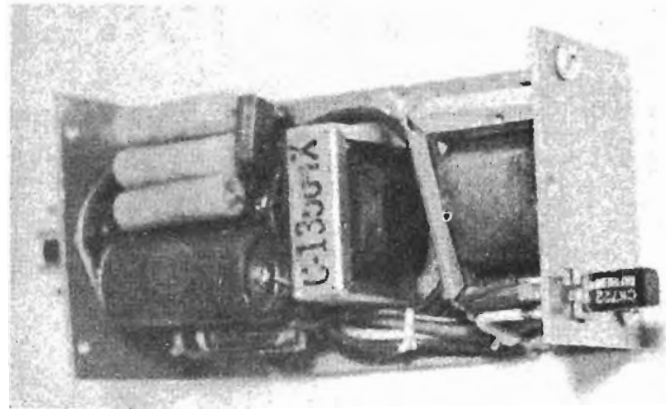

The advantage of clipper filter units in the speech circuits of transmitters has been pretty well accepted by the amateur fraternity as a means of overmodulation prevention together with increased communication range. Prior to the advent of the transistor these advantages could be attained only at the expense of one or two triodes, a duo-diode, the bias for the diodes, as well as the extra plate and filament power required to supply this additional load. The transistor, however, has an exceptionally sharp cut off as compared to vacuum tubes, together with high gain at reasonably low values of load resistance.

In this transistor clipper amplifier it was desired to use a carbon microphone input to the clipper amplifier and to use this one stage of gain to drive a 6AQ5 to more than 2 watts output. A grounded emitter circuit was chosen together with a collector voltage of 20 volts. This voltage being generally unavailable in either fixed or mobile installations was obtained by means of a bleeder from the 300 volt supply at a cost of only 1 mil including the losses in the bleeder and the electrolytic condenser. A bleeder rather than a simple dropping resistor was deemed necessary due to the relatively low and not particularly stable resistance of the electrolytic condenser. The d.c. base bias current was obtained by use of a 1.2 meg resistor which established the collector current of the amplifier and was sufficiently high compared to the base impedance to have only negligible effect on the input signal. The clipping action was obtained by the sharp cut-off characteristics of the transistor which in itself gives better clipping than the usual combination of duo-diode and triode without their additional circuitry and biasing requirement. The use of a clipper amplifier requires the use of a filter to avoid generation of high frequency harmonics when the signal exceeds the clipping level. Iron core chokes were used to permit a reasonably high value of load resistor at a cut-off frequency of 3000 cycles. The input of this

amplifier may be coupled by means of a .1 mfd. condenser for a low frequency cut-off of 400 cycles. This is usually considered to be most satisfactory for this type of amplifier. No volume control was considered for the output of the transistor since negative feedback should be used in the driver stage and may be readily adjusted to limit the modulator output to just under 100% modulation. For those who prefer unclipped high fidelity speech, a larger coupling condenser together with a higher frequency cut-off low pass filter may be used. This will provide the performance of a straight unclipped amplifier with the exception that regardless of errors in loudness of speech or gain control setting the operator will find it impossible to overmodulate his transmitter. The only precautions necessary are that the negative feedback of the driver be adjusted so that no stage subsequent to the low pass filter be overdriven and that the input to the clipper stage be adjusted to provide the desired degree of clipping. This amplifier has a maximum output of 20 volts peak to peak and may, if desired be used with a transformer output to drive anything up to push pull 6L6's in class "A". The stage gain of this transistor amplifier is 80 so that only 25 millivolts peak to peak are required to drive this amplifier to full output although 75 millivolts are desirable for moderate clipping.

If it is desired to use other than a carbon mike, a preamplifier stage should be used. In design of a preamplifier, consideration must be given to the fact that the clipper stage has an input impedance of about 5000 ohms which will probably rate a second transistor as the most acceptable choice.

The use of this transistor circuit will provide the advantage of a clipper amplifier together with marked circuit economy and simplicity. In addition, the basic circuit without filter may also be adapted to such other devices as noise clipping audio amplifiers, and FM limiting i.f. amplifiers.

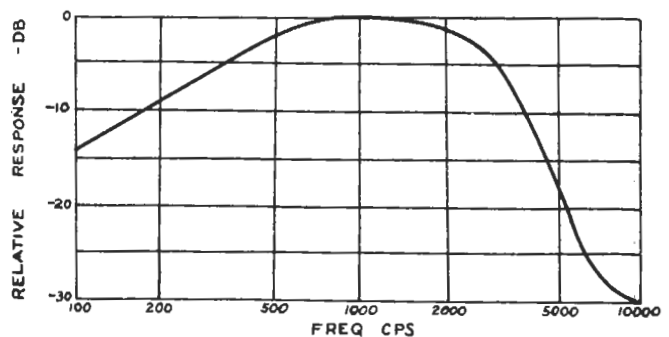
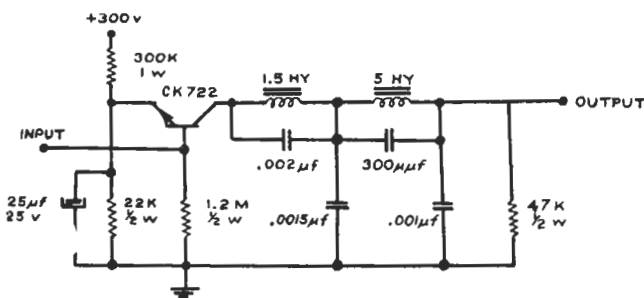

A TRANSISTOR PHASE INVERTER

By W. H. CALDWELL

A PHASE inverter is a circuit which provides coupling between the output of a single-ended stage and the input to a push-pull stage. A phase inverter provides two outputs which are 180 degrees out-of-phase, so that when one grid of the push-pull stage is driven positive, the other is driven negative.

Phase inverter coupling can be provided by a transformer, a vacuum-tube stage, or by a transistor stage.

The transformer stage is the simplest to use. It requires no power for operation, and provides a voltage gain. There are several disadvantages to the transformer, however. It has a limited frequency response, and is sensitive to hum pickup from the magnetic fields of power transformers. In some applications the weight of a transformer is a serious disadvantage.

These difficulties led to the development of the vacuum-tube phase-inverter circuit. The vacuum-tube stage is insensitive to power transformer hum fields, has an excellent frequency response, and is lighter in weight than most transformers. Its disadvantage lies in its requirement of heater and plate power, and, in some designs, in hum pickup from the heater of the tube.

These drawbacks led to the transistor phase-inverter development. The transistor stage has the same advantages as the tube stage, with respect to frequency response and insensitivity to power fields, with the further advantage of lighter weight. In addition, the transistor stage needs no heater power, so there is no hum pickup from this source.

The transistor circuit uses a base input, with an emitter-follower output to provide isolation, and a collector output for phase reversal. The equivalent circuit is given in Fig. 1A.

The two loop equations are:

$$R_e(I_b - I_c) = E \dots (1)$$

and:

$$I_c(R_c + R_L) = E - R_m I_b \dots (2)$$

Solving equation (1) for I_b gives:

$$I_b = \frac{E}{R_e} + I_c \dots (3)$$

and substituting in (2):

$$(R_c + R_L) I_c = E - \frac{R_m}{R_e} E - R_m I_c \dots (4)$$

$$\frac{I_c R_L}{E} = \frac{R_L(R_c - R_m)}{R_e(R_c + R_L + R_m)} = -1 \dots (5)$$

Equation (5) must equal minus one to give phase inversion at unity gain in the collector branch of the circuit. Therefore:

$$R_L(R_m - R_c) = R_e(R_c + R_L + R_m) \dots (6)$$

Choosing $R_e = 27,000$ ohms from d.c. considerations, and using a CK722 transistor with collector resistance, $R_c = 500,000$ ohms, and mutual resistance, $R_m = 200,000$ ohms; then, substitution in equation (6) gives the load resistance, $R_L = 120,000$ ohms.

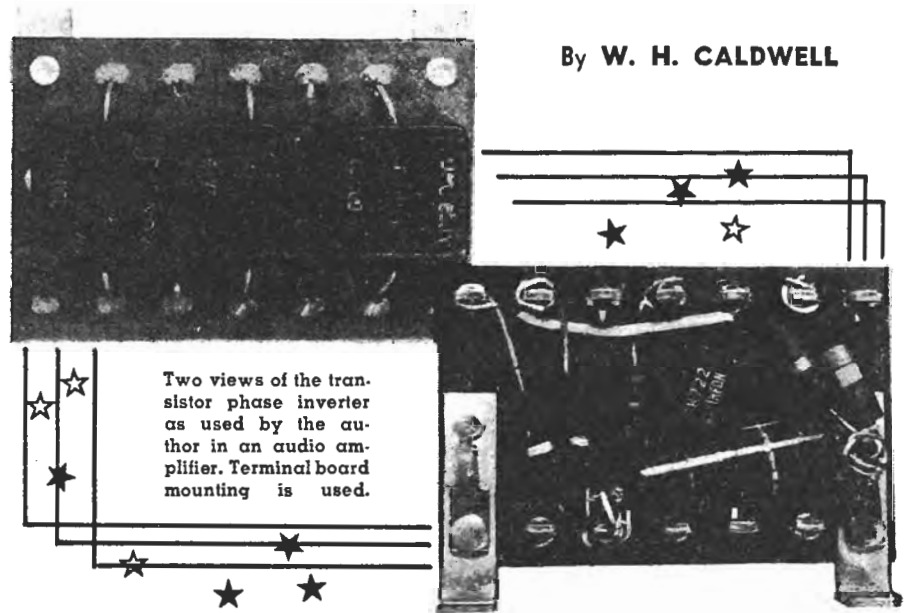

Details on a novel application of transistors of interest to experimenters. It may be used in audio amplifier circuits.

Add a dropping resistor for operating from 250 volts, add coupling and bias resistors, coupling and bypass condensers, and the circuit of Fig. 1B is derived.

The photographs show a compact terminal-board mounting of the circuit. The phase inverter serves to drive push-pull 6V6 tubes in an audio amplifier. The unit serves as a good project to introduce the experimenter to transistor techniques. The design was discussed in some detail to show how it can be adapted to other transistors.

The variations in the gain of the circuit, especially in the collector branch, with different CK722 transistors depends on how close tolerances the manufacturer holds on the characteristics of the transistor. There are,

however, two aspects of this circuit which favor uniformity of performance. One is the use of the transistor to provide unity gain, so that there is no multiplication of variations. The other factor is the large amount of degeneration introduced in the emitter branch of the circuit. Of five CK722 transistors used in the circuit, the maximum variation was found to be less than ten per-cent.

The gain in the emitter branch is constant to within two per-cent for various CK722 transistors. The balance between collector and emitter is quite good, and can be made as close to unity as desired by adjusting the collector load resistor, although this is not necessary for most applications.

The maximum signal level that the

(Continued on page 104)

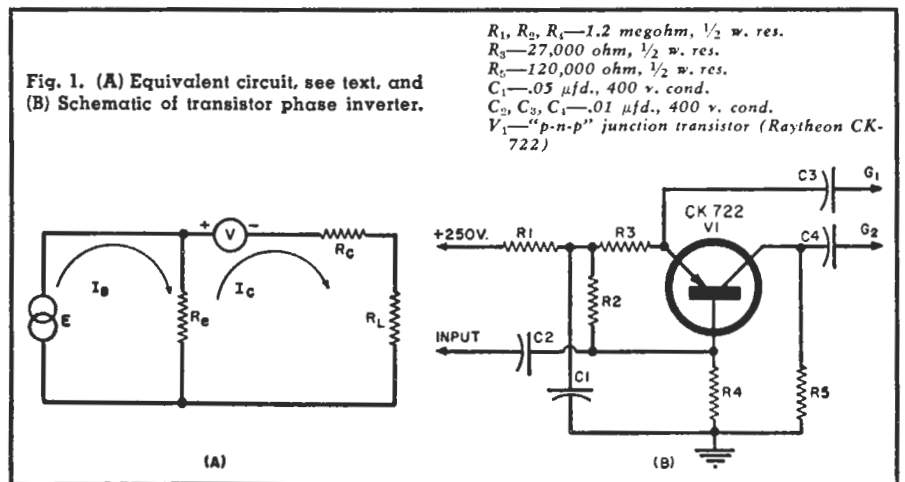

BUILD THIS TRANSISTOR HEARING AID

By RUFUS P. TURNER

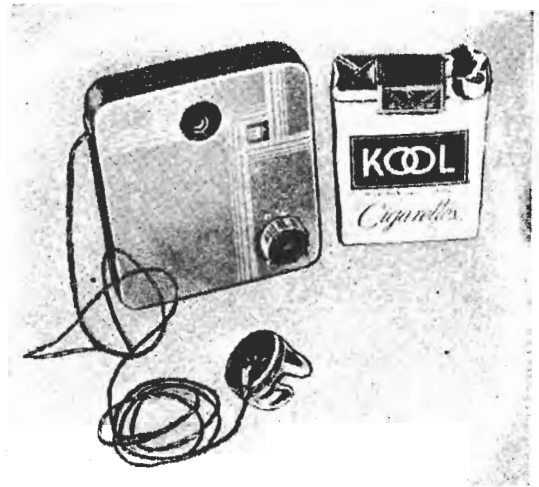

Fig. 1—Hearing aid is cigarette-case size.

COMMERCIAL transistor hearing aids employ type CK718 junction transistors. The CK718 is special type supplied to manufacturers of hearing aids. The simple hearing aid described in this article uses type CK722 transistors which are available to the experimenter.

The task of developing a transistorized hearing aid that might be duplicated by any electronic-technician proved intriguing, but this author met obstacles at every turn. First, no amount of experimenting with the CK722 in resistance-coupled circuits seemed to give the required gain and power output with tolerable noise level, even when four R-C stages were cascaded. Transformer coupling finally was used. Also, the much desired operation on a single 1½-volt cell did not pan out. We had to go to 15 volts. Undoubtedly, the CK721, with its higher power gain and different coefficients, would furnish the required drive. But this is an expensive type, and is not as readily available to the private experimenter as the CK722. And finally, most of the subminiature circuit components we wanted to use just were not to be had. So we used the smallest parts available to the general radio public and made them work in a small space.

The finished hearing aid is shown in photo. It is built into a du Maurier cigarette tin. Many types of inexpensive housings were considered, but preference finally was given to this extra-light, attractively colored aluminum box with hinged lid. Over-all dimensions are 3½ inches high, 3 inches wide, and ¾ inch thick. As Fig. 1 shows, the instrument is just slightly larger than the standard cigarette package beside which it is posed. In fact, it is only 2.8 cubic inches larger and it weighs only approximately 3 times as much as the full pack of cigarettes.

This hearing aid will fit easily into a man's shirt pocket. It is entirely self-contained except for the miniature earphone. Operating current is supplied by a single 15-volt Burgess U10 hear-

ing-aid battery, 1¼ x 15/16 x ½ inches in size; total current drain is 1.4 milliamperes.

Fig. 2 is the complete circuit schematic. Three ground-emitter amplifier stages are used. Transformer coupling is used between stages and between the crystal microphone M and the first stage. The crystal earphone P is bridged directly across to the collector-output circuit of the last stage. It is possible also to use a 1,000-to-3,000-ohm magnetic earphone by connecting it in place of the 25,000-ohm resistor. If the magnetic unit is used, some system of volume control other than that shown in Fig. 2 must be employed. A satisfactory alternative would be a 10,000-ohm potentiometer connected across the secondary of transformer T3, with the wiper (center contact) of this potentiometer connected to the coupling capacitor.

To match the high collector impedance of one stage to the low base-input impedance of the following stage, transformers T2 and T3 are used backward. That is, the collector is connected to the normal secondary (high-impedance winding) and the following base to the normal primary (low-impedance winding). Input transformer T1 is connected so that its high-impedance winding goes to the microphone, and its low-impedance winding to the base-input circuit of the first transistor. While the sub-subouncer transformers shown here do not provide perfect impedance matches, the discrepancy does not appear to hamper good performance, and an important point is that these transformers are available now at radio stores. Undoubtedly, the tiny new Stancor transistor transformers (type UM-110

inter-stage, and UM-112 crystal microphone) would do the job more satisfactorily, and by the time this article is printed they probably will be obtainable from jobbers' stocks.

The coupling capacitors are necessary to prevent short-circuiting the transistor bases to ground through the transformer windings. They should be as high in capacitance as possible for the necessary small physical size, in the interest of good low-frequency response. One microfarad is as high as the author could obtain readily in "smallish" size. The components shown here are Astron Metalite 200-volt metallized-paper 1-µf tubular units. The new tantalum electrolytic capacitors, when available will be considerably smaller, and should aid materially in reducing the size of homemade hearing aids.

The four fixed resistors *must be selected by EXPERIMENT for the individual transistors*. There is enough normal variation in CK722 characteristics to necessitate this picking process. The base resistors may be expected to vary between 100,000 ohms and 3 megohms. The collector resistance in the output of the last transistor will vary from 15,000 to 100,000 ohms. At least, that has been this author's experience. The best test procedure is to connect a variable resistor (potentiometer) temporarily in the position to be occupied by the base resistor, and then to vary it until the best compromise is obtained between low collector current, loud signal with minimum distortion, and lowest noise output. When the best setting has been obtained, remove the variable resistor from the circuit, measure its resistance setting carefully, and replace it in the circuit with the same amount

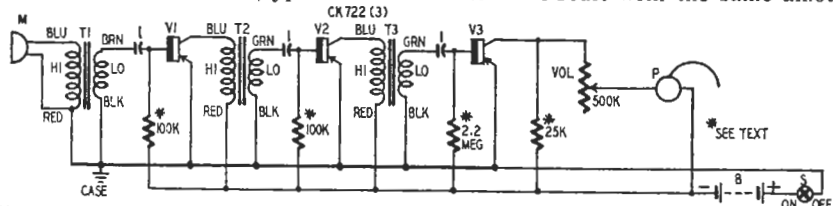

Fig. 2—Schematic of the hearing aid. Asterisked components were chosen by experiment.

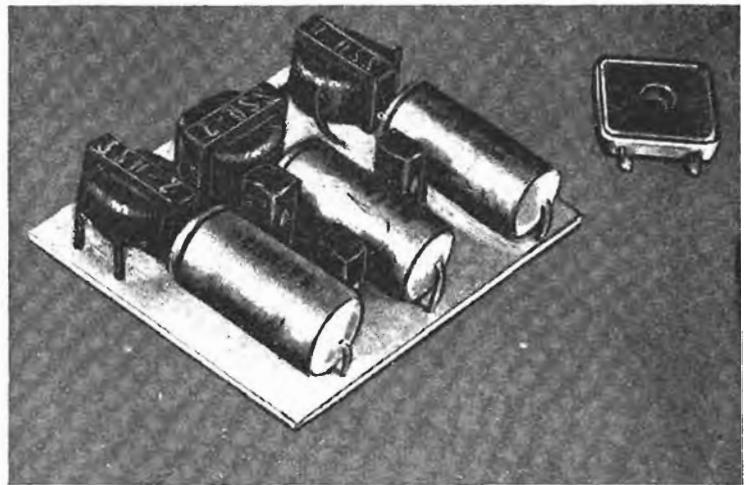
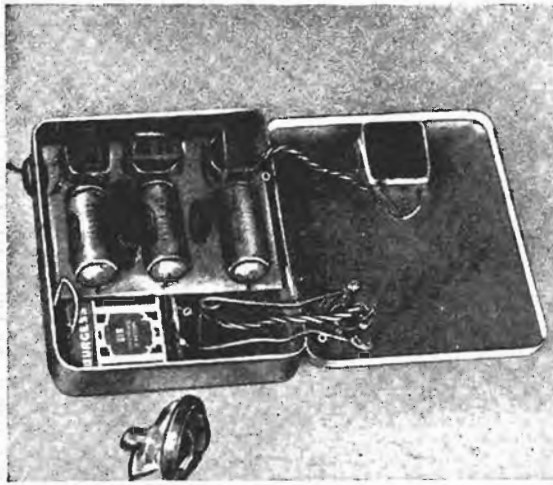

Fig. 3, left, and Fig. 4, right, show the interior of the case and the way the parts are mounted on a plastic card. The transistors are mounted on the card between the cylindrical capacitors. The one farthest to the right is amplifier V1

of fixed resistance. Finally, try it in place of the single collector resistor, and adjust for highest undistorted output with low collector current.

To facilitate these tests, the reader may start out with the author's values as given in the schematic, then substitute the variable resistor progressively in each position. In this way, the entire system will be in operation while one stage is being "pruned." During this test, the microphone may be disconnected temporarily and a 1,000-cycle signal fed into transformer T1 from a low-distortion audio oscillator. An a.c. vacuum-tube voltmeter or oscilloscope may be connected in parallel with the earphone for quantitative observations of output while listening to the signal.

In general, it is a good procedure to minimize the noise level by making adjustments in the input stage, and to maximize output by means of adjustments in the output stage, although some compromise necessarily must be reached between adjustments in each of the three stages.

Once the fixed resistors have been installed, swapping transistors between stages will not be practical. But no inconvenience should arise from having to keep each transistor in its own stage, since their life is said to be 70,000 hours (approximately 8 years if you run the hearing aid 24 hours continuously each day!).

Speech at a comfortable conversational level originating about 4 feet from the microphone will produce a 1-volt swing across the crystal earphone when the VOL control is set for maximum volume. At this setting, the residual noise level varies from 0.05 to 0.1 volt and is a gentle rushing sound. The noise level may be higher or lower with other transistors.

The volume control is a Centralab type B16-218 subminiature potentiometer with ganged switch S. This unit is smaller than a dime, and is in the lower right-hand corner of the case in Fig. 1. The back of the control, showing the three potentiometer lugs and the two switch lugs, can be seen in the lower left-hand corner of the opened

lid in one of the other photographs.

Construction

Construction details are shown in the photographs.

The microphone is mounted in the upper center portion of the hinged lid of the cigarette case. A $\frac{5}{8}$ -inch-diameter hole is cut with a socket punch. This hole is then covered with a square of gauze cloth which serves as a grill when Duco-cemented inside the lid back of the hole. A square washer of thin sponge rubber then is cemented around the hole, over the cloth, and the microphone is cemented to this rubber. This makes a good shock mount.

The volume control is mounted through another $\frac{5}{8}$ -inch-diameter hole in the lower right-hand corner of the lid. One switch lug must be bent temporarily slightly perpendicular to allow passage of both lugs through the hole. The control is held by small screws (furnished) which pass through holes in the switch lugs. One of these screws (and the corresponding switch lug) accordingly must be insulated from the metal lid. This is the lug connected to the positive terminal of the battery. Cellophane (Scotch) tape was used for this insulation in the author's instrument.

One photo (Fig. 4) shows how the circuit components are mounted on a thin plastic card. The three transformers are Duco-cemented to the card, and their leads are passed through holes. The pigtail leads of the transistors and of the three 1- μ f capacitors likewise are passed through holes. Circuit connections are completed under the card by soldering together appropriate pigtails. The four fixed resistors are under the card. To prevent short-circuits, leads that must cross each other are covered with thin spaghetti tubing. After the under-card wiring is completed, coil dope is brushed copiously over the wiring to form a solid cake that prevents grounding to the metal case. Leads are soldered directly to the battery terminals and a covering of Scotch tape is used to insulate the terminals after the connection has been

made. As can be seen in the photographs, the thin earphone cord passes out of the edge of the case through a hole lined with a baby rubber grommet.

Very thin plastic-covered flexible wire is used for the connections from the volume control, switch, microphone, and battery. Note that the transformers have been mounted with their cores at right angles to minimize undesired coupling. The transformer lead colors are indicated in the schematic, to permit proper connections to be made with least confusion. If oscillation should arise, reversing the leads of one of the transformer windings usually will correct it.

Howling due to acoustic feedback will occur whenever the earphone is held close to and pointed at the microphone. With the plastic ear plug attached, the earphone must be placed within 1 inch of the microphone to start the howl. The plug's narrow canal introduces some attenuation of sound, and without it whistling occurs when the earphone faces the microphone from 1 foot away.

Conclusion

Without apology, it should be pointed out that this instrument does not represent the ultimate in subminiaturization and low power drain that may be possible to obtain in transistorized hearing aids. Rather, it is an answer

Materials for hearing aid

Resistors: 1—25,000, 2—100,000 ohms, 1—2.2 meg-ohms, $\frac{1}{4}$ watt; 1—500,000-ohm potentiometer with switch, Centralab 816-218.

Capacitors: 3—1- μ f, miniature Astron 200-volt Metallite.

Transistors: 3—Raytheon CK722 junction type.

Transformers: 1—UTC type S506 subsubouncer (T1);

2—UTC type S502 subsubouncer (T2, T3).

Other equipment: B—Miniature hearing aid battery, Burgess U10. M—Crystal-type hearing-aid microphone, Brush BB-142-2. P—Crystal-type hearing-aid earphone, Brush EB with cord and ear-plug. Cigarette case, etc., as described in text.

to a challenge to develop the smallest practical instrument that can be built from parts obtainable, which would use the readily available CK722 transistor, and which we might reasonably expect a radioman to duplicate with ordinary tools. **END**

A TRANSISTORIZED AUDIO OSCILLATOR

Fig. 1. "Light-powered" audio oscillator which is housed in tiny pill box.



By LOUIS E. GARNER, JR.

A miniature test unit which requires neither batteries nor power lines. It has several unique service applications.

MOST electronic and electrical devices have one circuit in common—the power supply. In some cases, the power supply consists of one or more batteries, and may include additional components such as a vibrator, transformer, rectifier, and filter components. In other cases, the equipment is "line-operated," and the power supply may include a power transformer, rectifier (whether a vacuum tube or "dry disc"), and filter components.

But the audio oscillator shown in Fig. 1 (together with its small earphone) is completely self-contained and requires neither batteries nor "line plug-in" for operation! *All that is required for operation is for a reasonable amount of light to fall on its face.* While not quite "something for nothing," it is a close approach.

The unit shown is not an expensive "laboratory device" but a practical piece of equipment that can be easily duplicated by almost any technician or experimenter.

Its design and construction has been made possible by utilizing two semiconductor devices—a self-generating selenium photocell and a Raytheon type CK722 junction transistor.

Circuit Description

The complete schematic diagram for the *light-powered oscillator* is given in Fig. 2, while an interior view of the unit is shown in Fig. 3.

Referring to the schematic diagram, the transistor collector is connected

to the primary of a small "Sub-Ouncer" transformer, T_1 . The return lead is connected to the "negative" terminal of the self-generating photocell, PS .

The transformer secondary winding is connected between the transistor emitter and, through coupling condenser C_1 , to the transistor base. R_1 serves as a "base return" resistor and is connected to the negative terminal of the photocell.

An output signal is obtained through coupling condenser C_2 and applied to a standard crystal earphone, the lower lead of which connects directly to the transistor emitter. The "positive" terminal of the photocell is also connected to the transistor emitter.

In operation, light striking the photocell generates sufficient voltage to drive a small current through a low impedance load (the maximum current obtained with the photocell shown does not exceed a few hundred microamperes).

This current flows over two paths. Part of the current flows through the R_1 and base-emitter path, establishing the "bias current" for the transistor. Another part of the current flows through the primary of T_1 and the collector-emitter path.

As is readily apparent, the transistor itself is connected in a modified "tickler feedback" grounded-emitter oscillator circuit, with feedback obtained through the primary and secondary winding of T_1 . Current varia-

tions in the primary winding cause a.c. variations in the secondary winding through magnetic coupling. The signal thus developed in the secondary is applied to the base-emitter circuit of the transistor, where amplification takes place, resulting in further variations in the primary current (since this is equal to the collector current).

The oscillation obtained continues as long as sufficient light falls on the photocell.

With the parts values shown, there is a certain amount of "blocking oscillator" action, with the result that the frequency of operation varies with large changes in the amplitude of light falling on the photocell (and hence with changes in the amount of generated current). When the model shown is held in sunlight and gradually turned so that greater amounts of light strike the photocell, the tone gradually increases in pitch, then suddenly changes over to a low frequency "buzz."

Good results can be obtained under incandescent lights, but when the unit is used under fluorescent lamps, the 60-cycle line buzz modulates the normal signal, with the result that a "buzz" is heard in the earphone.

Construction is fairly straightforward and no particular difficulty should be encountered by the skilled technician. However, a few special suggestions appear to be in order.

The author's model has been assembled and wired in a small plastic box (an old "pill box"). As is easily seen in the interior view, Fig. 3, the inside of the box is mostly "empty space." If a smaller plastic box had been available at the time of construction, the entire unit could have really been "miniaturized."

Either a larger or smaller case may be used by the builder, as he prefers. However, two points should be kept in mind when selecting the case—first, it should be large enough so that the photocell used can be easily mounted. Secondly, if the builder plans to mount the photocell inside the case (as the author did), the case should be of clear (transparent) plastic.

This brings up an important point—obtaining the photocell. All parts used in constructing the small unit are commonly available and can be obtained from the majority of wholesale electronics parts distributors—except the photocell. Two possible sources of supply are open to the experimenter, (a) he can salvage a unit from a discarded or used photographic exposure meter, and (b) he can watch for “surplus” sale ads, where these units are sometimes offered at low prices. (*Concord Radio*, of New York, recently offered similar photocells at less than one dollar each.)

Once the photocell has been obtained, the polarity of lead connections must be identified. If these connections are not already marked on the photocell, a 0-1 ma. or 0-500 microammeter should be connected to the photocell and the unit held under a reasonably strong light. By noting whether an “up-scale” or “down-scale” deflection is obtained, the lead polarity can be quickly determined.

In the unit used by the author, the rear surface was positive and two narrow strips on the front (or light-sensitive) surface formed the negative terminals.

When mounting the photocell, make sure that the light-sensitive surface faces in the proper direction. Also make sure that positive contact is made to the photocell terminals. This contact is preferably made through spring surfaces (phosphor bronze is good material to use for this). *No attempt should be made to solder directly to the photocell unless special terminals are provided for this on the unit itself.*

Although the transistor could be wired directly into the circuit, using its leads, it is suggested that a standard 5-pin subminiature tube socket be used instead, as shown in the model. This step is necessary because the short lead lengths used in subminiature wiring might result in the transistor being overheated during soldering.

However, if the builder does not have the proper socket available, and cannot easily obtain one, the transistor may be soldered into the circuit if special care is taken to hold each transistor lead during soldering with a pair of flat-nosed pliers (the pliers should be on the “transistor side” of the soldered joint).

Both the transistor socket (where used) and the “Sub-Ouncer” transformer may be mounted simply by cementing them to the plastic case, using either “Duco” cement or any

general-purpose radio service cement.

Other parts are supported on their own leads.

Adjustment

Once the wiring is completed, the unit should be checked for operation by placing the earphone in the ear and holding the completed oscillator near a reasonably strong light source so that light falls directly on the photocell.

If oscillation is not obtained, try varying the size of R_1 . If necessary, a 250,000 ohm potentiometer may be temporarily connected in place of this resistor and an adjustment made. The value is then checked and a fixed resistor of approximately the same value permanently connected in place.

Should it be impossible to obtain oscillation, even by varying the size of R_1 , reverse the transformer secondary leads (the two black leads, Fig. 2) and again check for oscillation. If necessary, again try varying the size of R_1 .

Where the last step does not permit oscillation to be obtained, it may indicate that the photocell is defective or “weak.” Check this unit for operation by connecting a 0-1 ma. or a 0-500 microammeter across it and holding the unit under a strong light source; a current of at least 50 to 100 microamperes should be obtained, with as high as several hundred microamperes obtained from a really sensitive cell.

In an extreme case it may be necessary to try another transistor, but, in general, this should not prove necessary. The author tried this circuit with a number of different transistors (of the same type) and obtained satisfactory results in every case.

Applications

While the *light-powered audio oscil-*

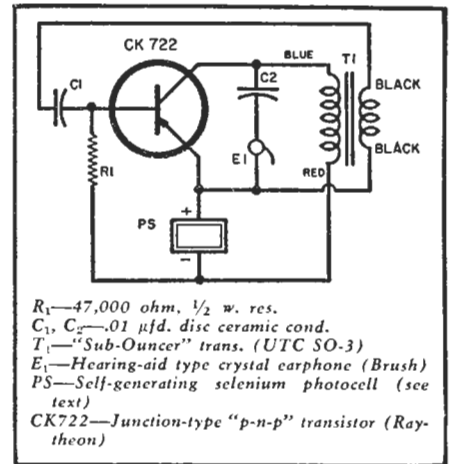

Fig. 2. Schematic of audio oscillator unit.

lator, as shown in the photographs, is basically an experimental “gadget,” the unit does offer a number of practical applications. For example, by providing a hand-key in the emitter circuit, the unit could be used as an extremely compact and inexpensive-to-operate code-practice oscillator.

The unit could also be used by a blind person to determine if a room is lighted or dark. Since the tone pitch varies somewhat with light intensity, this would provide some indication as to the amount of light in a room and as to the light sources.

In addition to the applications of the audio oscillator, the use of “light-power” suggests many other possibilities. The author plans to eventually construct a small light-powered transmitter, a receiver, and possibly a small audio amplifier.

The reader can undoubtedly think of many additional applications of the light-powered audio oscillator, as well as other more general applications of light-powered “electronic” equipment.

—30—

Fig. 3. Internal view. Unit can be constructed in even smaller cabinet if desired.

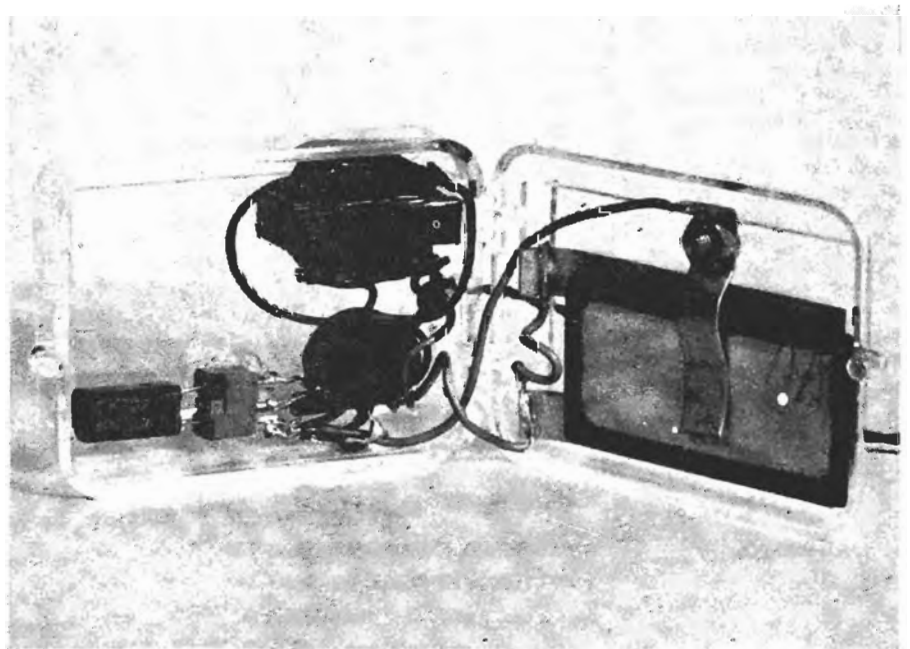

JUNCTION TRANSISTORS

for high-frequency oscillators

Using the junction transistor as an i.f. and r.f. oscillator

By I. QUEEN
EDITORIAL ASSOCIATE

JUNCTION TYPE transistors are made and sold as low-frequency, low-power units. Catalog specs usually call for a certain minimum gain at 1 kc or perhaps 5 kc. No high-frequency specifications are given, but it is known that frequency response begins to droop early. Therefore it may surprise many readers to find that the junction transistor is efficient as an i.f. and r.f. oscillator. I have carried on many experiments with the CK722. Of several tried, all oscillated easily in the i.f. range near 400 and 500 kc. For most transistors tried, less than 1 volt was sufficient power supply. About half could oscillate above 1 mc! These active units required about 3 volts at this high frequency.

Transistors cannot be made as uniform as vacuum tubes. All transistors are efficient at audio frequencies, but even there it is usual to choose a bias resistor for the particular unit in the circuit. At intermediate and radio frequencies the nonuniformity is even more important. Substituting one transistor for another may call for retuning,

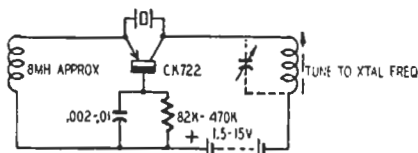

Fig. 1—Crystal oscillator circuit.

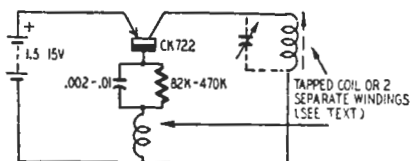

Fig. 2—A self-controlled oscillator.

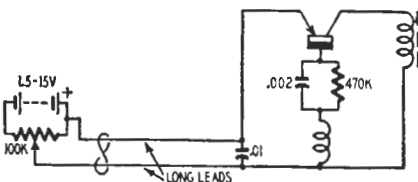

Fig. 3—Using resistance control.

changing the applied voltage, or even redesigning the circuit. Often, the circuit must be designed around the transistor.

If you plan high-frequency experiments and if you have access to several units, determine which are most active at r.f. or i.f. The more sluggish transistors may be set aside for a.f. circuits. Fig. 1 is a typical circuit for a crystal oscillator. Fig. 2 is a self-controlled oscillator. The values shown were found to work well for the particular transistors used. The base resistor, voltage supply, and base capacitor may need adjustment for best operation of your particular transistor.

In Fig. 1, the collector coil has to be tuned to approximately the crystal frequency. Due to transistor loading, the adjustment may vary with the transistor used. I obtained good results using a slug-tuned coil rather than a conventional capacitance-tuned tank.

The tank in Fig. 2 may be a single winding with an intermediate tap, or it may have two separate windings. The collector portion may be 3 or 5 times as large as the base winding. The windings must be correctly polarized. Connect them so that an electron starting out at the base will travel in the same direction around both coils to reach the collector. In other words, the winding should have the same effect as a single coil with an intermediate tap. If capacitor tuning is desired instead of slug-tuning, connect as shown by dotted lines in Fig. 2.

A broadcast oscillator coil is not suitable for a junction-transistor oscillator. Its frequency range is too high. Instead, use an antenna coil with primary, if you want a broadcast-band oscillator. A 455-kc i.f. transformer also makes a good tank. If used as is, it generates a signal near 300 kc. By removing turns, you can reach the broadcast band with it. As turns are taken off, monitor the frequency on a nearby receiver. The oscillator frequency equals the difference between consecutive beats. For example, if you hear signals at 600,

900 kc, etc., your frequency is 300 kc.

It is a good idea to leave a milliammeter or microammeter in series with the battery during experiments on the transistor oscillator. It offers a means of measuring the input to the transistor, and can indicate if the circuit is oscillating. Maximum input to a CK722 is 5 ma, but 1 or 2 ma is generally sufficient for a low-power oscillator. I obtained ample output in most circuits with an input of only 100 μ a. In any case, the current is controlled by the base resistance and the applied voltage, and depends on the individual transistor. A lower base resistance increases the current input and the power output.

Ordinarily, the amount of oscillating current differs from the nonoscillating flow. In a typical case, a current of 44 μ a flowed when the circuit was oscillating. In the nonoscillating condition, this dropped to 40 μ a. This circuit used a 470,000-ohm base resistance and 3 volts input. With a small base resistance, the oscillating value will be less than the nonoscillating current. For example, in the above circuit a 40,000-ohm resistor raised the oscillating current value to 0.5 ma. When not oscillating, it climbed to 0.65 ma. In any circuit the oscillations may be killed by simply shorting out one or both tank coils.

Knowing the oscillating and the nonoscillating current values can save much time. For example, if you are trying to increase frequency by removing coil turns, you can watch the meter to see whether oscillations are still present. After a while, the difference (between oscillating and nonoscillating readings) will narrow down. This shows that you are approaching the frequency limit of your transistor.

One remarkable thing about a transistor self-controlled oscillator is its stability. When properly designed, its signal will be clear as a crystal tone. A slug-tuned high-Q tank, using no shunt capacitance gives a better signal than most heavily capacitance-loaded tube oscillators. This is evidently due to the loading of the transistor itself. It is only when the oscillations are on the verge of dying out that the tone sounds poor. This can happen if you use too low a voltage on the transistor, or if you operate it too close to its frequency limit. It happened here during an experiment when I was using low voltage on a transistor oscillating near 700 kc, and the r.f. signal was modulated by spurious whistles, and hum. The trouble was that I had my meter on the 40- μ a range to measure the very low input current. On this range the meter has a resistance of 2,500 ohms. When I switched to the 1-ma range (100 ohms) the signal immediately became pure unmodulated r.f. again.

The base resistance of a self-controlled oscillator has a considerable effect on frequency. With one circuit I obtained a frequency of 780 kc. The base resistor was 470,000 ohms and the base capacitor 500 μ μ f. Changing the

(Continued on page 105)

TRANSISTOR TOY OSCILLATOR

By G. E. KNAUSENBERGER

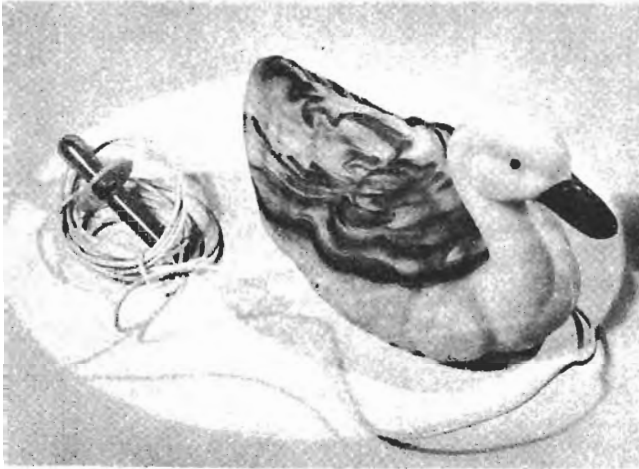

This is a simple device with a Raytheon CK722 pnp-junction transistor in an R. F. oscillator circuit. It can be used in conjunction with a home radio for monitoring any motion which involves capacity changes and thereupon shift in oscillating frequency of the transistor transmitter.

The oscillator, operated from a hearing aid battery, is enclosed in a rubber toy. A lead, acting as antenna, and sensing probe, extends from it. The device may be used for monitoring a baby's rest. The toy is suspended from the rails of the crib, the lead with a pacifier at its end extended within Baby's easy reach.

The home radio in a neighboring room tuned to give an audible beat with the transistor oscillator. As long as Baby rests, the beat frequency will not change. If Baby drops the pacifier or starts playing, rapid tone changes occur.

When the child plays with the toy itself and listens to the tuned in radio, "birdie-whistling" emerges from the loudspeaker, giving great enchantment to the child.

There is no danger connected with the operation; the device is rugged and of long operation time.

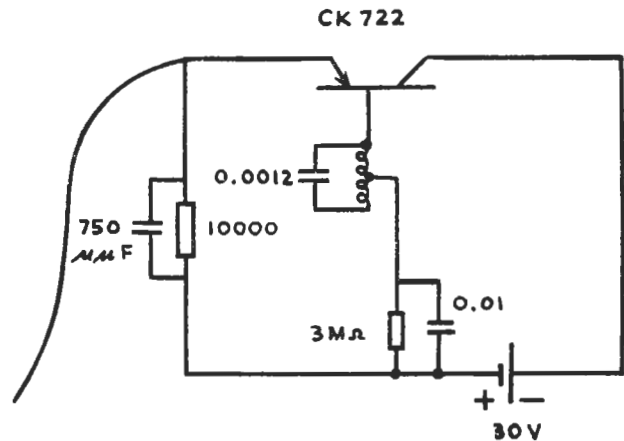

Circuit:

A junction transistor CK722 circuit in grounded collector amplifier connection is destabilized by a parallel tuned circuit in the base. Emitter bias is provided by a resistor, shunted a.c. wise in the base, therefore allowing one battery operation. Output is taken off on emitter side, where a capacitor-resistor combination contributes to a.c. destabilization and d.c. stabilization.

PARTS:

1 resistor $\frac{1}{2}$ W	10000Ω
1 resistor $\frac{1}{2}$ W	3 MΩ
1 capacitor	750 μμF
1 capacitor	0.0012 μF
1 capacitor	0.01 μF

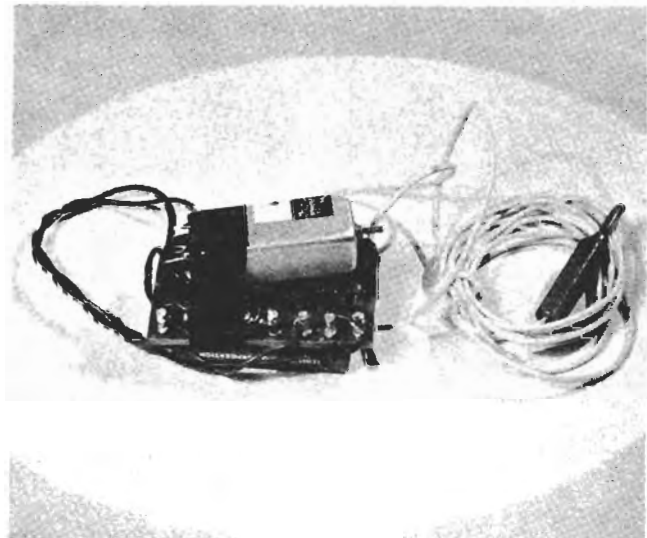



TRANSISTOR PHONO OSCILLATOR

By EDWIN BOHR

The small transistor phono oscillator in actual operation.

MUSIC and conversation can be broadcast over short distances with this tiny transistor oscillator. The basic circuit uses one transistor plus a few inexpensive components. An extra audio stage may be added for more amplification.

The idea that junction transistors are useful only at audio and low radio frequencies is fading away. Practically all CK722 transistors will oscillate in the broadcast band. Some will go as far as 3 megacycles. All of the transistors I've been able to get my hands on have worked in the phono oscillator circuit.

The first experimental circuits with transistor phono oscillators used a separate transistor amplifier to *collector-modulate* another transistor oscillator. At least two transistors were necessary plus some sort of modulation transformer. The circuit evolved into a simpler one-transistor layout that performed better than the two-transistor circuit.

The circuit makes a single transistor do double duty as audio amplifier and oscillator. The oscillator is grounded base and the audio amplifier is grounded emitter. Let us see how it works.

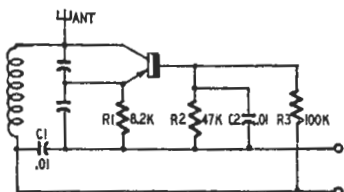
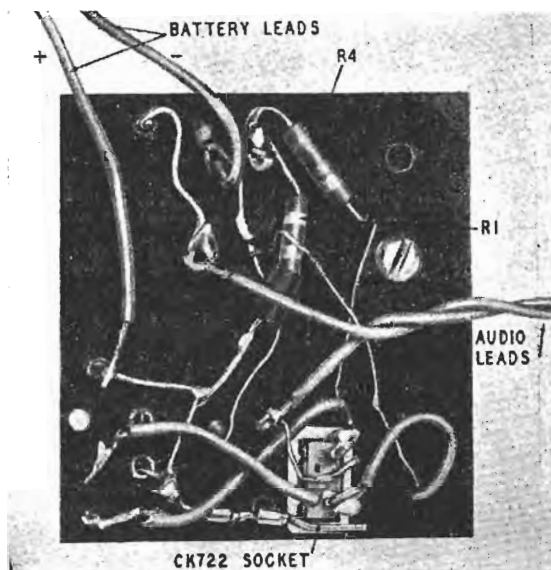
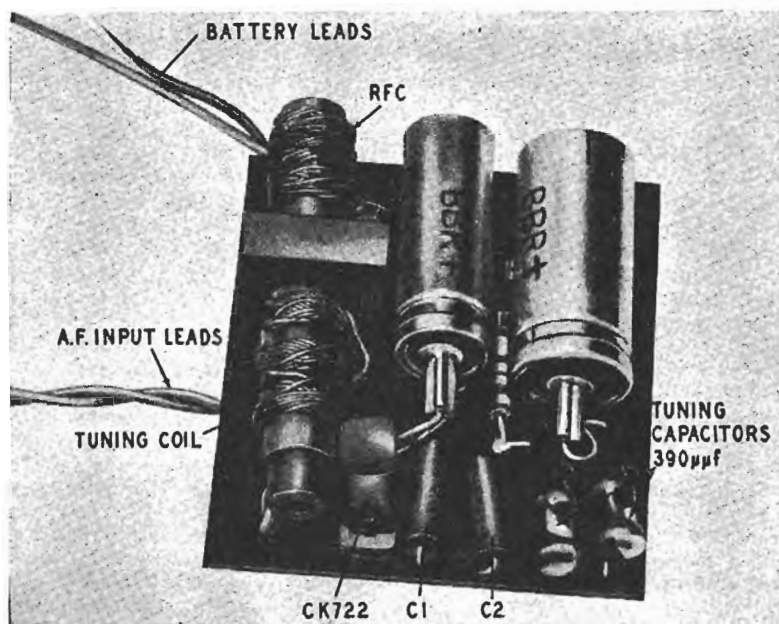

Fig. 1—The basic oscillator circuit.



Despite small size, there is ample room for wiring.



All major components are neatly laid out for maximum compactness.

Circuit

Fig. 1 shows the oscillator alone. Except for resistors R1, R2, and R3 which stabilize the d.c. operating points of the transistor, the circuit is a simple type where feedback is tapped from the tuning capacitors rather than the coil. This is a matter of convenience so permeability tuning can be used. Capacitors C1 and C2 bypass the r.f. around the battery and base resistor.

To also function as an audio amplifier and modulator a few extra components are necessary. (See Fig. 2.) The microphone is connected in the base circuit from the bias resistor R2. This resistor—and also R1—must be bypassed with electrolytics to prevent audio degeneration. Since R1 must be bypassed for audio, we must keep the r.f. feedback from going to ground too. The choke labeled RFC prevents this.

Resistor R4 stops a periodic blocking of the r.f. oscillator by the voltage developed across R1, C3. Two hundred ohms for R4 kills instability for all transistors, but 100 ohms is usually enough. The lowest value that prevents motorboating of the carrier is the most desirable since high values of R4 reduce audio gain.

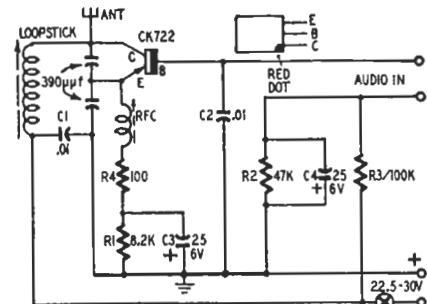

Fig. 2—Diagram of transistor phono oscillator showing component values.

Some of the battery voltage is lost in the stabilizing resistors. So, up to 30 volts can be used without exceeding the transistor ratings. Thirty volts of course gives the greatest power output, but the circuit oscillates down to 15 volts (subject to variations in individual transistors).

Construction

The oscillator chassis is a 2 x 1 3/4 x 1/16-inch piece of insulating board. The components are mounted by pulling their leads through holes drilled in the board. As shown in the photographs, the electrolytics and coils take up the greatest room.

The tuning coil and choke are both cut-down Ferri-Loopstick units. Take off the cardboard sleeve over the loopstick winding and cut off the mounting bracket plus most of the form. The oscillator coil and choke are then mounted to the chassis by pushing them into a block of fiber board. The block has a hole drilled in it the same size as the outside of the coil form.

Push the iron core all the way into the choke, otherwise the oscillator may not work at the lowest end of the tun-

ing range. The iron core in the tuning coil is pushed in and out to adjust the carrier frequency. This way the oscillator can be tuned from about 600 kc to over 1 mc.

The transistor plugs into a hearing-aid tube socket. It is made into a three-pin socket by pushing out two of the contacts.

Some shopping of the mail-order catalogs was necessary to find the smallest inexpensive capacitors. Capacitors C1 and C2 are 200-volt miniature units made by Aerovox (type P83Z). They cost about the same as regular capacitors. The electrolytics are Cornell-Dubilier BBR tubulars.

A few precautions are necessary. Most of the transistor circuit polarities are just opposite to those of vacuum tubes. Note that positive sides of the electrolytics and battery go to ground.

Disconnect the battery before the transistor is removed from its socket.

One end of the socket for the transistor has a raised identifying dot. The socket pin nearest the dot is wired to the collector circuit. This corresponds with the red dot on the transistor case. It certainly will not do the transistor any good to plug it in backward.

The antenna is a whip type, two feet long, mounted by a banana plug and jack. Antennas this short can be connected directly to the collector. Longer antennas must be connected to the collector through a 30-µF trimmer. Without this trimmer, long antennas load the circuit so heavily it will not oscillate.

The complete phono oscillator—batteries and all—is mounted in a 1 1/2 x 2 1/2 x 2 3/4-inch aluminum case.

Operation

To test, connect an earphone to the audio input and slide the iron core about halfway into the tuning coil. Next place a radio within a few feet of the oscillator and tune across the broadcast band. A "shwoosh" or "shistle" will be heard as the transistor carrier is passed over. If a whistle is heard, the carrier is heterodyning with a broadcast station. To cure this, find a quiet spot on the dial and tune the transistor oscillator to that frequency by moving the core. The oscillator will drift for the first few minutes, so let it operate a while before the frequency is set.

If the carrier motorboats, increase the value of R4. To get an idea of the tuning range of the oscillator, follow the carrier with the radio dial as the tuning slug is moved in and out of the coil. The two 390-µF tuning capacitors may be changed to other values. If each capacitor is changed to 100 µF, the oscillator will tune from 1 mc to about 1.8 mc.

Tap on or talk into the earphone and the sound should come through the radio. There will be feedback squeal if the microphone is too close to the speaker of the radio. The earphone gives a pretty good impedance match to the transistor input, but it overloads

and distorts easily on loud sounds. A 3-inch speaker connected through an output transformer to the oscillator makes a better microphone. Carbon microphones are suitable and much more sensitive. Carbon mikes must have a coupling transformer. A small filament transformer will do. Fig. 3 shows

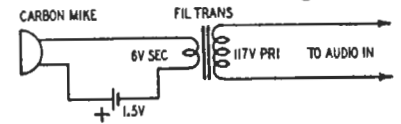

Fig. 3—Circuit for carbon mike input.

how it is connected. The 6-volt side goes to the microphone and battery and the 110-volt winding goes to the transistor.

Clarkstan or Pickering VR cartridges can be connected directly to the oscillator, but the modulation will be very low. A G-E cartridge, because of its lower output, can just barely be heard. Crystal pickups are not satisfactory, even with matching transformers.

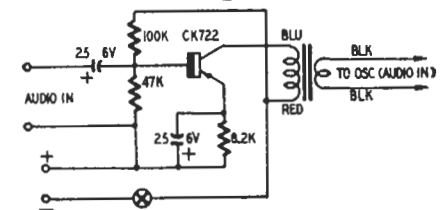

Fig. 4—Schematic of audio amplifier for the transistor phono oscillator.

Before the battery voltage is turned on, the microphone should be connected, or a shorting jumper should be placed across the "audio input" terminals.

Parts for phono oscillator

Resistors: 1—100, 1—8,200, 1—47,000, 1—100,000 ohms, 1/2 watt.

Capacitors: 2—390 uuf, ceramic; 2—.01 uf, 200 volts, paper (Aerovox P83Z); 2—25 uf, 6 volts, electrolytic (Cornell-Dubilier BBR).

Miscellaneous: 1—CK722 transistor; 2—Ferri-Loopstick; 1—socket for transistor; 1—on-off switch; 1—battery (22.5 to 30 volts); 1—1 1/2 x 2 1/2 x 2 3/4-inch aluminum case; 1—fiber board; 1—2-foot whip antenna; 1—jack for antenna.

Parts for amplifier

Resistors: 1—8,200, 1—47,000, 1—100,000 ohms, 1/2 watt.

Capacitors: 2—25 uf, 6 volts, electrolytic.

Miscellaneous: 1—CK722 transistor and socket; 1—plate-to-line transformer, primary impedance 10,000, 25,000 ohms, primary current 3, 1.5 ma, secondary impedance 200, 500 ohms (UTC SO-3).

Amplifier

Once the oscillator is built you may want to add an extra stage of audio amplification. This gives satisfactory operation with VR cartridges. An amplifier is shown in Fig. 4. Like the oscillator, the amplifier is d.c. stabilized. There is no need to make any circuit adjustments for individual transistors. The output of the amplifier is connected directly to the audio input terminals of the oscillator.

Conclusions

The phono oscillator makes a very good experimental transistor project. The range is limited because of the low power, yet it can transmit a signal from room to room. END

A SUBMINIATURE CODE PRACTICE OSCILLATOR

By
LOUIS E. GARNER, JR.

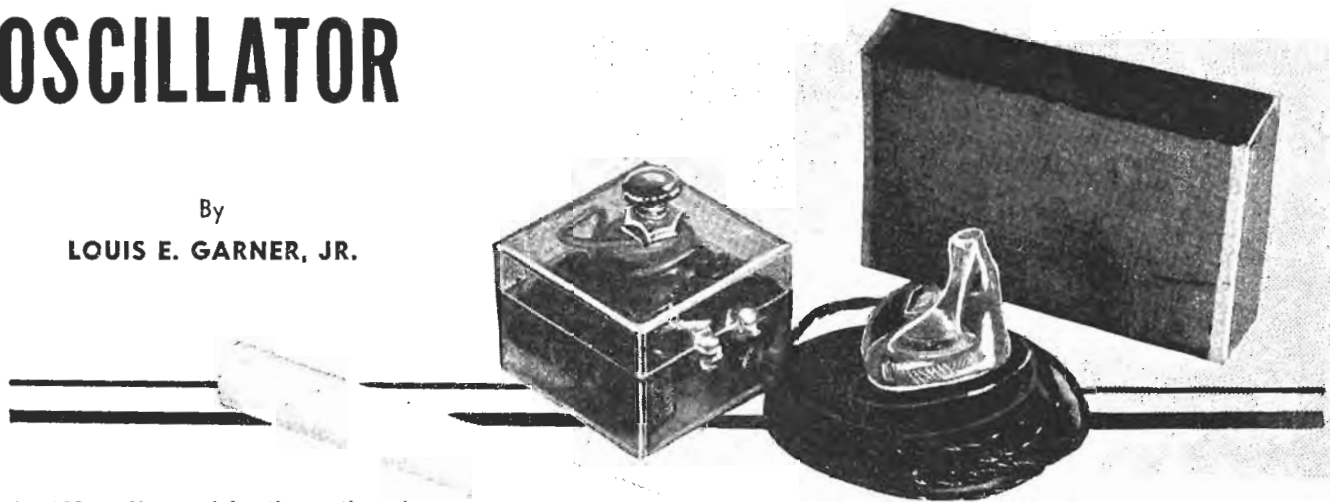

Fig. 1. The tiny code practice oscillator and earphone shown with matchbox and king-sized cigarette.

IN AN earlier article, the author described the construction and use of a compact "pocket" sized code practice oscillator ("A Transistor Code Practice Oscillator, April, 1953, RADIO & TELEVISION NEWS). Although the unit described in the earlier article was quite compact, no real attempt was made to "miniaturize" it . . . except for a hearing aid type battery and the transistor, all components used were standard-sized, and the unit was intended to be used with a regulation hand-key and standard earphones.

Nonetheless, the author received a good deal of good-natured kidding from friends about the size of the oscillator. Such remarks as "why not build a vest-pocket sized oscillator?" and "sure the oscillator is small, but the key and headphone take up too much space" were not uncommon.

Being human, a decision was quickly reached to build a code practice oscillator that was *really small* . . . one in which every part would be so compact that the entire practice set-up, oscillator, power source, key and headphones, could be easily fitted not only in a vest-pocket, but *even in a watch pocket* . . . and yet one which could be used for serious code practice, rather than a tiny "museum piece" destined to collect dust in a forgotten corner. It was also decided to design a unit that could be easily duplicated by any competent technician, using parts available through most of the larger wholesale electronic parts distributors.

The result is shown in Fig. 1 alongside a standard matchbox and a king-sized cigarette. The entire code practice set-up is shown here, including the "key," the oscillator, the power source, and the headphone. The key, oscillator, and power supply are all within the small plastic box, with the hearing aid type earphone (and its cord) shown alongside.

As can be seen by reference to the schematic diagram of Fig. 2, the *Raytheon* junction transistor ("*p-n-p*")

type) is connected in a modified "tickler" feedback grounded-emitter audio oscillator circuit, with feedback provided by transformer T_1 .

In operation, no current flows until the "key" is depressed . . . this eliminates the need for a separate "on-off" switch.

When the key is closed, d.c. can flow over two paths. Part of the current flows over the R_1 -base-emitter path, establishing the base "bias" current for the transistor. Another part of the current flows over the path consisting of the primary of T_1 and the collector-emitter circuit of the transistor.

The current drain on the power source depends primarily on the size of R_1 , not only because this resistor is in series with the base-emitter current path, but also because the amount of base current flow, in turn, determines the d.c. collector current flow. By keeping R_1 large (10 megohms in the author's model) the current drain is kept small and long battery life is insured. The actual battery life, in normal use, should approach the "shelf" life of the cell.

Variations in the primary current of T_1 are coupled, through magnetic lines of force, to the secondary winding, where they appear as an a.c. voltage. This signal, in turn, is applied through the d.c. blocking condenser C_1 to the base-emitter circuit of the transistor. The step-down turns ratio between the primary and secondary winding of T_1 permits matching the low input impedance of the transistor amplifier stage.

The signal is amplified by the tran-

sistor and re-applied to the primary of T_1 . In this fashion, the basic condition of signal amplification with positive feedback is set up, and oscillation occurs.

The output audio signal is obtained through coupling condenser C_2 and applied to the *Brush* crystal earphone.

Construction Hints

All the electrical and mechanical components for this unit, except the earphone and its cord, are assembled in a small plastic box measuring $\frac{7}{8}$ " x $1\frac{1}{8}$ " x $1\frac{1}{8}$ ". A somewhat larger case may be employed, if desired, and will make the wiring easier.

Although a metal case may be used in place of the plastic box, plastic is preferred as it simplifies insulation problems.

The general parts arrangement used by the author is apparent from the exterior and interior views of the oscillator, Figs. 1 and 4, respectively. Layout is not critical, however, and the builder may use any layout that will permit fitting the various parts compactly into the particular case used.

Mounting Parts: Only the two major components, the "*Sub-SubOuncer*" transformer and the *Mallory* RM-1000 mercury cell are actually "mounted." The other parts, *i.e.*, the transistor, the two condensers, and the resistor are allowed to more or less "hang free." Actually, the wiring is sufficiently compact so that the pressure between parts when the case is closed is adequate to hold them immobile.

The transformer is mounted by

Although housed in a plastic box measuring just $\frac{7}{8}$ " x $1\frac{1}{8}$ " x $1\frac{1}{8}$ ", this "watch pocket" unit really works

cementing it to the case, using either *Duco cement* or general purpose *radio service cement*.

A small "L" bracket is used to hold the mercury cell in place, pressing it against the side of the case. This bracket also serves to make electrical contact to the outer shell (positive terminal) of the cell.

Wiring: Special care must be exercised when wiring the oscillator unit, both to prevent damage to the transistor and to the plastic case. Because so little space is available for components, it was not found practicable to use a socket for the transistor, and soldered connections had to be made directly to the transistor leads.

If the builder uses a somewhat larger case, so that a little "extra" space is available, it is suggested that a socket be used for the transistor, and that the transistor not be installed until all wiring is completed. A standard 5-pin subminiature tube socket is suitable for the CK722 transistor (only three pins are used.)

For best results, a small "pencil" type iron should be used. Keep the iron well-tinned and clean. Tin each wire or component lead prior to making the final connection, and use *quickly* soldered lap joints.

The transformer secondary leads (black) should be arranged so they can be easily interchanged should such a step prove necessary during final testing of the completed unit.

Once the oscillator wiring has been completed, and the unit tested, exposed connections may be effectively insulated by applying two or three coats of fingernail polish. Do not coat the negative terminal of the mercury cell, or the contact of the "key," however!

Assembling the "key": The construction of the miniature "key" is clearly visible in the photographs and in the side view sketch given in Fig. 3. Required parts are a small machine screw (preferably one having a smooth head), a small compression spring, and a nut to fit the machine screw used.

A small hole is drilled in the plastic case directly above the location of the

mercury cell, and the key assembled so that contact is made with the negative terminal of the cell when the key is depressed.

Contact to the key is made by lap-soldering a wire to the side of the machine nut. This connection should be made *before* assembling the key to avoid melting the plastic case.

For best results the threads of the machine screw above the section where the nut fits on should be filed smooth. Otherwise, there is a certain tendency to catch on either the spring or the sides of the hole (in the case).

The side of the nut facing the battery should be filed smooth to insure good positive contact each time the key is depressed, as well as to reduce the thickness of the nut.

Testing And Adjustment

Once all wiring is completed, *carefully* check each connection to make sure there are no errors in wiring and that all joints are secure. Holding the earphone close to the ear, depress and release the "key" a few times.

If oscillation does not take place, try reversing the secondary (black) leads of the transformer (T_1). It is important that these leads be connected correctly to insure proper phasing of the feedback signal if oscillation is to take place.

Should it still be impossible to obtain operation, it may indicate that good electrical contact to the battery is not made when the "key" is depressed, or that the battery, transistor, transformer, or some other part is defective. Check each part in turn. Since it may prove somewhat difficult to properly check the transistor, all tests may be concentrated on other parts, including the earphone and cord.

In some instances it may be necessary to change the value of R_1 . Should this be the case, temporarily connect a potentiometer or resistance substitution box in place of R_1 , adjusting the value until oscillation takes place. Then install a fixed resistor having the appropriate value.

Because of the small size and construction of the "key" used this unit

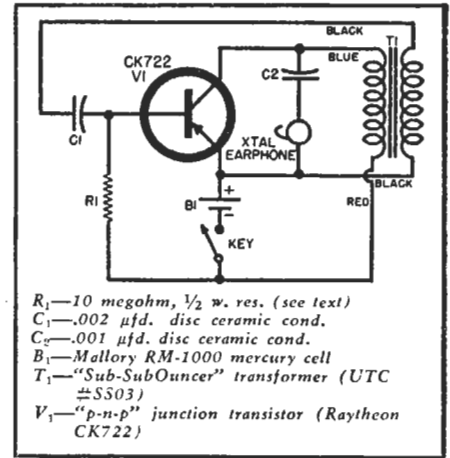

Fig. 2. Complete schematic of the subminiature oscillator which uses a transistor.

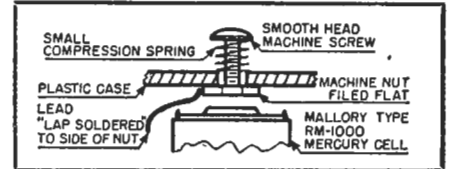

Fig. 3. Mechanical details for building the key to be used with the oscillator.

should not be used exclusively in learning the radiotelegraph code. A standard hand-key (which, if desired, may be connected in place of the miniature key) should be used for regular practice sessions in order to develop a good "fist." Use the miniature key only for supplementary practice.

When using the miniature key, try to simulate, as far as is practicable, the normal hand movements used with a standard hand-key. One technique is illustrated in Fig. 5.

The oscillator is held *lightly* between the thumb and middle finger, with the forefinger pressing on the "key." Code is sent using a normal wrist motion, *not the motion of the forefinger alone*. In order to do this, the thumb and middle finger (holding the oscillator) are allowed to flex slightly as the key is depressed.

A little practice will enable almost anyone to acquire this technique.—50—

Fig. 4. Interior view of unit showing parts layout.

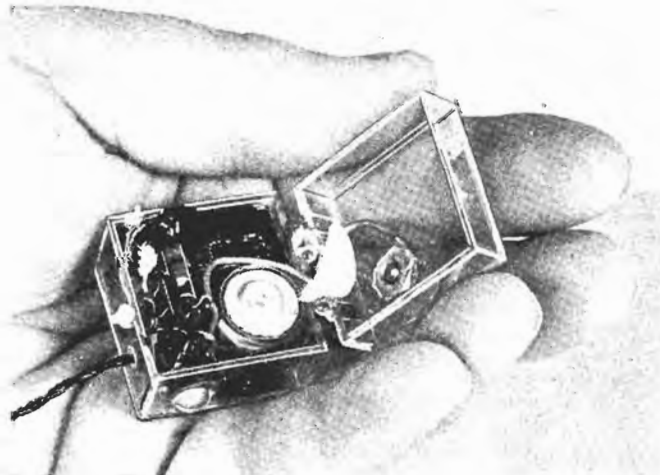
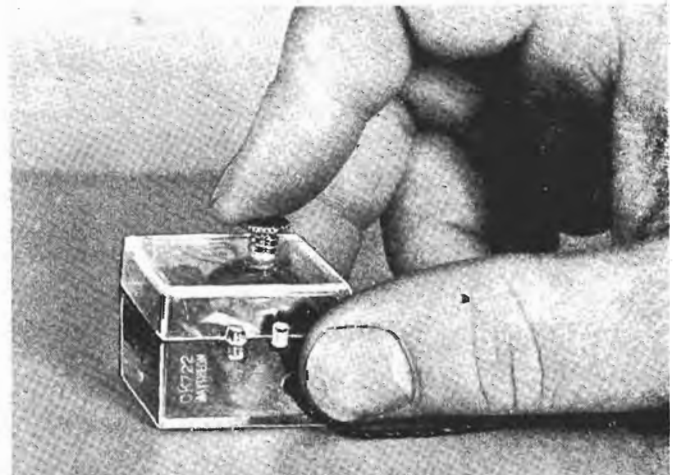

Fig. 5. Correct position for operating oscillator.



TRANSISTOR OSCILLATOR PRODUCES SUBHARMONICS

By I. QUEEN

If you like to experiment with new, unconventional circuits, try this one. It is a subharmonic crystal oscillator using a junction transistor. It acts just like an oscillator with a crystal frequency between 75-125 kc. Crystals in this range are very expensive and not generally available. We get the same results with a surplus crystal in the 400-kc range. The cost of transistor plus surplus crystal is actually less than that of a standard low-frequency crystal.

The circuit uses a CK722 transistor. This is the low-cost junction unit now available at most parts distributors. The crystal is connected between emitter and collector as shown in the diagram. If desired, it may be connected between emitter and base instead, results being about the same.

The two coils are part of a 262-kc i.f. transformer with about 30% of the turns removed from the primary (red-blue) winding. Without the crystal, this circuit looks and acts like a conventional Hartley (tapped coil) circuit. It generates a low-frequency signal with strong harmonics through the broadcast band. The oscillator frequency is approximately 140 kc, and harmonics can be heard at 560 kc, 700 kc, 840 kc, etc. One or both trimmers may be used to vary the fundamental over a small range. These self-excited signals will sound about T7 or T8. Like those from any low-C oscillator they will be shaky and susceptible to hand capacitance and other external effects.

To set the subharmonic generator, tune the circuit (still without crystal) so that its output is slightly lower than the desired subharmonic. For example, if you use a 375-kc crystal and want a 125-kc subharmonic, set the oscillator to about 120 kc. You will hear harmonics at 600 kc, 720 kc, etc. When you insert the crystal into its socket, the signal will change to a pure T9 tone. It will suddenly become highly stable regardless of hand capacitance.

Adjust one or both trimmers for maximum stability and output. A good test is to turn the battery on and off several times to see if the oscillations start each time. If you have a 400-kc crystal, and wish to build a 100-kc crystal oscillator, tune the i.f. transformer to about 100 kc or slightly below. If 100 kc is too low for your transformer, you may need added capacitance across the secondary (green-black) winding (see dotted lines in diagram).

A single 1.5-volt penlight cell supplies sufficient power for the transistor. Its drain is low, so battery life should approach shelf life.

A few different transistors were tried in this circuit. All functioned satisfactorily. All were good subharmonic generators, and in each case the

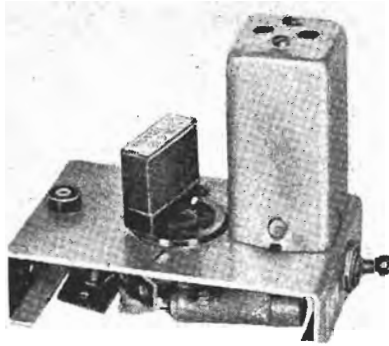

The complete subharmonic oscillator. harmonics were strong—well into the high-frequency spectrum. For example, a 100-kc subharmonic generator (using a 400-kc crystal) provided harmonics beyond 20 mc. For greatest output, connect the antenna lead of the oscillator to the receiver antenna post.

I arrived at this unusual circuit while experimenting with transistor crystal oscillators. I am not sure what the theory is, but the following may come quite close to the truth. Evidently the two coils in series act like a Hartley tank, tapped near the middle. The tank resonates near 125 kc, and may be adjusted over a narrow range by tuning either trimmer of the transformer. This is the frequency which I have observed when the crystal is removed from its circuit. Now, one of the

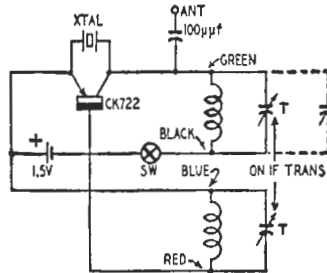

Diagram of the subharmonic generator.

transformer coils alone resonates near 400 kc, the crystal frequency. The coil is between collector and base, and acts like the plate tank of a conventional tube oscillator. The "plate" coil, with the crystal, makes a crystal oscillator. Thus we have two signals, one near 125 kc, the other, approximately 400 kc. The first signal is self-controlled, the other is crystal-controlled. By tuning one or both trimmers we can adjust these frequencies so that one is an exact subharmonic of the other. When this happens, the low-frequency signals can be heard but their quality equals that of the high-frequency crystal tone. In other words, they are synchronized and controlled by the crystal.

A similar explanation is offered by Frank Dukat of Raytheon. He says:

"It looks as if we have two oscillators operating somewhat independently, but when one is a harmonic of the other, they lock together at the frequency of the more stable one, or, in

this case, at a sub-harmonic of the crystal. It appears that the lower frequency oscillator is a Colpitts oscillator. This is the upper tuned circuit, and its feedback is set by collector-to-base and base-to-emitter capacitance within the transistor. We think that the crystal oscillator is a Hartley oscillator with feedback due to the inductive coupling between the coils and only able to oscillate at 400 kc because at other frequencies the lower tuned circuit is shunted out by the crystal."

Not all transistors tried in this circuit act alike. I tried three and all gave satisfactory results. However, one transistor generated much lower frequencies than the other two. For example, with the crystal removed from its socket, we have a self-controlled oscillator as already explained. Now with the tank values we have we would expect a fundamental frequency near 140 kc. This is what I observed when two of our transistors were used. The third generated a frequency only half as much, 70 kc, and without changing the tuning of the transformer. Possibly this particular transistor is more active than the others. Evidently it acts as a "halver" as well as subharmonic generator. Other tests show that this transistor performs better than the others in high-frequency circuits.

The transistors which generate oscillations near 140 kc are used to generate 125 kc from a 375-kc crystal. With a small capacitor across the transformer winding (black-green) we can reach 100 kc. This gives the equivalent of a 100 kc-crystal oscillator when we plug in a 400 kc crystal. As for the transistor which oscillates near 70 kc, I am using this in a 75-kc crystal oscillator by plugging in a 375-kc crystal. With slight change in trimmer tuning, I have an excellent 80-kc crystal oscillator when I insert a 400-kc crystal.

If your transistor does not generate low enough oscillations and you want a very low-frequency oscillator, shunt the transformer coils until you reach the desired frequency. Of course it is preferable not to use a capacitor across the transformer if you don't need it. For one thing, the instrument will be smaller.

Regardless of what actually makes this circuit "tick", there are many useful applications for it. A low-frequency crystal oscillator provides numerous stable check points over the broadcast band. It generates standard frequencies on the ham bands, and for testing receivers. There is nothing to plug in and nothing to tune (once the instrument is working). Also, if your oscillator does not start each time you switch it on (due to sluggish crystal or other causes) flip the switch on and off a few times or simply disconnect and reconnect the transistor oscillator antenna lead. END

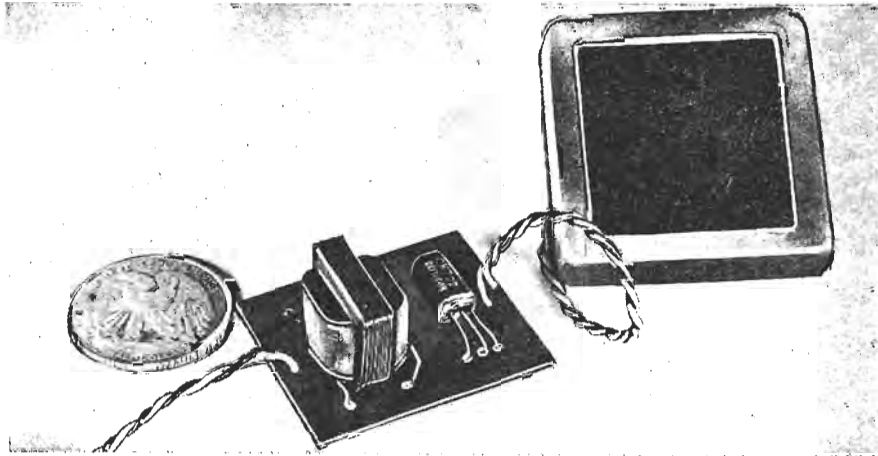

Oscillator is little larger than half dollar. Photocell power supply is at right.

TRANSISTOR OSCILLATOR IS POWERED BY LIGHT

By RUFUS P. TURNER

THE high efficiency of the junction transistor and its ability to operate on extremely low d.c. voltages make possible many interesting low-powered devices hitherto unattainable in the electronic field.

A typical example is the miniature audio oscillator shown in the accompanying illustrations. It receives all its d.c. operating voltage from a self-generating photocell. An interesting fact to note is that both the active units in this circuit are semiconductor devices—the triode is a *germanium* transistor (CK722) and the power supply is a *selenium* photocell (International Rectifier Corporation Type DP-5 or equivalent).

In subdued room light, 0.02 millivolt r.m.s. is developed across a 2,000-ohm magnetic headset. A 100-watt lamp, 1 foot from the cell, gives a signal of 0.5 millivolt. From 1 to 2 millivolts can be obtained when the cell is illuminated by direct sunlight. All these signals can be heard easily in the headphones.

With the UTC type SO-3 oscillator transformer shown, the signal frequency is approximately 900 cycles and the waveform good. The frequency can be lowered by means of suitable capaci-

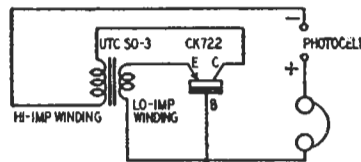

The oscillator has very little circuitry.

tance values in parallel with the high-impedance winding of the transformer.

If the reader does not have a sub-miniature transformer available, any microphone transformer or line transformer (200 or 500 ohms to single or push-pull grids) will do the job. Connect the high- and low-impedance windings as shown in the figure. Polarity of the windings is important, since the phasing must be correct for oscillation. If the device does not oscillate readily when the photocell is illuminated, reverse the connections of one of the transformer windings.

While this oscillator is a novel gadget, it is not as much of a toy as it might appear first-hand. For example, in one very practical application, the output signal (which is proportional to the amount of light falling upon the photo-

cell) may be amplified directly with a conventional amplifier, and the amplified output may be rectified and caused to operate a d.c. relay or high-current meter. For this purpose, the headphones may be replaced with a 2,000-ohm resistor across which the input terminals of the amplifier are connected.

In this way, one of the knottiest problems connected with self-generating photocells is solved—that of amplifying the low d.c. output of these devices. Stable d.c. amplifiers which might be used for the purpose are complicated, bulky, and expensive. The only previous alternative has been to chop the light beam to obtain from the photocell an "a.c." output which might be handled by a conventional amplifier, or to feed the d.c. from the cell into some sort of modulator whose a.c. output would be proportional to the applied d.c. This transistor oscillator converts the direct current from the photocell immediately into a.c. *without* light-chopping or modulation in bulky preamplifier equipment. It has no standby power requirements, no batteries to replace, no connections to the power line, and its active components have almost unlimited life. **END**

TRANSISTOR OSCILLATOR

By LOUIS CARCANO

A SIMPLE transistor oscillator circuit is shown in the accompanying diagram. The constants given are for operation at approximately 1 kc. The waveform is excellent.

Resistor R_1 determines the emitter current, hence the collector current. If the oscillator output is heavily loaded, R_1 will have to be made a lower value than that specified. If it is lightly loaded, the value can be made higher.

Resistor R_2 is used to limit the reverse collector current which flows when the collector end of the tuned circuit swings positive. If its value is too low, flat-tops appear on the positive peak of the wave.

If the value is too high, oscillation stops. The waveform is better at high values. The value of R_2 depends on the load and on the "Q" of the coil. Use from 10,000 to 20,000 ohms with a high-"Q" toroid coil and from 0 to 1000 ohms with a low-"Q" choke.

The battery voltage is not critical. The drain is about .1 ma. with the values shown. The peak output voltage is about equal to the collector battery voltage.

A crystal diode, with its "anode" polarized toward the collector, can be used to replace R_2 ; but its performance is just about on a par with the resistor.

Operation is class C.

Oscillator using "p-n-p" junction transistor.

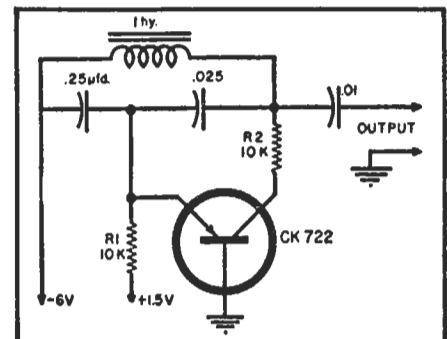

I.F.-R.F. CRYSTAL OSCILLATOR USES JUNCTION TRANSISTOR

By I. QUEEN

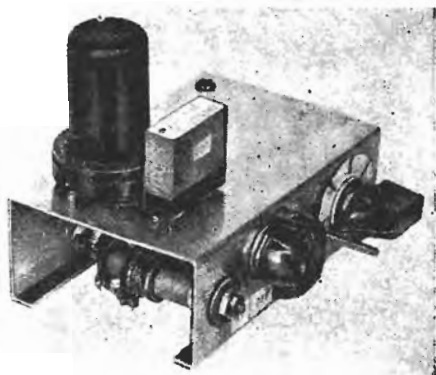

I.f.-r.f. crystals are mounted on top

MANY experimenters assume that junction transistors are effective only at audio frequencies, so they don't try to use them in high-frequency circuits. Actually most junction transistors I have tried perform well as oscillators through the i.f. range, often beyond 1 mc. This crystal oscillator uses a CK722 junction transistor, and oscillates in the intermediate-frequency and radio-frequency range. It is equipped with an output control and is suitable for measuring, aligning, and calibrating.

Fig. 1 shows the hookup. The transistor is powered by a pair of penlight cells that will last a long time. Provision is made for two different frequencies. I used a 1-mc crystal (looks like a metal tube in the photo) and a 375-kc crystal (surplus type). Both crystals are left in the circuit at all times. Only the coils are switched. The circuit oscillates when the collector coil is tuned close to either one of the crystal frequencies.

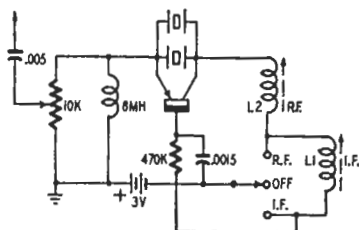

Fig. 1—The i.f.-r.f. crystal oscillator.

The i.f. coil (L1) is a Grayburne Vari-Choke whose inductance may be varied from 0.65 to 6.0 mh. It may be replaced by a coil with an inductance of about 3.5 mh. For example, I found that a standard 2.5-mh coil in series with a 1-mh coil works fine. The r.f. coil (L2) is a slug-tuned broadcast oscillator unit (for 465 kc i.f.). It tunes to

1 mc with the slug almost all the way in. If a Q meter or test oscillator is available, the coils may be pretuned to the desired frequencies. Final tuning may then be done in the crystal oscillator.

The i.f. coil tunes broadly; the same setting can be used for crystals ranging from below 375 kc to over 400 kc. Thus, if you have a number of surplus i.f. crystals, you can easily change frequency without retuning. Simply plug in the crystal you want.

The oscillator is adjusted first with the switch in the R.F. position. Set the slug in L2 for output on 1 mc or whatever frequency you select. Next, throw the switch to I.F. and adjust the tuning of L1 for output on the desired frequency in the i.f. range.

Materials for i.f.-r.f. oscillator

1—47,000-ohms, 1/2-watt, resistor; 1—10,000-ohm potentiometer; 1—.0015- μ f capacitor; 1—.005- μ f capacitor; 2—crystals; 1—CK722 transistor; 3—sockets for crystals and transistor; 1—3.5-mh coil; 1—slug-tuned broadcast oscillator coil; 1—3-position switch; 2—penlight cells.



Underchassis view shows chassis layout.

A single penlight cell is sufficient for the i.f. band. However, I found it advisable to use at least two cells for the 1-mc range; otherwise the oscillator does not start each time and the output is weak. Since transistors are not uniform, you may find that still greater voltage is needed for the r.f. oscillator. You may have to use 9 volts or more. However, of several tried here, I found all functioned satisfactorily. One even oscillated at 1 mc with less than 1.5 volts! END

MINIATURE AUDIO-FREQUENCY TEST OSCILLATOR

By I. QUEEN

THIS tiny oscillator is self-contained (except for load) and is mounted inside a plastic box only 2 1/4 x 1 1/4 x 7/8 inches. The heart of the circuit is a Raytheon transistor, type CK722. It is powered by one AA dry cell. Output is strong enough to provide a good headphone signal.

Audio feedback is maintained by a "Sub-Ouncer" 3:1 ratio audio transformer. Any other transformer may be used but will require considerably more space. If the "Sub-Ouncer" is used, follow the terminal connections specified. If another type is used, connect the low-impedance winding in the base circuit, the high-impedance winding in the collector circuit. If no oscillations are heard, try reversing connections to one of the windings.

The frequency is determined by the particular transformer used and the capacitor in series with the base. With

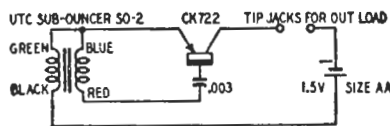

the circuit and constants shown in the figure the frequency is 1,500 cycles. To change the tone use a different value of capacitor. The frequency will vary (upwards) to some extent when the oscillator is used near a strong incandescent lamp. For example, the frequency will rise to about 2 kc if a 40-watt lamp is brought a few inches from the oscillator. A fluorescent lamp does not cause a perceptible change. Sunlight, even indirect, makes a considerable difference in the frequency. Evidently the transistor is slightly photosensitive.

The oscillator was constructed to see

how compact a reliable instrument could be. It is more than a mere toy. It may be used to test a.f. amplifiers or for long-distance CW communication by wire. It may be used as a source of known frequency (if shielded from light). It is easily carried about in a pocket to permit indulging in code practice during lunch hours or recess, or other spare periods.

The efficiency of the CK722 transistor is astounding. In this circuit it consumes 5 microwatts. This is about .005 of 1% as much power as required by a sensitive high-frequency buzzer, or a low-power tube oscillator.

This oscillator contains an unusual degree of miniaturization. With an extremely small cell for power, the CK722 transistor, and the UTC subouncer SO-2 transformer (10,000-ohm primary, 90,000-ohm secondary), the unit can be easily handled. END



Fig. 1. Over-all view of the home-built counter with its associated accessories (from left to right): selenium photocell, mercury switch, the "Microswitch", and push-button switch.

By
LOUIS E. GARNER, JR.

Details on a versatile unit of many applications which features a compact, battery-powered transistor amplifier

THERE is probably not an industry or business in the nation that has not, at one time or another, been confronted with a "counting" problem of some sort. Manufacturing firms may wish to count the items passing a given point in a production line, department stores may wish to count the number of customers entering a certain door, a real estate firm may wish to count the persons visiting a model

home, and almost every merchant has a good-sized counting job at inventory time.

Although there are numerous commercial counters on the market, most units are designed to perform limited types of counting operations. In some instances, these limitations so restrict the applications of particular units that it is very often necessary to rely

on "custom-built" counting devices.

However, the counter and accessories shown in Fig. 1 combine to provide so many different types of counting operations as to be considered an almost "universal" counter. Not only will the instrument handle routine counting operations, where the closure of a simple switch is involved, but it will also "count" where the actuating signal is a small current, as might be obtained from a photocell or thermopile.

This extreme versatility has been made possible by combining the characteristics of a direct-coupled transistor amplifier, a sensitive relay, and an electromagnetic counter in one compact assembly.

The basic design is straightforward and fairly simple, so the average technician should have little or no difficulty in assembling a similar unit in less than a day's time. Once assembled, the technician may keep the counter for his own use, or sell or rent it to firms requiring such an instrument.

Fig. 2. Rear view of the counter with the terminals and controls labeled.

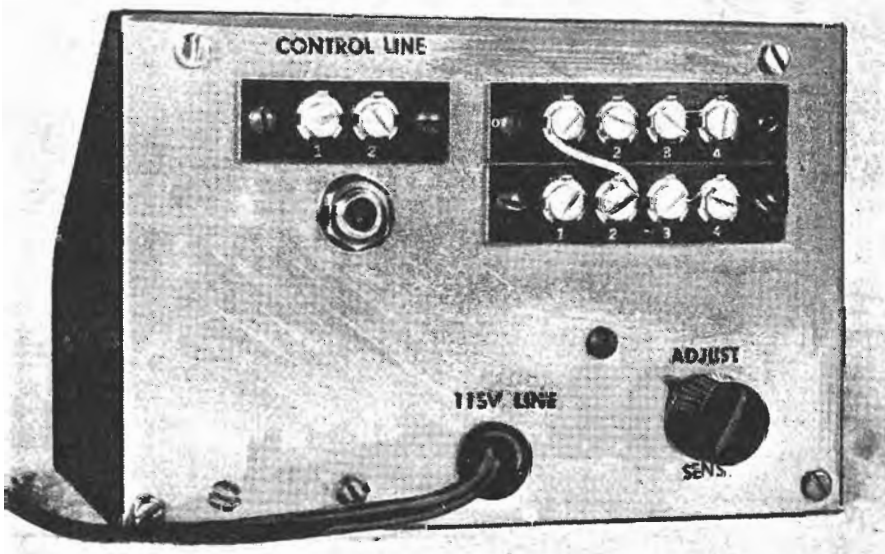

Circuit Description

Reference to the schematic diagram given in Fig. 3 will show that the counter consists of three related but independent sections: a sensitive "electronic" relay featuring a transistor amplifier, a low voltage a.c. supply (T_1), and an electromagnetic counter. The connections from each section are

brought out to separate terminals on screw-type terminal strips, permitting maximum flexibility in choosing a particular combination.

Let us discuss each section separately:

The "electronic" relay consists of a type CK722 *p-n-p* junction transistor connected as a direct-coupled grounded-emitter amplifier. A sensitive relay, RL_1 , serves as the collector "load." Power is supplied by a 6 volt battery, B_1 , controlled by power switch S_1 .

Two modes of operation are possible, depending on whether the control signal is furnished through the closed circuit jack J_1 or "control line" terminals "A." Closed circuit jack J_1 is used where the control signal consists of a small current (from 150 to several hundred microamperes), such as might be obtained from a photocell. The "A" terminals are used where the actuating signal is the simple closing (or opening) of a circuit.

Let us first consider the operation of the circuit where the "A" terminals are used, and where a simple push-button switch is used to close the circuit.

With power switch S_1 closed, a voltage is applied between the collector and emitter of the transistor. However, there is little or no current flow in this circuit since the base-emitter circuit is open (at the "A" terminals) and base current flow cannot take place. Thus, relay RL_1 remains open.

When the external push-button is depressed, shorting the "A" terminals together, base current can flow over the path consisting of the negative terminal of the battery, switch S_1 , R_2 , through the shorted "A" terminals, R_1 , through jack J_1 (now closed), the base-emitter of the transistor, and back to the positive terminal of the battery. This base current flow permits a corresponding collector current flow, though of much greater amplitude due to the current amplification of the transistor stage. Relay RL_1 is thus closed and held in until the push-button is released, stopping base and collector current flow.

Resistor R_1 is used to limit the maximum base current flow, while R_2 is used to set the current flow to a fixed value within this maximum limit.

If the external switch is normally closed ("A" terminals shorted together), the action is just the reverse. Relay RL_1 is normally held closed, and "drops out" when the external circuit is opened.

Let us now consider the action of the circuit when a current generating device is plugged into the "control line" jack J_1 . Since this is a closed-circuit jack, inserting a phone plug immediately disconnects R_1 , "A" terminals, and the R_2 circuit.

Two conditions may exist. The external current generating device can supply a current only when the "counting" operation is to take place, or it can supply a current at all times, with the current dropping sharply or ceasing to flow when "counting" occurs.

In the first case, the relay will normally remain open, closing only when current is supplied to the base-emitter circuit of the transistor through J_1 . In the second case, the relay will close and "hold in" until the current supplied through J_1 drops appreciably.

Since the base-emitter current of the transistor is supplied solely by the external circuit, this source should be capable of supplying at least 150 microamperes, and should not supply more than 5 ma. If there is a possibility of the current supplied by the external source exceeding 5 ma., an external current limiting resistor should be provided.

A typical "current generating device" that might be plugged into J_1 is an ordinary self-generating (barrier type) selenium photocell. Another such device could be a heat-operated thermopile (a series-parallel connection of several thermocouples to obtain greater current).

In any case, the connections of the external device to the phone plug should be such as to apply the negative terminal to the base of the transistor. See Fig. 5.

The low voltage a.c. supply is the next section of the "universal" counter to consider. This consists simply of a 6.3 volt transformer (T_1), a line cord, a power switch (part of S_1), and a pilot light.

The electromagnetic counter is a commercial unit having "reset" provision and operating on 6 volts a.c.

An a.c.-operated supply was not provided for the transistor amplifier circuit for several reasons. First, there is no real need for such a supply since, with normal use, battery life is quite long (due to the small power requirements of the transistor). Secondly, a battery supply permits completely independent operation of the transistor amplifier and relay circuit. This allows the circuit to be used alone for control purposes without requiring line connections. Finally, providing an a.c. supply would needlessly overcrowd an already well-filled cabinet.

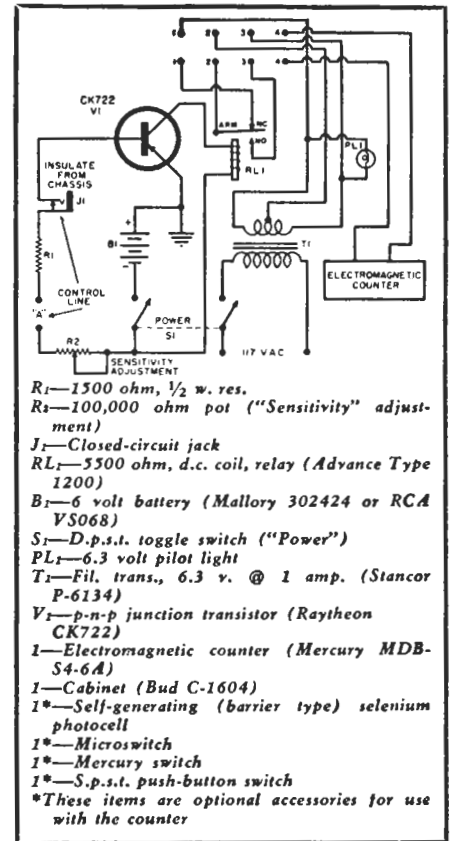
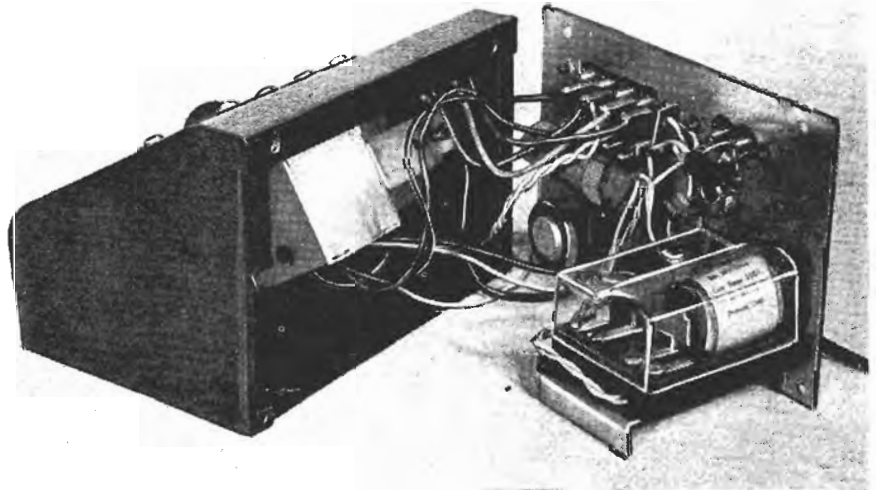

Fig. 3. Complete schematic diagram of the counter. It uses a Raytheon transistor.

Construction Hints

The general layout used in the author's model is clear from the exterior, back, and interior views of the instrument, given in Figs. 1, 2, and 4, respectively. The entire counter circuit has been assembled within a standard Bud sloping panel utility box. The electromagnetic counter, the 6.3 volt transformer (T_1), the power switch (S_1) and the pilot lamp socket and jewel are all mounted in the "cabinet." All other parts, including the relay, transistor, phone jack (J_1) and battery are mounted on the back panel. The Mal-

Fig. 4. Interior view of the instrument showing components mounted on panel.



lory battery is held in place by a large cable clamp.

Layout and wiring are not critical, however, and another builder may easily vary the layout to suit his own requirements.

Commercially available "decals" were used for labeling both the front panel (white decals) and the back (black decals). After application, the decals were protected with several coats of clear plastic, applied from a "spray can."

Two methods may be followed when installing the transistor. A socket may be provided or the transistor may be permanently wired into the circuit.

If the builder prefers to use a socket, a standard 5-pin subminiature tube socket is satisfactory. Only three of the pins are used.

On the other hand, if the builder prefers to solder the transistor directly into the circuit, he should exercise special care to avoid overheating this component. Do not cut the leads any shorter than necessary, and complete the soldering as quickly as possible.

Assembling the Accessories

The versatility of the "universal" counter depends not only on the counter circuit proper, but on the choice and use of various accessory "control" units. While the number of possible accessory control units is limited only by the imagination and requirements of the individual user, the group of four shown with the counter in Fig. 1 should give the reader some idea of the possibilities.

Reading from left-to-right, the accessories shown in Fig. 1 are as follows: (a) selenium photocell, (b) mercury switch, (c) "Microswitch," and (d) push-button switch.

The photocell is typical of a current generating type of accessory and is equipped with a phone plug to fit in the proper "control line" jack (J_1). The selenium cell used is of the type employed in exposure meters. It has been mounted in a small plastic box. The connections for the photocell are given in Fig. 5.

The other three accessories are typical of "simple switch" controls. Each has been equipped with a short flexible line and spade lugs, for easy connection to the screw-type "A" terminals (see Fig. 3).

Typical applications of these accessories will be discussed later.

Fig. 5. How the photocell, one of the accessories, can be connected to counter.

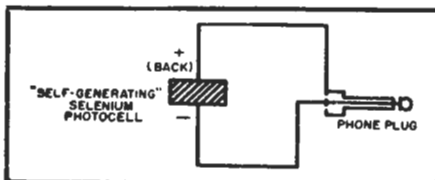

Adjustment and Operation

Once the wiring is completed and checked, the counter may be tested for proper operation. The first step, however, is to identify the various screw-terminals on the back panel. The connections used in the author's model are apparent when Figs. 2, 3, and 6 are compared.

Without plugging the line-cord into a wall socket, turn the instrument "on." Next, with R_2 set in its maximum resistance position, temporarily short out the "A" terminals (Fig. 3). Gradually adjust R_2 until the relay (RL_1) clicks as it is pulled in. Remove the short from the "A" terminals and the relay armature should drop out.

If the outlined action is not obtained as each step is carried out, it indicates either a defective part in the

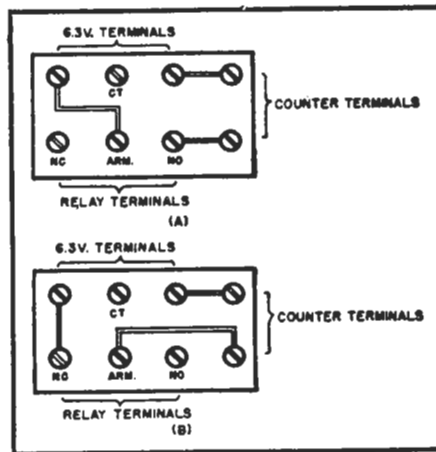

Fig. 6. Two ways of connecting the electromagnetic counter: (A) if relay is normally held open. (B) relay normally closed.

circuit or an error in wiring. Carefully recheck all connections and parts.

Once the relay circuit is operating properly, the rest of the counter may be checked. This will require connecting the electromagnetic counter, the 6-volt a.c. power source, and the relay circuit together properly. Use the relay contacts to switch the a.c. voltage so that it is applied to the electromagnetic counter whenever a counting operation is to take place.

Two connections are possible, and both are illustrated in Fig. 6. If the relay is normally to be held open, and to close for each count, the armature (Arm.) and "normally open" (NO) contacts are used. This connection is shown in Figs. 2 and 6A.

A typical example where this connection might be employed is where a s.p.s.t. push-button switch is connected across the "control line" ("A" terminals), with a count being registered each time the button is depressed and released.

On the other hand, if the relay is

normally to be held closed, and to open for each count, the armature (Arm.) and "normally closed" (NC) contacts are used. This connection is shown in Fig. 6B.

An example of the second case is where the photocell accessory is used to count the number of objects moving along an industrial assembly line. The photocell is plugged into the J_1 jack and set up on one side of the line. A good light source is arranged on the other side of the line so as to strike the photocell.

Under such conditions, the relay is pulled in and held in until a moving object interrupts the light beam, allowing the relay to drop out and register a count.

A minor circuit modification: The electromagnetic counter used is also available with a 115-volt coil. If the builder prefers to use the 115-volt unit, the transformer (T_1) may be omitted from the circuit. The pilot light may then either be left out or a 115-volt unit used instead.

Should the builder decide to use a 115-volt coil, a cover should be arranged for the back panel of the instrument to avoid accidental short circuits or electrical shock from the exposed terminals.

Applications

As mentioned previously, the possible applications of the "universal" counter are almost unlimited. However, reviewing a few typical applications should give the reader a sufficient understanding of the potentialities of the unit so that he will have no difficulty in devising other applications of his own.

The photocell accessory might be used for counting the number of objects passing a given point on a production line, or the number of persons entering or leaving a specific area or room. The mercury switch could be used for counting the number of times the lid on a tool box or supply cabinet is opened and closed. The "Microswitch" might be used in a similar application, or could also be used for recording the number of times a door is opened or shut.

The push-button switch could be used advantageously at inventory time. Held in the hand, it might be used for quickly recording the number of objects on a merchant's shelves. For each count, the user simply depresses and releases the button.

In addition to its uses just as a counter, the completed instrument has other possible applications. For example, the relay and amplifier circuit, used alone, could well serve for remote or automatic control of solenoids, motors, lights, or similar equipment. Any of the accessories may be used as the basic control device in such an application.

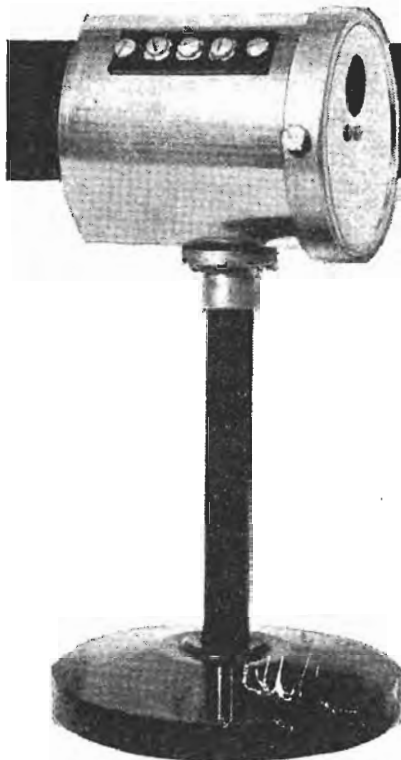

Fig. 1. Over-all view of author's unit. A discarded exposure meter cell was used.

WHILE battery-operated, self-contained photocell relays are certainly not new (see "A Photoelectric Headlight Dimmer" by P. J. Vogelgesang, *RADIO & TELEVISION NEWS*, January, 1953), the unit shown in Fig. 1 does possess several unique features. First, no resistors, coils, transformers, condensers, or vacuum tubes are used in its construction. Secondly, a single inexpensive, comparatively low voltage battery is all that is required for its operation and this is contained within the small housing shown. The battery life is fairly long, due to the low current drain.

All these features are made possible by the use of a self-generating photocell, together with a direct current transistor amplifier. Only a few parts are required for the device, as can be seen in the schematic diagram (Fig. 2), and the interior view given, Fig. 6.

Circuit Description

The operation of the circuit may be easily followed by reference to the schematic diagram of Fig. 2. The *Raytheon* CK721 transistor ("p-n-p" type) is the "heart" of the device, and is connected as a direct-coupled grounded emitter amplifier. This serves to amplify the weak current obtained from the photocell sufficiently to operate the relay, RL_1 .

As long as no light falls on the photocell, the base current of the transistor is essentially zero, and negligible collector current flows through RL_1 , which remains open. When light is allowed to fall on the photocell, a small base current starts to flow, permitting a corresponding in-

TRANSISTOR-OPERATED PHOTOCELL RELAY

By

LOUIS E. GARNER, JR.

Construction details on a simple unit which has many uses in the home or shop. Power requirements are low and cheap.

crease in the flow of collector current through the relay. The collector current is several times greater than the base current, with a current amplification of ten comparatively easy to achieve.

As the light intensity increases, base current and collector current also increase, until the current through the relay is sufficient to close it.

If the light intensity falls off, a corresponding decrease in base and collector current is obtained. However, the relay does not open until the light level drops appreciably, since less current is required to hold the relay closed than is needed to close it. Under normal conditions, the base current does not exceed a few hundred microamperes, while the collector current does not exceed a few milliamperes.

Collector voltage is supplied by battery B_1 , with switch S_1 provided to open the collector circuit when operation of the unit is not desired.

Thus, only five electrical components are used in the entire device—a photocell, a transistor, a relay, a switch, and a battery.

Construction Hints

With the single exception of the photocell, all the parts used in building the device are easily obtained from radio-electronic wholesale parts distributors. A "self-generating" photocell may or may not be available at a particular distributor, depending on local demand. Although this item is commercially manufactured, not all supply houses have sufficient demand for the item to warrant stocking it.

The photocell used by the author in building the model shown is a selenium cell salvaged from a defective

exposure meter of the type used in amateur photographic work. These meters consist of the basic photocell together with a microammeter. Since the meter movement is more susceptible to mechanical damage than is the photocell, it is sometimes possible to pick up a "defective" unit in which only the meter movement is damaged—the photocell is virtually in perfect condition. In most cases, the cost is negligible.

Even where it is necessary to purchase an exposure meter in "operating" condition, the price of a used unit is likely to be quite low. A used but operating unit offers the further advantage of supplying the experimenter with a sensitive microammeter for other work.

A certain amount of ingenuity may have to be exercised by the builder in mounting the photocell, depending upon its actual shape and size—some are round, others square, and still others rectangular. The one used by the author is shown in Fig. 5.

In mounting the photocell proper, it is best not to attempt to solder leads to it. Use spring contacts made from phosphor bronze or similar material. If a commercial unit is used, it will generally have leads or terminals provided.

No special precautions are necessary when assembling and wiring the circuit, and the builder may follow his own inclinations as far as layout is concerned. The unit shown in the photographs was housed in an old shield can, but almost any type of housing may be used—a plastic or wooden box, a small metal utility box, or even a small chassis, with a bottom plate used as a "cover."

A hole must be provided in housing, of course, to permit

strike the photocell. Generally, no lens will be required unless the builder wishes to increase the over-all sensitivity somewhat by concentrating light from a large area on the cell, using a good sized lens.

The effect of light striking the unit from an angle can be reduced either by using a lens ahead of the photocell or by mounting a closed tube in front of the cell, as shown in Fig. 3. The interior of the tube should be finished in dull black to reduce interior reflections. The tube has not been used in the model shown in the photographs.

Parts Substitutions: A toggle, lever, rotary, or almost any type of switch may be used in place of the slide switch employed in the model. A lock switch is particularly good for this application, as it permits only the owner to turn the unit "on" or "off."

Other relays may be used in place of the one specified in the parts list. When choosing a substitute relay, pick one having good sensitivity. The relay should have a reasonably high coil resistance and should close on less than 5 ma. However, the so-called "plate" relays are not suitable for use here due to their high coil resistance, requiring much higher supply voltages for proper operation. Best results will be obtained with sensitive relays having a coil resistance of 3000 ohms or less.

In general, the more sensitive the relay, the more sensitive will be the complete device (requiring less light for operation).

If other relays are used, it may be found possible to use a supply voltage of less than 15 volts.

In any case, the choice of a battery should depend on the intended operation of the unit. A hearing aid type battery (Burgess U10) was used in the model and is given in the parts list. This particular battery was chosen because of its low cost, ready availability, and reasonable life under the low current drain required by the device.

Where the unit is to be used in an application requiring extreme battery life, a larger battery might well be employed.

Adjustment and Operation

Once the wiring has been completed, a milliammeter should be connected in series with the relay and the unit turned "on." Light should then be permitted to fall on the photocell. A marked increase in collector current flow should occur, as indicated by the milliammeter reading. If this current increase does not occur, reverse the connections to the photocell—base current must have the correct polarity.

Next, the relay's sensitivity must be adjusted so that the relay closes when light is falling on the photocell and opens when the light source is interrupted. Use a focused light source supplying the same amount of light as will later be used in the intended ap-

plication. The relay's sensitivity can be changed by tightening or weakening the tension on the armature spring and by adjusting the armature's position relative to the core piece.

Be sure sufficient light is employed, the sensitivity of the completed unit may vary considerably, depending on the photocell used, the relay used, the adjustment of the relay, and other factors.

In the model built by the author, the light obtained from a 3-cell flashlight held two to three feet away from the opening in the housing was sufficient to operate the relay. This light fell through a 3/4" diameter round hole in the housing to strike the photocell. Because of this, only about half the photocell's area was used. Greater sensitivity could have been obtained by using all of the photocell's active area. The set-up employed in this test is shown in Fig. 4.

Applications

The applications of the photocell relay described in this article parallel the applications of photoelectric relay units in general, although there is somewhat greater versatility because operation is possible anywhere (special power is not required) and because of the small size possible in assembling a complete unit. However, a review of possible applications might be of interest to the reader, and may aid him in selecting or devising special applications of his own.

In considering applications for the photocell relay, the device can be considered as a switch that performs any one of the following functions, depending on how the connections to the relay contacts are made:

1. To open a circuit when light strikes the photocell.
2. To open a circuit when light striking the photocell is interrupted.
3. To close a circuit when light strikes the photocell.
4. To close a circuit when light striking the photocell is interrupted.

Irrespective of the connections chosen, it is best to supply power to operate the external device from a separate power source, rather than to attempt to use the small battery in the photocell relay circuit proper.

A few possible applications follow, but these should, by no means, be considered a complete list.

Burglar Alarm: The light source and photocell relay may be arranged

Fig. 5. Photocell used by author. Other sizes and shapes may be used. See text.

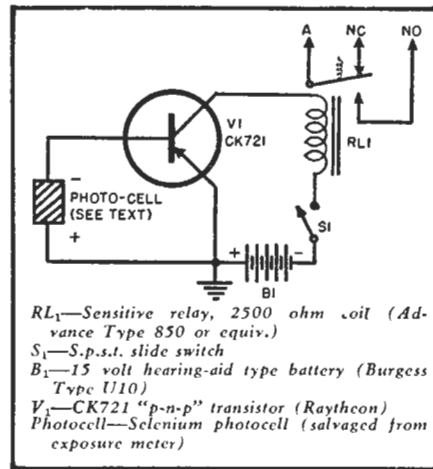

RL₁—Sensitive relay, 2500 ohm coil (Advance Type 850 or equiv.)
S₁—S.p.s.t. slide switch
B₁—15 volt hearing-aid type battery (Burgess Type U10)
V₁—CK721 "p-n-p" transistor (Raytheon)
Photocell—Selenium photocell (salvaged from exposure meter)

Fig. 2. Complete circuit diagram of photocell relay. Only five components are used.

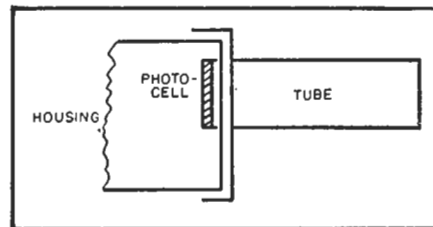

Fig. 3. A shield in front of cell cuts off light which might strike cell from an angle. Suitable for door-opener application.

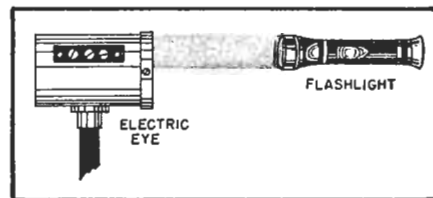
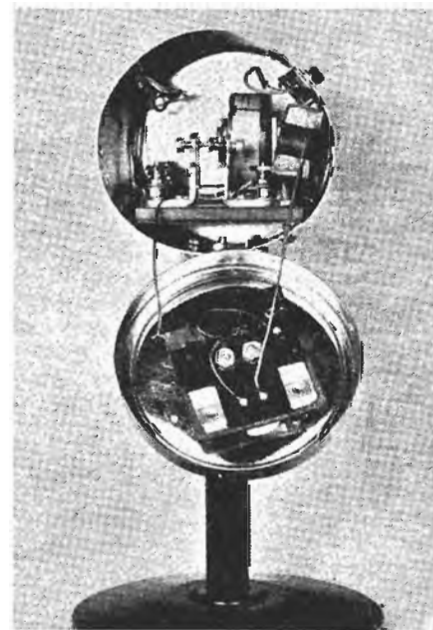

Fig. 4. Test set-up for photocell relay.

so that anyone entering a protected area causes an alarm bell to sound.

Doorway Annunciator: A light
(Continued on page 104)

Fig. 6. Interior view of photocell relay.



TRANSISTOR CONTROL RELAY

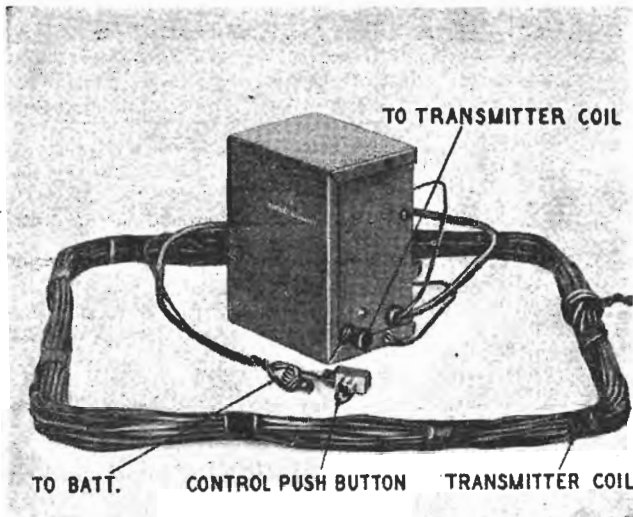

(Above)—The car-transmitter case and loop winding.
(Right)—Inside layout of the control-relay housing.

A tubeless gadget for remote switching with radio, light-beam, or magnetic-field control

By EDWIN BOHR

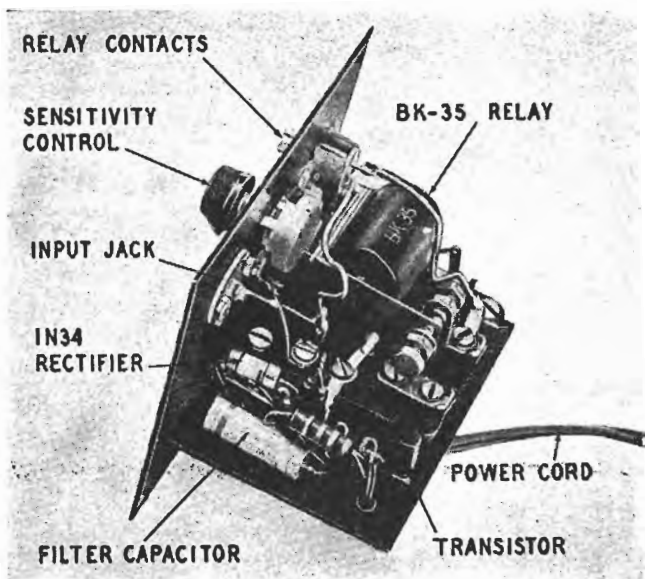

NOTE
Use of a CK 705 Germanium Diode in place of the IN 34 is recommended

THE HEART of this tubeless remote-control relay is the new Raytheon CK-722 junction transistor. It will operate garage-door openers, lighting circuits, or alarms, or will perform almost any type of switching operation. The relay can be operated by a photocell, radio signal, thermocouple, or any device that will furnish .00025 watt of power.

Many transistor-operated circuits have been more novel than practical. We assure you this one is entirely practical—for two reasons. First, this transistor relay fills some honest-to-goodness everyday applications. Second, it costs only a little more than most vacuum-tube operated circuits.

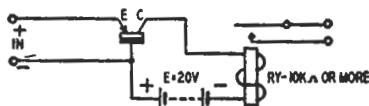

Fig. 1—Basic P-N-P junction-transistor relay circuit. Relay operates only when a positive signal or pulse is applied to the emitter electrode of the transistor.

The total cost of the unit—including the transistor—was only \$13.15.

When you consider that the transistor will probably give years of service without attention, with negligible power consumption, also its ruggedness and small size, the transistor-operated circuit in this instance is a real buy.

Basic circuit

The basic circuit is shown in Fig. 1. Note that no bias is applied to the emitter circuit. Under these conditions only a few microamperes of collector *hole* current will flow through the relay. This type of operation is similar to biasing a vacuum tube to cutoff. With this P-N-P transistor, however, zero bias cuts off the emitter current and any further negative bias produces no effect.

The transistor will pass only the positive half-cycle of an a.c. input signal or a positive-polarity d.c. signal. These are desirable features in a relay circuit.

Since the current amplification of a

junction transistor is a little less than 1 (see "Transistors," by John R. Pierce, in the June RADIO-ELECTRONICS), the power gain of the unit depends on the resistance of the relay in the collector circuit. For a given current change through the transistor, the voltage change across the relay coil depends on the coil resistance.

A relay with a high-resistance winding will operate on a much lower current than a low-resistance relay. But a 10,000-ohm relay, for example, that will operate on one milliampere of current, requires 10 volts across the winding, or a power input of 10 milliwatts. It is difficult to get this much voltage and power from a radio control signal, but it is entirely practical with low-frequency magnetic fields.

The transistor will amplify a signal current with a small voltage change to a much larger voltage change across the relay coil. A 10,000-ohm relay in the collector circuit will give a power gain of about 10. As the relay resistance is increased, the supply voltage

the same as in the transmitter. END

If a greater operating radius for the unit is desired, it can be obtained in two ways. Either add an extra transformer amplifier ahead of the relay stage or install a low-frequency r.f. oscillator in the car. An effective and simple transmitter operating at about 420 kc is shown in Fig. 3. At the relay end simply connect the transistor input to a parallel resonant circuit instead of to the pickup coil and matching transformer. The coil and trimmer can be

But, if the relay unit is more than about 20 feet from the pickup loop, the transformer at the loop end must have to be shielded, as there is not much likelihood of picking up hum or other disturbances at these low impedances.

The wires from the pickup coil do not have to be shielded, as there is not much likelihood of picking up hum or other disturbances at these low impedances.

But, if the relay unit is more than about 20 feet from the pickup loop, the transformer at the loop end must have to be shielded, as there is not much likelihood of picking up hum or other disturbances at these low impedances.

But, if the relay unit is more than about 20 feet from the pickup loop, the transformer at the loop end must have to be shielded, as there is not much likelihood of picking up hum or other disturbances at these low impedances.

But, if the relay unit is more than about 20 feet from the pickup loop, the transformer at the loop end must have to be shielded, as there is not much likelihood of picking up hum or other disturbances at these low impedances.

But, if the relay unit is more than about 20 feet from the pickup loop, the transformer at the loop end must have to be shielded, as there is not much likelihood of picking up hum or other disturbances at these low impedances.

But, if the relay unit is more than about 20 feet from the pickup loop, the transformer at the loop end must have to be shielded, as there is not much likelihood of picking up hum or other disturbances at these low impedances.

But, if the relay unit is more than about 20 feet from the pickup loop, the transformer at the loop end must have to be shielded, as there is not much likelihood of picking up hum or other disturbances at these low impedances.

But, if the relay unit is more than about 20 feet from the pickup loop, the transformer at the loop end must have to be shielded, as there is not much likelihood of picking up hum or other disturbances at these low impedances.

But, if the relay unit is more than about 20 feet from the pickup loop, the transformer at the loop end must have to be shielded, as there is not much likelihood of picking up hum or other disturbances at these low impedances.

But, if the relay unit is more than about 20 feet from the pickup loop, the transformer at the loop end must have to be shielded, as there is not much likelihood of picking up hum or other disturbances at these low impedances.

But, if the relay unit is more than about 20 feet from the pickup loop, the transformer at the loop end must have to be shielded, as there is not much likelihood of picking up hum or other disturbances at these low impedances.

But, if the relay unit is more than about 20 feet from the pickup loop, the transformer at the loop end must have to be shielded, as there is not much likelihood of picking up hum or other disturbances at these low impedances.

But, if the relay unit is more than about 20 feet from the pickup loop, the transformer at the loop end must have to be shielded, as there is not much likelihood of picking up hum or other disturbances at these low impedances.

But, if the relay unit is more than about 20 feet from the pickup loop, the transformer at the loop end must have to be shielded, as there is not much likelihood of picking up hum or other disturbances at these low impedances.

But, if the relay unit is more than about 20 feet from the pickup loop, the transformer at the loop end must have to be shielded, as there is not much likelihood of picking up hum or other disturbances at these low impedances.

But, if the relay unit is more than about 20 feet from the pickup loop, the transformer at the loop end must have to be shielded, as there is not much likelihood of picking up hum or other disturbances at these low impedances.

But, if the relay unit is more than about 20 feet from the pickup loop, the transformer at the loop end must have to be shielded, as there is not much likelihood of picking up hum or other disturbances at these low impedances.

But, if the relay unit is more than about 20 feet from the pickup loop, the transformer at the loop end must have to be shielded, as there is not much likelihood of picking up hum or other disturbances at these low impedances.

- Materials for relay**
- Resistors: 1-3,000 ohms, 1 watt; 1-5,600 ohms, 1/2 watt; 1-10,000-ohm potentiometer.
 - Capacitor: (Electrolytic) 1-10 uf, 50 volts.
 - Miscellaneous: 1-CK-722 junction transistor; 1-5-pin, in-line subminiature socket; 1-BK-35 relay or equivalent (see text); 1-1N34 germanium diode; 1 plate-to-voice coil output transformer; 1-4-prong vibrator socket; 1 horn relay; push-button switch; 6.3-volt vibrator; 1 horn relay; push-button switch.

istics can be changed by excessive heat. place, since the transistor's character in to the socket with the transistor in red dot on the transistor. Do not solder on the socket should line up with the spaces between them. The raised dot contacts, leaving three contacts with You can push out the second and fourth in-line subminiature socket is used for the transistor. A standard five-prong in-line subminiature socket is used for the transistor.

Construction

A standard five-prong in-line subminiature socket is used for the transistor. A standard five-prong in-line subminiature socket is used for the transistor.

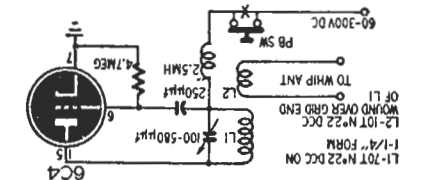

operation of the controlled device. Pulses from the transmitter coil are unidirectional or polarized. If the relay fails to operate, or lacks sensitivity, it is actuated as the automobile passes over the pickup coil. You may find it convenient to use a ratchet-type relay in conjunction with the transistor relay. This will allow up-down or on-off operation of the controlled device.

operation of the controlled device. Pulses from the transmitter coil are unidirectional or polarized. If the relay fails to operate, or lacks sensitivity, it is actuated as the automobile passes over the pickup coil. You may find it convenient to use a ratchet-type relay in conjunction with the transistor relay. This will allow up-down or on-off operation of the controlled device.

operation of the controlled device. Pulses from the transmitter coil are unidirectional or polarized. If the relay fails to operate, or lacks sensitivity, it is actuated as the automobile passes over the pickup coil. You may find it convenient to use a ratchet-type relay in conjunction with the transistor relay. This will allow up-down or on-off operation of the controlled device.

operation of the controlled device. Pulses from the transmitter coil are unidirectional or polarized. If the relay fails to operate, or lacks sensitivity, it is actuated as the automobile passes over the pickup coil. You may find it convenient to use a ratchet-type relay in conjunction with the transistor relay. This will allow up-down or on-off operation of the controlled device.

operation of the controlled device. Pulses from the transmitter coil are unidirectional or polarized. If the relay fails to operate, or lacks sensitivity, it is actuated as the automobile passes over the pickup coil. You may find it convenient to use a ratchet-type relay in conjunction with the transistor relay. This will allow up-down or on-off operation of the controlled device.

operation of the controlled device. Pulses from the transmitter coil are unidirectional or polarized. If the relay fails to operate, or lacks sensitivity, it is actuated as the automobile passes over the pickup coil. You may find it convenient to use a ratchet-type relay in conjunction with the transistor relay. This will allow up-down or on-off operation of the controlled device.

operation of the controlled device. Pulses from the transmitter coil are unidirectional or polarized. If the relay fails to operate, or lacks sensitivity, it is actuated as the automobile passes over the pickup coil. You may find it convenient to use a ratchet-type relay in conjunction with the transistor relay. This will allow up-down or on-off operation of the controlled device.

operation of the controlled device. Pulses from the transmitter coil are unidirectional or polarized. If the relay fails to operate, or lacks sensitivity, it is actuated as the automobile passes over the pickup coil. You may find it convenient to use a ratchet-type relay in conjunction with the transistor relay. This will allow up-down or on-off operation of the controlled device.

operation of the controlled device. Pulses from the transmitter coil are unidirectional or polarized. If the relay fails to operate, or lacks sensitivity, it is actuated as the automobile passes over the pickup coil. You may find it convenient to use a ratchet-type relay in conjunction with the transistor relay. This will allow up-down or on-off operation of the controlled device.

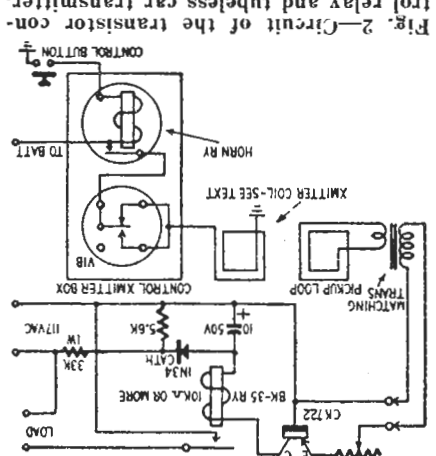

A small power supply with a 1N34 rectifier was built for the relay circuit. It has a coil resistance of about 11,000 ohms. The relay will close on less than 0.5 milliamperes without any readjustment. The surplus 75-mc marker-beacon receiver, or it can be removed from a receiver advertised by several dealers for about \$8.

We found that a surplus relay—the BK-35—was the ideal unit for use with the transistor relay. This relay has been advertised by several dealers for about \$8, or it can be removed from a surplus 75-mc marker-beacon receiver. The relay will close on less than 0.5 milliamperes without any readjustment and has a coil resistance of about 11,000 ohms. A small power supply with a 1N34 rectifier was built for the relay circuit.

At this point it is well to remember that few components have been designed to match the characteristics of the transistor. We must still use vacuum-tube-engineered components. This situation will change in the months to come.)

At this point it is well to remember that few components have been designed to match the characteristics of the transistor. We must still use vacuum-tube-engineered components. This situation will change in the months to come.)

A TRANSISTOR TIMER

By LOUIS E. GARNER, JR.

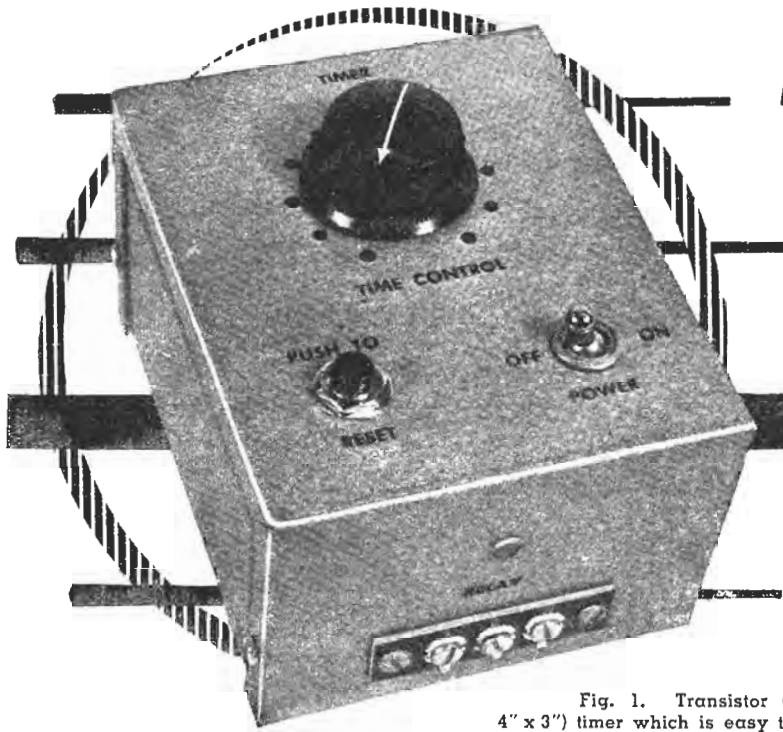

Fig. 1. Transistor (5" x 4" x 3") timer which is easy to operate, easy to build, rugged, and compact.

A "natural" for the photo lab, this timer requires no external power source and offers a wide selection of timing intervals.

MOST electronic timers suffer from two disadvantages—they require a source of line voltage and they become extremely warm when left on for any length of time. Both disadvantages result from the necessity of using vacuum tubes and comparatively high voltages.

Although the necessity of having line voltage available seems like a small problem, occasions do arise when it is desired to control (turn "off" or "on") battery-operated or portable equipment over pre-determined time intervals.

The second disadvantage mentioned is of real importance in some applications. Anyone who has worked in a darkroom in summer soon realizes that *any* heat is too much! Yet it is in the photographic darkroom that a large percentage of electronic timers are employed.

With these problems in mind, an effort was made to design a timer that would meet the following specifications: (a) Simple in construction and wiring; (b) Easy to operate; (c) Completely self-contained, using no line power; (d) Generating as little heat as possible; (e) Rugged, yet compact. The result is shown in Fig. 1.

The timer shown in Fig. 1 is reasonably small (over-all dimensions of the case are 5" x 4" x 3") and lightweight, requires no line voltage, is easy to operate (only three controls—"Power" switch, "Reset" button, and "Time Control"), produces virtually no heat in its operation, and

yet is fairly simple to wire (refer to the schematic diagram of Fig. 2).

All of these features have been made possible by employing a *Raytheon* Type CK722 junction transistor as a control element in place of the usual vacuum tube and providing for battery operation. Battery life is unusually long, since the maximum current drain is only slightly over a milliamper, and this only for short periods. In fact, the battery life should equal the normal "shelf life" of the units.

Circuit Description

The operation of the circuit is not at all complex, as can be readily observed by reference to the schematic diagram of Fig. 2.

In operation, when the "Power" switch, S_2 , is closed, current can flow through R_2 and R_1 , charging condenser C_1 and permitting a momentary surge of base current. The base current flow, in turn, permits collector current to flow, closing the relay.

As soon as condenser C_1 is charged, the current flow over the R_2 , R_1 , C_1 and the base-emitter path ceases. The drop in base current flow to virtually zero results in a corresponding drop in collector current flow, permitting the relay to open or "drop out."

The time period in which the relay "holds in" depends on the period of collector current flow, which, in turn, depends on the period of base current flow, and hence on the time it takes condenser C_1 to charge. This,

in turn, depends on the time constant of C_1 , R_1 , R_2 and the base-emitter impedance.

If any of the parameters in the RC charging circuit thus formed are changed, then the time interval may be changed. In practice, an adjustable time interval is obtained by using a rheostat for R_2 , keeping R_1 at a small value simply to limit base current flow and hence to protect the transistor. However, if fixed time intervals are desired instead of a continuously adjustable control, a single fixed resistor may be used in place of R_1 and R_2 , and different values of C_1 chosen by using a conventional selector switch.

Once the unit is "set-up" for operation as described, the desired "timing interval" is selected by adjusting R_2 . The "Reset" switch, S_1 , is then depressed, shorting out and discharging C_1 . When the "Reset" switch is released, C_1 starts to charge again and the relay closes, opening again after C_1 is charged. The timing interval may be repeated as often as desired simply by depressing and releasing the "Reset" button.

The layout and parts arrangement used by the author are readily seen by referring to the interior and exterior photographs of the model, given in Figs. 3 and 1, respectively. As is easily seen, no attempt was made to "miniaturize" the model and hence there is no crowding of parts. Because of this, wiring the unit should be simple, even if the builder is not highly skilled.

Leads can be any length desired, and the builder may use either "point-to-point" or "right-angle cabled" wiring, or a combination of both, as he prefers.

Although the author wired the transistor directly into the circuit, soldering the leads, the builder might prefer to use a socket—an ordinary 5-pin flat subminiature tube socket is employed. Should the builder follow the author's practice, however, take care to keep the transistor leads at least an inch long and do the soldering as quickly as possible to avoid overheating and damaging the transistor. Use the same "safety rules"

that are followed when working with germanium diodes.

The author's model was assembled in a standard *Bud* "Minibox" (5" x 4" x 3"), but the unit may be built in any way preferred by the reader. A plastic, or even a wooden, box might well be employed.

Should the reader wish to incorporate the timer circuit in some other piece of equipment, the entire assembly may be easily wired on a flat metal panel or on a small sub-chassis.

Inexpensive "rubber feet" were provided in the model shown by using thick rubber grommets, mounted in holes drilled in the back of the "Minibox."

The batteries were mounted by using a flat metal strap and two long 6-32 machine screws.

Parts Substitutions

Although the relay used by the author is moderately expensive, it is positive-acting, quite rugged, and can handle currents up to 5 amperes at 117 volts a.c. (ample for almost all uses). A less expensive or a more expensive relay may be substituted by the builder if desired; however, the following considerations should be kept in mind.

The relay should be positive acting. Another relay tried by the author had, such a weak spring that the armature moved slowly from the "front" to the "back" position as the collector current dropped. Where a reasonable load is connected to the contacts, such slow movement would cause excessive arcing and pitting of the contacts.

The relay should be reasonably sensitive. A "very sensitive" relay is not required in this application. However, the relay should be capable of closing on five milliamperes or less, since 5 ma. is the maximum rated collector current for the CK722 transistor.

Battery voltage should be adjusted for the relay coil resistance and sensitivity. The relay used by the author has a 5500 ohm coil, requiring 5.3 volts d.c. to operate, hence the six volts provided by the battery is ample (there is little drop in the transistor when conducting). However, if a different relay is used, it may be necessary to use either greater or less battery voltage.

Resistor R_1 is used primarily to limit base current and hence its size is not too critical. As little as 500 ohms may be used here, although the larger resistor is preferred.

With the components specified in the parts list, the timing range is from slightly less than three to slightly less than ten seconds (ample for most photographic enlarger timing, where average paper is used). Shorter time intervals may be obtained by using a small condenser in place of C_1 , while longer intervals may be obtained by increasing the value of C_1 .

The timing range of another model, even using the parts values as given, may be found to vary somewhat from the values given due to tolerances in

components. Such variation should be considered normal and not as an indication that any part is defective or that wiring mistakes have been made.

Black decals were used to label the model. A "factory-built" appearance was obtained by spraying three coats of plastic on the front panel after applying the decal labels.

Operation and Adjustment

No attempt was made to calibrate the main "Timing Control" in the model. However, the average builder will undoubtedly wish to calibrate the control settings. This may be done accurately by using a stop watch to time the relay clicks and marking the dial settings accordingly.

If a stop watch is not available, reasonably accurate calibration may be obtained by using a "one-second" count — one-pause-two-pause-three-pause-four-pause-five, etc.

To use the unit, the following procedure may be employed:

(1) Connect the switch lead of the equipment to be turned "on" or "off" to the proper relay contacts.

(2) Turn on the "Timer" and wait until the relay drops out.

(3) Set the "Time Control" (R_2) to the desired time interval and press the "Reset" button. If another time interval is desired, press the "Reset" button a second time after the relay has dropped out. The interval may be repeated as often as desired simply by pressing the "Reset" button each time operation is desired.

(4) If a different time interval is desired, wait until the relay "drops out" (that is, until the unit is ready for recycling) and set the "Time Control" to the new time, pressing the "Reset" button to initiate operation. If the setting is from a longer to a shorter time interval, the "Time Control" should be moved *slowly* back, to prevent a current surge that may cause the relay to close.

If the relay specified in the parts list is employed, it should not be necessary to change the manufacturer's adjustment. If another relay is employed, however, some change either in spring tension or in armature position might prove necessary.

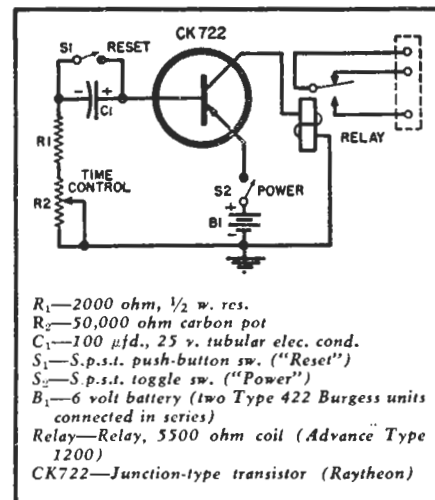

Fig. 2. Circuit diagram of transistor timer.

In general, the armature spring tension should be adjusted so that really positive action is obtained. If it is necessary to increase the spring tension to accomplish this, it may also be found necessary to change the armature spacing with respect to the pole piece in order to regain sensitivity.

The relay's sensitivity may be increased by adjusting the "front" and "back" contacts until the armature is moved *closer* to the pole piece. Sensitivity is reduced by moving the armature *away* from the pole piece (or increasing spring tension, or both).

Applications

One major application of a timer is in photographic work. In this field, the timer is especially valuable when making a series of identical prints. Once the proper time interval has been determined (using test prints or an enlarging meter), the timer may be set to this interval, and any number of additional prints made, almost "automatically."

The relay contacts are simply used as a switch to turn the enlarger or printing box "on" and "off."

Still another application of the timer is in scientific work and in chemistry, where it is desired to turn a heater

(Continued on page 103)

Fig. 3. Internal view of timer. Layout can be changed to suit the individual builder.

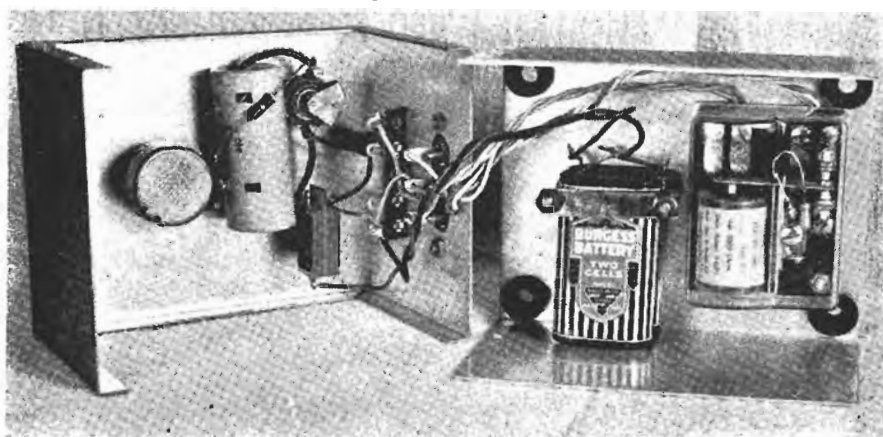

RADIO CONTROL CIRCUIT

A. L. MORGAN

201 South Walnut Street
Wilmore, Kentucky

With the development of the RK61 thyatron, Raytheon made a tube available to radio control hobbyists, which would operate reliably with a very simple superregenerative circuit. This tube has seen rather extensive use in the radio control field. The useful life of the tube is governed principally by the amount of plate current drawn during operation. This indicates the desirability of a D.C. Amplifier following the RK61 circuit, permitting the thyatron to idle at a lower value of plate current and yet retain sufficient relay current change for reliable operation. Several such circuits have been developed in the past using vacuum tubes. These circuits increase considerably the size of the radio control receiver and require increased battery weight due to the filament current requirements of two tubes.

The CK722 transistor seemed a very logical choice for a much improved D.C. Amplifier which would overcome these disadvantages. Exhibiting a current gain on the order of ten, it would permit the RK61 to idle with a plate current of less than 0.5 ma.

The next task was to apply the CK722 to the basic RK61 circuit with a minimum of additional components, for such a receiver when used in a model plane or boat must be compact and require a minimum of batteries.

The final circuit is shown in figure 1 and requires only the addition of one electrical component other than the CK722, to the basic circuit. The base of the transistor is connected through R_2 to the plate circuit of the RK61 and the emitter is returned to $B+$, resulting in the plate current of the RK61 serving as bias current for the transistor.

The relay is located in the collector circuit and is returned to the mid-point of the two $22\frac{1}{2}$ volt batteries, thereby supplying the necessary negative potential for the collector. It is necessary that R_{y1} have a resistance of at least 5000 ohms in order that collector current of the transistor be held below its maximum rated value. J_1 facilitates metering this circuit for tuning and relay adjustment. Adjustment of R_2 results in a reduction of the RK61 plate current such that its idling value is on the order of 0.4 ma.

The CK722, exhibiting a current gain on the order of ten, produces a collector current, under these circumstances, of approximately 4.4 ma. Upon receipt of a signal the plate current of the RK61 drops to 0.1 ma and the transistor collector current is now down in the vicinity of 1.4 ma.

We now have a current change available for

relay operation which varies from 4.4 ma (signal off) to 1.4 ma (signal on), a difference of 3 ma.

This compares with a current difference of 1.4 ma for the RK61 circuit alone. The idling current of the RK61 has been reduced from 1.5 ma to 0.4 ma which will extend its useful life many times. In order to accomplish this it is only necessary to add the CK722 transistor and R_2 to the basic RK61 circuit.

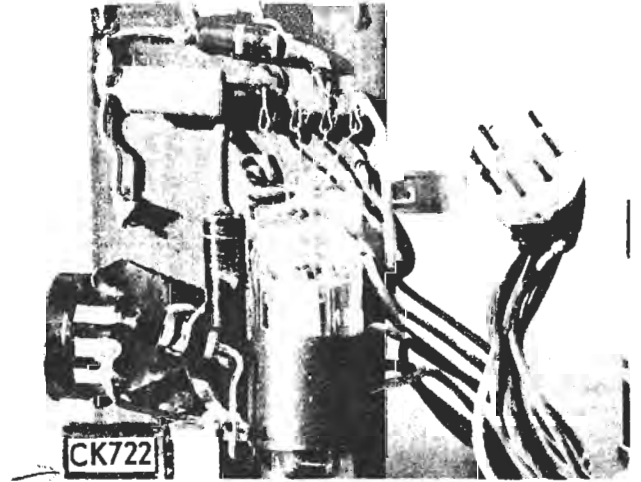

PARTS LIST

- C_1 —4-30 mmf ceramic trimmer capacitor
- C_2 —18 mmf ceramic capacitor
- C_3 —100 mmf ceramic capacitor
- C_4 —.05 mf 200V paper capacitor
- R_1 —3 megohm $\frac{1}{2}$ watt
- R_2 —25,000 ohm subminiature pot.

- L_1 —8 turns #14 wire $\frac{1}{2}$ inch dia.
 $\frac{3}{4}$ inch long-tapped 2 $\frac{1}{2}$ turns
from plate end. (6 meter band)
- J_1 —subminiature phone jack
- Ry_1 —5000 ohm sensitive relay
- RFC— $\frac{3}{16}$ " dia. $\frac{5}{8}$ long form wound full
#36 wire close spaced
- S_1 —D.P. S.T. Switch

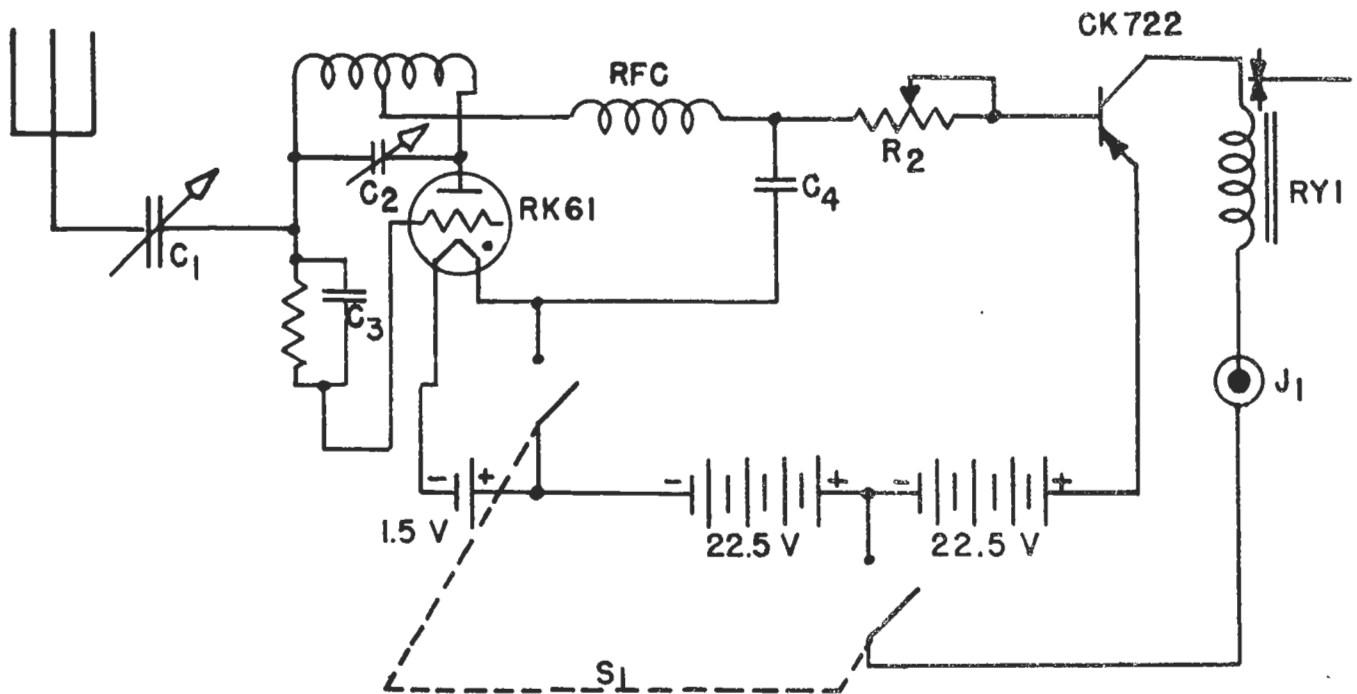

A SELF-POWERED TRANSISTOR C. W. MONITOR

One of the salient features of transistors that make their use attractive for radio transmitter control and auxiliary equipment is the extremely low power requirement for their efficient operation. It is this attribute that has made possible the compact, reliable instrument described in this paper. The unit should prove especially interesting to the amateur radio C W operator, and is intended to augment a growing number of monitoring schemes which use vacuum tubes and power supplies. One popular device is currently described in the Radio Amateurs Handbook, 30th Edition, p. 237-238; and utilizes a power supply, type 6J5 swamping tube, a NE-2 saw-tooth generator, and 6SL7 mixer-amplifier.

The unit described here is simple and effective. A Raytheon type CK-705 or 1N66 Germanium crystal diode provides the necessary d. c. voltage from the R. F. pick-up line for the proper operation of the CK-722 transistor A. F. oscillator. The oscillator is capable of driving a 3" PM loud-speaker to comfortable volume. A length of 5" pick-up line placed within $\frac{3}{4}$ " of the 4D32 power amplifier in the author's transmitter (a Viking I), and fed through shielded line to the unit serves to drive the oscillator to full output. A gratifying observation made of the transistor oscillator in action is its clean make-break characteristics which make it a pleasure to listen to the unit. This is in sharp contrast to the inferior keying characteristics of the V/T sidetone oscillator which it has replaced.

CONSTRUCTION DETAILS

The transistor monitor is self-contained in an ICA sectional box, $1\frac{1}{2}$ " x 2" x 4". The layout is straightforward and requires nothing more than good wiring practice. Before mounting the output transformer, the mounting lugs must be filed in close to the mounting holes to allow it to be installed as shown. There is just sufficient clearance for size 6/40 hex nuts between the transformer and sides of the chassis. Be sure, also, to solder a 3" lead to the #1 terminal (bottom) of the secondary winding before mounting the transformer.

A common ground tie point for all return circuits is essential. The first model of the monitor depended upon the box for ground returns for the coax connectors, R. F. choke, and the transformer. Operation of the unit was quite erratic, and the oscillator was affected by hand-capacity. However, all grounds were brought to a common tie-point in the final model, and the unit is now completely stable.

The base resistor used with the transistor is 15,000 ohms, $\frac{1}{2}$ watt. With the

transformer used, this value proved to be optimum, combining usable output, a tone frequency for minimum listening fatigue (870cps), and excellent starting characteristics. However, a transformer of different characteristics from that shown may require a base resistor of higher or lower value best determined by trial. In any case, the value should not exceed 30,000 ohms, or be less than 8,500 ohms. A miniature 25,000 ohms variable resistor in series with a 8,500 ohm fixed resistor would provide continual adjustment if desired. However, this unit is installed inside the TVI enclosure of the Viking transmitter, and is therefore fixed.

It is recommended that the 2.5-mh R. F. choke shown be used in duplicating the unit. A 1-mh R. F. choke was used in the development model to conserve space, but the developed d.c. voltage from the germanium diode dropped appreciably on the 14 and 28-mc frequency bands. Replacing the choke with the 2.5-mh value shown provided uniform d.c. voltage throughout the range of the transmitter.

INSTALLATION AND ADJUSTMENT

The monitor may be conveniently mounted with transmitter enclosures provided ambient temperatures do not exceed recommended upper limits for the transistor. Sufficient R. F. pick-up may be derived from a 300-ohm twin lead by coupling a length of lead to the monitor. Scotch electrical tape provides a neat and effective means of fixing the pick-up to the twin lead.

Adjustment of pick-up should be made carefully, since permanent injury to the transistor is possible by over-coupling. First, a pair of head-phones is connected to the output jack. The R. F. pick-up, consisting of shielded single conductor cable, or coax (RG-59/U) of suitable length with the shield braid stripped back about 5" from the end is fitted to the input jack. With the transmitter loaded to rated output, the pick-up is carefully moved into the R. F. field of the power amplifier. The oscillator will operate as the final tank or tube is approached, and volume will increase as the pick-up is moved closer to the final tube or tank. It is here that care should be exercised. If head-phone operation, or coupling to the receiver A. F., is desired, adjust the distance of the pick-up from the final tank for the desired volume level. For loud-speaker operation with the unit shown, coupling is adjusted until the d.c. current to the emitter reaches 0.5 ma. This is adequate for the output connections shown, and is ample volume. For the Viking I, a 5/8" cone insulator is mounted at one of the 4D32 socket mounting holes, a 1/8" x 5" threaded rod is screwed into the top of the insulator, and connected to the monitor by shielded line. The output of the unit drives a Utah 3" PM speaker.

This device performs a most useful function without the penalty of supplying additional power to the unit.

DIAGRAM OF SELF-POWERED TRANSISTOR MONITOR

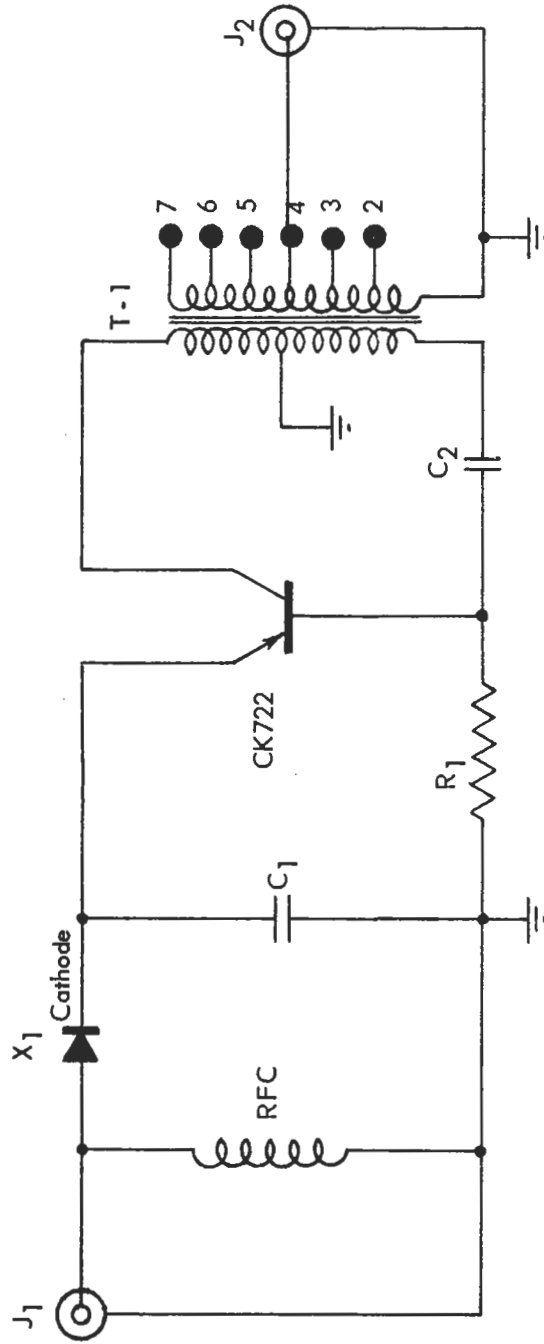

PARTS LIST

- R1 - 15,000 ohm, 1/2 watt, comp. res. (IRC)
- C1 - .01 uf, 500-v, disc. ceramic fixed cond. (Eric)
- C2 - .02 uf, 200-v, paper cond. (Sprague)
- X1 - CK705 Germanium Diode (Raytheon)
- Rfc - 2.5 mh r.f. Choke (National R-100 S)
- T1 - Output Transformer (Hallardson HVAT-4)
- J1 - Phone tip jack, ceramic insulated, (ICA)
- J2 - Single conductor mike connector (ICA)
- 1 - Sectional box, 1 1/2"X2"X4" (ICA)
- 1 - Terminal strip, 5-point (Cinch)
- 1 - CK722 Junction transistor (Raytheon)

TRANSISTOR KEYING MONITOR

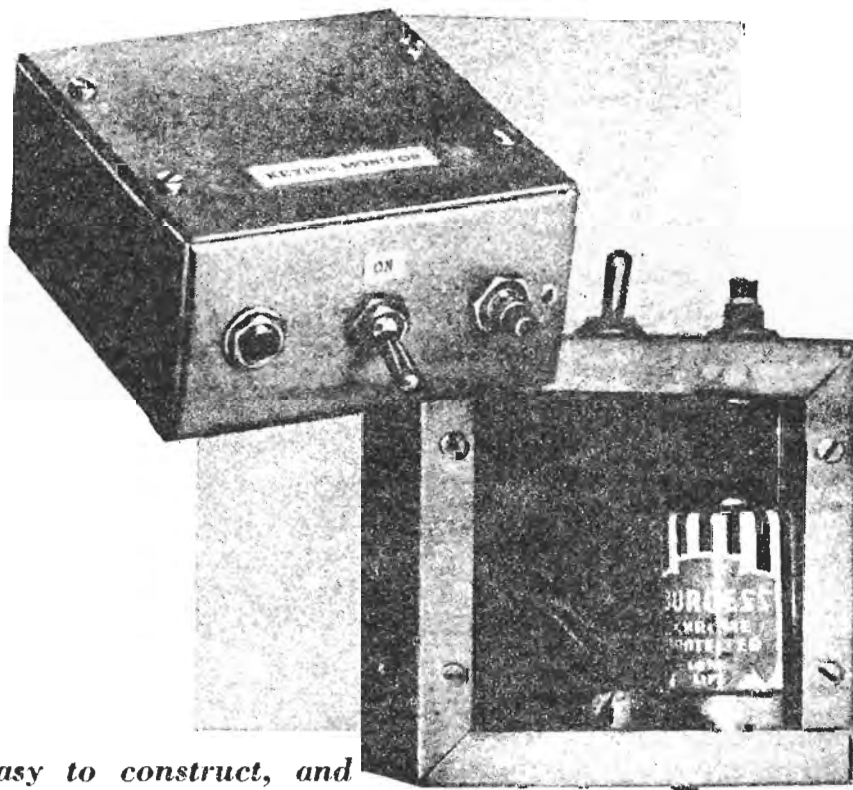

Easy to construct, and easy to use, the monitor makes for clean keying

By I. QUEEN

MANY c.w. operators monitor their keying by listening to the blocking of the receiver or to the clicks of the key. These methods are O.K. when sending at slow speeds but are definitely no go when sending at 15 words per minute and higher speeds. Receivers often block for periods long enough to convert a dot into a dash and make the operator stumble over his own fist. Using a bug without a keying monitor is one sure way to make the other fellow break off the contact with some weak excuse like QRM, QRN, or gotta QRT for chow.

This keying monitor makes it possible for you to follow your own keying with ease so you are more relaxed and can really enjoy the contact. Your keying will be cleaner and the fellow on the other end will find it easier to copy and won't be so eager to run off and work someone else. It is so easy to construct and use that no c.w. man should be without one.

The circuit is essentially an a.f. oscillator with trigger characteristics. No positive emitter bias is used, so the transistor tends to remain blocked. If a positive signal energizes the emitter, the

transistor begins to conduct. Current flows in the high-resistance base circuit. Due to the voltage drop in this circuit, a positive bias is placed on the emitter. The transistor, once conducting, tends to remain that way.

The base resistor is adjustable. It may be set to a medium value, so that triggering is only temporary. Then the circuit oscillates only for an instant after its emitter is energized. Removing the external signal permits oscillations to die out at once and the transistor blocks again. This is the correct adjustment for a keying monitor. The monitor is coupled very loosely to a transmitter antenna or final tank. When the key is pushed down, the strong r.f. field triggers the transistor and a tone is heard. Releasing the key stops the tone. I didn't need a crystal to rectify the r.f. field. Evidently the periodic disturbance of the r.f. keeps the circuit triggered and operates the oscillator. This circuit will follow dots up to any speed Mackay can transmit.

Few adjustments or controls are needed. Finding the proper resistance between switch and ground may require a little experimenting. I found 330,000

ohms O.K. If it is too high, oscillations will continue with the key up. If too low, the circuit may not oscillate.

The base resistor varies tone. It also determines trigger conditions. Near zero, the transistor will be too critical. It will oscillate at the slightest touch of the headphones. Results are best with about 4,000 ohms in the base circuit.

The transformer is the type used in a TV vertical blocking oscillator. It measures 250 ohms across the primary (between GR and BR) and 1,600 ohms across the secondary. There is no reason why high-ratio audio transformers should not work in this circuit.

I have used this monitor on all bands with a low-power (30-watt input) transmitter. The only coupling procedure required is to wrap the short insulated lead from the emitter once or twice around the antenna. Placing it near the final tank also works fine.

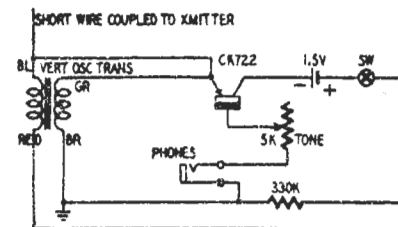

Schematic of transistor keying monitor.

Materials for Keying Monitor

Resistors: 1—330,000 ohms, 1/2 watt; 1—5,000 ohms, potentiometer.

Miscellaneous: 1—vertical blocking oscillator type transformer; 1—transistor, type CK-722; 1—p.s.t. toggle switch; 1—1.5-volt dry cell; 1—phone jack; 1—4 x 4 x 2-inch utility box.

This instrument can also serve as an excellent a.f. oscillator. The base resistor varies tone over a fairly wide range, almost 3 octaves. With a larger resistor, the variation is even greater. If much use is to be made of this unit as a generator, it might be better to add a switch to disconnect the high resistance. This will do away with the trigger characteristic and permit the transistor to oscillate at all times.

This circuit has another curious characteristic, mentioned earlier. When used as a trigger circuit, you will find that the instrument is sensitive to mechanical shock as well as acoustic and r.f. signals. For this reason, turn the tone control as near to zero as you can without oscillations. Now, if you tap the headphones ever so lightly, the circuit will be tripped and oscillations will be heard. Speaking or whistling into the phones will do the same thing. Once oscillations begin, they may be stopped by turning off the switch or returning the tone control to maximum. This resets the trigger.

Most c.w. men take pride in their signal quality, and this transistor keying monitor will enable them to hear themselves as others hear them. Its compactness and ease of installation make it a valuable instrument. **END**

A TRANSISTORIZED AUDIO FILTER FOR AMATEUR RECEPTION

An audio filter which will select or reject one audio frequency is a handy accessory to a receiver which is to be used in today's crowded amateur bands. On CW it will boost a desired signal or reject an undesired signal. On phone it will reject heterodynes which will be present until all amateurs switch to single sideband suppressed carrier. The audio filter takes the place of the crystal filter in a receiver which does not have one and supplements it in a receiver which does have one.

A vacuum tube circuit, popularly known as the select-o-ject, which will select or reject one audio frequency has been described in the literature,^{1,2,3} and the circuit described here uses the same basic principle with Raytheon CK-722 transistors as the active circuit element. The transistorized version has the advantage that it will run for a long time on its self contained battery and therefore the only connection necessary to the receiver is to plug the filter into the headphone jack.

A UTC SSO-1 is used as an input transformer in case the filter is to be employed with a receiver where the headphone jack is connected to the output of the first audio stage. The transformer steps down the high impedance of the audio stage to the low impedance of the input of a transistor stage. One volt on the high impedance side of the transformer gives good volume in the headphones. The transformer can be omitted if the receiver has a low impedance output feeding the headphone jack. In this case padding will probably be needed between the receiver and the filter.

The amplifier consisting of JT1, JT2, and JT3 includes a variable phase shift network and will give a phase shift of 0° at one selected frequency and a different phase shift but relatively constant gain at all other frequencies. When the switch is in the reject position the output of this amplifier is combined with the output of the stage consisting of JT4 which gives 180° phase shift and constant gain at all frequencies. When the reject control is set so that both channels give the same gain at the selected frequency, that frequency will be canceled out in the load. In the boost position the stage consisting of JT4 gives regenerative feedback which will be maximum at the selected frequency. The selectivity can be varied by the boost control and is greatest at the point where the circuit is about to break into oscillation.

JT1 is a split load phase inverter. It should be noted that when this circuit is used with a transistor it will not give perfect balance because there is a finite input current into the base and most of this current will flow in the emitter circuit because the emitter resistance is much lower than the collector resistance. This balance is not as

important as some authors think; if the balance were perfect and the frequency response of the amplifiers were completely flat, the boost or reject control would not have to be readjusted when the frequency control was changed. The author has found that these controls do have to be readjusted even in the vacuum tube version in which precision resistors are used in the phase inverters.

JT2 is another split load phase inverter but here the input is returned to the emitter to increase the gain of the stage and to improve the balance by preventing the input current from flowing through either of the load resistances. Transformers are used between each phase shift network and the next transistor to present a high impedance to the output of the network and to match the input of the transistor.

JT3 drives the headphones and also provides an out of phase voltage for JT4 when the switch is in the boost position. In the boost position, JT4 gives another 180° phase shift so that the output of JT4 will be in phase with the input and therefore give regenerative feedback at the selected frequency. In the reject position, JT4 drives the headphones in addition to JT3.

It is important in the boost position that the stages have sufficient gain so that the device can be made to oscillate and in the reject position it is necessary that all stages have low distortion so that harmonics of the undesired frequency will not be produced. Such harmonics will not be filtered out when the fundamental is filtered out and the usefulness of the device will be reduced.

The transistorized audio filter is a useful accessory to an amateur receiver and is a good starting place for the amateur who wants an introduction to the newest active circuit element.

REFERENCES

1. O. G. Villard, Jr., "Selective A-F Amplifier," *Electronics* July, 1949, p.77.
2. O. G. Villard, Jr. and Donald K. Weaver, Jr., "The Select-o-ject," *QST* November, 1949, p.11.
3. G. L. Countryman, "A C. W. Filter" *Radio and Television News* November, 1949, p.42.

DIAGRAM OF TRANSISTORIZED AUDIO FILTER

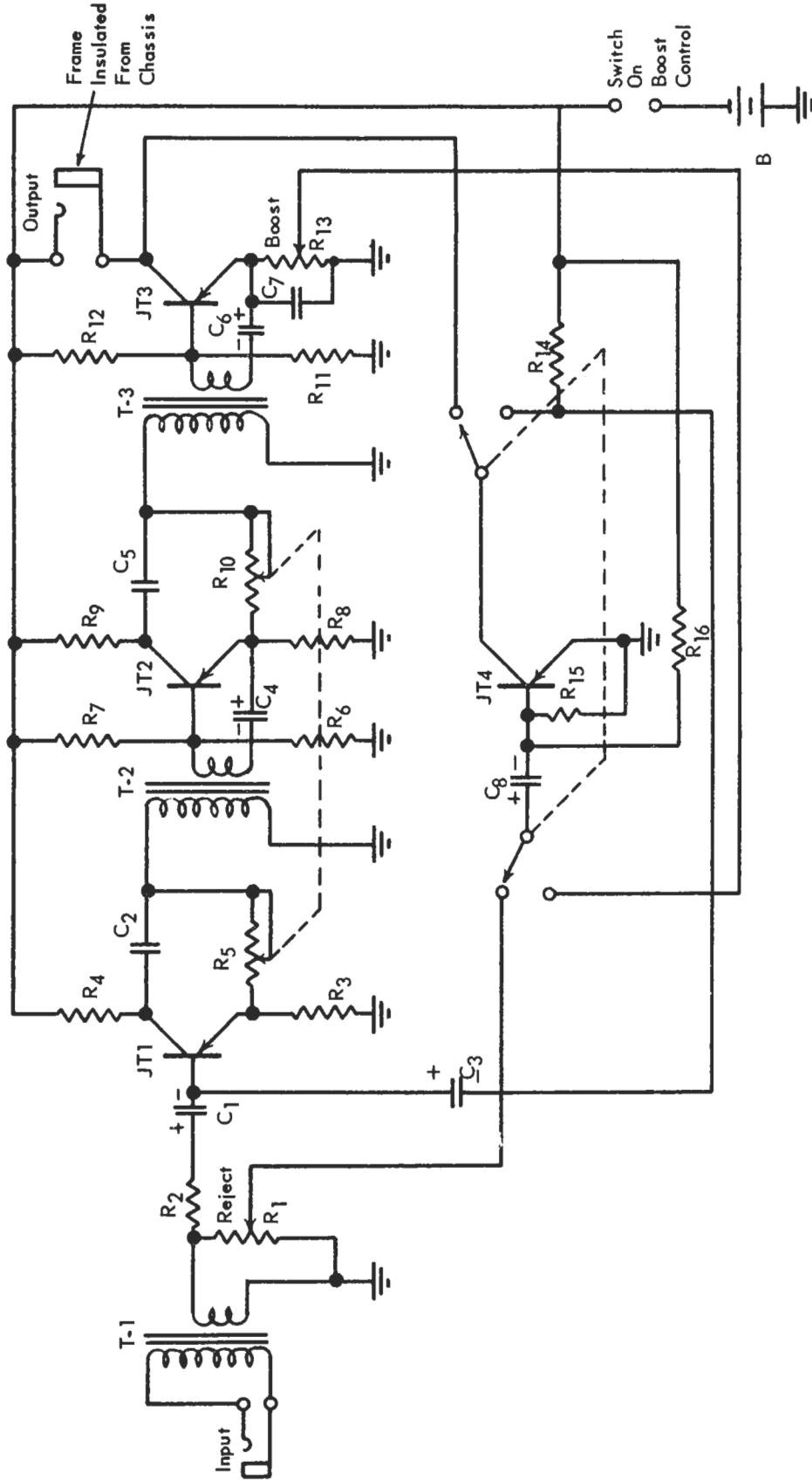

PARTS LIST

- | | | | |
|--------------|--------------------------------|-------------------|--------------------|
| R1 - 1000 | R9 - 4700 | T1 | - UTC SSO-1 |
| R2 - 1000 | R10 - 100,000 (section of R's) | T2 | - UTC SSO-3 |
| R3 - 4700 | R11 - 3900 | T3 | - UTC SSO-3 |
| R4 - 4700 | R12 - 18,000 | JT1 | - CK722 Transistor |
| R5 - 100,000 | R13 - 1000 | JT2 | - CK722 Transistor |
| R6 - 1200 | R14 - 1000 | JT3 | - CK722 Transistor |
| R7 - 3900 | R15 - 3900 | JT4 | - CK722 Transistor |
| R8 - 4700 | R16 - 22,000 | BATTERY | - Mallory TR132 |
| | | C1 - 20 μ fd. | |
| | | C2 - .01 | |
| | | C3 - 20 μ fd. | |
| | | C4 - 20 μ fd. | |
| | | C5 - .01 | |
| | | C6 - 20 μ fd. | |
| | | C7 - .02 | |
| | | C8 - 20 μ fd. | |

TRANSISTOR BAND SPOTTER

By PETER G. SULZER, W3HFW

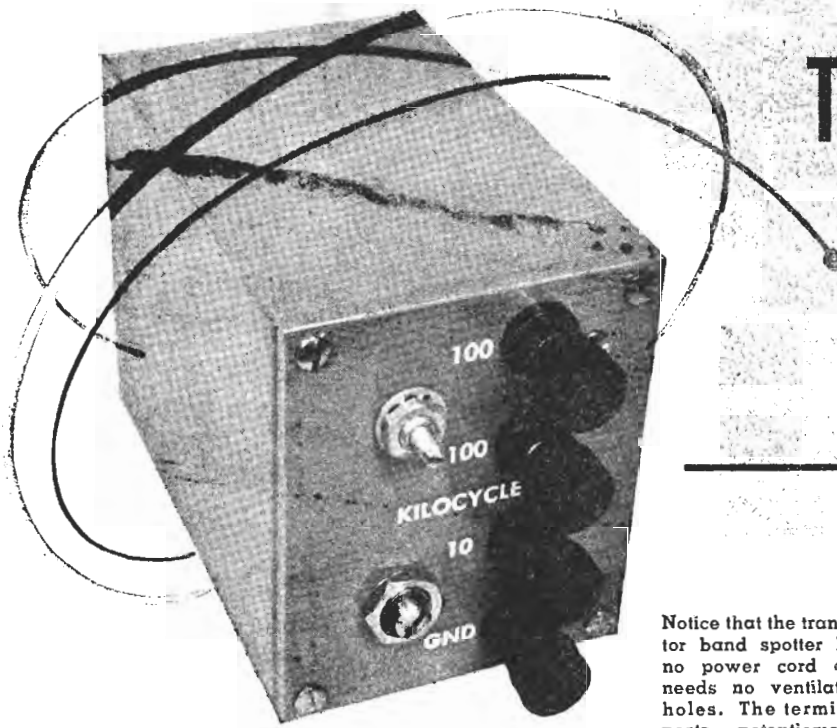

Notice that the transistor band spotter has no power cord and needs no ventilation holes. The terminal posts, potentiometer, lettering, etc., give an idea of its size.

Any amateur can now have a transistor frequency standard at low cost. Simple, stable, with no warmup drift, this unit runs continuously off its internal flashlight cell.

THE availability of "p-n-p" junction transistors¹ has opened many interesting possibilities in the field of compact test equipment. One example of such equipment is the small frequency standard to be described here. Although compactness is in itself a virtue in the crowded ham shack or service shop, the low power consumption of the transistor provides an additional benefit, of value in the fixed station as well as for portable operation.

Consider a typical a.c.-powered frequency standard used for locating band edges, calibrating receivers and v.f.o.'s, and for checking service-type signal generators. It contains a rectifier tube, a 100-kc. crystal oscillator, and perhaps a multivibrator to produce markers at 10-kc. intervals. It consumes about 30 watts, and runs hot because it is built in a small box. As a result, its frequency drifts as it warms up, and its multivibrator may have to be readjusted to compensate for circuit-element changes during the heating cycle. A better design with a sufficient provision for heat dissipation would improve mat-

ters, but a crystal oven would really be necessary to complete the job of stabilizing the oscillator. Unfortunately, however, the equipment, and particularly the crystal oven, would have to be in operation at all times to avoid the warmup problem which would run up the power bill and constitute a fire hazard.

Here is where the additional benefit of the low-powered transistor comes in. The total power required by the band spotter is 300 microwatts, 1.5 volts at 200 microamperes. This is so small that a single flashlight cell

Fig. 1. Cross-sectional representation of a "p-n-p" transistor, used in this circuit, and standard transistor diagram symbol.

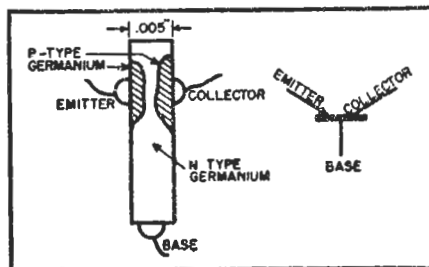

should operate the unit for years, and therefore an "on-off" switch is not required. Since the band spotter operates at all times there is no warmup problem, and an accurate frequency calibration is available at all times, particularly if there is no hot equipment nearby. An additional point worth mentioning is the lack of a power cord to add to that ever-growing "tree" at the power outlet.

The band spotter contains a 100-kc. crystal oscillator and a 10-kc. synchronized blocking oscillator, each using a "p-n-p" junction transistor. Two outputs are provided at 100 kc.: a clipped sine wave at Terminal 1, which provides usable receiver-calibration markers up to 30 mc., and a sine wave at Terminal 2 for oscilloscope frequency comparison. The 10-kc. output at Terminal 3 is a 1-microsecond pulse having strong harmonics beyond 30 megacycles.

The "P-N-P" Transistor

In order to discuss the circuits used in the band spotter, a brief and much simplified description of the "p-n-p" junction transistor² is in order. This type of transistor contains a small (0.08 inch by 0.12 inch by 0.005 inch thick) wafer of "n"-type germanium. It will be recalled that most of the conduction in an "n"-type semiconductor takes place via electron flow, in contrast to the "p"-type, in which conduction effects occur through the flow of holes (places where electrons are missing in the crystal structure). A small dot of indium is placed on the two opposite flats of the wafer, which is then heated, permitting a portion of the indium to diffuse into the germanium. In this manner the diffused portions of the germanium are converted to the "p"-type. The heating process is continued until the thickness of the remaining "n"-type ger-

manium at the wafer center is small, perhaps 0.001 inch, as shown in the drawing. Small wires are soldered to the dots, which become the emitter and collector connections and a third wire is soldered to one end of the wafer, which is the base connection.

Suppose, now, that the collector is made negative with respect to the base. A very small current will flow because of the direction of the electric field across the "p-n" junction. Here the negative charge on the collector will tend to repel electrons back into the "n"-type base, while the positive charge on the base will repel holes (which behave something like positive charges) back into the collector. A similar situation would exist in an imaginary vacuum tube containing an electron emitter at its cathode and a positive-ion emitter at its anode. With the anode negative with respect to the cathode, cathode-current cut-off would occur because the electrons would be repelled back toward the cathode, and anode cut-off would occur because positive ions would be repelled back toward the anode. Since cathode current must flow through the anode, and *vice versa*, cut-off in a double sense is obtained.

If, while keeping the collector negative, the emitter is made slightly positive with respect to the base, a heavy emitter current will flow as electrons are drawn out of the "n"-type base by the positively-charged emitter, and holes are drawn out of the "p"-type emitter by the negatively charged base. It is seen, therefore, that the emitter behaves as a rectifier biased in the conducting direction, while the collector behaves as a rectifier biased in the non-conducting direction, and therefore the emitter has a low dynamic (a.c.) resistance, and the collector has a high dynamic resistance. However, according to this simple theory most of the holes drawn out of the emitter can pass right through the thin base region, and they will do so because they behave as positive charges, and are accelerated by the negatively-biased collector. These holes then constitute the collector current, which is almost independent of the collector voltage as long as the collector is negative. This is another way of saying that the collector dynamic resistance is very high.

It is not immediately apparent that such a device will amplify, but it does, and this is because of the large ratio of collector impedance to emitter impedance. If a small a.c. voltage is applied between the emitter and base, an alternating emitter current will be produced and, in a good transistor, most of this current will pass through the base and appear across a much higher impedance in the collector circuit producing a comparatively high voltage between the collector and base.

To consider some typical figures, suppose that the input (emitter-base) dynamic resistance is 100 ohms, the

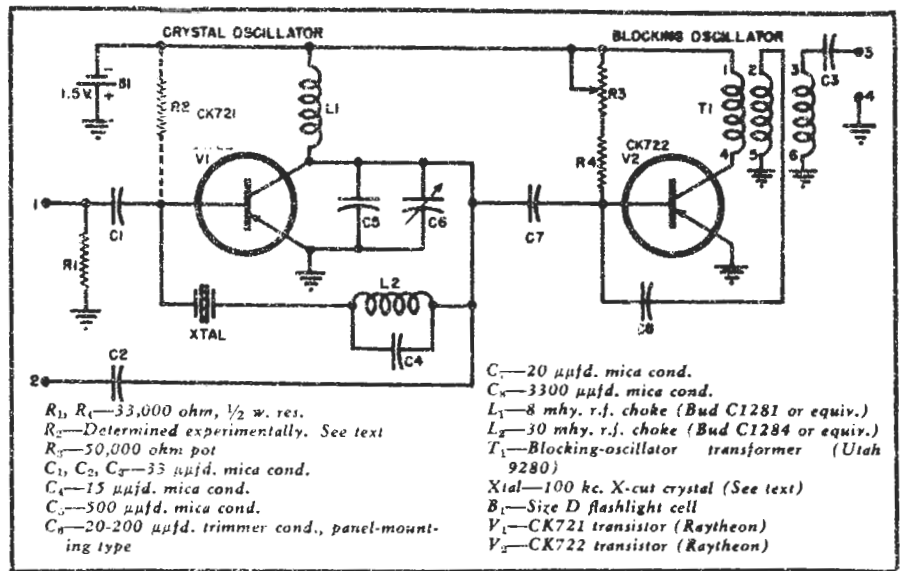

Fig. 2. The schematic shows the remarkable simplicity of the transistor frequency standard. R_2 is used if the measured current through L_1 is less than the normal value (see text). C_5 , a trimmer, is the final front-panel adjustment. The economy of parts more than offsets the "expense" of using transistors rather than tubes.

output (collector-base) dynamic resistance is 100,000 ohms, and suppose that 95% of the emitter signal current appears in the collector circuit (α , the short-circuit current gain = 0.95). Suppose, also, that a 100,000-ohm collector load resistance is used. If a 0.1-volt a.c. signal is applied to the emitter, the emitter signal current will be 1 milliampere, and therefore the collector signal current will be 0.95 milliampere. One half of this will go to ground through the collector dynamic resistance, while the other half will produce a useful signal of 47.5 volts across the 100,000-ohm load.

The voltage gain is thus 475, a very substantial figure.

It has been seen, then, that the grounded-base connection can produce a large voltage gain at the expense of a very low input impedance. A more useful amplifier is obtained if the emitter is grounded, so that the base can be driven.³ Since most of the current leaving the emitter passes through the base to the collector, the base current itself is much smaller than the emitter current. Consequently the base-driven circuit can produce a current gain as well as a voltage gain, and a much more versatile am-

This internal view shows that the construction, while compact, is "roomy." There is no chance of overheating; the unit is left running continuously for its maximum stability, without danger of breakdown or running up the power bill. It is as nearly independent of external conditions of temperature, etc., as it is of power lines.

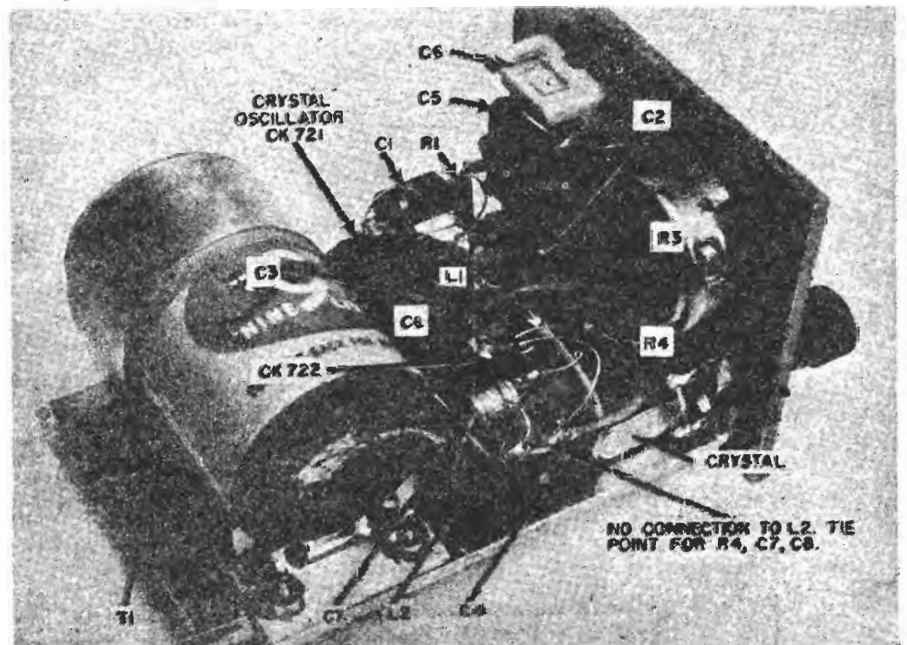

plier of higher input impedance is obtained. The current gain, which depends critically upon the value of α , may be 10 or more, while typical values for the input and output impedance are 1000 ohms and 100,000 ohms respectively.

It should be pointed out that the base-driven connection produces a phase reversal, as does the grounded-cathode vacuum tube. In fact, the properties of a small voltage-amplifier pentode with a resistance on the order of 1000 ohms connected between grid and cathode resemble those of the base-driven transistor, although the transistor will operate with a much smaller power supply.

The base-driven connection is used in the crystal oscillator and blocking oscillator in the band spotter.

Considering the crystal oscillator, one might be tempted to "borrow" the conventional Miller vacuum-tube oscillator, connecting the crystal (considered as a parallel-resonant circuit) between the base (grid) and ground, and tuning the collector (plate) with a parallel-resonant circuit. Perhaps a small feedback condenser might have to be connected between the collector and base to make it oscillate. It will not oscillate, though, because of the 1000 ohms between base and ground, which shorts the high parallel-resonant impedance of the crystal. Fortunately here the design engineer has recourse to the useful concept of duality⁴, which suggests that grid voltages should be replaced by emitter (or base) currents and parallel-resonant circuits should be replaced by series-resonant circuits. This is easy here because the crystal can act as a series-resonant circuit, and therefore it is simply connected in series with the transistor base and the rest of the circuit. The maximum feedback is obtained at the series-resonant frequency, where the crystal impedance is minimum, and the base current is maximum.

The rest of the circuit could consist simply of a phase-reversing transformer, which could have a one-to-one ratio. Such a transformer was not readily available and, therefore, a collector choke L_1 , condensers C_2 and C_3 , and parallel circuit L_2C_1 were used to obtain a portion of the phase shift necessary for positive feedback. The voltage across C_3 is nearly sinusoidal because of the filtering effect of the tuned circuit L_2C_1 . The small condenser C_2 isolates the oscillator from load changes at Terminal 2. The voltage at the transistor base, which is coupled to Terminal 1 through a similar small condenser C_1 , consists of a clipped sine wave which has strong harmonics throughout the high-frequency range.

Operation of the blocking oscillator is analogous to that of a vacuum-tube

blocking oscillator, and can be understood if the following facts are restated: In a transistor, collector current flows when emitter current flows. In a "p-n-p" junction transistor, collector current flows when the emitter is positive with respect to the base or, since the grounded-emitter connection is used, collector current flows when the base is negative with respect to the emitter (providing, of course, that the collector is also negative with respect to the base).

Suppose now, that C_1 is charged so that the base is positive with respect to the emitter. The collector current will be cut off (or nearly so, if it is a good transistor), and C_1 will discharge through R_2 and R_1 until the base goes slightly negative with respect to the emitter. Emitter and collector current will then flow, and a regenerative action will take place through the blocking-oscillator transformer T_1 , which is connected to produce a phase reversal. A heavy collector current flows, and the voltage across C_1 builds up very nearly equal to that of the supply voltage. At this point the charging current must decrease since the charge in C_1 has reached its maximum value. The transistor is soon cut off and the conditions existing at the start of the cycle have been restored. Since the charging cycle is much shorter than the discharging cycle, the voltage across C_1 is of saw-tooth form.

A sinusoidal synchronizing current is coupled to the emitter by C_2 , and it is the purpose of one (out of 10) of the negative half-cycles of this current to initiate the regenerative charging action slightly in advance of its normal time, thus effecting synchronization.

The small condenser C_3 isolates the blocking oscillator from load changes at Terminal 3.

Construction

The details of parts layout and mounting are shown in the photographs. The box is 2½" by 3" by 4" deep. The depth could have been decreased by 1½ inches by using a hearing-aid type mercury cell in place of the flashlight cell and by removing the blocking-oscillator transformer from its case.

The transistors were mounted by means of bent soldering lugs. Although subminiature tube sockets could have been used, the transistors should last as long as the rest of the equipment, and therefore there is little reason for a change.

The crystal holder was wrapped in a piece of sponge-rubber to decrease the effects of shock, and mounted by means of a metal "strap."

Looking at the internal-view photograph, the crystal oscillator, using a CK721 transistor, is toward the far edge, although the top of the crystal

holder is visible at the lower right. The blocking oscillator uses a CK722 in this unit. It will be noted that several leads are soldered together on the edge of one of the chokes, L_2 in the foreground. This is the junction of C_1 , C_2 , R_1 , and the transistor base. It is not one of the connections of L_2 itself. It so happened that an extra hole in the choke base made a convenient tie point for these connections.

Adjustment

In setting up the crystal oscillator, the crystal and L_2 and C_1 should be disconnected, and the current through L_1 should be measured. If it is much less than the normal value of 100 microamperes a resistor, R_2 (shown dashed in Fig. 2) should be connected and adjusted to obtain 100 microamperes.

Next the crystal should be connected directly between the base and the emitter, a large variable condenser substituted for C_1 , and C_2 adjusted to produce the maximum output as observed at Terminal 2. The frequency should then be checked, and if it is high an inductor, L_2 , should be connected in series with the crystal and the frequency adjusted to zero beat with WWV. For this test the receiver antenna terminal should be connected to Terminal 1. A small condenser C_3 across L_2 will facilitate the initial adjustments while C_3 is used as the final (external) frequency trimmer.

If the frequency of the oscillator is low initially, a condenser should be connected in series with the crystal. A large variable condenser should be used for the initial adjustments.

Although a small X-cut bar was used in the oscillator described here, it has been found that 100-kc. loran-indicator crystals will work in the same circuit.

Adjustment of the blocking oscillator is comparatively simple, the best method requiring the connection of a receiver to Terminal 3. Switch on the beat-frequency oscillator and, if possible, tune the receiver to the low end of the broadcast band. Note the frequencies of two adjacent harmonics of the 100-kc. oscillator, and then adjust R_1 so that nine signals are observed between the 100-kc. points. To produce the best stability R_2 should be set to the middle of the range producing this result.

REFERENCES

1. Raytheon Manufacturing Co., 55 Chapel Street, Newton, Mass.
2. Larc, Mueller, & Pankove: "A Developmental Germanium P-N-P Junction Transistor," *Proceedings of the IRE*, Nov. 1952.
3. Wallace & Pietsenpol: "Some Circuit Properties and Applications of n-p-n Transistors," *Proceedings of the IRE*, July 1951.
4. Wallace & Raisbeck: "Duality as a Guide in Transistor Circuit Design," *Bell System Technical Journal*, April 1951.

Transistor—Varistor Modulator

for low-level audio

NOTE

Use of a CK 705 Germanium Diode in place of the IN34 is recommended

Semiconductor unit gives excellent results

By ALBERT H. TAYLOR

A UNIT, based on the principles and applications of Balanced Modulators for Low-Level Audio (December, 1954) and using a transistorized carrier oscillator and a varistor modulator containing two germanium diodes, is described in this article.

The transistor oscillator is essentially that published by Bohr¹. It contains a Ferri-Loopstick coil with the core fixed symmetrically and ceramic tuning capacitors. My transistor self-excited r.f. oscillators sound doleful against a receiver heterodyne, and I would use a crystal in a modification of Queen's circuit² if I had one in a small holder like his LM crystal. Fortunately the quavering r.f. doesn't seem to hurt the audio quality and the stability is not bad.

The modulator (Fig. 1) is, from the balancing standpoint, a mutual inductance bridge like those commonly used in metal detectors. Two identical secondaries (L2 and L3) are moved to adjust their relative couplings to the oscillator coil (L1) for balance. They should by rights be electrostatically shielded from it, but I haven't yet made a shield that doesn't kill the oscillator. Fortunately the amount of unbalanceable carrier that gets through—even with no attempt at capacitance balance—is so little that the Pickering pickup overmodulates it and the coils must be moved off center to increase the unbalance for better quality. For still weaker audio sources, shunt the 1N34 rectifiers with small capacitors and adjust the coil and the variable trimmer alternately until the balance is as fine as you like. In this, as in the tube circuit ("Balanced Modulators," December, 1954), even harmonics are not balanced.

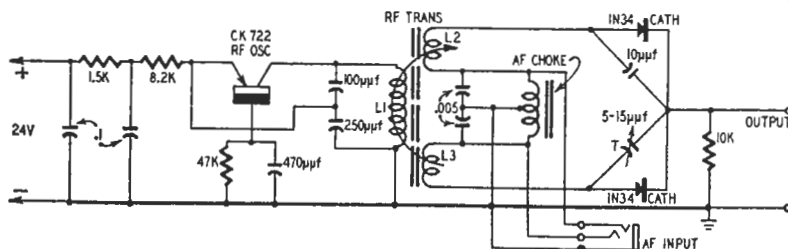

Fig. 1—The varistor modulator—a balanced bridge to cancel the carrier.

The pickup is applied in push-pull between the two secondaries and bypassed for r.f. The bypass capacitors are essential to carry the r.f. current of the rectifiers. If they reduce the audio fidelity, try in their place series-resonant circuits with smaller capacitors, tuned to the carrier frequency.

To provide the necessary d.c. path for the rectifiers, the primary of an Ouncer type push-pull output transformer from a BC-347-A interphone amplifier serves as a center-tapped audio choke. It has a resistance of 500 ohms. A pair of resistors would probably do if they did not load the pickup nor throttle the rectifiers. The output load resistor is not critical and satisfactory modulation with little change in level takes place with anything from wide open to a direct short through the receiver's antenna coil or an r.f. choke. Too low a resistance probably loads the pickup but I can't say I missed any highs in a broadcast receiver.

I generally use a 10,000-ohm resistor and a 200- μ F coupling capacitor to avoid misalignment. A d.c. voltmeter across the output conveniently indicates oscillation and reads about 0.5 volt with the coil turns I am using. The output impedance is so low that if I make another unit I shall use more turns on the twin secondaries for a higher carrier-to-audio ratio in the diodes.

Construction

Any small metal box will make a good chassis—I found that of the BC-347-A ideal. Simple filtering keeps the transistor oscillator signal where it belongs and no shielding is necessary between oscillator and modulator sections.

The only critical job is making and

mounting the r.f. transformer, but it can be done very neatly even without special tools. If you are afraid of it, try Fig. 2 instead of Fig. 1. You may get away with using an unshielded, stock receiver antenna transformer if you use trimmers from the bridge corners to the live side of the secondary.

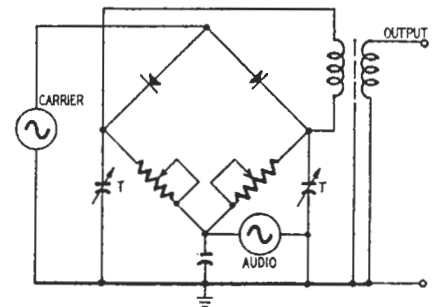

Fig. 2—Diagram of another varistor bridge; has grounded input, balanced output.

Fig. 3 shows my transformer in cross-section. The form for the secondaries is a paper tube that just slips over the waxed-paper cover of the Ferri-Loopstick primary. I made it by wrapping two layers of drawing paper onto the end of a dowel and binding tightly with tape and thread. I dropped this into a can of hot coil wax and cooked it till it quit bubbling. A piece of dowel necked-down to plug into the foot of the Loopstick cooked at the same time. When the waxed paper form had cooled and stiffened, I mounted it and the Loopstick on their brackets, set them side by side in the positions they would occupy in mid-setting, and marked the secondary form with a pencil opposite the center of the Loopstick coil.

The narrow secondary coils are 0.5-inch apart and are symmetrically

Parts list for modulator

Resistors: 1—1,500; 1—8,200; 1—10,000, 1—47,000 ohms, 1/2 watt.

Capacitors: 1—10, 1—100, 1—250, 1—470 μ F; 2—.005, 2—0.1 μ F; 1—5—15 μ F, trimmer.

Miscellaneous: 1—CK722 transistor and holder; 2—IN34; 1—Ferri-Loopstick; 1—center-tapped audio choke (see text); 1—chassis; 1—2-circuit jack; 1—rubber band; 1—22.5-volt battery; 1—1.5-volt cell; 1—r.f. transformer (see text); hardware.

spaced from this mark. They are wound with the Litz wire that comes with the Loopstick, which is just enough for the two 5-turn coils with a little over for leads. I wove them as Turk's heads³ to hold them in place till they could be dipped. Then I plugged the open end of the form with a wad of cotton and flash-dipped the completed coils into the wax, also dipping the butt of the Loopstick to hold it onto its dowel.

The Loopstick primary L1 and the two secondaries are held to their brackets at identical heights by wood screws in the dowels. They must fit accurately and squarely so as not to bind when the secondaries travel back and forth.

In the assembled modulator (see photo) the transformer takes up a great deal of room because the Loopstick must be kept away from large pieces of metal. If it gets too close, the oscillator quits. A single screw holds the bracket of the Loopstick at one end of the case, while the long-footed bracket of the secondaries at the other end has two 10/32 screws tapped into it which travel in slots in the case, parallel to the axis of the coils. A 1-inch 10/32 adjusting screw through the end of the case is tapped into the moving bracket and is turned from the outside to move the secondaries gradually. A rubber band between the brackets pulls against the screw to take up backlash, and the moving bracket may have to be grounded by a pigtail unless the guide screws are set up hard after it has been set. The oscillator stops and starts if the bracket makes intermittent contact. Tie the coil leads to convenient points and leave slack for motion. Watch the polarity.

Band Conversion

This modulator can be used as a frequency changer or converter if the r.f. input, suitably filtered against spurious responses, is applied in place of the audio. The bypasses would then be tuned to the local oscillator frequency. Fig. 2 appears a little better suited for this job.

Both this and the tube modulator save tuning elements and radiation worries by connecting directly to receivers. But they can be used remotely by tuning the outputs. The low-impedance transistor-varistor modulator should be tapped down on the tank circuit. In the tube modulator the tank circuit would replace the plate load resistor, with small r.f. chokes in place of the extra resistors if finer balance is needed. But be careful! My father worked New Zealand from Washington, D.C., 'way back then, with just two 201-A's. END

References

- ¹Edwin Bohr, "Transistor Photo Oscillator," *RADIO-ELECTRONICS*, p. 74, May, 1954.
- ²I. Queen, "I.F.-R.F. Crystal Oscillator Uses Junction Transistor," *RADIO-ELECTRONICS*, p. 92, May, 1954.
- ³Garaumont and Hensel, *Encyclopedia of Knots and Fancy Rope Work*, Cornell Maritime Press, 1945.

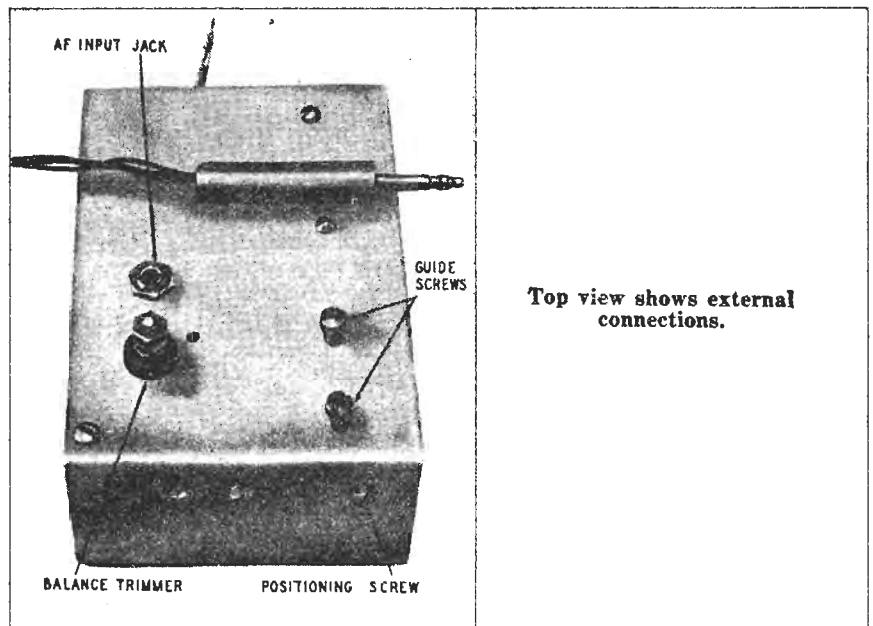

Top view shows external connections.

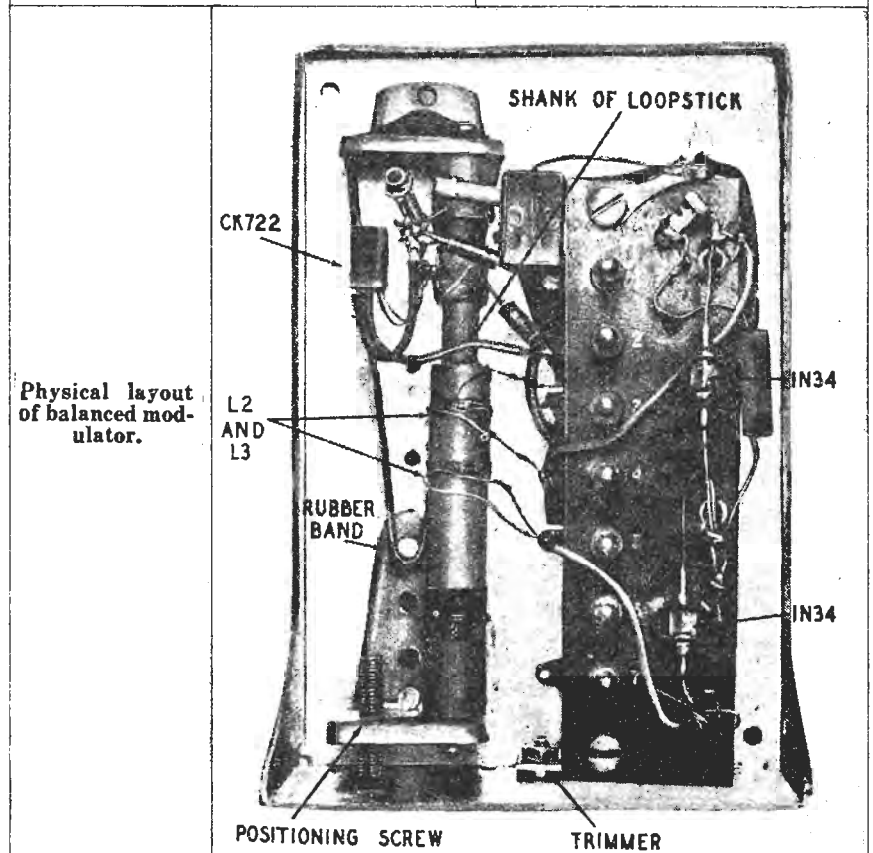

Physical layout of balanced modulator.

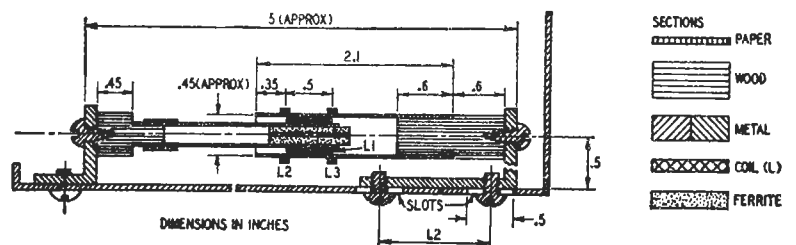

Fig. 3—Cross-section of transformer.

Transistor AM Test Oscillator

An extremely small and portable instrument for servicing radio receivers

By EDWIN BOHR

THIS pocket-size, battery-operated, transistor oscillator generates four spot frequencies for testing and servicing AM receivers. The frequencies are 455 kc, 600 kc, 1 mc, and 1.4 mc. These signals may be modulated or unmodulated. In addition, the oscillator will supply an audio signal for testing audio stages. The oscillator, in combination with a volt-ohmmeter, will lick just about any AM service job.

The oscillator is fine for i.f. alignment, tracking front-ends, and troubleshooting by signal injection. In contrast to signal tracing, signal injection makes the receiver under test supply all the amplification. Where a signal tracer must have many stages of amplification and a loud speaker, the signal injector may be a one-stage oscillator.

For signal-injection testing, hold the oscillator in one hand and move it from stage to stage, starting from the output tube and moving forward into the i.f. and r.f. stages. The trouble is located immediately behind or in the stage where the signal disappears.

Intermediate-frequency stages can be aligned with the 455-kc signal. Tracking is checked at the standard test frequencies of 600 kc, 1 mc, and 1.4 mc. And remember, the entire oscillator fits easily into a shirt pocket.

Test Oscillator

The instrument (Fig. 1) uses a single CK722 junction transistor. At audio frequencies this transistor operates on even less than 1 volt. However, at broadcast frequencies, most CK722

transistors require at least 15 volts. They are not designed to operate on the broadcast band. But, at this voltage, the operation is sometimes erratic, so a 22.5-volt battery is used for the collector supply. This voltage assures easy oscillation and greater interchangeability of transistors.

The four test frequencies are obtained by switching capacitors across the collector tuning coil L1. Coil L2 is a tickler that feeds energy back into the emitter where it is reamplified by the transistor.

Fixed mica capacitors shunt the tuning trimmers for the two lowest frequencies. This "bandspreads" the trimmer tuning and makes the calibration adjustment easier.

Switching C3 across R1 produces audio modulation of the r.f. carrier and the audio test signal. The frequency of this modulation varies with individual transistors and may vary from a slow putt putt to several hundred cycles. The more actively the transistor oscillates, the lower the frequency of the modulation. If the frequency is too low, the oscillator will put harmonics all across the broadcast band when switch S2 is in MOD position. This is not always desirable. The modulation frequency in this case may be raised by decreasing the value of C3. The 1-mh choke prevents the r.f. signal from bypassing to ground when C3 is switched in.

An oscillogram of the oscillator's AM carrier is shown in Fig. 2. The modulation is greatly in excess of 100%. The r.f. is periodically blocked off completely. A.f. oscillations decrease the positive bias on the emitter until the oscillations stop. The emitter then begins to return to a higher positive bias as C3 recharges. When the bias reaches a high enough value, the r.f. oscillations begin again. The positive emitter bias comes from the divider network R2 and R3.

Capacitor C6 has appreciable reactance compared to the emitter input impedance. Therefore, should you wish to operate the oscillator at frequencies lower than 455 kc, the value of C6 must be increased accordingly.

When the frequency selector is rotated to any of the four spot frequencies, the unit is turned on. A fifth contact is the OFF position. With this arrangement, the operator is more like-

ly to turn the oscillator off and not run down the battery.

A single jack serves for both the audio and r.f. test signals. The jack is isolated from the transistor circuit by C5. Since the output is taken from the low-impedance emitter circuit, the oscillator is virtually immune to loading effects. No ground jack is included to ground the oscillator to the circuit being tested. The reason is this: If the oscillator case were grounded and the oscillator output jack were accidentally connected to a high-voltage a.c. wire in the receiver, there might be enough signal coupled to the emitter, through C5, to damage the transistor.

Construction

The design of a good layout for small pieces of electronic equipment is more difficult than seems obvious. A 1½ x 2½ x 3¼-inch aluminum case houses the oscillator. Volume-wise there is adequate space, but the size and shape of the parts is such as to oppose arrangement.

If the oscillator is built in the same size box that I used, follow the drilling details of Fig. 3; this is the only way the parts will fit. Some aluminum cases are made from 1/16-inch stock; others are made of less rigid stuff.

The measurements of Fig. 3 are based on a 1/16-inch wall thickness. Other boxes may require a slight revision of these measurements to compensate for a different thickness.

The largest component is the selector

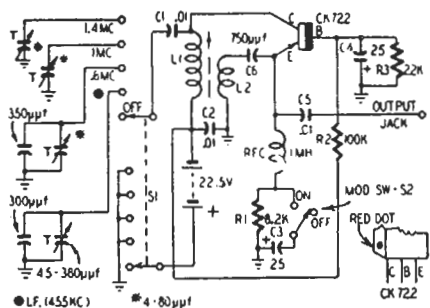

Fig. 1—Schematic diagram of the transistor AM test oscillator. For stable operation, a 22.5-volt battery is used for the unit's collector supply.

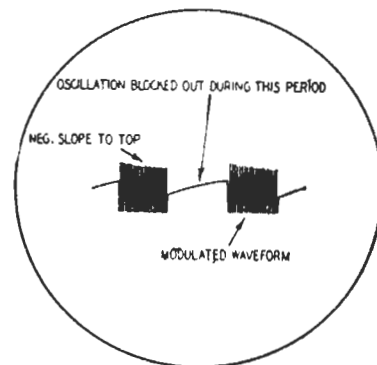

Fig. 2—Oscillogram of oscillator's AM carrier. Modulation exceeds 100%.

switch—one of the new miniature PA-1000 series made by Centralab. The trimmers and their shunt capacitors are wired to this switch. The selector switch also acts as the support for the phenol-board chassis. The chassis contains two holes that slip over the switch bolts. Two 4-40 nuts then hold the chassis board to the switch.

The exact chassis size is shown in Fig. 4. A 5-pin hearing-aid tube socket is used for the transistor and the cutout dimensions are for this type of tube socket.

Other holes must be cut in the chassis.

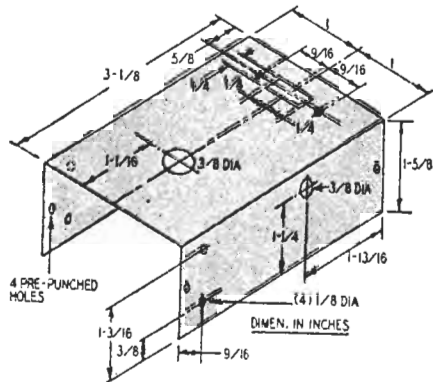

Fig. 3—Layout for the aluminum case.

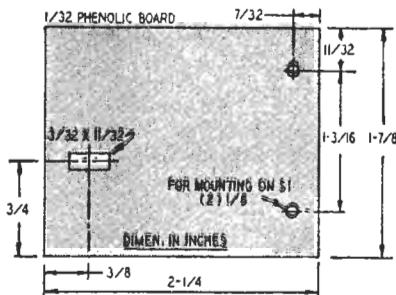
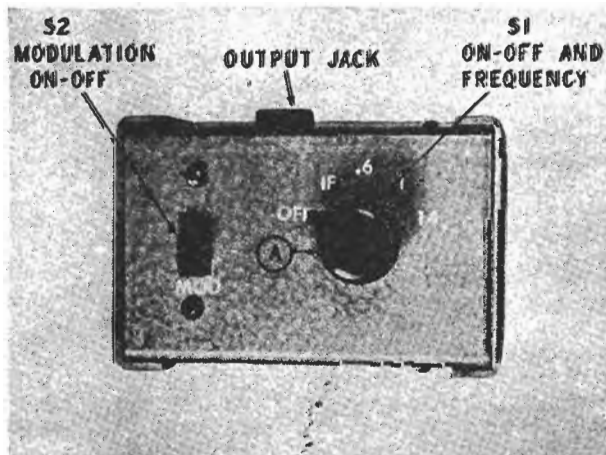

Fig. 4—Chassis layout dimensions.

Components are rigidly mounted to the board by pulling through and soldering their leads to the other side. Even the coil is mounted this way. The position of these holes is best determined by placing the component directly on the board and marking the best hole location.



Front-panel view of test oscillator.

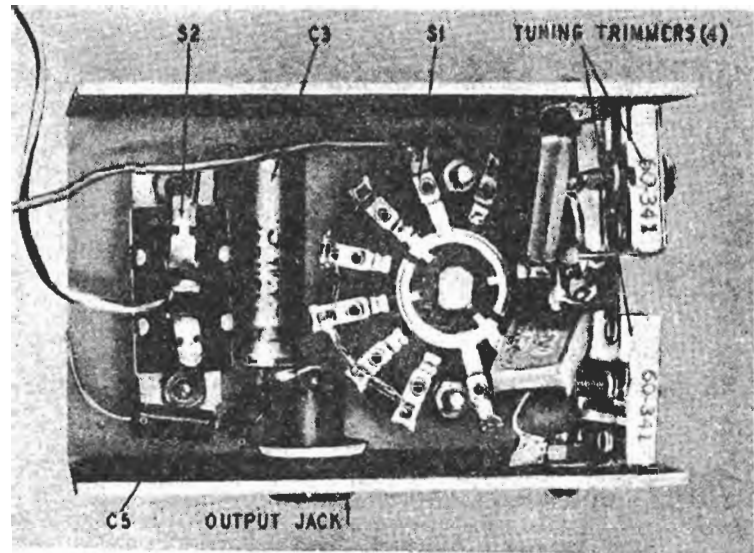

Fig. 5—Components mounted to case.

Several of the parts are mounted to the case under the chassis board (Fig. 5). The loose wires from these parts are soldered to appropriate tie points on the chassis board once it is in place and mounted to the switch.

Coil L1 is a Ferri-Loopstick, modified by removing all of the unnecessary coil form to reduce the size. The number of turns on the coil is unchanged and the slug is centered lengthwise in the coil for maximum inductance. Coil L2 is wound directly over L1 as shown in Fig. 6. Coil L2 is 7 turns of any convenient-size wire. If the coil is wound as shown in Fig. 6, the connections can be made with the assurance that the feedback polarity is correct for oscillation. (But if there are no oscillations, try reversing it!)

Capacitors C1, C2, and C5 are sub-miniature paper units made by Aerovox. The electrolytics are 3-volt d.c. units made by Cornell-Dubilier. C4 may be operated slightly beyond its rating but there will be no difficulty. It is important that the smallest parts obtainable be used. The battery is a small unit made especially for photo-flash purposes.

Calibration and use

An easy way to calibrate the oscillator is to track it with a communications receiver. Ordinary broadcast receivers are usually too poorly calibrated. The 455-kc spot could be set by adjusting it until the second harmonic is picked up at 910 kc. Another way to set the 455-kc trimmer is to feed the oscillator output directly into the i.f. stages of a receiver and adjust the oscillator until it generates a 455-kc signal. If this procedure is followed it is advisable to short out the oscillator section of the receiver beforehand.

There are many stations on 600 kc, 1 mc, and 1.4 mc and at least one station can be received on each of these frequencies. These stations can be used for calibration. For example, tune in a 1400-kc station, turn the transistor oscillator knob to the 1.4 position, and turn the 1.4 trimmer all the way in. Now back off the trimmer about 1/2 to 1 1/2 turns. The oscillator should be heard as it passes 1400 kc. Place the modulation switch in the OFF position and slowly adjust the oscillator trimmer until it zero-beats with the station. All the trimmers will be adjusted within a turn or so of complete closure when they have been tuned to their proper frequency.

The accuracy of the 600-kc adjustment can be ascertained by checking the 600-kc harmonic at 1200 kc. Also, the third harmonic of 455 kc falls in the broadcast band at 1365 kc. For most work with the oscillator, the calibration

(Continued on page 106)

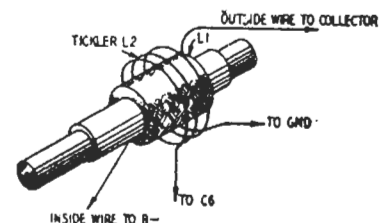
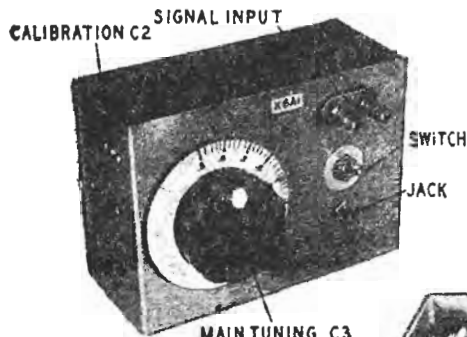

Fig. 6—Coil-modification details.

Heterodyne Frequency Meter uses pair of Transistors

Portable test instruments offer an excellent opportunity for transistors to do their stuff. Small size and light weight make them ideal.

By RUFUS P. TURNER



Front view of the transistorized frequency meter in its compact metal case.

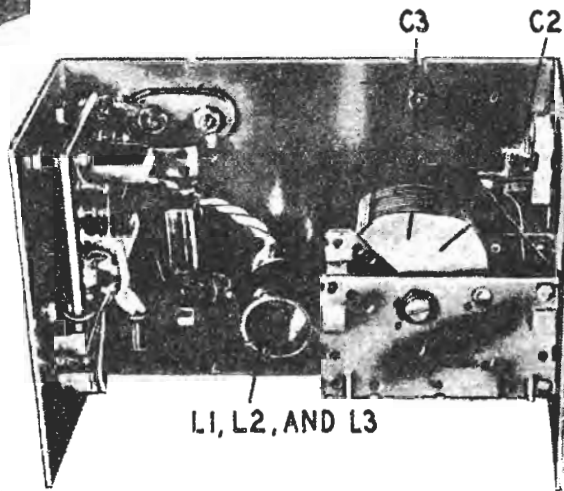

The meter with rear cover removed. All parts are visible except R1, C1, and V1.

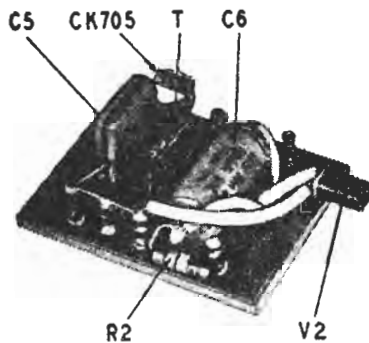

Photograph of the mixer and audio components mounted on a terminal board.

WITHIN its frequency and power limitations, the junction transistor offers interesting possibilities of application in portable test instruments. In our fervor to transistorize amplifiers, receivers, transmitters, and control devices, we should not overlook the heterodyne frequency meter. It is one instrument which can be transistorized readily, and its operation is not handicapped by the limited high-frequency response of the type CK722 transistor now easily obtained.

Battery operation of the heterodyne frequency meter always has been desirable in the interest of complete isolation from power lines, of portability, instant operation, and low heat generation. But battery operation usually has not been feasible because of the cost, weight, and size of the A and B batteries required; comparatively short battery life, especially if the instrument is left running by mistake; and annoying microphonics in battery-type tubes.

A frequency meter using junction transistors has none of those disadvantages and has the following desirable advantages: (1) Complete isolation and portability. (2) Small size. (3) Light weight. (4) Practically zero heat generation. (5) Low-current operation from a single battery. (6) Instant operation. (7) No microphonics. (8) Long battery life with small loss during accidental left-on periods. (9) Infrequent "tube" replacements, since the transistors are believed to have a life of tens of thousands of hours. (10) Ability of the instrument to take rough handling without damage.

The basic instrument

The heterodyne frequency meter is well known to commercial radio operators who use it frequently to measure transmitter carrier frequency. Hams use this instrument supplementarily as a c.w. monitor and receiver calibrator. The heterodyne frequency meter is a common instrument in radio-frequency laboratories where it is used to check the frequency of r.f. oscillators and signal generators and as a comparator.

The block diagram in Fig. 1 shows the basic arrangement of a heterodyne frequency meter. The r.f. oscillator uses

an inherently stable circuit tunable over a single frequency band. Its output is fed into an aperiodic detector or mixer together with the test signal to be measured. The oscillator and test signals (or some harmonics of one or both) produce a beat note which then is amplified by the audio amplifier and monitored with headphones or a visual indicator. The r.f. oscillator is tuned to zero-beat with the signal and the frequency is read off the oscillator dial. The dial may be directly calibrated.

The test-signal frequency may be lower than the fundamental frequency range of the oscillator. Its harmonics then beat with the oscillator. Or the signal frequency may be higher than that of the oscillator, in which case an oscillator harmonic will beat with the signal. In this way, we use the instrument over a wide frequency range extending from f/n to nf , where f is the oscillator fundamental frequency at some suitable setting, and n is a multiplier or divisor representing the most remote useful harmonic or subharmonic which will give a sufficiently strong beat note. Thus, in one commercial heterodyne frequency meter, the oscillator is tunable from 100 to 200 mc, and the useful measurement range (from f/n to nf) is 10 to 2,000 mc. (In this instance, the factor n is 10.)

(Continued on page 102)

A GENERAL-PURPOSE TRANSISTOR VOLTMETER

G. FRANKLIN MONTGOMERY, W3FQB

4557 South Chelsea Lane
Bethesda 14, Maryland

ABSTRACT

A compact and rugged voltmeter of moderate accuracy and high sensitivity has been designed using two junction transistors. Full-scale ranges are 1, 10, 100, and 1000 volts d.c. at 100,000 ohms per volt and 10, 100, and 1000 volts a.c. at 10,000 ohms per volt. The instrument is based on a one-milliampere meter movement and is powered by a single 1.5-volt flashlight cell.

INTRODUCTION

Vacuum-tube voltmeters have become very popular for electronic test and service purposes. In general, these instruments are highly sensitive and are of reasonable size for portable work but usually require external a.c. power. Those that are battery-powered are limited in usefulness by the size and relatively short life of the battery supply. In contrast to vacuum-tube instruments is the portable multirange type of voltmeter that needs no supply but whose sensitivity is limited to that of its basic movement, generally not exceeding 20,000 ohms per volt. The current-amplifying ability of junction transistors provides the means for increasing the sensitivity of a basic movement more rugged than that ordinarily used in either of the first two types of instrument to produce a voltmeter intermediate in sensitivity and powered by a small battery of long life.

DESIGN

The capabilities of the CK722 are such that a properly designed d.c. amplifier using two in cascade to operate a one-milliampere movement should provide a sensitivity of about 100,000 ohms per volt, which is useful for most test

functions. The junction transistor exhibits current amplifications in two amplifier connections, giving a choice of four basic circuits for an amplifier of two transistors in cascade. Of these four possibilities, only two — the grounded-emitter to grounded-collector, and the grounded-emitter to grounded-emitter — have the advantage that the output current tends to be independent of temperature-induced current changes in the two transistors. In addition, when operated from a low-voltage supply where the bias currents for the transistors are fed through relatively small resistances, the short-circuit current amplification of each transistor is most nearly approached if each works into as low a load resistance as possible. Accordingly, the grounded-emitter to grounded-emitter connection was chosen for the amplifier, the basic circuit for which is given in Figure 1.

Feedback seems desirable for ensuring a linear relation between meter indication and input current, but since the transistor is a current-amplifying device indeed, as opposed to a voltage-current transducer such as the vacuum tube, the application of inverse feedback inevitably reduces the amplifier current sensitivity; it is therefore not used in the present application. Adequate d.c. linearity has been achieved by proper choice of transistor operating points, although inverse feedback, if it were used, would have the additional advantage of tending to maintain a given absolute sensitivity.

THE TRANSISTOR VOLTMETER

The complete circuit diagram of the instrument is given in Figure 2. Resistor R_1 , in conjunction with the setting of the *METER* control R_5 ,

determines the base bias current of JT_1 . The bias current for JT_2 is determined by R_2 , R_3 , and the zero-input collector current of JT_1 . Because of the variability of different transistors, adjustment of the values of R_1 , R_2 , and R_3 will usually be required in setting up the circuit initially. In making this adjustment, R_2 and R_3 should be chosen so that R_2 is from five to ten times R_3 .

Variation of R_1 provides a convenient adjustment of the absolute sensitivity. Because of the connection of the lower end of R_5 to the meter terminal, a small fraction of the output current is fed back in positive sense to the input through R_1 . Meter zero can be attained by setting R_5 for a large range of R_1 , the positive feedback being smaller as R_1 is increased. The overall gain of the amplifier can thus be standardized for a considerable variation in transistor current amplification factor. For transistors that give excessive gain with no feedback, the absolute sensitivity can be lowered by reducing the ratio of R_2 to R_3 . Accuracy of the completed instrument for d.c. is within five percent of full scale and depends mainly upon the care taken in

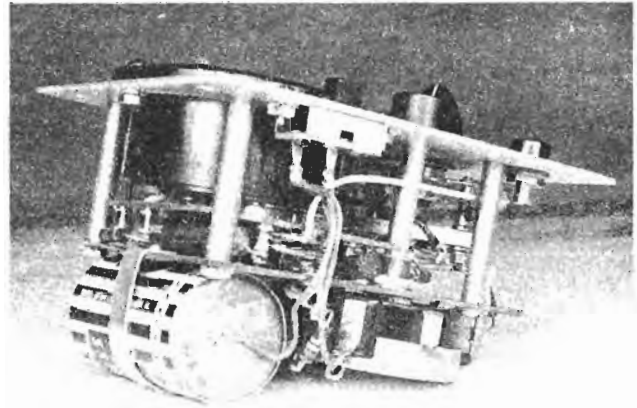

selecting precise resistance values for the multiplier and in selecting R_1 .

A.c. rectification is provided by the germanium diode, D . Since the diode operates at a low voltage level, its d.c. output is not linear with a.c. input, and the non-linearity results in calibration inaccuracies of about ten percent of full scale. The inaccuracy could be reduced, of course, by providing a non-linear scale for a.c. readings. Resistors R_7 and R_8 determine the absolute sensitivity for a.c. and have been adjusted in the completed instrument to provide accurate readings (sinusoidal r.m.s. values) at about mid-scale. Calibration is constant over the frequency range from 30 cps to 150 kc.

As shown in the photographs, the instrument is housed in a 3x4x5-inch utility box. In use, the meter is first zeroed with the *METER* control, R_5 . The test leads are then shorted, and the meter is zeroed again with the *SHORT* control, R_6 . The second zeroing adjustment is usually necessary only on the lowest two d.c. ranges; for a.c. or high-range d.c. measurements, any necessary adjustment can be made with the *METER* control only. Note that if a.c. measurements are to be taken in a circuit containing a steady d.c. potential in addition to the a.c. term, a series capacitor should be added externally. Battery drain is about four milliamperes, so that a size D flashlight cell should give either intermittent or continuous service for 500 hours or more.

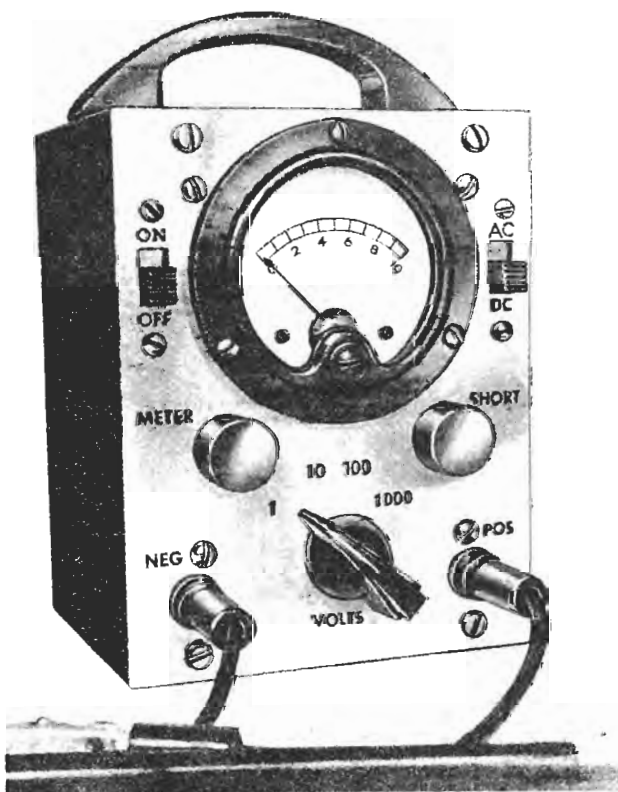

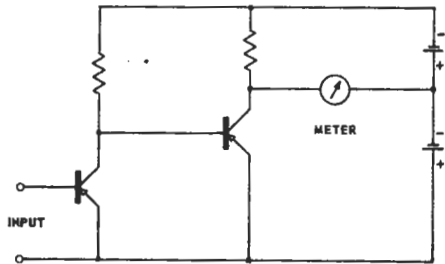

FIGURE 1 (Basic current amplifier)

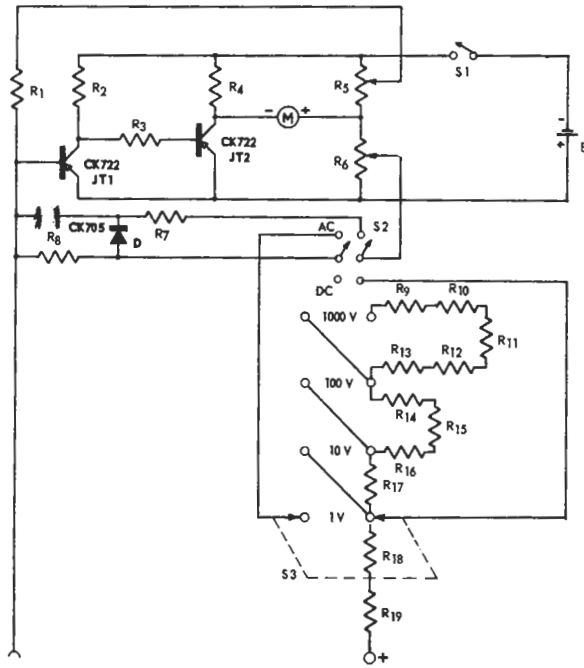

FIGURE 2 (Voltmeter circuit diagram)

VOLTMETER PARTS LIST

B—1.5-volt dry cell, size D.
 C—0.5 μ f paper capacitor, 200 volts.
 D—germanium diode, Raytheon CK705.
 JT₁, JT₂—junction transistor, Raytheon CK722.
 M—0.1 milliamperemeter.
 R₁—330K, $\frac{1}{2}$ w (see text).
 R₂—4.7K, $\frac{1}{2}$ w (see text).
 R₃—470, $\frac{1}{2}$ w (see text).
 R₄—470, $\frac{1}{2}$ w.
 R₅—1000 wirewound potentiometer.
 R₆—200 wirewound potentiometer.

R₇—82K, $\frac{1}{2}$ w (see text).
 R₈—15K, $\frac{1}{2}$ w (see text).
 R₉, R₁₀, R₁₁, R₁₂, R₁₃—20M, $\frac{1}{2}$ w.
 R₁₄, R₁₅, R₁₆—3.3M, $\frac{1}{2}$ w.
 R₁₇—1M, $\frac{1}{2}$ w.
 R₁₈—100K, $\frac{1}{2}$ w.
 R₁₉—10K, $\frac{1}{2}$ w.
 S₁—s.p.s.t. slide switch.
 S₂—d.p.d.t. slide switch.
 S₃—double-pole, four-position wafer switch.

MINIATURE AUDIO FREQUENCY METER

by
ROBERT T. BAYNE

As usually constructed, the Audio Frequency Meter is rather large and is dependent on 110 volts, 60 cycles for a source of power. One popular model weighs 12 lbs. and occupies just slightly less than a cubic foot of space.

Since the advent of Transistors and Germanium Diodes, a very small and light-weight Audio Frequency Meter may be constructed which has the further advantage of operating entirely from self-contained batteries. The Audio Frequency Meter then gains all the portability enjoyed by the indispensable Volt-Ohm-Millammeter and becomes just as convenient to use.

The Audio Frequency Meter to be described is the portable type and uses two CK722 Raytheon Transistors and four CK706 Raytheon Germanium Diodes. The overall characteristics are, as follows:

Dimensions	4 by 5 by 3 inches
Frequency Ranges	0 - 300 cycles 0 - 3,000 cycles 0 - 30,000 cycles
Accuracy	Approximately plus or minus 5%
Input Impedance	15,000 ohms
Input Voltage	Minimum 5 volts R.M.S. Maximum 40 volts R.M.S.
Acceptable Signal Wave Forms	Sine, Square, Sawtooth, Triangular and Irregular Shaped Waves. Pulses where pulse duration is more than 0.3 of the period between pulses.
Power Source	7 Burgess No. 7 or Ever-ready No. 912 flashlight cells.

Total Current Drain	2.5 Milliampere
Calibration	Internal calibration of battery voltage before measurement.
Controls	Range Selector Switch Calibration Adjust Rheostat On-Off Switch Cal. — Read Switch

CIRCUIT OPERATION

As shown in the schematic Fig. 1, the input signal is fed to a clipping circuit composed of R_1 and diodes D_1 and D_2 . Since there are 1.5 volt cells in the diode ground returns, the output of the clipper cannot exceed 3 volts peak to peak over a wide range of signal input. The primary purpose of the clipper is to provide overload protection for the limiting transistor P_1 . Needless to say, it also assists in limiting the input signal.

The output of the clipper is connected to the base of transistor P_1 by means of R_2 . The emitter of P_1 is grounded, and the entire stage functions as a limiter-amplifier. A small amount of negative "bias" current is supplied to the base of P_1 by means of R_3 . The Collector of P_1 is capacitively coupled to the base of transistor P_2 through C_1 .

Transistor P_2 is used both as a second limiter and as a switch to provide pulses of charging current to one of the condensers C_2 , C_3 or C_4 , depending upon the position of the Range Switch, SW_1 .

With no signal impressed on the base, P_2 has approximately 140 Microamperes of base cur-

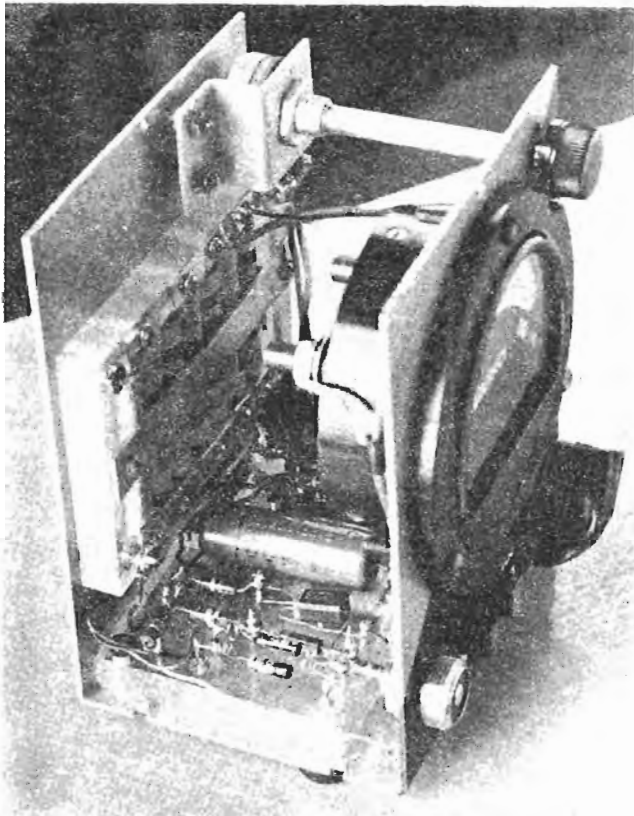

rent supplied through R_5 . The corresponding collector current is about 2 Milliamperes so that a large voltage drop occurs across R_6 . This drop is almost equal to the total Emitter-Collector Potential, 7.0 volts. Under these conditions, the only potential across the condenser (for example C_2) is the difference between the supply (7.0 volts) and the drop across R_6 (6.6 volts) or 0.4 volts.

When a signal is impressed, a positive pulse appearing at the Base of P_2 effectively "cuts-off" P_2 so that the potential at point A becomes that of the supply. C_2 is then able to charge through R_6 , Diode D_4 , and Meter M_1 to approximately 7.0 volts. When a negative cycle of signal reverses the potential of the Base at P_2 , the potential at point A falls to a low value and C_2 discharges through Diode D_3 .

The long time constant of the meter movement integrates the uni-directional charging pulses to provide a steady meter reading which is a linear function of the input signal frequency according to the equation:

$$i_m = fCE_o$$

$$i_M = fCE_o$$

Since Capacity and E_o (amplitude of the charg-

ing current pulse) are fixed by choice of capacity and the action of the limiting circuit, i_M becomes a function of frequency only. The Meter Scale can thus be calibrated directly in cycles.

The single Meter Scale is marked 0-30 and frequency readings are multiplied by 10, 100 or 1,000, according to the position of the Range Selector Switch. This necessitates capacity ratios of 1:10:100 between C_1 , C_3 , and C_2 respectively. Since the accuracy of the entire device depends upon the accuracy of the 1:10:100 ratio, C_1 , C_3 , and C_2 should be selected using a bridge to determine their exact capacity. If desired, small trimmer condensers may be placed in parallel with C_3 and C_1 and adjusted for the proper capacity ratio with respect to C_2 .

The amplitude of the charging current pulse depends on the Collector Voltage. This potential must therefore be of constant value to insure accuracy. To accomplish this, a Calibrate-Read Switch SW_2 and Calibrate Adjust Rheostat are included. When SW_2 is in the Calibrate position, M_1 becomes a voltmeter due to R_8 which is in series with its negative terminal and the battery supply. The supply potential can then



be set to the proper magnitude by adjusting the series Rheostat R_7 . The exact point to which the voltage is set is indicated by a small arrow on the meter scale.

The On-Off Switch SW_3 short circuits the meter terminals in the "Off" position. This damps the movement heavily, protecting it from damage due to shock or vibration.

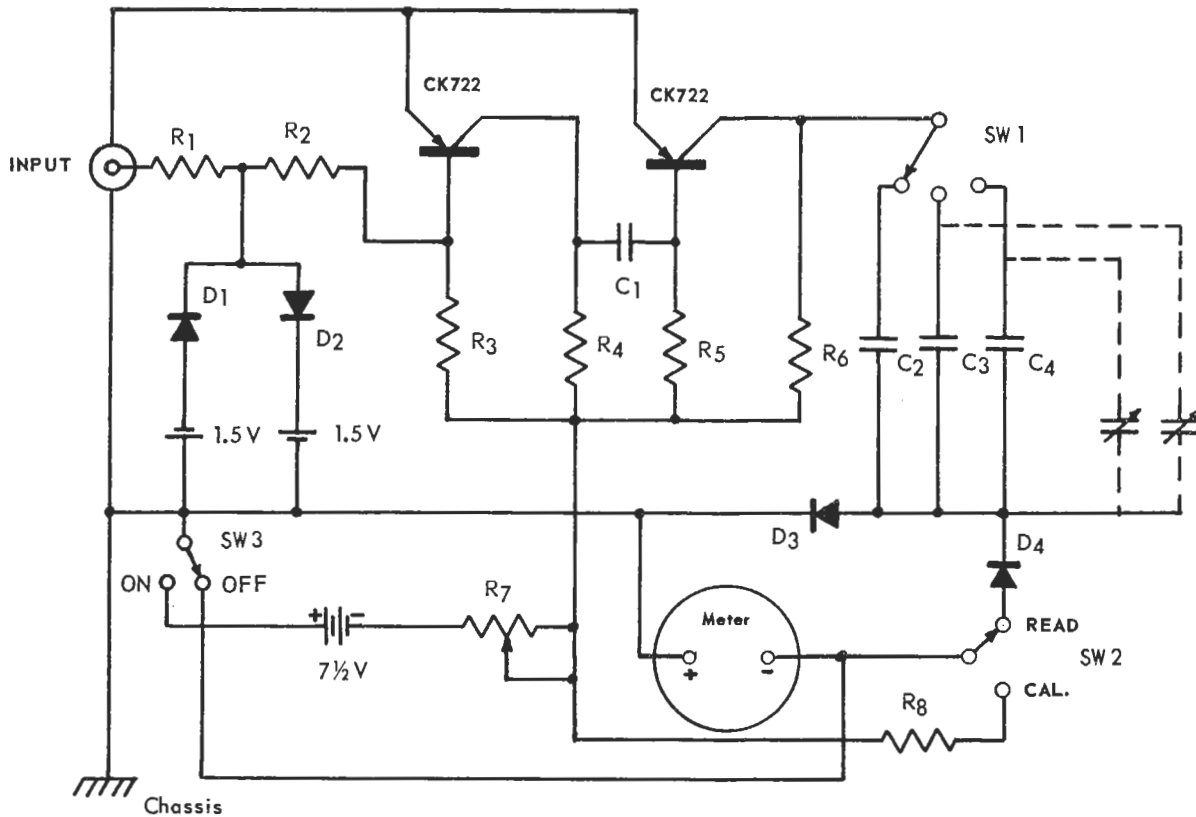

MINIATURE AUDIO FREQUENCY METER

PARTS LIST

Chassis	"Channel-Lock" Box, 5x4 x3 inches	SW_2 , SW_3	Wirt S.P.D.T., Type 724
J_1	Amphenol 75-PCIM	R_7	Centralab Type B, 500 ohms
D_1 , D_2 , D_3 , D_4	{CK706 or CK705 Raytheon Germanium Diodes	C_1	0.1 MFD., Sangamo "Redskin" 400 volts
P_1 , P_2	{CK722 Raytheon Junc- tion Transistors	C_2	.05 MFD., Sprague 400 volts
M_1	{0-100 Microammeter, Triplet, type 321-T	C_3 , C_4	.005 MFD. and 500 MMF. Centralab TCZ
SW_1	Centralab S.P. 3 Pos. Type 1461	All Resistors $\frac{1}{3}$ watt IRC Type BTR	
		R_1	15,000 ohms
		R_2	8,200 "
		R_3	0.1 meg.
		R_4	12,000 ohms
		R_5	47,000 "
		R_6	3,300 "
		R_8	0.1 meg.

TRANSISTOR AUDIO FREQUENCY AND VOLTAGE STANDARD

by
Peter G. Sulzer, W3HFW

10605 St. Paul St.
Kensington, Md.

There is a need for a miniature, self-powered source of accurate audio frequency and voltage suitable for voltmeter and oscilloscope calibration, signal tracing in radio and television sets, and frequency comparison. The oscillator to be described fills such a need, since it provides 1 volt, 1/10 volt, 10 millivolts, and 1 millivolt with an accuracy of $\pm 2\%$ at one kilocycle. The frequency is accurate to better than $1/4\%$ over the normal range of room temperature. Although it is little larger than a cigarette package it will operate for more than two years on its self-contained mercury battery. The current required is but 50 microamperes, and therefore an on-off switch is not necessary. Because of its small size and lack of power cord the oscillator should readily find a place in the service kit or on the laboratory bench.

A very interesting feature of the circuit is that, as explained below, an accurate audio-frequency voltage is obtained automatically without requiring calibration from any other standard.

Consider the simplified circuit of Fig. 1(a), which is a form of the Colpitts oscillator with the emitter of the junction transistor receiving its drive from a portion of the voltage across the tuned circuit. The base is held at ground potential. Assuming that oscillation will start, an alternating voltage will build up across the tuned circuit until limiting takes place somewhere in the circuit. It will be recalled that, in a pnp transistor, the collector is biased negatively with respect to the base. This is in the

non-conducting direction, and therefore the signal current flowing in the collector results from "holes" injected through the base by the emitter. However, a large collector current will flow if the collector goes positive with respect to the base. This is the form of limiting obtained here, and it takes place when the peak voltage across the tuned circuit exceeds the supply voltage. When the collector clips it does so in a very abrupt manner, because it now functions as a part of a high-conductance junction diode.

Consequently, if the feedback and the amplitude are increased, the onset of the clipping is readily observed with an oscilloscope or a voltmeter, and, if the feedback is adjusted so that clipping is just detectable, the peak voltage across the tuned circuit is almost exactly equal to the supply voltage E . An accurate voltage E can be obtained with mercury hearing-aid cells, which provide 1.34 volts to better than 0.5%.

The actual circuit used is shown in Fig. 1(b), in which two mallery type RM-1 cells in series provide 2.68 volts. As a matter of convenience the negative battery terminal has been grounded. The feedback voltage appears across C_2 , while C_1 is used to adjust the frequency. The inductance L is a small, uncased, powdered-permalloy toroid, which is available from any one of several transformer manufacturers. The capacitors C_1 , C_2 , and C_3 are paper-tubular units. The resistors in the voltage divider should have an accuracy of $\pm 1\%$ if possible.



In setting up the circuit, the resistor R should be omitted, and the presence of oscillation should be checked with an oscilloscope or a high-impedance voltmeter. If the circuit does not oscillate, the dashed-line connection of R should be used, and R should be decreased from 1 megohm until oscillation starts and clipping commences.

This will be observed with the oscilloscope or, if a voltmeter is used, the output will increase but very slowly as the resistance is decreased past a given point. If oscillation is obtained with R disconnected, the solid-line connection of R should be used, and R should be decreased until the clipping almost stops. One connection or the other will be required depending upon the condition of the transistor and the Q of the tuned circuit.

The final frequency adjustment can then be made by adjusting C₁. It is convenient to use the 600-cycle modulation from WWV as a standard, employing Lissajous figures for frequency comparison. The output across the tuned circuit was found to be 1.83 volts rms., which is about 3% lower than the battery voltage would indicate. The difference results from the

fact that the base of the transistor is not held exactly 2.86 volts positive with respect to ground. The resistances in the voltage divider have been chosen to compensate for this difference, which has been found consistent in the three breadboard oscillators constructed. The distortion is about 1% with the proper circuit adjustment. The source impedance of the oscillator must be considered when making a calibration. The impedance at the 1-volt tap is approximately 30,000 ohms with loads greater than 100,000 ohms. Thus, if a meter with a resistance of 1 megohm is connected to the 1-volt tap, it will read about 3% low. The impedances at the other taps are approximately 5,000, 500, and 50 ohms respectively.

The oscillator is constructed in a brass tube 3 inches long and 1 $\frac{3}{4}$ inches in diameter. Bakelite end caps are used, and the mercury battery is held in a small bakelite tube running down the center of the brass tube. The negative terminal of the battery, which is ground, is located at the center of the four audio-frequency-output terminals. The positive terminal of the battery, which is recessed to prevent shorts, is available at the other end of the oscillator for battery checks and also to permit the calibration of dc voltmeters.

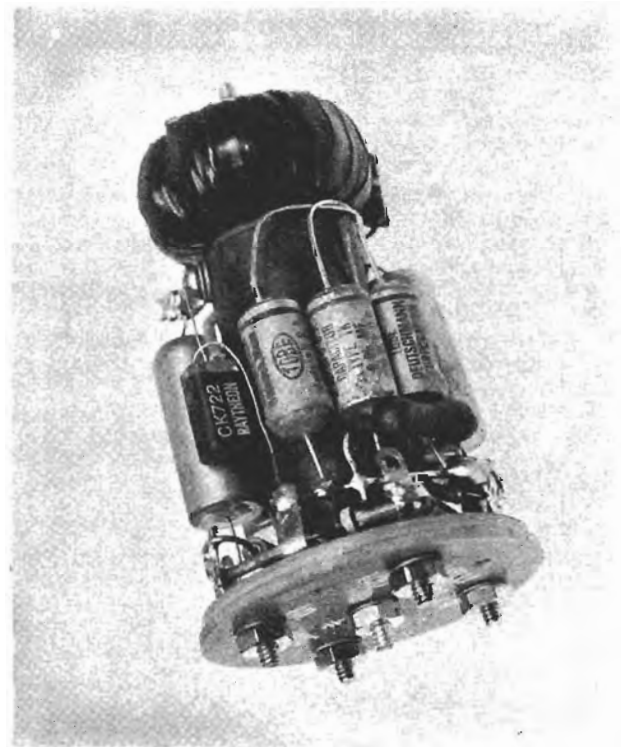

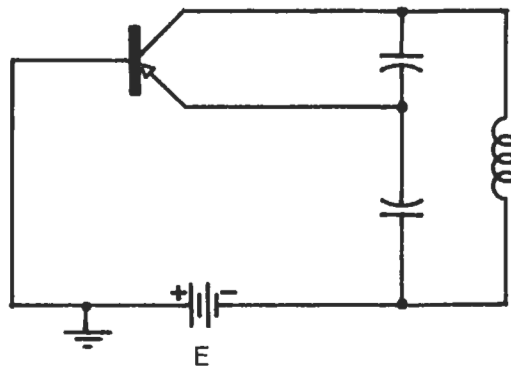

(a)

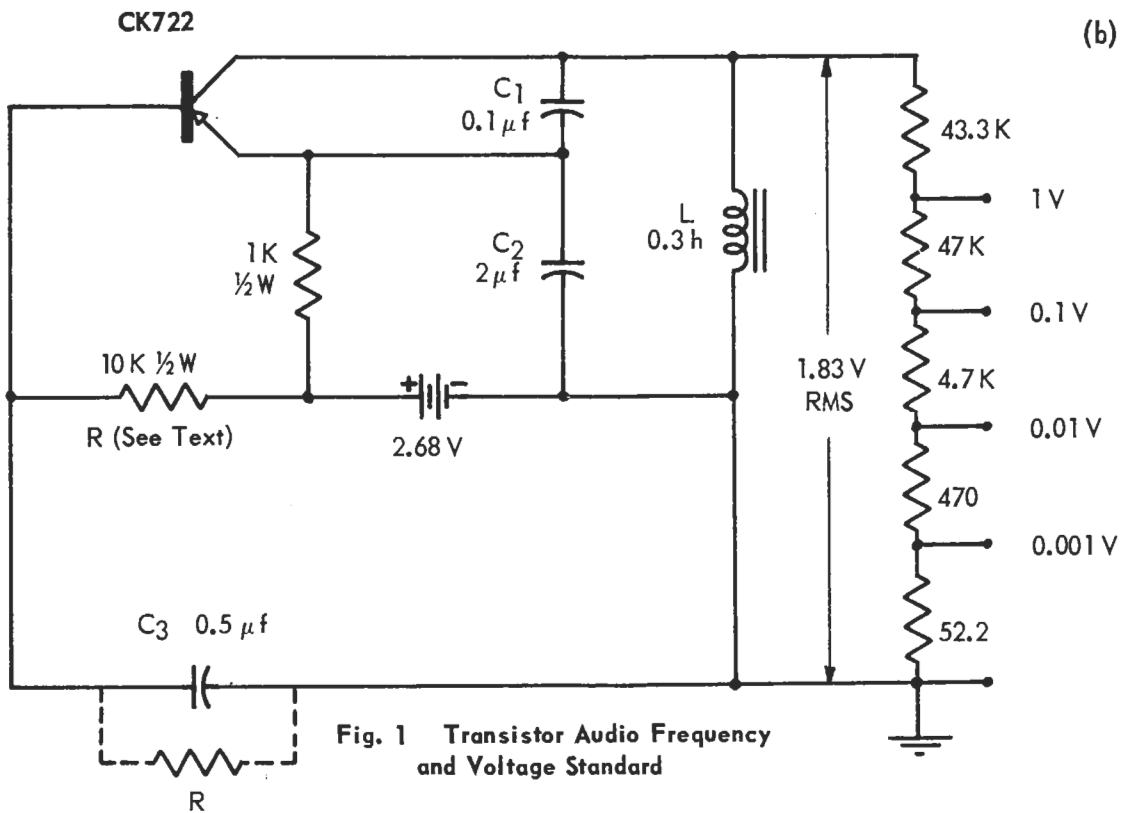

Fig. 1 Transistor Audio Frequency and Voltage Standard

PARTS LIST

- 1—Raytheon CK722
- 1—0.3 hy toroid
- 1—0.1 μf capacitor (see text)
- 1—2 μf capacitor
- 1—0.5 μf capacitor
- 1—1K $\frac{1}{2}w$ resistor
- 1—43.3K $\frac{1}{2}w$ 1 percent resistor
- 1—47K $\frac{1}{2}w$ 1 percent resistor
- 1—4.7K $\frac{1}{2}w$ 1 percent resistor
- 1—470 ohms $\frac{1}{2}w$ 1 percent resistor
- 1—52.2 ohms $\frac{1}{2}w$ 1 percent resistor
- 1— $\frac{1}{2}w$ resistor R (see text)
- 2—Mallory type RM-1 cell

TRANSISTORIZED VOLTMETER

*Operating from a single cell,
instrument has an input
resistance of a v.t.v.m.*

By RUFUS P. TURNER

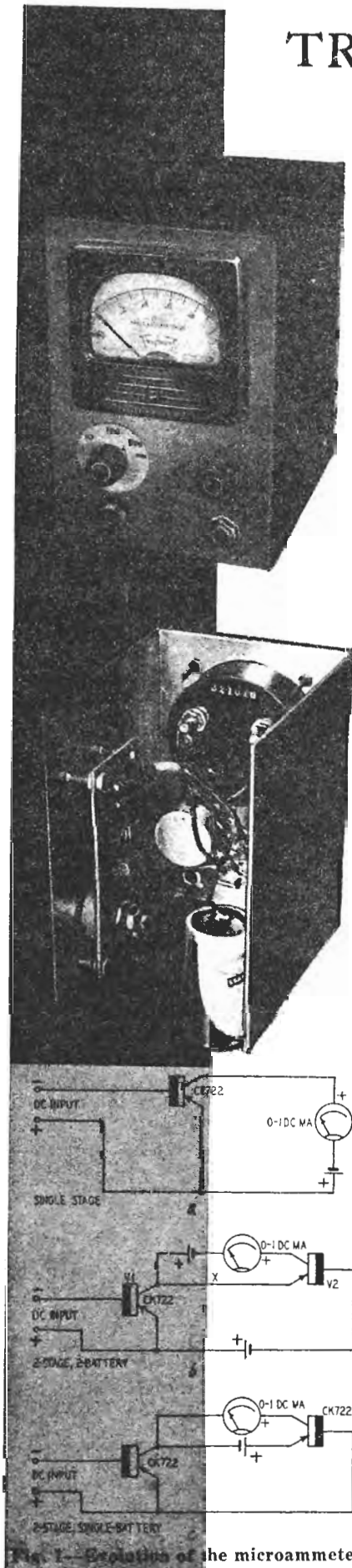

Fig. 1—Exploded view of the microammeter.

HIGH values of current amplification are obtained in the grounded-emitter junction transistor circuit by using the base as the input electrode. A small change in base current produces a rather large change in collector current.

Such base-to-collector current amplification is designated by the Greek β (beta), and in commercial transistors has a value many times higher than the familiar emitter-to-collector amplification α (alpha). β is equal approximately to $\alpha/(1-\alpha)$. From this relationship, we see how a junction transistor having an alpha of only 0.909 can give current amplification of 10 in the grounded-emitter circuit. It is clear also that junction transistors with the highest alphas, approaching 1, also show the highest betas.

High-beta performance permits operating the grounded-emitter circuit as a d.c. amplifier with low power drain. The amplifier has a current gain of 10 when alpha is 0.909 and can have a gain of approximately 100 when alpha is very slightly greater than 0.99. Taking advantage of this gain, a d.c. milliammeter in the collector circuit will respond to microamperes applied to the base-input circuit.

Fig. 1-a shows such a simple amplifier type microammeter. Input current of 100 microamperes will deflect the 0-1 d.c. milliammeter to full scale. For simplicity, zero-setting circuits for bucking the static collector current out of the meter have been omitted from each circuit in Fig. 1. In Fig. 1-b, a second common-emitter amplifier stage has been added in cascade for 10-microampere operation of the meter. Note that transistor V2 has been "turned over" so that current flows through its base in the correct direction to increase collector current. The collector current of transistor V1 flows directly through the base-emitter input circuit of V2, so no load resistors are required and interstage impedance-matching problems disappear. Inasmuch as current from both batteries flows in the same direction through lead X, a single battery may

be inserted in this lead to supply both transistor stages. This has been done in the final circuit shown in the Fig. 1-c diagram.

It is entirely possible to use low-priced junction transistors, such as the CK722, in this d.c. amplifier circuit. However, for a total current gain of 100, the transistors would have to be selected for a minimum alpha of 0.909 each. There is gain to spare when using a combination of one CK722 and one higher-alpha unit, such as the CK721, in cascade. This combination requires no special picking of transistors.

An interesting and useful application of the transistorized microammeter is as the basis of an electronic d.c. voltmeter—the transistor equivalent of the v.t.v.m.—by adding suitable multiplier resistors to the input of the d.c. amplifier circuit. Since the two junction transistors require only about 2 ma from a 1.5-volt cell for complete circuit operation, the result is a completely portable electronic voltmeter having operating economy not obtainable with conventional battery-operated v.t.v.m.'s.

A 0-10 d.c. microammeter has been shown before as the basis of a d.c. voltmeter having 100,000 ohms-per-volt sensitivity.¹ A 10-microampere d.c. meter is expensive, however, and not obtainable except on special order. The transistorized d.c. amplifier permits use of the more rugged, inexpensive, and readily obtainable 0-1 d.c. milliammeter.

To readers who compare a sensitivity of 100,000 ohms per volt unfavorably with the input resistance of the conventional v.t.v.m., we would like to point out that the 100-volt range has an input resistance equal to that of many v.t.v.m.'s, and on all higher ranges the transistor voltmeter has a higher input resistance than the v.t.v.m.!

Instrument circuit

The complete circuit of the transistorized electronic voltmeter is shown in

¹"New Volt-Ohm Microammeter" RADIO-ELECTRONICS, Sept., 1953, page 80.

Fig. 2. To the simple two-stage transistor microammeter circuit of Fig. 1-c have been added the input multiplier resistors (R1 to R6) and the zero-setting meter circuit (R7 to R10). The zero-setting circuit is of the four-arm-bridge type common in v.t.v.m.'s.

Resistors R1 to R6 must be selected to the exact specified values. The 50-megohm value required for the 500-volt range is obtained by series-connecting one 10- and two 20-megohm resistors. For highest accuracy on the 1-volt range, the input resistance of the CK722 (approximately 2,000 ohms) should be subtracted from the normal 100,000-ohm value of R1, making it 98,000 ohms. If this is not done, the 1-volt range will read 2% low. To check the input resistance of the first transistor in the complete circuit, feed in an input current of 10 microamperes and measure the voltage drop between base and emitter. Determine the resistance by dividing the voltage by .00001.

On all but the last range, the 0-1 scale of the milliammeter can be used by merely adding zeros mentally where necessary. The author found the 1-, 10-, 100- and 500-volt ranges suitable for his purposes. Other ranges may be included if those shown are undesirable. The table shows multiplier resistor values for common voltage ranges other than those shown in Fig. 2.

ADDITIONAL VOLTAGE RANGES	
Range (volts)	Multiplier Resistance (megohms)
2.5	0.25
3	0.3
5	0.5
7.5	0.75
15	1.5
25	2.5
50	5.0
250	25
300	30
750	75
1,000	100

One pole of the range selector switch disconnects the battery. For protection of the instrument, the OFF position is placed after the highest voltage range.

Phone jack J1 is provided for the "high" d.c. input lead which in this circuit is connected to the negative pole of the voltage source under test. A

conventional shielded input lead and probe are advantageous when working around strong fields. The "low" (positive) lead is connected to pin jack J2.

The CALIBRATION control R8 permits the instrument to be standardized initially and provides for its periodic recalibration. This control has a slotted shaft for screwdriver adjustment and is mounted inside the instrument case for protection from disturbance.

Adjusting the ZERO ADJUST rheostat R7 allows the meter to be set to zero against the effects of steady collector current through both transistors. Static collector current in the CK722 is amplified and increases the static collector current of the CK721.

Construction

Being a straight d.c. instrument, the problems of stray coupling and frequency dependence are absent. The model shown in the photos is built in an aluminum utility box 6 inches high, 4 inches wide, and 5 inches deep.

The two transistors and components R8, R9, and R10 are mounted on a 1 3/4 x 4 1/4-inch bakelite board attached to an inner wall of the case with long 6-32 screws. Transistor and resistor leads are pulled through small holes in the board and connections are made underneath.

Resistors R1 to R6 are soldered directly to the range switch. The flashlight cell is held to an inner wall by a curved bracket which does not appear in the photo.

Leads from the meter, battery, zero-set rheostat and battery section of the range switch are cabled together and run to the component board, underneath which connections are made.

The instrument can be built much smaller than shown here. Smaller meter, components, battery and case are entirely feasible.

Initial adjustment

After the wiring has been inspected, make the initial adjustment in the following manner: 1. Set the range switch to the 10-volt position, and set R8 about halfway between its minimum and maximum rotations. 2. Zero the meter by adjusting R7. 3. Apply an accurately known 10-volt d.c. potential to the input terminals. 4. Adjust R8 for exact full-scale deflection of the meter. 5. Remove the voltage. If the meter does not read

exactly zero, reset by adjusting R7. 6. Reapply the voltage and readjust R8, if necessary, for full-scale reading. 7. Repeat steps 4, 5 and 6 until the meter reads full scale when the voltage is applied and falls back to zero when the voltage is removed.

Even when substituting transistors, the author found the circuit response surprisingly close to true linearity. This had made it possible to obtain good accuracy with the regular meter scale. Such operation was not anticipated, since we expected alpha and beta would vary greatly with input current. However, where highest possible accuracy must be insured, the builder should calibrate as many scale points as possible during the initial adjustment. Suggested points would be 1-volt apart from 1 to 10 volts. They should be checked after completing the full-scale adjustment. If the calibration then did not follow the milliammeter scale, a special meter card might be drawn or a calibration chart prepared.

Performance

The transistorized electronic voltmeter will give a good account of itself as a completely portable instrument having high input impedance and excellent economy of operation.

It can be used in place of the v.t.v.m., which it usually will supplement, especially in tests involving voltages which can be read on the 100-volt and higher ranges. The input resistance on these ranges equals or betters that of the tube type d.c. instrument.

Parts for electronic voltmeter

2-500 ohms, 1-100,000 ohms (see text), 1-1 megohm, 2-10 megohms, 2-20 megohms, 1/2 watt, resistors; 1-2,000 ohms, 1-10,000 ohms, potentiometers, wirewound or Ohmite AB composition; 1-0-1 d.c. milliammeter; 1-phone jack; 1-pin jack; 1-1.5-volt flashlight cell; 1-2-pole 5-position single-gang rotary selector switch; 1-CK721; 1-CK722; 1-cabinet; 1-mounting board.

All operating power is furnished by a 1.5-volt cell. Total current drain, at full deflection of the milliammeter, is approximately 2 ma. A jumbo-size flashlight cell will give long life even when the instrument is accidentally left running. A penlight cell will give somewhat shorter service, while a mercury cell will very nearly give its shelf life of several years continuous operation. Operation is instantaneous, without warmup periods, as a result of battery and transistor operation.

With good transistors, zero-setting drift is negligible except during wide changes of temperature—the static collector current increases rather severely with temperature. However, the author finds that resetting zero compensates for this drift. The instrument was kept in continuous operation for 5 hours at a controlled temperature of 30° C with no zero drift.

Other operational features, such as current, resistance, and a.c. voltage ranges, may be added in the conventional manner, borrowing from v.t.v.m. techniques.

END

Fig. 2—The transistorized voltmeter. Instrument has high input resistance.

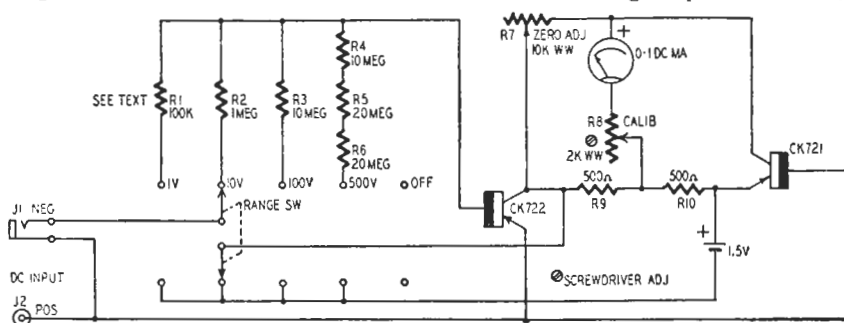

NOTE
Use of a CK 705
Germanium Diode in
place of the 1N34
is recommended

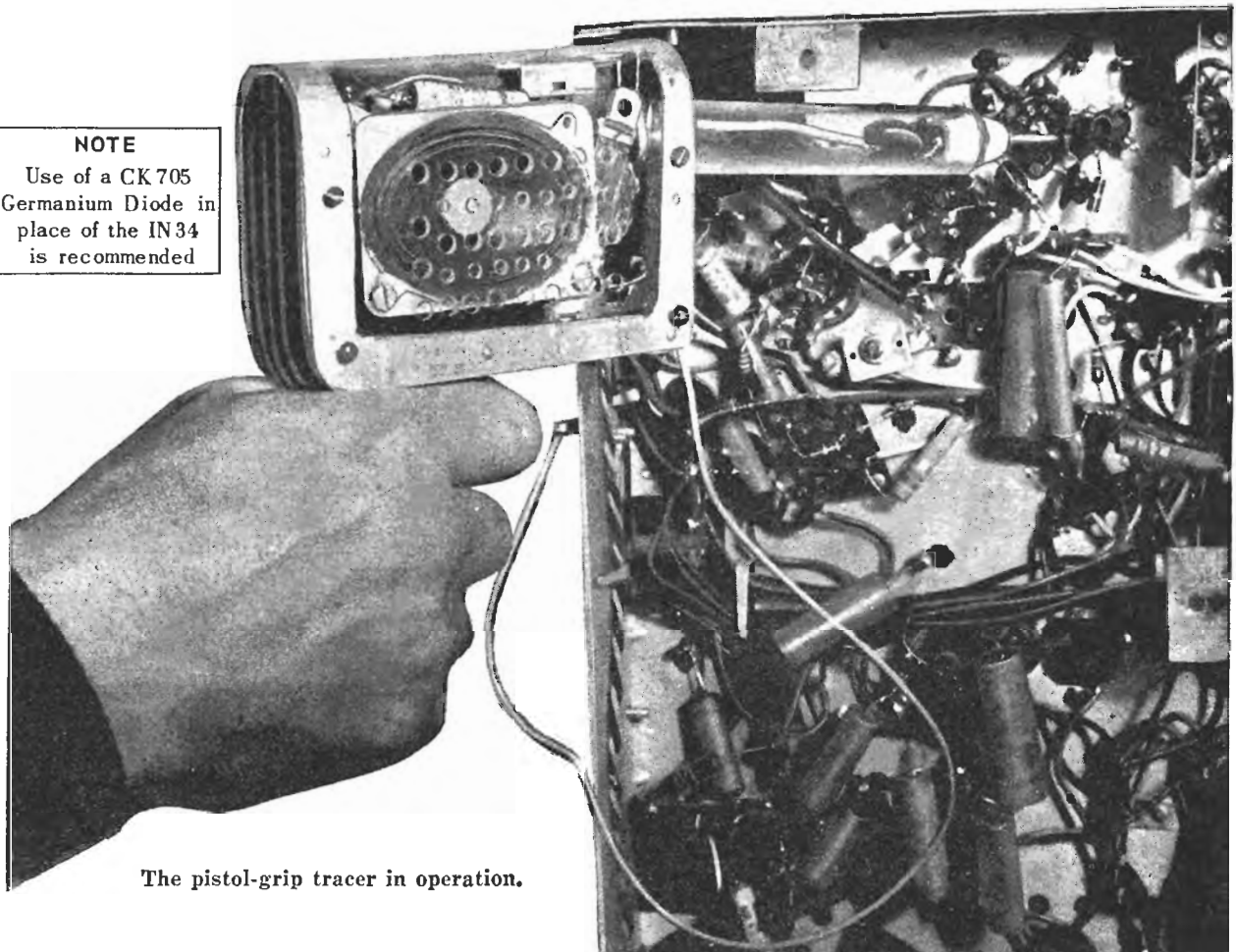

The pistol-grip tracer in operation.

PISTOL-GRIP SIGNAL TRACER

*This small and
compact transistorized
instrument features
unique design,
yet is easy
to construct*

By HOMER L. DAVIDSON

THIS little transistorized signal tracer resembles the pistol type soldering iron used by many experimenters and service technicians. It is compact and has only one outside lead—an alligator grounding clip. The nozzle or pointer of the tracer is touched to the circuit being tested; the signal is rectified and amplified, then reproduced through a 2-inch speaker.

A .001- μ f disc type capacitor couples the incoming signal to the amplifier. A 1N34 crystal rectifies any r.f. signal picked up and feeds it to a volume control. This control is used to reduce signal strength when necessary. It is a standard type but a midget unit could have been used. Had that been done, the d.p.s.t. switch could have been placed on the control instead of at the top of the unit.

A midget electrolytic capacitor cou-

ples the incoming signal to transistor V1. Both transistors used in this signal tracer are CK722's. They are mounted in hearing-aid tube sockets that were lying around, although regular sockets can be used. Be careful when wiring the leads because heat from a soldering iron can easily damage transistors. A good trick is to let long-nose pliers absorb the heat. This also applies to the 1N34.

Resistor R1 is a base return and develops bias for this stage. Since transistor characteristics vary, R2 should be chosen for the value that provides maximum volume within the applied current limits. To find the correct value, use a 500,000-ohm potentiometer in place of R1 and vary it for maximum signal. At the same time, connect a milliammeter in series—the current should not rise higher than 5 ma. The audio amplifier stage is

transformer-coupled to the output stage. This little transformer is a Stancor UM-113; primary impedance 20,000 ohms, secondary impedance 1,000 ohms. It was designed primarily for transistor amplifying stages. A standard interstage transformer could be used if the signal tracer is constructed on a chassis where space is not limited. A 10- μ f electrolytic capacitor couples the signal to the base of V2. The base-return resistor R2 was measured before being placed in the circuit as R1 was. A small output transformer steps down the amplified signal and feeds it into a 2-inch speaker.

Wiring the unit

When wiring the signal tracer be sure the transistors are properly connected—and be sure neither one draws more than 5 ma. The wiring is not critical but all leads and components must be closely spaced with the leads as short as possible. There isn't any separate chassis, the two transistor sockets being soldered to the speaker frame. Pins 3, 4, and 5 of the hearing

aid sockets are soldered together. A heavy piece of brass wire is soldered to both sockets and then anchored to the 2-inch speaker frame. Also, the positive lug on the small 22.5-volt hearing aid battery is soldered directly to the 1-inch bolt fastened directly to the speaker frame.

The transistor sockets are soldered directly together. When plugging the CK722 transistors into their sockets, be sure both red dots or pins are plugged in properly. A d.p.s.t. push type switch is mounted on top.

Construction of the gun holder is easy. Get a few scraps of three-ply wood and draw a gun on each piece. On two of the pieces cut off the handle. Place the other piece between these handleless pieces and glue and nail them together. After the assembly dries, round the edges, carve and sand, giving it the appearance of a pistol. The middle section of the pistol is not sawed or cut out until the plastic is formed around it.

A small piece of Lucite is used as a cover for the pistol signal tracer. It is

fitted around the pistol assembly while heat is applied from a gas flame. Be sure to hold the plastic away from the flame. Then the plastic can be formed around the gun assembly and held there until it sets. The speaker holes can be drilled before or after the plastic is bent. All protruding corners are then cut and rounded off to fit snugly around the wooden assembly.

At this point the center of the gun assembly is sawed out. Only a narrow border is left and the plastic piece is screwed to it. A $\frac{3}{8}$ -inch hole is drilled into the bottom for the volume control, which resembles a trigger. A 1-inch hole is then drilled for the pistol barrel. The barrel consists of a 1-inch piece of round plastic tubing with a plastic bottle cap and 2-inch bolt fastened into the end as the test probe. To save mounting space the small coupling capacitor and the 1N34 can be mounted in the plastic tube.

The results obtained from the small transistor signal tracer were surprising. Troubles were easily located in small radios, TV sets and amplifiers. END

Parts for signal tracer

1—33,000, 1—220,000 ohms, resistors; 1—1 megohm, potentiometer; 1—.001 μ f, ceramic disc capacitor; 2—10 μ f, 25 volts, electrolytic capacitor (small as possible); 1—interstage transformer, primary impedance 20,000 ohms, secondary impedance 1,000 ohms (Stancor UM-113 or equivalent); 1—output transformer, primary impedance 2,000 ohms, secondary 3.2 ohms (Stancor A-3332 or equivalent); 2—hearing-aid or transistor sockets; 2—CK722 transistors; 1—sheet of plastic; 3—pieces of 3-ply plywood; 1—2-inch speaker; 1—d.p.s.t. switch (see text); 1—1N34; 1—alligator clip; 1—plastic tubing; 1—22.5-volt hearing-aid battery.

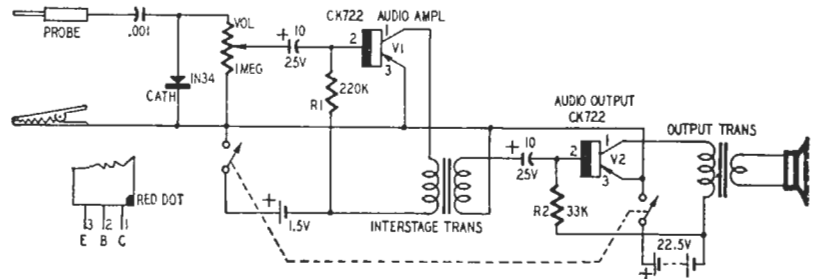

Schematic pistol-grip signal tracer.

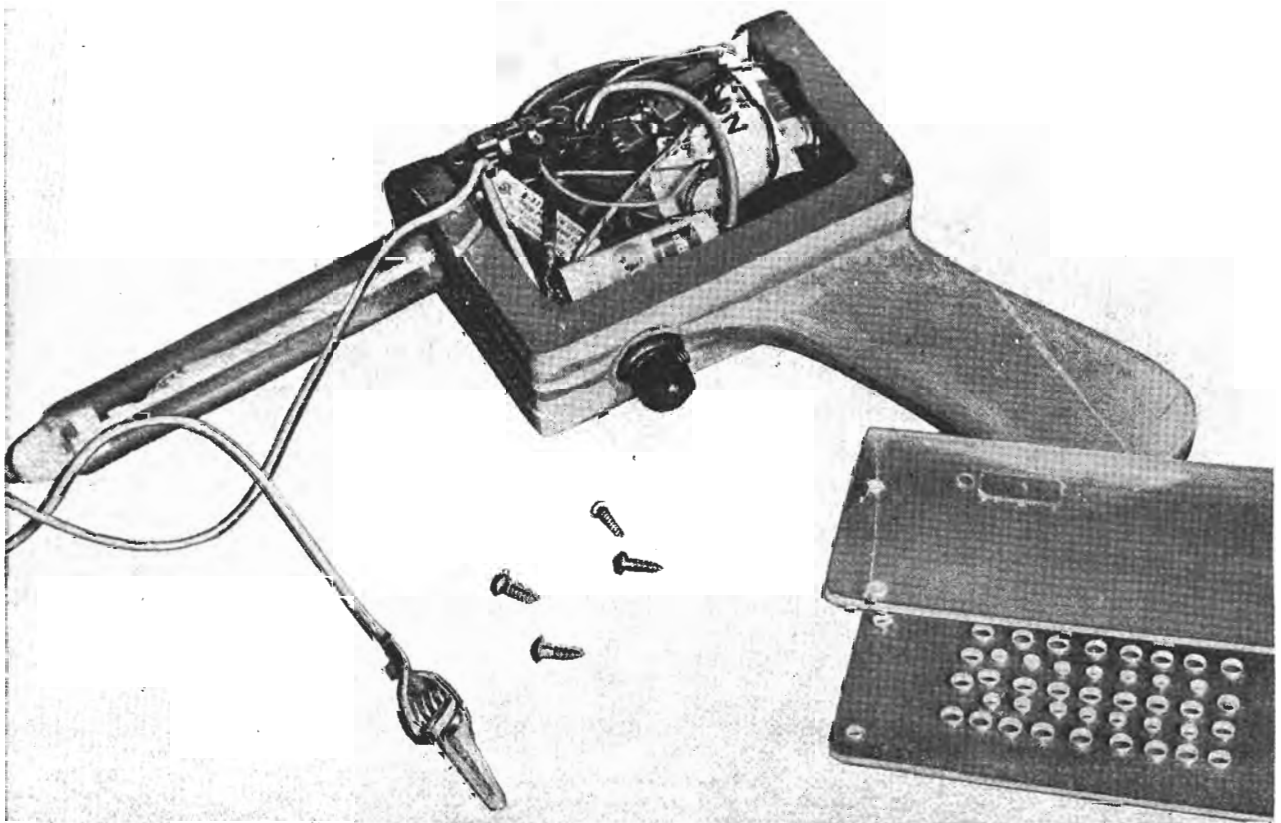

Assembly of the signal tracer—unit is compact; completed plastic cover at right.

DEMONSTRATION TRANSISTOR CIRCUITS

By EDWIN BOHR

Kit for the transistor experiments.

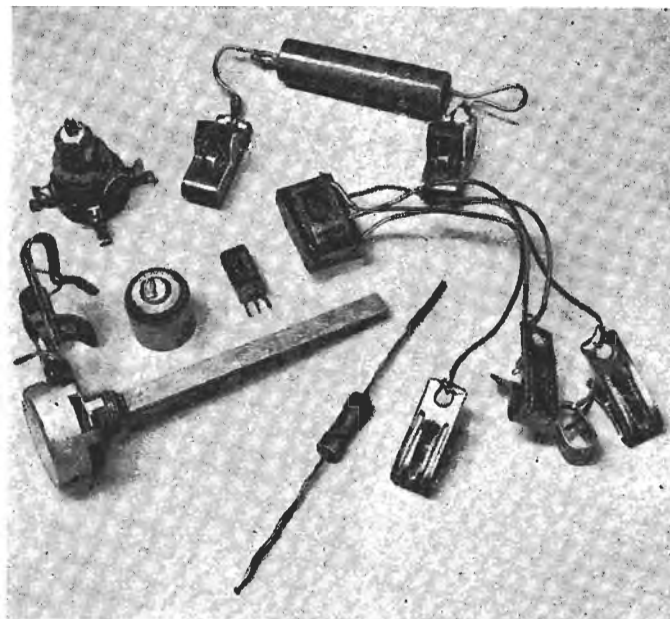

TRY all of these circuits and really get the feel of transistorized equipment. Experiment for personal pleasure or for an audience—the layouts are ideal for club demonstrations.

A single transistor is used in each circuit. Other parts are standard and easily obtained—if not available from the junkbox. Every circuit has been checked out with several CK722 production transistors and found to be fool-proof. (A demonstration circuit must work without embarrassing tinkering and fumbling.)

Components are mounted breadboard style, allowing the individual circuits to be connected or torn down quickly. Since a single transistor is involved in all the circuits, it should be especially protected from continuous handling and soldering.

Two types of breadboard mountings for the transistor are used. In one layout, the leads are run to Fahnestock clips held to a heavy base of clothboard or masonite by 6-32 screws. This base should be heavy and large enough to prevent accidental upsets. The other breadboard model sports a small five-prong hearing-aid tube socket into which the transistor can be plugged. Only the first, third and fifth pins of this socket are used. The other two pins are given a slight twist and pushed out. It is a good idea to mark clearly which lead is the emitter, base and collector. Another suggestion: Slip spaghetti over all wires that might touch or short.

Microwatt oscillator

The most remarkable feature of the transistor is its ability to perform useful electronic tasks with a minimum of power consumption. The first project is an audio oscillator requiring a total power input of 4 microwatts—a perfect example of low power consumption! A simple electrolytic cell, constructed from

a dime and a piece of absorbent paper, supplies the energy.

The circuit (Fig. 1-a) must use transformer feedback to operate at this low power level. For this purpose, and in keeping with the size of the transistor, a tiny U.T.C. SO-3 or SSO-3 subouncer transformer is used. Larger transformers will do, but the data given in this article is for the SO-3.

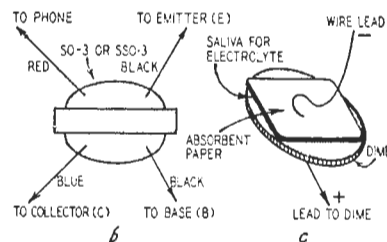
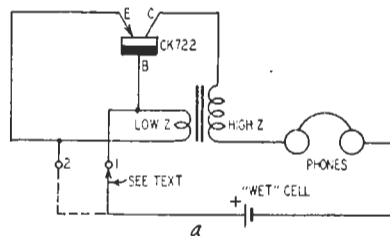

Fig. 1-a—The microwatt oscillator.
Fig. 1-b—Wiring diagram for the SO-3.
Fig. 1-c—Experimental “power supply.”

The exact connections for the SO-3, with the correct feedback polarity, are shown in Fig. 1-b. One wire from the “plate” side of the transformer goes to the collector and the other wire is connected to one side of the headphones. The two low-impedance wires from the transformer are connected to the base and emitter.

Either grounded-emitter (point 2) or grounded-base (point 1) operation is available by switching the wet-cell connection. Operation of the two circuits is essentially the same, but the grounded-base circuit gives a tone of

slightly higher pitch. The frequency of the oscillator changes with the voltage of the wet cell. Increasing the voltage lowers the tone.

Make the wet cell (Fig. 1-c) by placing a piece of absorbent paper moistened with saliva against a dime. The dime forms the positive electrode and a wire lead held against the other side of the moist paper provides the second electrode. A few drops of soft drink also make an excellent electrolyte.

Several of these dime-saliva cells were checked on a potentiometer and the voltage was always around 0.7. When the cell is connected to the transistor oscillator, the voltage drops to about 0.5. With this voltage, the oscillator draws 8 microamps of collector current—a total input power of .000004 watt!

By making a megaphone out of paper and placing it to one of the earphones, the tone can be heard several feet away. For larger groups, an audio amplifier input can be connected directly across the earphones for room volume.

The microwatt oscillator operates from other flea-power sources. Replace the saliva cell with a self-generating photocell and the oscillator will “sing” from the power produced by ordinary room illumination. Automobile headlights at night as far as 30 feet away will give enough light for oscillation. The tone changes with light intensity. This could possibly be used as a blind man’s light meter or in a steering device to bring an electronic animal to its nest.

A peak a.c. output voltage greater than the applied d.c. voltage can be obtained from transistor oscillators. This offers some novel transistor uses. For example, it is often necessary to send small d.c. signals over long-wire distances from remote locations. The microwatt oscillator can operate from these small voltages and, at the point of origin, change them to a.c. for more

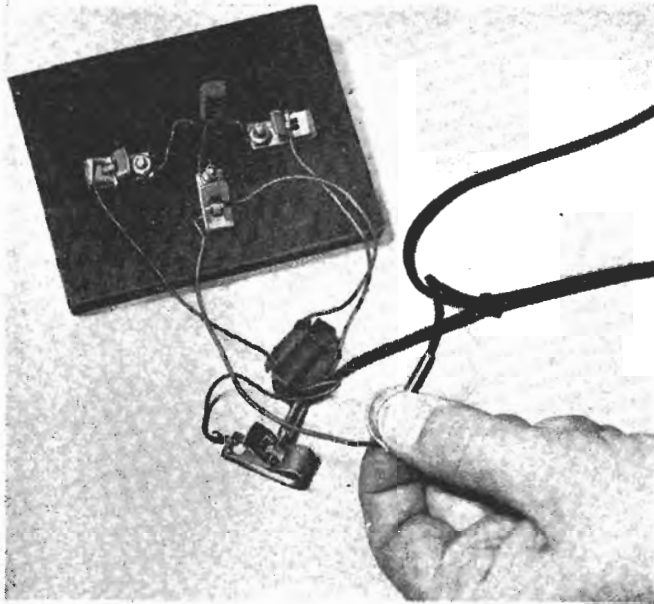

Microwatt oscillator with saliva cell.

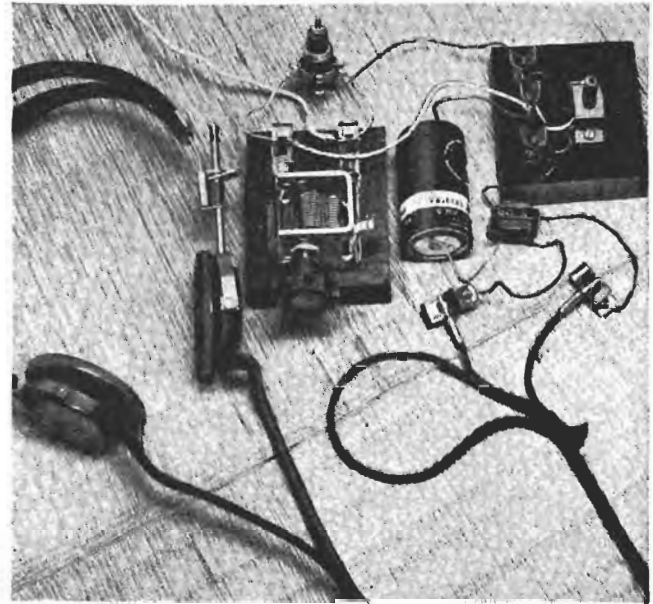

The high-gain radio demonstration.

convenient transmission and amplification.

High-gain radio

Astounding! is the only way to describe the feelings of most people when they first hear this set (Fig. 2) in operation. Only a single tuned circuit, transistor, SO-3 transformer and a battery are used.

The tuned circuit is coupled to the emitter by a tap on the coil, a 6SA7 oscillator type—only here it is used as an antenna coil. A broadcast tuning capacitor (410 μf) covers the band with perhaps only a few stations missing on the low end of the dial. The tuning is broad enough so these stations will be picked up anyway.

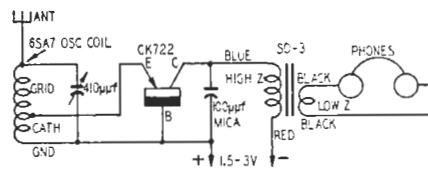

Fig. 2—High-gain transistor radio.

Simply connect the set as shown in the diagram. The grid connection of the 6SA7 coil goes to the tuning capacitor stator plates, the ground side of the coil goes to the frame (rotor) and the cathode tap to the emitter.

The emitter conducts only on the positive half of the carrier swing, like an ordinary diode detector; therefore, the instantaneous emitter current follows the modulation pattern. The emitter thus controls the current in the high-impedance collector circuit, producing amplification.

The secret of the receiver's performance is the SO-3 matching transformer. Ordinary medium-impedance earphones connected directly in the collector circuit do not realize the full gain possible from the transistor. But, with the circuit of Fig. 2, much higher gain is

possible. Even Army type moving-coil (low-impedance) earphones connected across the output winding give very good performance.

A small 0-100-microamp meter connected in series with the collector makes a very good tuning indicator. With a single dry cell for current, and no signal, the collector draws about 10 microamps. As a signal is tuned in, the current increases. A signal producing 20 microamps of collector current is loud enough to be heard faintly 3 or 4 inches from the earphones, while 40-microamp signals are exceedingly loud. Generally, a ground is not needed, but it does eliminate hand-capacitance tuning effects. For demonstrations, just touch the tip of a transformer type instant-heat soldering iron (plugged in but not turned on) to the antenna terminal of the receiver. This makes a very effective antenna with a whopping big signal of over 50 microamps. For even more volume, simply increase the collector supply to 3 volts.

Audio amplifier

The grounded-emitter circuit has become the established transistor audio circuit. There are two reasons for this: First, the gain is highest and, second, the proper bias voltage can be obtained most easily and with the least wasted power by grounding the emitter.

The transistor emitter is basically a rectifier circuit and a bias voltage must be placed on it to cause forward current to flow. For the CK722 this voltage must be positive. Without this bias, any negative swing of the emitter signal would drive the emitter into its "backward" region and produce collector cut-off distortion. In the grounded-emitter circuit, the base is made slightly negative by a series-dropping resistor from the negative collector supply, which is equivalent to making the emitter positive.

Fig. 3 is a typical amplifier circuit of this type. The input impedance being roughly 1,000 ohms, it can be fed from a single magnetic headphone used as a microphone, the transistor radio or a variable-reluctance cartridge.

To try out the circuit, connect a single earphone to the input and another to the output. Place the input earphone (microphone) in one room and the output one in another room. Sounds near the microphone can be heard clearly. The transistor amplifier can be built complete with a mercury-cell power supply in a volume as small as that of the earphone. You can't do this with a vacuum tube! On the debit side, the transistor amplifier has a noise level higher than an equivalent vacuum-tube circuit. This noise, heard as a soft frying sound in the earphones, is not obtrusive.

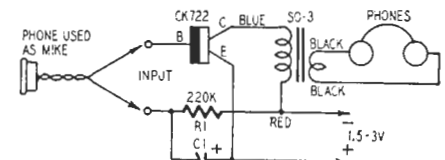

Fig. 3—Transistorized audio amplifier.

A variable-reluctance pickup connected to the input of the amplifier makes a pretty good transistor stethoscope for tracing the source of vibrations in solids and machinery. To detect the vibrations, simply touch the stylus to the vibrating material or machine part.

Capacitor C1 can be any electrolytic with a capacitance larger than 25 μf and a voltage rating of 3 or more. The unit shown in the picture is 200 μf at 3 volts. Resistor R1 can be from 100,000 to 270,000 ohms.

Utility oscillators

The utility oscillator is a demonstration circuit operating from a single-

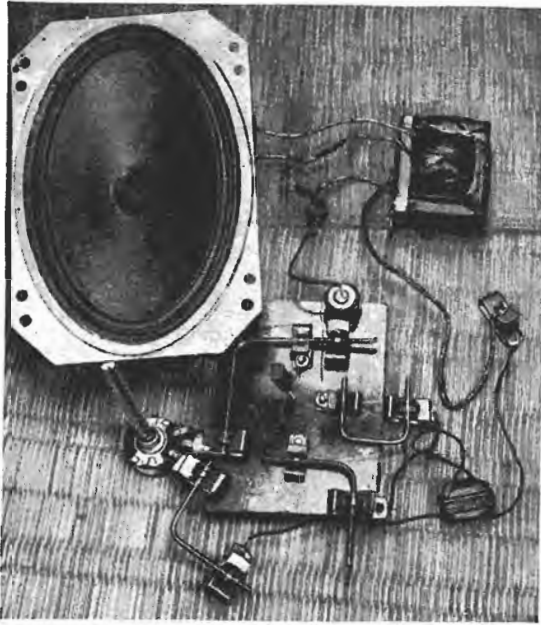

Oscillator of Fig. 4 using mercury cell.

cell. It is useful as a self-contained signal source for Wheatstone bridge circuits, toy musical instruments or an audio test generator. When operating at very low frequencies (60 cycles or less), the output is sufficiently rich in harmonics to radiate signals into the lower end of the broadcast band. The circuit of Fig. 4 is the same as Fig. 1, except for the power source and a variable resistor inserted in the emitter circuit to vary the frequency. Figs. 5-a, b, c and d give the waveshapes and frequencies obtained as the resistance is varied from zero to 7,000 ohms. Notice that the waveshape improves and the harmonic content decreases as the emitter resistance is increased.

Output is sufficient to operate headphones or a speaker at very low volume. Either earphones or the speaker output transformer may be connected to the OUTPUT terminals of the oscillator shown in Fig. 4.

A short antenna can be connected to the collector for signal radiation. The audible tone generated by the oscillator can be heard all across the low end of the band where it is strongest. Just turn on any radio within a few feet of the antenna.

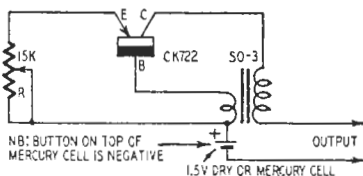

Fig. 4—Variation of Fig. 1 oscillator. Frequency controlled by potentiometer.

Another utility oscillator circuit is shown in Fig. 6. This is an "easier starting" circuit than that of Fig. 4. Some circuit disturbance is always necessary to start an oscillatory circuit in operation. A pendulum or tuning fork, for example, must be given that first push or impact to start it oscillat-

ing at its natural frequency. Vacuum tubes receive this push the instant the plate voltage is applied. When the plate voltage is switched on, the grid has zero bias and heavy plate current flows. This heavy surge of current excites the tuned circuit which oscillates and in turn builds up a grid-leak bias that limits the plate current to a lesser value.

With the transistor, this same situation is not obtained. Like the vacuum-tube grid, the emitter also has zero bias at the instant the collector voltage is switched on. But, conversely, zero

emitter bias allows *very little* collector current to flow, since a positive emitter bias is needed to increase the collector current to a point higher than the normal back current.

The Fig. 4 oscillator develops a starting bias across the variable base resistor. As the collector starting current flows through this resistor, it places a positive bias on the emitter.

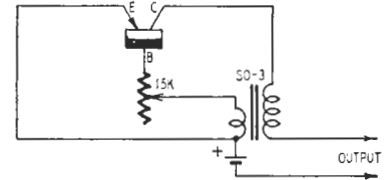

Fig. 6—An "easy start" oscillator.

Loading the circuit with an antenna or hand capacitance changes the waveshape considerably but causes little if any frequency variation.

These circuits will provide plenty of new entertainment and experimental material. You will hate to disassemble some of them—especially the radio.

Parts for transistor demonstration

1—CK722 transistor; 1—SO-3 (U.T.C.) transformer; 1—6SA7 oscillator coil; 1—1-section tuning capacitor, 410 μ f; 1—15,000-ohm potentiometer; 1—resistor, any value from 100,000 to 270,000 ohms; 1—electrolytic capacitor, 25 μ f or greater; 1—mercury or dry cell; several Fahnestock clips.

However, even one transistor is too expensive to limit to any single circuit. Furthermore, the clip-breadboard technique makes it possible to set up any of the other circuits in short order. END

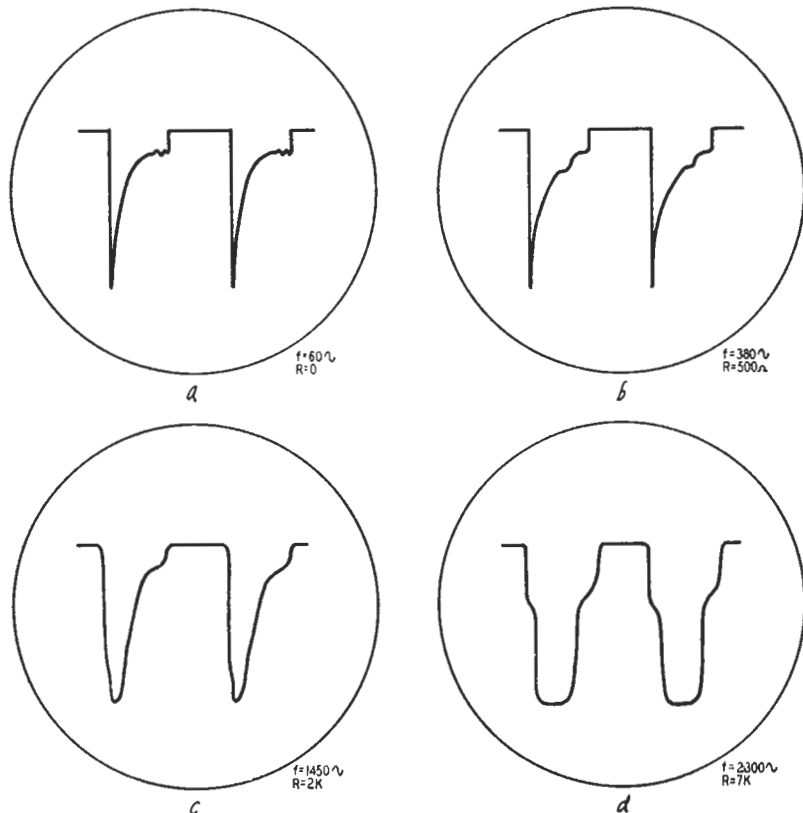
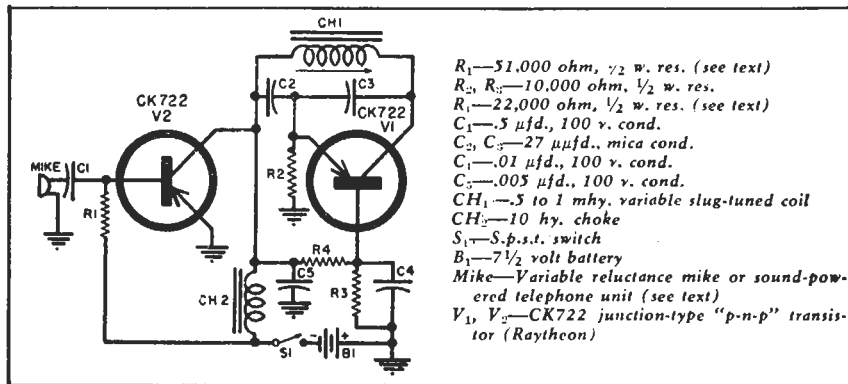

Fig. 5—Waveforms of Fig. 4 oscillator for variations in emitter resistance.

TRANSISTOR "WIRELESS MIKE"

By A. H. HELLMERS



AN ENTERTAINING gadget of durable popularity is the "wireless mike," a voice-modulated r.f. oscillator which can be picked up in a standard broadcast receiver at distances up to 20 or 30 feet. In common with "wireless" phonograph oscillators and the radio remote-tuning devices sold some years back, these units are not transmitters in the FCC sense of the term as long as their range is small compared to the wavelength at the operating frequency.

The transistor circuit shown operates in the low-frequency half of the broadcast band, where the wavelength is upwards of 900 feet. V_1 is the r.f. oscillator. The Colpitts-type circuit is tuned by means of a powdered-iron slug to an empty spot in the broadcast band, somewhere in the vicinity of 700 kc. This oscillator is "plate" modulated in the

regular Heising style by a second transistor V_2 . The microphone was a balanced-armature magnetic unit having a d.c. resistance of 200 ohms, obtained from a surplus collection. Since the input impedance of V_2 is on the order of 1000 ohms, a low-impedance mike is required. Crystal microphones will not work.

It was found that the tank capacitances in the r.f. oscillator circuit shown must be small, or the circuit will not oscillate at frequencies as high as the lower edge of the broadcast band. Hence an inductance somewhat larger than the usual broadcast coil (0.3 millihenry) is needed. The one used here is a commercial surplus item. However, it should be effective to rewind a broadcast-band coil to about twice the original number of turns. Experimentation is easy because no tap is required, and the "Q"

need not be particularly high. In the present state of the transistor art there is, of course, no assurance that all individual transistors of any particular type will have the same upper frequency limit of oscillation. Broadcast band frequencies are definitely at the high limit, for junction transistors, apparently, and all that can be said is that two transistors worked in this circuit.

The battery drain for the oscillator should be between 0.4 milliamperes and 1 milliamperes. Before operating the circuit, this must be checked. Proper bias will vary with different transistors. Bias is adjusted by selecting the value of resistor R_1 . The lower it is, the higher the collector current. Bias for the modulator transistor V_2 is determined by resistor R_4 , which should be selected to give a collector current of 0.8 to 1.5 milliamperes.

TRANSISTOR DOT MAKER

A series of dots gets more attention and is less tiring than a continuous tone. It can be used to modulate a signal generator or as a standby signal while adjusting a phone transmitter, wireless phono attachment, or intercom. A dot generator can also be used as a signal source for remotely controlling a model plane or for speed key practice without a Vibroplex or other automatic key. One of the simplest possible dot generators can be made with a junction type transistor and an audio transformer. (See diagram).

The transformer is connected in a conventional feedback circuit. If it has

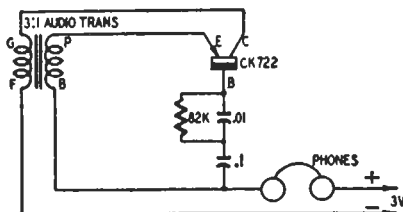

a third winding (as in a transceiver transformer) the added coil may be used as the output winding. The transistor base is isolated by a capacitor. Thus the oscillations build up, are blocked, and so on. With values shown, the dot rate is 2 a second. The power supply may be a 3-volt battery.

When the voltage is increased, the sound level increases, and the dots become more crisp. They become shorter with respect to the spaces between them. The rapidity of dots increases when a high resistance shunts the collector and base. For example, an 8.2-megohm resistor doubles the dot rate.

A TRANSISTOR METRONOME

By
LOUIS E. GARNER, JR.

MECHANICAL metronomes are known to almost every musician and student of music and have been in use for perhaps two centuries or more. In their simplest form they consist of a pivoted pendulum with one fixed and one movable weight. The position of the movable weight determines the number of oscillations or "beats" per minute when the pendulum is set in motion. More complicated versions employ a clockwork mechanism to drive the pendulum, and it is this version that is perhaps the best known.

In modern times, electrical and, later, electronic metronomes have seen wider use. Today, electronic metronomes are probably more widely used than the mechanical versions because of their lower cost, ease of setting, and ready availability. A number of articles have appeared giving construction information on such units.

Most electronic metronomes suffer from a disadvantage not shared by the mechanical units—they require a line power source. Power may not always be available or convenient to the musician in his "working" location. Battery operated metronomes have, in the past, not proven too satisfactory because of the large and heavy batteries required to deliver reasonable "loudspeaker" volume from vacuum tube operated equipment, as well as the comparatively short battery life obtained.

Today, however, with the ready availability of the highly efficient transistor, it becomes practicable to design and build a battery operated electronic metronome that is simple, compact, reliable, light in weight, and comparatively low in cost, yet delivers sufficient power to give a distinct "beat" of sufficient loudspeaker volume for all normal use.

The "Transistor Metronome" designed and built by the author is shown in Fig. 1. Standard, easily available components are used throughout. The average technician should have little or no difficulty in assembling and wiring a similar or duplicate unit in a few evenings' time.

Circuit Description

A Raytheon CK722 junction transistor is used in a modified grounded emitter "tickler feedback" oscillator circuit, as can be easily seen by refer-

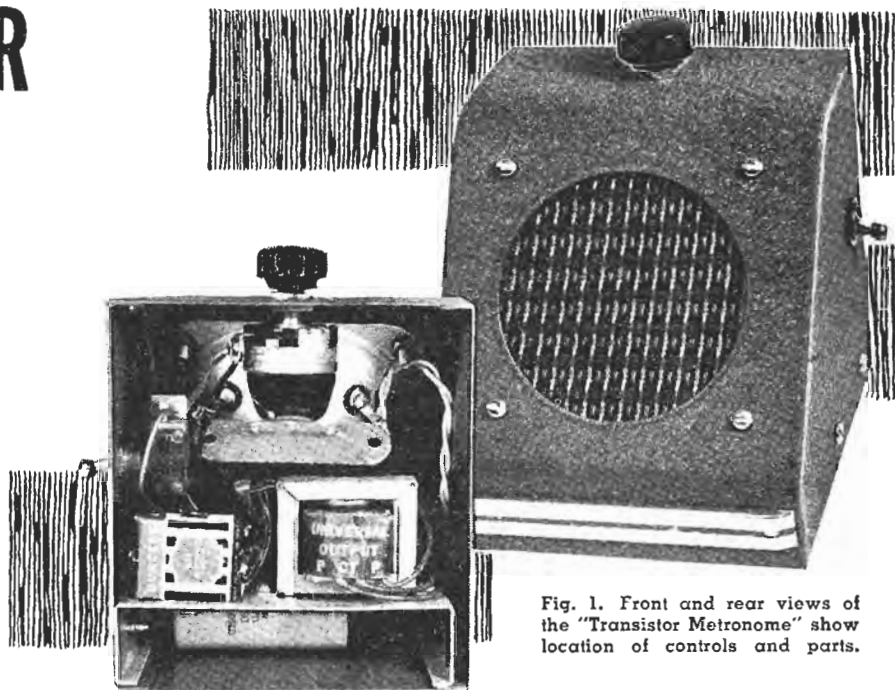

Fig. 1. Front and rear views of the "Transistor Metronome" show location of controls and parts.

In addition to its obvious application as an aide to musical studies, this instrument can double as a photo timer for the darkroom or as a mechanical process timer.

ence to the schematic diagram, Fig. 2. A standard "universal" audio output transformer, T_1 , serves both to provide the feedback necessary to maintain oscillation and to drive the small $3\frac{1}{2}$ " PM loudspeaker.

In operation, the start of a current flow in the collector circuit and through the primary of T_1 induces a signal across the secondary winding of the transformer. This signal, in turn, causes C_1 to charge rapidly through the base-emitter circuit of the transistor and the secondary winding of T_1 .

As C_1 starts to charge, the resulting base current flow permits an increase in the collector current flow, thus increasing the signal amplitude in the secondary winding of T_1 . The net effect is cumulative, with both base and collector currents reaching a peak as C_1 charges.

The voltage across C_1 soon reaches its maximum value and the charging current starts to decrease. This means that the base current drops, with a resulting drop in collector current. The drop in collector current reverses the polarity of the voltage induced in the secondary winding of T_1 .

If the base-emitter of the transistor were a bilateral conductor, this reversal of signal polarity across the secondary of T_1 would simply result in the rapid discharge of C_1 . However, since the base-emitter passes current in only one direction (that is, acts like a diode), C_1 cannot discharge over its charging path and must, instead, discharge through R_1 and R_2 .

The result is a sudden pulse of current flow as C_1 charges rapidly, with a comparatively long period of virtually no current flow as C_1 discharges slowly through R_1 and R_2 . The charging time depends on the value of C_1 and upon the combined impedances of the base-emitter circuit of the transistor and the secondary winding of T_1 . The discharge time depends on the value of C_1 and upon the values of R_1 and R_2 , that is, upon the resulting RC time constant of these components.

Once C_1 has discharged sufficiently to permit the start of base current flow again (over a path consisting of the battery, B_1 , R_1 , R_2 , and the base-emitter of the transistor), the charging cycle is repeated.

This action then continues, with the pulses repeated at intervals determined primarily by the RC time constant (R_1 , R_2 , C_1) and by the battery voltage, and with each pulse giving a "plop" of fairly good volume in the loudspeaker. Adjusting R_2 permits the repetition rate ("beats" per minute, or frequency) to be varied.

Since appreciable current flow occurs only during the short time interval of the pulses, the average current drain from the battery is small, and battery life is long, even though a small "hearing aid" type battery is employed. The average current drain will depend, however, upon the number of "beats" per minute, with high repetition rates requiring considerably more power.

A stepdown turns-ratio is used in the transformer (T_1) to match the

high impedance of the collector circuit to the low input impedance of the base-emitter circuit. A still greater stepdown ratio (taps on the secondary winding) is used to match the even lower impedance of the loudspeaker voice coil.

A toggle switch, S_1 , is provided to turn the unit "on" and "off."

Construction Hints

The entire "Transistor Metronome" has been assembled in a commercially available 3" meter case, with the small loudspeaker mounted behind the meter opening. Plastic grille "cloth" was used by the author to cover the speaker opening, but this may be left uncovered, if desired, or plain screening or flock-covered screening used instead.

In assembling the unit, a small aluminum chassis was used to mount the transformer, battery, transistor, and condenser (C_1), with the control (R_2) and power switch (S_1) mounted on the cabinet.

The location of all major components except the transistor itself is clearly visible in the interior view of the unit, Fig. 1. Note that the condenser (C_1) is mounted below the chassis. The transistor is mounted on a terminal strip directly behind the small battery.

When installing the transistor, the author simply soldered the unit in place. Another builder might prefer to use a socket, however. A small 5-pin subminiature tube socket is suitable, with only 3 of the pins being needed.

Should the builder decide to follow the author's example and wire the transistor into the circuit, he should exercise special care when soldering the connections. Transistors are easily damaged by excessive heat. Each connection should be made as quickly as possible, using a very hot, clean, well-tinned iron. The transistor leads should not be cut short.

A small "Z" bracket was used to hold the battery in place. The author found that small size paper clips made almost perfect connection clips for the battery, slipping over the projecting terminals. However, if the builder prefers, battery connections may be made by soldering the leads directly to the brass battery terminals. Care should be taken not to overheat the battery if this technique is used.

Parts Substitutions

A number of parts substitutions are possible, depending on the needs and requirements of the individual builder. For example, a larger speaker and different case might well be employed (a larger speaker will provide somewhat greater volume). A wall speaker baffle makes an excellent cabinet where a wooden case is preferred.

A type CK721 transistor may be substituted for the type CK722 used by the author, with no changes in connections or circuit values. (Both are "p-n-p" junction transistors.)

The prospective builder may prefer to use a different battery in place of the 15-volt hearing aid type battery used by the author. The circuit is not at all critical and will operate with comparatively low voltages, although the operating frequency as well as the output amplitude (volume) may change. Other suggested batteries are the *Mallory* 302424 (a 6.7 volt battery designed specifically for transistor applications), the *Eve-ready* type 411 (another 15 volt battery), and the *RCA* type VSO68 (a 6.3 volt "A" battery).

Any standard "universal" audio output transformer should give satisfactory results, although the builder may have to experiment somewhat with the tapped secondary connections. The terminal connections and color-coding given in the schematic diagram (Fig. 2) refer specifically to the *Stancor* unit.

A slide or rotary switch might be used in place of the toggle switch employed in the author's model, or, if preferred, a control type switch on R_2 may be used as a power switch. This move would reduce the number of controls from two to one.

Substitutions for C_1 , R_1 , and R_2 will depend on the operation desired.

Circuit Modifications

A fairly wide range of "beat" signals is provided by the component values given in the parts list. In the author's model, the range is from 1 beat for every 7 seconds to about 20 beats-per-second. This is a far wider range than is needed for musical applications only—a range of from 1 beat-per-second to 5 per-second should be satisfactory for most musical requirements (60 to 300 beats-per-minute).

Where the builder has a specific application in mind, he will find it quite easy to choose parts values giving the desired repetition rates and range coverage. Different values of C_1 , R_1 , and R_2 may be used to give almost any range desired.

The fixed resistor, R_1 , is chosen to

give a particular maximum (or minimum) repetition rate for specific values of C_1 and R_2 .

All three component values may vary with different transistors and supply voltages, and hence it is difficult to determine these components in advance. Rather, the circuit is built up and an easily available value chosen for C_1 (50, 100, 150, 200, or 250 μ fd.). This condenser is connected into the circuit, and a resistance substitution box used in place of R_1 and R_2 .

The resistance is then adjusted until the desired *minimum* repetition rate is obtained. This value is the total value of R_1 and R_2 , and may be termed R_1 .

Next, the resistance is varied until the desired *maximum* repetition rate is obtained. This value is equal to R_2 .

R_2 is a potentiometer having a standard value most closely approaching the difference of the two values determined experimentally, that is, $R_2 = R_1 - R_1$.

Where the value of R_2 does not even closely approach a commercially available potentiometer, a different value of C_1 may be used.

If several ranges are desired, a selector switch may be provided to insert different values of C_1 into the circuit.

Another circuit modification is to dispense with a continuously adjustable control entirely and to provide a selector switch inserting fixed values of C_1 and R_1 . In this way, two, three or more fixed beat rates may be provided (depending on the number of switch positions available).

Still another circuit modification is to provide earphone, rather than loudspeaker, output. Simply connect a pair of low-impedance magnetic earphones in place of the loudspeaker voice coil.

Calibration

No effort was made by the author to accurately calibrate the settings of R_2 in terms of "beats"-per-second (or per-minute), since this was not necessary in the application in which the author's model was used.

However, for many applications a calibrated control will be desirable.

Several techniques may be used for calibrating the completed instrument, depending on the repetition rate and the accuracy desired. First, however, a scale and a pointer knob should be provided for the control. For maximum accuracy, a large scale is desirable, and it may be found best to mount the control on the side of the meter case, where greater panel space is available.

For low repetition rates and an approximate calibration, an ordinary stop-watch may be employed, the operator "counting" between beats (or between seconds at higher rates).

Where a more accurate calibration is desired, the builder may borrow another metronome (either a mechanical or electronic model) that is ac-

(Continued on page 104)

Fig. 2. Complete schematic of the metronome which uses one "p-n-p" transistor.

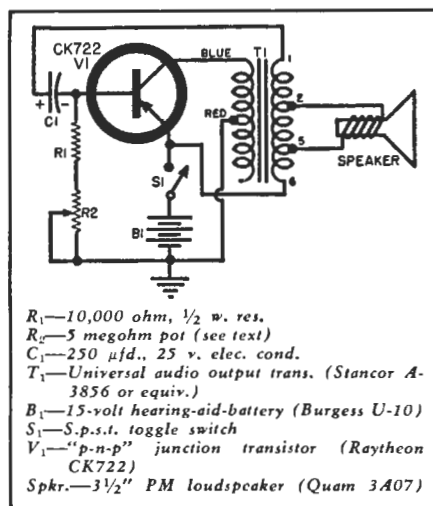

A TRANSISTORIZED APPLAUSE METER

By LOUIS E. GARNER, JR.



Fig. 1. Over-all view of the transistorized applause meter. It measures 4" x 6" x 4 1/4" and is battery-operated.

Build this compact unit for rental or "loan." It can be used as an output meter or for sound-survey work.

WITH the increasing general interest in square-dance competitions, amateur shows, and similar contests, the radio-TV service shop is frequently in a position to pick up extra money or to obtain good publicity by renting or lending and installing p.a. systems, record players, and juke boxes. General practice is to rent the systems or equipment to clubs and money-raising groups, and to "lend" the systems to churches and similar charitable organizations.

At such contests, prizes are often awarded on the basis of "audience reaction." The only fair way to determine audience reaction to a particular act is by means of the impartial judgment of an electronic applause meter. In this way, there is no possibility of favoritism on the part of the emcee, nor any question as to the fairness of decisions.

Since the radio-TV service shop may be called on to furnish or operate the p.a. system, it is only natural that it also be requested to supply or obtain an applause meter or similar device. Commercial applause meters may not only be difficult to obtain locally but quite expensive, so the service organization handling such work may find it worthwhile to consider building its own instrument.

In choosing the design for such an instrument, several features are desirable. The applause meter should be self-contained, compact, light weight, sensitive, easy to use, and, preferably, independent of both the power line

and the p.a. system. These last two features are important because the instrument may sometimes be used outdoors where power is not available or in small groups where a p.a. system is not needed.

The instrument shown in Fig. 1 comes close to meeting all of these requirements. It is completely self-contained. No extra "mike" or other pick-up is required. It is compact as the over-all dimensions are only 4"x6"x4 1/4". It is quite sensitive, yet easy to operate and use—only three simple controls are provided. It is battery operated and no power line connections are necessary!

These features have been made possible by utilizing *p-n-p* junction transistors in the design of the instrument.

Circuit Description

The complete schematic diagram for the transistorized applause meter is given in Fig. 2. The basic circuit consists of a two-stage transformer-coupled transistor amplifier followed by a single stage combination amplifier-detector. A built-in crystal microphone cartridge (Mic.) serves as the pickup.

In operation, audio signals picked up by the microphone are applied to the primary of transformer T_1 , a step-down unit used to match the high impedance of the crystal microphone to the low input impedance of the first transistor amplifier stage.

In order to adjust the gain of the

instrument for different sized audiences, a simple step-type attenuator, consisting of rotary switch S_1 and resistors R_1 , R_2 , R_3 , R_4 , and R_5 , is provided between the secondary winding of T_1 and the input to the CK721 amplifier stage.

The audio signal obtained from the "arm" of S_1 is applied through coupling condenser C_1 to the base of the transistor, connected as a conventional "grounded-emitter" amplifier. This basic circuit has been used throughout the instrument as it provides good gain and permits a single battery power source to be employed.

Resistor R_6 serves as the "base return" resistor. Connected to the negative terminal of the power supply, it establishes the base current "bias" for the first stage.

Transformer T_2 is used to match the high output impedance of the first stage to the low input impedance of the second stage, a CK722 "grounded-emitter" amplifier. The primary winding of this transformer serves as the collector load for the CK721 stage.

Coupling condenser C_2 offers a low impedance path for the audio signal to the base of the CK722 amplifier, yet prevents the secondary winding of T_2 from acting as a d.c. short from base to ground. R_7 is the base return resistor for the second stage; again, the value of this resistor determines the base "bias" current.

Condenser C_3 serves to bypass the higher frequency components of the audio signal and thus to reduce the effects of high-pitched whistles on the final meter reading. This condenser also reduces, to some extent, the amplitude of the noise "hiss" generated by transistor amplifier stages.

If desired, crystal headphones may be inserted in the monitor jack, J_1 , coupled to the second amplifier stage through condenser C_4 . This provision permits the operator to hear the signal as picked up by the applause meter.

Transformer T_3 serves to perform a function similar to that of T_2 , that is, its primary winding serves as the collector "load" for the second amplifier stage, and it is used to match the high output impedance of one stage to the low input impedance of the next.

C_5 serves as the coupling condenser to the last stage, a CK722 transistor operated without base "bias" current. Note that base resistor R_8 is returned directly to ground rather than to "B—".

When a transistor amplifier is op-

erated without base "bias" current, it acts to rectify as well as to amplify the applied signal. Thus, collector current depends directly on the amplitude of the applied audio signal and this current is indicated on the microammeter, M_1 .

Provision is made for "smoothing out" the peaks of audio signals by means of a large capacity bypass condenser, C_6 , across the meter. The use of this filter is optional with the operator, since it may be thrown out of the circuit by means of switch S_3 .

Power for the entire instrument is obtained from a single 6 volt battery, B_1 , controlled by a s.p.s.t. power switch, S_2 .

Construction Hints

The assembly and wiring of the instrument are straightforward and should present no problem to the skilled technician. The placement of major parts is apparent from the interior view of the instrument given in Fig. 3. The microphone cartridge and the input transformer (T_1) are mounted on the back panel.

A small chassis is used for the transistor circuits. An under chassis view is not shown because the final wiring, with the author's layout, must be done with the chassis in place.

The subminiature transformers are held in place by small "Z" brackets.

Wiring and layout are not especially critical, and the builder may modify the layout shown or choose a new one to suit his own requirements. Care should be taken to follow good audio practice, that is, leads should be kept reasonably short and the "input" and "output" portions of the instrument should be kept well separated.

Although the author's model has been assembled in a standard sloping panel utility box, another type cabinet may be preferred by the builder. Almost any small metal box will serve well in this capacity; a Bud "Minibox" is a good choice.

The transformer leads are identified by color-coded wires—the proper connections are shown in Fig. 2 for the transformers specified in the parts list.

In rare instances it may be found necessary to readjust the values of the "base return" resistors R_6 and R_7 for optimum results with a particular transistor. To do this experimentally, connect an audio sine-wave generator to the input and an oscilloscope to the output of the stage to be checked. Adjust the value of the resistor for best gain with minimum distortion, but in no case choose a value which permits the collector current to rise above 5 ma.

The builder can use one of two methods when installing the transistors. He may either use sockets or wire the transistors directly into the circuit. Should sockets be preferred, standard 5-pin subminiature tube sockets are suitable.

If the transistors are to be soldered in position, however, special care

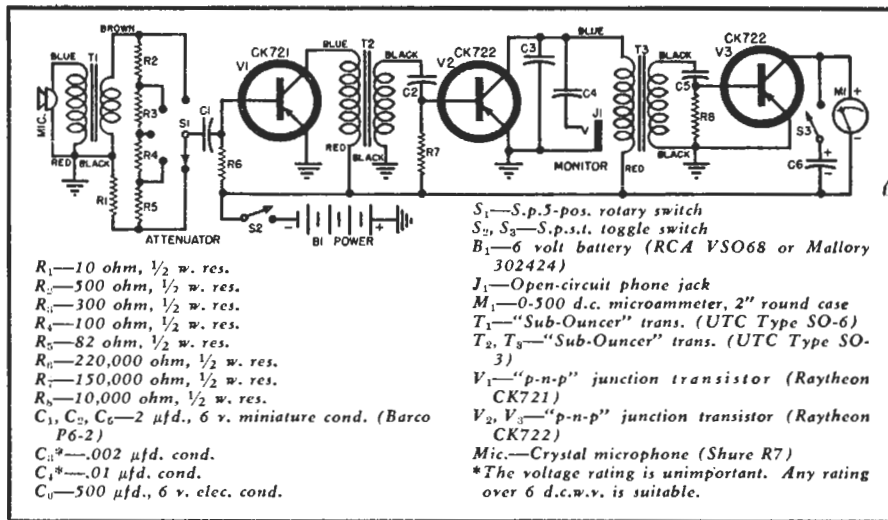

Fig. 2. Complete schematic of the transistorized applause meter. The "p-n-p" type junction transistor has been used in this construction. Three are required.

should be exercised to complete the soldering as quickly as possible to avoid possible damage by overheating these expensive components.

Circuit Modifications

A considerable number of modifications in the basic applause meter circuit are possible to meet the special needs of the individual builder. However, because the number of possibilities is so large, only a few suggestions are outlined here.

First, the monitor circuit may be eliminated entirely if desired. Simply remove C_4 and J_1 . No other circuit changes are necessary.

Another meter may be substituted for the 0-500 microampere unit specified in the parts list without making any other circuit changes. An 0-100

microammeter will provide increased sensitivity, while less sensitivity will be obtained with a 0-1 ma. unit. Irrespective of the meter chosen, however, care must be taken to set the attenuator so that serious overload will not occur. The exact setting will vary with different sized audiences.

In the author's model, the resistors in the attenuation network (R_1, R_2, R_3, R_4 , and R_5) were chosen arbitrarily and no attempt was made to provide a precise degree of attenuation at each switch position. This method was employed since the instrument is used only to indicate relative peaks and exact meter readings are unimportant.

Some builders might prefer that the attenuator switch provide precise steps of attenuation, either in terms

(Continued on page 102)

Fig. 3. Rear view of instrument. Microphone and transformer are mounted on the panel.

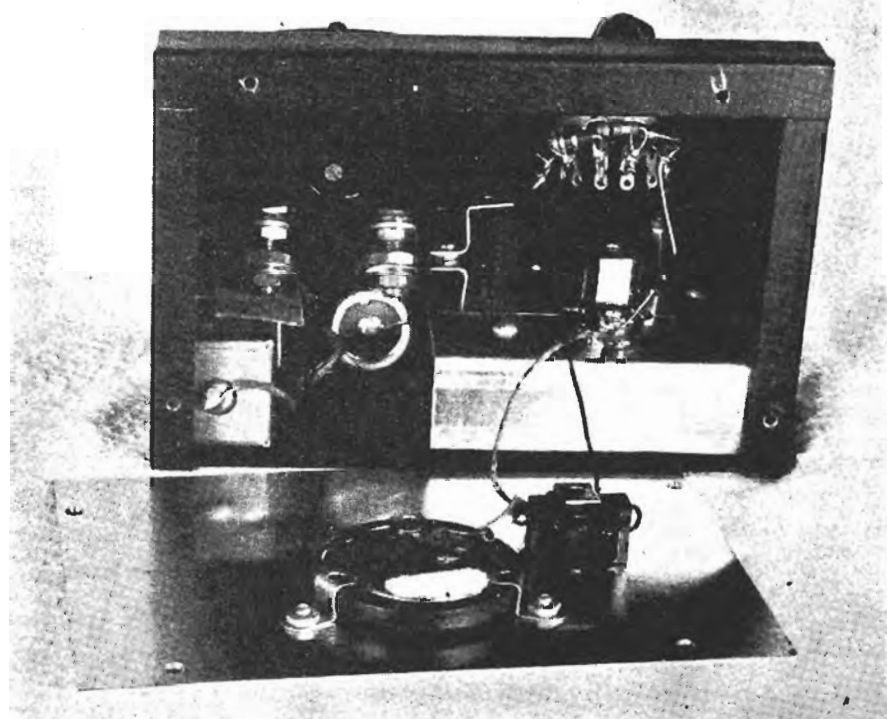

TRANSISTORIZED MOISTURE DETECTOR

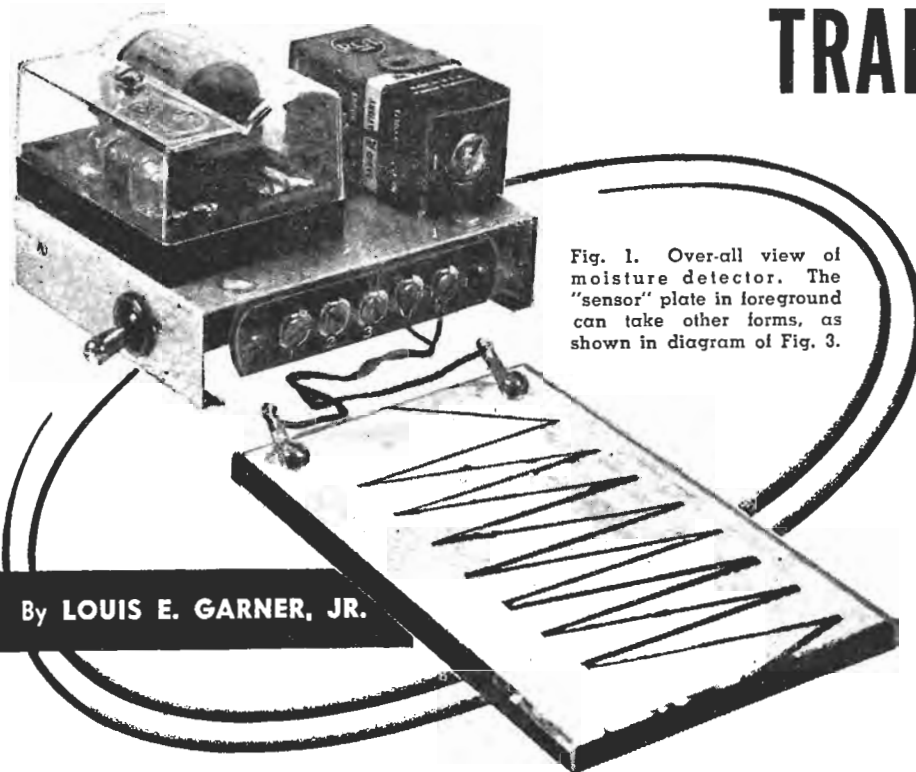

Fig. 1. Over-all view of moisture detector. The "sensor" plate in foreground can take other forms, as shown in diagram of Fig. 3.

By LOUIS E. GARNER, JR.

Construction details on a compact unit which can be used to warn the householder of unusual or dangerous leakage.

ELECTRONIC experimenters and technicians occasionally find it necessary to devise and build some type of simple moisture or rain detector. The unit may be destined for their own use, or may be built at the request of a friend, relative, or neighbor.

There is no doubt that the applications of a reliable moisture detector are quite varied . . . from closing a window with the first few drops of rain to protecting the family washing (by sounding an alarm so clothes may be removed from the line), or from detecting leaks and excessive condensation to giving a signal when "bed-wetting" occurs.

Unfortunately, many of the "rain detector" designs suggested and used in the past required vacuum tubes or thyratrons for their operation . . . making line voltage operation almost mandatory, and battery operation, at the best, expensive and cumbersome. Line voltage operation restricts the possible applications of a moisture detector considerably—outdoor use is limited, and applications involving possible body contact may be dangerous.

By *transistorizing* a moisture detector, however, low voltage battery operation becomes economically feasible, and such an instrument has virtually unlimited application. A typical transistorized moisture detector, suitable for construction by the home builder, is illustrated in Fig. 1, with the complete schematic diagram given in Fig. 2.

Since only a few components are required, the cost of the completed device is reasonable and compares favor-

ably with vacuum-tube operated units. Wiring and assembly is straightforward and simple, and the average technician should have little or no difficulty in assembling a similar unit in an evening's time.

Circuit Description

As can be seen by reference to Fig. 2, the basic device consists of a moisture sensing element ("sensor"), a *p-n-p* junction transistor connected as a "grounded-emitter" direct-coupled amplifier, and a relay, used for controlling an external circuit.

The "sensor" consists of two pieces of aluminum foil cemented to a piece of plastic, with a very narrow separation between the conductors (from 1/16" to 1/8").

In operation, the base-emitter circuit of the transistor is normally open, and little or no collector current can flow through the relay. The relay thus remains open.

Should a drop of moisture fall on the "sensor" plate so as to contact both pieces of foil simultaneously, the base-emitter circuit is closed, and base current may flow. The electron path in the base circuit is from the negative terminal of the battery, through the power switch, *S*₁, through resistor *R*₁, through the drop of moisture on the "sensor" plate, and through the base-emitter of the transistor back to the positive terminal of the battery.

This base current flow permits a corresponding collector current flow to take place, though of much larger amplitude due to the current amplification of the transistor stage. The col-

lector current flow closes the relay which may be used to switch on some external circuit.

A single battery, *B*₁, supplies both base and collector current. A power switch, *S*₁, is provided to turn the unit "off" when operation is not desired.

Series resistor *R*₁ serves to limit base current to a safe value, even if the "sensor" elements are accidentally short-circuited. The high d.c. resistance of the relay coil satisfactorily limits collector current well within the maximum ratings of the transistor.

Construction Hints

The author's model of the moisture detector has been assembled on a small standard aluminum chassis. Parts layout and wiring are clearly visible in the over-all (Fig. 1) and under-chassis (Fig. 4) views. However, this type of assembly need not be followed by another builder since the circuit is completely non-critical—leads may be made as short or as long as may be desired.

However, if the builder decides to solder the transistor directly into the circuit, as in the author's model, he should exercise care to avoid overheating the transistor leads. The transistor is quite susceptible to heat damage. Allow the transistor leads to remain reasonably long, covering them with insulating tubing, and complete the soldering as quickly as possible, using a hot, clean, well-tinned iron.

As an alternative, a socket may be provided for the transistor. Use a standard five-pin subminiature tube socket. Only three of the socket terminals are needed.

The moisture detector might easily be assembled in a standard metal utility box or *Bud* "Minibox" to provide a completely enclosed unit.

Parts Substitutions: Although comparatively few parts are required for the construction of this device, it is still possible to make a number of parts substitutions to utilize components that may already be available in the builder's "junk box."

A slide, rotary, lever, or even key-operated switch may be substituted for the toggle switch (*S*₁) used in the model. A key-operated switch is an especially good selection as it permits one or two persons to exercise complete control over the operation of the unit.

A type CK721 junction transistor may be directly substituted for the type CK722 shown in the schematic diagram, and will provide somewhat greater sensitivity. No other component changes are necessary.

Another relay may be substituted for the unit specified in the parts list. Choose a relay which will not require more than about 2 milliamperes coil current for operation, and with a moderately high d.c. resistance. In a few instances it may be necessary to use a higher voltage battery should a different relay be employed.

Since very little current is drawn from the battery until the moisture detector actually operates (relay closes), battery life is quite long. In some instances the battery life in the detector may approach the normal "shelf life."

Because of this, the builder may exercise wide latitude in his choice of a battery. A conventional zinc-carbon dry battery, a "wet-cell" storage battery, or a mercury battery may be used as the power supply for the unit.

Assembling "Sensor" Plate

The "sensor" plate consists, basically, of two conducting elements separated by a narrow strip of insulating material. It may be made up in any one of several ways, depending on the inclinations of the individual builder and the facilities available to him. The "sensor" plate used in the author's model is clearly visible in the foreground of Fig. 1, and has been made up using heavy-duty aluminum foil, a piece of Bakelite (lucite, polystyrene, or similar plastic will do as well), and cement.

A piece of aluminum foil was first cemented firmly to the flat Bakelite plate. A narrow strip (about 1/8" wide) of the aluminum was then cut out in a saw-tooth pattern, leaving two insulated conductors. Contact to the foil was made by means of soldering lugs held in place by small machine screws.

A variety of patterns may be used in place of the "saw-tooth" employed by the author, provided the foil is clearly divided into two separate conducting elements. A few possible patterns are illustrated in Fig. 3.

A "sensor" plate may also be made up by using a "sandwich" consisting of two pieces of copper or brass screening separated by a piece of plastic screening. Over-all dimensions may be as large or as small as is desired.

However, irrespective of the method chosen for assembling the "sensor" plate, care should be taken that the two conducting elements are not so close together that accidental short-circuits may easily occur (resulting in "false alarms"), nor so far apart that a single drop of moisture cannot make contact with both conductors.

Once the wiring is completed, the moisture detector may be easily checked for operation by closing the power switch (S₁), wetting the finger, and touching the "sensor" plate in the gap between the two conducting ele-

ments (there is no danger of shock). The relay should close. Remove the finger and allow the damp spot to dry, the relay should then open.

If satisfactory operation is not obtained, carefully check all connections. Look out especially for "cold-soldered" joints and errors in wiring. Make sure that the battery has been connected with the correct polarity.

If a different relay has been used in place of the unit specified in the parts list, it may be that insufficient current flows to operate the relay. This may call for a larger battery.

When using a larger battery, take care that the maximum ratings of the transistor are not exceeded. The collector voltage should not exceed 20 volts and collector current should not exceed 5 ma. In addition, a new value should be chosen for R₁. Using Ohm's law, calculate a resistance value which will not allow more than 5 ma. base current flow, even if the "sensor" elements are shorted together.

Once the moisture detector is operating properly, it may be set up to perform the desired function. Let us discuss a few typical applications:

Rain Alarm: To use the moisture detector as a rain alarm, connect the relay contacts to operate an alarm bell, buzzer, or signal light. Place the "sensor" plate on a window sill or in a similar exposed location.

For maximum response two or more "sensor" plates should be provided, simply connect the additional plates in parallel. A separate "sensor" plate may be placed on each window sill if desired.

If the builder prefers, the relay may be used to actuate a small electric motor (set up to close the open window) instead of sounding an alarm signal. Should this arrangement be employed, a small "limit switch" should be placed on the window frame to shut off the motor after the window is closed.

Such a "limit switch" may be installed quite easily by using either a *Micro-switch* or small push-button switch in series with the motor leads, arranged to open the motor circuit when the window is fully closed.

Condensation or Leakage Detector:

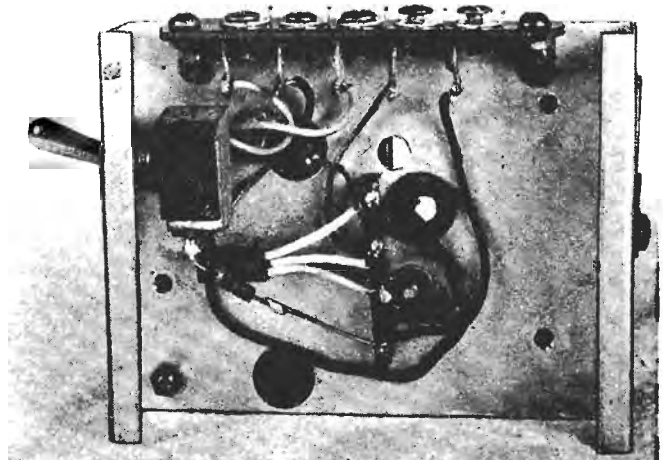

Fig. 4. Underchassis view of detector. Any parts arrangement is suitable as circuit operation is far from critical. See article.

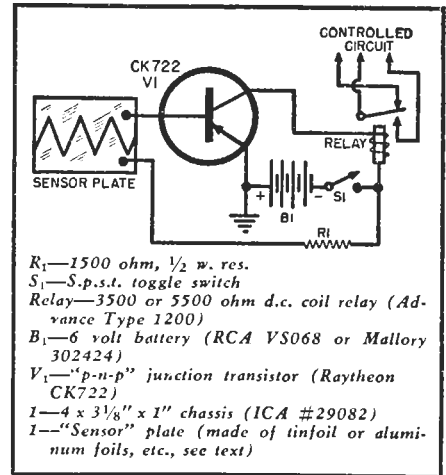

Fig. 2. Complete schematic of moisture detector. Parts variations are possible.

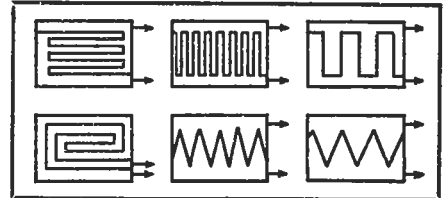

Fig. 3. Possible arrangements of "sensor."

Where condensation or water leakage is a problem, the "sensor" plate may be placed under the suspected pipes so that the first drop of water to fall will sound an alarm. Locate the "sensor" at the lowest point under the suspected pipe.

"Bed-Wetting" Alarm: To use the moisture detector in this application, a flexible "sensor" plate should be made up that can be easily slipped under bed-sheets. Such a flexible "sensor" may be obtained either by using the screen "sandwich" previously mentioned or by cementing aluminum foil to thin plastic sheeting material.

The relay may be connected to turn on a soft light or to sound a gentle bell or chime—harsh, loud, and sudden noises should be avoided.

Controlling Water Level in a Tank: The moisture detector may be easily used to maintain a constant water

(Continued on page 102)

A TRANSISTOR "ELECTRIC ORGAN"

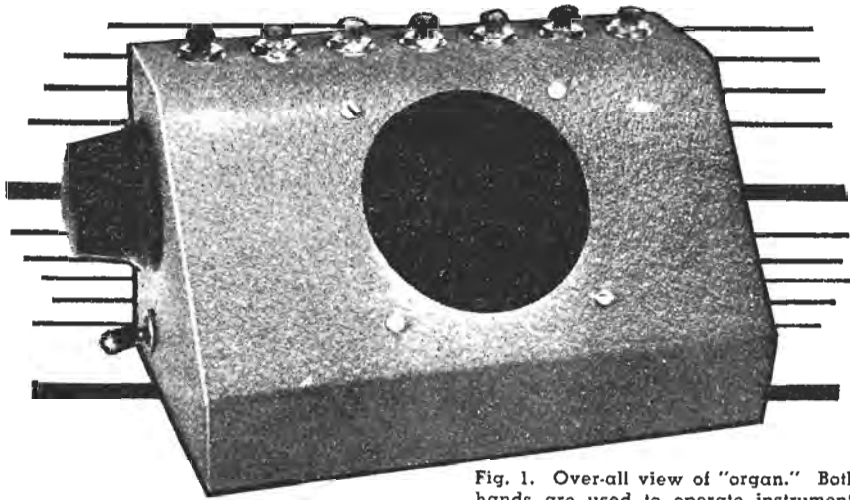

Fig. 1. Over-all view of "organ." Both hands are used to operate instrument.

An interesting project for the experimenter, this battery operated unit requires few parts for its construction.

ALTHOUGH the device shown in Fig. 1 is not an "organ" in the truest sense of the word, it is capable of producing tunes when operated by a person of moderate skill. In fact, the operator need not be a skilled musician. The average person, with a little practice, can "pick out" tunes, playing one note at a time.

As a toy, the "electric organ" shown is of real value. The author has several times turned his model over to his children, who enjoy playing with it in preference to their more conventional toy pianos, toy xylophones, toy guitars, and other toy musical "instruments." But the value of the device as a toy is not limited to its appeal to children. Although the output is obtained through a loudspeaker, the volume is not so high as to prove distracting to the parents. The children can "make music" to their little hearts' content while the parents, in an adjoining room, can watch television, listen to the radio, or even read, without distraction.

Another real advantage of the "electric organ" shown is its independence from the power line, and the fact that there is relatively no danger of electric shock. Nor is the design such that the battery used has to be replaced every day or so. With average use, the battery should last its normal "shelf life."

These desirable characteristics, for a toy, have all been made possible by utilizing a Raytheon junction transistor in a simple oscillator circuit. As can be seen by reference to the schematic diagram, Fig. 2, relatively few other parts are required for the operation of the unit.

Referring to the schematic diagram, Fig. 2, a type CK722 transistor is con-

nected as a modified grounded-emitter "Hartley" oscillator. The emitter is connected through push-button switch S_1 to the positive terminal of a small hearing-aid type battery, and the collector is connected through one-half of the transformer (T_1) primary winding to the negative terminal of the battery.

The necessary feedback signal for operation is obtained from the other half of the transformer primary winding, which is connected through coupling condenser C_1 to the base of the transistor.

Resistors R_2 to R_4 serve as "base return" resistors, with the desired resistance selected by depressing the proper push-button (S_2 to S_4). If toggle switch S_5 is thrown, the "base return" resistor becomes R_1 and R_2 in series. Since R_1 is variable, the total resistance value can be adjusted from the value of R_2 to the sum of R_2 and R_1 , or from 8200 ohms to more than 2 megohms.

The 3" PM loudspeaker is connected to the proper taps on the secondary winding of T_1 . Transformer T_1 thus serves both as an "oscillator coil" and as an "output transformer."

In operation, one of the resistor switches, S_1 to S_4 , and the power switch, S_5 , are thrown simultaneously. Battery current can then flow over two paths.

Part of the current flows through the "base return" resistor and the base-emitter of the transistor, establishing the bias current for the transistor. The amount of bias current obtained depends on the battery voltage and the total impedance of the resistor plus the internal base-emitter impedance of the transistor. Since the external resistor generally has a

greater value than the internal impedance of the transistor base-emitter circuit, the base current, for practical purposes, can be said to depend primarily on the size of the "base return" resistor.

Current also flows over the path including half of the transformer primary winding and the collector-emitter circuit of the transistor. This is the collector current and its value depends primarily on the amount of base current flow (as well as on the battery voltage).

Any changes in collector current induce an a.c. voltage in the primary of transformer T_1 . This voltage is coupled through condenser C_1 to the base of the transistor, adding an a.c. component to the d.c. base current, and causing corresponding changes in collector current. Thus, the basic conditions for oscillation are set up—positive feedback from output to input circuit, coupled with stage gain.

The frequency of operation depends on the transistor characteristics, on the transformer used, on the value of coupling condenser C_1 , and on the size of the "base return" resistor. Varying any of these factors permits the frequency to be changed. In practice, it has been found easiest to vary the size of the "base return" resistor, hence a selection of resistors (R_2 to R_4) with corresponding switches (S_2 to S_4).

Where a continuously variable resistor is used (R_1), the frequency can be easily varied over wide ranges. In the model shown, the output frequency can be varied continuously from about 20 cps to about 10 kc. simply by adjusting R_1 .

The frequency of operation bears an inverse relationship to the size of the "base return" resistor, that is, as the resistor value is reduced, the frequency of operation increases.

At the same time, the base current (and hence the collector current) increases. Thus, at high frequencies the battery current drain is several times greater than at lower frequencies. It is this characteristic that makes it necessary to provide a fixed resistor (R_2) in series with the continuously variable control. Thus, R_2 , although limiting the maximum frequency of operation when the variable control is used, also limits the maximum base and collector current and thus serves to protect the transistor from damage.

Since oscillation is obtained by means of "brute force" feedback rather than by employing a tuned cir-

cuit, the signal obtained is not a sine wave. Rather, it is extremely rich in harmonics. The exact waveform obtained varies with frequency, and also with the characteristics of the transistor and transformer used.

Construction Hints

Because of the simplicity of the circuit, duplication of the model should not prove at all difficult for the average technician. The only real care that must be exercised is when installing the transistor. If the transistor is soldered directly into the circuit (instead of a socket being used), especial care must be taken that the transistor leads are not overheated.

Circuit layout, lead length, and lead arrangement all are completely non-critical. It is suggested, however, that standard good wiring practice be followed.

The author's model has been assembled in a standard ICA sloping front cabinet, and easily obtained push-button switches used for the various "keys." A different color push-button (black) was used for the "power" key (S_1) than for the "tone" keys (S_2 to S_7 ;—red push-buttons were used here). Six notes were provided, plus a continuously variable control (R_1).

The prospective builder may use any arrangement of keys and case which he feels is desirable. An ingenious technician should have no difficulty in modifying the keys of a toy piano to serve as switches for the "electric organ," assembling the rest of the components within the case of the piano. If space permits, the loudspeaker could be mounted within the toy piano case, otherwise it could be mounted separately (a sloping panel meter case makes an excellent "baffle" for a 2" or 3" speaker).

If preferred, a 5", 6", 8" or larger speaker may be used in place of the 3" speaker used by the author.

The transformer used by the author is of the "universal replacement" type with a multi-tapped secondary winding. If the builder uses a similar transformer, he should experiment with loudspeaker connections to the different taps, choosing the pair giving the best results.

Although only six "keys" (and hence six notes) are provided in the model shown, any number of keys may be used, simply by adding more switches and different value resistors. Thus, if a child's toy piano is used as the basic unit, a different note can be supplied by every key on the board.

Since the frequency (tone) of the note obtained as each key is depressed depends not only on the size of the "base return" resistor (R_1 to R_6) but also on the individual characteristics of the transistor and transformer used, there is no simple way of determining the size of these resistors in advance. Rather, they are determined experimentally after the unit is wired and tested.

Two methods may be employed for choosing these resistors. If the com-

pleted unit is to be used primarily as a toy, the resistor values may be chosen arbitrarily without regard to the notes obtained. This method was used in the author's model. A series of resistors having values of 150,000, 170,000, 190,000, 210,000, and 260,000 ohms were used.

On the other hand, if the builder intends to use the completed unit to play actual tunes, each key should be adjusted to give the desired musical note. This can be done either by using a potentiometer to determine the proper resistor value, later permanently installing a fixed resistor, or by using a rheostat for each resistor. The second method is the more flexible as it permits readjustment at any time, but is also the more expensive, requiring a separate potentiometer for each note to be sounded.

(Note: For the frequency of various musical notes, refer to "Fun with a Home-Built Electronic Organ," by Jim Kirk, RADIO & TELEVISION NEWS, March 1953.)

The continuously variable control was included in the author's model more as a novelty than for any serious purpose. However, it does permit unusual tonal effects to be obtained, and may be either retained or omitted, as desired by the builder. Some builders may even wish to provide several such controls.

Operation

In the author's model a separate power switch, as such, has not been provided. Rather, the power switch (S_1) becomes one of the "playing keys."

To sound a particular note, the desired "tone key" (S_2 to S_7) and the "power key" (S_1) are depressed simultaneously. They are held down long enough to sound the desired interval (quarter note, half note, full note, etc.) and then released together.

Either one finger of each hand may be used, in approved "hunt and peck" typewriter style, or the fingers of both hands may be employed to cover all the operating "keys." The latter tech-

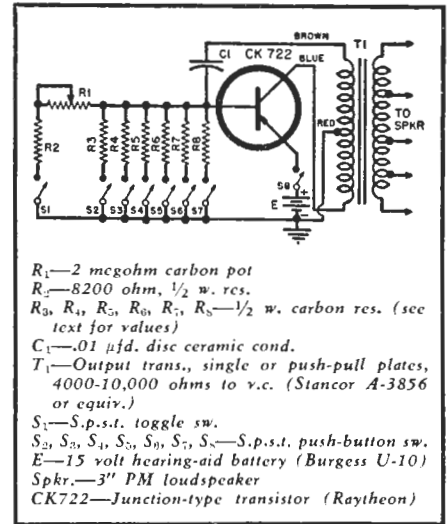

Fig. 2. Schematic of transistor "organ."

nique requires considerably more practice to be used successfully than the former.

To use the continuously variable control, the toggle switch (S_1) is thrown. One note at a time may be sounded by rotating the knob (on the side of the case in the author's model) to the desired position, then depressing and releasing the "power key." If a continually changing note is desired, the "power key" is held down while the control knob is rotated back and forth. Quite eerie effects can be obtained by doing this.

Since depressing more than one "tone key" at a time essentially connects two or more resistors in parallel, considerable change in resistance, and hence in the frequency of the note sounded, results. This enables the operator to achieve unusual tonal effects by depressing two, three, or more of the "tone keys" simultaneously. Other effects may be obtained by using the continuously variable control in conjunction with the individual "tone keys" (by throwing toggle switch S_1 and then depressing a "tone key" and the "power key" simultaneously).

—30—

Fig. 3. Internal view of unit. The "organ" is housed in a standard instrument cabinet.

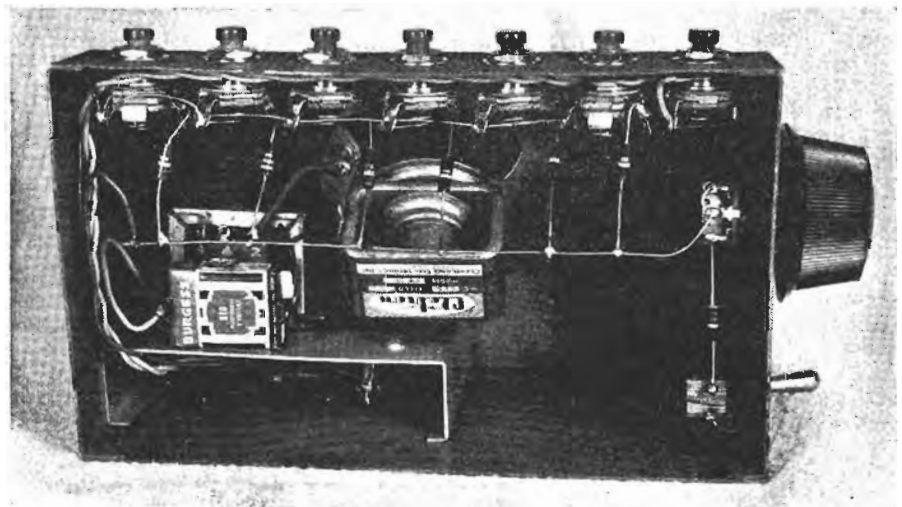

A TRANSISTOR SINE-WAVE CLIPPER

By

LOUIS E. GARNER, JR.

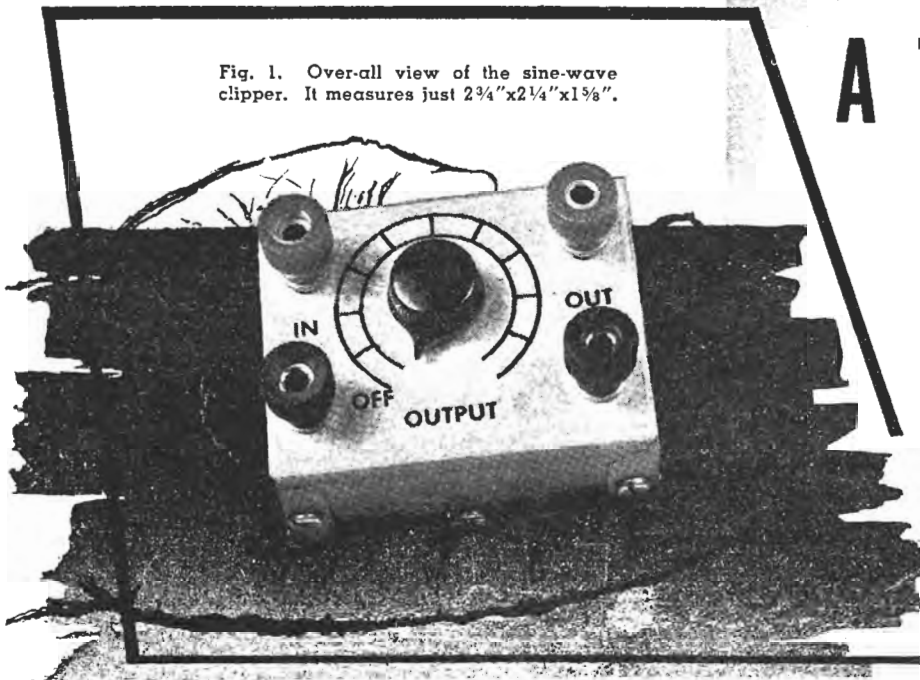

Fig. 1. Over-all view of the sine-wave clipper. It measures just 2 3/4" x 2 1/4" x 1 5/8".

This useful test accessory can be used alone or built into an existing audio oscillator. It is compact and reliable.

THE instrument shown in Fig. 1, although small enough to be held comfortably in the palm of the hand, is, nonetheless, capable of producing good quality rectangular signal waves when driven by a sine-wave signal of moderate amplitude. A further feature of the instrument is that the level of the output signal can be easily controlled, from zero to an amplitude several times greater than the input signal. The instrument is completely self-contained! No external power source or batteries are required for its operation.

These features have been made possible in the compact instrument shown by utilizing the new Raytheon CK722 junction ("p-n-p") transistor in a clipper circuit requiring a minimum of additional components. This is apparent from the interior view, Fig. 5, and from the schematic diagram, Fig. 2.

Circuit Description

Referring to the schematic diagram of Fig. 2, the CK722 transistor has been connected in a conventional grounded emitter amplifier circuit, but

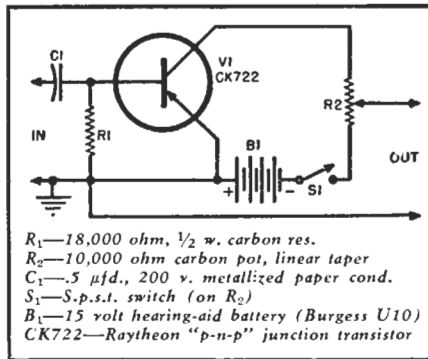

Fig. 2. Complete schematic of the sine-wave clipper. CK722 "p-n-p" transistors are used.

without "bias" voltage between the base and emitter. C_1 serves as the input d.c. blocking condenser, R_1 as the input resistor, R_2 as the load resistor, and battery B_1 as the power source.

When a transistor amplifier is operated without "bias," and a sine wave is applied to its input, the output consists of a series of fairly narrow rounded pulses. This effect has been noted previously (see "The Transistor in Simple Circuits" by W. H.

Minor, December, 1952, *Radio-Electronic Engineering* Edition of *RADIO & TELEVISION NEWS*). The appearance of the output signal when a 10 kc. sine-wave signal of low amplitude is applied to the input of the circuit is shown in Fig. 4D.

As the amplitude of the input signal is increased, the top of the pulse is clipped, and a rectangular waveform is obtained, as shown in Figs. 4A, B, and C. The frequency of the sine-wave signals used to obtain these patterns are, respectively, 45 cps, 5 kc., and 25 kc.

Peak clipping occurs because the peak collector current reaches the maximum possible with the load resistor and voltage source used and, therefore, no further increase in current flow is possible. This was demonstrated in the circuit shown by measuring the peak-to-peak signal across load resistor R_2 . The measured value was approximately 15 volts, or equal to the supply voltage.

With the circuit shown, clipping occurs when the input signal is between three and five volts. A good output waveform is obtained over the entire audio range from 30 cps to 30 kc. as long as the input signal level is maintained. In addition, the output waveform remains of constant amplitude regardless of minor variations in input as long as sufficient signal is supplied to maintain the clipping action.

The output waveform is also relatively unaffected by the setting of the output control, R_2 , except as far as amplitude is concerned, due to the low value of this potentiometer. An output "blocking condenser" has not been included in the model.

In order to prevent even a minute current flow when the unit is not in use, a switch has been provided in the collector circuit (S_1) and is mounted on control R_2 . When in use, the current drain averages only a fraction of a milliampere (the peak is about 1.5 ma. drain) and, therefore, the battery life

Fig. 3. Basic instrument set-up for making gain measurements with test unit.

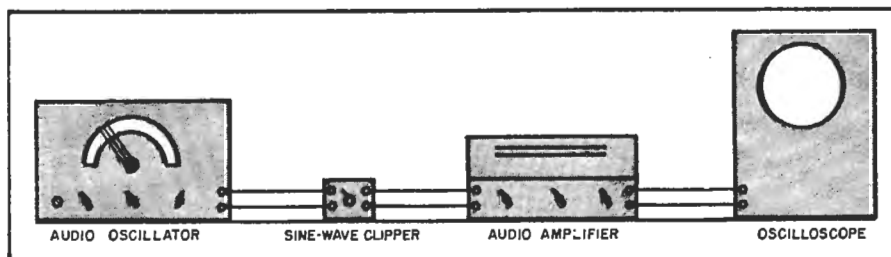

should approach the normal "shelf life."

Construction Hints

The entire circuit is easily assembled in the smallest of the *Bud* "Miniboxes" (CU-3000, 2 $\frac{3}{4}$ "x2 $\frac{1}{4}$ "x1 $\frac{5}{8}$ "") if reasonable care is taken and the components specified in the parts list are used. The use of a *metallized* tubular paper condenser in the input is particularly important as it is virtually impossible to fit a conventional paper condenser of large capacity (.5 μ fd.) into a box of this size and still have room for the remaining components.

Leads should be kept reasonably short and direct to avoid stray capacities to ground with resulting deterioration of the output waveform. This should not prove too difficult as short leads are almost naturally used in a circuit wired as compactly as is shown in the photographs (Figs. 1 and 5).

The arrangement of parts used by the author is apparent from the illustrations, but the reader need not follow this layout exactly. As long as excessively long leads are avoided, the layout is non-critical.

For best results, it is essential that a *carbon* potentiometer be used for R_2 , although a linear taper is not absolutely necessary. If a wirewound pot is used, however, deterioration of the signal waveform at high frequencies (due to residual inductance) is likely.

In the model shown, connections to the battery have been made by soldering leads directly to the battery terminals and wrapping with *Scotch* electrical tape to prevent accidental shorts. The battery is held in place by a simple bracket found in a commercial "hardware assortment."

The "panel" of the instrument has been labeled by using standard black decals and then spraying with clear plastic to provide additional protection.

The transistor has been wired directly into the circuit by its tinned leads. Although there are special sockets available for the CK722, the author feels that their use would only be justified in equipment designed for continuous 24-hour-per-day operation, due to the inherent long life of transistors.

Circuit Modification

The 15 volt hearing aid battery, B_1 , may be replaced by batteries of lower voltage without affecting signal waveform or the action of the circuit—the only difference will be in the amplitude of the output signal. The lower the supply voltage, the lower the maximum output signal. Voltages as low as 3 volts have been tried experimentally without deterioration of output waveform quality.

If a fixed output signal level is preferred to an adjustable output, R_2 may be a fixed carbon resistor, the $\frac{1}{2}$ watt size is satisfactory for use here.

An output d.c. blocking condenser, similar to C_1 , but connected between the circuit output and the output

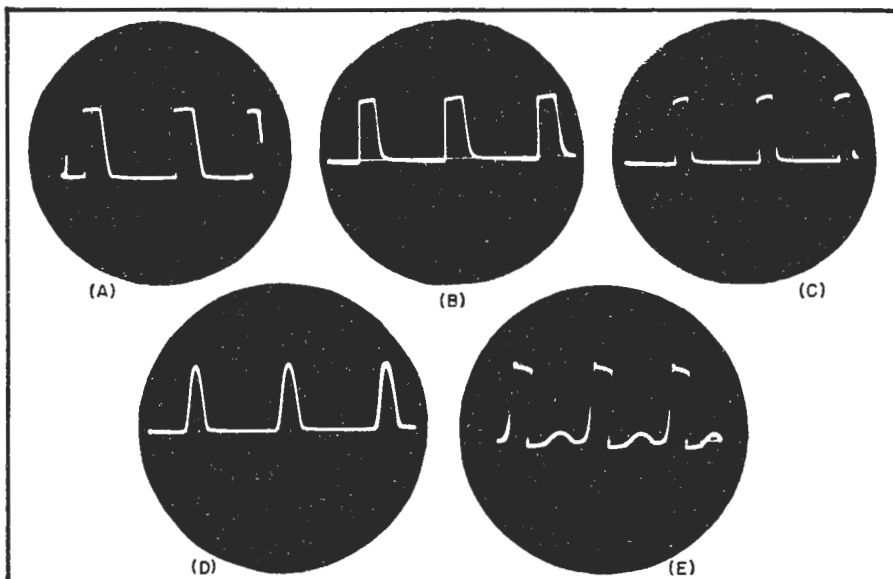

Fig. 4. Waveforms from clipper. (A) 45 cps. (B) 5 kc. (C) 25 kc. (D) Output when 10 kc. sine-wave signal of low amplitude is applied. (E) Overdriven unit.

terminal or binding post, may be used if desired, and will make it unnecessary to check for a blocking condenser in the circuit to which the clipper is connected for test purposes (or to use an external blocking condenser).

The switch on the output control may be replaced by any suitable s.p.s.t. switch—a toggle, lever, rotary, or slide switch may be used.

If both input and output blocking condensers are used, and a battery of larger size than the one given in the parts list used, it may be necessary to assemble the unit in a larger container. The next largest size *Bud* "Minibox" should be suitable unless regular paper condensers and an extremely large battery are employed.

Where preferred, the circuit may be assembled as part of an existing audio oscillator rather than as a separate accessory. If this alternative is adopted, a switch should be provided so that a choice of either "Sine" or "Rectangular" waves may be made by the operator, or separate output terminals should be provided so that both sine and rectangular waves are available on the front panel simultaneously.

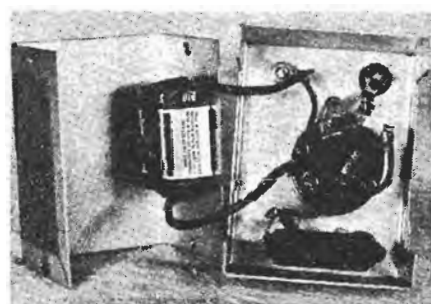
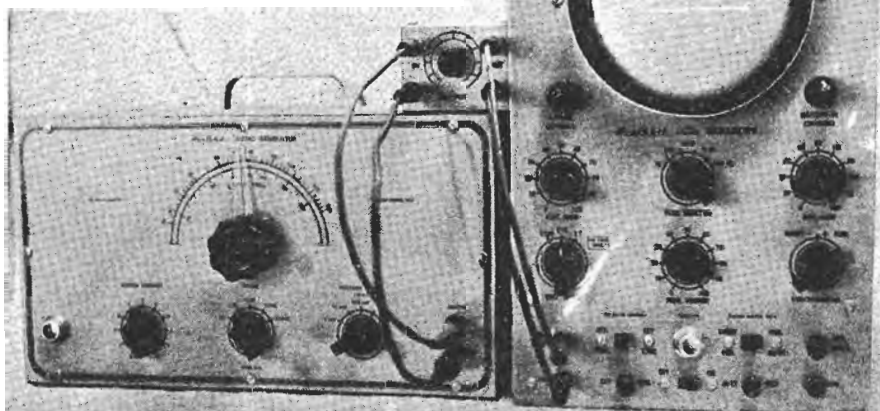

Fig. 5. Internal view of clipper. All hook-up leads should be kept as short as possible.

Operation: Once the wiring is completed, the builder should become familiar with the basic operation of the clipper before attempting to use it in practical test and experimental work. The best way to do this is to connect the output terminals of the clipper to the "Vertical Input" terminals of an oscilloscope. An audio sine-
(Continued on page 101)

Fig. 6. Sine-wave clipper used in conjunction with audio generator and scope. See text.



TWO TRANSISTORIZED METAL LOCATORS

By EDWIN BOHR

Two lightweight units—one small and one large—feature stable oscillators, simple construction and low cost

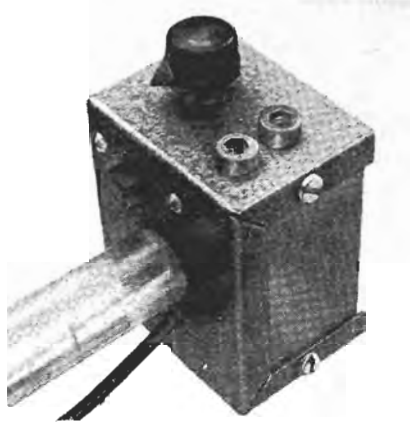

Chassis of the small metal locator.

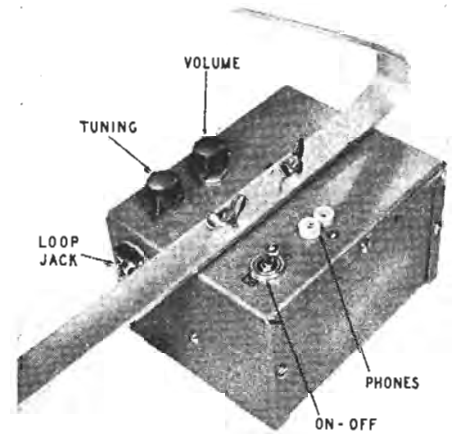

Chassis of the large metal detector.

THESE two metal locators are built with the available low-cost transistors. The larger locator contains four CK722 transistors, the smaller unit two.

Each locator, although the two circuits are very much alike, serves a different purpose. The smaller locator is suitable for finding small objects, such as plastered-over conduit boxes; the larger locator is designed to detect larger masses of metal at greater depth.

As metal locators go, both units are small; in fact, the smaller one is truly miniature and, complete with batteries, weighs only 8½ ounces. As shown in the photos, each locator can be carried with one hand.

Both transistorized r.f. and audio circuits are used. The oscillators are extremely stable, using a separate-battery bias form of resistance stabilization. Battery life is long and standard easily obtained components are used throughout.

Circuit description

Small circulating eddy currents are

generated in metals placed in a radio-frequency field. These currents oppose the back e.m.f. of the coil producing the field, lowering its inductance. If the coil is part of an oscillator circuit, the frequency of oscillation is *increased* as metals are approached.

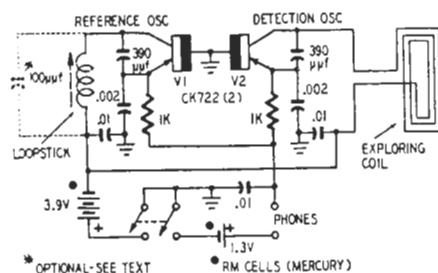

Fig. 1—The transistorized metal detector uses two beat-frequency oscillators.

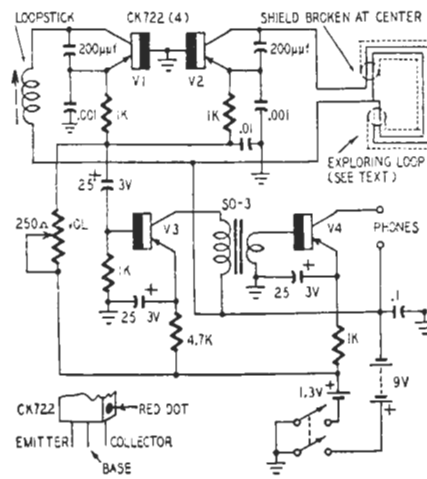

Fig. 2—Schematic of metal detector using additional two-stage amplifier.

Parts for small metal locator

Capacitors: 2—390 µf, tubular ceramic; 2—.002 µf, disc ceramic; 3—.01 µf, metalized paper (Aerovox P83Z).

Miscellaneous: 2—CK722 transistors; 2—5-prong hearing-aid tube sockets; 2—1,000-ohm ½-watt resistors; 1—adjustable Ferri-Loopstick; 1—broadcast-band loop antenna; 4—mercury cells (Mallory RM625RT); 1—d.p.s.t. switch; 1—aluminum case, 1½ x 2½ x 2¾ inches; 1—knob; 2—pin jacks; 1—Lucite rod, ¾-inch diameter, 9 inches long; 1—sheet Lucite.

Parts for large metal locator

Resistors: 4—1,000 ohms, 1—4,700 ohms; 1—250 ohms, variable (IRC Q11-201).

Capacitors: 2—200 µf, ceramic or mica; 2—.001 µf, ceramic or mica; 1—.01 µf, paper; 1—.01 µf, paper; 3—25 µf, 3 volts, electrolytic.

Miscellaneous: 4—CK722 transistors; 4—5-pin hearing-aid tube sockets; 2—4.5-volt BC batteries (RCA V50-28); 1—mercury cell (Mallory RM-401R); 1—adjustable Vari-Loopstick; 1—audio interstage transformer, plate-to-line 50:1 impedance ratio (UTC SO-3, SSO-3 or equivalent); 1—d.p.s.t. switch; 2—pin jacks; 1—3 x 4 x 5-inch aluminum box; 1—2-foot length of RG-58A/U (50 ohms) coaxial cable; 1—length of litz wire (see text); 1—phono plug and jack; 1—length of ¼-inch diameter copper tubing; 1—length of ¾ x 1/8-inch aluminum; 1—insulating board; 2—knobs.

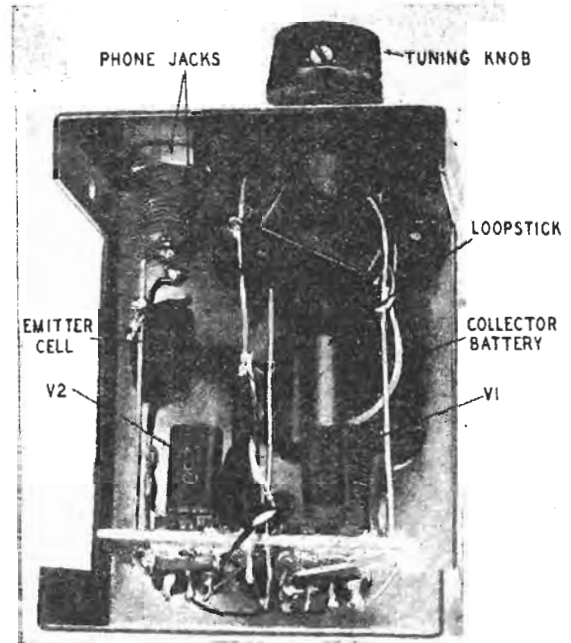
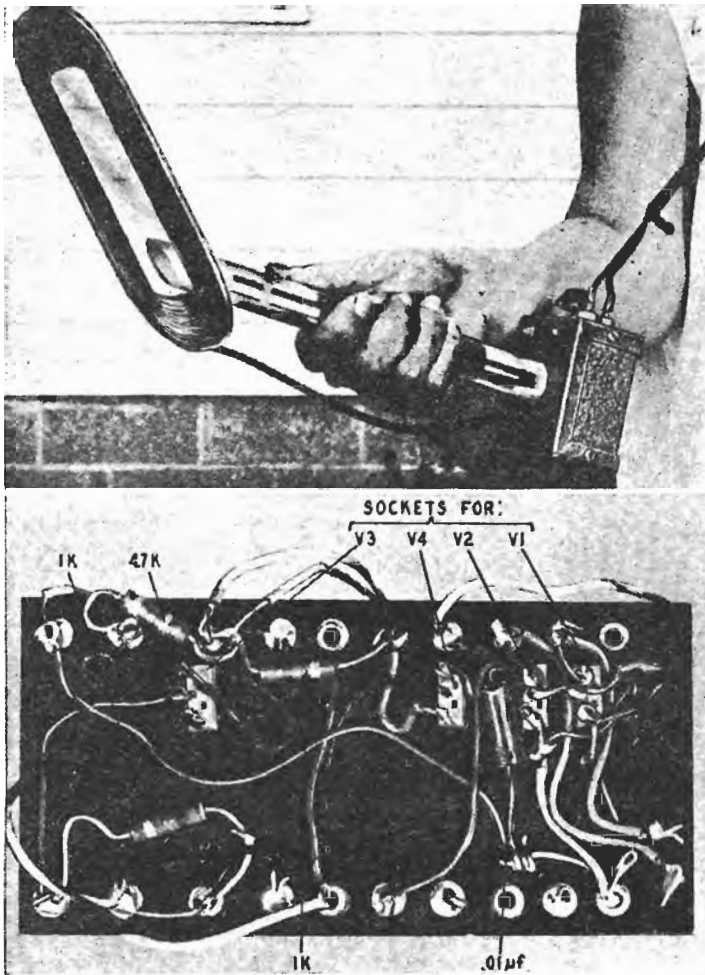

Underchassis view of the small metal locator, showing major components. Photo at upper left illustrates carrying and operating positions of small locator. Photo at lower left shows underside of mounting board in large model.

Of several ways for detecting metals, this *inductance change* method is the most simple and requires very little in the way of complicated circuits.

The change in inductance must be translated into some sort of signal that can be detected by the human mechanism. This might seem difficult, since the change in inductance is small. But, the problem is easily solved by beating two oscillators, producing an audible indication.

The two oscillators, in Fig. 1, are labeled REFERENCE and DETECTION. The reference oscillator operates at a fixed frequency, adjustable by an iron core. However, the detection oscillator changes frequency when the exploring coil comes near metals. The oscillators are coupled to headphones where their outputs combine to form a different beat. The locator in Fig. 2 has an additional two-stage amplifier between the oscillators and the headphones. This requires very stable oscillators.

Two features increase the stability of the transistorized circuit. First, the oscillators are similar electrically. Thus, their drift rates are similar—the beat note change is not so pronounced if there is a shift in the oscillator frequencies. Second, the separate-battery bias stabilization reduces—as much as possible—the drift troubles produced by

the transistors.

Why bias stabilization is necessary may not be too clear. The problem is unique with the transistor and very interesting. To clear up the picture, special characteristics of semiconductors must be known.

Stabilization

Germanium diodes and transistors do not perform well at high temperatures. Neither should allow current to flow in the reverse direction; but they do, and that is a fact we have to live with. The amount of back current increases with junction temperature and, in the case of transistors at a given temperature, may vary from one unit to the next by a factor of 10.

Because there is resistance within the transistor base, part of the back current takes a path to ground through the emitter, generating positive emitter bias. The "hole" current thus generated causes a further increase in collector current. The resistance within the transistor base, alone, causes instability. But, many of the published circuits add fuel to the fire by placing large biasing resistances (perhaps a megohm) in the base circuit.

With very high performance tran-

sistors, high resistance in the base can cause this temperature plus back current plus bias effect to become cumulative and destroy the transistor. For standard-gain transistors, however, resistance in the base usually does not produce anything as drastic. But, it does result in a circuit undesirably sensitive to transistor variations and temperature changes.

Stabilization is obtained by putting as much resistance as possible in the emitter circuit and as little as possible in the base circuit. One way to do this is to place a voltage divider across the collector supply. The base is then returned to the divider, and enough resistance inserted in the emitter circuit to bring the bias current to the correct value.

A better way, and the one used in the locator, returns the base directly to ground. The bias, then, is supplied by a separate emitter battery and resistor.

The small locator

A capacitance type dividing network across the tuning coil provides the feedback and proper impedance match between the collector and emitter. There is a further advantage in that a simple two-terminal coil, without taps or tickler

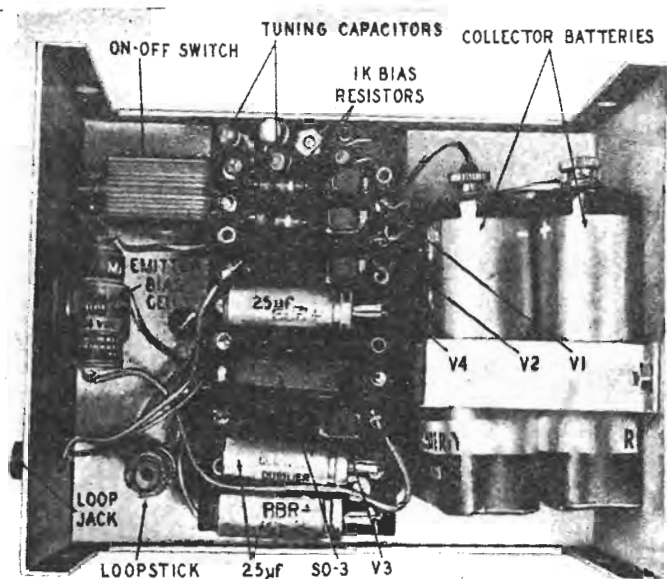

Underchassis of the oscillator—amplifier model.

winding, can be used. The value of the capacitor for the emitter tap in Fig. 1 (.002 μ f) may seem extremely large by vacuum-tube standards, but it is correct for the low emitter impedance of the transistor.

Positive emitter bias flows through the headphones and the 1,000-ohm emitter resistances. This current is necessary to start the transistors into oscillation. After the oscillations have begun, the emitters are self-biased, class C.

The values of the components are rather delicately balanced. For example, two .01- μ f capacitors bypass the collector supply. More capacitance than this will reduce pulling between the oscillators, but will also reduce the loudness of the beat note. Less capacitance produces severe pulling. If the headphones have too much internal resistance, the oscillators will not start. The headphone resistance should be limited to 1,000 ohms. For higher resistances an extra

emitter bias cell, connected in series, could be used, but the oscillators may lock together more readily.

The oscillators operate at about 500 kc. Most transistors will operate to this frequency with 4 volts of collector supply. The *poorest* transistor tested in the circuit was able to make it to 600 kc before it quit oscillating.

Also, at this frequency an ordinary radio can be used to check the locator. And the frequency is low enough for the locator coil to be used without a Faraday shield being absolutely necessary.

Small locator construction

The exploring coil for Fig. 1 is an ordinary loop antenna salvaged from an abandoned portable radio. The loop is cemented, with polystyrene coil dope, to a Lucite panel.

Saw off one end of a 9-inch length of Lucite rod, at a 60° angle, and weld it to the Lucite loop panel. A 75% ethylene dichloride, 25% acetic acid solution is excellent for welding plastic surfaces. Cover each surface with the solution and press them together, pushing out all air bubbles. The resulting weld will be almost as strong as the plastic material.

Tap the other end of the rod for two 6-32 screws, which mount the aluminum case. The switch, coil, and headphone jacks are mounted on the case. The transistor chassis and other parts are mounted by support leads to these three components.

The transistor chassis is a section of plastic from the lid of a small radio-hardware assortment box. Rectangular holes for hearing-aid sockets are made with the end of an instant-heat soldering iron. While the plastic is still warm and soft, the sockets are pushed into place. Support and connection wires to the chassis are treated in the same way. The wire is heated and pushed through the chassis.

Mercury cells, type RM625RT, power the locator. Because of their long life, they are wired into the circuit. Three cells are wired in series to form the collector battery. The tab is bent upward at a right angle, near its tip, and soldered to the side of the next cell. Tin each surface first, and be quick with the soldering iron. The cell is small and quickly becomes overheated, with possible damage from an internal short.

After the cells are soldered together, give them several coats of TV corona dope for insulation. A small piece of cloth, pressed into the wet dope, improves the insulation.

To fit a knob to the variable loopstick, wind a single piece of solid hookup wire, in two layers, near the end of the adjusting screw. The solder is then flowed into the wire and screw for a solid mass.

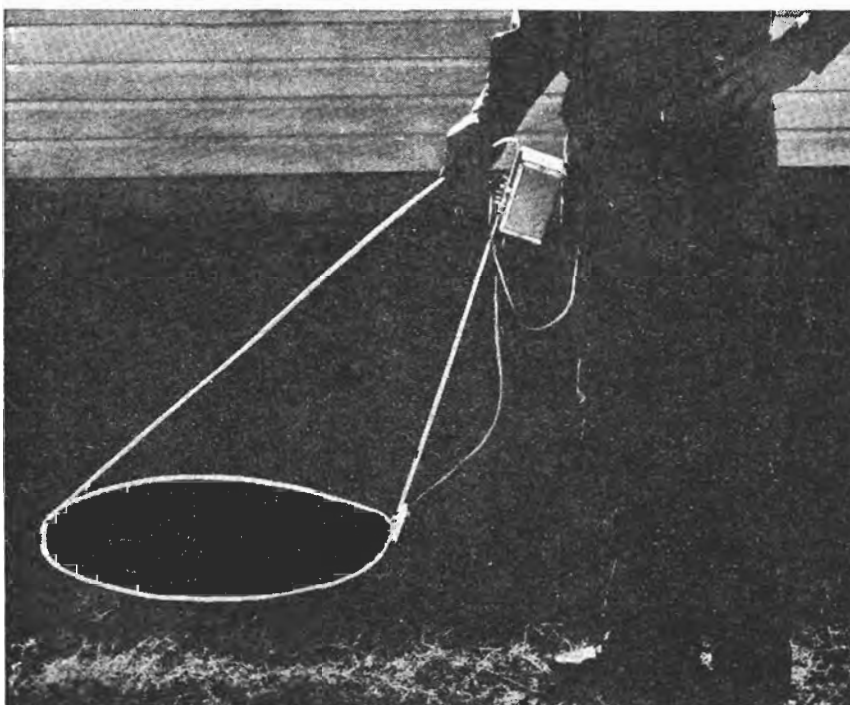

Large metal detector in operation. Low weight increases its portability.

The two leads from the loop run through flexible spaghetti into the case.

Small locator operation

Turn on the power switch and rotate the tuning knob until an audio signal is heard in the phones. If no audio signal is detected, either or both of the oscillators are not operating; or, they are too far out of tune to be brought to zero beat.

A few tests will indicate what is happening. Short out the earphone terminals and bring the locator near a radio tuned to the low end of the broadcast band. At some point on the radio dial a strong carrier from the detection oscillator should be received. The reference oscillator should also be received, but it will be weaker. It can be identified since its frequency changes when the locator tuning knob is turned.

If the loopstick can not bring the reference oscillator to the same frequency as the detector oscillator, it may be necessary to add capacitance across either the loop or loopstick. I had to add a 100- μ f mica capacitor across the loopstick. It can be seen in the photograph.

Plug the phones in again. This may shift the frequency slightly, but the oscillators should continue to work. If they do not, the headphone resistance is too high. I used a single phone and had no trouble. If high-resistance phones must be used, short out the regular headphone terminals and connect the phones in series with the collector battery. An alternative is to use an additional emitter bias cell. But, to repeat, the oscillator should give no trouble with 1,000 ohms in the headphone circuit.

Best performance is attained with the reference oscillator tuned to the lowest possible beat note, just before the oscillators lock together. When the exploring coil comes near metals, the pitch will rise. The reference oscillator can be set for a constant high pitch note that goes down to zero beat as metal is approached, but the sensitivity is less.

The operator must practice with the locator until the "feel" of operation is acquired. Practice first with objects that can be seen.

Maximum range for the locator is about a foot in the case of relatively large-surfaced metals. The boundaries of large objects are easily determined within an inch at a distance of 6 inches. Retune the beat note to its lowest value each time the object is approached closer; otherwise, the note will be too high for the ear to easily distinguish small pitch variations.

Large locator

The larger locator varies in several respects with the smaller locator. The oscillator frequency is 1 mc and the search coil is electrostatically shielded and of much larger diameter. Also, a two-stage a.f. amplifier is included. These modifications to the r.f. circuits tend to increase the range of the locator. Larger search coils spread out the magnetic lines of force (the range varies roughly as the radius of the coil) and the higher operating frequency gives an increased frequency change for a given inductance change of the search coil.

When a coil approaches a large mass of metal, the eddy currents tend to reduce the inductance of the coil and increase the oscillation frequency. But, the increased circuit capacitance, caused by the nearness of the metal, tends to reduce the frequency. (The capacitance effect is more pronounced at higher frequencies.) This opposing capacitance effect is removed by shielding the coil with an open loop of copper or aluminum tubing called a Faraday shield.

Without the shield—because of the increased capacitance—the beat note goes down as nonmetals are approached. The shield almost completely eliminates this and the locator responds only to metals.

Large locator construction

Assemble the locator circuit on a strip of insulating board. Use a No. 26 drill to cut out holes for the transistor sockets. Just drill two of these holes side by side and square them to fit, with a small file. The SO-3 transformer is held down with a solid wire harness that is pulled through and soldered to the terminal board eyelets.

Take care in soldering to the negative center pole of the mercury cell. It is more delicate than the cell used in the small locator, since it has no metal tab. Check the cell with a voltmeter after the leads have been soldered.

The entire loop-and-handle assembly is detachable. Wing nuts hold the handle to the locator box and a small phonograph jack is used as a disconnect to the loop coil. Both leads to the coil are above ground. Thus, the jack must not be mounted directly to the box. Cut out a plastic washer and place it between the outside of the box and the jack. The connecting cable to the loop consists of a small length of coax. The coax shield should be used as the coil lead to the collector batteries.

A 2-foot loop of $\frac{1}{4}$ -inch copper tubing

encloses the exploring coil. This tubing is grounded at its midpoint to the aluminum handle. The two free ends of the tube are left floating electrically and clamped mechanically to a Lucite insulating block. If the loop ends were brought together, they would form a shorted turn in the r.f. field.

The coil is made by pulling six strands of wire through the tubing. The ends are then soldered together to form a single six-turn loop. I used litz wire (Belden 8817), but almost any small size wire will do.

Other size coils can be built by winding 38 feet of wire into the loop. For this length of wire the smaller loops will have larger inductance, but this can be adjusted by decreasing the tuning capacitance slightly. Use the same methods of checking the oscillators as outlined for the smaller locator.

Try all four transistors in the oscillator circuits. The most active transistor should be used in the detection oscillator, the second most active in the reference oscillator, and the other two in the audio amplifiers. If there is any trouble in obtaining oscillation (if none of the transistors have good r.f. characteristics), the collector supply can be increased to 15 volts.

The small-locator operating procedure is used with the larger locator, with one exception. The variable 250-ohm resistor can be used as a combination volume control and fine frequency adjustment. The bias current varies the collector capacitance, changing the oscillator frequency. There is plenty of audio gain and power output—enough for the signal to be heard with the headphones hanging about the operator's neck. The range of detection is around 3 feet.

Metal locators in many ways are very limited. They do not tell what has been detected or located, how deep it lies, or very much about its exact size—if it is very small or deeply buried. Most metal-locator operators are surprised at first by the amount of trash material that has been dug up before they find the item in which they are interested. The locator has gloved feeling, but it certainly does not have eyes.

To go beyond 3 feet in detection depth will require different techniques and more elaborate equipment. A few of these have been outlined in the *Handbook of Industrial Electronic Circuits* (McGraw-Hill). END

Front view of the relay. The variable bias control is seen on the left side.

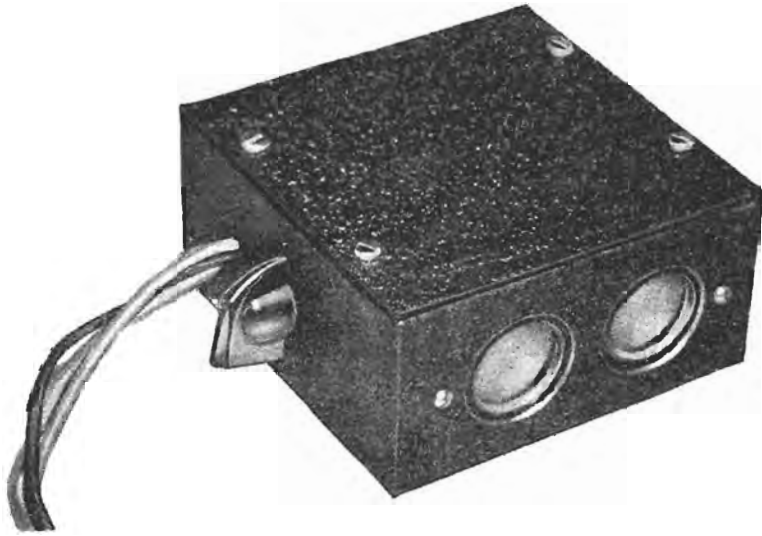

*A novel approach
for eliminating
the sponsor's message*

The killer in normal position under the TV set. Switch is on right side.



TRANSISTORIZED COMMERCIAL KILLER

By HAROLD REED

EXPERIMENTERS often use transistors in many applications, which although neither practical nor profitable on a commercial basis, prove interesting and satisfying to the hobbyist. These experimental applications contribute to familiarization and greater knowledge of transistor theory and circuitry. One such application is the transistorized commercial killer described in this article.

The unit is essentially a transistorized photoelectric relay that opens or short-circuits the voice-coil leads to the TV receiver's speaker. When the unit is connected and operating, I no longer have to get up and turn down the volume during commercials or when the phone rings. I simply turn on a small table lamp beside my favorite chair and the relay does the rest. I glance at the screen occasionally while the set is silenced to ascertain when the commercial is over.

The commercial killer can be used also with a radio receiver but the listener is at a disadvantage because he has no indication when the undesired part of the program has ended. In this application, however, the relay may be used to connect a resistor across the speaker voice coil to reduce the volume to a level where the program is barely audible when the table lamp is on.

This photoelectric relay (see Fig. 1) is built around the Raytheon CK722 p-n-p junction transistor connected in a grounded-emitter circuit. Two self-generating photocells are wired in series and connected between the base and emitter of the CK722. A sensitive relay is connected in the output, or collector circuit, along with a 50,000-ohm variable control for adjusting the negative voltage to the collector. All component parts are mounted in a 4 x 4 x 2-inch metal box with room to spare.

Construction

There is no critical arrangement in the mounting of the parts of the unit, except of course that the photocells be in proper position to allow light to strike the active surfaces. The relay, a surplus BK-7-B, has an adjustable slider and scale for adjusting its sensitivity. With the sliding arm at zero on the scale, the relay operates with a current flow of 100 μ a at 0.4 volt. The switch disconnects the battery and also prevents base-current flow which would occur when light strikes the active surface of the photocells.

The photocells are mounted on a strip of bakelite in which holes were cut, the exact diameter of the active portion of the cell surfaces. A larger cut, equivalent to the over-all diameter of the cell, is made halfway (counter-

sunk) through the back of the bakelite, allowing the cell to be recessed into the back of the strip. There is a small metallic ring deposit at the outer edge of the cell plate. I placed a strip of tinfoil under this ring and fastened it to a lug for the negative connection of the cell. Each plate and tinfoil is then held in place by the pressure from a spring leaf of a discarded phone jack or switch, which also provides contact with the back or positive connection of the cell, as shown in Fig. 2. Observe polarity and take care to prevent shorting between the tinfoil and positive coating on the back and edges of the plate.

After wiring the unit as in Fig. 1, experiment to obtain positive relay action when the control light source strikes the photocells. Several variable factors must be considered: the setting of the relay slider arm, the battery voltage applied through the variable control, the ambient room illumination, and the distance between the photo-relay and the table lamp.

The following operating characteristics were obtained with the unit described here: With a 25-watt lamp in the corner of the room 15 feet from the TV set (this lamp is normally turned on during a TV program), the collector voltage is adjusted to minus 12 and the relay sensitivity control

set to 13 on the scale. Collector current is 560 μ a and the base current is 4 μ a. The relay is not energized.

The controlling light source is a table lamp with a 100-watt bulb, 10 feet from the TV set. When this lamp is on, the base current drops to 3 μ a and the collector current increases to 575 μ a. This operates the relay and short-circuits or opens the speaker voice-coil leads. At 5 feet, the device can be operated with just one photocell. Also, using the two cells, a 75-watt lamp gives satisfactory operation at 5 feet. With less illumination and for

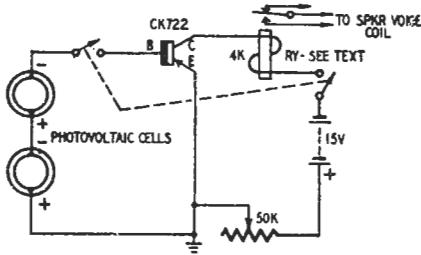

Fig. 1—The transistorized photoelectric relay used in commercial killer. greater distances, more than 2 of these inexpensive cells could be used in series. Sensitivity could also be increased by using a larger photocell plate or Raytheon's CK721 transistor, which has a current amplification of

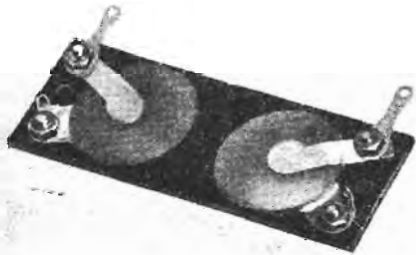

Fig. 2—Rear view of photocells counter-sunk into the bakelite mounting strip.

40. However, the cost will increase considerably.

A miniature radio tube could be made to function in this device, but the great advantage of the transistor in this application is its ability to operate without filament or plate voltages which would require a power supply

Parts for commercial killer

Miscellaneous: 1—CK722 transistor, 1—15-volt miniature battery (Eveready type 411 or equivalent), 1—50,000-ohm linear potentiometer, 1—d.p.s.t. toggle switch, 1—Cardwell BK-7-B relay, 2—photovoltaic cells (see text).

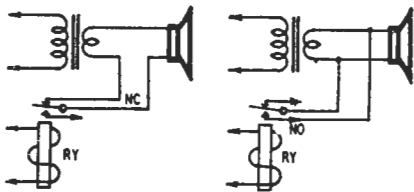

Fig. 3—Connections for opening voice coil at a or shorting it out as at b.

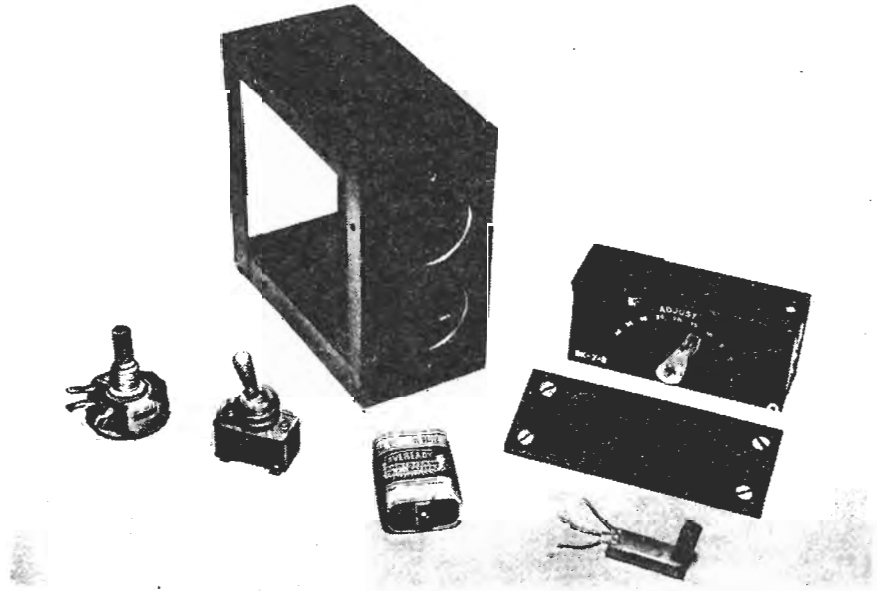

Photo of all parts used in the relay. The transistor, used in other experiments, is cemented to a small plastic block which supports its fragile leads.

or a means of obtaining these voltages from the TV chassis. The unit is small and completely self-contained, with just two wires to be attached to the TV speaker. Fig. 3 shows connections between the relay contacts and the speaker voice coil leads. The life of the small 15-volt battery in this circuit will probably be equivalent to its normal shelf life.

The cost of the unit is minimized by using surplus photocells and relay. I purchased the photocells for 29c each and the relay for \$1.95, from Burstein-Applebee Co., in Kansas City, Missouri. Olson Radio Warehouse, of Akron,

Ohio, has rectangular-shaped selenium cells which give the same output as the round ones used in this instrument. Advance type 850 or Potter and Brumfield series LS-5, 2,500-ohm relays can be used with a CK721 transistor. The components listed in the parts list are the least expensive.

While the immediate purpose of this unit is as a commercial killer, the basic circuit arrangement lends itself to many applications. Making use of the sensitive relay in the collector circuit, this unit can be used to energize or de-energize many types of electrical equipment.

END

Raytheon Transistors are available through all leading parts suppliers.

ELECTRONIC HEADPHONE

*Baby tending and actor cueing
are but two of many uses for this
vest-pocket transistor
receiver and midget transmitter*

By JOHN A. IRWIN and
I. QUEEN

THERE are times when some way of transmitting a radio signal a short distance to a small or inconspicuous receiver may be very useful. The first application that comes to mind is a cueing or prompting device for actors. Such apparatus (which can be very costly) is often used by magicians or "mentalists."

In the home such equipment may be used to hear radio or phonograph music without disturbing other persons in a room. (True, the listener could wear headphones, but they would limit his movements and the long leads would be

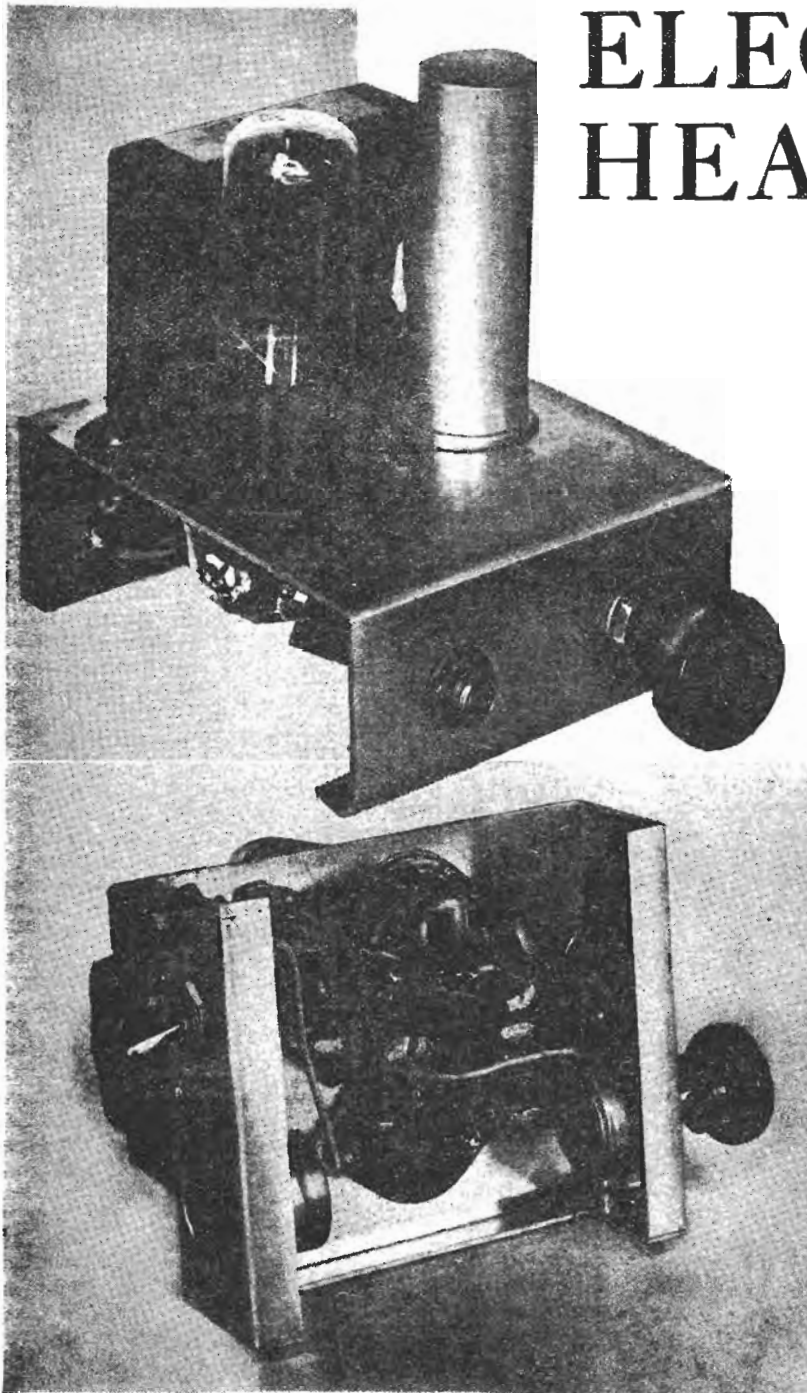

Top, the one-tube transmitter—unit tunes between 1.5 and 1.8 mc. Center, underchassis view of transmitter. A single 117L7 is used. Right, the receiver, containing a single audio frequency stage.

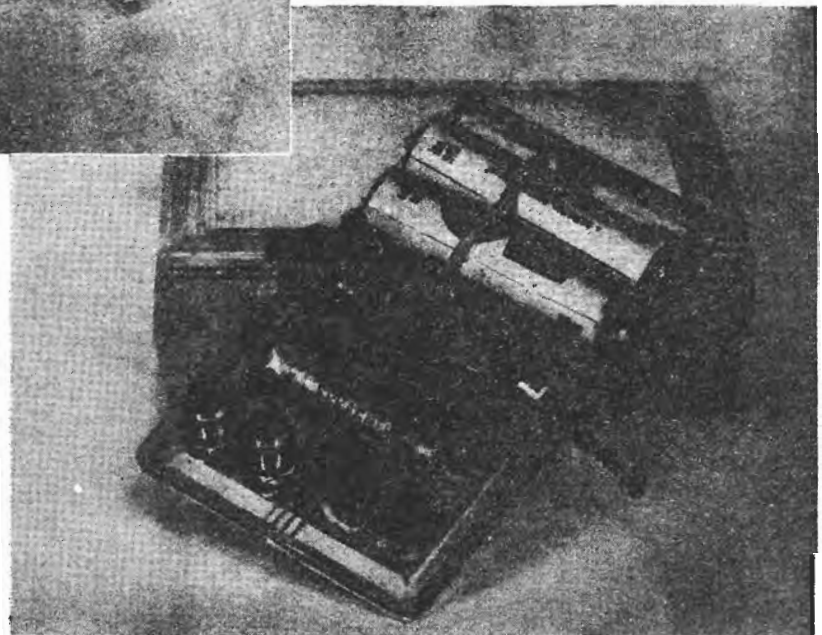

a safety hazard.) In some cases this transmitter-receiver combination might even be used as a radio "nurse," with the advantage that the mother could move from room to room without getting out of the "nurse's" range.

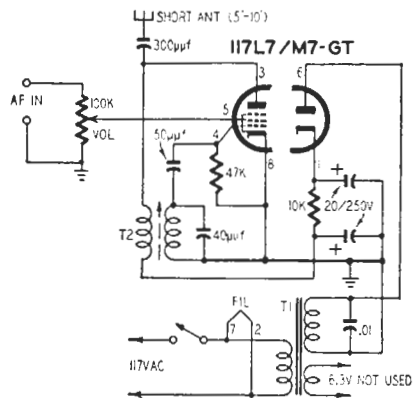

Fig. 1—One-tube transmitter. Isolation transformer reduces shock hazard.

A 117L7 tube (actually called a 117L7/M7-GT) makes a fine oscillator for the transmitting end. Its filament requires 117 volts which may be supplied directly from the line, avoiding the need for a 6.3-volt transformer. This tube has, in one envelope, a diode and a pentode. The diode is used as line rectifier (Fig. 1). The pentode is the oscillator tuned to the high end of the broadcast band or slightly above. The oscillator will work without isolation transformer T1, but its use is definitely recommended. It prevents a shock hazard when the chassis (or any other normally grounded point) is touched. The transformer may be any small unit delivering up to 150 volts at a few milliamperes.

The pentode screen is not returned to B plus as might be expected, but to ground. It is varied about 1 volt above and below ground potential by the modulation input.

Typical modulation sources are: speaker voice coil (working out of a radio, phono, or tape machine amplifier), FM or AM tuner, crystal pickup, high output mike. In any case the signal amplitude should be about 1 volt or more.

The oscillator tunes between 1.5 and 1.8 mc. The iron core of oscillator coil T2 controls the frequency. Adjust it while listening in on a near-by broadcast or all-wave receiver. Any unoccupied channel is recommended. Use as short an antenna as possible for the receiver used. If the antenna is too long, you may create radio interference over a wide area. With a 5-foot antenna on an ordinary home-type radio receiver, you should be able to hear the oscillator signal 20 or 30 feet away.

A simple portable receiver is shown in Fig. 2. It is a crystal set followed by an audio-frequency stage. The detector is a CK707; it was found more efficient than the usual 1N34. The amplifier uses a CK722 junction tran-

sistor, although a CK721 provides still more gain. Two penlight cells power the transistor.

With this receiver, signals are audible several feet from the oscillator. Thus if the "transmitting antenna" is strung across the ceiling of a small room, the signals will be heard over most of it. A small antenna, perhaps a foot or two, may be added at the receiver if necessary. Of course the *Superloop* (at the receiver) should be tuned to the same frequency as the oscillator. Adjust the iron core of the *Superloop* for maximum output.

The receiver uses such tiny components that the chief problem is mounting them. In the photo shown, parts are mounted on a plastic sheet. Leads are passed through small holes drilled in the plastic. Thus the parts are held in place by their own leads. All soldering is done under the plastic sheet. If desired, each part may be held in place with polystyrene cement. When completed, the plastic subchassis is put inside a plastic box to protect it. This may be a cigarette case, for example, which can be carried in a shirt pocket.

The *Superloop* is an antenna coil now available in most radio stores. It has an adjustable iron core. The tap is not used here. The coupling transformer is manufactured by Gramer. It is a tiny unit only 11/32 x 3/8 x 3/8 inch and weighs only a fraction of an ounce.

If your oscillator uses an antenna from 5 to 8 feet long, this receiver will pick up its signals 3 or 4 feet away. With an antenna 15 feet long, the effective range is nearly doubled,

and so on. The length of antenna you

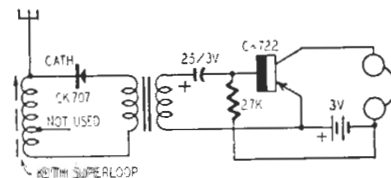

Fig. 2—Schematic of the receiver.

may use depends upon your location. If you live in an apartment house, your antenna must be a very short wire. Otherwise you may hear from your neighbors or even the FCC.

Parts list for transmitter

1—10,000 ohm, 1/2 watt, resistor; 1—100,000-ohm potentiometer; 1—40 µf, 1—50 µf, 1—300 µf, mica, 400 volts, capacitor; 1—.01 µf, paper or ceramic, capacitor; 1—20-20 µf, 250 volts, electrolytic. 1—117L7-GT tube; 1—octal socket; 1—slug-tuned broadcast oscillator transformer; 1—power transformer, 150-volt secondary @ 15 ma (or more); 1—s.p.s.t. switch; 1—phone jack; 1—pin jack.

Parts list for receiver

1—27,000-ohm, 1/2 watt, resistor; 1—25 µf, 3 volts, electrolytic; 1—Keith *Superloop* antenna coil; 1—CK707 crystal; 1—a.f. coupling transformer, 20,000 to 1,000 ohms (Gramer); 1—CK722 transistor and socket; 2—penlight cells; 1—plastic sheet and box; 2—jacks for phones.

If a more powerful receiver is needed, try a superhet tuner. (See "A More Compact Battery Portable," September, 1954, page 90). The speaker and output transformer are not needed here, and one audio stage may be sufficient.

Such a portable set may be built within a space 3 x 3 x 2 inches or less. It will pick up signals from the oscillator up to 20 feet away when a short transmitter antenna is used. END

**Raytheon Transistors are
available through all leading
parts suppliers.**

A transistorized GEIGER COUNTER

By **NATHAN O. SOKAL*** and **IRA L. RESNICK***

TOURIST gets \$10,000 for Uranium claim staked out with Geiger counter." Occasional headlines like this dramatize the fact that many vacationers now carry Geiger counters with them wherever they go.

If you don't plan to go in for modern-style treasure-hunting, this Geiger-Mueller counter (see photo) will at least make a pleasant project good for an evening's education in ionizing radiation physics, Geiger-Mueller tubes, and transistors, all in one fell swoop. And you *might* discover uranium in your own back yard!

Geiger-Mueller tubes

A Geiger-Mueller (G-M) tube¹ is a metal cylinder with a wire running along its axis, as shown in Fig. 1. The tube is filled with gas, and a high-voltage d.c. source, usually about 900 volts, is connected between the cylinder and the wire, the wire being positive. Ordinarily, there is no current flow in the tube.

Ionizing radiation—alpha rays (helium nuclei), beta rays (fast-moving electrons), gamma rays (electromagnetic radiation similar to light, but of much shorter wavelength), or cosmic rays (very fast-moving nuclei of hydrogen or other elements, or their by-products after passing through the atmosphere) — passing through the tube ionizes a gas molecule. The electron knocked out of the gas molecule travels to the center wire, and the now positively charged gas molecule travels more slowly toward the negative cylinder. The moving electron collides with gas molecules along its path, knocking electrons out of these molecules; these electrons in turn knock out others; within a few microseconds an electron "avalanche" has built up. The electrons and ions flowing inside the tube show up as a pulse of current drawn from the high-voltage source. The pulse for a typical G-M tube is shown in Fig. 2.

If an earphone is connected in series with the tube and the voltage source, as in Fig. 3, a faint click will be heard in the earphone each time a current pulse flows. The 1-megohm resistor in Fig. 3 is to limit the current drawn from the battery in case of an accidental short-circuit.

G-M tubes are made from about ½ inch to several feet in length, and with metal or metal-coated glass walls. Depending on the diameter and the gas inside the tube, the operating voltage

The transistorized Geiger counter. Resistor appearing beneath transistor was for experimental purposes and is not required for proper operation.

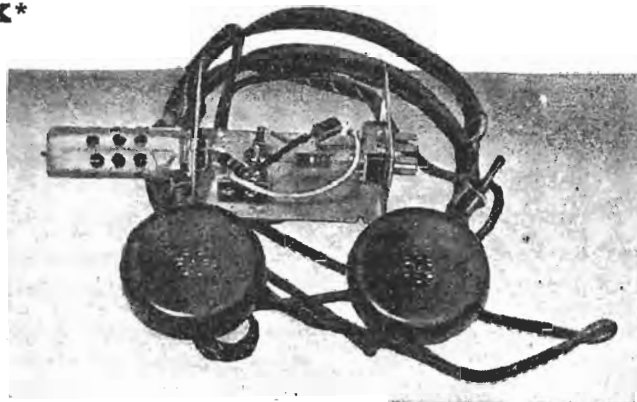

may be from about 300 to 1,200 volts d.c. The price ranges from about \$3 to several hundred dollars, depending on many factors. A good choice out of all these possibilities is the Raytheon CK1026 (used by the authors) which operates at 900 volts and costs \$3.15.

Transistor amplifier

A transistor amplifier can be added to the basic circuit of Fig. 3; the clicks will then be louder, making for easier listening. A circuit using a grounded-emitter amplifier is shown in Fig. 4. In this circuit, the current pulse from the G-M tube is drawn out of the transistor base. A similar pulse, amplified by the transistor, flows through the headphone in the collector circuit. The amount of amplification depends on the characteristics of the particular transistor, and on the pulse rise-time and duration. In the authors' equipment, the amplification was about seven times, using a CK721 transistor.

High-voltage sources

The authors used batteries for their high-voltage source. Three Burgess U200 or Eveready 493 300-volt batteries in series give the 900 volts required for most G-M tubes.

A way to get the 900 volts without so

(continued on page 106)

Parts for Geiger counter

1—CK721 transistor; 1—Raytheon CK1026 tube; 1—chassis, 3¼ x 1¼ x 2½ inches; 1—magnetic headphone set, 2,000 to 20,000 ohms; 3—Burgess U200 or Eveready 493 300-volt batteries. Or, one such battery and two 0.5-µf, 400-volt capacitors plus a 4-pole 2-position switch (Mallory 7242L). If the 1B88 tube is used, only one 300-volt battery is needed, without the capacitors and the switch; 1—6-volt battery; 1—d.p.s.f. switch; 1—7-pin miniature tube socket with tall shield; 1—high-voltage connector plug; 1—1-megohm, ½-watt resistor; 1—pin jack for phones.

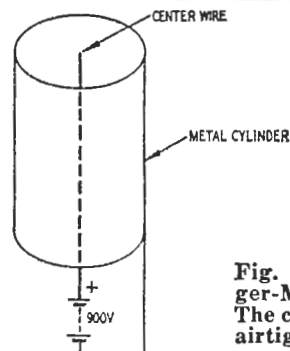

Fig. 1—Basic Geiger-Mueller tube. The cylinder has an airtight seal.

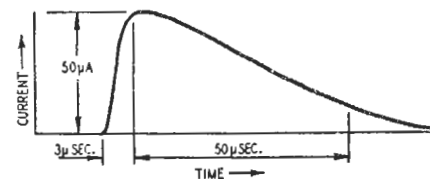

Fig. 2—Typical GM current pulse.

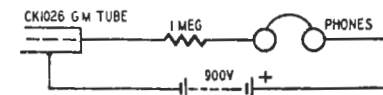

Fig. 3—The basic circuit. The earphones are in series with GM tube.

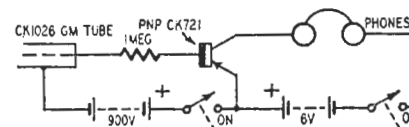

Fig. 4—Grounded-emitter amplifier.

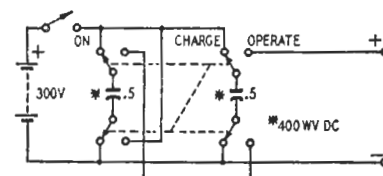

Fig. 5—A possible high-voltage source—using charged capacitors.

*Lincoln Laboratory, M.I.T.

A TRANSISTOR BRIDGE NULL DETECTOR

By LOUIS D. CARCANO

IMPEDANCE bridges and capacitance bridges which employ headphones for null detectors, offer good opportunity for transistorization. A visual null indicator is more convenient than a pair of "cans." Null detector circuits using vacuum tubes, however, are inconvenient because of long warm-up time, and require a separate power supply.

The transistor circuit shown requires no waiting after it is turned on and takes all its power from the 6-volt battery us-

ually included in the impedance bridge.

The circuit consists of two grounded-emitter stages using junction transistors, and a rectifier and a microammeter. Sensitivity is not quite as great as with headphones, but was found to be adequate.

The input impedance is about 20,000 ohms. Ordinary midget output transformers make satisfactory interstage coupling units. Transformer T_2 is tuned to 1000 cycles with a condenser C_2 . The value of C_2 will vary with the particular

model of transformer, but should be around .002 to .005 μ fd.

The second stage should overload just before the meter goes off scale. Overload level depends on the emitter bias current, which is determined by resistor R_2 for any particular battery voltage. R_2 may require adjustment for the particular transistor used. A more sensitive microammeter can be used if R_2 is increased accordingly.

-50-

Circuit of a bridge null detector which uses two CK722 "p-n-p" junction transistors.

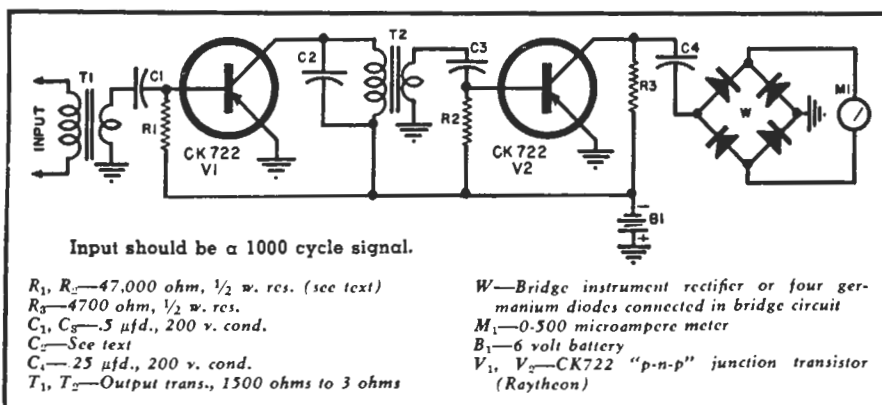

NOISE GENERATOR

The junction type CK722 transistor may be used as a noise generator to provide signals over a wide spectrum (see diagram).

The circuit, a Hartley type, uses a high base resistance and small capacitor. Evidently it superregenerates and sets up sidebands on either side of the carrier. This carrier is determined by the tank coils. In this case I have chosen 900 kc. The tank is slug-tuned and no shunt capacitor is added. On either side of 900 kc numerous sideband signals may be heard. They are spaced approximately 10 kc, and extend to about 200 to 250 kc on either side of the carrier.

In the broadcast band, the individual sidebands may be distinguished from each other. As we tune, one sideband after another comes and goes. On the higher frequencies, the sidebands tend

to merge or blend. For example, signals are heard at 1800 kc, 2700 kc, etc. On each side of these harmonic carriers, the sidebands generate a veritable bed-

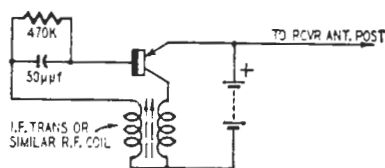

lam. It is like a half-dozen air-raid sirens wailing at once, each with a different pitch. Of course, these tones do not change unless the tuning is varied.

On the shortwave bands, the noise appears at every 900 kc. A tuning meter

shows an increase in noise until a maximum is reached at the harmonic of 900 kc, then there is a gradual decrease down to zero. At any point within this region, there are many simultaneous whistles, and the receiver may be tuned, adjusted, or aligned. No other modulation is needed from the generator.

With a more sluggish transistor, it may not be possible to use a carrier frequency as high as 900 kc. Then the circuit should be set for some lower frequency. Some transistors may also require a higher voltage, but I found that satisfactory results are obtained with as little as 3 volts.

The connection to the emitter seems to be necessary. It may be either a direct connection to the receiver antenna post or a long lead left floating near it.

—I. Queen

Sine-Wave Clipper

(Continued from page 90)

wave generator is connected to the input terminals of the instrument. The set-up used is shown in Fig. 6.

Turn on all the equipment, allow sufficient time for "warm-up" of the scope and generator, then adjust the scope controls until three or four cycles of the signal can be easily observed. The frequency is not too important, and the generator may be set to deliver a sine wave from 30 to 30,000 cps.

Gradually turn "up" the amplitude or output control of the sine-wave generator. The output signal should first appear as shown in Fig. 4D, then the pulse peak should flatten, as the signal level is increased, until a pattern similar to those shown in Figs. 4A, B, and C is obtained. The output of the sine-wave generator should be between 3 and 5 volts when the proper pattern is obtained.

If too much signal is applied, a pattern similar to the one shown in Fig. 4E will be obtained. Under these conditions there is some danger of damaging the transistor.

After the output signal level of the sine-wave generator has been set, the frequency of the generator should be varied and "spot checks" made at different frequencies over the audio range. The scope should be readjusted at each point as may be necessary to obtain a complete and steady pattern of two or three cycles.

In a few instances, it may be found that the output of the sine-wave generator varies sufficiently to require readjustment of its amplitude control to insure complete "clipping" at some frequencies. In such a case, an effort should be made to select a signal level that will insure a good rectangular output signal from the clipper at any frequency, but without distortion at any point (as shown in Fig. 4E). If such a setting of the amplitude control can be found, it will save considerable time when a series of tests is to be made at different frequencies.

Applications: There are three major applications of the output signal obtained from the sine-wave clipper. It may be used for gain measurements, for rapidly checking frequency and transient response characteristics of an amplifier, or as a source of pulse signals. Let us discuss each application separately.

Gain measurements: When proper clipping occurs, the output signal level of the sine-wave clipper remains constant, irrespective of minor variations in the input signal level. Because of this, the output signal is ideally suited for gain measurements at different frequencies.

The basic instrument set-up illustrated in Fig. 3 may be employed. The scope is first used to check the output from the sine-wave clipper so that the sine-wave generator can be ad-

justed to supply sufficient signal for proper clipping. Once this is done, the output control of the sine-wave clipper (R_2 , Fig. 2) is adjusted to deliver the desired input signal to the amplifier.

The input signal amplitude to the amplifier will now remain constant at the predetermined level, even if the frequency of the sine-wave generator is changed (provided, of course, that the signal supplied to the sine-wave clipper by the generator does not drop so low as to prevent proper clipping action. Should this occur, however, it is readily spotted as a change in the waveform of the signal observed on the scope).

Gain measurements now become merely a matter of determining the output signal level. Since the input signal is of known amplitude and unvarying, actual gain is a matter of simple calculation.

Frequency and transient response checks: The rectangular wave signal obtained from the sine-wave clipper may be used in a fashion similar to square waves for rapidly checking the over-all frequency response of an amplifier, attenuator, or filter network (see "Wide Frequency Range Square-Wave Clipper," March, 1950, RADIO & TELEVISION NEWS.)

The high frequency response of a circuit or network is determined by applying a high frequency rectangular wave to its input and observing the output signal waveshape on the screen of an oscilloscope. Poor high frequency response will cause excessive rounding at the peak of the "leading edge" of the sharper rectangular pulse (see Fig. 7). Poor transient response or "ringing" will cause a signal overshoot at this point.

A low frequency signal is used to check the low frequency response of the circuit, but, in this case, the broader "flat top" (again, refer to Fig. 7) is observed. Excessive "tilting" of the flat top indicates phase shift at lower frequencies.

When using the rectangular wave in checking a circuit's response, it must be remembered that the rectangular wave's narrow pulse is representative of a square wave of somewhat higher frequency than the actual repetition rate of the signal.

In a similar fashion, the wider portion of the signal is representative of a square wave of somewhat lower frequency.

Fig. 7. Poor high frequency response causes rounding at the peak of "leading edge."

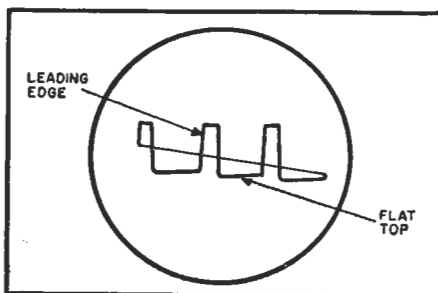

If an analysis of the signal waveshapes is qualified with these facts in mind, then the techniques of square-wave testing may be applied directly to the use of rectangular waves in circuit analysis.

Pulse signal source: Since a pulse is basically a rectangular waveform, the output of the sine-wave clipper may be used in the same fashion as the signal obtained from a pulse generator. If narrower pulses are desired, an RC or RL differentiation network may be used after the clipper.

Conclusion

The sine-wave clipper circuit described, although designed for a specific application, is basically nothing more than an overdriven transistor amplifier, operated without bias. Because of this, the basic circuit given should offer the experimenter ample opportunity to become familiar with the operation of the basic resistance-coupled transistor amplifier.

However, those experimenters who have not previously worked with transistor circuits should exercise reasonable care when experimenting with modifications of the basic circuit given. Be sure the maximum ratings of the transistor are not exceeded. Transistors are both relatively expensive and easily damaged.

-30-

Vibration Amplifier

(Continued from page 16)

tening to and interpreting vibrational movement in machinery, the transistor vibration amplifier has been found to have another valuable application.

When the point of the probe is moved lightly across a material surface, a sound is produced in which the frequency depends on the number of surface irregularities encountered (and the speed of movement) and in which the amplitude depends on the degrees of surface irregularity.

Used in this fashion, the instrument permits the operator to determine even very small differences in the surface smoothness of various materials.

Best results are obtained when the probe is held at a slight angle, with the apex facing away from the direction of movement. The probe tip should make firm, but light, contact with the surface of the material being checked.

When comparing the surface smoothness of two different materials or objects, special care must be taken to move the probe across each surface at exactly the same speed. Otherwise, the results are somewhat difficult to interpret.

The user will soon discover additional applications for the transistor vibration amplifier as he works with it.

-30-

Applause Meter

(Continued from page 84)

of voltage gain or db level. In such a case, new resistors may be chosen for this network. Refer to *Federal's* "Reference Data for Radio Engineers" for the necessary design formulas.

A continuously variable attenuator control may be provided if desired. Simply use a standard 1000 ohm potentiometer in place of S_1 and its associated resistors.

If the completed instrument is to be used in other than "applause meter" applications, the builder may wish to provide frequency selective filter networks so the frequency response of the amplifier can be adjusted for special measurements. Again, filter network design data will be found in the handbook mentioned previously.

Calibration: As long as the instrument is used only as a peak-reading device, there is no need for meter scale calibration, either in db or in other terms, and none is provided in the model. Should the builder wish to use the instrument for absolute sound level measurements, however, not only will scale calibration be necessary, but the attenuator switch will have to provide precisely known amounts of attenuation.

Meter calibration is best carried out by borrowing a standard sound-survey meter or similar instrument and obtaining comparative readings. The final calibration may either be a chart or curve or, if preferred, a new scale may be prepared for the meter itself.

Applications

To use the completed instrument as an applause meter, place it on a small stand or table with the microphone facing the audience. Set the attenuator switch (S_1) in the maximum attenuation (minimum signal) position. The meter switch (S_2) may be set either in the "filter" or "peaks" position, as preferred by the individual operator, but the switch position should be left fixed during any series of tests.

The power switch should now be turned "on." The meter reading should be noted during the program and the attenuator switch adjusted for a one-third to one-half full-scale reading during a particularly good "hand" and before actual "voting" takes place. As an alternative, the audience may be asked for a good "hand" before the program starts, and the attenuator switch adjusted at this time.

Once set, the switch is left in position until all contestant "voting" is completed.

In some cases it may be desirable to have two or three "judges" to note the meter reading during voting to avoid any possibilities of error.

In addition to its use as an applause meter, the completed instrument has many other possible applications. For example, when placed in front of a

receiver's loudspeaker, it may be used as a "no connection" output meter. Good results can be obtained in this application if the background noise level is not too high.

When calibrated, the instrument may be used as a sound-survey meter and, in this application, is useful for checking noise levels in offices, stores, schools, and factories. In many cases, the background noise level has a definite effect on workers' efficiency.

When used in conjunction with a fixed audio signal source, the instrument will permit tests of the comparative sound absorption qualities of different types of draperies, acoustic tile, and floor coverings.

Installers of p.a. systems could use such an instrument for checking sound distribution in a particular installation, both to insure adequate coverage and to prevent "loud spots."

These suggestions cover only the more obvious applications, however. The reader will undoubtedly think of many additional applications both in regard to his own work and of a general nature. -30-

Moisture Detector

(Continued from page 86)

level in a tank. The "sensor" plate is not used in this application. Instead, a special "sensor" unit is made up by mounting two metal rods or tubes a short distance apart ($\frac{1}{4}$ " to $\frac{1}{2}$ ") in an insulating block.

The "sensor" is then mounted on the side of the tank so that the rods project downward to the desired level. The insulating block, to which terminal connections are made, should be so located as not to be dampened by the inlet pipe.

A solenoid-operated valve is placed in the inlet pipe, with the solenoid connected in series with the "normally-closed" terminals of the moisture detector relay.

As long as the water level stays below the two rods, the relay is open and the solenoid valve is actuated, permitting water to flow through the inlet pipe and into the tank. As soon as the water level reaches the predetermined point and makes contact with the "sensor" rods, the relay is pulled closed, opening the solenoid circuit and permitting the inlet valve to close.

When the water level drops below the two rods, as when water is drawn from the tank, the moisture detector relay again drops out, permitting the valve to operate.

Note that this application differs from those previously discussed in that the relay is normally held closed. This places a small, but constant, current drain on the battery.

Because of this, and in any application where a current drain may exist for comparatively long periods of time, a periodic "battery inspection and test" schedule should be set up and followed.

Sump Pump Control: In this application the rod type "sensor" element is also employed. Mount the rods in the sump at the desired level (slightly above the intake of the pump).

Connect the moisture detector relay contacts to operate the sump pump motor when the relay is closed.

There is very little current drain from the battery unless water collects in the sump to a sufficiently high level to make contact with the "sensor" rods. When this happens, the moisture detector relay closes, turning on the sump pump motor. The relay will stay closed, and the motor will continue to operate, until the water level drops below that of the "sensor" rods.

If desired, a 100,000 ohm rheostat may be connected in series with R_1 . This rheostat may be used as a sensitivity control and will permit some degree of operational adjustment. -30-

Heterodyne Frequency Meter

(Continued from page 63)

When using a junction transistor in the r.f. oscillator section of a heterodyne frequency meter, the designer is limited by the fact that this type of transistor ordinarily will not oscillate beyond the top of the standard broadcast band. However, by tuning the transistor oscillator from 500 to 1,000 kc., the practical

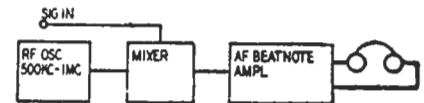

Fig. 1—Block diagram of the meter.

measurement range is found to be 50 kc or less to 30 mc. Response at the high frequencies is dependent to a great extent upon the strength of the test signal.

Fig. 2 shows the complete circuit of the transistorized heterodyne frequency meter. Type CK722 transistors are used in the r.f. oscillator and a.f. amplifier stages, and a CK705 germanium diode is used in the mixer stage. The r.f. oscillator is a high-gain grounded-emitter amplifier provided with inductive feedback through the tickler coil L1. The r.f. output from the oscillator is coupled to the diode mixer circuit through pickup coil L3. Coil L2 is a Miller type 20-A antenna coil (113 turns of No. 32 wire closewound on a 1-inch-diameter form) with the slip-over primary removed. L1 consists of 40 turns of No. 26 enameled wire closewound on top of L2 and wound in the same direction as L2. L3 is 15 turns of insulated hookup wire jumble-wound and cemented inside the form on which L2 is wound. So that the reader may phase these coils properly for oscillation, the tops of L1 and L2 have been labeled X and Y respectively in Fig. 2. X and Y are the beginnings or ends of each coil. It is immaterial which is chosen as long as they correspond.

Construction

The photographs show construction details of the heterodyne frequency meter. The entire instrument is built into an aluminum utility box 7 inches long, 5 inches high, and 3 inches deep. Considerable reduction in size is possible by the use of smaller components.

Tuning capacitor C3, calibration trimmer C2, and the r.f. coil assembly are mounted directly to the box (see rear-view photo). The mixer and a.f. amplifier components are mounted between the turret terminals of a UsecO 2½ x 2 inch terminal board. Placement of these parts will be seen in the photo of the audio subchassis. Oscillator transistor V1, capacitor C1, and resistor R1 are mounted on a small bakelite terminal strip attached to the front of the main tuning capacitor C3, and are not visible in the rear-view photo.

Base resistors R1 and R2 are the only critical components. Their values vary with individual transistors and must be selected for the particular transistors used. The resistance values given in Fig. 2 worked satisfactorily in the author's instrument and will be good starting values from which to begin tests. Resistor R1 should be selected for lowest collector current which will permit strong oscillation over the entire range of the tuning capacitor. For this test, connect a multirange d.c. milliammeter temporarily in the lead from L1 to the negative terminal of the battery. Note the indicated collector current for each experimental value of R1. To test for oscillation, touch the collector lead of the transistor with the finger. The milliammeter should change reading vigorously. A slight change shows weak oscillation. After each change of R1, make this check at each setting of C3.

To adjust R2, insert a pair of 2,000-3,000-ohm headphones into the jack. Feed in an r.f. test oscillator signal (500 to 1000 kc) at the SIGNAL INPUT terminals, and obtain a beat note by tuning C3. Using this beat note, adjust the value of R2 for loudest undistorted signal. Remove the headphones and plug a d.c. milliammeter into the jack. The current reading ordinarily should not exceed 1 ma. Choose R2 for the low-

est current which gives a loud signal with low background noise.

Calibration

The best final calibration will be obtained with a 100-kc frequency standard. However, follow these steps for the initial calibration: (1) Feed a 500-kc signal to the SIGNAL INPUT terminals. (2) Set the main tuning capacitor to its full-capacitance position. (3) Plug headphones into the jack and adjust the CALIBRATION trimmer C2 for zero beat. The C3 dial now may be marked 500 kc at this point. (4) Substitute a 100-kc frequency standard for the signal generator. (5) Reset C2, if necessary, to establish a more accurate zero-beat with the standard. (6) Tune C3 slowly from this setting until another standard frequency point is brought in on zero-beat.

The test signal is applied to the mixer through coupling capacitor C4. Audio output from the mixer is coupled through transformer T (a UTC type SO-2) to the grounded-emitter a.f. amplifier. Note that the interstage transformer is connected backward to match the low input impedance of transistor V2.

The entire instrument is powered by a miniature 15-volt battery. The 15-volt potential is necessary for high-frequency oscillation because with 1.5 to 10 volts, not all CK722 transistors will operate up to and including the broadcast band. While for size considerations, a hearing-aid-type battery is shown here, a larger-sized battery can be used and may be more desirable, from a life standpoint, to individual builders. Total measured current drain is 440 microamperes d.c. in this instrument, but this may be expected to vary in each direction with individual transistors.

Mark this point 600 kc on the dial. (7) Repeat at each standard spot frequency, marking the dial 700, 800, 900, and 1000 kc accordingly. If the frequency standard is equipped also with a 10-kc multivibrator, 10-kc points may be located and marked between adjacent 100-kc graduations on the dial.

It is advisable to check against a standard-frequency source before be-

ginning use of the heterodyne frequency meter at any subsequent time. A single spot check will suffice. A rapid method is to set the dial to 1000 kc (1 mc) and, with the 100-kc standard feeding into the SIGNAL INPUT terminals, adjust trimmer C2, if necessary, to re-establish exact zero-beat. This compensates for any frequency shift due to transistor temperature characteristics or to battery variation.

Application

Always use high-resistance magnetic headphones (minimum 2,000 ohms). Crystal phones will not work, because transistor V2 relies upon the d.c. path through the phones for its collector current. When using a visual zero-beat indicator, such as an oscilloscope or meter, complete the d.c. collector path by connecting a 2,000-ohm resistor in parallel with the jack.

When checking a transmitter (and some oscillators), satisfactory coupling into the frequency meter is obtained by using 1 or 2 feet of stiff wire.

Longer ones may cause interference on nearby broadcast receivers. Ordinarily, such interference is not created because of the low power output of the transistor oscillator stage.

Remember that a relatively low input impedance appears at the SIGNAL INPUT terminals. This is an important factor when the frequency meter is used to calibrate an r.f. oscillator or signal generator connected to those terminals. Usually, the only mischief is the requirement of a stiffer signal from the oscillator under test. But the situation is not much worse than feeding a signal generator into the antenna coil of a receiver. END

Transistor Timer (Continued from page 46)

on for a specific short interval (as when warming solutions). Where a heating element or other piece of equipment requiring large current is used, care must be taken that the maximum current rating of the relay contacts is not exceeded.

Still another application is in controlling a tape machine or record player so that a specific commercial message may be delivered when the "Reset" button is pressed. A typical example would be in the display room of a convention or show. When a passerby presses the button, a tape playback machine operates for a specific period of time, giving any desired message or "sales talk."

A similar application is in the operation of mechanical displays.

The reader can undoubtedly list many other possible applications of the timer. Then, too, once the builder has had a chance to experiment with the completed unit, other possibilities will occur to him.

-30-

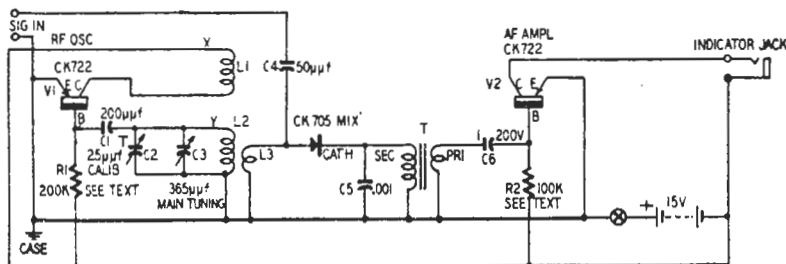

Fig. 2—Circuit of the transistorized 50-kc to 30-mc heterodyne frequency meter.

Materials for frequency meter

Capacitors: 1—25 µF air trimmer; 1—365 µF single-section tuning capacitor; 1—50, 1—200 µF, midget mica or ceramic; 1—.001 µF, mica or ceramic; 1—1.0 µF, 200 volts, metallized paper.
Miscellaneous: 2—CK722 transistors; 1—CK705 germanium diode; 1—s.p.s.t. toggle switch; 2—resistors

(see text); 1—3:1 interstage a.f. transformer (U.T.C. type SO-2 or equivalent); 1—J. W. Miller broadcast antenna coil type 20A; 1—miniature 15-volt battery (Burgess U10 or equivalent); 1—aluminum utility box 7 x 5 x 3 inches; 1—insulated open-circuit phone jack; 1—2 x 2½-inch terminal board with 10 posts (USECO or equivalent); 1—tuning dial; hookup wire, hardware.

Transistor Phase Inverter

(Continued from page 24)

phase inverter will handle is ten volts peak, which is sufficient for push-pull 6V6 tubes in class A operation. The minimum signal level is determined by the noise factor of the transistor. The transistor phase inverter may be excessively noisy, if used directly from a low-output microphone; a minimum signal level of -40 db should be obtained, by a vacuum-tube stage, if necessary, for good performance.

For good frequency response the phase inverter should be used with high-impedance input and output circuits, and the shunt capacity should be kept low. Short, direct wiring to other stages should be used. If the phase inverter must be used with an input circuit or output circuit of low impedance, the input or output coupling condensers may be increased, if it is desired to improve the low-frequency response.

A voltmeter of 20,000 ohms-per-volt or better, or a v.t.v.m. should be used in measuring the voltages. The base voltage, measured at the junction of R_2 and R_1 , is +70 volts above ground. Emitter voltage, at the junction of R_3 and C_2 , is +72 volts. Collector voltage, at the junction of R_4 and C_1 , is +18 volts.

R_1, C_1 form a decoupling and voltage-dropping network to supply +90 volts at the junction of R_1 and C_1 . The input signal is fed through C_2 to the transistor base at the junction of bias resistors R_2 and R_1 . The emitter current flowing through load resistor R_3 develops the in-phase output voltage, which is coupled through the blocking-condenser C_3 to one grid G_1 . Collector current flowing through R_4 gives the phase-reversed output, which is coupled through blocking condenser C_1 to the other grid, G_2 , of the push-pull stage.

It would appear that the transistor will find increasing use as a phase inverter in audio amplifiers of the push-pull class, provided that transistors are available at a price competitive with the triode.

When this happy day dawns, we can expect to see not only smaller and more compact amplifiers but units of unparalleled reliability. —30—

Photocell Relay

(continued from page 42)

source may be arranged to fall across a doorway so that anyone entering the room interrupts the light beam. This, in turn, may cause a chime, doorbell, or buzzer to sound. Such an arrangement is particularly useful for small stores, small offices, etc.

Door Opener: The photocell relay may be arranged in a garage so that light striking the unit from an auto's headlights acts to operate a door-opening motor. In this application, the long tube (see Fig. 3) should be used to prevent operation due to extraneous light from passing cars, street lamps, etc.

Counter: A light source may be arranged to fall across a hall or area-way so that anyone passing interrupts the light beam. An electromechanical counter can be used to keep a record of the number of persons passing a given spot in a day or for any other period of time.

Light Switch: The photocell relay may be arranged so that daylight falls on it, and connected so that when the light level falls, due to clouds or the approach of evening, room lights are automatically switched on.

Smoke Alarm: If the light source and photocell relay are arranged across the top of a room, smoke from a beginning fire will interrupt the beam and operate the unit. An alarm signal could be sounded if such an arrangement seems desirable. —30—

The Transistor DC Amplifier

(Continued from page 21)

Such d.c. amplifiers working from low impedance thermal and mechanical transducers and not requiring the electrometer input stage will undoubtedly pose rather severe problems in relation to temperature drift at the input transistors—the severity of the problem varying according to the over-all gain required and the maximum drift that can be tolerated. In applications where these requirements are particularly stringent, the most careful attention to the complete thermal circuit associated with the input stage will be necessary. In those extreme cases where temperature control appears to be unavoidable, the separate transistor amplifier associated with such a control would be a relatively simple and straightforward affair since, as already remarked, a transistor amplifier intended to amplify a temperature signal is much easier to design, circuit wise, and construct than one which must produce nearly zero output for the same kind of signal.

The long-term stability of the temperature characteristics of junction transistors has yet to be determined. However, to judge by our present knowledge of this subject, it appears likely that the "zero adjust" control

commonly found in d.c. amplifiers need have no greater (and quite possibly less) range in a transistor amplifier than in the vacuum-tube instrument it replaces.

To those who have not yet touched transistors, the meter amplifier described earlier in this article may be recommended as a relatively painless introduction; while the design engineer, steeped in the lore of his own particular specialty—whether it be microwaves, radar, pulse modulation, or computers—should not have too much difficulty in mastering the intricacies of the circuit illustrated in the diagram of Fig. 3. —30—

Transistor Metronome

(Continued from page 82)

curately calibrated. The "Transistor Metronome" is adjusted until it is in step with known settings of the other instrument, and the settings of R_2 so marked.

Finally, for higher repetition rates, the output of the "Transistor Metronome" and that of an audio signal generator may be connected to an oscilloscope and the calibration points obtained by means of Lissajous figures. The figures obtained will be distorted, since a pulse is obtained from the metronome, but the operator should have little or no difficulty in distinguishing 1:1 ratios.

Applications

Although the "obvious" use of the "Transistor Metronome" is in music, there are numerous other applications, depending on the individual needs and requirements of the operator, and upon his ingenuity in adapting the instrument to his use.

One application, for example, is in the photographic darkroom, where the metronome may be used to audibly "tick" off seconds for timing printers, enlargers, and chemical processes. In this application, a "switch" type unit adjusted to deliver either 1-second or 5-second "ticks" would be valuable.

Still another application is in timing mechanical processes or work movements where the eye cannot be transferred to a stop watch or, similarly, in timing chemical or biological processes. Since the unit is battery operated, it is especially valuable in these applications, and can be easily carried to the job—even outdoors.

Battery operation of transistors also offers the advantage of virtually zero "warm-up" time. Simply turn the unit "on," and it starts working.

Another application is in marking time for physical exercises. Here again, the ease of obtaining extremely slow beats (one for every several seconds) gives advantages over other units. —30—

Junction Transistors For High Frequency Oscillators

(Continued from page 29)

resistance to 40,000 ohms dropped the frequency to 700 kc. The lower base resistance also increased current input from 50 μ a to 600 μ a from the 1.5-volt battery.

Battery voltage affects frequency to a great extent. The following table illustrates this. The tank was a slug-tuned pair of coils wound over the same half-inch core. The collector winding had about 75 turns No. 28 enamelled wire and the base winding about 30. Each was close-wound with 7 turns per layer. The coils were about $\frac{7}{8}$ inch apart.

Voltage	Frequency	Current
1.5	700 kc	50 μ a
3.0	770 kc	120 μ a
4.5	800 kc	200 μ a
10.0	830 kc	650 μ a

The frequency control can be operated at a distance. For example, I used a remote 100,000-ohm potentiometer across a battery (Fig. 3). A .01- μ f capacitor bypassed the leads where they connect to the oscillator itself. Thus the remote network (potentiometer and battery) are bypassed. Of course, the power increases as we raise the frequency. If the circuit is to be used as a frequency modulator its output may be fed into a limiter to keep the power constant.

Frequency may also be controlled by a resistance in series with the battery. A 1,000-ohm resistor shifted frequency from 610 to 600 kc. This method is not suitable for remote control. It seems that the capacitance between leads cancels out some of the resistive effect. Unless the resistor is right at the circuit, much of its effect is lost through this capacitance.

The combination of an active transistor high-voltage supply (4.5 or more) and a high base resistor gives rise to an unusual effect. The circuit goes into multiple oscillations like a superregenerator or multivibrator. The output is composed of a strong carrier (at the frequency of the tank coil) and numerous sidebands. These frequencies may be spaced by about 3 kc or less. Thus, as the band is tuned, one signal comes in just as the next is leaving, so there is a more or less continuous signal. With a certain adjustment here, we obtained the carrier at 800 kc. The sidebands occupied a width of about 200 kc on either side.

Of course the multiple signal appears on the short-wave bands as harmonics. Thus we hear a maximum signal at 1.6 mc, 2.4 mc, etc. In each case the noise signal is maximum near these frequencies but drops off to zero on either side. For a good noise signal, adjust the circuit so that the individual side frequencies merge or blend to become continuous. Such a noise is fine for alignment or adjustment of a receiver, and for many test purposes. END

Guitar Amplifier

(Continued from page 18)

Because battery life is long, due to the small current requirements of transistors, the author soldered lead connections directly to the battery terminals. Some builders might prefer to provide a simple socket, however, so that the battery could be easily removed and replaced without using a soldering iron.

No attempt was made to obtain either maximum gain, maximum overall frequency response, minimum distortion, or maximum power output in the model assembled by the author but, rather, parts values were chosen experimentally to give a good compromise between these factors consistent with the characteristics of the transformers and speaker employed. Because of this, the builder may exercise wide latitude of judgement in making circuit modifications to obtain especially desired characteristics.

For example, the 10 μ fd. coupling condensers used in the model (C_2 , C_3 , C_4 , and C_5) were chosen because of ready availability. Much smaller coupling condensers will do as well, and values as low as 4 μ fd. or even 2 μ fd. may be used without changing the low frequency response appreciably.

The low frequency response of the model is limited primarily by the low frequency response of the miniature interstage transformers employed (T_1 , T_2 , and T_3) rather than by the size of the coupling condensers. This does not indicate that the transformers are of poor quality. The small transformers used are of excellent quality, but are simply not designed as "hi-fi" transformers. Their small size precludes using enough iron in their cores to insure good low frequency response.

Should the builder have, or be able to obtain, proper interstage transformers having a wider frequency response, he should not hesitate to use them.

The builder may also find it worthwhile to experiment somewhat with the sizes of those resistors affecting "bias" current and hence individual stage characteristics (R_2 , R_3 , R_4 , R_5). The following technique may be used:

- Connect an 0-10 milliammeter in the collector circuit of the stage to be checked.
- Connect the "Vert. Input" terminals of an oscilloscope to observe the signal appearing across the output load of the stage (generally the primary or secondary winding of a transformer).

- Connect a variable resistor or a resistance substitution box in place of the "base return" resistor.

- Connect an audio sine-wave generator to supply a signal to the stage being checked. When connecting the generator, use a blocking condenser if necessary to avoid a change in the d.c. value of the input circuit.

Whether or not a blocking condenser will be required will depend on the output circuit of the generator.

- Applying a sine-wave signal to the stage, and observing the output signal on the scope, adjust the value of the "base return" resistor for the desired characteristic — maximum gain, minimum distortion, etc. When making gain checks, be sure to keep the input signal level constant. When checking distortion, be sure the input is not overloaded.

- Do not use any value of "base return" resistor that permits more than maximum collector current to flow (5 ma. for the CK721 and CK-722).

A number of possible parts substitutions have already been mentioned but several others are possible. Let us review a few of these.

The Mallory type 302424 transistor power supply battery may well be substituted for the battery specified in the parts list. This is a long-life 6.7 volt mercury cell unit.

A larger speaker might well be used instead of the 6" PM speaker used by the author. If a larger speaker is employed, it will be necessary to use a larger case, of course.

If the builder prefers, any other type of cabinet might be substituted for the wall speaker baffle. A standard speaker cabinet, an old receiver cabinet, or even a small "overnight" case might well be used.

The rotary power switch may be left out and a control type switch mounted on either the "Gain" or "Tone" control used instead.

As mentioned previously, the guitar amplifier is not powerful enough to be used as a substitute for a standard vacuum-tube amplifier. Rather, it is designed primarily to supplement the guitar in small gatherings and in the home.

When used in this application, it gives good results, and even permits the guitarist to achieve some interesting musical effects by adjusting the tone control.

In addition, the guitar amplifier has sufficient over-all gain to permit its use with a standard crystal microphone, provided the "mike" is not held too far from the mouth of the speaker, that is, provided a reasonably strong output signal is obtained from the "mike" Used in this application, it permits the technician to perform a number of interesting experiments.

Still another application of the guitar amplifier is to provide loud-speaker output from a crystal or transistor receiver (a resistive load is connected in place of the usual magnetic headphones, and the audio signal appearing across this resistor connected to the input of the amplifier).

Even where the amplifier is not assembled for a specific application, it makes an excellent construction project for the student, technician, or engineer desiring greater familiarity with transistor circuits.

Transistorized Geiger Counter

(Continued from page 99)

many batteries is to use a single battery to charge two capacitors in parallel. If the capacitors are then connected in series with each other and with the battery, you have a high-voltage source which decays slightly each time the G-M tube draws current. The larger the capacitance, the longer the unit operates between recharges. The capacitors and the battery can be connected to a 4-pole, 2-throw, nonshorting switch as shown in Fig. 5, giving the equivalent of a 900-volt battery from only a 300-volt battery and two capacitors. One switch position is used for charging the capacitors, and the other is for operation. Of course, the switches must be capable of withstanding the voltages placed on them.

High voltage can be obtained from the low-voltage transistor battery by using a vibrator, a step-up transformer, and a rectifier.

(Note that 900 volts—especially from batteries—can be dangerous. Be careful!—Editor)

A transistor oscillator can be used instead of the vibrator; full details on such a unit are given by G. W. Bryan³ in an article in the *Proceedings of the I.R.E.*, November, 1952. A high-voltage power supply of this type is manufactured by Technical Operations, Inc., Arlington, Mass.

The CK1026 tube can be mounted in a 7-pin miniature tube socket by pushing the center wire through the hole in the center of the socket. A tall tube shield (such as for the 6AQ5) holds the G-M tube in the socket. (Drill holes in shield to pass radiation.) A strip of spring copper can be fitted inside the shield to connect the shield (and thus the chassis) to the outside of the tube envelope, the negative connection for the tube. The negative side of the high-voltage source is also connected to chassis, thus completing the high-voltage circuit. Provide insulation between chassis and the headphones and transistor adequate for 900 volts, or else connect the positive side of the high voltage to chassis and insulate the negative connection of the G-M tube from chassis.

When soldering the transistor into the circuit, hold the lead with pliers between the transistor and the soldering iron to prevent damaging the transistor by excessive heat from the iron.

The headphones used in the authors unit were 2,000 ohms impedance. Better results can probably be obtained with 20,000-ohm headphones if they are available. If the utmost in portability is desired, a hearing-aid earphone can be used instead of the larger headphones shown in the photograph. END

AM Test Oscillator

(Continued from page 62)

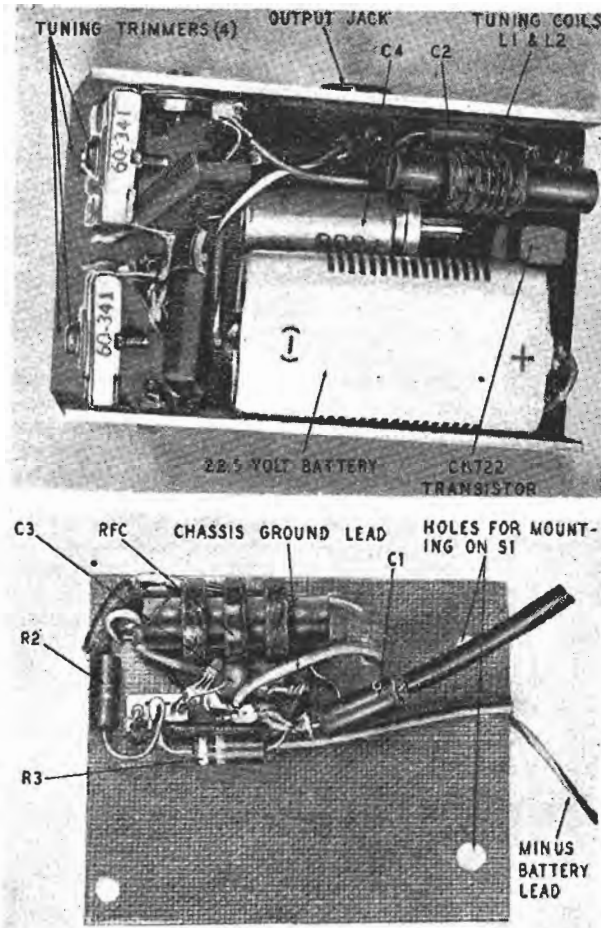

Parts layout—
top side of
chassis.

Under-chassis
view of test
oscillator.

does not have to be particularly precise.

Drift is very small. There is some drift when the oscillator is first turned on, but it takes only about a minute to stabilize. Compared to the 15 or more minutes warm-up for a vacuum-tube oscillator, this is very good. The large amount of tuning capacitance used at 455 kc lowers the tuned circuit impedance and gives the greatest stability.

The oscillator is simple to use. Suppose we want to check the audio stages of a receiver. Plug a short length of stiff wire or test-lead into the output jack and place S2 at MOD. Whenever the oscillator is in that position the audio test signal is available at the jack since C5 is large enough to pass both audio and r.f. In other words, both the modulated r.f. and audio are available at the same time.

The wire or probe can now be touched to various points of the audio circuit and the test signal should be heard. For example, if the signal disappears on one side of a coupling capacitor and is present on the other side, the capacitor is obviously open. If by signal injection one of the stages is shown to be inoperative, a voltage check usually locates the trouble. Essentially the same procedure is followed in servicing r.f. stages by signal injection.

A strong inductive field is created around the test oscillator by the Ferri-Loopstick. Receivers with loop antennas are very sensitive to this field and can pick up the oscillator many feet away, even though it has no probe or antenna plugged into the output jack. As the oscillator is slowly rotated in one hand, the signal strength from the inductive coupling to the loop-antenna will change tremendously. In some positions a complete null will be reached and in others the signal will be terrific. A 455-kc signal can be fed into some i.f. transformers this way.

Parts list for AM test oscillator

Resistors: 1—8,200, 1—22,000, 1—100,000 ohms, 1/2 watt.

Capacitors: 1—300 μf , 1—350 μf , mica; 1—750 μf , ceramic; 3—.01 μf , 200 volts, paper; 3—4.80 μf , 1—45-380 μf , trimmer; 2—25 μf , 3 volts, electrolytic.

Miscellaneous: 1—CK722 transistor; 1—5-pin subminiature tube socket; 1—Ferri-Loopstick; 1—1-mh r.f. choke; 1—22.5-volt battery; 1—Centralab switch, PA1002; 1—s.p.d.t. slide switch; 1—aluminum case, 1 1/2 x 2 1/4 x 3 1/4 inches; 1—knob; 1—insulating board; 1—output jack.

There are other uses for the oscillator. You can make a wireless code-practice oscillator out of the test unit by substituting a telegraph key for S2 and reducing the value of C3 for a sharp practice tone. END



Excellence in Electronics

TYPE

CK721

The CK721 is a PNP junction transistor intended primarily for use in audio or low radio frequency applications. The tinned flexible leads may be soldered or welded directly to the terminals of circuit components without the use of sockets. Standard inline subminiature sockets may be used by cutting the leads to a suitable length.

MECHANICAL DATA

CASE: Plastic and Glass

BASE: None (0.016" tinned flexible leads. Length: 1.5" min.
Spacing: 0.08" center-to-center)

TERMINAL CONNECTIONS: (Red Dot is adjacent to Lead 1)

- Lead 1 Collector
- Lead 2 Base
- Lead 3 Emitter

MOUNTING POSITION: Any

ELECTRICAL DATA

RATINGS - ABSOLUTE MAXIMUM VALUES:

Collector Voltage (V_c)	- 15 volts
Peak Collector Voltage (V_c) \oplus	- 30 volts
Collector Current	- 10 ma.
Collector Dissipation *	
Emitter Current	10 ma.
Ambient Temperature ■	70 °C

AVERAGE CHARACTERISTICS: (at 27°C)

Collector Voltage	- 6 volts
Emitter Current	1.0 ma.
Collector Resistance	2.0 meg.
Base Resistance	700 ohms
Emitter Resistance	25 ohms
Base Current Amplification Factor	45
Cut-off Current (approx.)	6 μ a.
Noise Factor (max.) ●	22 db

AVERAGE CHARACTERISTICS - COMMON EMITTER: (at 27°C)

Collector Voltage	- 1.5	- 6 volts
Emitter Current	0.5	1.0 ma.
Input Resistance	2400	1500 ohms
Load Resistance	20,000	20,000 ohms
Power Gain (Matched Input)	39	41 db

AVERAGE CHARACTERISTICS - COMMON COLLECTOR: (at 27°C)

Collector Voltage	- 6 volts
Emitter Current	1.0 ma.
Input Resistance ▲	0.6 meg.
Load Resistance	20,000 ohms
Power Gain (Matched Input)	15 db

AVERAGE CHARACTERISTICS - COMMON BASE: (at 27°C)

Collector Voltage	- 6 volts
Emitter Current	1.0 ma.
Input Resistance	70 ohms
Load Resistance	0.1 meg.
Power Gain (Matched Input)	31 db.

■ This is the maximum operating or storage temperature recommended.

● Measured under conditions for grounded emitter operation at $V_{cb} = -2.5$ volts for a 1 cycle bandwidth at 1000 cycles.

▲ Higher input impedances, without appreciable loss in gain, can be achieved by operating at lowered collector current.

* This is a function of maximum ambient temperature (T_A) expected. It is approximately equal to $4(70^\circ C - T_A)$ milliwatts.

◆ In circuits stabilized for I_c or I_e and which do not have critical distortion requirements, absolute maximum peak voltage is 60 volts.

⊕ Collector voltage V_{ce} at which I_c rises to 2 ma. in common emitter circuit with base lead connected directly to emitter lead. Ambient temperature = 25°C.

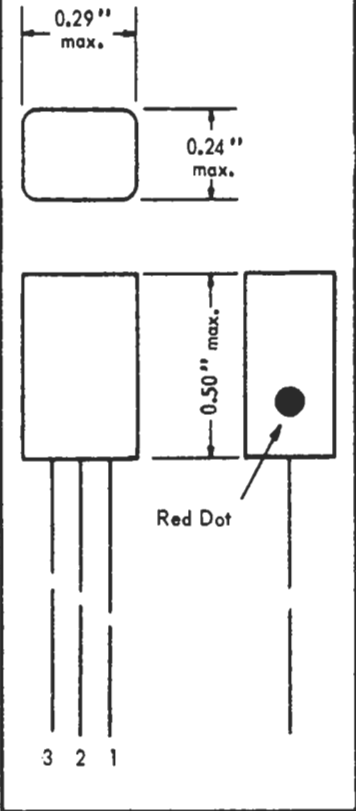

Tentative Data



GROUNDING BASE
Typical Collector Characteristics

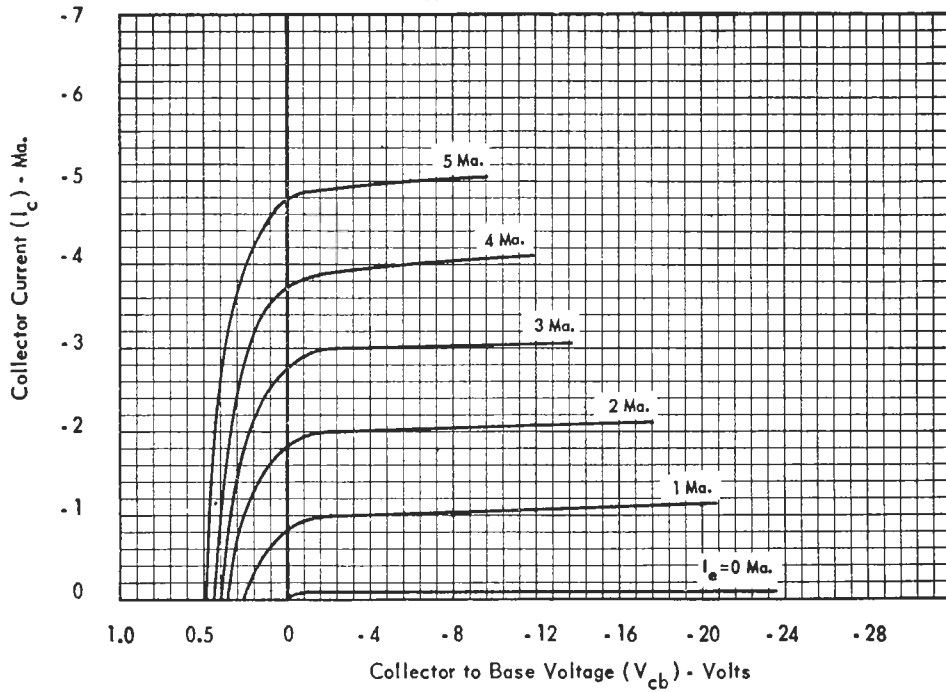

GROUNDING EMITTER
♦ Typical Collector Characteristics

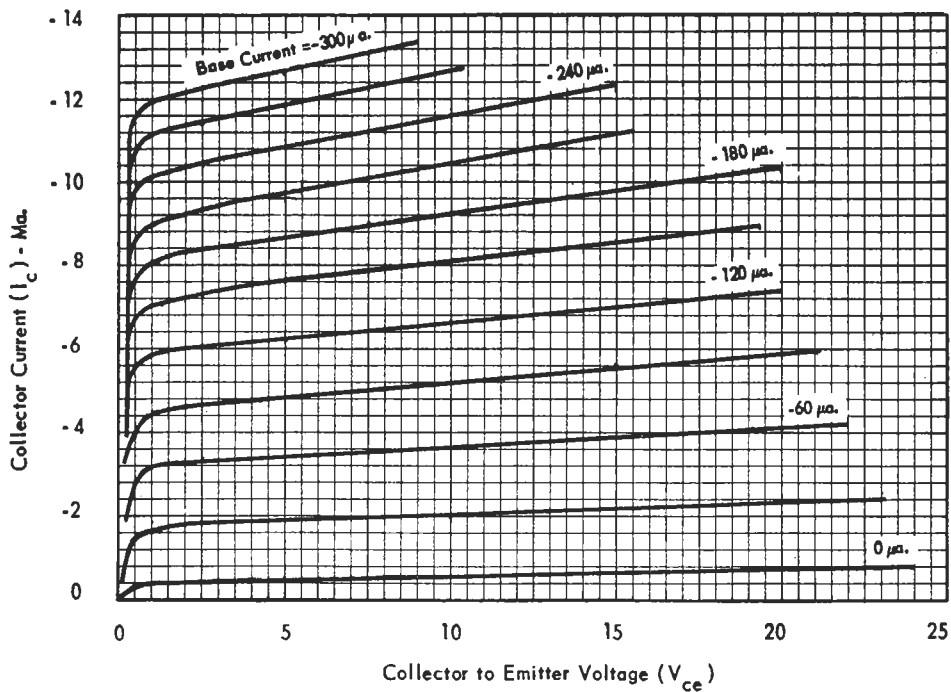

♦ This family is a function of $1 - \alpha$ and thus changes appreciably with small changes in α .

GERMANIUM TRANSISTOR

TYPICAL CHARACTERISTICS AS A FUNCTION OF JUNCTION TEMPERATURE

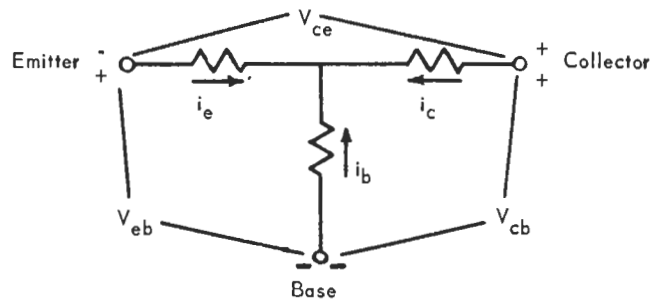
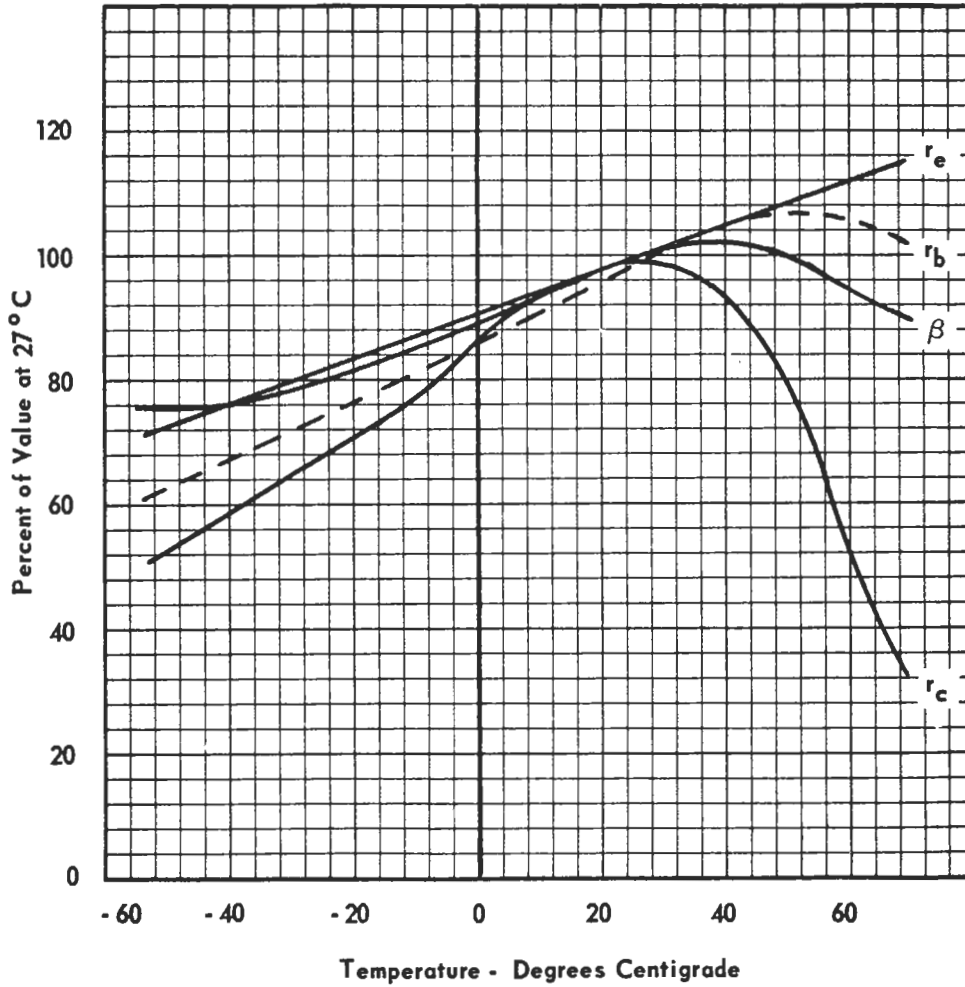

Arrows refer to positive electrode current flow.



Excellence in Electronics

TYPE CK722

The CK722 is a PNP junction transistor intended primarily for use in audio or low radio frequency applications. The tinned flexible leads may be soldered or welded directly to the terminals of circuit components without the use of sockets. Standard inline subminiature sockets may be used by cutting the leads to a suitable length.

MECHANICAL DATA

CASE: Plastic and Glass

BASE: None (0.016" tinned flexible leads. Length: 1.5" min. Spacing: 0.08" center-to-center)

TERMINAL CONNECTIONS: (Red Dot is adjacent to Lead 1)

- Lead 1 Collector
Lead 2 Base
Lead 3 Emitter

MOUNTING POSITION: Any

ELECTRICAL DATA

RATINGS - ABSOLUTE MAXIMUM VALUES:

Table with 2 columns: Parameter and Value. Includes Collector Voltage (Vc), Peak Collector Voltage (Vc), Collector Current, Collector Dissipation, Emitter Current, and Ambient Temperature.

AVERAGE CHARACTERISTICS: (at 27°C)

Table with 2 columns: Parameter and Value. Includes Collector Voltage, Emitter Current, Collector Resistance, Base Resistance, Emitter Resistance, Base Current Amplification Factor, Cut-off Current, and Noise Factor.

AVERAGE CHARACTERISTICS - COMMON EMITTER: (at 27°C)

Table with 2 columns: Parameter and Value. Includes Collector Voltage, Emitter Current, Input Resistance, Load Resistance, and Power Gain.

AVERAGE CHARACTERISTICS - COMMON COLLECTOR: (at 27°C)

Table with 2 columns: Parameter and Value. Includes Collector Voltage, Emitter Current, Input Resistance, Load Resistance, and Power Gain.

AVERAGE CHARACTERISTICS - COMMON BASE: (at 27°C)

Table with 2 columns: Parameter and Value. Includes Collector Voltage, Emitter Current, Input Resistance, Load Resistance, and Power Gain.

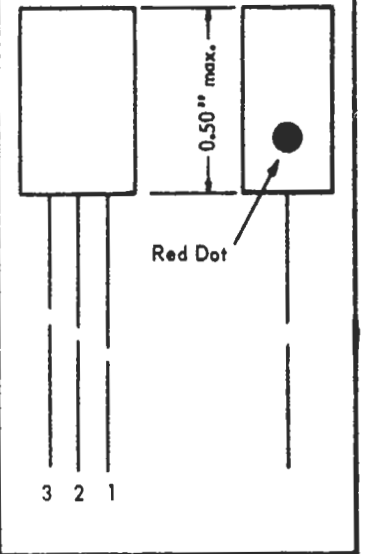
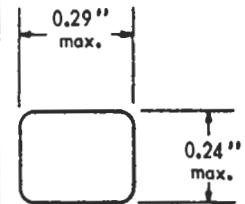

- This is the maximum operating or storage temperature recommended.
● Measured under conditions for grounded emitter operation at Vcb = -2.5 volts for a 1 cycle bandwidth at 1000 cycles.
▲ Higher input impedances, without appreciable loss in gain, can be achieved by operating at lowered collector current.
* This is a function of maximum ambient temperature (TA) expected. It is approximately equal to 4 (70°C - TA) milliwatts.
♦ Collector voltage Vce at which Ic rises to 2 ma. in common emitter circuit with base lead connected directly to emitter lead. Ambient Temperature = 25°C.
⊕ In circuits stabilized for Ic or Ie and which do not have critical distortion requirements, absolute maximum peak voltage is 75 volts.

Tentative Data



GERMANIUM TRANSISTOR

GROUNDING BASE
Typical Collector Characteristics

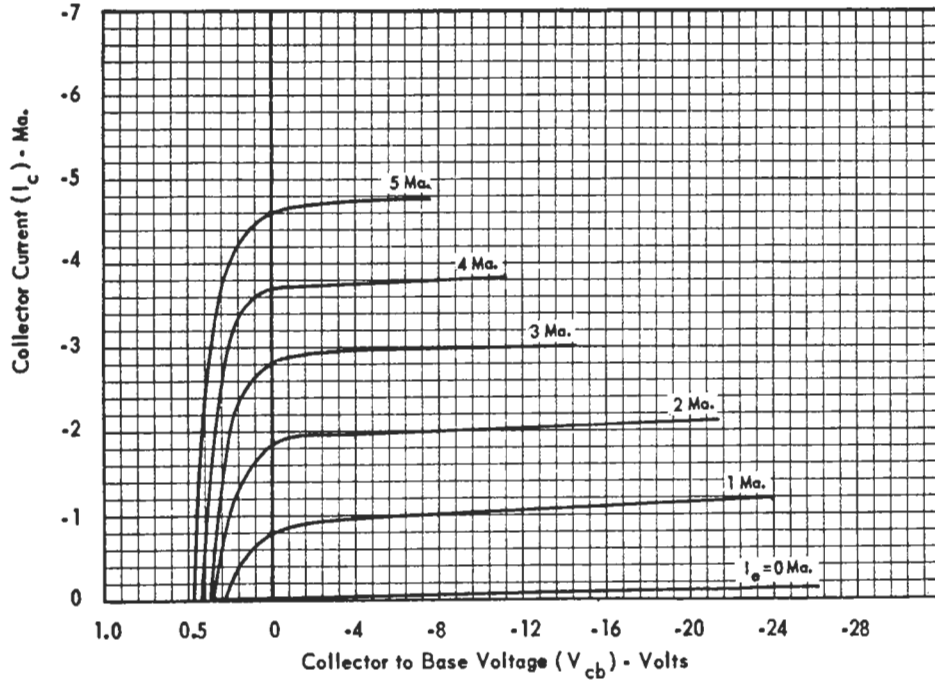

GROUNDING EMITTER
♦ Typical Collector Characteristics

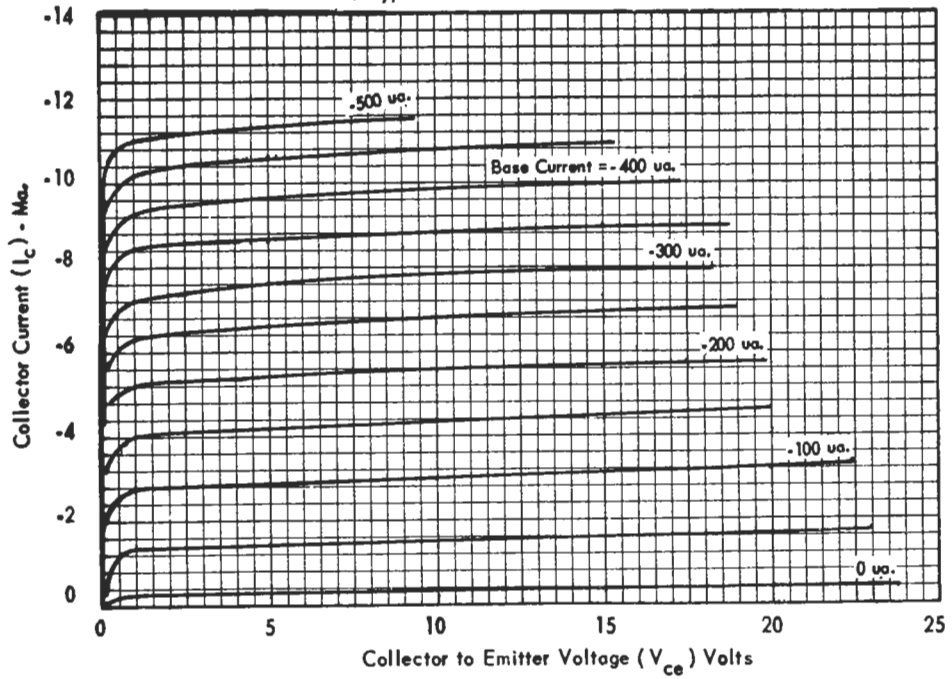

♦ This family is a function of $1-\alpha$ and thus changes appreciably with small changes in α .

GERMANIUM TRANSISTOR

TYPICAL CHARACTERISTICS AS A FUNCTION OF JUNCTION TEMPERATURE

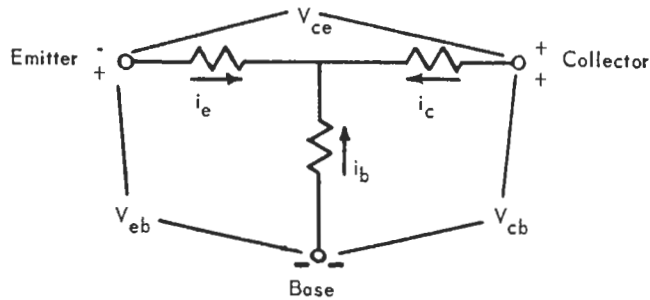
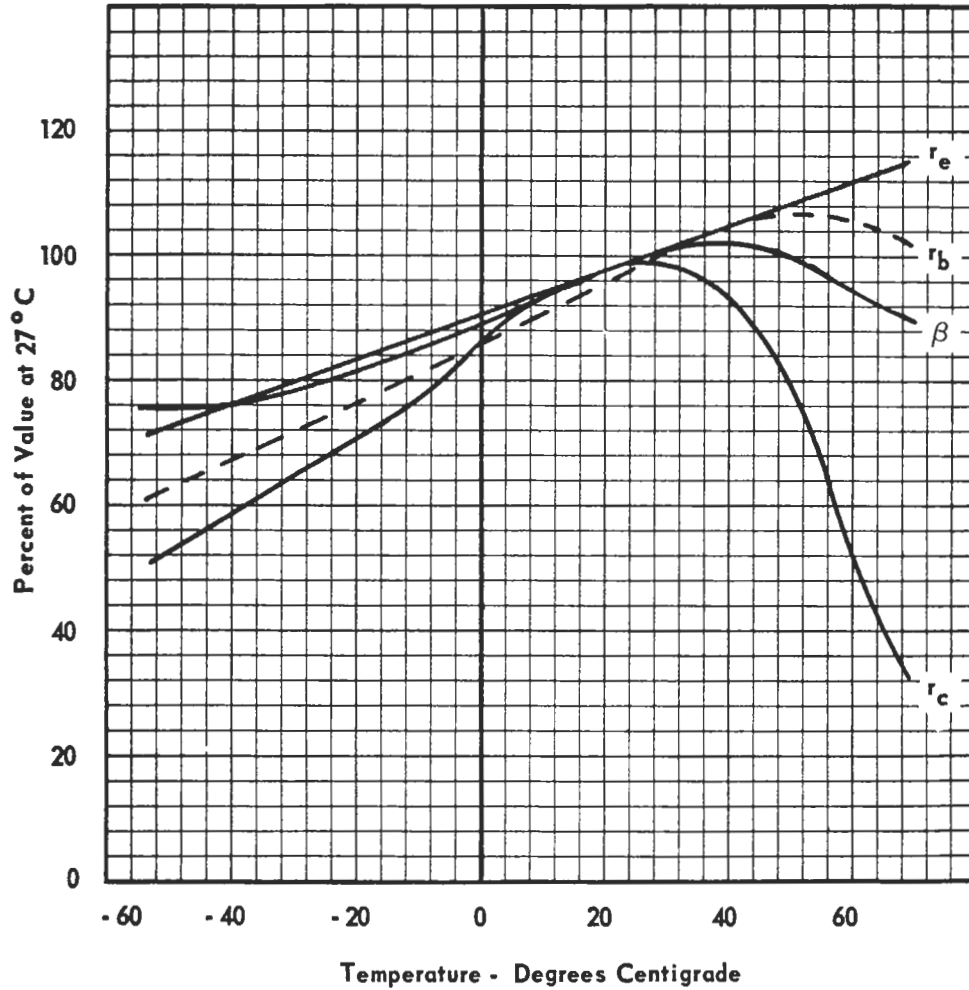

Arrows refer to positive electrode current flow.



Excellence in Electronics

TYPE CK727

The CK727 is a PNP junction transistor intended for use in low level audio applications where low noise factor is of prime importance. The tinned flexible leads may be soldered or welded directly to the terminals of circuit components without the use of sockets. Standard inline subminiature sockets may be used by cutting the leads to a suitable length.

MECHANICAL DATA

- CASE: Plastic and Glass
BASE: None (0.016" tinned flexible leads. Length: 1.5" min. Spacing: 0.08" center-to-center)
TERMINAL CONNECTIONS: (Red Dot is adjacent to lead 1)
Lead 1 Collector
Lead 2 Base
Lead 3 Emitter
WEIGHT: 0.025 ounces
MOUNTING POSITION: Any

ELECTRICAL DATA

RATINGS - ABSOLUTE MAXIMUM VALUES:

Table with 2 columns: Parameter and Value. Includes Collector Voltage (-6 volts), Collector Current (-10 ma.), Collector Dissipation* (10 ma.), Emitter Current (70 °C), and Ambient Temperature.

CHARACTERISTICS: (at 27°C)

Table with 2 columns: Parameter and Value. Includes Collector Voltage (-1.5 volts), Collector Current (-0.5 ma.), Current Amplification Factor (min.) (25), Collector Resistance (min.) (1.0 meg.), Collector Cutoff Current (max.) (12 µa.), and Noise Factor (max.) (12 db).

AVERAGE CHARACTERISTICS - COMMON EMITTER CIRCUIT: (at 27°C)

Table with 2 columns: Parameter and Value. Includes Collector Voltage (-1.5 volts), Collector Current (-0.5 ma.), Generator Resistance (1000 ohms), Load Resistance (20,000 ohms), Gain (36 db), and Noise Factor (10 db).

AVERAGE CHARACTERISTICS - COMMON BASE CIRCUIT: (at 27°C)

Table with 2 columns: Parameter and Value. Includes Collector Voltage (-1.5 volts), Collector Current (-0.5 ma.), Generator Resistance (100 ohms), Load Resistance (0.2 meg.), Gain (28 db), and Noise Factor (10 db).

AVERAGE CHARACTERISTICS - COMMON COLLECTOR CIRCUIT: (at 27°C)

Table with 2 columns: Parameter and Value. Includes Collector Voltage (-1.5 volts), Collector Current (-0.5 ma.), Generator Resistance (0.1 meg.), Load Resistance (10,000 ohms), Gain (14 db), and Noise Factor (25 db).

■ With zero emitter current in grounded base connection.
● In a one-cycle bandwidth at 1000 cycles.
▲ Measured under conditions described in 'Common Emitter Circuit'.
* This is a function of maximum ambient temperature (TA) expected. It is approximately equal to 4 (70° C - TA) milliwatts.

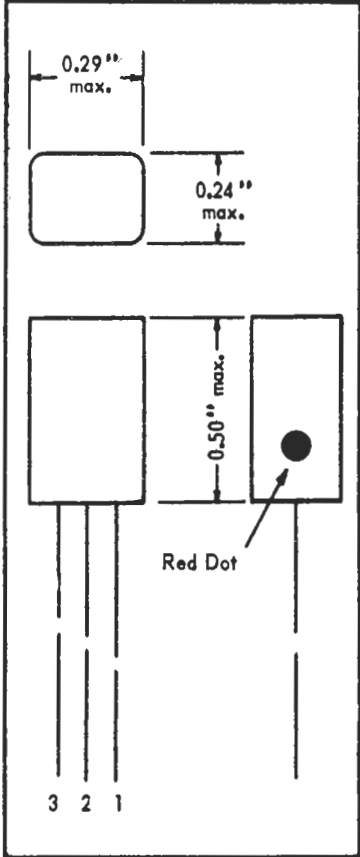

Tentative Data



GERMANIUM TRANSISTOR

AVERAGE NOISE CHARACTERISTICS
Common Emitter

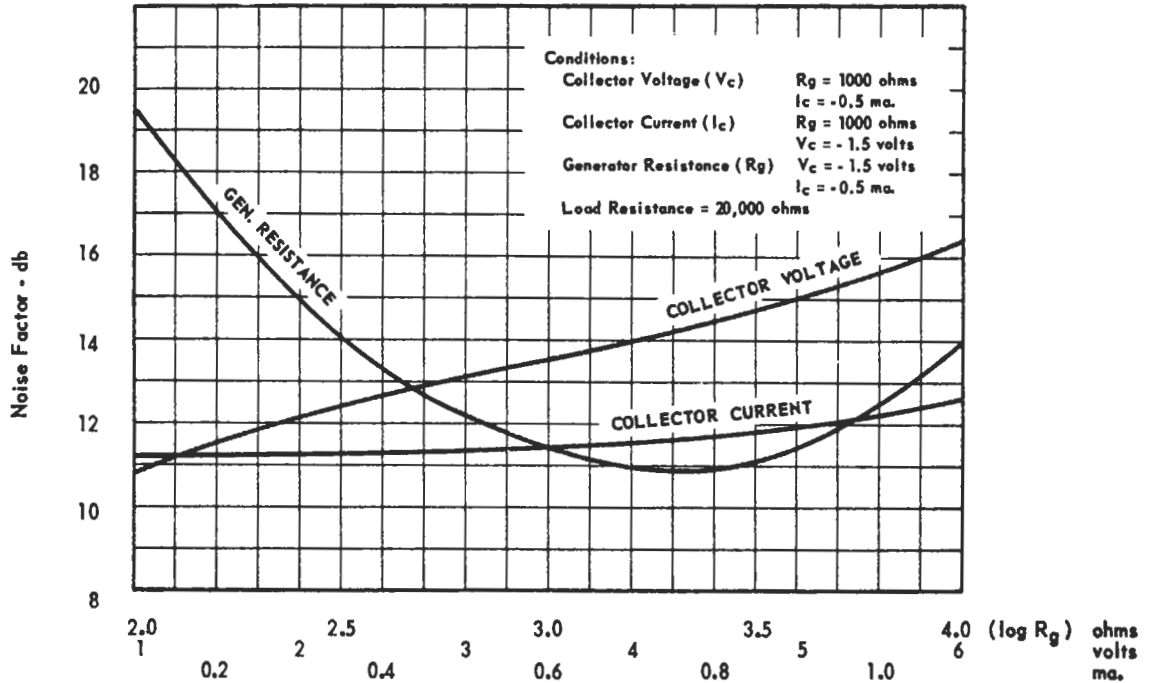

AVERAGE NOISE CHARACTERISTICS
Common Base

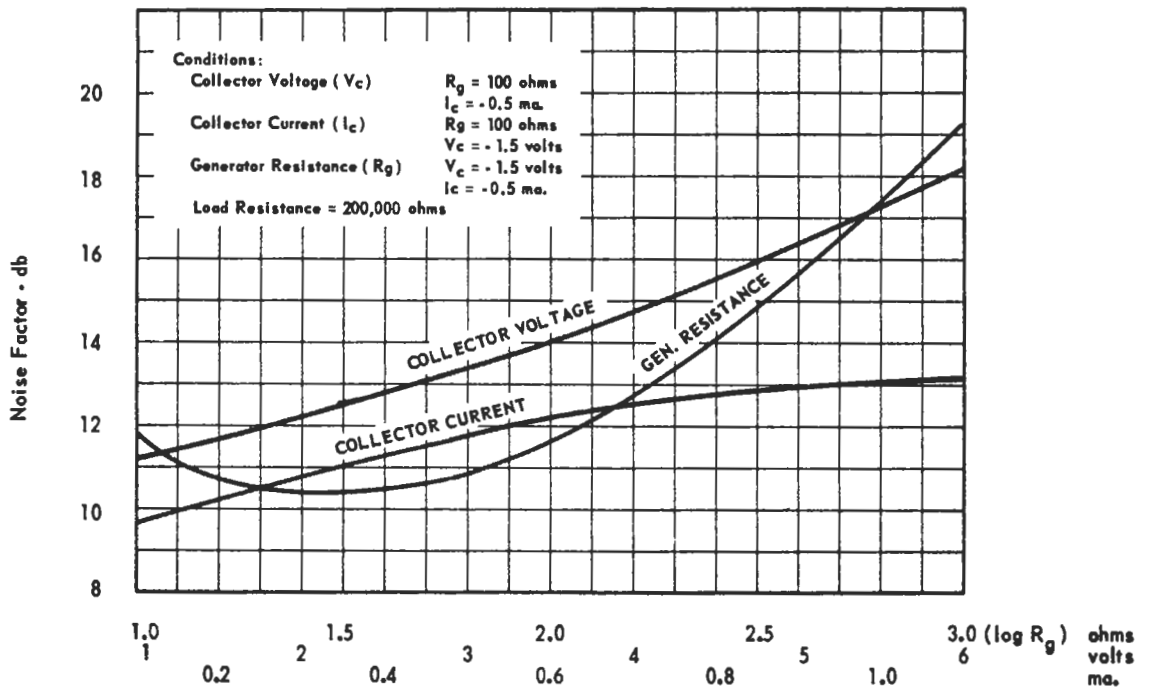

GERMANIUM TRANSISTOR

AVERAGE NOISE CHARACTERISTICS
Common Collector

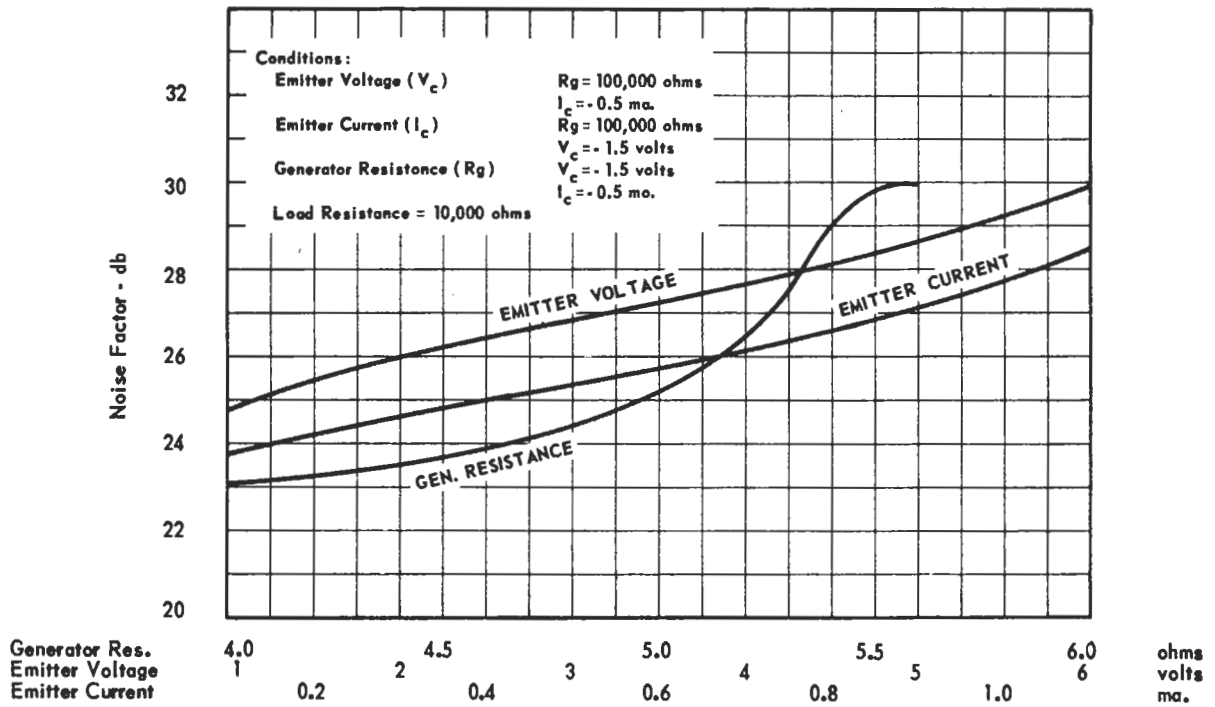

RAYTHEON GERMANIUM PNP JUNCTION TRANSISTORS

CHARACTERISTICS MEASURED AT 27°C

TYPE	Typical Application	Collector Voltage (volts)	Emitter Current (ma)	Average Collector Resist. (megohms)	Average Base Resist. (ohms)	Average Emitter Resist. (ohms)	Average Base Current Ampl. Factor	Average Cut-off Current (Approx.) (μ a)	Max. Noise Factor (db)†	Alpha Cut-off (mc)	TYPE
*2N63	AF-RF AMPLIFIER	-6	1.0	2.0	350	25	22	6	25	0.6	*2N63
*2N64	AF-RF AMPLIFIER	-6	1.0	2.0	700	25	45	6	22	0.8	*2N64
*2N65	AF-RF AMPLIFIER	-6	1.0	2.0	1500	25	90	6	20	1.2	*2N65
*2N106	LOW NOISE AF AMPLIFIER	-2.5	0.5	1.0	700	50	25	6	12	0.8	*2N106
*2N112 (CK760)	HIGH FREQ. AMPLIFIER	-6	1.0		75	25	40	1.0		5	*2N112 (CK760)
*2N113 (CK761)	HIGH FREQ. AMPLIFIER	-6	1.0		75	25	45	1.0		10	*2N113 (CK761)
*2N114 (CK762)	HIGH FREQ. AMPLIFIER	-6	1.0		75	25	65	1.0		20	*2N114 (CK762)
2N130	AF-RF AMPLIFIER	-6	1.0	2.0	350	25	22	6	25	0.6	2N130
2N131	AF-RF AMPLIFIER	-6	1.0	2.0	700	25	45	6	22	0.8	2N131
2N132	AF-RF AMPLIFIER	-6	1.0	2.0	1500	25	90	6	20	1.2	2N132
2N133	LOW NOISE AF AMPLIFIER	-2.5	0.5	1.0	700	50	25	6	12	0.8	2N133
CK721	AF-RF AMPLIFIER	-6	1.0	2.0	700	25	45	6	22	0.8	CK721
CK722	AF-RF AMPLIFIER	-6	1.0	2.0	350	25	22	6	25	0.6	CK722
CK725	AF-RF AMPLIFIER	-6	1.0	2.0	1500	25	90	6	20	1.2	CK725
CK727	LOW NOISE AF AMPLIFIER	-2.5	0.5	1.0	700	50	25	6	10	0.8	CK727

NOTES

* HERMETICALLY SEALED.

† MEASURED UNDER CONDITIONS FOR GROUNDLED Emitter OPERATION AT $V_{CB} = -2.5$ VOLTS FOR A 1 CYCLE BANDWIDTH AT 1000 CYCLES.

MECHANICAL DATA

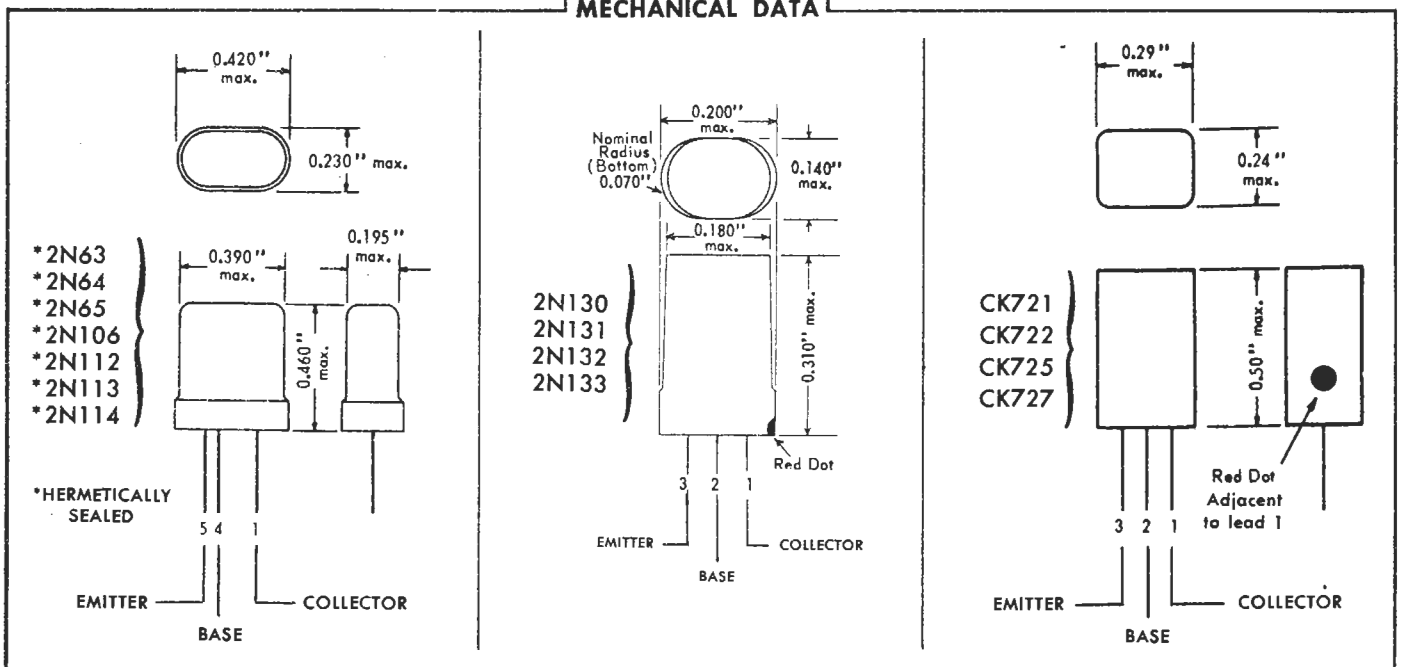

RAYTHEON POINT CONTACT GERMANIUM DIODES

These diodes combine good transient response, low capacity and high frequency capabilities with low cost and dependability. Ambient temperature range -50 to +100°C.

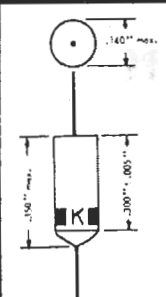

A



B

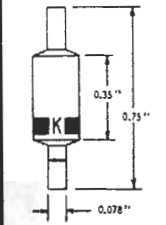

C

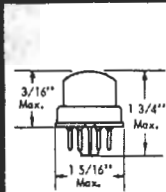

D

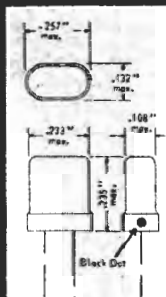

E

Type General Purpose	Dimension Outline	Peak Inverse Volts	Average Rectified mA (max.)	Peak Rectified mA (max.)	Maximum Inverse Currents in μ A				Forward mA at +1v
					at -5v	at -10v	at -50v	at -100v	
1N66 (CK705)	A	60	50	150		50	800		5.
1N67	A	80	35	100	5		50		4
1N68 (CK708)	A	100	35	100				625	3.
1N294 (CK705A)	A	60	50	150		10	800		5.
1N297 (CK707)	A	80	35	100	10		100		3.5
1N298 (CK713A)	A	70	50	150		250 μ A (max.)	at -40v. (50°C)		30mA (min.) at +2v.
CK801	A	60	50	150			50		5.
CK802	A	80	50	150			100		7.5
VHF and UHF									
1N82A	B	5	50	150	UHF mixer	14 db max. noise - see data sheet for test circuit			
1N295 (CK706A)	A	40	35	125		200	Video detector		
CK715	A	40	35	125		Special tests for VHF to UHF freq. multiplier			
Multiple Assemblies									
CK709	C	Four 1N66 matched within 2.5% at +1.5 and -10 volts for bridge circuits							
CK711	C	Four 1N67 matched from 0 to +3 volts. 30 μ A (max.) at -50v. for bridge circuits							
CK717	C	Four 1N66 matched within 2.5% at +1.5 and -10 volts for common anode circuits							
CK719	C	Four 1N67 matched from 0 to +3 volts. 30 μ A (max.) at -50v							

RAYTHEON GOLD BONDED GERMANIUM DIODES

This group of diodes features small size, high forward conduction, high back resistance, and good temperature characteristics. Because junction area is increased over that of point contact types, capacity is slightly higher, transient response slightly slower.

Type	Dimension Outline	Peak Inverse Volts (max.)	Average Rectified mA (max.)	Peak Rectified mA (max.)	Maximum Inverse Currents in μ A				Forward mA at 0.8v at 1.0v	Ambient Temperature Range °C
					at -10v	at -20v	at -50v	at -100v		
1N305 (CK739)	D	60	125	300	2.0		20		100	-55 to +70
1N306 (CK740)	D	15	150	300	2.0				100	-55 to +70
1N307 (CK742)	D	125	50	300	5.0			20	100	-55 to +70
1N308 (CK741)	A	10	100	350	500 μ A at -8 volts				300	-55 to +90
1N309 (CK747)	A	40	100	300	100				100	-55 to +90
1N310 (CK745)	A	125	40	100		20		100	15	-55 to +90
1N312 (CK748)	A	60	70	250			50		30	-55 to +90
1N313 (CK749)	A	125	40	100		10		50	15	-55 to +90

Note: 1N305-6-7 have very high back to forward ratio, high back resistance, sharp Zener characteristic, average transient response
1N308-13 have good transient response with good forward characteristics, high back resistance

RAYTHEON BONDED SILICON DIODES

Raytheon Bonded Silicon diodes provide high back resistance, a sharp Zener characteristic and fair transient response (large overshoot, fast recovery) over an ambient temperature range of -55 to +150°C.

Type	Dimension Outline	Peak Inverse Volts	Average Rectified mA	Peak Rectified mA	Maximum Reverse Currents in μ A			Forward mA at +1v	100°C Average Rectified mA	Max. Reverse mA at -10v
					at -5v	at -10V	at Volts shown			
1N300 (CK735)	D	15	40	120	0.001			8	15	0.01
1N301 (CK736)	D	70	35	110	0.01		0.05 at -50	5	12	0.2
1N302 (CK737)	D	225	25	80	0.01		0.2 at -200	1	8	0.2
1N303 (CK738)	D	125	30	100	0.01		0.1 at -100	3	10	0.2
1N432 (CK856)	D	40	40	120	0.005			10	20	0.05
1N433 (CK860)	D	145	30	100	0.03		0.3 at -125	3	15	0.5
1N434 (CK861)	D	180	30	100	0.05		0.5 at -160	2	15	1.0
1N438 (CK852*)	D	7	100	200	10			50	50	

*8 volt Zener regulator

Note: All ratings at 25°C unless otherwise indicated.

RAYTHEON SILICON POWER RECTIFIERS

This new Raytheon silicon rectifier is the first to give high current rectifying capacity in extremely small volume. The rectifiers operate to 175°C, to 200 volts peak and to over 99% efficiency. Back to forward resistance ratio is over 100,000.

Type	Dimension Outline		Maximum Voltage		Maximum Current		Typical Dissipation Watts	
			RMS Volts	Peak Volts	Peak Amperes	Average Amperes		
CK775	E	Case Temp. 30°C*	40	60	50	15	40	
		Case Temp. 170°C*	40	60	15	5	10	
		No Heat Radiator						
		Ambient Temp. 25°C	40	60	6	2.0	3.0	
CK776	E	Ambient Temp. 170°C	40	60	2.0	0.5	0.5	
		Case Temp. 30°C*	125	200	50	15	40	
		Case Temp. 170°C*	125	200	15	5	10	
		No Heat Radiator						
Ambient Temp. 25°C	125	200	6	2.0	3.0			
	Ambient Temp. 170°C	125	200	2.0	0.5	0.5		

ADDITIONAL RATINGS (25°C)

Both CK775 and CK776 have maximum drop at 5 amperes of 1.5 volts
CK775 has maximum reverse current at -60 volts of 25 mA
CK776 has maximum reverse current at -200 volts of 25 mA

*maintained by external heat radiator



RAYTHEON MANUFACTURING COMPANY

Receiving and Cathode Ray Tube Operations

55 CHAPEL STREET, NEWTON 58, MASS.

1150 ZONOLITE ROAD, ATLANTA 6, GA.

9501 GRAND AVE., FRANKLIN PARK (CHICAGO), ILL.

2419 SO. GRAND AVE., LOS ANGELES 7, CALIF.

SP-Q-7555

Printed in U.S.A.